

WINDS, SLOWED BY HEADWINDS  
DS TOO STRONG OR HEAVY  
RECEIVE AN  
N,  
OE  
AS  
DD  
THWARD 180; WESTWARD, 270  
TWEEN I.E. SEE=160  
K. (YOU'LL NEED IT.)

JULY 1980 Vol. 5, No. 7 \$2.50 in USA/\$2.95 in Canada  
A MCGRAW-HILL PUBLICATION

# BYTE

the small systems journal



COMPUTERS AND EDUCATION

ROBERT  
BO INN



## Someday all terminals will be smart.....

- ◆ 128 Functions—software controlled
- ◆ 7 x 12 matrix, upper/lower case letters
- ◆ 50 to 38,400 baud—selectable
- ◆ 82 x 16 or 92 x 22 format—plus graphics
- ◆ Printer output port
- ◆ "CHERRY" keyboard

CT-82 Intelligent Terminal, assembled and tested. . . . . \$795.00 ppd in Cont. U.S.



SOUTHWEST TECHNICAL PRODUCTS CORPORATION  
 219 W. RHAPSODY  
 SAN ANTONIO, TEXAS 78216

Circle 296 on inquiry card.

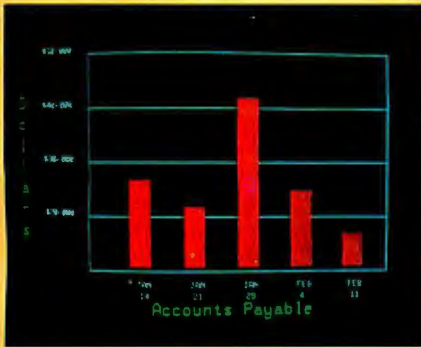

Management Information Display

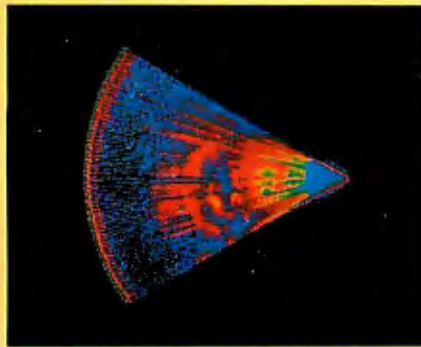

Ultrasonic heart sector scan



High-resolution display with alphanumerics

## Get the professional color display that has BASIC/FORTRAN simplicity

### LOW-PRICED, TOO

Here's a color display that has everything: professional-level resolution, enormous color range, easy software, NTSC conformance, and low price.

Basically, this new Cromemco Model SDI\* is a two-board interface that plugs into any Cromemco computer.

The SDI then maps computer display memory content onto a convenient color monitor to give high-quality, high-resolution displays (756 H x 482 V pixels).

When we say the SDI results in a high-quality professional display, we mean **you can't get higher resolution than this system offers in an NTSC-conforming display.**

The resolution surpasses that of a color TV picture.

### BASIC/FORTRAN programming

Besides its high resolution and low price, the new SDI lets you control with optional Cromemco software packages that use simple BASIC- and FORTRAN-like commands.

Pick any of 16 colors (from a 4096-color palette) with instructions like DEFCLR (c, R, G, B). Or obtain a circle of specified size, location, and color with XCIRC (x, y, r, c).

\*U.S. Pat. No. 4121283

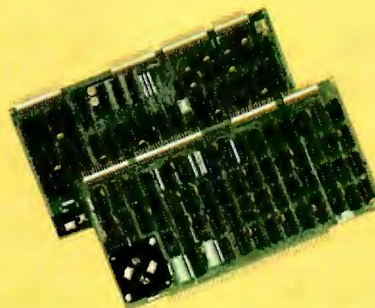

Model SDI High-Resolution Color Graphics Interface

### HIGH RESOLUTION

The SDI's high resolution gives a professional-quality display that strictly meets NTSC requirements. You get 756 pixels on every visible line of the NTSC standard display of 482 image lines. Vertical line spacing is 1 pixel.

To achieve the high-quality display, a separate output signal is produced for each of the three component colors (red, green, blue). This yields a sharper image than is possible using an NTSC-composite video signal and color TV set. Full image quality is readily realized with our high-quality RGB Monitor or any conventional red/green/blue monitor common in TV work.



Model SDI plugs into Z-2H 11-megabyte hard disk computer or any Cromemco computer

### DISPLAY MEMORY

Along with the SDI we also offer an optional fast and novel **two-port** memory that gives independent high-speed access to the computer memory. The two-port memory stores one full display, permitting fast computer operation even during display.

### CONTACT YOUR REP NOW

The Model SDI has been used in scientific work, engineering, business, TV, color graphics, and other areas. It's a good example of how Cromemco keeps computers in the field up to date, since it turns any Cromemco computer into an up-to-date color display computer.

The SDI has still more features that you should be informed about. So contact your Cromemco representative now and see all that the SDI will do for you.



**Cromemco**  
I n c o r p o r a t e d

280 BERNARDO AVE., MOUNTAIN VIEW, CA 94040 • (415) 964-7400  
Tomorrow's computers today



## Here's the state of the art in low-cost hard-disk computers

### 11 MEGABYTES OF

#### FAST HARD-DISK STORAGE

Yes, the Cromemco Model Z-2H is in a class by itself in the computer field.

These Z-2H features tell you why:

- 11 megabytes of hard-disk storage
- 64 kilobytes of fast RAM
- Two dual-sided floppy disk drives
- Z-80A type processor
- Fast 4 MHz operation—150 nanosecond access time
- Fast hard-disk transfer rate of 5.6 megabits/second
- Low cost

And that's not all you get. Not nearly.

#### BROAD SOFTWARE SUPPORT

You also get Cromemco software support—the broadest software sup-

port in the microcomputer field. Software that Cromemco is known for. Like this:

- Structured BASIC
- FORTRAN IV
- RATFOR (RATional FORtran)
- COBOL
- Z-80 Macro Assembler
- Word Processing System
- Data Base Management

And more all the time.

#### FIELD PROVEN

The Z-2H is clearly in a class by itself. We introduced it last summer. It's field proven. It's reliable.

And it's rugged. Housed in a sturdy, all-metal cabinet.

#### EASILY EXPANDABLE

As always with Cromemco, you get expandability. The fast 64K RAM in this Model Z-2H can be expanded to 512 kilobytes. That amount of RAM combined with 11 megabytes of hard-disk storage gives you enormous

computer power—the equal or even beyond what much larger computers sometimes offer.

What's more, this computer gives you a 12-slot card cage. That's to plug in your special circuits as well as additional RAM and interface cards.

This expandability is supported by still more Cromemco value—the Z-2H's heavy-duty power supply that gives you 30A at 8V and 15A at  $\pm 18V$  to support plug-ins.

#### LOW COST — SEE IT NOW

The Z-2H is real. It's been in the field for many months. It's proven itself.

You should see the Z-2H now. Contact a Cromemco representative and arrange for a demo. Learn that Cromemco is a survey-winner for reliability.

And learn that the Z-2H is under \$10K.

In the long run it always pays to get the best.



**Cromemco**  
i n c o r p o r a t e d

280 BERNARDO AVE., MOUNTAIN VIEW, CA 94040 • (415) 964-7400

Tomorrow's computers today



page 22



page 50

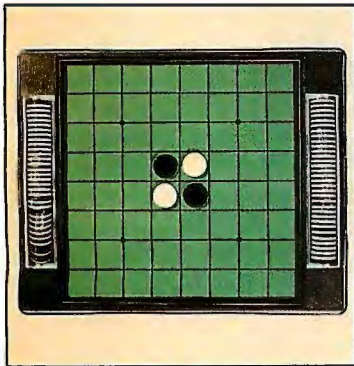

page 56



page 236

## Foreground

**22 HANDHELD REMOTE CONTROL FOR YOUR COMPUTERIZED HOME**  
*by Steve Ciarciq*

Steve presents three schemes to conveniently send control data to the computer.

**116 INTERACTIVE CONTROL OF A VIDEOCASSETTE RECORDER WITH A PERSONAL COMPUTER**  
*by Dr Richard C Hallgren*

Hardware and software link a Sony Betamax with an Apple II or TRS-80.

**154 PILOT/P: IMPLEMENTING A HIGH-LEVEL LANGUAGE IN A HURRY**  
*by David Mundie*

Here's how to write a preprocessor in Pascal that translates the target language's source code into Pascal source code.

## Background

**46 THE 1980 WEST COAST COMPUTER FAIRE: A Watershed Year for Personal Computers**  
*by Chris Morgan*

BYTE brings you pictures and comments about this record-breaking show!

**56 SIMULATING HUMAN DECISION-MAKING ON A PERSONAL COMPUTER**  
*by Peter W Frey*

The development of "intelligent" computer game programs, such as Othello, is traced from the early studies of human subjects to the final strategy.

**74 EDUCATION FORUM: BOOKS AS AN ANTIDOTE TO THE CAI BLUES or Take a Publisher to Lunch**  
*by Tom Dwyer*

A successful author presents the case for publishing a new breed of personal computer books.

**86 EDUCATION FORUM: THE PERSONAL COMPUTER—Last Chance for CAI?**  
*by Lou Frenzel*

A brief history of computer-aided instruction is followed by speculation on its future.

**98 EDUCATION FORUM: COMPUTER ILLITERACY—A National Crisis and a Solution for It**  
*by Arthur Luehrmann*

More people need to know how to use computers.

**138 A PERSONAL COMPUTER ON A STUDENT'S BUDGET**  
*by J C Johnson*

Putting together a system by economical buying and building can be done.

**175 THE MICROCOMPUTER IN THE UNDERGRADUATE SCIENCE CURRICULUM**  
*by W N Hubin*

The current status of the microprocessor in colleges is assessed.

**198 THE USER'S COLUMN: OMIKRON TRS-80 BOARDS, NEWDOS+, and Sundry Other Matters**  
*by Jerry Pournelle*

Science fiction writer Jerry Pournelle begins a semiregular column of hardware and software reviews.

**210 CREATING A FANTASY WORLD ON THE 8080**  
*by Robert T Nicholson*

Here are some valuable tips on designing your own Adventure game.

**236 MICRO8: Using BASIC to Learn Assembly Language**  
*by Robert T Pickett III*

The BASIC program presented here simulates a very simple stored-program digital computer with its own assembly language.

## Nucleus

6 Guest Editorial: Computers in Learning Environments, An Imperative for the 1980s,  
*by Dr Ludwig Braun*

14 Letters

20 BYTE's Bits

20, 228 BYTE's Bugs

50 Product Description: The Apple III

104 Book Reviews

148 BYTELINES

216 Technical Forum: Some More On Performance Evaluation

220 Clubs and Newsletters

224 Event Queue

230 Ask BYTE

250 What's New?

302, 303 Unclassified Ads

303 BOMB, BOMB Results

304 Reader Service

**Publishers**

Virginia Londoner,  
Gordon R Williamson

**Associate Publisher**

John E Hayes

**Assistant**

Cheryl A Hurd

**Editorial Director**

Carl T Helmers Jr

**Editor-in-Chief**

Christopher P Morgan

**Editors**

Richard S Shuford, Gregg Williams,  
Curtis P Feigel, Harold Nelson

**Consulting Editor**

Mark Dahmke

**Book Editor**

Bruce A Roberts

**Chief Copy Editor**

David William Hayward

**Copy Editors**

Faith Hanson, Warren Williamson,  
Robin M Moss, Anthony J Lockwood

**Assistant to the Editors**

Faith Ferry

**Assistant**

Debe Wheeler

**New Products Editor****Clubs, Newsletters**

Charles Freiberg

**Drafting**

Jon Swanson

**Production Director**

Nancy Estle

**Assistant Production Director**

Christine Dixon

**Production/Advertising Coordinator**

Wai Chu Li

**Production Art**

Holly Carmen LaBossiere,

Deborah Porter

**Typographers**

Sherry McCarthy, Debi Fredericks,

Donna Sweeney

**Advertising Director**

Thomas Harvey

**Assistants**

Ruth M Walsh, Ms. Marion Gagnon

Barbara J Greene, Janet Ames

**Special Projects Coordinator**

Jill E Callihan

**Assistant**

Karen A Cilley

**Marketing Coordinator**

Laura A Hanson

**Circulation Manager**

Gregory Spitzfaden

**Assistants**

Pamela R H Spitzfaden, Agnes E Perry,

Melanie Bertoni, Barbara Varnum,

Louise Menegus, Andrew Jackson

**Dealer Sales**

Thomas Yanni

**Controller**

Daniel Rodrigues

**Assistant**

Mary E Fluhr

**Accounts Receivable Specialist**

Karen Burgess

**Accounts Receivable Assistant**

Jeanne Cilley

**Receptionist**

Jacqueline Earnshaw

**Traffic Department**

Mark Sandagata, Rob Hannings



## ON THE COVER

*Our cover this month, Computers in Education, by Robert Tinney, is a fanciful version of a personal computer "playground." Computers are becoming fixtures in our schools, and this month's BYTE takes a look at some of the implications of this new wave in education. For more details about the education articles in this issue, see the guest editorial by Dr Ludwig Braun beginning on page 6.*

Officers of McGraw-Hill Publications Company: Paul F. McPherson, President; Executive Vice Presidents: James E. Boddorf, Gene W. Simpson; Group Vice President: Daniel A. McMillan; Senior Vice President-Editorial: Ralph R. Schulz; Vice Presidents: Kemp Anderson, Business Systems Development; Stephen C. Croft, Manufacturing; Robert B. Doll, Circulation; James E. Hackett, Controller; William H. Hammond, Communications; Eric B. Herr, Planning and Development; John W. Patten, Sales; Edward E. Schirmer, International.

Officers of the Corporation: Harold W McGraw Jr, President, Chief Executive Officer and Chairman of the Board; Robert F Landes, Senior Vice President and Secretary; Ralph J Webb, Treasurer.

BYTE is published monthly by BYTE Publications Inc, 70 Main St, Peterborough NH 03458, a wholly-owned subsidiary of McGraw-Hill, Inc. Address all mail except subscriptions to above address: phone (603) 924-9281. Address subscriptions, change of address, USPS Form 3579, and fulfillment questions to BYTE Subscriptions, PO Box 590, Martinsville NJ 08836. Controlled circulation postage paid at Waseca, Minnesota 56093 - USPS Publication No. 528890 (ISSN 0360-5280). Canadian second class registration number 9321. Subscriptions are \$18 for one year, \$32 for two years, and \$46 for three years in the USA and its possessions. In Canada and Mexico, \$20 for one year, \$36 for two years, \$52 for three years. \$32 for one year air delivery to Europe. \$32 surface delivery elsewhere. Air delivery to selected areas at additional rates upon request. Single copy price is \$2.50 in the USA and its possessions, \$2.95 in Canada and Mexico, \$4.00 in Europe, and \$4.50 elsewhere. Foreign subscriptions and sales should be remitted in United States funds drawn on a US bank. Printed in United States of America.

Address all editorial correspondence to the editor at the above address. Unacceptable manuscripts will be returned if accompanied by sufficient first class postage. Not responsible for lost manuscripts or photos. Opinions expressed by the authors are not necessarily those of BYTE. Entire contents copyright © 1980 by BYTE Publications Inc. All rights reserved.

BYTE® is available in microform from University Microfilms International, 300 N Zeeb Rd, Dept PR, Ann Arbor MI 48106 USA or 18 Bedford Row, Dept PR, London WC1R 4EJ ENGLAND.



Subscription WATS Line: (800) 258-5485

Office hours: Mon-Thur 8:30 AM - 4:30 PM, Friday 8:30 AM - Noon, Eastern Time

### National Advertising Sales Representatives:

**NORTHEAST (617) 444-3946**

Hajar Associates  
280 Hillside Ave.  
Needham Heights, MA 02194

**EAST & SOUTH (212) 682-5844**

Hajar Associates  
521 Fifth Ave.  
New York, NY 10017

**MIDWEST (312) 864-3467**

Hajar Associates  
2405 Lawndale  
Evanston, IL 60201

**SOUTHWEST (714) 540-3554**

**NORTHWEST (415) 964-0706**  
Hajar Associates  
1000 Elwell Ct., Suite 227  
Palo Alto, CA 94303

• 512 x 484 resolution display supervised by its own Z80 microprocessor

• 32K bytes of dual port memory give a completely undisturbed screen image

• Resident software emulates an ASCII terminal and provides graphics routines for point, line, region, and light pen usage, and more

• Compatible with any S-100 system, yet easily interfaced to other computers

• 72 key keyboard with graphics function keys

• 15" high performance monitor

## MICROANGELO<sup>TM</sup> HIGH RESOLUTION GRAPHICS SUBSYSTEM

\$1995.00

Light Pen Optional



# SUBSYSTEMS

By  
SCION CORP.

## WORDSMITH<sup>TM</sup> VIDEO SUBSYSTEM

\$1595.00



- Wordsmith Word Processor software
- 40-line page display
- Selectric layout keyboard plus 20 Wordsmith function keys
- 15" high performance monitor
- Compatible with S-100 systems
- Complete documentation

Call or write:  
SCION CORP.  
8455-D Tyco Road  
Vienna, Virginia 22180  
(703) 827-0888



BLACK AND WHITE BLUES GOT YOU DOWN? WANT TO ADD AT LEAST A TINT OF COLOR TO YOUR COMPUTING? WISH SOMEONE WOULD COME UP WITH AN IDEA TO IMPROVE CONTRAST, RELIEVE EYE STRAIN, AND PROVIDE A SURFACE THAT IS EASY TO CLEAN FOR YOUR MONITOR?

THE 'ORIGINAL SMOKE SCREEN' IS YOUR ANSWER! CECO HAS FOUND THE RIGHT MATERIAL THAT COMBINES THE BEST FEATURES OF DURABILITY, PERFORMANCE, AND EASE OF INSTALLATION. MADE FROM TOUGH ACRYLIC MATERIAL, IT HAS SHOWN ITSELF TO BE RELIABLE AND OPTICALLY SUPERIOR. WHILE NOT RECOMMENDED FOR COLOR MONITORS, IT IS THE PERFECT MATCH FOR YOUR 12" BLACK AND WHITE.

THE 'ORIGINAL SMOKE SCREEN' COMES READY TO INSTALL, EVERYTHING YOU NEED IS IN THE PACKAGE, NO DRILLING, SCREWS, OR OTHER DAMAGING MOUNTING IS REQUIRED. FOR AS LITTLE AS \$9.95 YOU CAN FINALLY IMPROVE THE OPTICS OF YOUR MONITOR IN ONLY SECONDS. TRULY, THIS IS A VALUABLE ADDITION TO YOUR SYSTEM.

MONO-CHROMATIC IMAGING IS THE KEY TO THE 'ORIGINAL SMOKE SCREEN' BY CECO AND IT PROVIDES AN IMAGE THAT IS EASIER TO VIEW THAN AN UNPROTECTED MONITOR. MAKES GRAPHICS LOOK MORE INTERESTING. PROVIDES A REAL IMPROVEMENT TO MONITOR PROTECTION.

PLEASE SEND 'ORIGINAL SMOKE SCREEN (S)' @ \$9.95 ea. I UNDERSTAND THAT THIS PRICE INCLUDES POSTAGE AND HANDLING AS PART OF THE INTRODUCTORY OFFER.  
 SEND CHECK OR MONEY ORDER TO:  
 COMPUTER ENHANCEMENTS COMPANY  
 18966 G. DR. N.  
 MARSHALL, MICHIGAN 49068

NAME \_\_\_\_\_ STATE \_\_\_\_\_  
 ADDRESS \_\_\_\_\_ CITY \_\_\_\_\_ ZIP \_\_\_\_\_

TOTAL AMOUNT ENCLOSED: \_\_\_\_\_  
 ALLOW 6-8 WEEKS DELIVERY. MI. RESIDENTS ADD 4% TAX.

Dealer inquiries welcome



Circle 3 on inquiry card.

# Editorial

## Computers in Learning Environments

### An Imperative for the 1980s

Guest Editorial by Dr Ludwig Braun

**Editor's Note:** Our guest editorial this month is by Dr Ludwig Braun, professor and Director of the Laboratory for Personal Computers in Education at the State University of New York at Stony Brook. Dr Braun is well known in computer-education circles for his extensive work in making computers in the classroom a reality. His remarks serve as an excellent introduction to the series of education articles featured in this issue of BYTE.

BYTE firmly believes that the time to establish a dialog about the role of personal computers in the classroom is now. To this end we have established a feature called "Education Forum," which will appear in BYTE semi-regularly. (See the Education Forums in this issue by Tom Dwyer, Arthur Luehrmann, and Louis Frenzel.) Future Education Forums will include commentaries by MIT's Seymour Papert (the August 1980 BYTE) and James Garson of the University of Notre Dame (in the September 1980 BYTE).

Two articles in this issue discuss the controversial topic of CAI (computer-aided instruction), "PILOT/P: Implementing a High-Level Language in a Hurry," by David Mundie, and "The Personal Computer: Last Chance for CAI?," by Louis Frenzel. (Computer-aided instruction is a drill-and-practice approach to computerized education begun in the 1960s, which alienated many people both inside and outside of the educational community.) Some readers might take us to task for covering what they think is a moribund approach to computer learning. Nonetheless, we feel that Louis Frenzel's article puts CAI in a realistic perspective. David Mundie's article describes the PILOT language, which is designed to implement CAI programs. Some educators feel there is a place for drill-and-practice in the schools; that the "sin" of CAI is really one of omission rather than commission—it simply does not go far enough in making full use of the potential of the personal computer. Tom Dwyer, however, makes the case that the philosophy behind CAI is inherently wrong.

Whether you are for or against CAI, we invite you to contribute to and to join in this important debate through BYTE's Education Forum....CM

The computer has had a role in education in the United States for two decades. Until recently its role has been minimal for a number of reasons. Among these reasons are:

- The lack of adequate amounts of high-quality courseware.
- A lack of training among teachers and administrators in the uses of computers in education.
- The cost of providing computing, which frequently has been far beyond the budget even of the very interested school.

Because of the advent of the large-scale integrated (LSI) circuit technology in this country, the last inhibitory factor above has been decreased dramatically. It now is possible for schools to buy quite powerful microcomputers at





# “For reliable data storage, I recommend systems with Shugart disk drives”

Tom Knight, President—  
Nycom, Los Altos, California

“The last thing you need when you put your personal computer or small business system to work is a disk drive that you can't rely on. If the drive quits, your system is out of business.”

That's why more and more manufacturers and dealers depend on Shugart disk drives for reliable data storage. These professionals don't want disk drive problems any more than you do. Shugart has a

store from 5 to 58 megabytes. No other manufacturer offers such a wide variety of disk storage for personal computer and small business systems.

Word processing, general business, accounting—big system or small, you can rely on Shugart drives. We're known as the Headstrong company for good reason. We're Headstrong about reliability, quality, and value. Ask your dealer. He knows us.

large family of drives, too—in all sizes and capacities to suit your system storage needs. For the smaller system, the original 5¼-inch Minifloppy™ stores 250 to 500 kilobytes (single or double-sided)—that's about 50 to 100 pages of printed material. Our single and double-sided 8-inch floppies store 800 to 1600 kilobytes. And for systems that need a larger data base, our 8-inch or 14-inch fixed disk drives

## Rely on the Headstrong Company.

 Shugart

TM—Minifloppy is a trademark of Shugart Associates.

475 Oakmead Parkway, Sunnyvale, California 94086

prices in the order of \$500 to \$1000, with the possibility that these costs will decrease by a factor of two within the next five years. Now that the cost of computing is within the reach of most schools, there is an urgency for the elimination of the other two principal inhibitors cited above.

There are several compelling arguments in favor of immediate and dramatic intervention in our educational system in order to take advantage of the many benefits which the computer can contribute. Among these compelling arguments are:

A. *Our educational system is widely perceived as being unsatisfactory.*

Among the indicators which lead to this feeling of dissatisfaction are:

1. The significant increases in the number of dropouts (eg: in New York City more than 40% of students drop out before graduating from high school).
2. An increase in the number of students who are performing

## Our educational system is widely perceived as being unsatisfactory.

below their grade level. Frequently such students fall further and further behind the longer they stay in school. This may be a contributing cause of increased dropouts.

3. Declining Scholastic Aptitude Test (SAT) scores and increasing numbers of failures in statewide tests such as the Regents examinations in New York state.
4. Decrease in average daily classroom attendance among students currently enrolled.
5. Unacceptably high levels of youth unemployment, especially among minority youths.
6. Continuing decline in the education of our students in the sciences as measured by the recent National Assessment of Educational Progress (NAEP) studies as well as those of the National Research Council and the National Science Foundation.

In a September 17, 1979 excerpt from *Education Daily*, it is noted that the whole question of scientific literacy is a problem for the country. The National Assessment of Educational Progress report shows a decline in science knowledge in school children of all ages. The report points out that in the nine-year-old group, on a national basis, some 65,000 fewer of this group could answer the typical science questions in 1973 compared to 1970, while 70,000 fewer of the seventeen-year-old group could answer science questions correctly in 1973 than could in 1970.

7. Increased concern about spiraling costs incurred by the requirement to "mainstream" handicapped students (ie: put them into classrooms with other students), as well as by the introduction of programs for gifted children and children with learning disabilities. All of these problems are exacerbated by the general lack of training among teachers in dealing with these special students.
8. Unacceptable levels of failure in state-mandated competency tests for high school graduation.

## SAY AH...HA!

If you are a physician considering the installation of a billing system for your medical or dental office, then MicroMed™ and MicroDent™ are for you.

The Software Hows™ division of MicroDaSys is a leader in solution oriented office tools. Both MicroMed and MicroDent provide the most cost-effective way to automate your patient accounting and record keeping procedures. MicroMed and MicroDent offer:

- Complete billing for small practices or busy groups.
- Accommodates any insurance forms (including Medi-Cal).
- No more backlogs of tedious and troublesome forms.
- Allows multiple insurance coverage for any patient.
- Prints patient statements automatically.
- Instant recall of patient ledgers on CRT printer.
- Daily transactions include treatment details.
- Insurance preauthorization.
- Provides all the reports you need for a successful practice:
  - Activity reports itemized by physician.
  - Daily, monthly and year-to-date totals by physician.
  - Service profitability analysis.
  - Aged accounts receivable.
- Mail list data base sorts patients on the basis of 15 selection criteria.
- May be used for mailing labels, lists and form letters, automatically.

Not only is your medical billing system a time and money saver, but best of all it entitles you to terrific tax advantages. MicroMed and MicroDent include CBASIC source code and comprehensive documentation. And the price is right -- just \$995 each, including forms. A demo disk is available for \$50. Call or write today for your free brochure, sample forms and reports. Specify format.

Then say Ah...HA!

Lucrative quantity discounts to dealers and OEMs.

**SOFTWARE  
HOWS™**

a division of

MicroDaSys P.O. Box 36275 Los Angeles, CA 90036 Phone: (213) 731-0876 TWX: 9103212376

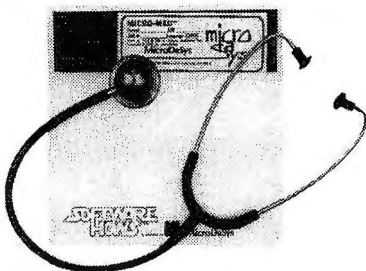

In each of the indicators of need cited above, there is evidence that the computer can provide assistance to the teacher in addressing these needs. Such assistance typically is not available otherwise.

It was not possible, within the constraints of time and finances, to do a complete literature search to support the contention above that the computer can help in improving our educational system; however, some major items of evidence will be mentioned below.

With respect to increasing attendance as a result of the use of the computer, two studies may be cited: one dealing with secondary schools in the District of Columbia, and the other dealing with community colleges in Ontario, Canada. (See references 1 and 2, respectively.) A finding from the secondary schools in the District of Columbia was that, at a tax cost to the public of \$8.43 per student day, there was an increase in student attendance across the three pilot schools totaling \$30,790 (from daily attendance revenues). This was based upon only 700 students in the pilot

# Z8000. You know it's better. Now, it's real.

Welcome to the next micro-computer revolution. A whole new generation of processors that bring big-machine architecture to small computers: Up to 10 times the throughput of Z80. *Eight megabytes* of directly-addressable memory. Plus, a rich, powerful set of over 400 instructions, data types and address modes.

Not a promise. A reality.

Introducing MPU-8000™ — our brand-new 16-bit CPU that makes the most of Z8000's many advantages, and then some.

With MPU-8000, you get *all* the computing power you need. And, you can have it with the low-cost Z8002, which addresses 64K, or the full eight

megabyte Z8001. There's plenty of room for expansion, too, via a top connector that makes adding an MMU or other Zbus-compatible accessories literally a snap.

Software support? Z8000 Pascal, editor, macro-assembler, operating system and more are on the way. But you don't even have to wait for them. Our new CPU is usable *now* in your present IEEE S-100 system, simply by slaving our MPU-8000 to your existing Z80 and cross-assembling your programs for the Z8000.

Think about it: 16-bit S-100. All the power, speed and flexibility of a mini, simply by plugging in the new MPU-8000. From Intersystems: Computer products you can rely on. And build on, too.

## InterSystems™

Ithaca Intersystems Inc.,  
1650 Hanshaw Road/P.O. Box 91,  
Ithaca, NY 14850  
607-257-0190/TWX: 510 255 4346

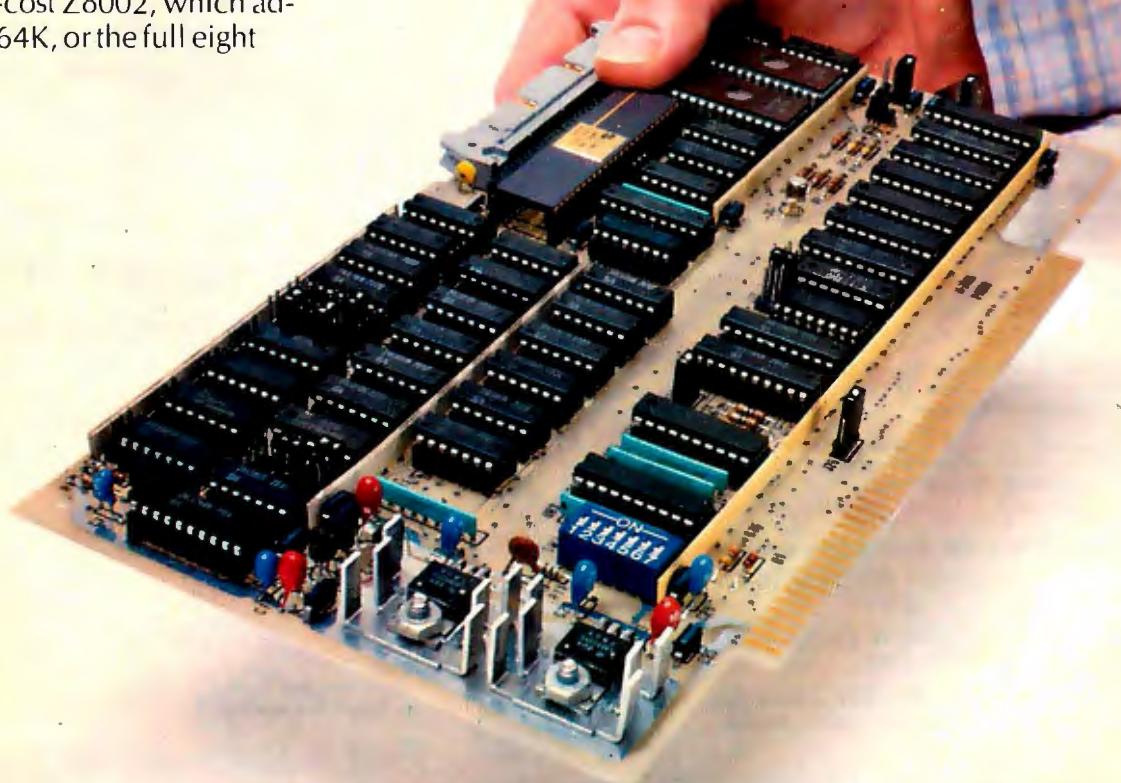

program. Extrapolating this to the proportion for the total number of students in all public secondary schools in the District of Columbia (approximately 24,000 students), conceivably such a productivity gain would be on the order of \$1 million per year. In the case of the community college system in Ontario, the use of the computer lowered the attrition rate or, conversely, increased the attendance rate of students in remedial or basic mathematics courses from a dropout rate of 60% with traditional instruction, to a rate of only 20% attrition with the CAI (computer-aided instruction) mathematics. In terms of a dollar's gain or cost-productivity gain index, the amount of money per year on a province-wide basis is \$9,600,000. The value of these two studies is that they demonstrate that the use of the computer to aid instruction can result in a substantial gain in the use of the tax dollar for education.

Other indicators come from a series of reviews on the value of CAI for achievement and time to learn in elementary and secondary education

—in particular the basic skills of mathematics and language arts. For example, Vinsonhaler and Bass (see reference 3) reviewed a series of elementary education drill-and-practice programs which compared

Because we are moving into an information age, and because computers are becoming ubiquitous in our society, it is essential that we develop a computer-literate society.

the use of CAI to traditional instruction. Their finding was essentially that augmenting classroom instruction with CAI provides superior performance on SAT or Master of Arts in Teaching (MAT) standardized tests. Other reviews of the literature include that by Jamison, Suppes, and Wells (see reference 4), and another by Edwards, Norton, Taylor, Weiss,

and Van Dusseldorp (reference 5), both of which support the notion that supplementary instruction with CAI led to higher achievement than occurred with traditionally taught students. In addition, the Human Resources Research Organization (HumRRO) project (reference 1) found that in consumer mathematics, the use of the computer to augment an already individualized course of instruction provided a significantly higher achievement record for the slower students over the so-called faster students. In this case, prior grade achievement scores and intelligence were unrelated to the achievement within the consumer mathematics course. Rather, the use of the computer provided the basis for their improved scores.

The most recent review of the effectiveness of the use of the computer (see reference 6) yields similar results, ie: when the computer is used to aid instruction in the elementary- and secondary-school level, the achievement and/or the time reduction to learn materials is significantly im-

*Text continued on page 108*

## SOFTWARE FOR

### NORTH STAR®

#### TEXT PROCESSORS

**TFS—Text Formatting System.** At last a full featured text processor for NorthStar that you can rely on! TFS has left & right margin justification, page numbering, chaptering, page headings, centering, paged output & MORE. Supports powerful text manipulation including: global & local search and change, file merges and block moves. This means that you can restructure your text file at any time to look the way you want it to, you can even 'chain' files together from disk for documents larger than your current memory.

TFS is completely 'load and go' therefore you can start using it at once. You get two (2) user's manuals: one is a Quick Start manual to get you going in minutes, the other is an in depth study of TFS. (TFS requires RAM from 0000H to 2000H) \$75.00 (Manual only: \$20.00)

#### PROGRAMMING LANGUAGES

**'Tiny' Pascal**—This is famous Chung/Yuen 'tiny' Pascal. FAST - ELEGANT - STRUCTURED. Local and global variables plus procedure and function independence make 'tiny' Pascal great for high speed applications. Compiles to 8080 code that executes up to 25 times faster than BASIC. You also receive SOURCE to 'tiny' Pascal written in Pascal. This means that you can compile the compiler! Add features, relocate, etc. (you will need 36K to do this) \$50.00

#### UTILITIES

**D E B E** —(Does Everything But Eat!) This is a must for NorthStar users. You can: COMPACT & EXPAND BASIC programs. Compacting removes unnecessary spaces and remarks. This saves money and makes programs run faster. Expanding puts them back again.

Cross-reference BASIC programs by variables and transfer statements.  
Global substitutions of variables and transfer statements  
Formatted print outs of BASIC programs as well. \$40.00

All Orders and General Information:

**SUPERSOFT ASSOCIATES**

P.O. BOX 1628

CHAMPAIGN, IL 61820

(217) 359-2112

Technical Hot Line: (217) 359-2691

(answered only when technician is available)



\* TRS 80 TRADEMARK © ANDY CORP

### TRS-80\*

#### SPEECH SYNTHESIZER SOFTWARE

**'ANGLOPHONE'**: At last you can take complete advantage of your TRS-80 voice synthesizer. Forget about cumbersome phonetic codes. With 'Anglophone' you can simply use ordinary English. Completely interfaces with BASIC, or just about any other programming language. 'Anglophone' applies sophisticated pronunciation rules to transform normal English spelling into speech using the TRS-80 Voice Synthesizer. Minimum hardware: Level II, 16K, Voice Synthesizer. Comes complete with user's manual and test program. \$45.00

#### SYSTEM MAINTENANCE

**DIAGNOSTICS I**: Easily the most comprehensive set of CP/M compatible system check-out programs ever assembled. Finds hardware errors in your system, confirms suspicions, or just gives your system a clean bill of health.

Tests:

- Memory
- CPU (8080/8085/Z80)
- Terminal
- Disk
- Printer

To our knowledge the CPU test is the first of its kind anywhere. Diagnostics I can help you find problems before they become serious. A good set of diagnostic routines are a must in any program library.

Minimal requirements: 24K CP/M. Supplied with complete user manual: \$60.00  
Manual alone: \$15.00

#### SOFTWARE SECURITY

**ENCODE/DECODE**: A complete software security system for CP/CP/M. Encode/Decode is a sophisticated coding program package which transforms data stored on disk into coded text which is completely unrecognizable. Encode/Decode supports multiple security levels and passwords. A user defined combination (One billion possible) is used to code and decode a file.

Encode/Decode is available in two versions.

Encode/Decode I provides a level of security suitable for normal use.

Encode/Decode II provides enhanced security for the most demanding needs.

Both versions come supplied on discette and with a complete user manual.

Encode/Decode I: \$50.00

Encode/Decode II: \$100.00

Manual alone: \$15.00

*SuperSoft*

**First in Software Technology**

# New from SSM.



**80 Character Video**

With 80 characters per line our VB3 is the perfect video interface for word processing. It produces a standard 80x24 display of upper and lower case characters or as much as 80x51 for a full page of text. The matrix for graphic display goes up to 160x204. And with optional EPROM, as many as 256 user programmed characters or symbols can be produced.

VB3 is memory mapped for rapid screen updating. But it occupies memory only when activated. So one or more VB3s can be located at the same address with a full 65K of memory still available to the user.

It generates both U.S. and European TV rates and meets the new IEEE S-100 standard. Other features include keyboard input, black on white or white on black, one level of grey, underline, strike thru, blinking char., blank-out char., and programmable cursor. Software includes a CP/M compatible driver and a powerful terminal simulator.

VB3 is available in several configurations. Retail prices start at \$375 kit, \$440 assembled.



**Z-80 CPU**

We spent over a year designing the CB2 to assure that it will be the most fully S-100 compatible Z-80 CPU on the market.

It operates at 2MHZ or 4MHZ by DIP switch selection and includes two sockets for 2716/2732 EPROMs or TMS 4016 2K RAMs. Memory sockets can be disabled. Separate run/stop and single step switches allow system evaluation without the benefit of a front panel.

CB2 also features an MWRITE signal, firmware vector jump, and an output port to control 8 extended address lines (allowing use of more than 65K of memory). Jumper options generate the new IEEE S-100 signals to insure future S-100 compatibility.

Retail price—\$210 kit, \$275, assembled.

Our line. CPU, Video, I/O, RAM, EPROM, EPROM Programmer, Music, Prototyping, Terminator, Extender, and Mother boards. Available assembled or as kits.

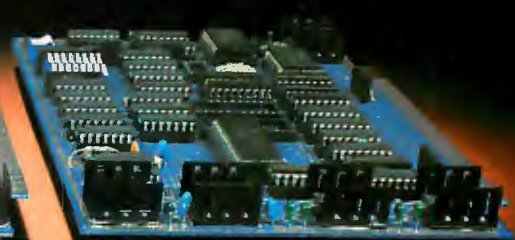

**8080 CPU**

Our new CB1A is identical to our popular CB1 with the exception that the on-board RAM has been increased from 256 bytes to a full 1K.

It also features an optional 2K of 2708 EPROMs, power-on/reset vector jump, MWRITE, parallel input port with status and DIP switch addressing.

Retail price—\$159 kit, \$219 assembled.



SSM Microcomputer Products  
2190 Paragon Drive  
San Jose, CA 95131 (408) 946-7400

Send for our free brochure and find out why SSM has become the favorite of discerning Hobbyists and OEMs.



# The man, the lig



# ht and the Apple.

If you could talk to Thomas Edison, he'd tell you what it was like to turn the lights on in 1879. You could tell him about some bright ideas of the 20th century... particularly, a technological phenomenon that can handle everything from solar heat control to lighting your home via voice command. The Apple personal computer.

## Expand your own inventiveness with the always-expandable Apple.

Take a look inside your local computer store. There's a range of Apple systems for you... whether you want expansion capabilities of four or eight accessory slots... or memory expandable to 64K bytes or 128K bytes. With this kind of flexibility, the possibilities for creating your own computer system are endless.

Want to add an A to D conversion board? Apple makes it happen. Want to plug into time sharing, news and elec-



*With Apple, Edison could've written a program to determine why some filaments burned longer than others.*

tronic mail services? Apple does it all. Because Apple is the most popular personal computer with the least complicated interface, over 100 companies supply peripherals for the Apple family... including an IEEE 488 bus for instant control.

## Disk drives, a tool kit and creativity in color.

Apple was one of the first to use disk drives for increased performance and application versatility. Today, our 5 1/4" disk drive offers high density (143K bytes)

high speed and low cost. No wonder this drive is the most popular on the market.

But now Apple goes one better with the DOS Tool Kit. A series of utility programs, it gives you the freedom to easily design 280hx192v graphic displays in a palette of living color... depending on your choice of Apple system.

Edison was first with the movie camera and projector. Now, with Apple's DOS Tool Kit, you can be first to work wonders with colorful creative animation.

## Imagine the broadest line of software programs ever.

Apple's broad line of peripherals is equalled only by the most extensive line of software you'll find in the personal computing world. Since more than 170 companies offer software for the Apple family, you can have one of the most impressive program libraries ever.

When you write your own programs, your Apple speaks creatively in BASIC,



*Edison had the first movie camera... and Apple has the DOS Tool Kit that takes you into the colorful world of animation.*

Pascal, FORTRAN, PILOT and 6502 assembly language. Use these languages to score a sonata. Apple will play back your musical masterpiece on its built-in speaker.

Edison listened to his voice on a revolutionary phonograph in the 1800s... now you can listen to the sounds of today with Apple's inventive family of personal computers.

## Where to find even more illuminating Apple experiences.

There's always something new being invented at Apple to set your imagination soaring. And there's always an expert to tell you all about it in detail. Your Apple dealer. If you already own an Apple, there's a whole future ahead to

challenge man, mind and machine.

If you're considering a personal computer, stop by the computer store and compare. Apple's reliability, proven performance and recognized technological leadership will help you see the light. Don't let history pass you by. Visit your nearest Apple dealer, or call 800-538-9696. In California, 800-662-9238.

 **apple® computer**



## Statement from the Heath Company

In the February 1980 BYTE on page 16, Sol Libes stated in reply to a letter that the Heath Company has discontinued production of the H-8 computer. I wish to state flatly and categorically that this is simply *not* the case. Not only does Heath have plans to continue sell-

ing the unit, but we have scheduled additional production, and are modifying the unit — including expensive changes to our tooling — to meet the proposed Federal Communications Commission RFI (radio-frequency interference) guidelines, as will be required for the continued production of the H-8 after July 1st, 1980.

Additionally, Heath has begun offer-

ing new products (as printed-circuit boards) for the H-8, including two items in the April catalog, and additional items planned for possible introduction in later catalogs. This activity is justified based on the H-8's sales, which have increased significantly in the last six months as an unexpected result of our introduction of the H-89.

The continued popularity of the H-8 was reported in both *BUSS* and *Intelligent Machines Journal* (IMJ) in November, 1979. IMJ had previously and erroneously reported that the H-8 was to be discontinued, which may have been the source of Mr Libes's incorrect information. A report to this effect had also appeared in the *Amateur Computer Group of New Jersey News*, which was also in error.

Further, in discussing the S-100 bus, Mr Libes states that there are "several times more languages, operating systems, and applications packages for S-100 systems than for any other system." This statement exhibits a "syntax error"; the S-100 bus has nothing at all to do with software, and it is obvious that Mr Libes is referring to "CP/M" systems, and not to "S-100" systems.

Barry Watzman  
Computer Product Line Manager  
Heath Company  
Benton Harbor MI 49022

## Sol Libes Replies

Since items in the Letters column of BYTE are printed on a space-available basis, several months elapsed between the writing of my reply and its printing in the February BYTE. The report that Heath was stopping production of the H-8, due to poor sales, was told to me by a vice-president of Heath, who, you must agree, is an unimpeachable news source. Some time later, I was informed that Heath had decided to resume production of the H-8. Regretfully, it was too late to change the item in question. Hence, I still consider my news reporting to be true and reliable, as I always try to make it.

Further, at the time that I wrote the reply, S-100-based systems were the only systems capable of running CP/M and hence my statement that "several times more languages, operating systems, and applications packages are available for S-100 systems than for any other system" was also true. In fact, I feel that this statement is still true today; for, although CP/M has now been adapted

# Siliconix VMOS ends bipolar dominance

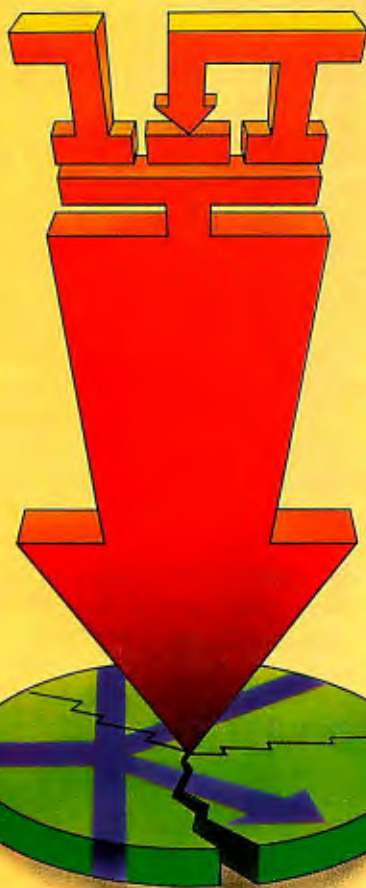

Announcing a breakthrough in power economy: new Siliconix VMOS Quad power FETs. They're here today, in volume, and on distributor shelves.

Our new Quads are ideally suited to power today's peripheral drive equipment. Housed in one standard 14-pin DIP, Quads mean easier, more economical handling. Use automatic insertion equipment and you lower production costs even further. Add this to the savings you gain when you switch to VMOS (no predrivers, no protective circuitry) and you've got a breakthrough in power economy.

## VQ1000 Specifications

$BV_{DDS}$	60	$t_{(on)}, t_{(off)}$	10
$I_{D(on)}$	0.3	$P_D$ (max. total)	1.2
$I_{D(on)}$ pulsed	1.0	$R_{DS(on)}$	5.5

For more information call (408) 496-6660. Or write "VMOS Quads" on your business card and send it to: Siliconix Inc., P.O. Box 4777, Santa Clara, CA 95054.

**Siliconix**

# The Quad breakthrough in power economy





**The easiest, least expensive way to generate spectacular multi-color graphics, sharp two-color alphanumerics: Your computer, a color tv set and the Percom Electric Crayon™.**

Add the Electric Crayon™ to your system and your keyboard becomes a palette, the tv screen your medium.

You dab and stroke using one-key commands to create dazzling full-color drawings, eye-catching charts and diagrams.

Or you run any of innumerable programs. **Your own BASIC language programs** that generate dynamic pyrotechnic images, laugh-provoking animations.

From a combined alphanumerics-semi-graphics mode to a high resolution 256- by 192-element full graphics mode, the microprocessor-controlled Electric Crayon™ is capable of generating **10 distinctly different display modes.**

Colors are brilliant and true, and up to eight are available depending on the mode.

As shipped, the Electric Crayon™ interfaces a TRS-80\* computer via your Expansion Interface or Printer

Adapter. It may be easily adapted for interfacing to any computer or to an ordinary parallel ASCII keyboard.

**But that's not all**

The Electric Crayon is not just a color graphics generator/controller.

It is also a **complete self-contained control computer.** With built-in provision for 1K-byte of on-board program RAM, an EPROM chip for extending EGOS™, its on-board ROM graphics OS, and a dual bidirectional eight-bit port — over and above the computer/keyboard port — for peripherals. The applications are endless.

Shipped with EGOS™, 1K-byte of display memory and a comprehensive user's manual that includes an assembly language listing of EGOS™ and listings of BASIC demo programs, the Electric Crayon™ **costs only \$249.95.**

**Options include:**

- LEVEL II BASIC color graphics programs on minidiskette: \$17.95.
- A 34-conductor ribbon cable to interconnect the Electric Crayon™ to a TRS-80\*: \$24.95.
- RAM chips for adding refresh memory for higher density graphics modes: \$29.95 per K-byte.
- Electric Crayon™ Sketchpad, a sketching grid of proportioned picture elements (pixels) in a tv aspect ratio. For 128 x 192 or 256 x 192 graphics modes. 11-inch by 17-inch, 25-sheet pads: \$3.95 per pad.

**SYSTEM REQUIREMENTS:** the video circuitry of the Electric Crayon™ provides direct drive input to a video monitor or modified tv set. An internal up-modulator for rf antenna input may be constructed by adding inexpensive components to the existing video circuitry.

Prices and specifications subject to change without notice.

™ = trademark of Percom Data Company, Inc.

\* = trademark of Tandy Radio Shack Corporation which has no relationship to Percom Data Company.



PERCOM DATA COMPANY, INC.  
211 N. KIRBY GARLAND, TEXAS 75042  
(214) 272-3421

Get into computer color graphics the easy, low-cost way with a Percom Electric Crayon™. Available at Percom dealers nationwide. Call toll-free, **1-800-527-1592**, for the address of your nearest dealer, or to order direct if there is no Percom dealer in your area.

to run on the H-8, there are still many other operating systems, languages, etc that still run only on S-100-based systems.

Thus, I feel, despite your request, that no correction is required.

### A Computer Tutor

I read with great interest the article entitled "SETS — Tutoring in BASIC" by Linda M Schreiber (March 1980 BYTE, pages 244, 245). Not only does the idea of tutoring preschoolers with a microcomputer hold true, but it also holds true for students in any age group, kindergarten thru college.

As interest in education declines, and as the basic areas of reading, writing, and mathematics begin to suffer, we as a country must make an effort to correct this situation. The microcomputer is a new tool that is beginning to catch on. Schools and universities are buying large numbers of these devices for many uses, including teaching. However, the expertise in using the computer to teach or tutor is not there in the schools, at this time. Why not make use of the pool of talent that abounds in the local computer enthusiasts?

Programs such as SETS could be written based on the needs of local educational institutions by local computer hobbyists. With a patient and interesting

device (the computer) and the expertise of teachers and hobbyists, we can begin to change the trend in education and make education meaningful again.

As a final technical note, please note that in other versions of BASIC lines 120 and 130 should be changed to:

```
120 C = INT(RND(0),4) + 35
130 N = INT(RND(0),9) + 1
```

For a complete listing of the SETS routine that has been written in a business-oriented dialect of BASIC and includes 45 symbols, written messages under the faces, and other items, please contact me.

David A Schneider  
1929 Browning Rd  
Madison WI 53704

# LYNX

## makes your TRS-80 a whole new animal.

**LYNX isn't just a telephone coupler.** LYNX is a one-piece total telephone linkage system for TRS-80 Level I and II computers. It contains all the functions you need to tap The Source. Engage your business computer. Play games with a computer friend. Or do nearly anything you wish.

Best of all . . . LYNX costs only \$239.95\*. A mere fraction of what you used to have to pay for equipment to do the same job. LYNX. To get your paws on one, call or write:



\*TRS-80 is a trademark of the Radio Shack Division of Tandy Corporation.

## ESI EMTRON SYSTEMS, INC.

1262 Loop Road  
Lancaster, Pennsylvania 17601  
Phone 717/291-1116

VISA or Master Card Welcome



\*Add \$2.50 for shipping and handling.  
PA residents add 6% sales tax.  
Includes "Terminal" program on cassette, instruction manual.

### A Much Appreciated Comment

For once, I would like to write you, not as a longtime contributor to BYTE, but as an ordinary reader of BYTE.

The subject: the comments by Carl Helmers against biorhythms in the November 1979 editorial ("Is Pseudo-Science Done by Computer Pseudo-Computer-Science?", page 6).

And the message: RIGHT ON!

I am profoundly heartened by the social responsibility that BYTE has taken upon itself with articles such as these. Please keep up the good work.

W D Maurer  
George Washington University  
SEAS  
Washington DC 20052

### Don't Let Interrupts Disturb Conversion

I would like to compliment Michael McQuade for his article "A Fast, Multibyte Binary to Binary-Coded-Decimal Conversion Routine" in the February 1980 BYTE (page 106). Both his description of the method and the algorithm itself are straightforward and clear. In fact, his listing was well enough documented that I was prompted to read it very carefully.

Twice in the program occurs the following sequence:

```
POP H ;RESTORE HL ...
DCX SP
DCX SP ;LEAVE HL ON STACK.
```

While this code seems to do the job indicated by the comments, a problem arises if an interrupt comes along between the POP and the second DCX. In

this case, the value to be left on the stack will be overwritten by the program counter as the interrupt is acknowledged. The following sequence is not only shorter, but always performs the desired function:

```
POP H ;RESTORE HL ...
PUSH H ;LEAVE HL ON STACK.
```

Keep up the good work at BYTE. After becoming a computer professional, I was very pleased to find out that the magazine which I read as a hobbyist contains articles which are much better written and provide more useful information than those in the trade journals.

Donald Reaves  
64 S Madison Ave  
Spring Valley NY 10977

### A Simplification...And a Bug Report

It wasn't until a friend's comment directed my attention to the Update adjoining Carl Helmers' Editorial in the February 1980 BYTE (page 8) that I became aware of problems regarding ASCII idle (DLE) characters in an implementation of the UCSD Pascal routine GOTOXY.

First of all I regret the contortions that Carl felt necessary to find a solution, particularly since there is an alternative solution provided by the system, *even if undocumented and less devious*. It involves the fifth, or CONTROL, parameter that the user passes to UNITWRITE. If bit number 2 of this parameter is set (on), special-character processing of ALPHALOCK, EOF, and that troublesome DLE is disabled. Thus

```
UNITWRITE(1,ABYTE,1,,5);
(bits 0 and 2 are set, all others cleared)
```

would pass the character at address ABYTE to the CONSOLE asynchronously regardless of whether it was a control-P.

Second, as attested to on page 109 of the *APPLE Pascal Reference Manual*, decimal constants may be achieved on the 6502 Version of the UCSD Assembler by ending the constant in a decimal point ".", for example

```
13 hexadecimal
equals 19. decimal
```

The assembler was designed to be able to deal with binary, octal, decimal, and hexadecimal constants. It is up to machine-specific compile-time constants to determine which base is the default and which if any other bases are usable, and the postfix character that discriminates them.

# E-Z BUS™ FARE



Regardless of which microprocessor system you've selected, the E-Z BUS™ SYSTEM will provide you with a free ride to flexibility in implementing *your design* — quickly . . . simply . . . successfully.

### So What?!

Circle The Reader Service Number  
And Find Out.

**E-Z CIRCUIT™**  
by Bishop Graphics, Inc.

5388 Sterling Center Drive / P.O. Box 5007  
Westlake Village, CA 91359  
(213) 991-2600 Telex: 66-2400

Again I am sorry for the lack of documentation. Also thanks for the friendly words about the UCSD Assembler.

Bill Franks  
Assembler Author  
Institute for Information Systems  
University of California, San Diego (UCSD)  
La Jolla CA 92093

*Thanks for clearing up a misconception that crept into a previous editorial....CH*

### Electronic Anticipatory Democracy?

Please consider asking readers of BYTE how many personal computer owners would be interested in responding to government issues via personal computer equipment or through personal computer information networks.

I recently read that a major computer time-share or systems-support company had made arrangements with one of the wire services to make available the latest news items directly on personal terminals.

It occurred to me that this is about half of what is needed to implement the concept of "anticipatory democracy characterized by electronic transmission and sharing of information," proposed

by some members of the World Future Society as the hope for America's future. The other half would be the installation of small computer systems accessible to government representatives in the various levels of government.

Too often government is considered to be a separate entity, essentially alienated from the people it represents. As evidence of this, consider that most individuals have an opinion on at least one issue, but few have communicated that opinion to a representative in any level of government.

In addition, government issues are often complex, and submission of an opinion may result in a reply not exactly encouraging to the constituent. The awesome workload of representatives makes it difficult for them to provide long, detailed explanations of pending legislation or the dependence of one issue on seemingly unrelated issues. Thus, the constituent faces a relative lack of complete information or the prospect of having to go through *n* iterations to obtain and assimilate it.

An electronic democracy can alleviate this problem by providing high-speed access to vast quantities of information and "canned" responses to submitted opinions in most cases. Presently, about a month elapses before I receive a reply from my Representative or Senators in

the federal government. The speed-up factor alone could provide an order of magnitude or better improvement in efficiency in administering the representative end of government.

Finally, electronics enthusiasts are a special breed, and while performing a vital service simply by participating in government, they also concurrently form a subtle lobbying element for their special interests.

David I. Knoper  
4652 E 19th St  
Tucson AZ 85711

*It is not clear that a "canned" response done electronically is any better than a*

*similar reaction carried out via quill and ink.*

*Might the problem lie elsewhere? Is not a government that tries to do too much guaranteed to be "complex" and unresponsive? Look instead upon the communications technologies as ways of illustrating that much of what government pretends to do is unnecessary now that we have a cheaper and more efficient product....CH*

### A Synthetic Instrument

Hal Chamberlin's article in the April 1980 BYTE ("Advanced Real-Time Music Synthesis Techniques," page 70) was

very good. It provides an extreme wealth of detail that could only be otherwise had from reading many volumes on the subject. I question, however, the possibility of such an instrument as shown in figure 9a on page 186. The drawing represents a physical impossibility similar to the tuning-fork optical illusion. How many ends does this device have? How can a square prong have a cylindrical end? Where do the left-side piece and right-top piece end? Viva the poetic license!

Oh well, the article was good, anyway.

Andrew Shektor  
4022 Pilgrim Rd  
Plymouth Meeting PA 19562

*Please observe that the Glockenflute was described as "a hypothetical instrument..."RSS*

### Comments on Text Compression

I enjoyed (as always) the December 1979 issue of BYTE, in particular the article "Text Compression" by J L Peterson (page 106). My interest in the topic is a long-standing one, and I believe Mr Peterson has several good points to offer (and does well in doing so).

I offer the following comments on the article:

- Figure 3 on page 108 notes that: "This scheme is useful only when the repeat count is greater than 2." I would suggest that if an escape flag, a count, and a character are needed, then the method is useful only when the count is greater than 3. For example, in figure 3, top-left, the string of "\*\*\*\*" has been replaced with "\$3\*" — no savings at all.

One approach which will allow lengths of 3 or more to be compressed is if an escape character and count can be combined into one byte. If, for instance, all values below X'40' were not used, then X'00' thru X'3F' could be an escape/count character (which allows repeats up to 128).

- The comments on the problem of escape character presence in the data are also good. While the implication was there, Mr Peterson could have been more explicit about the data expansion that takes place in this event; ie: \$ replaced by \$0\$ or \$1\$.
- From figure 4, page 110, I would also suggest that SQR() would be as appropriate as any other keyword, and would provide a compression of 3 bytes.

## Call on John D. Owens for all Your Computer Needs

**SUMMER SALE ON IBM 3101 CRT** ..... \$1,195  
List price \$1,295. Sale price includes shipping. Quantity discounts available. 9 x 16 dot matrix. Many human engineering features. Selectric-like keyboard. Service contract from IBM only \$70 per year. Works on both 50 and 60Hz, 110 or 220 v.

**HAWKEYE GRAFIX COMMUNICATIONS SOFTWARE FOR 8080/Z80/ CP/M®**  
Enables communications with a time sharing system thru Modem port. Modes of operation: TERMINAL (your system acts like an intelligent terminal), FILE-TO-FILE, LOCAL (Disk commands), Full/ Half Duplex on 8" or 5" disks COM to COM mode does full CRC 16 error check and retransmits block on error.

Binary Code..... \$75 Source Code..... \$150  
Other Z80 software from HAWKEYE: Chess and other games.

**WORDSTAR®** from MICROPRO ..... \$395

**TELETYPE MODEL 43** ..... \$985  
with RS232 ..... \$1,085  
220 v., 50 Hz. transformer, installed ..... \$100

**IMS 5000 SYSTEM** ..... \$2,765  
Z-80 CPU, S-100. Runs CP/M.® Dual, double density 5¼ drives, 32K RAM.

**IMS 8000** ..... \$4,185  
Like 5000 system but with 8 inch drives.  
Double sided drives also available.

### DRIVES

**SIEMENS 8"** ... \$395 **SHUGART** ... \$525  
**MPI B51** ..... \$264 **PER SCI 227**\$1,210  
**B5Z**..... \$365 **INNOTRONICS**..... \$590

**4116 RAM CHIPS** ..... \$10  
For Superbrain and TRS-80  
**IMS 16K Memory, 250 ns** ..... \$285

**MARINCHIP 9900 16 BIT CPU** \$700

Extensive software package included in price.  
Text editor and word processor worth over \$500  
by itself! Manuals skillfully written.

**CPU Kit** ..... \$550  
**TMS 9900 CPU CHIP** ..... \$35

**PAPER TIGER** ..... \$945  
with graphics ..... \$100

**HAZELTINE 1500** ..... \$885  
1510 ..... \$980 1520 ..... \$1,210

### TEI MAINFRAME SALE

12 slot ..... \$415 22 slot ..... \$510

### TELEVIDEO Smart CRTs.

Many edit features and remote commands. B models have TTY-like keyboard; C models have Selectric-like keyboards.

912 B and C ..... \$780  
920 B and C ..... \$850

### DEC LA 35/36 UPGRADE

..... \$750  
Increases baud rate to 1200. Micro-processor controlled. Many features including TOF, tabs and margins control. Quantity pricing.

### CONTROLLERS

**KONAN Hard disk, S-100** ..... \$1,650  
**TELETEK Double density** ..... \$415  
for 5¼ and 8 inch and single density  
**TARBELL Double density** ..... \$465

### NEW CONTROLLER FROM CALIFORNIA COMPUTER

..... \$395  
Price includes CP/M® 2.2. For both 5 or 8 inch drives, single or double density, single or double sided.

WE ALSO CARRY DIABLO, NEC SPINWRITER, QUME, DEC LA 34 and TEXAS INSTRUMENTS PRINTERS, CAT MODEMS, PET COMPUTERS, ITHACA INTERSYSTEMS, AND MANY, MANY OTHER ITEMS.

Call on us for product sheets.  
Dealer inquiry invited.  
(Prices subject to change without notice.)

CODs accepted at no extra charge.  
Shipping: \$13 for light printers and CRTs.  
Credit cards add 4%. NY residents add tax.

Overseas Callers:  
Phone 212 448-6298

WE EXPORT

TWX 710 588 2844  
Cable: OWENSASSOC

We have no reader  
inquiry number.  
Please call or write.

**JOHN D. OWENS**

Associates, Inc.

12 Schubert Street

Staten Island, New York 10305

212 448-6283 • 212 448-6298

We Are Known  
for Our Prompt  
and Courteous Service!

# Mountain Hardware MusicSystem™

## All the Instruments Anyone with an Apple can Play

MusicSystem generates the sound of any musical instrument—real or imagined! Solo or sextet. Rock or classical. Laid-back or loud. At home or in the concert hall or classroom. MusicSystem sets new standards for computer generated music.

Digital Synthesizer with 16 voices. Stereo output. Polyphonic-multi-voice chords and note sequences. Additive synthesis of instruments. Waveforms, envelopes, and amplitudes are fully programmable for each voice to create instrument definitions and music dynamics. 32 KHz sample rate. Frequency resolution is .5Hz steps. Graphical input of sheet music on high-resolution screen using standard music notation. Print out sheet music with a graphics printer. Complete software operating system. Graphical music editor using light pen (provided), game paddles, or keyboard. Pre-entered music provided for immediate playing and enjoyment. Thorough documentation and tutorial user's manual.

Drop by your Apple Dealer and ask to hear for yourself. You'll know what we mean when we say MusicSystem is all the instruments anyone with an Apple can play!

Available at Apple Dealers worldwide



### Mountain Hardware

LEADERSHIP IN COMPUTER PERIPHERALS

A Division of Mountain Computer, Inc.

300 Harvey West Blvd., Santa Cruz, CA 95060  
(408) 429-8600

Music I can play? Send details.

Name \_\_\_\_\_

Address \_\_\_\_\_

City \_\_\_\_\_ State \_\_\_\_\_ Zip \_\_\_\_\_

Phone \_\_\_\_\_

- Figure 4, page 110, the last line states "... and \$5 would mean "READ"." This should have been "and \$5 would mean " READ "."

For interested readers, I offer the following additional references:

1. Ruth, S R, "Data Compression for Large Business Files"; *Datamation*; volume 18, September 1972.
2. Wells, M, "File Compression Using Variable Length Encoding"; *Computer Journal*; volume 15, 1972.
3. Hagamen, W D, "Encoding Verbal Information As Unique Numbers"; *IBM Systems Journal*; volume 12, number 4.

4. Floyd, R E, "Data Compression Using A Noun-Vector Lookup Table"; *IBM Technical Disclosure Bulletin*; volume 13, number 12.
5. Heaps, H S, "Data Compression of Large Document Data Bases"; *Journal of Chemical Information and Computer Science*; volume 15, number 1.
6. Floyd, R E, "Improved Data Base Compression Through Combined Software Techniques"; *IBM Technical Disclosure Bulletin*; volume 21, number 2.

R E Floyd  
1501 S W 7th St  
Boca Raton FL 33432■

## BYTE's Bits

### 8088 System from Ciarcia's Circuit Cellar

A printed circuit board for the small (5 integrated circuits) Intel 8088 system described in a recent Ciarcia's Circuit Cellar series is now available for purchase. (See "Ease Into 16-Bit Computing," by Steve Ciarcia, March 1980 BYTE, page 17, and April 1980 BYTE, page 40.)

The bare, unpopulated printed circuit board may be obtained for \$29.95 from John Bell Engineering, POB 338, Redwood City CA 94064, (415) 367-1137.

### TRS-80 Model II Available on Lease

Radio Shack is now leasing complete TRS-80 Model II microcomputer systems. A & A Financial Corporation, is offering a thirty-six-month true lease, preceded by a ninety-day warranty period. The ninety-day warranty permits the customer to evaluate the system and determine that it will handle the necessary applications. The lease can be cancelled during the warranty period. At the end of the lease term, the customer has the option to buy, to continue leasing, or to move to a larger system. Rental payments may be fully tax deductible as a business expense. Another aspect of the lease program is that the customer will be able to work directly with Radio Shack to inquire about warranty claims and learn about the operation of the system.

Further information on leasing a Radio Shack TRS-80 Model II is available at Radio Shack stores, dealers,

and Radio Shack Computer Centers, or from A & A Financial Corporation, 800 Two Tandy Center, Fort Worth TX 76102.

### A Brainstorm of a Contract

Synchro-Sound Enterprises, 193-25 Jamaica Ave, Hollis NY 11423, (212) 468-7067, has signed a contract with Intertec Data Systems of Columbia, South Carolina, for 1000 SuperBrain Computer Terminals. This stock of terminals will be available for distribution to dealers throughout the country. Synchro-Sound distributes a variety of computers and computer peripherals.

## BYTE's Bugs

### Just a Little Bit More...

The February 1980 issue of BYTE contains an incorrect price in the What's New? section. The Alpha Micro 90-megabyte disk subsystem on page 212 is pictured with a microprocessor unit. This configuration should read as \$30,000. The disk subsystem alone costs about \$15,000 and is sold only as an upgrade for existing Alpha Micro integrated systems. We apologize for the disappointment and trouble this has caused.

## Industrial quality components for S-100 system builders, from California Computer Systems.

... controls...  
single-sided drives, or two double-sided drives. Shipped with CP/M 2.0, the controller reads and writes IBM-standard single density. Automatically determines disk density—single or double. Supports PerSci auto eject, plus fast-peek for voice coil systems.

**2810 Z80 CPU Board.** Capable CPU for S-100 Systems operates at 2 or 4MHz, is fully Altair/Imesai compatible. Z-80 monitor is available separately. Includes auto addressing to 4K boundaries, plus a serial port for serial devices, including terminals and printers. Supports both front-panel operation and power-on memory jump, plus wait-state generation for slower memories. Compatible with proposed IEEE S-100 standards.

**2032A 32K Static RAM.** Fast static memory operates without wait states at a full 4MHz. Supports full and partial bank select, for expansion beyond 64K. Addressable in 8K blocks at 8K boundaries. Address and data lines are fully buffered, and there are no DMA restrictions.

**2016 16K Static RAM.** Fully buffered board features 2114 static RAMs for +5v operation. Bank select available by bank port or bank byte, for system expansion beyond 64K. Addressable in 4K blocks at 4K boundaries. LED indicators for board selection and bank selection. Available in 200, 300, or 450 nsec versions. All versions support 4MHz operation with no wait states.

**2200A Mainframe.** Rock solid, heavy gauge cabinet includes 12-slot, actively terminated S-100 motherboard, fan, and power supply. Power supply features 105, 115, or 125 volt AC input power; provides +8vDC at 20 amps, ±16v DC at 4 amps. Available in five colors. Includes convenient, front mounted, lighted reset switch.

**2501A Mother Board.** 12 slots, actively terminated, with all S-100 connectors included. Distributed power line bypass, low inductance interconnect—extremely low bus noise.

**Prototype Boards.** Four high quality prototype boards: Solder Tail, Extender/Terminator, Wire Wrap, and Etch.

**P2802AA 6502 CPU.** Stand-alone GPU generates fully S-100 compatible I/O signals; executes 6502 machine language. Operates at 2MHz; capable of DMA operation.

### Available nationally.

California Computer Systems industrial quality S-100 products are available at over 250 computer retailers. Volume customers should contact the marketing department at CCS.

## CCS. Industrial standards.

# We see the S-100 a little differently.

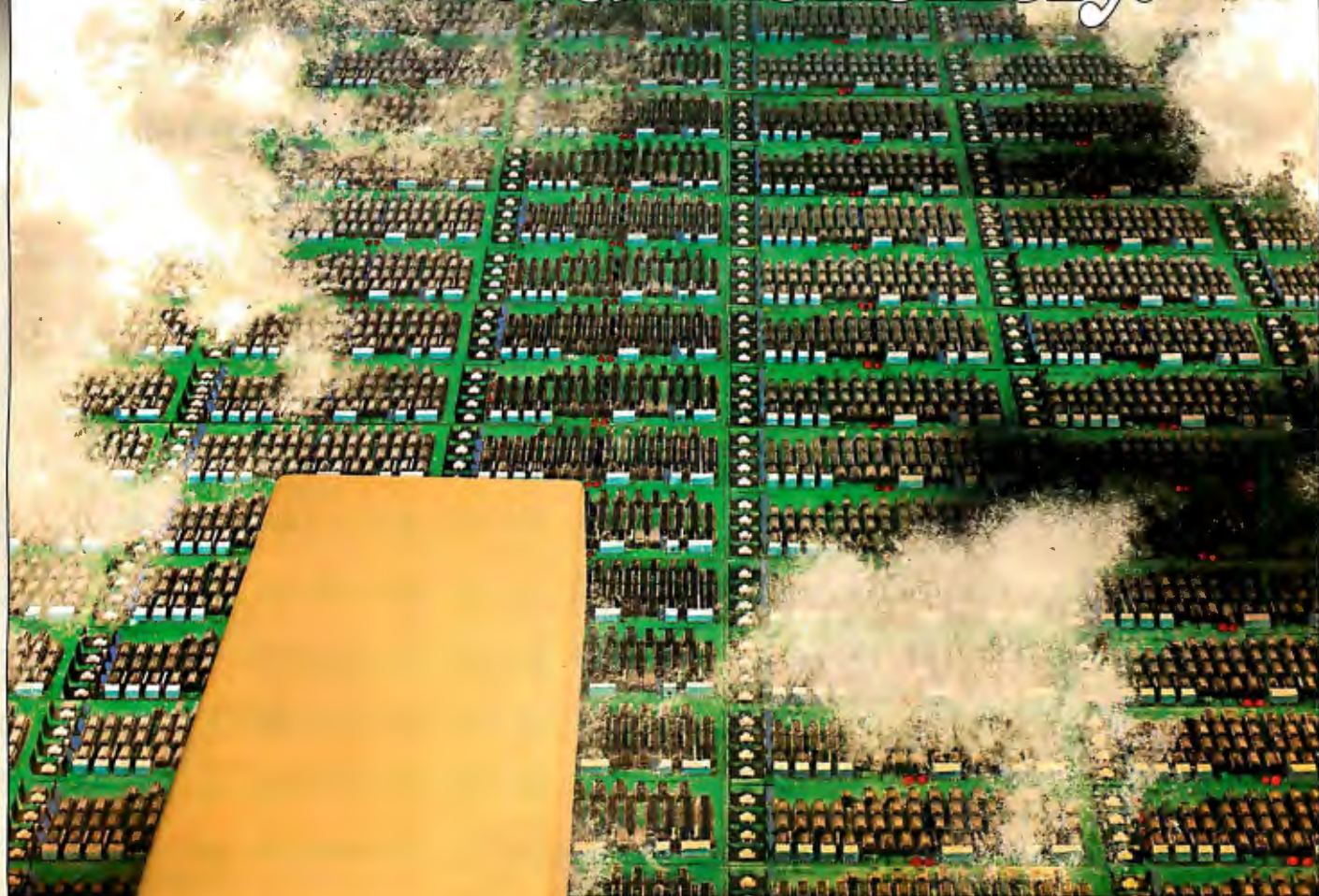

## We mass-produce S-100 products to deliver industrial quality, at industrial prices.

You systems builders who need top quality, full featured, *workhorse* S-100 building blocks at the most competitive prices now have a source. California Computer Systems.

Industrial quality means top grade materials, components, and assembly, plus complete testing for absolute reliability.

Industrial quality means solid designs, a full complement of the important features you require, and a product line that delivers performance.

Industrial pricing comes from mass production. We buy at the right prices, and build *in quantity*, using state-of-the-art facilities and techniques. Including complete burn-in, for full performance right off the shelf.

Our industrial point of view means you get higher performance, greater reliability, and lower prices. If these are features you would like to see in your S-100 system, see things our way.

Because for serious users with serious uses for the S-100, these are the industrial standards.



**California Computer Systems**

250 Caribbean Sunnyvale, CA 94086 (408) 734-5811

## Handheld Remote Control for Your Computerized Home

Steve Ciarcia  
POB 582  
Glastonbury CT 06033

Remote control is on the minds of many people these days. The Busy Box AC remote-control interface for household appliances I presented in January has been received with great interest. (See "Computerize a Home" January 1980 BYTE, page 28.) It probably just whetted the appetites of most experimenters.

The Busy Box interface, which connects the BSR X-10 Home Control System (as sold by Sears) to a personal computer, is intended to facilitate inexpensive AC remote control. When attached to a computer such as a Radio Shack TRS-80, it can easily turn on the television set precisely at 7 o'clock as you flop in your easy chair after a hard day at the office. (Delivering slippers is still the dog's job.) By using a sufficient quantity of the remote output modules and coordinating software, the appearance of a completely computer-controlled home can be obtained.

This control is limited, however. Without physically typing on the computer keyboard, there is no direct method for the operator to command the computer to turn on remote-control channel 2 of the X-10, or for the computer to verify that this activation has in fact occurred. It is left to the operator to either indicate the status of each output or clear everything at the start. While this might at first seem to be unimportant in most domestic control applications, it is a major annoyance. In critical control applications, it is a definite liability.

Control systems incorporating no feedback of status are called *open-loop* systems. When feedback on the effect of control outputs is provided,

the control loop is completed, and the system is then referred to as a *closed-loop* control system.

While various methods may be employed to directly drive the BSR system with control information, any change in output status is not relayed back to the computer. The control computer does not know that you have overridden the system and manually turned on the TV. Nor does it know that you have just changed your mind about staying up to watch the late, late show. It is easy for you to get out of synchronization with

preprogrammed timing, and you may find yourself suddenly sitting in the dark with the TV off.

For example: I thought I'd like to automatically shut off the TV set after the late show in case I fell asleep. I set the real-time software to shut off the X-10's remote-control channel 4 at 2:30 AM. It turned out, however, that the only one who could keep time was my computer. Even allowing an extra hour to make up for changes in schedules and interruptions, invariably everything would go black just as Charlie Chan gathered everyone together in the living room to disclose the identity of the murderer.

True, I could have kept changing the shut-off time in software, but that would have cured only one symptom and would not have attacked the real problem. I needed a way to tell the computer, "Tonight, I will retain control of the TV set," and to tell the control system when it can take over again. It is difficult to have effective automatic activation of household appliances unless both controllers, you and the computer, communicate directly. It sounds easier to do than it is.

### Closing the Loop

Two immediate alternatives come to mind. One is to pull the plug on the computer when you walk in the house. Then you are the only one in command. Or, if you prefer to retain automated control, you can always command the control system directly through the computer. For a truly computer-controlled environment, this is the only possible solution.

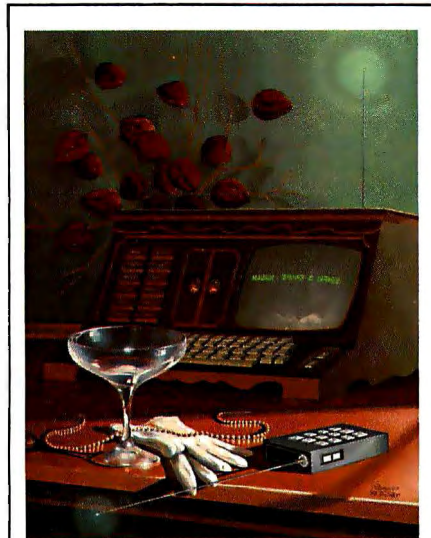

*Illustration 1: The January 1980 BYTE featured several articles on the theme of home control, including the Circuit Cellar article "Computerize a Home." This month's Circuit Cellar includes designs for the wireless remote-control unit depicted by artist Robert Tinney on the January cover.*



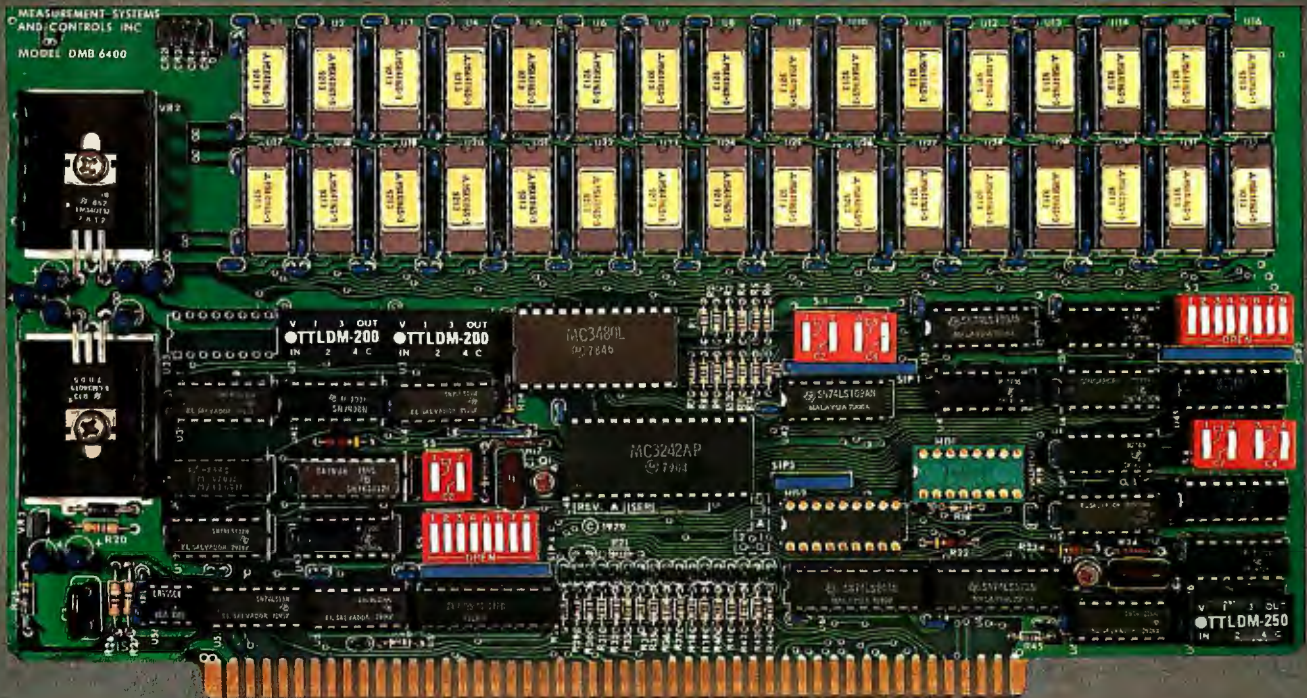

## BANK SELECT — 64K BYTE EXPANDABLE MEMORY BOARD

MODEL DMB6400 SERIES  
**FULLY COMPATIBLE WITH:**

**ALPHA MICRO  
 CROMEMCO  
 NORTH STAR  
 MP/M**

and most other  
 S-100 systems

- Four independent, 16K software selectable banks.
- Switch selectable bank sizes — from 16K to 64K in 16K increments.
- Eight banks (512K) per I/O port for each of the 256 ports.
- Z-80 4MHz operation with no wait states.
- Low power — 8 watts maximum.
- Reliable, tested and burned-in memory.
- **ONE YEAR GUARANTEE**
- IEEE S-100 compatible timing.
- Attractive Dealer & OEM Prices

**MEASUREMENT**  
 systems & controls  
 incorporated

867 North Main Street • Orange, CA 92668  
 Telephone: 714/633-4460

The limiting factor in constructing remote-control devices lies more in the complexity of checking out the hardware than in the communication techniques employed.

The next question is "How do we indicate to the control system what actions it is to perform when we are not there sitting at the console?" There has to be some facility for remote communication. In its least complicated form, this facility might be nothing more than a single switch at the end of a long cable. This switch can be used to initiate execution of particular control programs on the computer, or to let the computer

know that a specific, controlled event has occurred. While the idea of a 100-foot cable might sound rather questionable to most computer users, it is inexpensive and it will work. However, it is a rather cumbersome approach. Since I have an aversion to being attached to my computer by an umbilical cord, and since the actual feedback mechanism does not have to be especially complicated, I propose a less conspicuous connection using wireless communication. More on this later.

### Handheld Remote Control

The most convenient communication mechanism is a handheld transmitter or controller. On it can be a button, or buttons, which you press to initiate various computerized activities, which can range from running a Star Trek game program automatically to activating and deactivating the house security system. Entire chains of events can be trig-

gered by a single output command. And, by utilizing the simple radio-frequency (RF) transmitter I have designated, remote operation of AC-powered appliances can be carried out from much greater distances than presently accommodated with the standard BSR X-10 system.

The purpose of this article is to present a circuit for the construction of a handheld, transmitting communication device. With a receiver attached appropriately to an input port on the computer, and using software that coordinates its activities, we can effectively have a "handheld remote controller."

The limiting factor in constructing remote-control devices lies more in the complexity of checking out the hardware than in the communication techniques employed. I shall describe three different systems which can function as control communicators. They vary considerably in complexity of construction. Your choice of which to build should be tempered somewhat by a frank assessment of your engineering abilities. Use of the latest large-scale integrated circuits in these systems does not necessarily make them easier to check out. The three designs to be discussed are:

- biphase frequency-shift-keyed (FSK) transmitter/receiver
- complementary metal-oxide semiconductor (CMOS) large-scale integration (LSI) remote-control transmitter/receiver integrated circuits
- single-channel transmitter/receiver using inexpensive walkie-talkies

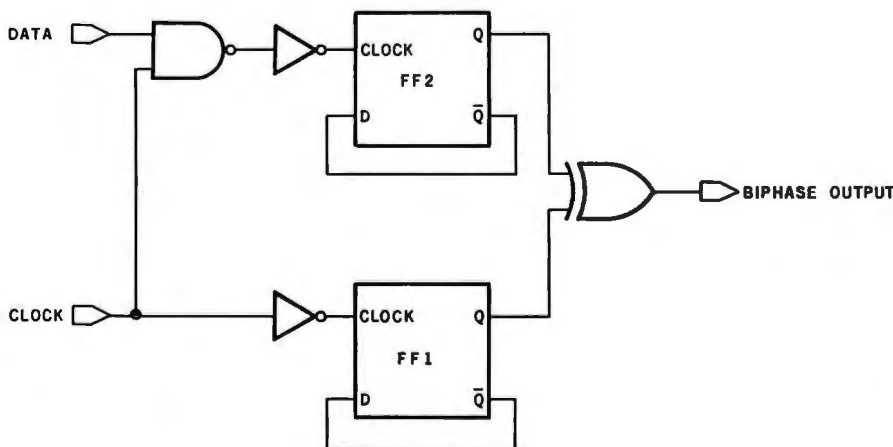

Figure 1a: Diagram of a circuit that performs biphase encoding of data for transmission to the BSR X-10 Home Control System. Two type-D divide-by-two flip-flops are gated into an exclusive-OR, producing the output shown in the timing diagram of figure 1b.

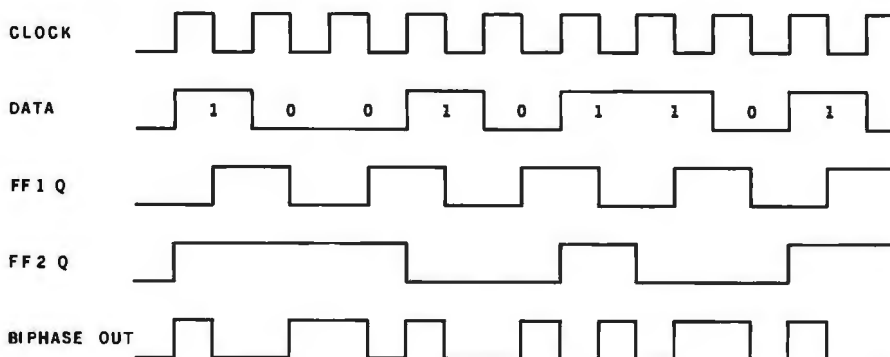

Figure 1b: Timing diagram of the biphase encoder of figure 1a. The clock and data pulses are combined into the biphase output.

### Biphase Frequency-Shift-Keyed Communication

If we wanted to communicate an off/on signal through wires to a computer we would simply use two voltage levels. "On" could be a +5 V potential and "off" could be a ground (0 V) potential. Does it sound familiar? In a wireless communication link, we cannot use DC voltage levels. The simplest alternative is to use two bursts of tones at different frequencies instead. Communicating more than a single control function over this same link is accomplished by serializing the data and time-multiplexing its transmission.

Usually when we hear the word

“serial” we think of the standard serial-communication system protocol employing universal asynchronous receiver/transmitters (UARTs), etc. This form of serialization is but one of the many possible techniques and is not necessarily the most convenient for our purposes.

Figures 1 and 2 demonstrate *biphase encoding* and *decoding* of clock and data signals. This method uses relatively few components and allows recovery of the clock signal as well as the data.

To encode data we use the circuit of figure 1a. It consists of two type-D divide-by-two flip-flops sending their outputs into an exclusive-OR gate. The resulting output is demonstrated in the timing diagram of figure 1b. Close comparison of the input data and the biphase-encoded output shows how the process works. You will notice that if the data input is at a 0 level during one clock period, the output level changes *once*, but if the input is at a logic-1 level during the clock period, the output changes *twice*. These changes are called *transitions* and can be either 1-to-0 or 0-to-1 logic changes.

Simply stated, during a clock period there are two transitions for a

# PLAIN FACTS

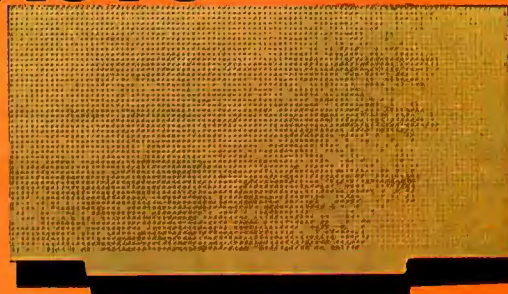

The unique E-Z BUS™ SYSTEM is your ticket to creativity in designing interfaces for your microprocessor! It makes no difference whether you have selected S-100, Apple, Intel, Motorola, Zilog, Heath, or any other . . . the E-Z BUS™ SYSTEM puts you in total control.

**To Get The Plain Facts**  
Circle The Reader Service Number.

**E-Z CIRCUIT™**  
by @Bishop Graphics, Inc.

5388 Sterling Center Drive / P.O. Box 5007  
Westlake Village, CA 91359  
(213) 991-2600 Telex: 66-2400

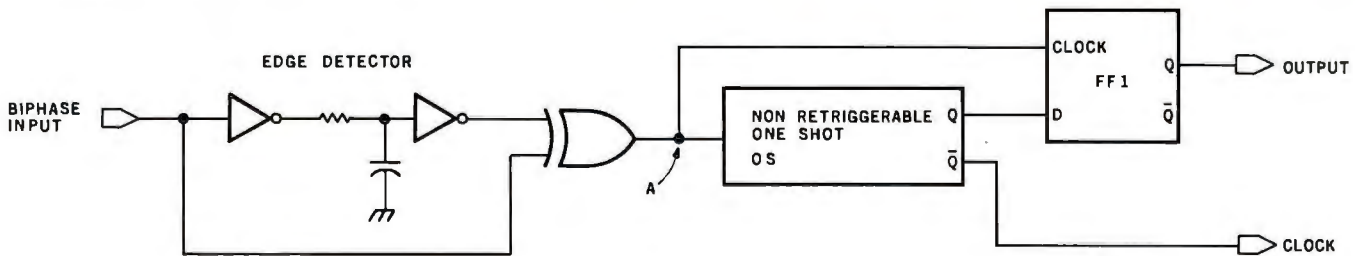

**Figure 2a:** Diagram of a possible circuit for a biphase data decoder. The cycle time of the nonretriggerable one-shot (a monostable multivibrator) is set equal to about three-quarters of the duration of a bit in the incoming data stream. The corresponding timing diagram is presented in figure 2b.

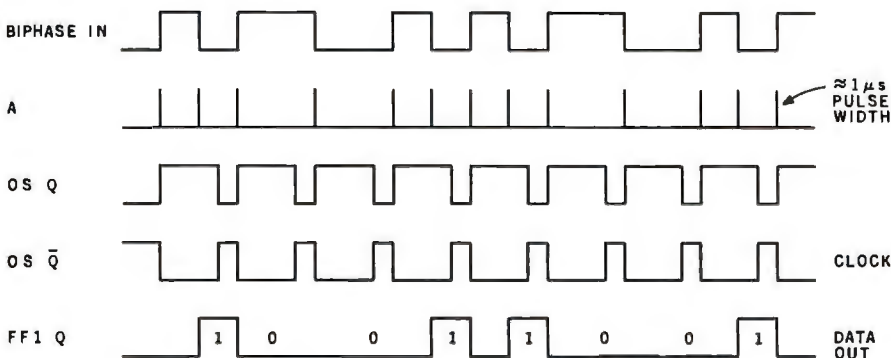

**Figure 2b:** Timing diagram of the biphase data decoder of figure 2a.

logic-1 data input and only one transition for a logic-0 input. Biphase encoding relies upon timing between transitions rather than absolute voltage level. This makes the method relatively immune to power-line transients, power-supply fluctuations, and filter phase shifts.

Recovering the biphase-encoded data is done with the decoder circuit of figure 2a. It consists of an edge detector which produces a 1 μs pulse upon detecting any transition in the input voltage, a nonretriggerable one-

**SAVE MORE THAN 20%**  
**NORTH STAR—INTERTUBE—MICROTEK**  
**ZENITH—HEATH—ITHACA**  
**THINKER TOYS—GODBOUT—SOFTWARE**

*The smartest computers at the smartest price*



FACTORY ASSEMBLED & TESTED	LIST	ONLY
HORIZON-1-16K-DOUBLE DEN KIT	SPECIAL	\$1269
HORIZON-1-32K-DOUBLE DEN KIT	\$1999	1575
HORIZON-2-32K-DOUBLE DEN KIT	2399	1879
HORIZON-1-32K-DOUBLE DEN	2695	2129
HORIZON-2-32K-DOUBLE DEN	3095	2435
HORIZON-2-32K-QUAD DENSITY	3595	2839
HORIZON-2-64K-QUAD+HARD DISK	9329	7229
HORIZON MEMORY 16K 389	32K	579
NORTH STAR HARD DISK 18 Mb	4999	3949
PASCAL FOR NORTH STAR ON DISK	199	190
Powerful NORTH STAR BASIC..The Best.....	FREE	
2 NORTH STAR SOFTWARE DISKS w/HORIZON.....	FREE	
NORTH STAR BUSINESS PROGRAMS & NORTHWORD,PHONE		
COLOR! RAINBOW-2000 & CAT-100		PHONE
ITHACA FRONT PANEL COMPUTER 64K	2885	2449
Z-8000 CPU CARD 16-bit ITHACA S-100		PHONE
ITHACA MEMORY 8/16-bit		PHONE
8086 CPU 16 bit 10xfaster SEATTLE COMPUTER		PHONE
SEATTLE COMPUTER MEMORY		PHONE
SSM Z-80 CPU, VIDEO BOARD, MEMORY		PHONE
MEASUREMENT MEMORY 64K A & T 4mHz		650
JAWS MEMORY 64K A & T 4mHz		PHONE
GODBOUT MEMORY - Static, Super Selection & Price		
THINKER TOYS DISCUS/2D A & T	1199	975
THINKER TOYS HARD DISK 26 Mb	4995	4149
DISCUS/2+2 1.2 Mbytes A & T	1545	1285
THINKER TOYS SUPERRAM		PHONE
DELTA COMPUTER & DISK DRIVES		PHONE
TARBELL COMPUTERS & DISK DRIVES		PHONE
INTERTUBE II SMART TERMINAL	995	725
ZENITH-HEATH SMART TERMINAL Z-19 A & T		795



ZENITH COMPUTER-TERMINAL-DISK Z-89	2595	2195
CAT NOVIATION MODEM	179	169
MICROTEK PRINTER	795	725
AXIDM PRINTER	795	695
ANADIX PRINTER	995	865
NEC PRINTER Fast Typewriter Quality	2915	2799
SECRETARY WRD PROCESSOR The Best!	85	77
TEXTWRITER III Book Writing Program	125	112
GOFAST NORTH STAR BASIC Speeder Upper	79	71
PDS Super Z-80 ASSEMBLER & More	99	89
CDMPILER FOR NORTH STAR \$150 w/PDS & HDS		90
EZ-80 MACHINE LANGUAGE TUTORIAL \$25	HDS	40
EZ-CODER Translates English to BASIC	79	71
ECOSOFT FULL ACCOUNTING PKG	350	315
DATABASE, THE SOURCE 90, CROSS ASSEMBLERS-CALL		
BDX OF DISKETTES 29	IN PLASTIC CASE	30
Which Computers are BEST? BROCHURE.....	FREE	
North Star Documentation refundable w/HRZ		20
ORDER 2 or more COMPUTERS....	BIGGER DISCOUNTS	
FACTORY ASSEMBLED & FACTORY WARRANTY		

**AMERICAN**  
**SQUARE COMPUTERS**  
 KIVETT DR • JAMESTOWN NC 27282  
 (919)-889-4577

It isn't necessary for you to spend much money and time on an elaborate circuit, if you can be satisfied with a less sophisticated control system.



Photo 1: The handheld biphase FSK remote-control transmitter, which uses the circuit shown in figure 3. The transmit (XMIT) switch is a momentary power switch; the other four switches are used to set a 4-bit control-channel code.

shot (that is, a monostable multi-vibrator) set for a period equal to approximately three-fourths of the clock period of the originating transmission, and a flip-flop. As biphase data is presented to the circuit, it produces the edge-detector pulses shown as line A on the timing diagram of figure 2b.

When the first input pulse comes along, it fires the one-shot. (For a clock rate of 35 Hz, the one-shot period is set for 21 ms). If another edge is detected before the one-shot times out, it clocks a logic 1 out of the flip-flop. If a second pulse does not occur during the one-shot period, the output stays at a logic-0 level. Also, since voltage transitions in the received data coincide exactly with the transmitter clock, the receiver's one-shot becomes synchronized to the transmitter. Neglecting duty cycle, this clock rate is exactly the same as the transmitter's clock rate.

This technique has a few advantages that experimenters will appreciate. Since the one-shot is set at 75% of the optimum clock period, it essentially allows up to a 25% variation in timing between the transmitter and receiver while still maintaining synchronization. Compare this to about a 5% tolerance for the usual methods of serial data transmission! No crystals or elaborate clock generators are necessary for low-speed transmissions, either.

**A Functional Biphase Remote-Control Unit**

Figure 3 and figure 4 are the com-

Number	Type	+ 5 V	GND	- 12 V	+ 12 V
IC1	74LS151	16	8		
IC2	74LS93	5	10		
IC3	74LS00	14	7		
IC4	74LS04	14	7		
IC5	74LS74	14	7		
IC6	74LS86	14	7		
IC7	CO4049	14	7		
IC8	CO4027	14	7		
IC9	NE555	8	1		
IC10	74LS04	14	7		
IC11	74LS86	14	7		
IC12	74121	14	7		
IC13	74LS74	14	7		
IC14	74LS95	14	7		
IC15	74LS95	14	7		
IC16	74LS20	14	7		
IC17	74LS75	5	12		
IC18	LM741			4	7
IC19	LM741			4	7
IC20	LM741			4	7
IC21	LM741			4	7

Table 1: Power connections for integrated circuits of figure 3.

# INTRODUCING THE EMULATOR™

The trouble with video terminals today is that most of the low-cost models just don't have the performance to handle your tough applications. And the few that do are usually not compatible with your existing system. But now, Intertec has resolved this age old dilemma with the introduction of its new Emulator™ Video Terminal.

The \$895\* Emulator™ performs exactly as you command. With the depression of just a few keys, Emulator users can select terminal control codes of any one of four popular video terminals. The Lear-Siegler ADM-3A. The Soroc 10-120: The DEC VT-52. Or the Hazeltine 1500. Incredible! It's like having four terminals for the price of one.

But, best of all, not only does the Emulator replace these terminals, it outperforms them by offering enhanced user-oriented features. Features that those other terminals just don't have - at any price.

Standard Emulator™ features include: a sharp, crisp 12" non-glare screen with a full 24 line by 80 column display. Twin RS232C serial ports - one for the host computer and one for your printer. Four separate cursor control keys. A separate 18 key numeric pad. Keyboard selectable baud rates and operating modes. And, a host of visual attributes.

No matter which dumb or smart terminal you're using today, don't buy another until you check out our new Emulator™. You'll get the

performance of four terminals for the price of one. And you'll probably save hundreds of dollars over the price you paid for your last terminal. Plus, you'll get unparalleled reliability, nationwide service and quick delivery. Call or write us today for all the details. Intertec terminals are distributed worldwide and may be available in your area now.

 **INTERTEC  
DATA  
SYSTEMS®**

2300 Broad River Rd., Columbia, SC 29210  
(803) 798-9100 TWX: 810-666-2115



\*Quantity one - Dealer inquiries invited.

plete schematic diagrams of a functional sixteen-channel biphase FSK remote-control unit. The transmitter circuit of figure 3, including an RF transmitter, is packaged in the unit shown in photo 1. The circuit includes a switch- and sync-word scanner, an FSK modulator, and a biphase encoder. The four switches are used to set a 4-bit control code.

Because this unit is handheld, I have chosen to use a very low clock rate to reduce possible data errors. At 35 Hz, it takes approximately one quarter of a second to send the 4-bit switch status. Functionally, IC2 (a 74LS93) counter is attached to an 8-input multiplexer (IC1, a 74LS151 device). The first 4 bits of the multiplexer input are hardwired to a

binary code of 1001 and the last 4 bits are connected to the data-input switches. As the counter (IC2) increments, IC1 steps through the binary sync word 1001 and then the four switch settings. This process keeps repeating for as long as power is applied to the circuit. This data is in turn encoded and modulated so that

*Text continued on page 32*

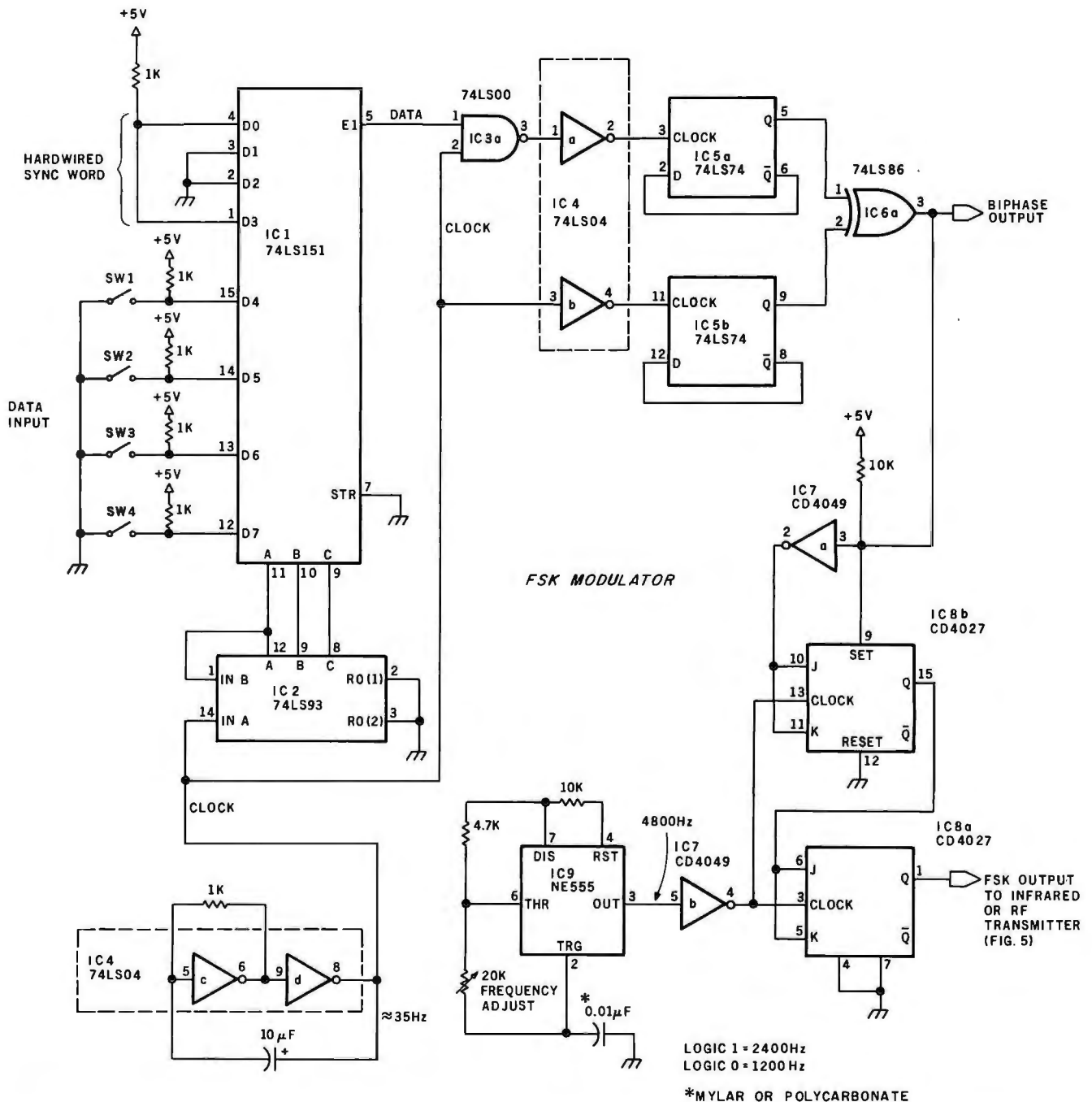

**Figure 3:** Schematic diagram of a functional sixteen-channel biphase FSK remote-control transmitter. This circuit, with the addition of an RF modulator, is packaged in the handheld unit illustrated in photo 1.

Power for the handheld device is provided by a rechargeable nickel-cadmium (ni-cad) battery of 4.8 V potential. If the transmitter is to be used for extended periods without recharging, CMOS parts may be substituted for the transistor-transistor logic (TTL) parts listed here.

# New on the North Star Horizon: 18Mb Hard Disk Drive!

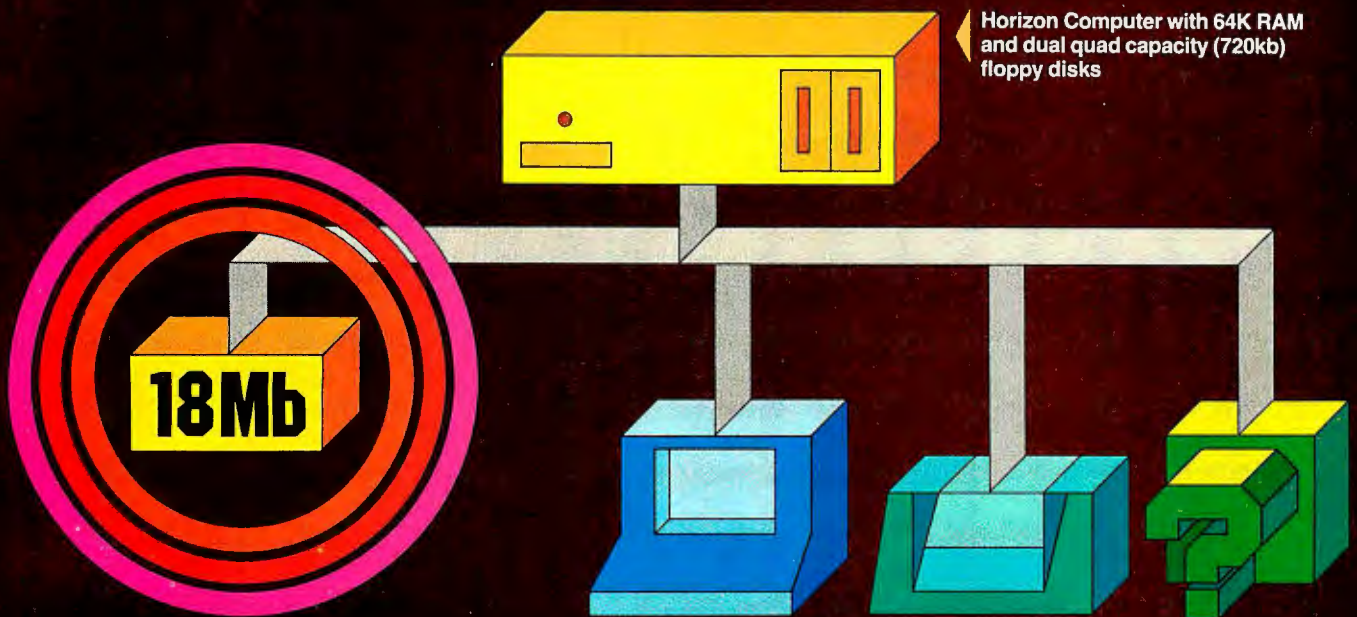

Horizon Computer with 64K RAM and dual quad capacity (720kb) floppy disks

Up to four 18Mb Winchester-type hard disk drives

Display terminal

Letter-quality or dot matrix printer

Horizon I/O flexibility allows expansion to meet your needs

## Unsurpassed Performance and Capacity!

North Star now gives you hard disk capacity and processing performance never before possible at such a low price! Horizon is a proven, reliable, affordable computer system with unique hardware and software. Now the Horizon's capabilities are expanded to meet your growing system requirements. In addition to hard disk performance, the Horizon has I/O versatility and an optional hardware floating point board for high-performance number crunching. The North Star large disk is a Century Data Marksman, a Winchester-type drive that holds 18 million bytes of formatted data. The North Star controller interfaces the drive(s) to the Horizon and takes full advantage

of the high-performance characteristics of the drive. Our hard disk operating system implements a powerful file system as well as backup and recovery on floppy diskette.

## Software Is The Key!

The Horizon's success to date has been built on the quality of its system software (BASIC, DOS, PASCAL) and the very broad range and availability of application software. This reputation continues with our new hard disk system. Existing software is upward compatible for use with the hard disk system. And, with the dramatic increase in on-line storage and speed, there will be a continually expanding library of readily available application software. For more information, see your North Star dealer!

# NorthStar

North Star Computers, Inc.  
1440 Fourth St.  
Berkeley, CA 94710  
(415) 527-6950 TWX/Telex 910-366-7001

### HORIZON-HD-18

Horizon computer with 64K RAM, 2 quad capacity mini drives and one HDS-18 hard disk drive **\$9329**

### SYS-1N

Complete Horizon HD-18 plus 80 x 24 display terminal and NEC Spinwriter printer **\$13,239**

### HDS-18

Additional 18Mb hard disk drive for expansion of Horizon HD-18, or your present Horizon **\$4999**

### SYS-1A

Complete Horizon HD-18 with 80 x 24 display terminal and Anadex printer **\$11,319**

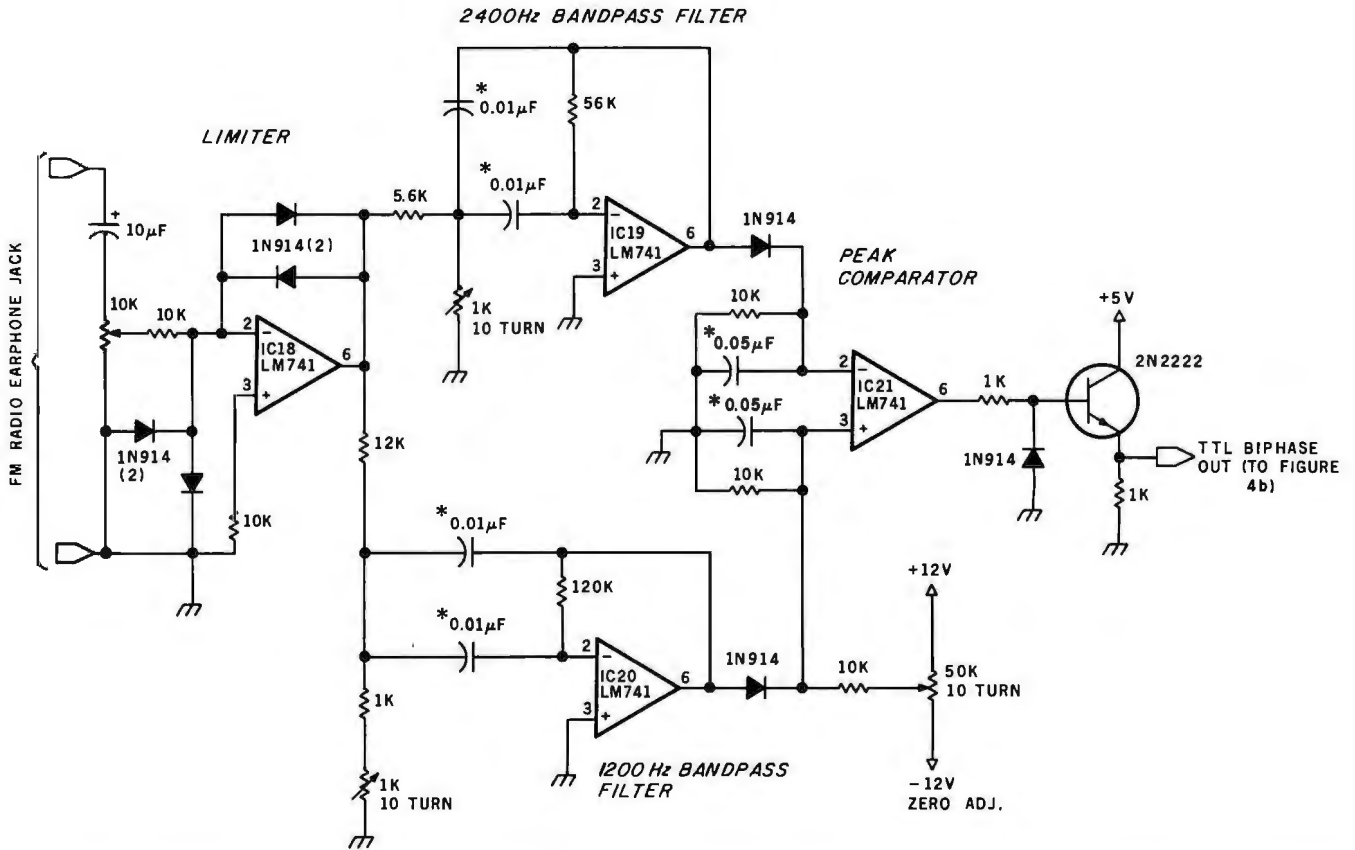

Figure 4a: Section of schematic diagram of the biphase FSK remote-control receiver. Here is the FSK demodulator, which connects to the audio output of an FM radio receiver and produces a TTL-level biphase output, which is further processed by the circuit in figure 4b. The capacitors marked with asterisks (\*) should be mylar or polycarbonate types.

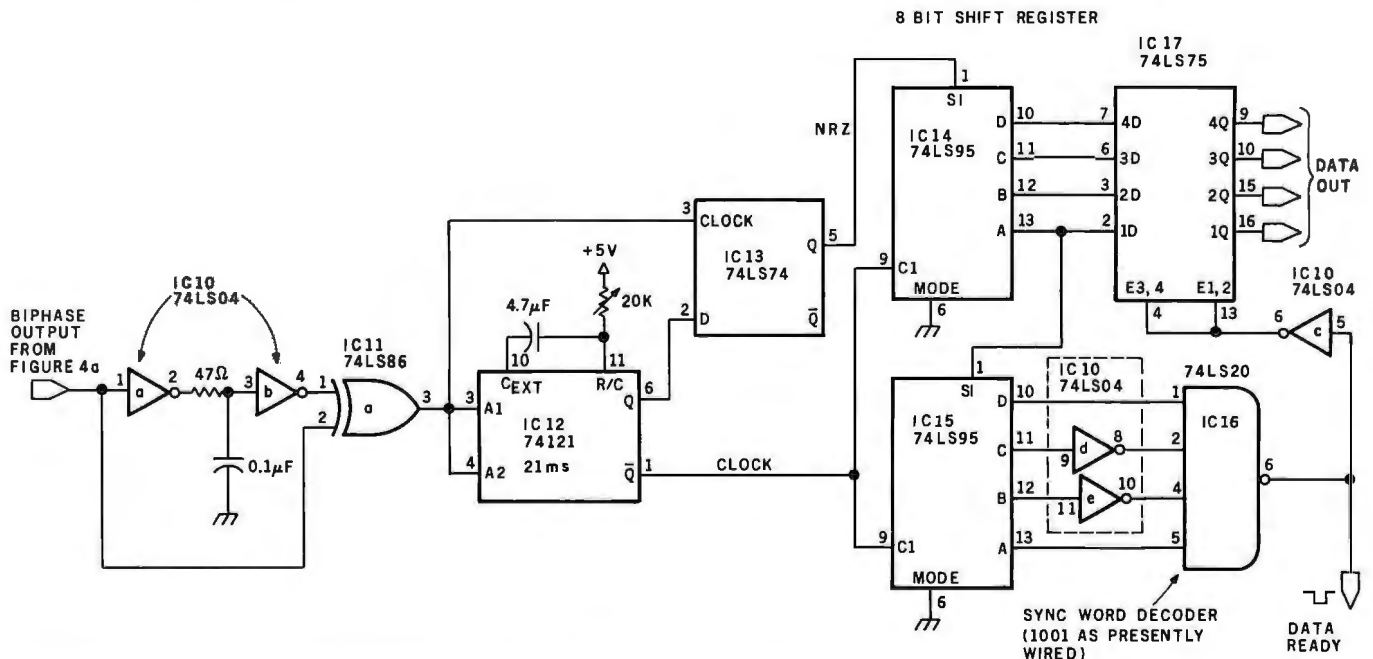

Figure 4b: Section of schematic diagram of the biphase FSK remote-control receiver; here is shown the biphase decoder and data discriminator, which decodes 4 bits of data and sends them to an input port on the computer. The period of the one-shot is set approximately equal to three-quarters of the transmitter clock period.



# MEMORY EXPANSION FOR TRS-80\*

All you have to remember is to plug it in

Memory expansion. It's a field packed with intriguing theories. For instance, it has been suggested that the memory areas of the human brain are transferable from one body to another, like transplanted kidneys. In man or machine, a larger memory is always a welcome acquisition.

If you are interested in expanding your TRS-80 memory without shelling out dollars for a full blown expansion interface, we have just the solution.

Introducing the MT-32. Our new, brilliantly designed Printer/Memory expansion module for the TRS-80. This unit will add 16K or 32K of dynamic RAM to your basic 16K machine. The module also contains circuitry to drive Microtek's MT-80P dot matrix printer, or any other Centronics-compatible printer.

No hardware modification to your TRS-80 is required. Just plug into your bus connector and you are ready to go.

All Microtek products are covered by a one year warranty.

Four configurations are available:

Without RAM in kit form (MT-32K @ \$79.50)
Without RAM assembled and tested (MT-32A @ \$99.50)
With 16K RAM assembled and tested (MT-32B @ \$159.50)
With 32K RAM assembled and tested (MT-32C @ \$199.50)

Available from Microtek  
or your nearest computer dealer.

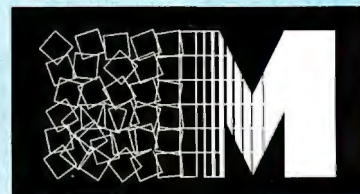

**MICROTEK**inc.

9514 Chesapeake Drive  
San Diego, CA 92123  
Tel. (714) 278-0633  
TWX 910-335-1269

\* TRS-80 is a Registered Trademark of Tandy Corp.

# MEMORY TRANSPLANT



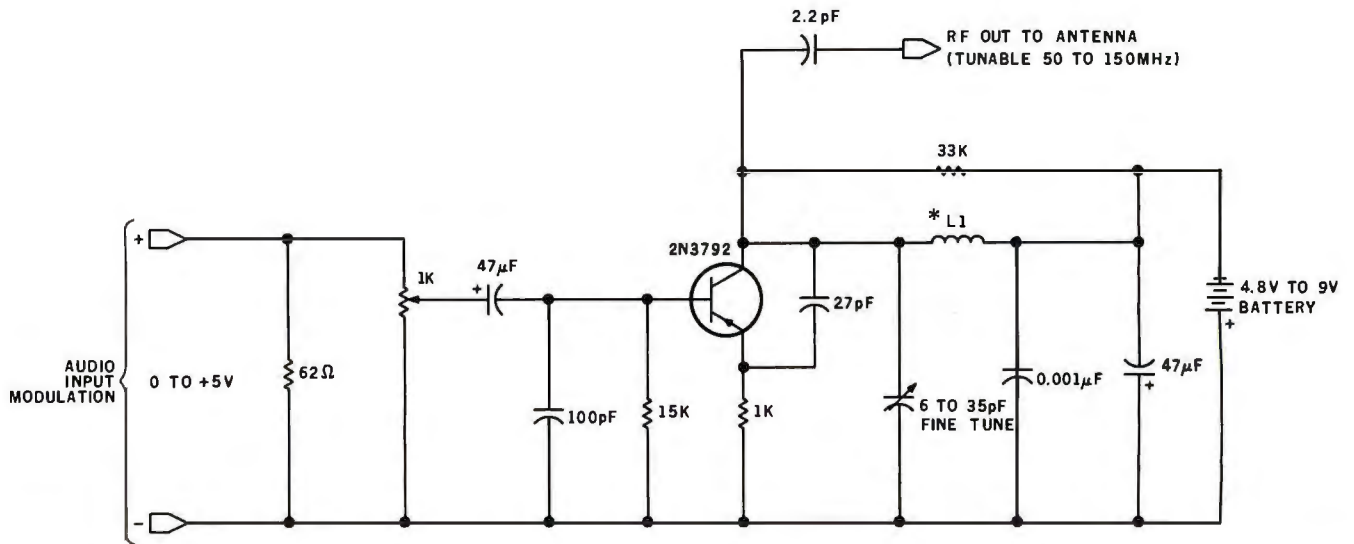

Figure 5: Schematic diagram of a VHF (very high frequency) transmitter, tunable 50 to 150 MHz, for use in the wireless remote-control system. This circuit is also suitable for use in wireless microphone systems. The coil L1 consists of eight turns of number-26 wire wrapped around a coil form with one-quarter-inch inside diameter.

Text continued from page 28:

it can be conveniently transmitted on a frequency-modulated (FM) RF carrier using the transmitter circuit of figure 5 or sent as an infrared-light pulse train using the circuit of figure 6. In either case, a logic 1 is encoded as a burst of 2400 Hz signal and a logic 0 is 1200 Hz. These tones can be easily received on an ordinary FM radio if the transmitter is set to a frequency between 88 and 108 MHz.

At the receiving end, the FM-radio audio output is first processed

through an FSK demodulator. (See figure 4a.) This consists of an amplitude limiter, two bandpass filters, and a peak comparator. The resultant output should be the same as the biphase signal being transmitted. IC10, IC11, IC12, and IC13 separate this output into data and clock signal as I previously outlined and as shown in figure 4b. This data is in turn shifted into an 8-bit shift register. When the sync word gets to the end of the shift register (IC10 and IC16 decode a binary 1001) the con-

tents of the last 4 bits shifted in will be clocked into holding register IC17. These 4 bits reflect the switch settings on the transmitter. They will be updated every one-quarter of a second if the transmitter remains on. The data-out lines in figure 4b are connected to the computer.

The transmitter circuit as I have shown it uses low-power Schottky (LS) transistor-transistor logic (TTL) devices. If powered by a 4.8 V rechargeable nickel-cadmium bat-



Photo 2: Assembled here are the parts needed to build a remote-control unit that uses the Motorola MC14422 CMOS LSI remote-control transmitter and MC6525 receiver.

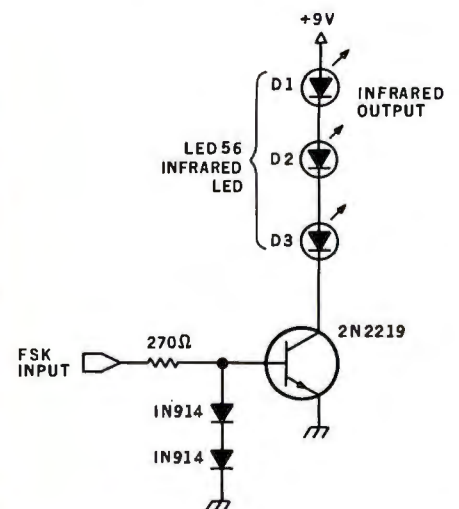

Figure 6: Schematic diagram of an infrared-light transmitter for use in the wireless control application, where use of the radio-frequency transmitter is impractical or undesirable. A series of LEDs emits bursts of infrared light that carry the control information to the phototransistor receiver illustrated in figure 9.

# You'll be a little richer after building one of these.

H-19 Professional Video Terminal



H-8 Personal Computer with Dual Floppy Disk Storage



H-11A 16-Bit Computer with Dual Floppy Disk Storage



H-89 All-In-One Computer with Floppy Disk Storage



H-14 Serial Printer



Self-Instruction for Assembly and BASIC Programming

## Richer in knowledge

Once you build your own computer, you'll know it inside out. You'll know how to make it work for you, how to make it grow as your skills grow.

## Richer in savings

Build-it-yourself kits cost less — about 30% less than comparable assembled computers. And you'll probably never need to pay someone for service because no one will know your computer better than you.

## Is it hard?

Not at all. Heath makes it simple with easy-to-assemble designs and with step-by-step manuals that guide you from unpacking to final plug-in. And a Heathkit helping hand is always just a phone call away.

## Innovative software

Heath offers you innovative programs for running your home or business, and exciting games for your family. You can have Microsoft™ BASIC™, one of the most powerful and widely used languages.

Heath User's Group (HUG) will share with you a library of over 500 programs to make your computer serve you in ways you never imagined.

## Complete hardware

Choose from three computer systems:

The H89 All-In-One Computer gives you everything in one compact, convenient unit.

The flexible H8 gives you the freedom to combine memory and interfacing for exactly the system you require.

And the powerful H11A gives you 16-bit

power for your most complex programs.

The Heathkit line includes video terminals, matrix and letter-quality printers and a complete selection of accessories. You'll even find award-winning self-instruction packages to teach yourself programming in BASIC or Assembly.

## FREE CATALOG



It's all in the new 104-page Heathkit Catalog, along with nearly 400 electronic kits for your home, work or pleasure. Send for your free catalog today, or pick one up at your Heathkit Electronic Center.\*

# Heathkit®

\*Visit your Heathkit Electronic Center in the U.S. or Canada where Heathkit Products are displayed, sold and serviced. See your white pages for the location nearest you. Heathkit Electronic Centers are units of Veritechnology Electronics Corporation in the U.S.

Write to Heath Company, Dept. 334-672, Benton Harbor, MI 49022  
(In Canada write Heath Company, 1480 Dundas St. E., Mississauga, Ont. L4X 2R7)

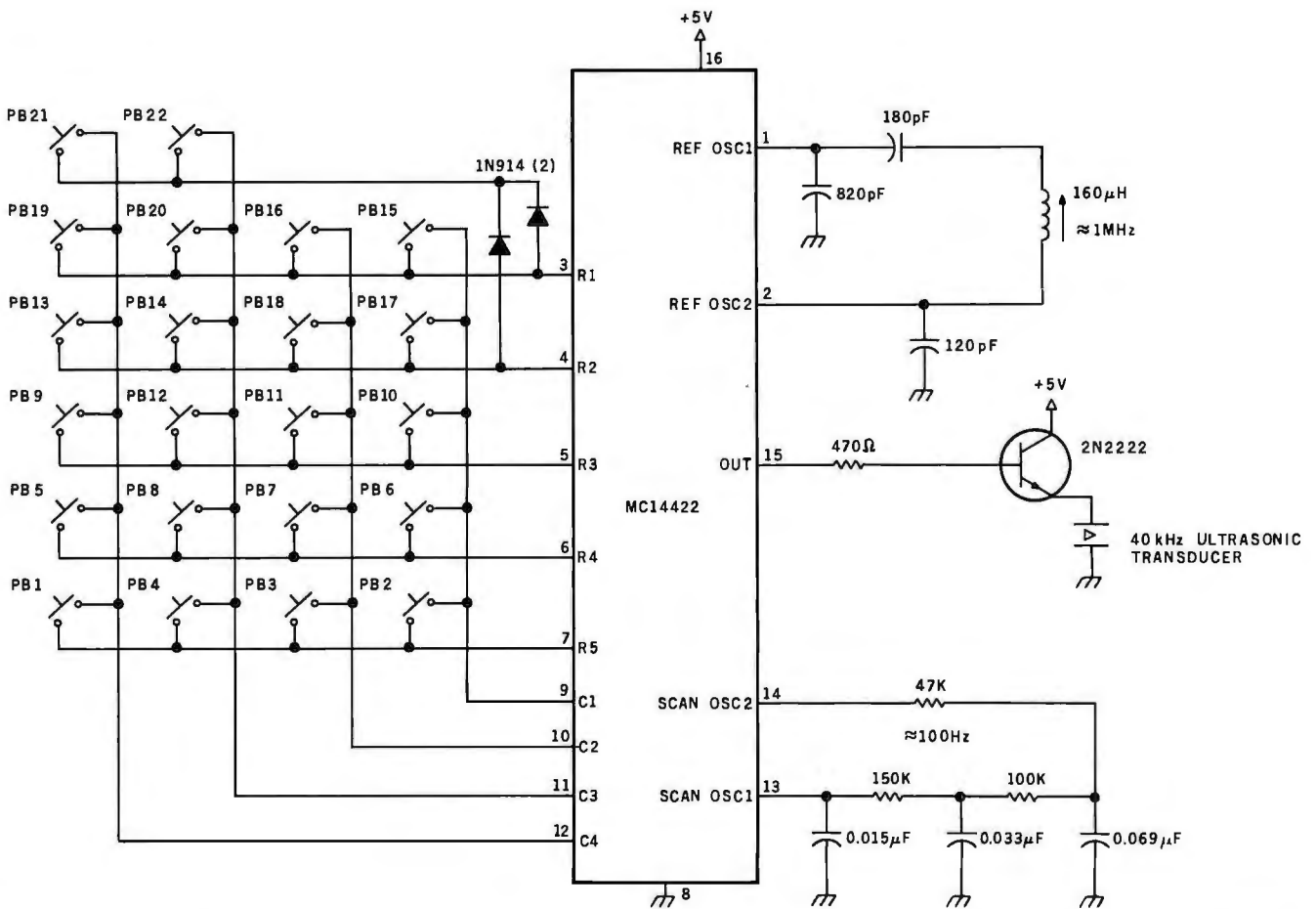

**Figure 7:** Schematic diagram of a remote-control transmitter that incorporates a specialized integrated circuit, the Motorola MC14422 (a device mostly used in remote controls for television sets). Signals are transmitted as ultrasonic sound. The frequency-encoding scheme is presented in tables 2 and 3.

Channel	Matrix Connections Pin to Pin		Transmitted Frequencies			
			t1	t2	t3	t4
1	7	12	fe			
2	7	9	fe	fa		
3	7	10	fe		fb	
4	7	11	fe	fa	fb	
5	6	12	fe			fc
6	6	9	fe	fa		fc
7	6	10	fe		fb	fc
8	6	11	fe	fa	fb	fc
9	5	12	fe			fd
10	5	9	fe	fa		fd
11	5	10	fe		fb	fd
12	5	11	fe	fa	fb	fd
13	4	12			fb	
14	4	11		fa	fb	
15	3	9				fc
16	3	10		fa		fc
17	4	9			fb	fc
18	4	10		fa	fb	fc
19	3	12				fd
20	3	11		fa		fd
21	3,4	12			fb	fd
22	3,4	11		fa	fb	fd

**Table 2:** Control channels, key closures, and corresponding transmitted tone frequencies used by the Motorola MC14422 remote-control transmitter used in the circuit of figure 7. See table 2 for the exact frequencies used. The column headers "t1", "t2", "t3", and "t4" refer to the sequential time segments during the total transmission; this is part of the transmission protocol.

Frequencies	Output Frequency	Division Ratio
fa	34.688 kHz	f2/26.5
fb	36.048 kHz	f2/25.5
fc	37.519 kHz	f2/24.5
fd	39.116 kHz	f2/23.5
fe	42.755 kHz	f2/21.5

**Table 3:** Frequencies of control tones used in the Motorola MC14422 remote-control transmitter in figure 7.

tery, it consumes less than 50 mA. In this unit, the transmit switch is in fact a power switch. Sending a remote command requires only 1 or 2 seconds of transmitter operation. While CMOS devices *could* be substituted, it isn't necessary, considering the low duty cycle of the unit.

### CMOS LSI Remote-Control Integrated Circuits

The idea of handheld remote control isn't new. The television industry

# The Microsoft Z-80 SoftCard. Leading a Whole New Lineup for Your Apple II.

Plug the new Microsoft Z-80 SoftCard into your Apple II™ and start using all of the system and application software written for Z-80 based computers. Software that you could never use before on your Apple II.

The SoftCard actually contains a Z-80 processor and lets you switch between the Apple's 6502 and the Z-80 with simple commands, so you can use software written for either processor.

**Starting with Two Software Standards.** Versatile CP/M,\* the most widely used microcomputer operating system ever, is included on diskette in the SoftCard package, ready to run on your Apple II.

You get Microsoft's 5.0 BASIC too, the most powerful version to date of our famous BASIC interpreter.

PRINT USING, 16-digit precision, CALL, and CHAIN and COMMON are just some of the major BASIC features you'll add. Applesoft's graphics extensions are still included.

**More Power Down the Line.** You can get even more programming power and versatility by adding Microsoft's FORTRAN, COBOL, BASIC Compiler and Assembly Language Development System. All are available separately to run with the SoftCard system.

And the whole host of CP/M-based business, scientific and educational applications can be easily transferred to your Apple with SoftCard.

The Microsoft Z-80 SoftCard is compatible with most every Apple product from the Apple II to the Apple II Plus, Language Card and peripherals. Independent peripherals for the Apple are supported as well. The SoftCard package requires a system with 48K and a disk drive.

Line up a SoftCard demonstration at your Microsoft Consumer Products dealer today. They'll be glad to show you how the Z-80 SoftCard and your Apple computer combine to form a system that can't be beat for either practicality or pure pleasure by any personal computer available today. Or give us a call, 206/454-1315, for more information.

But act quickly. At the low price of \$349 for SoftCard, CP/M, Microsoft BASIC and complete documentation, you may have to stand in line to get one!

™Apple II is a trademark of Apple Computer, Inc.

\*CP/M is a registered trademark of Digital Research.



## MICROSOFT

**CONSUMER PRODUCTS**

10800 Northeast Eighth, Suite 507  
Bellevue, WA 98004  
(206) 454-1315



# Have some great memories.

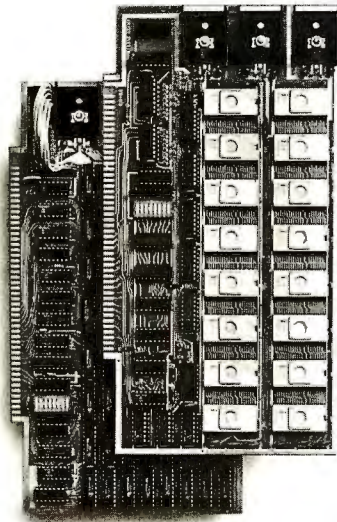

### 16K PROM boards.

- PROM card has 2708-type memory
- Quality board construction
- 0-4 wait states
- Address any 4K group to any 4K boundary
- Control up to 8 banks of memory
- Fully assembled and tested
- PRICE—\$300

(California residents add 6% sales tax)

### Expandable 5 MHz RAM boards.

- 8—32K expandable RAM board uses TI 4044 memory
- Runs at 5MHz
- Fast 250ns access time
- Bank select
- Address any 4K block to any 4K boundary
- Quality board construction

PRICE—8K—\$210; 16K—\$378; 24K—\$570; 32K—\$744; 8K add-on kits—\$162

(California residents add 6% sales tax)

Call or write Artec for details

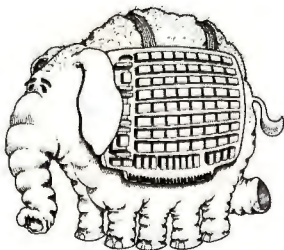

## ARTEC ELECTRONICS, INC.

605 Old County Rd., San Carlos, CA 94070  
Telephone (415) 592-2740

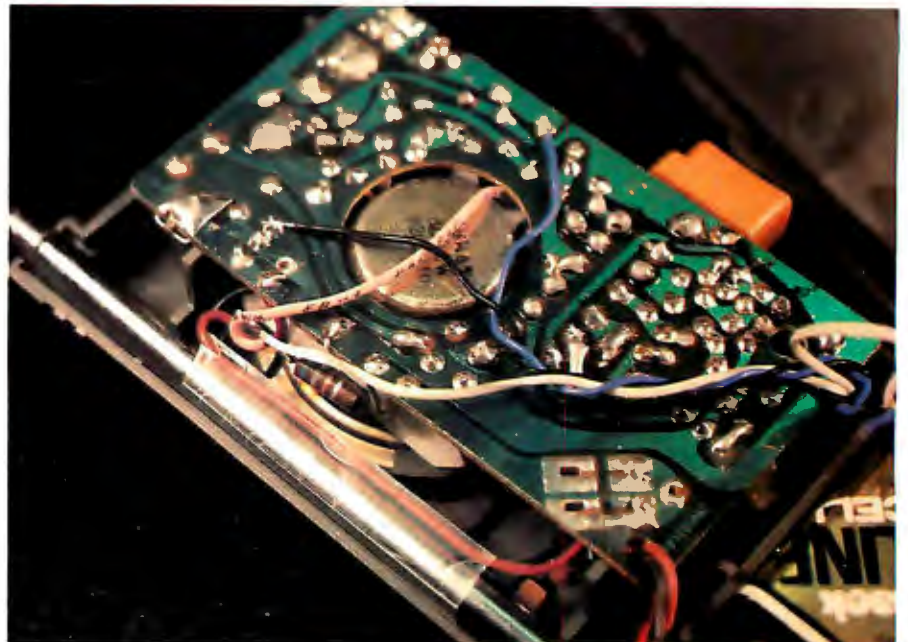

*Photo 3: Two walkie-talkies can be used in a simple remote-control scheme. One walkie-talkie, used as the receiver, is modified by connection to the circuit illustrated in figure 10a. The new circuit is attached to the rear of the walkie-talkie's case, as shown. These walkie-talkies are sold by Radio Shack as catalog number 60-4001; they incorporate a Morse-code tone oscillator necessary to the control scheme. Transmission is on a frequency of 49.86 MHz.*

has had it for years. To meet the demand for remote-controlled TV sets, special CMOS remote-control integrated circuits were designed, employing LSI. It is possible to use a pair of these for computerized remote control as well. Figure 7 shows the Motorola MC14422 remote-control transmitter part and a typical application circuit. Photo 2 illustrates the number of components necessary to implement this circuit. Figure 8 outlines the receiver circuit which uses the Motorola MC6525 receiver.

These specialized devices are very powerful. They use digital frequency multiplexing and transmit any or all of the five different frequencies sequentially to form a code corresponding to the particular selected function. These frequencies range from 34 to 43 kHz and accommodate twenty-two control channels including the ability to remotely adjust three analog-output signals in the receiver.

My experience in building these circuits warrants some mention. While the transmitter section (figure 7) went together easily, the receiver portion (figure 8) is a bear, and entailed difficulty in alignment. Even though it finally worked quite well, I don't recommend it for the novice builder. I'm presenting it in this article because it is a high-level controller and may be "just what the doctor ordered" for some individuals. Anyone interested



*Photo 4: Three wires and an optional resistor are needed to attach the remote-control modification to the receiving walkie-talkie.*



# INTRODUCING VIDEOPRINT: The picture perfect peripheral.

Videoprint is the convenient economical means of obtaining distortion-free line or continuous tone hardcopy from raster line computer graphics displays in full, brilliant color. The entire system is self contained in the convenient desk-top unit shown above.

Videoprints eliminate such off-the-screen photography problems as barrel distortion, color de-saturation and loss of color fidelity. Videoprints also minimize the effects of raster lines and video noise.

Videoprints are instantly produced with Polaroid® SX-70 or Polacolor 4" x 5" films, as well as with conventional color negative or 35 mm slide transparency films, offering you a range of handy sizes. The pictures can be made by untrained personnel at the push of a button.

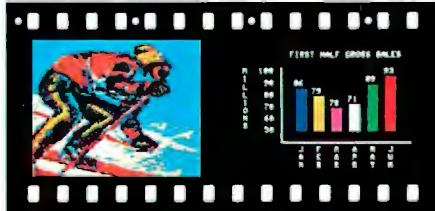
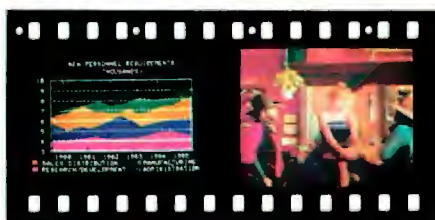
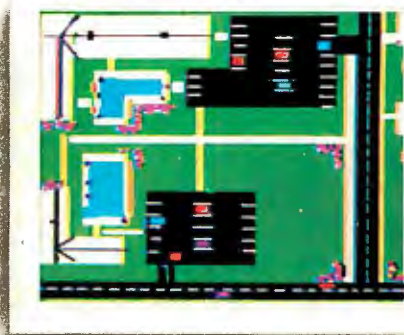

If you've ever wanted to distribute copies of computer graphics or TV video stills or file them in your permanent records, or send them through the mail or project them as slides, you need Videoprint.

If you've ever wanted to document alternatives in an interactive graphics process, or monitor periodic events without 24-hour observation, you need Videoprint.

In fact, if you use computer graphics in any form, you really need Videoprint. Find out all about this exciting new tool. Write or call us today.



**IMAGE  
RESOURCE**

The Videoprint People.

Image Resource Corporation  
2260 Townsgate Road, Westlake Village, CA 91361  
(805) 496-3317

"Polaroid," "Polacolor" and "SX-70" are registered trademarks of the Polaroid Corporation.

in further information on these devices should contact a Motorola distributor directly.

### Single-Channel Walkie-Talkie Remote-Control Interface

It isn't necessary for you to run out

and spend much money on expensive integrated circuits or to spend 3 weeks building an elaborate circuit, if you can be satisfied with a less sophisticated control system. My final offering consists of two Radio Shack walkie-talkies (catalog number

60-4001) and a two-chip circuit. When I bought them, they were \$10 each. Other walkie-talkies can be used, but the Morse-code tone generator built into these units is necessary for the operation of my circuit design.

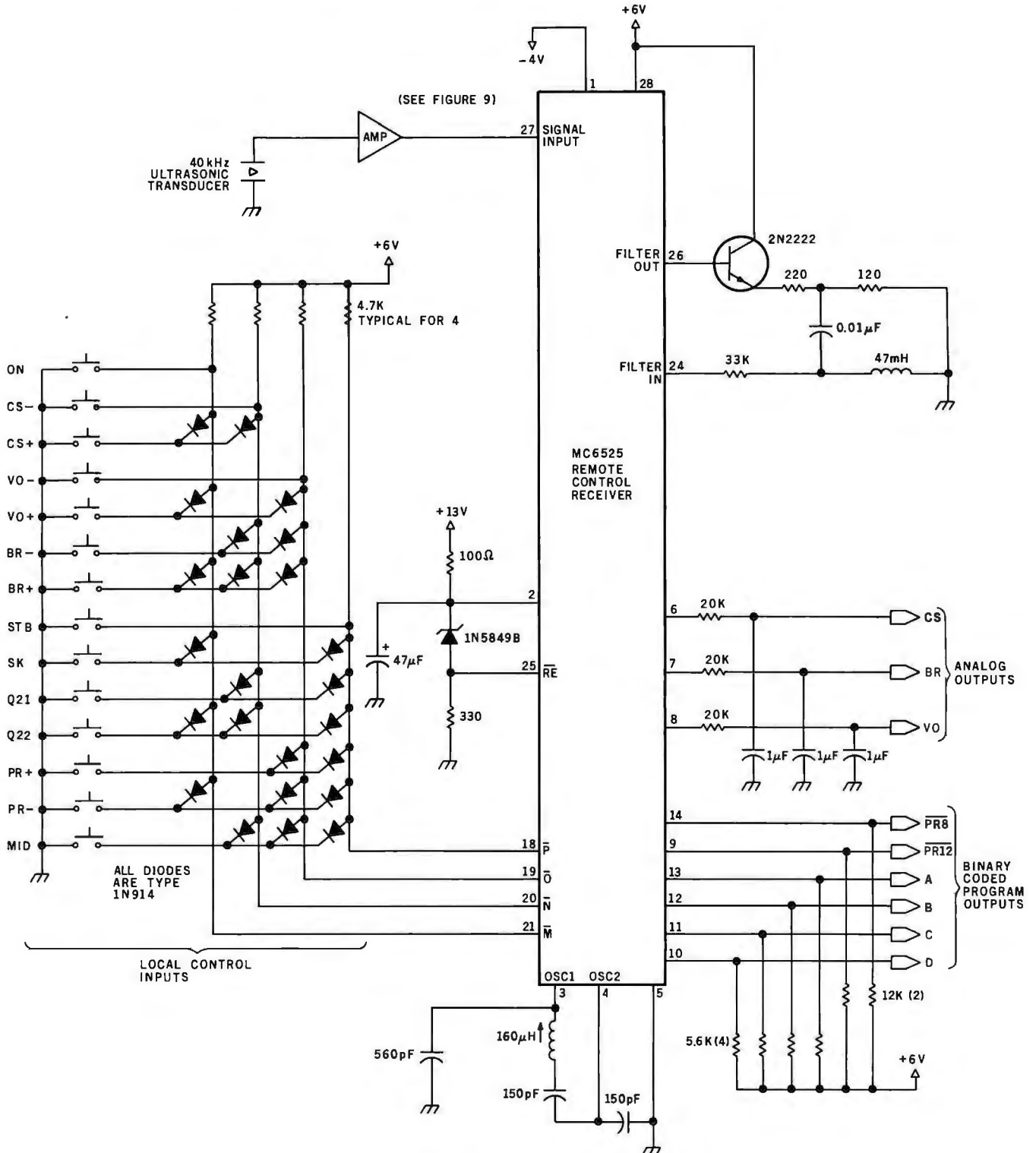

Figure 8: Schematic diagram of a remote-control receiver that employs the Motorola MC6525, a part chiefly used for television remote control.



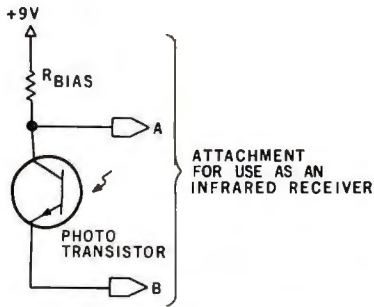

Figure 9a: This phototransistor circuit can be substituted for the ultrasonic transducer in figure 9b to change the preamplifier circuit into a receiver for the infrared transmitter shown in figure 6.

This interface, shown in figure 10, is terribly simple. To transmit a command, turn on the transmitter and press the Morse-code button. This transmits a tone. At the receiving end, the circuit just signals the computer that it has received a tone.

The circuit of figure 10 is an AC amplifier with some bandpass characteristics. The tone frequencies on these walkie-talkies vary all over the lot. A narrow bandpass filter is useless. Instead, the circuit detects a minimum threshold of a midfrequency AC signal. More often than not this is from the tone generator and is the signal we want.

The circuit can be assembled on a piece of perforated circuit-layout board and screwed to the back of the walkie-talkie. (See photo 3.) Connections to the board are made from inside the walkie-talkie case and consist of only three wires. The blue wire picks up +9 V power and the black

is walkie-talkie ground. A pink wire is either attached to the speaker or disconnected and soldered to a 6.8 to 10-ohm resistor connected to ground. The white wire in my circuit is tied to the pink-wire-and-resistor junction. Finally, the filter/amplifier (IC1) output goes to an opto-isolator. This device shields the walkie-talkie from the high-frequency electrical noise present on the computer input con-

nections. Without it, walkie-talkie reception is so poor as to be useless.

The receive walkie-talkie is connected to 1 bit of a parallel input port on the computer, as shown, and is switched on. The Data-Received light-emitting diode (LED) will be off; the input to the computer will be a logic 1. The LED will remain off as the transmitter is switched on.

Text continued on page 42

# S-100% EFFICIENCY

Want to build your S-100 interface *without* the hassle of modifying standard hardware? Take the *direct route to efficiency*. The E-Z BUS™ SYSTEM frees your design of unnecessary contacts, etching, and other extras that serve *no purpose!*

**Like To See Some Proof?**  
Circle The Reader Service Number.

**E-Z CIRCUIT™**  
by Bishop Graphics, Inc.

5388 Sterling Center Drive / P.O. Box 5007  
Westlake Village, CA 91359  
(213) 991-2600 Telex: 66-2400

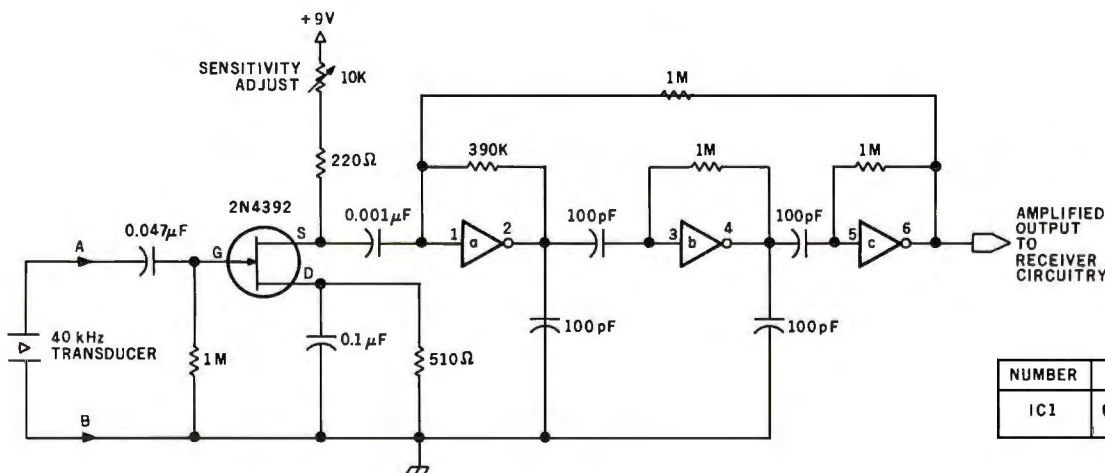

Figure 9b: Schematic diagram of a preamplifier circuit to be used with the ultrasonic remote-control receiver.

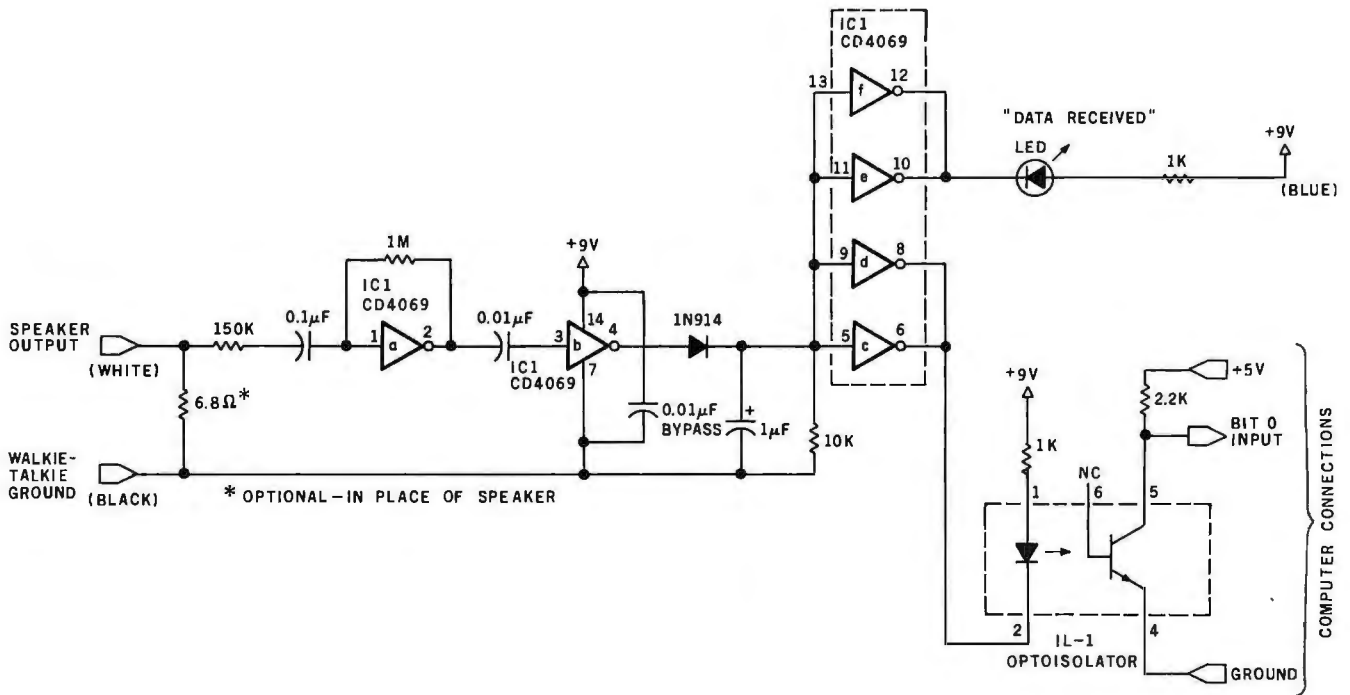

Figure 10a: A receiver circuit that allows use of inexpensive walkie-talkies for the transmission of control data. The two walkie-talkies used in this application were Radio Shack catalog number 60-4001 types, which have an integral Morse-code audio oscillator. One walkie-talkie is used as the handheld remote transmitter, the other as the receiver.

This arrangement allows transmission of only a single bit of control information, but this 1 bit can be modulated in various ways (even in Morse code) to control various functions. Decoding of this modulation must be carried out by a program running on the host computer.

A 0.01  $\mu\text{F}$  bypass capacitor must be soldered directly to pins 7 and 14 on the CD4069.

**MR. PROGRAMMER**

Are you finding programming the most tedious pursuit you've ever engaged in?

**MR. DEALER**

Would you find your hardware sales increased 100 fold if your prospective purchasers could create their own programs immediately?

**MR. HOBBYIST**

How about you? Spending lots and lots of time debugging?

**MR., MRS., MS.**

Who ever you are - if programming has become unpalatable or if you've gotten off more than you can chew . . . . .

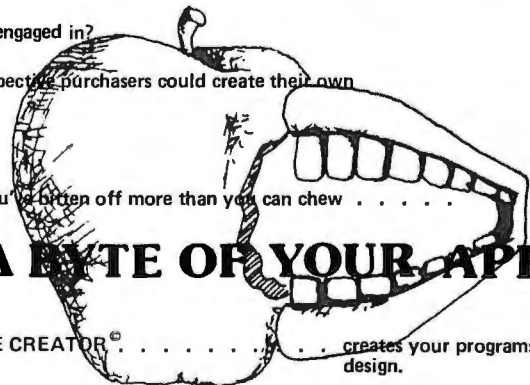

**LET THE CREATOR® TAKE A BITE OF YOUR APPLE**

- THE CREATOR® . . . . . does the work! You answer the simple direct questions and THE CREATOR® creates ... all in Basic language.
- THE CREATOR® . . . . . makes complete running programs that are modular and fully documented.
- THE CREATOR® . . . . . cuts programming time up to 90 %
- THE CREATOR® . . . . . requires NO (none) prior programming knowledge or skills

- THE CREATOR® . . . . . creates your programs to your design.
- THE CREATOR® . . . . . is presently available for Apple II
- THE CREATOR® . . . . . is presently available for TRS 80 Model I TRS 80 Model II Tandy 10
- THE CREATOR® . . . . . will soon be available for CP/M systems

<p>Enclosed is my check (or money order) in the amount of \$250.00. Please send me my serial numbered, registered copy of THE CREATOR® as soon as my check clears. (No wait for Certified checks, bank checks or money orders.) Sorry, no credit cards accepted.</p>	Please Print
	Name _____
	Address _____ Apt. No. _____
	City _____ State _____ Zip _____
	Computer make _____ Model _____

We are seeking qualified dealers and distributors to handle our growing software lines. Address inquires, on your company letterhead, to: Complete Business Systems, Inc., Software Division, 9420 W. Foster Ave., Chicago, Illinois 60656.



MODEL 800 • WITH SUNFLOWERS

# A NEW MASTERPIECE IN PRINTERS

The MODEL 800 MST is certainly pleasing to look at, but its true beauty lies beneath the surface. A glimpse at its features reveals why it is rapidly becoming the most sought after printer in the world . . .

- Four standard interfaces:  
RS-232 (15 baud rates)  
Centronics compatible parallel  
IEEE-488  
20ma current loop
- Six line densities: 64, 72, 80, 96, 120, 132
- 100 CPS at all six densities
- Unidirectional or bidirectional printing
- Sixteen horizontal and ten vertical tabs
- Elongated characters in all six densities
- 1920 character buffer
- Uses either perforated or roll paper
- Fully adjustable tractors to 9½"
- Auto self-test
- Up to 10 character fonts  
Standard 96 character ASCII  
User defined character font  
Provision for up to eight additional fonts
- Dot resolution graphics in six densities
- Variable line spacing control from 0 to 64 dots in half-dot increments
- Auto form-feed for any form length at any line spacing
- Heavy-duty all aluminum chassis
- 110vac or 220vac, 50/60Hz.
- 100 million character printhead
- Measures only 15" wide, 3" high, and 11" deep
- Weighs only 15 lbs.

. . . . but maybe its most attractive feature is the price . . . . \$699.00.

base 2<sup>o</sup> inc.

P.O. BOX 3548 FULL., CAL. 92634 / (714) 992-4344

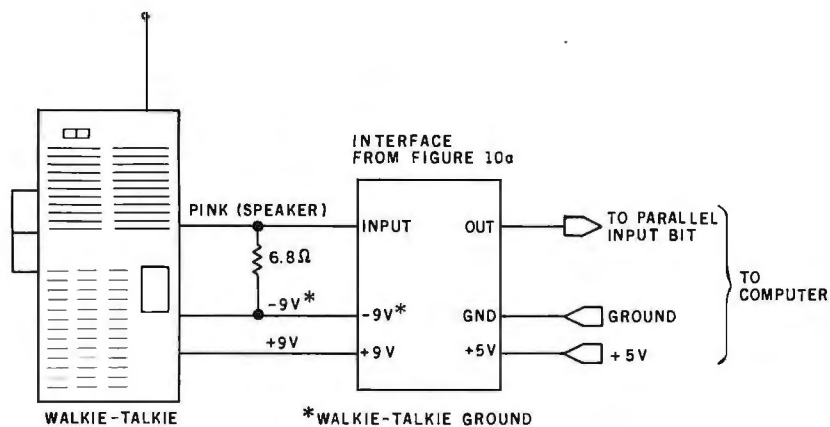

Figure 10b: In the walkie-talkie remote-control scheme, one walkie-talkie is used as the receiver for the RF transmission of the other. The circuit of figure 10a is attached to the receiving walkie-talkie.

Text continued from page 39:

the Morse-code tone button on the transmitter is pressed, the LED will light and the computer input will go to a logic 0. That is the simple principle by which the whole interface operates.

You are not limited to a single on/off remote-control operation (as with our switch on the cable) if you want to consider adding a little software such as that in listing 1. This simple BASIC routine monitors the walkie-talkie interface, waiting for an input signal (here, a logic 0 on bit 0 of port 3). When the computer detects an input signal, the program simply starts a 10-second sampling routine and counts how many times the tone button is pressed during the sample period. Three pulses could mean "go to application program 3," and six pulses could mean "go to program 6." Using this sampling technique, it would not be difficult to actually send remote-control instructions in Morse code. (You may consult the code table imprinted on the front of the walkie-talkie.) That would provide twenty-six or so control functions with a maximum number of only four pulses on the key. [See the October 1976 BYTE for several discussions of how to decode Morse code using computer software....RSS]

## In Conclusion

There are many other ways to remotely activate control programs through a computer. I have outlined only three. Other special LSI integrated circuits exist that are equally as powerful as the two discussed here. But it is impossible to cover them all. Perhaps one of the three designs I have presented is suitable for use on your system.

In the meantime, I have a few other applications in mind for these remote-control devices. As soon as I get the interfaces designed and tested, I'll be back with an article on a remote-controlled whatchamacallit.

## Next Month

We'll look at an easy-to-build acoustically coupled modem. ■

**Listing 1:** A BASIC program that monitors the walkie-talkie interface of figure 10a, waiting for a logic 0 on bit 0 of input port 3. When the logic 0 appears, the program starts a 10-second sampling period. During the period, the program counts how many times the tone button on the transmitter is pressed (that is, how many times a logic 0 is detected at the input port). The number of pulses received can be used to indicate which of the various control routines is to be activated. A more sophisticated program could decode more complex information from the transmitter, even information encoded in Morse code.

```

100 REM TIME SEQUENCED REMOTE CONTROL INTERFACE
110 REM
120 REM THIS PROGRAM MONITORS THE STATUS OUTPUT OF A
130 REM WALKIE-TALKIE (W/T) CONNECTED TO BIT 0 OF PORT 3
140 REM AND DEMONSTRATES HOW IT CAN BE USED TO VECTOR
150 REM TO VARIOUS CONTROL PROGRAMS BY REMOTE ACTIVATION
160 REM
170 REM
180 REM READ PORT 3 AND CHECK FOR AN OUTPUT FROM THE W/T
190 X=INP(3) :Y=X-1
200 IF INP(3)=X THEN GOTO 200
210 IF INP(3)=Y THEN GOTO 220 ELSE 200
220 PRINT"START":FOR D=25000 TO 25100
230 REM SET MEMORY LOCATIONS 25000 TO 25100 FOR BIT MAP
240 REM ANY 100 BYTE SEGMENT CAN BE DESIGNATED
250 GOTO 440
260 POKE D,M :REM STORE A BIT MAP OF W/T OUTPUT FOR GATE TIME
270 GOSUB 520
280 NEXT D
290 PRINT"END":REM SIGNIFIES END OF GATE TIME
300 Z=0:T=0 :A=0
310 FOR D=25000 TO 25100 :REM EXAMINE BIT MAP
320 IF PEEK(D)=0 THEN GOTO 560
330 A=0
340 NEXT D
350 REM T= TOTAL PULSES DURING GATE TIME
360 REM AT THIS POINT BRANCH TO OTHER PROGRAMS BASED UPON
370 REM THE VALUE OF T, IF T=2 THEN GOTO APPLICATION PROGRAM #2
380 PRINT"BRANCH TO APPLICATION PROGRAM #T
390 GOTO 190 :REM RETURN TO BEGINNING
400 REM
410 REM
420 REM READ INPUT TWICE AND VERIFY THAT IT IS TRUE
430 REM IF TRUE THEN MEMORY BIT IS A 0. IF NOT TRUE THEN M=1
440 H=INP(3)
450 GOSUB 520
460 H1=INP(3) :IF H<>H1 THEN GOTO 270
470 IF H=Y THEN M=0 ELSE M=1
480 GOTO 260
490 REM
500 REM
510 REM READ SAMPLE DELAY --- 10 SEC. GATE TIME
520 FOR W=1 TO 20: NEXT W :RETURN
530 REM
540 REM
550 REM INCREMENT PULSE TOTAL AT 1 TO 0 TRANSITIONS OF BIT MAP
560 IF A=0 THEN A=A+1 :T=T+1
570 GOTO 340

```

READY

# The Imagination Machine™



The only computer with color, sound, user programmability and expandability at \$599.

A built-in, dual-track cassette tape deck with 1500 baud rate, for APF's digitally recorded, "saturated," tape programs. A built-in sound synthesizer. And two, built-in, game style controllers, with joysticks and numeric keypads.

When you want to go beyond APF's library of educational, home-and-personal management or entertainment programs... when you want to create your own programs... you can. The Imagination Machine is programmable in BASIC and 6800 machine language. The Imagination Machine

is also expandable. Just add our "Building Block", an optional, four-port expansion device, and you can hook up a printer, telephone modem, and additional memory cartridge or mini-floppy disk drive.

For the name of your nearest Imagination Machine dealer call, TOLL FREE: 1-800-223-1264. (New York residents call: (212) 758-7550) or write: APF Electronics, Inc. 444 Madison Avenue, N.Y., N.Y. 10022.

\$599. Manufacturer's suggested retail price.

**APF**electronics inc.

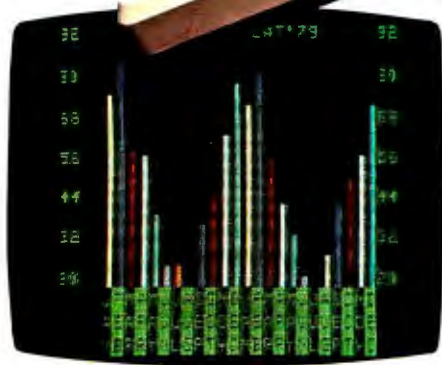

The Imagination Machine offers more at its price than any other personal computer on the market today.

Consider these features: 9K RAM, with 14K BASIC in ROM, 53-key typewriter keyboard. A fine resolution picture, generated on your television set or monitor in 8 colors!

**"YOUR LIFE WILL NEVER BE THE SAME!"**

# The industry's most

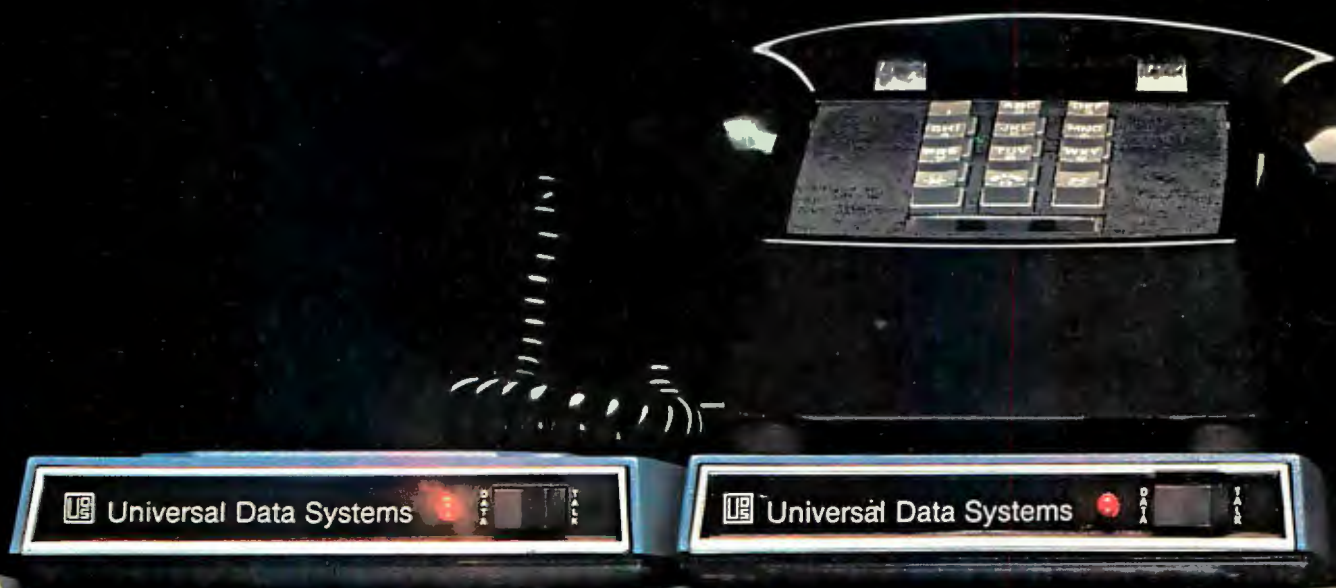

103 LP, Jan. 1980  
(\$195)

202 LP, May 1980  
(\$295)

## Now showing...

UDS line-powered modem technology has already put two sensational acts on stage!

The 202 LP is the newest line-powered star. Just announced, it offers compatibility with Bell 202-series modems at a fraction of the cost, power consumption and space requirement of earlier units. It is FCC-certified for direct connection to the dial-up telephone network; three snap-in plugs complete such a connection in seconds. All operating power is drawn directly from the phone line; no AC connection is required.

The unit is designed to fit directly under your telephone handset, requiring 1 1/8" of additional height and no additional desk/counter space at all! An RS-232C interface is provided. Communication rate is 0-1200 bps asynchronous, half-duplex, over two-wire DDD circuits. The 202 LP follows the act originated by...

The 103 LP announced by UDS in January, 1980. It's Bell 103 compatible, features RS-232C and current-loop (TTY) interfaces and, like the 202 LP, draws all operating power direct from the telephone line. Communications are 0-300 bps asynchronous, full-duplex over a two-wire circuit. The 103 LP operates in the "originate only" mode.

Contact UDS for details about either of these currently available line-powered modems.

# exciting modem show!



Aug. 1980

Dec. 1980

## Coming attractions...

The UDS line-powered modem show is by no means over! Additional models are expected in August and December, 1980, and product planning is well under way on others. More introductions are scheduled for early 1981.

Breakthroughs in line-powered modem technology typify the UDS approach: hard-nosed engineering, combined use of the latest datacomm techniques.

For more information about UDS and its exciting thrust into line-powered modem technology, call your UDS District Sales Office, or contact Universal Data Systems, 5000 Bradford Drive, Huntsville, AL 35805. Phone 205/837-8100.

"Confidence in Communications"

# Universal Data Systems



Member  
IDCMA

DISTRICT OFFICES: **Summit, NJ**, 201/522-0025 • **Blue Bell, PA**, 215/643-2336 • **Atlanta**, 404/952-3463  
**Chicago**, 312/441-7450 • **Dallas**, 214/385-0426 • **Santa Ana**, 714/972-4619 • **Sunnyvale**, 408/738-0433

Circle 27 on Inquiry card.

Created by Dayner/Hall, Inc., Winter Park, Florida

# The 1980 West Coast Computer Faire: A Watershed Year for Personal Computing

**Photo 1:** Studying a Computhink Minimax small-business computer system at the Matthews Computer Connection booth.

**Photo 2:** The West Coast show in high gear.

**Photo 3:** Artist Saul Bernstein (creator of the Einstein image for the Apple II) of Thousand Oaks, California, created this image of Sally Ann Londer using a digitizing pad.

**Photo 4:** The CompuServe booth. CompuServe's MicroNet is a computer time-sharing and software-distribution service similar to The Source.

**Photo 5:** Cromemco's new SDI Super Dazzler high-resolution color graphics system.

**Photo 6:** Here's a Japanese Kana character-set generator for your TRS-80 from Ron Johnson, Racet Computes, 702 Palm-dale, Orange CA 92665. Price: \$150.

**Photo 7:** No, this computer was not left out in the sun. It's the work of Elaine Pura, of Computer Service Systems Network. This "malleable main-frame" is actually a soft sculpture of CSSN's System 1000, a computer system featuring a Winchester hard-disk system and tape backup in one package, shown in photo 8.

**Photo 8:** CSSN's System 1000 in real life.

**Photo 9:** Studying hardware at the Heath Company booth.

**Photo 10:** Shopping for floppy disks.

**Photo 11:** The Computer Faire attracted a good number of handicapped people who use personal computers in their everyday lives. BYTE author Mark Dahmke is at left.

**Photo 12:** Ithaca Intersystems' new Z8000 processor board gets a close inspection from show-goers.

**Photo 13:** Sally Ann Londer sits for her computerized portrait.

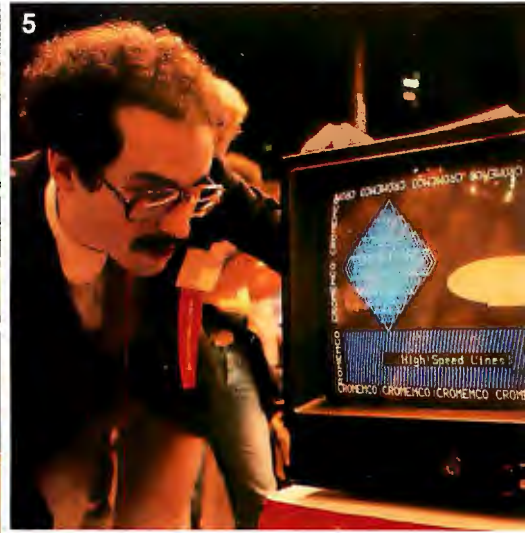



CP/M programs running on your Apple computer? How about a Japanese character set for your TRS-80 — or maybe a \$298 pocket computer from Sharp that runs Tiny BASIC?

These are no fantasies because the future was definitely on view at this year's West Coast Computer Faire, and a record audience of about 20,000 people jammed San Francisco's Civic Center last March to get a good look at it. What they saw was encouraging to hobbyists,

business people, and computer scientists alike. The industry is rapidly maturing, and products only dreamed of a short time ago are now being offered matter-of-factly for sale.

As expected, one of the hottest areas of growth on view at the show was the small business computer, but the Faire proved that this is not the only area of growth by far: MicroNet and The Source both exhibited their telecommunication-based information services for personal computers. New, highly sophisticated computer games were on display from Atari and Apple (to name only two). Software is growing in several directions at once, and Pascal made a strong

showing. However, new BASIC compilers were also in evidence, and the FORTH language is gathering momentum. (The August 1980 BYTE's theme will be FORTH.)

Another trend is the multi-user computer system. Micromation's Multi-user Z System Computer offers separate memory and a separate processor for each user. The system also features the CP/M operating system and a Shugart SA4000 Winchester hard-disk drive. With the Nestar Clusterbus system, anyone can connect as many as 64 Apple IIs together in a resource-sharing network.

The Japan Microcomputer Club rented booth space at the Faire to promote their organization of Japanese microcomputer enthusiasts, now 3000 strong. Industry watchers will definitely want to keep in touch with this organization. Their address is: Japan Microcomputer Club, c/o Japan Electronic Industry Development Association, 3-5-8, Shibakoen, Minato-ku, Tokyo 105, Japan.

Microsoft announced the Z80 Softcard, a plug-in processor card for the

Apple II computer that enables users to run software written for Z80-based computers. Included with the package is the CP/M operating system and Microsoft's Disk BASIC. The Softcard, which costs \$349, allows the user to select either the Apple's 6502 processor or the Z80 processor using

a keyboard command. Both processors cannot run at the same time. Products like the Softcard point the way to CP/M's emergence as a de facto industry standard.

On the educational front, sad to say, there was little evidence of growth in the industry. Most of the "educational" programs I saw were trivial drill-and-practice exercises. (See the BYTE Education Forum in this issue.) Perhaps matters will improve in the coming year. There is some interesting work going on now at Texas Instruments in the area of secondary-school use of personal computers.

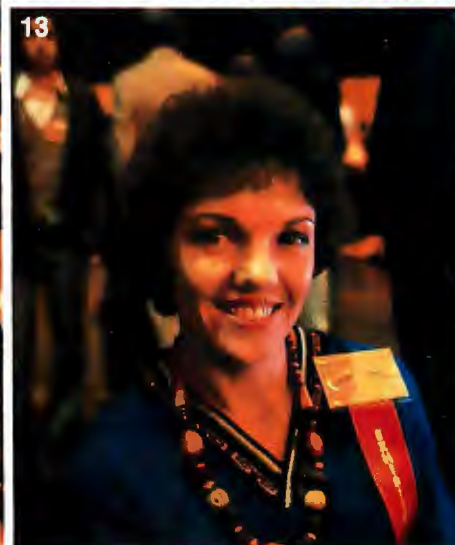
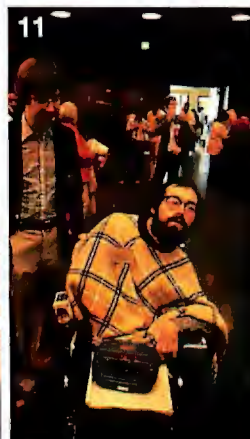

**Photo 14:** Digitized images of attendees at the Faire generated by Digital Graphics Systems' CAT-100 color image system, which consists of two S-100 boards. It can capture an image in 1/60 of a second and store it in its on-board 32 K-byte memory.

**Photo 15:** Two young chess players take turns vying with a computerized chess-playing unit made by Chafitz.

**Photo 16:** Micro Matrix's \$19.95 light pen for the TRS-80.

**Photo 17:** Mychess, the winner of the computer chess tournament at the Faire, was written by Dave Kittinger, proprietor

of Computer Services, 2431 Lyvona Ln, Anchorage AK 99502. The program is available on either 5-inch or 8-inch floppy disk for the TRS-80, North Star CP/M, or Cromemco CDOS for \$50.

**Photo 18:** Book business was brisk at BITS Inc.

**Photo 19:** Playing games on an Atari 800.

**Photo 20:** The easy way to program — with a giant TV screen.

**Photo 21:** Sharp's new PC-1210 pocket

computer, price: \$298. The main processor unit, which can run Tiny BASIC programs up to 400 bytes long, is shown being plugged into the cassette interface. A new version, the PC-1211, is due out next month; it will have a capacity of 1424 bytes of user memory.

**Photo 22:** Ten colors in Apple II high-resolution mode? You can get them with Synergistic Software's Higher Text package, which lets you design your own character set, mix text and graphics, and change the shape of letters.

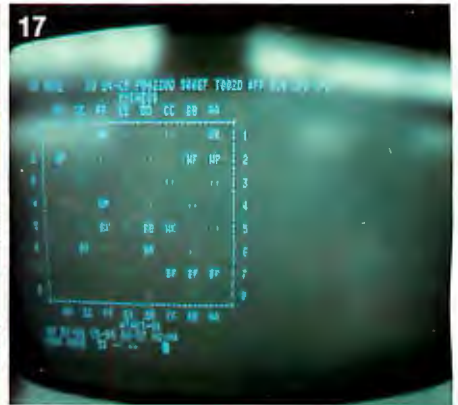

Probably the most important trend at the show was that the software industry is beginning to catch up with the hardware industry. A new sophistication is very apparent, and we'll be seeing many new developments in the areas of word processors, music systems (like Syntauri Ltd's alphaSyntauri Apple II-based synthesizer on view at the show), adventure games (watch for our special issue on Adventure and its offspring coming up in BYTE), high-resolution color graphics, and ultra-small personal computers.

We're looking forward to a very exciting time in personal computing in the new few months, and we hope the pictures in this photo essay will convey some of that excitement. ■



# If you can type, you can handle your accounting, word processing and much more on ISC's Small Business Computer!

The Intecolor® 8963 is just one of a complete line of ISC desktop computers designed for businessmen who don't know how – or don't have time – to write programs. It's CP/M® compatible, so you can choose from hundreds of CP/M business programs – programs that have been proven in hundreds of actual applications.

Programs like General Ledger, Accounts Receivable and Payable, Payroll, Mailing List and Inventory Control are now available *in color*. You'll comprehend data faster, thanks to the proven readability of ISC's eight-color display.

To compose letters and other documents quickly and easily, you'll want ISC's unique *color-coded* Word Processing program. With an optional printer, you can print out as many mistake-free originals as you want!

The Intecolor 8963 is just \$6395,\* and includes a 19" color graphics display, typewriter-like keyboard, dual disk drive for data storage – even a color version of Microsoft® Business BASIC for those of you who do want to program.

Don't let your business get behind the times. Call your ISC sales representative or visit your nearest Factory Authorized ISC dealer and get a "hands on" demonstration today.

**Color Communicates Better**



\* U.S. domestic price. Unretouched photo of screen. CP/M is a registered trademark of Digital Research Corp.

DEM Quantity Discounts are available to Qualified Dealers and Volume Users of 25 Systems (or greater) per year. Call your nearest ISC Representative listed below.

**ISC SALES REPRESENTATIVES:** AL: 205/883-8660, AZ: 602/994-5400, AR: (TX) 214/661-9633, CA: Alhambra 213/281-2280, Goleta 805/964-8751, Irvine 714/557-4460, Los Angeles 213/476-1241, Los Altos 415/948-4563, San Diego 714/292-3525, CO: 303/355-2363, CT: 203/624-7900, DE: (PA) 215/542-9876, DC: (VA) 703/569-1502, FL: Ft. Lauderdale 305/776-4800, Melbourne 305/723-0766, Orlando 305/425-5505, Tallahassee 904/878-5642, GA: Atlanta 404/455-1035, HI: 308/524-8633, ID: (UT) 801/292-8145, IL: (No.) 312/564-5440, (So. MO) 816/765-3337, IN: (IL) 312/564-5440, IA: (Scott County Only) 312/564-5440, (MO) 816/765-3337, KS: (MO) 816/765-3337, KY: 606/273-3771, LA: 504/626-9701, ME: (MA) 617/729-5770, MD: (VA) 703/569-1502, MA: 617/729-5770, MI: Brighton 313/227-7067, Grand Rapids 616/363-9839, MN: 612/645-5816, MS: (AL) 205/883-8660, MO: 816/765-3337, MT: (CO) 303/355-2363, NB: (MO) 816/765-3337, NH: (MA) 617/729-5770, NJ: (No.) 201/224-6911, (So.) 215/542-9876, NV: (AZ) 602/994-5400, NM: 505/292-1212, NY: Metro/LI(NJ) 201/224-6911, N. Syracuse 315/699-2651, Fairport 716/223-4490, Utica 315/732-1801, NC: 919/683-1580, ND: (MN) 612/645-5816, OH: Cleveland 216/398-9200, Dayton 513/435-7684, OK: (TX) 214/661-9633, OR: 503/644-5900, PA: (E) 215/542-9876, (W) 412/922-5110, RI: (MA) 617/729-5770, SD: 612/645-5816, TN: 615/482-5761, TX: Austin 512/454-3579, Dallas 214/661-9633, El Paso Area (Las Cruces, NM) 505/524-9693, Houston Only 713/681-0200, UT: 801/292-8145, VT: (MA) 617/729-5770, VA: 703/569-1502, WA: 206/455-9190, WV: (PA) 412/922-5110, WI: (IL) 312/564-5440, WY: (CO) 303/355-2363.

**EUROPEAN EXPORT SALES:** EUROPE: (MA) 617/661-9424, BELGIUM: Brussels 02-242-36-04, DENMARK: 02-913255, FRANCE: Rueil Malmaison 749-47-65, Paris 33-1-306-4606, GREECE: Athens 642-1368, ITALY: Milano 02600733, THE NETHERLANDS: Poeldijk 01749-47640, Amsterdam 020-360904, SPAIN: Barcelona 204-17-43, SWEDEN: Vallingby 08-380-370, SWITZERLAND: Muttschellen 057-546-55, UNITED KINGDOM: Bournemouth 0201671181, WEST GERMANY: Koblenz 01149-31025/6, AUSTRALIA & NEW ZEALAND: Auckland 876-570, Canberra 58-1811, Chermerside 59-6436, Christchurch 799-210, Melbourne 03-543-2077, Sydney 02-808-1444, Wellington 644-585, CANADA: Dorval 514/636-9774, Ottawa 613/224-1391, Toronto 416/787-1206, Vancouver 604/684-8625, CENTRAL AND SOUTH AMERICA & CARIBBEAN: (GA) 404/394-9603, MEXICO: Monterrey 564-876, FAR EAST: (CA) 213/382-1107, HONG KONG: 5-74221 1, JAPAN: (Tokyo) (03) 463-9921, TAIWAN: (Taipei) 02 7022156, MIDDLE EAST: (GA) 404/581-0243, EGYPT T: 809933, ISRAEL: Ramat Gan 03725749, KUWAIT: Kuwait 438-1801/2, LEBANON: Beirut 221731/260110, SAUDI ARABIA: Jeddah 27790, Riyadh 25083-39732.

For sales and service in other countries contact ISC headquarters in Norcross, GA., U.S.A.



**Intelligent Systems Corp.®**

Intecolor Drive □ 225 Technology Park/Atlanta □ Norcross, GA 30092 □ Telephone 404/449-5961 □ TWX 810-766-1581

Circle 28 on inquiry card.

# Product Description

## The Apple III

Christopher Morgan  
Editor-in-Chief

This past May at the National Computer Conference in Anaheim, California, the Apple Computer Company introduced "Sara" (its code name for the Apple III), the

long-awaited new computer from this closely watched company.

We spent some time recently at Apple getting a first-hand look at a product that has been the object of industry speculation and anticipation for nearly a year.

Personal computer designers are fond of using feminine names for computers during the development stages. The Atari 800, for instance, was referred to as "Colleen," within the company, for security purposes. A similar veil of secrecy surrounded "Sara." This led to speculation that the Apple III would use the Motorola 6809 processor, or that it would use bit-slice architecture, and that it would cost anywhere from \$700 to \$10,000.

The rumors were mostly off-base. In fact, the Apple III is a logical upgrade of the Apple II for use in professional applications like word processing and information management.

"It's also the ultimate hobbyist computer," says Apple vice-president Steve Jobs, lightheartedly. "The Apple III was conceived primarily to fill in gaps in the Apple II. It will not replace the Apple II by any means. It's designed to enhance it."

The price of the Apple III (\$4500 to \$8000) buys a lot of computer power. For these prices, the company will be selling not just a computer but a total system, including software and peripheral devices.



**Photo 1:** The Apple III, a new 6502A-based personal computer with built-in 5-inch floppy-disk drive, up to 128 K bytes of memory, and high-resolution color graphics. Pascal and Apple Business BASIC are built-in, and the machine features a new Sophisticated Operating System called SOS. The Apple III will sell in the premium price range of \$4500 to \$8000, which includes a complete software and hardware system with peripherals. Reportedly FORTRAN will be available for the unit later in the year. Although the Apple III can be used for a wide range of general applications, the keyboard has been designed with financial, small-business, and word-processing applications in mind. An Apple II-emulation mode is included to enable Apple II software to run on the Apple III.

### Hardware Features

First, the basics. The Apple III uses a 6502A processor running at 2 MHz. Custom large-scale integration (LSI) circuitry enables the computer to address up to 128 K bytes of memory. The circuitry is housed in an aluminum chassis that keeps radio-frequency interference (RFI) in and conducts heat out (no cooling fan is required). The chassis is housed in a plastic shell. The Apple III looks like the Apple II, with its distinctive white plastic case; however, the aluminum chassis adds some weight to it.

One important feature is the addition of an on-board, 5¼-inch floppy-disk drive.

"We no longer consider the floppy-disk drive to be a peripheral device. It's an integral part of today's computer systems," says Apple's Product Marketing Manager, Don Bryson. The decision to keep the video monitor as a separate, off-board unit was dictated by the fact that the computer would otherwise not be portable enough. "We wanted Apple III users to be able to take their machines home from the office at night," says Bryson.

### The Keyboard

The Apple III shows signs of careful design throughout. The keyboard is a particularly good example of this care, being an outgrowth of the Apple II's popular keyboard. A numeric keypad has been added to the sculpted, Selectric-like keyboard. In fact, it has the same layout as an IBM Selectric typewriter, to make it as easy as possible for office workers to use the machine. Refinements include moving the Reset key off the keyboard. It is now located above and to the right of the keyboard; a reset operation now requires that the Control key be pressed along with Reset, thus eliminating a minor but irritating problem on the Apple II keyboard.

There are four cursor-control keys on the keyboard for applications such as word processing, and raised "dimples" on the D, K, and 5 keys to help the user locate those keys by feel. The Alpha-Lock key enables the entry of numerals in uppercase mode, and there are two user-definable keys for various software applications. Other handy features include built-in repeat on each key (there is no repeat key), and a fast-repeat feature useful for filling the screen with characters. The Shift-Tab and Shift-Space operations can be programmed to act as Back-Tab and Back-Space, respectively.



Photo 2: An example of the Apple III's high-resolution color graphics (290 by 192 lines of resolution with sixteen colors) displayed on an RGB (red, green, blue) color monitor. This particular demonstration is an animation program: the horses gallop on the screen.

# TOTAL CONTROL

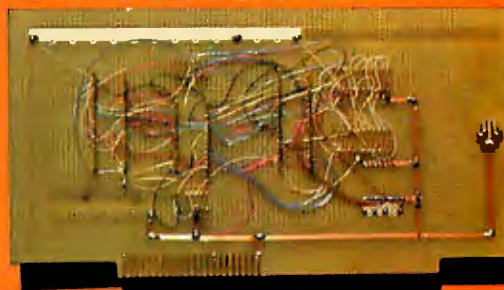

The unique E-Z BUS™ SYSTEM gives you maximum flexibility and the control you need to execute *your* design. Whatever your particular application — motor control, modem control, or a brand new microprocessor design — the E-Z BUS™ SYSTEM gives you the performance you demand!

### Take Control

Circle The Reader Service Number.

## E-Z CIRCUIT™

by Bishop Graphics, Inc.

5388 Sterling Center Drive / P.O. Box 5007  
Westlake Village, CA 91359  
(213) 991-2600 Telex: 66-2400

# INTRODUCING NOBUS-Z™



### A PROFESSIONAL MICROCOMPUTER

The NOBUS-Z has all the hardware features you want in a personal system, and the power to handle professional applications.

4 MHz Z80A CPU • 64K 200ns Main Memory • 6K 300ns Video Memory • 8-Inch Dual Density Floppy Drives • Color Video Text and Graphics • Sound Generator • 2-Serial Ports • 2-Parallel Ports • 4-Counter/Timers • CP/M™ 2 Operating System

Order a NOBUS-Z from your local Computer Dealer or write to EXO Electronics for complete information. OEM inquiries welcome.

©CP/M is a registered trademark of Digital Research, Inc.

## EXO ELECTRONICS COMPANY

CIRCLE 000 ON THE INQUIRY CARD

P.O. BOX 3571, CULVER CITY, CALIFORNIA 90230 • (213) 390-6527  
TELEX: 181149 WESTLSA "ATT: EXO"

**NEW**

Traditional

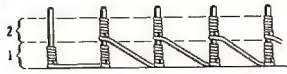

Wire-Wrapping

**JUST WRAP**



Wire-Wrapping

**WHY CUT?  
WHY STRIP?  
WHY NOT ...**

**JUST WRAP™** WIRE WRAPPING TOOL

- AWG 30 Wire
- .025" Square Posts
- Daisy Chain or Point To Point
- No Stripping or Slitting Required
- Built In Cut Off
- Easy Loading of Wire
- Available Wire Colors:
- Blue, White, Red & Yellow

PATENTED U.S.A.  
FOREIGN PATENTS PENDING

JUST WRAP TOOL WITH ONE 50 FT. ROLL OF WIRE		
COLOR	PART NO.	U.S. LIST PRICE
BLUE	JW 1 B	\$ 14.95
WHITE	JW 1 W	14.95
YELLOW	JW 1 Y	14.95
RED	JW 1 R	14.95
REPLACEMENT ROLL OF WIRE 50 FT.		
BLUE	R JW B	\$ 2.98
WHITE	R JW W	2.98
YELLOW	R JW Y	2.98
RED	R JW R	2.98
JUST WRAP-UNWRAPPING TOOL		
	JW 1	\$ 3.49

\*Minimum billings \$25.00, add shipping charge  
\$2.00/New York State residents add applicable tax



**OK Machine & Tool Corporation**

3455 Conner St., Bronx, N.Y. 10475 U.S.A.  
Tel. (212) 994-6600 Telex 125091



Photo 3: The Apple III with its plastic case removed to reveal the shielded aluminum chassis, designed for heat dissipation and RFI (radio-frequency interference) containment.

There are four slots inside the Apple III for insertion of peripheral cards, compared with eight in the Apple II. This is not a disadvantage, because many of the applications that require the use of special peripheral cards on the Apple II are either built into the Apple III, or are taken care of by the very complete array of connectors on the back of the computer. These include a special 26-pin flat ribbon connector for daisy-chaining up to three additional floppy-disk drives into the unit; two DB-9 connectors for a silent dot-matrix thermal printer, joysticks, etc; a DB-15 video-out connector with a choice of black-and-white, NTSC-color, or RGB (red, green, blue) outputs, plus power supply voltages; an RCA video-out connector (black-and-white only); an external speaker jack that disables the internal speaker when in use; and an RS-232C serial I/O (input/output) port for a letter-quality printer, modem, etc. The Apple III also features an event timer and a battery-driven clock calendar.

Can Apple II peripheral cards be used in the Apple III? First a word about the design of the new peripheral cards. In order to meet Federal Communications Commission (FCC) RFI emission guidelines, new Apple III peripheral cards will have special shielded connectors and shielded cables going to the outside world. The new cards use the same bus structure and the same timing as the old cards, so an update to the new format will be straightforward for manufacturers. You can plug Apple II peripheral cards into the Apple III, but this might violate the RFI guidelines in some cases. The legality of the matter is somewhat up in the air at present.

The built-in 5¼-inch floppy-disk drive is manufactured by Shugart and is being second-sourced to Apple. It should be considerably faster than the Apple II drives both because of its mechanical design and because of the more efficient disk controller and operating system built into the Apple III.

### Graphics

The Apple III's graphics capabilities go considerably beyond the Apple II's, offering 80 columns by 24 lines of text on the monitor screen—a must for serious word processing. The character dot-matrix is 8 dots high by 7 wide. Graphics modes include 560 by 192 lines (black

Most small system users think all microcomputers are created equal. And they're right. If you want performance, convenience, styling, high technology and reliability (and who doesn't?) your micro usually has a price tag that looks more like a mini. It seems big performance always means big bucks. But not so with the SuperBrain.

Standard SuperBrain features include: twin double-density 5¼" drives which boast over 300,000 bytes of disk storage. A full 32K of dynamic RAM - easily expandable to 64K. A CP/M\* Disk Operating System which insures compatibility to literally hundreds of application packages presently available. And, a 12" non-glare, 24 line by 80 column screen.

You'll also get a full ASCII keyboard with an 18 key numeric pad and individual cursor control keys. Twin RS232C serial ports for fast and easy connection to a modem or printer. Dual Z80 processors which operate at 4 MHz to insure lightning-fast program execution. And the list goes on. Feature after feature after feature.

Better yet, the SuperBrain boasts modular design to make servicing a snap. A common screwdriver is about the only service tool you'll ever need. And with the money you'll save on purchasing and maintaining the SuperBrain, you could almost buy another one. For under \$3,000, it is truly one of the most remarkable microcomputers available anywhere.

Whether your application is small business, scientific or educational, the SuperBrain is certainly one of today's most exciting solutions to your microcomputer problems. Call or write us now for full details on how you can get big system performance without having to spend big bucks. So, why not see your local dealer and try one out today. Intertec systems are distributed worldwide and may be available in your area now.



2300 Broad River Rd. Columbia, SC 29210  
(803) 798-9100 TWX: 610-666-2115

\*Registered trademark of Digital Research, Inc.

# SUPERBRAIN™



and white only) and 280 by 192 lines featuring sixteen high-resolution colors or sixteen shades of gray. (Compare this with the 280-by-160-line resolution in the limited-color, high-resolution mode of the Apple II.) Another mode offers forty characters with color-on-color; moreover, the Apple III offers the three Apple II graphics modes (yes, Apple II programs will run on the Apple III—more about this later).

### Software Features

At the heart of the Apple III is the SOS (Sophisticated Operating System), designed to handle multiple languages and peripherals. (Speaking of languages, the Apple III offers Pascal as a built-in feature, along with Apple Business BASIC. Although not officially announced, Apple will probably be offering FORTRAN later in the year for the Apple III.) The system architecture offers several new features, including extra instructions in the instruction set, a relocatable stack, relocatable base register, and extended addressing.

Floppy disks for the Apple III will have sixteen sectors, and the power supply has been made more "robust" to better handle multiple drives. The Apple III's designers believe that this will also clear up the occasional problems encountered in the past in trying to copy from one disk to another on the Apple II. Total capacity on a disk will be 143 K bytes. Pascal should also run considerably faster on the Apple III because it is built-in.

### Compatibility with the Apple II

Considerable effort has been expended to make the Apple III as compatible as possible with the Apple II. In fact an Apple II-emulation mode has been built into the Apple III. Thirteen-sector Apple II floppy disks can be quickly updated to the new 16-sector format (there is a problem, however, if the old disks are protected against copying). Some older BASIC programs with PEEKs and



**Photo 4:** Back view of the Apple III, showing (from left to right) the 26-pin flat-ribbon connector for daisy-chaining up to three additional floppy-disk drives into the computer; two DB-9 connectors for joysticks, etc.; a DB-15 video-out connector with black and white, NTSC color (the standard North American color-television system), and RGB (red, green, blue); an RCA-type video-out connector (for black and white only); an external speaker jack; and an RS-232C serial I/O (input/output) port for a letter-quality printer, modem, etc.

POKEs may not run on the Apple III without modification, but the great majority should work unchanged.

"The Apple II emulation is a true emulation," says Don Bryson. "You'll be locked into the 40-character uppercase mode."

### System Configurations and Availability

The Apple III will be sold as a *system*. This is central to the company's philosophy that a computer is more than just hardware, and that professional customers want a complete working package with software and documentation. The initial offering will be the \$4500 "Information Analyst" package, consisting of an Apple III with a Trendcom silent 80-column dot-matrix thermal printer; 96 K bytes of memory; black-and-white monitor; a special version of Visicalc, called Visicalc III, featuring 80 columns (Visicalc is a general-purpose, matrix-oriented program for handling financial and general data); SOS (Sophisticated Operating System); and Extended BASIC. This system will be available starting this month, July, at Apple dealers; widespread availability should occur in another few months.

Starting in the fall, Apple will offer another version of the Apple III, called the Software Development System, ranging in price from \$4500 to \$8000. The \$8000 version will be a word-processing package featuring a letter-quality printer (such as Qume or Diablo); an extra disk drive; a high-quality monitor; a word-processing software package; and a training course offered through Apple dealers. A less expensive version of the word-processing package will be available for \$4500; it will use the thermal printer.

### The Market

Apple is banking on the fact that the Apple III can compete head-on with a wide variety of computers. Steve Jobs believes it will give a product like the Wang word processor a run for its money.

"It's easier to use than the Wang and costs less," Steve points out.

Its color graphics are another strong feature. We were treated to a beautiful demonstration of high-resolution color graphics using an RGB color monitor. Apple plans eventually to market an RGB color monitor with the Apple III.

"The Apple III was conceived to fill in the gaps in the Apple II. One small technical deficiency (40 columns instead of 80 columns on the Apple II) prohibited us from entering some of the markets we wanted to go after," said Jobs. "The Apple III complements the Apple II, but the Apple II is still better for some things. I see it continuing to carry the educational and low-end professional markets."

Apple is confident that outside suppliers of peripheral cards and software will be encouraged to offer products for the Apple III because of its evolutionary approach to product design. We applaud the careful design of the Apple III and the commitment of the company to making it as compatible as possible with the Apple II.

We look forward to examining the potential of the Apple III in future issues of BYTE. ■





## every smart COMPUTER needs an SD SYSTEMS HEART.

We design and manufacture a complete line of industry compatible microcomputer boards and kits that can serve as the heart of your system. All are S-100 Bus compatible and use the Z80 microprocessor.

**MPC-4** — This SD Systems exclusive is a multi port controller which uses the Z80 for multi-user operations offering four serial RS-232 I/O channels.

**SBC 100/200** — A 2.5/4 megahertz range of single board computers which are effective standing alone or combined with the complete SD board range.

**ExpandoRAM IIII** — For use with 250/200 nanosecond RAM, these high density boards offer 16 to 64K memory; the ExpandoRAM II can achieve RAM capacities up to 256K using 64K chips.

**Versafloppy IIII** — A floppy disk controller for up to four drives, supporting single/double density and single/double-sided disk formats.

**VDB-8024** — A full function visual display board with a Z80 controller that adds display capabilities to your system.

**Prom 100** — A specialty board of SD Systems which allows you to program 2708/2716/2732 proms.

**Z-80 Starter Kit** — A low-cost entry into the world of microcomputers designed primarily for education and experimentation.

# SD SYSTEMS

P.O. Box 28810 • Dallas, Texas 75228 • 214-271-4667 • Telex 6829016

### NOW YOU CAN SAVE \$25 PER BOARD\*

when you purchase any SD Systems microcomputer board from participating SD Systems dealers listed below. \*Offer expires 10/31/80

**ADVANCED COMPUTER PRODUCTS, INC.**  
Irvine CA • 714-558-8813

**FUTURE ELECTRONICS**  
Natick MA • 617-237-6340

**ANCRONA**  
Culver City CA • 213-641-4064

**JADE COMPUTER PRODUCTS**  
Hawthorne CA • 800-421-5500

**COMPUTER CITY**  
Charlestown MA • 800-343-6652  
or 617-242-3350

**MINI MICRO MART**  
Syracuse NY • 315-422-4467

**THE COMPUTER MART**  
Waltham MA • 617-899-4540

**COMPUTER PRODUCTS STORES**  
Springfield IL • 217-528-0027

**PRIORITY ONE**  
Sepulveda CA • 800-423-5633 or  
213-894-8171

**CUSHMAN ASSOCIATES**  
Wilmington DE • 302-995-6733

**S-100**  
Clark NJ • 201-382-1318

**DAL-COMP**  
Dallas TX • 214-350-6895

**Q.T. COMPUTER SYSTEMS, INC.**  
Lawndale CA • 800-421-5150  
(ex. CA) or 213-970-0952

For complete product information, send for SD Systems' board and kit brochure (BK-101).

# Simulating Human Decision-Making on a Personal Computer

The world champion intently surveys the chessboard. Two thousand spectators expectantly wait in reverent silence. Finally, the champion reaches forward and moves his dark-squared Bishop; his opponent blinks with astonishment. The crowd is aghast with disbelief. Has the champion committed a fatal blunder? His Bishop is attacked by three different pieces and appears to be defenseless. The onlookers solemnly analyze the position. The room begins to rustle with excitement. The move is not a blunder at all! There is a hidden defense for each assault and the Bishop in its new position is devastating. The opponent's look of surprise slowly fades and is replaced by one of dejection. There is no escape; the position is hopeless. After a protracted delay, the challenger overturns his King, congratulates the champion, and quickly departs from the hall.

To a serious chess enthusiast, there is nothing more sensational than the startling change in fortune which is produced by a chess brilliancy. A single move transforms a seemingly even position into a one-sided contest. The move is one which most players would ordinarily dismiss at first glance. Only deep analysis unveils its magical power.

Scientists attempting to develop intelligent machines have regarded chess as an ideal test environment. Computer-chess devotees are gratified when a program plays a respectable game against a good human player. Even more pleasing, however, would be a victory involving a bona fide chess brilliancy. Such an event would be impressive to even the most intransigent critic.

---

Professor Peter W Frey  
Northwestern University  
Cresap Neuroscience Laboratory  
2021 Sheridan Rd  
Evanston IL 60201

---

Recent developments in computer chess have led to steady improvement in the quality of play. The ironic circumstance, however, is that this newly evolved machine intelligence has not resulted from a more sophisticated simulation of human thought processes. Instead, the quest for the elusive chess brilliancy has focused on a purely mechanical strategy: fine-tuning the  $\alpha$ - $\beta$  (alpha-beta) minimax algorithm to run at an incredible speed on advanced hardware. Computer programs making an exhaustive search of many thousand potential positions have consistently outplayed rival programs which are designed to

emulate the selective search process used by humans.

This surprising turn of events probably is more a reflection of our present programming limitations than an indication of the strategy which will ultimately be most productive. There are many knowledgeable individuals who believe that chess programs must more closely emulate human playing techniques if they are to become serious contenders for the world championship. It takes many years of experience before humans can excel at chess. This slow learning process involves the assimilation of thousands of complex patterns and the acquisition of detailed knowledge regarding appropriate goals and playing strategies for each of these. It is very difficult to fully embody such a complex data base in a computer program. Many man-years of effort would be required by a highly knowledgeable team. Such an enterprise is beyond the capacity of isolated individuals working in their spare time. Consequently, it is improbable that we will ever see a quality chess program that mirrors human thought processes unless some wealthy individual or government agency initiates a large-scale computer chess effort.

The artificial-intelligence community has also displayed considerable interest in the game of Go. This game surpasses chess in the depth and complexity of its strategic ideas. Because of its enormous branching factor, Go cannot use the mechanical tree-searching strategy which has worked well in chess. Instead, Go programs have to be patterned after human playing strategies. Since this approach is an enormous

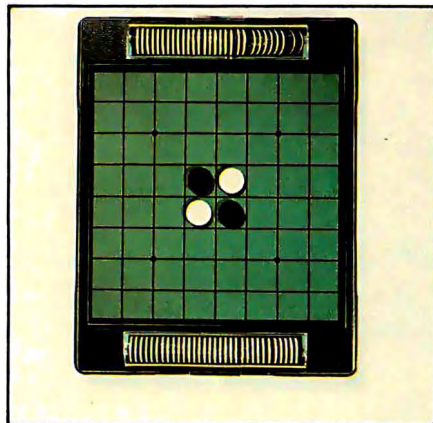

Photo 1: The initial board layout for Othello. Shown here is the commercial version of Othello manufactured by Gabriel. Othello is a trademark of Gabriel Industries Inc.



# Launch Yourself...

... into a world where bold ideas are welcomed, and where innovation, creativity, and performance are valued and highly respected characteristics. As a DP professional — a programmer, tech. rep, systems engineer, or programmer analyst — you've probably come up with a lot of good ideas . . . ideas you may have wanted to develop a bit further just to see where they would take you. But usually, something always seemed to get in the way. Maybe it was a lack of resources or opportunity. Or perhaps someone told you "There just isn't enough time to try that idea right now." But those good ideas are still there, waiting . . . waiting . . . waiting for a chance to be tested.

**Dare To Be Different . . .** At National CSS we know what creative DP professionals are looking for, because since the beginning, information processing has been our only business. We know that by offering people a chance to perform, and by providing them with the resources and a receptive environment, that they will come up with the ideas that shape the future of information processing. That philosophy has made National CSS **the place** for DP professionals . . . a place where you can dare to be different and come out a hero.

Sure, you may not be looking for a new job right now, but . . . maybe not today, maybe not tomorrow, but someday you're going to have another one of those good ideas, and when that happens, we hope you'll remember the name National CSS . . . it could launch your career in a bright, new direction.

*I'd like to know more about National CSS. Please send me your free brochure and poster.*

Name: \_\_\_\_\_ Address: \_\_\_\_\_

City: \_\_\_\_\_ State: \_\_\_\_\_ Zip: \_\_\_\_\_

*National CSS is an equal opportunity employer.*

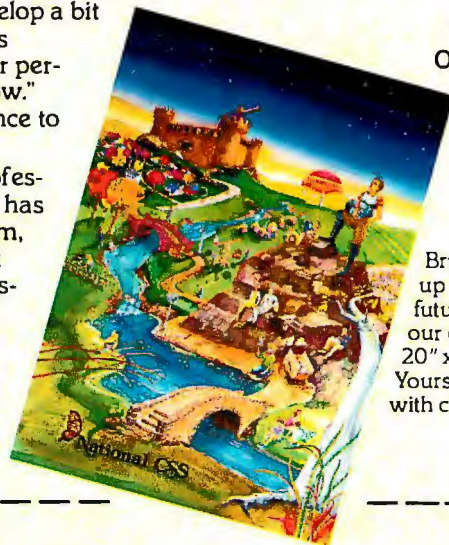

"Land of Opportunity" poster **FREE**

Brighten up your future with our colorful 20" x 28" poster. Yours free with coupon.

## National CSS

Mail to: National CSS, Inc.  
Dept. ADC 05074, P.O. Box 209,  
West Haven, CT 06516

# ENTREPRENEURS NEEDED

MORE THAN EVER IN THE MICRO-COMPUTER INDUSTRY.

The shortage of knowledgeable dealers/distributors is the #1 problem of microcomputer manufacturers. Over 300 new systems houses will go into business this year, but the number falls short of the 1200 needed. It is estimated that the nationwide shortage of consultants will be over 3000 by 1981. The HOW TO manuals by Essex Publishing are your best guide to start participating in the continued microcomputer boom.

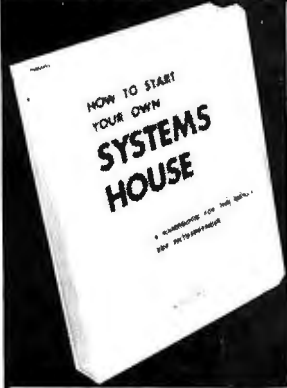

\$36. No. 10

Documentation • Solutions to the Service Problem • Protecting Your Product • Should You Start Now? • How to Write a Good Business Plan • Raising Capital

## HOW TO START YOUR OWN SYSTEMS HOUSE

6th edition, March 1980

Written by the founder of a successful systems house, this fact-filled 220-page manual covers virtually all aspects of starting and operating a small systems company. It is abundant with useful, real-life samples: contracts, proposals, agreements and a complete business plan are included in full, and may be used immediately by the reader.

Proven, field-tested solutions to the many problems facing the small systems house are presented.

From the contents:

- New Generation of Systems Houses
- The SBC Marketplace
- Marketing Strategies
- Vertical Markets & IAPs
- Competitive Position/Plans of Major Vendors
- Market Segment Selection & Evaluation
- Selection of Equipment & Manufacturer
- Make or Buy Decision
- Becoming a Distributor
- Getting Your Advertising Dollar's Worth
- Your Salesmen: Where to Find Them
- Product Pricing
- The Selling Cycle
- Handling the 12 Most Frequent Objections Raised by Prospects
- Financing for the Customer
- Leasing
- Questions You Will Have to Answer Before the Prospect Buys
- Producing the System
- Installation, Acceptance, Collection



\$28. No. 16

pitfalls • How consultants' associations can help you • The National Register of Computer Consultants • How others did it: real-life sample cases • and much more.

## HOW TO BECOME A SUCCESSFUL COMPUTER CONSULTANT

by Leslie Nelson, May 1980

Independent consultants are becoming a vitally important factor in the microcomputer field, filling the gap between the computer vendors and commercial/industrial users. The rewards of the consultant can be high: freedom, more satisfying work and doubled or tripled income. HOW TO BECOME A SUCCESSFUL COMPUTER CONSULTANT provides comprehensive background information and step-by-step directions for those interested to explore this lucrative field:

- Established consulting markets
- How to get started
- Itemized start-up costs
- Are you qualified?
- Beginning on a part-time basis
- The Marketing Kit
- Should you advertise?
- Five marketing tips
- Getting free publicity
- How much to charge
- When do you need a contract?
- Sample proposals
- Which jobs should be declined
- Future markets
- The way to real big money
- Avoiding the legal



\$30. No. 32

training users and providing maintenance and support. It also contains sample software contracts that have been used in actual software transactions. Also included are tips on how to negotiate with a large corporation, ways of avoiding personal liability, techniques for obtaining free computer time and hints on how to run a free-lance software business while holding a full-time job.

## FREE-LANCE SOFTWARE MARKETING

3rd edition, June 1980

Writing and selling computer programs as an independent is a business where • you can get started quickly, with little capital investment • you can do it full time or part time • the potential profits are almost limitless. Since the demand for computer software of all kinds is growing at an explosive rate, the conditions for the small entrepreneur are outstanding.

This manual will show you how to sell your own computer programs using these proven techniques: • direct to industries • through consulting firms • through manufacturers of computer hardware • in book form • mail order • through computer stores. It will show you how to profitably sell and license all types of software ranging from sophisticated analytical programs selling for thousands of dollars, down to simple accounting routines and games for personal computers.

The book will guide you step by step through the process of marketing, advertising, negotiating a contract, installing software, marketing, advertising, negotiating a contract, installing software, marketing, advertising, negotiating a contract, installing software, marketing, advertising, negotiating a contract, installing software,

Othello is played on an 8 by 8 grid with sixty-four flat pieces colored differently on each side.

challenge even with chess, it is unlikely that we will see a competitive Go program for some time.

This assessment does not provide encouragement for personal computing enthusiasts who wish to develop their own intelligent programs. Very few of us have the time, skill, or resources which are needed to write a chess or Go program. Therefore it is reasonable to search for a more manageable challenge. We need a game which is less complex than either chess or Go. The elusive machine brilliancy may be more attainable if we focus our efforts on a task compatible with the resources at hand.

## The Game of Othello

About a year ago I was introduced to the game of Othello, produced and marketed by Gabriel Industries. This game is a minor modification of one which was quite popular in England in the 1890s. The English game was known as Reversi, and there are accounts of a similar game in Hungary that goes back at least several hundred years under the name Annexation. Early manuscripts on the game seem to be as sophisticated as contemporary documents.

Othello is played on an 8 by 8 grid with sixty-four flat, circular pieces that are colored differently on each side. The exposed color of a piece (ie: the top surface) indicates which of the two players controls the particular square on which the piece is sitting. A change in control is denoted by flipping the piece and thus exposing the opposite color. The contest begins with four pieces (two of each color) occupying the four central squares. (See photo 1.) The two players alternate in placing one piece on the board at each turn. If one contestant has no move, his opponent plays again. The game ends when all sixty-four squares are occupied or when neither competitor can move. The winner is the contestant who controls the most territory (ie: the most squares) at the conclusion of the game.

## ESSEX PUBLISHING CO. Dept. 2

285 Bloomfield Avenue • Caldwell, N.J. 07006

Order books by number. Send check, money order (U.S.\$), VISA or Master Charge #. Publisher pays 4th class shipping. For rush Air Mail shipping add \$2.50 per book in USA and Canada, \$5.00 in Europe, \$8.00 elsewhere. N.J. residents add 5% sales tax.

No. 10     No. 16     NO. 32     Check enclosed     Credit card

Name \_\_\_\_\_

Address \_\_\_\_\_

City \_\_\_\_\_ State \_\_\_\_\_ Zip \_\_\_\_\_

Card # \_\_\_\_\_ Exp. \_\_\_\_\_

For immediate shipment on credit card orders call (201) 783-6940 between 9 and 5 Eastern time.

ALTOS COMPUTER SYSTEMS PROUDLY ANNOUNCES

**SUN-SERIES**

**ACS8000-6**



## THE VERY FIRST

Double Density Z80 Micro-Computer  
plus Twin 8" Floppies  
plus 14.5Mb Winchester Disk  
for under \$9,500!

And more! 4 user CP/M® for under \$12,000!

\* CP/M is a registered trademark of Digital Research, Inc.

ALTOS COMPUTER SYSTEMS, LEADER IN SINGLEBOARD TECHNOLOGY  
DOES IT AGAIN WITH ITS SINGLEBOARD ACS8000-6. TOTAL BUSINESS COMPUTER

### HIGH TECHNOLOGY AGAIN

The new ACS8000-6 single board computer is packed with ultra-high technology: Z80 double-density computer, up to 208Kb of high speed RAM, Floppy-disk and Winchester Hard Disk controllers, DMA, up to 6 serial/2 Parallel I/O, optional 32 bit floating point processor . . . All on One Board, fully socketed, fully documented reliable and maintainable.

### ADVANCED MULTI-USER SOFTWARE

Our new ALTOS Multi-User Executive (AMEX) supports four independent CP/M compatible programs in any of six languages: Basic, Fortran, Cobol, Pascal, APL, C, and a wealth of complete business application packages.

### WINCHESTER MASS STORAGE

We're staying with Shugart for both floppies and Winchester hard disk. Why? Simple, low price, solid reliability and they're our next door neighbor. Our single board computer supports up to 4 Mbytes of floppies and 58 Mbytes of Winchester running under AMEX.

**ALTOS**

**COMPUTER SYSTEMS**

2338-A Walsh Avenue  
Santa Clara, Ca 95050

### MINI PERFORMANCE FOR 1/2 COST

Prices you will love. Entry level ACS8000-6 Hard Disk System \$9,450  
2 users \$10,670, 4 users \$11,960,  
AMEX separate at \$250.

### AVAILABLE NOW!

Call for your nearest Altos dealer. (408)  
244-5766. Telex 171562 ALTOS SNTA.

# PASCAL/M™: \$175<sup>00</sup>!

Sorcim's software delivers all the advantages of PASCAL — from ease of learning to sophistication of application — at a price you'd expect to pay for BASIC. And, the features are as impressive as the price:

- Totally CP/M\* compatible (for 8080 or Z80 based systems)
- Built-in error checking
- Console cursor controls for word-processing like editing capabilities
- Extensions chosen for compatibility with other popular PASCALS
- Complete random file and longer integer (32 bit, 9 digit) support
- Case statement includes otherwise clause
- Full Wirth implementation
- All I/O totally compatible with CP/M file structure
- Special version available for Z80 + 9511 math chip based systems
- Optional updating service protects your investment
- Runs under both CP/M 1.4 and 2.2
- Full access to CP/M data files written in other languages and stored under CP/M
- Assembly code external support for added flexibility

Still need convincing? The 90 page manual is available separately for \$10, and tells all about PASCAL/M's implementation. Need more background? Jensen and Wirth's definitive book on PASCAL is \$7.90. You may never go back to BASIC again!



2273 CALLE DE LUNA  
SANTA CLARA, CALIFORNIA 95050

**How to order:** PASCAL/M requires 56K of RAM and one floppy disk; specify Z80, 8080, or Z80 + 9511 version (all are \$175). All disks are shipped on single-sided, single-density, soft-sectored CP/M compatible media. We accept UPS COD, Mastercard®, VISA®, personal checks (allow time to clear), and certified checks. Californians add sales tax. Add \$10 outside USA.

\*CP/M is a trademark of Digital Research  
PASCAL/M™ is a trademark of Sorcim

There are a number of ways for the computer to recognize and store values for specific edge patterns.

A player can legally place a piece on a square if: the square is presently empty; the square is immediately adjacent to one controlled by the opponent; and the new piece *outflanks* one or more of the opponent's pieces. *Outflanking* means that a row (one or more pieces without an intervening empty square) of the opponent's pieces must be bordered by the new piece and one of the player's existing pieces.

When an opponent's piece is outflanked, it changes color and becomes the property of the player. If a newly placed piece simultaneously outflanks two or more rows, all of these pieces are flipped. This characteristic of the game is probably the rationale for both of the earlier names, Reversi and Annexation. Readers who are new to the game might consider purchasing the commercial version marketed by Gabriel, which includes a descriptive pamphlet with examples and playing hints.

### Othello Strategy

Many of the strategic ideas in Othello are delightfully counter-intuitive. To be proficient, a player must learn many complex principles. As in chess and Go, there are many levels of competency. Individuals who think they have mastered the game usually discover that their skill level is only at one of the lower plateaus. In my experience with the game, I have yet to meet a modern Othello player who is aware of strategic ideas that were known in the 1890s.

In writing a computer program to play Othello, I was determined to follow a specific set of guidelines. As a psychologist, I wanted to write a program which simulated the cognitive processes used by humans. In addition, I wished to avoid using a multi-million-dollar computer which could simply "crunch out" a solution in a mindless, inefficient manner. The more powerful the machine used, the less likely it is that a human-type

## NEW FROM MOUNTAIN HARDWARE. THE APPLE CLOCK.

### New utility for your computer.

Now, there's a real time clock for the Apple II\*: the Apple Clock from Mountain Hardware. It keeps time and date in 1ms increments for one year. On-board battery backup keeps the clock running in the event of power outage. Easy to use with BASIC using routines carried in on-board ROM. That means you can time events, put time and date on printouts, create games in which elapsed time is important...and many more. Mountain Hardware offers a complete line of peripheral products for many fine computers.

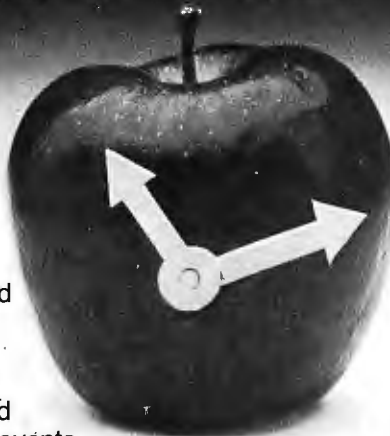

Available at your dealer's. Now.

## Mountain Hardware, Inc.

300 Harvey West Blvd.  
Santa Cruz, CA 95060 (408) 429-8600

\*Apple II is a trademark of Apple Computer, Inc.



APPLE •

ALTOS •

LSI-11 •

*Are your needs beyond the  
reach of your computer?*

*With the Corvus Constellation,  
the sky's the limit.*

S-100 BUS •

TRS-80  
MODEL 1 •  
MODEL 2 •

Now you can transform your personal computer into a multi-user system for business or educational applications. From two to sixty-four computers can be linked together sharing up to 40 million bytes of Corvus hard disk capacity.

A true multi-processing system, the CONSTELLATION™ provides open or secured access to all data files on the Corvus disk drive. Additional benefits include the ability to share peripherals and communicate with other computers in the CONSTELLATION network. Providing performance usually found in much more expensive systems, the price of the CONSTELLATION multiplexer is only \$750. Interfaces for additional computers are as low as \$235.

The CONSTELLATION is another innovative new product in the growing family of intelligent peripherals from Corvus. Our 10 million byte disk drives, MIRROR™ back-up/archival storage system, and now the CONSTELLATION, are all fully compatible with the most popular microcomputers available today: APPLE\* (DOS and Pascal), TRS-80\*\* (Model I & II), S-100 BUS, LSI-11, and ALTOS. Our Z-80 based intelligent controller handles up to four 10 million byte Winchester disks of proven performance and reliability—the IMI-7710.

Corvus—recognized leader in intelligent peripherals for microcomputers—provides solutions, not just hardware.

For complete information call or write Corvus today.

\*Trademark of Apple Computers, Inc.

\*\*Trademark of Radio Shack, a Tandy Co.

Corvus CONSTELLATION photo courtesy Science Graphics, Tucson, Ariz.

**CORVUS SYSTEMS, Inc.**

2029 O'Toole Avenue  
San Jose, California 95131  
408/246-0461 TWX: 910-338-0226

# RAINBOW MARKETWARE INTRODUCES STOCKMARKET COMPUTER PROGRAMS FOR APPLE II\* OWNERS

## A STOCK MARKET DATA SYSTEM

Apple owners now have sophisticated stock market computing capabilities at their finger tips. Use our introductory programs to input daily stock prices from your newspaper quickly, effortlessly and accurately. In no time you have appended a long working file adjusted for splits and exdividends. Free to digest the vital information you need to make important decisions, you view charts of the last forty days of your stock's action.

Introductory programs ..... \$49.95

## CREATE AND TEST MARKET STRATEGIES

Learn how you can put more than 10,000 stock entries on one 5 1/4" diskette. Experiment with our sample point and figure charting program. Devise programs that test the profitability of your personal stock trading ideas. Rainbow introduces you to the ultimate challenge. Your horizons widen as you improve your programming skills and your knowledge of the market.

Advanced programs ..... \$49.95

## LOW COST HISTORICAL DATA

Daily transaction data for 60 stocks for 180 days. Four libraries available now. Each library ..... \$14.95

## APPLE PORTFOLIO ANALYSIS INTERFACE

Convert the data you presently get by phone to the Rainbow System. Upgrade your computerized operation by adding Rainbow's charting and research capabilities.

Conversion program ..... \$19.95

Programs furnished on 5 1/4" diskettes. Written user instructions included. Required Apple II\* with at least 36 K memory and one disk. ROM card optional.

Call 301-426-6812 for Master and Visa orders 5 to 9 PM Eastern time. COOs \$2.00 extra. MO. residents add 5%.

\*Apple II is a registered trademark of Apple Computer, Inc.

RAINBOW MARKETWARE  
3111 BERKSHIRE RD.  
BALTIMORE, MD. 21214

algorithm will be selected. I decided to use a small microcomputer, the Radio Shack TRS-80.

The project was initiated by examining the playing strategies used by humans. A Northwestern University student, Steven Grady, recruited five volunteers and asked them to report their thoughts as they were learning to play Othello. All of these subjects were unfamiliar with Othello at the inception of the project. This research strategy is similar to the one used by De Groot in his pioneering work on chess skill. Our subjects were asked to examine a series of positions and to select the best moves. During the decision process, they reported their thoughts and indicated why the chosen move was better than the alternatives. This pilot research provided a number of valuable observations.

The most interesting general finding was that the subjects displayed a remarkable uniformity in the order in which they developed various playing strategies. After learning the rules for the game, every subject adopted an initial tactic of selecting the move in each position which flipped as many as possible of the opponent's pieces. The unanimous choice of this strategy by our subjects speaks to its apparent rationality. This approach was also used by Tim Quinlan when he wrote an Othello program for Mad Hatter Software. If you have played that program, you are probably aware that this is a poor strategy. Our subjects began to realize this after one or two games.

The first major revelation for them was that control of the squares on the edge, and especially the corners, is important. The subjects quickly

realized that pieces placed on the edge of the board are more stable than those placed in the middle of the board. In addition, the players observed that a piece placed on a corner square can never be flipped. Our subjects seemed to acquire these two insights at about the same time. A short time after gaining this new perspective, they reported that an edge move was preferable to other moves even if it flipped fewer pieces. In essence, our subjects were overcoming their initial bias and were starting to play for territorial control rather than to immediately maximize their piece count.

Once these players had discerned the value of the edges and the corners, they rapidly acquired several other important ideas. They reasoned that if the corners are good, then the squares adjacent to a corner on the edges or on the diagonal are bad—the rationale being that an opponent can never play on the corner if you refrain from placing a piece on any of the squares adjacent to the corner. A similar line of reasoning led to the observation that it is dangerous to play on the squares one row in from the edge since such a move gives the opponent an opportunity either immediately or in a few turns to play to the edge.

Our subjects also gained several specific insights about positioning pieces on the edge. These included some easily stated principles: the square two-removed from the corner is very desirable because it is a launching point for gaining the corner; it is bad to play a piece on an edge square between two enemy pieces when they are separated by

1	49	5	17	18	6	50	2
51	57	41	33	34	42	58	52
7	43	13	25	26	14	44	8
19	35	27			28	36	20
21	37	29			30	38	22
9	45	15	31	32	16	46	10
53	59	47	39	40	48	60	54
3	55	11	23	20	12	56	4

Figure 1: Priority values for each of the sixty potential move squares on the 8 by 8 playing board. A move is selected by choosing the lowest numbered square that satisfies the rules for move legality.



# "Now, go mini disk to multi-user with no software conversion."

Tony Famiglietti  
Applications Development Manager

"At ADDS, we've just designed a compact computer family with software that takes you all the way from mini disk to multi-user.

"MULTIVISION™ 1 (top module) starts you off with a 5 MHz processor, 64K bytes of RAM, and 700K bytes of mini disk storage. All for \$3,785.

"MULTIVISION 2 (top and bottom) adds 5M or 10M bytes of hard-disk storage.

"MULTIVISION 3 (entire stack) adds multi-user capability. It can serve up to four display terminals simultaneously.

"ADDs' advanced software enables this upgrading with no costly conversion, no change in operating system, utilities, or program languages.

"It includes a multi-user operating system that can run one to four CP/M®-compatible programs simultaneously... a Microsoft BASIC Interpreter to help you develop and run your own programs... Microsoft BASIC Compiler for high-speed running of protected, proprietary programs... and BASIC Data Management for multi-key, multi-record access to large ISAM files.

"We even offer an ADDS-developed package that permits Multivision to be used as a word processor."

Before you decide upon any small computer, look into ADDS Multivision. Write: Systems Division, Applied Digital Data Systems Inc., 100 Marcus Boulevard, Hauppauge, N.Y. 11787. Dealer inquiries invited.

CP/M is a registered trademark of Digital Research, Inc.



# ADDS

**SOMETHING EXTRA IN EVERYTHING WE DO**

# MULTIVISION

# New Pascal 1M SUPER-MICRO™

Executes Pascal 13x faster than an LSI-11!

The SUPER-MICRO™ series of X-pert Systems™ designed by Computex, combine high performance with low cost. The X9000 system line features the Pascal MICROENGINE™ 16-bit CPU and is now available for delivery.

\*Trademark Western Digital Corp

## SYSTEM X9020 (CPU Manual \$19.95)

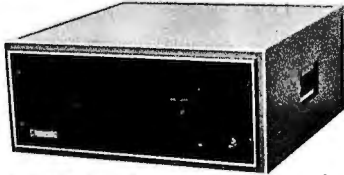

**\$4195\*** READY TO RUN

### SYSTEM FEATURES (partial list) Pascal MICROENGINE™ X9000

- 16 bit P-code CPU
- 64K bytes RAM/Full DMA
- Floppy disk controller (SS or DS)
- Floating point hardware (IEEE standard)
- System software with enhancements
- 2 serial, 2 parallel ports
- Pascal compiler, text editors, file manager, CPU & memory diagnostics, symbolic Pascal debugger, linker, utilities and more.

### Floppy Disk Drives (2)

- 1M combined memory
- Double density, single sided
- Standard 8" diskettes
- 6 ms track to track



## SYSTEM X9023

**\$5095\***

PLUS...

SYSTEM FEATURES (same as above)



## MODEL X-920 DISPLAY/EDIT TERMINAL (Manual \$10)

### X-920 FEATURES (partial list)

- Microprocessor controlled
- Serial RS232C and 20 ma current loop
- 10 baud rates—75 to 19,200
- 24 lines x 80 characters
- 12 x 10 character resolution
- Dual intensity display
- Programmable reverse video & underline
- 14 key numeric pad with decimal
- 16 special function keys
- 8 edit function keys
- 2 block transmission keys
- Block, protect & self-test modes
- 80 storage tabbing
- Insert/delete character and line
- Addressable cursor
- A host of other features, including cursor controls and remote commands such as: clear to nulls, spaces, end of line, end of screen; set hi, low, zero intensity; set blink, etc.

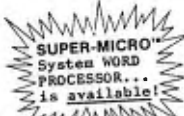

\*LIMITED TIME cash price. 10% DOWN guarantees priority. Master Charge & VISA cards accepted.

Prices: X9000 CPU \$2995. Manual \$19.95. X-920 CRT \$995. Manual \$10. Perkin-Elmer "Bantam" CRT \$799. X-800 disk drive \$495. Hardware F.O.B. Chicago. Manuals postpaid. Custom systems are also available. We service what we sell. Written hardware warranty. Nationwide service contracts. Custom software. We provide expert technical support.

(312) 684-3183

**COMPUTEX**  
Microcomputer Systems  
"The Computer Experts"  
5710 Drexel, Chicago, IL 60637

two empty squares, since the opponent can immediately reverse the piece; and it is good to play a piece on an edge square between two enemy pieces when they are separated by one empty square because the opponent cannot reverse the piece. Although these strategic ideas are quite rudimentary from the perspective of an experienced competitor, we were encouraged by the speed and ease with which our subjects learned them. After only a few games they had completely altered their initial strategy and were playing much more skillfully.

### A Simple Othello Strategy

In order to examine the importance of these ideas, we set up an interesting demonstration. A simple algorithm was designed which selected Othello moves based only on the location of the squares. This algorithm was pitted in a game against Tim Quinlan's program, which employs a "flip-the-most-pieces" strategy. Our algorithm was based on a square-priority scheme in which each square is assigned a priority number. A sequential search is made, in which the squares are visited in order of their priorities and a determination is made to see if a piece can be legally played on that square. The first square considered which permits a legal move is selected. Our choice of priority assignments was based on the strategic ideas developed by our subjects. These assignments are summarized in figure 1.

When implemented appropriately in a BASIC program, this algorithm selected moves on the TRS-80 in about one-fifth the time of Tim

Quinlan's program and easily defeated it by the lopsided score of 57 to 7. This demonstration provided convincing evidence that territorial considerations are of much more consequence in Othello than immediate material gain.

To implement our algorithm, it was necessary to solve two additional problems. How should the machine represent the current status of the playing board? How should it determine move-legality? After a lot of thinking, we developed a simple solution for each of these questions.

To represent the current status of the board we borrowed a technique commonly employed in computer chess. A one-hundred-item array was utilized to represent the sixty-four squares on the board and thirty-six imaginary squares which border the board. The array was arranged in the manner depicted in figure 2. This arrangement creates consistent algebraic relationships among the squares. For example, the number of the square to the right of square A is always the value of square A plus 1. The square above is always A plus 10. By inspection you will note that consistent numerical relationships exist for movement in all eight directions.

To represent the pieces on the board, the following convention was used. An empty square was labeled as a 0. A square off the board was a 9. A square controlled by the machine was a 1 and an opponent's square was a 2. The starting configuration for Othello is depicted by the array values presented in figure 2. As the game proceeds and pieces are placed, values of 1 and 2 are substituted ap-

**Listing 1: Algorithm for determining whether a piece can be legally placed on a square. See text for an explanation of the notation.**

```

100 DIM B(99), O(7), F(20)
110 N=0
120 IF B(I) <> 0 THEN 250
130 FOR J = 0 TO 7
140 K = I + O(J)
150 IF B(K) <> 2 THEN 230
160 K = K + O(J)
170 IF B(K) = 2 THEN 160
180 IF B(K) <> 1 THEN 230
190 K = K - O(J)
200 IF K = I THEN 230
210 N = N + 1: F(N) = K
220 GO TO 190
230 NEXT J
240 IF N > 0 THEN 260
250 PRINT "NO MOVE POSSIBLE.": STOP
260 PRINT "LEGAL MOVE WHICH FLIPS": N; "PIECES.": STOP
    
```

(Set the flip count to 0.)  
(Is the square empty?)  
(Select a direction.)  
(Move one square over.)  
(Opponent's square?)  
(Check for a row of opponent's pieces.)  
  
(My piece on the end?)  
(Back-track.)  
  
(Record flip square.)

# Chief Relief

For years many small business system buyers thought that in order to get "real" performance and enough storage to be a "real" business system they would have to sacrifice the family jewels.

But with the introduction of the Smoke Signal Chieftain series office computers a lot of people's minds have been changed.

Because we designed the highly reliable Chieftain small business system with the most innovative combination of performance and efficiency around.

At your fingertips there are 64,000 characters of random access memory and you can address anywhere from 740,000 characters to 2 million characters with Smoke Signal's new double density controller. For larger concerns, there's a 20M byte hard disk available.

At a time when other small computer manufacturers tell you "you're on your own", Smoke Signal offers an abundance of easy-to-use software programs such as order entry, inventory control,

accounts receivable, invoice entry, payroll, word processing and much, much more. There's BASIC, COBOL and FORTRAN — even a multi-user BOS (Business Operating System) that allows for numerous users simultaneously.

Chieftain systems starting at under \$200.00 per month display performance on par with systems costing twice to three times as much.

So call (213) 889-9340 for your nearest authorized Smoke Signal dealer — he'll be glad to demonstrate the Chieftain's high reliability and ease of operation.



For dealers only, circle 42  
All other inquiries, circle 41

**SMOKE SIGNAL**



**BROADCASTING**

31336 Via Colinas, Westlake Village, California 91361. (213) 889-9340



B(90)=9	B(91)=9	B(92)=9	B(93)=9	B(94)=9	B(95)=9	B(96)=9	B(97)=9	B(98)=9	B(99)=9
B(80)=9	B(81)=0	B(82)=0	B(83)=0	B(84)=0	B(85)=0	B(86)=0	B(87)=0	B(88)=0	B(89)=9
B(70)=9	B(71)=0	B(72)=0	B(73)=0	B(74)=0	B(75)=0	B(76)=0	B(77)=0	B(78)=0	B(79)=9
B(60)=9	B(61)=0	B(62)=0	B(63)=0	B(64)=0	B(65)=0	B(66)=0	B(67)=0	B(68)=0	B(69)=9
B(50)=9	B(51)=0	B(52)=0	B(53)=0	B(54)=1	B(55)=2	B(56)=0	B(57)=0	B(58)=0	B(59)=9
B(40)=9	B(41)=0	B(42)=0	B(43)=0	B(44)=2	B(45)=1	B(46)=0	B(47)=0	B(48)=0	B(49)=9
B(30)=9	B(31)=0	B(32)=0	B(33)=0	B(34)=0	B(35)=0	B(36)=0	B(37)=0	B(38)=0	B(39)=9
B(20)=9	B(21)=0	B(22)=0	B(23)=0	B(24)=0	B(25)=0	B(26)=0	B(27)=0	B(28)=0	B(29)=9
B(10)=9	B(11)=0	B(12)=0	B(13)=0	B(14)=0	B(15)=0	B(16)=0	B(17)=0	B(18)=0	B(19)=9
B(0)=9	B(1)=9	B(2)=9	B(3)=9	B(4)=9	B(5)=9	B(6)=9	B(7)=9	B(8)=9	B(9)=9

Figure 2: Representation of the starting position in Othello by placing specific values in a 100-item array. The number 0 represents an empty space. The number 9 represents an imaginary square that borders the 8 by 8 playing field. The number 1 represents a square controlled by the computer and the number 2 represents a square controlled by the opponent.

propriately in the array in place of the initial values of 0.

Determining whether a piece can legally be placed on a square is straightforward. The algorithm presented in listing 1 accomplishes this goal in a reasonably efficient manner. The notation employed in this algorithm represents the following variables. The one-hundred-item B array is the playing board organized in the manner depicted in figure 2. The eight-item O array provides a set of eight offset values which are used to move in each of the eight possible directions around a square. The values are: O(0)=1, O(1)=9, O(2)=10, O(3)=11, O(4)=-1,

O(5)=-9, O(6)=-10, and O(7)=-11. The variable I represents the square being considered for move legality. The variable N counts the number of pieces (if any) which will be flipped by the move. The F array provides a list of the flip squares. The variables J and K are used to index the O and B arrays, respectively. If the various squares on the board are visited in the order prescribed by the priority values listed in figure 1 and the algorithm in listing 1 is applied to each square in sequence, selection of the first square that is legal will produce surprisingly decent Othello moves. Such a program will regularly defeat experienced children, begin-

ning adults, and many commercial computer Othello programs. A little knowledge can go a long way if it is applied appropriately.

Our success with this simple territorial strategy provided encouragement to investigate more complex human tactics. Our initial effort might challenge a beginner, but it would be no match at all for a serious player. We proceeded to learn more about human Othello and to implement these ideas in BASIC on the TRS-80. Our human subjects varied greatly in the speed with which they discovered the relative values of different areas of the playing board. One subject acquired most of the ideas summarized in figure 1 by the third game. Another subject required eight games to grasp these fundamental principles.

Once these basic territorial concepts were mastered, our subjects showed further improvement in highly individualistic ways. Each person seemed to concentrate on one or more specific ideas which had not occurred to the others. These idiosyncratic developments are probably a reflection of Othello's character. Many of the deeper strategic considerations in Othello are not particularly obvious. Several of our subjects at this stage even developed notions which were totally erroneous.

### Advanced Analysis

To continue our analysis of Othello I will concentrate on specific strategic ideas which have been acquired by experienced players. No attempt will be made to provide an exhaustive analysis of the game. Instead, several important concepts will be examined to emphasize the ways in which human decision strategies can be made compatible with relatively simple computer algorithms.

During the early and middle portion of the game, a struggle develops

## Now **MONTY™** challenges you to **SCRABBLE\***

**MONTY™'s no ordinary Scrabble\* player! He spices up his game with music and colorful graphics. And he can challenge you at any skill level- beginner to expert with tens of thousands of words. Available on disk only for Apple II, TRS-80 LEVEL II and CP/M based systems (16K required) for use with your Scrabble game. Send \$29.95 check or money order or CALL NOW Toll Free (see below) for VISA or MASTERCARD purchase. Iowa add sales tax. "MONTY™ plays Monopoly" also available.**

**Another Incredible Computer Opponent Program**



<b>"MONTY™ plays Scrabble"</b>	<b>"MONTY™ plays Monopoly"</b>
<input type="checkbox"/> Apple II disk \$29.95	<input type="checkbox"/> Apple II cassette \$24.95
<input type="checkbox"/> TRS-80 Level II disk 29.95	<input type="checkbox"/> Apple II disk 27.95
<input type="checkbox"/> CP/M 5" disk 29.95	<input type="checkbox"/> TRS-80 cassette 24.95
<input type="checkbox"/> CP/M 8" disk 29.95	<input type="checkbox"/> TRS-80 disk 27.95

**Ritam Corporation**  
P.O. Box 921  
Fairfield, Iowa 52556

\*Scrabble is a trademark of Selchow & Righter Co. Monopoly is a trademark of Parker Bros., Inc. Apple is a trademark of Apple Computer, Inc. TRS-80 is a trademark of Tandy Corp. CP/M is a trademark of Digital Research Inc. MONTY™ is not sponsored or endorsed by Selchow & Righter Co. or Parker Bros., Inc. ©Ritam Corp. 1980

Charge my  VISA  MASTERCARD Exp. Date. \_\_\_\_\_  
 Credit Card # \_\_\_\_\_ MC Bank # \_\_\_\_\_  
 Signature \_\_\_\_\_  
 Name \_\_\_\_\_  
 Address \_\_\_\_\_  
 City \_\_\_\_\_ State \_\_\_\_\_ Zip \_\_\_\_\_

ORDER NOW TOLL FREE ● 800-824-7888 ● 800-852-7777 (Calif.) ● 800-824-7919 (HI & AL) Ask for Operator 975.  
 Please note our corrected toll free number-sorry for any inconvenience.



# 9900

## New easy-to-use educational module. Your best ticket to the microprocessor world. Ideal for teaching. Yourself. Or others.

TI's new TM990/189 University Module is a stand-alone learning lab. Fully assembled and designed for maximum hands-on experience. To ease and simplify learning and teaching.

Outstanding features include powerful 16-bit microprocessor with easy-to-learn, easy-to-use minicomputer instruction set; 45-key alphanumeric keyboard and ten-digit seven-segment display for easy **assembly-language** programming; ROM-resident software including system monitor for program debug and symbolic assembler; audio cassette interface; easy-to-add EIA and TTY interface; 1K-byte RAM expandable to 2K; 4K-byte ROM and 2K-byte expansion EPROM socket; 16-bit programmable I/O controller;

user addressable LEDs, and sound indicator.

A 570-page tutorial text accompanies the module. It is a detailed guide for self-paced learning. Or the basis for a

three-hour university course. Chapters include an overview of microprocessors; programming exercises; assembly language; memory systems; I/O concepts and designs; software engineering; product development; a variety of lab experiments, and much more. Also with the module: a 300-page user's guide.

The University Module complete with tutorial text and user's guide is only \$299.00.\*

To order your University Module contact your nearest authorized TI distributor. For more information, write Texas Instruments Incorporated, P.O. Box 1443, M/S 6404, Houston, Texas 77001.

### OPTIONAL ACCESSORIES

#### TM990/189 Kit K1 \$72.00\*

An I/O expansion kit that provides the following options to TM990/189:

1. Asynchronous Communication port
2. On-board relay for audio cassette interface
3. Off-board CRU expansion

#### TM990/189 Kit K2 \$34.00\*

A RAM expansion kit that will double on-board RAM from 1K bytes to 2K bytes.

\*U.S. prices, subject to change without notice.

Circle 44 on inquiry card.

© 1980 Texas Instruments Incorporated

TEXAS INSTRUMENTS  
INCORPORATED



85577A

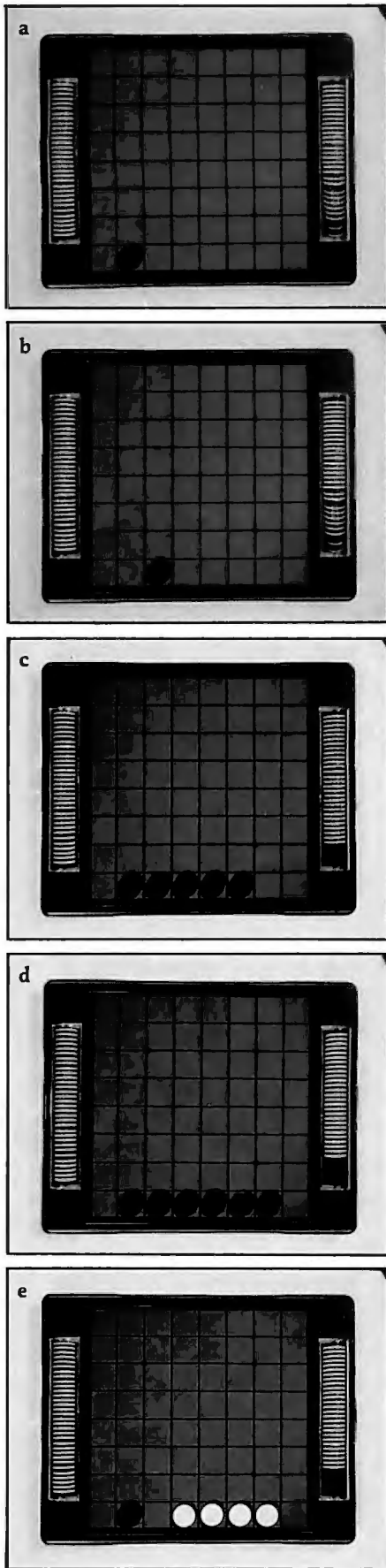

Photo 2: Specific edge configurations that have important strategic implications in Othello. See text for details.

between the two contestants for control of the edges. To win this battle, it is necessary to comprehend several significant strategic ideas. Since a reasonably adroit opponent will not willingly make moves which give you an opportunity to play to the edge, it is necessary to create situations which force your opponent to provide such opportunities. An important principle which is relevant to this goal is that you should select moves which result in an increase in the number of move options you have on future turns and decrease the number of move options available to your opponent. The greater your move options (somewhat akin to the notion of mobility in chess), the less likely it is that you will have to select an undesirable move. The fewer options your opponent has, the more likely it is that he will be forced to select an unwanted move which gives you access to the edge.

Which piece placements are most effective in reducing your opponent's options? The answer may come as a surprise. To increase your future move potential and decrease your opponent's, you should make piece placements which keep a minimum number of your men on the board (ie: flip as few as possible on each of your turns) and keep them in the middle of the board as much as is feasible (ie: try not to have your pieces on the outside of the game). Note that this advice is exactly the opposite of the strategy which was intuitively selected by each of our subjects when they initially played the game. Also note that this principle helps to explain why the "flip-the-most-pieces" strategy used by Tim Quinlan led to a lopsided defeat when his program was pitted against our simple territorial strategy.

To implement the move option concept in a computer program, a player need only keep a count of the number of pieces flipped by each move and then give preference to moves which flip the smallest number of the opponent's pieces. This idea can be combined with the territorial principle by using the number of pieces flipped as a tie-breaker among moves which are equally good from a territorial perspective. An even more sophisticated implementation would consider the location of the pieces and give preference to placements which affect pieces on the inside of the

gamefield. This latter plan is not easily implemented since the notion of *inside region* is difficult to define in terms of a brief algorithmic rule. Following a tradition begun years ago by textbook writers, I will leave the specific implementation of this idea as an exercise for the reader.

### Edge Configurations

If you are successful in forcing your opponent to make a move which gives you access to the edge, you will soon discover that you need information concerning which piece patterns on the edge are most useful for launching a successful campaign to win the corners. Experience shows that in this endeavor also, the best strategies are not necessarily the most obvious ones. In fact several key ideas are a bit devious. To gain the flavor of this aspect of the game, let us consider the five edge configurations presented in photo 2. In these photos, the machine is playing black and the opponent is playing white. Which of these positions is favorable to the machine, favorable to the opponent, or of equal advantage to both players? To convince yourself that Othello is not a trivial game, consider each position with this question in mind before reading on. See if your analysis agrees with the information which follows.

Two of the positions are good for the machine, two are very bad for the machine, and one is about equal for both players. Positions b and d are the good ones, a and c are the bad ones, and position e is equal. Since you may doubt these answers, let me explain the rationale for my classifications.

Position b is good because the machine has gained an undisputed foothold on the edge and is in a position where it may eventually force its opponent to move adjacent to the corner and thus surrender the corner to the machine. When a player has an opportunity to make the first move to an empty edge, the square two from the corner, as in position b, is the most desirable one to obtain.

Position d is favorable because the machine is in a position to permanently retain all six of the interior edge squares if it can gain control of either corner. The position does have the disadvantage of permitting the opponent to gain control of the entire edge if he is first to gain one of the

# Hard and Fast...



## ...Bulk Storage from Industrial Micro Systems

### THE NEW MODEL 16

The new Industrial Micro Systems Model 16 HardDisk Subsystem is a "fixed-removable" high speed, bulk storage device providing from 32 megabytes (32 million characters) to 96 megabytes of on-line storage for the Industrial Micro Systems 8000 or Series 5000 *microcomputer* systems. The Model 16 includes a credenza enclosure that provides a quiet, strong and attractive package for office or industrial applications where large memory is required. The Model 16 also includes a fully buffered DMA S-100 bus controller for fast and easy interfacing.

### WINCHESTER TECHNOLOGY WITH BUILT-IN BACKUP

The Model 16 includes a 16 megabyte removable cartridge and a 16, 48, or 80

megabyte fixed media that employs Winchester 3340 technology. Files and programs may be copied between the fixed media and the removable cartridge for fast, easy backup and archival storage.

### FAST ACCESS

The interface between the Model 16 hard disk and the Industrial Micro Systems computer is provided by the Hard Disk Controller. The Hard Disk Controller utilizes Direct Memory Access (DMA) for fast data transfer with minimum processor intervention. The maximum data transfer rate is 1.2 megabytes per second and the controller fully buffers the data, a sector at a time, to and from the disk. **Available in 220 V, 50 HZ Versions**



Now you don't have to look hard for fast computing power. Contact your Industrial Micro Systems Dealer today.

## INDUSTRIAL MICRO SYSTEMS

### Marketing

628 N. Eckhoff, Orange, CA 92668  
(714) 978-6966

### Manufacturing

2800 Lockheed Way, Carson City, NV 89701  
(702) 883-7611

corners and the machine cannot reply by immediately taking the remaining corner. The double-edged character of the position (no pun intended) is more apparent than real since careful play by the machine should permit it to maintain control of the edge.

The position in e is essentially even. Neither player can move to square 3 without immediately giving up a corner and subsequently the entire edge. Thus a stalemate exists in respect to play on this edge. This same conclusion would hold if black controlled two adjacent squares and white controlled three adjacent squares as long as a single empty square separated the two antagonists. Positions like e are quite common in Othello and the eventual outcome for the edge usually depends on which player is forced to play on the empty square for lack of a better move. In this respect the end game in Othello is similar to that in chess, because the person with the move sometimes wishes that it were the other player's turn.

The positions in a and c are very bad for the machine since the opponent can force the surrender of important real estate. In position a, the opponent, if he plays skillfully, can almost always win the left-hand corner. The strategy is not a simple one, and therefore it should be educational to examine it in some detail. A seemingly good move for the opponent in this situation would be to square 5. If the machine fails to defend properly, the opponent can then move to square 3 and force a win of the corner since the machine has no means of defense. If the machine replies by moving to square 4, this will flip the opponent's piece at square 3 but will leave the opponent's piece at square 5 untouched. This piece at square 5 will then serve as the necessary anchor for the capture of the corner.

The move to square 5 by the opponent is good, however, only if the machine is unable to reply by a move to either square 3 or 4. If it can, the plan misfires and the opponent gains nothing. A more sophisticated strategy can be seen if the opponent's first move is to square 6, establishing the position depicted in photo 3. The machine then has several options: make a non-edge move; move to square 3; move to square 4; or move to square 5. None of these replies can save the corner. If the machine makes

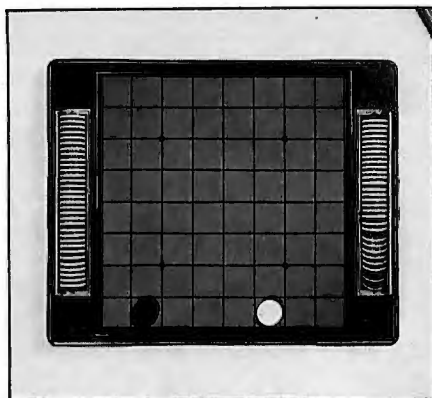

Photo 3: An edge position that leads to a forced win of the corner.

a non-edge move, the opponent responds by playing to square 4 and then eventually to square 3. There is no defense for the machine, and the corner is lost. If the machine replies to the position in photo 3 by moving to square 3, the opponent moves to square 4 and wins the corner. If the machine replies to the diagrammed position by moving to square 4, the opponent moves to square 3 and wins the corner. The last potential defense for the machine is a move to square 5. This is effective if the opponent replies by moving to square 4 and flipping the machine's piece at square 5. However, the opponent can move to square 3 instead, and this forces a win of the corner because the machine lacks an effective reply. The moral of this short presentation is that you should never move to the edge square adjacent to the corner when the edge row is empty. Such a move is tantamount to throwing the game away.

*Creative Computing* (November-December, 1977, pages 140 thru 142) presented a FORTRAN program written by Ed Wright which plays Othello using a tree-searching approach. This program seems to be unaware that the edge square adjacent to the corner is dangerous, and it will readily place a piece on this square given the opportunity. For this reason, it regularly loses to my TRS-80 even though the FORTRAN program has been implemented on the Control Data 6600. In a game that requires long-range planning like Othello, there is no substitute for essential strategic knowledge.

The edge pattern depicted in position c in photo 2 is also very bad for the machine. The disadvantage of this

pattern is that the opponent is free to make a move which offers the right-hand corner to the machine. If the machine takes the corner, however, the opponent can then move to square 7, permanently winning the left-hand corner and seven of the eight squares on that edge. If the machine does not take the corner, the opponent has gained an important tempo (ie: an additional move). In either case, this particular edge pattern turns out to be a major disadvantage when the game reaches its final stages with only a few moves remaining for each side.

Although I have discussed only a few edge patterns, an accomplished Othello player must know the significance of many. My Othello program, which plays a fairly decent game on the TRS-80, has evaluation scores for several hundred edge patterns. It would play an even stronger game if more edge information were included.

The edge-information part of the program consists of a neatly organized catalog of human knowledge. The program is given a specific score for each pattern and uses this information in making decisions about when it should or should not make an edge move. The instructions the machine receives are not that different from those one might give to a beginner, ie: this configuration gives you a slight advantage, that one is terrible, this one is about even, that one is very good for you, etc.

### Pattern Recognition

There are a number of ways for the computer to recognize and store values for specific edge patterns. A powerful technique which has been used with considerable success in chess is the bit-map idea. This strategy involves the representation of specific edge patterns in terms of particular bit configurations, and recognition occurs when an edge configuration (represented as a bit map) matches one of the configurations permanently stored in the computer's memory. In Othello, this technique would require two 8-bit words for each edge pattern, since each of the eight squares has three possible states: empty, machine control, or opponent control. If only two states were involved, a single 8-bit word could represent each pattern.



# Look what's happened to HIPLØT™



## It's grown into a complete family of quality low cost digital plotters

*Yes, they are UL listed! \*\**

In just two short years. The HIPLØT has become the most popular digital plotter among small systems users. With a record like that, what can we do for an encore? WE'VE INTRODUCED A COMPLETE LINE OF HIPLØTS...with a model suited for just about every plotting application.

The HIPLØT DMP Series is a new family of digital plotters with both "standard" and "intelligent" models available with surface areas of 8½" x 11" (DIN A4) and 11" x 17" (DIN A3). For the user needing a basic reliable plotter, we have the "old standard" DMP-2 (8½" x 11") and the "new standard" DMP-5 (11" x 17"). For those needing a little more capability, there are the DMP-3 (8½" x 11") and the DMP-6 (11" x 17")—both

microprocessor controlled and providing easy remote positioning of the X and Y axes (perfect for the OEM). For those who want this intelligence plus the convenience of front panel electronic controls, we've provided the DMP-4 (8½" x 11") and the DMP-7 (11" x 17").

The "standard" plotters come complete with an RS-232-C and a parallel interface. The "intelligent" DMP plotters accept data from either an RS-232-C or Centronics data source. For the "standard" plotters, software is available from our ever expanding "Micrographic Users Group." The "intelligent" HIPLØTs use our exclusive DM/PL™ language which minimizes plot software to a fraction of that normally as-

sociated with digital plotting.

With the new DMP Series, high quality digital plotting can now be a part of your system. It just doesn't make sense to be without this valuable tool when there is a DMP plotter with the plot size, speed and capabilities that are exactly tailored to your specific needs...and your budget.

Prices for the DMP series range from \$1,085\* to \$1,985\*. For complete information and descriptive literature, contact Houston Instrument, One Houston Square, Austin, Texas 78753. (512) 837-2820. In Europe contact Houston Instrument, Rochesterlaan 6 8240 Gistel, Belgium 059/277445. For rush literature requests and sales office information, persons outside Texas call toll free 1-800-531-5205.

**houston instrument**  
GRAPHICS DIVISION OF  
**BAUSCH & LOMB**



\*U.S. suggested retail prices only.  
\*\*DMP 2, 3 and 4 UL listed  
DMP 5, 6 and 7 UL listing pending

A second strategy is to generate information for the edge configurations on each side of a particular edge square at the time when a move to that square is being considered. Sets of  $n$  patterns for the short side and  $m$  patterns for the long side can be identified and an  $n$  by  $m$  array of values for each combination can be stored in memory. This array is consulted each time a move decision is made.

During the early and middle stages of an Othello game, skillful players are very careful to minimize the number of pieces flipped. At the end of the game, however, this strategy is no longer viable since the object of the game is to finish with more pieces than the opponent. Even at this stage, however, indiscriminately flipping as many as possible can often be disastrous. Thoughtful play requires a detailed lookahead search in which the number of pieces flipped for each side in each potential sequence of moves is carefully counted. It is not feasible to make these calculations until only a few (eg: 6 to 8) empty squares remain. The limitation on this forward search process is caused by the combinatorial explosion which

characterizes lookahead trees. The number of end positions in the tree is an exponential function of the number of empty squares. This lookahead procedure is very different from that used in chess because it is invoked only when each and every limb can be analyzed to a final position. If the calculations are made correctly, this search accurately foretells the eventual winner.

It is not difficult (at least conceptually) to create a mechanical imitation of this human lookahead process. A player can implement the same minimax algorithm which is used in chess or checkers and painstakingly examine all possible move combinations. The algorithm can be advanced considerably by using the  $\alpha$ - $\beta$  cut-off procedure in conjunction with other sophisticated searching techniques. Getting this part of the program running correctly, however, is quite a challenge. I have yet to see a textbook description of the technique which clearly presents the essential ideas. Many of the relevant publications, in fact, present the algorithm incorrectly. If you can unravel this algorithm on your

own, you will have accomplished something special.

## Conclusion

Let us summarize our major observations. Othello is a game which offers a worthwhile challenge to the personal computing enthusiast who is interested in artificial intelligence. The game can be programmed by simulating human playing strategies such as those discussed in this article. These include territorial priorities, move-option considerations, knowledge about specific edge configurations, and a lookahead search which is triggered during the last few moves of the game. Each of these ideas can be implemented in BASIC in a fairly straightforward manner on most personal computers.

Artificial intelligence is a murky uncharted sea. Many ambitious young programmers have attempted to get their feet wet by writing a chess program. In most cases, this endeavor has been a sobering experience. Those who have avoided drowning have done so at the price of many harrowing experiences in deep waters. Only a handful of these intrepid sailors have returned to port with a respectable chess program in their grasp.

If you are new to these waters and wish to avoid a punishing experience, I heartily recommend that you start with a manageable enterprise. With Othello you can gain the satisfaction of creating an impressive player while simultaneously developing valuable programming skills. If you have a Level II 16 K TRS-80, you can get a head start on this project by sending for a copy of my Othello program. With Othello you have an opportunity to create your first truly intelligent program. After all, an Othello brilliancy is almost as impressive as a chess brilliancy. ■

*My Othello program is available on cassette for the TRS-80 (Level II, 16 K) for \$12 and for the Apple (integer BASIC, 32 K) for \$16. The program has five levels of play, neat graphics, and selects a move in 30 seconds or less. Write to Peter Frey, 2407 Prospect Ave, Evanston IL 60201.*

## References

1. Maggs, P B, "Programming Strategies in the Game of Reversi," BYTE, November 1979, page 66.
2. Maurer, W D, "Alpha-Beta Pruning," BYTE, November 1979, page 84.

# SUPERPASCAL PLUS!

New Features.  
Relocatable Object Modules.  
Reduced Compile Time. AND MORE!

Meet our new, improved Pascal/Z.™ The true Z-80 compiler that's 5-10 times faster than P-code, and produces ROMable re-entrant code for true multi-tasking capability.

Our new compiler adds features like variant records, strings and random access. Also included are an improved macro-assembler that generates Microsoft-compatible relocatable object modules; a linker/loader and source on the full library. All six programs on a CP/M®-compatible disk, \$395. (Other formats and OEM licenses available.) For more information, call or write.

## InterSystems™

Ithaca Intersystems, Inc., 1650 Hanshaw Road/P.O. Box 91,  
Ithaca, NY 14850 • 607-257-0190/TWX: 510 255 4346

© 1980, Ithaca Intersystems Inc. CP/M registered trademark of Digital Research

Look to



for the ...

# BIG +

**IEEE S-100 COMPATIBLE** There's a BIG+ in every interface that QT manufactures. That's because every one of our products is an improvement over any other on the market. And every one is an S-100-based unit that meets the exacting IEEE standards. Most items in our BIG+ line are available as bare boards, a kit or a completely assembled and tested unit. What's more, we have the S-100 mainframe available for all our boards.

## EXPANDABLE + DYNAMIC MEMORY (16K to 64K)

STOCK

- + Works With Cromemco Systems
- + Bank Selectable Write Protect
- + Uses 3242 Refresh Chip
- + Phantom Output Disable
- + 4 Layers Mean A Quiet Board
- + Switch Selectable Output Disable

Bare Board \$ 49.95	32K Kit \$360.00	48K A&T \$494.95
16K Kit \$280.00	32K A&T \$419.00	64K Kit \$510.00
16K A&T \$325.00	48K Kit \$440.00	64K A&T \$569.95

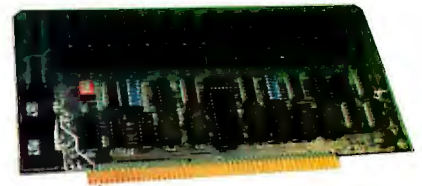

## Z + 80 CPU

AVAILABLE AUGUST

- + 1K Ram On Board + 2 Programmable Timers
- + Programmable Baud Rate Selection (110 to 9600)
- + Power On Jump to On-Board 1K or 2K EPROM (2708-2716-2732) Can be Addressed on any 1K or 2K Boundary
- + On-Board EPROM May be Used in Shadow Mode, Allowing Full 64K RAM to be Used
- + Parallel I/O Port
- + On-Board USART for Synchronous or Asynchronous RS-232 Operation (Serial I/O Port)

Bare Board \$ 45.00	A&T \$229.95
Kit \$169.95	1K Memory Kit \$ 12.00

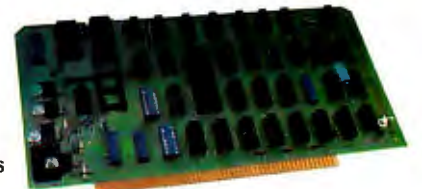

## CLOCK CALENDAR +

STOCK

- + Time of Day in Hours, Minutes and Seconds
- + Simple Read Instructions Allow Simple Interface to Basic, CPM, Etc.
- + 24 Hour Time Format
- + Will Run With 4 MHZ Processors
- + Month and Day Date Function
- + Can be Located at any Group of 4 I/O Port Addressed

Bare Board \$45.00	Kit \$99.95	A&T \$149.95
--------------------	-------------	--------------



## SILENCE + MOTHER BOARDS

STOCK

- + No Need for Termination
- + Fits in Most Mainframes
- + Very High Crosstalk Rejection
- + 6, 12 and 18 Slots Available
- + LED Power Indicator

6-SLOT		12-SLOT		18-SLOT	
Bare Board \$24.95	Bare Board \$39.95	Bare Board \$ 59.95			
Kit \$49.95	Kit \$89.95	Kit \$129.95			
A&T \$59.95	A&T \$99.95	A&T \$149.95			

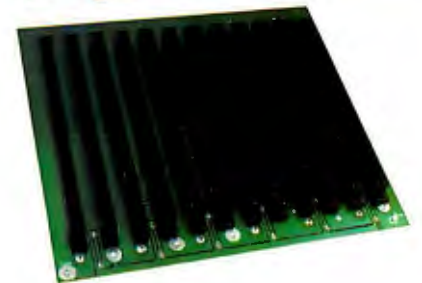

## I/O +

STOCK

- + Two Independent SYNC/ASYN Serial Ports
- + Eight Level Priority Interrupt Controller
- + One Strobed Eight Bit Parallel Input Port With Handshaking
- + Large Prototyping area has regulated +5VDC, +12VDC, -12VDC
- + Three Eight Bit Parallel Ports (Undedicated, User Configured)
- + Two software programmable baud rate generators with crystal controlled frequencies ( $\pm 0.1\%$ )
- + Three Independent Sixteen Bit Timers

Kit \$275.00	A&T \$375.00
--------------	--------------

Circle 48 on inquiry card.



**COMPUTER SYSTEMS INC.**

15335 South Hawthorne Boulevard  
Lawndale, California 90260  
(213) 970-0952,  
800/421-5150 (Continental U.S. Only)  
(Except Calif.)

## ASK FOR THE FOLLOWING NEW INTERFACES:

- Mainframe + (Stock)
- EPROM Programmer + (Oct.)
- Video + (Sept.)
- Disk Controller + (Dec.)
- Modem + (Dec.)

"QUICK & TIMELY"  
Dealer Inquiries Invited

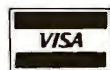

## Books as an Antidote to the CAI Blues, or Take a Publisher to Lunch

Tom Dwyer  
Project Solo  
University of Pittsburgh  
Pittsburgh PA 15260

There are a number of predictions being made about the future of computers in education. One goes something like this:

- By the year 1984 there will be millions of general-purpose microcomputers in schools, colleges, and universities, with an even greater number available for educational use in the home.

A second common—but somewhat less optimistic—statement about the future of educational computing can be paraphrased as follows:

- The potential of microcomputers for education will never be realized unless a massive effort is immediately undertaken to produce educational software and courseware.

The first prediction will undoubtedly become fact. To anyone who has been following the dramatic technological breakthroughs of the last few years, the image of millions of microcomputers in schools and homes must seem a conservative one. There is also little doubt that more



Figure 1: The Pascal Microengine is shown here in a system which includes two Shugart 8-inch disk drives in an Integrand cabinet and a Boroc IQ120 terminal. The computer uses a 16-bit processor chip and it executes p-code directly through the use of three Microengine integrated circuits on which the processor microinstructions are stored. The Microengine also includes 64 K bytes of memory, a 24-bit parallel port, and two RS-232C serial interfaces. The software provided is the UCSD extended Pascal system.

educators and parents will acquire microcomputers because of the promised educational benefits.

But what about the second prediction? Is it true that the missing ingredient in all of this is going to be educational software and courseware? Does it follow that the production of this courseware is a task of such monumental proportions that only the largest publishing corporations can manage it? Will the track record of some publishers for favoring and marketing low-level,

committee-produced texts carry over into the educational computing field? In short, will the "small is beautiful" effect that made microcomputing possible in the first place be undone by a "big means mediocre" syndrome that measures success in terms of mass acceptance at the lowest possible denominator?

Before attempting an answer to these questions, it is important to define—or at least clarify—a few terms. In educational circles, the words *software* and *courseware* refer to materials meant to help teachers use computers for instruction. The bad news is that this material often takes the form of prepackaged "teaching"

programs that ignore the built-in inventive streak found in most students. The good news is that there are refreshing exceptions to this rule, and there is a growing underground of exceptional ideas developed by teachers and students with both imagination and daring.

The purpose of this article is to elaborate on the reasons why this kind of imagination needs to be supported, and in doing so clarify both terminology and concepts. A second goal is to enlist as many readers as

# MICRODASYS MAKES IT EASY...

With the Hardware and Software products you need to do it right!

<p><b>MD-690a</b></p>  <p>The 6802/ S-100 based CPU: 1K RAM, 10K PROM space, parallel keyboard interface, 2400 baud cassette interface, PROM monitor. \$198 Kit, \$298 A&amp;T.</p>	<p><b>MD-690b</b></p>  <p>America's favorite 6809 CPU: S-100 based, 1K RAM, 10K PROM space, parallel keyboard interface, 2400 baud cassette interface, PROM monitor. \$239 Kit, \$339 A&amp;T.</p>	<p><b>The ColorMaster™</b></p> <ul style="list-style-type: none"> <li>* 80x25</li> <li>* Flashing</li> <li>* Dimming</li> <li>* Reversing</li> <li>* 8 Colors</li> <li>* Graphics</li> </ul> <p>The most powerful video and graphics board available! phantom memory-mapped 6100, programmable screen formats: 80x25, 64x32, 128x16 etc. Upper, lower case, 160x100 graphics, optional character set in PROM. Underlining, reverse field, flashing, dimming. 8 colors or black/white and gray. \$399 Kit, \$499 A&amp;T.</p>	<p><b>The Commander™</b></p> <p>* Real-time Control</p> <p>Powerful 6809 Controller Card with 1K RAM, 32K PROM space, 40 bi-directional I/O lines (20 fully buffered), serial monitor available. Only 4"x5", \$299 assembled.</p>
--	---	--	---

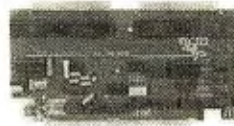
<p><b>M2D2</b></p> <ul style="list-style-type: none"> <li>* Memory-Mapped</li> <li>* Double Density</li> </ul> <p>Super Reliability Plus Auto Density Select: Memory-mapped phantomable S-100 disk controller for 8" single/double density drives. Multiple sector buffered to minimize disk accesses. \$299 Kit, \$399 A&amp;T.</p>	<p><b>The Super-Z™</b></p> <ul style="list-style-type: none"> <li>* Z-80A CPU</li> <li>* 64K RAM</li> <li>* PROM</li> <li>* 2 Parallel Ports</li> <li>* RS-232 Interface</li> </ul> <p>The OEM's Choice. A complete Z-80 based computer for the price of just one S-100 board. Would you believe 64K RAM, 2 parallel ports, 1 serial RS-232 port, switch selectable baud rates to 500K. PROM monitor can be phantom by CP/M*. \$795 Kit, \$995 A&amp;T. For 16K deduct \$200.</p>	<p><b>The 4P4S</b></p>  <p>New! Packed with I/O power! S-100, 4 parallel fully bi-directional ports, 4 serial RS-232 ports with handshaking, programmable baud rates to 307.2K, plus a prototyping area. Why pay more for less? \$199 Kit, \$299 A&amp;T.</p>	<p><b>The 8P2SM</b></p>  <p>An old favorite. Packed with parallel I/O -- 8 fully bi-directional ports! Plus 2 serial ports with handshaking (1 RS-232, 1 MODEM) programmable baud rates to 307.2K. S-100 based. Our 1000 users can't be wrong! \$199 Kit, \$299 A&amp;T.</p>
--	---	---	---

<p><b>MD-68K™</b></p> <p>Are you ready for the 68,000? We are! The 68K is a complete mini-computer on a board. Just add a terminal and you're up and running! In addition to the 68,000 MPU, the 68K offers 128Kx16 RAM, single &amp; double density disk controller, 8 serial RS-232 ports, 8 parallel ports, 8Kx16 PROM, and 2 programmable counter-timers. \$2395 A&amp;T.</p>	<p><b>The MiniFrame™</b></p> <p>Our fabulous 68K single board is also available in a rack mountable "mini-frame" with two 8" double density drives. The first personal mini computer is ready. Are you? \$3995 A&amp;T.</p>	<p><b>68,000 Software!</b></p> <p>Now...the powerful software tools you'll need to take advantage of the phenomenal capabilities of the 68,000! Resident and Cross Assemblers, Fast 68K-BASIC Interpreter, Concurrent Pascal Compiler, and Powerful D.O.S.</p>	<p><b>ASM68 and ASM69</b></p> <p>6800 and 6809 Cross Assemblers. Loaded with powerful features including complete option specifications, symbol table with cross references, and extensive documentation. Available as a command file for direct execution in any CP/M based system, or purchase complete FORTRAN source code for your custom application. \$99 for command file, or \$295 includes source code. Price is per assembler.</p>
---	---	--	--

**Unerase™**

Unerase means never having to say F#%!QR#. Next time you accidentally erase a CP/M file, use our new utility to recover it. UNERASE instantly restores lost files to your diskette! Buy it today or you may be sorry afterwards. \$95.

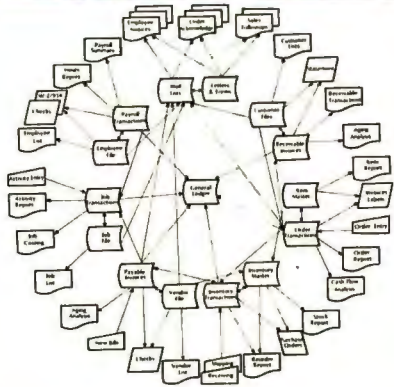

Software from **SOFTWARE™**

A division of **MicroDaSys**

**VersaSort™**

The Sort Routine You've Been Waiting For! Now you can call a powerful SORT subroutine from within a BASIC program. When it's done, it returns control to your program! Sorts records of up to 1024 bytes on 5 keys. Sorts string or numeric data. Powerful record select or delete option. FAST! Can also be executed directly under CP/M\*. \$195.

**SelectraSort™**



SelectraSort pulls selected records from vendor, customer, and mail list files on the basis of over 60 different sort criteria! Printing mailing labels and personalized form letters is a snap. The data base headings may be assigned by the user and data entry is quick and automatic. \$195.

**MicroMed and MicroDent™**

There's a doctor in the software! Now's a complete medical billing and patient management system designed for the serious doctor or dentist. Regular and insurance billing. New forms may easily be added at any time. Complete mail list and patient record modules. Forms included. \$195.

**Receivables, Payables, Payroll, Ledger, Inventory, Order-Entry**

How often have you purchased software only to be disappointed by its features or frustrated by the inability of the different programs to work together? If your accounting, word processing, inventory, order entry and mail list systems don't all work together, then you need our software. Our products offer the perfect blend of performance, price and flexibility. Although each package can operate as a stand alone module, all programs interact with common files. Every single transaction feeds your master records. You'll be amazed at how much better you'll understand the cash flow of your business. And better understanding means better planning -- and higher profits for you! Check out our software today and you'll agree. Can you afford not to use the very best? \$195 each.

Software customization and consulting available. Call for quote.

- Accounts Payable
- Accounts Receivable
- General Ledger
- Payroll with Cost Accounting
- Order-Right™
- Inventory

Call or Write now for the solution to your software needs!

All software is available on 5 1/4" IBM soft-sectored diskettes and most 5 1/4" formats. Please specify when ordering. Lucrative sales opportunities available.

**How To Order:**

By Phone: Call (213) 731-0876 for VISA, MC and COD.  
By Mail: Send check or money order.

**MicroDaSys**

P.O.Box 36275, Los Angeles, CA 90036 TWX: 910-321-2378

## Books, Learning, and Machines: The Case of the Pascal Microengine

Solo-mode learning, whether it is connected with flight in an aircraft or with analogous explorations of the mind, can be a risky business. There is more chance of failure than in a dual-mode situation, especially when the solo exploration tries something brand new. This same principle holds when it comes to buying a microcomputer. It's usually very risky to be the first one on your block to own the latest computing marvel, no matter how enticing the specifications. It's for this reason that newcomers should select a machine that's been out for some time and for which lots of dual-mode hand-holding and support are available.

About a year ago I decided to ignore this advice and became the first one on my block to own a Pascal Microengine. And as ex-

pected, there were problems with both hardware and software. But the one problem that did not materialize was lack of vendor support. The manufacturer, Western Digital Corporation, bent over backwards to work with the group that had decided to buy the first models off the line. The effect was like having a long-distance community of learners sharing ideas, frustrations, and (happily enough) eventual fixes.

The reason for relating this story is that, overall, I would rate my first year with the Pascal Microengine as one of the best learning experiences I have ever had. The key factors that made this learning possible were:

- an ingenious idea embedded in the form of a manipulatable "thing" (the Microengine itself)
- people willing to share ideas and think problems through
- the availability of books (par-

ticularly those derived from the Pascal software project at UCSD, including the Pascal Microengine Reference Manual and the new Ken Bowles book, *Beginner's Guide to the UCSD Pascal System*).

The postscript to all of this is that the Microengine now seems to have entered the domain of "solid citizen" computers, and new owners will miss all the fun we "pioneers" had! Of course this is as it should be for most purchasers of computers. But I think the correspondence between learning and personally elected struggle brought out by this example is an important one. The real challenge to educators is to find ways of embedding analogous solo experiences within more normal classroom activities. I believe that the triad "computers + people + books" will be the real key to making this happen. ■

possible in an informal lobby group that will help publishers recognize the need for building on such imaginative ideas. The tools I will suggest for conducting this lobby will range from the luncheon-type contact suggested by the title to direct involvement as both contributors and critics to the world of publishing.

Before explaining how you can sign up for this "tilt with city hall" (or whatever the analogous term is in the world of educational publishing), let me explain why it's important to use the word *publish* in its old-fashioned sense of "print on paper," and not muddy the waters by adding the complexities of *electronic publishing* to those of computer-enhanced learning.

### Computers, Publishing, and Learning

The word *publishing* has taken on an enlarged meaning in recent years. In particular, the term electronic publishing now includes such things as radio and television, special services based on data-based retrieval systems, and digitally encoded data-communication networks. The recent interest in piggybacking home data-retrieval services on cable television systems stems from a belief that future fortunes are to be made in this

market. Significantly, a number of newspaper publishers and other media giants are prime investors in these developments.

The term electronic publishing is also applied to the production, distribution, and sale of computer software. Again, many publishing houses that now deal in conventional media, principally book publishers, are asking if tapes and disks are the wave of the future. This question seems to be on the minds of educational publishers in particular. Publishers are also reevaluating the future of their traditional products: books, journals, and magazines. They are asking what place these will hold in the computer age, particularly in computer-based instruction and/or learning systems.

To anyone reading this journal, the answer should be obvious: the print medium is indispensable. For anyone who has compared the information in a set of good books to that available on even the fanciest computerized information-retrieval system, the winner is crystal clear. Printed media—including the use of good graphics—represent the pinnacle of a sophisticated heritage that has taken centuries to perfect. The nuances of style developed over the years are

considerable. Style is a difficult concept to define, but its importance in even such prosaic areas as technical documentation has long been recognized. Today, more than ever, paper and ink are the best, and often only, means for providing that documentation. There is a digestibility and mental maneuverability associated with the printed media that is just what the thinking and learning person needs.

It is important to point out that my unabashed enthusiasm for good books and journals does *not* imply a rejection of newer media. Ours is not an exclusive-OR world; one must be careful to avoid the fallacy "if X is good, Y must be bad." It is also important to remember that these enthusiasms apply to the cream of the crop in publishing; certainly, all is not cream. I have already implied that much school publishing today is mediocre. In particular, the pabulum-like content of contemporary "back to basics" textbooks is being recognized more and more as an insult to the intellects of both students and teachers.

This situation may be beyond redemption for conventional subjects. Right now, the realistic question to ask is whether we can prevent

# MULTI-USER MULTI-TASKING MULTI-PROCESSOR

## ibs Betasystem II



### THE FINEST OPERATING SOFTWARE AVAILABLE ON A MICRO

- The enormously popular UCSD PASCAL™ extended by IBS to allow up to 8 simultaneous and independent timeshared users, including
  - powerful screen oriented text editor
  - PASCAL and BASIC compilers
  - file handling system with interlocks for multiple access files
  - segmentation and precompiled "units" facilities
  - easily reconfigurable I/O unit assignment
- CP/M™ and MP/M™ available
- Multiple independent Z-80 processors for up to 10 users. Each processor card has 64K RAM, Z-80 processor, 2 serial, 2 parallel ports, optional hardware floating point (available July, 1980)
- Wide variety of applications software including medical office, retail point-of-sale, and general accounting and taxes

### WIDE RANGE OF CONFIGURATION OPTIONS

- 2 to 4 Micropolis™ 5.25" floppy drives for 1.2 Mbyte storage
- 11 to 40 Mbyte 8" winchester drives
- 17 Mbyte cartridge or 110 Mbyte video tape backup
- Up to 400kbyte RAM, 336k configurable as super-fast "RAM DISK"
- I/O cards (each with 4 bidirectional fully buffered parallel ports with hardware stobe generation and 4 software-selectable baud rate serial ports) to drive virtually ANY combination of peripherals
- Low price — floppy systems from \$4,695.00

### THE SINGLE HANDSOME DESKTOP ENCLOSURE WITH ALL THE FEATURES YOU'VE DREAMED OF

- 12 slot S-100 fully terminated bus, giving the versatility of components from many different manufacturers
- 4 Mhz Z-80 processor for high throughput and extended software compatibility
- Dual Whisperfan cooling and optimal heat-sinking for maximum reliability and long life.
- High capacity power supply adequate for all system configurations and upgrades
- Chassis designed for easy interchange of mass storage media
- On-off-reset switch protects against inadvertent reset or unauthorized access
- Furniture quality cabinet

INDEPENDENT BUSINESS SYSTEMS INC 5476 Cleo Ct., Livermore, CA 94550 (415) 443-3131  
 TYPE III, 3021 Germantown Pike, Fairview Village, PA (215) 539-0122  
 Distributors: ELIF, 725 DeCarle, Suite 304, Saint-Laurent, Canada; H4L3L4 (514) 747-4751  
 EEI, P.O. Box 5088, Sharjah, U.A.E. Tel: 354688, Telex: 68188 EEI SH

UCSD PASCAL is a trademark of the Regents of the University of California.  
 CP/M and MP/M are trademarks of Digital Research, Inc.

DEALER INQUIRIES INVITED

Circle 50 on inquiry card.

the same mindless spirit from taking over computer-related publication. The answer we can just as realistically offer is, "yes indeed"—provided that the growing body of knowledgeable users of microcomputers employ the leverage of their expertise and common sense to point educators and publishers in the right direction.

Let me start by showing that you already know far more about the subject of computers and learning than many of the so-called experts. In particular, allow me to demonstrate that even if you think the letters CAI stand for a secret government

organization, you may still be the person to set educators and publishers straight on what the letters *should* mean.

### What Is CAI and Why Is It Confusing the Issue?

It has been noted elsewhere (see for example the interview with Don Knuth in the January 1980 issue of *Creative Computing*) that new users of microcomputers are spending much time reinventing the wheel of computer science. This isn't really all that bad a thing; what is to be deplored more is the situation in

which newcomers spend most of their time reinventing and *perpetuating* the mistakes of the past.

Judging from the questions asked by educators and publishers, many of the pre-microcomputer errors in educational computing are also being reinvented and perpetuated. There seems to be a built-in trap in the phrase computer-aided instruction (CAI) that leads even the best-intentioned educators astray.

The errors in the CAI trap are derived from a doubly false logic that assumes (1) what we now call *instruction* is the best way to promote human learning, and (2) the role of technology is to automate this instructional process so that it becomes cost-effective, mechanically reproducible, and "teacher-proof."

The fallacy of this view has long been noted in other applications of computers. The pioneer George Forsythe reminded his colleagues of the dead end that such thinking represented in numerical analysis by comparing the invention of computers to airplanes. He noted that viewing a computer as a new and super-efficient way to do the same *kinds* of things that were once done with pencil and paper is like viewing an airplane as a faster version of the bicycle. True, you *could* taxi a Lear jet down many of the roads used by bicyclists, but—well, the point is obvious. Yet, all too many educators and publishers are blithely pedaling their newfound microcomputer marvels down the same old paths of drill and practice, multiple-choice tutoring, and other equally uninspired dead ends.

What then is the new kind of thinking we need if the real potential of computers in learning is to get off the ground? There are many good answers to this question; in fact, one of the best answers is *diversity*. Just as a uniform formula for using the power of the printing press would have killed all of its potential, so too will a uniform use of computers as Skinnerian teaching machines—even when it is disguised with such sleight-of-hand phrases as "customized adaptive branching" or "learner-initiated information retrieval"—destroy the power of computing for learning.

Diversity does not mean vagueness; it is a principle that invites a continual uncovering of the unknowns in computer-enhanced



## Avoid the hassle by upgrading your LA36 for 1200 baud operation with a DS120 Terminal Controller.

The Datasouth DS120 gives your DECwriter® II the high speed printing and versatile performance features of the DECwriter® III at only a fraction of the cost. The DS120 is a plug compatible replacement for your LA36 logic board which can be installed in minutes. Standard features include:

- 165 cps bidirectional printing
- Horizontal & Vertical Tabs
- Page Length Selection
- 110-4800 baud operation
- 1000 character print buffer
- X-on, X-off protocol
- Self Test
- RS232 interface
- 20 mA Current Loop interface
- Top of Form
- Adjustable Margins
- Double wide characters
- Parity selection
- Optional APL character set

Over 4000 DS120 units are now being used by customers ranging from the Fortune 500 to personal computing enthusiasts. In numerous installations, entire networks of terminals have been upgraded to take advantage of today's higher speed data communications services. LSI

microprocessor electronics and strict quality control ensure dependable performance for years to come. When service is required, we will respond promptly and effectively.

Best of all, we can deliver immediately through our nationwide network of distributors. Just give us a call for all the details.

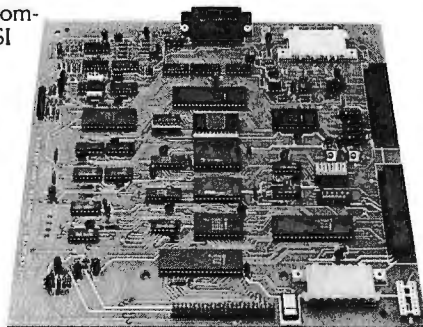

## DATASOUTH COMPUTER CORPORATION

4740 Dwight Evans Road • Charlotte, North Carolina 28210 • 704/523-8500



# QUALITY

## THAT'S WHAT SEPARATES THIS PRINTER FROM THE TOYS



## MICROTEK MT-80

SOLID VALUE FOR YOUR DOLLAR

The market is flooded with low-cost printers that look and last more like toys.

The Microtek MT-80, our versatile alphanumeric line printer, has a high quality print mechanism that gives you solid value for your dollar. It has been designed with a superior brain resulting in more advanced features and more dependable performance. Our printer is so reliable that we offer you an incredible 365 days warranty.

We stand behind every printer we make because we build quality into each one. So stop tinkering with toys and get serious. Demand 100% value by specifying the MT-80.

### OUR UNIT PRICE

\$795 Parallel

\$895 Serial (RS-232C)

### LOADED WITH INNOVATIONS

- 40, 80 or 120 columns (software selectable)
- Non-thermal paper, pin feed
- 125 CPS, 70 lines per minute
- 9 x 7 dot matrix
- Vertical format unit
- 96-character ASCII (upper and lower case)
- Adjustable forms width to 9½"
- Parallel and serial (RS-232C) interfaces available

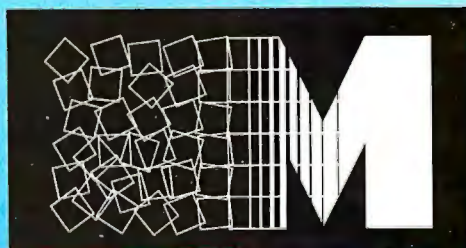

**MICROTEK**inc.

For more information contact:

MICROTEK, Inc.,  
9514 Chesapeake Drive,  
San Diego, CA 92123  
Tel.(714)278-0633  
TWX 910-335-1269

learning. The danger of a uniform view of CAI is that it (like the other "big brother" uses of computers predicted for 1984) will make computer control of learners the accepted norm. Diversity insists that the norm should be learner control of computing.

Let me illustrate why diversity in educational computing is centrally important by introducing some of the terminology developed by Project Solo. This project started in pre-micro days (1969) with the goal of finding out what teachers and students could do when they, not the authors of CAI programs, were in charge of computing. The terminology of *solo* versus *dual* that was developed to explain this goal seems more appropriate than ever for the 80s.

### Solo versus Dual Learning

One reason why the term CAI causes confusion is that it has no useful definition. The words are clear enough, but the interpretation of what it means to assist instruction depends entirely on one's view of *instruction*. To help people see the range of possibilities, I have found

that examples drawn from adult experiences with learning are best. Here are three that illustrate some of the nuances that underlie words like *instruction* and *learning*.

The first example, which also explains our use of the word *solo*, has to do with flight instruction, where a distinction is made between *dual* and *solo* mode training. *Dual* mode involves an instructor; much of it is authoritarian. The student must use a certificated aircraft, must obey air traffic control, must use the right airspeed to optimize climb, and so on. However, he knows that he is moving to a *solo* flight where he can succeed only if he develops his own models of how to use all this past experience. The student alone can build the *right* model for solving a given problem (eg: making a landing). The instructor knows how to land an airplane in the sense that he can do it; he can also theorize about how he does it. But he will never know much about the student's internalization of this information. So the instructor's primary task is really not to tell the student how to land the aircraft, but to help the student build his own

model of the process.

A second example—really a group of examples—comes from the problem of communicating with students who must clearly use a mode of learning different from that of the instructor. For example, the importance of helping students build their own models of the world comes home in a striking way when one observes experienced teachers of blind children at work. These teachers know that the manner in which the children *see* the world will forever be a mystery to the instructor. Such instructors become educators only when they respect this mystery, and organize their instruction accordingly. As one teacher put it, "You don't help them do it—you help them do it for themselves." I submit that adding the sense of sight does not change the essential rightness of education based on this important distinction.

The third example is a much more familiar one. Imagine that you have just arrived at an airport in a strange city, and now need to reach your final destination by way of unfamiliar roads. One possibility is to take a taxi. This option is direct and efficient, and it can have the bonus of being a personalized tour along a tried and proven route. It has all the potential for being a first-rate educational experience. Yet it is not likely that upon arrival you could pass a test asking for an accurate description of the route just taken. Your individualized treatment will have gotten you to your destination, but you will still be a stranger to the territory. The ingredients for a true adventure were missing.

Consider another option. Suppose that you rent a car and drive yourself. The simple act of moving into the driver's seat will have a profound effect upon the hundreds of interactions about to take place as you move into the role of problem solver, becoming an adventuresome and necessarily creative learner. This option comes at a price, of course. There will be the need to find and negotiate for a car, ask directions, study a map, and choose between alternatives. There are also likely to be mistakes—*inefficiencies* by some standards. Landmarks missed or instructions misunderstood will mean backtracking and revised planning. Questions will have to be asked and time lost. And the cost of having exclusive use

## ARTIFICIAL INTELLIGENCE For Your C/PM® or S-100 SYSTEM

"SHIVA®" is a highly-sophisticated VIRTUAL-PERSONALITY® multi-level multi-user multi-tasking executive (operating system) for S-100 based systems. It provides your microcomputer system immediately with power comparable to that of large-frame maxi-computers for a remarkably small price, yet SHIVA® requires surprisingly little R.A.M. area, and is conversational!!! SHIVA's® English-like input/output is interactive, dynamic, and may be reconfigured or expanded by the user. And SHIVA® gives you the freedom to expand indefinitely... with tremendous hardware and software choice: SHIVA® supports hard disks and floppies... R.A.M. addressing beyond 64 kilobytes... time-sharing... multi-level user-reconfigurable password protection... and features shell-commands similar to UNIX® in structure!! SHIVA® is compatible with C/PM® and C/DOS® for easy implementation and near universal software support!!! SHIVA® is available for 8080, 8085, MC6800, 6502, and Z80®-based systems.

Versions are in development for ZILOG Z8000® 16-BIT, INTEL 8086® and INTEL 88002® 32-BIT PROCESSORS...

And Omega Research® is dedicated to non-obsolescence and system superiority in software choice... SHIVA® supports BASIC, FORTRAN, COBOL, a MACRO-ASSEMBLER, DATA BASE MANAGEMENT, ALGOL-60, PASCAL... interfaces in development for UNIX®, C, LISP, PL/I, APL, and RT-II®.

And needless to say, SHIVA® is very fast...

SHIVA®... \$350 --- Available on 8" I.B.M. Soft-Sector Disk and 5" C/DOS® (Cromemco) Diskettes. Includes complete Documentation... M.C. & Visa orders accepted

"SHIVA", "VIRTUAL-PERSONALITY", and "OMEGA RESEARCH" are trademarks of OMEGA RESEARCH.  
 "RT-11" is a trademark of DIGITAL EQUIPMENT CORPORATION.  
 "UNIX" is a trademark of BELL LABORATORIES  
 "C/P/M" is a trademark of DIGITAL RESEARCH OF CALIFORNIA  
 "C/DOS" is a trademark of CROMEMCO, Inc.  
 "Z-80" and "Z-8000" are trademarks of ZILOG, Inc.  
 "INTEL" is a trademark of INTEL CORPORATION

No shipments prior to return of signed software license agreement. For detailed information on "SHIVA®," send \$1.00 postage and handling to:



CALIFORNIA RESIDENTS ADD 6% SALES TAX



**OMEGA RESEARCH**

P.O. Box 479  
 Linden, Ca. 95236  
 (209) 334-6666

9am to 5pm Mon.-Fri.

# The new microcomputer FORTRAN you'll be proud to take anywhere.

Microcomputer users like you want the best of all worlds. A single development and run-time system that can support FORTRAN on hundreds of thousands of systems... a standard FORTRAN that is available immediately for whatever micro you have... plus the power, portability and completeness of the UCSD™ System. Impossible? It was until now. Until SofTech Microsystems introduced FORTRAN-77, a major extension to the UCSD System.

market your applications to the broadest range of microcomputers possible.

Since UCSD Pascal and our new FORTRAN-77 are fully compatible, you can write applications that use the advantages of each language. For instance, you can utilize powerful Pascal subroutines for data display and graphics and FORTRAN subroutines for numerical calculations. And, because our system is modular, you can start now with

Pascal or FORTRAN and add additional language compilers when you are ready.

## Power... ANSI-77 FORTRAN

FORTRAN-77 is the newest ANSI standard language for engineering and scientific applications, with powerful new features included

for more rapid development of reliable software. Support for structured programming and improved character types are just a few of the FORTRAN-77 features designed to increase your productivity.

And, since most FORTRAN-66 programs can be run with little or no change, you can take advantage of the FORTRAN applications programs that already exist.

## Solution... the complete UCSD System

For all the tools and support you'll ever need, order the UCSD System. Get a complete development and

runtime package that includes an operating system, screen editor, file handler, macro assemblers, linker, P-code interpreter, the language compiler of your choice, and full documentation.

Whether you run UCSD Pascal or our new FORTRAN-77 on whatever microcomputer you have, you'll join the more than 10,000 satisfied UCSD System software users worldwide.

Call or write for more information; Master Charge or Visa orders accepted.

**SOFTech**  
**MICROSYSTEMS**  
A SUBSIDIARY OF SOFTECH

9494 Black Mountain Road, San Diego, CA 92126. (714) 578-6105.

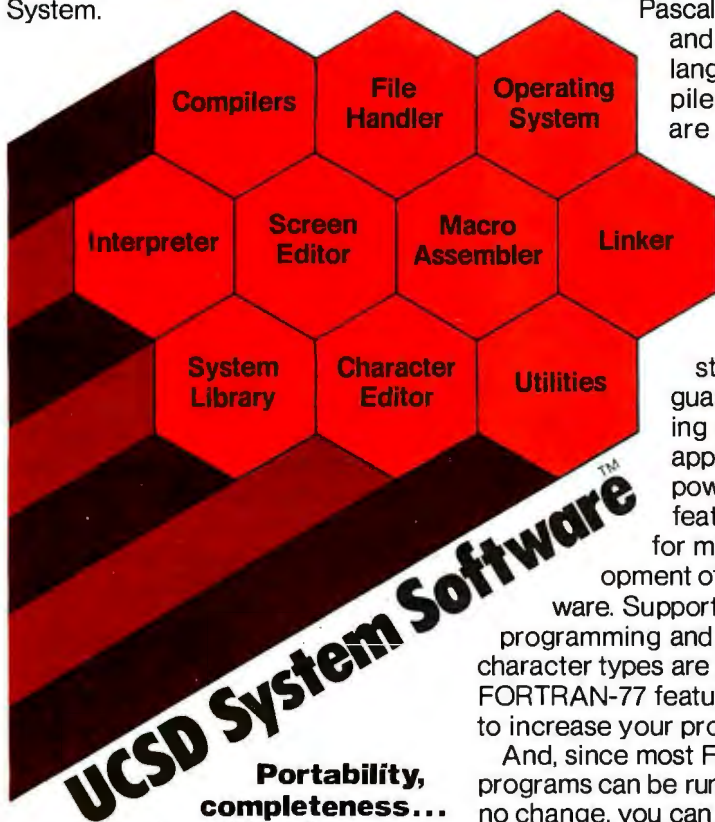

## Portability, completeness... the UCSD System

FORTRAN-77 applications are as portable as UCSD Pascal™ applications. This is because the UCSD System runs on most all major micros... giving you the freedom to choose the hardware best suited to your needs... and the ability to

You've got your choice with UCSD™ System Software. Use it on microcomputers with CP/M, or on any system using a Z-80, 8080/8085, LSI-11™ 6502, 6800, 6809, or 9900 microprocessor.

- Send me the Complete set of UCSD System documentation including the FORTRAN and Pascal languages. My check or money order for \$50 is enclosed. \$50
- Send me more information about the UCSD System with FORTRAN
- Send me more information about the UCSD System with Pascal
- Send me more information about the UCSD System with both FORTRAN and Pascal

Name \_\_\_\_\_

Company \_\_\_\_\_

Address \_\_\_\_\_

City/State/Zip \_\_\_\_\_

Telephone \_\_\_\_\_

Massachusetts and California residents add applicable sales tax. CM-17E-(5/80)

CP/M™ is a registered trademark of Digital Research Corporation. LSI-11 is a registered trademark of Digital Equipment. UCSD Pascal and UCSD are registered trademarks of The Regents of the University of California.

of a car will be higher. But in the end, the person who goes solo will have learned things about getting from A to B that are accessible in no other way.

The paradox we see from this illustration is this: the guidance of others may very well inhibit the best kinds of human learning. The conclusion it suggests is that people have far more intrinsic talent for the business of learning than they have for the business of describing it, or bringing it about in others through institutions organized expressly for that purpose. Placing students within the structure

of scientifically designed CAI programs—meant to be the electronic equivalent of scientifically designed schools—would certainly appear to be the best way of assuring that they are transported along curricula paths that visit many important educational points. The predicament faced is that for most students these are *only* visits, and dimly remembered ones at that. They never get to know the territory.

### The Connection with Publishing

The conclusion that can be drawn from these examples is that words like

education, instruction, and learning represent some of the most challenging problems ever faced by society. But as anyone who has worked in real school environments knows, the educational strategies teachers have been forced to adopt fall far short of a thoughtful solution to these problems. The mistake that is easy to make in connection with use of computers is to assume that, because microcomputers represent one of the most ingenious inventions developed by man, coupling these inventions with old instructional practices will cancel out the errors in these practices.

In particular, publishers might assume that what educators need are materials that make it easy to couple old practices with the new technology. The challenge to all of us is to say no to this; to insist on materials that bring out the ingenuity found in all learners, both young and old.

The form these materials should take is again expressed by the word "diversity." The best proof that this is the right approach is found in the new computing literature that has arisen over the past few years. Certainly not all of it can be recommended, but the quality is improving. More importantly, there is a spirit about the new writing that invites inventiveness on the part of the reader. Often this means digging and cross-digging, experimenting and reexperimenting. But even as you think black thoughts about the frustrations of not being handed simple ABC directions on a platter, you begin to realize that you have become the best kind of learner—an inventive one. (For an example of this phenomenon, see the text box entitled "Books, Learning, and Machines: The Case of the Pascal Microengine.")

The new computing literature has a second plus: it invites you to look at the more theoretical works written by scholars, especially books published by the quality textbook firms. I am continually amazed and delighted to see sets of Donald Knuth's *The Art of Computer Programming*, Volumes 1, 2, and 3 sitting on shelves next to the most elementary books on BASIC programming. I am even more delighted to see clearly written articles and books that not only prepare, but *motivate* one to read more theoretical treatises.

# Disk Memory Power Supplies

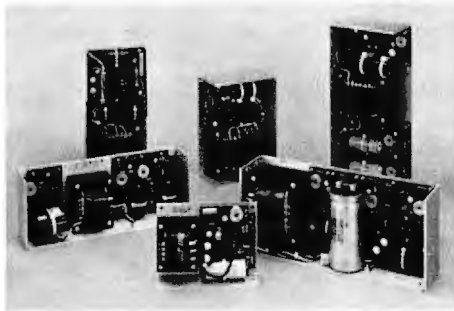

Power-One, a leading supplier to the Disk Drive industry, now offers a complete line of power supplies for FLOPPY DISK and new WINCHESTER FIXED DISK applications.

Call or Write for our New Catalog.

#### WINCHESTER FIXED DISK

SHUGART - CENTURY - MICROPOLIS are just a few drives powered by this new universal model. Powers (1) Winchester drive plus controller circuitry.

1st Output	2nd Output	3rd Output	Model	Price (1-9)
+ 5V @ .9A	- 5V or - 12V @ .8A	+ 24V @ .7A/4.5A PK	CP384	\$120.00

#### FLOPPY DISK - 5 1/4" MEDIA

BASF - SHUGART - PERTEC - SIEMENS plus all other popular 5 1/4" media drives.

1st Output	2nd Output	Model	Price (1-9)
+ 5V @ .5A/ .7A PK	+ 12V @ .9A/1.8A PK	CP340	\$ 44.95
+ 5V @ 2A	+ 12V @ 4A	CP323	\$ 74.95

CP323 powers up to (4) drives simultaneously.

#### FLOPPY DISK - 8" MEDIA

SHUGART - PERSCI - CDC - WANGCO plus many other single and multiple drive applications.

1st Output	2nd Output	3rd Output	Model	Price (1-9)
+ 5V @ 1A	- 5V @ .5A	+ 24V @ 1.5A/1.7A PK	CP205	\$ 69.95
+ 5V @ 2.5A	- 5V @ .5A	+ 24V @ 3A/3.4A PK	CP206	\$ 91.95
+ 5V @ 3A	- 5V @ .6A	+ 24V @ 5A/6A PK	CP162	\$120.00
+ 5V @ 1.7A/2.2A PK	- 5V @ .15A/ .2A PK	+ 24V @ .2A/3A PK	CP272A	\$ 91.95
+ 5V @ 2A	+ 12V @ .4A	- 12V @ .4A	HTAA-16W	\$ 49.95

CP272A powers Percsi Drives (includes unregulated 7 - 10V @ 1.2A/10A PK). HTAA-16W powers Percsi controller.

**Power-One** D.C. POWER SUPPLIES

Power One Drive • Camarillo, CA 93010 • (805) 484-2806 • TWX 910-336-1297  
Eastern Regional Headquarters • (518) 399-9200

# the ABC's of CP/M®



## NEW! CP/M HANDBOOK MAKES CP/M EASY AS ABC

CP/M—the industry standard in operating systems: now Sybex makes it easy as ABC with a new step-by-step guide: THE CP/M® HANDBOOK (with MP/M™).

Gain a clear understanding of CP/M's basic operation, learn how to use the editor and assembler, then explore all versions of CP/M, including CDOS and multi-user MP/M.

Numerous sample programs, practical operating hints and handy reference tables make the CP/M HANDBOOK a must for anyone—from beginner to experienced programmer.

For sophisticated editing or simple copying, the new CP/M HANDBOOK gives you a hand—and makes CP/M easy as ABC.

**By Rodney Zaks, 250 pp., Ref. C300, \$13.95**

CP/M® and MP/M™ are trademarks of Digital Research  
Circle 56 on inquiry card.



**Dept. B7  
2344 Sixth St.  
Berkeley, CA.  
94710**

**AVAILABLE AT BOOKSTORES  
AND COMPUTER SHOPS  
EVERYWHERE**

**TO ORDER:**

**By Phone:** (415) 848-8233, Visa, MC, Am Ex  
**By Mail:** Indicate quantity. Prepayment required  
**Shipping:** \$1.50 per book (UPS) or 75¢ (4th Class)  
**Tax:** In California please add tax

MAIL TO: SYBEX 2344 Sixth St., Berkeley, CA 94710

Send me \_\_\_ copy(s) of The CP/M Handbook @ \$13.95

Name \_\_\_\_\_

Company \_\_\_\_\_

Address \_\_\_\_\_

City \_\_\_\_\_ State \_\_\_\_\_ Zip \_\_\_\_\_

Amount enclosed \_\_\_\_\_  UPS  4th class

Charge my  Visa  Master Charge  Am. Ex.

Card number \_\_\_\_\_

Expiration date \_\_\_\_\_

Signature \_\_\_\_\_

Send me your free catalog C300B7

## Should You Become a Writer?

Most of the articles in this and similar journals are written by their readers. One of the best things that could happen to educational computing is a similar infusion of fresh thinking in the world of education.

The best advice to give to anyone harboring the idea of becoming an author is to try it, but allow time to learn your trade. I estimate that the time required to write a good book is at least two years for an experienced author. A beginner should plan on an additional few years to learn by trying different styles. Write articles for your local computer club newsletter. Then try some of the computer magazines. Write and give papers at the personal-computer conferences.

You've got to try your material on the road before going big time. And of course you must have something to say, which also takes time and experience.

Teachers have a particular advantage, provided they really *do* prepare for class, and provided they basically write a fresh set of notes each time around. Teaching exclusively from a textbook will not develop one's talents as an author. The same advice applies to those who may teach informally, whether in the home, at work, or at a club.

There are, of course, many technical questions to be considered, ranging from writing style to selection of a publisher. My advice in this latter matter is to talk to other authors.

Their experience with publishers is valuable information, and most of them are willing to share it, provided they know something about your writing. And once you've got a good manuscript ready to sell, just think: if the publisher likes it, he or she will take you to lunch. ■

*Education Forum is an occasional feature in BYTE intended to foster debate about the uses of personal computers in the schools and colleges. We encourage reader participation. Contributors should supply their full names and addresses for publication, along with their telephone numbers, which will not be published.*

# Anti-Static Dust Covers

Protect your computer and accessories.

- Anti-static vinyl helps prevent static from damaging sensitive components and causing faulty operation.
- Double-fold stitching will not rip out and is unmatched for strength and long life.
- Heavy gauge textured vinyl blends with any decor and folds easily for convenient storage.
- Over 1000 custom designs guaranteed to fit precisely.
- 100% satisfaction guarantee means we stand behind our product.

Yes, there are differences in Dust Covers. Differences which can be vitally important to the proper functioning of your system.

At Cover Craft we've manufactured the highest quality Dust Covers for the electronics industry for more than six years. We've been selected by major equipment manufacturers to make covers for their products. Our covers are in use in every state and in more than 50 countries. We know what it takes!



THE BEST  
DUST COVERS  
AT ANY PRICE

MOST PRICED  
\$7.95 to \$11.95  
PLUS POSTAGE AND  
HANDLING  
VISA-MasterCharge

So visit your dealer or contact Cover Craft for our latest catalog and list of over 200 dealers.

**C COVER CRAFT**  
P.O. BOX 555 • AMHERST, NH 03031 • (603) 889-6811

COVER CRAFT  
DUST COVERS  
ARE AVAILABLE  
FOR MOST MODELS  
MADE BY THESE  
MANUFACTURERS:

(OTHER DESIGNS ARE  
CUSTOM MADE)

ADDS  
ALTAIR  
ALTOS  
ANADIX  
ANDERSON-JACOBSON  
APPLE  
ATARI  
AXIOM  
BASIC FOUR  
BEEHIVE  
CENTRONICS  
COMMODORE  
COMPRINT  
COMPUCOLOR  
CROMEMCO  
DATA GENERAL

DATA POINT  
DECISION DATA  
DIABLO  
DIGITAL  
DYNABYTE  
EXIDY  
GENERAL ELECTRIC  
HAZELTINE  
HEATH  
HEWLETT-PACKARD  
HONEYWELL  
IBM  
INDUSTRIAL MICRO SYSTEMS  
IMSAI  
INFOTON  
INTEGRAL DATA

INTERTEC  
LEAR-SIEGLER  
LEEDEX  
MICROMATION  
MICROTEK  
MICROTERM  
MICROPOLIS  
NEC  
NORTHSTAR  
OSI  
OKIDATA  
ONTEL  
PERCOM  
PERKIN-ELMER  
POLYMORPHIC  
PROCESSOR TECH.

QUME  
RADIO SHACK  
SANYO  
SPERRY-UNIVAC  
SWTP  
SOROC  
TEKTRONIX  
TELETYPE  
TELEVIDEO  
TEI  
TELRAY  
TEXAS INSTRUMENTS  
TRENDCOM  
VECTOR GRAPHIC  
WANG



Please send your free software catalog.

(Check which software is of particular interest)

C COMPILER. Optimized native code for VAX 11/780, PDP-11, LSI-11, Z80, 8085, 8080. Full C language as defined in Kernighan and Ritchie, with comprehensive portable library. Cross compilers available. Runs under VMS, IAS, RSX-11D, RSX-11M, RSTS/E, RT-11, UNIX, Idris, CDOS, CP/M. From \$600

IDRIS OPERATING SYSTEM. System calls and file system identical to UNIX V6, including pipelines. Utilities include shell, editor, assembler, loader, archiver, compare, copy, grep, etc., plus system utilities for file system maintenance. Runs on LSI-11, PDP-11. From \$1000.

PASCAL COMPILER. Optimized native code for VAX 11/780, PDP-11, LSI-11, Z80, 8085, 8080. Full Pascal language as defined in Jensen and Wirth, with standard library. Includes C compiler and portable library, permitting intermixed C and Pascal. Cross compilers available. Runs under VMS, IAS, RSX-11D, RSX-11M, RSTS/E, RT-11, UNIX, Idris, CDOS, CP/M. From \$750.

Idris is a trademark of Whitesmiths Ltd.  
UNIX is a trademark of Bell Laboratories.  
CP/M is a trademark of Digital Research Co.

VMS, RSX-11, RT-11, RSTS/E, VAX,  
PDP-11, LSI-11 are trademarks of Digital  
Equipment Corporation.

Name \_\_\_\_\_

Company \_\_\_\_\_

Street \_\_\_\_\_

City \_\_\_\_\_ State \_\_\_\_\_ Zip \_\_\_\_\_

**Whitesmiths, Ltd.**  
Software for grownups.  
(212) 799-1200

P.O.B. 1132 Ansonia Station, New York, N.Y. 10023

## The Personal Computer— Last Chance for CAI?

---

Lou Frenzel  
1588 Oak Ter  
St Joseph MI 49085

---

Education is rapidly emerging as one of the most important applications of personal microcomputers. Microcomputers are showing up both in schools and in homes, and they are becoming the central focus in school courses that teach computer operation, programming, and applications. But perhaps just as important, the computer is being used as an effective tool to teach varied subjects in schools and in the home. One term

### Editor's Note:

*Computer-Aided Instruction (CAI) has come under fire over the years. Some claim that it is an unimaginative and wasteful use of computers in the classroom. Others contend that the system was maligned because of poor management on the part of those who attempted to introduce CAI systems into the schools during the 1960s, and that CAI still has potential usefulness in the educational system. Author Lou Frenzel presents the case for CAI....ed*

### About the Author

Lou Frenzel is the vice-president of Heath Company's recently formed Education and Publishing Division. Formerly a product manager, Lou conceived and helped establish Heath's personal computer product line. Previously with McGraw-Hill, Lou received his Bachelor's degree in electronics from the University of Houston and his Master's degree in education from the University of Maryland. Lou is the author of numerous books and articles on personal computing.

that has been used to describe the process of teaching by computer is *computer-aided instruction*, or CAI. CAI is a system of individualized instruction that uses a program presented by a computer as the learning medium. While computer-aided instruction is widely known and acclaimed as an effective teaching technique, it has never been extensively used nor has it lived up to its expectations. But now, thanks to the small, low-cost personal computer, CAI is getting a new lease on life. Personal computers may be what is needed to make computer-aided instruction practical.

### What Is CAI and From Where Did It Come?

Computer-aided instruction is the process by which written and visual information is presented in a logical sequence to a student by a computer. The computer serves as an audio/visual device. The student learns by reading the text material presented or by observing the graphic information displayed. The primary advantage of the computer over other audio/visual devices is the automatic interaction and feedback that the computer can provide. Multiple paths through the course material can be taken, depending upon the individual student's progress.

The concept of computer-aided instruction has existed for many years. Its origins are traceable to a machine invented by Dr Sidney Pressey in 1924 for grading multiple-choice examinations. His machine was prov-

en to be quite effective in teaching. The concept of teaching by machine was later improved and expanded by B F Skinner at Harvard University in the late 1950s.

The teaching machine is an outgrowth of the programmed-instruction concept. Programmed instruction (PI) is an approach in which material to be learned is divided into many small, logically linked sequential segments called *frames*. Each fact or concept to be learned is presented sequentially in frames. Each frame ends with a question which the pupil answers by filling in a blank or selecting the correct answer from several choices. The student reads a fact or concept and is immediately questioned. If the question is correctly answered, the student automatically proceeds to the next frame. If the answer is incorrect, the student will be told the correct answer, or in some forms of programmed instruction, will branch to a review or remedial frame before proceeding further.

Most early programmed instruction was available in printed form, but soon many special teaching machines using film were invented to present the material. Teaching machines were used in the late 1950s and mid-1960s, but never became popular or widely used because of the lack of standards and teaching materials. It was soon discovered that a computer could present programmed instruction frames with greater flexibility. In the early 1960s, programmed-instruction teaching programs were often implemented on computers.



**Not Just Another Limited Area Motion Detector!**

# guardex™

**Protects Every Square Inch Of Your Building**

**Turns On Lights Automatically**

**Powerful Electronic Siren**

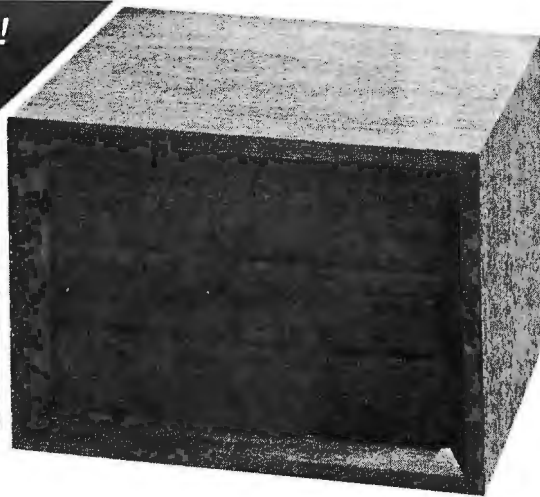

## **Low Cost Computerized Burglar Alarm System Home - Office - Business**

### **NO INSTALLATION**

Just plug the Guardex 8000 alarm system in, make two simple control adjustments to suit your particular building and it works! There are no other wires to run. This totally self-contained burglar alarm can completely seal off every square inch of the surface of your building. It protects doors, windows, and what most alarms miss... your roof, walls and floors.

### **HOW CAN ONE SMALL COMPUTER PROTECT MY WHOLE BUILDING?**

Guardex 8000 Alarm System works on the principle of audio discrimination. This, put simply, is the process of electronically separating normal everyday sounds, such as voices, telephones, etc. from break-in type noises such as breaking glass, prying metal, or forcing a door open. The Guardex 8000 protects one story homes and offices up to 2000 square feet and open commercial buildings up to 10,000 square feet. The Guardex 9300 with wireless remote sensor capability is available for multi-story homes and offices or single story with more than 2000 square feet. Call the factory for more detailed information.

### **TURNS ON LIGHTS AUTOMATICALLY**

When the first break-in type sound is detected, the system will instantly turn on lights, radio, or other electronic equipment that you have plugged into the back of the alarm. These lights or other equipment will remain on for a period of five minutes, then automatically turn off.

### **POWERFUL ELECTRONIC SIREN**

The Guardex 8000 alarm is equipped with a loud built-in siren. If during the five minute period the lights or other electronic equipment has been activated, a second break-in sound is detected, (it can be only a second or two after the first break-in sound) the built-in siren will start blasting for 90 seconds. At the end of approximately 90 seconds the siren will shut off and the alarm listens again. If another break-in sound is heard, the siren will come on for another 90 seconds. If no other break-in sound is detected, the siren will stay off and at the end of the five minute period the lights will shut off and the alarm instantly resets.

*The rear control panel contains two standard AC plug receptacles for a table lamp, spot lights, radio, etc.; terminals for connecting optional outside siren and back-up battery (not included); entry delay time control and sensitivity control*



*The Guardex 8000 Alarm System is walnut grained and disguised to look like a small stereo speaker (6<sup>3</sup>/<sub>4</sub>" x 9<sup>3</sup>/<sub>4</sub>" x 8") and weighs less than 6<sup>1</sup>/<sub>2</sub> pounds.*

### **EXIT AND ENTRY DELAY**

The Guardex 8000 alarm has a built-in exit delay allowing you approximately one minute to lock up and leave the building before the alarm is armed. When you enter your building you may find that just your normal entering sounds activate the siren. You may delay it from starting for up to 30 seconds by turning up the siren entry delay control.

### **BATTERY BACK-UP**

Burglars rarely cut power. However, to give you total protection from a burglar and possible power failure, our alarm has provisions for a battery back-up. (Batteries not included). 12 volt lantern batteries are available at most hardware stores.

### **THE BURGLARY PROBLEM**

The F.B.I. statistics show that at the present rate, one out of every four Americans are going to be burglarized. That is not a very pleasant fact, but it is true. You have a greater chance of being burglarized than being a victim of a fire or automobile accident. The time is now to help protect yourself and your valuables with a Guardex 8000 alarm system.

### **OUTSIDE SIREN**

The Guardex 8000 alarm is equipped with a loud, built-in siren, but if you desire an additional siren to mount outside or in an area away from the main alarm, they are available with 50 feet of wire for \$24.95. (Connecting terminals are provided on the back of the alarm).

### **30 DAY NO RISK TRIAL**

This is your opportunity to purchase an alarm system directly from the factory for only \$199.95. Try it in your home or business for thirty days without risking one cent. Put our Guardex 8000 alarm to your own test. See for yourself! It will protect every window and door from break-in. If you are not completely satisfied, return the alarm within 30 days for a complete refund. To order your Guardex 8000 alarm, CALL TOLL FREE to charge your credit card or send your check to Guardian Electronics, Inc. in the amount of \$199.95. If you want the optional outside siren, add \$24.94. (California residents add 6% sales tax.)

(If you require more information, call during California business hours, Monday - Friday)



Dealer Inquiries Invited

**CALL TOLL FREE**  
**(800) 423-5499**

California residents:  
**(213) 889-1414 collect.**

**GE GUARDIAN  
ELECTRONICS, INC.**

31133 Via Collinas, Dept. WW

Westlake Village, Calif. 91361

Thus computer-aided instruction was born.

Many computer-aided instruction research projects were initiated in the 1960s through government funding. Although a lot was learned about CAI, it was still considered an impractical way to teach. The size and cost of computers in the 1960s were such that few institutions or companies could afford them. Two computer companies, IBM and RCA, did an extensive amount of work in an attempt to produce commercially viable computer-aided instruction systems. Many people predicted that this would revolutionize education. Others felt that this was *the* major breakthrough in learning that everyone was waiting for. But the cost was still far beyond what most schools and companies could afford. Therefore, computer-aided instruction was not widely used, and interest waned.

In the mid and late 1960s, minicomputers inspired a spurt of interest in CAI. The technique became more practical with the lower cost of computers. While CAI techniques were more widely implemented, they still did not become a significant teaching

technique. Computer-aided instruction was not living up to its reputation and again fell into a state of limbo.

However, during the late 1960s and early 1970s, a major project called PLATO was developed. Sponsored by Control Data Corporation, funded by the National Science Foundation, and developed at the University of Illinois, PLATO is a CAI system implemented on a very large time-sharing computer. Special terminals with touch-sensitive video screens and superior graphics capability are used to communicate with the computer. A considerable amount of courseware has been developed for PLATO, and today it is probably the most successful CAI project in existence. Less well-known but just as effective is Mitre Corporation's TIC-CIT system using a Data General minicomputer and a color television set. TIC-CIT was developed during the same period as PLATO.

The newest surge of interest in CAI was sparked in 1975 by the introduction of low-cost microcomputers. The same rhetoric about CAI being the ultimate teaching technique is again

being heard. The question remains whether microcomputers will indeed make CAI practical and more widely used than ever. A partial answer is yes. Because microcomputers are small and relatively inexpensive, their use will expand. However, there is some doubt among educators whether CAI will ever become the ultimate teaching method. It is certainly not the panacea everyone expected.

### Pros and Cons

Computer-aided instruction has many advantages and disadvantages that tend to offset or cancel one another, thus making CAI the enigma that it is. Let's take an in-depth look at the good and bad points.

First, the bad news. Why is computer-aided instruction not more widely used? The answer to this question lies in several key—but not so obvious—points. First, while it has proven to be an effective teaching technique, it has never demonstrated any superiority over other teaching techniques. Computer-aided instruction is essentially self-instruction with a computer, using materials prepared for the purpose. While individuals do indeed learn from computer-aided instruction, they learn just as well from other techniques (ie: reading books, attending lectures, watching television, participating in lab experiments, etc). As a result, computer-aided instruction is no better or worse than any other teaching techniques. Its main value is as an effective technique for individual rather than group instruction. With this approach, students can learn at their own pace and convenience.

Second, most computer-aided instruction is an extremely expensive and inefficient form of programmed instruction. Programmed instruction can be presented in a very low-cost, printed-book format. On the other hand, CAI still requires an expensive computer. It seems almost ridiculous to resort to a computer for the presentation of programmed instruction when the material to be learned can be printed at a significantly lower cost. Even when low-cost microcomputers are used, it is inefficient to present material on a \$500 to \$1000 machine when a low-cost book can be used to present the same material with the learning outcome being equal.

In addition to the high cost of the

A CREATION OF COMPUTER HEADWARE

# WHATSIT?™

*(Wow! How'd All That  
Stuff get In There?)*

---

*A sophisticated, self-indexing filing system—  
flexible, infinitely useful and easy to use,  
that adapts to **your** needs.*

---

*WHATSIT comes ready to run on your Apple, NorthStar, or  
CP/M computer. See your dealer... or write or call:*

**HARDHAT**  
Software

P.O. Box 14815 • San Francisco, CA 94114 • Tel: (415) 621-2106

# PRIAM Hard Disks Now Available from SIRIUS SYSTEMS!

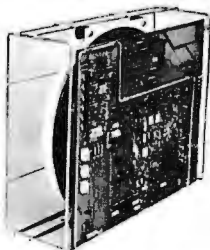

PRIAM's high-performance, low-cost Winchester disc drives speed up throughput and expand data storage from 20 megabytes to 154 megabytes. And a single controller can be used to operate 14-inch-disc drives with capacities of 33, 66, or 154 megabytes or floppy-disc-size drives holding 20 and 34 megabytes. So it's easy to move up in capacity, or reduce package size, without changing important system elements or performance.

- Fast, Linear Voice Coil Positioning
- 10 ms track-to-track positioning
- Fully servoed head positioning
- Dedicated servo tracks
- DC Power required only!
- Simple, parallel Interface
- Optional SMD Interface
- 50 ms Average Positioning time
- 90 ms Maximum Positioning Time
- 6.4 ms Average Latency

## THE PRIAM LINEUP

Model/Disc Size	Capacity	Size	Weight	Price
DISKOS 3350 (14")	33Mbytes	7" x 17" x 20"	33 lbs.	\$2995
DISKOS 6650 (14")	66 Mbytes	7" x 17" x 20"	33 lbs.	\$3749
DISKOS 15450 (14")	154 Mbytes	7" x 17" x 20"	33 lbs.	\$4695
DISKOS 2050 (8")	20 Mbytes	4.62" x 8.55" x 14.25"	20 lbs.	\$2995
DISKOS 3450 (8")	34 Mbytes	4.62" x 8.55" x 14.25"	20 lbs.	\$3745
DISKOS 570	5.3 Mbytes	floppy-size	(low)	(low)
DISKOS 1070	10.6 Mbytes	floppy-size	(low)	(low)

All PRIAM DISKOS Drives have a Transfer Rate of 1.03 Mbytes/Sec. Optional SMD interface available for \$150.

SIRIUS SYSTEMS offer cases and enclosures for all PRIAM Hard Disk Drives. All 14" Winchester Drives will mount in our 14" Standard Case. The 8" Winchester have two alternatives: a single drive case and a dual drive case. All SIRIUS SYSTEMS Winchester drive cases include Power Supply, internal cabling, switches, fan, extra AC outlet (not switched, but fused) and possess very adequate ventilation. Drive addressing is done on the rear of the Case and not on the drive itself to provide ease of use during operation. All WINCHESTER DRIVE Cases are Warranted for a full year and come in our standard blue-black color scheme. Consult us for current availability and pricing.

## Remex RFD 4000/4001 8" Floppy Disc Drives Double sided ... Double density!!

# \$549<sup>95</sup>

RFD 4001, \$569.95

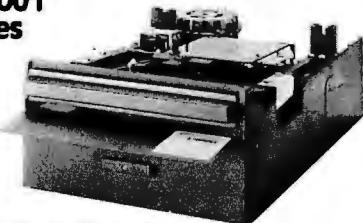

Offers quality and features found in drives costing much more! ■ Single or Double Density ■ Double-Sided Drive ■ Door Lock INCLUDED ■ Write-Protect INCLUDED ■ 180 Day Warranty ■ Compatible with Shugart 850/B51 ■ Low Power Operation ensures LONGER LIFE!! ■ Model RFD 4001 offers Data and Sector Separator

RFD 4000/4001 Technical Manual ..... 6.95  
 Connector Set #3 (AC, DC, Card Edge) ... 10.95  
 Connector Set #4 (AC and DC) ..... 2.95

RFD 4000C/B Cabinet (for use with Power Modules) ..... 29.95

## Remex 1000B ... If you've been looking for a less expensive floppy disc drive, but not wanting to sacrifice quality — this is it!

# \$419<sup>95</sup>

You get both in the Remex 1000B! For only \$419.95 look at what you get: ■ 8" Floppy Drive ■ Single or Double Density ■ Hard or Soft Sectoring ■ Media Protection Feature ■ Single Density Data Separator ■ 180 Day Factory Warranty

Door Lock Option ..... \$19.95  
 Interface Adapter (REMEX-to-Shugart) .. \$14.95

Write Protect Option ..... \$19.95  
 Connector Set #1 (AC, DC, & Card Edge) .. \$10.95

RFD 1000B Technical Manual .. \$5.95  
 RFD 1000B CASE (for use with Power Modules) ..... \$29.95

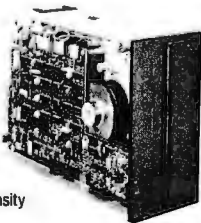

## SIRIUS 8" DISK POWER MODULES

The Single and Dual Drive Power Modules are designed to provide DC and (switched) AC power for one (the Single Drive Power Module) or two (the Dual Drive Power Module) the DDPM will power three RFD 4000s or 4001s 8" Floppy Disk Drives. Many features are included for safe and reliable operation and the Power Modules come with our stan-

dard 180 day WARRANTY (the Open Frame Power Supply warranty is for 2 years). All Power Modules will work with either the RFD 4000C/B or RFD 1000B case (color schemes match also).

Dual Drive Power Module (DDPM) ..... \$139.95  
 Single Drive Power Module (SDPM) ..... \$119.95

## SIRIUS 80+ Perfect Add-Ons for Your Computer System!

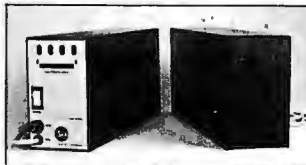

The SIRIUS SYSTEMS 80+ Series of Floppy Disk add-ons are designed to provide unmatched versatility and performance for your computer. Consisting of four different add-ons, there is a 80+ Series Floppy Disk to meet your need. All 80+ Series Floppy Disk are compatible with the TRS-80\* and come ready to plug in!

### COMMON CHARACTERISTICS

- 5 ms track-to-track access time
- Auto-eject
- 180 day WARRANTY
- Exceptional speed stability — 1%±
- Single density (FM) or double density (MFM/MFFM)
- Ultra high reliability
- 2 year Power Supply Warranty
- Mix any or all 80+ Series on the same cable!
- Includes user accessible plugboard for drive reconfiguring

### SPECIFIC CHARACTERISTICS

The SIRIUS 80+1 is a single sided, 40 track, highly reliable Floppy Disk add-on. Offering 5 more tracks than the Radio Shack model, it cost \$140 less! Formatted data storage is 102K/20K bytes single/double density.

SIRIUS 80+1 ..... \$359.95

The SIRIUS 80+2 is a dual sided, 70 track (35 per side), highly versatile Floppy Disk unit. It appears to be the TRS-80\* as TWO 35 track drives, yet COST LESS THAN HALF THE PRICE! Even greater savings result, since data is recorded on both sides of the media instead of only a single side. Using the plug board, it may be reconfigured for other computer systems! (The 80+2 operates as Drive 0 and any of the other three addresses (with the standard Radio Shack Cable) or as any of four drives (with the SS Standard Cable).) Formatted data storage is 80.6K/161.2K bytes single/double density.

SIRIUS 80+2 ..... \$449.95

The SIRIUS 80+3 is a single sided, 80 track, "Quad" density Floppy Disk unit. Offering 2 1/2 times the storage of a Standard Radio Shack drive, the 80+3 greatly reduces the need for diskettes correspondingly. Additionally, because of the increased storage and faster track-to-track access time, the 80+3 allows tremendously increased throughput for disk based programs!!! The 80+3 INCLUDES SIRIUS's TRAKS-PATCH on Diskette. Formatted data storage is 204K/40K8 bytes single/double density.

SIRIUS 80+3 ..... \$489.95

The SIRIUS 80+4 Floppy Disk add-on is a double sided, 160 track (80 per side), 5 1/4" monster! The ultimate in state-of-the-art 5 1/4" Floppy Disk technology, to 80+4 is seen by the TRS-80\* as two single sided disk drives, each with 80 tracks. Thus, in terms of capacity one 80+4 is equivalent to 4 1/2 standard Radio Shack drives — a savings of over 73% (not to mention diskettes!!!). (With a double density converter, the available memory is huge!) The 80+4 is similar to the 80+2 in that it arrives configured as Drive 0 and any of the other three addresses (with the standard Radio Shack Cable) or as any of four drives (with the SS Standard Cable). The 80+4 INCLUDES TRAKS-PATCH on Diskette. (The plug board is also included.) Formatted data storage is 408K single density or 816K bytes double density.

SIRIUS 80+4 ..... \$624.95

All 80+ Series Floppy Disk add-ons operate a 5 milliseconds track-to-track access time (eight times faster than the SA 400) but are Expansion Interface Limited to 12 milli-seconds for the TRS-80\*.

\*TRS-80© Tandy Corp.

## MPI 51/52 ... A Great Reliable Mini-Drive!

- Fast! 5ms track to track access
- Exclusive Pulley-Band Design
- Unique Door/Ejector Mechanism
- Reliable 1 1/2% Speed Stability
- Single/Double Standard Operation
- Industry/ANSI 120K Interface

MPI 51 (Single Head, 40 tracks, 120K/240K bytes Single/Double Density\*\*) ..... \$259.95

MPI 52 (Dual Head, 70 tracks, (35/side), 218.8K/437.5K Single/Double Density\*\*) ..... \$349.95

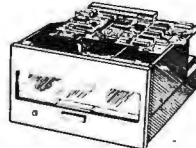

## MPI 91/92 ... NEW STATE-OF-THE-ART DISK DRIVE!

MPI 91 (Single Head, 80 tracks, 240K/480K Single/Double Density\*\*) ..... \$389.95

MPI 92 (Single Head, 160 tracks (80/side), 480K/960K Single/Double Density\*\*) ..... \$499.95

\*\*Unformatted data storage

## Introducing the Versatile, Low-Cost OMEGA Series Controller

As new technological advances bring down the cost of fast, reliable mass data storage, the need for an inexpensive, versatile controller has become greater and greater. To meet this need, SIRIUS SYSTEMS' OMEGA Series Controller was designed.

The SIRIUS OMEGA Series Controller Module utilizes an on-board microprocessor to mediate data transfer to a wide variety of peripherals from an equally wide variety of host computer systems. Up to four Winchester Hard Disks (8" or 14"), four 5 1/4" Floppy Disk Drives and/or up to eight 8" Floppy Disk Drives may be in use at one time. Host systems interfacing is accomplished via a parallel or a serial interface. With the addition of a Personality module, the OMEGA Series Controller Module is directly compatible with many popular computer systems (among them the TRS-80\*, Apple, Heath, and others). Provision is made for the addition of a streaming tape drive, also.

### SPECIFIC HARDWARE FEATURES INCLUDE:

- Control of up to 16 Floppy Disk Drives (eight 8" and/or four 5 1/4")
- 8" and/or 14" Disk Drive Utilization
- Single (FM) or Double (MFM) density data storage
- Hard or Soft sector'd diskette usage
- Utilization of "Quad" density (96 tpi) 8" or 5 1/4" Disk Drives
- Control of up to four WINCHESTER type PRIAM DISKOS Disk Drives
- 8" or 14" may intermix on the same cable
- Accommodates 8" and/or 14" drives of 5.3Mbytes to 154Mbytes
- Ultra-Fast data transfers
- Extremely flexible host-controller interfacing

### SPECIFIC SOFTWARE FEATURES INCLUDE:

- Dynamic format modifications via command words
- Extremely flexible format acceptance for unusual data storage formats
- Easily interfaces to standard operating systems (TRS-DOS\*, CP/M\*\*\*, etc)
- Operates in either get/put sector mode or data string mode
- Performance parameters may be changed by EPROM replacement or Dynamic Re-programming

Dedicated systems cards are also available on a limited basis for the STD-BUS and the S 100. These cards feature shared memory also (again, software selectable) in addition to the regular OMEGA Series Controller Module features. Consult SIRIUS SYSTEMS for current price and availability for the entire line of OMEGA Series Memory Units and Controllers. Dealer inquiries are invited.

7528 Oak Ridge Highway  
 Knoxville, Tennessee 37921

## TO ORDER CALL (615) 693-6583

Phone Orders Accepted 9AM-7PM (ESDT)

We accept MC, VISA, AE, COD (requires Certified Check, Cashier's Check or Cash) and Checks (personal checks require 14 days to clear). SHIPPING AND HANDLING: \$7.00 per Floppy Disk Drive or 80+ Module ■ 5% for other items (any excess will be refunded) ■ Foreign Orders add 10% for Shipping & Handling. Payment in U.S. currency ■ Tennessee residents add 6% Sales Tax ■ VOLUME DISCOUNTS AVAILABLE

computer itself, the programmed-instruction material to be learned must also be converted into a format suitable for presentation on the computer. This means that some programming is involved. Some special programming languages have been developed to write and present CAI (IBM's Coursewriter, Digital Equipment Corporation's DECAL, etc). With microcomputers, the BASIC and PILOT languages are widely used for this purpose. Because of the time and effort required to convert the programmed-instruction material into a computer program, the cost of preparing CAI rises considerably.

Computer-aided instruction may be the *least* efficient form of learning in terms of development time and cost. Many other techniques are just as effective and significantly lower in cost. The common textbook is the lowest cost and most efficient form of presenting material to be learned. Audio tutorial material (cassette tapes), printed visuals, and workbooks are also effective yet very inexpensive. Audio/visual materials presented by slides, filmstrips, and audio cassettes are far less expensive.

Video material produced for video cassettes or disks is expensive to develop and is probably equivalent in cost to CAI. With video materials, development costs are high and relatively expensive video-tape players are required to present the material. The situation is not unlike computer-aided instruction. However, the video format offers a tremendous advantage over material presented on a computer. Computer presentation is limited primarily to text and simple graphical information. In video productions, virtually any form of presentation can be made. Certainly video with its color, sound, and variety offers improved presentation of material and better learning. Video materials are more effective at the same cost as computer-aided instruction. The new random-access video disk gives video the same interactive and feedback capability as a computer.

A third reason why computer-aided instruction has never become extremely popular is that author sources are severely limited. Producing the "courseware" for a computerized presentation requires a

subject-matter specialist who is totally familiar with the material to be presented. This individual must also be familiar with programmed-instruction techniques (ie: breaking the material down into the small frames of logically sequenced information). Finally, the author of the courseware must be able to adapt the material to the computer by programming it in one of the available computer languages. There are very few individuals who have this combination of skills and capabilities. With limited author sources, few good course programs have become available. What computer-aided instruction is available is only fair to poor, and most of it is too simple.

However, this problem is *not* insurmountable. It is relatively easy to take subject-matter experts and teach them concepts of programmed instruction and programming languages. But, this has not been done. One of the greatest needs and opportunities existing today is to develop materials that will teach individuals how to write learning programs.

Another reason for the lack of widespread use of computer-aided instruction techniques is distribution. Most computer-aided instruction programs have been developed by interested individuals for their own specific computers. As a result, standardized materials have never become commercially available.

While a lot of computer-aided instruction has been developed, most of it is very specialized. Also, since most of it is buried in many hundreds of university computers, it is almost impossible to get at. There has never been any serious attempt to collect significant amounts of this material and disseminate it on a large-scale basis. In other words, there has never been a computer-aided instruction publisher as such. It appears practical and realistic as a business opportunity, yet locating the sources of courseware and providing that courseware in a wide variety of computer formats makes the task difficult.

Compounding the situation is the lack of standards. A program developed on one computer typically cannot run on another. Because of the wide differences in computer hardware, software, and peripherals, programs for instructional use cannot be easily transported from one machine to another. Some attempt to develop

## From the printed word to the processed word.

Not since the invention of movable type has there been a revolution in communications comparable to the computerization of the newspaper industry. Costs are down, special interest and suburban supplements are booming, relationships between writer and story, reporter and editor are undergoing subtle but far-reaching changes. Goodbye Gutenberg, companion to the forthcoming PBS series of the same name, tells the story of this revolution that touches all our lives.

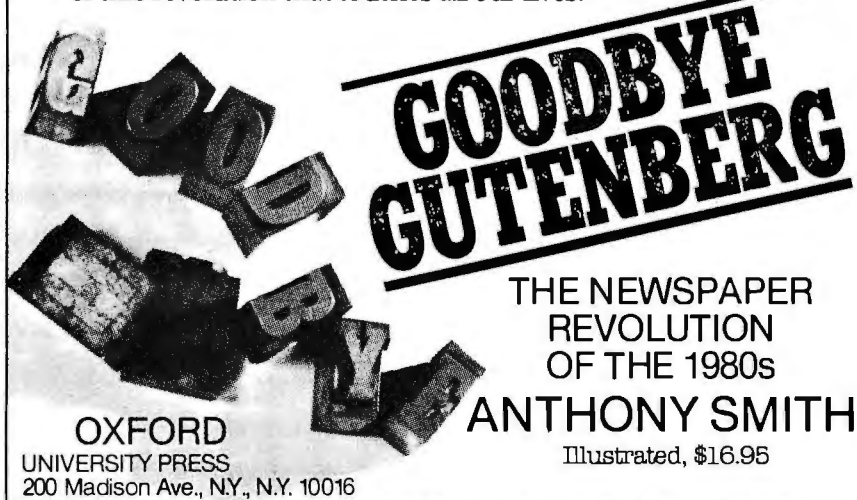

**GOODBYE  
GUTENBERG**

THE NEWSPAPER  
REVOLUTION  
OF THE 1980s

**ANTHONY SMITH**

OXFORD  
UNIVERSITY PRESS  
200 Madison Ave., N.Y., N.Y. 10016

Illustrated, \$16.95

# QUASAR DATA PRODUCTS

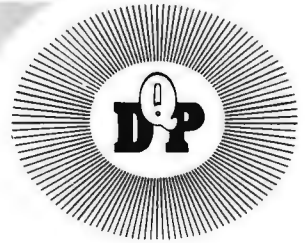

## You can have it all . . . .

UNIX for Z-8000  
Available soon

# Z-80 OR Z-8000

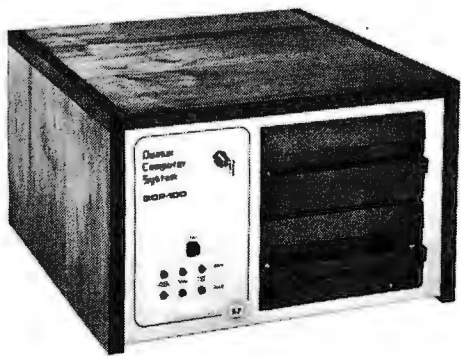

With a

## Quasar Computer System

**QDP - 100**  
Z-80 Computer

Z-80 Emulator - allows Z-8000  
to run Z-80/8080 Programs

**QDP-8100**  
Z-8000 Computer

- Z-80 4 Mhz CPU
- 64 K Memory
- Two 8" Double Sided Double Density Floppies
- Smart CRT Terminal
- Four Ports - 2 Serial - 2 Parallel
- Disk Controller - Double Sided Double Density - up to 4 M.B.
- Monitor in Prom
- CP/M 2.2 DOS
- S-100 (I-EEE) Motherboard
- Basic Language Included
- Real Time Clock
- Upgradable to QDP-8100

**\$4995**

30 Day ARO

- Z-8000 4 Mhz CPU I-EEE-100
- 64 K Memory
- Two 8" Double Sided Double Density Floppies
- Smart CRT Terminal
- Three Ports - 2 Serial - 1 Parallel
- Disk Controller - Double Sided Double Density - up to 4 M.B.
- CP/M 2.2 DOS
- Z-80 Software Emulator
- I-EEE 100 Motherboard
- Basic Language Included
- Z-8000 Pascal Available

**\$6395**

Unix™ - Bell Lab CP/MTM - Digital Research



Checks, money orders accepted  
Add \$2.50 freight charges on orders under 10 lbs. Over 10 lbs. F.O.B. Cleveland

## QUASAR DATA PRODUCTS

25151 Mitchell Dr., No. Olmsted, Ohio 44070 (216)779-9387



standard programming languages and input/output (I/O) formats would help overcome this problem.

The closest anyone has come to providing computer-aided instruction on any large-scale basis is CONDUIT. CONDUIT is a nonprofit educational organization whose job it is to accumulate CAI information and distribute it to interested individuals and educational institutions. It has established standards for presenting the material. Virtually all materials available through CONDUIT have been written in BASIC or FORTRAN. Because these languages are generally the same on a wide variety of computers, some measure of transportability is attained. CONDUIT makes available printed listings as well as computer tapes and disks for selected widely-used machines. CONDUIT also publishes a magazine called *Pipeline* and a variety of helpful CAI books. Despite this significant effort, distribution is still not large. Prices are high and CONDUIT is basically unknown. Most of the programs are on high-level esoteric subjects and are generally too large to be accommodated by the average micro-

computer. Most materials have been designed for minicomputers and large-scale time-sharing and batch processing machines which are widely used in educational institutions. CONDUIT has recently established a program to collect and disseminate CAI for microcomputers. So some progress is being made. (Readers interested in *Pipeline* may contact CONDUIT, POB 338, Iowa City IA 52240.)

The single greatest reason why computer-aided instruction has not succeeded in schools or in the home is the lack of "canned" or prepared courseware. The computer manufacturers do not supply it nor are there publishers for developing, accumulating, and disseminating such material. [*Atari and Texas Instruments, among others, have begun to distribute educational programs.* . . .ed] As a result, most computer-aided instruction is created by instructors for use in their own classrooms. Needless to say, few instructors have the desire or capability to do this. Computers would become much more widely used if standard computer-aided instruction programs

were available. Teachers and individuals could then justify the purchase of computers, just as they can justify the purchase of a slide projector or video-tape player.

There have been only limited attempts to develop microcomputer courseware. Some manufacturers do offer a few computer-aided instruction programs. Most notable are Radio Shack, Apple, and Commodore. It is doubtful that the computer manufacturers will ever become major courseware suppliers.

There is one positive trend which could help the CAI cause. A number of software houses are beginning to produce a variety of application programs for microcomputers. Perhaps some of them will discover CAI.

Now the good news. Computer-aided instruction is obviously not the world's final answer to education. It has problems and disadvantages. But these can be overcome. It also has some very positive qualities. For example, computer-aided instruction is a very popular and visible topic. People are highly interested in it. It is a proven self-instruction technique. Computer-aided instruction is also

## PRINTERS & CRT'S From Orange Micro



base 2 inc.



IMPACT PRINTER  
**\$699<sup>00</sup>**

"The base 2 outperforms every printer in its price range. Do a comparison and see for yourself..."

### ★ GRAPHICS ★ TRACTORS / FRICTION FEED

- 2K Input Buffer • RS-232 Serial, Centronics® Parallel, IEEE-488, 20 ma • TRS-80 Cable option • 60 LPM - 100 CPS • Fast form feed • User programmable character set • 64, 72, 80, 96, 120, 132 Columns / line • Expanded characters • 9.5" wide paper • Automatic skip-over-perforation • Horizontal & Vertical tabs • Programmable vertical line spacing • Intel 8085 Microprocessor — over 40 software commands • Self test • 15 Baud rates to 9600 Baud • Optional foreign character sets

Interfaces to TRS-80, Apple, Atari, PET, Northstar, and most other computers.

Circle 62 on inquiry card.



### TELEVIDEO CRT'S PRICES SLASHED!

912B \$699<sup>00</sup>\*  
912C \$ CALL  
920C \$ CALL

\*While they last

### PRINTERS

#### AXIOM

IMP-1 ..... 795  
IMP-2 ..... 895  
Other models ..... \$ Call

#### CENTRONICS

779 w/tractors ..... 1039  
730 ..... 895

#### COMPRINT

912 Parallel ..... 549  
912 Serial ..... 579

#### OKIDATA

Printer ..... 845  
w/tractors ..... 955

#### PAPER TIGER

w/o graphics ..... 1059  
w/graphics ..... 899

#### QUME

Letter Quality ..... 2499  
w/tractors ..... 2684

TOLL FREE (800) 854-8275

CALIF. ONLY (714) 630-3322

Call for FREE CATALOG



Phone orders WELCOME. Same day shipment for VISA, MASTER CHARGE, and AMERICAN EXPRESS. Personal checks require 2 weeks to clear. Add 3% for shipping and handling. California residents add 6%. Manufacturer's warranty included. Prices subject to revision.

Orange  
Micro



P.O. Box 2076  
Yorba Linda, CA 92686



# \$10,000.00 GIVE AWAY

SPONSORED BY THE MAKERS OF THE

# BASIC SOFTWARE LIBRARY NOW ★ 10 ★ Volumes and Growing

And unlike others we are giving a portion in CASH that you Don't have to spend with us.

You are eligible NOW! Your name may already be entered.

First Prizes Awarded starting in mid September. More details in future advertisements. Our software is UN-EQUALLED in performance and excellence. If you are looking for compatible software to perform useful tasks you won't find a better deal Anywhere in the WORLD!!!

We have over 100,000 in circulation since 1975 and we are still around and That's more than Anyone else can say. We used to sell hundreds of programs individually, the programs in Volume X were sold for several years at over \$10,000, in Volume III for over \$6,000 but a few years ago we decided to promote software to the mass public and it was an instant success. We are still several years ahead of our time in our marketing concepts as well as our products and we are going to be making another major change in the market. We are going to offer our programs in cassette form. NOT just one of two programs like everybody else. But a book full of programs for just \$9.95.

**For Homeowners, Businessmen, Engineers, Hobbyists, Doctors, Lawyers, Men and Women**

<b>Vol. I \$24.95</b>	<b>Vol. II \$24.95</b>	<b>Vol. III \$39.95</b>	<b>Vol. IV \$9.95</b>	<b>Vol. V \$9.95</b>	<b>Vol. VIII \$19.95</b>	<b>Vol. IX \$19.95</b>	<b>Vol. X \$69.95</b>
Business & Personal Bookkeeping Programs	Animals Four Astronaut Bagel Bio Cycle Cannons Checkers Craps Dogflight Golf Judy Line Up Pony Roulette Sky Diver Tank Teach Me	Binomial Chi-Sq. Coeff. Confidence 1 Confidence 2 Correlations Curve Differences Dual Plot Exp-Distri Least Squares Paired Plot Plotpts Polynomial Fit Regression Stat 1 Stat 2 T-Distribution Unpaired Variance 1 Variance 2 XY.	Beam Conv. Filter Fit Integration 1 Integration 2 Intensity Lola Macro Max. Min. Navaid Optical Planet PSD Rand 1 Rand 2 Solve Sphere Trian Stars Track Triangle Variable Vector	Billing Inventory Payroll Risk Schedule 2 Shipping Stocks Switch	Andy Cap Baseball Compare Confid 10 Descrip Football Differ Engine Fourler Horse Integers Logic Playboy Primes Probab Quadrac Red Baron Regression 2 Road Runner Roulette Santa Stat 10 Stat 11 Steel Top Vary Xmas	1040-Tax Balance Checkbook Instal 78 Deprec 2 APPENDIX C Favorites	Intro. A/R A/P Mer Inv Check Assets Payroll Bal Sh P/L Year End Data Base Tax Up Basic St.
Bond Building Compound Cyclic Decision 1 Decision 2 Efficient Flow Installment Interest Investments Mortgage Optimize Order Perl Tree Rate Return 1 Return 2 Schedule 1 Games & Pictures	A. Newman J.F.K. Linus Ms. Santa Nixon Noel Noel Nude Peace Policeman Santa's Steigh Snoopy Virgin	APPENDIX A	Vol. VI \$49.95 Mini-Ledger Payroll A/R Inventory Peprec. Ledger	Enterprise Football Funds 2 Go-Moku Jack Life Loans Mazes Poker Popul Profits Qubic Rates Retire Savings SBA Tic-Tac-Toe	APPENDIX B	Volume VII — Part 1 — Chess Add \$1.00 per tape Post./ Handling	

Available on TRS-80 Level II — 16K compatible cassette \$9.95  
 Volume III — Part 1 — Billing Inv. Pyrl.  
 Volume VII — Part 1 — Chess  
 Add \$1.00 per tape Post./ Handling  
 Volume VI — Disk programs are compatible with TRS-80 disk basic  
 The disk programs in Volumes VI, VII and X are written in (CP/M) M Basic and Disk Extended Microsoft Basic. Other programs written in 8K Basic.

## SELECTED PROGRAMS AVAILABLE ON CASSETTE

Circle 63 on inquiry card.

### Unconditional Money Back Guarantee.

Add \$1.50 per volume handling, all domestic shipments sent U.P.S. except APO and P.O. Box which go parcel post. Foreign orders add \$6.00/volume for air shipment and make payable in U.S. dollars only.

AVAILABLE AT MOST COMPUTER STORES

Master Charge and Bank Americard accepted.

Our Software is copyrighted and may not be reproduced or sold.

Unlike others we have NOT raised our prices in five years

No PURCHASE Necessary, to enter send name & address on a 3 x 5 card. You are automatically entered every time you make a purchase from us. Void where prohibited by LAW.

## KEMCO, LTD.

P.O. Drawer 2208L Petersburg, VA 23803

Sales HOT LINE 800-241-7131 ext. 440

In Georgia call 800-282-2686

IN GERMANY  
Ing. W. Hofacker, GmbH  
Holzkirchen, W. Germany

IN HOLLAND  
Electronica Top Int'l  
Den Dolder, Holland

# OVER 116,000 IN USE TODAY

If sufficient demand we will make requested programs available for Apple, Atari, Pet, TRS-80, etc.

## PROFESSIONAL SOFTWARE

### ACT™ NEW!

CP/M™ COMPATIBLE  
MACRO ASSEMBLER FOR  
Z80, 8080/85, 6502  
& 6800

Finally, one assembler that supports all major 8 bit microcomputers and runs under CP/M. ACT is available now in 8" soft sector & NorthStar CP/M formats. Coming soon: ACT for 8086/88 & 6809.

- Macros
- Absolute assemblys
- Link file support
- Over 25 pseudo-ops
- Local label definition
- System text file support
- Standard Intel Hex code file format
- Assembly speed of 1000 lines/minute
- Complete cross reference including defs vs usage
- Independent control of list file org vs Hex file

\$125. Manual alone - \$15.

### PASCAL/M™

New Features! The CP/M compatible language for 8" 8080/Z80 CPU's, NorthStar 2D, Cromemco CDOS & TRS-80 Mod II

- Random access files
- Otherwise clause on Case statement
- Runtime debug support
- Over 45 extensions to Standard Pascal

NEW PRICE! \$175.

Manual alone - \$10.

### CBASIC2™

\$95. Manual alone - \$15.

## DIGITAL MARKETING

2670 Cherry Lane  
Walnut Creek, CA 94596  
(415) 938-2880

ACT & PASCAL/M are trademarks of Sorcim  
CP/M is a trademark of Digital Research  
CBASIC is a trademark of Compiler Systems  
TRS-80 is a trademark of Radio Shack  
Outside the USA add \$10. for postage  
& handling

one more thing you can do with a computer. People like and want computers. Therefore, they support CAI as yet another useful computer application, among many. Even though there are better and more efficient ways to learn, computer-aided instruction will survive because it is an interesting, exciting, and valid use of a computer. When the personal computer is purchased and used for a broad spectrum of practical purposes, computer-aided instruction fits in as one of these purposes. The marginal cost of adding computer-aided instruction capabilities to the software libraries of a small computer will be quite low.

Learning by computer is fun. You do not have to read a large, imposing book nor do you really have to study. In fact, most people find it hard to associate "study" with computer learning. Most computer-aided instruction is interactive and fast-paced. The computer presents material, you learn it; the computer tests you, you respond; moreover, the computer provides immediate feedback. You become part of the learning process. In simulations, you are in full control and are totally involved with the action. It is hard *not* to learn. Even though computer-aided instruction may not help you to learn any faster or better or allow you to retain your learning longer, it is certainly just as good as other methods and often a lot more entertaining.

The best way to sum this up is to say that there is a "mystique" to computer-aided instruction that makes it popular. It just seems like a good and logical thing. As long as there are computers, there will be an interest in computer-aided instruction. Computers will not replace teachers, but will provide teachers with another tool to supplement and enhance education.

### Conclusions

- Computer-aided instruction is a viable and effective technique for self-instruction in the home, industry, or schools. It is more costly and no more effective than printed programmed instruction, audio/visual, video, or other self-instruction techniques. But CAI works, it is fun, and more interesting than other teaching methods.
- Many professionals, hobbyists,

teachers, and industry/government trainers are interested but lack the difficult and costly courseware development skills.

- Computer-aided instruction is not more widely used because there is little or no "canned" or commercially available courseware; nor are there any standards in languages, formats, and media.
- Low-cost microcomputers may make CAI potentially more practical.
- There are business opportunities for publishers, computer manufacturers, and software houses that accumulate and develop computer-aided instruction systems.

### Glossary

**CAI:** Computer-aided (assisted or administered) instruction, sometimes referred to as computer-aided learning (CAL). A process of teaching by computer. A technique for individualizing instruction. Also called computer-based learning or instruction (CBL or CBI).

**Courseware:** A combination of the terms course and software. Courseware is the material to be learned written with a computer language to form a program or a special piece of application software.

**PI:** Programmed instruction. A technique for presenting material to be learned in short sequential segments called frames. Each frame presents a fact or concept to be learned, then ends by testing the learner with a question. PI can be printed or put into other media. Most CAI is essentially PI on a computer.

**Linear PI:** The most common form of programmed instruction. The material to be learned is divided into many short frames of information which are presented sequentially. Each frame tests the student on the facts or concepts presented by requiring them to write in the correct answer before proceeding to the next frame.

**Branching PI:** A sophisticated form of programmed instruction in which the information to be learned is presented in a sequence of frames similar to linear PI. However, in





## Here's to your health! Six Vitafacts™ programs for you and your family.

Being healthy and happy is so very important. And now you can use your Apple,™ PET/CBM™ or TRS-80™ computer to help stay that way.

Introducing six new Personal Software™ Vitafacts Series programs for your health: Growing Up, Heart Attacks, Talking About Sex, Drinking & Drugs, Birth Control, and Your Blood Pressure.

Using a Vitafacts program is like getting advice from your family doctor. Accurate, up-to-date medical information about physical and mental health, presented in a friendly, straightforward way. You'll feel even more confident knowing that each program is approved and endorsed by The College of Family Physicians in Canada, where the Vitafacts Series is created by The Richmond Software Group and Medifacts Ltd.

Each program includes a manual with diagrams and glossary, a computer cassette, and an audio cassette. The audio tape uses short dramas and straight talk to tell the story. Then the computer exercises verify your new knowledge. And because you use your knowledge right away, you remember more. It's fun! And a great way to learn.

**Growing Up** helps families cope with the teenage years. Teenagers learn more about their physical and emotional changes, and parents learn more about helping their children through it all.

**Heart Attacks** describes what one is, how to recognize it, what to do

when someone is experiencing one, and—most important—how to help prevent one.

**Talking About Sex**, presented by two of Canada's foremost sex counselors, offers to adults the proper information and appropriate attitude for a satisfying sex life.

**Drinking & Drugs**. No lecturing or talking down. Just straight facts about the very real dangers of alcohol and drugs. Prepared for teenagers, but good for adults.

**Birth Control** explains clearly and completely conception, birth and prevention of unwanted pregnancies. Important information for teenagers, and helpful for adults.

**Your Blood Pressure**. No one is immune to the risks of high blood pressure. Knowledge is your best defense, and this program has the information.

"Vita" means "Life" in Latin. We hope these programs make your life healthier and happier.

Retail price is just \$19.95.

Ask your Personal Software dealer for a demonstration, and for our new catalog. Call or write to find your nearest dealer. (408) 745-7841. Personal Software Inc., 1330 Bordeaux Dr., Sunnyvale, CA 94086.



# PERSONAL SOFTWARE



Circle 65 on inquiry card.

... a multiple-choice question; the student chooses the correct answer. If the correct answer is selected, the program branches to the next frame, where the correct answer is verified and more information is presented. If an incorrect answer is chosen, the program branches to a frame where the student is informed of his or her incorrect choice and given remedial information before being sent back to the original frame.

**PILOT:** An interactive, conversational programming language developed at the University of California, San Francisco by Dr John Starkweather. PILOT was designed as a CAI author language to simplify courseware development. PILOT is usually implemented as an interpreter and is available for many microcomputers. PILOT is faster and easier to learn and use than BASIC.

### Types of CAI

**Testing:** Perhaps the first use of a computer in education. Computers are ideal test givers, particularly for true or false, multiple-choice, and matching tests. The computer presents the question and the student responds. The computer determines whether a correct answer is given. A record of the number of correct and incorrect answers is kept, and a score or grade is computed and displayed. Other functions include student feedback on individual test items and examination evaluation to determine which questions are

most often missed. A good application for microcomputers.

**Drill and Practice:** The most widely used type of computer-aided instruction, the presentation of practice problems and exercises to reinforce learning gained from another source. In addition to keeping track of right and wrong answers, the computer can provide useful student feedback and remedial information. An ideal use of microcomputers.

**Tutorial:** Second most widely used form of computer-aided instruction. This is individual instruction via a computer. Tutorial CAI is essentially programmed instruction implemented on a computer. The computer presents the material to be learned in sequential frames. Either the linear or branching modes of programmed instruction can be used. Most computer-aided instruction for microcomputers is of this type.

**Dialog:** The least used form of computer-aided instruction. This is a sophisticated form of teaching where the computer and the student carry on a conversation. The interaction between student and computer leads to the learning or understanding of a subject. The student may ask unstructured questions or provide data to the computer. The computer answers the questions and supplies additional data, practice problems, and the like. Dialog computer-aided instruction is complex and difficult to write. It requires a huge data-storage

facility. Impractical for microcomputers.

**Simulation:** A mode of learning in which the computer imitates a real situation or environment. The computer is programmed to act like some physical or social system. In most applications, mathematical equations describing the system are written, then solved on the computer. Simulations allow the student to test various input conditions and make changes in various parameters to see the outcome. Simulation is widely used in science and engineering for design, and in business for constructing models to predict profitability or make decisions based on dissimilar economic conditions. Many computer games are simulations. (For example, the popular game Hamurabi is the simulation of a small country.) Difficult to develop, but great potential for microcomputers. ■

### Product Note: CAI for LSI-11 Systems.

Readers interested in a general-purpose multi-user interactive operating system for computer-aided instruction courseware development on the Digital Equipment Corporation PDP-11/03 or Heath H11A computer systems should contact Advanced Interactive Systems Inc about their AVID system. Write to Advanced Interactive Systems Inc, POB 7, Dresher PA 19025.

IN STOCK

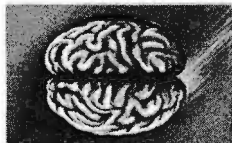

#### S-100 8086

CPU with \$450.  
Vectored Interrupts

PROM-I/O \$495.

RAM \$395.

8K x 16/16K x 8

Parallel I/O \$350.  
and Timer

#### A/D - D/A

##### S-100 A/D

8 Ch. Differential or  
16 Ch. Single-Ended,  
12 Bit, High Speed \$495.

**S-100 D/A** 4 Channel  
12 Bit, High Speed \$395.

##### TRS-80 A/D-D/A

12-Bit, High Speed  
Available Soon



#### S-100 VIDEO DIGITIZATION

Real Time Video \$850.  
Digitizer and Display  
Computer Portrait  
System \$4950.

### S-100 Boards

Video and/or Analog  
Data Acquisition  
Microcomputer Systems



The High Performance S-100 People

TECMAR, INC.

23414 Greenlawn • Cleveland, OH 44122  
(216) 382-7599



# FLEX™

## The Disk Operating System For 6800 and 6809 Users

FLEX™ is the most widely used disk operating system for the 6800 and 6809 microprocessors. Field proven for over two years, it has become an industry standard. FLEX is unparalleled in the amount of 6800/6809 support software being marketed. Two new versions are now available and each includes a disk editor and assembler:

### **FLEX for the EXORciser™ \$150.00**

Runs on a Motorola EXORciser with EXORDisk™ II or III. Requires no hardware modifications with the possible exception of memory re-addressing. Uses the same boot as MDOS™.

### **FLEX for General Use \$150.00**

Fully documented to allow a user to write his own terminal and disk I/O routines to adapt to most any hardware. Three system requirements are: (1) at least 12K of RAM at \$0000; (2) 8K of RAM at \$A000 for 6800 or \$C000 for 6809; (3) floppy disk drive capable of 256-byte, soft sectors. This package is not for beginners!

### **FLEX Support Software**

Extended BASIC	\$100.00
Standard BASIC	65.00
6809 Diagnostics Package	75.00
Text Processing System	60.00
Sort/Merge	75.00
68000 Cross Assembler	250.00
6809 Cross Assembler	100.00
6809 FLEX Utilities	60.00
6800 FLEX Utilities	100.00
6809 Debug Package	75.00
6800 Debug Package	55.00
FLEX for SWTPc	90.00

Be sure to specify disk size and 6800 or 6809. All orders should include 3% postage and handling (10% on foreign orders). Mastercharge and Visa are welcomed. Write for a complete software catalog.

 **technical systems  
consultants, inc.**

Box 2570, West Lafayette, IN 47906  
(317) 463-2502 Telex 276143

FLEX is a trademark of Technical Systems Consultants, Inc. EXORciser, EXORDisk, and MDOS are trademarks of Motorola, Inc.

# Computer Illiteracy—A National Crisis and a Solution for It

### The Problem

Computing plays such a crucial role in everyday life and in the technological future of this nation that the general public's ignorance of the subject constitutes a national crisis.

The ability to use computers is as basic and necessary to a person's formal education as reading, writing, and arithmetic. As jobs become increasingly oriented toward the use of information, society demands and rewards individuals who know how to use information systems. The American computer industry, which leads the world today, depends for its future upon a mass market of computer-literate workers and consumers.

Yet, despite computing's critical importance today, the overwhelming majority of this country's general public is woefully ill-prepared to live and work in the Age of Information, as some have called it. How many high-school graduates have taken a hands-on course in computer use? How many teachers are prepared to teach such a course? How many company presidents can operate their own computer departments? Yet, they could probably do a respectable job with most other departments. How many legislators can interact with a computer-based information-retrieval system? How many office workers are ready for office automation—or even know what they want from office automation? How many consumers are ready for general-purpose home computers that they can program themselves?

The answer to all these questions is the same: very few such people exist today.

Why is this true? Vocational incentives are powerful enough. People with programming skills command jobs with far higher salaries than are average for people with similar education; and word-processing

---

Arthur Luehrmann  
Director of Computer Research  
Lawrence Hall of Science  
University of California  
Berkeley CA 94720

---

specialists earn more than clerks. Corporate profitability incentives are equally strong, because the success of businesses depends as much on the creative use of information as upon the efficient use of material and energy resources. Personal incentives are also great. The children and adults I see learning to use computers display an unusual intensity of concentration and an evident satisfaction with their results.

Clearly, it takes more than incentive to cause things to happen. There must also be a mechanism—an educational mechanism, in this case—if our society is to emerge from our preliterate state of computer ignorance. *The present educational mechanism is grossly inadequate to the task—a situation that must change and change quickly.*

Two kinds of computer education are needed. First, all future students should acquire basic skills in computer use, including hands-on operation, programming, and problem solving, during their early secondary-school years. They should also make further use of these skills in other courses in mathematics, science, language, etc., and in vocationally oriented courses in word processing, accounting, and the like.

The need for a second kind of computer education is dictated by the fact that most of us have finished our formal education. School-based programs will take care of future needs, but today's adults have pressing incentives to develop their own computer skills. How can that be done?

### Obstacles to Computer Education

While computer awareness can be

arrived at by means of books, lectures, films, and television shows, computer literacy can be reached only by practice. Therefore, if schools are to provide students with basic computer literacy, they must give each student many "laboratory hours" at the keyboard of an interactive computer system. While surveys show that most secondary schools have some sort of computer, nevertheless, the average student probably spends less than an hour at a computer keyboard during all of his or her precollege years. *With a very few exceptions, therefore, it is fair to say that computer literacy is not now a part of the curriculum.*

To provide computer literacy, four specific needs have to be met:

- adequate and appropriate equipment in every secondary school
- an available, usable curriculum with materials for students and teachers
- one or more teachers in each school trained in teaching computer use
- community, political, and financial support for such school-based programs

Each of these needs can be satisfied rather easily; that should be grounds for optimism. Nevertheless, each need is currently faced with a significant obstacle.

The inexpensive microcomputer, more than any other event, has made school-based computer education a possibility. The development of small time-sharing systems about ten years ago brought hardware costs per student terminal down to about \$10,000—a major breakthrough, but still far too costly for most schools. Worse yet, time-sharing systems lack robustness against hardware failure:

*Text continued on page 101*

# MICROSOFT AND TRS-80™ MODEL II. RUNNING THE SHOW.

TRS-80 Model II is designed for professional business applications. Your ultimate goal for your Model II is probably a fast, turnkey system that's easy to use and easy to expand. To get there you need dependable, flexible system software to write the programs that run the whole show.

Microsoft's COBOL-80 and BASIC compilers are now available in versions fully compatible with Model II TRSDOS. You can have either of these universally popular programming languages plus all the advantages of a compiler: faster execution times, compact executable code, security for your programs.

With Microsoft's compiled languages you get a complete program development system, including our standard MACRO-80 Assembler and LINK-80 Linking Loader. Your compiled programs are relocatable modules that can be linked to each other or to Z80 assembly language subroutines.

## COBOL-80 Compiler

Microsoft's COBOL-80 is an ANSI-74 standard COBOL that supports such advanced data manipulation verbs as COMPUTE, INSPECT, STRING, UNSTRING, and SEARCH. Plus three-dimension arrays, full COPY facility, compound and abbreviated conditions, and an optional packed decimal format that saves on mass storage by as much as 40%. In addition to Sequential and Relative files, COBOL provides Indexed files, allowing records to be retrieved with a user-specified key instead of a record number.

**Interactive Screen Handling** Most business applications require machine interaction, formatted screen displays, and the ability to insert and delete information as the machine prompts the user. The COBOL ACCEPT/DISPLAY verbs are implemented for this purpose—to DISPLAY formatted screens and ACCEPT operator input.

**CHAIN and Segmentation** Ideal for menu-driven application programs is COBOL-80's CHAIN feature. With

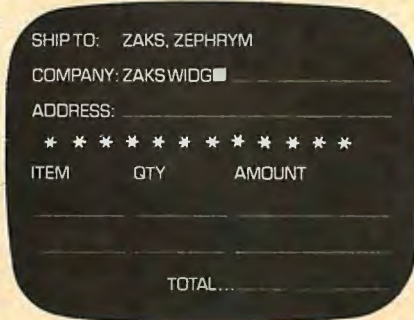

COBOL-80 formatted screen display

CHAIN, control is transferred from the menu program to any executable module as specified at runtime. COBOL-80 also supports Segmentation to make maximum use of memory when large programs are executing.

## BASIC Compiler

The Microsoft BASIC Compiler has the fastest execution times of any BASIC available. It is language compatible with the Model II's interpreter so you can write and test your programs using the interpreter, then compile them for secure storage and efficient execution.

**New BASIC Features** In addition to those language features provided with the interpreter, the BASIC compiler supports all the latest features of Microsoft BASIC 5.1: WHILE conditional statement, CALL, long variable names, and ANSI compatibility. Plus the compiler has double precision transcendental functions (SIN, COS, TAN, ATN, LOG, EXP, SQR).

**Secure** Besides being an indispensable system software tool for developing your own utilities and application programs, the BASIC compiler is ideal for producing programs for resale. The machine code for any application program may be placed on a diskette, ROM, or other media, but the BASIC source program need not be distributed. Thus the original application program is protected from unauthorized alteration.

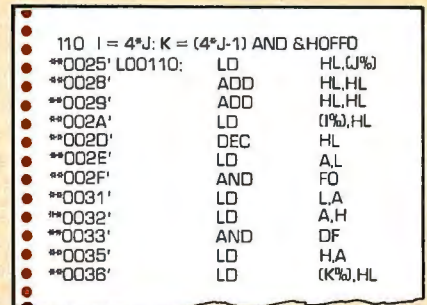

BASIC compiler object code listing

**Optimized Machine Code** Compiled BASIC programs are fast and compact due to extensive optimizations performed during compilation:

1. Expressions are reordered to minimize temporary storage and eliminate common subexpressions
2. Constants are folded wherever possible
3. Peephole optimizations are performed
4. The code generator is template-driven, allowing optimal sequences to be generated for the most commonly used operations
5. String operations and garbage collection are extremely fast

Get Microsoft BASIC Compiler or Microsoft COBOL-80 and get serious with your Model II. After all, who's running this show?

Prices for COBOL-80 and BASIC Compiler include the MACRO-80 Assembler and LINK-80 Linking Loader and all documentation. Documentation purchased separately, \$20.

COBOL-80 \$750.  
BASIC Compiler \$395.

**For TRS-80 Model I software, contact Microsoft Consumer Products.**

## MICROSOFT

10800 NE 8th  
Suite 819  
Bellevue, WA 98004  
(206) 455-8080  
Telex 328945



We set the standard.

# No.14:

# Lifeboat

Software for most popular 8080/280\* computer disk systems including NORTH STAR, iCOM, MICROPOLIS, DYNABYTE DB8/2 & DB8/4, EXIDY SORCERER, SD SYSTEMS, ALTAIR, VECTOR M2, MECA, 8" IBM, HEALTH H17 & H89, HELIOS, IMSAI VDP42 & 44, REX, NYLAC, INTERTEC SUPER-BRAIN, VISTA 80 and V200, TRS-80\* MODEL I and MODEL II, ALMS, OHIO SCIENTIFIC, DIGI-LOG, KONTRON PSI-80, IMS 5000 diskette formats and CSSN BACKUP cartridge tapes.

Genuine CP/M for Apple II  
Coming soon! Call for details.  
Prices reflect distribution on 8" single density diskettes. If a format is requested which requires additional diskettes, a surcharge of \$8. per additional diskette will be added. Purchases of \$25 will be added for hardware in CSSN format DC 300XL cartridges. Media charge for 5440 disk is \$100.

## CP/M\* VERSION 2 FOR TRS-80 MODEL II NOW AVAILABLE

## All Lifeboat programs require CP/M, unless otherwise stated.

System	Version	Price
North Star Single Density	1.4	145/25 v
North Star Double Density	1.4	145/25
North Star Double/Quad	2.x	170/25
iCOM Micro-Disk 2411	1.4	145/25
iCOM 3712	1.4	170/25 v*
iCOM 3812	1.4	170/25 v*
Mits 3202/Altair 8000	1.4	145/25
Health H8 + H17	1.4	145/28
Health H89	1.4	149/25
Health H89 by Magnolia	1.4	250/25
TRS-80 Model I	1.4	145/25
TRS-80 Model II	2.x	170/25
TRS-80 Model II - Corvus	2.x	250/25
Processor Technology Helios II	1.4	145/25
Cromemco System 3	1.4	145/25
Intel MDS Single Density	1.4	145/25
Intel MDS Single Density	2.x	170/25
Micropolis Mod I	1.4	145/25
Micropolis Mod II	1.4	145/25

Software	Manual	Price
MICROSOFT BASIC-80 - Disk Extended BASIC, ANSI compatible with long variable names, WHILE/WEND, chaining, variable length file records		\$325/\$25
BASIC COMPILER - Language compatible with BASIC-80 and 3-10 times faster execution. Produces standard Microsoft relocatable binary output. Includes MACRO-80. Also linkable to FORTRAN-80 or COBOL-80 code modules		\$350/\$25
FORTRAN-80 - ANSI 66 (except for COMPLEX) plus many extensions. Includes relocatable object compiler, linking loader, library with manager. Also includes MACRO-80 (see below)		\$425/\$25
COBOL-80 - Level 1 ANSI '74 standard COBOL plus most of Level 2. Full sequential, relative, and indexed file support with variable file names. STRING, UNSTRING, COMPUTE, VARYING/JUNL, EXTEND, CALL, COPY, SEARCH, 3-dimensional arrays, compound and abbreviated conditions, nested IF. Powerful interactive screen-handling extensions. Includes compatible assembler, linking loader, and relocatable library manager as described under MACRO-80		\$700/\$25
MACRO-80 - 8080/280 Macro Assembler, linker, and Zilog mnemonics supported. Relocatable linkable output. Loader, Library Manager and Cross Reference List utilities included		\$149/\$15
XMACRO-86 - 8086 cross assembler. All Macro and utility features of MACRO-80 package. Mnemonics slightly modified from Intel ASM86. Compatibility data sheet available		\$275/\$25
EDIT-80 - Very fast random access text editor for text or with or without line numbers. Global and intra-line commands supported. File compare utility included		\$89/\$15

Software	Manual	Price
KBASIC - Microsoft Disk Extended BASIC version 4.51 integrated by implementation of nine additional commands in language. Package includes KISS.REL as described above, and a sample mail list program		\$585/\$45
YXBASIC Interactive Process Control BASIC - Full disk BASIC features plus unique commands to handle bytes, rotate and shift, and to test and set bits. Available in integer and extended versions.		\$295/\$25
Extended ROMABLE, ROM Squared and CP/M \$395/\$25		\$495/\$25
Extended disk YXBASIC for CP/M		\$295/\$25
RECLAIM - A utility to validate media under CP/M. Program tests a diskette or hard disk surface for errors, restoring the imperfections in invisible files, and permitting continued usage of the remainder. Essential for any hard disk. Requires CP/M version 2		\$80/\$5
BASIC UTILITY DISK - Consists of: (1) CRUNCH-14 - Compacting utility to reduce the size and increase the speed of programs in Microsoft BASIC 4.51, BASIC-80 and TRS-80 BASIC. (2) DPFUN - Double precision subroutines for computing infinite transcendental functions. (3) ARES - ASCII to ROMABLE log, log base 10, sine, arc sine, hyperbolic sine, hyperbolic arc sine, etc. Furnished in source on diskette and documentation		\$50/\$35
STRING-80 - Character string handling plus routines for direct CP/M BODS calls from FORTRAN and other compatible Microsoft languages. The utility library contains routines that enable programs to chain to a COM file, retrieve command line parameters, and search file directories with full wild card facilities. Supplied as linkable modules in Microsoft \$85/\$20		\$95/\$20
STRING-80 source code available separately \$295/NA		
THE STRING BIT - FORTRAN character string handling routines for very reliable character detection, concatenate and compare character strings. This package completely eliminates the problems associated with character string handling in FORTRAN. Supplied with source		\$65/\$15
VSORT - Versatile sort/merge system for fixed length records with fixed or variable length fields. VSORT can be used as a stand-alone package or loaded and called as a subroutine from CBASIC-2. When used as a subroutine, VSORT maximizes the use of buffer space by saving the TEA on disk and restoring on completion of sorting. Records may be up to 255 bytes long with a maximum of 5 fields. Upper/lower case translation and numeric fields supported		\$175/\$20
CP/M\$74X - Has full range of functions to create or re-name an IBM 3741 volume, display directory information and edit the data set contents. Provides full file transfer facilities between 3741 volume data sets and CP/M files		\$195/\$10
BSTAM - Utility to link one computer to another also equipped with BSTAM. Allows file transfers at full data speed (no conversion to hex), with CRC bit control check for very reliable error detection and automatic retry. We use it! It's great! Full wild card expansion to send *.COM, etc. 9600 baud with wire. 300 baud with phone connection. Both ends need one. Standard and @ versions can talk to one another		\$150/\$10
WHATSI? - Interactive data-base system using associated tables to retrieve data. Includes auxiliary WHASHT and random access used for fast response. Requires CBASIC-2		\$175/\$25
SELECTOR IIC-2 - Data Base Processor to create and maintain multi key data bases. Prints formatted sorted reports with numerical summaries or mailing labels. Comes with reliable error detection and Sales Activity, Inventory, Payables, Receivables, Check Register, and Client/Patient Appointments, etc. Requires CBASIC-2. Supplied in source		\$295/\$20
GLECTOR - General Ledger option to SELECTOR IIC-2. Interactive system provides for customized COA. Unique chart of transaction types insure proper double entry bookkeeping. Generates balance sheets, P&L statements and journals. Two year record allows for statement of changes in financial position report. Supplied in source. Requires SELECTOR IIC-2. CBASIC-2 and 56K system		\$350/\$25
CBS - Configurable Business System is a comprehensive set of programs for defining custom data files and application systems without using a programming language such as BASIC, FORTRAN, etc. Multiple tables for each application supported. Set-up program customizes system to user's CRT and printer. Provides fast and easy interactive data entry and retrieval with transaction processing. Report generator program does complex calculations with stored and derived data. Record selection with multiple criteria, and custom formats. Sample inventory and mailing list systems included. No support language required		\$295/\$40

All Micropro prices are discounted!

Software	Manual	Price
MICROPRO SUPER-SORT I - Sort, merge, extract utility as absolute executing program or linkable module in Microsoft format. Sorts fixed or variable records with data in binary, BCD, Packed Decimal, EBCDIC, ASCII, floating & fixed point, exponential, field justified, etc. Even variable number of fields per record		\$225/\$25
SUPER-SORT II - Above available as absolute program only		\$175/\$25
SUPER-SORT III - As II without SELECT/EXCLUDE		\$125/\$25
WORD-STAR - Menu driven visual word processing system for use with standard terminals. Text formatting performed on screen. Facilities for text pagination, page number, justify, center and underscore. User can print one document while simultaneously editing a second. Edit facilities include global search and replace, read/write to other text files, block move, etc. Requires CRT terminal with addressable cursor positioning		\$445/\$40
WORD-STAR Customization Notes - For sophisticated users who do not have one of the many standard terminal or printer configurations in the distribution version of WORD-STAR		\$85/\$5
WORD-MASTER Text Editor - In-line mode has superseded the old CP/M\$ EDC commands including global search and replacing, forwards and backwards in file in video mode, provides full screen editor for users with serial addressable-cursor terminal		\$145/\$25
TEXTWRITER III - Text formatter to justify and paginate letters and other documents. Special features include insertion of text during execution from other disk files or console, permitting recipe documents to be created from linked fragments on other files. Has facilities for sorted index, table of contents and footnote insertions. Ideal for contracts, manuals, etc. Now compatible with Electric Pencil* prepared files		\$125/\$20

Now applications software for Microsofts BASIC interpreter.

Software	Manual	Price
PEACHTREE SOFTWARE GENERAL LEDGER - Records details of all financial transactions. Generates a balance sheet and an Income Statement. Flexible and adaptable design for both small businesses and firms performing client wrapup services. Produces reports as follows: Trial Balance, Transaction Registers, Balance Sheet, Prior Year Comparative Balance Sheet, Income Statement, Prior Year Comparative Income Statement and Departmental Income Statements. Interactive with other PEACHTREE accounting packages. Supplied in source code for Microsoft BASIC		\$990/\$30
ACCOUNTS PAYABLE - Tracks current and aged payables and incorporates a check writing feature. Maintains a complete vendor file with information on purchase orders and discount terms as well as active account status. Produces reports as follows: Open Voucher Register, Accounts Payable Aging Report and Cash Requirements. Provides input to PEACHTREE General Ledger. Supplied in source code for Microsoft BASIC		\$990/\$30
ACCOUNTS RECEIVABLE - Generates invoice register and complete monthly statements. Tracks current and aged receivables. Maintains customer file including credit information and account status. The current status of any customer account is instantly available. Produces reports as follows: Aged Accounts Receivable, Invoice Register, Payment and Adjustment Register and Customer Account Status Report. Provides input to PEACHTREE General Ledger. Supplied in source code for Microsoft BASIC		\$990/\$30
PAYROLL - Prepares payroll for hourly, salaried and commissioned employees. Generates monthly, quarterly and annual returns. Prepares employee W-2's. Includes complete tax information on current item costs, pricing and sales. Produces reports as follows: Physical Inventory Worksheet, Inventory Price List, Departmental Summary Report, Inventory Status Report, The Record Register for the Period-to-Date and Year-to-Date reports. Supplied in source code for Microsoft BASIC		\$1190/\$30

The following configurations are scheduled for release soon:

Apple II	2.x	350/25
North Star Double/Quad + Corvus	2.x	250/25
North Star Horizon HD-1	2.x	250/25
Ohio Scientific	2.x	200/25
Ohio Scientific C3-C	2.x	250/25
Micropolis Mod I	2.x	200/25
Mostek MDX STD Bus System	2.x	350/25
iCOM 3812	2.x	170/25
iCOM 4511/Perfec D3000	2.x	375/25 +
Durango F-85	2.x	170/25

Software consists of the operating system, text editor, assembler, debugger and other utilities for file management and system maintenance. Complete set of Digital Research documentation and additional implementation notes included. Systems marked \* and \*\* include firmware on 2708 and 2716. Systems marked # include 5440 media charge. Systems marked @ require the special @ versions of software in this catalog. Systems marked v have minor variants available to suit console interface of system. Call or write for full list of options. † includes hardware addition to allow our standard versions of software to run under II.

280 DEVELOPMENT PACKAGE - Consists of: (1) disk file editor, with global enter and intra-line facilities; (2) 280 relocatable versions of software mnemonics, conditional assembly and cross reference table capabilities; (3) linking loader producing absolute Intel hex disk file		\$95/\$20
ZDT - Z80 Monitor Debugger to break and examine registers with standard Zilog/Mostek mnemonic disassembly displays & 35 when ordered with Z80 Development Package		\$50/\$10
XASM-68 - Non-macro cross-assembler with nested conditionals and full range of pseudo operations. Assembles from standard Motorola MC68000 mnemonics to Intel hex		\$200/\$25
XASM-65 - As XASM-68 for MOS Technology MCS-6500 series mnemonics		\$200/\$25
DISTEL - Disk based disassembler to Intel 8080 or TOLXitan 280 source code listing and cross reference files, Intel or TOLXitan pseudo ops optional. Runs on 8080		\$65/\$10
DISILOG - As DISTEL to Zilog/Mostek mnemonic files. Runs on Z80 only		\$65/\$10
SMAL/80 Structured Macro Assembler Language - Package of powerful general purpose text macro processor and SMAL structured language compiler. SMAL is an assembler language with IF-THEN-ELSE, LOOP-REPEAT-WHILE, DO-END, BEGIN-END constructs		\$75/\$15

tiny C - Interactive Interpretive system for teaching structured programming techniques. Manual includes full source listings		\$105/\$50
BDS C COMPILER - Supports most features of language, including Structures, Arrays, Pointers, recursive function evaluation, overlays. Includes linking loader, library manager and library containing general purpose, file I/O, and floating point functions. Lacks initializers, statics, floats and longs. Documentation includes "The C PROGRAMMING LANGUAGE" by Kernighan and Ritchie		\$125/\$20
WHITESMITHS C COMPILER - The ultimate in systems software tools. Produces faster code than a pseudo-code Pascal with more extensive facilities. Conforms to the full UNIX* Version 7 C language, described by Kernighan and Ritchie, and makes available over 75 functions for performing I/O, string manipulation and storage allocation. Linkable to Microsoft REL files. Requires 60K CP/M		\$630/\$30

PASCAL/M* - Compiles enhanced Standard Pascal to compressed efficient Pcode. Totally CP/M compatible. Random access files. Both 16 and 32-bit integers. Runtime error recovery. Convenient STRINGS. OTHERWISE clause on CASE. Comprehensive manual, linker and source code language interface. Real variables can be BCD, software floating point, or AMD 9511 hardware floating point. Includes strings enumerations and record data types. Manual explains BASICS to PASCAL conversion. Requires 32K		\$250/\$30
ALGOL-60 - Powerful block-structured language compiler featuring economical run-time dynamic allocation of memory. Very compact (24k total RAM) system implementing almost all Algol 60 report features plus many powerful and useful string handling direct disk address I/O etc. Requires Z80 CPU		\$199/\$20
CBASIC-2 Disk Extended BASIC - Non-Interactive BASIC with pseudo-code compiler and run-time interpreter. Supports full file control, chaining, integer and extended precision variables, etc.		\$120/\$15

Software	Manual	Price
MICRO FOCUS STANDARD CIS COBOL - ANSI '74 COBOL standard and compiler fully validated by U.S. Navy tests		\$175/\$25
ANSI level 1. Supports many features to level 2 including dynamic loading of COBOL modules and a full ISAM file facility. Also, program segmentation, interactive debug and powerful interactive extensions to support protected and unprotected CRT screen formatting from COBOL programs used with any dumb terminal		\$850/\$50
FORMS 2 - CRT screen editor. Output is COBOL data descriptions for copying into CIS COBOL programs. Automatically creates a query and update program of indexed files using CRT protected and unprotected screen formats. No programming experience needed. Output program directly compiled by STANDARD CIS COBOL		\$200/\$20

KEYED INDEX SEQUENTIAL SEARCH - Offers complete Multi-Keyed Index Sequential and Direct Access file management. Includes built-in utility functions for 16 or 32 bit arithmetic, string/integer conversion and string compare. Delivered as a relocatable linkable module in Microsoft format for use with FORTRAN-80 or COBOL-80, etc.		\$335/\$23
---	--	------------

KEYED INDEX SEQUENTIAL SEARCH - Offers complete Multi-Keyed Index Sequential and Direct Access file management. Includes built-in utility functions for 16 or 32 bit arithmetic, string/integer conversion and string compare. Delivered as a relocatable linkable module in Microsoft format for use with FORTRAN-80 or COBOL-80, etc.		\$335/\$23
---	--	------------

KEYED INDEX SEQUENTIAL SEARCH - Offers complete Multi-Keyed Index Sequential and Direct Access file management. Includes built-in utility functions for 16 or 32 bit arithmetic, string/integer conversion and string compare. Delivered as a relocatable linkable module in Microsoft format for use with FORTRAN-80 or COBOL-80, etc.		\$335/\$23
---	--	------------

KEYED INDEX SEQUENTIAL SEARCH - Offers complete Multi-Keyed Index Sequential and Direct Access file management. Includes built-in utility functions for 16 or 32 bit arithmetic, string/integer conversion and string compare. Delivered as a relocatable linkable module in Microsoft format for use with FORTRAN-80 or COBOL-80, etc.		\$335/\$23
---	--	------------

Prices and specifications subject to change without notice.

**GRAHAM-DORIAN SOFTWARE SYSTEMS**

- ① **GENERAL LEDGER** — An on-line system; no batching is required. Entries to other GRAHAM-DORIAN accounting packages are automatically posted. User establishes customized C.O.A. Provides transaction register, record of journalized trial balances and monthly closings. Keeps 14 month history and provides comparison of current year with previous year. Requires CBASIC-2. Supplied in source ... \$995/\$35
- ① **ACCOUNTS PAYABLE** — Maintains vendor list and check register. Performs cash flow analysis. Flexible — writes checks to specific vendor for certain invoices or can make partial payments. Automatically posts to GRAHAM-DORIAN General Ledger or runs as stand alone system. Requires CBASIC-2. Supplied in source ... \$995/\$35
- ① **ACCOUNTS RECEIVABLE** — Creates trial balance reports, prepares statements, ages accounts and records invoices. Provides complete information describing customer payment activity. Receipts can be posted to different ledger accounts. Entries automatically update GRAHAM-DORIAN General Ledger or runs as stand alone system. Requires CBASIC-2. Supplied in source ... \$995/\$35
- ① **INVENTORY SYSTEM** — Captures stock levels, costs, sources, sales, ages, turnover, markup, etc. Transaction information may be entered for reporting by salesperson type of sale, date of sale, etc. Reports available both for accounting and decision making. Requires CBASIC-2. Supplied in source ... \$590/\$35
- ① **JOB COSTING** — Designed for general contractors. To be used interactively with other GRAHAM-DORIAN accounting packages for tracking and analyzing expenses. User establishes customized cost categories and job phases. Permits comparison of actual versus estimated costs. Automatically updates GRAHAM-DORIAN General Ledger or runs as stand alone system. Requires CBASIC-2. Supplied in source \$995/\$35
- ① **APARTMENT MANAGEMENT SYSTEM** — Financial management system for receipts and security deposits of apartment projects. Captures data on vacancies, revenues, advertising, etc. Journal entries. Daily report shows late rents, vacancy notices, vacancies, income lost through vacancies, etc. Requires CBASIC-2. Supplied in source ... \$590/\$35
- ① **CASH REGISTER** — Maintains files on daily sales. Files data by salesperson and item. Tracks sales, over-rings, refunds, payouts and total net deposits. Requires CBASIC-2. Supplied in source ... \$590/\$35

**POSTMASTER** — A comprehensive package for mail list maintenance that is completely menu driven. Features include keyed record extraction and label production. A form letter program is included which provides neat letters on single sheet or continuous forms. Complete with NAD files. Requires CBASIC-2 ... \$150/\$15

**STRUCTURED SYSTEMS GROUP**

- ① **GENERAL LEDGER** — Interactive and flexible system providing proof and report outputs. Customization of COA created interactively. Multiple branch accounting centers. Extensive checking performed at data entry for proof, COA, corrections, etc. Journal entries may be batched prior to posting. Closing procedure automatically backs up input files. Now includes Statement of Changes in Financial Position. Requires CBASIC-2 ... \$1250/\$25
- ① **ACCOUNTS RECEIVABLE** — Open item system with output for internal reports and customer credit statement and billing purposes. On-Line Enquiry permits information for Customer Service and Credit departments. Interface to General Ledger provided if both systems used. Requires CBASIC-2 ... \$1250/\$25
- ① **ACCOUNTS PAYABLE** — Provides aged statements of accounts by vendor, with check writing for selected invoices. Can be used alone or with General Ledger and/or with NAD. Requires CBASIC-2 ... \$1250/\$25
- ① **PAYROLL** — Flexible payroll system handles weekly, bi-weekly, semi-monthly and monthly payroll periods. Tips, bonuses, re-imbursments, advances, sick pay, vacation pay, and compensation time are all part of the payroll records. Prints government required periodic reports and will post to multiple SSG General Ledger accounts. Requires CBASIC-2 and 54K of memory ... \$1250/\$25
- ① **INVENTORY CONTROL SYSTEM** — Performs control functions of adding, deleting stock items, adding new items and deleting old items. Tracks quantity of items on hand, on order and back-ordered. Optional hard copy audit trail is available. Reports include District Master Item Lists, Stock Activity, Stock Valuation and Re-order List. Requires CBASIC-2 \$1250/\$25
- ① **ANALYST** — Customized data entry and reporting system. User specifies up to 75 data items per record. Interactive data entry, retrieval, and update facility makes information management easy. Sophisticated report generator provides customized reports using selected records with multiple level break-points for summarization. Requires a disk sort utility such as QSORT, SUPER-SORT or VSORT and CBASIC-2 ... \$250/\$15
- ① **LETTERRIGHT** — Program to create, edit and type letters or other documents. Has facilities to enter, display, delete and mail text, with good video screen presentation. Designed to integrate with NAD for form letter mailings. Requires CBASIC-2 ... \$200/\$25
- ① **NAD Name and Address selection system** — Interactive mail list creation and maintenance program with output as full reports with reference data or restricted information for mail labels. Transfer system for extraction and transfer of selected records to create new files. Requires CBASIC-2 ... \$100/\$20
- ① **QSORT** — Fast sort/merge program for files with fixed record length, variable field length information. Up to five ascending or descending keys. Full back-up of input files created ... \$100/\$20

**CONDIMENTS**

- ① **HEAD CLEANING DISKETTE** — Cleans the drive head/Write head in 30 seconds. Diskette absorbs loose oxide particles, fingerprints, and other foreign particles that might hinder the performance of the drive head. Lasts at least 3 months with daily use. Specify 5" or 8". Single sided ... \$20 each/\$55 for 3 Double sided ... \$25 each/\$65 for 3
- ① **FLIPPY DISK KIT** — Template and instructions to modify single sided 5 1/4" diskettes for use of second side in single sided drives ... \$12.50
- ① **FLOPPY SAVER** — Protection for center holes of 5" and 8" floppy disks. Only 1 needed per diskette. Kit contains centering post, pressure tool and tough 7 mil mylar reinforcing rings for 25 diskettes. 5", Rings only ... \$14.95 5", Kit ... \$7.95 8", Rings only ... \$16.95 8", Kit ... \$8.95
- ① **PASCAL USER MANUAL AND REPORT** — By Jensen and Wirth. The standard textbook on the language. Recommended for use by PascalIZ, Pascal/M and Pascal/MT users ... \$10
- ① **THE C PROGRAMMING LANGUAGE** — By Kernighan and Ritchie. The standard textbook on the language. Recommended for use by BDS C, Tiny C, and Whitesmiths C users ... \$12
- ① **STRUCTURED MICROPROCESSOR PROGRAMMING** — By the authors of SMAL/80. Covers structured programming, the 8051/8085 instruction set and the SMAL/80 language ... \$20
- ① **ACCOUNTS PAYABLE & ACCOUNTS RECEIVABLE** — CBASIC — By Osborne/McGraw-Hill ... \$20
- ① **GENERAL LEDGER—CBASIC** — By Osborne/McGraw-Hill ... \$20
- ① **LIFEBOAT DISK COPYING SERVICE** — Transfer data or programs from one media format to another at a moderate cost ... from \$25

**Hearty Appetite.**

\*CP/M and MP/M are trademarks of Digital Research. Z80 is a trademark of Zilog, Inc. UNIX is a trademark of Bell Laboratories. WHATSIT? is a trademark of Computer Hardware. Electric Pencil is a trademark of Michael Strayzer Software. TRS-80 is a trademark of Tandy Corp. Pascal/M is a trademark of Sorcim.

†Recommended system configuration consists of 48K CP/M, 2 full size disk drives, 24 x 80 CRT and 132 column printer.

② Modified version available for use with CP/M as implemented on Heath and TRS-80 Model I computers.

③ User license agreement for this product must be signed and returned to Lifeboat Associates before shipment may be made.

④ This product includes/excludes the language manual recommended in Condiments.

**Ordering Information**

**MEDIA FORMAT ORDERING CODES**  
When ordering, please specify format code.

Computer system	Format Code	Computer system	Format Code
Altair 8800 Disk	See MITS 3200	RAIR Double Density	RE
Apple + Microcal Software	RA1	Research Machines 8"	RA
BASF System 7100	RD	Research Machines 5 1/4"	RH
Blackhawk Single Density	CG	SD Systems 8"	Q3
Blackhawk Microplus Mod II	CG	SD Systems 5 1/4"	RA
CDS Versatile 3B	Q1	Sorcerer	See Eddy Sorcerer
CDS Versatile 4	Q2	Spacebyte	See Intertec SuperBrain
CDS Versatile 5	Q2	SuperBrain	See Intertec SuperBrain
Cromemco System 3	A1*	Tarbell	A1*
Cromemco Z80	R6	TEI 5W	RD
CSOFT/MSK (Inpel)	A1	TEI 8"	RD
Delta	A1*	Thinklabs	See Morrow Discus
Digi-Log Microform II	RD	TRS-80 Model I 5 1/4"	R2
Digital Microsystems	A1*	TRS-80 Model I + FEC Freedom	RN
Discus	See Morrow Discus	TRS-80 Model I + Micromation	A4*
Durango F-85	RL	TRS-80 Model I + Omikron 5 1/4"	RM
Dynabyte DB2/2	R1	TRS-80 Model I + Omikron 8"	A1
Dynabyte DB4/4	A1*	TRS-80 Model I + Shuffleboard 8"	A1
Eddy Sorcerer + Lifeboat CP/M	Q2	TRS-80 Model II	See Morrow Discus
Eddy Sorcerer + Eddy CP/M	Q4	VDP-40/42/44/80	See IMSAI
Heath 88 + H17/H27	P4	Vector M2	Q2
Heath 88 + Lifeboat CP/M	P4	Versatile	See CDS Versatile
Heath 88 + Magnolia CP/M	P7	Vista V80 5 1/4" Single Density	P5
Heath II	See Processor Technology	Vista V200 5 1/4" Double Density	P6
Horizon	See North Star	Zenith 286 + Lifeboat CP/M	P4
ICOM 2812 Micro Floppy	R3	Zenith 286 + Magnolia CP/M	P7
ICOM 370	A1		
ICOM 3812	A1*		
ICOM 4811 5440 Cartridge CP/M 1.4 01	D1		
ICOM 5111 5440 Cartridge CP/M 2.2 02	D2		
IMS 5000	RA		
IMS 8000	RA1*		
IMSAI VDP-40	RA*		
IMSAI VDP-42	RA*		
IMSAI VDP-44	RA*		
IMSAI VDP-80	RA1*		
Intel MCS Single Density	A1		
Intertec SuperBrain DOS 0.1	RA		
Intertec SuperBrain DOS 0.2	RA		
Intertec SuperBrain DOS 0.3	RA		
Intertec SuperBrain DOS 0.4	RA		
Kontron PSI-80	RF		
Maca 5 1/4"	PS		
Morrow Discus	A1*		
Montek	A1*		
MSD 5 1/4"	RC		
North Star Single Density	P1		
North Star Double/Quad	P2		
Nyac Single Density	Q3		
Nyac Microplus Mod. II	Q2		
MITS 2000 3202	Q1		
Morrow Discus	A1*		
Montek	A1*		
Ohio Scientific C3	A3		
Proce Processor Technology	A1*		
Processor Technology Helios II	B2		
RAIR Single Density	R6		

\*Single-Side Single-Density disks are supplied for users of old Double-Density and Double-Side 8" soft sector format systems.

\*\*MSAI formats are single density with directory offset of zero.

The list of available formats is subject to change without notice. In case of uncertainty, call to confirm the format code for any particular equipment.

Text continued from page 98:

97% uptime is achievable and sounds good, but it means that there is no computer one day per month, and no computer class. The new personal computers have brought the cost down to from \$1000 to \$2000 and have increased robustness dramatically: 97% uptime for personal computers means that out of a collection of ten machines, nine are working all the time and all ten are working most of the time. Class goes on.

On the other hand, the use and administration of a collection of separate personal computers is often extremely difficult. Since personal computers are not linked to a shared-file system, it falls to the teacher to make duplicate cassettes or floppy disks for each machine, to shelve the copies, to retrieve them, to check them out, to check them in, and to periodically revise all copies when a program change is made. Furthermore, loading a program from a cassette is both time-consuming and unreliable. We have found in our Lawrence Hall of Science computer classes that it takes 5 to 10 minutes to succeed in loading ten program tapes into ten computers.

Adding floppy-disk drives cuts the loading time down, but only at great monetary cost. Furthermore, it does nothing to alleviate any of the problems of maintaining a library of hundreds of floppy disks.

Although there have been a few steps in the right direction, some good enough right now for school use, the industry has not yet solved the relatively simple problem of combining a set of microcomputers with a large, centralized, tree-structured file system of the sort found on any decent time-sharing system. That is what schools need, and probably many businesses, also.

The lack of curriculum is another major obstacle to computer education. We simply cannot expect 25 to 50 thousand school teachers to invent curricula and prepare materials for students to use. The fact that anyone is teaching computing today is powerful testimony to their commitment and to the interest computing seems to generate among teachers.

The traditional secondary-school book publishers have nothing to offer schools; instead, they resort to ped-

**NEW! NEW! NEW! NEWSLETTER FROM LIFEBOAT**

- Latest Version Numbers List of Software
- Update on CP/M Users Group
- The Great ZOSO Speaks Out from Behind the Scenes

\$18 ppd. for 12 issues (U.S., Canada, Mexico) \$40. elsewhere  
Send check to "Lifelines," 1651 3rd Avenue, New York, N.Y. 10028 or use your VISA or MasterCard—call (212) 722-1700

Copyright © 1980 Lifeboat Associates. No portion of this advertisement may be reproduced without prior permission.

Prices F.O.B. New York. Shipping, handling and C.O.D. charges extra. Manual cost applicable against price of subsequent software purchase. The sale of each proprietary software package conveys a license for use on one system only.

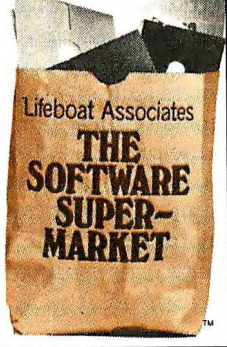

dling books designed for the college market or the hobbyist market—usually programming manuals full of syntax rules and definitions but with little relevant problem-solving semantics. Specific new materials are needed for the schools.

Another obstacle is the lack of trained teachers and educational opportunities to learn to teach computing. I know of only a few schools of education that offer content courses appropriate for a future computer teacher, and they are usually pre-service courses for new teachers. In this job market, what is needed is in-service training for existing teachers who are in the process of becoming computer teachers.

The lack of such a program in schools of education is difficult to explain, especially in these times. It represents just about the only economically viable possibility for an in-service program. The teachers I know would willingly pay for a good program, even if they are at the top of the ladder in their current field.

The last significant obstacle to school-based computer education is the lack of public clamor for such a program. Evidently, if the school is to teach computing, members of the community must foot the bill. Parents who see computer education as little more than game playing are bound to treat it as a frill and give it a lower priority than what they perceive as "the basics." They need to understand that computer problem solving is itself a basic intellectual skill with academic and vocational payoffs.

My recent experience in consulting with schools in several districts in California has given me grounds for optimism about the state of community awareness and concern. I find, for example, many parents whose work involves computer use and who speak convincingly about the need for school-based programs. Other parents are simply impressed that their children are visibly excited by the computer class at school. Although concerned about rising costs and the general quality of education, they seem to recognize that computer education needs to be evaluated on its merits.

### Who Will Take the Necessary Steps?

There is a role for everyone: the

computer industry, textbook publishers, universities, teachers, parents, and government agencies.

The computer industry has to recognize that there is a billion-dollar market for computer equipment in secondary schools (26,000 schools, times fifteen computers per school, times \$2500 per computer). After that soaks in, they have to design and produce an appropriate computer *system* for school use, along the lines suggested earlier: microcomputers connected in a network to a hard disk and printer, plus a tree-structured file system with account security and cross-account access.

The textbook publishers need to support—perhaps in combination with computer manufacturers—one or two substantial curriculum-development projects aimed at producing materials that concern not just the syntax rules of a programming language, but which also focus on general problem-solving applications. I used to think that this was too big a job for the private sector, but the potential \$50 million annual sales volume changed my mind (26,000 schools, times 300 students per year, times \$6 per student manual). A proper job of writing, evaluating, rewriting, field trials, and more rewriting would cost a few million dollars, perhaps, but that can be easily recovered in short order.

University schools of education need to gear up to handle both pre-service and in-service training needs of future schoolteachers of computer classes.

Teachers with an active or latent interest in computing need to inform themselves of career opportunities in this emerging field, find out what other teachers are doing, and put pressure on the schools of education to satisfy their training needs.

Parents need to know why Johnny and Janey should learn to compute as well as read and write. Then they need to develop community support for programs in their junior high schools and high schools.

Finally, government agencies have to keep a close watch on the way computer education develops and evolves in the schools, and possibly to intervene at critical points. In particular, if the private sector is unwilling to risk investment in curriculum, or if certain communities cannot afford to pay for equipment, the federal

government should help to do so, for compelling reasons. Possession of basic computer skills is a distinct vocational and intellectual advantage to the possessor. Declining prices of personal computers put them within easy reach of people who now have the advantages of above-average income and the education to recognize the benefits of knowing about computers. The disadvantaged will be left behind. It is an *entirely appropriate* use of federal funds to provide broad social access to new and powerful skills.

### What About the Adults?

It is probably true that most of the people who need to know about computers and their uses during the next five to ten years are already in the work force. They are, quite frankly, at the mercy of the "U S system of continuing education"—which is no system at all. Among their options are going back to school, evening classes at a community college or university, extension courses, technical training institutes, topical professional seminars, and self-study.

My standing advice to persons faced with such alternatives is to first enroll in a course that will teach them to write computer programs, and to run and debug them by means of hands-on use of an interactive computer system. Such a course should offer both formal instruction and at least ten hours of computer use by the individual. (Beware of lecture and reading courses alone, as well as those using punch-card equipment.)

Such a course should cost less than a hundred dollars and will determine pretty clearly what the next step should be. If the experience has been a good one, then the person may want to take more advanced courses, or to look for specific career-oriented programs in the computer field, or to buy a personal computer and study on his or her own.

### Summary

As a nation we depend more and more on computer technology, on computer applications, and on the success of our computer industry. However, we are also a nation of computer illiterates. The means exist to set in motion education programs that will change the situation.

All we have to do is decide to do it. ■



# ALMOST PERFECT.

The **MAGIC WAND**<sup>TM</sup> is the most powerful, most flexible, most reliable, *most usable* word processing software available for a CP/M<sup>®</sup>-based computer.

That's not bragging. That's just telling it like it is.

The MAGIC WAND is the best word processing software ever written for a microcomputer. It can do more work in less time with higher quality than any other product you can buy.

The MAGIC WAND is a rock solid piece of software. The command structure is simple and logical and complete. We have not tossed in features without thought to the overall design of the package. Nor have we included any feature that is not thoroughly implemented. The programs are crash-proof and completely reliable.

And the system is supported by what we are told is the best user's manual ever produced for microcomputer software. It contains a step-by-step instructional program designed for the novice. The trainee uses sample files from the system disk and compares his work to simulated screens and printouts in the manual.

Support doesn't stop when you buy the package. As a registered user, you receive our bi-monthly newsletter which answers questions, reports upgrades and teaches new applications of the MAGIC WAND.

It's through a lot of hard work that we are able to offer you a product that is "almost perfect," but we aren't about to stop working until we can say that the MAGIC WAND is perfect.

#### Full screen text editing

The MAGIC WAND has probably the most responsive and easy-to-use editor available for either a serial or DMA terminal. It uses only single stroke control keys to give command and takes advantage of the special function keys on your terminal whenever possible. In addition, you can set up library files with coded sections that you can merge by section name.

#### Full text formatting commands

The MAGIC WAND allows you to set the left, right, top and bottom margins, page length, indentation, paragraph indentation, (including "hanging" paragraphs), text left flush, right flush, justified (two ways), literal or centered, variable line and pitch settings, variable spacing (including half lines), bold face, underlining (solid or broken), conditional hyphenation, sub- and superscripting. You may change any of these commands at run-time *without reformatting the file*.

#### Merging with external data files

You may access any external data file, with either fixed length or sequential records. The MAGIC WAND converts the record into variables that you define and can use like any other variable. Of course, you may use the data for automatic form letter generation. But you can also use it for report generation.

#### Variables

You may define up to 128 variables with names of up to seven characters. The current value of a variable may be up to 55 characters, and you may print it at any point in the text without affecting the current format. Although the MAGIC WAND stores the variables as strings, you may also treat them as integer numbers or format them with commas and a decimal point. You may increment or decrement numeric variables or use them in formatting commands.

#### Conditional commands

You may give any print command based on a run-time test of a pre-defined condition. The conditional test uses a straight-forward IF statement, which allows you to test any logical condition of a variable. You may skip over unneeded portions of the file, select specific records to print, store more than one document in a single file, etc.

#### True proportional printing

The MAGIC WAND supports proportional print elements on NEC, Diablo and Qume printers. Other formatting commands, including justified columns, boldface, underline, etc., are fully functional while using proportional logic.

Available on 8" soft-sectored and 5 1/4" Northstar or Micropolis (hard or soft sectored) diskettes, as well as ONYX hard disk. Terminals supported include—ADDS, Beehive, Cromemco, Dynabyte, Hazeltine, Heath, Imsai, Intertec, Lear Siegler, Microterm Act V, Perkin Elmer, Sol VDM1, Soroc, TEC, TEI, Televideo, TRS80 Mod II, Vector Graphics, plus a variety of video boards.

Also available in OASIS

**small business applications, inc.**

3220 Louisiana • Suite 205 • Houston, Texas 77006 • 713-528-5158

CP/M is a registered trademark of Digital Research Corp.

# Book Reviews

## Introduction to Microprocessor System Design

by Harry Garland  
McGraw-Hill Book Company, 1979  
Textbook, \$10.95

One of the most important pieces of hardware in any microprocessor system is an intelligent human user. This book, by one of the country's leading small-systems manufacturers, assumes that the reader has a supportive background in both hardware and software. If basic logic circuits and the binary number system are familiar topics to you, *Introduction to Microprocessor System Design* is the next logical step into the world of small systems. Despite its textbook

format, nowhere does the author leave the discovery of an important concept as "an exercise for the student."

The book is very logical and precise in its layout. It differs from the popular "cookbooks" in that it deals with a wide variety of microprocessor integrated circuits, devoting the whole introductory chapter to a discussion of their similarities and common principles. The following chapters discuss the relative advantages and shortfalls of the various technologies used in implementing microprocessors. The speed-versus-power trade-offs of saturated-bipolar and complementary metal-oxide semiconductor (CMOS) technology are covered, as well as design considerations for N- and P-channel MOS,

emitter-coupled logic (ECL) and Schottky bipolar technologies. The short summary at the conclusion of each chapter should help any design engineer select the proper integrated-circuit technology for a particular application, whether it is for industry or for a hobby.

Throughout the book, the author stresses the need for any designer to understand not only the hardware behind the system he is working on, but also the software that will be required. With this in mind, successive chapters explore the evolution of the microprocessor from an architectural standpoint, which necessarily includes the increased power of new software as well as simplified design considerations, such as number of power supplies required and maximum memory-addressing capacity.

The student is exposed to detailed information on each of the evolutionary steps in microprocessor development (from the 8008 micropro-

cessor through the Z8000) early in the book. This helps to familiarize the student with microprocessors and demonstrates how both hardware and software design have actually become easier despite the increase in complexity. It is here that the reader learns how the increased data processing capacity of the latest generation of 16-bit processors has been accomplished.

Of course, even the latest microprocessor requires support circuitry. Power-supply circuitry, for example, is needed to deliver proper voltages at adequate current levels to both the microprocessor and its associated logic. Power supplies, clock circuitry, external memory, various signal buffers, and additional logic are covered in detailed circuit diagrams. Specific components are labeled, so that by the end of Chapter 4 the reader can construct his own microcomputer.

Even after this point, however, the reader can continue his studies. Later chapters contain information on expanding the basic single-board computer by adding memory and interfacing to peripherals. Important concepts such as synchronized data transfer and the uses of interrupts are covered in detail. Direct-memory-access (DMA) and memory-mapped input/output (I/O) information is presented along with basic and advanced binary arithmetic and assembly and high-level languages.

The final chapters include such topics as interfacing to analog systems and the various bus standards. This last topic emphasizes the flexibility of microprocessor designs and shows how various portions of a single system may be designed by different members of a team, while avoiding the problems of "design by committee."

By following the outline of this text and completing the numerous exercises presented, the reader should be able to pick up information usually found only in college-level courses.

## P&T CP/M® 2 & TRS-80 MOD II versatility!

P&T CP/M 2 is customized to take maximum advantage of the Mod II hardware and still be compatible with standard CP/M.

**So What?** There are hundreds of applications programs available (from dozens of sources) to run under CP/M and most of them can run unmodified on the Mod II with P&T CP/M 2.

**So Why P&T CP/M 2?** When you compare CP/M's for the Mod II you will find that P&T CP/M 2 is way out in front of the pack. We were the first to offer **596K bytes** (610,304 bytes) of storage at double density. We have the most **advanced screen driver** with features like cursor addressing, insert/delete line, optional non-scrolling lines, change cursor size and blink, clear to end of line or screen, read cursor position, read character at cursor, and more. We also support a **time of day clock**, a user supplied real time interrupt routine, and the Line Printer III. Our serial port drivers support, ETX/ACK, XON/XOFF, and status line (CTS and DCD) handshaking.

**Ok - What about documentation?** We supply the 7 standard Digital Research manuals for CP/M plus our own 150 page manual describing in detail how to use P&T CP/M 2.

**What's all this cost?** ONLY \$175! (\$185 after Aug. 1)

We also carry:

MAGIC WAND text processor	\$350
CBASIC2 (improved performance)	\$105
PASCALUM	\$175
Microsoft BASIC-80	\$325

Contact us for latest information.



**PICKLES & TROUT**  
P.O. BOX 1206. GOLETA, CA 93017. (805) 967-9563



CP/M is a trademark of Digital Research Inc. TRS-80 is a trademark of Tandy Corp.

```

REM MERGE SORT USING LINK () FOR INDEX
FUNCTION MERGE (I,J=INTEGER)=INTEGER
VAR T,KM,M=INTEGER
IF ARRAY (I) < ARRAY (J) THEN
BEGIN
M=I
I=J
I=M
END
I=I
KM=I
I=LINK (I)
WHILE K > 0 DO
BEGIN
IF ARRAY (I) < ARRAY (J) THEN
BEGIN
M=I
I=J
I=M
END
LINK(KM)=I
KM=I
I=LINK(I)
END
LINK(KM)=J
END=T
FUNCTION SORT (IS,JS=INTEGER)=INTEGER
VAR KS,II,JJ=INTEGER
IF IS=JS THEN
BEGIN
LINK (IS)=0
RETURNED.VALUE=IS
GOTO OEND
END
KS=IS+(JS-IS)/2
II=LINK (IS,KS)
JJ=LINK (KS+1,JS)
RETURNED.VALUE=MERGE (II,JJ)
OEND
END=RETURNED.VALUE

```

# Now there's no need to switch

This new Structured Basic™ language offers all the power you've been waiting for.

The language produces chainable (passing common variables), relocatable .COM files in the CP/M\* world. It uses CP/M 2.xx capabilities while remaining 1.4x compatible.

**It gives you:** fully defined user functions and procedures (both recursive); local and global variables, functions and procedures; REPEAT - UNTIL, WHILE - DO, IF - THEN - ELSE, BEGIN - END, CASE - OF structure techniques; single and double precision floating point, fixed point packed BCD, integer, string and character data types; packed binary disk storage (requiring no memory / disk type

\*CP/M is a trademark of Digital Research.

conversions); and much, much more... and still retains the flexibility of BASIC.

As a software house always looking for that great, powerful, new language... we're excited about making Structured BASIC™ available to the software community.

**Order your copy now at an introductory price of \$250., from...**

**MICRO•AP, INC.**

9807 Davona Drive  
San Ramon, CA 94583

Telephone (415) 828-6697 **MICRO•AP**

\*Structured BASIC is a trademark of Topaz Programming.

**ONE PROGRAM  
THAT DOES IT ALL!**

REPORT

CREATE

LABEL

High Tech's

**DATA BASE MANAGEMENT SYSTEM**

MODIFY

UPDATE

SORT

DELETE

SELECT

Now you can organize and manipulate large amounts of related data to meet YOUR application needs. DBMS's user-designed system layout and report format allows for wide-range flexibility and utility, making this a truly multi-purpose, highly individualized program.

All this, plus High Technology's unsurpassed combination of performance, clarity, and quality in an affordable program that does it all.

Software with

**HIGH TECHcitement**

Exciting business solutions using the Apple II.™ See your dealer or write High Tech for details.



High Technology, Inc.™  
P.O. Box 14665 · Oklahoma City, Oklahoma 73113  
(405) 840-9900

*Introduction to Micro-processor System Design* will continue to be useful after the first reading, because it makes an excellent reference book.

Curtis P Feigel  
Editor

### The Nature of Human Consciousness

Robert E Ornstein, Editor  
W H Freeman, 1973  
Softcover, \$8.95

*The Nature of Human Consciousness* is a book of readings on the workings of the mind. As such, it is valuable for two groups of readers in the computing field: those involved in artificial-intelligence research and development, and those who are trying to design "user-friendly" computer systems. That the book is of interest to the former is probably obvious; it is of interest to the latter group because of the difficulty of designing good user interfaces without knowing how users will perceive sensory inputs and react to them. A working knowledge of how the human information processing system (IPS) functions is a good antidote to batch mentality and to abominations like IBM Job Control Language (JCL).

In *The Nature of Human Consciousness*, Robert Ornstein has drawn together readings from several fields: psychology, medicine, anthropology, and oriental philosophy. The last may seem out of place to those who regard oriental thought as so much mumbo jumbo. It is not. (Since I have a Master of Arts degree in Chinese philosophy, I confess the possibility of prejudice here.) While reading several of the earlier medical studies on brain functions, I was impressed to see that the results of these studies differed from standard Western thought, and that they were compatible with the classical Chinese point of view. Having marked up my

copy of the book with comments on this, I was delighted to find that the next section contained a concise summary of the Chinese point of view on the dual nature of the mind. Of course, the book is dominated by current Western studies on the nature of mind and consciousness. The major advantage of reading this collection is that the editor has made an extremely good choice of articles. Unless you are trying to do original research in the area, this book provides a very time-efficient way of getting "on-line."

The main theme of the book seems to be the dual nature of the brain (right-hand and left-hand) and its impact on the way we perceive things. Consideration of these implications would be valuable for anyone working with computer graphics, since the "unknown" right side of the brain is the one that deals more with shapes and forms rather than with words. The various articles in the book might also provide inspiration for those who want to use computers to expand creativity and self-awareness.

In short, this is a good sourcebook for modern theories of human consciousness, useful for anyone who needs to better understand how people think. ■

John A Lehman  
716 Hutchins #2  
Ann Arbor MI 48103

A Public Service of The Magazine & The Advertising Council 

**Need help?  
Call us.  
Want to help?  
Call us.**

 **Red Cross is  
counting on you.**

# THE ORIGINAL MAGAZINE FOR OWNERS OF THE TRS-80™\* MICROCOMPUTER

SOFTWARE  
FOR TRS-80™  
OWNERS

# H & E COMPUTRONICS INC.

MONTHLY  
NEWSMAGAZINE  
FOR TRS-80™  
OWNERS

## MONTHLY NEWSMAGAZINE Practical Support For Model I & II

- PRACTICAL APPLICATIONS
- BUSINESS
- GAMBLING • GAMES
- EDUCATION
- PERSONAL FINANCE
- BEGINNER'S CORNER
- NEW PRODUCTS
- SOFTWARE EXCHANGE
- MARKET PLACE
- QUESTIONS AND ANSWERS
- PROGRAM PRINTOUTS
- ... AND MORE

### PROGRAMS AND ARTICLES PUBLISHED IN OUR FIRST 12 ISSUES INCLUDE THE FOLLOWING:

- A COMPLETE INCOME TAX PROGRAM (LONG AND SHORT FORM)
- INVENTORY CONTROL
- STOCK MARKET ANALYSIS
- WORD PROCESSING PROGRAM (FOR DISK OR CASSETTE)
- LOWER CASE MODIFICATION FOR YOUR VIDEO MONITOR OR PRINTER
- PAYROLL (FEDERAL TAX WITHHOLDING PROGRAM)
- EXTEND 16-DIGIT ACCURACY TO TRS-80™ FUNCTIONS (SUCH AS SQUARE ROOTS AND TRIGONOMETRIC FUNCTIONS)
- NEW DISK DRIVES FOR YOUR TRS-80™
- PRINTER OPTIONS AVAILABLE FOR YOUR TRS-80™
- A HORSE SELECTION SYSTEM\*\*\* ARITHMETIC TEACHER
- COMPLETE MAILING LIST PROGRAMS (BOTH FOR DISK OR CASSETTE SEQUENTIAL AND RANDOM ACCESS)
- RANDOM SAMPLING\*\*\* BAR GRAPH
- CHECKBOOK MAINTENANCE PROGRAM
- LEVEL II UPDATES\*\*\* LEVEL II INDEX
- CREDIT CARD INFORMATION STORAGE FILE
- BEGINNER'S GUIDE TO MACHINE LANGUAGE AND ASSEMBLY LANGUAGE
- LINE RENUMBERING
- AND CASSETTE TIPS, PROGRAM HINTS, LATEST PRODUCTS COMING SOON (GENERAL LEDGER, ACCOUNTS PAYABLE AND RECEIVABLE, FORTRAN-80, FINANCIAL APPLICATIONS PACKAGE, PROGRAMS FOR HOMEOWNERS, MERGE TWO PROGRAMS, STATISTICAL AND MATHEMATICAL PROGRAMS (BOTH ELEMENTARY AND ADVANCED) ... AND

**FREE**

- WORD PROCESSING PROGRAM (Cassette or Disk) For writing letters, text, mailing lists, etc., with each new subscriptions or renewal.
- LEVEL II RAM TEST (Cassette or Disk) Checks random access memory to ensure that all memory locations are working properly.
- DATA MANAGEMENT SYSTEM (Cassette or Disk) Complete file management for your TRS-80™
- CLEANUP (Cassette or Disk) Fast action Maze Game
- ADVENTURE (Cassette or Disk) Adventure #0 by Scott Adams (From Adventureland International)

**FREE**

\* TRS-80™ IS A TRADEMARK OF TANDY CORP.

SEND FOR OUR NEW 48 PAGE SOFTWARE CATALOG (INCLUDING LISTINGS OF HUNDREDS OF TRS-80™ PROGRAMS AVAILABLE ON CASSETTE AND DISKETTE). \$2.00 OR FREE WITH EACH SUBSCRIPTIONS OR SAMPLE ISSUE.

## H & E COMPUTRONICS INC.

Box 149 New City, New York 10956

- ONE YEAR SUBSCRIPTION \$24 .....
- TWO YEAR SUBSCRIPTION \$48 .....
- SAMPLE OF LATEST ISSUE \$ 4 .....
- START MY SUBSCRIPTION WITH ISSUE .....
- (#1 - July 1978 • #7 - January 1979 • #12 - June 1979 • #18 - January 1980)
- NEW SUBSCRIPTION ..... RENEWAL .....



**24 HOUR ORDER LINE**  
**(914) 425-1535**



**NEW TOLL-FREE ORDER LINE**  
**(800) 431-2818**  
(OUTSIDE OF N.Y. STATE)

CREDIT CARD NUMBER \_\_\_\_\_ EXP. DATE \_\_\_\_\_

SIGNATURE \_\_\_\_\_

NAME \_\_\_\_\_

ADDRESS \_\_\_\_\_ CITY \_\_\_\_\_ STATE \_\_\_\_\_ ZIP \_\_\_\_\_

\*\*\* ADD \$6/YEAR (CANADA, MEXICO) - ADD \$12/YEAR AIR MAIL - OUTSIDE OF U.S.A., CANADA & MEXICO \*\*\*

Text continued from page 10:

proved. This covers skills in elementary mathematics and in the language arts.

An additional review of thirty-two studies in simulation and adaptive testing provides further support for the notion that computer-based education can be an improvement over conventional educational methods. This study (see reference 7) performed by HumRRO for the Office of Technology Assessment is

summarized in table 1. The majority of these studies show savings in the learner's time to complete a course of study (as much as 50% savings), greater efficiency in terms of achievement per unit of time, improved skills, and the provision of instruction not previously available by the conventional method. As noted in the review, the studies cut across all levels of education and include training as well.

B. Because we are moving into an information age, and because computers are becoming ubiquitous in our society, it is essential that we develop a computer-literate society.

Licklider (reference 8) makes the observation that:

*The world is rapidly moving into the information age. In order to make the transition*

Source	Time saved	Cost saved	Greater efficiency	Improved skills	Provision of training not previously available
S Abernathy and McBride, 1978	+	+	+	+	+
S Allen, 1976	+	+	+	+	+
T Bejar et al., 1977	+	0	+	+	+
S Bentz, 1975	+	-	+	+	+
S Brown et al., 1977	+	0	+	+	+
S Brown, 1977	+	0	+	+	+
T Brown and Weiss, 1977	+	+	+	+	+
S Buchanan, 1978	+	+	+	+	+
S Ellis, 1978	+	-	+	-	+
S Gregory, 1975	+	-	+	+	+
T Guerra et al., 1977	+	0	+	+	+
T Hansen et al., 1974	+	+	+	+	+
S Johnson, 1976	0	0	0	+	+
T Lippey and Partos, 1976	+	0	+	0	+
T McLain and Wessels, 1975	+	0	+	+	+
S Misselt and Call-Himwich, 1978	-	-	-	-	-
S Mockovak et al., 1974	+	-	+	+	(conventional superior)
S Orlansky and String, 1977	+	+	+	+	+
S Puig, 1976					
Tanks	0	+	0	0	-
Aircraft carrier	+	0	+	+	+
Weapons trainer	+	+	+	+	-
Air traffic controller	+	0	+	+	-
Automobile	0	+	+	+	-
Airborne ECN system	+	+	-	+	-
S Roberts, 1977	+	+	+	+	+
T Sealy, 1975	+	0	+	0	+
T Vale, 1977	+	+	+	+	+
S Willey, 1975					
Dartmouth	+	0	+	+	+
Ohio State	+	-	+	-	+
University of Wisconsin	0	-	+	+	+
University of Illinois	+	0	+	+	+
University of Michigan	+	+	+	+	+
Totals	+	13	28	26	25
	-	7	2	3	7
	0	12	2	3	0

Key: S = simulation  
T = testing  
+ = positive results  
- = no significant difference  
0 = no results

SOURCE: Human Resources Research Organization, 1978.

Source: *Computer Technology in Medical Education and Assessment*, page 25.

**Table 1:** Summary of the results of thirty-two studies on the effectiveness of computerized simulations and testing in the classroom. The majority of these studies show savings in the learner's time to complete a course of study (as much as 50% savings), greater efficiency in terms of achievement per unit of time, improved skills, and the provision of instruction not previously available by conventional methods.

# SIEMENS

## 4 OF A KIND

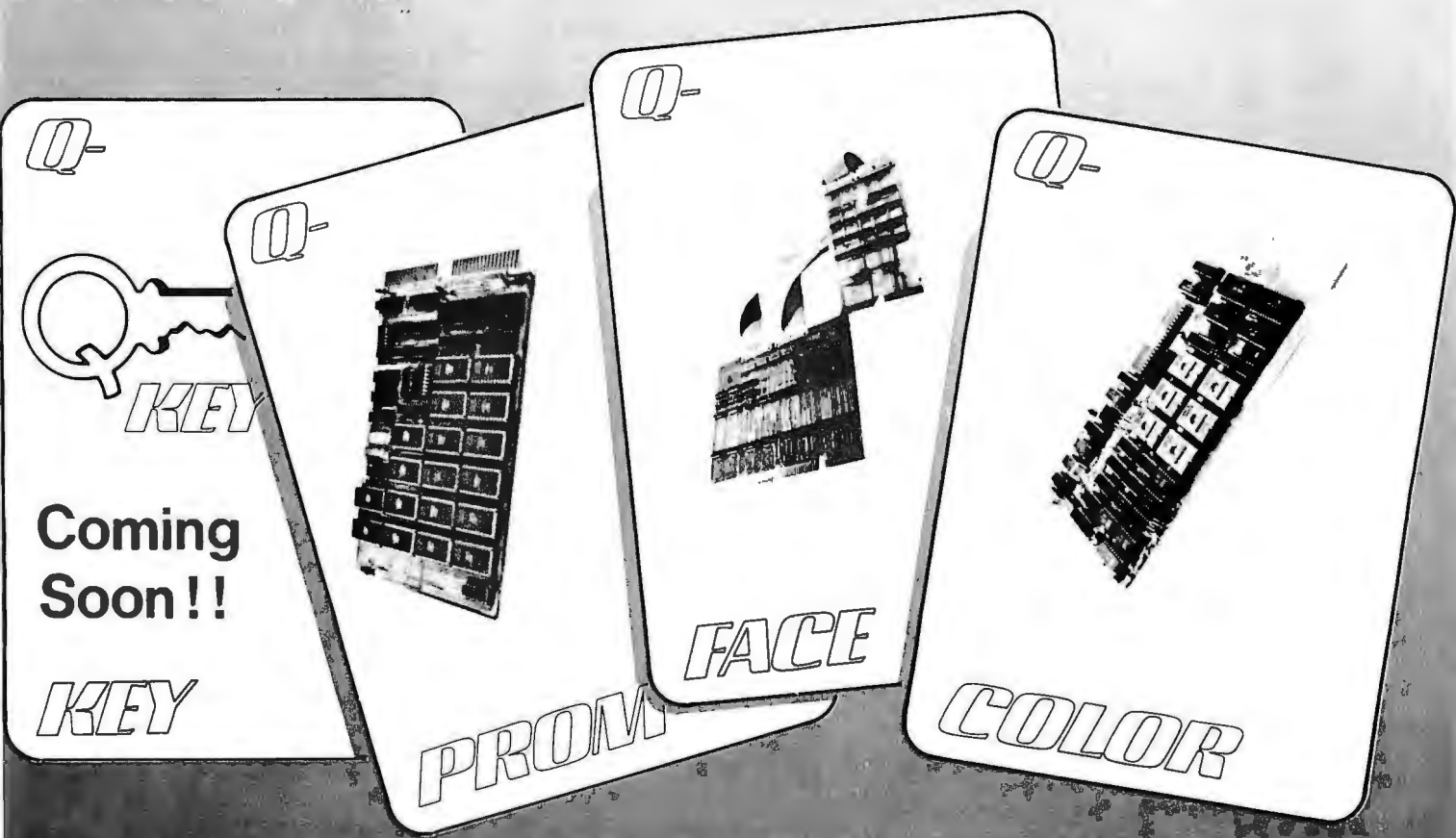

When you are looking for efficient, cost-effective ways to develop your LSI-11\* product, turn to SIEMENS for answers. We deal winning hands starting with Q-Face, the Q-Bus\*-Unibus\* translator that lets your PDP-11\* act as a development system or use LSI-11\* peripherals on your PDP-11\*. Need Color displays? Q-Color is plug-compatible with the LSI-11\* and generates user-defined character sets in 8 colors, without CPU overhead.

If you have lots of program, but minimal space in your backplane, the 16K x 16 bit Q-Prom is for you.

**Distributor inquiries invited**

All that memory density on a dual board for your LSI-11\* costs only a medium density price.

So, for a complete hand on the deal, come to SIEMENS for the right cards the first time.

For more information contact:

Digital Systems

Siemens Electric Limited

9829 - 45 Avenue

Edmonton, Alberta, Canada T6E 5C8

Tel: (403) 436-6640

Tlx: 027-2300 TWX: 610-831-1566

**Q-KEY**  
Model 11

**Q-PROM**  
Model 816

**Q-FACE**  
Model 54

**Q-COLOR**  
Model 45

wisely and well, the public must understand information science and technology. People must master the technology or be mastered by it.

Molnar (reference 9) comments:

*A nation concerned with its social needs and economic growth cannot be indifferent to the problems of literacy. If we are to reap the benefits of science-driven industry, we must develop a computer-literate society.*

C. *Computers will move into our homes and our schools whether or not anyone does anything to ensure their effective use.*

This contention is underscored in a recent survey (reference 10) by Creative Strategies Inc, a market research firm, which indicates that school purchases of microcomputers will quadruple in the four years between 1978 and 1982. Their projections are that the unit purchases by

## Computers will move into our homes and our schools whether or not anyone does anything to ensure their effective use.

schools on a national basis will grow from 26,700 in 1978 to 105,000 in 1982. Secondly, the estimates are that 70% of the demand will originate in elementary and secondary schools. Thirdly, a justification for the use of the microcomputer as opposed to the "maxicomputer" (ie: the large time-sharing computer), according to their survey, is based upon decreased cost and increased ease of use. Control Data Corporation's PLATO system (the major one that is being marketed today as a system in the maxicomputer field for education) costs \$10,000 per terminal and roughly an additional \$800 a month for usage fees. A typical microcomputer system costs in the range of \$500 to \$2500, depending on the peripheral devices purchased with it.

It is imperative that computers

enter our educational system in an orderly, intelligent manner, in contrast to our experience with television. In its infancy, television offered educators an excellent learning tool. Unfortunately, we did not capitalize on its potential. It was dominated by commercial interests and became the "wasteland" many people decry. Massive efforts by the Public Broadcasting Service (PBS) with series like *Nova*, and the Children's Television Workshop with *Sesame Street*, although excellent demonstrations of the role that television could play in education, have little overall impact because of the entrenchment of commercial interests.

If the educational community (including federal agencies and private foundations interested in education) does not move forcefully and soon to ensure proper support for teachers and students in making intelligent use of personal computers, computers will become the "wasteland" of the 1980s, being used for playing more and more sophisticated versions of "Star Wars" games, instead of helping our young people to develop their intellects to the fullest extent possible.

D. *There is an inequality of opportunity across the spectrum of our society.*

For a wide variety of reasons, young people from our lower socioeconomic levels currently do not obtain the same benefits from our educational system as do their contemporaries in middle- and higher-income communities. Already schools in the latter category are purchasing personal computers in large numbers (eg: in several Long Island school districts there is at least one personal computer in each elementary school), while inner-city schools are unable to find the funds to participate in this "revolution."

Every year that goes by widens the gap in the preparation between the young people in these two groups at social, human, and economic costs which cannot be tolerated in a modern democratic society.

E. *Our present educational system is a mature industry which cannot be improved even with massive infusions of funds.*

The urgency of the need of our

### Attention COMPUTER DEALERS!



**MULTI-TERMINAL COMPUTERS**

THE NEW IBC SYSTEM 40 OFFERS MULTI-USER PERFORMANCE AT SINGLE-USER PRICES.

- Up to 6 CRT/printers can operate independently and simultaneously.
- 64K to 128K BYTE memory.
- 2-24 M BYTE disk storage.
- Multi-user wordprocessing concurrent with data processing.

The IBC System 40 was designed from the ground up to be a true multi-user, multi-tasking computer, and at prices below those of single-user systems. For pricing and complete information on IBC dealerships contact

**IBC/Integrated Business Computers**

22010 S. Wilmington Ave., Suite 306, Carson, CA 90745 (213) 518-4245



# SYNCHRO-SOUND

The ORIGINAL Computer People  
who KNOW Computers  
and offer EVERYTHING you need  
in Small Computer Systems



## TERMINALS

ADDS Regent 25

## LEAR SIEGLER

ADM 3A  
ADM 31  
ADM 42

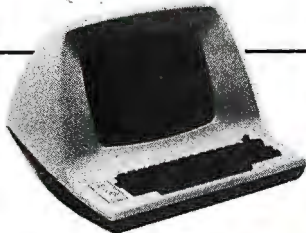

## SOROC Technology

IQ 120  
IQ 140



## PRINTERS

### QUME Sprint

5/45 KSR  
5/55

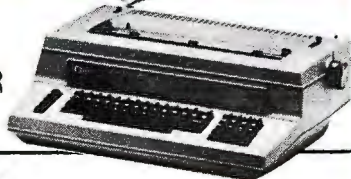

DECwriter IV  
LA 34

TELETYPE  
43

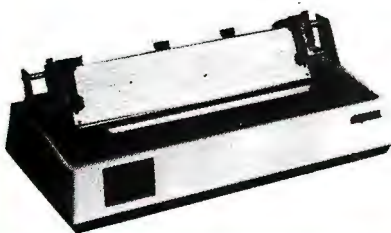
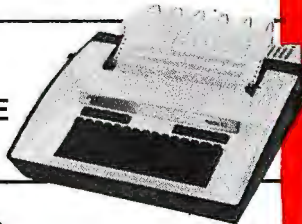

OKIDATA  
Microline 80

A PERFECT  
SUPER SPECIAL MATCHED PAIR!



Texas Instrument  
810 Multi Copy  
Impact Printer  
150 characters per sec.  
bi-directional printing



Intertec  
Super Brain  
Computer Terminal  
Dble. Density Dual Mini-  
Floppies, CPM based  
Development or Business System

ONLY \$3995.

## COMPUTERS

### DIGITAL SYSTEMS

HDS 4004  
14 Megabyte  
Hard Disk



NORTHSTAR  
HORIZON II  
HORIZON II Quad

### CROMEMCO System 3

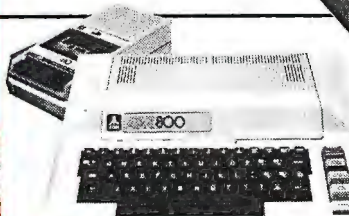
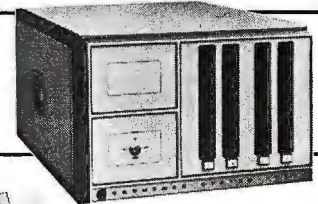

ATARI  
400  
800

## MORE SPECIALS

Okidata SL125 . . . . .	\$2595.00	Livermore Acoustic Coupler . . . . .	\$195.00
Okidata SL300 . . . . .	2995.00	Centronics Micro Printer . . . . .	349.00
Persci277 . . . . .	1395.00	5" Scotch Diskette Box . . . . .	34.95
Integral Data Systems Paper Tiger Printer . . . . .	895.00	8" Scotch Diskette Box . . . . .	39.95
Televideo 912 . . . . .	825.00		
Televideo 920 . . . . .	895.00		

MANY OF OUR PRICES ARE TOO LOW  
TO ADVERTISE. PLEASE CALL OR WRITE

We carry a full line of Alpha-Micro Products.  
We have a full staff of Programmers and Computer  
Consultants to design, configure and deliver a Turnkey  
Computer System to meet your specific requirements.



# SYNCHRO-SOUND

ENTERPRISES, INC.

THE COMPUTER PEOPLE  
193-25 Jamaica Ave., Jamaica, New York 11423 • TWX 710-582-5886

PHONE ORDERS, CALL:  
New York 212/468-7067  
Los Angeles-213/628-1808  
Chicago-312/641-3010  
Dallas 214/742-6090

educational system for help is presented very effectively by Dr Dustin Heuston, Chairman of the World Institute for Computer-Aided Teaching (reference 11). He points out that:

- Our current educational-delivery system is mature—ie: it is insensitive to additional investment. He feels that the system cannot be improved without the dramatic change producible only with new technologies.
- The current educational-delivery system provides about 15 seconds of personal attention per hour. With computers, that proportion can reach almost 100%.
- Dr Heuston describes an interesting analogy which is instructive for all educators: "If this were 1478, the business of foundations and government would be to encourage the introduction of the book into the educational system, not to work with monks in monasteries to improve their manuscript production abilities by

funding studies on handwriting legibility, the placement of candles for lighting, or the design of better pens or superior ink."

- After many years of expensive efforts to improve teacher productivity and other aspects of the educational system, the system seems to have achieved its maximum effectiveness.

### What Must We Do?

The evidence in favor of placing computers in our schools in massive numbers is already compelling and growing stronger every year. In addition, there is danger that the United States will lose its world leadership in this field. Most of the countries represented at the International Federation for Information Processing (IFIP) Working Conference on Computer-Assisted Learning in September 1979 have a national effort in place to bring computers into their schools (eg: France has a program called "Ten Thousand Computers in the Schools").

Dr Sylvia Charp, of the Phila-

delphia School System, points out that for at least a decade, visitors have come from many foreign countries, learned about our successes and failures, and have gone home to implement programs of their own. Especially within the past three to five years, these programs have been national in scope and have been funded at significant levels. During this same period, little funding has been available in the United States for such activities, and what has been available has had no focus.

Despite this lack of national commitment, there are a number of active efforts around the United States, including:

- Bob Albrecht (the Dragon and Friend of Children), who is well on his way to turning Menlo Park, California, into Computer Town USA.
- Karen Billings and her Microcomputer Resource Center at Columbia Teachers College, which provides advice and hands-on experience for New York area educators.
- This author and Jo Ann Comito and their Laboratory for Personal Computers in Education, which has been in existence for five years providing advice for educators nationally, and which has developed a graduate program in computers in education as well as a large number of courseware units.
- Sylvia Charp, the "grand lady" of educational computing, who has more experience with the *real* world of computers in education than anyone else in the world.
- Tom Dwyer, who, for over a decade, has been developing novel ways of using computers to provide learning environments for our young people. [See his article on page 74 of this issue....CM]
- Judy Edwards of the Northwest Regional Educational Laboratory in Portland, Oregon, who recently received a federal grant to establish a clearinghouse for microcomputer-based courseware.
- Joyce Hakansson of Children's Television Workshop, who, in conjunction with the Busch Gardens people, is developing neighborhood parks with micro-

## TRS-80, PET, APPLE, SORCERER

### Communications Interface Systems



- Send & Receive Morse Code / Radioteletype
- Teaches Morse Code! / Copies wire services!
- Complete Hardware & Software Package
- Extensive User Manuals
- From \$129

**Write or call for complete catalog**

**MACROTRONICS, inc. ®**

1125 N. Golden State Blvd. / Suite G  
Turlock, CA 95380 (A)  
(209) 667-2888 / 634-8888

California residents add 6% tax





We are experiencing telephone difficulties, please keep trying.

# Your micro-computer deserves the best in data base management

**Get the most out of your micro-computer.** Use an advanced and progressive data management system...one with many large-computer features...one designed to meet your present *and* future needs.

**HDBS** is an extended hierarchial data base system offering

- fixed length records
- file-level read/write protection
- one-to-many set relationships

**MDBS** is a full network data base system offered as an upgrade from HDBS...or it may be ideal as your initial system. **Unique and versatile**, it adds these features:

- full network CODASYL-oriented data structures
- variable length records
- multiple levels of read/write protection
- one-to-one, many-to-one, and many-to-many sets
- non-redundancy of data, easy updating
- occurrences of a record type may own other occurrences of the same type
- a single set may have multiple owner and member record types

**MDBS-DRS.** As an add-on to MDBS, the DRS system offers extraordinary flexibility in data base restructuring to meet new needs.

- Item, record, and set types can be added, deleted, or renamed in an existing data base as well as other data base characteristics. You can redesign the data base after it is already on-line!

**MDBS-RTL.** As an add-on to MDBS, the RTL (Recovery Transaction Logging) logs all data base transactions, so that in the event of a system failure, the data base can be recovered with minimal loss of information.

- The recover processor permits selective reloading of the data base from the transaction file. Users can log messages, indicate complex transaction sequences, and effect selective control over the recovery process.

## HDBS and MDBS Packages Include:

- DDL data definition language analyzer/editor
- 260-page users manual
- DMS data management routines callable from host language
- Sample application program and DDL files
- Relocator to re-org all routines
- System specific manual for bringing up our software



**Coming soon:** Query System/ Report Writer, Multi-User Versions of MDBS, and a Z8000 Version.

**Write or call for free copy of 54-page "primer" on data base systems for micro-computers.**

## Both HDBS and MDBS Systems . . .

- Run under . . .  
CP/M with Microsoft BASICs, FORTRAN or COBOL, InterSystem PASCAL/Z, Sorcim PASCAL/M, MVT/FAMOS with BASIC, TRSDOS and NEWDOS (Models I and II) with Disk BASIC, OASIS with BASIC, North Star DOS with North Star BASIC, Apple DOS and Applesoft BASIC, Machine Language Interface available on all above systems.
- Up to 254 record-types definable in the data base; each record-type may contain up to 255 item-types; each item-type may be up to 9,999 bytes in length.
- Names of data items, records, sets, and files are wholly user definable.
- Commands to add, delete, update, search, and traverse the data base.
- Straightforward use of ISAM-like structures.
- Records can be maintained in several sorted orders.
- Written in machine language for maximum execution efficiency and minimal memory usage.
- Independent of types and sizes of disk drives. Support data base spread over several disk drives (max. 8); disks may be mini- or full-sized floppies or hard disks.
- Available in versions Z80 (requires approx. 18K), 6502 (approx. 26K), 8080 (approx. 22K), and 8086 (approx. 22K).

## Ordering and pricing information:

HDBS - Z80	\$250.00	When ordering, specify intended use with . . . 1. North Star DOS and BASIC 2. CP/M - Microsoft BASIC 4.XX 3. CP/M - Microsoft BASIC 5.XX 4. CP/M - Microsoft BASIC Compiler or FORTRAN-80 5. CP/M - Microsoft COBOL-80 6. CP/M - InterSystem PASCAL/Z 7. CP/M - Sorcim PASCAL/M 8. TRSDOS/NEWDOS and TRS Disk BASIC (Models I and II) 9. Apple DOS and Applesoft BASIC 10. Machine Language Interface (Specify operating system) 11. MVT/FAMOS and BASIC 12. OASIS and OASIS BASIC
HDBS - 6502	325.00	
HDBS - 8080	325.00	
HDBS/MDBS Manual	35.00	
HDBS - Upgrade to MDBS	550.00	
System Specific Manual (each)	5.00	
MDBS - Z80	\$750.00	
MDBS - 6502	825.00	
MDBS - 8080	825.00	
MDBS/HDBS Manual	35.00	
MDBS - DRS add-on	100.00	
MDBS - DRS Manual	5.00	
MDBS - RTL add-on	300.00	
MDBS - RTL Manual	5.00	

For machine language callable forms, add \$75.00

We accept Visa and Master Charge.

Add \$2.50 handling fee for non-cash order (\$5.00 outside U.S.).

Indiana residents add 4%.

**Finally, our software may cost a little more . . . but it's worth a lot more in quality and versatility.**

# Micro Data Base Systems, inc.

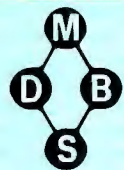

Box 248, Lafayette, Indiana 47902 / 317-742-7388

computer halls to make such equipment easily accessible to children.

- Arthur Luehrmann of the Lawrence Hall of Science, who has developed a variety of innovative ways of using microcomputers in a museum setting. [See his article on page 98 of this issue....CM]
- The staff of the Minnesota Educational Computing Consortium, which has established a statewide network of microcomputer users and has developed a large library of courseware.
- Seymour Papert (the father of the LOGO language), who is conducting an exciting experiment with a group of children who are in an environment where each child has instant access to a personal computer at home and at school. [Look for his article in a future issue of BYTE ....CM]
- Michael Zabinski, who runs a summer overnight camp where children learn about computers.
- Karl Zinn of The Center for Research on Learning and Teaching at the University of Michigan at Ann Arbor, who serves as a source of information, courseware, and advice to school people all over the US.

Although these groups are making important and continuing contributions to the field, and although there is informal communication among these people, there is no national focus and, in toto, inadequate funding to accomplish the tasks that must

be carried out to achieve the goal of improving education using the computer.

The essential problem here is that the private sector (ie: publishers and computer manufacturers) is unwilling to commit resources at the level required because the market has not developed sufficiently to ensure profitability in courseware production. Consequently, until courseware is developed in sufficient quantities, school people are unwilling to commit *their* resources to the provision of computing power for their students—thus establishing a “vicious cycle” which will dissipate very slowly unless there is substantial intervention. Because of the magnitude of funding required to develop a market of sufficient size that the private sector will take over, such funds must come from the federal government.

This problem was recognized a decade ago, and efforts have been under way for several years to obtain federal funding to establish one or more national centers for computers in education. The earliest of these arose as a set of recommendations by the Carnegie Commission on Higher Education in 1972 (reference 12), while the most recent is a bill (reference 13) introduced into the House of Representatives by Long Island Congressman Thomas Downey. [The text of this bill was published in the June 1980 BYTE, beginning on page 186....RSS]

Such national centers will serve the educational community by:

1. Keeping abreast of developments in information technology.
2. Advising educators about capabilities and limitations of hardware and courseware.
3. Training teachers in the uses of computers in learning environments.
4. Developing large amounts of high-quality courseware and training teachers to develop their own.

A serious look at the amount of effort required to accomplish these purposes at a significant level reveals that the funding levels of these centers must be 1 to 3 million dollars per year.

In the present economic climate, such sums appear to be difficult to obtain. But when we weigh these sums against the cost to individuals and to the nation of lost educational opportunity and inadequate intellectual development of many of our young people, the choice is clear. ■

---

#### Acknowledgements

Although this author takes full responsibility for the content of this article, the ideas expressed herein emerged, in part, from a series of discussions during the fall of 1979 with Dr Norman Kurland of the New York State Education Department, Dr Robert Seidel of HumRRO, and Dr Karl Zinn of The Center for Research on Learning and Teaching at the University of Michigan at Ann Arbor. This author gratefully acknowledges their contributions of ideas which helped him to formulate his own.

The author wishes also to acknowledge the assistance of the Alfred P Sloan Foundation, which provided partial support for the development of the ideas expressed here.

---

---

#### References

1. Hargan, C, N Hibbits, and R Seidel, *DC Secondary Schools Project for Adopting Computer-Aided Education* (HumRRO Final Report 78-11), Human Resources Research Organization, Alexandria VA, August 1978.
2. Mason, R E A, and R Seidel, *Individualization Project of the Ontario Institute for Studies in Education* (Consulting Report), December 12, 1978.
3. Vinsonhaler, J F, and R K Bass, "A Summary of Ten Major Studies on CAI Drill and Practice," *Educational Technology*, July 1972, pages 29 thru 32.
4. Jamison, D, P Suppes, and S Wells, "The Effectiveness of Alternative Instructional Media: A Survey," *Review of Educational Research*, volume 44, 1974, pages 1 thru 67.
5. Edwards, J, et al, "How Effective is CAI? A Review of the Research," *Educational Leadership*, volume 33, November 1975, pages 147 thru 153.
6. Thomas, D B, "The Effectiveness of Computer-Assisted Instruction in Secondary Schools," *AEDS Journal*, volume 12, number 3, 1979, pages 103 thru 116.
7. *Computer Technology in Medical Education and Assessment* (Background Report), Office of Technology Assessment, Congress of the United States, Washington DC, September 1979.
8. Licklider, J C R, "Impact of Information Technology on Education in Science and Technology," *Technology in Science Education: The Next Ten Years*, Directorate for Science Education, National Science Foundation, Washington DC, July 1979.
9. Molnar, Andrew, "The Next Great Crisis in American Education: Computer Literacy," *T. H. E. Journal*, volume 5, number 4, 1978, pages 35 thru 38.
10. *Instructional Technology*, August 1979.
11. Heuston, Dustin H, *Technology and the Educational Delivery System*, WICAT Inc, Orem UT, Fall 1978.
12. *The Fourth Revolution: Instructional Technology in Higher Education*, A Report and Recommendations by The Carnegie Commission on Higher Education, McGraw-Hill Book Company, New York, June 1972.
13. Downey, Thomas J, *H. R. 3822*, "A Bill to Amend Title III of the Elementary and Secondary Education Act of 1965 to Establish a National Center for Personal Computers in Education," 96th Congress, 1st Session, 1979.
14. *Exemplary Institutions in Academic Computing*, HumRRO, Washington, DC, January 1978.

# What's the difference between BASIC and Pascal?

## COMPARE THESE APPROACHES TO DRAWING A CIRCLE

### in BASIC

"This is easy..."

```
100 MOVE R,0
110 FOR T=0 TO 360 STEP 25
120 DRAW R* $\cos(T)$ , R* $\sin(T)$ 
130 NEXT T
```

"Oops, didn't quite meet ..."

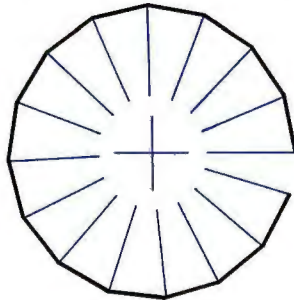

... but that's easy to fix."

```
100 MOVE R,0
110 FOR T=0 TO 360 STEP 25
120 DRAW R* $\cos(T)$ , R* $\sin(T)$ 
130 NEXT T
```

"Oh, now it closes ...  
in fact, it overlaps."

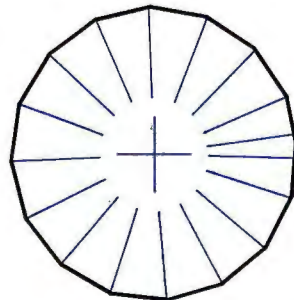

Programming by trial and error

### in Pascal

"The simplest circle drawn with line segments is a regular polygon ..."

```
procedure Circle (X, Y, Radius: real);
const Sides = 16; Pi = 3.14159265;
var N: integer; Theta: real;
begin
  Move (X+Radius,Y);
  for N: = 1 to Sides do begin
    Theta: = 2 * Pi * (N/Sides);
    Draw (Radius *  $\cos$  (Theta) + X,
          Radius *  $\sin$  (Theta) + Y);
  end;
end;
```

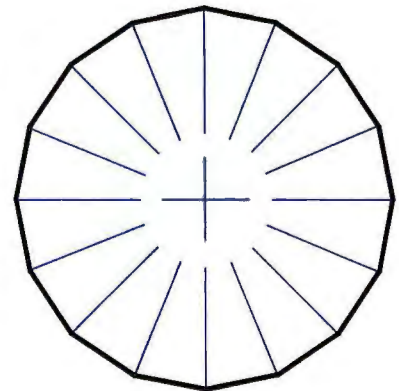

Programming by design

## GET IT RIGHT THE FIRST TIME

### INTERNATIONAL DISTRIBUTORS

Australia: Sydney  
Network Computer Services  
290-3677

Canada: Vancouver  
Valley Software  
(604) 291-0651

England: London  
Real Time Products  
01-588-0667

Japan: Tokyo  
Rikai Corporation  
03-345-1411

If you like the feel of precision tools, give us a call or return this coupon.

# Oregon Software

2340 SW Canyon Road • Portland, Oregon 97201  
(503) 226-7760 • TWX 910-464-4779

Name \_\_\_\_\_

Firm \_\_\_\_\_

Address \_\_\_\_\_

City \_\_\_\_\_

State \_\_\_\_\_ Zip \_\_\_\_\_

By 7

# Interactive Control of a Videocassette Recorder with a Personal Computer

---

Dr Richard C Hallgren  
Dept of Biomechanics  
Michigan State University  
East Lansing MI 48823

---

The use of computers in education is not a new concept. Many colleges have effective time-sharing systems for use by both students and faculty. However, the recent widespread acceptance of small personal computers has opened up many opportunities for increased use of computers in education. One such use is for computer-aided instruction (CAI).

This article describes the method used to interface a Sony Betamax videocassette recorder, Model SL0-320, to two popular computers, the Radio Shack TRS-80 and the Apple II computer, so that a low-cost, lecture-supplemented, computer-aided instructional system is achieved. The system was originally designed for medical students, but it has a wide range of applications.

Medical colleges make considerable use of videotaped lectures. These

allow a student to review material presented at a lecture which the individual was not able to attend, or to review material in preparation for examinations. Often the student does not need to review an entire lecture, but needs to be concerned only with specific segments.

---

If a computer could be used to control the presentation of videotaped material to a student, perhaps learning could be more efficient.

---

The Sony SL0-320 videocassette recorder has the capability of selectively searching for and playing specific segments of a videotape through the use of an RM-300 Auto Search control. The operator can enter a number representing a specific location on the tape. The recorder will move the tape to that location and begin playing. This search process uses a timing signal which is placed onto the tape during the recording process. The autosearch

function allows students to review or examine material without having to sit through a whole lecture.

As part of any learning experience, it is important that the student know whether he or she has retained facts and understood concepts. This question is usually answered at examination time, often to the dismay of the student. If a computer could be used to control the presentation of videotaped material to a student, perhaps learning could be more efficient.

For example, if a student wants to review the symptoms of the disease hypercalcemia, the computer can not only control the presentation of the material, but after the material has been reviewed, the computer can *ask* the students *questions* related to the material. If the student retains the material and answers the questions correctly, new material can be covered.

However, if the student cannot answer the questions correctly, the videotape is rewound, and the material on the tape is presented again. By doing this, the student gains confidence that he or she is really learning the material.

It is a relatively straightforward

---

## About the Author

*Richard C Hallgren is an assistant professor in the Department of Biomechanics at Michigan State. He works on applications of microprocessor-based systems to scientific research. This project was supported by Independent School District #196, Rosemount, Minnesota.*

---

1. Outlasts every competitor—200,000,000 character head warranty
2. No duty cycle limitations—even in demanding business applications
3. Professional print quality—9 x 7 matrix
4. Rugged business use construction—metal chassis—two motors
5. 80 characters per second
6. Upper and lower case—full 96 character ASCII set
7. Double width characters
8. Connects directly to TRS-80™ APPLE® and other computers
9. Block graphics—64 shapes for charts, graphs, diagrams
10. Friction and pin feed
11. Plain paper—up to 3 parts
12. 6 and 8 lines per inch—program controlled paper savings
13. 80 and 132 columns—program controlled
14. Price—the best value in the industry. Call or write today for the name of your local Microline 80 dealer.



# 14 REASONS WHY TRS-80™ OWNERS CHOOSE THE MICROLINE 80

All fourteen are standard with every Microline 80. The only options are snap-on tractors and a buffered (up to 2000 characters) RS232 interface.

## OKIDATA

Okidata Corporation  
111 Gaither Drive, Mount Laurel, New Jersey 08054  
Telephone: 609-235-2600

TRS-80 is a registered trade mark of Radio Shack, a division of Tandy Corp.

Betamax Connector Pin	Signal	Source/Destination	BASIC Command	Machine-Language Command
CN1-20	<u>BEGINNING OF TAPE</u> <u>CASSETTE IN</u> <u>REWIND</u>	from Betamax	PEEK(- 16137)	LDA \$C0F7
CN1-7		from Betamax	PEEK(- 16133)	LDA \$C0FB
CN1-11		to Betamax	POKE - 16142,3	LDA #03
CN1-8	<u>STOP</u>	to Betamax	POKE - 16142,0	STA \$C0F2 LDA #00
CN1-13	<u>PLAY</u>	to Betamax	POKE - 16142,1	STA \$C0F2 LDA #01
CN1-12	<u>FAST FORWARD</u>	to Betamax	POKE - 16142,2	STA \$C0F2 LDA #02
CN1-15	<u>COUNT</u>	from Betamax	PEEK(- 16141)	STA \$C0F2 LDA \$C0F3

**Table 1:** Videocassette recorder functions controlled through the Apple II interface of figure 1. The recorder being controlled is the Sony Betamax SL0-320 videocassette recorder; this is done through the pins that connect the recorder to the RM-300 Auto Search control unit. The software commands necessary to activate these functions are given in both BASIC and 6502 machine-language forms.

task to interface either the Apple II or the TRS-80 to the Betamax SL0-320 recorder. This article will describe both the hardware and software necessary to interface the Apple II computer to the Betamax, followed by the necessary changes to translate this to the TRS-80.

### Interface Implementation—Apple II

The Apple II, with its eight peripheral-board connectors, makes the job of designing and implementing interface cards relatively simple. Since these connectors are on the main computer board, any interface

cards will be inside the computer, using the computer's power supply.

Figure 1 shows the Betamax to Apple II interface in schematic diagram form. The left side of the schematic shows connections made to the Betamax through the connector normally used for the RM-300 Auto Search control. The right side of the diagram shows the connections made to the Apple II through the interface connector.

## Hard Disk Made Easy

Now you can move up to hard disk trouble free. Just select the XCOMP X/S series controller for your disk drive: SMD, Cartridge drive, 8 inch disk bus or Shugart® SA1000. Our complete package, including first class support software, will get you up and running fast. And the cost will be less than you would expect. We specialize in getting OEM's into hard disk systems. Our customers include the most successful companies in the microcomputer world.

Move up to hard disk the easy way. Call XCOMP—we'll get you going with hard disk right now.

**XCOMP**  
INCORPORATED

9915A Businesspark Avenue,  
San Diego, CA 92131  
(714) 271-8730

It is a relatively straightforward task to interface either the Apple II or the TRS-80 to the Betamax recorder.

Connector pin CN1-20 from the Betamax goes low when the videotape has been completely rewound. Connection CN1-7 from the Betamax goes low when the videotape has been loaded into the player. These two signals are sampled at the beginning of the program to assure that the videocassette starts from a predetermined point. Connection CN1-15 from the Betamax carries the timing signal that has been formatted onto the videotape. This signal is divided by a factor of 60 by IC1 and IC2.

IC3 is an 8-channel data selector which is used to selectively connect signals from CN1-20, CN1-7, or the divided timing signal, to data-bus line seven (D7) in the Apple II. D7 was chosen because its state can be easily



# 6809 PROCESSING POWER!

only \$199.95

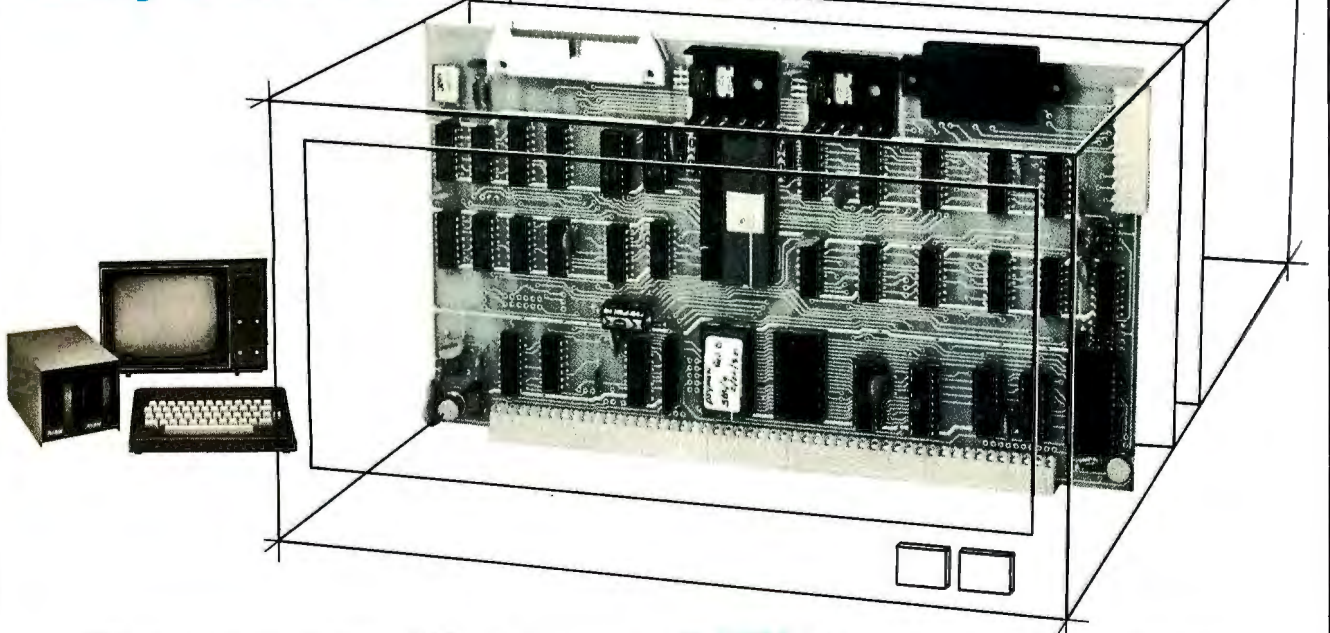

## The Percom SBC/9™: A "10" By Any Measure.

Available with either the new, powerful 6809  $\mu$ P or an optional 6800-software-compatible 6802, here are 10 beautiful reasons why the Percom SBC/9™ is not just another runner-up MPU/Single-Board-Computer card.

- 1 SS-50 bus direct, plug-in-compatible upgrade MPU. Requires **no** modification of the system bus, I/O or memory.
- 2 Full-capability stand-alone single-board computer. Accommodates a 6809 microprocessor or optional 6802 microprocessor **without modification**.
- 3 On-card 1 K ROM monitor "auto-links" to optional second 1 K PROM — if installed. Second PROM may be used to easily extend or modify the primary monitor command set.
- 4 Eight-bit parallel port is multi-address extension of system bus. Accommodates an exceptional variety of peripheral devices ranging from game paddles and keyboards to memory management modules. Connector is optional.
- 5 Serial port includes a full-range selectable bit rate generator. Optional subminiature 'D' connector provides RS-232 compatibility.
- 6 Extendable addressing via SS-50 bus baud lines to 1 Mbyte. Extendable addressing to 16 Mbytes or more through the parallel "super port."
- 7 Includes 1 Kbyte of static RAM.
- 8 All on-card I/O is fully decoded so that adjacent memory space may be used.
- 9 ROM circuit may be jumper-wired for single- or triple-voltage 2716 EPROM.
- 10 On-card power regulators simplify power supply design by minimizing regulation demands.

Plug the SBC/9™ into your SS-50 system bus, and just that easily you've upgraded to the new super-fast super-powerful 6809 MPU with such programming amenities as 10 addressing modes, 16-bit instructions, auto-increment/auto-decrement and position-independent code. Plus, you now have extended addressing capability, and operation under control of PSYMON™, the most powerful and flexible 1K ROM 6809 operating system yet written.

Percom SYstem MONitor PSYMON™ provides the usual ROM monitor functions in 1 Kbyte. It is easily extended and customized because its unique "look-ahead" program structure first searches an alternate command table. The table, if present, may be used to redefine or extend PSYMON's™ command set.

And with PSYMON™, I/O is easily directed to any peripheral device — even a disk system — through a Device Control Block table located

in memory. This allows you to leave the details of I/O software to the separate I/O device drivers.

A PSYMON™ ROM is included free with the purchase of an SBC/9™. The Users Manual includes a source listing.

The 1 Kbyte ROM monitor for the SBC/9™ 6802 option includes a primary set of typical 6800-compatible monitor commands. As for PSYMON™, the commands are easily extended or modified.

Products are available at Percom dealers nationwide. **Call toll-free, 1-800-527-1592, for the address of your nearest dealer, or to order direct.** Prices and specifications subject to change without notice.

™ trademark of Percom Data Company, Inc.

PERCOM DATA COMPANY, INC.  
211 N. KIRBY GARLAND, TEXAS 75042  
(214) 272-3421



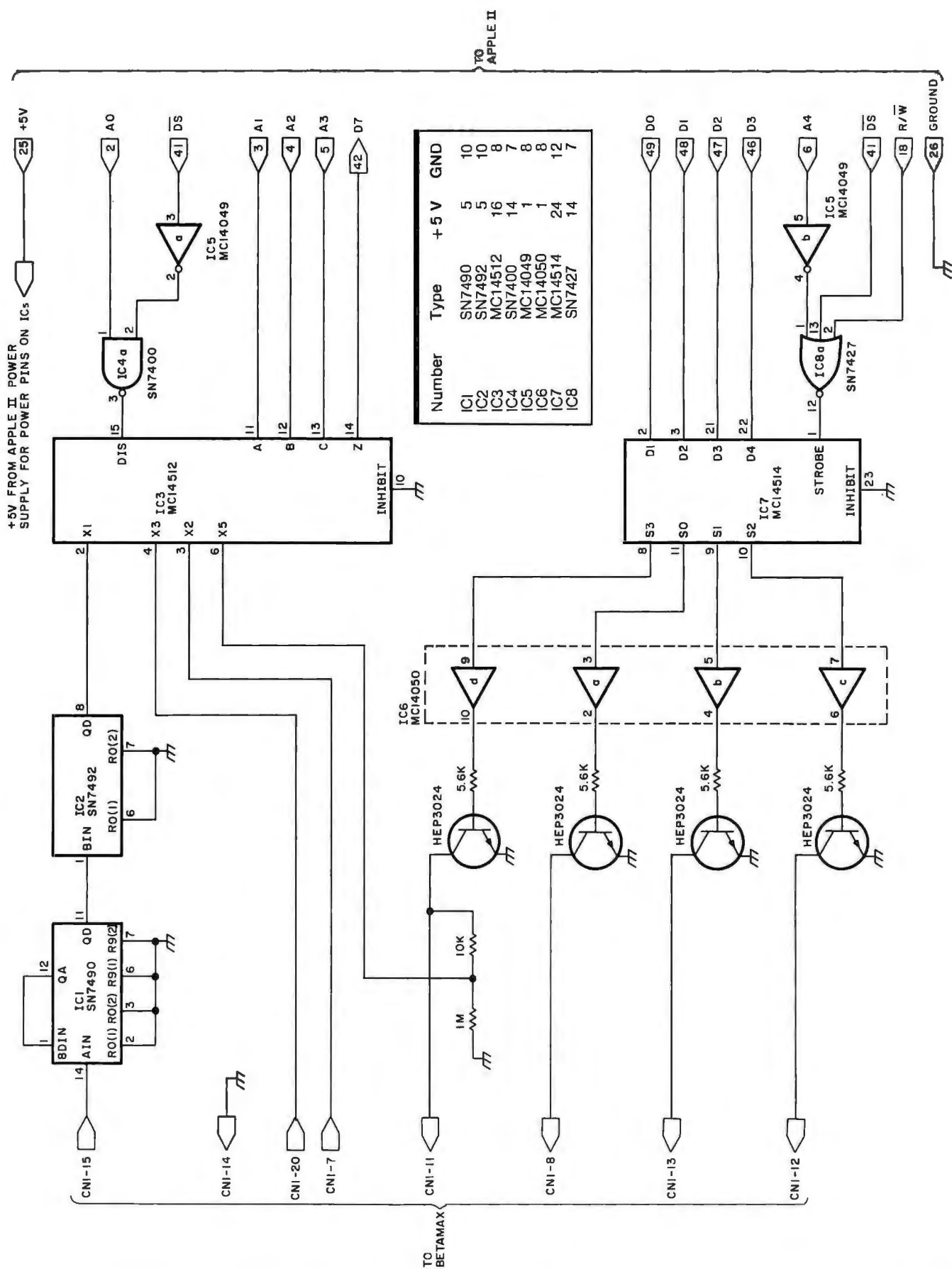

**Figure 1:** Schematic diagram of the videotape control interface used to connect the Apple II computer to the Sony Betamax SLO-320 videocassette recorder. Connection to the Betamax unit is made through the RM-300 Auto Search control connector. Connection to the Apple II is made through one of the input/output card slots on the main computer circuit board. Connections to the videocassette machine are shown on the left side of the diagram; connections to the computer are shown on the right side. The "DS" line of the Apple II is a device-select line that is active when in a low logic state.



**free  
freight!**



# MICROWORLD

## New Products

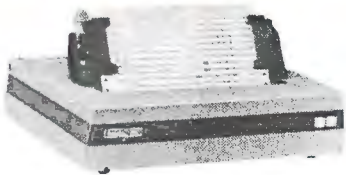

### Base 2 Model 800

Lightweight, compact 80-column dot matrix printer with 60 lpm speed. Features 5 print densities and 15 baud rates up to 19,200 baud.

**Call for Price!**



### Texas Instruments 99/4 Color Monitor

High quality 13" color monitor for high-resolution charts, graphs, animated displays, and more! Simple, sure hookup.

**Call for Price!**

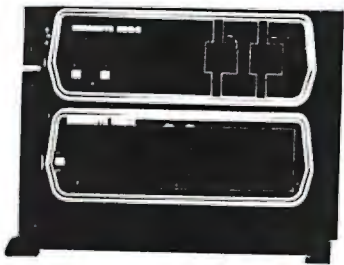

### Dynabyte DB8/6

A multi-user, hard disk microsystem with expanded capabilities needed by a growing business! 32, 64 or 96 megabytes of storage.

**Call for Price!**

## MicroWorld® Attacks Inflation With Free Freight, Low Pricing . . .

MicroWorld introduces the most attractive mail-order offer in the computer industry. *The nation's largest inventory*, plus our own automated order processing, allows us to pass along unrivaled cost savings. And now, as an additional measure to counter inflation, we offer *free freight* on any product featured on this page. We'll pay the surface freight on all pre-paid products in this ad, to any of 18,000 U.S. tariffed locations. *No handling charges*, add-on costs, insurance fees or credit card fees! Most items are *in stock* for fast delivery at exceptional discounts!

*Call us* before you buy anywhere else. Find out *their* total cost. Then compare with our low, freight-free price. Our industry-trained staff stands behind every order. We're *the source you can trust*. We grew up with the microelectronics revolution: We helped pioneer its growth. Our Free Freight program, our attractive pricing, and off-the-shelf delivery are our "thanks" to the thousands of satisfied computer users who made MicroWorld the *world's leading mail-order source* for micro-computers and peripherals!

### Soroc IQ 120



High quality; text editing terminal, 73-key board, built-in 2KRAM, RS232 interface.

**\$789**

### Comprint GP



Low priced electrostatic matrix printer, 225 cps; ideal for personal computers, or professional applications requiring second printer.

**Call for Price!**

### TeleVideo 920B



Low-cost terminal loaded with features: full-function keyboard, 24X80 display, blink, reverse, self-test!

**Call for Price!**

### Atari 800

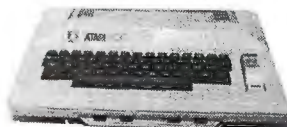

"Timeless" home computer system; expandable memory, full software library.

**Call for Price!**

### Texas Instruments 99/4 Home Computer



Superior sound, 16-color graphics; low price includes 13" color monitor.

**We will try to beat any advertised price!**

### TI 810



150 cps, RS232 tractors, 3" to 15" form width; bidirectional printing. Also have 820's and 825's.

**\$1589**

### Okidata MicroLine 80

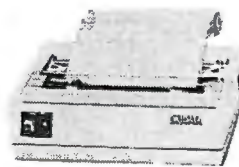

Compact, 80 cps printer; 9x7 matrix, 132 col. w/ compressed print, graphics, and more!

**Call for Price!**

### North Star Horizon



Quad- or double-density, while they last! Plus, hard disk drives for expansive storage requirements.

**Call for Price!**

**TOLL-FREE 1-800-528-1418**

Circle 84 on inquiry card.

1425 W. 12 Pl. • Tempe, AZ 85281 • 602-894-1193

Prices subject to change without notice; products subject to availability.

© Copyright 1980 The Phoenix Group, Inc.

tested by rotating it left from the accumulator into the carry bit.

Apple has conveniently provided an internal decoding scheme that forces a DS (Device Select, active low) line to go low whenever certain

address locations are accessed. The Betamax interface card was designed to reside in input/output (I/O) card slot 7. This means that the DS line (pin 41) will go low whenever hexadecimal memory locations C0F0 thru C0FF are addressed. Table 1 shows the Betamax connections and functions that will be accessed for a given BASIC statement or a given machine-language command.

The Betamax can be commanded to move the tape in any of the play, rewind, fast forward, or stop modes by dropping the appropriate line from connector CN1 to ground logic state. IC7 is a 4 to 16 line decoder latch which is used to selectively turn on one of the four transistors that control the function of the videocassette recorder.

### Software Control of the Video Recorder—Apple II

The software portion of the project was handled in two parts:

- A machine-language routine was written to count the pulses coming from the timing track on the videotape and to determine when the desired destination location along the videotape is reached.
- A routine written in Applesoft floating-point BASIC loads the videotape destination location and controls the video recorder. In addition, all of the routines used to quiz the students were written in Applesoft BASIC, but are not shown in this article.

Figures 2 and 3 show the flowcharts for the machine-language routines. Listings 1 and 2 show the actual program code in assembler format with comments. The programs are quite similar. The *increment* routine in listing 1 is used when the videotape is being moved forward (play or fast-forward modes) and the *decrement* routine in listing 2 is used when the videotape is being moved in reverse (rewind).

Upon entering the appropriate subroutine from the BASIC program, the processor status and the accumulator are pushed onto the stack. The line carrying the pulses from the timing track on the videotape is then sampled until it has been determined that the tape has moved a distance

equal to 1 pulse width. A present-location register consisting of two 8-bit words is then incremented or decremented depending on whether the tape is being moved forward or reverse.

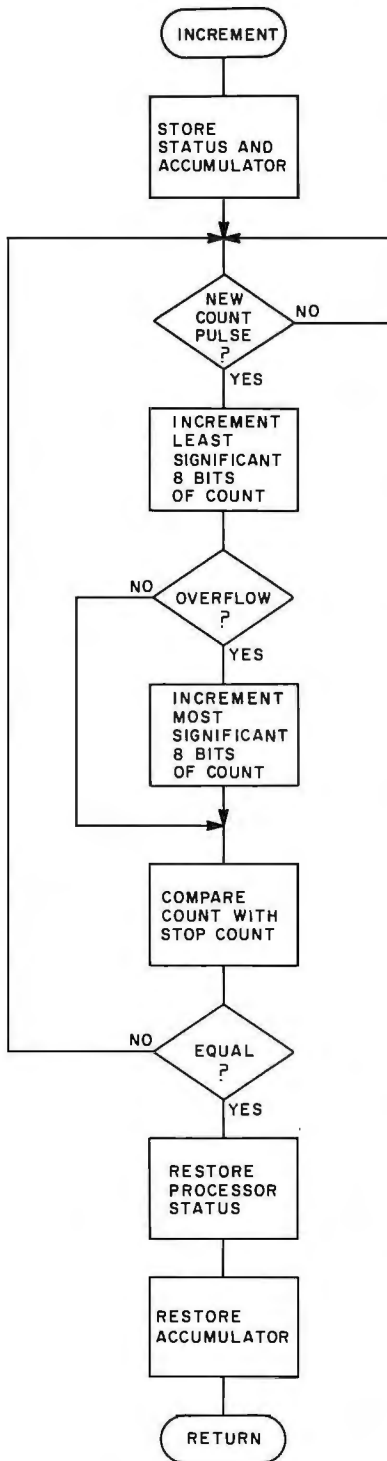

Figure 2: Flowchart of the increment machine-language subroutine that monitors forward motion of the videotape. See listing 1 for the 6502 code; see listing 4 for the Z80 code.

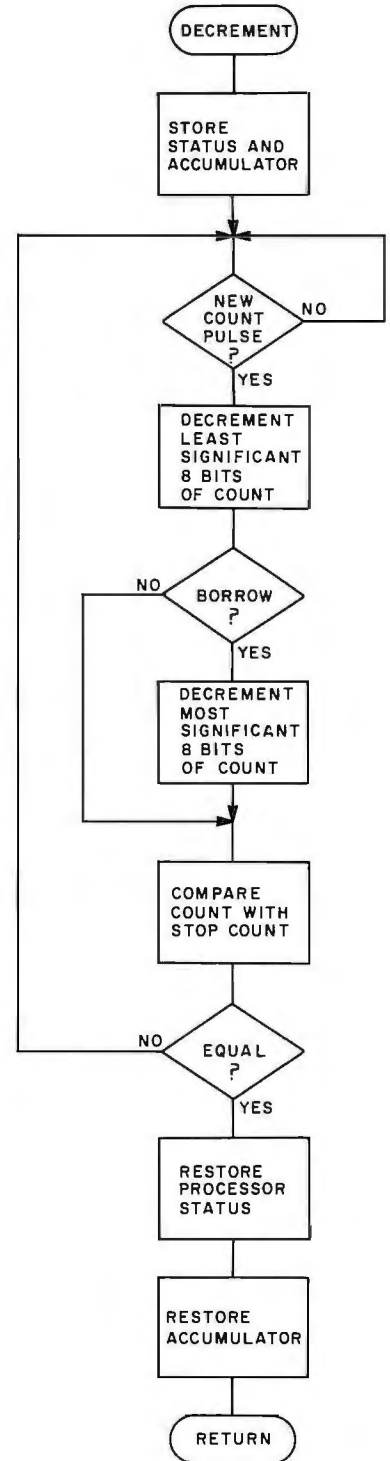

Figure 3: Flowchart of the decrement machine-language subroutine that monitors reverse motion of the videotape. See listing 2 for the 6502 code; see listing 5 for the Z80 code.

# Announcing an Intel Seminar on Microcomputer Solutions for the '80s.

The 1980s will require total microcomputer system solutions to enable you—the system designer—to keep pace with ever increasing application complexities. To help you plan for the '80s, Intel is sponsoring a series of one-day seminars discussing the directions for future VLSI computer solutions.

In these seminars, you'll learn how our VLSI solutions uniquely address the needs of the future. Topics discussed will include system-level integration in 16-bit, 16/32-bit, and 32-bit microcomputers; peripherals; software; single board computers—and more. In short, you'll find all the information you need to get a head start on your next generation of products.

## Who should attend.

The seminar is intended specifically for software, hardware, and system engineers and managers who will be responsible for designing systems for the '80s. The seminar is structured to give you a comprehensive look into future directions in VLSI computer system development, such as:

- New microprocessor families designed to meet increasing application complexity.
- Tools to speed your product to market by increasing programmer productivity.

- Highest performance micro-system configurations achieved through co-processing and multi-processing.
- Integration of system programming and software functions into silicon.
- Integration of memory management and protection facilities.

Course materials will include a seminar notebook, and an *Advanced Data Catalog* which will outline Intel's comprehensive line of new products.

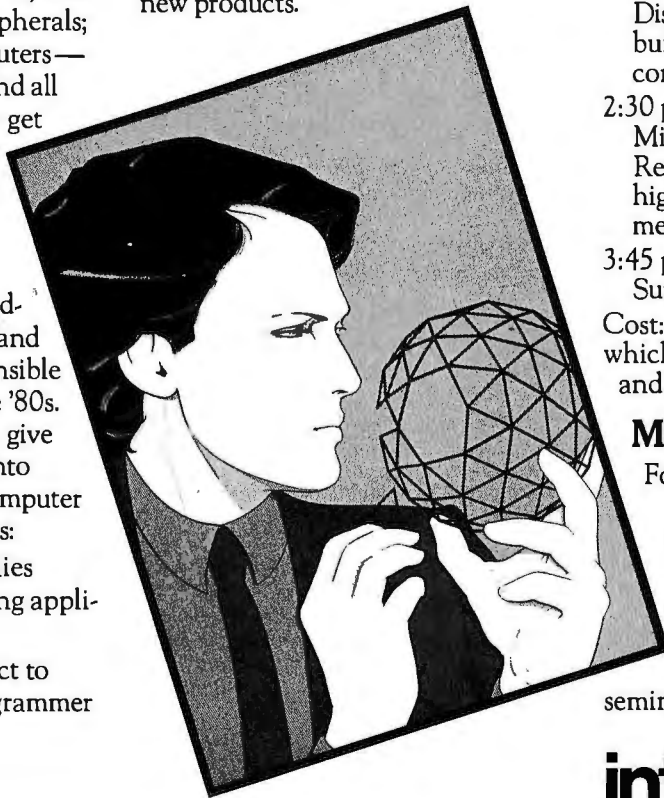

## Agenda

- 8:00 a.m.  
Registration
- 8:30 a.m.  
Introduction of Intel's total solution approach
- 10:30 a.m.  
New Microprocessor Products  
Preview of three microprocessors covering 16-bit, 16/32-bit, to 32-bit complexity
- 12:00 Noon—Lunch
- 1:00 p.m.  
Microsystem architecture  
Discussion of new peripheral building blocks and system interconnects
- 2:30 p.m.  
Microsystem software  
Review of new operating systems, high level languages and development tools
- 3:45 p.m.  
Summary and questions/answers
- Cost: There is a \$15.00 registration fee which will cover seminar material and lunch.

## More information.

For registration information and to guarantee reserved space at the seminar, please contact your local Intel sales office a minimum of one week prior to the seminar in your area. The person to contact for your seminar is listed below, so call today.

**intel® delivers solutions.**

Seminar Date	Location	Contact	Phone
May 13	Santa Clara, Ca.	Bob Cifranic	(408) 987-8086
May 16	Seattle, Wa.	Steve Prue	(206) 453-8086
May 20	Baltimore, Md.	Steve Kay	(301) 796-7500
May 21	Cincinnati, Oh.	Dave O'Hanian	(513) 890-5350
May 22	Detroit, Mi.	Stan Korus	(313) 353-0920
May 28	Minneapolis, Mn.	Blain Erskine	(612) 835-6722
May 29	Chicago, Ill.	Tom Alwicker	(312) 981-7200
May 29	Orange County, Ca.	Dave Neubauer	(714) 835-9642
May 30	Cleveland, Oh.	Steve Turcola	(216) 464-2736
June 16	Los Angeles, Ca.	John Alfoldy	(213) 986-9510
June 16	Boston, Mass.	Bruce Giron	(617) 667-8126
June 17	Manhattan, N.Y.	Don Buckhout	(516) 231-3300
June 17	Denver, Colo.	Pat Maley	(303) 321-8086
June 18	North New Jersey, N.J.	Tom Trainor	(201) 225-3000

Seminar Date	Location	Contact	Phone
June 19	Houston, Tx.	Larry Gast	(713) 784-3400
June 19	Philadelphia, Pa.	Gene Murphy	(215) 542-9444
June 20	Dallas, Tx.	Dave Takacs	(214) 241-9521
June 24	Toronto, Canada	Franca Martinek	(416) 675-2105
June 25	Montreal, Canada	John Freeman	(613) 829-9714
June 27	Long Island, N.Y.	Don Buckhout	(513) 231-3300
July 10	Phoenix, Az.	Phil Richards	(602) 997-9695
July 15	Portland, Ore.	Steve Dallman	(503) 641-8086
July 16	Salt Lake City, Ut.	Bob Spina	(303) 321-8086
July 22	Milwaukee, Wisc.	Karl von Spreckelsen	(414) 784-9060
July 23	Kansas City, Ks.	Tom Izzo	(913) 642-8080
July 24	San Diego, Ca.	John Linn	(714) 268-3563
August 5	Melbourne, Fla.	Don Dabney	(305) 628-2393
August 6	New Haven, Conn.	Bill D'Eramio	(203) 792-8366
August 7	Rochester, N.Y.	Bill D'Eramio	(716) 254-6120

**Listing 1:** *Assembly-language subroutine for the 6502 processor. This routine, used in the Apple II, monitors the forward motion of the videotape by counting timing pulses derived from the videotape and sent over connector pin CN1-15 of the RM-300 Auto Search control connector.*

Hexadecimal Address	Hexadecimal Code	Instruction Mnemonic	Operand	Commentary
0310	08	PHP		Save processor status
0311	48	PHA		Save accumulator
0312	AD F3 C0	LDA	\$C0F3	Sample count line
0315	2A	ROL		Rotate bit 7 into carry
0316	B0 FA	BCS	\$0312	Branch if carry set
0318	AD F3 C0	LDA	\$C0F3	Sample count line
031B	2A	ROL		Rotate bit 7 into carry
031C	90 FA	BCC	\$0318	Branch if carry clear
031E	EE 03 03	INC	\$0303	Increment least significant 8 bits
0321	D0 03	BNE	\$0326	Branch if no overflow
0323	EE 04 03	INC	\$0304	Increment most significant 8 bits
0326	AD 03 03	LDA	\$0303	Load least significant 8 bits
0329	CD 05 03	CMP	\$0305	Compare with least significant stop count
032C	D0 E4	BNE	\$0312	Branch if not equal
032E	AD 04 03	LDA	\$0304	Load most significant 8 bits
0331	CD 06 03	CMP	\$0306	Compare with most significant stop count
0334	D0 DC	BNE	\$0312	Branch if not equal
0336	68	PLA		Restore accumulator
0337	28	PLP		Restore processor status
0338	60	RTS		Return from subroutine

**Listing 2:** *Assembly-language subroutine for the 6502 processor. This routine is called from the Applesoft BASIC program to monitor the reverse motion of the videotape by counting timing pulses derived from the tape.*

Hexadecimal Address	Hexadecimal Code	Instruction Mnemonic	Operand	Commentary
0360	08	PHP		Save processor status
0361	48	PHA		Save accumulator
0362	AD F3 C0	LDA	\$C0F3	Sample count line
0365	2A	ROL		Rotate bit 7 into carry
0366	B0 FA	BCS	\$0362	Branch if carry set
0368	AD F3 C0	LDA	\$C0F3	Sample count line
036B	2A	ROL		Rotate bit 7 into carry
036C	90 FA	BCC	\$0368	Branch if carry clear
036E	38	SEC		Set carry
036F	AD 03 03	LDA	\$0303	Load least significant 8 bits
0372	E9 01	SBC	#\$01	Decrement least significant 8 bits
0374	8D 03 03	STA	\$0303	Save
0377	AD 04 03	LDA	\$0304	Load most significant 8 bits
037A	E9 00	SBC	#\$00	Decrement if borrow
037C	8D 04 03	STA	\$0304	Save
037F	AD 03 03	LDA	\$0303	Load least significant 8 bits
0382	CD 05 03	CMP	\$0305	Compare with least significant stop count
0385	D0 DB	BNE	\$0362	Branch if not equal
0387	AD 04 03	LDA	\$0304	Load most significant 8 bits
038A	CD 06 03	CMP	\$0306	Compare with most significant stop count
038D	D0 D3	BNE	\$0362	Branch if not equal
038F	68	PLA		Restore accumulator
0390	28	PLP		Restore processor status
0391	60	RTS		Return from subroutine

The contents of this present-location register are then compared to the contents of a register containing the two 8-bit words representing the destination. If the two registers are equal, the tape has reached its destination, and the computer returns control to the BASIC routine. If the two registers are not equal, the routine loops back to wait for the next timing pulse.

Figure 4 shows the flowchart of the BASIC program, and listing 3 shows the BASIC program code with comments. (Only the tape-control routines are given here.) During execution the program first sets the physical location of the videotape to 0. If the cassette has not been loaded into the machine, a message is printed on the video display and the program waits until the cassette has been load-

ed. The program then checks to see if the tape has been rewound to the beginning; if not, it rewinds the tape. The tape is now at its beginning and the count register has been set to 0.

Next, the number representing the destination location of the desired program material is loaded into the destination register, and the present physical location is compared with the desired location. If the present

New,  
Exciting

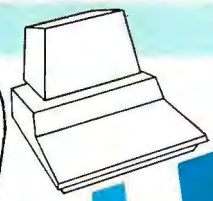

# APPLE/PET BREAKTHROUGHS

"Precise, humanized, well documented an excellent value" are the applauds now being given to United Software's line of software. These are sophisticated programs designed to meet the most stringent needs of individuals and business professionals. Every package is fully documented.

## APPLE WORLD

By Paul Lutus

### 3-D ANIMATED COLOR GRAPHICS



The Program made famous on National TV!

FOR 48K APPLE II COMPUTERS WITH DISK

APPLE WORLD turns your Apple into a sophisticated graphics system capable of creating animated three-dimensional color images, projecting them in true perspective on the screen, rotate them, move them closer, further away, and many other exciting and imaginative things.

A powerful screen-oriented text editor is included to facilitate image formation. This program was recently featured on Tom Snyder's Prime Time Saturday TV Show and is now available for sale.

APPLE WORLD'S powerful editor is so easy to use that children will love it. You can now "sketch" your dream house, boat, car, or fantasy empire. Then view it as it would be seen from 10,000 feet, or you can ZOOM in until the screen is filled with a doorknob. You could then go inside and move from room to room examining furniture placement as your screen rotates within the room. Images or specific parts of images can easily be saved to disk or printer.

Does all this sound like science fiction? You won't think so after you have visited **Apple World**.

**Introductory Price \$59.95**  
36 page manual included

Look for the RED-WHITE-BLUE United Software Display at your local computer dealer, or send check or money order, plus \$3.00 shipping to:

**USA UNITED SOFTWARE OF AMERICA**

750 3RD Avenue,  
New York NY 10017  
(212) 682-0347 Telex 640055  
**DEALER INQUIRIES INVITED**

## KRAM

By Ken Germann

### KEYED RANDOM ACCESS METHOD

Many times more powerful and efficient than the primitive "relative record" method used by Apple & Commodore.

#### FOR APPLE II & COMMODORE PET

KRAM is the **FASTEST** and **MOST POWERFUL** keyed access method available for the Apple & Commodore CBM (Pet) Computers. Written entirely in 6502 machine code, KRAM is extremely fast, comprehensive in scope, very compact, and easy to use. KRAM function calls are invoked via a single instruction.

Using the sophisticated capabilities of KRAM the Apple & CBM (Pet) can now fully meet the requirements of information management applications, such as: Accounts Receivable/Payable, Inventory Control, General Ledger, Payroll, Mailing lists, and Database Management. Programs can now be 30% to 90% shorter and run many times faster! Less experienced users can now create powerful programs!

- KRAM Release 2.0 Functions:**
- Create/Open a dataset
  - Put record by Key
  - Add & delete records by Key
  - Get any record by Full/Partial key in 4/10ths of a second (2/10ths with Corvus Disk)
  - Supports multiple disks
  - Read next or previous record
  - Dynamic space allocation
  - Dynamic space reclamation
  - Dynamic index compression
  - Never needs file reorganization!

An 87 page manual fully documents KRAM 2.0 detailing KRAM functions and illustrating with programming samples. KRAM architecture is fully explained and a sample mailing list application program is included.

#### PET & Apple Requirements

KRAM is designed to work with both Apple's Disk II, or Corvus Systems 10 Megabyte Winchester Disk, and Commodores 2040, 3040, and 8050 Disk units. KRAM 2.0 requires an integer Apple or Apple Plus with integer card and at least one disk drive. KRAM works on any 40/80 column 16K/32K PET.

### Introductory Special \$99.95

#### FOR COMMODORE 16K/32K COMPUTERS

**DATABASE MANAGEMENT SYSTEM** — A comprehensive, interactive system like those run on mainframes! Six modules comprising 42K of programming allow you to; create, edit, delete, display, print, sort, merge, etc., etc. - databases of up to 10,000 records. Printer routines automatically generate reports and labels on demand. 60 pages of concise documentation are included. Requirements - 16-32K PET and 2040 Dual Disk (printer optional) ..... **COST \$125**

#### OTHER UNITED SOFTWARE PRODUCTS

- APPLE COMPUTERS**
- Super Space Wars ..... \$ 9.95
  - States & Capitals ..... 9.95
  - Moving Point Average ..... 19.95
  - Stock Options ..... 24.95
  - Finance ..... 12.95
  - Bonds ..... 12.95
  - Stock Analyzer ..... 22.95
  - Mortgage ..... 15.95

#### COMMODORE PET

- Space Intruders ("Best Game of 1979") ..\$19.95
- Jury/Hostage ..... 9.95
- Kentucky Derby/Roulette ..... 9.95
- Alien I.Q./Tank ..... 9.95
- Tunnelvision/Maze Chase ..... 14.95
- Submarine Attack ..... 9.95
- Battle of Midway ..... 7.95
- Laser Tank Battle ..... 9.95
- Swarm ..... 14.95
- Baseball ..... 9.95
- Super Startrek ..... 14.95
- PET Music Box ..... 29.95

**Listing 3:** Tape control routines from the Applesoft floating-point BASIC computer-aided instruction program. The routines that ask questions of students have been omitted from this listing. This program calls the machine-language subroutines of listings 1 and 2 (for the Apple), listings 4 and 5 (for the TRS-80).

```

50      REM START
52      POKE 771,0: POKE 772,0: REM INITIALIZE COUNT REGISTER
54      X = PEEK ( - 16133): REM SAMPLE LINE CNI-7 FROM BETAMAX
56      IF X < 127 THEN GOTO 70: REM IF CASSETTE LOADED THEN GOTO 70
58      VTAB 10: REM SET VERTICAL TAB TO 10
60      PRINT "!!!!!!!!!!LOAD TAPE!!!!!!!!!!"
62      GOTO 54
70      X =PEEK ( - 16137): REM SAMPLE LINE CNI-20 FROM BETAMAX
72      IF X < 127 THEN GOTO 80: REM IF TAPE REWOUND THEN GOTO 80
74      POKE - 16142,3: REM REWIND TAPE
76      GOTO 70: REM RETURN TO C IF TAPE REWOUND
80      SR=92:SP=114: REM LOAD DESTINATION COUNT
90      GOSUB 10000: REM JUMP TO CONTROLLER ROUTINE
99      END

10000   REM CONTROLLER ROUTINE
10002   R1 = 0:R2 = 0:P1 = 0:P2 = 0
10010   X = PEEK (771) + 256 * PEEK (772): REM GET ACTUAL LOCATION
10020   R1 = SR: REM DETERMINE DESTINATION COUNT
10021   R1 = R1 - 256
10022   IF R1 = 0 THEN GOTO 10030
10023   IF R1 > 0 THEN GOTO 10032
10024   IF R1 < 0 THEN GOTO 10035
10030   R2 = R2 + 1: GOTO 10090
10032   R2 = R2 + 1: GOTO 10021
10035   R1 = R1 + 256
10050   P1 = SP: REM DETERMINE NEW DESTINATION COUNT
10051   P1 = P1 - 256
10052   IF P1 = 0 THEN GOTO 10080
10053   IF P1 > 0 THEN GOTO 10082
10054   IF P1 < 0 THEN GOTO 10085
10080   P2 = P2 + 1: GOTO 10090
10082   P2 = P2 + 1: GOTO 10051
10085   P1 = P1 + 256
10090   IF X < SR THEN GOTO 10100: REM DETERMINE RELATIONSHIP OF ACTUAL COUNT TO DESTINATION COUNT
10091       REM
10092   IF X > SR THEN GOTO 10200: REM COUNT
10094   IF X = SR THEN GOTO 10300
10100   REM FAST FORWARD
10110   POKE 773,R1: POKE 774,R2
10112   POKE - 16142,2: CALL 784
10114   POKE - 16142,0
10116   GOTO 10300
10200   REM REWIND
10202   R3 = 0:R4 = 0
10210   R3 = SR + 2
10211   R3 = R3 - 256
10212   IF R3 = 0 THEN GOTO 10220
10213   IF R3 > 0 THEN GOTO 10230
10214   IF R3 < 0 THEN GOTO 10249
10220   R4 = R4 + 1: GOTO 10250
10230   R4 = R4 + 1: GOTO 10211
10240   R3 = R3 + 256
10250   POKE 773,R3: POKE 774,R4
10252   POKE -16142,3: CALL 864
10254   POKE -16142,0
10256   POKE 771,R1: POKE 772,R2
10300   REM PLAY
10310   POKE 773,P1: POKE 774,P2
10320   POKE -16142,1: CALL 784
10400   REM STOP
10410   POKE -16142,0: POKE -16142,10:RETURN
99999   END

```

physical location value is less than that of the desired location, the videocassette recorder is commanded to move the tape in fast-forward mode. The BASIC program calls the machine-language subroutine which monitors the forward motion. When

the destination is reached, the machine language returns to the BASIC program.

If the present physical tape location is greater than the desired location, the Betamax is commanded to rewind, and the program jumps to the

machine-language subroutine which decrements the count, monitoring the reverse motion. When the destination is reached, the machine-language routine returns to the BASIC program. If the present physical location

*Text continued on page 132*



# One small word about computers.

# Osborne

The Leader In Microcomputer Books

**The 8089 I/O Processor Handbook,**  
by Adam Osborne

Intel is developing the co-processor concept: the 8089 is the first of the Intel co-processors. **The 8089 I/O Processor Handbook** provides a fully detailed description of this innovative device, its operation, and use in 8086 systems. This Osborne Handbook contains complete discussions of pins, signals, timing, the instruction set, and programming and configuration guidelines. Also describes the 8289 Bus Arbiter.

#39-X \$5.95

**The 8086 Book**  
by Russell Rector and George Alexy

**THE 8086 BOOK**  
A handbook for all 8086 microcomputer users, it includes 8086 programming instruction, a thorough analysis of the 8086 instruction set, and detailed hardware and interfacing guides which reveal the full power of the 8086 multiprocessing capabilities.

#29-2 \$15.00

**Z8000 Assembly Language Programming**  
by Lance Leventhal et al.

The first in this popular series of books to have the combined authorship of Dr. Leventhal, Dr. Adam Osborne, and Charles Collins. The Z8000 processor instruction set is described in detail, and the discussion of assembly language programming techniques makes the book an invaluable teaching tool, programming manual, and Z8000 reference book.

Available August. #36-5 \$12.50

**An Introduction to Microcomputers: Vol. 1, Basic Concepts, 2nd Ed.**  
by Adam Osborne

Since this book first appeared in 1976, more than 200,000 copies in four different languages have been sold, making it the best selling book on microprocessors ever written. Now it has been completely revised to reflect changes in this dynamic field. **Basic Concepts, 2nd edition** contains the most current information on microprocessor fundamentals to be found in any publication.

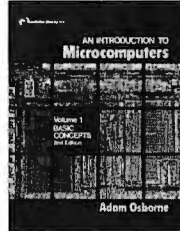

#34-9 \$12.50

**6809 Assembly Language Programming**  
by Lance Leventhal

Another book in the popular series of assembly language programming texts, this for the powerful 6809 processor. In a comprehensive style and format, Dr. Leventhal describes the 6809 instruction set, provides numerous sample programs, and discusses the merits of assembly language programming techniques.

**Available this fall.** #35-7 \$12.50

**PET Personal Computer Guide**  
by Carroll Donahue and Janice Enger

For all users of the Commodore PET, this step-by-step guide offers advice on operating and equipment maintenance, how to cope with PET peculiarities and make the most of PET graphics. It gives instruction on PET programming techniques along with a complete PET BASIC command reference.

#30-6 \$15.00

**PET and the IEEE 488 Bus (GPIB)**  
by Eugene Fisher and C. William Jensen

The only complete reference available on interfacing the Commodore PET computer to any I/O device using the IEEE 488 Interfacing port. It includes a list of the available IEEE 488 Bus-compatible instruments.

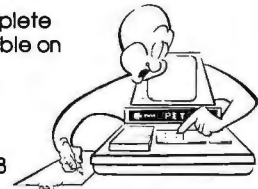

#31-4 \$15.00

**Practical BASIC Programs**  
edited by Lon Poole

A collection of 40 BASIC programs for office and home use. Programs include Home Budgeting, Critical Path Method, and Income Averaging.

#38-1 \$15.00

## NEW and Upcoming Titles



To order, return coupon with check or money order. include 75¢ per item for 4th class mail, \$1.25 per book UPS, or \$2.50 per book air mail in the U.S. California residents also include local sales tax. To place an order by phone call 415/548-2805.

Notify me when available:  Z8000 ALP  
 6809 ALP

**OSBORNE/McGraw-Hill**  
630 Bancroft Way Dept. B6  
Berkeley, CA 94710

Book	Price	Quantity	Amount

Name \_\_\_\_\_ Tax

Address \_\_\_\_\_ Shipping

City \_\_\_\_\_ State \_\_\_\_\_ ZIP \_\_\_\_\_

Phone \_\_\_\_\_ HOW TO SHIP \_\_\_\_\_ TOTAL

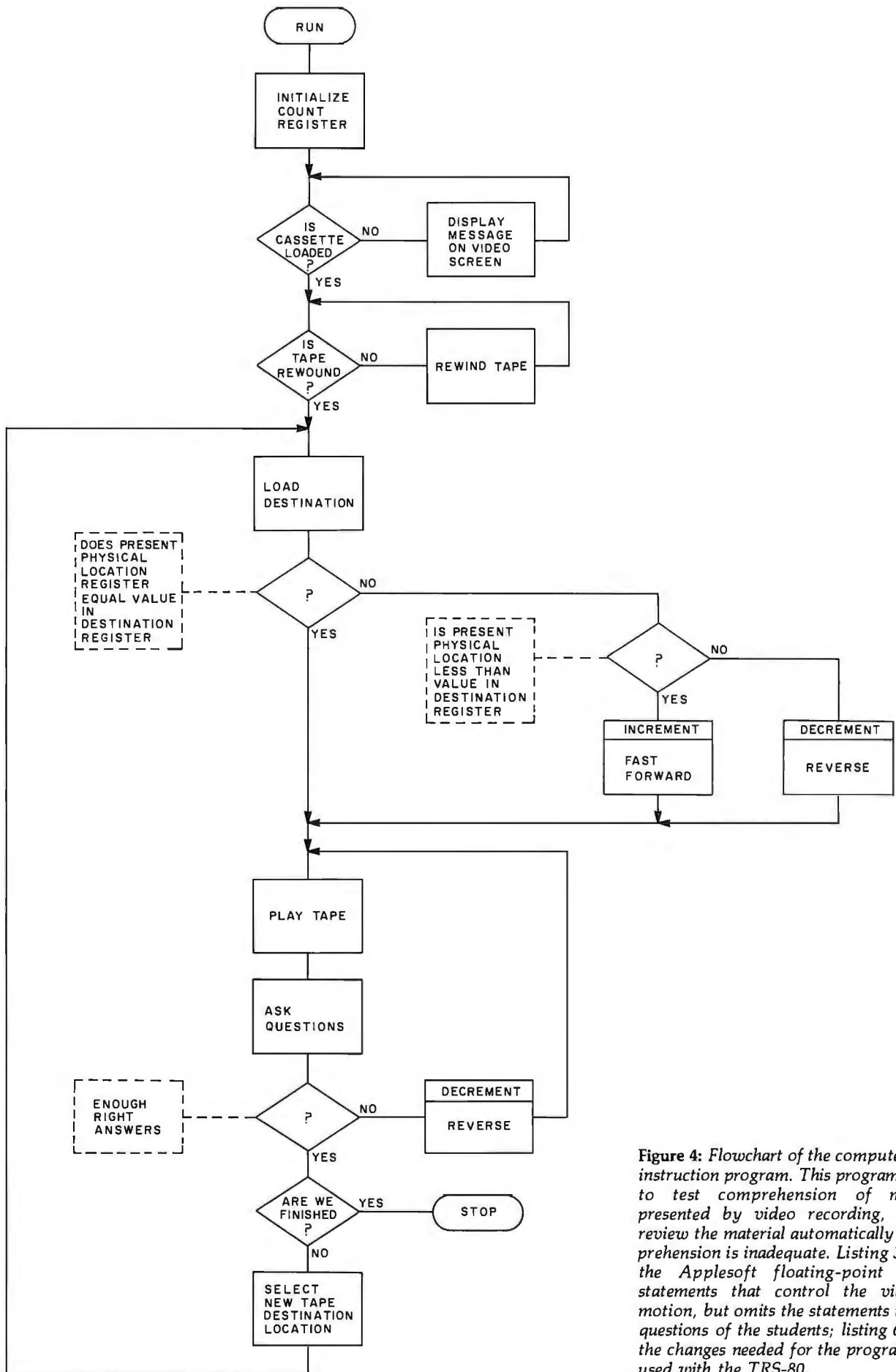

**Figure 4:** Flowchart of the computer-aided instruction program. This program is used to test comprehension of material presented by video recording, and to review the material automatically if comprehension is inadequate. Listing 3 shows the Applesoft floating-point BASIC statements that control the videotape motion, but omits the statements that ask questions of the students; listing 6 shows the changes needed for the program to be used with the TRS-80.

# NEW FROM LOBO:

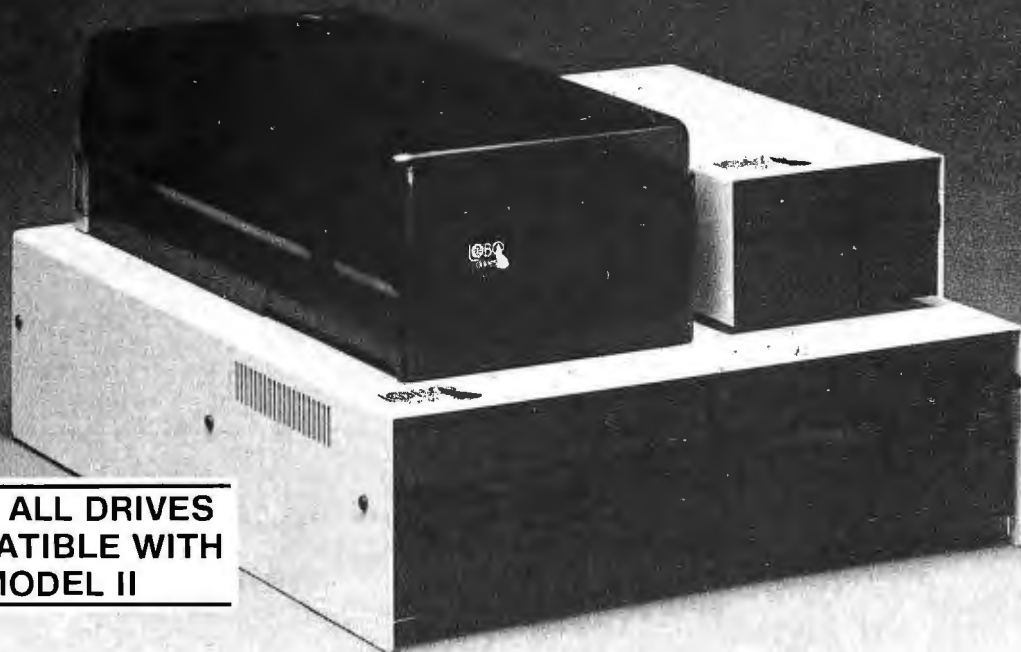

**NOW! ALL DRIVES  
COMPATIBLE WITH  
MODEL II**

## An Entire Family of Disk Drives for APPLE, TRS-80\*, and S-100 Computers

Only LOBO DRIVES offers you an entire family of fully-compatible disk drives to select from. Whatever computer you're using, APPLE, TRS-80, or S-100, you can add a LOBO drive now, with the peace-of-mind of knowing there's a whole family of drives available when you're ready to expand.

And every drive you order comes complete with chassis and high reliability power supply. Each drive is 100% calibrated, burned-in, and performance tested on either an APPLE, TRS-80, or S-100 computer before it's shipped. We are so proud of our drives... our quality, reliability, and performance, that we back-up every drive with a one year, 100% parts/labor warranty.

### 400 SERIES FLOPPY DISK DRIVES

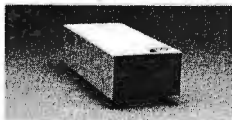

Meet our low-cost 5.25-inch mini drive that records data in either hard or soft sectored format. It is available in single or double

density configurations, with a total storage capacity of 220K bytes.

### 800/801 SERIES FLOPPY DISK DRIVES



Here is our dual 8-inch Floppy disk memory unit. It records and retrieves data on standard 8-inch diskettes to provide 800K bytes of data storage unformatted, or 512K bytes

of data storage unformatted, or 512K bytes

in IBM format per drive. It is also available with double-sided, double-density capabilities, for a maximum storage capacity of 1.6 Megabytes.

### 7000 SERIES HARD DISK DRIVES



The latest member of our drive family, the Series 7000 is an 8-inch, 10 Megabyte Winchester Technology, hard disk drive. It is fully

hardware/software compatible and comes complete with disk controller. Now you can have the convenience, speed, reliability, and all the storage capacity you need.

Call or write for the complete LOBO DRIVES story. Find out just how competitively priced a quality drive can be.

Quantity discounts available - Dealer inquiries invited.

Yes, I want to know more about LOBO Drives and what they can do. Send me information on:

- TRS-80     APPLE     S-100
- 5 1/4-in. Floppy drive     8-in. Winchester hard disk, 10 Mbyte drive
- 8-in. Floppy drive  
Single sided     Double density  
Double sided    expansion interface

Name \_\_\_\_\_

Company \_\_\_\_\_

Address \_\_\_\_\_

City \_\_\_\_\_ State \_\_\_\_\_ Zip \_\_\_\_\_

Phone No. \_\_\_\_\_

If dealer, provide resale no. \_\_\_\_\_



935 Camino Del Sur  
Goleta, California 93017  
(805) 685-4546

"CAN YOU REALLY AFFORD  
TOPAYLESS?"

\*TRS-80 is a registered trademark of Radio Shack, a Tandy Company.

Betamax Pin	Signal	Source/ Destination	BASIC Command	Machine-Language Command
CN1-20 CN1-7 CN1-11	BEGINNING OF TAPE CASSETTE IN REWIND	from Betamax from Betamax to Betamax	PEEK(-9) PEEK(-11) POKE-1, 3	LDA \$8007 LDA \$8005 LDA #03 STA \$8001 LDA #00
CN1-8	STOP	to Betamax	POKE-1, 0	STA \$8001 LDA #01
CN1-13	PLAY	to Betamax	POKE-1, 1	STA \$8001 LDA #02
CN1-12	FAST FORWARD	to Betamax	POKE-1, 2	LDA #01 STA \$8001
CN1-15	COUNT	from Betamax	PEEK(-13)	LDA #02 STA \$8001 LDA \$8003

**Table 2:** Videocassette recorder functions controlled through the TRS-80 interface of figure 5. The software commands necessary to activate these functions are given in both BASIC and Z80 machine-language forms.

**Listing 4:** Assembly-language subroutine for the Z80 processor. This routine, written for the TRS-80, monitors the forward motion of the videotape by counting timing pulses derived from the videotape and sent over connector pin CN1-15 of the RM-300 Auto Search control connector.

Hexadecimal Address	Hexadecimal Code	Label	Instruction Mnemonic	Operand	Commentary
7B00	F5		PUSH	PSW	Save accumulator and processor status
7B01	3A 02 80	RESTR:	LDA	\$8003	Sample count line
7B04	17		RAL		Rotate bit 7 into carry
7B05	DA 01 7B		JC	RESTR	Jump if carry set
7B08	3A 02 80	AGAIN:	LDA	\$8003	Sample count line
7B0B	17		RAL		Rotate bit 7 into carry
7B0C	D2 08 7B		JNC	AGAIN	Jump if carry not set
7B0F	21 03 7F		LXI	H,\$7F03	Load H,L registers
7B12	34		INR	M	Increment least significant 8 bits
7B13	C2 1A 7B		JNZ	AHEAD	Jump if no overflow
7B16	21 04 7F		LXI	H,\$7F04	Load H,L registers
7B19	34		INR	M	Increment most significant 8 bits
7B1A	21 05 7F	AHEAD:	LXI	H,\$7F05	Load H,L registers
7B1D	3A 03 7F		LDA	\$7F03	Load least significant 8 bits
7B20	BE		CMP	M	Compare
7B21	C2 01 7B		JNZ	RESTR	Jump if not equal
7B24	21 06 7F		LXI	H,\$7F06	Load H,L registers
7B27	3A 04 7F		LDA	\$7F04	Load most significant 8 bits
7B2A	BE		CMP	M	Compare
7B2B	C2 01 7B		JNZ	RESTR	Jump if not equal
7B2E	F1		POP	PSW	Restore accumulator and processor status
7B2F	C9		RET		Return

# OHIO SCIENTIFIC USERS

SOFTWARE - GAME AND UTILITY PROGRAMS FOR AS LOW AS \$1.00. ALL WITH LISTINGS AND COMPLETE DOCUMENTATION.

KITS - UPDATE YOUR COMPUTER TO PLAY MUSIC, INCREASE OPERATING SPEED, HIGH RESOLUTION GRAPHICS AND MUCH MORE. KITS INCLUDE PARTS AND COMPLETE ASSEMBLY INSTRUCTIONS. LOW AS \$3.00.

OUR \$1.00 CATALOG INCLUDES OSI PROGRAMMING TIPS PLUS DESCRIPTIONS OF AVAILABLE PROGRAMS AND KITS.

**MITTENDORF ENGINEERING 905 VILLA NUEVA DR. LITCHFIELD PARK, AZ 85340**

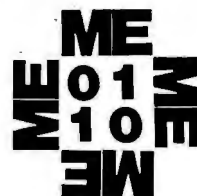

# SAVE / on TRS-80® and Apple® Software and Hardware

## NEWDOS 80

### A new enhanced NEWDOS for the TRS-80.

The most powerful Disk Operating System for the TRS-80, designed for the sophisticated user and professional programmer who demands the ultimate.

NEWDOS/80 is the planned upgrade from NEWDOS 2.1. Some of the features are:

- New BASIC commands for files with variable record lengths up to 4095.
- Mix or match drives. Use 35, 40 or 77 track 5" disk drives or 8" disk drives, or combo.
- Security boot-up for BASIC or machine code application programs.
- New editing commands.
- Enhanced RENUMber that allows relocation.
- Command chaining.
- Device handling for routing to display and printer simultaneously.
- DFG function: striking of D, F and G keys allows user to enter a mini-DOS without disturbing program.
- Compatible with NEWDOS & TRSDOS.
- Machine language Superzap/80, 2.1 utilities and enhanced debug and copy.

## \$149

### Limited Upgrade Offer

NEWDOS owners up-grade to NEWDOS/80 and receive trade-in allowance toward purchase of NEWDOS/80 by including in your order:

- Serial # on your NEWDOS diskette
- Where purchased, amount paid

In most cases that purchase price will be subtracted from the price of NEWDOS/80. Add \$10 for postage and handling (limited offer—good for 30 days only).

## APEX

### A new disk operating system for the Apple.

Fully Professional DOS for the Apple II. The result of two years of extensive development, APEX provides a complete program development and file management system, both powerful and useable. A comprehensive command set allows the user to perform almost any imaginable disk operation. Here are some of APEX's features:

- Command structure similar to CPM® and main frame systems. Contains 20 command words, with ability to treat external programs as transient commands to the operating system.
- Easy program interface. Simple communications between the DOS and user program.
- Capable of handling 5 inch, 8 inch and hard disks.
- Safety features to protect against accidental data loss. Features include backup files, directory, read-after-write and limit checks.
- 4 times faster than CPM.
- Auto default structure eliminates tedious typing by automatically setting up command strings, file names, etc.
- Functional on both single and multi-drive systems. Includes utilities for file copy.
- Device handler structure for interfacing peripherals.

The APEX package includes all of the tools for a complete assembly language development system, high speed two pass resident assembler and a powerful macro editor.

The complete APEX package with operating system, assembler, editor and manuals also includes utilities to maintain files on single or multiple drive systems.

## \$99

Related Software  
XPLØ ..... \$79  
FOCAL™ ..... \$59

## Disk Drive Sale!

\$70 worth of FREE merchandise with purchase of Shugart SA400 with power supply and chassis, the disk that Radio Shack sells for \$499.

SAVE \$200. ....	\$369
TF-Pertec FD200, 40 track, use both sides. ....	\$389
TF-5 MPI B51, 40 track .....	\$389
TF-70 Micropolls, 77 track with 195K storage. ....	\$639
TDH-1 Dual Sided drive, 35 track. ....	\$499
NEWDOS+, 40 track. ....	\$110
35 track .....	\$ 99
Business Programs (Interactive A/R, A/P, & GL) .....	\$349
Radex Data Base Program .....	\$ 99
Mailing List .....	\$59

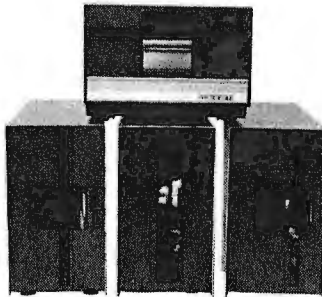

## Disk Drive Expansion System

	<u>List Price</u>
• 2 Shugart SA400 drives with power/chassis .....	\$ 738
• 1 Two-Drive Cable .....	\$ 25
• 1 Expansion Interface 32K .....	\$ 499
• 1 35-track DOS+ .....	\$ 99
TOTAL LIST PRICE .....	\$1,361
SPECIAL PRICE ONLY .....	<b>\$1,199</b>

### MOD I 8" Disk System

- One SA800R Floppy
  - 2 Drive Chassis and Power Supply
  - DOS and Cable .....
- \$1,095**

### MOD II 8" Disk System

- 3 Drive Chassis
  - 2 Drive Expansion System .....
  - 3rd Drive ... Add \$479
- \$1,399**

## Drives for any microcomputer

Does not include power supply & cabinet.

Pertec FD200 ....	\$ 282	FD250 .....	\$ 399
Shugart SA400 ..	\$ 279	SA800/801 .....	\$ 479
MPI B51 .....	\$ 279	B52 .....	\$ 349

## PRINTERS

Centronics 779 ..	\$1,069
Base 2 .....	\$ 599
Centronics 737	
Text processing capabilities, lower case descenders, underlining, subscripts and superscripts, 80 cps \$939	

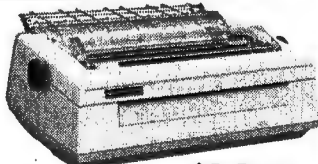

Spinwriter ..... \$2,549

## More Savings



Introductory Offer—  
Save \$200 TRS-80  
Graphics Oldata  
Microline 80...

List \$949 **\$749**  
Our price

Save on Apple II 16K  
FREE memory upgrade kit  
to 48K with purchase of  
Apple II 16K .....

**\$1,195**

Introductory Offer—  
Mini-Floppy for Apple  
(2nd Drive) ... Only **\$419**

Apple 8" Disk System • One SA800R Floppy  
• 2 Drive Chassis & Power Supply  
• Controller, Cable and DOS .....

**\$1,449**

16K Memory Upgrade Kits .....

**\$ 79**

BO/2



**Apparat, Inc.**

(303) 741-1778

7310 E. Princeton Ave. • Denver, CO 80237 • (303) 758-7275



**MICROCOMPUTER  
TECHNOLOGY  
INCORPORATED**



3304 W. MacArthur • Santa Ana, CA 92704 • (714) 979-9923

**All prices cash discounted / Freight: FOB factory. Ask for our free catalog.**

Number	Type	+5 V	GND
IC1	SN7490	5	10
IC2	SN7492	5	10
IC3	MC14512	16	8
IC4	SN7400	14	7
IC5	MC14049	1	8
IC6	MC14050	1	8
IC7	MC14514	24	12
IC8	SN7427	14	7

Text continued from page 126:

is the desired location, there is no need to move the tape and the BASIC program continues.

After the present physical tape location is made equal to the desired location, the Betamax is instructed to play, and a new value representing a new destination at the end of the instructional segment is loaded into the destination register. After the desired length of tape has been played, the tape is stopped and the program jumps to the subroutines which quiz the students on the material.

### Interface Implementation — TRS-80

The concept of controlling a video-cassette player with a personal computer is equally applicable to other systems such as the Radio Shack TRS-80. The TRS-80 has a number of subtle niceties such as low cost and distributed service centers which make it very popular with educators; and the existence of an external bus connector makes the design of specialized interface circuitry relatively easy. The TRS-80/Betamax combination can provide all of the educational benefits that have been discussed in the Apple/Betamax section; in addition, the TRS-80 has a bold 32-character format that makes reading text on the video monitor very easy.

Figure 5 shows the TRS-80/Betamax interface schematic. Lines CN1-20 and CN1-7 from the Betamax are sampled at the beginning of the program to ensure that the cassette has been inserted into the player and that the tape has been rewound. Once

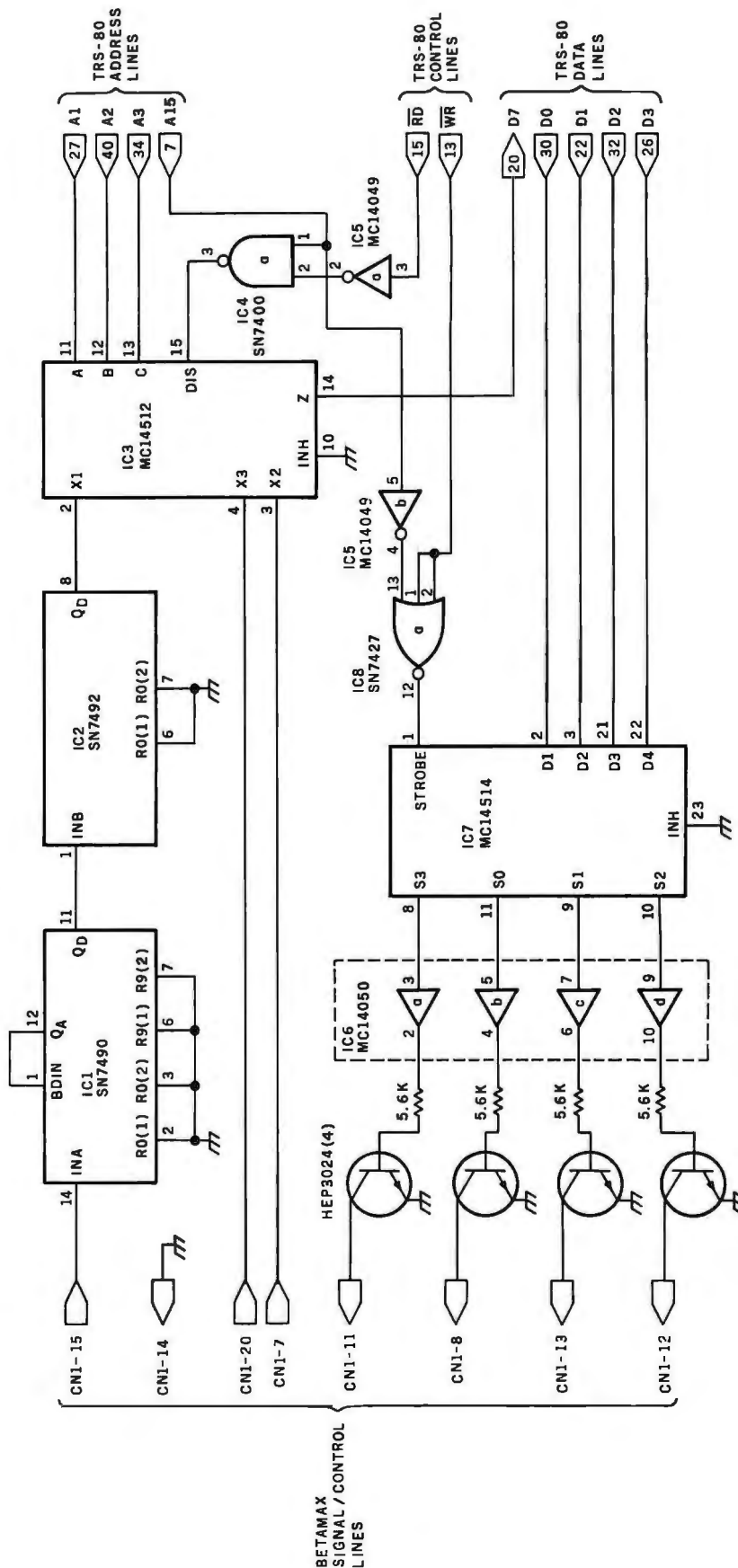
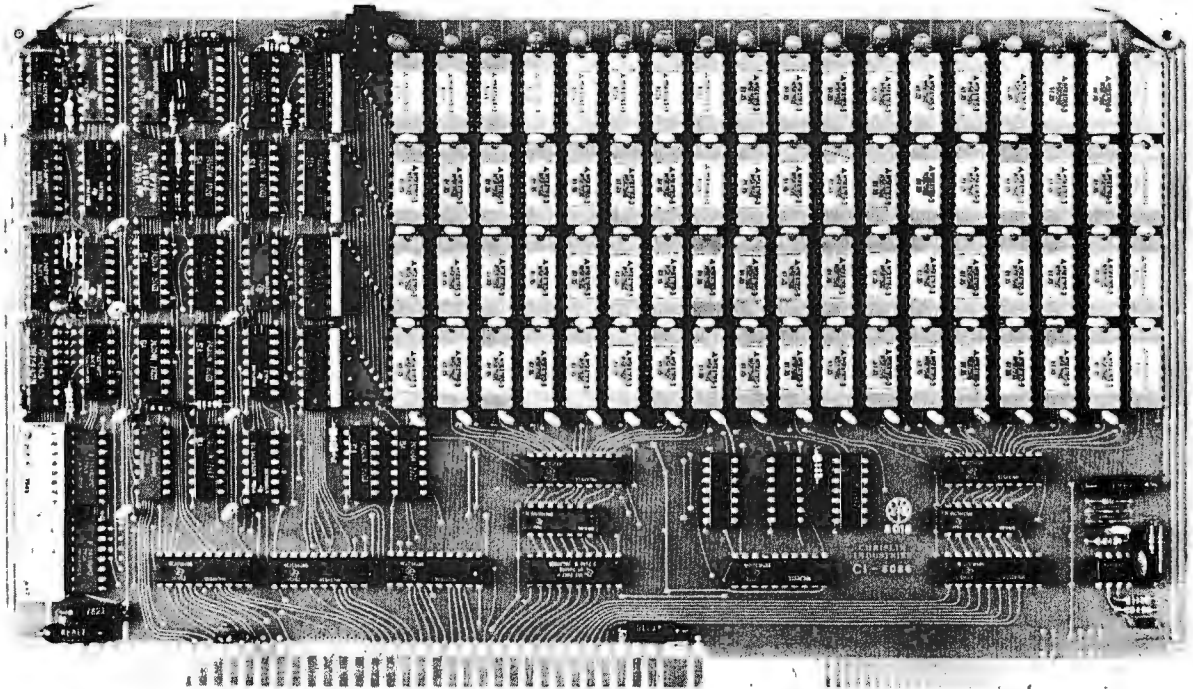

Figure 5: Schematic diagram of the videotape control interface used to connect the TRS-80 to the Sony Betamax SLD-320 videocassette recorder. Connection to the Betamax unit is made through the RM-300 Auto Search control connector. Connection to the TRS-80 is made through the external bus connector on the rear left-hand side of the TRS-80.

# 128K X 9 MULTIBUS MEMORY Only \$1500



**WE'VE DONE IT AGAIN — State of the Art Multibus® Memory Design.** First to offer up to 512K on one board, and Chrislin again brings pricing sanity to the memory market. Why pay over \$2000 for our competitor's 64K x 8 memory board when we will give you the CI8086 128K x 9 memory for just \$1500 or better yet, the CI8086 512K x 9 memory module for \$8700.

Up to 512K bytes in a single option slot. Available in 64K, 96K, 128K, 256K or 512K configurations. On board parity generator checker, for both 8 bit or 16 bit systems. Off shelf deliveries.

**DON'T ASK WHY WE CHARGE SO LITTLE, ASK WHY THEY CHARGE SO MUCH.**

Multibus is a trademark of the Intel Corp.



## *Chrislin Industries, Inc.*

Computer Products Division

31352 Via Colinas • Westlake Village, CA 91362 • 213-991-2254

**Listing 5:** *Assembly-language subroutine for the Z80 processor. This routine is called from the Level II BASIC program to monitor the reverse motion of the videotape by counting timing pulses derived from the tape.*

Hexadecimal Address	Hexadecimal Code	Label	Instruction Mnemonic	Operand	Commentary
7B60	F5		PUSH	PSW	Save accumulator and processor status
7B61	3A 02 80	REST:	LDA	\$8003	Sample count line
7B64	17		RAL		Rotate bit 7 into carry
7B65	DA 61 7B		JC	REST	Jump if carry set
7B68	3A 02 80	AGANE:	LDA	\$8003	Sample count line
7B6B	17		RAL		Rotate bit 7 into carry
7B6C	D2 68 7B		JNC	AGANE	Jump if carry not set
7B6F	37		STC		Set carry
7B70	3A 03 7F		LDA	\$7F03	Load least significant 8 bits
7B73	DE 01		SBI	01	Subtract one
7B75	32 03 7F		STA	\$7F03	Store result
7B78	3A 04 7F		LDA	\$7F04	Load most significant 8 bits
7B7B	DE 01		SBI	00	Subtract one if borrow occurred in previous SBI
7B7D	32 04 7F		STA	\$7F04	Store result
7B80	21 05 7F		LXI	H,\$7F05	Load H,L registers
7B83	3A 03 7F		LDA	\$7F03	Load least significant 8 bits
7B86	BE		CMP	M	Compare
7B87	C2 61 7B		JNZ	REST	Jump if not equal
7B8A	21 06 7F		LXI	H,\$7F06	Load H,L registers
7B8D	3A 04 7F		LDA	\$7F04	Load most significant 8 bits
7B90	BE		CMP	M	Compare
7B91	C2 61 7B		JNZ	REST	Jump if not equal
7B94	F1		POP	PSW	Restore accumulator and processor status
7B95	C9		RET		Return

the cassette has been inserted, the tape will be automatically rewound if necessary.

Line CN1-15 from the Betamax carries the timing signal formatted onto the videotape. The signal is divided by a factor of 60 by IC1 and IC2. IC3 is an 8-channel data selector used to selectively connect line CN1-20, CN1-7, or the divided timing signal to data line seven (D7) in the TRS-80. D7 was chosen because its state can be easily tested by rotating it left into the carry bit.

Address line A15 from the TRS-80 is not normally used because of memory size restrictions. It was therefore pressed into service to provide a signal line for addressing the interface board. IC7 is a 4-to-16 line decoder latch that is used to selectively turn on one of the four transistors, causing the Betamax to either play, rewind, fast forward, or stop. Table 2 shows the Betamax pin connections and the function that will be accessed for a given BASIC statement or a given machine-language command.

The software used by the TRS-80 is virtually identical in design to that of the Apple. Figures 2 and 3 are still valid as flowcharts for the routines that position the videotape during forward and backward tape movement, respectively. The implementation of these routines in Z80 machine code (designed specifically for the TRS-80) are in listings 4 and 5, respectively.

The BASIC driver program, given in figure 4 (flowchart) and listing 3, is valid as written for the TRS-80, with the exception of lines containing the PEEKs and POKEs specific to the TRS-80 interface (see table 2). The BASIC program for the TRS-80 is obtained by substituting the lines given in listing 6 for their counterparts in listing 3.

**Listing 6:** *Modifications of listing 3 needed to create a tape control Level II BASIC computer-aided instruction program for the TRS-80. The lines in this listing should replace their counterparts in listing 3 to create a program that will run on the TRS-80 and its associated interface board.*

```

52      POKE 32515,0: POKE 32516,0: REM INIT COUNT REGISTER
54      X=PEEK(-11): REM INITIALIZE COUNT REGISTER
70      X=PEEK(-9): REM SAMPLE LINE CN1-20 FROM BETAMAX
74      POKE (-1,3): REM REWIND TAPE
76      GOTO 70: REM RETURN TO SEE IF TAPE REWOUND
99      END

10010     X=PEEK(32515)+256*PEEK(32516): REM GET ACTUAL LOCATION
10110     POKE 32517,R1: POKE 32518,R2: POKE -1,2
10112     POKE 16526,0: POKE 16527,123: X=USR(0)
10114     POKE -1,0
10250     POKE 32517,R3: POKE 32518,R4: -1,3
10252     POKE 16526,96: POKE 16527,123: X=USR(0)
10254     POKE -1,0
10256     POKE 32515,R1: POKE 32516,R2
10310     POKE 32517,P1: POKE 32518,P2: POKE -1,1
10320     POKE 16526,0: POKE 16527,123: X=USR(0)
10410     POKE -1,0: POKE -1,14: RETURN

```

### User Reaction

Initial response to the system has been enthusiastic. Since immediate feedback is an important part of an educational experience, it is expected that the system will enhance retention and understanding. At present, lectures and program materials for medical students are being generated for use in the College of Osteopathic Medicine. Upon completion of the material, experiments will be conducted to see if the system does enhance learning capabilities. ■





# Hard disk and hardtape™ control

## Up to 2400 Megabytes of hard disk control for the S-100 bus.

Konan's SMC-100 interfaces S-100 bus micro computers with all hard disk drives having the Industry Standard SMD Interface. It is available with software drivers for most popular operating systems. Each SMC-100 controls up to 4 drives ranging from 8 to 600 megabytes per drive, including most "Winchester" drives -- such as Kennedy, Control Data, Fujitsu, Calcomp, Microdata, Memorex, Ampex, and others.

SMC-100 is a sophisticated, reliable system for transferring data at fast 6 to 10 megahertz rates with onboard sector buffering, sector interleaving, and DMA.

SMC-100's low cost-per-megabyte advanced technology keeps your micro computer system micro-priced. Excellent quantity discounts are available.

## Konan's HARDTAPE™ subsystem... very low cost tape and/or hard disk Winchester backup and more.

Konan's new DAT-100 Single Board Controller interfaces with a 17½ megabyte (unformatted) cartridge tape drive as well as the Marksman Winchester disk drive by Century Data.

The DAT-100 "hardtape" system is the only logical way to provide backup for "Winchester" type hard disk systems. (Yields complete hard disk backup with data verification in 20-25 minutes.)

Konan's HARDTAPE™ subsystem is available off the shelf as a complete tape and disk mass storage system or an inexpensive tape and/or disk subsystem.

## Konan controllers and subsystems support most popular software packages including FAMOS™, CP/M® version 2.X, and MP/M.

Konan, first (and still the leader) in high-reliability tape and disk mass storage devices, offers OEM's, dealers and other users continuing diagnostic support and strong warranties. Usual delivery is off the shelf to 30 days with complete subsystems on hand for immediate delivery.

Call Konan's TOLL FREE ORDER LINE today:

**800-528-4563**

Or write to Bob L. Gramley  
Konan Corporation, 1448 N. 27th Avenue  
Phoenix, AZ 85009. TWX/TELEX 9109511552

CP/M® is a registered trade name of Digital Research,  
FAMOS™ is a trade name of MVT Micro Computer Systems.  
HARDTAPE™ is a trade name of Konan Corporation.

# KONAN

# NEECO

# PROUDLY ANNOUNCES OUR NEW ONE YEAR WARRANTY ON ALL CBM COMPUTERS!

"All CBM Computers purchased between June 15th and Sept. 15th will automatically carry a full one year NEECO warranty"

The 8032 CBM Computer is now available!

## CBM™ 8000 SERIES BUSINESS COMPUTERS

The new Commodore 8000 series computers offer a wide screen display to show you up to 80-character lines of information. Text editing and report formatting are faster and easier with the new wide-screen display. The 8000 series also provides a resident Operating System with expanded functional capabilities. You can use BASIC on the 8000 computers in both interactive and program modes, with expanded commands and functions for arithmetic, editing, and disk file management. The CBM 8000 series computers are ideally suited for the computing needs of the business marketplace.

**SCREEN**  
2000 character display, organized into twenty-five 80-column lines  
64 ASCII, 64 graphic characters  
3 x 8 dot matrix characters  
Green phosphor screen  
Brightness control  
Line spacing: 1½ in Text Mode  
1 in Graphics Mode

**SCREEN EDITING CAPABILITIES**  
Full cursor control (up, down, right, left)  
Character insert and delete  
Reverse character fields  
Overstriking  
Return key sends entire line to CPU regardless of cursor position

**KEYBOARD**  
73-key typewriter style keyboard with graphic capabilities  
Repeat key functional with all keys

**INPUT/OUTPUT**  
Parallel port  
IEEE-488 bus  
2 cassette ports  
Memory and I/O expansion connectors  
**FIRMWARE**  
24K or ROM contains:  
BASIC (version 4.0) with direct (interactive) and indirect (program) modes  
9-digit floating binary arithmetic  
Tape and disk file handling software

**MEMORY**  
CBM 8016: 16K (15359 net)  
random access memory (RAM)  
CBM 8032: 32K (31743 net)  
random access memory (RAM)

**POWER REQUIREMENTS**  
Volts: 110V  
Cycles: 60 Hz  
Watts: 100

**CBM 8032 Computer \$1795**



## CBM™ 8050 DUAL DRIVE FLOPPY DISK

The CBM 8050 Dual Drive Floppy Disk in an enhanced version of the intelligent CBM 2040 Disk Drive. The CBM 8050 has all of the features of the CBM 2040, and provides more powerful software capabilities, as well as nearly one megabyte of online storage capacity. The CBM 8050 supplies relative record files and automatic diskette initialization. It can copy all the files from one diskette to another without copying unused space. The CBM 8050 also offers improved error recovery and the ability to append to sequential files.

<b>HARDWARE SPECIFICATIONS</b>	<b>FIRMWARE</b>
Dual Drives	DOS version 2.0
Two microprocessors	Sequential file manipulation
974K Bytes storage on two 5.25" diskettes (ss)	Sequential user files
Tracks 70	Relative record files
Sectors 17-21	Append to sequential files
Soft sector format	Improved error recovery
IEEE-488 interface	Automatic diskette initialization
Combination power (green) and error (red) indicator lights	Automatic directory search
Drive Activity indicator lights	Command parser for syntax validation
Disk Operating System Firmware (12K ROM)	Program load and save
Disk Buffer (4K RAM)	

CBM	PRODUCT DESCRIPTION	PRICE
2001-8KN	8K RAM-Graphics Keyboard	\$ 795.00
2001-16KN	16KN RAM-Graphics Keyboard	\$ 995.00
2001-16KB	16K RAM-Business Keyboard	\$ 995.00
2001-32KN	32K RAM-Graphics Keyboard	\$1295.00
2001-32KB	32K RAM-Business Keyboard	\$1295.00
8016	16K RAM-80 Col.-4.0 O/S	\$1495.00 *
8032	32K RAM-80 Col.-4.0 O/S	\$1795.00
2023	Friction Feed Printer	\$ 695.00
2022	Tractor Feed Printer	\$ 795.00
2040	Dual Floppy-343K-DOS 1.0	\$1295.00
2050	Dual Floppy-343K-DOS 2.0	\$1295.00
8050	Dual Floppy-974K-DOS 2.0	\$1695.00 *
C2N Cassette	External Cassette Drive	\$ 95.00
CBM to IEEE	CBM to 1st IEEE Peripheral	\$ 39.95
IEEE to IEEE	CBM to 2nd IEEE Peripheral	\$ 49.95
8010	IEEE 300 Baud Modem	\$ 395.00 *
2.0 DOS	DOS Upgrade for 2040	\$ 50.00
4.0 O/S	O/S Upgrade for 40 Column	\$ 100.00

\*Asterisks indicate summer delivery — all others are immediately available.



\*CBM is a registered trademark of Commodore. All prices and specifications are subject to change without notice.

# NEECO

679 Highland Ave.  
Needham, MA  
02194

Mon-Fri 9:30-5:30  
MasterCharge &  
Visa Accepted  
**(617) 449-1760**  
Telex: 951021

# MICROAMERICA DISTRIBUTING

"Nationwide distributors of Computer Equipment"

21 Putnam Street  
Needham, MA  
02194

**(617) 449-4310**



NEECO  
PROUDLY  
INTRODUCES

# MULTI-CLUSTER

"Multi User Management System for  
Commodore CBM/PET\* Computers"

**UP TO 8 CBM/PETS MAY NOW SIMULTANEOUSLY ACCESS ONE 2040!**



Channel Module  
CM-100



- Up to 8 Channel (3 Standard) for CBM/PET Computers.
- Up to 8 CBM/PETS can multi-use one Commodore 2040 dual disk drive simultaneously with equal access.
- Multi-Cluster supports all 2040 disk O/S commands including sequential, random access, and user files.
- Multi-Cluster does not utilize any RAM or ROM from the 2040 or host CBM/PET units.
- Multi-Cluster is compatible with all known software that utilize the IEEE port.
- Multi-Cluster can be fully implemented on 8 PETS, completely ready to use, in less than 15 minutes.
- Simply plug the Multi-Cluster unit into the IEEE port of the 2040 Disk Drive, then attach a Channel Module, #CM800, (3 Channel Modules are standard with unit), to the IEEE port of each PET.

Multi-Cluster  
Model MC-800A  
Standard 3 Channels)

**\$995**

Multi-Cluster is ideal for industrial, OEM, Vertical Markets, and Educational Institutions. Multi-Cluster allows you to make full use of the Commodore 3 units for the price of 2 educational programs.

**Standard Components:**

- 1 Multi-Cluster ..... #MC800A
- 3 Channel Modules ..... #CM-100
- 3 6' Ribbon Cables ..... #RC6

**Optional Component Prices:**

- Each additional CM-100 ..... \$250
- Each 12' Ribbon Cable (RC12) ..... \$ 40
- Each 18' Ribbon Cable (RC18) ..... \$ 60
- Output Printer Module (PM200) ..... \$200  
(For Centronics Protocol Printers)

\*Dealer pricing available via Microamerica

## **SPECIAL OFFER ON CBM BUSINESS SOFTWARE!**

Purchasing software has always been difficult due to the "you buy it - you own it" attitude of most vendors. We at NEECO, recognize this problem and can now, on all of the Software Packages listed, offer a full 30 day refund policy to NEECO's customers. Now you can purchase with confidence. Buy it - try it; if the program package is not suitable for any reason, send it back to us within 30 days and we will refund the full purchase price - less shipping charges!

SOFTWARE	APPLICATION	REQUIRES	AUTHOR	AVAILABILITY	PRICE
Word Pro I	Word Processing	8K + cassette	Pro Micro	July/August	\$ 29.95
Word Pro II	"	10K + 2040	"	Immediate	99.95
Word Pro III	"	32k + 2040	"	"	199.95
Word Pro IV	"	8032 + 2040/8050	"	"	299.95
BPI Integrated G/L	Business	32K + 2040	BPI	"	360.00
BPI Inventory	"	"	"	July/August	T.B.A.
BPI Payroll	"	"	"	"	"
BPI Enhanced A/R	"	"	"	"	"
CMS G/L	"	"	CMS Software	Immediate	295.00
CMS A/R	"	"	"	"	195.00
CMS A/P	"	"	"	"	195.00
CMS Mail List	"	"	"	"	100.00
CMS Payroll	"	"	"	"	350.00

\*PET is a registered trademark of Commodore Business Machines. Small Keyboard PETS require a ROM Retrofit Kit.  
Multi-Cluster is available in Canada from BMB Compu Science, P.O. BOX 121, Milton, Ontario, L9T2Y3



**NEECO**  
679 Highland Ave.  
Needham, MA  
02194

**Dealer Sales:**  
**Microamerica Distributing**  
21 Putnum St., Needham, MA 02194  
(617) 449-4310 **Telex: 951021**

**Customer Sales:**  
**NEECO**  
679 Highland Ave., Needham, MA 02194  
(617) 449-1760

# A Personal Computer on a Student's Budget

---

J C Johnston  
26481 Shirley Ave  
Euclid OH 44132

---

About four years ago I decided that I wanted to obtain a microcomputer. I had done some programming on an IBM 370 and on a Texas Instruments 960 minicomputer at Cleveland State University.

Those who are starting in microcomputers have a problem in deciding what equipment they want, what to get, and how much to spend. When I began to obtain my machine, I figured on building the SwTPC (Southwest Technical Products Corp) CT-1024 video terminal for about \$200, and spending only about \$400 on the minimum computer system. As it turned out, I spent:

\$120	processor board
90	4 K memory board
60	I/O (input/output) board
45	mother board
25	power supply
40	enclosure
+12	power supply extension
<hr/>	
\$392	Total

I have since expanded the system, but I kept within my original budget fairly well.

I started by buying the printed circuit board set for the SwTPC

---

This article was written bearing in mind the things I wish I had known four years ago, when this adventure started. It is possible to put together a good system on a limited budget.

---

CT-1024, figuring that any machine would require some type of terminal, and this was the only affordable one I could find. Considering the problems I had getting parts, the CT-1024 turned out to be a good choice.

As I built up the terminal, I looked for the right computer. We were using some of the original Altair 8800s in the Chemistry Department and I learned about some of the problems involved in making them operational. It took fifteen fuses to track down one problem in the power supply in which a bad bridge was shorting out the +8 V supply. My opinion of the Altair 8800 has since risen, but I was wary at the time.

I was attracted to the Southwest

Technical Products 6800. The kit was more nearly complete, requiring only the terminal to make a functional system. The SwTPC 6800 was also inexpensive. I could not touch its price with any 8080-based system then available. The monitor in read-only memory was a great convenience. My reservations about getting the system came from the vagaries of mail order kit building.

During my consideration of the SwTPC machine, a friend showed me the instruction set of the just introduced Z80 microprocessor. I was enchanted, but the problem remained of building an affordable system.

Having no idea of which computer system I wanted, I went to the MACC (Midwest Affiliation of Computer Clubs) Computerfest. Amid the fascinating computer equipment that I knew I could not afford, I discovered the display booth of the

---

## About the Author

*Chris Johnston is a graduate chemistry student at Cleveland State University in Ohio. Exposure to FORTRAN in undergraduate chemistry courses sparked his interest in computers. Writing simple software for computer-controlled laboratory experiments led him to an interest in minicomputers and microcomputers, and "things snowballed from there."*

---

Ithaca Audio company (now Ithaca Intersystems Co). They were showing their Z80 processor circuit board for the S-100 bus. This board was the key to building an affordable system.

It is a Z80 processor board, but to the system bus it appears to be an 8080 processor board. It carries memory-write circuitry and a power-on jump vector. One of the nicest things about it is the provision for a 2708 erasable programmable read-only memory. Here in one board was the answer to a big problem. I could not afford an IMSAI front panel, and I did not want to spend all of the extra money on a read-only memory board. The 2708 capability was convenient because I could program it using the Cromemco Bytesaver board in one of the Altair systems at school. Finally, the prices were excellent—\$35 for the board, \$25 for the Z80 processor, and \$20 for the 2708 programmable read-only memory. I estimated that the rest of the board could be built for around \$40.

The Ithaca Audio Z80 board is neat in appearance, and is solder-masked and silk-screened. An impressive, twenty-seven-page documentation package comes with it. There were many components to put on the board, but the soldering was not too difficult. The board had one minor, but annoying, problem: there was no component placement diagram. The position of only one end of each resistor or capacitor was marked with the silk screening.

This helped me detect one other problem with the board. While tracing the circuitry near the 8224 clock generator and driver, I noticed a mix-up in the silk screening where the schematic and parts list did not match the silk screen. I examined my Intel 8224 data and found the problem. The capacitor in the circuit with the crystal should be a 10 pF-type (C7 on the schematic, C9 on the board). To make everything agree, I changed C7 to C9 (and vice versa) on the schematic and parts list. Now the board, the schematic, the parts list, and page two of the documentation agreed. More recent revisions of this board have corrected this problem.

One inconvenience for me was that the front-panel connector is a 16-pin dual-in-line socket. This is fine for those lucky enough to own an IMSAI, or another machine with this

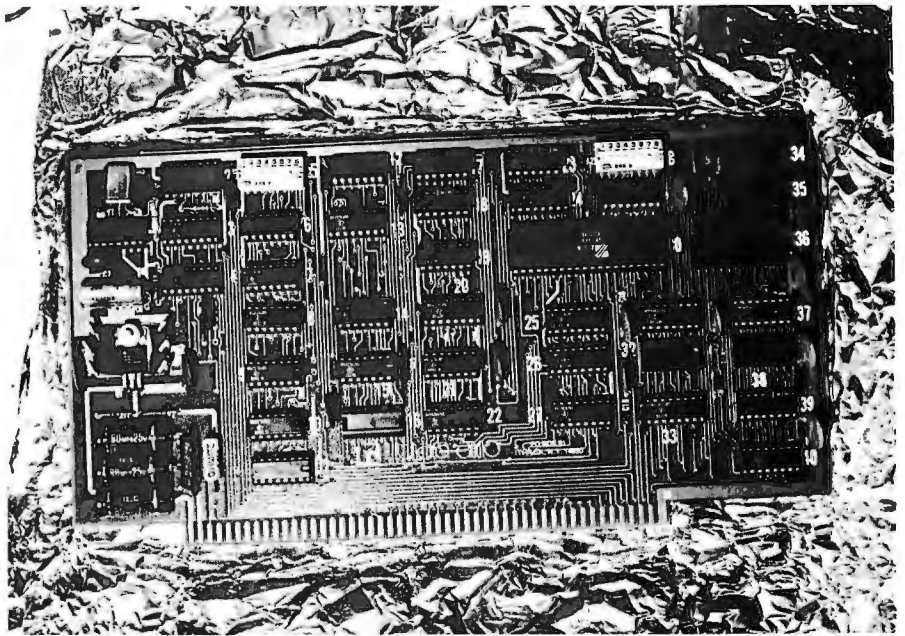

Photo 1: Ithaca Audio Z80 processor board for the S-100 bus.

---

The Ithaca Audio Z80 processor board was precisely the board I needed to build an affordable system.

---

type of connector. I found it necessary to construct an adapter to connect the board to one of the Altair systems for checkout.

### Diagnosing Problems

I followed the checkout procedures outlined in the documentation package and encountered my first problem. The Z80 board would not reset the A0 and A2 address lines of the S-100 bus. I spent a long time searching for the cause of this problem and finally decided that it had to be a bad integrated-circuit socket. When replacing the socket did not help, I was almost ready to give up for the day. However, it occurred to me that the problem might be with the plated-through holes. I tried sticking a wire through the holes on the afflicted address lines. This cured the reset problem, but identified a more serious problem: that of insufficiently plated-through holes. I eventually traced all of the problems with this board to bad holes in one area. The

rest of the board appeared to be all right, so I patched the holes in the bad area.

At first the processor would not run, but later it would not stop when it began running. The reason for this was that the 8080-style status signals are not available on the data lines. The Altair 8080a front panel looks at the data lines so it can stop on an M1 cycle (fetch cycle for first byte of instruction). If data bit 5 is high during the time that you are trying to stop the computer, it stops, but not on an M1 cycle. If this bit never goes high, the processor never stops. There is an explanation of this situation in the documentation.

I do not know the situation for other S-100-type computers, but you cannot examine the on-board 2708 read-only memory with the 8800a front panel. This is caused by the lack of buffering between the 2708 and the front panel. The 2708 simply cannot drive it. This is the only design error I found that I thought was objectionable.

I spent about fifteen hours debugging the board. Most of the time was spent tracking down problems on the board itself. A call to Ithaca Audio for assistance was reassuring in two ways. First, they were willing to provide the type of information necessary to service their boards. Second, I got the impression from our conversation that the

problem with the plated-through holes was not common. The chances are reasonably good that any board you purchase from them will be suitable.

I consider myself lucky to have found this board at the Computerfest, where I could see it. I probably would not have purchased a processor board from a company with which I had not had contact.

This illustrates one of the greatest advantages in joining a local computer club — you can talk to people who have seen or built a large number of different computer kits. I am a member of the Cleveland Digital Group; it has been more helpful to me than I had ever imagined. My friends at school, who ordered some of the first Altairs several years ago, have been similarly helpful.

### Memory

My efforts now turned to finding a memory board I could afford. I had heard good things about the SD Sales 4 K board, so I ordered one. I was told they were shipping immediately. However, the normal shipping delay was two weeks; the memory board came two weeks after my order.

Like all memory boards, this one can be somewhat tedious to build, but the instructions are clear and complete. The documentation even included instructions on how to insure that all of the sockets are down tight on the board. The sockets included were good-quality, low-

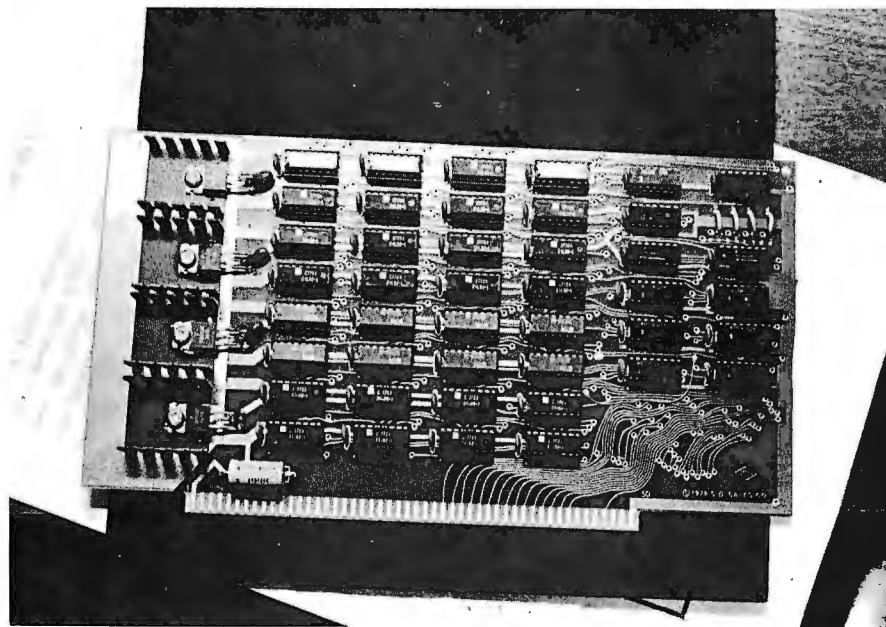

Photo 2: SD Sales 4 K static memory board. The jumper and cut trace were factory modifications.

profile devices.

The board took about a half hour to debug with some expert help. The two problems I had were trivial: one was a folded-under integrated-circuit pin, the other a solder bridge. The solder bridge occurred in the tightest part of the board — the back side above and outside of bus pin 51.

The only construction problem occurred during the installation of the voltage regulators. With the heat sinks in place, there is just enough lead length on the regulators to solder them to the back of the board. The

problem was not in the kit, however. Fairchild has evidently found some new alloy for coating leads that renders them completely unsolderable. Ten minutes' worth of filing removed enough of the alloy to make reasonable solder connections.

I am still constructing an 8 K dynamic memory board of my own design. It will depend on the Z80 for refresh operations. The board uses sixteen Texas Instruments 4060 4 K by 1 dynamic memory circuits or the equivalent. This board has major power consumption advantages over

## Control Your Life!

Now have full computer control of up to 256 lights, appliances and even wall switches **without special wiring**. The SciTronics REMOTE CONTROLLER permits direct control of the inexpensive BSR remote line-carrier switches sold by Sears, Radio Shack and many others.

- Controls all 256 BSR remote switches — not just 16
- Hardware driven — requires minimum software
- No ultrasonic link — prevents erratic operation
- No BSR command module necessary

The controller comes complete with full documentation, sample software and is designed to work with most of the popular computers including any S-100 based system, TRS-80-1, Apple II, Heath H8 and others.

#### Applications:

- Make your entire home or apartment computer controlled
- Save energy by controlling lights & appliances
- Control security systems & alarms

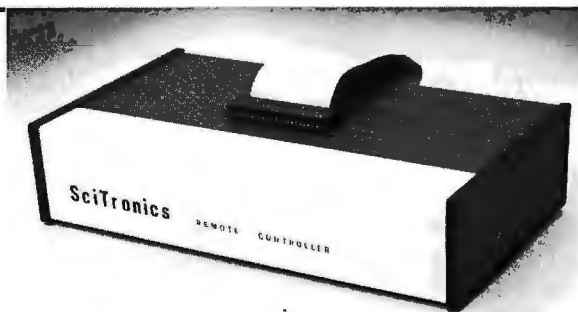

*Remote switches not included*

CONTROLLER BOARD (S-100) **\$159.**  
ENCASED CONTROLLER (TRS-80, Apple, etc.) **\$184.**

Send check or **SciTronics Inc.**  
money order to: 523 S. CLEWELL ST., PO. BOX 5344  
BETHLEHEM, PA 18015  
(215) 868-7220

Please list system with which you plan to use controller. Master Charge and Visa accepted. PA residents add sales tax.



# We make our Floppys as if your job depends on them. Because it does.

In your work, data is too important to lose. So if you use a Floppy Disk with even a minor flaw—like a dropout—you risk a lot. That's why Maxell has taken the danger out of Floppy Disks.

## **Maxell: the worlds most dependable Floppy Disks.**

We've devoted two generations to building our reputation as manufacturers of the world's finest magnetic media. Our Floppy Disk technology achieves a consistency that is rarely equalled . . . and never surpassed.

Even the jackets our floppys come in are made to resist heat and mechanical shock. And they're specially treated to prevent the build-up of static charges, so they do their part to increase the total reliability of their precious contents.

## **Made better than most specifications.**

To guarantee complete interchangeability, all Maxell floppys conform to ISO, ECMA, ANSI, JIS, and IBM standards.

Circle 97 on inquiry card.

But even more important to you, Maxell's own tolerances are tougher than the industry's.

And our inflexible Quality Control inspections permit nothing to blemish our hard-earned reputation.

So when your job depends on full data retrieval, depend on Maxell Floppy Disks. They work best . . . and so will you.

Maxell offers the full range of Floppy Disks, from standard 8-inch to 5¼ -inch, plus Data Cassettes. *Dealer inquiries invited.*



**maxell.**  
DATA PRODUCTS  
The Quality Alternative

Maxell Corporation of America. Data Products Group  
60 Oxford Drive, Moonachie, NJ 07074 Tel. (201) 440-8020

---

It is necessary to use the white plastic wiring spacers.

---

a similar board using 2102 static memories (even the low-power versions). It should also have major advantages over the newer 4 K by 1 static memory devices in terms of cost. The 4060s are easy to design with, especially when you have the Z80 Refresh register and the Refresh signal available on the bus. Bus pin 67 on the Ithaca Audio processor board is RFSH (an inverted version of the RFSH signal available on pin 28 of the Z80 package).

### Input and Output

The next major part of my system was an I/O (input/output) board. After shopping around I realized these boards were expensive, especially in view of what they do. I needed a board with some type of parallel port and a serial port including a universal asynchronous receiver-transmitter (UART). A friend with a similar need designed a circuit board containing both serial and parallel I/O. We constructed two boards by wire-wrapping procedures. I used the Vector 8800V prototyping board and had some trouble with shorting the little wiring-pencil wires to the ground plane when I soldered the pins of the integrated-circuit sockets. The next time I build a board, I will build it on a Vector 8801 which has a solder pad on every hole in the board. An absolute necessity when working with the wiring pencil is Vector's white plastic wiring spacers. I built the board without them and had so many problems that I spent an entire evening taking all of the little wires back off the board, installing the spacers, and, during the following nights, rewiring the board.

The wire used in the pencil has insulation which melts or decomposes at temperatures over 750° F. If you accidentally touch a wire or a bundle of wires with a hot soldering iron, it will go "poof," leaving you with a bare wire or a major short. I did this at one especially congested point and had to replace twenty-five wires.

Some techniques which help when you work with a wiring pencil are:

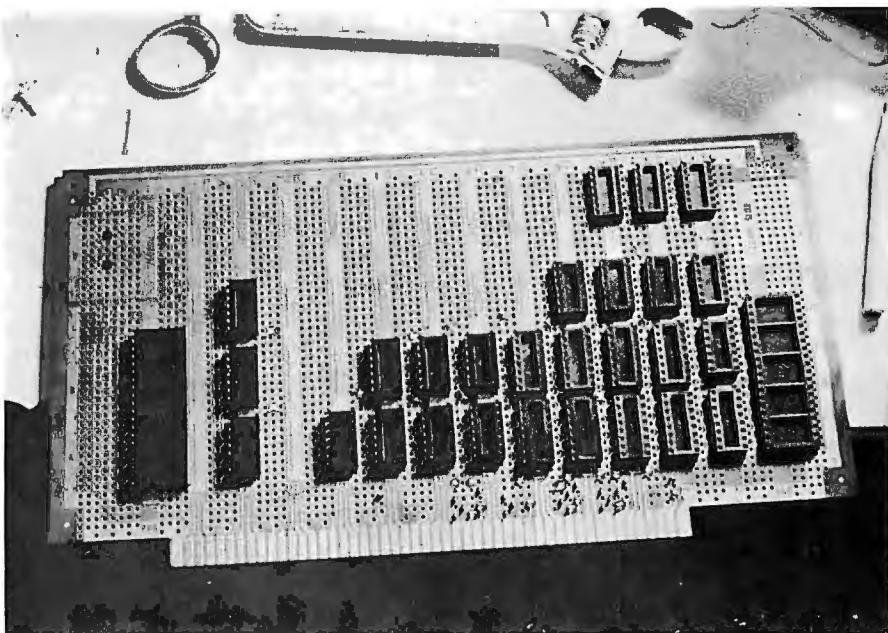

Photo 3: The parallel and serial I/O (input/output) board under construction. The sockets are attached with Eastman 910 adhesive.

- Leave as much room as possible between integrated circuits. Try to arrange the layout so that wire runs do not cross over component pins.
- If you have to cross over or near a component pin, make sure the pin is soldered before you begin to run wires over it. Failure to do so invites touching the wire bundle and causing a big short.
- Color code if possible. I used red wires for the parallel port, green for the serial port, and blue for repairs.

Again, make sure that you use the wiring spacers. Little metal pins used as substitutes may scuff off the insulation to the point of creating nearly undetectable shorts. The wiring spacers are Vector part number P179WS-3.

The parallel port output from the board is done through a 24-pin dual-in-line socket. The 6820 peripheral interface adapter (PIA) used in the port is what we needed to handle a paper-tape reader and, more important to our systems, a card reader.

### Mother Board

I am using the SSM (formerly Solid State Music) 15-slot mother board as the backbone of my system. The board fits well within my budget. It has provision for filter capacitors on

all power lines and for passive termination of the bus lines. From what I have read, termination is probably not necessary for this board.

The big Altair system at school is completely filled out with the infamous MITS 3-slot extension mother boards. It has never presented any problems that bus termination would fix. If I suspect that the system needs

---

If you accidentally touch the wrapping wire with a hot soldering iron, the insulation will go "poof" and you will have a bare wire or a short.

---

to be cleaned up, I will get the Godbout active termination card. While this will take up one slot, I have enough available room to extend the mother board if I have to.

### Read-Only Memory

The systems in the chemistry department all needed some read-only memory, so an 8 K 2708 board was designed. A friend and I each made one of these boards for our own systems, so I now have room for a great deal of permanent software



# INDUSTRY LEADER ANNOUNCES MERGER.

## MicroPro proudly announces MailMerge capabilities along with Wordstar 2.0

Now you have another terrific reason to purchase WordStar, the industry's leader in microcomputer word processing. And that reason is called MailMerge. A new option that allows you to churn out letter quality form letters with full substitution capabilities, as well as chained and multiple copy printing.

And lots more.

Plus WordStar 2.0 also offers other new and powerful features. Like hyphen

help, decimal tab, paragraph indent, and copy/rename/run-another-program.

No wonder that in less than a year, more than 7500 people have purchased WordStar from over 350 dealers around the world.

So go ahead. Call (415) 457-8990 for a dealer nearest you. And just think, WordStar was a very popular software package *before* MailMerge.

Imagine how incredibly popular it will be *now*.



INTERNATIONAL CORPORATION

Leads the way.

MicroPro International Corporation 1299 4th Street, San Rafael, California 94901 Telex 340388  
Dealer/Distributor/O. E. M. inquiries invited.

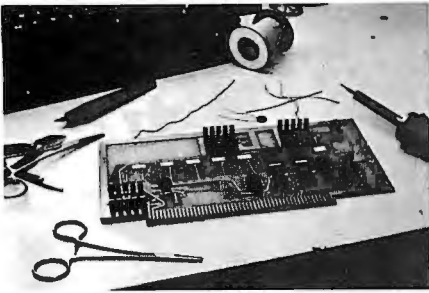

**Photo 4:** Our homebrew board for housing the 2708 programmable read-only memory.

(firmware). The printed circuit board without parts cost us about sixty cents. The reasons for this were that the negative had already been made, we had everything we needed to make printed circuit boards in our electronics shop, and we did the work ourselves.

From a large (6 by 44 inch) two-sided blank bought at a surplus electronics store, we cut four S-100-sized printed circuit blanks. We obtained two good boards on the first try. We could not make plated-through holes, but the board was designed to use a small number of "jump-throughs," and to have no places where it was necessary to solder to both sides of a component pin.

The board holds only 7 K bytes in my system, because the 2708 circuit on the Z80 board can be located in the first 1 K segment of any 4 K address block in the upper half of memory. If the address segment of the 2708 on the processor board is not coincident with the address space of the bottom (or middle) 2708 on the read-only memory board, I have an almost unusable 3 K "hole" in memory. There is no problem addressing two boards at the same place at the same time: whenever the 2708 on the processor board is addressed, the data input drivers are placed in the high-impedance state, so it does not matter what is in the socket on the firmware board that has the same address.

The read-only memory board does not have provisions for the generation of a wait state. This is not a major problem, as long as full-speed 2708 devices are used. The processor board, however, has extensive wait-state capabilities. A wait state can be put into any input cycle, any output

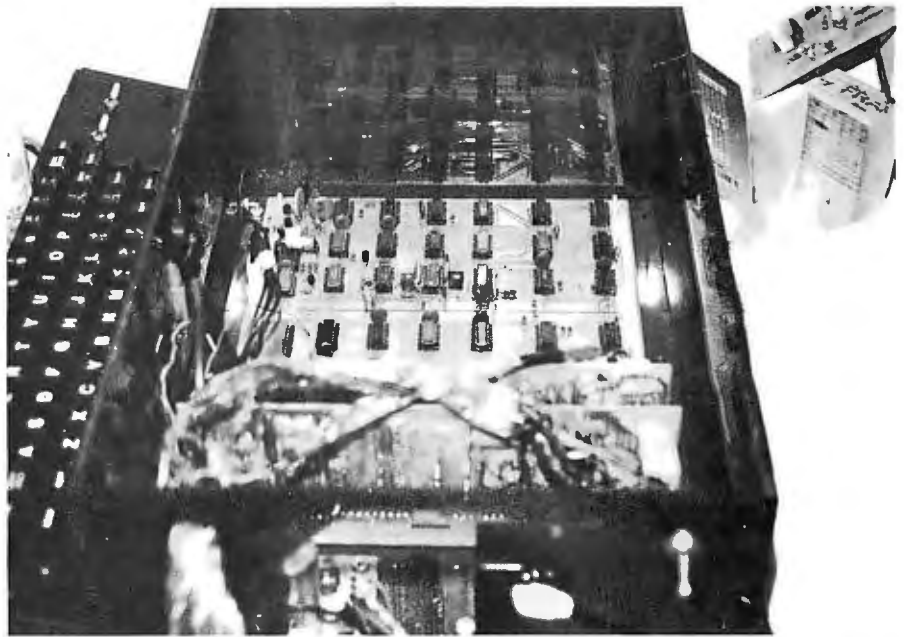

**Photo 5:** Logic (under Plexiglas) and separate keyboard for the Southwest Technical Products Corp CT-1024 video terminal.

cycle, any on-board read-only memory cycle, the first-byte instruction-fetch (M1) cycle, or any memory request cycle. Being able to put a wait state in only the M1 cycle allows for the use of marginally slow memory.

### Enclosure and Power Supply

My power supply provides a maximum of 13 A on the +8 V line and 2.5 A each on the +16 and -16 V lines. A split 10 V supply caused me to split the 8 V power bus. The split was made reversible, so if I need to upgrade my power supply, I can reconnect the bus.

The computer's enclosure is another bow to economics. I liked the commercially available enclosures, but could not justify spending the money required for microcomputer-sized boxes. I bought an aluminum rear-panel plate with connector cutouts from Vector. This panel has cutouts for ten DB-25S connectors. I also bought some of their TS series T-slot struts, some plain and some with printed scales. I bought enough plastic card guides for twelve cards, and some of the square 4-40 nuts that fit into the T-struts. This was enough material for the entire box, except an aluminum panel for the front and the plastic trim panels.

I tried to obtain the aluminum from a dealer who sells scrap sheet metal,

but he had just emptied his bins, so there was nothing usable. I finally bought a rack panel (8¾ inch, 22.2 cm) and cut it to size. I went to a plastics dealer who also sells scrap for the plastic that I needed. The power supply is built on a separate sheet that mounts in the main box. With this setup, any future power supply upgrades will be built on a similar sheet and bolted into place.

### Serendipitaurus Card Reader

The eighty-column card reader mentioned before is, without a doubt, the neatest I/O device I have ever seen, with the possible exception of the floppy disk (which I could not afford at the time the computer was brought up). The unit in question is a small tabletop unit that I found at a surplus house. The chemistry department bought an entire set of them, and most of my friends bought one. Luckily, one friend bought several readers, and supplied me with one.

The units were built by Taurus Corporation and appear to have sold for several hundred dollars originally. We got ours for \$20 each. The card reader works very simply: you feed it 110 VAC and a card, and it feeds you transistor-transistor logic (TTL) level data. It reads all twelve columns, but it cannot see blanks. Our TI 960 minicomputer has an 8080/Z80 cross assembler. We use the

# Now Graphics for your computer

## \$680

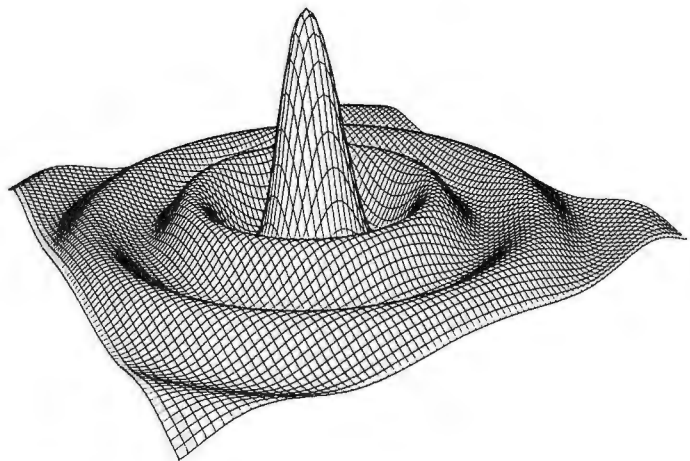

Expand your computer's capabilities with this easy-to-use drum plotter. The Strobe Model 100 interfaces to any computer to generate professional quality graphics.

**OFFERING** High Resolution Graphics Output \* Outstanding Performance \* Assembler Coded Drivers for High Speed Plotting \* Precise Operator Controls \* Interactive Coordinate Input

**ALSO AVAILABLE** Hardware Interfaces for — TRS-80 \* APPLE II \* PET \* S-100.

Applications Software Package providing vector plotting and variable size alphanumerics for: TRS-80 Level II BASIC, Applesoft BASIC, Northstar BASIC, CBASIC, Microsoft BASIC & FORTRAN.

\* TRS-80, APPLE II, and PET are trademarks of Tandy Corp., Apple Computer Co and Commodore Business Machines, respectively

Circle 98 on inquiry card.

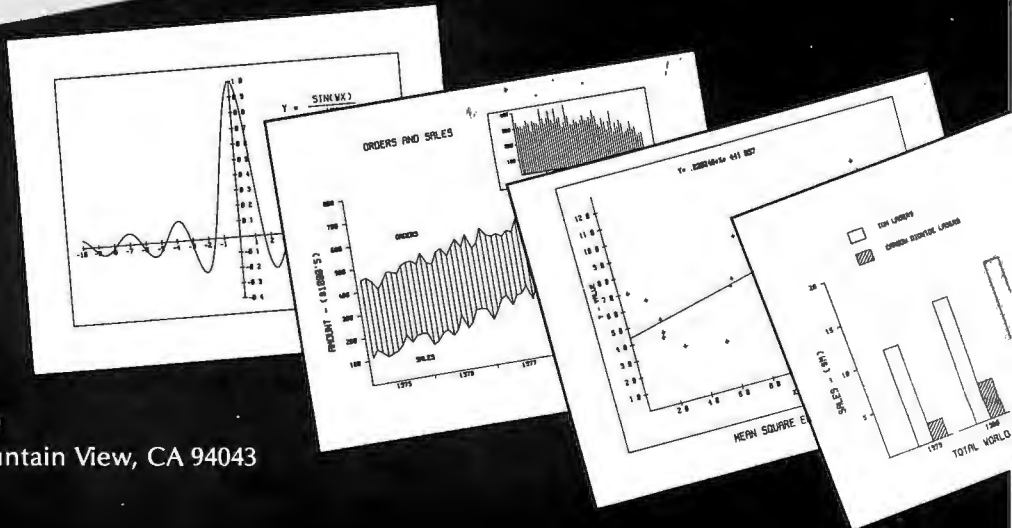

**STROBE INCORPORATED**

897-5A Independence Avenue, Mountain View, CA 94043

(415) 969-5130

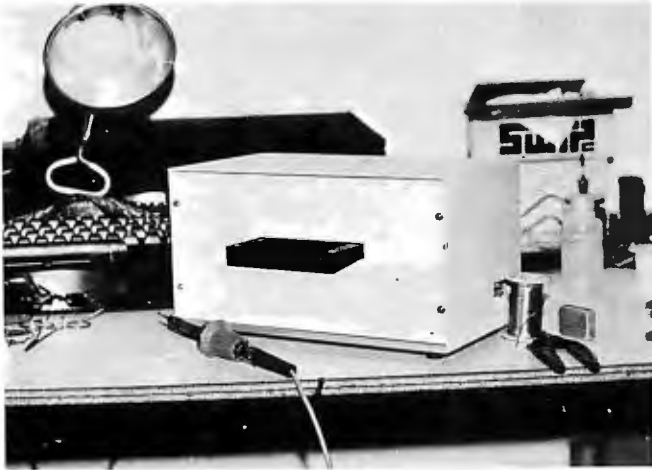

Photo 6: Taurus card reader. Cards are inserted through the slit above the black shelf on the front. Output is through the DB-25 connector on the side (partially obscured by roll of solder).

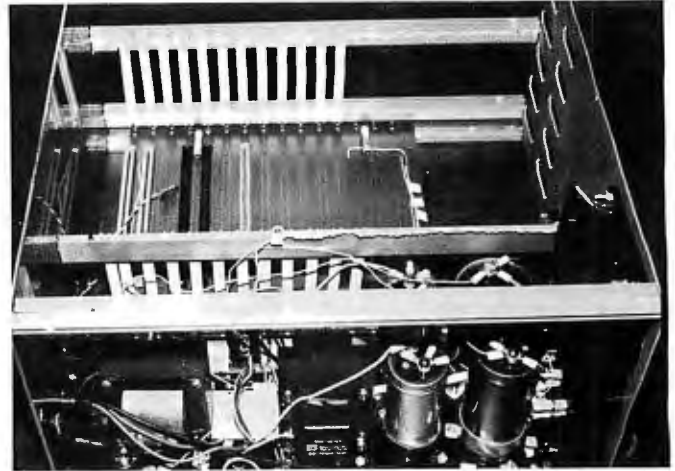

Photo 7: Side view of the system enclosure, showing the power supply and card cage.

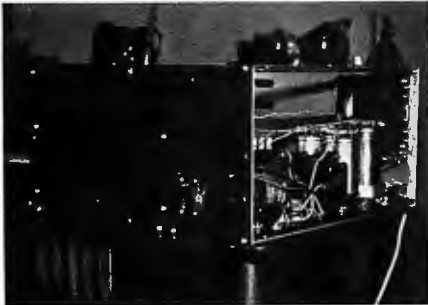

Photo 8: Front view of computer enclosure. The only switches are for power, run/stop, and system reset. The monitor in read-only memory handles other functions of a front panel.

faster 16-bit TI machine to assemble software to run on the 8080 or Z80.

The cross assembler can punch object code onto cards. Each card carries its own load address and checksum. The cards may be read in any order. The storage capacity is sixty-four object bytes per card. Cards allow for easy maintenance of an object program. Cards may be easily and individually duplicated, seem tougher than paper tape, and are cheaper than cassettes; of course, you do need a keypunch. We built a cassette board to provide a more portable system.

## Software

I had to provide some type of software monitor to be placed in the 2708 on the processor board. I started with an octal monitor. I converted from octal to hexadecimal notation, partly for convenience, and partly to save on line width on the terminal.

One of the next major changes in the monitor was the inclusion of the binary card loader which lets the card reader talk to the computer. I modified the cassette tape routines to reflect the specific requirements of our tape interface and my own preferences. The last major change was the inclusion of a register load and dump routine, and a memory dump routine. Several other more minor changes were made in the monitor to support my other major software project, a Z80 assembler.

The next step in software is to obtain a BASIC interpreter to satisfy my need for system software until I expand the hardware. Eventually I want to get a floppy disk system and a video graphics display.

## Closing Thoughts

I have described the process of building and operating my machine. One of the most important things about building my computer was that I could build a customized system

while staying within a limited budget. It has many of the features that are important in a microcomputer, and it is expandable. I have tried not to limit the evolution of this system in terms of hardware or software, and have succeeded to some extent. I chose the S-100 bus chiefly because of its popularity and wide support.

When I decided to experiment with personal computing, I was faced with making a major purchase of something I knew very little about, and a limited budget within which to work. My previous experience with computers had been in the remote use of a high-level language. (I could not even get into the same room with the computer I used to learn FORTRAN.)

Although the delay involved in waiting for parts was frustrating, I can honestly say that with one exception, I had very good luck. The majority of people from whom I purchased parts went out of their way to make sure that I got what I wanted.

Despite the number of frustrations, I still recommend building up your own system piece by piece. There is a certain satisfaction in building *everything* in your machine, and in knowing that your system is configured the way it is because *you* want it that way, not because it was part of a package you bought. ■

# Time is precious Why lose it?

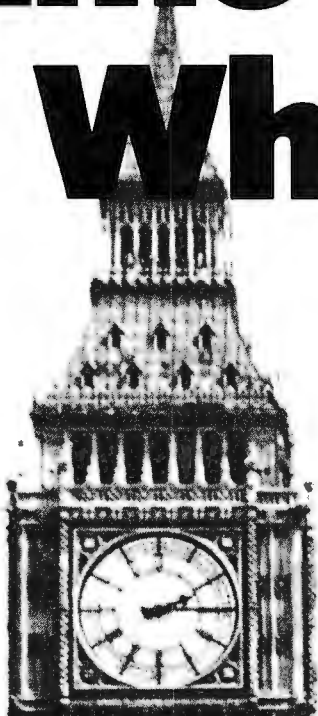

## BATTERY SUPPORTED CALENDAR CLOCKS

PDP-11 <sup>1</sup>	TCU-100	• \$495
	TCU-150	• \$460
LSI-11/2 <sup>1</sup>	TCU-50D	• \$325
Multi-Bus <sup>2</sup>	TCU-410	• \$325
EXORcisor <sup>3</sup>	TCU-68	• \$325
HP 2100	TCU-2100	• \$395
Lockheed SUE	TCU-200	• \$550
Naked Mini <sup>4</sup>	TCU-310	• \$385

If automatic and accurate date and time entry is important to your system on power-up — you need a Digital Pathways battery supported calendar clock. All Digital Pathways' TCUs have on board NICAD batteries to maintain date and time during power down (typically up to

**Serial Line Clock . . . SLC-1 • \$640**  
(RS 232 or 20mA) Microprocessor controlled. Auto message intercept and response. 10 Digit display option \$190.

three months). Timing is provided by a crystal controlled oscillator. Prices are U.S. domestic single piece. Quantity discounts available.

*For more information on these timely products, contact:*

Digital Pathways Inc.  
4151 Middlefield Road  
Palo Alto, CA 94306  
Phone: (415) 493-5544

<sup>1</sup>Trademark of Digital Equipment Corp.

<sup>2</sup>Trademark of Intel Corp.

<sup>3</sup>Trademark of Motorola Inc.

<sup>4</sup>Trademark of Computer Automation Inc.



# DIGITAL PATHWAYS

# BYTE LINES

NEWS AND SPECULATION ABOUT PERSONAL COMPUTING

Conducted by Sol Libes

## More Companies Jumping On UNIX Bandwagon:

**Bell Laboratories** developed the UNIX software system originally to run on Digital Equipment Corporation's larger PDP-11 minicomputer systems. Now UNIX has been adapted to run on at least a dozen other systems. One of the reasons many companies are implementing UNIX on their systems is that American Telephone and Telegraph's planned Advanced Communications Service (ACS) requires UNIX to incorporate computers into the system.

Western Electric has licensed Onyx Systems Inc of Cupertino, California, to develop a microcomputer version of UNIX. Onyx will offer UNIX on its C8002 microcomputer system. It will support eight terminals and several high-level languages. Microsoft Inc of Bellevue, Washington, has disclosed that it is close to signing an agreement on a UNIX license. Microsoft plans to implement UNIX for Z8000-, 8086-, and 68000-based systems. Zilog Inc has reportedly already signed a UNIX license. In all cases, these companies are implementing UNIX on 16-bit microcomputers.

(UNIX is a registered trademark of Bell Laboratories.)

**Microcomputer Makers Changing Marketing For 1980s:** The 1980s are seeing significant changes in microcomputer marketing, as sales may soon pass the \$1 billion mark. The 1970s

were dominated by a large number of cottage-type sales operations trying to make general-purpose systems for sophisticated hobbyists.

Already we are seeing the personal-computer market being dominated by a few large manufacturers—Radio Shack, Commodore, Apple, Texas Instruments, and Atari—and soon possibly IBM and Digital Equipment Corporation. Further, these companies are starting to move toward specialized computers that focus on specific customer needs, even computers which are immediately useful to less knowledgeable users. These companies are planning to have several computers oriented toward specific vertical markets and thus cover a broad spectrum of users.

In some markets, the change will concern only software and peripherals. In others, it may require an entirely new machine (eg: TRS-80 Model I versus TRS-80 Model II). Thus we can expect to see similar processors packaged and promoted differently. For example, Apple Computer Company has introduced the Apple III, a larger and more powerful machine than the Apple II, designed with the business and professional user in mind. (See the preview in this issue on page 50....CPM)

Another example of the specialization of the microcomputer market is the introduction of the HP-85 by Hewlett-Packard. This \$3250 personal computer is aimed at scientific,

engineering, and financial users. HP has also disclosed that it plans to introduce other personal computers.

Thus, I am sure that, as we move further into the 80s, we will see computer manufacturers with a broad line of different microcomputers which are tailored to the small-business, educational, scientific, process-control, and financial markets.

The computer that is proving the most elusive for manufacturers is the true home computer. Not the hobbyist computer, but the home computer. Several are quite close (eg: Texas Instruments, Atari, and Apple), but the primary problem is still that the price is too high. The home computer may prove to be the last market to be cracked. Texas Instruments (TI) introduced its 99/4 as a "home computer"; however, because of disappointing sales TI is now reorienting the sales campaign to the small-business market. Possibly the small business is in the home.

The retail sales business is also changing. Digital Equipment Corporation (DEC) and IBM are changing the retail marketing of computers. DEC presently has 21 stores and at least 6 more are planned. IBM is also retailing through its 50 "Business Computer Centers," which have doubled in number from last year.

DEC is now selling its popular LA34 terminal at a discount through its stores. This move is viewed as

undercutting by DEC's regular dealers and they are up in arms. IBM is selling its new video terminal on a cash-and-carry basis also.

There is no doubt that we will see an increase in the retail cash-and-carry market as the traditional mini- and large-computer makers realize the possibilities. I am sure that we will soon see IBM stores in shopping malls just as we now see Bell Telephone stores. These companies realize that if they are to continue their high growth rates, they must move into new markets—and the personal-computer retail market is a prime candidate.

## Bell System Testing Home Data-Base System:

The Bell System is testing a two-way home data-base service, called "Viewtron," in Coral Gables, Florida. Television terminals, operating at 1200 bits per second (bps) over conventional telephone lines, have been placed in 160 homes. The test is sponsored by the Viewdata Corporation of America, a Knight-Ridder Newspaper Inc subsidiary. Thirty of the terminals will be rotated among test homes over a 6-month period. The terminals provide a 20-line by 40-character color display.

The services include Sears "Teleshop," which allows users to order consumer items, and Grand Union grocery ordering for home delivery. Access to Associated Press (AP) news reports, weather informa-

# Diablo introduces the first printer that runs on four wheels.

The Diablo 630 printer is the most versatile printer you can get.

It's the only one that gives you a choice of 4 different interchangeable print wheels and over 100 different type styles.

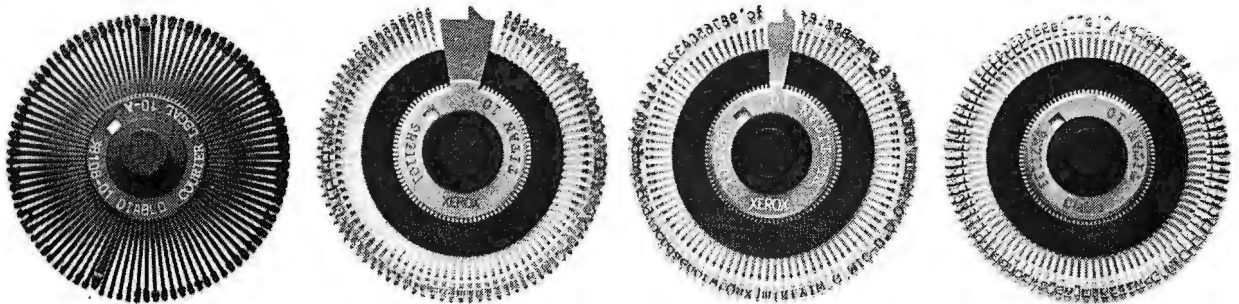

Every 630 works just as well with a 96-character plastic daisy print wheel as it does with an 88, 92, or 96-character metal daisy print wheel.

The 630 also has fewer moving parts than competitive printers, which makes it exceptionally reliable.

This new addition to our line offers unsurpassed print quality. Compatibility with existing Diablo supplies. And automatic bi-directional printing.

The Diablo 630 printer.

Probably the best thing to happen to printing since we re-invented the wheel.



**Diablo Systems**

tion, stock market reports, airline travel information, educational, and other data is also planned.

**R**OM Programs Held Not Copyrightable: A decision made in a federal court has held that object-code programs in read-only memory cannot be copyrighted, even though the source code was copyrighted. One of the bases for the decision was that the object code is not a true copy of the source code, because it is not in a human-readable form.

The decision was made in a case involving two competing computerized chess-game manufacturers. Data Cash Systems Inc sued J S & A Group Inc for producing a chess game that uses read-only memory code identical to its chess-game program, which was copyrighted in source code.

### **P**ersonal Computers Are In For Another Banner Year:

According to a report by the well-known market-research firm Arthur D Little Inc of Cambridge, Massachusetts, sales of personal computers will double this year. The company predicts that sales will reach \$950 million, with 600,000 units produced, up from \$500 million last year. 1979 showed a 67% increase over 1978, which was not up to the experts' expectations.

The firm predicts that a large part of the personal-computer sales increase will be due to products from Texas Instruments, Mattel, Atari, and Canon, plus the mass merchandising by Sears Roebuck, J C Penney, Montgomery Ward, and Foleys.

**C**omputer Communication Via Amateur Radio Growing: With the Federal Communications Commission's (FCC) approval of ASCII (the American Standard Code for Information Interchange) for transmis-

sion over the airwaves, more computerists are turning to amateur radio for computer-to-computer communication. All that is needed is a terminal with (or without) a computer, a modem, and a 2-meter FM transceiver. Articles on how to accomplish this have appeared in the *AMRAD Newsletter* published by an extremely active amateur-radio group, the Amateur Radio Research and Development Corporation. To join AMRAD and receive their newsletter, write: AMRAD, 1524 Springvale Ave, McLean VA 22101.

The protocol used in computer-to-computer transmission is the CBBS (computerized bulletin board system) protocol developed by Ward Christensen and Randy Suess of the Chicago Area Computer Hobbyist Exchange (CACHE). Ward wrote an article on this topic which appeared in November 1978 *BYTE* (page 150).

**C**BBs Increasing Rapidly: The number of Computerized Bulletin Board Systems in operation is now approaching 100. Some provide mailbox facilities, and some have the ability to transmit and receive software. AMRAD will soon publish a listing of CBBSs. To obtain a copy send \$1 to AMRAD, 1524 Springvale Ave, McLean VA 22101.

**A** Association Formed: The American Association for Artificial Intelligence (AAAI) has been formed. The AAAI is headed by Allen Newell from Carnegie-Mellon University and Edward A Feigenbaum of Stanford University. The association will have its first annual conference August 19th thru 21st and also hopes to publish a regular magazine. For information write AAAI, Stanford University, Box 3036, Stanford CA 94395.

**C**P/M On The Apple: Apple computer owners suddenly have the whole CP/M (by Digital Research) software world available to them. Microsoft Inc, the recognized leader in developing microcomputer software, has introduced a plug-in card for the Apple which makes it able to directly execute 8080, 8085, and Z80 programs. The card contains a Zilog microprocessor. The Z80 processor executes the application program while the Apple's processor (a 6502) handles the input and output of the keyboard, display, disk, etc. With the Z80 Softcard many powerful languages (eg: FORTRAN, COBOL, APL, etc.), word-processor systems, and business application packages can be run on an Apple. Provided with the card is Microsoft BASIC Version 5.0 and CP/M for \$349.

**I**EEE Forms Network Standards Committee: The first meeting of the IEEE (Institute of Electrical and Electronics Engineers) Local Network Standards Committee took place in March and switched the new network-standards project into high gear. The committee will develop a computer-communications standard that will define, among other things, physical media and line-access methodology. For more information write: Local Network Standards Committee, IEEE, POB 500, Beaverton OR 97077, or call (503) 644-0161.

**G**old Cost Causing Computer Prices To Rise: One S-100 computer-board supplier has reported to me that it now costs him \$30 to flash gold onto the printed circuit contacts that are inserted into mainframe motherboard connectors. That manufacturer is now seriously considering doing away with gold plating and living with the resulting oxidation problems.

This indicates to me that the days of substantial price cuts on computer equipment appear to be over. Until now the improvements in integrated circuit technology have resulted in either price cuts or increases in computing power. But now the price increases of gold and other materials, added to the increased costs of doing business, are more than offsetting technological gains. IBM, DEC, Datapoint, Univac, and many other computer makers recently increased prices by 4 to 20%.

**P**rograms That Write Programs: Watch out, programmers! Computers may soon take over your job. The only question is how well will they program? These programs include data field, edit, and I/O facilities. For example, Computer Pathways Unlimited, of Salem, Oregon, has introduced a program called PEARL (Producing Error-Free Automatic Rapid Logic) which purports to generate customized business software. PEARL produces a program which is a combination of precoded BASIC utility routines. PEARL does its job by presenting the user with a series of menus and prompts which define the controls and interrelationships between data elements and files. PEARL runs under CP/M and CBASIC. The supplier boasts that little or no programming knowledge is needed to create programs. Now we need a program to write system-level programs, so all of us can retire!

**F**CC Extends Radio Interference Deadline: The Federal Communications Commission (FCC) has extended the deadline for compliance with regulations concerning radio-frequency interference (RFI) by personal computers. Originally set for July 1,



# DATASPEED INC

## S-100 BUS PRODUCTS

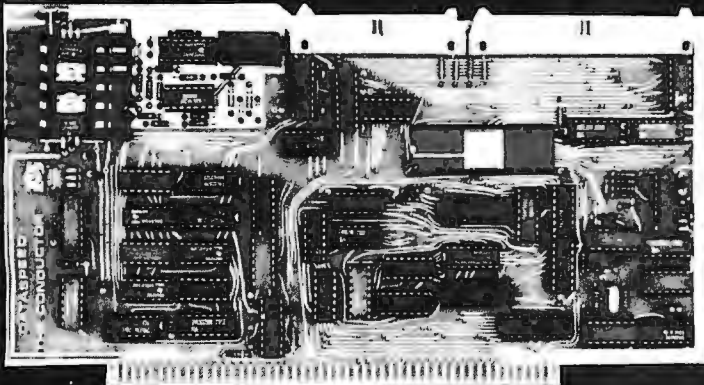

### THE CONDUCTOR™

A versatile dual density floppy disk controller. Works with most popular drives such as SHUGART, MPI, SIEMENS, PERSCI, etc., and guaranteed to work with virtually all leading CPU boards and RAM cards. Backed up with dual density CP/M 2.2 (\$150) and available NOW!!!

**\$325** assembled.

5 AND 8 INCH SINGLE-AND DOUBLE-DENSITY CONTROLLER ON ONE BOARD



### VCB-1™ VIDEO CONTROLLER

Memory mapped 80 x 24 with dual character sets (PROGRAMMABLE!) parallel port, 1K user ROM and HARDWARE SCROLLING. Firmware available.

**\$349** assembled

THE PERFECT I/O COMPANION TO THE CONDUCTOR

We feature SHUGART drives. Each drive system includes the CONDUCTOR dual density controller, cabinet, power supply and cables. EVERYTHING you need for a solid dual-density system at solid savings.

### DOUBLE-DENSITY MINI-FLOPPY SYSTEMS

- Single-Sided System (SA-400) . . . . . **\$795**
- Double-Sided System (SA-450) . . . . . **\$895**

### 8" DRIVE SYSTEMS

- |                     |                                  |                                  |
|---------------------|----------------------------------|----------------------------------|
|                     | single-sided                     | double-sided                     |
| Single Drive System | (one SA-800) . . . <b>\$1149</b> | (one SA-850) . . . <b>\$1349</b> |
| Dual Drive System   | (two SA-800) . . . <b>\$1849</b> | (two SA-850) . . . <b>\$2049</b> |

### DISK SYSTEMS

Let DATASPEED package your disk system. All the hardware you need for a complete floppy disk system. Just add CP/M and a computer. PLUS-FREE Osborne Accounting software.

complete systems from **\$795**

DATASPEED INC. IS NOT AFFILIATED WITH ANY BELL SYSTEM COMPANY OR PRODUCT.

Canada:  
ARDEX DISTRIBUTING CO., LTD.  
31 PROGRESS CT., UNIT 12  
SCARBOROUGH  
ONTARIO

Exclusive European Distributor:  
TRANS AM COMPONENTS  
12 CHAPEL STREET  
LONDON  
ENGLAND

DATASPEED, INC.  
1300 NOE STREET  
SAN FRANCISCO, CA 94131  
(415) 641-8947

VISA AND  
MASTER CHARGE  
ACCEPTED

1980, the deadline has been extended to January 1, 1981. The change was due to widespread industry opposition to the July 1st date.

The regulations are aimed at stemming the interference with radio and television reception caused by computers and other electronic equipment.

**CDC To Offer Home PLATO Service:** The PLATO educational computer service will soon be made available to home-computer users by Control Data Corporation (CDC). CDC calls the service "Homework." It will provide programs for people with medical disabilities who wish in-home job training. A special video terminal with a touch-sensitive screen is used.

**IBM Reports Record Backlog:** IBM has disclosed that at the start of 1980 it had an order backlog of \$450 million per month, up from \$375 million in 1978 and \$285 million in 1977. On the other hand, IBM disclosed that computer revenue for the year rose only 0.4% in the US and 6.5% overseas.

Frank T Cary, Chairman and Chief Executive Officer of IBM, took a pay cut for 1979 due to a decrease in company earnings. However, he did get an increase in benefits. His effective earnings for 1979 were \$927,902 compared to \$892,540 the previous year, an increase of only 4%. Well, times are hard for all of us...I guess.

**Random News Bits:** Tandy Corporation will soon start a lease plan for the TRS-80 Model II computer that will include a 90-day "warranty" period during which customers can evaluate the machine before committing to a 3-year lease. At the end of 90 days the customer can cancel the lease and pay only for the time used. No

figures have yet been released on costs, but it sounds like a good way to find out if the machine will do the job for the customer....A recent DEC advertisement run in a newspaper advertised "cash-and-carry" prices for terminals at its local computer stores. Who knows, we may soon see DEC "Washington's Birthday Specials."...CIS COBOL, from Micro Focus Inc, Santa Clara, California, is the first microcomputer COBOL to be certified by the General Services Administration (GSA) as conforming to ANSI-74 Specifications, Levels 1 and 2. It runs under CP/M or RT-11 DOS...Godbout Electronics, Oakland, California, will soon make available an S-100-bus programmable-memory card that will operate with processors having clock rates as high as 10 MHz, without wait states....Apple Computer Company is enlarging its marketing capability. It recently purchased one of its distributors and discontinued four other distributors. Apple will set up its own regional distribution centers, where it will stock and service Apple products. Dealers will do business directly with Apple via these distribution centers....More details are being made available on the Micro-Winchester hard-disk drive due from Tandon Magnetics Corporation, Chatsworth, California (reported in a previous BYTE News column). The drive will contain two 5-inch platters storing a total of 5 to 6 megabytes and will take up about the same space as a 5-inch floppy. Samples were shown at the NCC (National Computer Conference) in May, and production units are expected by year's end. Two other companies also are rumored to be developing 5-inch hard-disk drives....The Wang Institute, Tynngsboro, Massachusetts, will be the first school to offer a

"Master of Software Engineering" degree....General Telephone and Electronics (GT&E) expects to soon begin operation of an intelligent mail/message service via data terminals. Called "Telemail," it will operate 24-hour interoffice communications....Financial users of microcomputers may be interested in a new publication called *The Financial Systems Report*. For a free sample copy, write (on business letterhead): Vernon Jacobs, POB 8137-B, Prairie Village KS 66208.

**Random Rumors:** Data General (DG, number 2 in the minicomputer field) may introduce a personal computer soon. Actually, DG has been marketing its 16-bit micro-Nova computer for about two years through a few select retail outlets. Now apparently, DG is ready to expand its activities into the personal system marketplace. There still is no word as to whether DEC (number 1 in minicomputers) plans a personal computer....I heard a rumor that one of the large computer-component direct-mail sellers will soon set up a Computerized Bulletin Board System (CBBS) for answering calls and taking orders....Lastly, it is rumored that Texas Instruments is about to introduce two new microcomputer systems. One will be a business-oriented system, while the second will be engineering-oriented and will compete with the recently introduced Hewlett-Packard machine.

**Apple And Dow Jones Together Again:** Following the success of Apple Computer Company's portfolio-evaluator program — developed with the cooperation of Dow Jones — the two companies have teamed up again to present a new offering, the *News and Quotes Reporter*. An-

nounced by Apple in May at the National Computer Conference in Anaheim, California, *News and Quotes Reporter* is priced at \$95, and will be available this month, through Apple dealers.

*News and Quotes Reporter* has been written for the Apple II personal computer system. Through communication over telephone lines, it allows the user to retrieve past and current news stories and editorials from the *Wall Street Journal*, *Barron's*, and the Dow Jones news service, as well as quotations for more than 6000 securities traded on the major exchanges. Users access the Dow Jones data base under password protection, and can request news by category (eg: computer industry) or by company name. According to Apple, *News and Quotes Reporter* can be used in conjunction with the portfolio evaluator for sophisticated portfolio creation and management.

Look for more details in the Fall issue of *onComputing*.

**MAIL:** I receive a large number of letters each month as a result of this column. If you write to me and wish a response, please include a stamped, self-addressed envelope.

**Sol Libes**  
**Amateur Computer Group**  
**of New Jersey (ACG-NJ)**  
**1776 Raritan Rd**  
**Scotch Plains NJ 07076**

# You Know Tarbell

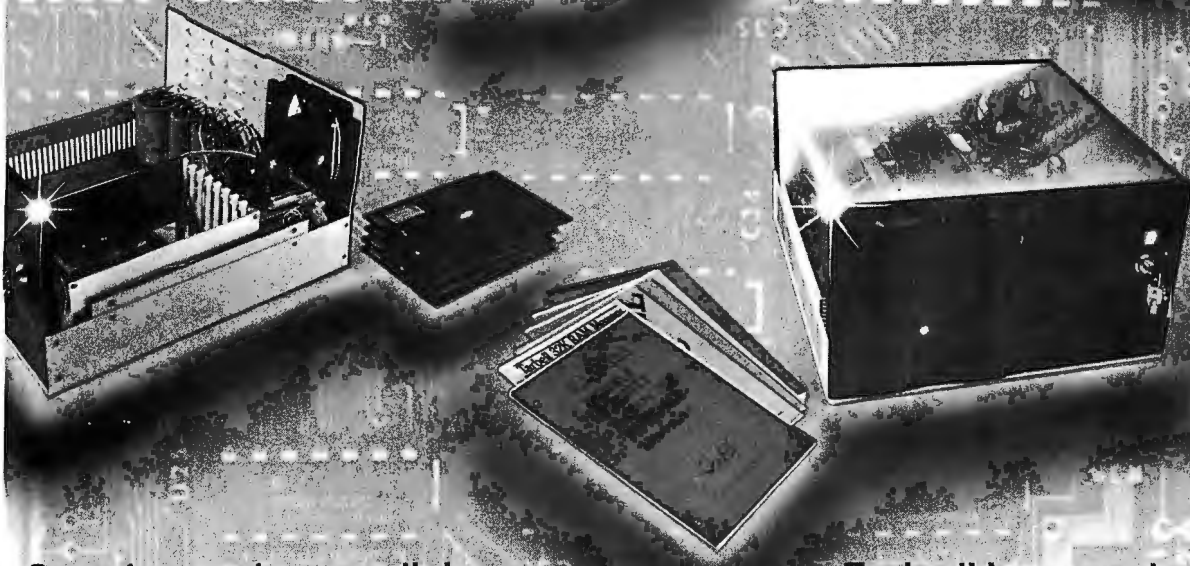

## But, do you know all the components Don Tarbell has ready for you?

When someone says "Tarbell" there's no doubt what's meant . . . the cassette interface whose reliability and solid engineering made it an industry standard.

Since that first breakthrough-product, Don Tarbell has expanded his list of useful, dependable components . . . components to meet your needs of today, and keep you prepared for tomorrow.

Check this partial list of quality components Don Tarbell has ready for you. You're probably ready for them, right now.

- When it comes to RAM memory, Tarbell means reliability. 16K and 32K static memory that offers you easier trouble shooting, and far easier maintenance. Remember that.

- Tarbell BASIC brings simplicity and sophistication to your programs. Our BASIC is easier to program, and offers unique commands and statements not found in regular BASICS under any name.

- CP/M® disk operating system is, of course, the standard for software exchange. At Tarbell we provide our own approved CP/M system modified for all Tarbell floppy disk interfaces. Note. We also have MP/M® for those interested in multi user systems.

- The Tarbell VDS line comes as a complete package . . . or, as separate units. For example, the Tarbell mainframe can be ordered with 1 or 2 Shugart or Siemens drives, or no drives. Whichever way you go, you get the reliability of Tarbell tested components.

- With the Tarbell Double Density floppy disk interface, storage capacity, speed and versatility are greatly increased. Under our DD CP/M, single and double density disks may be intermixed with no penalty. The system automatically determines which is in place.

We also still have our Single Density floppy disk interface. It's specifically designed to operate with many different and unusual drives. Naturally, they're Tarbell tested.

*Tarbell*  
Electronics

950 Dovlen Place, Suite B  
Carson, California 90746  
(213) 538-4251 / 538-2254

\*CP/M & MP/M are products of Digital Research Corp.

# PILOT/P: Implementing a High-Level Language in a Hurry

---

David Mundie  
104B Oakhurst Cir  
Charlottesville VA 22903

---

PILOT is a simple but entertaining language which is useful for introducing beginners to computing and for writing computer-aided instruction (CAI) programs. I recently decided to add it to the repertoire of languages available for UCSD Pascal systems.

Larry Kheriaty has written a "tiny-PILOT" interpreter in Pascal. (See "WADUZITDO: How To Write a Language in 256 Words or Less," September 1978 BYTE, page 166.) However, I wanted a more powerful language. My goals were rather ambitious:

- implement all of the standard PILOT commands in their most powerful forms
- allow easy extensions to the language without modifying the standard PILOT syntax
- provide a powerful editor for preparing PILOT programs
- spend an absolute minimum of time and effort on the implementation

After a few hours of programming and debugging, I achieved all of these goals and ended up with a new language called PILOT/P.

PILOT/P has the following features:

- a complete battery of built-in functions, including trigonometric functions, logarithms, set manipulations, and string functions
- the use of real variables, arrays, files, and other advanced data structures from within the PILOT/P program
- sophisticated control structures such as CASE statements, REPEAT statements, and FOR loops
- subroutines and parameter passing
- only standard PILOT commands
- a very powerful screen-oriented editor with find, replace, copy, insert, jump, and other commands, including an automatic indent feature which allows painless formatting of PILOT programs

By now you are probably wondering how I accomplished this magic in less than a day of development effort. The trick was actually quite simple. Instead of writing a PILOT/P interpreter or compiler, I wrote a *preprocessor* that accepts PILOT/P source code and

translates it into Pascal source code. The translated program may then be run like any other Pascal program.

The advantages of this technique are numerous. All of the drudgery of parsing expressions, handling subroutine calls, allocating memory, and so forth is passed on to the Pascal compiler and pseudocode (p-code) interpreter. Any Pascal feature may be added to PILOT/P simply by adding a WRITE statement to the translator. Because the PILOT/P programs are ultimately compiled into p-code, they probably run faster and use less memory than any interpretive approach I could have implemented. Finally, programs may be edited simply by using the UCSD system text editor, which is far more convenient to use than any editor I could have written.

## Using the Preprocessor

Once a PILOT/P program has been edited and saved, the preprocessor is invoked by executing the file PILOT.CODE. The preprocessor then prompts for the name of the file containing the PILOT program to be processed (for example, DEMO). The preprocessor then writes its translation onto a text file whose name is the input file name preceded by a slash—for example, /DEMO.TEXT.

If a syntax error is discovered, the line containing the error is displayed along with an error message, and processing is interrupted until the user signals the program to continue. If errors are discovered, the output file is purged; otherwise, the output file may be compiled and executed in the normal manner.

It would be more convenient to have the preprocessor translate directly into the system work file, which could then be run with a single command. However, the North Star system on which I developed the program does not allow the use of work files.

## PILOT/P

The syntax diagram in figure 1 defines PILOT/P. Tables 1 and 2 give the standard and extended uses of the PILOT commands, respectively. Listing 1 is a trivial demonstration program illustrating the standard use of PILOT commands, while listing 2 shows how the same program looks after being preprocessed. Listing 3 is a

**NEECO  
PROUDLY  
INTRODUCES**

# ALLOS COMPUTERS

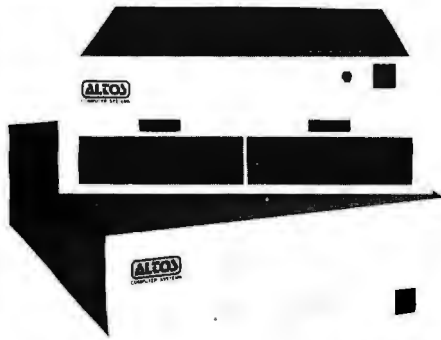

## ALLOS ACS 8000-5

- Dual 8" floppy disks
- Megabyte storage
- 64K RAM
- Totally expandable to Hard Disk (29MB) and Multi-User

## ALLOS OFFERS OUR USERS TOTAL SYSTEM CAPABILITIES AND FLEXIBILITY . . .

- Z80 based • CP/M • Multi-User
- Hard Disk • Seven languages
- MP/M • NEECO system support
- Full Word Processing

**\$5990**

"ALLOS Computers offer you System Flexibility and Reliability"

**CONTACT NEECO FOR ADDITIONAL INFORMATION ON  
HOW ALLOS CAN BECOME YOUR COMPUTER SOLUTION.**

Altos computers range in price from less than \$3000 to over \$14,000. Altos Computer Systems' capabilities range from single disk-single user to 29 Megabytes-Multi-User.

ALLOS computers are distributed to Dealers/OEMs in the N.E. Region by MICROAMERICA

## SUPERBRAIN SOFTWARE

(Business Packages written in MicrosoftBASIC)

Trial Tested Osborne Business Packages on the Superbrain

- |                       |          |   |
|-----------------------|----------|---|
| • Accounts Receivable | \$250.00 | <b>Complete 4 Module<br/>Package \$795<br/>MicrosoftBASIC<br/>\$325</b> |
| • General Ledger      | \$250.00 |   |
| • Accounts Payable    | \$250.00 |   |
| • Payroll Package     | \$250.00 |   |

### SUPERBRAIN

**32K RAM \$2795**

**64K RAM \$2995**

**FORTAN \$ 450**

#### SPECIAL OFFER!

Purchase a 64K Superbrain at \$2995 and will include MBASIC5 for only \$250! (regularly \$350)

#### SPECIAL OFFER! - Purchase

a Centronics 704-9 (RS232, 180 CPS, retail \$2380) printer and a 64K Superbrain together for only \$4595 - cash price only.

"The Superbrain is ideal for use as an intelligent terminal or stand alone microcomputer system for OEM's, commercial customers, and other sophisticated computer users."



- Two 5.25" Shugart Minifloppies with over 300 K (CP/M Version 2.2 or later) Disk Storage.
- Integrated in a single compact housing.
- CP/M operating System with MBASIC5 and other interpreters/compiler available.
- 32K or 64K RAM models available.
- 2 I/O Ports - one fully enabled RS232 port for communications. Other port for RS232 serial printer output.
- Too many software packages are now available to list them here.

#### OEM/DEALER INQUIRIES

All pricing and specifications are subject to change.

## SUPERBRAIN™

**\$2995** The Honor Graduate

### NEECO

679 Highland Ave.  
Needham, MA  
02194

Mon-Fri 9:30-5:30  
MasterCharge &  
Visa Accepted

**(617) 449-1760**  
Telex: 951021

### MICROAMERICA DISTRIBUTING

"Nationwide distributors of Computer Equipment"

21 Putnam Street  
Needham, MA  
02194

**(617) 449-4310**

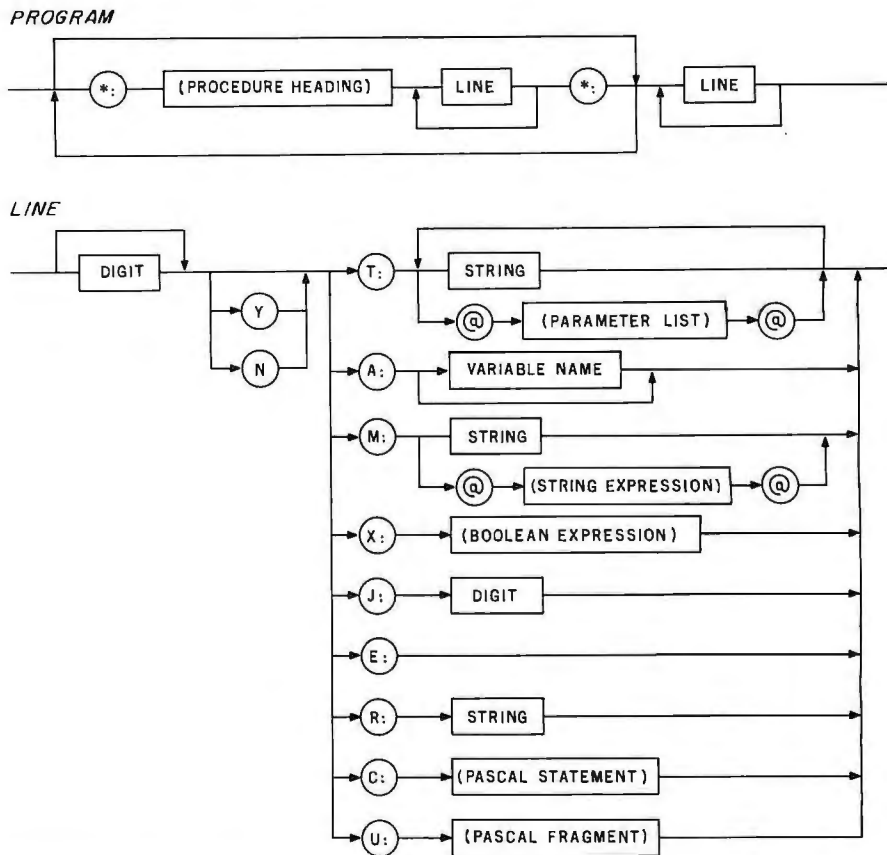

Figure 1: PILOT/P syntax diagram. Items in circles are terminal symbols that appear in the program as shown. Items in rectangles are metalinguistic constructs. The preprocessor does not check the syntax of the constructs in parentheses.

program illustrating a few of the language's extended features.

In spite of my commitment to standardization, I made three minor changes in PILOT syntax. I made them basically for aesthetic reasons, although I cannot deny that they made the translation process somewhat simpler.

The first change is that the assignment operator is Pascal's ":= " rather than BASIC's "=". I think the equals sign in standard PILOT is contamination from BASIC.

The second change is that the tokens "Y" and "N" must precede, not follow, their related commands. This is the only order that makes sense to me. As listings 1 and 3 show, this allows all of the commands to be aligned vertically, with a neat row of colons setting them off.

Finally, I have always hated the use of dollar signs (\$) in string variable names. PILOT/P, as it stands now, offers the twenty-six integer variables "A" to "Z" and the twenty-six string variables "AS" to "ZS". Of course, other variables may be added as needed by making trivial modifications to the preprocessor.

Users should be aware that at certain places indicated in figure 1, the translator simply copies the PILOT/P source code into the Pascal program. This means that powerful Pascal statements may be embedded directly into the PILOT/P program. It also means that syntax-checking is put off until compile-time. To be safe, those who are unfamiliar with Pascal would be wise to limit

themselves to the simpler forms of the commands concerned.

### The Preprocessor Program

Program "pilot", shown in listing 4, is the preprocessor. It should be fairly self-explanatory to anyone conversant with Pascal, although source code that generates source code can seem very strange at first sight. (You should remember that Pascal uses two apostrophes to represent an apostrophe inside a string constant.)

Procedure ERROR handles errors, as described above. Procedure SKIP skips leading blanks, so that PILOT/P programs may be indented for maximum legibility. Procedure HEADING writes the heading for the target program, including declarations for all global constants, variables, types, procedures, and functions. It is here that PILOT/P's features may be expanded indefinitely. As a trivial example, the real variable "r1", the file "f1", and the array of strings "a1" may be added to PILOT/P's variables by simply adding:

```
writeln(o,'r1:real; f1:text; a1: array 1..10 of string');
```

after the other declarations in HEADING.

T is a special procedure to handle the messy transformation of a PILOT "type" (T) command into a Pascal

*Text continued on page 170*

Combine the **POWER** of **PASCAL**  
with the **MUSCLE** of your **MICRO!**  
Get the tool to do your job right:

# PASCAL/MT<sup>®</sup> 3.0

Executes under  
CP/M<sup>®</sup> in as little as  
32K bytes.

Compiles directly to  
Romable 8080  
object code at up to  
2000 lines per  
minute.

Contains built-in mini  
assembler for in-line  
machine code.

Supports CP/M<sup>®</sup> files  
including CP/M<sup>®</sup> 2.0  
random access files.

Includes program  
chaining facilities.

```
{HANDLE A/D CONVERSION EVERY SECOND FOR 3 HOURS}
PROGRAM SAMPLER:
{ * DEMONSTRATES THE POWER OF PASCAL/MT * }
CONST
  RTC___VECTOR=6; {FOR RTC___ISR}
TYPE
  TIME___OF___DAY=RECORD
    HOURS      : 0..24;
    MINUTES    : 0..60;
    SECONDS    : 0..60;
  END;
VAR
  NOW: TIME___OF___DAY;
  SAMPLE: INTEGER;

PROCEDURE INCREMENT___TIME___OF___DAY;
BEGIN
  ... { * INCREMENTS NOW BY ONE SECOND * }
END;

PROCEDURE GET SAMPLE; {TALK TO A/D CONVERTER}
BEGIN
  SAMPLE:=INPUT [$3B]; {GET I/O PORT DATA}
  OUTPUT [$FA] = SHR (SAMPLE, 3); {USE SHIFT RIGHT}
  WHILE TSTBIT (INPUT [$6C], 2) <> TRUE DO; {WAIT}
  INLINE ("LOA / $FOCD / "STA / $309B); {DJB CODE}
END;

PROCEDURE INTERRUPT (RTC___VECTOR) RTC___ISR;
BEGIN {INTERRUPT SERVICE ROUTINE}
  GET SAMPLE { * EVERY SECOND * }
  INCREMENT___TIME___OF___DAY
END;

BEGIN
  NOW. SECONDS:= 0; NOW. MINUTES:= 0; NOW. HOURS:= 0;
  INLINE ("MVI A, /$3E / "SIM (BOB5)); {START CLOCK}
  GET SAMPLE; {TAKE FIRST SAMPLE}
  WHILE NOW. HOURS <> 3 DO; {SAMPLE FOR 3 HOURS}
  END. {AT END RETURN TO OPERATING SYSTEM}
```

Features a  
SYMBOLIC debugger  
which allows variable  
display and  
breakpoints.

Supports I/O port  
access and interrupt  
procedures.

Contains bit and byte  
manipulation facilities.

Minimum overhead of  
1.25K bytes.

Includes business and  
scientific arithmetic.

Price: \$250 : Business & Scientific Compilers, Runtime Source, Debugger, User's Manual  
\$ 30 : Manual Only, refundable with purchase of total package

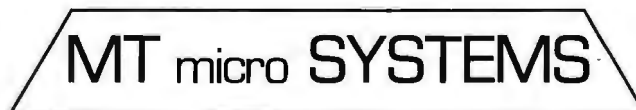

1562 Kings Cross Drive  
Cardiff, CA 92007 (714) 753-4856  
We ship on 8" single density floppies

© PASCAL/MT tradename of MT MICROSYSTEMS, CP/M trademark of Digital Research  
OTHER DISK FORMATS: LIFEBOAT [212] 580-0082, FMG [817] 294-2510

Symbol	Use
+	Identifies and delimits subroutines. The first occurrence is followed by the subroutine name, while the second occurrence marks the end of the subroutine.
Y	Execute the following command if the flag is true.
N	Execute the following command if the flag is false.
A:	Accept input from the terminal. If followed by a variable name, input is assigned to that variable. If not, input is assigned to the special string variable ANS.
J:	Jump to the following label. Labels must be single digits.
E:	Exit from the main program (or the current subroutine).
R:	Remark.
T:	Type remainder of the line to the terminal. Variables may be displayed if their names are surrounded by at-signs (@). Example: T: Very good, @ns@, I'm proud of you.
M:	Match ANS to the following string. A string variable may be used if its name is included between at-signs. Example: M: yes,y,ok,sure,fine,swell,great
X:	Examine the following boolean expression and set the flag accordingly. Operators are +, -, *, /, =, < =, > =, < >, AND, OR, and NOT. Example: X: (c>0) AND (c<11)
C:	Compute or Call. Perform the following assignment statement, or invoke the following subroutine. Examples: C: i:=i+1    C: GETCHOICE
U:	Not needed. The compute command fulfills the function of the standard U command.

Table 1: PILOT/P implements the standard command set for PILOT.



**10%  
DISCOUNT  
Off  
List**

64K 1 Drive  
\$3499.00

## AUTHORIZED TRS-80<sup>®</sup> DEALER A301

COMPUTER SPECIALISTS

Popular 16K Level II System.....	\$ 715.00
26-1145 RS-232 Board.....	84.00
26-1140 "O" K Interface.....	254.00
26-1160 Mini Disk.....	424.00
26-1171 Telephone Modem.....	169.00
Cat Telephone Modem.....	159.00
Fast 100 CPS Centronics 730 Printer.....	675.00
Text Quality Centronics 737 Printer.....	850.00
Plug Compatible Lobo 5 1/4 Drives.....	375.00
Versatile Lobo Interface, 8" Drives and Hard Drives.....	<b>Call For Prices</b>

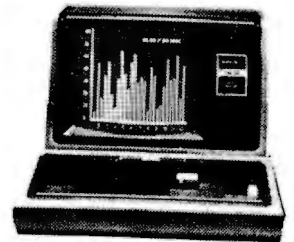

**15%  
DISCOUNT  
Off  
List**

4K Level II  
\$527.00

# 1-800-841-0860 Toll Free Order Entry

No Taxes on Out Of  
State Shipments

Immediate Shipment  
From Stock.

**MICRO MANAGEMENT SYSTEMS, INC.**  
DOWNTOWN PLAZA SHOPPING CENTER  
115 C SECOND AVE. S.W.  
CAIRO, GEORGIA 31728  
**(912) 377-7120 Ga. Phone No.**

\*TRS-80 is a registered trademark of the Tandy Corp.

Full Factory Warranty  
on All Items Sold.

Largest Inventory  
In the S.E. U.S.A.



# CP/M\* compatible software

## ACCOUNTING

SuperSoft offers a complete, interactive accounting system at an affordable price. We started with the Osborne accounting system, the standard of the industry, and made it even better. Since either the General Ledger and the Accounts Payable/Receivable can stand alone, you do not need to purchase the entire system at once. This means that you can start with what you need and up-grade later. Look for a compatible Payroll package in the future.

**ACCOUNTS PAYABLE/RECEIVABLE:** A complete, user oriented package which features:

- automatic postings to general ledger (optional)
- accounts payable: • check printing with invoice • invoice aging
- accounts receivable: • progress billing • customer statements
- partial invoice payments • invoice aging

The entire package is menu driven and easy to learn and use. It incorporates error checking and excellent user displays. This package can be used stand alone or with the General Ledger below. Requires: 48K CP/M, terminal with cursor positioning and clear screen, one 8" disk or Two 5" disks. CBASIC2 required. Supplied with extensive user manual: \$200.00. Manual alone: \$20.00.

**GENERAL LEDGER:** A complete, user oriented package which features:

- Accepts postings from external programs (i.e. AP/AR above)
  - Accepts directly entered postings
  - Maintains account balances for current month, quarter, and year and previous three quarters
  - Financial reports: trial balance, income statement balance sheet, and more.
- Completely menu driven and easy to learn and use. Excellent displays and error checking for trouble free operation. Can be used stand alone or with Accounts Payable/Receivable above. Minimal requirements: 48K CP/M, terminal with cursor positioning, home and clear screen, one 8" disk or Two 5" disks. CBASIC2 required.

Supplied with extensive user manual: \$200.00. Manual alone: \$20.00.

## TEXT PROCESSING

**TFS—Text Formatting System:** An extremely powerful formatter. More than 50 commands. Features include:

- left & right margin justification
- headers and footers
- page numbering
- chaptering
- dynamic insertion from disk file
- extended & indented paragraphs
- works with any printer or CRT
- tabbing
- auto paragraphing
- auto list numbering
- centering
- user defined macros
- underlining and backspace
- much, much more

TFS lets you make multiple copies of any text. For example: Personalized form letters complete with name & address & other insertions from a disk file. Text is not limited to the size of RAM making TFS perfect for reports, manuals or any big job.

Text is entered using CP/M standard editor or most any CP/M compatible editor. TFS will link completely with Super-M-List making personalized form letters easy.

Requires: 24K CP/M.

Supplied with extensive user manual: \$85.00. Manual alone: \$20.00.

Source to TFS in 8080 assembler (can be assembled using standard CP/M assembler) plus user manual: \$250.00.

## MAILING LIST

**SUPER-M-LIST:** A complete, easy to use mailing list program package. Allows for two names, two address, city, state, zip and a three digit code field for added flexibility. Super-M-List can sort on any field and produce mailing labels direct to printer or disk file for later printing or use by other programs. Super-M-List is the perfect companion to TFS. Handles 1981 Zip Codes!

Requires: 48K CP/M.

Supplied with complete user manual: \$75.00. Manual alone: \$10.00

## UTILITIES

**Utility pack #1:** A collection of programs that you will find useful and maybe even necessary in your daily work (we did!). Includes:

- CMP:** Compare two files for equality.
- ARCHIVER:** Compacts many files into one, useful when you run out of directory entries.
- SORT:** In core sort of variable length records.
- XDIR:** Extended, alphabetical directory listing with groupings by common extension.
- PRINT:** Formatted listings to printer.
- PG:** Lists files to CRT a page at a time.
- ... plus more ...

Requires: 24K CP/M.

Supplied with instructions on discette: \$50.00.

## SYSTEM MAINTENANCE

**DIAGNOSTICS I:** Easily the most comprehensive set of CP/M compatible system check-out programs ever assembled. Finds hardware errors in your system, confirms suspicions, or just gives your system a clean bill of health. Tests:

- Memory • CPU (8080/8085/Z80) • Terminal
- Disk • Printer

To our knowledge the CPU test is the first of its kind anywhere. Diagnostics I can help you find problems before they become serious. A good set of diagnostic routines are a must in any program library.

Minimal requirements: 24K CP/M. Supplied with complete user manual: \$60.00. Manual alone: \$15.00.

## SOFTWARE SECURITY

**ENCODE/DECODE:** A complete software security system for CP/M. Encode/Decode is a sophisticated coding program package which transforms data stored on disk into coded text which is completely unrecognizable. Encode/Decode supports multiple security levels and passwords. A user defined combination (One billion possible) is used to code and decode a file. Uses are unlimited. Below are a few examples:

- data bases • general ledger • inventory
- payroll files • correspondence • accounts pay/receiv
- programs • tax records • mailing lists

Encode/Decode is available in two versions:

Encode/Decode I provides a level of security suitable for normal use. Encode/Decode II provides enhanced security for the most demanding needs. Both versions come supplied on discette and with a complete user manual.

Encode/Decode I: \$50.00

Encode/Decode II: \$100.00. Manual alone: \$15.00

## PROGRAMMING LANGUAGES

**ENHANCED 'TINY' PASCAL:** We still call it 'Tiny' but it's bigger and better than ever! This is the Famous Chung/Yuen 'Tiny' Pascal with more features added. Features include:

- recursive procedures/functions • integer arithmetic • CASE
- FOR (loop) • sequential disk I/O • one dimensional arrays
- IF ... THEN ... ELSE • WHILE • 'PEAK' & 'POKE'
- READ & WRITE • REPEAT ... UNTIL • more

'Tiny' Pascal is fast. Programs execute up to ten times faster than similar BASIC programs.

**SOURCE TOO!** We still distribute source, in 'Tiny' Pascal, on each discette sold. You can even recompile the compiler, add features or just gain insight into compiler construction.

'Tiny' Pascal is perfect for writing text processors, real time control systems, virtually any application which requires high speed. Requires: 36K CP/M. Supplied with complete user manual and source on discette: \$85.00.

Manual alone: \$10.00.

## INTERCOMPUTER COMMUNICATIONS

**TERM:** a complete intercommunications package for linking your computer to other computers. Link either to other CP/M computers or to large timesharing systems. TERM is comparable to other systems but costs less, delivers more and source is provided on discette!

With TERM you can send and receive ASCII and Hex files (COM too, with included conversion program) with any other CP/M computer which has TERM or compatible package. Allows real time communication between users on separate systems as well as acting as timesharing terminal.

- Engage/disengage printer • error checking and auto retry
- terminal mode for timesharing between systems • conversational mode
- send files • receive files

Requires: 32K CP/M.

Supplied with user manual and 8080 source code: \$110.00

Manual alone: \$15.00.

formats: CP/M 8" SOFT SECTORED, NORTHSTAR CP/M

All Orders and General Information:  
**SUPERSOFT ASSOCIATES**  
P.O. BOX 1628  
CHAMPAIGN, IL 61820  
(217) 359-2112

Technical Hot Line: (217)359-2691  
(answered only when technician is available)



\*CP/M REGISTERED TRADEMARK DIGITAL RESEARCH

*SuperSoft*

First in Software Technology

Symbol	Use
*	Parameters may be included Pascal-fashion after the procedure name. Example: * : TEST(s:string)
T:	Any Pascal write-parameter list may be included between the at-signs (@). This facility gives the PILOT/P programmer full control over the display, and eliminates the need for such commands as 1802 PILOT's K command. Example: T: @char(12)@ clears the screen on many video terminals.
M:	Any Pascal string expression may be used if it is surrounded by at-signs. Example: M: @concat(vs,'ing')@
X:	Any Pascal boolean expression may be used, whether arithmetic or not. Examples: X: copy(ns,1,1)='T' X: length(ans)>10
C:	Any Pascal statement or series of statements may be used. (The preprocessor automatically adds a trailing semicolon as a statement separator.) Examples: C: for i:=1 to 25 do write(ts[i*2]) C: ns='David'
U:	Any Pascal statement or statement fragment may be used. (The preprocessor does <i>not</i> add a trailing semicolon.) The following example shows how Pascal's REPEAT statement may be used in PILOT/P: * : GETCHOICE( var c:integer) R: Accepts a number and checks its value R: U: REPEAT T: What is your choice (1 to 10)?; A: c X: c in [1..10] NT: @c@ is out of range U: UNTIL flag * :

**Table 2:** Several of the commands used by PILOT have extensions in PILOT/P.

**Listing 1:** A trivial PILOT/P program intended to show the use of simple PILOT/P commands.

```
R: Tests the ability to find a verb.
lC: t:=t+1
T: What is the verb in "Peter Piper picked pickled peppers."?
A:
M: picked
YT: Right!
YE:
X: t>3
NT: Wrong! Try again.
NJ: 1
T: The verb was "picked"
E:
```

**Listing 2:** The preprocessed (or translated) version of the PILOT/P program in listing 1. Except for the program heading, the declaration part has been omitted. Since the Pascal source code is meant to be invisible to the PILOT/P user, no attempt has been made to construct a more readable listing format.

```
PROGRAM demo;
BEGIN initialize;
{ Tests the ability to find a verb. }
l:t:=t+1;
writeln('What is the verb in "Peter Piper picked pickled peppers."?');
readln(ans);
match('picked');
```

*Listing 2 continued on page 162*

# COMPLEMENTARY PLOTTING PRODUCTS

ROAD  
to  
LEAPAC

ROAD  
to  
LEAPAC

LEAPAC

PERSPECTIVE  
PLOT  
PACKAGE  
\$195

MAURO

ELEVEN INCH  
MP-250  
PLOTTER  
\$795

ROAD  
to  
LEAPAC

ROAD  
to  
LEAPAC

Has over 40 entries and is capable of special effects such as ANIMATION FLYBYS, ZOOMING, STEREO GENERATION, INDEPENDENT TOKEN OR OBJECT PLACEMENT, ROTATION, AND SCALING. And much more.

Includes two LEAPAC 2D plot packages, Driver for MP-250 and Character Plot Package. Will plot on 11" wide paper of any length at resolution of .005" per step. Requires five bits of an output port

This advertisement was created by LEAPAC SERVICES plotting software using Mauro Engineering MP-250 Plotter. The software was expressly written in ANSI FORTRAN compatible SUBROUTINE PACKAGES. They are supplied as Relative Linking Libraries on eight inch CP/M soft sectored disks. The subroutines in these libraries can be selectively linked to programs compatible to MICROSOFT software products, FORTRAN-80, COBOL-80, and COMPILER BASIC.

\* CP/M is a registered trademark of Digital Research Inc.

The above LEAPAC PERSPECTIVE PLOT PACKAGE and MAURO MP-250 PLOTTER, if purchased together, will include the perspective plot application modules, L3P-CHAR and L3P-ARC. The packages can be purchased individually. See below

L3P	— LEAPAC Basic Perspective Plot Subroutine Package (requires external subroutine PLOT)	\$195.00
L3P-CHAR	— Perspective ASCII Character Plot Subroutine Package. (requires L3P and L2D-CHAR)	\$65.00
L3P-ARC	— Perspective Elliptical Curve Plot Subroutine Package. (requires L3P)	\$65.00
L2D-CHAR	— X-Y ASCII Character Plot Subroutine Package (requires ext. subroutines PLOT and WHERE)	\$95.00
L2D-MPD	— X-Y Vector Plot Driver for the MAURO MP-250 Plotter (contains PLOTS, PLOT, WHERE, FACTOR and SETORG)	\$65.00
L2D-DPD	— X-Y Vector Plot Driver for 1600 type DIABLO Printers. (contains PLOTS, PLOT, WHERE, FACTOR, RESET and SETORG)	\$65.00
MICRO PLOT	— Extensive X-Y Vector Plot Subroutine Package from MICAH for daisy wheel bi-directional printers such as Diablo 1620, Sprint-5, etc.	\$195.00

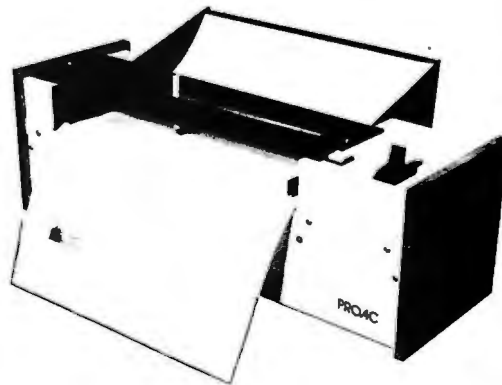

ALL ORDERS PREPAID OR C.O.D.  
TELEPHONE ORDERS ARE ACCEPTED

Prepaid — send certified or cashiers' check. Personal and company checks require 20 days to clear the banks

C.O.D. — add \$10 or 2% for handling, whichever is greater.

Deliveries in California — add 6% sales tax.

DEALER INQUIRIES ARE INVITED — Inquire about other diskette formats.

LEAPAC SERVICES  
8245 Mediterranean Way  
Sacramento, California 95826  
(916) 381-1717

Listing 2 continued:

```
IF flag THEN writeln('Right!');
IF flag THEN GOTO l0;
flag:=t>3;
IF not flag THEN writeln('Wrong! Try again. ');
IF not flag THEN GOTO l;
writeln('The verb was "picked"');
GOTO l0;
l0:END.
```

Listing 3: A more useful PILOT/P program showing several of PILOT/P's more advanced features. The program tests the user's knowledge of four phonetic terms.

```
*: TEST(x:string; y:charset)
T: Name as many @x@ as you can.
A:
C: i:=1
lX: ans[i] in y
YC: s:=s+1
NT: @ans[i]@ is wrong
YC: y:=y-[ans[i]]
C: i:=i+1
X: i<length(ans)
YJ: l
*:
C: test('stops', ['d','t','p','b','k','g'])
C: test('bilabials', ['p','b','m'])
C: test('labio-dentals', ['f','v'])
C: test('apico-alveolars', ['t','d','s','z','l','r','n'])
T: Your score was @s@ out of 18.
```

Listing 4: The PILOT/P preprocessing program, "pilot", written in Pascal.

```
PROGRAM pilot;
CONST
  apostrophe='''';
  el=l0; { label for end of procedure or program }
VAR
  badsyntax:BOOLEAN;
  zzz, { snooze string to interrupt translation }
  ws, { the work string }
  name:STRING;
  i,o:TEXT;
  variables,digits,letters:SET OF CHAR;
  c:CHAR;
  j:INTEGER;

PROCEDURE error(message:STRING);
BEGIN
  writeln(ws);
  writeln('ERROR: ',message);
  writeln('Type anything to continue');
  readln(zzz);
  badsyntax:=true
END;
```

Listing 4 continued on page 164

# CAREFUL... NOT ALL CPU BOARDS ARE CREATED EQUAL!

You'll appreciate the extra effort and experience that goes into our CPU boards... take IEEE spec compatibility, for example. While other boards may claim compatibility, we meet all timing specs - and we'll be glad to send you timing diagrams for our CPUs to prove it (just include an SASE). We also give you more useful features - plus the reliability that comes from our 5+ years of S-100 board design. When choosing a CPU, you don't have to end up with another "me-too" product... CompuPro boards are priced competitively, and are available through computer stores world-wide.

## THE DUAL PROCESSOR S-100 CPU BOARD: INNOVATIVE, POWERFUL, FLEXIBLE

The Dual Processor Board gives true 16 bit power with an 8 bit bus, is downward compatible with the vast library of 8080 software, is upward compatible with hardware and software not yet developed, accesses up to 16 megabytes of memory, meets all IEEE S-100 specifications, runs 8085 and 8086 code in existing S-100 mainframes as well as Microsoft 8086 BASIC and Sorcim PASCAL/M™, runs at 5 MHz for speed as well as power, and is built to the same stringent standards that have established our leadership in S-100 system components.

What accounts for this unprecedented level of performance? The Dual Processor Board includes two CPUs: the 8088, an 8 bit bus version of the 8086 16 bit CPU, and the 8085 (an advanced 8 bit CPU that can run existing software such as CP/M).

Amazingly enough, all this power is still cost-effective. Introductory prices are \$385 unkit, \$495 assembled, and \$595 CSC. The Dual Processor Board is here... and CPU boards will never be the same again.

## 8085 SINGLE PROCESSOR S-100 CPU BOARD

This is a single processor version of the Dual Processor Board for those who do not yet need 16 bit capability. Includes all standard 8085 features. Introductory prices: \$235 unkit, \$325 assm, \$425 CSC.

## THE ENHANCED/ADVANCED Z-80A S-100 CPU BOARD

Includes all standard Z-80 board features, conforms to all IEEE timing specifications, and features power on jump/clear, on-board fully maskable interrupts for interrupt-driven systems, selectable automatic wait state insertion, provision for adding up to 8K of EROM, 4 MHz operation, and on-board IEEE compatible 16/24 bit extended addressing.

These advanced features give you the power you need for future expansion, as well as the system flexibility that comes from superior design... combined with competitive pricing: \$225 unkit, \$295 assembled, and \$395 for boards qualified under the CSC high-reliability program.

## THE "RAM" SERIES OF STATIC MEMORY

Recommended for commercial, industrial, and scientific applications. 4/5 MHz standard operation, no dynamic timing problems, meets all IEEE specifications, low power/high speed chips used throughout, extensive bypassing, careful thermal design.

### S-100 STANDARD MEMORY

	unkit	assm	CSC
8K RAM IIA	\$169	\$189	\$239
16K RAM X-16	\$329	\$379	\$479
24K RAM XX-24	\$449	\$499	\$599
32K RAM X-32	\$599	\$689	\$789

### S-100 EXTENDED ADDRESSING MEMORY

(16/24 address lines; addressable on 4K boundaries)

16K RAM XIV	\$299	\$349	\$429
-------------	-------	-------	-------

### S-100 BANK SELECT MEMORY

(Cromemco etc. compatible; addressable on 4K boundaries)

16K RAM XIII-A-16	\$349	\$419	\$519
24K RAM XIII-A-24	\$479	\$539	\$649
32K RAM XIII-A-32	\$649	\$729	\$849

### SBC/BLC MEMORY

32K RAM XI	n/a	n/a	\$1050
------------	-----	-----	--------

**NOTE:** Most CompuPro boards are available in unkit form (sockets, bypass caps pre-soldered in place), assembled, or qualified under the Certified System Component (CSC) high-reliability program (200 hour burn-in, more). CSC memories run at 8 MHz and draw even less power than standard models.

## SPECTRUM S-100 COLOR GRAPHICS BOARD

Includes 8K of IEEE-compatible static RAM; full duplex bidirectional parallel I/O port for keyboard, joystick, etc. interface; and 6847-based graphics generator that can display all 64 ASCII characters. 10 modes of operation, from alphanumeric/semi-graphics in 8 colors to ultra-dense 256 x 192 full graphics. 75 Ohm RS-170 line output and video output for use with FCC approved modulators. Introductory prices: \$339 unkit, \$399 assm, \$449 CSC. Don't settle for black and white graphics or stripped-down color boards; specify the CompuPro Spectrum.

Want graphics software? Sublogic's 2D Universal Graphics Interpreter (normally \$35) is yours for \$25 with any Spectrum board purchase.

## PASCAL/M™ + MEMORY SPECIAL

PASCAL - easy to learn, easy to apply - can give a microcomputer with CP/M more power than many minis. We supply a totally standard Wirth PASCAL/M™ 8" diskette by Sorcim, with manual and Wirth's definitive book on PASCAL, for \$150 with the purchase of any memory board. Specify Z-80 or 8080/8085 version. PASCAL/M™ available separately for \$175.

## SPECIAL ON H8 MEMORY

Limited quantity; 32K static RAM in kit (not unkit) form. With all parts, documentation, mounting bracket, etc. Includes solder masked, fully legended board for easy assembly. 32K kit: \$549

## OTHER S-100 BUS PRODUCTS

Godbout Computer Enclosure	\$289 desktop, \$329 rack mount
6 Slot Hi-Performance Motherboard	\$89 unkit, \$129 assm
12 Slot Hi-Performance Motherboard	\$129 unkit, \$169 assm
20 Slot Hi-Performance Motherboard	\$174 unkit, \$214 assm
Active Terminator Board	\$34.50 kit
2708 EPROM Board (less EPROMs)	\$85 unkit
Memory Manager Board	\$59 unkit, \$85 assm, \$100 CSC
25 "Interfacer I" I/O Board	\$199 unkit, \$249 assm, \$324 CSC
3P Plus S "Interfacer II" I/O Board	\$199 unkit, \$249 assm, \$324 CSC
Mullen Extender Board	\$59 kit
Mullen Relay/Opto-Isolator Control Board	\$129 kit, \$179 assm

**FREE FLYER:** This ad is only the tip of the iceberg; our catalog tells the rest of the story. Add 41 cents in stamps for 1st class delivery. Outside USA, include \$2 to cover postage (refundable with order). Thank you for your business!

**TERMS:** Cal res add tax. Allow 5% for shipping, excess refunded. VISA®/Mastercard® orders (\$25 min) call (415) 562-0636 24 hrs. COD OK with street address for UPS. Prices good through cover month of magazine.

# CompuPro™

from

# GODBOUT ELECTRONICS

Bldg. 725, Oakland Airport, CA 94614

Listing 4 continued:

```
PROCEDURE skip;
BEGIN
  WHILE i^=' ' DO get(i)
END;

PROCEDURE translate;

PROCEDURE heading;
BEGIN
  writeln(o,'PROGRAM ',name,');');
  writeln(o,'(*$G+*)');
  writeln(o,'LABEL 0,1,2,3,4,5,6,7,8,9,10;');
  writeln(o,'TYPE charset=SET OF CHAR;');
  writeln(o,'VAR a,b,c,d,e,f,g,h,i,j,k,');
  writeln(o,'l,m,n,o,p,q,r,s,t,u,v,w,x,y,z:INTEGER;');
  writeln(o,'as,bs,cs,ds,es,fs,gs,hs,is,js,ks,ls,');
  writeln(o,'ms,ns,os,ps,qs,rs,ss,ts,us,vs,ws,xs,ys,zs:STRING;');
  writeln(o,'ans:STRING; flag:BOOLEAN;');
  writeln(o,'PROCEDURE match(s:STRING); VAR x,y:STRING;');
  writeln(o,'BEGIN x:=concat('',' ',ans,',''); y:=concat('',' ',s,','');');
  writeln(o,'flag:=pos(x,y)>0 ');
  writeln(o,'END;');
  writeln(o,'PROCEDURE initialize;');
  writeln(o,'BEGIN');
  FOR c:='a' TO 'z' DO
    BEGIN
      write(o,c,':=0; ',c,'s:=''');');
      IF ord(c)mod 4 =0 THEN writeln(o);
    END;
  writeln(o,'END;');
END;
PROCEDURE T(ws:STRING);
VAR
  i:INTEGER;
  b:BOOLEAN;
BEGIN
  write(o,'write');
  IF ws[length(ws)]=';' THEN
    ws:=copy(ws,1,length(ws)-1)
  ELSE write(o,'ln');
  i:=1; b:=true;
  WHILE i<=length(ws) DO
    BEGIN
      IF(ws[i]=apostrophe) and b THEN
        BEGIN
          insert(apostrophe,ws,i); i:=i+1
        END
      ELSE
        IF ws[i]='@' THEN
          BEGIN delete(ws,i,1);
            IF b THEN insert(' ',' ',ws,i)
            ELSE insert(' ',' ',ws,i);
            i:=i+1; b:=not(b)
          END;
        i:=i+1
      END;
    END;
END;
```

Listing 4 continued on page 166

By Netronics

ASCII/BAUDOT, STAND ALONE

# Computer Terminal

COMPLETE FOR ONLY \$149.95



The Netronics ASCII/BAUDOT Computer Terminal Kit is a microprocessor-controlled, stand alone keyboard/terminal requiring no computer memory or software. It allows the use of either a 64 or 32 character by 16 line professional display format with selectable baud rate, RS232-C or 20 ma. output, full cursor control and 75 ohm composite video output.

The keyboard follows the standard typewriter configuration and generates the entire 128 character ASCII upper/lower case set with 96 printable characters. Features include onboard regulators, selectable parity, shift lock key, alpha lock jumper, a drive capability of one TTY load, and the ability to mate directly with almost any computer, including the new Explorer/85 and ELF products by Netronics.

The Computer Terminal requires no I/O mapping and includes 1k of memory, character generator, 2 key rollover, processor controlled cursor control, parallel ASCII/BAUDOT to serial conversion and serial to video processing—fully crystal controlled for superb accuracy. PC boards are the highest quality glass epoxy for the ultimate in reliability and long life.

## VIDEO DISPLAY SPECIFICATIONS

The heart of the Netronics Computer Terminal is the microprocessor-controlled Netronics Video Display Board (VID) which allows the terminal to utilize either a parallel ASCII or BAUDOT signal source. The VID converts the parallel data to serial data which is then formatted to either RS232-C or 20 ma. current loop output, which can be connected to the serial I/O on your computer or other interface, i.e., Modem.

When connected to a computer, the computer must echo the character received. This data is received by the VID which processes the information, converting to data to video suitable to be displayed on a TV set (using an RF modulator) or on a video monitor. The VID generates the cursor, horizontal and vertical sync pulses and performs the housekeeping relative to which character and where it is to be displayed on the screen.

**Video Output:** 1.5 P/P into 75 ohm (EIA RS-170) • **Baud Rate:** 110 and 300 ASCII • **Outputs:** RS232-C or 20 ma. current loop • **ASCII Character Set:** 128 printable characters—

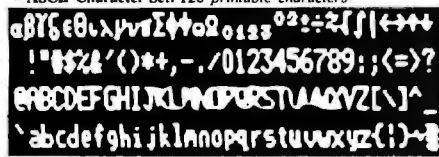

**BAUDOT Character Set:** ABCDEFGHIJKLMNOPQRSTUVWXYZ-? !@#\$%^&\*.,-./0123456789:;<=>? **Cursor Modes:** Home, Backspace, Horizontal Tab, Line Feed, Vertical Tab, Carriage Return. Two special cursor sequences are provided for absolute and relative X-Y cursor addressing • **Cursor Control:** Erase, End of Line, Erase of Screen, Form Feed, Delete • **Monitor Operation:** 50 or 60Hz (jumper selectable).

Continental U.S.A. Credit Card Buyers Outside Connecticut

**CALL TOLL FREE 800-243-7428**

To Order From Connecticut Or For Technical Assistance, Etc. Call (203) 354-9375

**Netronics R&D Ltd., Dept. B-7  
333 Litchfield Road, New Milford, CT 06776**

Please send the items checked below—

- Netronics Stand Alone ASCII Keyboard/Computer Terminal Kit, \$149.95 plus \$3.00 postage & handling.
- Deluxe Steel Cabinet for Netronics Keyboard/Terminal In Blue/Black Finish, \$19.95 plus \$2.50 postage and handling.
- Video Display Board Kit alone (less keyboard), \$89.95 plus \$3 postage & handling.
- 12" Video Monitor (10 MHz bandwidth) fully assembled and tested, \$139.95 plus \$5 postage and handling.
- RF Modulator Kit (to use your TV set for a monitor), \$8.95 postpaid.
- 5 amp Power Supply Kit In Deluxe Steel Cabinet (±8VDC @ 5 amps, plus 6-8 VAC), \$39.95 plus \$2 postage & handling.

Total Enclosed (Conn. res. add sales tax) \$ \_\_\_\_\_

- By—
- Personal Check  Cashiers Check/Money Order
- Visa  Master Charge (Bank # \_\_\_\_\_)

Acct. # \_\_\_\_\_ Signature \_\_\_\_\_ Exp. Date \_\_\_\_\_

Print Name \_\_\_\_\_

Address \_\_\_\_\_

City \_\_\_\_\_

State \_\_\_\_\_ Zip \_\_\_\_\_

Send Me More Information

Start Computing For Just \$129.95 With An 8085-Based Professional Computer Kit—

# Explorer/85

100% compatible with all 8080A and 8085 software & development tools!

No matter what your future computing plans may be, Level "A"—at \$129.95—is your starting point.

Starting at just \$129.95 for a Level "A" operating system, you can now build the exact computer you want. Explorer/85 can be your beginner's system, OEM controller, or IBM-formatted 8" disk small business system... yet you're never forced to spend a penny for a component or feature you don't want and you can expand in small, affordable steps!

Now, for just \$129.95, you can own the first level of a fully expandable computer with professional capabilities—a computer which features the advanced Intel 8085 cpu, thereby giving you immediate access to all software and development tools that exist for both the 8085 and its 8080A predecessor (they are 100% software compatible)—a computer which features onboard S-100 bus expansion—plus instant conversion to mass storage disk memory with either 5-1/4" diskettes or standard IBM-formatted 8" disks.

For just \$129.95 (plus the cost of a power supply, keyboard/terminal and RF modulator, if you don't have them already), Explorer/85 lets you begin computing on a significant level... applying the principles discussed in leading computer magazines... developing "state of the art" computer solutions for both the industrial and leisure environment.

## Level "A" Specifications

Explorer/85's Level "A" system features the advanced Intel 8085 cpu, an 8355 ROM with 2k deluxe monitor/operating system, and an 8155 ROM-I/O—all on a single motherboard with room for RAM/ROM/PROM/EPROM and S-100 expansion, plus generous prototyping space.

(Level "A" makes a perfect OEM controller for industrial applications and is available in a special Hex Version which can be programmed using the Netronics Hex Keypad/Display.)



Level "A" at \$129.95 is a complete operating system, perfect for beginners, hobbyists, or industrial controller use.

...cassette tape recorder output...cassette tape recorder input...speaker output...LED output indicator on SOD (serial output) line...printer interface (less drivers)...total of four 8-bit plus one 6-bit I/O ports • Crystal Frequency: 6.144 MHz • Control Switches: reset and user (RST 7.5) interrupt...additional provisions for RST 5.5, 6.5 and TRAP interrupt onboard • Counter/Timer: programmable, 14-bit binary • System RAM: 256 bytes located at F800, ideal for smaller systems and for use as an isolated stack area in expanded systems...RAM expandable to 64k via S-100 bus or 4K on motherboard.

**System Monitor (Terminal Version):** 2k bytes of deluxe system monitor ROM located at F800 leaving 0000 free for user RAM/ROM. Features include tape load with labeling...tape dump with labeling...examine/change contents of memory...insert data...warm start...examine and change all registers...single step with register display at each break point, a debugging/training feature...go to execution address...move blocks of memory from one location to another...fill blocks of memory with a constant...display blocks of memory...automatic baud rate selection...variable display line length control (1-255 characters/line)...channelized I/O monitor routine with 8-bit parallel output for high speed printer...serial console in and console out channel so that monitor can communicate with I/O ports.

**System Monitor (Hex Version):** Tape load with labeling...tape dump with labeling...examine/change contents of memory...insert data...warm start...examine and change all

**Netronics R&D Ltd., Dept. B7  
333 Litchfield Road, New Milford, CT 06676**

Please send the items checked below—

- Explorer/85 Level "A" Kit (ASCII Version), \$129.95 plus \$3 p&h.
- Explorer/85 Level "A" Kit (Hex Version), \$129.95 plus \$3 p&h.
- 8k Microsoft BASIC on cassette tape, \$64.95 postpaid.
- 8k Microsoft BASIC in ROM Kit (requires Levels "B," "D," and "E"), \$99.95 plus \$2 p&h.
- Level "B" (S-100) Kit, \$49.95 plus \$2 p&h.
- Level "C" (S-100 6-card expander) Kit, \$39.95 plus \$2 p&h.
- Level "D" (4k RAM) Kit, \$69.95 plus \$2 p&h.
- Level "E" (EPROM/ROM) Kit, \$5.95 plus 50¢ p&h.
- Deluxe Steel Cabinet for Explorer/85, \$49.95 plus \$3 p&h.
- ASCII Keyboard/Computer Terminal Kit (features a full 128 character set, upper & lower case, full cursor control, 75 ohm video output convertible to baudot output, selectable baud rate, RS232-C or 20 ma. I/O, 32 or 64 character by 16 line formats, and can be used with either a CRT monitor or a TV set (if you have an RF modulator), \$149.95 plus \$2.50 p&h.
- Hex Keypad/Display Kit, \$69.95 plus \$2 p&h.
- Deluxe Steel Cabinet for ASCII Keyboard/Terminal, \$19.95 plus \$2.50 p&h.
- Power Supply Kit (±8V @ 5 amps) in deluxe steel cabinet, \$39.95 plus \$2 p&h.
- Gold Plated S-100 Bus Connectors, \$4.85 each, postpaid.
- RF Modulator Kit (allows you to use your TV set as a monitor), \$8.95 postpaid.
- 16k RAM Kit (S-100 Board expands to 64k), \$199.95 plus \$2 p&h.
- 32k RAM Kit, \$329.95 plus \$2 p&h.
- 48k RAM Kit, \$459.95 plus \$2 p&h.
- 64k RAM Kit, \$589.95 plus \$2 p&h.
- 16k RAM Expansion Kit (to expand any of the above up to 64k), \$139.95 plus \$2 p&h each.
- Intel 8085 cpu User's Manual, \$7.50 postpaid.
- Special Computer Grade Cassette Tapes, \$1.90 each or 3 for \$5, postpaid.
- 12" Video Monitor (10 MHz bandwidth), \$139.95 plus \$5 p&h.
- North Star Double Density Floppy Disk Kit (One Drive) for Explorer/85 (includes 3 drive S-100 controller, DOS, and extended BASIC with per-

sonalized disk operating system—just plug it in and you're up and running!), \$69.95 plus \$5 p&h.

- Power Supply Kit for North Star Disk Drive, \$39.95 plus \$2 p&h.
- Deluxe Case for North Star Disk Drive, \$39.95 plus \$2 p&h.
- Experimenter's Pak (see above), \$199.90 postpaid.
- Student Pak (see above), \$319.85 postpaid.
- Engineering Pak (see above), \$514.75 postpaid.
- Business Pak (see above), \$1599.40 postpaid.

Total Enclosed \$ \_\_\_\_\_ (Conn. res. add sales tax) By—  
 Personal Check  M.O./Cashier's Check  Visa  Master Charge (Bank # \_\_\_\_\_)

Acct. # \_\_\_\_\_ Signature \_\_\_\_\_ Exp. Date \_\_\_\_\_

Print Name \_\_\_\_\_

Address \_\_\_\_\_

City \_\_\_\_\_

State \_\_\_\_\_ Zip \_\_\_\_\_

Send Me Information

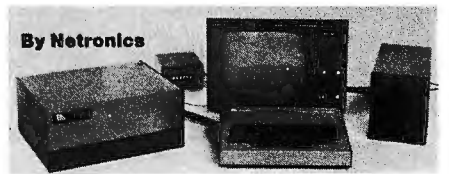

registers...single step with register display at each break point...go to execution address. Level "A" in the Hex Version makes a perfect controller for industrial applications and can be programmed using the Netronics Hex Keypad/Display.



Hex Keypad/Display.

## Hex Keypad/Display Specifications

Calculator type keypad with 24 system defined and 16 user defined keys. 6 digit calculator type display which displays full address plus data as well as register and status information.

## Level "B" Specifications

Level "B" provides the S-100 signals plus buffers/drivers to support up to six S-100 bus boards and includes: address decoding for onboard 4k RAM expansion select-able in 4k blocks...address decoding for onboard 8k EPROM expansion select-able in 8k blocks...address and data bus drivers for onboard expansion...wait state generator (jumper selectable), to allow the use of slower memories...two separate 5 volt regulators.



Explorer/85 with Level "C" cards.

## Level "C" Specifications

Level "C" expands Explorer's motherboard with a card cage, allowing you to plug up to six S-100 cards directly into the motherboard. Both cage and cards are neatly contained inside Explorer's deluxe steel cabinet.

Level "C" includes a sheet metal superstructure, a 5-card gold plated S-100 extension PC board which plugs into the motherboard. Just add required number of S-100 connectors

## Level "D" Specifications

Level "D" provides 4k or RAM, power supply regulation, filtering decoupling components and sockets to expand your Explorer/85 memory to 4k (plus the original 256 bytes located in the 8155A). The static RAM can be located anywhere from 0000 to EFFF in 4k blocks.

## Level "E" Specifications

Level "E" adds sockets for 8k of EPROM to use the popular Intel 2716 or the TI 2516. It includes all sockets, power supply regulator, heat sink, filtering and decoupling components. Sockets may also be used for soon to be available RAM IC's (allowing for up to 12k of onboard RAM).

## Order A Coordinated Explorer/85 Applications Pak!

**Experimenter's Pak (SAVE \$12.50)**—Buy Level "A" and Hex Keypad/Display for \$199.90 and get FREE Intel 8085 user's manual plus FREE postage & handling!

**Student Pak (SAVE \$24.45)**—Buy Level "A," ASCII Keyboard/Computer Terminal, and Power Supply for \$319.85 and get FREE RF Modulator plus FREE Intel 8085 user's manual plus FREE postage & handling!

**Engineering Pak (SAVE \$41.00)**—Buy Levels "A," "B," "C," "D," and "E" with Power Supply, ASCII Keyboard/Computer Terminal, and six S-100 Bus Connectors for \$514.75 and get 10 FREE computer grade cassette tapes plus FREE 8085 user's manual plus FREE postage & handling!

**Business Pak (SAVE \$89.95)**—Buy Explorer/85 Levels "A," "B," and "C" (with cabinet), Power Supply, ASCII Keyboard/Computer Terminal (with cabinet), 16k RAM, 12" Video Monitor, North Star 5-1/4" Disk Drive (includes North Star BASIC) with power supply and cabinet, all for just \$1599.40 and get 10 FREE 5-1/4" minidiskettes (\$49.95 value) plus FREE 8085 user's manual plus FREE postage & handling!

Continental U.S.A. Credit Card Buyers Outside Connecticut

**CALL TOLL FREE 800-243-7428**

To Order From Connecticut Or For Technical Assistance, Etc. Call (203) 354-9375

Listing 4 continued:

```
writeln(o,(' ',copy(ws,3,length(ws)-2),' '));
  IF not b THEN error('Unmatched @')
END;
PROCEDURE line;
VAR
  j:INTEGER;
BEGIN
  skip;
  IF i^ IN digits THEN
    BEGIN read(i,c); write(o,c,':');
      skip; IF i^ IN digits THEN error('Label must be single digit')
    END;
  readln(i,ws);
  IF ws[1] IN['Y','N'] THEN
    BEGIN
      IF ws[1] ='Y' THEN
        write(o,'IF flag THEN ')
      ELSE write(o,'IF not flag THEN ');
      ws:=copy(ws,2,length(ws)-1)
    END;
  IF length(ws)>2 THEN IF ws[3]=' ' THEN delete(ws,3,1);
  IF length(ws)<2 THEN
    error('Line too short')
  ELSE
    IF ws[2]<>':' THEN
```

Listing 4 continued on page 168

---

A REFURBISHED "SELECTRIC" ASCII TERMINAL  
FOR THE SMALL BUSINESSMAN OR SERIOUS HOBBYIST.

# The AJ 841 I/O terminal.

## Now available from dealers nationwide.

Demand for our AJ 841 I/O computer terminal has been great. And now it's getting even greater. So call your local computer shop dealer right away. Supply is limited! You may never have another opportunity like this one to buy your own *professional* terminal.



### The AJ 841 features:

- Choice of serial RS 232 or parallel interface
- ASCII code
- 14.9 cps printout
- High quality Selectric printing
- Heavy-duty Selectric mechanism
- Off-line use as typewriter
- Documentation included
- 30-day warranty on parts and labor (details available on request)

### Call toll-free now

For location of your nearest AJ dealer, call toll-free:

**800/538-9721**

California residents call 408/263-8520.

 **ANDERSON  
JACOBSON**



# ANNOUNCING COLLECTOR EDITION BYTE COVERS

SIGNED AND NUMBERED  
EDITIONS OF 100.  
\$15 EACH

Robert Tinney Graphics is now issuing limited editions of selected Byte Covers, each signed and numbered by the artist, Robert Tinney. The first four Collector Edition covers are shown at right. Unlike previously published Byte covers, these magazine-size prints are made from the original Byte color separations, and can be offered at a substantially lower price.

Collector Edition Byte Covers offer the following features:

- o THE PRINT—Each Collector Edition Byte Cover is 11"x14", including 1½" borders at top and sides, and a 1¾" border at bottom. The paper stock is a smooth finish, 65 lb. antique cover weight. This heavy, very white sheet reproduces the depth and brilliance of the original art.
- o THE EDITION—All Collector Editions are strictly limited to 100 prints, and the printing plates are destroyed after the run. Mr. Tinney

inspects and approves the quality of each print before personally affixing the individual number and signature at bottom. A Certificate of Authenticity accompanies each print and certifies the number of the edition as well as the destruction of the printing plates. Each certificate is also signed and numbered by Mr. Tinney.

- o SHIPMENT—Collector Edition prints are packed flat between heavy binder boards to avoid rolling and to assure undamaged shipment. However, should any damage occur, your print will be immediately replaced. Shipment, of course, is always first class.
- o PRICE—The price of each Collector Edition Byte Cover is \$15, plus \$3 for postage and handling (\$6 for orders outside the U.S. and Canada). If all 4 covers are ordered, the price is only \$50 plus postage and handling.

If you would like to order one or more of these beautiful Collector Edition Byte Covers, please use the convenient coupon below.



THE SEVEN BRIDGES OF KÖNIGSBERG



FUN AND GAMES



HOME BREW



SOFTWARE MIRAGE

February 1980

November 1979

March 1980

May 1980



"The Seven Bridges of Königsberg" shown mounted in a standard 12"x16" frame. Frame not included.

Please send me the following Collector Edition Byte Covers and Certificates of Authenticity.

Qty.	Cover	Amount
	The Seven Bridges of Königsberg	\$
	Fun and Games	\$
	Homebrew	\$
	Software Mirage	\$
<input type="checkbox"/>	All 4 - only \$50	\$
Post. & hand. (\$3 in US & Can., \$6 overseas)		\$
Total		\$

I have enclosed check or money order to Robert Tinney Graphics.

Visa  Mastercharge

Card # \_\_\_\_\_

Expiration Date \_\_\_\_\_

Signature \_\_\_\_\_

Send my print(s) to:

Name \_\_\_\_\_

Address \_\_\_\_\_

City \_\_\_\_\_

State \_\_\_\_\_ Zip \_\_\_\_\_

Mail this coupon to:

**robert tinney graphics**

P.O. Box 45047

Baton Rouge, LA 70895

Ph. (504) 357-5500



Listing 4 continued:

```
    error('Colon expected')
ELSE
  IF not(ws[1] IN ['T','R','A','M','J','E','C','U','X']) THEN
    error('Illegal command')
  ELSE CASE ws[1] OF
'R': writeln(o, '{', copy(ws,3,length(ws)-2), ' ');
'T': T(ws);
'M': BEGIN IF ws[3]='@' THEN
      writeln(o, 'match(', copy(ws,4,length(ws)-4), ');')
      ELSE writeln(o, 'match('', copy(ws,3,length(ws)-2), '');');
      END;
'J': BEGIN
      IF not (ws[3] IN digits) THEN error('Digit expected');
      writeln(o, 'GOTO ', ws[3], ';')
      END;
'E': writeln(o, 'GOTO ', el, ';');
'C': writeln(o, copy(ws,3,length(ws)-2), ');');
'U': writeln(o, copy(ws,3,length(ws)-2));
'X': writeln(o, 'flag:=', copy(ws,3,length(ws)-2), ');');
'A': IF length(ws)>4 THEN error('Ask statement too long')
      ELSE CASE length(ws) OF
2: writeln(o, 'readln(ans);');
3: IF ws[3] IN variables THEN writeln(o, 'readln(', ws[3], ');')
      ELSE error('Variable expected');
4: IF (ws[3] IN variables) and (ws[4]='s') THEN
      writeln(o, 'readln(', copy(ws,3,2), ');')
      ELSE error('String variable expected')
      END
      END; skip
END;
BEGIN{translate}
  writeln('Translating...');
  heading; skip;
  WHILE i^='*' DO
```

Listing 4 continued on page 170

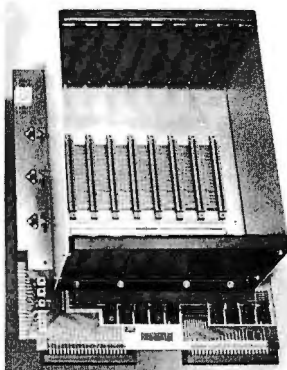

PRICE: \$139.00

We also carry the SYM-1  
Microcomputer with manuals \$229.00

### VAK-1 MOTHERBOARD

- Designed specifically for use with the AIM-65, SYM-1, and KIM-1 microcomputers
- Standard KIM-4\* Bus
- Fully buffered Address and Data Bus
- Provides 8 expansion board slots
- Complete with rigid card-cage
- All IC's are socketed
- Provides separate jacks for one audio-cassette, TTY, and Power
- Completely assembled (except for card-cage)

We manufacture a complete line of high quality expansion boards. Use reader service card to be added to our mailing list, or U.S. residents send \$1.00 (International send \$3.00 U.S.) for airmail delivery of our complete catalog.

\*Product of MOS Technology

 **ENTERPRISES**  
INCORPORATED

2967 W. Fairmount Avenue • Phoenix, AZ 85017 • (602) 265-7564

**If North Star or Cromemco offer it . . .**

# WE HAVE IT!!

**Immediate Delivery at Discount Prices**



**NORTH STAR  
Horizon® 2**  
32K Double Density  
Assembled and Tested  
List \$3095  
**ONLY \$2619**

North Star KIT products have been discontinued. MiniMicroMart HAS INVENTORY of most items!

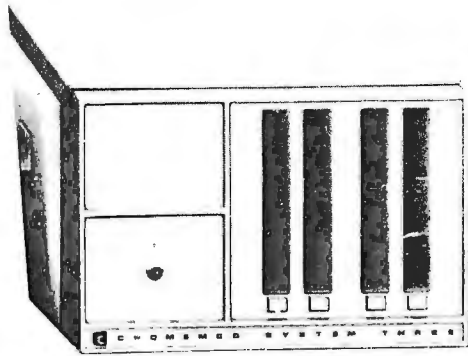

**CROMEMCO  
System 3**  
with 64K of RAM  
List \$6990  
**OUR PRICE  
\$5890**

**KITS**

- HORIZON 1 16K, DD . . . \$1474
- 32K, DD, List \$1999 . . . . 1684
- 32K, QD, List \$2199 . . . . 1869
- HORIZON 2, 16K, DD . . \$1824
- 32K, DD, List \$2399 . . . . 2034
- 32K, QD, List \$2779 . . . . 2359

**ASSEMBLED**

- HORIZON 1, DD . . . . \$2279
- 32K, QD, List \$2995 . . . . 2539
- HORIZON 2, 32K, DD . . \$2619
- 32K, QD, List \$3595 . . . . 3049
- 48K, DD, List \$3590 . . . . 3039
- 48K, QD, List \$4090 . . . . 3469
- 64K, DD, List \$3830 . . . . 3239
- 64K, QD, List \$4330 . . . . 3669

**NORTH STAR APPLICATIONS SOFTWARE**

- (Exclusive for use with North Star Disk Systems — specify Double or Quad Density)*
- NORTHWORD, List \$399 . . . . . \$339
  - MAILMANAGER, List \$299 . . . . . 249
  - INFOMANAGER, List \$499 . . . . . 419
  - GENERALLEDGER, List \$999 . . . . . 799
  - ACCOUNTSRECEIVABLE, List \$599 . . . . . 499
  - ACCOUNTSPAYABLE, List \$599 . . . . . 499

**NORTH STAR HARD DISK HD-18**

18 megabytes, plugs into parallel port of North Star Horizon. Utilizes tried-and-proven 14" Century Data Marksman. List \$4999.  
**OUR PRICE \$4199**

**NORTH STAR MDS-A** — Double (or Quad) Density Disk System, Kit, List \$799 . **OUR PRICE \$669**  
Assembled and Tested, List \$899 **SPECIAL \$719**

**NORTH STAR MEMORY BOARDS**

- 16K Dynamic RAM (RAM-16-A/A), Assembled, List \$499 . . . . \$420
- Kit, List \$449 . . . . . **SPECIAL \$299**
- 32K (RAM-32/A), Assembled, List \$739 . . . . . \$620
- Kit, List \$669 . . . . . **ONLY \$499**

**CROMEMCO SYSTEM 2**

— Now features dual-sided drives — double the capacity. Similar to System 3, except features dual, double-sided mini floppy disk drives. List \$3990 . . . . . **ONLY \$3390**

**Z-2 COMPUTER SYSTEM** (can be rack mounted), List \$995 . . . . . **\$845**

**SINGLE CARD COMPUTER — SCC-W**  
4 MHz. List \$450 . . . . . **\$382**

**NEW COLOR GRAPHICS INTERFACE — SDI**  
List \$595 . . . . . **OUR PRICE ONLY \$505**

**CROMEMCO HDD** — 11/22-megabyte Hard Disk for use with existing systems. DMA controller. Transfer rate of 5.6 megabytes/second.

**HDD-11**, List \$6995 . . . . . **OUR PRICE ONLY \$5939**  
**HDD-22**, List \$11,995 . . . . . **\$10,189**

**CROMEMCO Z-2H**

Full 11-megabyte Hard Disk system. Fast Z-80A 4 MHz processor, two floppy disk drives, 64K RAM memory, RS232 special interface, printer interface, and extensive software available. List \$9995



**OUR PRICE \$8489**

SHIPPING AND INSURANCE: Add \$15 or Horizons, \$2.50 for Boards and Software. Hard Disk Systems and Cromemco systems shipped freight collect. Advertised prices are for prepaid orders. Credit card and C.O.D. 2% higher. Deposit may be required on C.O.D. All prices subject to change and offers subject to withdrawal without notice.

— WRITE FOR FREE CATALOG —

# MiniMicroMart, Inc.

1618 James Street, Syracuse, NY 13203 (315) 422-4467 TWX 710-541-0431



Circle 114 on inquiry card.

Listing 4 continued:

```
BEGIN readln(i,ws); writeln(ws);
  writeln(o,'PROCEDURE ',copy(ws,3,length(ws)-2),',');
  writeln(o,'LABEL 0,1,2,3,4,5,6,7,8,9,10;');
  writeln(o,'BEGIN');
  WHILE (i^<>'*') and (not(eof(i))) DO
    line;
  writeln(o,el,':END;');
  readln(i)
END;
writeln('*:',name);
writeln(o,'BEGIN initialize; ');
WHILE not eof(i) DO
  line;
writeln(o,el,':END.')
END;

BEGIN {pilot}
  variables:=['a'..'z'];digits:=['0'..'9']; letters:=['A'..'Z'];
  badsyntax:=false;
  write('Translate what file?');
  readln(name);
  reset(i,concat(name, '.TEXT'));
  rewrite(o,concat('/',name, '.TEXT'));
  translate;
  IF badsyntax THEN
    close(o,purge)
  ELSE
    close(o,lock)
END.
```

Text continued from page 156:

"write" or "writeln" statement. The last character in the work string WS is examined to determine whether or not to suppress the carriage return at the end of the line. The preprocessor then goes through the work string removing the PILOT delimiter "@" and inserting apostrophes as needed. Procedure LINE is the heart of the program; it converts one line of PILOT code into one line of Pascal code. The main program opens the input file, calls TRANSLATE, and performs appropriate actions on the output file depending on whether or not syntax errors were encountered.

Because the preprocessor is written in Pascal, it should be easy to modify and add still more features. For example, PILOT/P's labels are currently restricted to the ten digits 0 thru 9. This is because I wanted to keep the preprocessing down to one pass; so to get around UCSD Pascal's restrictions on labels, I simply had the preprocessor predeclare ten labels for every program block. It is easy to modify the program to declare only needed labels. It would also be easy to make listings. By modifying the procedure TRANSLATE, you could allow the PILOT programmer to declare local variables, types, procedures, and so on. However, I feel that would be going too far. Anyone feeling restricted by PILOT/P's facilities ought to be programming in Pascal to begin with.

## Conclusion

Implementing PILOT/P has been an interesting experiment for me, and has given me an immense respect for the possibilities of preprocessors. They represent a tempting approach for anyone wishing to dabble in language design without going to all of the trouble of implementing a language from the ground up. ■

### The Origin of PILOT

*The PILOT language was developed in 1969 by John Starkweather, who was then the director of the computer center at the University of California at San Francisco. He now works for the Langley-Porter Institute at UCSF.*

*The name of the language is an acronym for Programmed Inquiry, Learning Or Teaching.*

---

### Author's Note

*I wish to thank Joe Berman, the University of Virginia department of computer science, and NASA contract #NASA-14862 for the use of the equipment on which the preprocessor was developed.*

---

# ... Terminals and Printers

## TELEVIDEO TVI-912



Upper case and lower case; 15 baud rates: 75 to 19,000 baud; dual intensity; 24 x 80-char. display, 12 x 10 resolution. Numeric pad. Programmable reversible video; aux. port; self-test mode; protect mode; block mode; tabbing; addressable cursor. Microprocessor controlled; programmable underline; line and character insert/delete.

OUR PRICE ONLY \$789

## INTERTUBE II by Intertec

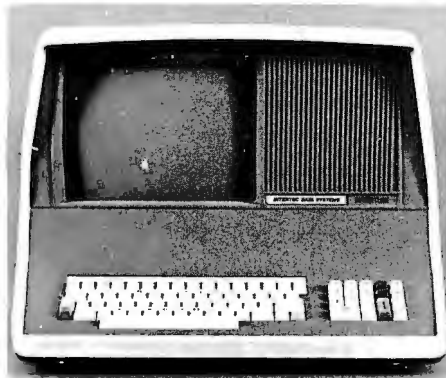

12" Display; 24 x 80 format; 18-key numeric keypad; 128 upper/lower case ASCII characters; Reverse video, blinking; Complete cursor addressing and control; Special user-defined control function keys; Protected and unprotected fields; Line insert/delete and character insert/delete editing; Eleven special line drawing symbols.

Only \$799

## BANTAM 550 From PERKIN ELMER



NOW FROM  
US AT  
\$799

Add \$20 for  
anti-glare  
CRT

## HAZELTINE



**HAZELTINE 1500**  
List \$1225 Only \$989

1400, List \$850 . . . . . \$ 699  
1410 w/numeric keypad, List \$900 . . . . . 749  
1420 w/lower case & numeric pad . . . . . 849  
1500, Kit, List \$1125 . . . . . 799  
1510, List \$1395 . . . . . 1089  
1520, List \$1650 . . . . . 1389  
Check our price and delivery on the new HAZELTINE 1420 with lower case, numeric keypad, and 2-year warranty.

## SOROC

120, List \$995 . . . . . \$ 795  
10-140, List \$1495 . . . . . 1249

## CENTRONICS PRINTERS

NEW 730 w/friction & tractor . . . . . \$ 895  
779-1 (TRS-80 Line Prtr. 1), List \$1245 . . . . . 949  
779-2 with tractor, List \$1350 . . . . . 1049  
702-2 120 cps, bi-directional,  
tractor, VFU . . . . . 1995  
703-2 185 cps, bi-directional,  
tractor, VFU . . . . . 2395  
780-2 w/tractor, List \$1725 . . . . . 1295

## ANADEX 80-COL. DOT MATRIX PRINTER



Complete upper and lower case ASCII char. set, bi-directional at 84 lines/min. Features RS232 20/60 mil current loop and Centronix parallel interface. Ideal for use with TRS-80, Sorcerer, Cromemco, and North Star systems.

OUR PRICE ONLY \$895

All prices subject to change and all offers subject to withdrawal without notice. Prices in this ad are for prepaid orders. Slightly higher prices prevail for other-than-prepaid orders, i.e., C.O.D., credit card, etc.

— WRITE FOR FREE CATALOG —

## T.I. 810



Bi-directional; 150 cps; logic seeking; adjustable tractor. Available with lower case compressed print; forms length control or vertical forms control option. Centronics style parallel interface also available.

TI-810 Basic Unit, List \$1895 ONLY \$1695  
TI-810 w/full ASCII (lower case), vertical forms control, and compressed print . \$1895

## PAPER TIGER®

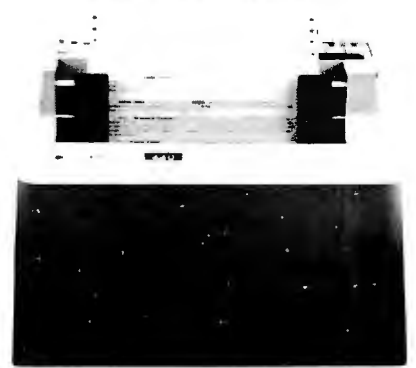

IDS-440 Paper Tiger, List \$995 . . . . . \$ 895  
w/graphics option, incl. buffer, \$1194 . . . . . 989  
IP-125 w/1210 option\*, List \$838 . NOW 724  
IP-225 w/1210, 1250 options, List \$984 . . . . . 834  
IP-225 w/tractor, 1210\*, 2K buffer, &  
graphics options, List \$1098 . . . . . 899  
TRS-80 cable . . . . . 45  
\*1210 option is expanded/compressed print.



## NEC SPINWRITER™

The Fantastic Letter-Quality  
Printer at 55 cps  
RO's as low as \$2475



# MiniMicroMart, Inc.

1618 James Street, Syracuse NY 13203 (315) 422-4467 TWX 710-541-0431

# STYLUS™

6809

## WORD PROCESSING SYSTEM

**6809 word processing has finally arrived !**

The **STYLUS™** text processor is an incredibly easy to use but powerful system for text editing and formatting.

- **FULL FEATURED CURSOR BASED EDITING-** cursor movement, scrolling, paging, deletes (character, word, or line), global search, block move and more!
- **FULL COMPLIMENT OF FORMATTING COMMANDS-** centering, justification, headers, footers, underlining, superscript, subscript, boldface.
- **TEXT FORMATTED ON THE SCREEN-** no surprises at printout time, effects of most formatting commands are instantly visible on the screen.
- **FLEX COMPATIBLE-** can be used to edit programs.
- **FULL SUPPORT-** versions for most common serial terminals with clear screen function running at 9600+ baud (memory mapped versions available fall 1980) —supported printers include Diablo, NEC, Qume, and regular tty.

When ordering specify your terminal, printer and disk size (5 or 8 inch).

Price: \$150.00

NY residents add

Manual only: \$15.00

sales tax.

STYLUS™ is a trademark of SONEX SYSTEMS. FLEX™ is a trademark of Technical Systems Consultants.



**SONEX SYSTEMS**

BOX 238 WILLIAMSVILLE, NY 14221

**716-634-2466**

**Radio Shack®**  
COMPUTER APPLICATIONS



## ARE YOU A TRS-80 PROGRAMMER?

(Wouldn't you like to be one?)

We are looking for a few new people to join our growing applications programming staff. Depending upon your background and experience, we will utilize your talents in such applications as games, business applications or word processing. The languages we are most interested in are BASIC, COBOL, and Z-80 assembler. If you think you have what it takes to be a part of "the Biggest Name in Little Computers®", then submit your resume and we'll take it from there.

**J.J. Mintz, Employment Manager**  
500 One Tandy Center  
Fort Worth, Texas 76102

an equal opportunity employer

A DIVISION OF TANDY CORPORATION

# CAT-100 FULL COLOR GRAPHICS

The original 256-color imaging system with high resolution video FRAME GRABBER for the S-100 bus.

Capture and digitize a video frame in 1/60 of a second. Select the best resolution for your application, from 256 to 1280 pixels per TV line. Display your digitized or computer processed image with 256 gray levels or 256 colors on standard BEW, NTSC or RGB color TV monitors.

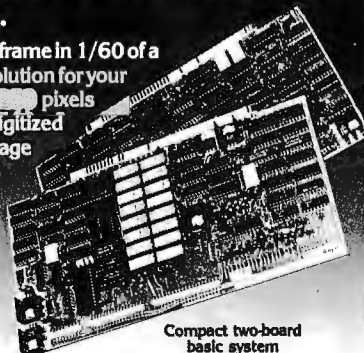

Compact two-board basic system



240x256 Digitized Image, 16 levels

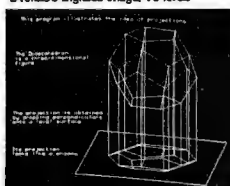

480x512 Computer-generated

### Features:

- Highest possible quality 480x512x8 digital video image presently available on the market
- Input capability from TV camera or other sources
- Variety of synchronization choices
- 2 selectable video A/D conversion circuits
- Choice of 1, 2, 4, 8, 16 or 32 bits per pixel
- 32K-byte image memory on the basic system
- 32, 64, 128 & 256K byte system capacity
- Lightpen input
- Photographic trigger control input
- Software selectable system parameters
- Interfaces for TRS-80 and other processors
- Comprehensive line of accessories, monitors and support software

**SEND FOR FREE CATALOG**



**DIGITAL GRAPHIC SYSTEMS**

441 California Ave., Palo Alto, CA 94306 415/494-6088

# ZS-SYSTEMS ZOBEX INC.

Complete computer on 3 S-100 boards for UNDER \$1000.00\*

Runs M/PM, C/PM and OMNIX

64K RAM  
4 MHZ  
No WAIT States  
IEEE Std.

Low power,  
DMA operation,  
Bank select in 16K sections  
Can be disabled in 4K increments

Z80 CPU  
2-4 MHZ  
IEE Std.

3 serial ports, 3 parallel, one 4K EPROM, Vectored interrupts, real time clock, Software controlled baud rates, Drives daisy wheel printer directly

DISK CONTROLLER  
8" and 5"  
DRIVES

All digital design for stable and reliable performance. No one-shots or analog circuitry.

CARD CAGE  
and Fan

Wide-spaced 6 slot shielded motherboard for good cooling and low noise.

**SEND FOR FREE INFORMATIONS**

6 months warranty on our boards with normal use

**ZS-SYSTEMS / ZOBEX INC.**

P.O. Box 1847, San Diego, Ca. 92112  
(714) 447-3997

\*introductory offer for limited time only

# MULTI-USER OASIS HAS THE FEATURES PROS DEMAND. READ WHY.

**Computer experts (the pros) usually have big computer experience. That's why when they shop system software for Z80 micros, they look for the big system features they're used to. And that's why they like Multi-User OASIS. You will too.**

## DATA INTEGRITY: FILE & AUTOMATIC RECORD LOCKING

The biggest challenge for any multi-user system is co-ordinating requests from several users to change the same record at the same time.

Without proper co-ordination, the confusion and problems of inaccurate or even destroyed data can be staggering.

Our File and Automatic Record Locking features solve these problems.

For example: normally all users can view a particular record at the same time. But, if that record is being updated by one user, automatic record locking will deny all other users access to the record until the up-date is completed. So records are always accurate, up-to-date and integrity is assured.

Pros demand file & automatic record locking. OASIS has it.

## SYSTEM SECURITY: LOGON, PASSWORD & USER ACCOUNTING

Controlling who gets on your system and what they do once they're on it is the essence of system security.

## (THEN COMPARE.)

Without this control, unauthorized users could access your programs and data and do what they like. A frightening prospect isn't it?

And multi-users can multiply the problem.

But with the Logon, Password and Privilege Level features of Multi-User OASIS, a system manager can specify for each user which programs and files may be accessed—and for what purpose.

Security is further enhanced by User Accounting—a feature that lets you keep a history of which user has been logged on, when and for how long.

Pros insist on these security features.

OASIS has them.

## EFFICIENCY: RE-ENTRANT BASIC

A multi-user system is often not even practical on computers limited to 64K memory.

OASIS Re-entrant BASIC makes it practical. How?

Because all users use a single run-time BASIC module, to execute their compiled programs, less

memory is needed. Even if you have more than 64K, your pay-off is cost saving and more efficient use of all the memory you have available—because it services more users.

Sound like a pro feature? It is. And OASIS has it.

## AND LOTS MORE...

Multi-User OASIS supports as many as 16 terminals and can run in as little as 56K memory. Or, with bank switching, as much as 784K.

**OASIS IS AVAILABLE FOR:** Altos; Bell Controls; Billings; CompuCorp; Cromemco; Corvus; Delta Products; Digital Group; Digital Microsystems; Dynabyte; Godbout, IBC; Industrial Microsystems; Konan; Micromation; Micropolis; North Star; Onyx; SD Systems; Tarbell; Thinkertoys; TRS 80 Mod. II; Vector Graphic Vorimex; X Comp; and others.

Multi-Tasking lets each user run more than one job at the same time.

And there's our BASIC—a compiler, interpreter and debugger all in one. An OASIS exclusive.

Still more: Editor; Hard & Floppy Disk Support; Keyed (ISAM), Direct & Sequential Files; Mail-Box; Scheduler; Spooler; all from OASIS.

Our documentation is recognized as some of the

best, most extensive, in the industry. And, of course, there's plenty of application software.

Put it all together and it's easy to see why the real pros like OASIS. Join them. Send your order today.

## CIRCLE WHAT YOU WANT

Product	Price with Manual	Manual Only
<b>OPERATING SYSTEM</b> (Includes: EXEC Language; File Management; User Accounting; Device Drivers; Print Spooler; General Text Editor, etc.) SINGLE-USER MULTI-USER	\$150 350	\$17.50 17.50
<b>BASIC COMPILER/INTERPRETER/DEBUGGER</b>	100	15.00
<b>RE-ENTRANT BASIC COMPILER/INTERPRETER/DEBUGGER</b>	150	15.00
<b>DEVELOPMENT PACKAGE</b> (Macro Assembler; Linkage Editor; Debugger)	150	25.00
<b>TEXT EDITOR &amp; SCRIPT PROCESSOR</b>	150	15.00
<b>DIAGNOSTIC &amp; CONVERSION UTILITIES</b> (Memory Test; Assembly Language; Converters; File Recovery; Disk Test; File Copy from other OS; etc.)	100	15.00
<b>COMMUNICATIONS PACKAGE</b> (Terminal Emulator; File Send & Receive)	100	15.00
<b>PACKAGE PRICE</b> (All of Above) SINGLE-USER MULTI-USER	500 850	60.00 60.00
<b>FILE SORT</b>	100	15.00
<b>COBOL-ANSI '74</b>	750	35.00

Order OASIS from:  
**Phase One Systems, Inc.**  
**7700 Edgewater Drive, Suite 830**  
**Oakland, CA 94621**  
 Telephone (415) 562-8085  
 TWX 910-366-7139

NAME \_\_\_\_\_  
 STREET (NO BOX #) \_\_\_\_\_  
 CITY \_\_\_\_\_  
 STATE \_\_\_\_\_ ZIP \_\_\_\_\_  
 AMOUNT \$ \_\_\_\_\_  
 (Attach system description; add \$3 for shipping; California residents add sales tax)  
 Check enclosed  VISA  
 UPS C.O.D.  Mastercharge  
 Card Number \_\_\_\_\_  
 Expiration Date \_\_\_\_\_  
 Signature \_\_\_\_\_

MAKES MICROS RUN LIKE MINIS.

# OASIS

# The Microcomputer in the Undergraduate Science Curriculum

---

W N Hubin  
Associate Professor of Physics  
Kent State University  
719 Cuyahoga St  
Kent OH 44240

---

The inevitable confrontation between science student and computer is occurring in today's colleges and universities. In this article I provide a biased perspective on the current use of computers in science education, try to awaken any latent interest you might have in number crunching (by presenting formulas that could be used to construct a realistic race track simulation), describe a simple microprocessor interface project for the student laboratory, and summarize the action at a recent conference on the use of computers in education. Since I teach physics, a physics flavor is inevitable, but other disciplines will be granted honorable mentions.

## Computer-Aided Instruction

CAI (computer-aided instruction) remains a rainbow in the sky that continues to promise gold but has so far delivered little. The major obstacles are probably two: equipment cost and software transportability. Advances in solid-state technology give some promise of surmounting the first obstacle.

The computer can clearly help the student in rote memorization. At the Kent State University's Kent campus (containing about 15,000 students), CAI is growing up in a huge 12-story library building, fathered by a psychology professor who was able to capture the requisite outside funding for the hardware (photo 1). Eleven stations containing six video terminals and five DecWriters are readily available to students and faculty. Their major use may well be that of a computer center substation, though, because only six drill programs are currently available (three languages, general

psychology, statistics, and nutrition), six tutorial programs (algebra, climatology, Esperanto, marketing, psychology, nutrition), and 15 manufacturer supplied simulations (mostly ecological and biological systems). The paucity of pedagogical offerings clearly illustrates the transportability problem and a faculty awareness problem. With some notable exceptions, most other large or small schools are in the same predicament, and the outlook isn't very encouraging.

How can computers help science students learn the art? The problem is that science (and particularly physics) seeks to convey physical principles and then asks its inquirers to solve new problems by using these general principles. Such a level of understanding is new and difficult for many students; in this case, intense concentration at a quiet desk is probably the best approach. But where the computer really provides a unique contribution is in extending the physical insight of the students. It gladly shows them the electric or magnetic field caused by a rather arbitrary collection of sources. It happily pictures the changing planetary orbits as the gravitational force law or orbital speed is changed. Astrophysics students can watch the evolution of stars and star systems and test the properties of evolving black holes. Computer-generated rays of light reveal the focal lengths of arbitrary lens shapes and combinations of lenses and pictorialize lens aberrations. Transfer functions for various active filter designs are displayed as fast as parameters can be altered. Radioactive decay and the flight paths of interacting elementary particles can be watched. What's more, these computer-aided instruction programs



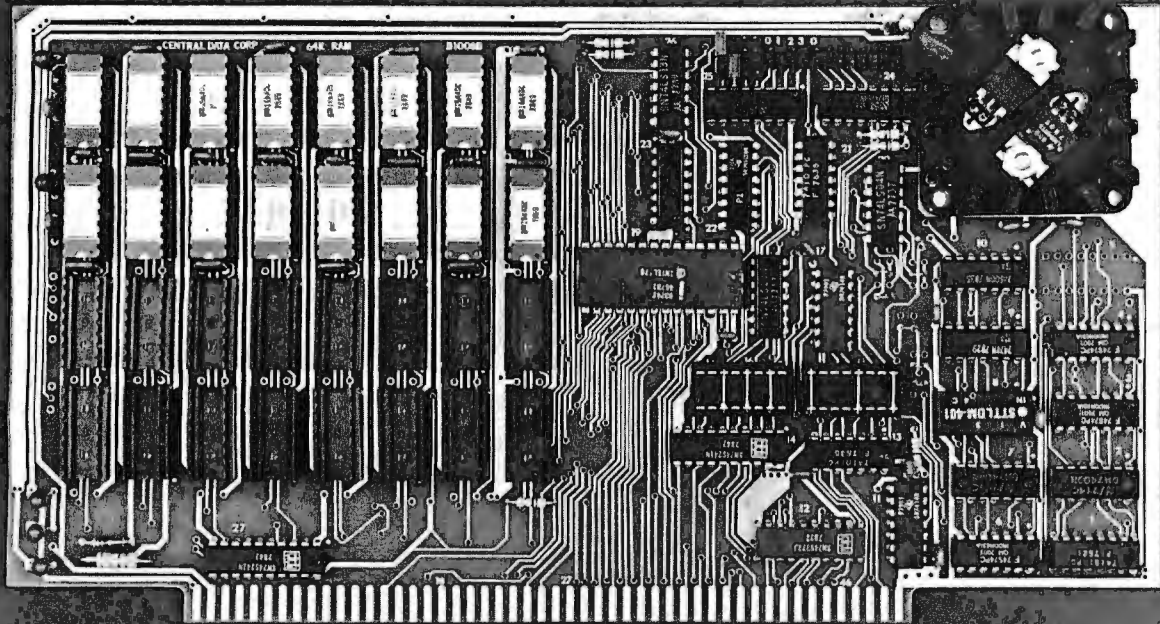

32K Board Pictured Above

# Why Not the Best?

## From The Dynamic RAM Company.

2MHz	4MHz
16K—\$249	\$259
32K—\$375	\$395
48K—\$500	\$530
64K—\$625	\$665

We have now been shipping our 2MHz dynamic RAM boards for over two years. Hundreds of 4MHz boards have been going out every month since early 1979. Our reliability is proven in the thousands of systems which contain our board. Many quality-minded systems houses across the country and overseas are using our boards for their equipment.

**Our prices still beat all.** Despite rising 16K memory chip prices (at least from reputable suppliers), Central Data continues to give you the best buy in memory today. Nobody offers a board with a capacity of 64K, assembled, tested, and guaranteed for a full year at the price we do.

Circle 120 on inquiry card.

**Deselect around PROMs.** Our boards have the important deselect feature which lets you overlap any fixed memory in your system with no interference.

**Our features make the board easily used and expanded.** You address our boards on 16K boundaries with mini-jumps (small shorting plugs that slide over wire-wrap pins) near the top of the board for easy access. If you want to expand your board after you have purchased it, all that you need to do is add memory. We can supply you with expansion packages (\$150-2MHz, \$160-4MHz) which include eight RAMs that you can depend on as well as two mini-jumps for addressing. And of course, our board **never** generates wait states.

**Low power consumption keeps your computer running cool and reliable.** The total power consumption of our 16K board is typically less than 4 watts (+8V @ 300ma, +16V @ 150ma and

–16V @ 20ma). Boards with additional memory typically increase power consumption only 1 watt per 16K!

**Standard S-100 Interface.** Our board is designed to interface with any standard S-100 CPU. All of the timing of the board is independent of the processor chip, and the board is set up for different processors by changing two plugs on the board.

**Call or write us today.** That will guarantee a fast response with more information on the board. Or make an order — you'll probably have the board in two weeks! **If you're interested, also ask for a catalog on our Z8000 16-bit processor board designed for the MULTIBUS.** All of these products are available to your local dealer, also.

Central Data Corporation, 713 Edgebrook Drive, PO Box 2530, Station A, Champaign, IL 61820. (217) 359-8010

**Central Data**



Photo 1: The computer-aided design laboratory at Kent State University.

can be just as interactive as the student is willing to be inquisitive.

#### Data Analysis in the Science Laboratory

The computer was quickly accepted by the sciences for its number-crunching powers. But it grew up in an air-conditioned computer center, and there it did its batch mode "thing". When programmable calculators and minicomputers arrived, they were promptly ensconced in computer rooms in the physics, chemistry, or engineering building. With the proliferation of low-cost microcomputer systems there is no longer any good excuse for keeping computers out of the student science laboratory. Computers can help to teach good laboratory practices, of course, but the

intention here is to take some of the drudgery out of repetitive calculations and to provide new information on the significance of the student's laboratory data. The following are some examples.

#### Application Examples

One of the first experiments in a typical college physics course is two-dimensional vector addition. Each pair of students is assigned two hypothetical forces and is asked to obtain the direction and magnitude of the single force that will precisely balance any object that might be subjected to the first two forces. This is to be accomplished both graphically and analytically and then the results are tested on a "force table" where failure produces a noisy collapse

NO FRILLS! NO GIMMICKS! JUST GREAT

# DISCOUNTS

MAIL ORDER ONLY

## ATARI 800

Personal Computer System

**\$799<sup>00</sup>**



## SOROC Technology

IQ 120 **\$699<sup>00</sup>**

IQ 140 **999<sup>00</sup>**



## NORTHSTAR

Horizon II  
32K

**\$2349<sup>00</sup>**

Horizon II Quad

**2799<sup>00</sup>**

Horizon II 64K

**2999<sup>00</sup>**

Horizon Quad 64K

**3399<sup>00</sup>**



## CROMEMCO

System 3 **\$5695<sup>00</sup>**

Z2H **7995<sup>00</sup>**



## TELEVIDEO

912 **\$749<sup>00</sup>**

920 **\$799<sup>00</sup>**

## INTERTEC

Superbrain  
32K Computer

**\$2495<sup>00</sup>**

Superbrain 64K

**\$2795<sup>00</sup>**



## HAZELTINE

1420 **\$795<sup>00</sup>**

1500 **\$849<sup>00</sup>**

1510 **\$1049<sup>00</sup>**

1520 **\$1229<sup>00</sup>**



## DECwriter IV

LA 34 **\$979<sup>00</sup>**



## TEXAS INSTRUMENT

810 Multi Copy  
Impact Printer

**\$1499<sup>00</sup>**



## OKIDATA Microline 80

**\$699<sup>00</sup>**



We'll meet or beat any advertised prices!

Most items in stock for immediate delivery. Factory-sealed cartons.  
Full manufacturer's guarantee.

# DATA DISCOUNT CENTER

Box 100 135-53 Northern Blvd., Flushing, New York 11354

Visa • Master Charge • N.Y.S. residents add appropriate Sales Tax • Shipping F.O.B. N.Y.

PHONE ORDERS  
CALL  
212  
465-6609

of the simulated object. Here is one good example of an experiment in which the computer quickly provides an unbiased and friendly second or third opinion for the students.

There are many experiments in which theory predicts a linear functional relationship and students are asked to draw the "best possible" straight line through a set of data points and calculate something of significance from the slope and the intercept of that line. As examples, the average speed of a falling body increases linearly with time (in the absence of significant air drag), and the proportionality constant (the slope of the line) is the acceleration of gravity,  $g$ . Second, if the (period)<sup>2</sup> of various pendulums is plotted as a function of pendulum length, then the slope of the line (for small angular displacements of the pendulum bob) should be equal to  $(4\pi^2/g)$ . Third, the EMF (electromotive force) and internal resistance of a battery are the intercept and the slope, respectively, when the voltage at the terminals is plotted as a function of current drawn by an external circuit. Fourth, the natural logarithm of the voltage across a capacitor  $C$  that is discharging through a resistance  $R$  will, when

plotted versus time, yield a straight line whose slope is  $(-1/RC)$ . In all of these examples, students are to use their own judgment (or fertile imagination) in deciding how to average the scatter in the data and draw the line. A simple, linear, least-squares fitting program (that produces the equation of a line that has a minimum average distance from the data points) provides a second opinion from the computer. Then the student or the computer must plot the data and the straight line to visually gauge the linearity of the relationship and to ensure that one bad data point hasn't exerted an overbearing influence.

The data for this example was collected from a free-falling body apparatus. Here's how the computer analysis is set up: Operation of the apparatus consists of letting a small, metal plumb bob fall freely between two precisely vertical, parallel wires. A 60 Hz spark generator produces sparks that jump from one wire, through the falling object, then through a thin, colored, paper tape, and finally to the other wire. Students carefully measure the separation of the spark dots on the colored tape to obtain position-time data such as the following:

Vertical Height (cm)	Time (seconds)
Y(1) = 0.00	T(1) = 0
Y(2) = 0.33	T(2) = 1/60
Y(3) = 0.93	T(3) = 2/60
Y(4) = 1.73	T(4) = 3/60
Y(5) = 2.82	T(5) = 4/60
Y(6) = 4.23	T(6) = 5/60
Y(7) = 5.87	T(7) = 6/60
Y(8) = 7.75	T(8) = 7/60
Y(9) = 9.96	T(9) = 8/60
Y(10) = 12.41	T(10) = 9/60
Y(11) = 15.13	T(11) = 10/60
Y(12) = 18.18	T(12) = 11/60

It is pretty obvious that this object is accelerating because the distance intervals are getting progressively larger. The question is whether or not the acceleration is constant and, if so, what is it?

After the data is entered, the computer must calculate the average speed during each distance interval. Thus:

$$\begin{aligned}
 V(1) &= [Y(2) - Y(1)] / (1/60) \\
 V(2) &= [Y(3) - Y(2)] / (1/60) \\
 &\vdots \\
 &\vdots \\
 &\vdots \\
 V(11) &= [Y(12) - Y(11)] / (1/60)
 \end{aligned}$$

These average speeds, eleven of them, were the *instantaneous* speeds at the *midpoints* of the distance intervals *if* the acceleration was constant, as we expect. However, the

## Desk Main/Frame Desk Main/Frame

### LOW COST & ATTRACTIVE STYLING

- MAIN/FRAME INTEGRATED INTO FURNITURE QUALITY DESK
- ELECTRONICS PACKAGE SLIDE MOUNTED FOR EASY ACCESS
- SUPPORTS TWO 8" FLOPPY DRIVES FROM SEVERAL MANUFACTURERS (DRIVES NOT INCLUDED)
- 10 SLOT MOTHERBOARD INCLUDES CONNECTORS
- POWER SUPPLY FOR DRIVES AND CARDS
- DESK AND MAIN/FRAME AVAILABLE SEPARATELY
- MATCHING PRINTER DESK AVAILABLE



WRITE OR CALL FOR OUR BROCHURE WHICH INCLUDES OUR APPLICATION NOTE: 'BUILDING CHEAP COMPUTERS'

# INTEGRAND

8474 Ave. 296 • Visalia, CA 93277 • (209) 733-9288  
We accept BankAmericard/Visa and MasterCharge

# IDS Announces S-100 Energy Management Module

The 100-EMM Energy Management Module provides temperature measurement at four separate locations indoors or out; monitors eight (8) doors, windows, or fire sensors; controls six external devices via relay or optoisolator; and provides an intrusion alarm with battery backup (alarm operates even during primary power outages). Put the 100-EMM to use in your home or business and claim a 30% tax credit for the cost of your S-100 computer system including the 100-EMM. (Purchasing the 100-EMM can actually save you several times its cost in tax credits. Full instructions for filing are included in the 100-EMM manual.)

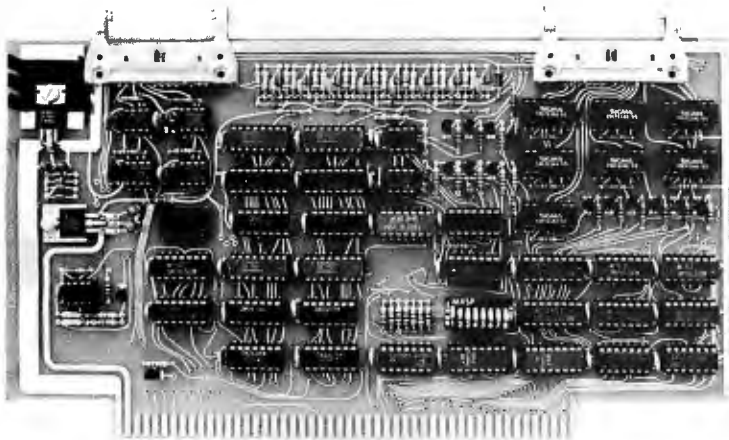

**BUY THIS S-100 BOARD  
AND GET UP TO A 30%  
TAX CREDIT BASED ON  
THE COST OF YOUR  
COMPUTER SYSTEM!**

**100-EMM Energy Management Module**  
Assembled and Tested **\$395.00**  
Kit **\$345.00**

#### Options for 100-EMM:

**CP-52 Cable Panel** - Terminates two 26-conductor flat cables in 26 screwlugs. Use it for convenient interconnection of the 100-EMM to the "outside world". **\$45.00**

**CABL-26-STD 26-Conductor Flat Ribbon Cable** - Four feet in length with connectors for 100-EMM and CP-52 above. **\$35.00** Other lengths available on special order. Add **\$1.00** per foot.

**OTHER PRODUCTS FROM IDS.** The most complete source of S-100 compatible modules for process control, data acquisition, energy management, and data communications.

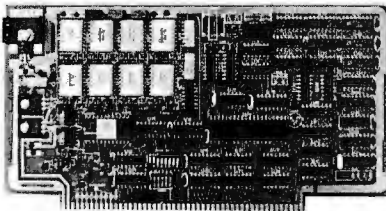

**88-MODEM S-100 ORIGINATE/ANSWER MODEM WITH AUTO-DIALER.** Software selectable baudrate provides any baudrate from 66-600 baud. Provides 1.5 stop bits when operated in 5-bit code mode. Auto-answer programs available for CROMEMCO CDOS, CP/M, North Star Horizon and MDS, and Alpha Micro.

Assembled and Tested **\$395.00** Kit **\$245.00**

#### 88-UFC UNIVERSAL FREQUENCY COUNTER

Four software selected inputs. Measure frequency from 0-650 MHz and period from .1uS to 1 Second. Extensive software included.

Assembled and Tested **\$299.00** Kit **\$199.00** Temperature-Compensated Crystal Oscillator option **\$145.00**

#### 88-SAI SYNCHRONOUS/ASYNCHRONOUS INTERFACE

The most versatile serial interface on the market. Computer access/control of all data and handshake lines and provision for masked interrupts, inversion of any input or output signal, and onboard baudrate generation for 110, 134.5, 150, 300, 600, 1200, 2400, 4800, 9600, and many other baud rates. Many more features.

Assembled and Tested **\$299.00** Kit **\$199.00**

**88-SPM TIME OF DAY CLOCK** with battery backup. Set the clock with three out instructions: no delays! Programs included in North Star BASIC, CBASIC, and 8080 assembly language.

Assembled and Tested with crystal option **\$199.00** Kit less crystal option **\$99.00** Crystal Option Kit **\$25.00**

#### 88-RCB RELAY CONTROL BOARD

16 Relays on one board. Control appliances, production equipment, or even musical instruments (See BYTE Magazine Sept 1977 page 12)

Assembled and Tested **\$299.00** Kit **\$199.00**

**INTERNATIONAL  
DATA SYSTEMS, INC.**

#### Mailing Address:

Post Office Box 17269  
Dulles International Airport  
Washington, DC 20041  
Telephone (703)661-8442

#### Shipping Address:

400 West Service Road, Suite 130  
Dulles International Airport  
Washington, DC 20041 USA  
TELEX 901112 IDS CTLY

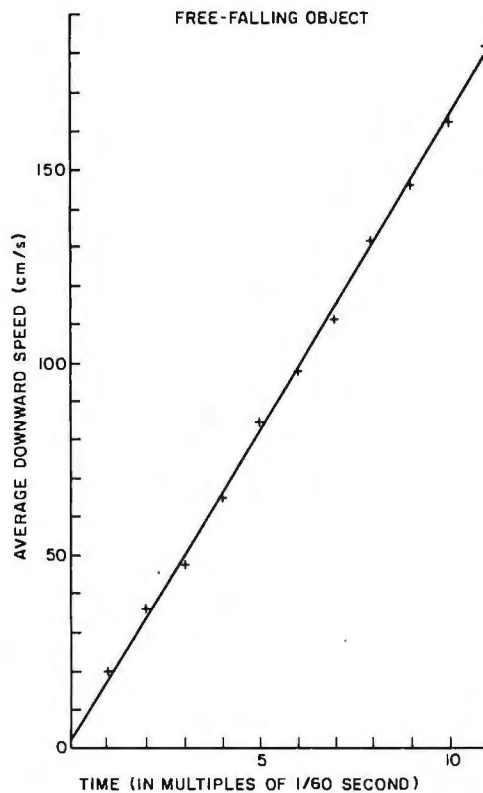

Figure 1: Data points from a free-falling body experiment (see text).

difference in times is still 1/60 second, so we can redefine our zero time to be the midpoint of the first interval and the data points which should then yield a straight line are  $V(l)$  and  $T(l)$  for  $l = 1$  to 11.

The equation of a straight line is:

$$V = (A1)(T) + A2$$

where  $A1$  and  $A2$  are calculated to bring the straight line as close as possible to the data points. The derivations of formulas for  $A1$  and  $A2$  appear in many texts, so I will just quote the results:

$$A2 = \frac{N \times \bar{V}T - \bar{V} \times \bar{T}}{N \times \bar{T}^2 - \bar{T} \times \bar{T}}$$

$$A1 = \frac{\bar{V} - A2 \times \bar{T}}{N}$$

In these equations,  $N$  is the number of data points and is equal to 11 for the sample data. The other variables are defined as follows:

$$\begin{aligned} \bar{T} &= \sum T(l) = T(1) + T(2) + \dots + T(N) \\ \bar{V} &= \sum V(l) = V(1) + V(2) + \dots + V(N) \\ \bar{V}T &= \sum V(l) \times T(l) = V(1) \times T(1) \\ &\quad + V(2) \times T(2) + \dots + V(N) \times T(N) \\ \bar{T}^2 &= \sum T(l) \times T(l) = T(1) \times T(1) \\ &\quad + T(2) \times T(2) + \dots + T(N) \times T(N) \end{aligned}$$

The average vertical deviation of the data points from the straight line, which has been minimized with this choice of  $A1$  and  $A2$ , is given by:

$$S = \text{Average deviation} = \sqrt{\frac{\sum [V_{\text{calc}} - V_{\text{exp}}]^2}{N}}$$

This expression means that we add up the sum of the *squared* deviations of the speeds obtained from the data [ $V_{\text{exp}} = V(l)$ ] from the speeds calculated for the same times using the derived equation of the straight line [ $V_{\text{calc}} = A1 \times T(l) + A2$ ], divide this sum by the total number of experimental speeds, and then take the square root. By squaring the vertical deviation we have ensured that points above and below the line are treated equally. See if you can obtain  $A1$ ,  $A2$ , and  $S$ . For comparison, I obtained  $A1 = 973.309 \text{ cm/s}^2$ ,  $A2 = 1.83276 \text{ cm/s}$ , and  $S = 1.75428 \text{ cm/s}$ . This means that the acceleration of gravity was a measured  $973 \text{ cm/s}^2$ . The uncertainty in this measurement can be estimated by dividing the average vertical deviation by the total time interval, thus:

$$g = \text{experimental value of acceleration of gravity} = 973 \pm 11 \text{ cm/s}^2$$

The actual acceleration due to the gravitational force depends on one's location on the earth; specifically, it depends on one's angular distance from the equator, the distance from the center of the earth, and local nonuniformities in the density of the earth. The first two effects are easily taken care of by using Helmert's equation:

$$\begin{aligned} g \text{ in cm/s}^2 &= 980.616 - 2.5928 \cos 2\phi \\ &\quad + 0.0069 \cos^2 2\phi \\ &\quad - 3.086 \times 10^{-6} H \end{aligned}$$

where  $\phi$  is the latitude in degrees and  $H$  is the elevation above sea level in centimeters. This equation gave a value of  $980.27 \text{ cm/s}^2$  for the laboratory where the sample data was taken, and thus there is comfortable agreement between laboratory and hand-book values. The experimental data and the derived straight line are shown plotted in figure 1.

Many physical properties exhibit a more complex functional relationship than the simple linear one. As one example, in *Cooke titration* the acidity is a parabolic function of the carbon dioxide added and a computer is invaluable to make the fit. As another example, a resistance thermometer (just a carbon or germanium resistor) at very low temperatures exhibits a complex logarithmic dependence of resistance on tem-

# The COMPUTER FACTORY

TO ORDER CALL (212) 687-5000

## SUPERBRAIN™

INTERTEC  
DATA  
SYSTEMS  
64K  
ONLY  
**\$2995**



32K \$2795  
More than an intelligent terminal, the SuperBrain outperforms many other systems costing three to five times as much. Endowed with a hefty amount of available software (BASIC, FORTRAN, COBOL), the SuperBrain is ready to take on your toughest assignment. You name it! General Ledger, Accounts Receivable, Payroll, Inventory or Word Processing... the SuperBrain handles all of them with ease.  
FEATURES INCLUDE:  
• 2 dual-density minifloppies with 360K bytes of disk storage • A CP/M Disk Operating System with a high-powered text editor, assembler and debugger.

### Model Q0

720K Bytes disk storage  
and 64K RAM  
**\$3895**

**NEW Super Brain**  
20 Megabyte  
Winchester  
Hard Disk  
Only **\$5995**

## NEW 1980/1981

# 80 COLUMN COMMODORE CBM

- 80 column by 25 line display
- 12" CRT
- New screen editor
- Split screen processing
- Super fast string handling
- 15 additional basic commands
- Supports relative record processing

Model 8016 16K memory **\$1495**  
Model 8032 32K memory **\$1795**

## NEW 8050 DUAL DISK

1 million bytes on-line storage  
and DOS 2.0 operating system

- Supports relative record (Random Access)
- Faster more reliable only **\$1695**

### CENTRONICS 704

• 180 cps Bi-Directional • Up to 15" Paper Width • 9 x 9 Matrix  
• Upper/Lower Case  
• Tractor Feed  
• RS-232  
• Serial Interface  
**\$1895**  
List \$2500

### CENTRONICS 700-9

**\$1295** List \$1895  
• 60 cps • Up to 15" paper width  
• Tractor Feed • Parallel Interface  
for Apple & TRS-80 • 2 channel  
vertical forms! • Top of Form!

### CENTRONICS (Letter quality)

737 Serial **\$995**  
737 Parallel **\$965**

### CENTRONICS

730 Serial **\$845**  
730 Parallel **\$795**

## Commodore Computer

These low cost Commodore PET Business Computers have virtually unlimited business capabilities. Accounts Receivable, Inventory Records, Payroll, and other accounting functions.

### PET 16N & 32N COMPUTERS

- Full size keyboard
- 16 or 32,000 Bytes memory
- Level III Operating System
- Full screen Editor
- Upper lower case & 64 graphic characters



### PET DUAL FLOPPY DISK

- Stores 360,000 Bytes on-line
- Microprocessor controlled
- Uses single or dual sided floppies

### HI-SPEED PRINTER

- 150 characters per second • Up to 4 copies 8" wide
- Microprocessor Controlled • Prints All Graphics • Full Formatting Capability

### PERIPHERALS

- 24K Memory Expansion ..... \$499
- 16K Memory Expansion ..... 399
- PET to RS232 Serial ..... 179
- 2 Way Serial/Communication ..... 229
- Modem Board for PET (for 16 Devices) ..... 275
- Second Cassette Drive ..... 95

### Great PET Software

**DATABASE MANAGEMENT SYSTEM**—Six modules comprising 48K of programming allows you to: create, edit, delete, display, print, sort, merge, etc.—databases of up to 10,000 records. Printer routines included. 60 Pages of documentation for 16-32K PET and 2040 Dual Disk...  
Cost \$125

**KRAM—Keyed Random Access Method**—The new, ultra-fast access method for the PET Disk, provides keyed retrieval/storage of data. In either direct or sequential mode, by either full or partial key values. 6502 coding.  
KRAM 2.0 for PET \$99.95  
KRAM 2.0 for Apple \$99.95

### ANDERSON JACOBSON Parallel

841 I/O Terminal Ideal for word processing and small businesses. **\$1130**

Serial **\$1230**

- ASCII Code
- 15 CPS Printout
- High Quality Selectric Printing
- Reliable heavy duty mechanism
- Completely Refurbished by A.J.
- Delivered FREE to nearest service center



## NEW AMPEX HARD DISK

5 Fixed  
5 Removable  
Only **\$5995**

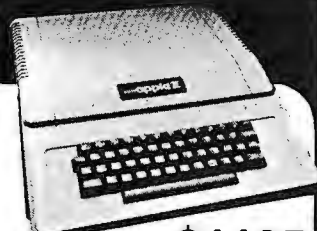

## APPLE II PLUS \$1195

A complete self-contained computer system with APPLESOFT floating point BASIC in ROM, full ASCII keyboard in a light weight molded carrying case.

### Features Include:

- auto-start ROM • Hi-Res graphics and 15 color video output.
- Expandable to 48K.

Supertalker .....	\$279	Micromodem .....	\$379
Disk .....	595	Superterm (24 x 80) .....	395
Add-on Disk .....	495	Speechlab .....	229
Pascal Card .....	495	Communication Card .....	225
Business Software .....	625	Modem .....	200
Monitor .....	159	Graphics Printer .....	595
Printer Card .....	180	Graphics Tablet .....	795



**IS FINALLY HERE  
128K RAM!!**

FOR BEST DELIVERY AND SUPPORT SEE IT AT THE COMPUTER FACTORY



## NEW XYMEC 1000 with QUADRA-PITCH \$2495

10, 12, 15 Pitch & Proportional Spacing  
The XYMEC HY-Q 1000 is "Tomorrow's Printer" - with virtually every advancement built in as standard. No other options are required. Its versatility matches your output format - and - it can be used as an off-line typewriter

- Z-80 Controlled
- Up to 198 Columns
- 30 CPS • Reverse Print • Electronic Digital Display
- Multi-Lingual
- Automatic recall

## RADIO SHACK • PET • SORCERER • APPLE • COMPUCOLOR • ETC. PRINTERS • PRINTERS • PRINTERS

The COMPUTER FACTORY'S extensive inventory and wide selection of computer printers assures you of finding the printer best suited for your needs and specifications. The following printers work well with all known personal computers.

Centronics 779-Z .....	\$1195
Centronics 730 .....	795
Eaton 7000 .....	389
Paper Tiger 440 .....	1095
Xerox 1740 .....	2895

## ★ FREE

\$35 of Software with purchase of any computer on this page.



Min Credit Card Order \$75



Open Mon.-Fri. 10-6 Sat. 10-4

N.Y. residents add 8% sales tax  
• Same day shipment on prepaid and credit card orders • Add \$5 shipping for computers, \$3 for boards, \$1 each cassette tape.

TO ORDER CALL (212) 687-5000

The COMPUTER FACTORY

485 Lexington Ave., New York, NY 10017 (46th St. Lobby)

Foreign order desk — Telex 640055

perature; a computer fit is needed in order to obtain temperatures between the calibration points.

For me, the really exciting and new aspect of computer analysis in the introductory student laboratory is the possibility of determining the validity of experimental data and calculated quantities. In the days of the slide rule there was little need to stress significant figures because both the measurements and the calculating device were good to at best three significant figures. The electronic pocket calculator has changed one part of that and has showed us how very hazy and difficult is the concept of significant figures. We now commonly observe students taking the distances they have measured to three significant figures (eg: 8.45 cm), dividing this by a time accurate to two significant figures (eg: 0.73 seconds), and proudly presenting a calculated speed with apparently seven significant figures (eg: 11.575342 cm/s) because that is what their calculators indicated!

There are two methods by which I try to get students to be more thoughtful and to throw out numerical garbage. One method is the "rules of significant figures," from which they should learn that the answer after a multiplication or division is limited by the accuracy of the least accurate factor; the rules for addition and subtraction are a little more difficult. Thus, in the example above, 11.6 cm/s would be a reasonable and accurate answer.

The second method is a powerful one and relatively easy to understand, but can become tedious rather quickly. It is therefore not usually employed in introductory laboratories. This method is "worst case error analysis" and is based on the reasonable assumption that Murphy's Law will certainly prevail. It suggests that we calculate the possible *range* of values for an answer by asking how our estimated inaccuracies could possibly combine to give a maximum deviation from the nominal value. In our previous example we probably could have estimated the accuracy of our distance measurement (eg:  $\pm 0.05$  cm) and of our time measurement (eg:  $\pm 0.03$  seconds). The speed could then have been as large as the *maximum* possible distance divided by the *minimum* possible time  $[(8.45 + 0.05)\text{cm}/(0.73 - 0.03) \text{ s} = 12.1 \text{ cm/s}]$ , or it could have been as small as the *minimum* possible distance divided by the *maximum* possible time  $[(8.45 - 0.05)\text{cm}/(0.73 + 0.03) \text{ s} = 11.1 \text{ cm/s}]$  and we could safely report that we determined the speed to be  $11.6 \pm 0.5 \text{ cm/s}$  for this example. In the actual research laboratory, we can often

repeat our measurements and apply statistical tests to determine validity, but worst case analysis is useful whenever a measurement is not or cannot be repeated, for measurements in any field.

After doing this type of error analysis with a pocket calculator a couple of times, the students understand the logic of the process and are quite ready to let the computer do it. They still reap the benefits of having to estimate their experimental accuracy and of reconciling their answers with the "known" value, but are spared the drudgery of the repeated calculations. In the student laboratory the measurement technique, the analysis technique, and the reinforcement of physical concepts, are all important — the actual answers obtained are not.

A surprising number of personal computers are used for laboratory calculations throughout the United States, particularly for those schools or departments that haven't been able to tap into a large computer. More and more, microcomputers will be telling mainframes to keep their terminals to themselves!

#### Data Acquisition in the Science Laboratory

Meter sticks, stopwatches, multimeters, and thermometers have been standard laboratory equipment for a long time. Here is an enclave ripe for microprocessor invasion. Two reasons suggest that only a mild invasion will occur in the near future: education's sensitivity to cost, and the fact that intelligent laboratory equipment may be less instructive for the student than the traditional tools.

Modern digital components should certainly be exploited much more than they are presently. Photo 2 shows an example of a home project design that does more than the available commercial equipment. A forensic physics class is shown in the process of making distance-time measurements on an air track with a 16-memory digital timer. Front-surface mirrors bounce a laser beam down and across the track at intervals just equal to twice the length of the air track glider and finally to a FPT-100 phototransistor detector. Times are recorded whenever the beam is broken or unbroken so that the times correspond to equal increments of traveled distance. (The laboratory air track was the progenitor of the air hockey table: air is blown through many small holes in the track so that the glider rides on a layer of air and can move along the track with almost negligible friction.) The timer uses 7489 integrated circuits for memory but the times are first latched into



YOUR COMPUTER PROFESSIONALS

# computique

PERSONAL ELECTRONICS AT PROFESSIONAL DISCOUNTS

SIX STORES  
IN SOUTHERN  
CALIFORNIA

OUTSIDE CALIFORNIA  
ORDER LINE

CALIFORNIA ORDER  
AND INFORMATION LINE

(800) 854-0523 (714) 549-7373



COMPLETE BUSINESS,  
EDUCATIONAL AND  
GAME SOFTWARE  
AVAILABLE

INTRODUCING

Now Apple has a new twist - the **APPLE II PLUS**, with extended **APPLESOFT BASIC** as standard language. Also, the **APPLE II PLUS** has 9 - digit arithmetic precision and exclusive Auto-start that can run programs automatically when you turn the computer on. As with Apple II, you get the same exciting color graphics, sound, hand controls and computational features.

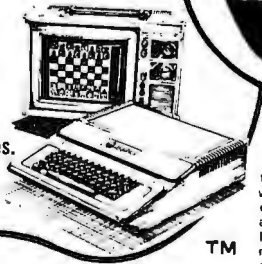

Introducing Apple III, the system that will revolutionize the way you think about personal computers. If you're serious about personal computing and have some complex application needs, Apple III is designed for you.

**APPLE II PLUS**  
**\$999<sup>95</sup>**  
16K MEMORY

## THE HP-85!

HEWLETT PACKARD'S  
PERSONAL COMPUTER  
FOR PROFESSIONALS!



The HP-85 is a powerful BASIC language computer complete with keyboard, CRT display, printer, and tape drive—all in one compact unit. **ONLY \$3250**



### MORE HP VALUES

HP-67 . . . . .	\$299.95	HP-31E . . . . .	41.95
HP-92 . . . . .	399.95	HP-32E . . . . .	54.95
HP-97 . . . . .	584.95	HP-33E . . . . .	73.95
HP-33C NEW . . . . .	109.95	HP-37E . . . . .	59.95
HP-34C NEW . . . . .	124.95	HP-38E . . . . .	94.95
HP-38C NEW . . . . .	124.95		
HP-41C Basic . . . . .	295.00		
Card Reader for 41C . . . . .	215.00		
Printer for 41C . . . . .	385.00		
Memory Modules . . . . .	45.00		
Solution Books . . . . .	12.50		
Application Modules . . . . .	45.00-70.00		

## Now—the Texas Instruments TI-99/4 Home Computer

**\$699<sup>95</sup>**

MONITOR  
NOT  
INCLUDED



You can begin using the TI Home Computer in minutes. Without any previous computer experience. You simply snap in one of TI's Solid State Software™ Command Modules. Step-by-step instructions are displayed right on the screen.



### TEXAS INSTRUMENTS INCORPORATED

TI-35 NEW . . . . .	\$24.95	PC 100C . . . . .	169.95	Business Analyst I . . . . .	21.95
TI-50 . . . . .	33.50	TI-1750 . . . . .	19.95	Business Analyst II . . . . .	39.95
TI-55 . . . . .	34.95	TI-5015 . . . . .	64.95	Business Card NEW . . . . .	39.95
TI-58C NEW . . . . .	109.95	TI-5040 . . . . .	94.95	Language Translator NEW . . . . .	249.95
TI-59 . . . . .	209.95	TI-5100 . . . . .	\$39.95	Digital Thermostat NEW . . . . .	114.95
TI 58/59 Libraries . . . . .	28.95	Programmer . . . . .	48.95	Speak & Spell . . . . .	54.95
TI-30SP . . . . .	17.95	MBA . . . . .	59.95	Chrono Alarm 806-31 . . . . .	39.95

## ATARI® 800 PERSONAL COMPUTER SYSTEM



Plot your investment strategy with confidence. Take the guesswork out of business decisions. Organize your household finances. Control your tax options. Come in and find out why some very shrewd people now own the versatile Atari Personal Computer System. **\$799<sup>95</sup>** SUGG. RETAIL \$1080



ATARI 400 Personal Computer System . . . . .	\$449.95
ATARI 410 Program Recorder . . . . .	69.95
ATARI 810 Disc Drive . . . . .	559.95
ATARI 820 40-Column Printer . . . . .	479.95

PLUS Complete Entertainment & Educational Software

<b>SHARP</b> 6200 NEW EXECUTIVE . . . . .	99.95
7000 NEW MEMO WRITER . . . . .	99.95
5813 NEW PROGRAMMABLE . . . . .	34.95
5100 NEW LCD Alphanumeric . . . . .	89.95

**CASIO®** ML-81 . . . . . 49.95  
FX-68 . . . . . 27.95

**CHESS CHALLENGER** "7" . . . . . 89.95

ALSO: Canon, Seiko, Craig, Sanyo, Martel, Pearlcarder, Record-a-Call, Code-a-Phone, and many others. All at GREAT PRICES!

<b>BSR SYSTEM X-10</b> COMMAND . . . . .	39.95
Each Module . . . . .	14.95
<b>INTELLIVISION®</b> Intellivision . . . . .	299.95

Send Orders to Dept BY-JL

WE WILL BEAT OR MEET ANY COMPETITOR'S PRICE ON MOST ITEMS IF HE HAD MERCHANDISE ON HAND. All units shipped in original factory cartons with accessories according to manufacturer's specification. CALL TOLL FREE (800) 854-0523 (outside CA) or (714) 549-7373 (within CA). VISA and Master Charge, money order, Pers. Ck. (2 Wks. to clear), COD accepted. Min. \$4.95 for shipping in USA. We ship AIR on request. CA residents add 6% sales tax. All merchandise subject to availability. Prices good only with this ad for limited time only. WRITE OR CALL FOR FREE CATALOG



*Photo 2: Forensic physics students taking data with a multimemory digital timer and an air track.*

7475 integrated circuits so that the last time is displayed until a new time is recorded. (Physics labs around the country generally use only two photocell timers on their air tracks, or, if they are still in the Stone Age, measure the spacing of dots burned into a sensitized paper tape by a sparker mounted on the glider.) With this timer a single, long air track serves a whole class; each pair of lab partners obtains unique, high-quality data. The fundamental mechanical concepts of speed and acceleration are most easily understood through graphs, and the data from this timer yield smooth curves with many points on them.

Should this timer be given intelligence? I think it will happen. It isn't clear, though, how much more instructional good will result: a microprocessor could very flexibly calculate speeds from distance and time data, but the students (in this case at least) need to do that calculation themselves if they are to understand the concepts involved.

This particular timer, only a few months old, has done some other useful things, too. It has directly measured the muzzle velocity of a 0.177 pellet pistol. It has measured pendulum periods and, thereby, simply and quickly provided highly accurate values for the acceleration of gravity. It will even try to outdo Galileo as it records balls being dropped down an intimidating 12-story stairwell in our university library.

One university recently reported the widespread possibilities of an interactive terminal

in the lab: the computer was programmed to give simulated, randomly generated, experimental data to supplement data taken by the student in the laboratory. Students are asked to discover for themselves, from the data, the nature of the functional relationship between the experimentally measured quantities.

Thermodynamics laboratory experiments are so inaccurate that many professors fear for their credibility during that time of year. Thermistors and resistance heaters and microprocessors could change all that. So far there is little inkling of it happening.

Upper division science labs can potentially make the most use of "smart" equipment because students are much better prepared for mathematical and instrumental sophistication by that time. Some commercial equipment, sometimes borrowed from a research laboratory, is now being used. The same problems of commercial feasibility, cost effectiveness, and transportability are present to inhibit the development of smart equipment optimized for the instructional laboratory. A most promising area is the senior project: a microcomputer teamed with some analog-to-digital converters has almost limitless possibilities.

Computers in Chemistry is a separate division of the American Chemical Society. Most of the society's publications are concerned with data analysis; a lot of minicomputers and microcomputers have turned up in their labs for experiment and process control. Other departments in the universities are realizing the advantages of dedicated resident computer systems, too. At Kent State University the psychology and sociology departments have purchased turnkey microprocessor systems so that they can directly record and analyze data.

Today's physics departments are searching for relevant courses for nonscience students. In such courses the experimental technique does not have to be understood by the student; real-time analysis of physical phenomena is the goal, and microprocessors are the appropriate tool. Cleveland State University recently reported an excellent example of such use in their acoustical physics laboratory. Aided by a National Science Foundation grant, they have interfaced a Texas Instruments TI 980 computer to eight stations in the laboratory. Each station has on-line voltage and time measurement capability, a keyboard, a video display, and a printer. In one experiment the reverberation time for the room is first calculated by the student and then measured with a microphone hooked to the voltage interface. In another experiment the harmonic spectrum of a student-selected sound source (eg: voice, violin, frog) is

# And now the news...



CompuServe announces the availability of international, national and regional news through your personal computer or terminal.

This up-to-the-minute service includes:

- late breaking international and national news, including features and syndicated columns
- national sports with tabular standings and box scores
- national business and financial news, including the latest stock prices and closings
- national broadcast wire
- Washington news wire
- weather updates
- and selected regional wires

Find out how your favorite football team fared or get a full account of the game in seconds. Find out how the market did today or what movies got good reviews. Check election results, key legislative votes, the latest on foreign affairs. Even background stories or predictions for the future. International events. National news. What diplomat is throwing a party in Washington.

All this and more is yours today through CompuServe.

A 300-baud modem is all your personal computer or terminal needs to access all the services available via local phone calls in more than 175 North American cities from 6 PM to 5 AM weekdays, weekends and most holidays. And the basic charge is only \$5.00 an hour, billed in minute increments, to your charge card. Want more information? Write.

**MicroNET**

**CompuServe**

Dept: B  
Personal Computing Division  
5000 Arlington Centre Blvd.  
Columbus, Ohio 43220

obtained. At yet another school, the music department is using a SwTPC 6800 system to generate a wide variety of musical sounds and thereby help very large numbers of music students develop ear training skills.

### Computer Science Courses

Computers have been traditionally associated with computer centers and with mathematics or computer science departments. Outsiders have been welcomed but it has sometimes been made clear that computer and programming courses were the sole province of the center. This has unfortunately tended to stifle the development of courses taught by engineering or science faculty in which the computer is simply a powerful tool for deeper penetration into nature's secrets.

There are many topics in science that are conceptually within the grasp of undergraduate students but are not even mentioned to them because of calculational complexity. A good example is projectile motion. Students dutifully calculate the range of a batted baseball from the equation  $R = (v^2 \sin 2\theta)/g$ , but they are almost never told that a real home run travels about 1/5 the distance they calculate from this formula!

Air drag is the reason and a great deal of fascinating insight into the real world of projectiles emerges when it is included.

If computer scientists love the computer for what it is, then physical scientists love the computer for what it can do for them. That is, there exists a powerful joy of number crunching.

Few introductory computer texts go beyond games or business applications. Alan Grossberg's *FORTRAN for Engineering Physics* (McGraw-Hill Inc, 1973) is a very early attempt to make computer analysis an integral part of an introductory lab. Robert Ehrlich's *Physics and Computers: Problems, Simulations, and Data Analysis* (Houghton Mifflin Co, 1973) is an effort to supplement the material of advanced undergraduate courses in a separate FORTRAN based physics course. He introduces FORTRAN and then gives applications in electrostatics and electric circuits, in classical and quantum waves, in Monte Carlo simulations, and in experiment data analysis.

The language that the student uses must be friendly and easily learned. Structured programming isn't necessary; we aren't trying to train systems programmers. Herbert Peckham's *Computers, BASIC, and Physics* (Addison Wesley, 1971) pointed out the BASIC way. This text is a self-contained book that covers Hewlett-Packard BASIC, numerical analysis including differential and integral equations, and some data analysis.

A recent and very impressive effort is the nearly 500 page tome produced by William Ralph Bennett Jr, *Scientific and Engineering Problem-Solving with the Computer*, (Prentice-Hall Inc, 1977). Bennett introduces BASIC in the first thirty pages and then launches into a bewildering and enticing variety of topics. One chapter is on languages: the probability of monkeys typing poetry; computer identification of literary authors; cryptography; etc. Another chapter is on dynamics: footballs and slicing ping-pong balls in flight; space travel; and charged particle motion. Yet another chapter is on random processes: statistical distributions; diffusion; and the spread of contagious diseases. (Hardware enthusiasts take note: You can save a great deal of money if you buy this book and don't buy additional memory or another peripheral until you've solved all of Bennett's problems.)

My own book, *BASIC Programming for Scientists and Engineers* (Prentice-Hall, Inc, 1978) is a more modest effort that is directed toward the more traditional education of the scientist or engineer. Sample answers are provided throughout the book

Marymac Industries Inc

# Radio Shack®

**AUTHORIZED SALES CENTER**

## Save 10% 15% OR MORE

DELIVERED TO YOUR DOOR

Owned and operated by Marymac Industries Inc. Houston's only independent Radio Shack® dealer. Warranties will be honored by all company owned Radio Shack® stores and most franchise and dealer authorized sales centers. Store open Mon.-Sat. 10-7. We pay freight and insurance. Save state sales tax. Texas residents add only 5% sales tax. Brand new in factory sealed cartons. Reference: Katy National Bank. Call us for a customer reference near your city. Offered exclusively by Radio Shack® Authorized Sales Center 21969 Katy Fwy., Katy (Houston) Texas 77450

Telephone 1-713-392-0747



**TRS-80™**

**FOR BUSINESS,  
LEARNING  
AND  
ENTERTAINMENT**



**Meet TRS-80's Big Brother!**

**The New TRS-80 Model II**

We are located just 5 hours from the giant Tandy Computerware House in Ft. Worth, Texas.

Call  
**Joe McManus**  
Today

We've added a bigger, more powerful "brother" to the TRS-80 family. It's TRS-80 Model II — a completely new microcomputer for business applications.



**CHARGE IT**



# NEU!

## MPI MODEL 88T IMPACT MATRIX PRINTER

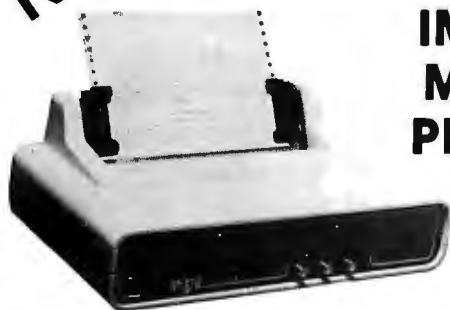

The first of a series of new, full-capability, low cost, high performance printers designed by MPI to meet the requirements of the general use computer market - hobbyist or professional.

### SPECIFICATIONS

- Impact Bidirectional
- 7x7 Dot Matrix
- 100 Characters Per Second
- 80, 96 and 132 Column
- 10 Lines Per Second
- Tractor and Friction Feed
- Normal Paper: Roll, Fan-fold or Cut Sheets
- 115/230 VAC ± 10%, 50/60 Hz
- 96 ASCII Upper and Lower
- RS232C: 20 ma. Current Loop
- 110-1200 BAUD
- 2 Line Buffer; 1 or 2 K Optional
- Centronics Parallel
- 41x27x16 cm; 7 Kg.

Sigma International, Inc. is master international distributor for MPI and seeks dealers/distributors worldwide. Please write us on your letterhead at the following address:

### SIGMA INTERNATIONAL, INC.

P.O.Box 1118 SCOTTSDALE, AZ 85252 USA  
Tel. (602) 994-3435 Tlx. 165-745 Sigma Cable: SIGMAS

## MICROCOMPUTERHÄNDLER WIR LADEN EIN!

Handeln Sie als Wiederverkäufer mit Microcomputer-systemen und Peripheriegeräten und sehen sich daher gezwungen, mit den immer noch überhöhten Preisen Ihrer jetzigen Lieferanten zu kalkulieren? Dann wählen Sie doch den einfacheren Weg und beziehen direkt aus den USA!

Sigma ist weltweiter Lieferant führender amerikanischer Hersteller und offeriert Preise und Service, wie sie Ihnen keine andere Quelle bieten kann.

Unter anderem verkaufen wir Geräte der Firmen:

Base 2	Impact Data	North Star
Centronics	Industrial Micro	Ohio Scientific
Century Data	Integral Data	PerSci
Control Data	Konon	Qume
Exidy	LRC Eaton	Soroc
Hazeltine	Micro Peripherals	Televideo
Houston Inst.	N.E.C.	Texas Instruments

Wir laden Sie daher ein, kostenlos unsere neueste Preisliste anzufordern, und Sie werden feststellen, dass Sie wesentlich günstiger kaufen können. Bitte schreiben Sie - auf Kopfbogen - an folgende Adresse:



### SIGMA INTERNATIONAL, INC.

P.O.Box 1118 SCOTTSDALE, AZ 85252 USA  
Tel. (602) 994-3435 Tlx. 165-745 Sigma Cable: SIGMAS

## LRC EATON MODEL 7000+ IMPACT PRINTER

# NEW



- Simple Design
- Simple Maintenance
- Simple Interfacing to:
  - Apple
  - Pet
  - TRS-80
  - Exidy
  - OSI
 and many other personal computers

The 7000+ was designed to provide the personal computer user with an inexpensive, yet reliable printer. Take a look - you won't regret it!

### SPECIFICATIONS

- Impact Unidirectional
- 125 LPS; 50 CPS
- 40 or 64 Column
- 5 x 7 Dot Matrix
- Standard Paper Rolls
- 100 Million Character Printhead Life (minimum)
- 6 LPI Line Spacing

Substantial Dealer Discounts are Available.

OEM inquiries are invited. Please contact:

### SIGMA INTERNATIONAL, INC.

P.O. Box 1118 SCOTTSDALE, AZ 85252 USA  
Tel. (602) 994-3435 Tlx. 165-745 Sigma Cable: SIGMAS

## IMPACT DATA MODEL 801

### THE HEAVY DUTY WORKHORSE AT THE AFFORDABLE PRICE.

- 7 x 7 Impact Dot Matrix
- 132 CPS (max.)
- 96 Character Upper/Lower ASCII
- 80 in. (20.3 cm) Line Length
- 80 or 96 Columns
- 6 LPI Line Spacing
- Tractor or Friction Feed
- 127 Character Buffer - 2 K Optional
- Feed at 50 LPM Printing - 560 LPM Slewing
- Continuous Loop Ribbon with Re-inking Roller - 5 Million Character Life
- Paper is Standard Fan-fold, Multi-copy Computer Forms up to 9-5/8" (24.45 cm)
- 8-bit Parallel (Centronics Compatible), RS232 or 20 ma. Current Loop Interfaces, 110/1200 BAUD, Switch Selectable
- 115 VAC, 3A, 60 Hz, or 220 VAC, 1.5A, 50 Hz
- 12"H x 18"W x 14"D (30 x 45 x 35 cm)

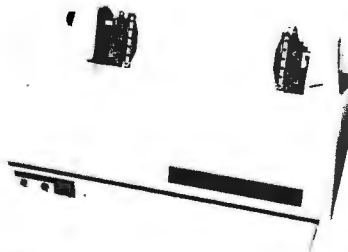

High Quality • High Technology • Low Price

Substantial Dealer/Distributor  
Discounts Available

### SIGMA INTERNATIONAL, INC.

P.O. Box 1118 SCOTTSDALE, AZ 85252 USA  
Tel. (602) 994-3435 Tlx. 165-745 Sigma Cable: SIGMAS

to encourage self-study. There is a formula oriented introduction to BASIC, a chapter on flowcharting based on a typical aircraft loading problem, language-independent methods for data analysis, and some 50 pages of science problems for computer solution. The problems include predicting a car's top speed from low speed data, the cost of heating a home, simulation of ground-based, collision-avoidance radar, circuit analysis, motorcycle jumping, Mars orbit insertion and landing, and a simulation of a smart temperature controller.

Here is a new example of a problem that is easily programmed and yet provides new insight into the problems of keeping a vehicle on the road. You might wish to use the provided equations to implement a dandy game that will tell you reliably how fast you could drive your fantasy automobile at your local race track, at Indianapolis, or at Monte Carlo.

Figure 2: Physics of a race car rounding a banked curve. This example is used by the author to illustrate a practical and interesting application of the microcomputer, which is used by students to calculate the maximum speed through the curve.

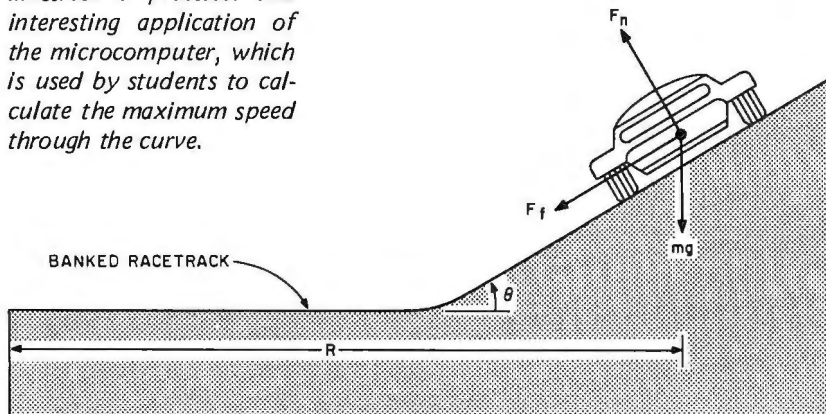

Consider the speedy sports car of figure 2 that is trying to round a banked curve with a radius of turn equal to  $R$ . A positively cambered, banked curve with angle of bank given by  $\theta$  is shown. Assume also that the curve is on a hill whose angle above the horizon is  $\beta$ , where  $\beta$  is positive if the car is going up the hill. Newton's equations of motion for the vertical ( $y$ ) and horizontal ( $x$ ) directions are:

$$\begin{aligned} \text{Sum of vertical forces} \\ &= \Sigma F_y = F_n \cos(\theta) - F_f \sin(\theta) \\ &\quad - mg \cos(\beta) = 0 \end{aligned}$$

$$\begin{aligned} \text{Sum of horizontal forces} \\ &= \Sigma F_x = F_n \sin(\theta) + F_f \cos(\theta) \\ &= \frac{mv^2}{R} \end{aligned}$$

in which  $F_n$  is the perpendicular component of the force of the road on the car and  $F_f$  is the parallel (ie: frictional) component of the

force of the road on the car. The weight of the car is equal to  $mg$ , where  $m$  is the car's mass and  $g$  is the acceleration of a free-falling object due to the gravitational force. The value of  $g$  is about  $32.2 \text{ ft/s}^2$ , but a more precise value for a particular location on earth can be obtained from the *Handbook of Chemistry and Physics* or from Helmert's equation given earlier.

If we make the usual assumption that the maximum frictional force  $F_f$  is proportional to the normal force  $F_n$  and that the constant of proportionality is the coefficient of static friction,  $\mu$  (so  $F_f = \mu F_n$ ), then we can solve these equations for maximum and minimum speeds. A first result is for the maximum speed through the curve:

$$V_{\max} = \sqrt{\frac{gR(\mu \cos \theta + \sin \theta) \cos \beta}{(\cos \theta - \mu \sin \theta)}}$$

This equation is valid for bank angles  $\theta$  that are greater than  $-\arctan \mu$  and less than  $\arctan(1/\mu)$ . This means that the equation also is valid for negatively cambered turns (banked the wrong way;  $\theta$  is a negative angle). If the angle of bank isn't greater than this negative minimum of  $-\arctan \mu$ , then the car will slide off the curve even if it isn't moving! For bank angles greater than  $\arctan(1/\mu)$ , frictional considerations do not limit the maximum speed at all, so a maximum speed does not exist for those angles either.

When the angle of bank gets large or the road gets very slippery, then there is also a minimum speed at which the turn can be negotiated. This is given by:

$$V_{\min} = \sqrt{\frac{gR(-\mu \cos \theta + \sin \theta) \cos \beta}{(\cos \theta + \mu \sin \theta)}}$$

A  $V_{\min}$  will exist and can be calculated from this equation for any bank angle greater than  $\theta = \arctan \mu$ .

The load factor, which is the ratio of the net force of the road on the car to the weight of the car, or the ratio of the net force of the car on the driver to the driver's weight, tells us a lot about the comfort of the driver. In fact load factors approximately greater than 5 cause blackouts if they last for more than a few seconds. Here is a formula for the load factor for our racing car, also derived from the equations of motion:

$$\text{load factor} = \frac{\sqrt{\mu^2 + 1} \cos \beta}{(\cos \theta - \mu \sin \theta)}$$

This equation is valid over the same bank angles as for  $V_{\max}$ .

# THE INFLATION FIGHTER



\*\$749

\*Suggested retail price.  
Substantial OEM and dealer  
discounts available

You can't buy more  
capability for less . . . But  
you can buy less for more.

MPI presents the perfect answer to your inflation-riddled printer budget. THE MODEL 88T DOT MATRIX PRINTER. The first in a series of new full-capability low-cost printers designed specifically for the general use computer market. The Model 88T is a fully featured printer with a dual tractor/pressure-roll paper feed system and a serial or parallel interface. The tractor paper feed system provides the precision required to handle multi copy fanfold forms, ranging in width from 1 inch to 9.5 inches. For those applications where paper costs are important, the pressure-roll feed can be used with 8.5 inch roll paper. A long-life ribbon cartridge gives crisp, clean print without messy ribbon changing. The microprocessor controlled interface has 80, 96 or 132 column formatting capability while printing upper and lower case characters bi-directionally at 100 characters per second.

With all of these features, **plus** quality construction, continuous duty print head and attractive styling, the Model 88T would easily sell at the competition's "under \$1000" (999.99) tag. But we are offering it for only \$749; this should make you happy and several hundred dollars richer.

Write for complete specifications and pricing information.



MICRO PERIPHERALS, INC. 2099 WEST 2200 SOUTH / SALT LAKE CITY, UTAH 84119 / (801) 973-6053

The first two equations yield speeds in ft/sec for  $g$  in  $\text{ft/sec}^2$  and for the radius  $R$  in feet ( $88 \text{ ft/s} = 60 \text{ mi/hr}$ , so multiply by  $60/88$  to convert from ft/s to mi/hr). The load factor is a dimensionless quantity but is often reported as so many  $g$ s.

Good values for the coefficient of friction can be obtained from the tests made by car magazines because the coefficient is numerically equal to the maximum lateral acceleration (expressed in  $g$ s) that they measure in their skid pan tests. For example, recent tests yielded a  $\mu$  of 0.653 for an American station wagon and 0.820 for an English sports car. Assume now that these vehicles are at the Daytona Speedway and are going into the high-speed  $31^\circ$  banked turn. The radius of the turn is about 1100 feet. The track is fairly flat so we'll consider  $\beta$  to equal 0. The equations (use  $g = 32.2 \text{ ft/s}^2$ ) then tell us that the station wagon would skid off the track at 184 mi/hr, but the sports car could get up to 215 mi/hr. The load factor would be 2.29 for the station wagon and 2.97 for the sports car. The sports car could make it around a curve having off-camber up to  $39^\circ$ . If water or oil should reduce the coefficient of friction to 0.45, there would be a minimum speed of 44 mi/hr on the  $31^\circ$  banked part of the track.

The effective coefficient of friction for maximum braking is generally different than the coefficient for turning, because complicating factors such as the extra heat build-up and tire deformation are different. The effective coefficient for braking is easily calculated from the braking performance tests performed by the car magazines, although this calculated coefficient does depend somewhat on the beginning speed. Physically, the derivation proceeds from the assumption that all the kinetic energy of the car is transformed into frictional (ie: heat) energy; this is nearly true but does neglect air drag and tire heating. The result of such a derivation is:

$$\mu_{\text{braking}} = \frac{v^2}{2gd}$$

where  $v$  is the beginning speed in ft/s and  $d$  is the distance in feet required to come to a complete stop. For example, one test found that a Ferrari 308 GTB could sustain a maximum lateral acceleration of 0.804  $g$  and could brake from 80 mi/hr to a stop in 288 feet. Our equation tells us that the braking coefficient was

$$\mu_{\text{braking}} = \frac{(80 \times 88/60)^2}{2 \times 32.2 \times 288} = 0.742$$

To really use this coefficient, we would like an expression for the maximum deceleration on a hill with slope  $\beta$  and/or a maximum-speed turn on a curve with bank  $\theta$ . Newton's equation of motion yields:

$$\begin{aligned} &\text{maximum braking deceleration} \\ &= -g \cos \theta \left[ \sin \beta + \frac{\mu_{\text{braking}} \cos \beta}{\cos \theta - \mu \sin \theta} \right] \end{aligned}$$

From this you can calculate a maximum deceleration of  $-33.5 \text{ ft/s}^2$  if the Ferrari is going *up* a  $20^\circ$  hill without turning; going down the hill would produce only  $-11.4 \text{ ft/s}^2$ . On a Daytona-type curve these values would be  $-52.9 \text{ ft/s}^2$  and  $-34.0 \text{ ft/s}^2$ , respectively. (The impressive performance on a banked track at maximum speed is because the car is pushing much harder on the ground. This is the reason that wings can be so helpful to racing cars.)

The distance traveled while a car is steadily decelerating from  $v_o$  to  $v_f$  is given by:

$$\text{slowing distance} = \frac{(v_f^2 - v_o^2)}{2a}$$

where  $a$  is the calculated deceleration. On a flat Daytona banked curve the maximum speed for the Ferrari is about 212 mi/hr and its maximum deceleration is about  $-46.2 \text{ ft/s}^2$ . It would therefore travel about 446 feet in a maximum performance deceleration from 212 mi/hr to 160 mi/hr.

Finally, the maximum accelerations of which a car is capable can be determined from the speed-time graphs presented by the car magazines. Combine all these formulas with a video display of the bank, the curve, and the slope and have joysticks for throttle, brakes, and steering, and a very realistic simulation of a race could be made. Add some oil on the track from a blown engine ahead of you ( $\mu$  down to perhaps 0.3) or ice ( $\mu$  down to perhaps 0.1) for some randomly generated, additional excitement.

To my way of thinking, the programming of a problem of physical interest is half the fun. I derive no pleasure from copying someone else's program and so I can't understand why so many complete BASIC programs appear in the periodical literature. If a difficult algorithm is involved, then it might be desirable to provide a flowchart of the logic. But the fundamental problem of most students is that they can't think of ways to utilize the power of a computer. Therefore my approach is to provide physical problems of significant interest with sample answers



# MUSIC SYNTHESIZER \$99.95

- Three simultaneous programmable voices and one programmable white noise generator
- Five octave range starting at 55 Hz (the A below bass clef) to 1760 Hz (the second A above the treble clef)



- On board amplifier capable of directly driving an eight ohm speaker
- Up to six synthesizers can be installed to create stereophonic, quadrasonic, and polyphonic operation

## KIS MUSIC EDITOR \$129.95\*



KIS stands for KEEP IT SIMPLE and we believe there is no existing software that remotely approaches the ease and convenience of this music editor. Some of the many features are as follows:

- Three part interactive program consisting of a play mode, a composition mode and an edit mode
- Play mode displays low resolution color graphics of each voice while the song is playing
- Composition mode enables the user to hear and see, in high resolution graphics, each note as it is input
- Edit mode sounds and displays, in high resolution graphics, each note as the user single steps through the song. Notes can be inserted, deleted, and changed.

## FLASH AND CRASH SOUND EFFECTS \$39.95



- Uses the channel of white noise to create a vast array of sounds. Some of these are as follows: explosions, steam engine, whistle, phasers, gun shot, race cars, sirens, chimes, and jet engines
- Detailed instructions illustrate how to generate sounds
- Includes two games with full sound effects.
- Modular so any one sound can easily be patched into an existing program.

## FUTURE SOFTWARE

Album III is an advanced music editor designed for knowledgeable users who want the ultimate in performance. Transpose, subroutines, comprehensive envelope control and percussion generating routines are a few of the powerful features.

Album IV is a complete game package that takes advantage of the channel of white noise to produce sound effects. The games become alive with explosions, phasers and machine gun sounds.

\*Includes Juke Box Synthesizer

\*Registered Trademark of Apple Computer

Circle 129 on inquiry card.



705 Bowser  
Richardson, Texas 75080  
(214) 238-1815

Distributed by:  
Hayden Publishing

Photo 3: The digital design laboratory at Kent State University.



so that programming skills, analysis techniques, and physical insight can be developed together.

#### Hardware Courses

In a recent survey of eighteen colleges and universities in northeast Ohio, fifteen departments reported offering microprocessor hardware courses. There were four electrical engineering and electrical engineering technology departments, four other engineering technology departments, five physics departments, and two chemistry departments! Microprocessor systems can be purchased as "electronic equipment," "calculators," or as "data processors"; they can be hidden in closets, and their proud owners are going to teach their students how to use them!

There are plenty of turf disputes still to come, particularly when format courses come up for college approval. In the survey, four computer science/mathematics departments reported courses in the programming of microprocessors. (It would be nice, but above par, if the programming faculty would use the same types of microprocessors as the application faculty.) The other science departments, at least to some extent, were offering both hardware and software material in their courses. Some of the offered courses are undoubtedly quite shallow, consisting of little more than a discussion of Boolean logic, a description of system components, and a few machine or assembly

language programs. (Computer experimenters tend to forget how much terminology and how many concepts they have learned through osmosis; most students possess little more than what they have learned from their formal coursework.) This kind of trivial introduction to microprocessors is particularly likely at the two-year or technical degree level, but it can be argued that a general knowledge of microprocessor systems is still worthwhile. On the other extreme, some electrical engineering departments are equipping themselves with elaborate microprocessor development systems and are fully prepared to generate serious process control designs.

Most professors are learning the material themselves as they develop and teach their new microprocessor courses. Outside of electrical engineering departments, there is so little room in the curriculum for the new courses that it is doubtful that very many undergraduate students are going to be proficient with either software or hardware practices when they graduate. But industry will still find them much better prepared than graduates of just a few years ago.

Physics departments have always taught electronics courses but the curriculum will burst if more than two or three are offered. At schools where there is no electrical engineering department, as is true of most private colleges, physics usually does all the electronics teaching. Photo 3 shows the physics digital electronics laboratory at Kent State. It has been found that there is no time left to do interfacing if an attempt is made to teach machine-language programming in this digital electronics course, and so present plans are to develop interfacing experiments under BASIC control.

Most educators began their own education in microcomputers with hobby kits. That survey mentioned earlier turned up 13 KIM-1s, 13 Intel development boards or systems, four Ohio Scientific systems, four MMD-1s, three Heath microprocessor trainers, two Digital Group systems, one Altair, one IMSAI, one SwTPC system, and several lesser known systems. One school had six programming stations mothered by a mini-computer that simulated the M6800 instruction set. If there is a perceptible trend, I would perceive it to be in three directions: bare trainers like the MMD-1, the Heath, or the KIM-1 for introductory courses; well-supported microcomputers that can number crunch, teach system theory, do some process control such as digital filtering, and teach programming; and complete development systems to emulate the designing being done in industry.

# COMPUTER BOOKS THAT TALK YOUR LANGUAGE ... FROM BEGINNER TO EXPERT.

Howard W. Sams is the source for the best and latest in computer technology. The world's leading authors. Clear, concise, easy-to-understand text. Fully illustrated for better comprehension. Actual programs for today's personal computers. Informative and entertaining. Titles for everyone... from the novice to the hobbyist to the expert.

## THE STARTERS

Entry-level books for the beginner can bring the novice up to a high level of knowledge quickly.

- THE HOWARD W. SAMS CRASH COURSE IN MICROCOMPUTERS**  
The short-cut to understand microcomputers. Spend a few hours with this self-instructional course and gain a working knowledge of all aspects of microcomputers from fundamentals to operating systems, programming, peripheral equipment and much, much more. 264 pages. No. 21634. By Frenzel. \$17.50.
- MICROCOMPUTERS FOR BUSINESS APPLICATIONS**  
A microcomputer expert discusses the benefits of microcomputer systems for small business owners. Explains types of microcomputers available, points out pitfalls to avoid, and defines computer-related terms in easy-to-understand language. 256 pages. By Barden. No. 21583. \$8.95.
- A GUIDEBOOK TO SMALL COMPUTERS**  
If you are contemplating buying a small computer system for home or business, this book can save you time and trouble. Covers fundamentals of small computers including hardware and software. Includes information on manufacturers' warranties, service and a handy directory of small computer manufacturers. By Barden. No. 21698. \$5.95.
- GETTING ACQUAINTED WITH MICROCOMPUTERS**  
Provides a complete working knowledge of microcomputer organization, operation, and programming. 288 pages. By Frenzel. No. 21486. \$8.95.
- FUNDAMENTALS OF DIGITAL COMPUTERS (2nd ED.)**  
Unravels the mysteries of computers and programming. 320 pages. By Spencer. No. 21534. \$9.95.
- INTRODUCTION TO MICROCOMPUTERS FOR THE HAM SHACK**  
Gives the radio amateur an opportunity to be in the forefront of utilizing and developing techniques in "computerizations." 96 pages. By Helms. No. 21681. \$4.95.
- LEARN ABOUT MICROCOMPUTERS, SAVE 10% ... AND GET A FREE GIFT!**
- THE COMPUTER PRIMER LIBRARY**  
This 3-volume "starter" library was selected for the novice who wants to learn about microcomputers. Concepts. Programming. Computer graphics. Languages. Games. By Mitchell Waite and Michael Pardee—two of the leading authors in the field of computers.  
**MICROCOMPUTER PRIMER**—368 pages of up-to-date facts on microcomputers and computer concept.  
**COMPUTER GRAPHICS PRIMER**—Over 20 programs for creating your own video graphics (complex drawings, plans, maps, and schematics) on the new 6502-based personal computers.  
**BASIC PROGRAMMING PRIMER**—Provides a working knowledge of BASIC, the most popular computer language today. Explains fundamentals of BASIC, program control, organization, additional functions, variations, and includes a game program.  
**3-VOLUME LIBRARY PACKAGE ONLY \$30.47**—includes a FREE COPY of YOUR OWN COMPUTER—an introduction to home computers. No. 21706

## THE PROGRAMMERS

A computer is only as good as the software. Sams offers several books that explain programming and tell you how to develop, debug and test programs for your equipment.

- PROGRAMMING & INTERFACING THE 6502, WITH EXPERIMENTS**  
Dr. De Jong has compiled 14 chapters of information and programs for 6502-based microcomputer systems. Experiments and examples are written so that a KIM, AIM or SYM system may be used to reinforce the material in each chapter. 448 pages. By De Jong. No. 21651. \$11.95.
- HOW TO PROGRAM AND INTERFACE THE 6800**  
Discusses the internal structure, instruction set, and programming techniques for the 6800. Experiments demonstrate "real world" applications. By Staugaard. 432 pages. No. 21684. \$13.95.
- DEBUG: AN 8080 INTERPRETIVE DEBUGGER**  
Covers program operation and how it's applied to program development and testing. 112 pages. By Titus and Titus. No. 21536. \$4.95.
- 6502 SOFTWARE DESIGN**  
Tells how to program for the 6502 assembly language. 288 pages. By Scanlon. No. 21656. \$10.50.
- 8080/8085 SOFTWARE DESIGN—2 VOLUMES**  
**VOLUME 1** gives you an introduction to assembly language programming. 336 pages. By Titus, Larsen, Rony, & Titus. No. 21541. \$9.50  
**VOLUME 2** is a unique, one-of-a-kind computer science book for the design engineer. Written in Intel machine code. 352 pages. By Titus, Larsen, & Titus. No. 21615. \$9.95.
- TWO-VOLUME SET No. 21659 ONLY \$17.50**
- TEA: AN 8080/8085 CO-RESIDENT EDITOR-ASSEMBLER.**  
256 pages. No. 21628. By Titus. \$8.95.

## THE COMPUTER TECHNOLOGY LEADERS

Even if you're an avid computer buff, rapidly changing technology makes it difficult to stay current. Sams has a complete line of books and reference publications to help you keep abreast of the current state-of-the-art.

- MICROCOMPUTER-ANALOG CONVERTER SOFTWARE & HARDWARE INTERFACING.**  
Concepts and techniques of interfacing digital computers to analog devices. 288 pages. By Titus, Titus, Rony, & Larsen. No. 21540. \$9.50.
- TRS-80 INTERFACING.**  
192 pages. No. 21633. By Titus. \$8.95.
- INTERFACING & SCIENTIFIC DATA COMMUNICATIONS EXPERIMENTS.**  
160 pages. By Rony, Larsen, Titus, & Titus. No. 21546. \$5.95.
- MICROCOMPUTER INTERFACING WITH THE 8255 PPI CHIP.**  
224 pages. By Goldsbrough. No. 21614. \$8.95.

- Z-80 MICROPROCESSOR PROGRAMMING & INTERFACING—2 VOLUMES.**  
800 pages. By Nichols, Nichols, & Rony. No. 21611. \$21.95.
- INTRODUCTORY EXPERIMENTS IN DIGITAL ELECTRONICS AND 8080A MICROCOMPUTER PROGRAMMING AND INTERFACING—2 VOLUMES.**  
912 pages. By Rony, Larsen, & Titus. No. 21552. \$20.95.

## A BEST-SELLER ... A TREMENDOUS VALUE!

This is the most comprehensive reference available on all phases of computers and their applications. Contains over 22,000 definitions, acronyms, and abbreviations. 14 appendices. Hardbound. 944 pages. By Sippl & Sippl. No. 21632. \$29.95.

## COMPUTER DICTIONARY & HANDBOOK (3RD EDITION)

## THE LOGIC COOKBOOKS

- LANCASTER'S COOKBOOK LIBRARY**  
A famous resource for all electronics buffs who want to know what makes TTLs, CMOS, and active filters cook—what they are, how they work and how to use them. By Don Lancaster, one of the most popular authors in the electronics industry.
- |                                  |                |
|----------------------------------|----------------|
| TTL Cookbook No. 21035           | \$ 9.50        |
| CMOS Cookbook No. 21398          | \$10.50        |
| Active-Filter Cookbook No. 21168 | \$14.95        |
| <b>TOTAL LIST PRICE</b>          | <b>\$34.95</b> |
| Less 15% Discount                | 5.24           |
| <b>YOU PAY ONLY</b>              | <b>\$29.71</b> |
- ORDER SPECIAL LIBRARY PACKAGE NO. 21707 AND SAVE!**

## ORDER FORM

HOWARD W. SAMS & CO., INC.  
4300 West 62nd Street, P.O. Box 7092  
Indianapolis, Indiana 46206  
(317) 298-5400

Indicate quantity in boxes above and complete ordering information below.

Sub Total \_\_\_\_\_

Add local sales tax where applicable \_\_\_\_\_

GRAND TOTAL \_\_\_\_\_

- PAYMENT ENCLOSED
- CHECK  MONEY ORDER
- MASTER CHARGE  BANK AMERICARD/VISA

Exp. Date \_\_\_\_\_

Account No. \_\_\_\_\_

Interbank No. (Master Charge only) \_\_\_\_\_

Minimum Credit card purchase \$10 AD025

Name (print) \_\_\_\_\_

Signature \_\_\_\_\_

Address \_\_\_\_\_

City \_\_\_\_\_ State \_\_\_\_\_ Zip \_\_\_\_\_

Prices subject to change without notice. All books available from Sams Distributors, Bookstores, and Computer Stores. Offer good in U.S. only. In Canada, contact Lenbrook Industries Ltd., Scarborough, M1H 1H5, Ontario, Canada.

Howard W. Sams & Co., Inc.

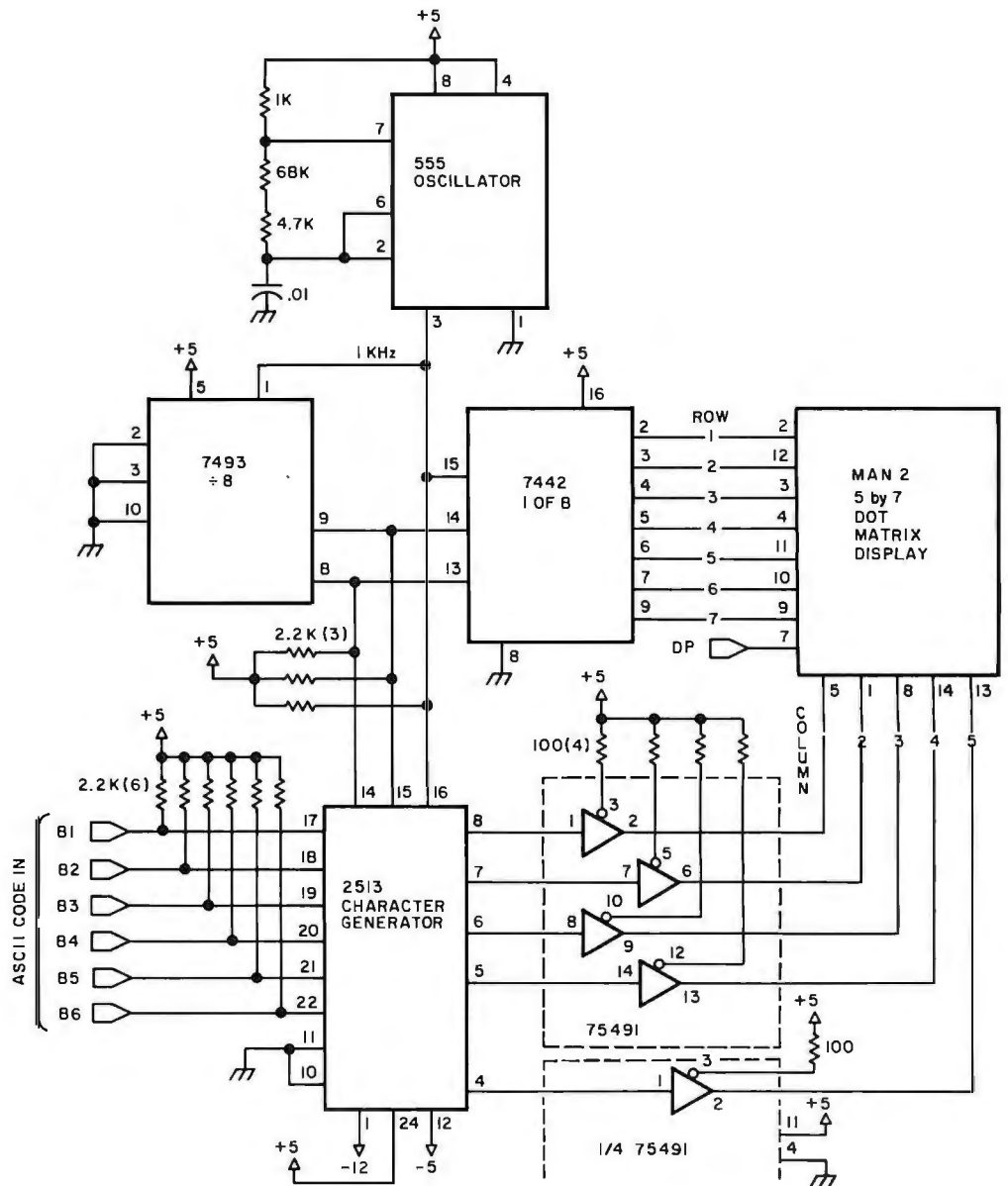

Figure 3: An LED (light-emitting diode) light display circuit designed by the author as a student project.

I recently built and interfaced a 12-character alphanumeric display to the Heath ET-3400 microprocessor trainer. Figure 3 shows the basic circuit, which uses a 0.3 inch (0.76 cm) 5 by 7 dot matrix display. In its single character form it makes a nice project for the student laboratory, where it presents many aspects of digital design: multiplexing, two logic families, ASCII encoded read-only memory, latches, and address decoding. Particularly in a multicharacter display, it provides an enticing excuse for doing some challenging machine-language programming. It also could be used as the primary display for a microcomputer on a board used to control some process. It has been used as a promotional display and then it is usually programmed in both a sweep mode and a flashing mode. (Circuit and pro-

gramming details are available from the author. For one who simply wants to quickly construct an alphanumeric display, I would recommend the 4-character modules made by Litronix. These are the DL-1414, the DL-1416, and the DL-2416 and they come complete with latches, ASCII decoder, and multiplexing circuitry. They are only half the height of the MAN3, though, and the cost would be about the same.)

#### Educational Displays

There is no reason why all the world's wild light displays have to be in baseball parks or in night clubs! Even the modest display of figure 3 has attracted considerable interest whenever it has been displayed. Such displays seem to help the general

# WHERE CAN YOU FIND...



- SOFTWARE - All the best from top authors and distributors.
- HARDWARE- Computers and everything you need to expand your system at the lowest prices around.
- BOOKS and MAGAZINES - To help you learn and to give you hours of computer entertainment.

## IN A SINGLE CATALOG?

- EVERYTHING you need for your APPLE, Atari, TRS-80 or Pet in our 136 page catalog.

Send \$1.(get double credit on your first order) to:  
Ye Complete Computer Catalogue  
P.O. Box 68, Milford, NH 03055

**TSE**

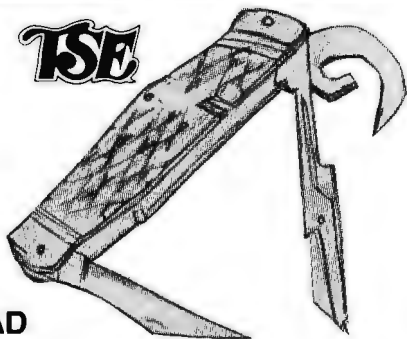

### STAD

*Symbolic Trace and Debug*

A powerful monitor for the TRS-80 with special ability in tracing and debugging. Single Step through machine language programs or set up to three break-points. All the power of regular monitors as well. 16K, 32K, and 48K versions on one cassette. Use from tape in Level II or as a command file from the disk. \$24.95.

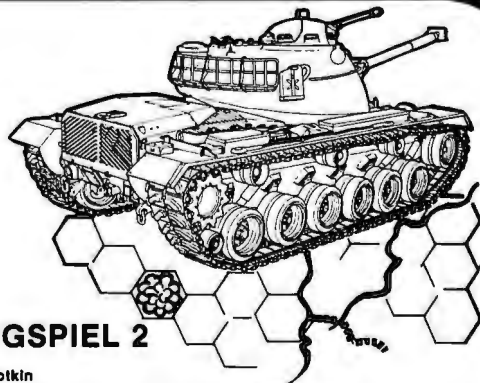

### KRIEGSPIEL 2

*By Ron Potkin*

A wargamer's delight! A much improved, two-player version of the original—machine language routines for extra speed. 9,999 scenarios (towns, tanks and terrain). To win, you must enter the Capitol city of your opponent or reduce his fighting strength below half of your own. Level II, 16K (cassette version only) \$14.95.

## TRS-80™

Level II, 16K

**\$669.**

Eaton LRC 7000 +  
Printer **\$369.**

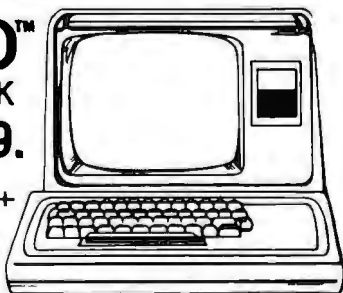

**ATARI 400™**  
8K RAM **\$499.**



**The Software Exchange  
SoftSide Publications  
Hardside**

6 South Street,  
Milford, NH 03055  
**TOLL-FREE 1-800-258-1790**  
in NH, 603-673-5144

public and nonscience students to realize that computers can be small and friendly rather than just intimidating storehouses for secrets.

There are also some exciting possibilities for interactive displays outside departmental offices and for educational displays in student unions. Many schools are recruiting in shopping malls these days and a good smart display is a real winner there. Visitor aids on campus badly need updating. In fact, schools need all the help they can get in presenting a favorable image to the public, who are footing the growing bill.

#### Computer Conference

One year I went to the Ninth Annual Conference on Computers in the Undergraduate Curricula. I hoped to observe the leading edge of the computer invasion into education. No such luck.

It started very well with a scintillating opening talk by Portia Isaacson (computer scientist, computer store owner, and writer). She provided a list of reasons that induce people to buy computers. Inventory control is one such common application, of course, but she was surprised one day to find out (after the fact) that one of her customers was a fence who used his microcomputer to organize his inventory of stolen goods.

There are some interesting, if not startling, papers. The US Naval Academy presented their development of an interface between a Honeywell 635 computer and video cassettes, and described applications to chemistry laboratory exercises, chemistry problem-solving drills, economics, and physics laboratory practice drills. Duke University presented a program that served as a general problem solver for mathematics courses. Other mathematics applications included mathematics for liberal arts students and graphical aids for calculus courses. Nonscience applications included computer-aided instruction English programs, computer-aided musical theory drill and musical composition (a most tuneful paper), sociology and psychology computer-aided instruction. Simulation and modeling programs for business courses and for ecological systems were presented. Cleveland State University described the musical acoustics laboratory discussed earlier.

There were *no* papers describing computer courses designed to provide new physical insights and there were *no* papers on microcomputer/microprocessor programming/design courses! Apparently the controlling group prefers to listen to reinventions of a better wheel on an annual basis. For excitement I'll try a personal computing conference next time. ■

## BUILD YOUR COMPUTER BREADBOARDS & INTERFACES FASTER AND EASIER WITH NEW VECTOR PLUGBOARDS

EASY TO USE!

COST EFFECTIVE!

CLEAN HOLES!

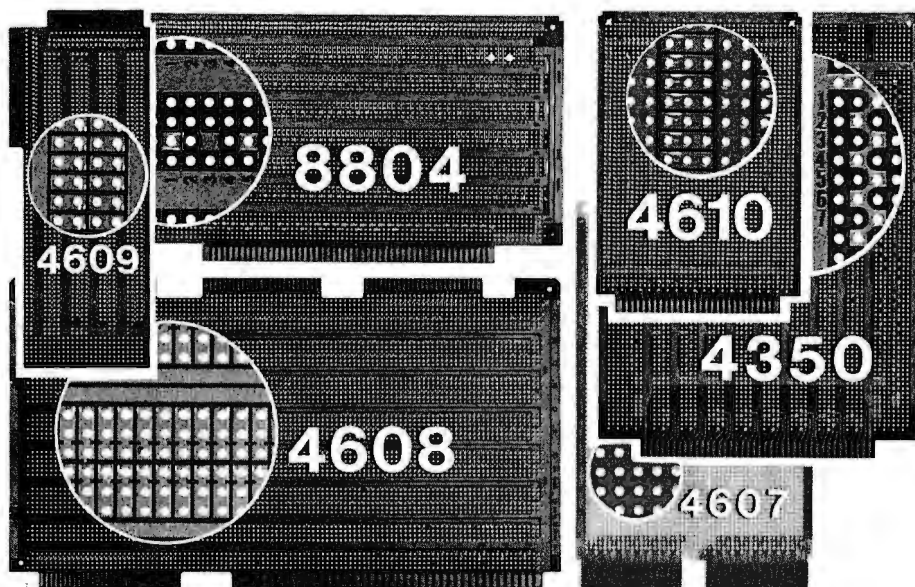

4610 Series - For STD-BUS-WW, solderable and unpatterned models

4608 Series - For Intel/National SBC/BLC 80-WW solderable, or unpatterned

8804 Series - For S100 - 5 models available

4607 - For DEC LSI 11/PDP8-11, Heath H-11

4609 - For Apple II, SuperKim, Pet Commodore with Expandamem

4350 - For TI 980 Computer



*Vector Electronic Company* INCORPORATED

12460 Gladstone Ave., Sylmar, CA 91342 (213) 365-9661 TWX (910) 496-1539  
Available through Distributors or Factory Direct if not available locally.

74801

# "WHAT WOULD YOU SAY TO BIG COMPUTER PERFORMANCE FROM YOUR MICROCOMPUTER?"

## "YOU'RE TALKING OUR LANGUAGE: PL/I-80™"

### New PL/I-80 from Digital Research Brings Big Computer Programming Power to Microcomputer Systems.

**PL/I-80 is the biggest news** for small system users and OEMs since we introduced CP/M® and MP/M. PL/I-80 is ANSI's General Purpose Subset of full PL/I, tailored into a language for 8080, 8085 and Z80 users who expect the software revolution they've seen in hardware—better results at lower cost. PL/I-80 works harder than any other general-purpose language for business, science, research and education.

**The PL/I-80 software package** includes a native code compiler, comprehensive subroutine library, linkage editor and relocating macro assembler. And it's backed by our CP/M and MP/M operating systems.

Best of all, **the complete PL/I-80 system diskette and documentation costs just \$500.**

**PL/I-80:** There's no better way to get big-machine results from your 8-bit processor.

### Single and Multi-User Operating Systems That Set Industry Standards.

**CP/M is the industry standard operating system for small machines.** With thousands of users throughout the world, it's the most popular and widely used. It's the original, hardware-independent 'bus' for users working with a broad array of languages, word-processing and applications software available from scores of suppliers at affordable prices.

Now we've made a great CP/M even better. CP/M 2.2 is the latest release of the efficient, reliable system that's truly universal, able to manage virtually any 8080, 8085 or Z80 micro and its floppy or hard-disk subsystems. Named to the 1979 Datapro Software Honor Roll, CP/M comes on a diskette with its own operating manual, for **just \$150 in unit quantity.**



**MP/M provides big-computer power at small-computer cost.** It provides multi-terminal access with multi-programming at each terminal. And it's CP/M compatible, so you can run many programming languages, applications packages and development software on your system.

Check these advanced capabilities. Run editors, translators, word processors and background print spoolers simultaneously. Use MP/M's real-time facilities to monitor an assembly line and schedule programs automatically, or control a network of micros. Even write your own system processes for operation under MP/M. The possibilities are endless, **yet MP/M costs just \$300 (unit price for diskette and manual).**

### Utilities That Work For You.

**Use our utilities. Thousands do.** They're designed to make your small system work extra hard, yet they cost surprisingly little.:

- MAC™ (Macro Assembler)—\$90.
- SID™ (Symbolic Instruction Debugger)—\$75.
- ZSID™ (Z80 Symbolic Instruction Debugger)—\$100.
- TEX (Text Formatter)—\$75.
- DESPOOL™ (Background Print Utility)—\$50.

All are supplied on a diskette, with operating manual.

Circle 133 on inquiry card.

 **DIGITAL RESEARCH**

**Digital Research**  
P.O. Box 579  
801 Lighthouse Avenue  
Pacific Grove, CA 93950  
408 649-3896  
TWX 910 360 5001

## Omikron TRS-80 Boards, NEWDOS +, and Sundry Other Matters

---

Jerry Pournelle  
c/o BYTE Publications Inc  
70 Main St  
Peterborough NH 03458

---

### Editor's Note

The other day we were sitting around the BYTE offices listening to software and hardware explosions going off around us in the microcomputer world. We wondered, "Who could cover some of the latest developments for us in a funny, frank (and sometimes irascible) style?" The phone rang. It was Jerry Pournelle with an idea for a funny, frank (and occasionally irascible) series of articles to be presented in BYTE on a semi-regular (ie: every 2 or 3 months) basis, which would cover the wild micro-computer goings-on at the Pournelle House ("Chaos Manor") in Southern California. We said yes. Herewith the first installment ....CM

### About the Author

Jerry Pournelle spent 15 years in the aerospace business before he became a full-time writer of science fact and fiction. He is the former director of the Human Factors Laboratories for the Boeing Company, and he worked on projects Mercury, Gemini, and Apollo, as well as military space systems.

Together with Larry Niven, Jerry Pournelle is coauthor of *Lucifer's Hammer* and *The Mote in God's Eye*; he has also written a dozen novels on his own, including *The Mercenary*, *Birth of Fire*, and *West of Honor*.

Dr Pournelle holds degrees in engineering, psychology, and political science. He succeeded the late Willy Ley as science editor for *Galaxy Science Fiction Magazine*; recently he has moved his science-fact column to the magazine *Destinies*, published by *Ace Science Fiction*.

My mad friend was raving again. "What this world needs," he said, "is some computer reviews by users."

"There are a lot of good reviews," I said.

"Yeah, some," he admitted. "But a lot more of them read like rewrites of the manufacturer's spec sheets. What I want is reviews by people who've really used the stuff."

I thought about that for a while and called BYTE. You're looking at the result. This will be a column by and for computer users, and with rare exceptions I won't discuss anything I haven't installed and implemented here in Chaos Manor. At Chaos Manor we have computer users ranging in sophistication from my 9-year-old through a college-undergraduate assistant and on up to myself. (Not that I'm the last word in sophistication, but I do sit here and pound this machine a lot; if I can't get something to work, it takes an expert.)

Fair warning, then: the very nature of this column limits its scope. I can't talk about anything I can't run on my machines, nor am I likely to discuss things I have no use for. Fortunately, that latter category is not so limiting as you might suppose. An author is most certainly running a small business, and I have accounting, mail-handling, and filing problems that you wouldn't believe. (Try sorting out data on subjects ranging from solar-power satellites and general relativity, on one end, to a concordance of the *chansons du geste* (French poems from the time of Charlemagne) on the other, coming from sources ranging from books and

journals to letters from readers.)

The equipment limitations are more severe.

Primarily, I use my friend Ezekiel, who happens to be a Cromemco Z-2 with iCom 8-inch soft-sectored floppy-disk drives. He talks to me through a Processor Technology VDM direct-memory-address (DMA) video-display board, driving a 15-inch Hitachi monitor. However, I can fool him into believing he's no more than a smart terminal to drive a Novation modem at 300 bits per second (bps); in that case he talks to me through an IMSAI VIO video board on a Sanyo 15-inch monitor because most of my network contacts prefer a 24 by 80 screen format. Incidentally, the VIO is set up for address hexadecimal B000 in memory-address space and routinely shares memory with the regular Industrial Micro static memory that fills Ezekiel from top to bottom. If I turn on the VIO screen I get a picture of what is in memory from location B000 to B780, and a weird picture it can be when we're running a long command file...

Zeke also turns out hard copy on a Diablo 1620 daisy-wheel printer running at 1200 bps. The Diablo is easily the most expensive part of my system, but in my business — writing books and articles, I require top manuscript quality, and the Diablo certainly delivers it reliably and efficiently (if noisily; sometimes it's a bit like being in the same room with a machine gun).

Ezekiel's main operating system is CP/M version 1.4, although we're



"THE ORIGINAL"

# Personal Computing<sup>®</sup> 80

## Presents: Personal Computing and Small Business Computer Show

### The Largest Personal Computing Show in 1980

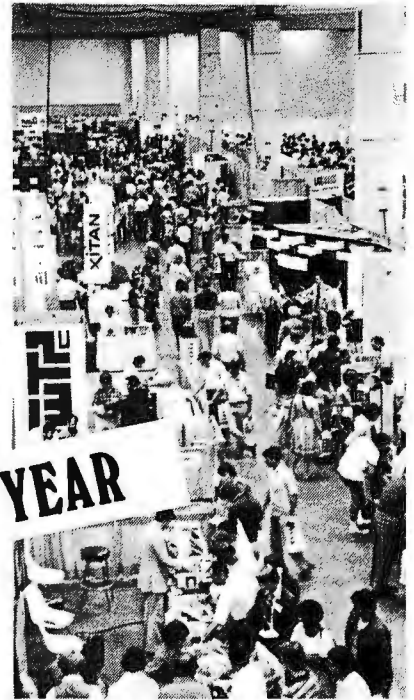
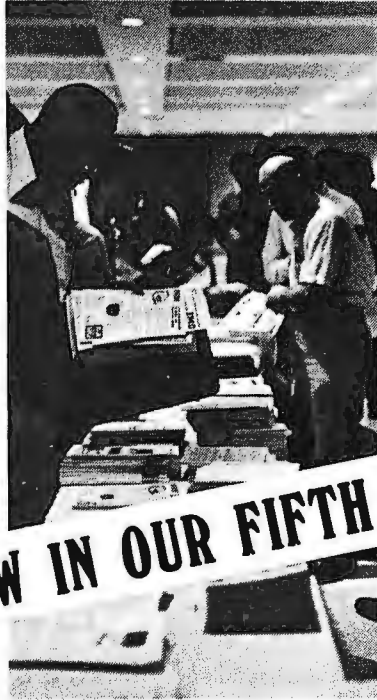
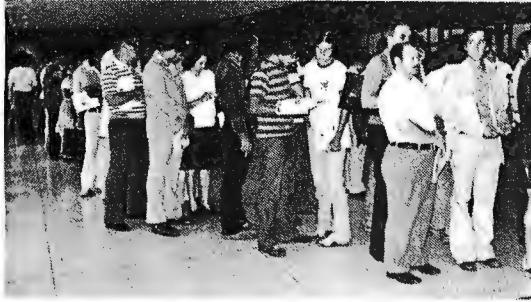

### August 21, 22, 23, 24th at the Philadelphia Civic Center

- Major exhibits by the industries leading companies
- Thursday, Aug. 21st, Dealer Day — 12 Noon to 6 P.M.
- Friday and Saturday, Aug. 22, 23rd — 9 A.M. to 6 P.M.
- Sunday, Aug. 24th — 10 A.M. to 5 P.M.
- Free Seminars ● Robotics Contest ● Antique Computer Display
- Special Seminars and Tutorials about Computer Music, Saturday, Aug. 23rd
- 3rd Annual Computer Music Festival, Saturday Evening, Aug. 23rd  
(Computer Music Festival is sponsored by the Philadelphia Area Computer Society-Tickets on sale at show)
- Computer Visual Arts Festival, Sunday, Aug. 24th

#### Advanced Registration Saves Time & Money

- Send \_\_\_\_\_ Dealer-Retailer (4 days) Registrations at \$10. each, \$12. at door for Thursday-Sunday, Aug. 21, 22, 23, 24
- Send \_\_\_\_\_ Regular Registrations (3 days) at \$8. each, \$10. at door for Friday-Sunday, Aug. 22, 23, 24 only.

Advanced Registrations will be mailed late July - early August. No Advanced Registrations accepted after Aug. 8th.

- Send Exhibitor information or Phone 609-653-1188

COMPANY NAME \_\_\_\_\_

NAME \_\_\_\_\_

STREET \_\_\_\_\_

CITY \_\_\_\_\_ STATE \_\_\_\_\_ ZIP \_\_\_\_\_

PHONE \_\_\_\_\_

Send To:

#### PERSONAL COMPUTING 80

Rt. 1, Box 242, Warf Rd., ● Mays Landing, NJ 08330

**The days of complicated, unreliable, dynamic RAM are gone:**

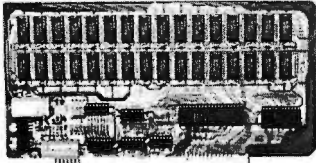

**INTRODUCING  
JAWS**

the ultrabyte memory board

**\$199.95** (complete kit with 16K memory)

Netronics consistently offers innovative products at unbeatable prices. And here we go again — with JAWS, the ultrabyte 64K S100 memory board.

**ONE CHIP DOES IT ALL**

JAWS solves the problems of dynamic RAM with a state-of-the-art chip from Intel that does it *all*. Intel's single chip 64K dynamic RAM controller eliminates high-current logic parts . . . delay lines . . . massive heat sinks . . . unreliable trick circuits.

**REMARKABLE FEATURES OF JAWS**

Look what JAWS offers you: Hidden refresh . . . fast performance . . . low power consumption . . . latched data outputs . . . 200 NS 4116 RAMs . . . on-board crystal . . . 8K bank selectable . . . fully socketed . . . solder mask on both sides of board . . . designed for 8080, 8085, and Z80 bus signals . . . works in Explorer, Sol, Horizon, as well as all other well-designed S100 computers.

**GIVE YOUR COMPUTER A BIG BYTE OF MEMORY POWER WITH JAWS — SAVE UP TO \$90 ON INTRODUCTORY LIMITED-OFFER SPECIAL PRICES!**

**UNDECIDED? TRY A WARED 16K JAWS IN YOUR COMPUTER ON OUR 10-DAY MONEY-BACK OFFER (SPECIFY YOUR COMPUTER).**

CONTINENTAL U.S.A. CREDIT CARD BUYERS OUTSIDE CONNECTICUT CALL

**CALL TOLL FREE 800-243-7428**

From Connecticut Or For Assistance: (203) 354-9376 Dept. B7

**NETRONICS RESEARCH & DEVELOPMENT LTD.**  
333 Litchfield Road, New Milford, CT 06776

Please send the items checked below:

- JAWS 16K RAM kit, No. 6416, \$199.95.\*
- JAWS 16K RAM fully assembled, tested, burned in, No. 6416W, \$229.95.\*
- JAWS 32K RAM kit, No. 6432, (reg. price \$329.95), SPECIAL PRICE \$299.95.\*
- JAWS 32K RAM fully assembled, tested, burned in, No. 6432W, (reg. price \$369.95), SPECIAL PRICE \$339.95.\*
- JAWS 48K RAM kit, No. 6448, (reg. price \$459.95), SPECIAL PRICE \$399.95.\*
- JAWS 48K fully assembled, tested, burned in, No. 6448W, (reg. price \$509.95), SPECIAL PRICE \$449.95.\*
- JAWS 64K RAM kit, No. 6464, (reg. price \$589.95), SPECIAL PRICE \$499.95.\*
- JAWS 64K RAM fully assembled, tested, burned in, No. 6464W, (reg. price \$649.95), SPECIAL PRICE \$559.95.\*
- Expansion kit, JAWS 16K RAM module, to expand any of the above in 16K blocks up to 64K, No. 16EXP, \$129.95.\*

\*All prices plus \$2 postage and handling. Connecticut residents add sales tax.

Total enclosed: \$ \_\_\_\_\_

Personal Check     Money order or Cashiers Check

VISA                     MASTER CHARGE (Bank No. . . . .)

Acct. No. \_\_\_\_\_ Exp. Date \_\_\_\_\_

Signature \_\_\_\_\_

Print Name \_\_\_\_\_

Address \_\_\_\_\_

City \_\_\_\_\_

State \_\_\_\_\_ Zip \_\_\_\_\_

Send me more information

putting up version 2.0 *real soon now*.

In addition to Ezekiel, I have a TRS-80 Model I Level II with expansion interface and a full 48 K bytes of memory. The TRS-80 will run 5-inch disks on the TRSDOS or NEWDOS+ disk operating systems. It will also run 8-inch disks on CP/M, and therein lies a tale.

This will be a column by and for computer users, and with rare exceptions I won't discuss anything I haven't installed and implemented here in Chaos Manor.

In fact, my TRS-80 will run both 8-inch and 5-inch disks on CP/M, and programs created on Ezekiel will run on the TRS-80, or vice versa. Moreover, I can take programs written for the TRS-80 on cassette tape or TRSDOS and bring them up onto the CP/M system, then carry the disks in, and run them on the Cromemco. All this happens painlessly and without glitches, which sounds miraculous.

When George Gardner of Omikron Systems (1127 Hearst St, Berkeley CA 94702, (415) 845-8013) told me about the possibility of full CP/M on the TRS-80, I admit I was skeptical. I'd originally intended to let the TRS-80 talk to the Cromemco through serial RS-232C ports, thus allowing my assistants to prepare text on the TRS-80 and then squirt it over at day's end. I'd already started on the program: get files off the TRS-80 5-inch disks into TRS-80 memory, then send them with handshaking over to Ezekiel where they would be put onto 8-inch disks in CP/M format. The code isn't very complicated, but the whole thing would have been w\*o\*r\*k, and I am as lazy as the next man. Fortunately, Omikron saved me all that trouble.

The Omikron system consists of a pair of neatly constructed circuit boards, comprehensible documentation, the CP/M operating system with a number of *excellent* additional utility programs, and, optionally, a pair of 8-inch floppy-disk drives (you can use your own drives if you like). The boards, which Omikron calls

*Mappers*, fit neatly inside the TRS-80 and can be installed by totally unskilled personnel in about 1 hour.

Omikron's Mapper I (\$199; specify memory size when ordering) fits into the TRS-80 keyboard unit. The installation instructions are exceptionally clear, at the level of "orient the unit so that the space bar is nearest yourself." They proceed step by step and end by telling you exactly how to reassemble the TRS-80. Omikron even tells you which length of screws go in which holes.

Although in theory you will have voided your Radio Shack warranty by breaking the seal (a dab of paint on one of the screws holding the TRS-80 case together), the Omikron Mapper requires no soldering, trace cutting, or any other alteration. What happens is that you pull out the Z80 processor, insert Omikron's board, and put the Z80 into a socket on the Omikron board.

When that's accomplished you can turn on the TRS-80; you get the message "T = TRS-80 C = CPM". If you hit T you will have a normal TRS-80; the Omikron equipment is totally invisible to both BASIC and assembly-language programs. (We've had our Mapper installed for weeks, and we have run some very sophisticated programs, without a glitch.)

If you hit C you have CP/M operating on your 5-inch disks. My disk drives happen to be forty-track Matchless units (Matchless Systems, 18444 South Broadway, Gardena CA 90248 (213) 327-1010), and they work about eight times as fast as Radio Shack's standard 5-inch disks. They have caused absolutely no problems with the Omikron Mapper and CP/M. Incidentally, my TRS-80 has Radio Shack's lowercase modification, and that has caused no problems either.

Omikron's Mapper II (\$99 plus \$10 per cable connector) installs in the TRS-80 expansion interface; installation is even simpler than Mapper I, and again involves no soldering, trace cutting, or other alteration of the TRS-80. If the Mappers are removed there is no way to know they were ever there.

The Mapper II in the expansion interface works under both CP/M and TRSDOS. In TRSDOS it acts as an external data separator for the floppy-disk drive, eliminating sector retry errors — those mysterious

## FROM THE ORIGINATOR OF THE TRS-80 PROJECT...

**FMG Corporation — for HIGH LEVEL LANGUAGES**

- ☐ FORTRAN
- ☐ PASCAL
- ☐ COBOL
- ☐ BASIC

Microcomputer software for business applications, engineers, consumers, hobbyists and others who have a serious interest in computers.



M-450



**SEND FOR FREE SOFTWARE CATALOG**

- CP/M — Industry Standard Operating System
- USCD PASCAL PACKAGE
- GENERAL LEDGER; PAYROLL; ACCOUNTS RECEIVABLE and ACCOUNTS PAYABLE
- FORTRAN-80 PACKAGE — New Capabilities for TRS-80 Users
- FMG's MICRO COBOL — For TRS-80 and TRS-80 Model II
- CP/M Z80 — Macro Assembler
- ZSID — Symbolic Debugger
- Custom Programming, Service, Installation and Training are Available at Additional Cost

**FMG Corporation is an Independent Software Company — from the ORIGINATOR OF THE TRS-80 PROJECT and the AUTHOR OF THE FIRST CP/M FOR THE TRS-80.**



5280 Trail Lake Drive  
Suite 14  
Ft. Worth, Texas 76133  
(817) 294-2510

CP/M is a registered trademark of Digital Research Corp.  
TRS-80 is a registered trademark of Radio Shack.

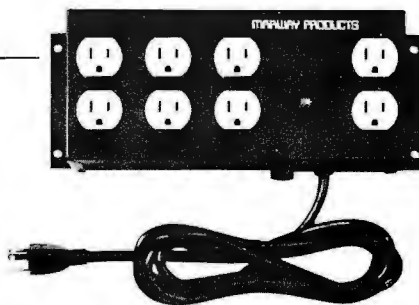

## No "Glitches", Surges Or Interference

Marway's MPD 117 turns an ordinary outlet into a controlled power source for up to 8 devices.

Today's electronics devices—microcomputer systems, stereo and audio visual components, and so on—require clean, filtered power for optimum performance.

Marway Products' new MPD 117 AC Power Controller transforms an ordinary AC outlet into a controlled power source for up to eight devices filtering and distributing power evenly to all of its outlets. The MPD 117 has a high-performance EMI filter, built-in circuit breaker, two direct and six switched outlets, illuminated "on-off" switch for switched outlets, and is built with rugged UL-approved components and housing in an all-steel chassis with convenient mounting flanges.

**The MPD 117 is the low-cost solution to your power distribution problems.**

Marway's MPD 117 sells for \$89.00 (plus tax), making it the lowest priced, high-performance AC Power Controller available.

To find out more, contact MARWAY PRODUCTS, INC.

Marway can solve your power distribution problems and save you money.

### MARWAY PRODUCTS INC.

2421 S. Birch St., Santa Ana, CA 92707 (714) 549-0623

# Why pay \$4000 for a Complete Accounting System?

**OMIKRON** is offering the four standard accounting packages (General Ledger, Accounts Payable, Accounts Receivable, and Payroll) at the unbelievable price of \$100 each. Please read the following description carefully to see why we claim they are worth \$1000 each.

During 1978 this software was developed for sale under the "PEACHTREE SOFTWARE" name. In 1979, with the software mostly done and fully functional, the principals involved in the development split up. RETAIL SCIENCES added their enhancements and now sells their version of this software to dealers nationwide

with a retail price close to \$1000 each. This software is extremely high quality and many people claim it is the best in the industry.

**OMIKRON** has acquired the right to market the software as it was when released in early 1979. We have also enhanced it and claim it is comparable to the "PEACHTREE SOFTWARE." We provide a total of over 500 pages of detailed documentation and the source listings are easily obtained for customizing.

Before you order please note the following three conditions of sale. 1) This software is not available to dealers or through dealers.

2) The extensive documentation is the only support we can offer at this price. 3) We feel the software is bug free, however we can not be responsible for losses incurred by its use.

**OMIKRON** offers the manuals for \$15 each with a two week return for full credit. The software requires a 48K CP/M system with two eight inch disk drives. Microsoft Basic Version 4.51 is also required and may be purchased for \$350. The complete package of four is available for \$350 including manuals. Versions for both the Radio Shack Model I and Model II are also available.

\*CP/M is a TM of Digital Research. TRS-80 is a TM of Tandy Corporation.



# MAKE YOUR S100 BUS SYSTEM DO ITS BEST

Here are three new advanced computer cards from IPDI which offer the small businessman or other users of S100 Bus systems performance and reliability at a level previously available only from more expensive systems.

## Central Processor CP-100

This low cost Z80 CPU card is fully Schmitt trigger buffered and has jumper selectable 2 or 4 MHz operation. Power-on/ reset jump to any location in 64K with on-board EPROM addressed independently of jump address.

## Memory Parity Card MP-100

Maintains continuous check on computer memory during execution of software. High-speed (6 MHz) error detection circuitry enhances reliability and protects stored data or program material. A program is aborted when a single bit of erroneous data is fetched by CPU. MP-100 consists of parity-generating circuitry and on-board RAM for storage of parity information. Bank switching allows multiple MP-100 to be used. Failed address is maintained in 2 ports.

## Video Graphics VG-100

This single-card high-density computer display system is designed for business graphics applications. Totally programmable font allows any character set of up to 256 characters to be defined in on-board RAM. Over 3000 display characters, each with a full byte of attribute. Versatile graphics applications can use 16 gray tones or 8 colors or combinations.

Call or write for further information:  
800-227-8420 (Toll free)

international  
**product**  
**development**  
incorporated  
2584 Wyandotte Street  
Mountain View, CA 94043

glitches that lose files.

With Mapper II installed I now run both 5-inch and 8-inch disks under CP/M, and I can transfer programs from 5- to 8-inch disks using the CP/M utility program PIP. George also furnishes a program to take files (including programs) from TRSDOS to CP/M format. My own operates with the Omikron disks. (Omikron sells a single 8-inch drive with both Mappers for \$1195; dual drives with Mappers are \$1795. Cables are included.) Omikron also furnishes the required software; we ran CP/M instantly after installing the Mapper boards.

The bottom line is that my TRS-80 with Omikron's additions has become a perfectly normal 48 K-byte Z80 computer, and yet can continue to function as a standard TRS-80 as well. It's as if I had both Model I and Model II TRS-80 in the same package. For those not familiar with the TRS-80 this may not seem so miraculous, but believe me, it is.

Nor is it hard to operate: my 9-year-old son is in the other room playing Temple of Apsai (an excellent real-time dungeon game) under TRSDOS, while his older brother (age 11) is impatiently champing to get on and run Adventure under CP/M. My secretary runs Electric Pencil on the TRS-80, then translates the files to CP/M format so that Ezekiel can read them.

Sure, Zeke is a better machine; but he cost a lot more than the TRS-80 plus the Omikron modifications. Omikron has made the TRS-80 a very convenient way to add a second computer without going bankrupt. Any TRS-80 owner feeling left out because all the good programs are written in CP/M (or who's using 5-inch disks for business systems and going mad because of the limited storage capacity of the little beasts) should get in touch with Omikron immediately. [Another device, the Maxi-Disk, that allows a user to run CP/M on both 5-inch and 8-inch floppy disks on the TRS-80 Model I is offered at a comparable price by Parasitic Engineering (1101 9th Ave, Oakland CA 94606). Although I have no direct experience with their product, the company is known for the soundness of their hardware design....GW]

"Impossible," my mad friend told me when I described the Omikron system. "The TRS-80 has BASIC in

read-only memory down in low memory-address space; CP/M can't run because hexadecimal locations 0 thru 0100 are full of BASIC. Radio Shack gave up on CP/M."

"But you see it does work," I said smugly. "Not only that, but you see the programs you brought from your machine work just fine on the TRS-80."

"Hmm," said he. "There's only one way he could do that."

And he was right. What Omikron's board does is "phantom out" all those read-only-memory parts down in low memory. It also re-addresses the TRS-80's memory-mapped video-display screen to hexadecimal FC00. The BIOS that Omikron furnishes does the rest. [BIOS is the module of CP/M that controls the transfer of data to and from the peripherals....RSS] George Gardner says there are some obsolete CP/M programs that might not run on the modified TRS-80, but I haven't found any. CBASIC and programs written in CBASIC run fine. So do all the various versions of Microsoft Disk BASIC, Tarbell BASIC, the BDS C Compiler, four programs written in Microsoft Compiling BASIC, the Vulcan data base, Microsoft's FORTRAN, Adventure, DDT, and a lot of utility programs obtained from the CP/M User's Group.

Omikron also furnishes utilities: a disk test, a memory test, programs to reformat 8-inch floppy disks as well as a formatter for 5-inch disks, copy utilities for both 8-inch and 5-inch disks, and some software to make the TRS-80 keyboard more convenient (allows absolute cursor addressing by emulating a Soroc IQ-120 terminal with all control characters plus square brackets), an initialization routine, and a program to set up your TRS-80's RS-232 port for serial input/output (I/O). All in all, it's quite a package. It's not often that I can recommend something without reservations, but I'm happy to say that Omikron (all equipment guaranteed for 6 months, parts and labor) is a real bargain that for a wonder works just as advertised. It really will make a TRS-80 Model I into a serious computer.

The basic TRS-80 is a lot of computer for the money. It comes ready to run right out of the box, and it can be set up by three boys — ages 9, 11, and 13. (At least mine was, not

StackWork's

# FORTH

A full, extended FORTH interpreter/compiler produces COMPACT, ROMABLE code. As fast as compiled FORTRAN, as easy to use as interactive BASIC.

## SELF COMPILING

Includes every line of source code necessary to recompile itself.

## EXTENSIBLE

Add functions at will.

## CP/M\* COMPATIBLE

## Z80 & 8080 ASSEMBLERS included

Single license

Supplied with extensive user manual and tutorial:

\$150.00

Documentation alone: \$25.00

OEM's, we have a deal for you!

CP/M Formats: 8" soft sector, 5"

Northstar, 5" Micropolis Mod II.

Please specify CPU type

Z80 or 8080

All Orders and General Information:

**SUPERSOFT ASSOCIATES**

P.O. BOX 1628

CHAMPAIGN, IL 61820

(217) 359-2112

Technical Hot Line: (217) 359-2691

(answered only when technician is available)



*SuperSoft*

**First in Software Technology**

\*CP/M registered trademark Digital Research

C-10

**SHORT  
CASSETTES**

50 FT.



Qty.	Price
1	\$1.00
10	\$0.75
50	\$0.65

Premium tape and cassettes acclaimed by thousands of repeat order microcomputer users. Price includes labels, cassette box and shipping in U.S.A. VISA and M/C orders accepted. California residents add sales tax. Phone (415) 968-1604.

**MICROSETTE CO.**  
475 Ellis Street  
Mt. View, CA 94043

Circle 306 on inquiry card.

**MARKET DATA LISTINGS****14 COMMON STOCKS**

▲ DAILY CLOSE & VOLUME  
Feb. 28, 1978 to present

▲ FOR THESE STOCKS

ASA	BallyMfg	HughsTI
AllisCh	CornG	IBM
AHess	EsKod	LeviStr
ABdost	GMot	NwtInd
Avon	Honwill	

\$20 Each, \$160 Lot - LISTS

△ Add \$30 Per Lot For Diskette

IBM 8" 2D (IBM 5120 BASIC)  
NORTH STAR 5 1/4" (N.S. BASIC)

MC, VISA, CHECK, MONEY ORDER

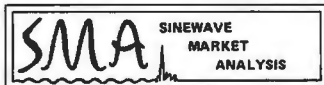

POST OFFICE BOX 415  
BURLINGTON, IOWA 52601

Circle 200 on inquiry card.

**JINSAM™ Data  
Manager**

- ★ CUSTOM DATA FILES
- ★ FAST/EASY/MENU DRIVEN
- ★ HELP COMMANDS
- ★ KEYED RANDOM ACCESS
- ★ MULTIPLE SEARCH KEYS
- ★ PRIVACY ACCESS CODES
- ★ WILD CARD SEARCH

For 16K-32K PET, Dual Disk, and Printer

FREE: LABEL PRINTER MODULE

FREE: REPORT GENERATOR MODULE

Specify CBM 2040 or COMPU/THINK

Package \$150      User's Guide only \$25  
Introductory      Demo Tape \$5      Disk \$ 8

Check or Money Order plus \$2 Shipping  
(NY residents add 8% Sales Tax)

- DEALER INQUIRIES WELCOMED -

**JINI MICRO-SYSTEMS, Inc.**  
P.O. Box 274-B • Bronx, NY 10463

Circle 307 on inquiry card.

without threats of mayhem which weren't the computer's fault.) The Tandy/Radio Shack documentation is excellent, and there are a lot of good programs available for the TRS-80. The Radio Shack service is speedy, efficient, and uncomplaining.

Just about every component of my TRS-80 has taken a trip to the local store to be fixed. None of that cost me anything; it wasn't even inconvenient, especially with local Radio Shacks all over the place. It was annoying (between my secretary and my boys, a day without the second computer can be an, uh, *interesting* day). Still, all computers have infant mortality problems. When Ezekiel was first installed, I thought Tony Pietsch of Proteus Engineering in Pasadena, California (the man who set up Ezekiel) was going to wire himself in as an integral component. Although each major part of my TRS-80 has been to the shop, my neighbor down the street has had a full system running from the first day with no glitches whatsoever. Given the price of the TRS-80, Tandy's quality control is better than you'd expect.

But there are some problems. The Tandy disk operating system, TRSDOS, is needlessly complex; the editor/assembler and T-BUG monitor aren't that good, and most of their business programs are simply not in the same class with their competition. Although Fort Worth (Tandy headquarters) lately seems anxious to fix up their act and send out revisions of both software and hardware, they remain secretive. For the moment, the best disk operating system for the TRS-80 is Apparat's NEWDOS+, a much better operating system than Radio Shack's, and it's upward compatible with TRSDOS. In fact, Tandy ought to be marketing NEWDOS+ themselves.

NEWDOS+ not only works better than TRSDOS, but also has Superzap: a routine which lets you go out to a disk file and examine and change it as easily as a good monitor will let you twiddle bits in memory! It's incredibly convenient. That's the good news. The bad news is that the documentation is nearly incomprehensible. Fortunately, though, there's a fix for that too: H C Pennington's book *TRS-80 Disk and Other Mysteries*, also available from Apparat (7310 E Princeton Ave, Denver

CO 80237) tells all you'll ever need to know about Superzap and the TRS-80 disk system.

NEWDOS+ and Superzap will let you read and write disk files sector by sector, change bits, defeat the TRS-80's silly "protection" systems, etc. It won't make TRSDOS as convenient as CP/M, nor will anything else except Omikron and CP/M itself; but they will make the TRS-80 operating system tolerable.

NEWDOS+ also has a disassembler. I haven't gotten around to aiming it at the TRS-80's read-only memory, but I'm about to; people I trust tell me it works fine. I already have Fuller Software's Supermap, which is an extensive set of comments to add to a disassembly of the TRS-80's Level II system firmware. Supermap has its problems, and strange lacunae; its author doesn't seem to know where the TRS-80 memory-mapped screen is addressed, as an example. Still, it's worth the price (about \$18) for anyone who wants to understand his TRS-80 (and there are some really nifty bit-twiddling routines in those read-only memories; with a good disassembly you can patch into them when writing your own assembly-language programs, thus saving a lot of memory and code).

I must admit I fail to understand Tandy's philosophy. Radio Shack charges about \$100 more for a 35-track 40 ms-access-time disk drive than Matchless, or Percom, or Vista is charging for the same type of equipment (which works better than Radio Shack's).

(Incidentally, most companies manufacturing disk drives for the TRS-80 write confusing advertising copy. For the record, the disk controller is in the TRS-80 expansion interface, and Matchless, Vista, or Percom 5-inch disks will work as either add-on drives or as the *first* disk drive. You will have to spend about \$20 at Radio Shack for a copy of the TRSDOS operating system and documentation, but I don't recommend Radio Shack disk drives.)

The TRS-80 with Omikron's Mappers is a truly competitive machine. You can buy a TRS-80 Model I with Level II BASIC, equipped with expansion interface, for under \$1500; fill it with memory for about \$200 more; add a pair of Omikron 8-inch disk drives for \$1795, and Matchless

# LIMITED EDITION



Offered for the first time, Volumes II and III of BYTE back issues, packed with articles by your favorite authors, are a real collector's item. Volume II contains issues from January '77 thru December '77 and Volume III contains issues from January '78 thru December '78. Each volume is priced at \$100.

These gold embossed, hard-cover volumes are individually numbered with only 100 sets available. Orders will be handled on a first-come, first-served basis. Based on our quick sell-out of Volume I, we know that this limited offer will sell rapidly. So fill out the coupon below and rush your order to BYTE BOOKS today.

- Volume II Parts 1 and 2 (Jan '77 thru Dec '77) \$100.00
- Volume III Parts 1 and 2 (Jan '78) \$100.00

**BYTE  
BOOKS**

Check enclosed for \_\_\_\_\_

Bill BankAmericard/Visa     Bill Master Charge

Card No. \_\_\_\_\_ Exp. Date \_\_\_\_\_

Name (please print) \_\_\_\_\_

Address \_\_\_\_\_

City \_\_\_\_\_ State \_\_\_\_\_ Zip \_\_\_\_\_



Mail to: BYTE Books, Inc.  
70 Main Street  
Peterborough N.H. 03458

**BYTE**

**II**

Volume II Part 1  
January 1977  
Through  
June 1977

**BYTE**

**II**

July 1977  
Through  
December 1977  
INDEX

5-inch drives for \$400 each; get a good line printer (again, I have Matchless at \$750). For a total cost of under \$5000, you have a 48 K-byte machine capable of running all the TRS-80 programs, CP/M software, and top-grade text editors like Word Master, Magic Wand, Electric Pencil, and the Proteus editor—and run both 5-inch and 8-inch disks in the bargain, all without building a single kit. And I can guarantee that a 9-year-old can use it.

I started off describing my system, and ended up talking a lot about the TRS-80. I don't use the TRS-80 all that much—it is the secondary system. So what *does* get run around here?

Well, first of course, text editors. I've written five or six books using Ezekiel, as well as countless articles and letters. Most of that has been described in articles in *BYTE's* companion magazine *onComputing*, but as Alice said in *Wonderland*, "things flow here so!"

In particular, there are at last a whole flock of new text editors, some excellent, some not as good as the old standards. One, unfortunately not

quite finished, promises to be better than anything available for the biggest machines. My next column will dissect a number of editors to show their good and bad points. (Also see my article, "A Writer Looks at Word Processors," in the Summer 1980 *onComputing*.) We'll not only include the big ones like Electric Pencil, WordStar and WordMaster, Magic Wand, Proteus, and the like, but even bigger ones like MIT's EMACS.

Secondly, here at Chaos Manor we have a file-management problem like nothing you have ever seen, and thus we have a plethora of file handlers and data bases. For quick and dirty work I use a simple (and inexpensive) data-base system from Workman Associates (112 Marion Ave, Pasadena CA 91106, for about \$75); it's far more than adequate for Christmas cards, telephone numbers, meal plans, and cooking-duty assignments for long-term Boy Scout hikes, and such statistics as mean, standard deviation, and two-variable correlations.

For more complicated work we use Vulcan (available for \$490 from SCDP Systems, 6542 Greeley St,

Tujunga CA 91042). Vulcan is a program that falls into a category I call "infuriatingly excellent"; that means it does everything you'd like it to, and perhaps a lot more, but the documentation is plain lousy. Vulcan will let you very quickly and easily structure a complex data base and enter data. You can add to it as you will, including taking files off other data bases like Workman's. Since Vulcan makes random-access disk files, the data base can be as large as you like.

It's much faster than any other disk-storage data base I've ever seen, and lets you do really complex things like: find all items with keywords "Solar" OR "Conservation" but NOT "Wind" AND NOT "Windmill"; sort by AUTHOR and create a new file; add the PRICE of all those items and INCREASE the price by 10%.

Actually, that wouldn't be a very complicated task for Vulcan, which is as much a language as a program; in fact, Vulcan has a limited BASIC-language system built into it. Vulcan can also execute command files (very handy if you have operations to be done at regular, say weekly or monthly, intervals). It will drive both

## Radio Shack's Low-Cost Answer to Your Hard Copy Needs!

TRS-80™ Quick Printer II is worth far more than the mountain of paper scraps you're forced to use to capture data and program listings that speed past on the CRT. Its on-board microprocessor-controlled electrostatic printhead zips through two 32-column lines per second on 2 $\frac{3}{8}$  in. aluminized paper. Prints upper/lower case plus expanded characters under software control with full wrap-around.

**Fits most computers!** TRS-80 owners can connect it to any Level II with or without the expansion interface. It will also connect to a 600 baud RS-232 serial or Centronics-type parallel printer port! Includes manual and TRS-80 Bus cable.

In-stock now at many Radio Shack stores and dealers!

**\$219<sup>00</sup>\***



**Radio Shack**®  
The biggest name in little computers™

\*Price may vary at individual stores and dealers. May require special order.





### What do you need?

Program listings . . . inventory listings . . .  
 custom logos and letters . . . mailing labels in a  
 multitude of sizes . . . custom forms and the data  
 to complete them . . . curve plotting or bar  
 graphs . . . digitized images from video or bit  
 pads . . . multi-part forms . . . preprinted forms  
 . . . tickets . . . and the list goes on . . .

### How do we do it?

High speed bi-directional full logic printing; two  
 standard character sets, upper/lower case  
 with descenders; high speed font at 165 cps;  
 letter quality font at 90 cps; expanded  
 characters, solid underlining; programmable  
 character sets; complete dot control graphics;  
 adjustable tractor feed 3"-16"; user adjustable  
 platen; programmable tabs, forms length and  
 line spacing; out of paper signal; self-test;  
 interface options — RS-232C, Centronics  
 parallel, Apple, S-100; and the list goes on . . .

## The Malibu Model 165

Find out if it's the easy solution to your hard copy needs — contact  
 your local computer dealer or you can write or call us today for  
 complete specifications and print samples — you won't be disappointed.

**Versatility, Quality and Reliability: We build it in.**

**malibu**  
 Electronics Corporation

*Dealers and OEM'S, call us about our new purchase programs  
 with prices, terms and delivery to meet your needs too.*

2301 Townsgate Road, Westlake Village, CA 91361 (805) 496-1990

a subsidiary of **Datametrics Corporation**

Circle 115 on inquiry card.

BYTE July 1980 207

## S-100 USERS: GIVE YOUR COMPUTER THE GIFT OF SIGHT!

The DS-80 Digisector® is a random access video digitizer. It works in conjunction with a TV camera (either interlaced or non-interlaced video) and any S-100 computer conforming to the IEEE standards. Use it for:

- Precision Security Systems
- Moving Target Indicators
- Computer Portraiture
- Fast To Slow Scan Conversion
- Robotics
- Reading UPC Codes, schematics, paper tape, musical scores



● IMAGE PROCESSED BY DS-80 ●

### CHECK THESE FEATURES:

- High resolution** — a 256 x 256 picture element scan
- Precision** — 64 levels of grey scale
- Speed** — Conversion time of 14 microseconds per pixel
- Versatility** — scanning sequences user programmable
- Economy** — a professional tool priced for the hobbyist; comes fully assembled, tested and burned in, with fully commented portrait printing software.

Price: \$349.95 MasterCharge and Visa

THE **MICRO**  
**WORKS**

P.O. BOX 1110, DEL MAR, CA 92014 714-942-2400

console and hard-copy devices. It is really useful.

But it drives you mad, because Vulcan's author didn't include enough examples in the instructions. We find Vulcan worth the effort, because it is fast, and comprehensive, and allows you to change the field structure of the data base at will, or create new data bases selectively out of the master; but we do a lot of pounding on the table and screaming in rage at the documentation.

There's a lot of software like that: infuriatingly better than its competition, but hampered by instructions meaningful only to the software's author. I sometimes think there is a secret school that teaches the black art of writing a document such that the author can prove conclusively

that every bit of needed information is contained in the book — but it is guaranteed to be useless to anyone who doesn't already know it to begin with. In fact, I am sure there is such a school, and someday I'm going to find it and put it out of business. Until then, though, we'll have "infuriatingly excellent" software with us and there's not a lot to be done about it.

An upcoming "User's Column" will discuss a number of data bases, including some I've been promised but haven't received, and go over their strengths and weaknesses.

We'll also look at languages, including the BDS and Whitesmith C compilers (see *The C Programming Language* by B Kernighan and D Ritchie, Prentice-Hall 1978; C is a really marvelous language); BASICs

that run source code interpretively and can then compile it (easily the best way to write quick and dirty programs that have to run this afternoon); FORTH; SMAL-80 if we can ever get a copy that runs; LISP (want 800-digit precision? cryptographers do!); and other alternatives to BASIC and FORTRAN.

I'm collecting accounting systems and other business software, and we'll have a column on those also.

I'm also open to suggestions and always interested in programs that can run on my systems and would be valuable to BYTE readers; if you're curious about software, let me know. Chances are I'll be as interested as you are, and we'll both learn something. ■

## WHY PLUG ALONG IN BLACK & WHITE WHEN YOU CAN HAVE A RAINBOW?

### The RAINBOW 2000 Color Video Board

Includes: Standard RS 232 Interfacing, up to 192 x 256 Resolution, 8 colors plus two-color alpha-numeric characters, 38.4 K baud with crystal clock, 6K RAM Memory, complete ROM software included, microprocessor on-board. Ideal for OEM Product Incorporation, Dealer-Distributors and Advanced Hobbyists. Made to Industrial Specifications.

**NEW!** 10" Monitor, Heavy-duty steel case, rack mounted. Quantity Prices Available. We Carry A Complete Line of Industrial Video Products!

**\$465**

For orders or information  
CALL TOLL-FREE 800-638-1473

### Panasonic INDUSTRIAL COLOR MONITORS

7" Monitor	10" Monitor	13" Monitor	19" Monitor
\$416.00	\$379.00	\$416.00	\$526.00

**Digitus**  
CORPORATION

In Maryland: Call 467-3223

A MCGRAW-HILL PUBLICATION

# onComputing™

GUIDE TO PERSONAL COMPUTING

**GETTING STARTED**  
What You Need And What It Will Cost

**EQUIPMENT REVIEWS**  
TRS-80, Apple, Sorcerer and PET

Best-Selling Author  
**JERRY POURNELL**  
"Writing With A Microcomputer"  
**THE BINARY WORLD**

Also...  
**A PERSONAL  
COMPUTER DIRECTORY**  
**COMPUTER CLUBS:  
WHO NEEDS THEM?**

Plus much much more  
for the new computer user



## When will the Personal Computer Explosion touch YOU?

Are you prepared for the explosive transformation? Right in your own home? Electronic mail. Personalized investment analysis. Foreign language tutorial. Home energy management. Robots. Computer music. Secretarial service. Diet and menu planning. And more, more, more.

**onComputing™** the new McGraw-Hill quarterly, prepares you for the enormous changes coming during the

1980's (Some are already here). **onComputing™** explains in nontechnical language what personal computers are, how they work, and how you can use them at home, for fun and profit.

Don't let the personal computer explosion catch you off guard. Know what's happening and help make it happen! Prepare now for the exciting future with a subscription to **onComputing™!**

**Call Toll-Free  
800-258-5485**

**Start your  
subscription today.**

**onComputing™** Subscription Dept. P.O. Box 307, Martinsville, NJ 08836

DOMESTIC subscription rate:

U.S. 1 yr. (4 issues) @ \$8.50  Canada & Mexico, 1 yr. (4 issues) @ \$10.00

FOREIGN (to expedite service, please remit in U.S. funds drawn on a U.S. bank.)

Europe (and all other countries, except above), 1 yr. @ \$12.00 — surface delivery.

Bill Visa  Bill Master Charge  Bill me (North America only)

Card Number

Expiration

Signature

Name (please print)

Street/Apartment Number

City

State/Province/Country Code

7B70

Please allow 6-8 weeks for processing.

UNBEATABLE...



APPLE II OR  
APPLE II PLUS



Shipped direct to you!

\$899<sup>00</sup>

(Plus Shipping)

We have orchard fresh Apple products ready to ship. Immediate delivery. Send cash or cashier's check for quick shipment. Orders with personal checks shipped after bank clearance.

16K UNITS.....\$899

32K UNITS.....\$999

48K UNITS.....\$1099

Apple Disk Drive \$550

Pascal Language Card

\$450

Above plus \$20 shipping charge. IMPORTANT—No shipments made within the state of Illinois.

MIGHTY MICROS  
P.O. BOX 11375  
CHICAGO, IL 60611

ORDER FORM

Enclosed \$ \_\_\_\_\_

For \_\_\_\_\_ Via U.P.S.

Ship to: \_\_\_\_\_

Name \_\_\_\_\_

Address \_\_\_\_\_  
(No P.O. Boxes—Street Address Only)

City \_\_\_\_\_

State \_\_\_\_\_ Zip \_\_\_\_\_

# Creating a Fantasy World on the 8080

Robert T Nicholson  
4920 Harmony Way  
San Jose CA 95130

Although personal computer owners have devised a remarkable number of applications for their machines, game playing probably still ranks as the number-one use. Besides providing entertainment, games can be challenging and educational; in addition, games are often fascinating programming problems.

The most mind-stretching computer games yet devised may be the fantasy-adventure games which have become popular in recent years. All of the current fantasy-adventure games, including Adventure and Zork, seem to be based on Dungeons and Dragons. Dungeons and Dragons is a noncomputerized game developed by Gary Gygax and Dave Arneson in the late 1960s. In Dungeons and Dragons, as in its computerized counterparts, the player represents a character in a fantasy world, taking part in great adventures, slaying monsters, and accumulating treasures.

The success of such a game, of course, depends upon the program's ability to produce a rich fantasy world; that is, an environment which poses many interesting problems for the player, and which responds in a reasonable way to the player's attempts at problem solving. For example, if the player finds matches and a candle in the course of the game, then the program should allow the player to light the candle when entering a dark chamber. A richer environment would also react appropriately to the player's attempts to light other objects with the matches ("DON'T BE SILLY... SWORDS DON'T

BURN!"), or to use the candle in some unintended manner.

Creating such a rich world requires a program which possesses a relatively large vocabulary and a great deal of logic to determine whether or not the player's actions are reasonable. It is also necessary for the program to have thousands of words of text to describe places, objects, and the results of any given action. These requirements are especially difficult to meet on a personal computer, where main memory is very limited and disk accesses are slow (by large computer standards). The problems, however, are certainly not insurmountable, as demonstrated by the existence of CASTLE, the author's 8080-based fantasy-adventure game.

Listing 1 shows a portion of a typical CASTLE session. The game is implemented in North Star disk BASIC and runs in 32 K bytes, with a response time of several seconds. Most of the program's time is spent in accessing its four major files. These files contain the vocabulary as well as descriptive text and details about the various props. The program itself is very simple, consisting of three basic sections: a command interpreter, a set of semantic routines, and an event routine.

The job of the command interpreter is simply to obtain a syntactically correct command from the player and translate it into a pair of numeric codes (a semantic pair). This is then passed on to the semantic routines. The syntax for CASTLE commands is very straightforward, as shown in listing 2; valid action words

# Take the mystery out of programming

with the latest from *BYTE Books*<sup>tm</sup>

## The BYTE Book of Pascal

Edited by Blaise W. Liffick

Based on the growing popularity of Pascal as a programming language, numerous articles, language forums and letters from past issues of *BYTE* magazine have been compiled to provide this general introduction to Pascal. In addition, this book contains several important pieces of software

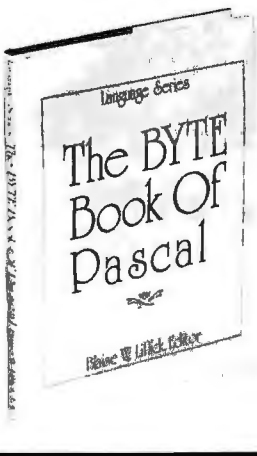

including two versions of a Pascal compiler - one written in BASIC and the other in 8080 assembly language; a p-code interpreter written in both Pascal and 8080 assembly languages; a chess playing program; and an APL interpreter written in Pascal. \$25.00 Hardcover pp. 342 ISBN 0-07-037823-1

## Beginners Guide for the UCSD Pascal System

by Kenneth Bowles

Written by the originator of the UCSD Pascal System, this highly informative book is designed as an orientation guide for learning to use the UCSD Pascal System. For the novice, this book steps through the System bringing the user to a sophisticated level of expertise. Once familiar with the System, you will find the guide an invaluable reference tool for creating advanced applications. This book features tutorial examples of programming tasks in the form of self-study quiz programs. The UCSD Pascal Software Systems, available from SofTech Microsystems Inc, 9494 Black Mountain Road, San Diego CA 92126, is a complete general purpose software package for users of microcomputers and minicomputers. The package offers several interesting features including:

- Programs which may be run without alteration on the General Automation or DEC PDP-11 minicomputers, or an 8080, 8085, Z80, 6502, 6800, or 9900 based microcomputers.
- Ease of use on a small, single-user computer with display screen and one or more floppy disk drives.

\$11.95 ISBN 0-07-006745-7

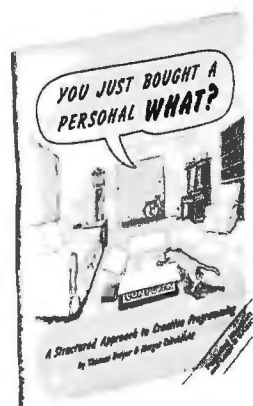
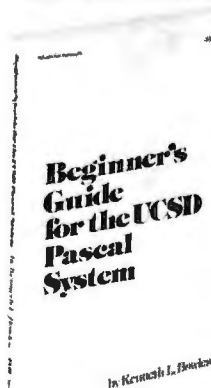

## YOU JUST BOUGHT A PERSONAL WHAT?

by Thomas Dwyer and Margot Critchfield

Whether you are a novice programmer or an experienced

computer user, this book is filled with practical ideas for using a personal computer at home or work. It will take you through the steps necessary to write your own computer programs, and then show you how to use structured design techniques to tackle a variety of larger projects. The book contains over 60 ready-to-use programs written in Microsoft and Level II BASIC in the areas of educational games, financial record keeping, business transactions, disk-based data file and word processing. \$11.95 pp. 256 ISBN 0-07-018492-5

These and other *BYTE*/McGraw-Hill books are available from *BYTE Books* or your local computer store.

Please send

\_\_\_\_\_ copies of *The BYTE Book of Pascal*

\_\_\_\_\_ copies of *You Just Bought a Personal What?*

\_\_\_\_\_ copies of *Beginner's Guide for the UCSD Pascal System*

Add 75c per book to cover postage and handling.

Name \_\_\_\_\_ Title \_\_\_\_\_ Company \_\_\_\_\_

Street \_\_\_\_\_ City \_\_\_\_\_ State/Province \_\_\_\_\_ Code \_\_\_\_\_

Check enclosed in the amount of \$ \_\_\_\_\_

Bill Visa     Bill Master Charge

Card No. \_\_\_\_\_ Exp. Date. \_\_\_\_\_

**BYTE BOOKS**    **McGraw Hill**

BYTE BOOKS Division • 70 Main Street  
Peterborough, NH 03458    B7

are identified by searching a file called VERBS, while *object words* are found in a file called NOUNS. When a match is found for a word, a code contained in the word's record is placed in the semantic pair; thus, a complete pair will contain a verb code and a noun code. If no match is found, the command interpreter prints an error message ("I DON'T UNDERSTAND THAT") and re-prompts the player.

The semantic routines actually carry out the player's command. There is one routine for each *action* which the program supports. The first number in the semantic pair (the verb code) is used as an index to the appropriate routine, and the second number (the noun code) is passed as a parameter. In the current version of CASTLE, each semantic routine must decide whether or not its particular action is allowable for the noun specified. For example, the BREAK routine knows that the crystal goblet (noun code 7) can be broken, but the sword (noun code 13) cannot. A better approach is to associate a bit string with each noun, using 1s to indicate allowable actions, and 0s to represent illegal actions.

Semantic routines currently have access to a number of item attributes. Most of these attributes are stored in a file called PROPS, which has one record for each noun code. The record contains:

- a *label*, such as "BEAUTIFUL STRING OF PEARLS", which routines may use in describing the object to the player
- the initial room *location* of the object, for use in CASTLE's initialization process (if this number is negative, CASTLE places the object randomly)
- the *value* of the object, which is used by the GET, WEAR, and DROP semantic routines for keeping track of the player's accumulated wealth
- the *weight* of the object, which is used by the GET, WEAR, and DROP routines to determine how much a player can carry.

CASTLE also maintains, in a large array, the current location of all objects.

Semantic routines may also require information on the player's location in the fantasy world. In CASTLE, the world consists of roughly one

#### Listing 1: Portion of a typical CASTLE game.

```
?LOOK
THIS IS THE KING'S CHAMBERS
THE ROOM IS DOMINATED BY A MASSIVE OAK BED, BUT ITS FURNITURE
ALSO INCLUDES A VARIETY OF LARGE CHAIRS AND CABINETS. STAIRS
IN OPPOSITE CORNERS LEAD UP AND DOWN, AND A DOORWAY LEADS WEST.
```

```
IN THE ROOM YOU SEE:
ERMINE ROBE
```

```
?GET THE ROBE
DONE.
```

```
?CLIMB THE STAIRS.
YOU ARE IN THE KING'S LOOKOUT
THE NORTH AND EAST WALLS OF THE ROOM CONTAIN A NUMBER OF SMALL
WINDOWS. A SMALL DOOR LEADS TO THE WEST. ON THE SOUTH WALL IS
A CURIOUS STONE INLAY, ROUGHLY THE SIZE OF A DOOR.
```

```
?OPEN INLAY
THAT WOULD TAKE MORE MAGIC THAN YOU CURRENTLY POSSESS.
```

```
?GO WEST
YOU ARE IN THE WIZARD'S WORKSHOP
THE ROOM IS FURNISHED WITH SEVERAL WOODEN TABLES AND BENCHES,
AND A GREAT FIREPLACE ON THE SOUTH WALL. DOORWAYS LEAD EAST
AND WEST, AND SMALL WINDOWS LOOK OUT TO THE NORTH.
```

```
IN THE ROOM YOU SEE:
GOLDEN RING
```

```
?WEAR THE RING.
AS YOU DON THE MAGIC RING, YOU ARE ENGULFED
IN A CLOUD OF THICK SMOKE. WHEN IT CLEARS...
YOU ARE IN THE DEEP FORTRESS
THIS ROOM WAS BUILT AS A 'LAST REFUGE' FOR THE INHABITANTS OF
THE CASTLE, SHOULD ITS OUTER WALLS EVER BE BREACHED BY ENEMIES.
THERE IS A MASSIVE WOODEN DOOR TO THE SOUTH, AND A DOORWAY EAST.
```

```
?EAST
YOU ARE IN THE SIEGE STOREROOM
THE LARGE ROOM IS EMPTY AND COVERED WITH DUST. ROW AFTER ROW OF
SHELVES ATTEST, HOWEVER, TO ITS ORIGINAL PURPOSE... AS A SOURCE
OF SUPPLIES IN TIMES OF SIEGE. DOORWAYS LEAD EAST AND WEST.
```

```
?EAST
YOU ARE IN THE UNFINISHED EXCAVATIONS
THE WALLS HERE ARE OF ROUGH-HEWN STONE. THE FLOOR IS UNEVEN AND
COVERED WITH BROKEN ROCKS AND RUBBLE WHICH HAVE FALLEN FROM THE
CEILING.
```

```
IN THE ROOM YOU SEE:
NASTY RED DRAGON
JEWELLED COLLAR
```

```
?ATTACK!
WITHOUT WEAPONS, THAT IS A VERY BAD IDEA!
THE NASTY RED DRAGON ATTACKS, BUT YOU ARE ONLY SLIGHTLY WOUNDED.
(COMFORTING, ISN'T IT?)
```

hundred rooms, each of which has a unique number. The numbers are used as keys into a descriptive file named MAP. Each record in the map file contains:

- the name of the room
- a one- to three-line description of the room
- a *transition array*, which lists the numbers of the rooms that can be reached by traveling in any one of the six directions which CASTLE

understands. (The first number in the array is the room reached by going north, the second by going east, etc. A value of 0 in the array indicates that there is no path in that direction.)

The primary users of the MAP file are the GO and LOOK semantic routines. LOOK uses the text in the current room's record to describe the room, while GO uses the record's transition array to determine the next

**TRS-80<sup>®1</sup> CP/M<sup>®2</sup> Business Software on . . .**  
**. . . the fastest Mod-II CP/M with the most features!!!**

- Over 610,000 bytes/disk
  - Downloading package included
  - 1,200 baud operation of serial printers without data loss
  - Single drive backup
  - Mixed single/double density on any of 4 drives (even a 1-drive system)
  - Ultra-fast disk operation
  - Emulation of cursor addressing for any of several "dumb" CRTs
  - Auto-LF printer support & ASCII top-of-form software (LPIII)
  - Supplemental document describing our implementation
  - User-settable function keys
- MOD-II CP/M** ..... \$250.00    **MOD-I CP/M** ..... \$150.00    **CBASIC2<sup>®3</sup>** (Mod I or II) ..... \$110.00

The following software for Mod-II CP/M only unless otherwise stated (\*-requires CBASIC2):

**RM/COBOL<sup>®4</sup>** - Only COBOL for CP/M with alternate keys (multi-key ISAM), CRT screen handling, interactive debug, Z80 code, and the most useful Level 2 features. **Compatible with Tandy's Cobol - but runs faster!** ..... \$495.00  
**PMS** (Property Management System) - Interactive, menu-driven system includes full G/L, budgeting, cash journal, delinquency list, tenant activity/rent roll, complete audit trail and reports on vacancies, lost rent, and vendors ..... \$650.00\*  
demo disk & manual ..... 75.00\*  
**APH** (Automated Patient History) - General-purpose question-asking, answer-printing system furnished as self-administered review-of-systems general patient history (Mod-I also) ... \$175.00\*

**MAGIC WAND<sup>®5</sup>** - Full-feature word processing, true proportional spacing, file merging, and use of full-screen editor for source programs or data ..... \$400.00  
**RPA** (Residential Property Analysis)- Analyzes income and expense, financing, taxes, inflation and depreciation on home, condo, or apartments over a user-selectable time. Shows payoff in terms of ROI, Cap rate, cash-on-cash. Amortization schedules and worksheet ..... \$300.00\*  
**RBC** (Rent/Buy Comparison) - Sales or investment tool to compare renting and savings account investment vs. purchasing a particular property ..... \$250.00\*

Osborne & Assoc. CBASIC source programs (Mod-I also):

**Payroll w/Cost Accounting** ..... \$250.00\*    **General Ledger w/Cash Journal** ..... \$250.00\*  
**Accts. Payable/Accts. Receivable** ..... \$250.00\*    **O&A CBASIC Books (ea.)** ..... \$ 20.00

Verbatim<sup>®6</sup> media: (Qty. 100 prices)

5 1/4" single density ..... \$2.50 ea.    8" single density ..... \$ 3.00 ea.  
8" certified double density ..... \$4.00 ea.    450' tape cartridges ..... \$20.00 ea.



8041 Newman Ave., Suite 208  
Huntington Beach, CA 92647  
(714) 848-1922

Registered trademark of:

- \*1 Radio Shack, a Tandy company
- \*2 Digital Research
- \*3 Compiler Systems, Inc.
- \*4 Ryan-McFarland Corp.
- \*5 Small Business Applications, Inc.
- \*6 Verbatim Corp.



Distributed in U.K. by:  
Microcomputer Applications Ltd.  
11, Riverside Court,  
Caversham, Reading, England  
TEL: (0734) 470425

# THE CONFIGURABLE BUSINESS SYSTEM™

**THE ONLY COMPLETE APPLICATION DEVELOPMENT SYSTEM**

- No Programming Experience Necessary
- User Definable Records Up To 2K Bytes
- Powerful Report Generating Capabilities
- Built-in, Self-reorganizing ISAM File Structure
- Interactive and Batch Information Processing
- Packed Fields For Efficient Disk Utilization
- System Completely Menu Driven
- Fast Execution - All Programs in 8080/Z80 Machine Code
- Easily Configured to Your CRT
- Field Proven
- Comprehensive Users Guide
- Supplied On 2-8" CP/M\* Compatible Disks

**DISKS AND MANUAL \$295.00**  
**MANUAL ALONE . . . \$ 40.00**

**DYNAMIC**  
**MICROPROCESSOR**  
**ASSOCIATES**

Dealer Inquiries Invited



Phone Orders Accepted  
N.Y. Residents Add 7% Sales Tax

36 Pinewood Drive  
Commack, N.Y. 11725  
**(516) 543-6006**

\*CP/M is a Trademark of Digital Research Corp.

# The subLOGIC FS1 Flight Simulator\*

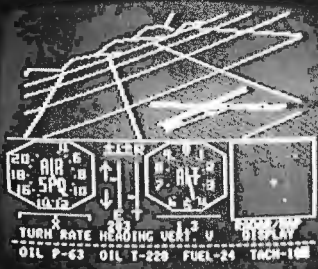

is just one  
application of  
our fine  
graphic  
software.

Other  
applications  
can be yours!

Choose from a coordinated software and hardware collection to fit your graphic needs . . .

## SOFTWARE

A23D1 animation package for the Apple II (\$45 on cassette, \$55 for disk).

8080/Z80 3D package for most S100 systems (\$41 on tarbell cassette or paper tape, \$51 on 5" North Star disk, or \$52 on 8" CPM disk).

## HARDWARE (\$100)

Matrox ALT-256 \$395  
Matrox ALT-512 \$595

Write or call for an informative catalog describing these and other graphic products and their easy use in your applications.

Most subLOGIC software is at your dealer's. If he doesn't stock it, order direct from subLOGIC. Add \$1.25 for UPS or \$1.75 for first class mail. Visa and MasterCard accepted.

\*The FS1 Flight Simulator is available for Apple II and TRS-80 Level I & II for \$25 on cassette.

(217) 359-8482

**subLOGIC**  
Box V, Savoy, IL 61874

The engineering and graphics experts.

**Listing 2: CASTLE command syntax, including examples of valid commands.** "Action words" and "object words" are any words which appear in the appropriate files. Square brackets denote an optional word; vertical lines denote a choice of one object from several.

<command> ::= <action word> [<object phrase>] [<punctuation>]

<action word> ::= (from VERB file)

<object phrase> ::= [<article word>] <object word>

<article word> ::= A | AN | THE

<object word> ::= (from NOUN file)

<punctuation> ::= . | !

EXAMPLES: GET THE GOLD! GO NORTH  
DON ARMOR LISTEN.

room that the player will enter.

For purposes of the GO routine, the words NORTH, SOUTH, EAST, WEST, UP, and DOWN are defined as object words and stored in the noun file. The routine can therefore decide which entry in the transition array to use, based on the noun code.

After the player's command has been executed by a semantic routine, CASTLE enters the event routine, which handles all periodic and random events in the fantasy world. Events are currently limited to the movements of creatures in the castle, and possible attacks by hostile creatures in the same room as the player. Other possible events include: candles burning out, magic visions which occasionally appear, or reduction of the player's load-carrying and fighting capacities due to fatigue. Depending on their type, events may occur either randomly or periodically (once every *n* turns).

Once the event routine has completed its job, control is returned to the command interpreter for the player's next command. This control loop may be exited, and CASTLE terminated, by entering a QUIT command. QUIT is simply another semantic routine which closes files, prints the player's final accumulation of wealth, and stops.

CASTLE currently has twenty-five semantic routines, the largest of which contains twenty-four lines of code. Coding was greatly simplified by the fact that the most important information is contained in the files described previously rather than being embedded in code.

Unfortunately, the heavy dependence on file access is somewhat of a

disadvantage on a typical microcomputer system. The CASTLE command interpreter currently performs sequential searches of the NOUN and VERB files. For this reason, the command vocabulary has been limited to approximately one hundred object words and sixty action words. Note that many of these words are synonyms and that the actual number of props and actions is more limited. A more sophisticated command interpreter might be designed to perform binary searches on the vocabulary files, thus allowing more words to be searched in the same amount of time.

Frequent accesses to the PROPS file also cause a noticeable delay. With sufficient main memory, a fantasy-adventure game could keep the prop information in memory-resident arrays.

In addition, more fundamental changes in the implementation could be made to greatly expand the possibilities of the game. The command interpreter could be made more sophisticated to accept a more general set of commands. The game could be modified to allow several players, who could either work together as a team, or compete for treasure. Also, the information content of the various files could be expanded, eliminating the need for game-specific logic in the program. Using such a scheme, new fantasy adventures could be created simply by replacing the files.

The real pleasure in fantasy-game development, however, is not simply the solution of programming problems, but the fact that the fantasy world the game portrays is limited only by the author's imagination. ■



# SuperBrain<sup>®</sup> Software.

	MICROSOFT	C-BASIC	PRICE
A/R	X	X	\$250.00
A/P	X	X	\$250.00
G/L	X	X	\$250.00
P/R	X	X	\$250.00
Inventory	X	X	\$250.00
Restaurant Payroll	X		\$250.00
Mailing List	X		\$150.00
Word Processing	X		\$195.00

"Industry Standard" programs on 5 1/4" diskette include source and complete professional documentation. Ready to run on SuperBrain.<sup>®</sup> One time charge, non exclusive license.



116 South Mission  
Wenatchee, WA 98801  
(509) 663-1626 Ask for wholesale division  
Also SuperBrain<sup>®</sup> computers check on prices.

® Trademark of Intertec Data Systems

## 779 UPPER CASE/lower case "Conversion Kit I"

Expand the capabilities of your 779 line printer to include word processing!! Available to all Centronics 779/TRS 80 Printer I owners is the option of lower case and changing slash 0 Zero to standard 0. No etch cuts or soldering needed. Installs in minutes with a screwdriver. No program modification or additional interface is required. **Price \$125.00**

## Motor Control "CONVERSION KIT II" FOR ALL CENTRONICS 779/TRS 80 PRINTER I LINE PRINTERS!!

Our "Conversion Kit II" Motor Controller gives your 779 the ability to turn the motor on and off automatically. Removes the annoying noise of constant run, increasing the life span of your 779 / TRS 80 line printer motor! No soldering, software or hardware changes needed. Installs easily. **Price \$95.00**

**SAVE!** Buy Service Technologies "Conversion Kit I" and "Conversion Kit II" together for the single price of **\$199.00**

To order, please send check or money order in the proper amount to:

*Service Technologies, Inc.*  
32 Nightingale Rd.  
Nashua, N.H. 03062  
(603) 883-5369

Visa and Master Charge accepted (please include signature, expiration date and phone number)

Service Technologies will pay all shipping and handling.

Call now for a quotation  
(312) 733-0497

## U.S. ROBOTICS, INC. 1035 W. LAKE ST. CHICAGO, ILL. 60607

Connect your TRS-80, Apple or ANY other computer to the phone lines with the...

### The 550 BANTAM from Perkin-Elmer



\$799

#### All the features of the Hazeltine 1400 & LSI ADM-3A plus

- Upper/Lower Case
- 7x10 Character Matrix
- White or Black Characters
- Transparent Mode
- Addressable Cursor
- Tab Function
- Backspace Key
- Shiftlock Key
- Print Key
- Integrated Numeric Pad
- Editing Functions
- Extremely Compact: 15" W x 19" D x 14" H
- Silent fan-free operation

All products in stock!

### LA34 DECwriter IV



\$1199

- Tabs
- 132 columns
- 10, 12, 13.2, 16.5 characters/inch
- 2, 3, 4, 5, 8 or 12 lines/inch
- Optional tractor feed
- 110 or 300 baud
- RS232C/ASCII
- Friction feed/up to 15" wide paper
- 9x7 dot matrix, impact printing
- Upper/lower case

### Teletype Model 43 KSR \$1049

- 110 or 300 baud
- RS232C/ASCII
- Pin feed/8 1/2" H x 11" W paper is perfect for filing and copying.

### PENRIL 300/1200 MODEM

Originate/Auto-Answer



\$799

- 0-300 or 1200 baud
- Bell 212A & 103/113 compatible
- 1 year warranty
- Stand alone
- RS232
- Full duplex over voice grade phone lines
- FCC certified for direct connection to phone lines via RJ11C voice jack (standard extension phone jack)

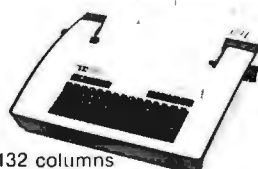

- 132 columns
- Upper/lower case, true descenders
- Dot matrix, impact printing

### USR-330 Originate/Auto-Answer Modem



\$339

FCC certified for direct connection to phone lines via standard extension phone jack

- 0-300 Baud
- Bell 103/113 compatible
- Stand Alone
- RS232
- 1 Year Warranty
- Crystal Controlled
- State of the Art LSI circuitry
- 5 stage active filters

### USR-310 Originate Acoustic Coupler



\$159

# The Working Analyst.

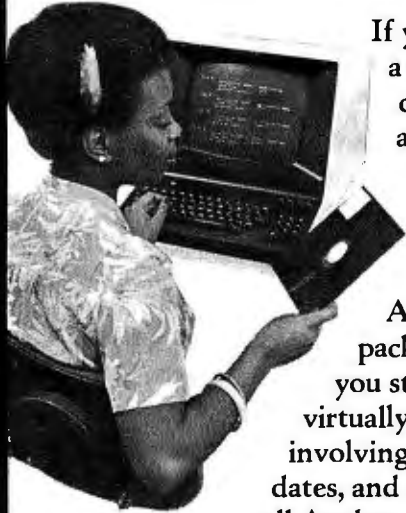

If you would like to put a computer to work collecting, organizing, and summarizing the information you need to make better decisions, take a look at Analyst.

Analyst is a software package designed to let you store and analyze virtually any information involving numbers, dollars, dates, and descriptions. Simply tell Analyst what kind of information

you want to store. Analyst creates a computerized file for that information. And Analyst creates an information entry program for your file that asks you for each entry, and checks your data for errors. (You can create any number of different files.)

Then tell Analyst what reports you want from your data file. There are all sorts of record selection and report formatting options, so you can design an unlimited variety of reports to focus on different aspects of the same data file.

Analyst is so flexible, you'll find a million ways to use it. It is easy to use, so you don't need to be a programmer to make your computer really work for you. If this bit of information intrigues you, find out the rest. You'll like what you see.

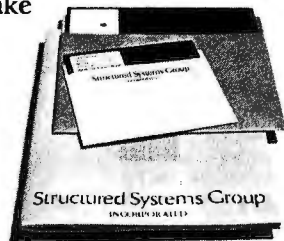

Analyst is a part of a full line of working software solutions from Structured Systems Group, all ready to run on any CP/M\* microcomputer system. For more information, see your computer retailer, or call us.

\*CP/M is a trademark of Digital Research.

## Structured Systems

5204 Claremont Oakland, Ca. 94618 (415) 547-1567

## Technical Forum

### Some More on Performance Evaluation

Notes by Carl Helmers

In a recent issue of BYTE, there was an article by James R Lewis entitled "TRS-80 Performance, Evaluation by Program Timing" (March 1980 BYTE, page 84). The article reported on the speed of execution of a program that calculates prime numbers. The technique of calculation was admittedly simplistic and inefficient. However, such a brute-force method is often useful in checking performance. By obtaining a significant time interval, measurement becomes easy.

The article produced a flurry of letters on various subjects. First, readers should note that a typographical error was made in listing 3 (on page 84). Statement 100 should read:

```
100 IFINT(M/K)*K=MTHENNEXTM
```

This is a highly compressed statement chosen for optimal speed when the interpreter executes it. The published version of this program had a letter "M" substituted for the second letter "K." This typo was pointed out by R B Nottingham of Deerfield Beach, Florida, and several others.

Mr Nottingham was one of several people who suggested speeding up the algorithm in various ways. He suggested using the fact that a prime number is a number which does not have an integral divisor that is less than its square root. Since the square root of a number  $N$  is much less than  $N/2$  for large  $N$ , this cuts down the time considerably.

But the goal of the exercise was not to code the most efficient algorithm. It was, rather, to code an algorithm that takes a measurable amount of time while performing a certain group of calculations. For the record, Mr Nottingham found that when he changed line 30 of listing 3 to:

```
30 FORM=3TOSQR(M)STEP2
```

the time requirements were reduced from the 6 hours, 31 minutes reported in Mr Lewis' article to approximately 20 minutes. However, this reduction is caused by a redesign of the program, not by any increase in computing power, which after all was the factor being measured. Similar reductions would be expected on any computer. This algorithm improvement was also suggested by John C Miller of New York, New York.

In another letter from New York, Donald Stevens reports on his findings running Mr Lewis' algorithm in FORTRAN and in the machine language of an ELF computer. The FORTRAN version was run on two Control

Data Corporation (CDC) machines with compiler optimization level 1. On a CDC 6600, the FORTRAN version took 17 seconds; on a CDC 7600 the FORTRAN version took 2.6 seconds. The machine-language program running on an ELF-II (ie: a CDP1802 microprocessor) took 37 minutes.

In the same vein, Charles H Porter, of Jackson, Michigan, provides us with listing 1, which was accompanied by the following letter:

*I own a TRS-80 and found your March article by James R Lewis ("TRS-80 Performance, Evaluation by Program Timing") interesting. It answered my own questions about performance.*

*I disagree with the implications of his conclusion, however. By implication: if you need the speed, then code in assembler.*

*My point is this, if you need faster performance, examine first the program design. The program of listing 1 lists all prime numbers less than 10,000. I wrote it from scratch in less than an hour. It is written in BASIC and executes in 6 minutes and 16 seconds as compared to Lewis's 22-minute execution of the assembler program.*

*Assembler code will undoubtedly execute the same logic faster than BASIC, but better logic is often the answer.*

**Listing 1:** This program, submitted by Charles Porter, is probably a better prime-number finder than that provided by James R Lewis on page 84 of the March 1980 BYTE. But the fact that it is more efficient (qua prime-number finding) is a side issue to benchmarking with a known algorithm. Its 6-minute execution time compares very favorably with the 6.5 hours taken by one version of James Lewis' algorithm on the same Radio Shack TRS-80 computer.

```

10 S$ = RIGHT$(TIME$,8)
20 ON ERROR GOTO 120
30 DEFINT A-Z
40 L = 10000
50 L1 = L + 1
60 DIM A(L1)
70 FOR I = 2 TO L : A(I) = 1 : NEXT
80 X = 2
90 FOR I = 2 * X TO L STEP X : A(I) = 0 : NEXT
100 X = X + 1
110 IF A(I) = 0 THEN 100 ELSE 90
120 FOR I = 2 TO L
130 IF A(I) <> 0 THEN PRINT I
140 NEXT
150 PRINT "START "; S$
160 PRINT "STOP "; RIGHT$(TIME$,8)
170 END

```

Note sample output below.

```

2
3
5
7
11
.
.
.
9973
START 00:45:48
STOP 00:52:04

```

## Multi-User North Star Horizon Hard Disk Computer Systems

Interrupt-driven, bank-switching timesharing, developed by Micro Mike's, Inc. for the North Star Horizon computer, has been mated to Micro Mike's hard disk operating system.

As many as *four* 26.5 megabyte (formatted) Winchester-type, sealed-media Shugart hard disk units can provide users access to as much as 106 megabytes (formatted) of stored information *in a flash*. Micro Mike's timesharing/hard disk operating system, **TIMESHAVER**,<sup>®</sup> allows as many as *seven* users per timesharing computer system, each user *simultaneously* running a different program.

The programming staff of Micro Mike's has written a wide variety of comprehensive business application programs in North Star BASIC, based around a set of defined Common SUBroutines (CSUB). Most programs are available separately or are included in Micro Mike's Program Library.

### IN STOCK:

North Star Horizon computers

Zenith Z 19 intelligent (Z80-based) terminals

Printers: NEC Spinwriter, Texas Instruments TI 810, IDS-440 Paper Tiger

Shugart 26.5 megabyte (formatted) hard disk units with S-100 controller card for North Star<sup>®</sup> systems

Call or write for details and descriptive literature.

*Mike's* **Micro Mike's, Inc.**  
905 South Buchanan  
Amarillo, Texas 79101 \*USA\*  
telephone: 806-372-3633

*making technology uncomplicated . . . for People*

Copyright 1980 Micro Mike's, Inc. All Rights Reserved Worldwide.

### INTRODUCING



MULTIPLE APPLICATION PROCESSING SYSTEMS

## MP/M<sup>™</sup> USERS GROUP

Digiac Corporation, a major manufacturer and supplier of automated Educational Training Systems, is proud to announce the formation of MAPS, a **National MP/M Users Group** which will provide all MP/M users with a vehicle to exploit MP/M's benefits.

### MP/M SUPPORT PRODUCTS

Digiac is supporting MP/M with a series of exclusive S100 products:

- **Universal MP/M Support Module**
- **MP/M XIOS Configurations for popular Disk Systems**
- **MP/M Multibank Memory Module**
- **CT-80 Multi-Workstation System**

For Additional Information:  
Contact Lorraine Keckeisen  
**MAPS**

Commercial Products Div.  
**DIGIAC CORPORATION**  
175 Engineers Road  
Smithtown, New York 11787  
Phone (516) 273-8600

MP/M is a trademark of the Digital Research Corporation



Discover Savings and Service with

# EBS

MAIL ORDER DIVISION

ORDER TOLL FREE



**Cromemco**  
incorporated  
Tomorrow's Computers Today

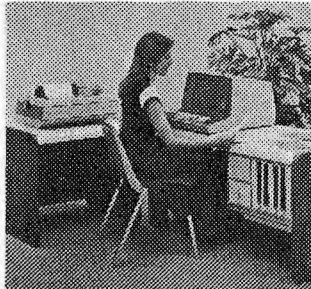

ALL CROMEMCO  
SYSTEMS NOW HAVE  
DOUBLE CAPACITY!

SYSTEM 3 1 Mbyte	5445.
SYSTEM 2	3190.
Z-2H 11 Mbyte	8445.
HDD-11 11 Mbyte	5945.
HDD-22 22 Mbyte	9995.
3102 CRT	1695.
3779 PRINTER	1270.
3703 PRINTER	2545.
3355 PRINTER	2715.
SCC	380.
BYTESAVER II	210.
ZPU	335.
4FDC	420.
64KZ	1510.
TU-ART	250.
Z3-SDSK	335.
Z3-MDSK	590.

**SOFTWARE**

CBASIC2 ver 2.05	85.
------------------	-----

**EBS G/L ACCOUNTING SYSTEM**

GENERAL LEDGER	400.
ACCTS. PAYABLE	500.
ACCTS. RECEIVABLE	500.
PAYROLL (Calif.)	600.
INVENTORY	200.
ORDER ENTRY	200.
MAILING LIST	100.

Manuals included  
Requires dual disk/48K 24x80  
CRT with curs and/or CBASIC2  
and CP/M or CDOS

**11 MEGABYTE HARD DISK BUSINESS SYSTEM**

CROMEMCO Z-2H  
CROMEMCO 3102 CRT  
CROMEMCO 3703 PRINTER  
EBS G/L ACCT. SYSTEM  
10 DISKETTES  
1 BOX FANFOLD PAPER  
Z3-MDSK DESK  
CBASIC2

ONLY

**\$15,500**

Over \$17,600 List Price

TERMINALS		PRINTERS	
SOROC IQ120	750.	BASE-2	499.
SOROC IQ140	1150.	with tractor	599.
TELEVIDEO 912B	780.	CENTRONICS 704-1	1795.
TELEVIDEO 912C	830.	CENTRONICS 703-2	2375.
TELEVIDEO 920B	805.	CENTRONICS 779-1	995.
TELEVIDEO 920C	855.	CENTRONICS 779-2	1095.
ADDS REGENT 25	925.	QUME SPRINT 5 RO	2650.
PERKIN ELMER 550	785.	includes power supply	

PERSCI 277	1195.	TEK COM COUPLER	175.
with eject options	1345.	acoustic, originate only	

**WE ALSO OFFER:**

- Complete analysis of your system needs
- Installation, training, support & maintenance
- Custom applications software

AT OUR REGULAR CONSULTING RATES  
Phone inquiries welcome

## EXECUTIVE BUSINESS SYSTEMS

20457 E. Valley Blvd., Walnut, CA 91789  
(714) 594-5736

**TO ORDER:** COLLECT PHONE ORDERS welcome or send check or M.O. Please include phone number. Personal or Co. checks require two weeks to clear. Items in stock will be shipped next business day upon receipt of certified funds. Within Calif. add 6% sales tax. All prices and offers subject to change without notice.

**SHIPPING:** We ship freight collect by UPS when possible. Larger items shipped by motor freight. Air and express delivery available.

CDOS<sup>®</sup> Cromemco, Inc.  
CP/M<sup>®</sup> Digital Research      CBASIC<sup>™</sup> Compiler Systems

**Listing 2:** The Pascal version of James R Lewis' simple prime-number finder. This program was converted to Pascal by Jim Nelson, of Westlake Village, California. Jim measured a time of 1 hour, 17 minutes for the execution of this version.

```
PROGRAM primes;

VAR
  k,m : INTEGER;

PROCEDURE is_it_prime;
BEGIN
  k := 3;
  WHILE (m MOD k <> 0) AND (k <= m DIV 2) DO
    BEGIN
      k := k + 2
    END;
  IF (m MOD k <> 0) THEN WRITELN('Prime No. = ',m)
  END (is_it_prime);

BEGIN (primes)
  m := 5;
  REPEAT
    is_it_prime;
    m := m + 2
  UNTIL m = 9999;
  WRITELN('Done Finally !!!')
END. (primes)
```

This program employs a table to cut the number of iterations even further. Mr Porter's program takes a mere 6 minutes and 16 seconds. But again, this is a different algorithm and comparisons of time reflect on the quality of the algorithm, not the effectiveness of the computer.

Keeping this point in mind, we received a letter (including listings) from Jim Nelson of Westlake Village, California, which presents some timings for various Apple II system-software configurations. He found that a version similar to the program of listing 3 from Mr Lewis' March article ran in 3 hours, 56 minutes on an Apple II using Applesoft floating-point BASIC. A version of Mr Lewis' algorithm run in Apple Integer BASIC was measured at 1 hour, 49 minutes by Mr Nelson. And finally he measured a version written in Apple Pascal at 1 hour, 17 minutes. Mr Nelson's Pascal version of the algorithm is shown here in listing 2.

The comparison made by Mr Nelson is certainly valid within the context of a performance evaluation. He used the same algorithm under different systems. Here there is a realistic and objective measure of time required in different hardware and system software. Everything is kept as constant as possible, so that the difference in one particular area (here, speed of execution of the program) is highlighted. By keeping a known algorithm while varying the computer system's configuration, the effects of hardware and system software are truly measured.

What can we conclude from all this? For one thing, it is now about time to consider performance evaluation with a little more emphasis. The personal computing field has now become sufficiently large that serious comparison is possible. People who look into performance evaluation on a formal basis often create one or more sets of "typical" test programs which evaluate some aspect of computer performance. Mr Lewis' factorial algorithm is an example of such a test of the execution-time performance of various language tools on two examples of computer processors. It is an excellent quick test (especially if the iteration count is reduced to 1000), which can be incorporated into one's bag of tricks when trying out a computer system in a store or at a trade show.

There are many such simple performance evaluations possible. I, for one, have two favorites. First, for text editors, how long does it take (worst case) to execute 100 search-and-replace operations, changing a 10-character string into an 11-character string within a file of 10,000 characters? By "worst case" I mean starting the operation so that the maximum number of characters has to be "moved" in the first replacement. My second favorite performance evaluation is the time it takes for a floppy-disk system to copy a 10,000-character file using an operating-system file-handling utility program.

These are just examples of simple performance tests. To help us define a suite of such tests, I ask that you send us *your* favorite test. Each benchmark routine should be appropriate to the typical language and operating-system environment of the contemporary small computer. It should be easily adaptable to other comparable languages and systems. Using such reader interaction, we should be able to come up with a compilation of "favorite benchmarks." It is our intention to define such a group of favorite benchmarks as part of increased editorial attention to performance evaluation.

Let us know what you think about the idea by sending your comments to:

Favorite Benchmarks  
Editorial Office  
BYTE Publications, Inc  
70 Main St  
Peterborough NH 03458 ■

# SPECTACULAR Introductory Offers

BASF "FLEXIDISK" Superior quality data storage medium, certified and guaranteed 100% error free.

5 1/4" Diskettes 10 @ \$24.00  
8" Disks 10 @ \$24.00  
Vinyl storage pages 8" or 5 1/4" 10 @ \$ 5.00

Write for quantity discounts



SFD CASSETTES "Super Ferro Dynamic" Using the finest Agfa PE 611 tape in a professional quality housing.

C-10 Sonic weld housing 10 @ \$7.00  
C-10 5 Screw housing 10 @ \$8.00  
Cassette album page \$1.89

Write for quantity discounts



LIBRARY CASE 3 ring storage album. Protects your valuable programs on disks or cassettes.

Library 3 ring binder \$6.50  
5 1/4" Kas-ette \$2.49  
8" Kas-ette \$2.99

Write for quantity discounts



PMC Power Consoles UL listed. 15 Amp circuit breaker. 3 prong outlets. Optional surge suppression and RFI filtration.

# 1 Main indicator lamp and AC switch. 5 outlets. \$ 43.50  
#10 as above, but with individual indicator lamps and switches, and Surge Suppression \$ 69.50  
#23 Same as #10, 3 outlets with RFI filtration, and shielded AC cord. \$145.00  
Other models starting @ \$28.50

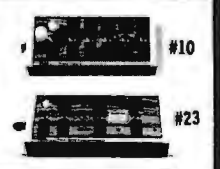

**ABM PRODUCTS**  
631 "B" ST.  
S.D., CA 92101

VISA. MASTERCHARGE. MONEY ORDER. CERTIFIED CHECKS. FOR PERSONAL CHECKS ALLOW 2 WEEKS. C.O.D. REQUIRES A 10% DEPOSIT. CAL. RES. ADD 6% SALES TAX. \$2.00 SHIPPING AND HANDLING PER ORDER. MIN. ORDER \$10.00 SATISFACTION GUARANTEED OR FULL REFUND.

# FANTASTIC MAIL ORDER DISCOUNTS!!!

**apple computer**

**16K\* \$959**

\*ADD 2% IF USING CREDIT CARD ONLY ON APPLE COMPUTERS APPLE II OR APPLE PLUS

APPLE II 32K \$1040\* APPLE II 48K \$1100\*

### APPLE II ACCESSORIES

- |   |   |
|---|---|
| CORVUS 10 MEGABYTE DISK DRIVE..... \$4650 | SUPER TALKER SPEECH SYNTHESIZER.....259   |
| PASCAL LANGUAGE SYSTEM..... 445           | ROMPLUS CARD w/KEYBD. FLTR..... 179       |
| GRAPHICS INPUT TABLET..... 675            | HEURISTICS SPEECHLINK 2000..... 225       |
| DISK II with CONTROLLER CARD..... 495     | DC HAYES MICROMODEM II..... 335           |
| DISK II without controller..... 440       | ALF MUSIC SYNTHESIZER..... 245            |
| APPLE SOFT II FIRMWARE CARD..... 155      | SSM A10 CARD (KIT)..... 129               |
| INTEGER FIRMWARE CARD..... 155            | SSM A10 CARD (ASSEMBLED)..... 170         |
| PARALLEL INTERFACE CARD..... 155          | NOVATION CAT MODE M..... 159              |
| SERIAL INTERFACE CARD..... 160            | COS GP16 IEEE INTERFACE..... 289          |
| COMMUNICATIONS CARD..... 190              | MICROSOFT T-2-80 SOFTCARD w/CP/M..... 349 |
| SUP-R-TERM 80 col. CARD..... 25           | MICROWORKS DS-65 DIGISECTOR..... 349      |
| SUP-R-TERM 80 col. CARD..... 349          | ROMWRITER..... 159                        |
| DAN PAYMAR Lower case kit..... 345        | SYMTEC LIGHT PEN CARD..... 229            |
| SV-8" DISK CONTROLLER CARD..... 349       | COS PROGRAMMABLE TIMER MODULE..... 159    |
| CCS ARITHMETIC PROCESSOR CARD..... 449    | CENTRONICS PRINTER INT. CARD..... 190     |
| CLOCK/CALENDAR CARD..... 239              | SILENTYPE PRINTER W/INT. CARD..... 529    |
| INTROL X-10 SYSTEM..... 239               |   |

### SOFTWARE

- |  |                                    |
|--|------------------------------------|
| PASCAL LANGUAGE SYSTEM..... \$445        | APPLEWRITER WORD PROCESSOR..... 69 |
| FORTRAN LANGUAGE PACKAGE..... 175        | VISI-CALC..... 125                 |
| THE CONTROLLER GEN. BUS. SYSTEM..... 529 | SARGON II on Disk..... 35          |
| THE CASHIER RETAIL MGT. & INV..... 209   | SUPER INVADER On Disk..... 25      |
| APPLEPOST MAILING LIST SYSTEM..... 45    |                                    |

WE WILL GLADLY PERFORM WARRANTY REPAIR ON ALL APPLE COMPUTER PRODUCTS.

**MONITORS**

**LEEDEX VIDEO 100**  
12" BLACK & WHITE MONITOR  
•VIDEO BANDWIDTH 12 MHz±3db  
•COMPOSITE VIDEO INPUT

**\$139** SOROC IQ 120 \$739  
SOROC IQ 140 \$1295

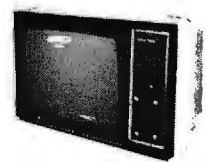

SANYO 9" B/W Monitor \$169 • SANYO 15" B/W Monitor \$259 • ZENITH 13" Color Monitor \$429

### PRINTERS

- |  |                          |
|--|--------------------------|
| PAPER TIGER ITS 440 w/graphics..... \$1050 | NEC SPINWRITER..... 2695 |
| TRENDCOM T-200..... 559                    | AXIOM EX-801..... 495    |
| CENTRONICS 737..... 850                    | AXIOM EX-820..... 750    |
| CENTRONICS 700-9..... 1149                 | COMPRINT 912S..... 599   |
| ANADEX DP-8000 OH AP..... 850              | COMPRINT 912P..... 559   |
| MP188-T..... 725                           | TRENDCOM T-100..... 349  |

### THE AMAZING SORCERER™ II 16K

The SORCERER is a 286 CPU based micro-computer internally expandable to 48K, 4K ROM resident monitor. I/O connector for S-100 expansion (Parallel and serial interface. Dual cassette I/O. Graphic resolution of 240 x 512. 30 lines of 64 characters. 8 x 8 dot matrix. Full ASCII set (upper and lower case), plus standard graphic symbols. User may define up to 128 characters. Keyboard is 63-key data processing type, plus a 16 key numeric keypad.

**\$995**



S-100 EXPANSION UNIT \$399  
WORD PROCESSOR PAC..... 189  
DEVELOPMENT PAC..... 99  
WE ALSO SELL "QUALITY SOFTWARE" FOR SORCERER AT 10% OFF LIST!

32K 1,145.00 48K 1,295.00

**ATARI 800**



**\$799**

A Warner Communications Company

- |                                    |                                      |
|------------------------------------|--------------------------------------|
| ATARI 400COMPUTER..... \$469       | BASKETBALL..... 30                   |
| ATARI 1200PRINTER..... 489         | VIDEASEL..... 30                     |
| ATARI 810DISK DRIVE..... 579       | SUPER BREAKOUT..... 30               |
| ATARI 410 PROGRAM RECORDER..... 69 | MUSICOMPOSER..... 45                 |
| ATARI 128 RAM MODULE..... 149      | COMPUTER CHESS..... 30               |
| ATARI 8 RAM MODULE..... 99         | 3D TIC TAC TOE..... 30               |
| ATARI BASICROM..... 45             | STAR TRAKERS..... 45                 |
| ASSEMBLER/EDITOR..... 45           | PERSONAL FINANCE..... 6              |
| *High resolution COLOR Graphics    | *Built-in RF TV modulator            |
| *10K Basic in ROM                  | *High speed serial I/O port          |
| *8K user RAM expandable to 48K     | *Includes ATARI 410 program recorder |
| *57 key full stroke keyboard       |                                      |

### • TO ORDER •

Phone orders invited, using credit cards. Or send cashiers check or money order that draws on a U.S. bank. Please add 3% (\$5.00 Minimum) for handling, shipping (air service) and insurance, or equipment will be shipped freight collect. California residents add 6% sales tax. All equipment is in factory cartons with the manufacturers warranty. Equipment is subject to price change and availability without notice.



**COMPUTER SPECIALTIES**

6363 EL CAJON BLVD., SUITE 205,  
SAN DIEGO, CA. 92115 • (714) 579-0330

# Clubs and Newsletters

## Z80 Microfans

Z80 Microfans is a group of Sorcerer computer owners based in Portland, Oregon. The purpose of the club is to share skills and programs as well as software and hardware problem solutions. A monthly newsletter is published with emphasis

on Sorcerer projects. The club meets twice a month, on the second and fourth Wednesday. Memberships are available to Portland area residents. Newsletter subscriptions are available to anyone for \$8 per year. A program exchange library is also available to all members. Classes are offered

in programming in BASIC and Z80 assembler languages. For further information, contact the Secretary, POB 12504, Portland OR 97212.

## CHIP-S Club

The CHIP-S Microcomputer Club meets on the

fourth Thursday of the month at 7:30 PM at Baker Hall, GE Electronics Park, Liverpool, New York. The club is open to anybody interested in microcomputers. All inquiries should be sent to CHIP-S Microcomputer Club, POB 504, Syracuse NY 13201.

## TI 990/189 Users—Unite

Fernand Barbeau, 250 Blvd de la Colline, Neufchatel, Qué, G2A 2E3, Canada, is looking for other enthusiastic users of the Texas Instruments' 990/189 system. If anyone would like to form a club or simply exchange information, ideas, programs, and other information, please contact Monsieur Barbeau.

## Apple Group in Indiana

Based in Lafayette, Indiana, The Greater Lafayette Apple User Group meets at 7 PM on the second Wednesday of each month at Digital Technology, 10 N 3rd, in Lafayette. The group supports a library of software and is interested in exchanging programs with other groups or individuals. One of the goals of the group is teaching its members about Apple II programming techniques. Programming workshops are held at each monthly meeting. There are no dues, but a small charge of \$0.50 is assessed for copying a disk from the library. For details, write or call The Greater Lafayette Apple User Group, Digital Technology, 10 N 3rd, Lafayette IN 47901, (317) 423-2548.

## Newsletter for Polymorphic Users

The Southeastern PolyMorphic Users Group announces their new publication, *PolyLetter*, a

# INTELLIGENT MODEM

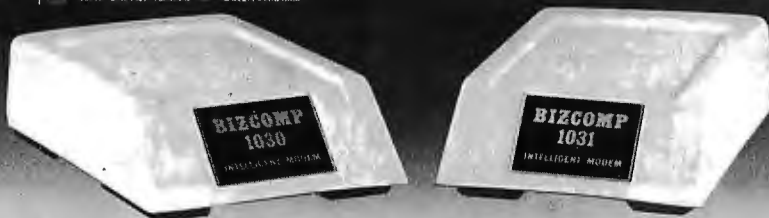

## Eliminate The Data Comm Hassles of Outmoded "DUMB" Modems

BIZCOMP's Intelligent Modem is new. Brand new. It teams a Bell 103-type "dumb" modem with a custom BIZ-080 microcomputer in an attractive desk-top enclosure. RESULT: Incredibly simple data comm for professional users. No more mad dash to get a handset into coupler muffs before being disconnected by the remote. No more exclusion-key telephone needed to do the dialing. No more outboard coupler boxes. And for computer sites, communications software written in high level language like BASIC or COBOL. How's that for simplicity!

The 1030 gives you automatic dial, automatic answer and, unique to the industry, automatic REPEAT dial. The top-of-the-line 1031 adds command-selectable tone or dial pulse dialing for TWX net applications and self-test for ensuring full functionality. Both models are FCC registered for direct connection and feature comm rates from 110, 134.5, 150, 200 to 300 baud. BIZCOMP's innovative Code-Multiplexed Design enables complete control using a simple 3-wire RS-232 interface. Don't burden your customers with data comm hassles. Install a BIZCOMP Intelligent Modem today.

**BIZCOMP Communications...**  
**Why not start with the best?**

# BIZCOMP

P.O. Box 7498 • Menlo Park CA 94025 • 415/854-5434

Suggested prices from \$395.00

Patent Pending

# DECwriter® GRAPHICS

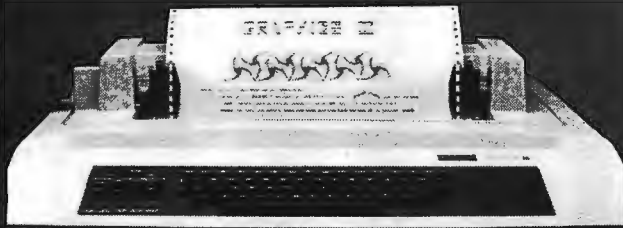

## Graphics II™ converts your DECwriter® to a plotter . . . . . . and a whole lot more!!

- Vector graphics (automatic line generator)
- 1320 x 792 dots per page
- Bi-directional *line feed*
- Multiple character sets (includes APL)
- Variable character styles
- Multiple interfaces including RS232
- Prints at 40 Characters/second
- Communicate up to 1200 BAUD
- 1000 character buffer with x-on/x-off
- Easy to install & plug compatible
- No mechanical changes required
- Raster graphics option
- Software option
- Time share compatibility

Graphics II for the DECwriter II does everything your old DECwriter did . . . and a whole lot more!!

Call or write today for more information



**SELANAR Corporation** (408) 727-2811  
2403 De La Cruz Blvd. Santa Clara, CA 95050

DECwriter is a registered trademark of Digital Equipment Corporation



# compas microsystems

*There is nothing like a*  
**DAIM**

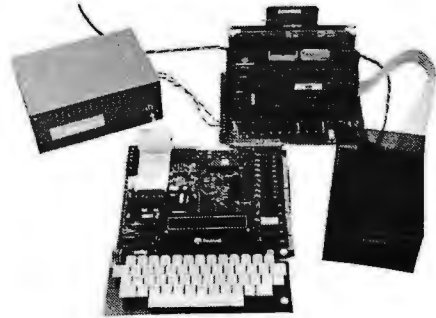

A complete disk system for the Rockwell Aim 65. Uses the Rockwell Expansion Motherboard. Base price of \$850 (U.S.) includes controller with software in Eprom, disk power supply and one packaged Shugart SA400 Drive.

224 SE 16th St.  
P.O. BOX 687

AMES, IA 50010  
(515) 232-8187

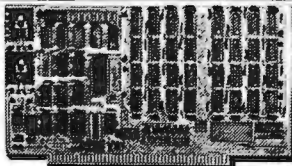

**64K BYTE EXPANDABLE RAM**  
DYNAMIC RAM WITH ONBOARD TRANSPARENT REFRESH GUARANTEED TO OPERATE IN NORTHSTAR, GROMEMCO VECTOR GRAPHICS, SOL, AND OTHER 8080 OR Z-80 BASED S100 SYSTEMS \* 4MHZ Z-80 WITH NO WAIT STATES.  
\* SELECTABLE AND DESELECTABLE IN 4K INCREMENTS ON 4K ADDRESS BOUNDARIES.  
\* LOW POWER—8 WATTS MAXIMUM  
\* 200NSEC 4116 RAMS.  
\* FULL DOCUMENTATION.  
\* ASSEMBLED AND TESTED BOARDS ARE GUARANTEED FOR ONE YEAR AND PURCHASE PRICE IS FULLY REFUNDABLE IF BOARD IS RETURNED UNDAMAGED WITHIN 14 DAYS.

	ASSEMBLED / TESTED
64KRAM	\$595.00
48K RAM	\$529.00
32K RAM	\$459.00
16K RAM	\$389.00
WITHOUT RAM CHIPS	\$319.00

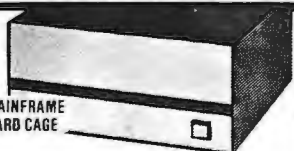

\$100 MAINFRAME AND CARD CAGE

- \* W/ SOLID FRONT PANEL \$239.00
- \* W/ CUTOUTS FOR 2 MINI-FLOPPIES \$239.00
- \* 30 AMP POWER SUPPLY \$119.00
- \* 8 SLOT MOTHERBOARD \$149.00
- \* 19 SLOT MOTHERBOARD \$199.00



**VISTA V-200 MINI-FLOPPY SYSTEM**  
\* S100 DOUBLE DENSITY CONTROLLER  
\* 204 KBYTE CAPACITY FLOPPY DISK DRIVE WITH CASE & POWER SUPPLY  
\* MODIFIED CPM OPERATING SYSTEM WITH EXTENDED BASIC \$695.00  
\* EXTRA DRIVE, CASE & POWER SUPPLY \$395.00

### 16K X 1 DYNAMIC RAM

THE MK4116-3 IS A 16,384 BIT HIGH SPEED NMOS. DYNAMIC RAM. THEY ARE EQUIVALENT TO THE MOSTEK, TEXAS INSTRUMENTS, OR MOTOROLA 4116-3.  
\* 200 NSEC ACCESS TIME. 375 NSEC CYCLE TIME.  
\* 16 PIN TTL COMPATIBLE.  
\* BURNED IN AND FULLY TESTED.  
\* PARTS REPLACEMENT GUARANTEED FOR ONE YEAR.  
\$8.50 EACH IN QUANTITIES OF 8

## BETA COMPUTER DEVICES

1230 W. COLLINS AVE.  
ORANGE, CA 92668  
(714) 633-9280

Call, residents please add 8% sales tax. Mastercharge & Visa accepted. Please allow 14 days for checks to clear bank. Phone orders welcome. Shipping charges will be added to all shipments.

### 32K BYTE MEMORY

RELIABLE/COST EFFECTIVE EXPANDABLE RAM FOR 6502 AND 6800 SYSTEM—AIM 65-\*KIM\*SYM\*PET\*S44-BUS  
\* PLUG COMPATIBLE WITH THE AIM-65/SYM EXPANSION CONNECTOR BY USING A RIGHT ANGLE CONNECTOR (SUPPLIED) MOUNTED ON THE BACK OF THE MEMORY BOARD.  
\* MEMORY BOARD EDGE CONNECTOR PLUGS INTO THE 6800 S 44 BUS.  
\* CONNECTS TO PET OR KIM USING AN ADAPTOR CABLE.  
\* RELIABLE—DYNAMIC RAM WITH ON BOARD INVISIBLE REFRESH—LOOKS LIKE STATIC MEMORY BUT AT LOWER COST AND A FRACTION OF THE POWER REQUIRED FOR STATIC BOARDS.  
\* USES +5V ONLY, SUPPLIED FROM HOST COMPUTER.  
\* FULL DOCUMENTATION. ASSEMBLED AND TESTED BOARDS ARE GUARANTEED FOR ONE YEAR AND PURCHASE PRICE IS FULLY REFUNDABLE IF BOARD IS RETURNED UNDAMAGED WITHIN 14 DAYS.

ASSEMBLED WITH 32K RAM	\$419.00
& WITH 16K RAM	\$349.00
TESTED WITHOUT RAM CHIPS	\$279.00
HARD TO GET PARTS (NO RAM CHIPS)	
WITH BOARD AND MANUAL	\$109.00
BARE BOARD & MANUAL	\$49.00

PET INTERFACE KIT—CONNECTS THE 32K RAM BOARD TO A 4K OR 8K PET. CONTAINS: INTERFACE CABLE, BOARD STANDOFFS, POWER SUPPLY MODIFICATION KIT AND COMPLETE INSTRUCTIONS. \$49.00

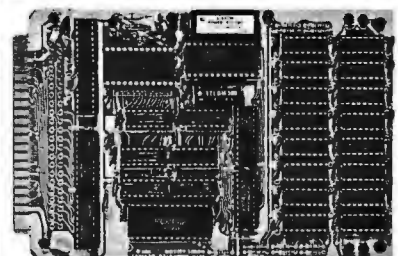

newsletter for the PolyMorphic computer. *PolyLetter* features program reviews, program listings, helpful hints, PEEK and POKE locations, want ads, and articles written by users. *PolyLetter* is not affiliated with PolyMorphic Systems in any manner. It is available for \$5 per year to nonmembers from *PolyLetter*, 207 Marray Dr, Atlanta GA 30341, (404) 458-9711.

### Computer-Using Educators

Computer-Using Educators (CUE) has been in existence since early 1979. They now number nearly 300 and have a large executive committee to plan and implement activities. They are working on the coming Asilomar 1980 annual meeting of the California Mathematics Council. CUE is also utilizing the Computer Van from Commodore. The van is a traveling teaching aid that is out-

fitted with 12 computers. The van travels on a reservation basis between schools, allowing students the opportunity to work on computers. CUE is also busy setting up a software exchange center for educators. Their newsletter contains articles on current projects, events, notes from meetings, computer-aided instruction (CAI), reviews of products and educational journals that deal with the use of computers. There are a number of useful ads and notices for educators in the newsletter. CUE is an affiliate of the International Council of Computer Educators. The membership dues are \$4 payable each September. For details, contact Computer-Using Educators, Mountain View High School, Mountain View CA 94041.

### Computer Careers News

If you are a systems analyst, programmer, or

computer scientist, you can receive a free subscription to *Computer Careers News*. Edited for working-level computer professionals, *Computer Careers News* is filled with advertisements from companies seeking programmers and data processing experts. There are articles that assist computer professionals to find the proper type of employment for their particular needs. For a subscription, write *Computer Careers News*, 708 Third Ave, New York NY 10017.

### Computerists of the North

The Sault Ste Marie and Area Computer Hobbyist Group has recently been formed. It meets on the third Tuesday of each month at various locations. For information, contact Jack Decker, 1804 W 18th St, Lot# 155, Sault Ste Marie, MI 49783, (906) 632-3248.

### Japan Micro-Computer Club

The Japan Micro-Computer Club was founded in 1976. There are now over 3000 active members. The club publishes a journal entitled *Micon Circular* eleven times a year. The newsletter contains summaries of club meetings, reports on new products, programs, technical reports, and tutorial papers on microcomputers. The club members wish to exchange ideas and newsletters and establish friendly relations with US clubs. Write to the Japan Micro-Computer Club, c/o Japan Electronic Industry Development Association, 3-5-8, Shibakoen, Minato-ku, Tokyo 105 Japan.

microprocessors. This group of about 60 members is interested in all types of 1802 systems. The club meets on the first Saturday of each month at a meeting place in the San Fernando Valley. Contact Richard Cox, 2670 Calle Abedul, Thousand Oaks CA 91360, (805) 492-4128

### Newsletter for Heath H8 Users

*H8SCOOP* is a monthly publication, not affiliated with Heath in any way. The newsletter contains a trading post section, monthly hardware and software projects, non-Heath product reviews, and other articles. Henry E Fale, the publisher, is also offering projects that he has designed for the H8. He welcomes articles and information on the H8 for publication in the newsletter. Subscription rates are \$12 per year with a yearly index compiled and supplied to subscribers. Contact Henry E Fale, 2918 S 7th St, Sheboygan WI 53081, (414) 452-4172.

### Connecticut Computer Club

The Connecticut Computer Club meets on the first Thursday of each month at 7:30 PM at the Suffield Connecticut Library. The club now has 70 members using a variety of computer systems. Each meeting is highlighted by talks by club members. Dues are \$6 per year or \$3.50 for the newsletter only. Contact Leo Taylor, 18 Ridge Ct W, West Haven CT 06516, (203) 933-5918. ■

### ELF of the Valley 1802 Users Group

The ELF of the Valley club is open to all users of RCA COSMAC ELF 1802



## LIGHT PEN

PET  
APPLE  
TRS-80  
(Level II)

- Bypass the keyboard and interact directly with the screen. Makes your computer more versatile for the novice as well as the more sophisticated user.
- The use of the 3-G Light Pen is limited only by your imagination! Use it to experiment with graphics, display a menu for quick data retrieval, as a teaching tool with your child, to proportion recipes instantly, or to play unique games.
- At a major medical center an anesthesiologist uses our pen to select proper dosages. In Holland they use it to create graphics. A man in New York uses it to teach his pre-school age daughter how to match capital with lower case letters. Teachers are using it in science and foreign language classes.
- NO ASSEMBLY NECESSARY. READY TO PLUG IN. Detailed sample programs included. Complete documentation so you can write your own programs in BASIC. No machine language coding necessary. All Professional models plug into machine ports and don't require batteries. Economy model plugs into tape recorder and batteries are included.
- YOU GET: 1) 3-G Light Pen  
2) Demo-Game Cassette (with Professional TRS-80, PET and Apple)  
3) Sample Program.  
4) Complete documentation and instructions.

MANY GAMES AND OTHER LIGHT PEN SOFTWARE AVAILABLE.



MAIL COUPON OR CALL TODAY FOR IMMEDIATE DELIVERY

3G COMPANY, INC. DEPT. BT (503) 662-4492

RT. 3, BOX 28A, GASTON, OR 97119

<input type="checkbox"/> TRS-80 Economy	<input type="checkbox"/> TRS-80 Professional	<input type="checkbox"/> PET Professional	<input type="checkbox"/> Apple Professional
\$19.95	\$34.95	\$31.95	\$32.95

Yes, I want to make my computer more versatile. Rush me \_\_\_\_\_ 3-G Light Pens. (Add \$1.50 for mailing and handling - \$6.00 foreign.)

Enclosed is:  check or money order  Master Charge  Visa  

---

Card No. \_\_\_\_\_ Exp. date \_\_\_\_\_

NAME \_\_\_\_\_

ADDRESS \_\_\_\_\_

CITY \_\_\_\_\_ STATE \_\_\_\_\_ ZIP \_\_\_\_\_

REMEMBER, 3G OFFERS A 30 DAY UNCONDITIONAL MONEY BACK GUARANTEE!



Take stock in America.

Join the Payroll Savings Plan.



## MAKE YOUR BASIC BETTER FOR BUSINESS

Developing business applications without keyed file support is like producing a play without the right cast — you can expend needless time and money, and end up giving an inadequate performance.

### Enter MAGSAM™

MAGSAM picks up where your BASIC leaves off by providing it with a powerful Keyed File Management System that's quick and easy to use. The result is applications that do exactly what you want them to — instead of only what BASIC allows you to.

### Supporting Cast

MAGSAM's advanced features and capabilities include:

- Random, sequential, and generic access by key
- Secondary indexing with any number of keys
- Key and record deletes with automatic space reclamation
- Dynamic file allocation and extension
- Complete compatibility with BASIC files
- Interactive tutorial program
- One year update service

The versatile MAGSAM file management is now available in two major versions. MAGSAM IV, the new high performance assembler version, is ideal for business applications in which response time is critical. Complete with an interface for CBASIC, MAGSAM IV is \$295. MAGSAM III is the standard version and is in use world wide. Written in BASIC, it is available for CBASIC, Microsoft BASIC, or Micropolis BASIC for \$145. The MAGSAM manual alone is \$25.

### You're the Star

MAGSAM is available immediately — off the shelf. So you can begin saving time and money now while providing your customers and clients with applications that truly meet their needs. Send for a free brochure telling the full story on MAGSAM. Or see a demonstration at your computer dealer today.

### Another Business Solution from:

**MAG** MICRO APPLICATIONS GROUP  
7300 Caldas Avenue, Van Nuys, CA 91606

# TERMINALS

## FROM TRANSNET

### PURCHASE FULL OWNERSHIP AND LEASE PLANS

DESCRIPTION	PURCHASE PRICE	PER MONTH		
		12 MOS.	24 MOS.	36 MOS.
LA36 DECwriter II .....	\$1,695	\$162	\$ 90	\$ 61
LA34 DECwriter IV .....	1,295	124	69	47
LA120 DECwriter III KSR ...	2,495	239	140	90
LA180 DECprinter I .....	2,095	200	117	75
VT100 CRT DECscope .....	1,895	182	101	68
VT132 CRT DECscope .....	2,295	220	122	83
DT80/1 DATAMEDIA CRT ....	1,895	182	101	68
T1745 Portable Terminal ...	1,595	153	85	57
T1765 Bubble Memory Terminal	2,795	268	149	101
T1810 RO Printer .....	1,895	182	101	68
T1820 KSR Printer .....	2,195	210	117	79
T1825 KSR Printer .....	1,695	162	90	61
ADM3A CRT Terminal .....	875	84	47	32
QUME Letter Quality KSR ...	3,195	306	170	115
QUME Letter Quality RO ....	2,795	268	149	101
HAZELTINE 1410 CRT .....	875	84	47	32
HAZELTINE 1500 CRT .....	1,195	115	64	43
HAZELTINE 1552 CRT .....	1,295	124	69	47
DataProducts 2230 Printer ..	7,900	757	421	284
DATAMATE Mini Floppy .....	1,750	168	93	63

FULL OWNERSHIP AFTER 12 OR 24 MONTHS • 10% PURCHASE OPTION AFTER 36 MONTHS

### ACCESSORIES AND PERIPHERAL EQUIPMENT

ACOUSTIC COUPLERS • MODEMS • THERMAL PAPER RIBBONS • INTERFACE MODULES • FLOPPY DISK UNITS  
PROMPT DELIVERY • EFFICIENT SERVICE



**TRANSNET CORPORATION**

1945 ROUTE 22, UNION, N.J. 07083

201-688-7800

TWX 710-985-5485

## SPECIALIZING IN

# QUALITY MICROCOMPUTER HARDWARE

INDUSTRIAL • EDUCATIONAL • SMALL BUSINESS • PERSONAL

BUILDING BLOCKS FOR MICROCOMPUTER SYSTEMS, CONTROL & TEST EQUIPMENT

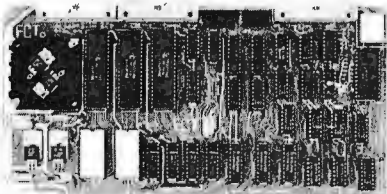

**R<sup>2</sup> I/O**  
2K ROM  
2K RAM  
3 Serial Ports  
1 Parallel Port  
**WIRED: \$295.00**

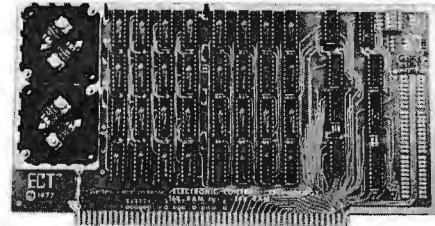

**16 K RAM**  
FULLY STATIC MEMORY  
**KIT: \$279.00**  
**WIRED: \$310.00**

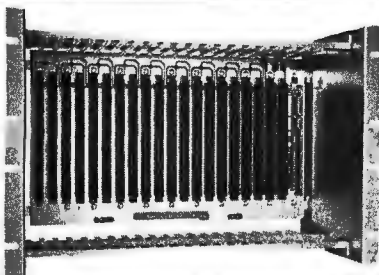

**ECT-100-F**  
RACKMOUNT CARD CAGES  
**KIT: \$200.00**  
**WIRED: \$250.00**



**TT-10**  
TABLE TOP MAINFRAMES  
**KIT: \$340.00**  
**WIRED: \$395.00**

POWER SUPPLIES, CPU's, MEMORY, OEM VARIATIONS

763 RAMSEY AVE.  
HILLSIDE, N.J. 07205

**ELECTRONIC CONTROL TECHNOLOGY (201) 686-8080**

# More Printing Terminals From MICROMAIL



**DIABLO 1650**

- Prints at 40 cps, using 88, 92, or 96 char. metalized printwheels.
- Vertical resolution 1/48"; Horizontal 1/120". Capable of proportional spacing, bidirectional printing, and graphics under software control.
- Bidirectional normal and direct tabs. Left, right, top and bottom margins.

**R.O. \$2890.00  
KSR \$3285.00**

**DIABLO 1640**

- Uses plastic printwheel and prints at 45 cps. Otherwise, shares identical features with 1650 including:
  - Friction or tractor feed, up to 15" wide.
  - Cartridge ribbon, fabric or carbon.

**R.O. \$2745.00  
KSR \$3140.00**



**T.I. 810**

- Includes upper/lower case option.
- Bidirectional printing at 150 cps.
- Tractor-feed forms, 3" to 15" wide.

**\$1599.00**

- Options:**
- Forms length control — \$100.00
  - Vertical Format Control with Compressed Print — \$125.00



**DEC LA 34**

(Shown with optional forms tractor and numeric keypad).

- Prints 10, 12, 13.2, or 16.5 characters per inch, upper/lower case.
- 2, 3, 4, 6, 8, or 12 lines per inch.
- Friction feed, paper width to 15 inches.

**\$999.00**

- Options:**
- Numeric keypad — \$80.00
  - Adjustable forms tractor — \$130.00



**TELETYPE 43**

- Prints 132 columns, upper/lower case with true descenders.
- 30 character/second print speed, 110-300 baud.
- Uses 12" wide by 8.5" pinfeed paper.
- Print position scale, paper guide and supply rack.

**\$999.00**

**We Also Represent the Following Manufacturers:**

**SOROC    TEC    GTC**

**Write or Call In for Our Free Catalogue!**

**MICROMAIL**™

MICROMAIL • BOX 3297 • SANTA ANA, CA 92703  
(714) 731-4338

**TO ORDER:** Send check or money order to: MICROMAIL, P.O. Box 3297, Santa Ana, CA 92703. Personal or company checks require two weeks to clear. Terminals in stock are shipped the business day after receipt of certified funds. All equipment includes factory warranty.

**SHIPPING:** We ship freight collect by UPS when possible. Larger terminals are shipped by motor freight. Air and express delivery is available on all products.

## Event Queue

JULY 1980

*July*

**TRS-80 Interfacing and Application for Scientific Instrumentation and Motorola 6801 Single Integrated Circuit Microcomputer Design, Interfacing, and Applications, Virginia Tech Facility, Dulles Airport.** These are hands-on workshops sponsored by Virginia Polytechnic Institute and State University. For more information, contact Dr Linda Leffel, CEC, Virginia Tech, Blacksburg VA 24061, (703) 961-5241.

*July-August*

**Introduction to Microcomputers, Oklahoma State University, Stillwater OK.** Approximately two-thirds of this workshop is devoted to hands-on instruction using the PET 2001 with one microcomputer station for every two participants. Contact Technology Extension, Oklahoma State University, Stillwater OK 74078, (405) 624-5714, for schedules of the two-day workshops.

*July-September*

**Pascal Programming Workshop, Boston MA.** These five-day courses will include application examples, lectures, informal sessions with instructors, and individual and group programming sessions. A preview of the Ada language will also be included. The fee is \$750. For a schedule of the courses, contact Professor Donald D French, Institute for Advanced Professional Studies, One Gateway Ctr, Newton MA 02158, (617) 964-1412.

*July-December*

**Intel Microcomputer Workshops.** Intel is offering 13 different microcomputer workshops at its training centers in the Boston, Chicago, and San Francisco

areas. They also have scheduled an introduction to microcomputers workshop which will be held in 33 cities in the US. To receive a brochure containing outlines and schedules, call in the Boston area (617) 256-1374; in the Chicago area (312) 981-7250; or in the San Francisco bay area (408) 734-8102; or write Intel Corp, Mail Stop: SV 3-1, 3065 Bowers Ave, Santa Clara CA 95051.

*July 1*

**IEEE Indy Microcomputer Show, Sheraton Motor Inn East, Indianapolis IN.** There will be exhibits, demonstrations, and technical seminars addressing applications of microcomputer systems. Contact Publicity Chairman, IEEE Indy Microcomputer Show, Naval Avionics Center, D/810, 6000 E 21 St, Indianapolis IN 46218, (317) 353-3047.

*July 7-11*

**Computers and Related Products, Hyatt Regency Hotel, Seoul, South Korea.** This show is limited to approximately forty firms for exhibition. For details, contact Robert Wallace, Rm 6015A, US Dept of Commerce, Industry and Trade Commission, Washington DC 20230.

*July 13-19*

**Educational Applications of Microcomputers, Mt Herman Campus, Northfield-Mt Herman School, Northfield MA.** This course is part of an on-going program for school and public librarians, teachers, and media specialists in the educational uses of microcomputers. Arrangements are being made for graduate level credit through Boston State College. Contact Stacey E Bressler, Field Coordinator, Massachusetts Educational Television, 54 Rindge Ave Extension, Cambridge MA 02140, (617) 876-9800.

July 14-16

**Diagnostic Software: Planning and Design**, Sheraton-Lexington Motor Inn, Lexington MA. This seminar is for design, test, and diagnostic engineers. Design examples, lectures, informal sessions, and programming are part of the course. The fee is \$450. Contact Professor Donald French, Institute for Advanced Professional Studies, One Gateway Ctr, Newton MA 02158, (617) 964-1412.

July 14-18

**Computers and Related Products**, Furma Hotel, Hong Kong. See July 7 for details.

July 14-18

**SIGGRAPH '80**, Seattle Center, Seattle WA. Topics will include graphic displays, animation and dynamics, cartography, input techniques, video and color hardware, and more. Panel discussions and readings will be included in this conference. For general information, write to SIGGRAPH '80, POB 88203, Seattle WA 98188.

July 14-25

**Introduction to Microcomputer Interfacing**, Virginia Military Institute (VMI), Lexington VA. This hands-on laboratory-oriented course will feature the Radio Shack TRS-80 Level II computer with 16 K bytes of programmable memory. There will be one microcomputer for every two students. The tuition is \$450 and academic credit is available. Contact Dr Philip B Peters, Dept of Physics, VMI, Lexington VA 24450, (703) 463-6225.

July 20

**Hamfest, Computerfest, Electronics Fair**, Franko's Farm, Bethlehem PA. This annual event is sponsored by the Lehigh Valley Amateur Radio Club and is aimed at ham radio users. A flea market will be featured and food will be available. Prizes will be given out. Contact Wayne Comstock WB3CDL, RR 1, Box

162B, Saylorburg PA 18353, (215) 381-3674.

July 22-24

**The 1980 Microcomputer Show**, Wembley Centre, London, England. New products will be exhibited, along with presentations of papers. For information contact TMAC, 680 Beach St, Suite 428, San Francisco CA 94109, (800) 227-3477 or in Canada and California (415) 474-3000.

July 28-August 1

**Microprocessors and Microcomputers**, George Washington University, Washington DC. Designed for engineers and others without previous experience with digital systems and microcomputers, this course is intended to help individuals manage and conduct design work in microprocessor-based systems. The course fee is \$635. For details, write Director, Continuing Engineering Education, George Washington University, Washington DC 20052, (202) 676-6106 or (800) 424-9773.

---

## AUGUST 1980

---

August 4-6

**Data-Entry Management and Supervision Seminar**, Chicago IL. This seminar is designed for data-entry managers and supervisors. Topics will range from data-entry control techniques and improving data-entry operator productivity, to personnel communications and motivation. Contact MIC, 140 Barclay Ctr, Cherry Hill NJ 08034, (609) 428-1020.

August 12-14

**Computer Graphics '80**, Birmingham, England. Computer Graphics '80 will bring together experienced users and specialists to present applications experiences and research findings. In addition to the conference, there will be an equipment exhibition and an animated film festival. To register,

# DYNACOMP

Quality software for: PET  
Apple II Plus  
TRS-80 (Level II)  
North Star

All software is supplied with complete documentation which includes clear explanations and examples. Each program will run with standard terminals (32 characters or wider) and within 16K program memory space. Except where noted, all software is available on PET cassette, North Star diskette (North Star BASIC), TRS-80 cassette (Level II) and Apple cassette (*Applesoft* BASIC). These programs are also available on *PAPER TAPE* (Microsoft *BASIC*).

**FLIGHT SIMULATOR**

(as described in SIMULATION, Volume II)

Price: \$17.95 postpaid

A realistic and extensive mathematical simulation of take-off, flight and landing. The program utilizes aerodynamic equations and the characteristics of a real airfoil. You can practice instrument approaches and navigation using radials and compass headings. The more advanced flyer can also perform loops, half-rolls and similar aerobic maneuvers.

SIMULATION, Volume II (BYTE Publications): \$6.00

**VALDEZ**

Price: \$14.95 postpaid

A simulation of supertanker navigation in the Prince William Sound and Valdez Narrows. The program uses an extensive 256x256 element radar map and employs physical models of ship response and tidal patterns. Chart your own course through ship and iceberg traffic. Any standard terminal may be used for display.

**BRIDGE 2.0**

Price: \$17.95 postpaid

An all-inclusive version of this most popular of card games. This program both *BIDS* and *PLAYS* either contract or duplicate bridge. Depending on the contract, your computer opponents will either play the offense OR defense. If you bid too high the computer will double your contract! *BRIDGE 2.0* provides challenging entertainment for advanced players and is an excellent learning tool for the bridge novice.

**HEARTS 1.5**

Price: \$14.95 postpaid

An exciting and entertaining computer version of this popular card game. Hearts is a trick-oriented game in which the purpose is not to take any hearts or the queen of spades. Play against two computer opponents who are armed with hard-to-beat playing strategies.

**DATA SMOOTHER**

Price: \$14.95 postpaid

This special data smoothing program may be used to rapidly derive useful information from noisy business and engineering data which are equally spaced. The software features choice in degree and range of fit, as well as smoothed first and second derivative calculation. Also included is automatic plotting of the input data and smoothed results.

**FOURIER ANALYZER**

Price: \$14.95 postpaid

Use this program to examine the frequency spectra of limited duration signals. The program features automatic scaling and plotting of the input data and results. Practical applications include the analysis of complicated patterns in such fields as electronics, communications and business.

**CHESS MASTER** Price: \$19.95 postpaid (available for North Star and TRS-80 only)

This complete and very powerful program provides five levels of play. It includes castling, en passant captures, and the promotion of pawns. Additionally, the board may be preset before the start of play, permitting the examination of "book" plays. To maximize execution speed, the program is written in assembly language (by *SOFTWARE SPECIALISTS* of California). Full graphics are employed in the TRS-80 version, and two widths of alphanumeric display are provided to accommodate North Star users.

**STARTREK 3.2**

Price: \$9.95 postpaid

This is the classic Startrek simulation, but with several new features. For example, the Klingons now shoot at the Enterprise without warning while also attacking starbases in other quadrants. The Klingons also attack with both light and heavy cruisers and move when shot at! The situation is hectic when the Enterprise is besieged by three heavy cruisers and a starbase S.O.S. is received! The Klingons get even!

**TEXT EDITOR I (Letter Writer)**

Price: \$14.95 postpaid

An easy to use, line-oriented text editor which provides variable line widths and simple paragraph indexing. This text editor is ideally suited for composing letters and is quite capable of handling much larger jobs.

**GAMES PACK I and GAMES PACK II**

Price: \$9.95 each postpaid

**GAMES PACK I** contains BLACKJACK, LUNAR LANDER, CRAPS, HORSERACE, SWITCH and more.  
**GAMES PACK II** contains CRAZY EIGHTS, JOTTO, ACEY-DUCEY, LIFE, WUMPLUS and more.  
Why pay \$5.95 or more per program when you can buy a DYNACOMP collection for just \$9.95?

All orders are processed within 48 hours. Please enclose payment with order. If paying by **MASTER CHARGE** or **VISA**, include all numbers on card. Foreign orders add 10% for shipping and handling.

Write for detailed descriptions of these and other programs available from DYNACOMP.

**DYNACOMP**

P.O. Box 162

Webster, New York, 14580

(716) 586-7579

New York State residents please add 7% NYS sales tax.



contact Paula Stockham, Online, Cleveland Rd, Uxbridge UB8 2DD, England, phone Uxbridge (0895) 39262.

August 14-24

**Electronics/China 80**, Guangzhou (Canton), China. This is the first exhibition of US electronic companies in the People's Republic of China. The United States-China Trade Consultants are the sponsors of the show. Products demonstrated will include circuit components, system elements, test instrumentation, product equipment, and materials. Details are available through Expo-consul Inc, Clapp and Poliak Inc, Princeton-Windsor Office Park, POB 277, Princeton Junction NJ 08550.

August 23-24

**Personal Computer Arts Festival**, Philadelphia Civic Center, Philadelphia PA. Tutorials, seminars, musical

performances, and graphic extravaganzas will be featured in this show. Contact PCAF '80, c/o Philadelphia Area Computer Society, POB 1954, Philadelphia PA 19105.

August 25-27

**Summer Computer Simulation Conference**, Olympic Hotel, Seattle WA. Emphasis will be on computer networks, graphics tools for simulation, database management, and management science models, in addition to papers in such traditional areas as simulation. For details, write Simulation Councils Inc, 1980 Summer Computer Simulation Conference, POB 2228, La Jolla CA 92038.

August 25-28

**Implementing Cryptography in Data Processing and Communications Systems**, University of Southern California. For information on this conference, contact the University of Southern

California, Continuing Engineering Education, Powell Hall 216, University Park, Los Angeles CA 90007, (213) 746-6708.

## SEPTEMBER 1980

September 9-10

**The 13th International Symposium and Exhibition on Minicomputers and Microcomputer Applications, MIMI'80**, Montreal, Canada. This symposium will cover communications, signal processing, data acquisition, control, robotics, education, hardware, languages, networks, and other topics. It is being held in conjunction with the first IASTED International Symposium and Exhibition on Office Automation. For more information, contact Professor M H Hamza, Dept of Electrical Engineering, University of Calgary, Calgary, Alberta, T2N 1N4 Canada.

September 11-13

**Internecon Semiconductor International Exposition and Conference**, Republic of Singapore. Featuring an exhibition of production machinery, tools, hardware, materials, and test instruments, this show includes conferences keyed to the needs of the engineering, manufacturing, and support personnel of Southeast Asia. It is open to all persons engaged in electronics and semiconductor manufacturing. Contact Industrial and Scientific Conference Management Inc, 222 W Adams St, Chicago IL 60606, (312) 263-4866.

September 16-18

**Wescon/80**, Anaheim Convention Center, Anaheim CA. This year's show will include a large exhibition and a variety of talks covering communications, computers, microprocessors, consumer electronics, energy, office automation, semiconductor technology, and more. Contact Wescon, 999 N

Sepulveda Blvd, El Segundo CA 90245, (213) 772-2965.

September 17-19

**ACM Small/Personal Computer Conference**, Rickey's Hyatt House, Palo Alto CA. This symposium will blend contributed papers, panel, and informal discussions. Included will be hardware and software topics involving theory, design, construction, marketing, and applications. Discussions will cover microcomputer applications in business, industry, education, and the home. Details are available from Conference Chairman, Philippe Lehot, PLA, 976 Longridge Rd, Oakland CA 94610.

September 22-25

**Software INFO**, Hyatt Regency, Chicago IL. This is the first national conference and exhibit on packaged software held in the US. For more information, or to reserve exhibition space, call (312) 263-3131 or write Software INFO, Suite 545, 222 W Adams St, Chicago IL 60606.

September 23-25

**Comcon 80 Fall**, Capital Hilton Hotel, Washington DC. Sponsored by the Institute of Electrical and Electronics Engineers (IEEE), this show explores distributed computing and related topics. Discussions will cover interfaces, standards, and protocols; data communications and networking; computer systems; data bases; security; office systems; and more. Details from Comcon 80 Fall, POB 639, Silver Spring MD 20901, (617) 879-2960 ext 3800.

September 24-27

**The 10th Annual Conference of the Society for Computer Medicine**, San Diego Hilton, San Diego CA. This conference has been planned for physicians, attorneys, administrators, computer professionals, comptrollers, engineers, nurses, and anyone interested in the use of computers for patient

## 8088 S100 CPU

Want to upgrade your 8 bit system to a 16 bit system? Don't want to discard your 8 bit boards? The **LDP88** offers 10 to 20 times the processing power of your present CPU while retaining compatibility with your 8 bit memory and peripherals. The **LDP88** is a single board computer with complete **IEEE S100** bus compatibility. The board has the following features:

- Up to 8K bytes of ROM/EPROM
- 1K bytes static RAM
- 8 vectored interrupts
- Serial I/O port
- 16 bit instruction set
- **8086** software compatibility
- Address up to 1 Megabyte of memory

PRICE: \$399.99 (assembled and tested)

Serial monitor for CRT or TTY: \$79.99 (Mass. residents add 5% sales tax)

See your March and April BYTE for Steve Ciarci's articles about the 8088.

To order send check or money order to:

**Lomas Data Products**  
11 Cross Street  
Westborough, MA 01581  
Telephone: (617) 366-4335

THE  
**MISSING LINK**<sup>®</sup>  
BY MIDNIGHT SOFTWARE

Transfer files between any two CP/M systems with full error checking and auto retry at up to 9600 baud.

- Sends and fetches all file types (including .COM)
- Multiple file transfer by list, indirect file list, and wild card match (eg ABC.HEX \*;.COM @PROGLIST)
- Remote and local directories
- Machine language program requires 16K CP/M
- Conversational mode
- Terminal mode for interacting with timesharing systems (w/download capability)
- Priced at only \$95, manual only is \$5

THIS PROGRAM IS A MUST FOR ALL CP/M SYSTEMS!

CP/M is a trademark of Digital Research  
Software is supplied on 8" single density diskettes.



**COMPUTER CAMP, INC.**  
1235 COAST VILLAGE ROAD, SUITE G,  
SANTA BARBARA, CALIFORNIA 93108  
(805) 965-7777

S.C. Digital Proudly Introducing  
"UNISELECT" Model 16KUS

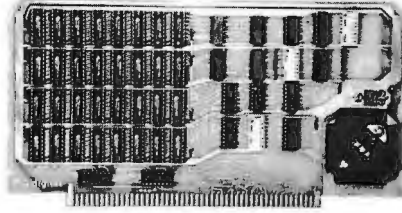

**16K Static Memory (Ram) with  
Universal Bank Select**

**Introductory Price: \$255**  
with 200 nsec memory chips  
Assembled, Tested, and Guaranteed.

*Featuring:*

- S-100 Compatible** - Meets IEEE-S100 standard.
- Fully Static** - 4045 or 2114, No DMA restrictions.
- Addressing** - Dip switch addressing in 16K blocks.
- Bank Select** - Port and bits dip switch selectable. Compatible with Alph Micro, Cromemco, Marinchips, North Star, etc.
- Phantom** - Built in memory disable via Phantom line.
- Quality** - Fully socketed, silk legend, solder masks, gold contacts.
- Orders** - MC, Visa or COD (\$4 handling charges for COD) or Personal check. Shipping from stocks to 2 weeks. Illinois residents add 5.25% sales tax.

**S.C. Digital** P.O. Box 906 Phone:  
Aurora, IL 60507 (312) 897-7749

RACET SORTS — RACET UTILITIES — RACET computes — RACET SORTS — RACET UTILITIES — RACET computes — RACET SORTS — RACET UTILITIES — RACET computes —

**NEW  
PRODUCT!**

**MOD II UTILITY PACKAGE**

**NEW  
PRODUCT!**

**Replacement Debug (DEBUG)**

35 basic functions + 8 edit commands! Single step or Multiple step. Automatic trace of logic flow with printing of trace, trace of instructions greater than stack pointer values, and rapid trace. Subroutine calling. Automatic program looping. Dynamic disassembly of instructions!!!

**Directory Catalog System (XDIR)**

Build directory of directories!! Sorts by disk or by program. Abbreviated or full form — full form includes dates of creation and last update, and other directory data.

Wild card select options with masks. Build consolidated directory of all GL\*?/\*BAS files. Select on filename and extension. Save or load XDIR catalog files.

Concatenate new data with loaded file.

**Directory Fix (DFIX)**

Automatic repair of HIT tables!  
List and flag directory errors.

**MOD II Utility Package \$150.00**

**INFINITE BASIC for MOD I TRS-80™ Tape and Disk System  
Extensions to Level II and Disk BASIC \$49.95**

Full MATRIX functions — 30 BASIC commands!  
50 more STRING functions as BASIC commands!  
Includes RACET in-memory sorts. Load only functions you want — where you want in memory! More than you expect!

**∞ BUSINESS (Requires Infinite BASIC) \$29.95**

Automatic printer pagination. Packed decimal arithmetic - 127 digit accuracy. Binary array searches. Hash code.

**COMPROC Command Processor for Disk Systems \$19.95**

Auto your disk to perform any sequence of commands.

**GSF (Specify 16, 32 or 48K Memory) \$24.95**

18 machine language routines including RACET sorts.

**Extended Copy (XCOPY)**

Copies multiple files with a single command using masked select options! Source disk may be non-operating system disk. Single drive capability. Recover bad files — invalid sectors itemized but copy continues.

Merge files with or without replacement.

**Superzap (SZAP)**

Display or print and modify standard TRSDOS diskette track and sector data. Full screen edit mode. Automatic repeat scan and print. Copy disk sectors — any number of sectors to same or other drive.

**Disk Identification (DISKID)**

Change diskette names!

**Extended Create (XCREATE)**

Creates and initializes file to end.

**DOCUMENTATION**

Complete documentation of above utilities including a full discussion on recovery of lost data on diskettes!!!

**DISK SORT MERGE (DSM) for MOD I and MOD II**

Random file disk sort merge — multi-diskette files. All machine language stand alone package. Sort on up to 15 fields — ascending or descending. Provides optional output field deletion, rearrangement, and padding. Sort an 85K diskette in less than 3 minutes!

**DSM for Mod I (Minimum 32K, 2-drives) \$75 on Disk**

**DSM for Mod II (Minimum 64K, 1 drive) \$150 on Disk**

**Mod II Development Package \$100**

Machine language Superzap — Editor Assembler, Disassembler Patches.

**Mod II Generalized Subroutine Facility \$50**

CHECK, VISA, M/C, C.O.D.

Calif. Residents add 6%

Telephone Orders Accepted (714) 637-5016

TRS-80 IS A REGISTERED TRADEMARK OF TANDY CORPORATION

**RACET COMPUTES**

702 Palmdale, Orange, CA 92665

DEALER INQUIRIES INVITED

WHEN ORDERING PLEASE  
ADVISE PUBLICATION SOURCE

RACET SORTS — RACET UTILITIES — RACET computes — RACET SORTS — RACET UTILITIES — RACET computes — RACET SORTS — RACET UTILITIES — RACET computes —

care. Sessions on medical subjects, technical subjects, and contributed papers on new research in computer medicine will be offered. For information, contact Society for Computer Medicine, 1901 N Ft Myer Dr, Suite 602, Arlington VA 22209, (703) 525-0098.

September 25-28

**Mid-Atlantic Personal and Business Computer Show,** Philadelphia Civic Center, Philadelphia PA. General admission for adults is \$5. The show is being produced by National Computer Shows, POB 678, Brookline Village MA 02147, (617) 524-0000.

September 26-27

**Classroom Applications of Computers in Grades K Through 12,** Independence High School, San Jose CA. A visit to "Silicon Valley," tutorials, workshops, and exhibits, will highlight this conference. The emphasis will be to inform teachers about the possible uses of

computers in all areas of education. Contact Computer-Using Educators, c/o W Don McKell, Independence High School, 1776 Educational Park Dr, San Jose CA 95133.

September 27-28

**New Jersey Personal Computer Show and Flea Market**—80, Holiday Inn (North) Convention Center, Newark NJ. This show will feature an indoor commercial exhibit and sales area, an outdoor flea market with room for 100 sellers, and forums for all popular hobby-computing systems. This show is primarily for hobbyists and small-business owners. The admission price is \$4 in advance and \$5 at the door. Contact NJPCS, Kengore Corp, 9 James Ave, Kendall Park NJ 08824, (201) 297-6918 after 7 PM.

September 30-October 4

**The 8th International Conference on Computational Linguistics,** Tokyo, Japan. This conference will provide

a forum for a variety of computational linguistics topics including theories, methods, and problems of computational linguistics; models of natural language processing; applications of natural language processing; hardware and software supports for language data processing; and more. For information, contact Professor David G Hays, Twin Willows, 5048 Lakeshore Rd, Hamburg NY 14075. ■

We apologize for the problems caused to our readers by this situation.

### More Ripple Than We Thought

A faulty figure caption appeared in John Thomas' article "Calculating Filter Capacitor Values for Computer Power Supplies" (April 1980 BYTE, pages 118 thru 122).

The caption of figure 4 on page 120 contained the clause "...an almost constant DC voltage with a small fluctuation (ripple) is presented to the voltage regulator stage of the power supply." Anyone looking at the published figure can see that the ripple voltage is indeed *not* small, and can in fact be quite large. The published figure 4 matches the conditions for the design example wherein the ripple voltage (6.8 V) is larger than the output voltage.

We apologize for any confusion this may have caused.



### Hiding Your Lamp Under a Bread Tin

The article by L B Golter "Build a Low-Cost EPROM Eraser" was published in the April 1980 BYTE on pages 234 thru 238. The article contained plans for building an EPROM-erasing device from a set of parts that included two bread-baking tins and an ultraviolet lamp tube.

Unfortunately, the author did not discover that he used the wrong type of ultraviolet lamp (an F6T5/BLB unit); erasable programmable read-only-memory (EPROM) parts placed in the unit will achieve only incomplete erasure. The lamp that should have been used, a General Electric G8T5, will not fit in the bread-tin case devised by Mr. Golter.

A different lamp, the General Electric G4T4/1, will fit, after some modification of the mounting. The G4T4/1 is a U-shaped lamp tube of a low-pressure mercury-vapor type and requires 4 W of power. Because of the lower power, EPROM parts may require longer periods of exposure to achieve complete erasure. Both the G8T5 and the G4T4/1 are widely marketed as "germicidal" lamps.

### Filter Capacitor Values

I wish to comment on the article by John Thomas, entitled "Calculating Filter Capacitor Values for Computer Power Supplies" (April 1980 BYTE, page 118). Although I have not actually used the formula given on page 118 for computing  $C_{min}$ , I did notice something that may be of value to your readers. It should be pointed out that in order for the formula to result in a value representing farads, it is necessary to express the quantity

$$\arcsin \frac{V_{min}}{V_{max}}$$

in terms of radians. A simple formula that may be used to convert degrees to radians is

$$\text{radians} = \frac{2\pi(x)}{360}$$

$$x = \arcsin \frac{V_{min}}{V_{max}}$$

expressed as degrees. ■

Gene A Chaves

MICRO MISCELLANY	
<b>APPLE II PARALLEL INTERFACE</b>  <b>\$79.95</b> Interfaces printers, synthesizers keyboards, and JBE A-DD-A Converter & Switches. This interface has 4 I/O ports with handshaking logic, 2-6522 VIA's and a 74LS74 for timing. Inputs and outputs are TTL compatible. 79-295K Complete Kit \$69.95 79-295A Assembled \$79.95	<b>SOLID STATE SWITCH</b>  <b>\$44.95</b>  <b>\$12.50</b> Your computer can control power (120VAC) to your printer, lights, and other 120VAC appliances up to 720 watts (6AMPS at 120VAC). Input 3 to 15 VDC, 2-13 MA TTL compatible, isolation 1500V. 79-282 1 Channel Kit \$ 9.95 Assm. \$12.50 79-282 4 Channel Kit \$34.95 Assm. \$44.95
<b>AtoD DtoA CONVERTER</b>  <b>\$69.95</b> Analog to Digital, Digital to Analog Converter, AtoD conversion time 20us. DtoA conversion 5us. Uses include speech and music synthesizing and slow scan TV. Single power supply (5V), 8 Bits wide, latched I/O, strobe lines. 79-287K Complete Kit \$49.95 79-287A Assembled \$69.95	<b>BARE BOARDS</b> <b>SINGLE BOARD COMPUTERS</b> 8088 5-CHIP SYSTEM \$29.95 8085 3-CHIP SYSTEM \$24.95 <b>MEMORY BOARD</b> 8208 64K DYNAMIC \$39.95 <b>ALL PRODUCTS AVAILABLE FROM:</b> <b>JOHN BELL ENGINEERING</b> P.O. Box 338 Dept. 4 Redwood City, CA 94064 (415) 367-1137 Add 6% sales tax in California and \$1.00 shipping and handling for orders less than \$20. Add 4% for VISA or M.C.
<b>JOHN BELL ENGINEERING</b>	

## GENERAL LEDGER PAYROLL ACCOUNTS RECEIVABLE & PAYABLE

Flexible and sophisticated business software that is among the highest quality on the market. Originally developed by OSBORNE & ASSOCIATES and rapidly becoming a standard. Our service is support. We will send you these programs with the proper I/O and CRT specific subroutines for your hardware configuration. Get back to business and leave the programming to us. Include hardware description with order.

- Accounts Receivable and Payable ..... 145.00
- Payroll (California) ..... 145.00
- Non California state tax calculations  
(please inquire) ..... 15-250.00
- General Ledger ..... 145.00
- Multiple profit center option for G/L ..... 25.00
- Manuals (each) ..... 20.00

All programs in CBASIC under CP/M (includes source)

These programs are up and running on the following computer systems: Altos, TRS-80 MOD II (under CP/M), Northstar, Vector Graphics, Intertec Super Brain, Cromemco, and others.

### Synergetic Computer Products

508 University Ave • Palo Alto, CA 94301  
(415) 328-5391

Visa • Mastercharge • COD • Certified Check  
CP/M is a trademark of Digital Research

## At Last! HIGH RESOLUTION S-100 GRAPHICS

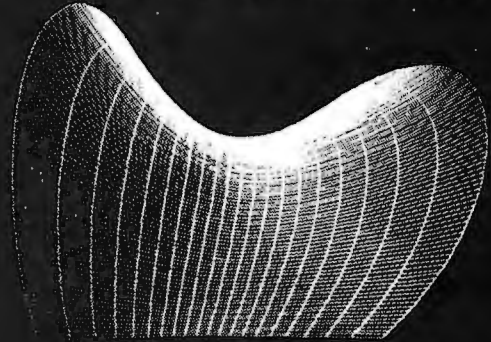

Unretouched photograph

# \$925

Complete interface  
Assembled and tested  
On-board memory  
Standard video output  
Monitor extra  
FOB Cambridge

- LIGHT PEN
- HIGH RESOLUTION
- 512 X 640 MATRIX
- S-100 PLUG-IN
- HIGH SPEED
- SOFTWARE

Send for brochure and data



**CAMBRIDGE DEVELOPMENT LAB**

44 Brattle Street, Cambridge, MA 02138  
Call (617) 547-3894

## New Produced and widely used in England and U.S.A. COMPLETE BUSINESS PACKAGE

**INCLUDES EVERYTHING FROM INVENTORY TO SALES SUMMARY  
PROMPTS USER, VALIDATES EACH ENTRY, MENU DRIVEN**

Approximately 60-100 entries/inputs require only 2-4 hours weekly and your entire business is under control.

**PROGRAMS ARE INTEGRATED-**

- 01 = ENTER NAMES/ADDRESS, ETC
- 02 = ENTER/PRINT INVOICES
- 03 = ENTER PURCHASES
- 04 = ENTER A/C RECEIVABLES
- 05 = ENTER A/C PAYABLES
- 06 = ENTER/UPDATE INVENTORY
- 07 = ENTER/UPDATE ORDERS
- 08 = ENTER/UPDATE BANKS
- 09 = EXAMINE/MONITOR SALES LEDGER
- 10 = EXAMINE/MONITOR PURCHASE LEDGER
- 11 = EXAMINE/MONITOR (INCOMPLETE RECORDS)
- 12 = EXAMINE PRODUCT SALES

**SELECT FUNCTION BY NUMBER-**

- 13 = PRINT CUSTOMER STATEMENTS
- 14 = PRINT SUPPLIER STATEMENTS
- 15 = PRINT AGENT STATEMENTS
- 16 = PRINT TAX STATEMENTS
- 17 = PRINT WEEK/MONTH SALES
- 18 = PRINT WEEK/MONTH PURCHASES
- 19 = PRINT YEAR AUDIT
- 20 = PRINT PROFIT/LOSS ACCOUNT
- 21 = UPDATE END MONTH FILES MAINTENANCE
- 22 = PRINT CASH FLOW FORECAST
- 23 = ENTER/UPDATE PAYROLL (NOT YET AVAILABLE)
- 24 = RETURN TO BASIC

**WHICH ONE? (ENTER 1-24)**

01 SUB. MENU EXAMPLE: 01 = EXAMINE: 02 = INSERT: 03 = AMEND: 04 = DELETE  
05 = PRINT (1,2,3): 06 = NUMERIC COMBINATIONS: 07 = SORT  
VERY FLEXIBLE. ADD YOUR OWN FUNCTIONS. EASY TO INTEGRATE.

All programs in BASIC for CP/M. PET. 6800

**G. W. COMPUTERS LTD, the producers of this beautiful package in U.K.**

**WE EXPORT TO ALL COUNTRIES:**  
BARCLAYCARD ACCEPTED  
CBM APPROVED

CP/M Ver. 9.00 is one 16 K core program using random access releasing both drives for data storage, and 250 word vocabulary is translatable in any foreign language.

**PRICES: Programs 1-23 EXC (19,20,22,23) £475**

**CALLERS BY APPOINTMENT ONLY**  
89 Bedford Court Mansions  
Bedford Avenue  
London WC1, U.K.

**CONTACT TONY WINTER 01-636-8210**  
BARCLAYCARD ACCEPTED  
CBM APPROVED

CP/M Ver. 9.00 is one 16 K core program using random access releasing both drives for data storage, and 250 word vocabulary is translatable in any foreign language.

**£575 Stock Integrated Option + £100 Bank Integrated Option + £100**

# Ask BYTE

Conducted by Steve Ciarcia

## The Very Busy Box

Dear Steve,

Thank you for writing that great article in January's BYTE about the BSR X-10 controller. I am interested in designing an interface for the Heath H-8 computer, but would like to avoid using analog circuitry, wherever possible, by deriving the timing from a single clock signal. Obviously, not many of the frequencies called for in your article are going to be met exactly. Could you give me some idea of the tolerances involved?

John R Souvestre

*In that article, I was careful to quote only the manufacturer's specifications, the time intervals 1.2*

*ms and 4.0 ms, and the frequency 40 kHz. Experimentation using an oscilloscope and a frequency counter has demonstrated a fairly large tolerance in these settings. I have been successful with settings in the ranges of 1.1 ms to 1.7 ms, 3.5 ms to 4.5 ms, and 39,500 Hz to 40,800 Hz, respectively. The amount is dependent upon the particular command controller.*

*If you really want bare bones, use an NE555 timer as a 40 kHz oscillator and gate its output with software timing.*

Steve

Dear Steve,

I have been considering methods to control most of the appliances in my house through my computer, and

your January article has given me the means. I have started collecting parts, but I ran into a problem: I cannot find the address of Massa Products, supplier of the ultrasonic transducer.

Mike McLennan

*Unfortunately, Massa Products has a minimum-order policy, so it may not be cost-effective to use their transducer unless you need other parts too. You can use a Panasonic EFROSB40K2, available from Panasonic's distributors, or as part number MM1002 from: The MicroMint, 917 Midway, Woodmere NY, 11598, (516) 374-6793; cost: \$6.*

Steve

Dear Steve,

Your recent article about

computer control of appliances prompted me to purchase a BSR X-10 system. I have devised a simple remote audio-volume control which uses a lamp-dimmer module, acting on a photoresistive cell. By inserting the cell in line between the preamp and power amp of my stereo system, the volume is controlled through an isolating optical link.

Jim Smirniotopoulos

*That's one idea I never considered. My experience using AC-powered lights to control a photocell has always required filtering out the 60 Hz power-line noise. One easy solution is to build an averaging circuit from a bridge-rectifier, thus driving the lamp with DC.*

Steve

# Put your computer in touch with the world.

## AJ makes it possible for only \$185 with the A 242 acoustic data coupler.

Experts call it "the best acoustic coupler ever made." Reliability is phenomenal—historically over 35,000 hours mean time between failure! Thousands are in use by companies all over the U.S.

And now, the A 242 from AJ, refurbished at the factory, can connect to your terminal or personal computer, putting you in touch with every other compatible terminal or computer. If you can telephone the site, you can send and receive data.

Bell 103/113 compatible, the originate-mode A 242 features quartz crystal control, RS 232 or TTY terminal interface, and operational speeds up to 450 bps. At just \$185—about half the original price—it's a tremendous bargain. And you can have even greater savings with purchases of 10 or more units.

The A 242 carries our standard 30-day parts and labor warranty, and we're offering a no-risk, 10-day money-back guarantee.\*

Call toll-free for details:

(800) 538-9721.

California residents call:

(408) 263-8520.



**ANDERSON  
JACOBSON**

Circle 172 on inquiry card.

\*Details on request.

Prices subject to change without notice.



## 16-Bit Systems

Dear Steve,

I was fascinated by your series of articles in BYTE ("Ease into 16-Bit Computing" March 1980 BYTE, page 40), and I am impressed by the added computing power available through the new 16-bit microprocessors, but I am interested in building a complete system, not just a computer. This practically requires that the processor board be S-100 compatible. How long will it be until these specifications are met, and will it be worth the wait? Which one will have the edge in performance under personal computing conditions?

Lynne Poderson

I have written articles about the Intel 8086 and 8088 processors, and generally like what I hear regarding the Motorola 68000. I try to refrain from making too many claims for hardware that I have not personally checked out. There are 8086 S-100 boards presently available, but it will be a while before any 68000 or Zilog Z8000 units are available. Industrial users are acquiring most of the parts, so prices are currently high. My opinion is that these third-generation microprocessors will all perform in the same league when used in personal computers. The true measure of efficiency will be a function of well-written operating systems and high-level language implementations.

Steve

Dear Steve,

Last spring I acquired an

8086 "University Kit" from Intel, with the intention of breadboarding a system. Several tinkerers dissuaded me, saying that the high frequencies involved would not be suitable to my intended medium. I decided to shelve the idea until a reasonably priced S-100 processor board became available. The boards that are presently available are all in the \$500 range. Would I be better off buying an 8088 and building your five-chip system described in the March and April Circuit Cellars, or are cheaper boards going to be available soon?

Tom Boerjan

*I disagree with the person that told you not to prototype an 8086 system because of the high frequencies involved. The frequencies are no higher than those used in the 8080. The key, of course, is good layout and proper construction techniques. You can still try an 8088, but a bird in the hand...*

*The 8088 is still new and University Kits did not exist when I wrote the article. An S-100 board for either processor will be expensive. Only time and increased chip production will lower the cost.*

*For a printed-circuit board for the 8088 system described in my article, write to John Bell Engineering, POB 338, Redwood City CA 94064. They should be able to provide the necessary components. For application notes on the 8088 processor, write directly to Intel Corporation at 3065 Bowers Ave, Santa Clara CA 95051.*

Steve ■

In "Ask BYTE," Steve Ciarcia answers questions on any area of microcomputing. The most representative questions received each month will be answered and published. Do you have a nagging problem? Send your inquiry to:

Ask BYTE  
c/o Steve Ciarcia  
POB 582  
Glastonbury CT 06033

If you are a subscriber to *The Source*, send your questions by electronic mail or chat with Steve (TCE317) directly. Due to the high volume of inquiries, personal replies cannot be given. Be sure to include "Ask BYTE" in the address.

# Diagnostics I

for CP/M\* & TRSDOS\*



Someday your computer is going to break; even the most reliable computer systems "go down". Often, finding exactly what is wrong can account for the most time consuming part of repairing the system, and the longer the system is down, the more money you lose.

DIAGNOSTICS I is a complete program package designed to check every major area of your computer, detect errors, and find the cause of most common computer malfunctions, often before they become serious. For years, large installations have run daily or weekly diagnostic routines as a part of normal system maintenance and check-out procedures.

DIAGNOSTICS I is designed to provide that kind of performance testing for 8080/Z80 micro computers.

DIAGNOSTICS I will really put your system through its paces. Each test is exhaustive and thorough. The tests include:

- Memory Test
- CPU Test (8080/8085/Z80)
- Printer Test
- Disk Test
- CRT Test

To our knowledge, this is the first CPU test available for 8080/Z80 CPU's. Many times transient problems, usually blamed on bad memory, are really CPU errors.

A good set of diagnostics is an indispensable addition to your program library even if your system is working fine. Hours have been wasted trying to track down a "program bug" when actually hardware was to blame!

DIAGNOSTICS I also allows you to be confident of your system. This can be critical when file merges or sorts and backups are involved. You want to be as sure of your computer as possible during these critical times. Running DIAGNOSTICS I prior to these and other important functions helps to insure that your system is operating at peak performance.

DIAGNOSTICS I is supplied on discette with a complete users manual.

**DIAGNOSTICS I: \$60.00 Manual only: \$15.00**

**Requires: 24K CP/M; 16K disc for TRS-80**

**formats: CP/M 8" SOFT SECTORED, NORTHSTAR CP/M AND TRS-80 DOS**



**All Orders and General Information:  
SUPERSOFT ASSOCIATES  
P.O. BOX 1628  
CHAMPAIGN, IL 61820  
(217) 359-2112**

**Technical Hot Line: (217) 359-2691  
(answered only when technician is available)**

\*CP/M REGISTERED TRADEMARK DIGITAL RESEARCH  
\*TRSDOS TRS-80 TRADEMARKS TANDY CORP

NEW FROM  
MICROWARE®

# OS-9

## THE ULTIMATE 6809 OPERATING SYSTEM

Here's an all-new, state-of-the-art operating system that lets you use the 6809 to its fullest capability. Pick the configuration you need: tape or disk-based, single- or multiuser. It's also easy to modify or expand. Here are some features:

- **Interrupt-Driven Multidevice I/O**
- **Hierarchical Disk File Structure**
- **Unix\*-Type I/O Calls**
- **Full Memory Management Capability**
- **System Executive on ROM**
- **Highly Hardware-Independent**

Versions are available off-the-shelf for most popular CPU's such as SWTPC, GIMIX, PERCOM, Motorola, etc.

\*UNIX is trademark of Bell Telephone Laboratories

### OS-9 System Software

We also offer a new generation of interactive software development tools for fast, efficient application programming.

- **Minimum-Keystroke Text editor**
- **OS-9 Assembler**
- **Microsoft Basic**
- **Interactive debug module**
- **Expansion device driver modules**

And Coming Soon . . .

- **OS-9 Level 2 Multiuser**
- **Motorola BASIC09**

Call or write today for information.

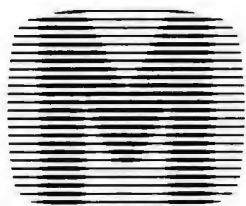

# MICROWARE®

5835 Grand Ave., P.O. Box 4865, Des Moines, IA 50304  
515/279-8844

## WHY PAY MORE? Compare our prices and service

**SOROC**  
IQ 120 ..... \$ 790.  
IQ 140 ..... \$1190.

**CENTRONICS PRINTERS**  
Prices too low to advertise.  
Call for best price.

**LIVERMORE DATA MODEMS**  
300 BAUD ..... \$170.  
RS-232, 2 yr. uncond. guarantee

**BASF DISKETTES**  
5 1/4" 10/\$30.  
8" 10/\$30.

**CABLES**  
IEEE to Centronics ..... \$100.  
RS-232 ..... \$ 25.

**COMMODORE SPECIALS FREE\***  
PET32K (N&B) ..... 1295 ... 175.  
PET 16K (N&B) ..... 995 ... 135.  
PET 8K ..... 795 ... 100.  
PET 2040 Disk  
Drive ..... 1295 ... 175.  
PET 2022 Tractor  
Printer ..... 795 ... 100.  
PET CZN Cassette  
Deck ..... 95 ... 12.

**BPI GENERAL LEDGER**  
Accounting System for Apple  
II Computers—Special... \$399.

**CDS SERIES 80 IPS-100**  
■ Main Frame  
■ Key Switch (ON/OFF)  
■ 8085 Processor  
■ 630,000 Byte Disks  
■ 10 Slot S-100 Buss  
■ 32K Ram  
■ 2 Independent RS-232  
I/O Ports  
■ Up to Four Users  
■ 110 Volts 60 HZ  
■ 220 Volts Available  
■ List Price \$3295.  
■ Sale Price \$2700.

**TO ORDER:**  
Send check or money order.  
VISA/Master Charge/C.O.D.

\*Free merchandise with purchase of C8M item.

## COMPUTER PRODUCTS INTERNATIONAL

P.O. Box 17675 Washington, D.C. 20041  
703-573-9633

# BYTE BACK ISSUES FOR SALE

The following issues are available:

1976: July and November  
1977: March, May thru December  
1978: February thru October, December  
1979: January thru December except March  
1980: January thru June except February  
Cover price for each issue thru August 1977 is \$1.75  
Domestic; \$2.75 Canada and Mexico; \$3.75 Foreign.  
September 1977 through October 1979 issues are \$2.50  
Domestic; \$3.25 Canada and Mexico; \$4.00 Foreign.  
November 1979 to current is \$3.00 Domestic; \$3.75 Canada  
and Mexico; \$4.50 Foreign.

Send requests with payment to:

**BYTE Magazine**

70 Main St, Peterborough, NH 03458  
Attn: Back Issues





# SOFTWARE CONCEPTS

## A NEW CONCEPT IN APPLE ][\* SOFTWARE

Finally, a company specializing in software for the APPLE ][ or ][ Plus and only **APPLES!** All your software shopping can now be done under **ONE ROOF** at **TREMENDOUS SAVINGS!** Because we sell software and only software, we receive discounts from **ALL** major Suppliers, such as:

**HAYDEN  
PROGRAMMA**

**CREATIVE COMPUTING  
MICROSOFT**

**PERSONAL SOFTWARE  
and MANY OTHERS**

and **WE CAN PASS THESE SAVINGS ONTO YOU, the APPLE USER!**

If you are tired of page thumbing looking for APPLE programs, and want the best prices on **ALL** programs written for the APPLE, send for our **FREE** 40-page catalog and a \$1 coupon good towards your first order or call us for our price on any APPLE program written and order by phone. M/C, VISA, BankAmericard accepted.

**IF WE HAVEN'T GOT IT, IT HASN'T BEEN WRITTEN!!**

\*Trademark of APPLE Computers Inc.

### Software Concepts

948 Danvers Ave., Westerville, OH 43081  
**(614) 882-8007**

Circle 177 on inquiry card.

Hours:  
10AM-9PM Weekdays  
12Noon-5PM Saturdays  
Closed Sundays

### ATTENTION: PROGRAMMERS!

We are looking for user-written software to sell on a per copy royalty basis. Please send description of any programs you have written and we can **MARKET** them for you!!

If you are interested, please circle 178 on inquiry card.

## Two Bits for Fortran String Handling Ease.



**You bet!** Two key bits are now available to make FORTRAN character string handling a pleasure. One features system portability, the other, high performance and file handling in the CP/M environment. Select the one that best meets your string handling requirements.

### The String Bit™

Features portability, it's written in FORTRAN. Functions include, moves, left, right, middle, length, scan, numeric conversions and more. Interactive demonstration program, utility library and all source code is included.

Price **\$45.00**

### The String/80 Bit™

Features high performance, it's written in assembler language. Assembler language programmers can also benefit from its many features in the CP/M environment. In addition to the string handling capabilities of the STRING Bit, it supports program chaining, CP/M calls, CP/M file handling and more. Several interactive programs and their source code are included.

Price **\$95.00**

All prices are FOB Miami. CP/M is a Trademark of Digital Research

Copyright © 1980 Key Bits, Inc. All rights reserved.

**KEYbits**

Key Bits, Incorporated P. O. Box 592293 Miami, FL 33159

Circle 179 on inquiry card.

813-485-3559

**NEED IT FAST?  
AT A FAIR PRICE?  
WITH SUPPORT?**

	LIST PRICE	OUR PRICE
Cromemco System II (64K, Two 160K disks)	\$3995	\$3292
Vector Graphic 64KZ	975	796
Dynabyte DB8/4-22	4195	3499
Nec 5515 Spinwriter	3200	2550
Thinker Toys		
16K Memory Master	399	345
Zenith WH 19	995	895
Word-Star	445	375
Microsource Timekeeper	595	499
Invmaster—Inventory w/A/R	1595	995

Send ad for free catalog.

**SARA TECH**  
P.O. Box 692 • Venice, FL 33595

Circle 180 on inquiry card.

BYTE July 1980 233

## BUSINESS - PROFESSIONAL - GAME SOFTWARE FOR APPLE AND TRS-80

- HOME FINANCE PAK I: Complete package \$49.95 Apple, TRS-80**
  - BUDGET:** The heart of a comprehensive home finance system. Allows user to define up to 20 budget items. Actual expense input can be by keyboard or by automatic reading of CHECKBOOK II files. Costs are automatically sorted and compared with budget. BUDGET produces both monthly actual/budget/variance report and a year-to-date by month summary of actual costs. Color graphics display of expenses...\$24.95
  - CHECKBOOK II:** This extensive program keeps complete records of each check/deposit. Unique check entry system allows user to set up common check purpose and recipient categories. Upon entry you select from this pre-defined menu to minimize keying in a lot of data. Unique names can also be stored for completeness. Rapid access to check files. Check register display scrolls for ease of review. 40 column print-out. Up to 100 checks per month storage. Files accessible by BU DGET program...\$19.95
  - SAVINGS:** Allows user to keep track of deposits/withdrawals for up to 10 savings accounts. Complete records shown via screen or 40 column printer...\$14.95
  - CREDIT CARD:** Keep control of your cards with this program. Organizes, stores and displays purchases, payments and service charges. Screen or 40 column printer display. Up to 10 separate cards...\$14.95
- THE UNIVERSAL COMPUTING MACHINE: \$39.95 Apple, TRS-80**

A user programmable computing system structured around a 20 row x 20 column table. User defines row and column names and equations forming a unique computing machine. Table elements can be multiplied, divided, subtracted or added to any other element. User can define repeated functions common to a row or column greatly simplifying table setup. Hundred of unique computing machines can be defined, used, stored and recalled, with or without old data, for later use. Excellent for sales forecasts, engineering design analysis, budgets, inventory lists, income statements, production planning, project cost estimates-in short for any planning, analysis or reporting problem that can be solved with a table. Unique cursor commands allow you to move to any element, change its value and immediately see the effect on other table values. Entire table can be printed by machine pages (user-defined 3-5 columns) on a 40 column printer. Transform your computer into a UNIVERSAL COMPUTING MACHINE.
- COLOR CALENDAR: HI-RES color graphics display of your personal calendar. Automatic multiple entry of repetitive events. Review at a glance important dates, appointments, anniversaries, birthdays, action dates, etc. over a 5 year period. Graphic calendar marks dates. Printer and screen display a summary report by month of your full text describing each day's action item or event. Ideal for anyone with a busy calendar... (Apple Only) ...\$19.95**
- BUSINESS SOFTWARE SERIES: Entire package \$239.95 Apple, TRS-80**
  - MICROACCOUNTANT:** The ideal system for the small cash business. Based on classic T-accounts and double-entry bookkeeping, this efficient program records and produces reports on account balances, general ledger journals, revenue and expenses. Screen or 40 column printer reports. Handles up to 500 journal entries per period, up to 100 accounts. Instructions include a short primer in Financial Accounting. \$49.95
  - UNIVERSAL BUSINESS MACHINE:** This program is designed to SIMPLIFY and SAVE TIME for the serious businessman who must periodically Analyze, Plan and Estimate. The program was created using our Universal Computing Machine and it is programmed to provide the following planning and forecasting tools.  

CASH FLOW ANALYSIS	PROFORMA BALANCE SHEET	SOURCE AND USE OF FUNDS
PROFORMA PROFIT & LOSS	SALES FORECASTER	JOB COST ESTIMATOR

 Price, including documentation and a copy of the base program. Universal Computing Machine... \$89.95
  - INVOICE:** Throw away your pens. Use the ELECTRONIC INVOICE facsimile displayed on your CRT. The program prompts and you fill in the data. Includes 3 address fields (yours, Bill to and Ship to), Invoice No., Account No., Order No., Salesman, Terms, Ship Code, FOB Pt. and Date. Up to 10 items per sheet with these descriptions: Item No., No. of units, Unit Price, Product Code, Product Description, Total Dollar amount per item and invoice total dollar amount. Generates, at your option, hard copy invoices, shipping memos, mailing labels, audit copies and disc updates to master A/R files. Compatible A/R module available Aug. 1980 (48K)...\$49.95
  - MAILING LIST:** The best mailing list program available, bar none. Options for keyboard or file input, alphanumeric sort on any of 7 fields, including zip code sort for bulk mailing. Multiple addresses per line, vertical space adjust. Up to 500 records per disc (48K)...\$49.95
  - BUSINESS CHECK REGISTER:** Expanded version of the Checkbook II program. Handles up to 500 checks per month with complete record keeping. (48K)...\$29.95
  - BUSINESS BUDGET:** As described above and companion program to Business Check Register. Handles 500 transactions per month, up to 20 cost categories. Accesses BCR files for actual costs. (48K)...\$29.95
- ELECTRICAL ENGINEERING SERIES: Both programs \$159.95 Apple only**
  - LOGIC SIMULATOR: SAVE TIME AND MONEY.** Simulate your digital logic circuits before you build them. CMOS, TTL, or whatever, if it's digital logic, this program can handle it. The program is an interactive, menu driven, full-fledged logic simulator capable of simulating the bit-time by bit-time response of a logic network to user-specified input patterns. It will handle up to 1000 gates, including NANDS, NORs, INVERTERS, FLIP-FLOPS, SHIFT REGISTERS, COUNTERS and user-defined MACROS. Edge triggered or 2 phase clocks. Up to 40 user-defined, random, or binary input patterns. Simulation results displayed on CRT or printer. Accepts network descriptions from keyboard or from LOGIC DESIGNER for simulation. Specify 1000 gate version (48K required) or 500 gate version (32K required)...\$89.95
  - LOGIC DESIGNER:** Interactive HI-RES Graphics program for designing digital logic systems. A menu driven series of keyboard commands allows you to draw directly on the screen up to 15 different gate types, including 10 gate shape patterns supplied with the program and 5 reserved for user specification. Standard patterns supplied are NAND, NOR, INVERTER, EX-OR, T-FLOP, JK-FLOP, D-FLOP, RS-FLOP, 4 Bit COUNTER and N-BIT SHIFT REGISTER. User interconnects gates just as you would normally draw using line graphics commands. Network descriptions for LOGIC SIMULATOR generated simultaneously with the CRT diagram being drawn. Drawing is done in pages of up to 20 gates. Up to 50 pages (10 per disc) can be drawn, saved and recalled. Specify 1000 gate (48K) or 500 gate (32K) system...\$89.95
- MATHEMATICS SERIES: Complete Package \$49.95 Apple only**
  - NUMERICAL ANALYSIS:** HI-RES 2-Dimensional plot of any function. Automatic scaling. At your option, the program will plot the function, plot the INTEGRAL, plot the DERIVATIVE, determine the ROOTS, find the MAXIMA and MINIMA and list the INTEGRAL VALUE. For 16K...\$19.95
  - MATRIX:** A general purpose, menu driven program for determining the INVERSE and DETERMINANT of any matrix, as well as the SOLUTION to any set of SIMULTANEOUS LINEAR EQUATIONS. Disk I/O for datasets. Specify 95 eqn. set (48K) or 35 eqn. (32K)...\$19.95
  - 3-D SURFACE PLOTTER:** Explore the ELEGANCE and BEAUTY of MATHEMATICS by creating HI-RES PLOTS of 3-dimensional surfaces from any 3-variable equation. Disc save and recall routines for plots. Menu driven to vary surface parameters. Demos include BLACK HOLE gravitational curvature equations...\$19.95
- ACTION ADVENTURE GAMES SERIES: Entire series \$49.95 Apple only**
  - RED BARON:** Can you outfly the RED BARON? This fast action game simulates a machine-gun DOG-FIGHT between your WORLD WAR I BI-PLANE and the baron's. You can LOOP, DIVE, BANK or CLIMB in any one of 8 directions- and so can the BARON. In HI-RES graphics (16K)...\$19.95
  - BATTLE OF MIDWAY:** You are in command of the U.S. HORNETS' DIVE-BOMBER squadron. Your targets are the Japanese carriers, Akagi, Soryu and Kaga. You must fly your way through ZEROS and AA FIRE to make your DIVE-BOMB run. In HI-RES graphics (16K)...\$19.95
  - SUB ATTACK:** It's April, 1943. The enemy convoy is headed for the CORAL SEA. Your sub, the MORAY, has just sighted the CARRIERS and BATTLESHIPS. Easy pickings. But watch out for the DESTROYERS- they're fast and deadly. In HI-RES graphics (16K)...\$19.95
  - FREE CATALOG-**All programs run on Apple II w/Disc & Applesoft ROM Card & TRS-80 Level II and require 32K RAM unless otherwise noted. Detailed instructions included. Orders shipped within 48 hours. Card orders include card number. Add \$1.50 postage and handling with each order. California residents add add 6% sales tax. Make checks payable to:



## SPECTRUM SOFTWARE

DEALER INQUIRIES INVITED P.O. BOX 2084 - SUNNYVALE, CALIFORNIA 94087 FOR PHONE ORDERS - 408-245-1415

## IBM + CP/M + OSM = CP/M Compatible Distributed Processing Multi-User Computer System



OSM Computer Corporation is introducing a true multi-user, multi-tasking computer system.

### Hardware features

1. IBM 3101 terminals.
2. Each user has its own complete system consisting of CPU, memory, console, and printer (optional).
3. Unlike MP/M system there is no speed degradation as you add users.
4. All users share common data base disk storage and host printer.
5. Users can select either host or local printer.
6. Dual floppy and up to 128 mega byte hard disk storage.
7. Up to 128 user terminals.
8. Each user has a hardware CPU reset button. If any of the users "crash" he can reset his CPU without affecting other users.

### Software Features

1. Use of CP/M 2.2 allows any CP/M compatible software to be used.
2. DPOS/2 multiuser supervisor executive
3. 2 file protect modes (in addition to CP/M's) prevent "fatal embrace" and "interleaved update sequences".
4. Automatic system printer spooling.
5. Messages can be passed among users.

### Prices

Single user Mainframe (Z80, 64K memory, 2 serial 3 parallel I/O, 1.2 M Byte 8 inch dual disk) . \$5,195.00  
 Two user Mainframe . . . . . \$7,790.00  
 Each additional user (CPU, 64K memory, I/O) . . . . . \$1,295.00  
 IBM 3101 terminal . . . . . \$1,250.00  
 Texas Instrument 820 RO . . . \$1,695.00  
 QUMES/45 RO . . . . . \$2,550.00  
 27 Mega Byte Hard Disk . . . \$4,995.00

## OSM Computer Corporation

2364 Walsh Ave. Santa Clara, CA 95051 (408) 496-6910

Dealer Inquiries Invited

# Reliable Business Bookkeeping Software

## ORDER ENTRY

MICROSOFT CP/M<sub>80</sub>, PET, APPLE II, MICROPOLIS: \$350/ea.

## GL, A/P, A/R, INVENTORY, PAYROLL

TRS-80 MOD I: \$100/ea.  
 CBASIC-CP/M<sub>80</sub>: \$200/ea.  
 ATARI, PET, APPLE II, TRS-80 MOD II, MICROPOLIS, VECTOR, EXIDY, DYNABYTE, CROMEMCO, MICROSOFT CP/M<sub>80</sub>: \$140/ea.

Buy simple, effective programs designed specifically for your machine. Call us once for same week delivery on a product you can use the day you receive it, and two years from now when your company is twice as big.

Order today by U.P.S. COD. We'll pay postage and handling on Am.Ex., Visa, Mastercharge, or pre-paid orders.

They all work together!

# COMPUMAX

467 HAMILTON AVE. PALO ALTO, CA. 94301

# Buy By Mail and Save!

COMPUTERS	DISK SYSTEMS
<b>INTERTEC SuperBrain®</b>	<b>THINKER TOYS®</b>
32K RAM \$2995 ..... <b>\$2495</b>	Discus 2D, \$1149 ..... <b>\$ 939</b>
64K RAM \$3345 ..... <b>\$2695</b>	Dual Discus 2D ..... <b>\$1559</b>
64K Quad, \$3995 ..... <b>\$3395</b>	Discus 2+2, \$1549 .... <b>\$1288</b>
<b>NORTH STAR Horizon® 1</b>	<b>NORTH STAR MDS-A . \$699</b>
32K Kit, List \$1999 .... <b>\$1579</b>	Kit Version ..... <b>\$639</b>
32K Assembled \$2695 . <b>\$2149</b>	
<b>Horizon 2</b>	<b>PRINTERS/TERMINALS</b>
32K DD, Assm. \$3095 . <b>\$2439</b>	<b>ANADEx DP-8000 .... \$ 799</b>
32K OD, Assm. \$3595 . <b>\$2859</b>	<b>T.I. 810 ..... \$1575</b>
<b>CROMEMCO</b>	<b>CENTRONICS 730-1 . . \$ 639</b>
System 3, 64K, \$6990 . <b>\$5479</b>	737, List \$995 ..... <b>\$ 849</b>
System 2, 64K, \$3990 . <b>\$3179</b>	<b>PAPER TIGER IDS-440 \$ 849</b>
Z-2, List \$995 ..... <b>\$ 829</b>	with Graphics Option . <b>\$ 949</b>
<b>COMMODORE PET 16K \$ 849</b>	<b>INTERTUBE II, \$995 .. \$ 729</b>
<b>APPLE 16K, List \$1195 . \$ 979</b>	<b>P-E Bantam 550 ..... \$ 789</b>
<b>TI-99/4, List \$1150 .... \$ 985</b>	<b>SOROC 120 ..... \$ 745</b>
<b>ATARI® 400, List \$630 \$ 489</b>	<b>TELEVIDEO 912B ..... \$ 739</b>
800 List \$1080 ..... <b>\$ 839</b>	912C ..... <b>\$ 779</b>
<b>FLOPPY DISKS, 5 1/4"</b>	920B ..... <b>\$ 789</b>
box of 10 <b>SPECIAL \$ 29.95</b>	920C ..... <b>\$ 839</b>

Most items in stock for immediate delivery, factory-sealed cartons, with full factory warranty. N.Y.S. residents add appropriate sales tax. Prices do not include shipping. VISA and Master Charge add 3%. COD orders require 25% deposit. Prices subject to change and offers subject to withdrawal without notice.

## Computers Wholesale



P.O. Box 144  
Camillus, NY 13031  
(315) 472-2582



# MONITORS

\$168 @ unit/\$2016 @dozen/\$13.00 @ pound (retail)



Any way you look at it, the Javelin Monitors are a real value for you and your customer. A value you can't get from the "big guys". Add it up: *Three models to choose from, 9", 15", 19"; Front panel controls; High linearity; Improved circuitry; Home and professional computer capability; plus a one-year warranty.* It's worth it for you to find out how we offer the highest value per dollar... And you need that today.

## JAVELIN ELECTRONICS

Subsidiary of Walter Kidde & Company, Inc.  
**KIDDE**

19831 Magellan Drive, Torrance, CA 90502/(213) 327-7440

# Improved!

## POSTMASTER

# Tomorrow's mail system. Today.

One package does it ALL. Teratek's Postmaster offers the most powerful and flexible mail-management system available for any CP/M or compatible derivative capable of running CBASIC II, now including Apple II.

### Menu Driven.

Up to 250K Records Per File Name.

Up to 16 Drives Supported. 9 Digit Zip Code Supported.

**Batch Entry:** Entering names and addresses to a mailing list is simple. Repeated elements of a record need only be entered once.

**Powerful Record Extraction:** Used in conjunction with the **Optional Reference Field**, this feature allows simple creation of user specified "target-files."

**Dedicated Record Editor:** List, modify or delete records. Allows intact or extracted backup of original file.

**Automatic "ID" Field Insertion:** (optional) Key in a name, and a unique 10 character record identifier will be entered automatically to the Reference area.

**Envelopes:** Postmaster prepares single or continuous envelopes.

**Mailing Labels:** Standard or user-specified formats up to five across. Any number of labels per name.

**Translator Program NAD to Postmaster Provided as Full Source.**

**Form Letters:** Supports courtesy titles, nicknames, single page or continuous form. Optional text or salutation inserts in any letter.

**Dedicated Record Sorting.**

**Attractive Reports:** Neat, paginated reports on either 80 or 132 column paper.

**Clear, Complete Documentation.**

**Quality That's Affordable and Available:** The Postmaster programs are available in a variety of 5" and 8" disk formats (40k of RAM, CP/M and CBASIC2 are required).

Among the formats supported are TRS-80, North Star, Heath H8 and H89, standard 8" IBM, Vector MZ and other CP/M derivatives capable of running CBASIC.

**Sample Data Files Included.**

**Powerful Yet Easy to Use.**

**All Output Programs Provided as Full Source.**

It's terrific!  
We use it ourselves!

Prices reflect distribution on 8" single density diskettes. If a format is requested which requires additional diskettes, a surcharge of \$8. per additional diskette will be added.

Dealer Inquiries Invited

**COMPLETE PACKAGE:**

**\$150.**

**MANUAL ALONE:**

**\$15.**

(Credited toward subsequent purchase)

\*CP/M is a trademark of Digital Research

*Plus lots more! Just ask!*

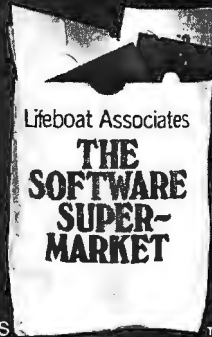

LIFEBOAT ASSOCIATES

2248 Broadway, New York, N.Y. 10024 ☐ (212) 580-0082 ☐ Telex: 220501

# "An altogether exciting story" of computer espionage

*Imagine*—a giant American corporation smuggling strategic computers to the KGB. *Imagine*—the supercorporation secretly selecting its own man for the U.S. presidency and using computer power to secure his election.

"The story of the century...presidential assassination, corporate blackmail, terrorism, love, sex, and death. A little bit of Forsyth, a dash of Arthur Hailey... a good read!"

—*Playboy* (Australia)

"Slick, convincing... Perry melds high-tech with espionage."

—*Publishers Weekly*



A NOVEL BY  
**ROLAND PERRY**

\**N.Y. Times Book Review*

\$9.95, now at your bookstore

**CROWN**

# MICRO8: Using BASIC to Learn Assembly Language

Robert T Pickett III  
Assistant Professor of Engineering  
Piedmont Virginia Community College  
Rt 6, Box 1-A Charlottesville VA 22901

In this article we present a program in BASIC which simulates a very simple digital computer and the assembly language which runs on it. The program is called MICRO8. MICRO8 was developed as a teaching tool to give students some idea of computer architecture and how to write in assembly language. The emphasis is on programming procedures and information flow, without the complexities of number-system conversions and fixed-point arithmetic. All input and output data is in floating-point decimal format, and op codes are in two-digit decimal form, so that the user need not struggle with

binary, octal, or hexadecimal number systems. The next step, using an actual microprocessor assembly language, is therefore made easier. [This tutorial approach is in many ways very similar to that taken by Donald Knuth in his MIX language found in the epic series *The Art of Computer Programming*...ed]

Many useful problems can be solved with MICRO8, including sum of infinite series to a specified convergence, area under curves, square roots, and others. It is quite a challenge for our students to accomplish these solutions with MICRO8, which has only 14 op codes. These students have previously solved these problems in BASIC; nonetheless, working with MICRO8 gives them a good understanding of the details of using an assembly language.

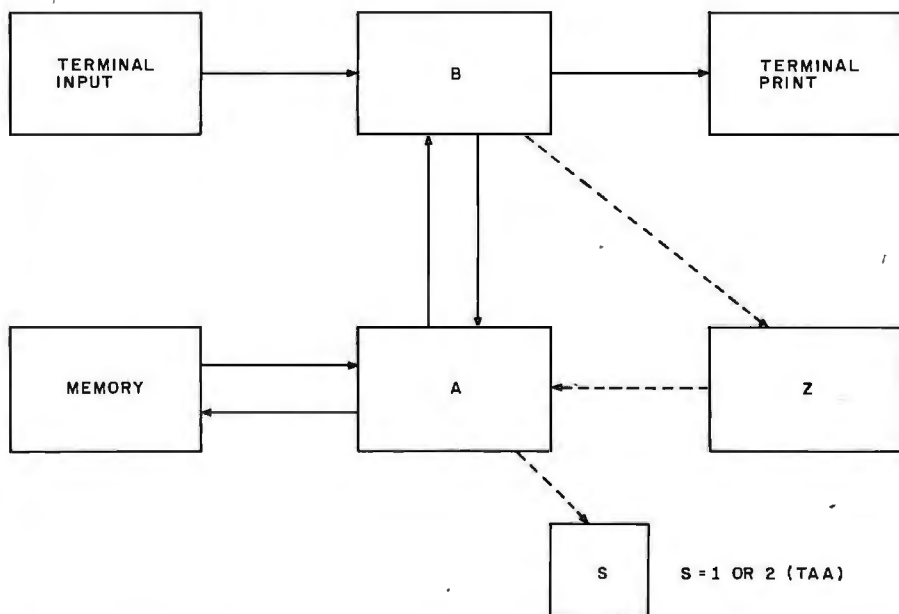

Figure 1: MICRO8 architecture. When the system is started, all registers and memory locations are cleared automatically. Arithmetic operations leave their results in register A. The exchange command (EXE) leaves the first value of B in Z. The maximum size of registers A and B is  $1 \times 10^{20}$ . The running time limit is five minutes, after which a dump command is performed. The limit on the number of machine cycles is 20,000.

## FOR SERIOUS USERS OF 8080, 8085, OR Z80 COMPUTERS

**PRINTER WIZARD** — Now add powerful capabilities to your printer. Free your computer for use while simultaneously printing backlogged output on a first-in-first-out basis. Transparent operation without noticeable slowing of the computer. Allows continuous computer and printer operation on programs having sporadic output. Will backlog up to 100 pages when used with a disk system. Adds optional automatic paging with numbers, adjustable margins on 4 sides, indented overflow lines. Occupies less than 2 1/2 K.

Documentation only	EX80M103	\$45.00
	EX80M103D	\$ 7.50

**DISASSEMBLER** — Disassemble machine code into standard source language. Modify or relocate existing programs such as DOS or BASIC using your existing assembler (not included). Disassembles any 8080, 8085, or Z80 code, including embedded data blocks and "trick" codes. Generates symbol and label tables.

Documentation only	EX80M217	\$75.00
	EX80M217D	\$12.50

ALL EXCOM products are fully supported and warranted indefinitely against original defects. Available on single or double density NORTHSTAR 5 1/4" diskettes, 300 or 1200 baud cassettes (specify). Washington residents add 5.3% tax.

# EXCOM

P.O. Box 1802 Bellevue, Washington 98009 U.S.A.  
Telephone (206) 641-6577

## TOLL FREE ORDERING



These Fine  
Products and More

<b>NORTHSTAR</b>	<b>ASM</b>	<b>KIT</b>	<b>TERMINAL</b>	
HRZ-1-16K-D	1600.	1275.	SOROC IQ-120	760.
HRZ-1-32K-D	1995.	1580.	HAZELTINE 1400	760.
HRZ-2-32K-D	2300.	1900.	HAZELTINE 1500	940.
HRZ-1-32K-Q	2300.	1750.	HAZELTINE 1510	1050.
HRZ-2-32K-Q	2700.	2230.	TELEVIDEO912	700.
			TELEVIDEO920	750.
RAM-16K	365.	325.	<b>PRINTERS</b>	
RAM-32K	565.	515.	BASE-2	450.
			TI-810	1580.
FPB-A	285.	220.	CENTRONICS-799	970.
MDS-A-D	710.	660.	NEC-5510	2550.
MDS-A-Q	880.	830.	NEC-5520	2800.
EXTRA DRIVE-D	—	350.		
EXTRA DRIVE-Q	—	525.	<b>SOFTWARE—DISCS—MISC</b>	
HARD DISC SYSTEM	CALL		AUTOSCRIBE	325.
Most NorthStar computers come standard with real wood cover, 2 serial ports, 1 parallel port, real time clock, disc operating system and NorthStar basic.			VERBATUM DISCS (10)	28.
			5 FOOT RS-232 CABLE	20.
			10 FOOT RS-232 CABLE	25.

WE WILL TRY TO BEAT ANY ADVERTISED PRICE

A. E. I.

4341 W. Commonwealth Ave Suite D  
Fullerton, Calif. 92633  
(714) 739-4701 (800) 854-6003

## What TECO\* does for minis, TED will do for your micro.

Like TECO\*, TED is a character-oriented editor that gives you everything you'd expect. Plus, you get many things you wouldn't expect.

- ▶ 36 command/text buffers
- ▶ 32-entry push-down stack
- ▶ Sophisticated macros
- ▶ Conditional & iterative command execution
- ▶ Conditional & absolute branching
- ▶ Multiple open files

TED and user manual \$90  
Manual alone \$20  
Coupon furnished with manuals purchased separately worth \$20 towards purchase of TED.

You'll also find some elegant enhancements among TED's 90-plus commands.

TED's compatible with Z-80\*-based systems supporting standard CP/M\*. We recommend at least 24K bytes RAM. TED's supplied on CP/M\*-compatible 8-inch disks.

SEND FOR FREE COMMAND SUMMARY

**small system design**

P.O. BOX 4546 MANCHESTER, NEW HAMPSHIRE 03108  
TELEPHONE: 603-432-7929

\*TECO® Digital Equipment Corp., Z-80® Zilog Inc., CP/M® Digital Research Inc

# TRS-80 LEVEL II

**\$675.** COMPLETE SYSTEM

Limited quantity in stock

The world's most popular microcomputer, with 16K of memory and Level 11 basic for only \$675, complete with full 90 day Radio Shack warranty. We accept check, money order or phone orders with Visa or Master Charge. (Shipping costs added to charge orders).

Disk drives, printers, peripherals, software and games . . . you name it, we've got it (Both Radio Shack & other brands). Write or call for our complete price list.



## C&S ELECTRONICS MART Ltd.

AUTHORIZED DEALERSHIP

# Radio Shack

32 E. Main Street • Milan Michigan 48160 • (313) 439-1400





# the electric pencil II™

© 1983 Michael Shroyer

for the TRS-80 Model II\* Computer



The Electric Pencil is a Character Oriented Word Processing System. This means that text is entered as a continuous string of characters and is manipulated as such. This allows the user enormous freedom and ease in the movement and handling of text. Since lines are not delineated, any number of characters, words, lines or paragraphs may be inserted or deleted anywhere in the text. The entirety of the text shifts and opens up or closes as needed in full view of the user. Carriage returns as well as word hyphenation are not required since each line of text is formatted automatically.

As text is typed and the end of a screen line is reached, a partially completed word is shifted to the beginning of the following line. Whenever text is inserted or deleted, existing text is pushed down or pulled up in a wrap-around fashion. Everything appears on the video display screen as it occurs thereby eliminating any guesswork. Text may be reviewed or will by variable speed or page-at-a-time scrolling both in the forward and reverse directions. By using the search or the search and replace functions, any string of characters may be located and/or replaced with any other string of characters as desired. Specific sets of characters within encoded strings may also be located.

When text is printed, The Electric Pencil automatically inserts carriage returns where they are needed. Numerous combinations of Line Length, Page Length, Character Spacing, Line Spacing and Page Spacing allow for any form to be handled. Right justification gives right-hand margins that are even. Pages may be numbered as well as filled.

## the electric pencil

-A Proven Word Processing System

The TRSDOS versions of The Electric Pencil II are our best ever! You can now type as fast as you like without losing any characters. New TRSDOS features include word left, word right, word delete, bottom of page numbering as well as extended cursor controls for greater user flexibility. BASIC files may also be written and simply edited without additional software.

Our CP/M versions are the same as we have been distributing for several years and allow the CP/M user to edit CP/M files with the addition of our CONVERT utility for an additional \$35.00. CONVERT is not required if only quick and easy word processing is required. A keyboard buffer permits fast typing without character loss.

	CP/M	TRSDOS
Serial Diablo, NEC, Qume	\$ 300.00	\$ 350.00
All other printers . . . . .	\$ 275.00	\$ 325.00

The Electric Pencil I is still available for TRS-80 Model I users. Although not as sophisticated as Electric Pencil II, it is still an extremely easy to use and powerful word processing system. The software has been designed to be used with both Level I (16K system) and Level II models of the TRS-80. Two versions, one for use with cassette, and one for use with disk, are available on cassette. The TRS-80 disk version is easily transferred to disk and is fully interactive with the READ, WRITE, DIR, and KILL routines of TRSDOS.

TRC	Cassette . . . . .	\$ 100.00
TRD	Disk . . . . .	\$ 150.00

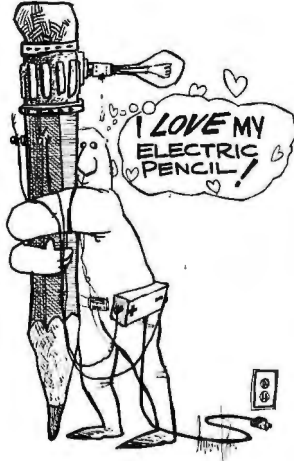

### Features

TRSDOS or CP/M Compatible • Supports Four Disk Drives • Dynamic Print Formatting • Diablo, NEC & Qume Print Packages • Multi-Column Printing • Print Value Chaining • Page-at-a-time Scrolling • Bidirectional Multispeed Scrolling • Subsystem with Print Value Scoreboard • Automatic Word & Record Number Tally • Global Search & Replace • Full Margin Control • End of Page Control • Non Printing Text Commenting • Line & Paragraph Indentation • Centering • Underlining • Boldface



\*TRS-80 is a registered trade mark of Radio Shack, a division of Tandy Corp.

**MICHAEL SHROYER SOFTWARE, INC.**  
1198 Los Robles Dr.  
Palm Springs, CA. 92262  
(714) 323-1400

# THE ESSENCE of output quality

- Any IBM SELECTRIC® can be converted to produce high quality output at an affordable price!
- Interfaces directly to S100, Parallel, RS-232 or IEEE-488.
- Compatible with TRS-80, Sorcerer, Pet, Apple, Horizon, etc.
- Why be printer bound? Prices from \$496 to \$675.

Call today.



Backspace and Tab Available NOW!



Escon Products, Inc.  
171 Mayhew Way, Suite 204  
Pleasant Hill, Ca., 94523  
(415) 935-4590

# DISCOUNT SOFTWARE

## CP/M®

**OSBORNE AND ASSOC.**  
business software in CBASIC-2

* General Ledger . . . . .	}	\$59/\$19 each
* Acct. Rec./Acct. Pay. . . . .		
* Payroll w/Cost Acct. . . . .		
Buy 2 get 1 free. . . . .	\$118/\$57	
All 3 plus CBASIC-2 . . . . .	\$199/\$71	

CBASIC-2® . . . . . \$89/\$14

**DIGITAL RESEARCH**  
CP/M® 2.2 for TRS-80® Model II \$149/\$24  
CP/M® 2.2 for Northstar . . . . \$149/\$24

WORDSTAR by MicroPro . . . . . \$249/\$36

**WHITESMITHS**  
\* "C" Compiler . . . . . \$600/\$29  
\* Pascal (includes "C") . . . . . \$750/\$44

\* SELECTOR III-C2 . . . . . \$269/\$19

**PEACHTREE** business software in Microsoft BASIC source code.

† General Ledger . . . . .	}	\$399/\$65 each
† Acct. Rec. . . . .		
† Acct. Pay. . . . .		
† Payroll . . . . .		
† Inventory . . . . .	\$1995/\$349	
All 5 plus WORDSTAR . . . . .	\$1995/\$349	

## TRS-80® MODEL II

CP/M® 2.2 Latest Version . . . . . \$149

**ELECTRIC PENCIL II**  
Standard Printer . . . . . \$249  
Diablo, Qume, NEC . . . . . \$279

## APPLE II®

VISICALC® by Personal Systems . . . \$122

**VISA • MASTERCHARGE**  
ORDERS ONLY — CALL TOLL FREE  
**1-800-854-2003 ext. 823 A**  
Calif. **1-800-522-1500 ext. 823 A**

For information write or call:  
**THE DISCOUNT SOFTWARE GROUP**  
1610 Argyle Ave., Bldg. 102  
Los Angeles, CA 90028  
(213) 461-3127

CP/M users: specify disk systems and formats  
Most formats available  
Arid \$2.50 postage and handling per each item  
California residents add 8% sales tax  
Allow 2 weeks on checks. C O D ok  
Prices subject to change without notice  
All items subject to availability

\* — Special Bonus with order      † — Requires CBASIC-2  
‡ — Requires Microsoft BASIC      @ — Mfgs. Trademark

P.S. — We want to be your software source. Give us the opportunity to beat any nationally advertised price!

## Join TI at its headquarters for Consumer Electronic Products and enjoy a bold new world.

### Software Engineers:

Program and document algorithms in software support programs for state-of-the-art, microprocessor applications and new consumer products, i.e., calculators, watches, and learning aids. These products utilize leading edge semiconductor and display technologies. Requires 1 year experience in assembly language or microcoding on mini or microcomputers. BS/MS in Math, Computer Science or EE, or BA/MA with strong math, physics or engineering background.

Send a resume in confidence to: Reuel Casey/P.O. Box 10508, M.S. 5893/Lubbock, TX 79408.



# TEXAS INSTRUMENTS INCORPORATED

An equal opportunity employer M/F



**PERSONAL  
COMPUTER  
SYSTEMS**

A Warner Communications  
Company

**ATARI® 800™**

List \$1080

**ONLY \$849**



**ATARI® 400™**, List \$630

**OUR PRICE ONLY \$499**

820 PRINTER, List \$599.95 ..... \$499  
810 DISK DRIVE, List \$699.95 ..... \$589

**Texas Instruments**

**TI-99/4 Home  
Computer**

List \$1150

**OUR PRICE**

**\$995**

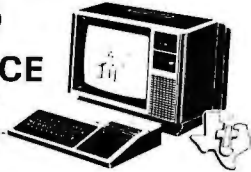

CALCULATORS BY

**HEWLETT PACKARD**

- HP-41C Calculator, "A System" . . . \$289.95
- HP-32E Scientific w/Statistics . . . \$ 53.95
- HP-33C Scientific Programmable . . . 99.95
- HP-34C Advanced Scientific  
Programmable . . . . . 123.95
- HP-37E Business Calculator . . . . . 58.95
- HP-67 Handheld Fully Advanced  
Programmable Scientific for  
Business & Engineering . . . . . 298.95
- HP-97 Desktop w/Built-in Printer . . 579.95

- APPLE II, 16K, List \$1195 . . . . . \$ 989
- 32K, List \$1395 . . . . . \$1169
- 48K . . . . . 1259

COMMODORE PET . . . . . Call for Prices

Prices do not include shipping by UPS. All prices and offers are subject to change without notice.

**Personal  
PC systems**



609 Butternut Street  
Syracuse, N.Y. 13208  
(315) 478-6800

**Listing 1:** Program input for calculation of  $R^2 + X^2$ . These program lines are added to listing 5.

```
1400 REM: NEXT LINE, NUMBER OF PROGRAM STEPS
1410 DATA 17
1420 REM: FOLLOWING LINES = PROGRAM
1430 DATA 17, 1, 19, 1, 22, 2, 13, 14, 17, 3, 19, 3, 17, 2, 25, 12, 27
1450 LET M[1] = 168
1460 LET M[3] = 12
```

**Listing 2:** Sample run of listing 1. The DMP command causes a complete printout of all registers and memory used.

```
RUN
MICRO8

B REGISTER = 28368    MACHINE CYCLES = 9    LAST ADDR = 26
DUMP ROUTINE
A = 0    B = 28368    Z = 0    LAST OPCODE = 27    LAST ADDR = 27
S = 0    MACHINE CYCLES = 10    RUN TIME = 0    MINUTES
```

```
MEMORY CONTENTS:
168 28224 12 0 0 0 0 0 0 0 17
1 19 1 22 2 13 14 17 3 19 3 17
2 25 12 27
DONE
```

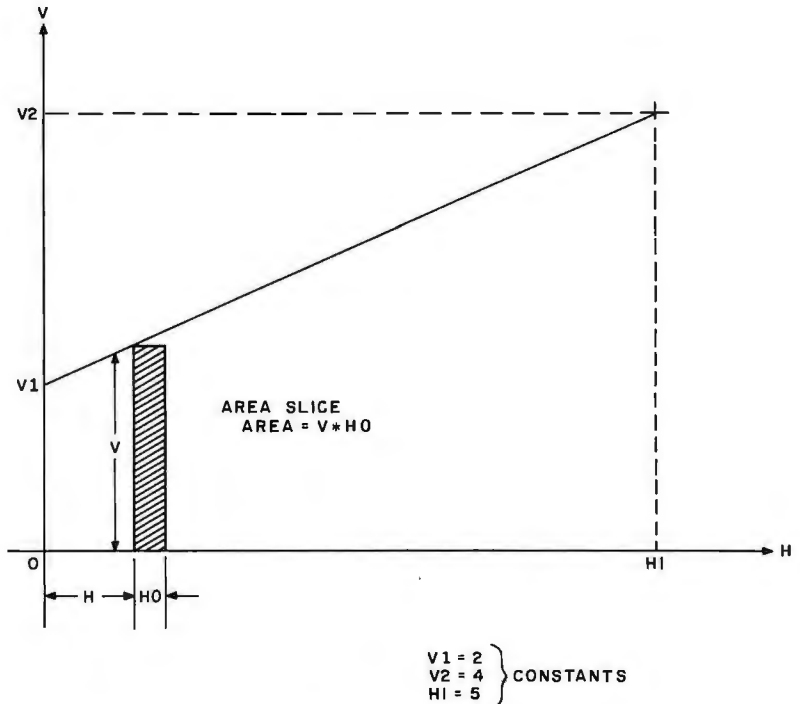

Figure 3: Problem setup for area under the curve problem.

another matter!). DMP provides a printout of the entire memory contents along with the contents of all registers.

To run this program in MICRO8, the desired sequence of op codes (the program) is typed in, beginning with line 1430 as DATA. The number of program steps is then typed in as DATA on line 1410. Next, any "scratch-pad" values are typed in as LET statements, beginning on line

1450. The complete MICRO8 program input then appears as shown in listing 1.

Next, type RUN. MICRO8 will store the entire program in memory, beginning at location M(11); it will then proceed to execute the instructions beginning at location 11, one step at a time.

The resulting run appears in listing 2; the particular numbers used for R and X were 168 and 12, respectively.

*Text continued on page 248*

# NORTH STAR BASIC GLOBAL LINE EDITOR PLUS 3 MORE UTILITIES

**N★BUS** is a system of assembly software designed especially for programmers using North Star BASIC

**EDITOR** — At last! A GLOBAL line editor for BASIC that features line scrolling and 26 separate commands including global locate and change, line insert and append, copy, move, erase columns, delete and print. Interfaces ANY release 4 or later BASIC.

**BPAK** — Packs BASIC source programs to eliminate unnecessary spaces and REMarks.

**BPRT** — Prints formatted BASIC listings with title, page number AND cross-reference broken down to simple variables, dimensioned variables, string variables, functions, string functions and subroutines.

**RE** — Renames files. **\$69** plus \$1.50 postage

FOR ALL THESE FEATURES JUST

Calif. Res. add 6% tax. No C.O.D.'s please. Send check or M.O. VISA or MASTER CHARGE accepted.

Dealer inquiries invited  
COMPLETE BROCHURE AVAILABLE



**Software Systems**  
1269 Rubio Vista Road  
Altadena, Calif. 91001



• Full line of APPLE  
Computers - Peripherals - Software  
See the NEW APPLE III!  
(and other new exciting products)

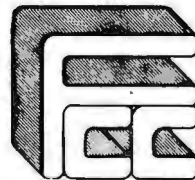

**FARNSWORTH  
COMPUTER CENTER**

1891 N. Farnsworth Ave.  
(At the E-W Tollway)  
Aurora, Il. (312)851-3888

Weekdays 10 to 8 - Sat. 10 to 5

**ANNOUNCING:**

**NEW!**

## MICROSTAT

A complete statistics package for business, scientific, education and research work. No other package has the features of MICROSTAT. For example:

- File oriented with COMPLETE editing
- A Data Management Subsystem for editing, sorting, ranking, lagging, data file transfers PLUS 11 data transformations (e.g., linear, reciprocal, exponential, etc.)
- Frequency distributions
- Simple and multiple regression
- Time series (including exponential smoothing)
- 11 Non-parametric tests
- Crosstabs/Chi-square
- Factorials (up to 1,000,000!), permutations, combinations
- 8 Probability distributions
- Scatterplots
- Hypothesis test (Mean, proportion)
- ANOVA (one and two-way)
- Correlation
- Plus many other unique features

Users manual: \$10.00 (credited towards purchase) and includes sample data and printouts. Uses NORTH STAR BASIC 32K of memory, one or two disk drives (2 recommended). Printer optional. Price: \$200.00



**ECOSOFT**

P.O. Box 68602  
Indianapolis, IN 46268

Phone orders:  
(317) 253-6828

### Lowest Prices on Computers (800-421-8045)

Nobody, but nobody, undersells Olympic Sales on computers and calculators. Our pledge: We will beat any advertised price as long as our competitor has the goods on hand. Call today.

Apple computer (made in USA)  
**Apple II personal computer**



**APPLE**  
Full line of peripherals and accessories 16-48K. Ask us about invaluable 15 months Apple service warranty for entire Apple system at low cost. For unprecedented lowest prices, call us.

**ATARI**  
The personal computers more and more people are wanting. Atari 800—console, BASIC card. Education system master cartridge, cassette recorder, TV modulator, 8K expandable to 48K, power supply. Atari 400—the personal computer system for less. For lowest prices on Atari, call us.

**APP**  
The "Imagination Machine" with built-in sound synthesizer. Call for our new low price.

**TEXAS INSTRUMENTS**  
(made in USA)

99/4 Console and keyboard 695.00  
99/4 color monitor 395.00  
RF Modulator for 99/4 69.95  
We carry software and accessories.

**HEWLETT-PACKARD**

HP 41C 264.95  
Card Reader for 41C 184.95  
Printer for 41C 324.95  
HP 34C 124.95 HP 67 297.95  
HP 38C 124.95 HP 97 579.95  
HP 85 computer Call us **WE ARE TAKING ORDERS ON THE HP85**

**MATTEL**

The Intellivision—the most animated TV game on the market (#2609) \$249.95  
Mattel keyboard component (#1149) 429.95  
We will beat any price if our competitor has the Mattel unit you want in stock.

Call Olympic Sales for the best prices in the country. Don't forget to ask for the lowest prices anywhere on SEIKO watches. We carry over 320 models. Ask for prices on products from Casio-Sharp-Canon-Victor-Sanyo-Pearl-corder-Polaroid-RCA-Sony-Panasonic-Amana-Litton-Navtronic-Juvena and others. Nobody undersells Olympic Sales. Prices f.o.b. L.A. Minimum freight & handling charge \$4.95. In CA, add 6% sales tax. Goods subject to availability. We'll beat any advertised price if competitor has goods on hand. Outside CA, toll free

Request our 130 page catalog in writing. **800-421-8045**  
**MASTERCHARGE** Call Mon. - Sat., 7AM - 6PM. In CA, call below #s VISA

**OLYMPIC SALES COMPANY, INC.**  
216 South Oxford Avenue • P.O. Box 74545 Los Angeles, CA 90004 • (213) 381-3911 or (213) 381-1202 • Telex 67-3477

PROGRAMMING SHEET

Memory Allocation

("Scratch Pad"): M(1) = 2 (V1) \_\_\_\_\_ M (6) = 0 (Area) \_\_\_\_\_  
 (2) = 4 (V2) \_\_\_\_\_ (7) = \_\_\_\_\_  
 (3) = 5 (H1) \_\_\_\_\_ (8) = \_\_\_\_\_  
 (4) = 0 (H) \_\_\_\_\_ (9) = \_\_\_\_\_  
 (5) = 0.01 (H0) \_\_\_\_\_ (10) = \_\_\_\_\_

PROGRAM: Description	Mnemonic	Op Code	Memory Location	Result
Bring V2 to Accum.	ADD	17	11	
		2	12	
Subtract V1	SUB	18	13	
		1	14	V2 - V1 in Accum.
Divide by H1	DIV	20	15	
		3	16	V2 - V1 H1
Multiply by H	MUL	19	17	
		4	18	
Add V1	ADD	17	19	
		1	20	$V = \frac{(V2 - V1)}{H1} \times H + V1$
Multiply by H0	MUL	19	21	
		5	22	V x H0 in Accum.
Add previous Area	ADD	17	23	
		6	24	Updated Area
	MAM	22	25	
Store Area in Memory (6)		6	26	Store updated Area
Clear Accum.	CLE	13	27	
		14	28	
Bring H to Accum.	ADD	17	29	
		4	30	
Add H0 to Accum.	ADD	17	31	
		5	32	New Value for H
Store New Value of H	MAM	22	33	
		4	34	H updated, in M(4)
Clear Accum.	CLE	13	35	
		14	36	
Bring H1 to Accum.	ADD	17	37	
		3	38	
Test if H1 < H	TAA	24	39	If yes, sets S = 1
		4	40	
Jump if S = 1	JMI	30	41	Jump to 47 if S = 1
		47	42	
Clear Accum.	CLE	13	43	
		14	44	
Jump to Memory (11)	JMA	28	45	
		11	46	Jump to 11
Clear Accum.	CLE	13	47	
		14	48	
	ADD	17	49	
Bring updated Area to A.		6	50	Area in Accum.
	EXE	25	51	Area in B
Print	PRB	12	52	Print out
	DMP	27	53	Dump routine

Figure 4: Programming sheet for the solution of area under curve problem presented in figure 3.

# UCSD Pascal\* for TRS-80† Model II

**The Standard Package:** Operating System  Compiler  Screen Editor  Filer  Library  Z-80 Assembler  Patch Utility Program  280 page User Manual  Jensen & Wirth Pascal Reference Manual  Bowles' Beginners Guide To UCSD Pascal  tutorial disk.

**Plus:**

- Single or double density diskettes in one or more standard formats. **\$350 Complete**
- Disk Formatting program. **\$300 without manuals or tutorial disk**
- Configuration program for serial I/O.

**Optional Utility Programs:**

- File conversion—  
 CP/M‡ to Pascal . . . . . \$50.00  
 TRSDOS† to Pascal . . . . . \$50.00
- Z-80 Disassembler/Dump Program . . . . . \$50.00

**PCD SYSTEMS**

P. O. Box 143 • Penn Yan • New York 14527 • 315-536-3734

\*Trademark of the Regents of the University of California

†Trademark of Tandy Corp.

‡Trademark of Digital Research Corp.

# DATA DISK SYSTEMS

## PROFESSIONAL SOFTWARE FOR NORTH STAR SYSTEMS

### DIGITAL RESEARCH

**CP/M 2.0** — Digital Research's latest disk operating system for 8080/8085/286 based microcomputers, now specially tailored for the North Star disk systems. Includes ED text editor, DDT debugger, A34 assembler, additional utility programs and complete documentation. CP/M 2.0 is upward compatible with earlier releases and makes a wealth of professional software available to your system. .... \$150/\$25

**TEX** — A powerful text formatter. Produces finished copy with automatic page numbering, left and right margin justification, indentation, page headers, line centering and other quality features. Output may be vectored to printer, disk or console. .... \$70/\$15

**MAC** — 8080 Macro assembler. Allows use of library programs, greatly increasing programming efficiency. Uses Intel macro conventions. Assembly toggles allow listing, hex and symbol table outputs to be directed to disk, printer, console or combination. A tremendous development aid. .... \$85/\$15

**SID** — Symbolic Instruction Debugger for the 8080. Allows multiple break points with user set pass counter. Displays user labels during debugging when used with MAC. Greatly reduces hard-copy listing requirements. Includes back-trace and histogram utilities. A must for serious software development. .... \$85/\$15

**ZSID** — Same as SID except incorporates complete 280 instruction set and uses Z-80 mnemonics. .... \$95/\$15

**DESPOOL** — Allows simultaneous printing of disk files and user access to other programs. No need to stop production while lengthy printouts are in progress. .... \$45/\$5

### SOFTWARE SYSTEMS

**CRASIC-2** — A commercially oriented, compiler-interpretor extended disk BASIC. Self documenting, using full length variable labels without penalizing speed. Compiler permits distribution of software without releasing source code. .... \$105/\$15

California residents add 6% sales tax. Specify single, double or quad capacity. Additional formats available soon. Structured Systems Group programs require CP/M and CRASIC-2. \*CP/M is a registered trademark of Digital Research. †Software and documentation/documentation only.

### BUSINESS SOFTWARE FROM STRUCTURED SYSTEMS GROUP

**GENERAL LEDGER** — A comprehensive applications package for business accounting or CPA multi-client write up. Produces financial reports to user defined specifications. Interactive posting, balance sheet, income statement, general and cash disbursement journals, sort, multiple profit centers, accounts distribution and much more. Outstanding package. .... \$895/\$25

**ACCOUNTS RECEIVABLE** — A complete open item or balance forward system. Operates alone, or interfaces with General Ledger. Produces customer statements, aged trial balance, on-line inquiry, sales reports, reminder notices and more. .... \$695/\$25

**ACCOUNTS PAYABLE** — A powerful cash management system. Aged account statements, writes checks, cash requirements projection, General Ledger update and more included. Stand alone operation or interfaces with General Ledger and QSORT. .... \$695/\$25

**NAD** — Name and Address System - Stores mailing lists on disk. Prints mailing labels or lists additional references information. Selective data extraction. .... \$75/\$10

**QSORT** — A generalized, full disk sort/merge package. Fast and flexible. Multiple key sorting. .... \$95/\$15

**LETTERIGHT** — Word processing for the business office. Produces professional correspondence, letters, envelopes, and more. High speed production with minimal training. Multiple personalized letters produced when used with list formed by NAD. Tremendous versatility. .... \$175/\$20

**ANALYST** — Generalized data base management program. Stores and retrieves disk data producing user formatted reports. Interactive input. Easy to use. .... \$225/\$20

**INVENTORY** — Complete inventory control program limited in capacity only by your disk size. On-line inquiry, average valuation, reorder and activity reports with report range option. Menu driven and fully auditable, the system uses full screen formatting and permits user defined record numbers. .... \$795/\$25

**NOW—AN AFFORDABLE HARD DISK**  
Ask about our 13.2 megabyte Winchester technology hard disk business system. Uses all above listed software. Price varies with software configuration.

Datadisk Systems, P.O. Box 195, Poway, CA 92064, (714) 578-3831

# At last...the Typewriter Interface!

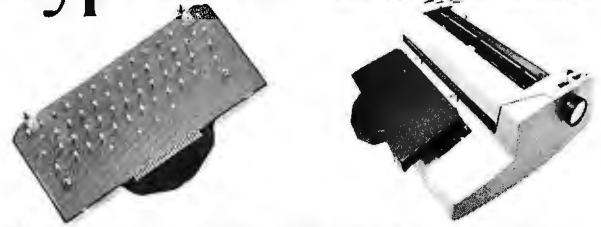

Turn your electric typewriter into a low cost, high quality hard copy printer. 1 Year Warranty

The patented\* RDI—I/O Pak is fast becoming the industry standard for typewriter output. Why? Because:

1. It takes 2 minutes to initially install and 5 seconds to remove or replace.
  2. You do not have to modify your typewriter. All factory warranties and maintenance agreements on your typewriter will be honored.
  3. You can use it with all powered carriage return typewriters that have U.S. keyboard. Our Model I works with all non Selectrics and our Model II works with Selectrics. Conversion between models takes 2 minutes and the kit (26 plungers) is available for a nominal charge.
  4. You don't have to lug around a bulky printer when you travel. If there is a typewriter at your destination, you can install the light (3 lbs.) I/O Pak in just 2 minutes.
  5. Same interface for TRS-80, Apple and GP1B. Centronics and Pet compatible interfaces are available in third quarter 1980. Electric pencil available.
- Delivery: stock to 2 weeks. Price: \$499.00, FOB Rochester, Do-

See your local distributor or call Bob Giese, 716 385-4336. We have the only "clean" approach to the typewriter/printer market.

\* Patent Pending

## ROCHESTER DATA

3100 Monroe Avenue, Rochester, New York 14618 incorporated



Micro Music Inc 309 W. Beaufort, Normal, Illinois 61761

## MICRO MUSIC — THE MASTER OF DISGUISE!!

MMI'S MUSIC COMPOSER plus ENVELOPE\*, now able to masquerade as a Caribbean Steel Band, or a Hollywood String Orchestra, or a Baroque Brass Choir, or a Berserk Banjo...the sounds go on and on!

### SOUNDS INCREDIBLE?

HEARING IS BELIEVING, and you can now listen to the actual sounds of MMI on our new "INCREDIBLE STEREO SAMPLER" audio cassette.

Order now - your \$5.00 cost can be applied to future purchases from MMI!

\*MUSIC COMPOSER, version 2.4 (\$205<sup>00</sup>), now with graphic entry and triplets, plus MMI's new ENVELOPE SHAPING (\$39<sup>00</sup>), another new addition to MMI's ever-expanding software library! For more information about these and other MICRO MUSIC Products, ask your local dealer or contact MICRO MUSIC, SPECIALISTS IN MUSIC AND MUSIC EDUCATION.



309/452-6991

# DON'T MISS THIS SURPLUS BONANZA!

## "SELECTRIC" RS-232 TERMINALS

Built by Datal or Dura for CARTERPHONE, off-lease, 15" carriage, self-contained power supply, solenoid drivers and RS-232 I/O. USED. "AS-IS" (may need some service). Incl.: Replacement line cord, schematics and some info. Unusual Bargain! Complete I/O typewriter, IBM Model 735 Printer (sorry, no choice of case style) ... Over 400 In Stock!  
BCD Code Selectric Terminal ..... ONLY \$469.00  
Correspondence Code Selectric Terminal ..... ONLY \$549.00  
Printer Refurbishing (check-out, cleaning & adjustment) Add \$80.00  
Add \$25.00 to cover crate cost. Shipped via truck, collect



## 12-INCH VIDEO MONITORS

12" (diag.) screen, BNC, composite video input, contrast & brightness controls. Mfd. by Motorola; rebuilt by OEM, then released. Features 80x24 character resolution, includes schematic & adjusting info.  
Model No. XM 35147 ..... Only \$99.00

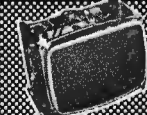

## SURPLUS DAISY TERMINALS

Diablo 1650 RS-232-C TERMINALS. Features: metal daisy wheel, 40 cps, 10 or 12 pitch, 88, 92, or 96 character wheels, 110, 300, 600 and 1200 Baud I/O, self-diagnostic, 256 character buffer, Diablo (Zerex) quality, switch-selectable ASCII or IBM 2741 (correspondence) line protocol, 132 columns @ 10 CPI, 158 col's. @ 12 pitch. Best of all, these are NEW & UNUSED! Hytype II mechanism.  
Diablo 1650 RO Daisy Terminal NOW ONLY \$3995.00  
Regularly Over \$5,000.00

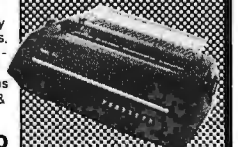

## KSR DAISY TERMINALS

Over 100 Sold! These exciting refurbished KSR terminals feature the Diablo 1200 HYTYPE Daisy Wheel Printer, Self-contained keyboard, power supply, I/O interface board & a quality drop-wing typing table with chrome legs & casters. Uses various plastic replaceable "daisy" wheels. Features include: 10 & 12 pitch, 6 & 8 vertical lines/inch. RS-232-C, 110, 150 & 300 Baud; 10, 15 & 30 cps, ASCII protocol, text and PLOT mode with 1/60" horiz. and 1/48" vert'l. spacing, keyboard or computer plotting. Includes pinfeed bidirectional platen for 15" paper, & unique case design for easy read-ability.  
This Exciting Daisy Terminal is Only ... \$1650.00  
Special 30 Day Warranty! Price includes shipping crate



Use Your Mastercharge or VISA SHIPPING  
We ship all units over 50 lbs. via truck. COD: This means you pay when you unit arrives.

Phone Orders are Welcome. Quantities are Limited. Prices are Subject to Change.  
**CFR Associates, Inc.**  
Newton, N.H. 03859 • (603)382-5179



**OPTIMIZED SYSTEMS SOFTWARE**

PRESENTS

**CONTROL PROGRAM/APPLE**  
the DOS you have been waiting for

OSS CP/A is an all new, disk-based operating system which provides commands and utilities similar to CP/M®. CP/A has byte and block I/O, a simple assembly language interface, and direct access via Note and Point. And it's easy to add your own commands or device handlers. CP/A is expandable, flexible, consistent, easy-to-use and available now with compatible program products:

**BASIC** — Some of the features of OSS BASIC are syntax checking on program entry, true decimal arithmetic (great for money applications), 32K byte string sizes, flexible I/O, long variable names (up to 255 significant characters), and the ability to get and put single bytes.

**BUSINESS BASIC WITH PRINT USING** — This is virtually the only basic available on the Apple that has PRINT USING. It also has record I/O statements and all the features of our standard BASIC.

**EDITOR/ASSEMBLER/DEBUG** — OSS EASMD is a total machine language development package. The editor provides functions like FIND, REPLACE, etc. The assembler uses standard 6502 mnemonics, can include multiple files in one assembly, and can place the object code in memory or to a disk file.

Prices of CP/A with:

BASIC .....	\$ 69.95
Business BASIC .....	84.95
EASMD .....	69.95
BASIC + EASMD .....	109.95
Business BASIC + EASMD .....	124.95

Requires 48K RAM and DISK

Add \$3.50 for shipping and handling in continental USA. California residents add 6%. VISA/Master Charge welcome. Personal checks require two weeks to clear.

**SEE YOUR DEALER or ORDER TODAY**

**OPTIMIZED SYSTEMS SOFTWARE**  
is a product of

Shepardson Microsystems, Inc.  
20395 Pacifica Dr., Suite 108B  
Cupertino, CA 95014  
(408) 257-9900

**Listing 3: Program input for calculation of area under a curve.**

```

1400 REM: NEXT LINE, NUMBER OF PROGRAM STEPS
1410 DATA 43
1420 REM: FOLLOWING LINES = PROGRAM
1430 DATA 17, 2, 18, 1, 20, 3, 19, 4, 17, 1, 19, 5, 17, 6, 22, 6
1440 DATA 13, 14, 17, 4, 17, 5, 22, 4, 13, 14, 17, 3, 24, 4
1450 DATA 30, 47, 13, 14, 28, 11, 13, 14, 17, 6, 25, 12, 27
1460 LET M[1] = 2
1461 LET M[2] = 4
1462 LET M[3] = 5
1463 LET M[4] = 0
1464 LET M[5] = .01
1465 LET M[6] = 0
    
```

**Listing 4: Sample run of listing 3.**

```

RUN
MICRO8

B REGISTER = 14.99    MACHINE CYCLES = 9002    LAST ADDR = 52
DUMP ROUTINE
A = 0    B = 14.99    Z = 0    LAST OPCODE = 27    LAST ADDR = 53
S = 1    MACHINE CYCLES = 9003    RUN TIME = 4    MINUTES
    
```

MEMORY CONTENTS:

```

2    4    5    5.00007    .01    14.99    0    0    0
0    17   2    18    1    20    3    19    4    17    1    19
5    17   6    22    6    13    14   17    4    17    5    22
4    13   14   17    3    24    4    30   47   13    14   28
11   13   14   17    6    25   12   27
    
```

DONE

**Listing 5: BASIC listing for the MICRO8 computer.**

```

10    REM: "MICRO8", SIMULATION OF AN ASSEMBLY LANGUAGE, IN BASIC
20    REM: VERSION "B" JULY 27, 1978 R.T. PICKETT
30    REM: TYPE IN PROGRAM AS DATA BEGINNING ON LINE 1430
40    REM: TYPE IN NUMBER OF PROGRAM STEPS AS DATA ON LINE 1410
50    REM: ALL REGISTERS AND MEMORY LOCATIONS ARE AUTOMATICALLY
60    REM: CLEARED AT START; ARITHMETIC OPERATIONS LEAVE RESULT IN
70    REM: REGISTER A; EXCHANGE (EXE) LEAVES FIRST VALUE
80    REM: OF B IN Z REGISTER; MAXIMUM SIZE OF A & B IS 10120; RUNNING
90    REM: TIME LIMIT IS 5 MINUTES; LIMIT ON NUMBER OF MACHINE CYCLES
100   REM: IS 20000, THEN DUMPS AUTOMATICALLY.
110   GOTO 1330
120   LET A=B=S=T=Z=0
130   DIM M[200]
140   REM: L = MEMORY LOCATION
150   LET L = 11
160   LET T0 = TIM(0)
170   GOTO 220
180   LET L = L + 1
190   REM: NEXT LINE IS FIVE MINUTE RUNNING TIME LIMIT
200   IF TIM(0) - T0 > 5 THEN 1250
210   REM: NEXT LINE, FETCH OPCODE "C" FROM MEMORY
220   LET C = M[L]
230   REM: T = MACHINE CYCLE COUNTER
240   LET T = T + 1
250   IF T > 20000 THEN 1290
260   REM: BEGIN DECODER
270   IF C < 10 THEN 1230
280   IF C = 11 THEN 500
290   IF C = 12 THEN 530
300   IF C = 13 THEN 550
310   IF C = 14 THEN 180
320   IF C = 15 THEN 180
330   IF C = 16 THEN 180
340   IF C = 17 THEN 660
350   IF C = 18 THEN 690
360   IF C = 19 THEN 720
370   IF C = 20 THEN 760
    
```

Listing 5 continued on page 246

# MICAH

## OSBORNE BUSINESS SOFTWARE

in CBASIC2 or CROMEMCO 16K BASIC

**\* features \***

- Four Complete Packages--
  - General Ledger
  - Accounts Receivable
  - Accounts Payable
  - Payroll with Cost Accounting
- Strong support from Osborne Manuals
- CBASIC2 runs under CP/M or under CDOS version 1.07 on Cromemco computers
- 16K BASIC runs on Cromemco computers
- Cursor addressing routines for Hazeltine, Lear Siegler and Cromemco (Beehive) Terminals
- Source Codes and Installation Instructions provided along with disks
- Automatic Command Start-up
- Easy to apply to all of your business and systems needs

**\* hardware required \***

- One or more 8" or 5" Floppy Drives
- CRT with cursor addressing
- 132-Column Printer

**\$95 per package**

TO ORDER  
Add \$5 shipping  
Call at 614-291-3400  
CREDIT CARDS ACCEPTED

• DEALER INQUIRIES INVITED •

MICAH'S PRODUCTS OF DISTINCTION

- OSBORNE BUSINESS SOFTWARE (in CBASIC2 & 16K)
- CBIOS (CP/M for Cromemco Computers)
- MICROPLOT (Versatile Printer Graphics)
- DUP1 (Disk Utilities for CP/M and CDOS)
- DUP2 (Disk Utilities for Cromemco)
- DUP3 (DUP/2 expanded)
- SPOOL (Cromemco Format Utility)
- EXPAND (Run Cromemco Software on CP/M)
- BLACKJACK (Tutorial Casino Action)
- DRIVE (Customized Printer Drivers)
- DBMS Conversion (to NAJ)

• Call or Write for Free Catalogue and More Information •

★ We will Customize any of our programs at our Standard Consulting Rates ★

**Ah! MICAH . . . Satisfyin' Software**

*That turns your system on!*

MICRO Applications and Hardware

• CONSULTANTS and SOFTWARE DEVELOPERS •

MICAH P.O. Box 4987 Walnut Creek, CA 94596 USA phone: 415/933-2783

## MICRO B+™ Breaks The Access Barrier. SEARCH AN INDEX OF OVER 10,000 KEY VALUES IN LESS THAN ONE SECOND ON A FLOPPY DISK SYSTEM!

*And you get this performance  
without ever reorganizing  
your Index Files.*

The world-wide standard for keyed file accessing, MICRO B+, is now available in assembly language for 8080 and Z80 microcomputers. The best is even better.

MICRO B+ offers the convenience of ISAMs and the performance of B-TREES.

Assembly Language Version....\$260.00  
Specify MICROSOFT "REL" Files or CBASIC Compatible

BASIC Source Code Version....\$195.00  
Specify MICROSOFT Basic-5 or CBASIC-2

Shipping \$2 USA/\$5 Foreign

### FAIR COM

2606 JOHNSON DRIVE  
COLUMBIA, MO 65201  
(314) 445-3304

We accept VISA and MASTERCARD

# HEATHKIT®

computer products and Zenith Data Systems get even better when you subscribe to Buss: The Independent Newsletter of Heath Co. Computers. Buss spreads the word on compatible hardware and software from other vendors. It is not affiliated with any of these, and does not depend on income from ads. So Buss has to please only its subscribers--over 2800 of them. Their candid reports of their discoveries save other readers headaches--and money. Innovations published in the newsletter have included hardware modifications and software fixes. To get the news out fast, Buss goes by first class mail (by air mail outside North America).

Recent Buss issues have included news about: H89 add-ons such as CP/M 2.2, double-sided drives, 10 megabyte hard disk • \$180 H8 bus expansion kit • Custom characters for H19/H88/H89 • \$150 Pascal for HT-11 • 8" drives for H8, H89 • HDOS software under \$40: Lisp, C, H19 screen editor

You have the choice of starting your Buss subscription with the latest issue or available back issues (about 14). Payment must be in U.S. dollars payable on a U.S. bank. Full refund guaranteed if not satisfied with this newsletter published since April 1977.

Issues	U.S. & Canada	Outside North America
12	\$10.50	\$15.00
18	15.25	20.00
24	18.75	25.00

Buss  
325-B Pennsylvania Ave., S.E.  
Washington, D.C. 20003

## CATCH THE S-100 INC. BUS!



	LIST PRICE	OUR SPECIAL CASH PRICE
North Star Horizon II — 64K Double density A&T	3830.00	2999.00
Intertec's "Super Brain" W/32K, 2 drives, CP/M etc.	2995.00	2495.00
Godbout Econoram XIII — 24K Static RAM "Unkit"	479.00	399.00
S.D. Systems VDB 80X24 kit	370.00	*309.00
S.D. Systems SBC-100 Single board computer kit	295.00	*252.00

\*Included free with every S.D. Systems board is an additional \$25.00 manufacturer's rebate coupon.

Subject to Available Quantities • Prices Quoted Include Cash Discounts. Shipping & Insurance Extra.

**We carry all major lines such as**  
S.D. Systems, Cromemco, Ithaca Intersystems, North Star, Sanyo, ECT, TEI, Godbout, Thinker Toys, Hazeltine, IMC  
For a special cash price, telephone us.

Hours: Mon.-Fri. 10 A.M.-6 P.M.  
Bus . . . . . **S-100, inc.**  
Address . . . . . **7 White Place**  
**Clark, N.J. 07066**  
Interface . . . . . **201-382-1318**

# ANNOUNCING PASCAL FOR CONNOISSEURS. FROM JRT.

The advantages of PASCAL are well recognized and accepted. Now, JRT Systems makes a good thing even better.

JRT PASCAL is a compiler and run-time package with extensions. Not a subset, it is a complete PASCAL and is fully CP/M\* compatible —because it's specifically designed for CP/M. It gives you all the standard PASCAL benefits —all data types, (records, arrays, sets, user defined types, etc.); 14 digit BCD floating point package

**PLUS** extensions to support commercial applications and reduce programming effort.

**Powerful dynamic storage management system** / dynamic variable allocation procedures NEW & DISPOSE are fully implemented / automatic dynamic storage compression / user assigned pointer variables allow access to any part of storage— example: a memory mapped video display could be accessed as an array of characters. **External procedures/ functions may be separately compiled and disk-stored in relocatable format** / allows development of large programs, not limited by main storage size / automatic loading into dynamic storage when procedure is referenced / automatic purging from dynamic storage by a least-recently-used algorithm. **Powerful disk I/O facilities** / data may be stored in ASCII text or space-saving binary format / random access by relative byte address, perfect for index file structures and data base systems / random access by relative record number. **String and structured variables** / entire arrays and records, strings of different lengths may be assigned, compared, input or output with simple statements / function return values may be string, array, record. **CASE statement with ELSE clause** / CASE labels may be full expressions. **More readable identifiers** / up to 32 characters / may contain underline characters. **Assembler routine interface.**  
**Hex constants.**

JRT PASCAL User Manual, Diskette, and PASCAL User Manual & Report by Jensen & Wirth: \$225. Manuals only: \$25. (VISA/ MC accepted. California residents add sales tax. Dealer inquiries invited.)  
Order today from:

**JRT SYSTEMS, INC.**  
P.O. Box 22365  
San Francisco  
CA 94122  
Telephone  
415/566-4240

CP/M is a registered trademark of Digital Research



Listing 5 continued:

```

380 IF C = 21 THEN 180
390 IF C = 22 THEN 810
400 IF C = 23 THEN 180
410 IF C = 24 THEN 840
420 IF C = 25 THEN 900
430 IF C = 26 THEN 940
440 IF C = 27 THEN 1000
450 IF C = 28 THEN 960
460 IF C = 29 THEN 180
470 IF C = 30 THEN 1100
480 GOTO 1230
490 REM: BEGIN OPERATIONS SPECIFIED BY OPCODES
500 INPUT B
510 IF ABS(B) > 1.E+20 THEN 1310
520 GOTO 180
530 PRINT "B REGISTER = "; B; "MACHINE CYCLES = "; T; "LAST ADDR = "; L; LIN(1)
540 GOTO 180
550 LET L = L + 1
560 IF M[L] = 14 THEN 600
570 IF M[L] = 15 THEN 620
580 IF M[L] = 16 THEN 640
590 GOTO 1210
600 LET A = 0
610 GOTO 180
620 LET B = 0
630 GOTO 180
640 MAT M = ZER
650 GOTO 180
660 LET L = L + 1
670 LET A = A + M[M[L]]
680 GOTO 180
690 LET L = L + 1
700 LET A = A - M[M[L]]
710 GOTO 180
720 LET L = L + 1
730 LET A = A * M[M[L]]
740 IF ABS(A) > 1.E+20 THEN 1310
750 GOTO 180
760 LET L = L + 1
770 IF M[M[L]] = 0 THEN 1270
780 LET A = A / M[M[L]]
790 IF ABS(A) > 1.E+20 THEN 1310
800 GOTO 180
810 LET L = L + 1
820 LET M[M[L]] = A
830 GOTO 180
840 LET L = L + 1
850 IF ABS(A) < M[M[L]] THEN 880
860 LET S = 2
870 GOTO 180
880 LET S = 1
890 GOTO 180
900 LET Z = B
910 LET B = A
920 LET A = Z
930 GOTO 180
940 PRINT "HALT"
950 STOP
960 LET L = L + 1
970 LET L = M[L]
980 GOTO 200
990 REM: DUMP ROUTINE PRINTS OUT MEMORY BEGINNING AT LOCATION 1
1000 PRINT "DUMP ROUTINE"; LIN(1)
1010 PRINT "A = "; A; "B = "; B; "Z = "; Z; "LAST OPCODE = "; C; "LAST ADDR = "; L
1020 PRINT
1030 PRINT "S = "; S; "MACHINE CYCLES = "; T; "RUN TIME = "; TIM(0) - T0;
1040 PRINT "MINUTES"; LIN(1)
1050 PRINT "MEMORY CONTENTS:"
1060 FOR D = 1 TO N + 10
1070 PRINT M[D];
1080 NEXT D
1090 STOP
1100 IF S = 1 THEN 1130
1110 IF S = 2 THEN 1160
1120 GOTO 1190
    
```

Listing 5 continued on page 248



# EVERY TRS-80\* MODEL II NEEDS

## DataBank

### Data Management & Reporting System

Configure it ... to what YOU want to do!

Inventory/Accounting Data  
Mailing/Membership lists  
School/Student Records  
Patient/Client Files

#### DataBank includes:

1. Configuration Utilities
2. File Management Program
3. Report Generator
4. User Subroutines
5. Complete Documentation

Call or write:

## DATA ACCESS CORPORATION

4221 Ponce De Leon Blvd.  
Coral Gables, FL 33146  
(305) 446-0669



\*TRS-80 is a registered trademark of Radio Shack

# DEC LSI-11 Components

Dependable service  
at discount prices  
Domestic  
and Export

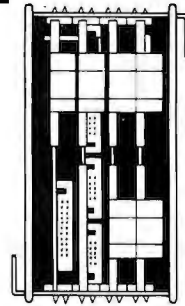

## Mini Computer Suppliers, Inc.

25 Chatham Rd., Summit, N.J. 07901  
Since 1973  
(201) 277-6150 Telex 13-6476

©Mini Computer Suppliers, Inc.  
1979

## The system of the 80's

### Easy to use

- Fully interactive
- Top down design
- Bottom up debugging
- Structured programming supported

### Powerful

- Fast, compact code generated
- Recursive and re-entrant
- Interfaces with CP/M\*
- Enhanced Forth vocabulary

### Versatile

- Machine independent code
- System can be configured as RAM or ROM based from a 2K controller to a 16K development system

### Ordering information

- Diskette and documentation \$150\*
- Documentation only \$25
- Please specify which version when ordering  
Z80 for CP/M<sup>8</sup> operating system  
8080 for CP/M<sup>8</sup> operating system
- OEM and dealer pricing available upon request
- VISA and MasterCard accepted

\*Single site, non-commercial license

## The StackWorks

Distributed by SuperSoft  
P.O. Box 1628, Champaign, IL 61820  
(217) 344-7596

Micro Computer Your One Stop For... Quality and Huge Savings

# DISCOUNT Company

COMPARE PRICE ★ QUALITY ★ DELIVERY ★ SERVICE  
you'll know why you don't have to look anywhere else!

★ <b>APPLE</b>		★ <b>COMPUCOLOR</b>	
16K Apple II or Plus .....	\$ 995	16K .....	1595
48K Apple II or Plus .....	1095	32K .....	1695
Diskw/Controller .....	539	★ <b>CROMEMCO</b>	
Disk .....	450	System 3 .....	\$ 5445
Pascal .....	505	Z-2H .....	9445
★ <b>ATARI</b>		★ <b>HAZELTINE</b>	
400 .....	\$ 495	1210 .....	\$ 825
800 .....	865	1500 .....	1095
Disk .....	639	★ <b>INTEGRAL DATA</b>	
★ <b>APF ELECTRONICS</b>		440 (Paper Tiger) .....	\$ 880
APF Computer .....	\$ 495	440-Graphics .....	929
★ <b>CENTRONICS PRINTERS</b>		★ <b>INTERTEC</b>	
730-1 Parallel .....	\$ 730	*SuperBrain 32K .....	\$ 2495
730-1 Serial .....	759	32K memory upgrade with purchase	\$19.95
*779-2 Tractor .....	995	*SuperBrain 64K .....	2695
*704 Floppy .....	1695	★ <b>NEC SPINWRITER</b>	
*700 Parallel .....	1095	*5530 RO .....	\$ 2695
★ <b>COMMODORE PET</b>		*5520 KSR .....	2990
8K "N" .....	\$ 795	*5510 RO .....	2795
Plus \$100 Free Merchandise		Tractor add .....	200*
★ <b>16K "N" or "B"</b>	995	★ <b>TEXAS INSTRUMENTS</b>	
Plus \$150 Free Merchandise		99/4 Computer .....	\$ 1095
★ <b>32K "N" or "B"</b>	1295	810 Printer .....	1695
Plus \$200 Free Merchandise		★ <b>XEROX TERMINALS</b>	
★ <b>2040 Floppy</b>	1295	*1740 RO .....	\$ 2619
Plus \$200 Free Merchandise		*1740 KSR .....	3000
★ <b>2022 Printer (Tractor)</b>	795	*1750 RO .....	2800
Plus \$100 Free Merchandise		*1750KSR .....	3170
C2 "N" Cassette .....	add \$ 89.90	Tractors add .....	235
★ <b>MAIL ORDER ONLY</b>		★ <b>PHONE (212) 986-7690</b>	
Send Certified Check (Personal or Company Checks require 2 weeks to clear.)		We pay all shipping and insurance charges except items marked with asterisk.	
VISA, MasterCard add 5% N.Y.S. Residents add appropriate sales tax.		* (DENOTES ITEMS SHIPPED F.O.B. NYC)	
★ <b>Micro Computer Discount Co</b>			
60 E. 42nd St., Suite 411, New York, N.Y. 10017			

# Discount Software

## BUSINESS PACKAGES

in MICROSOFT BASIC  
(Version 4.5 not supplied)

- GENERAL LEDGER
- ACCOUNTS RECEIVABLE
- ACCOUNTS PAYABLE
- PAYROLL

Extremely well documented with source code. BEST VALUE ON THE MARKET!

**ONLY \$99 per package**  
**All Four ONLY \$339**

CP/M<sup>®</sup> 1.4 ..... \$129  
2.X ..... \$149  
(available for most 8080/Z-80 systems—specify)

### COMPUTER DESIGN LABS

Complete line of software ..... Less 10%

TPM<sup>™</sup> — A CP/M<sup>®</sup> compatible Disk  
Operating System written specifically  
for the Z-80

.. A FANTASTIC VALUE AT ONLY \$69.95

CBASIC-2 Disk Extended BASIC ..... \$89  
MICROSOFT BASIC-80 ..... \$289  
BASIC Compiler ..... \$325  
Fortran-80 ..... \$399  
Cobol-80 ..... \$599  
MICROPRO Super-Sort I ..... \$219  
Super-Sort II ..... \$169  
Super-Sort III ..... \$120  
Word-Star ..... \$395  
Word-Star/Mail-Merge ..... \$525  
Word-Master ..... \$125  
Data-Star ..... \$279  
MICROAP Selector III-C2 ..... \$279  
Selector IV ..... \$469  
Glector ..... \$289

## MAGIC WAND<sup>™</sup>

The Super CP/M<sup>®</sup> based  
word processing software!

**ONLY \$379**

### MICHAEL SHRYER

Electric Pencil II ..... 15% off

STRUCTURED SYSTEMS ..... Call for Price

PEACHTREE ..... Call for Price

GRAHAM DORIAN ..... Call for Price

## OSBORNE

### Business Software

**Only \$89** per Package

All 4 for only \$289

General Ledger, Accounts Receivable,  
Accounts Payable, and Payroll (with Cost  
Accounting). Available in the following  
BASICS: CBASIC2, Cromemco 16K,  
North Star, Microsoft, and TRS-80

All packages available in 8" CP/M<sup>™</sup> and 5 1/4" CP/M<sup>™</sup> for North Star, Micropolis, Vector Graphic, SuperBrain, and others.

Shipping and Insurance: Add \$2.50 per order.  
All prices subject to change and all offers subject to withdrawal  
without notice. Advertised prices are for prepaid orders. Credit  
card and C.O.D. 2% higher. Deposit may be required with  
C.O.D.

— WRITE FOR FREE CATALOG —

## MiniMicroMart

1618 James Street,  
Syracuse, NY 13088 (315) 422-4467

### Listing 5 continued:

```

1130 LET L=L+1
1140 LET L=M[L]
1150 GOTO 200
1160 LET L=L+2
1170 GOTO 200
1180 REM: BEGIN DIAGNOSTIC MESSAGES
1190 PRINT "INVALID S =";S;"ADDR =";L;
1200 STOP
1210 PRINT "ILLEGAL DEVICE CODE UNDER CLEAR;LAST ADDR =";L
1220 GOTO 180
1230 PRINT "INVALID OP CODE; LAST MEM ADDR =";L
1240 STOP
1250 PRINT "FIVE MINUTE RUN TIME EXCEEDED"
1260 GOTO 1000
1270 PRINT "DIVIDE BY ZERO, MEM ADDR =";L
1280 STOP
1290 PRINT "EXCESSIVE NO. MACH. CYCLES; AUTO DUMP"
1300 GOTO 1000
1310 PRINT "OVERFLOW; LAST ADDR =";L
1320 GOTO 1000
1330 REM: BEGIN MEMORY LOADING(BEGINS LOADING AT LOCATION 11)
1340 READ N
1350 MAT M=ZER
1360 FOR K=11 TO N+10
1370 READ A
1380 LET M[K]=A
1390 NEXT K
1400 REM: NEXT LINE, NUMBER OF PROGRAM STEPS
1410 DATA 17
1420 REM: FOLLOWING LINES = PROGRAM
1430 DATA 17, 1, 19, 1, 22, 2, 13, 14, 17, 3, 19, 3, 17, 2, 25, 12, 27
1450 LET M[1]=168
1460 LET M[3]=12
1470 GOTO 120
1480 END
    
```

### Text continued from page 240:

The answer is 28368 which is the value of the B register printed out. Note also the DUMP routine: it prints out all register contents and memory contents sequentially, 1 thru 27 for this program.

An even better example for illustrating the capability of MICRO8 is the calculation of the area under a curve. The curve for this example is a straight line, as shown in figure 3.

The whole area can be calculated (approximately) by adding up the areas of many small rectangles,  $V \times H_0$ , from  $H = 0$  to  $H = H_1$ ; the height of each rectangle is  $V$ , which is given by the following relation:

$$V = \frac{V_2 - V_1}{H_1} \times H + V_1$$

The procedure is to start at the left side of the curve (at  $H = 0$ ), calculate the area slice ( $V \times H_0$ ), and save that value. Then move the slice over slightly (increment size  $H_0$ ), calculate the next height,  $V$ , and a new area slice ( $V \times H_0$ ), and add that to the previously calculated slice. Continue to add  $H_0$  to  $H$ , calculating and adding area slices until the right-hand boundary,  $H_1$ , is reached. The sum of the area slices is then equal to the

total area (approximately). The smaller the increment,  $H_0$ , the more accurate the area calculation will be (and the longer the computer running time). The programming sheet in figure 4 shows the 43 steps required.

The MICRO8 program input for this problem is shown in listing 3 and the results in listing 4. Of course, the known area here is 15.00; the MICRO8 calculation gives 14.9 for  $H_0 = 0.1$ , and 14.99 for an increment of 0.01. Note that this smaller increment gives a running time of 4 minutes, during which 9003 machine cycles occur (here, one "machine cycle" means one op-code procedure).

As shown in listing 5, MICRO8 has been used by three groups of students so far and has generated much interest. In all respects, it has simplified the teaching of programming techniques, before getting involved with the instruction set of the 8080 microprocessor.

We are currently developing an executive program to enable the user to single-step through a MICRO8 program, to alter contents of any memory location while single-stepping, and to provide a dump at any time for debugging purposes. ■

The shape of the future  
is smaller than a postage stamp!

# The Micro Millennium

— Christopher Evans —

Thanks to the proliferation of ultracheap microcomputers we are on the verge of an almost unimaginable revolution. A brilliant computer scientist here projects a vision of a computer-centered future that includes the collapse of the work ethic, a cashless society, sweeping social and psychological changes, and much more.

**"This could well be the most important book of the next two decades. Read it and wonder and laugh and weep."** —Playboy

Send \$10.95 plus necessary tax and \$1.00 for shipping to:

Dept. ATE-BYT  
**The Viking Press**  
625 Madison Ave., New York 10022



DIGITAL GROUP products are available through AEON Electronics in Denver, Colorado. We carry the complete line of cabinets, printers (Spinwriter & B-Printers), Disks (Shugart), Single & Double Density Controller Cards, Memory Cards, Z-80ACPU 2.5/6Mhz, Communications Card (for terminals & Modems), and Peripheral Boards. All items are from stock.

Bare Communications Card	Comm 4 Pcc	\$65.00
32k Static Mem. Board/sockets,	Decoding IC's	Mem 320 \$85.00
I/O Card/4 Port in & out	IO-F	\$50.00
Double Density Bare Card & Doc	BDD	\$95.00
D.G. Dress Mainframe Cabinet/metal only	CB	\$85.00
D.G. Dress Cabinet/metal plus Electronic Hardware	CB-CPU	\$185.00
D.G. Disk Cabinet/In Stock!!	DSSCB-2	\$165.00

**AEON** Manufacture of Digital Group Computers  
1855 S Pearl Denver, Colorado 80210  
Phone Orders 303-777-AEON



## A Message to our Subscribers

From time to time we make the BYTE subscriber list available to other companies who wish to send our subscribers promotional material about their products. We take great care to screen these companies, choosing only those who are reputable, and whose products, services, or information we feel would be of interest to you. Direct mail is an efficient medium for presenting the latest personal computer goods and services to our subscribers.

Many BYTE subscribers appreciate this controlled use of our mailing list, and look forward to finding

information of interest to them in the mail. Used are our subscribers' names and addresses only (no other information we may have is ever given).

While we believe the distribution of this information is of benefit to our subscribers, we firmly respect the wishes of any subscriber who does not want to receive such promotional literature. Should you wish to restrict the use of your name, simply send your request to BYTE Publications Inc, Attn: Circulation Department, 70 Main St, Peterborough NH 03458. Thank you.

## TWICE THE BYTE!



### 8" DISK CONTROLLER NOW—DOUBLE SIDED OPTION!

- DOUBLES APPLE II STORAGE
- APPLE DOS COMPATIBLE
- SHUGART 800 OR 850 COMPATIBLE
- IBM 3740 DATA ENTRY CAPABILITY
- CP/M, UCSD PASCAL CAPABILITY

Available at your local APPLE Dealer: \$400.



**SORRENTO VALLEY ASSOCIATES**  
11722 SORRENTO VALLEY RD.  
SAN DIEGO, CA 92121

# What's New?

## MISCELLANEOUS



# OCTEK



WE GIVE VISION TO YOUR DG COMPUTER

### Video Digitizer Gives Computer "Eyes"

A microprocessor-based video image analyzer, plug-compatible with Data General computers, is being manufactured by Octek Inc, 121 Middlesex Tpke, Burlington MA 01803, (617) 273-0851. The Octek Model 2000 is an 8-by-300 video image analyzer that can simultaneously digitize and store video from a television camera or other image sources, enter it into any Data General computer, and display it on a television monitor. The card also performs graphics generation, image processing,

and archival image storage. When used with a modem, it transmits images over telephone lines. With an access time of 800 ns, the Model 2000 offers a resolution of 320 by 240 pixels. The 16-level gray scale can be modified to emphasize or deemphasize image features. Some typical applications include automatic inspection, surveillance, product sorting, traffic control, optical character recognition (OCR), and video animation, map reading, and area and volume analysis. The Model 2000 is unit priced at \$5500 including the RDOS operating system and 320 K bytes of programmable memory. Contact John E Trombly, at Octek.   
Circle 452 on inquiry card.

### 64 K Memory Board from Industrial Micro Systems

The Model 460 64 K-byte programable memory board is a high-speed, low-power memory system that supports 8080 and Z80 microprocessors and operates at 4 MHz with no wait states. The Model 640 provides parity capa-

bility and 64 K bytes of memory organized into four blocks, each of which is individually deselectable for memory mapping. It is available from Industrial Micro Systems, 628 Eckhoff St, Orange CA 92668, (714) 978-6966. The suggested retail price for the model 460 is \$1050.   
Circle 453 on inquiry card.

#### Where Do New Products Items Come From?

The information printed in the new products pages of BYTE is obtained from "new product" or "press release" copy sent by the promoters of new products. If in our judgement the information might be of interest to the personal computing experimenters and homebrewers who read BYTE, we print it in some form. We openly solicit releases and photos from manufacturers and suppliers to this marketplace. The information is printed more or less as a first in first out queue, subject to occasional priority modifications. While we would not knowingly print untrue or inaccurate data, or data from unreliable companies, our capacity to evaluate the products and companies appearing in the "What's New?" feature is necessarily limited. We therefore cannot be responsible for product quality or company performance.

### Compact Modem from UDS

The Universal Data Systems (UDS) Model 103 LP modem is a fully Bell-compatible, originate-only device featuring full-duplex on a two-wire circuit, 0 to 300 bits per second (bps) asynchronous data rate, RS-232C and teletypewriter interfaces, and direct-connection to dial-up network so no data-access arrangement (DAA) is required. The unit fits under a standard telephone and requires three cable attachments for operation. The modem costs \$195 from Universal Data Systems, 5000 Bradford Dr, Huntsville AL 35805.   
Circle 450 on inquiry card.

### Sourcebook for Educators

Now available from Radio Shack is the *TRS-80 Microcomputer Sourcebook for Educators*, a guide to the use of microcomputers as a medium and an object of instruction in the classroom, and as a tool for school administrators. The booklet describes the uses of microcomputers in the classroom and provides guidelines for selecting a system based on potential applications, costs, services, reliability, and courseware. It is available free upon request from Radio Shack, Dept NR-17, 1300 One Tandy Center, Fort Worth TX 76102, (817) 390-3272.   
Circle 451 on inquiry card.

### Computer Furniture

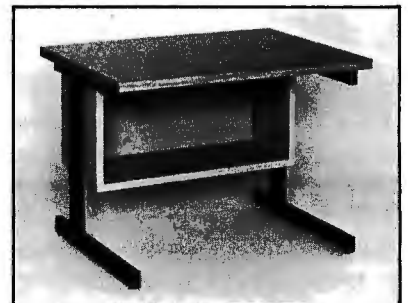

Computer Furniture and Accessories Inc, 1441 W 132 St, Gardena CA 90249, (213) 327-7710, now offers the Classic Series terminal stand in 124 cm (48 inches) or 91.5 cm (36 inches) width, with a shelf underneath for storage of manuals, printouts, and other items. The company also stocks other types of terminal stands, shelf desks, rack mount enclosures, and turntables. Contact the company for information about its product lines.   
Circle 454 on inquiry card.

# What's New?

## MISCELLANEOUS

### Percom Introduces Color Display for TRS-80 and Other Computers

The Electric Crayon is a computer-operated color graphics generator and controller. The system includes an operating system, EGOS, and has a provision for 1 K bytes of programmable memory, and an erasable programmable read-only memory (EPROM) for extending EGOS and a second dual-bidirectional 3-bit port for peripherals. Up to eight colors may be generated, depending on which of ten modes has been selected. In the highest density mode, the display resolution is 256 by 192 pixels. The Electric Crayon, a manual, an assembly-language listing of EGOS, and listings of other BASIC programs sell for \$249.95 from Percom Data Co, 211 N Kirby, Garland TX 75042.

Circle 455 on inquiry card.



### End the TRS-80 Loading Problem

The Data Dubber is a device for TRS-80 users who want easy loading from cassettes. With too low a volume during the loading of a program from cassette, the TRS-80 misses data bits. Too high a volume causes an overload.

The Data Dubber expands the upper and lower volume limits so that setting the volume is less critical. It connects between the cassette and the TRS-80 to filter the incoming data. The unit ignores noise, volume variations, static and distortion, and takes the incoming data and reproduces or regenerates the original data pulses. By connecting the

device between two recorders, tapes can be copied. The Data Dubber also allows monitoring of tapes to listen for dropouts or gaps. It costs \$39.95 by mail and \$49.95 at dealers. Contact The Peripheral People, POB 524, Mercer Island WA 98040.

Circle 456 on inquiry card.

### CMOS Circuit Soothes Infants with Prebirth Sounds

A unique product is available to help eliminate the "3-AM-walk-the-baby-blues." A 29 cm (11.5 inch) teddy bear reproduces the intrauterine sounds recorded inside an expectant mother's womb. The sounds are the pulse beat and blood going through the major arteries. It can make crying babies quiet in about five to ten seconds, and asleep in thirty to sixty seconds. The com-



plementary metal-oxide semiconductor (CMOS) integrated circuit that contains the sound, a linear power amplifier, resistors, capacitors, and a volume control are mounted on a printed-circuit board and are housed with a speaker and 9 V battery within the teddy bear. Volume is controlled from the front. The sounds were recorded by placing a specially designed eight millimeter microphone inside a pregnant mother's womb, directly next to the unborn infant's ear just prior to the mother's entering labor. The sounds were then transferred to records and tapes. These prebirth sounds are usually effective with infants up to the age of three months. The "Rock-a-Bye Bear" is priced at \$39.95. For information about the circuit, contact Motorola, POB 20912, Phoenix AZ 85036. Contact Rock-A-Bye-Baby Inc, POB 24160, Fort Lauderdale FL 33307, for information about the teddy bear.

Circle 457 on inquiry card.

# What's New?

## MISCELLANEOUS



### Multi-User, 20-Megabyte Hard-Disk Options Highlight This 6809-Based System

Smoke Signal Broadcasting, 31336 Via Colinas, Westlake Village CA 91361, (213) 899-9340, has introduced its 6809-based series of Chieftain Business Systems featuring multi-user and 20-megabyte hard disk options. The system is configured around SSB's Chieftain computer with 64 K bytes of programmable memory and the DCB-4 disk controller capable of handling four 8-inch floppy disks, each storing 1 megabyte of data. The hard disk pro-

vides 10 megabytes of fixed and 10 megabytes of removable storage and can be accessed by up to four users. Up to sixteen 64 K-byte blocks of memory can be addressed and 1 megabyte of memory can be accessed in 4 K-byte blocks. The system also includes a video display terminal and either a high-speed line printer or letter-quality daisy-wheel printer. A wide range of programs are available for business applications, including word processing. The Chieftain series of systems supports COBOL, FORTRAN, and UCSD Pascal. Prices range from \$5000 to \$8400, depending on disk storage and printer. The hard disk and multi-user options are \$8500. Circle 459 on inquiry card.

### Programmer Module for Intel 2732A Erasable Programmable Read-Only Memory (EPROM)

A generic module that enables all Series 90 programmable read-only memory (PROM) programmers to program Intel's 2732A HMOS EPROM has been developed. The PM9074 module will also accommodate other HMOS EPROMs and higher-density PROMs as they are developed. When plugged into a Pro-Log Series 90 PROM programmer master-control unit, the module provides the control lines and timing necessary to

list, program, duplicate, and verify these devices. The PM9074 features cold sockets that allow installation and removal of PROMs without applying supply voltage to the sockets; high/low voltage verification to permit reading of PROMs with the supply voltage adjusted to its high and low limits; and parametric testing, which adjusts the PROM output to its high and low limits during reading. The PM9074 adapts to the correct bit structure and memory size of each PROM. It is priced at \$550 from Pro-Log, 2411 Garden Rd, Monterey CA 93940, (408) 372-4593.

Circle 461 on inquiry card.

### Data Transceiver for ASCII/Baudot/Morse Code

The UDT-170 connects directly between an ASCII or Baudot (5-level) teletypewriter or video terminal and the station transceiver in an amateur radio station. The unit combines the power of two microprocessors as a radioteletypewriter (RTTY) terminal unit and Morse code converter. It has the capability of taking keyboard commands from a Teletype, computer, or video terminal. The UDT-170 can handle 60 to 100 words per minute Baudot and 110 to 1200 bits per second (bps) ASCII. The device can display 64 to 80 characters per line and automatically buffer up to 32 characters. The unit will operate at any frequency-shift keying (FSK) shift from less than 100 Hz to over 1000 Hz. The price for the UDT-170 is \$479. Information is available from Xitex Corporation, 9861 Chartwell Dr, Dallas TX 75243, (214) 349-2490.

Circle 458 on inquiry card.

### Flying Head for Removable Hard Disks

A new read/write head from Trans Datacorp, 1717 Old Country Rd, Belmont CA 94002, has a small core of hot-pressed manganese zinc ferrite, inserted in an extremely hard ceramic slider, achieving higher recording densities while virtually eliminating Winchester's extreme sensitivity to particle contamination and surface scratching. This design allows the head to be loaded and unloaded, enabling drive designers to provide very high-density removable pack and removable cartridge drives. Because of this design, drive motor size can be reduced, lubrication overcoat can be eliminated on the disk, and cleanliness requirements can be reduced. The flying head is designed specifically for individual systems and applications. Trans Datacorp also reconditions disk heads.

Circle 460 on inquiry card.

### BOSS Bus Catalog

Micro Link Corporation, 624 S Range Line Rd, Carmel, IN 46032, has made available a catalog describing its BOSS (BUS Oriented System Support) line of microprocessor system-support cards. The cards are designed for the STD BUS and measure 11.5 by 16.8 cm (4.5 by 6.5 inches) with standard 56-pin connectors. Features, applications, operating procedures, and data are detailed in the catalog.

Circle 462 on inquiry card.

# What's New?

## PERIPHERALS

### The 737 Printer from Centronics



The model 737 dot-matrix printer features right-margin justification, proportional spacing, forward and reverse paper motion, and three-way paper handling. It prints 7-by-8 dot-matrix characters at 10 and 16.5 characters per inch for standard data processing tasks, and generates n-by-9 dot-matrix characters in the proportional character spacing used for data and text processing. The printer incorporates an adjustable nine-wire, free-flight printhead. Under manual or software control, the

### VAMP's New Color Receiver/Monitor

Automatic fine tuning, automatic gain control, slotted mask, and a black matrix are some of the features of this color receiver/monitor from VAMP Inc, 1617 El Centro Ave, Suite 19, Los Angeles CA 90028, (213) 466-5533. In the monitor mode the set will accept standard composite video. Looping inputs are provided so that multiple sets can be linked. An audio input is also provided. The resolution is 300 lines horizontal and 350 lines vertical. The 13-inch model (VM-1300) is \$449 and the 19-inch model (VM-1900) is \$575.

Circle 463 on inquiry card.

operator can roll the paper forward or backward in half-line steps to print subscripts and superscripts for equations, footnotes, and other text printing tasks. The 737 accepts letterhead 80-column fanfold pinfeed paper. Under host computer control it will justify righthand margins. It also generates expanded print for headlines and column subheadings. The 737 printer is priced at \$995, from Centronics Data Computer Corporation, Hudson NH 03051, (603) 883-0111.

Circle 464 on inquiry card.

### The ACI Pascal Terminal



Associated Computer Industries Inc's ACI Pascal Terminal is a 12-inch, 24-line by 80-character video terminal for use with the UCSD Pascal operating system. It incorporates a separate ETX key along with standard UCSD Pascal X,Y cursor addressing. The terminal provides the standard uppercase and lowercase 96-character ASCII (American Standard Code for Information Interchange) set. Cursor display is switch selectable for steady or blinking underline or block. It accommodates several international-language character displays by internal switch changes. The terminal also incorporates provisions to display thirty-two control characters. The price for the Pascal Terminal is \$1095 from Associated Computer Industries Inc, 17751 Sky Park E, Suite G, Irvine CA 92714, (714) 557-0560.

Circle 465 on inquiry card.

### KB-2100 Word-Processing Keyboard

Algorithmics has announced the KB-2100 extended English keyboard for its line of word-processing and office information systems. The detachable

keyboard features 113 keys arranged in five key clusters. Mechanical keyboard features are designed to provide the operator with tactile feedback that closely matches the familiar feel of typewriter keyboards. Extra-large sculptured keys are used for the tradi-

tional special actions such as carriage return, shift, and tab. The shift-lock key contains a light to indicate uppercase mode. The keys have a capacitive action, insuring reliability through the elimination of mechanical switch contacts. To allow for fast typists, the keyboard has n-key rollover.

Used in the ALGO-2100 word-processing system, the keypads produce brackets, greater-than and less-than symbols, and 20 symbols for technical, mathematical, or foreign characters. The key clusters across the top of the keyboard permit block-move, word-delete, forward-search, and other word-processing functions. Cursor keys automatically repeat when held down, and any other key can be made to automatically repeat by depressing the repeat key. The keyboard is standard on ALGO-2100 systems and is offered to other computer and office equipment manufacturers for incorporation into their products. It is priced at \$450 from Algorithmics Inc, 177 Worcester Rd, Wellesley MA 02181, (617) 237-7226.

Circle 466 on inquiry card.



# What's New?

## PERIPHERALS

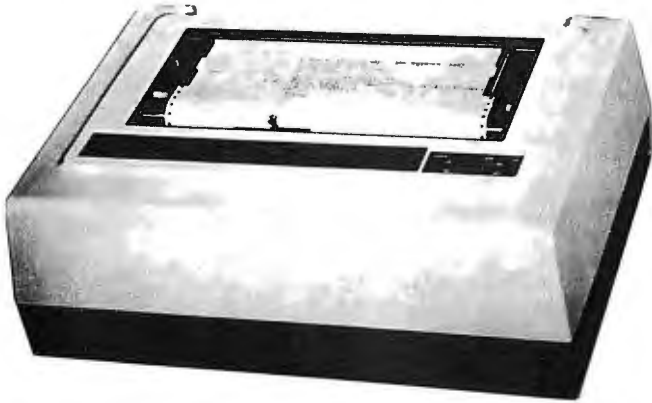

### Color Matrix Printer

Integrex has announced a color serial-matrix printer. The microprocessor-controlled bidirectional Model 454C prints 250 characters per second (cps) with a single printhead on a 9-by-9 matrix. Maximum line length is 155 characters. The standard character font is ECMA-42; custom fonts are available. The 454C is designed for color video display dumping. Graphics areas may be color mixed for mimic diagrams and

other applications. Vertical shifting of the three-color striped ribbon ensures maximum throughput. The printhead is momentarily retracted during color shifts. Serial and parallel interfaces are available, including IEEE-488. For prices and more details, contact Integrex Limited, Portwood Industrial Estate, Church Gresley, Burton on Trent, Staffordshire, DE11 9PT England, telephone Burton on Trent (0283) 215432 or Telex 377106.

Circle 468 on inquiry card.

### 300 bps Modem from Ireland

The CCITT V21 single-card modem is made by Bootstrap Limited of Dublin, Ireland. The modem has full-duplex operation at up to 300 bits per second (bps) over the public switched telephone network or over two-wire leased lines. It can be switched for use in call-originate mode with terminals or in automatic-answer mode at a central site. The modem is available in tabletop, 38 cm (19 inch) rack mounting, or single-card versions. The tabletop model measures 24 by 29 by 6 cm (9.5 by 11.5 by 2.4 inches). The 38 cm card cage can hold sixteen modem cards. The single card is suited for building into terminals and other equipment. The modem accepts serial asynchronous data via the CCITT V24 (RS-232) interface through a 25-pin female D-type socket. It will operate with a minimum of three connections. Telephone Bootstrap Limited at 01-887892 or write the company at 9 Georges Ave, Blackrock, County Dublin, Republic of Ireland.

Circle 467 on inquiry card.

### Low-Cost ASCII Keyboards from RCA

The VP-601 with a 58-key typewriter format at \$65 and the VP-611 with the typewriter format plus a 16-key numeric keypad for fast data entry at \$80 have been announced by RCA. Both boards feature fully encoded 128-character ASCII (American Standard Code for Information Interchange) sets and flexible-membrane key switches. The keyboard surface, which is impervious to liquids or dust, combines with complementary metal-oxide semiconductor (CMOS) circuitry to make the units suitable for use in hostile environments. The keyboards operate on a 5 VDC supply, and the buffered 7-bit ASCII output is transistor-transistor logic (TTL) compatible. The user may select either the full 128-character uppercase and lowercase alphanumerics or 102-character uppercase only. Two-key rollover circuitry, even-parity, buffered key-down, and handshake signals are also featured. For further information, contact RCA COSMAC VIP Marketing, New Holland Ave, Lancaster PA 17604.

Circle 469 on inquiry card.

### A Modem Inside a Telephone



A switched-network, 300 bits-per-second (bps) full-duplex Bell 103/113-compatible modem, housed inside a standard telephone set, is now being produced by Racal-Vadic. Users merely plug the VA103 ModemPhone, with its direct-connect originate/answer modem, into a standard telephone-company voice jack or programmable data jack. The device comes with an 8-foot cable and plug, plus a 25-pin connector to accept the RS-232 connection from a terminal. The ModemPhone uses a standard ITT rotary-dial or Touch Tone telephone with all modem circuitry mounted inside the case. An additional circuit board provides the originate/answer option. Many useful features are provided by the automatic originate/answer option, including loss-of-carrier line disconnect, forcing of the data-set-ready and data-terminal-ready conditions, and operator mode control. All models have local copy and 20 mA current-loop options. The VA103 is priced at \$250 and the automatic originate/answer models are \$330 each. Contact Racal-Vadic, 222 Caspian Dr, Sunnyvale CA 94086, (408) 744-0810.

Circle 470 on inquiry card.



# What's New?

## SYSTEMS



### Compact LSI 11/23 Computer System

A computer contained in a compact cabinet is the latest device from Chrislin Industries Inc, 31352 Via Colinas #102, Westlake Village CA 91361, (213) 991-2254. The CI-103 consists of a Digital Equipment Corporation VT100 video terminal, LSI 11/2 or LSI 11/23 microprocessor, and 64 K bytes of programmable memory. The unit has a detached keyboard, and Digital Equip-

ment's line of PDP-11 software is available. The DEC RX02 1-megabyte floppy-disk system or a 10-megabyte cartridge-disk system is offered as an option. The computer with the LSI 11/2 and 64 K bytes is \$4500. With the LSI 11/23 and 256 K bytes of programmable memory, the cost is \$9600. The optional RX02 floppy-disk system sells for \$3045 and the 10-megabyte cartridge-disk system is priced at \$6100.

Circle 471 on inquiry card.

### Multi-User Computer System for \$4700

IBC has introduced a multi-user, multitasking, small-business computer. The System 40 comes with the FAMOS operating system and a BASIC compiler. The computer includes 64 K bytes of programmable memory, two dual-sided, double-density 8-inch floppy-disk drives, six serial RS-232 ports, vectored interrupt, and a real-time clock. By using a compiled BASIC with re-entrant code, multiple users can share the same memory when running the same program. Memory is allocated dynamically, and fixed or hard memory partitions are not required. The single-board computer

can handle 128 K bytes of memory. The System 40 can accommodate five video terminals, a printer, and a second set of floppy-disk drives, for a total of 4 megabytes. The System 40 and 64 K bytes of memory, 2-megabyte disk storage, six serial ports, cabinet, and operating system with BASIC, is priced at \$4700. The 128 K-byte memory expansion is \$700. The floppy disk upgrade to four drives is \$1750. The price for a 20-megabyte Winchester drive is under \$4000. Contact Integrated Business Computers, 22010 S Wilmington Ave, Suite 306, Carson CA 90745, (213) 518-4245.

Circle 473 on inquiry card.

### Data General Offers Nova and MicroNova Computer Systems

Data General has announced microNova and Nova 4/C packaged computer systems based on the company's Winchester disk drives. Users can choose a packaged system with a 12.5-megabyte or a 25-megabyte Winchester-type nonremovable disk, with an integral 1.26-megabyte floppy disk. One package is a complete microNova MP/100 system with 64 K bytes of programmable memory, a 12.5-megabyte Winchester-type disk with integral 1.26-megabyte floppy disk, plus a Dasher terminal and cabinet for \$12,350. The price of the Nova 4/C in the same configuration is \$13,750. Address inquiries to Data General, Rt 9, Westboro MA 01581, (617) 336-8911.

Circle 472 on inquiry card.

### AlphaMicro Offers Small-Business Computer Systems

The AlphaMicro series 1011, 1031, and 1051 computers are multitasking, multi-user, and multiprocessor time-sharing computers. They are designed for programming in BASIC and other high-level languages. All three systems include a 16-bit processor, with two serial and one parallel input/output (I/O) port. They also feature 64 K bytes of user memory, which can be expanded up to 1 megabyte, in 64 K-byte increments. All programmable memory contains full error correction logic. Some of the other features include floating-point hardware, a real-time clock, eight levels of direct memory access (DMA), and multilevel vectored interrupt lines.

The AM 1011 includes dual floppy-disk drives (2.4 megabytes).

The AM 1031 has a 10-megabyte hard-disk drive with a 5-megabyte removable cartridge.

The AM 1051 system includes a 90-megabyte hard-disk drive with a 15-megabyte removable cartridge.

All operations are fully supported by the AlphaMicro Operating System (AMOS). The standard software package consists of a macroassembler; AlphaMicro versions of BASIC, LISP, and Pascal; word-processing software; and utility programs. Prices for the systems depend upon additional hardware and software features. Contact your local computer stores and dealers for information.

Circle 474 on inquiry card.

# What's New?

## SYSTEMS



### Microcomputer for Scientific Use

The Avtek 1800 Graphics and Scientific System is designed for scientific use. Standard hardware features include a 256-by-512 graphics terminal, 64 K bytes of memory, dual 8-inch floppy-disk drives, and floating-point processor. The software includes a screen-oriented editor, a word-processing package with features for creating scientific papers, a communications package,

and both subroutine and stand-alone packages for graphics and scientific applications. Programs may be written in FORTRAN or assembly language, with other languages available. A printer, an X,Y plotter, and double-density drives are also available. The computer with a terminal and software is priced at \$9995. Contact Avtek, 301 Side Cut Rd, West Redding CT 06896, (203) 938-3202. Circle 475 on inquiry card.

### Z8000-Based Multi-User System

Taurus Research Inc has announced a multi-user, multitasking computer system based on the Zilog Z8000 16-bit microprocessor. The Taurus T8000 series supports up to forty-eight users, and has a hard-disk capacity of up to 640 megabytes using Winchester-type disks.

The T8000/2 comes with two double-sided, double-density floppy-disk drives and two serial ports. The T8000/40 comes with 8 serial I/O ports, a 40-megabyte hard disk, and a single, double-density double-sided floppy-disk drive for backup. The Taurus Operating System (TOS) performs print spooling to multiple printers, security with multiple priority levels, user time accounting, and system status of all jobs running on the system. Included with TOS is an assembler, text editor, utilities, a sort function, and ISAM file handling. Business software is available for the series. Additional 10-, 20-, 40-, and 160-megabyte hard-disk drives are also available. The T8000/2 is priced at \$12,500 and the T8000/40 is \$19,000. For detailed information, contact Taurus Research Inc, 2880 S Main St-220, Salt Lake City UT 84115, (801) 485-1552. Circle 476 on inquiry card.

### Fast 8-Bit Microcomputer Aimed at Small-Business Applications

Artex Electronics Inc, 605 Old County Rd, San Carlos CA 94070, has introduced the Centurion system, which is approximately six times faster than comparable systems. The Centurion is built around Intel's 8085A-2 microprocessor. The latter has a processing speed of 5 MHz, but system speed is faster than that because of a floating-point-mathematics integrated circuit that handles all calculations. The system features 16 K bytes of programmable read-only memory (PROM), 64 K bytes of programmable memory, a floppy-disk controller, and the CP/M operating system. The Centurion I has two single-sided, double-density, 8-inch floppy-disk drives and is compatible with printers having RS-232 interfaces. The single quantity price of the Centurion I with a Hazeltine 1500 video terminal is \$10,825. Other models are available for \$9500 and \$8025. Additional twin 8-inch floppy-disk drives capable of storing one megabyte and a power supply are priced at \$2500.



Circle 477 on inquiry card.

# What's New?

## SOFTWARE

### Turbocharger Enhances CP/M Systems

Info 2000 Corporation's Turbocharger software enables CP/M 2.0 users to accomplish disk input/output (I/O) three to five times faster than standard CP/M in most applications, and to store 30 percent more data on each disk. The package can be used with most 8080 or Z80 systems with floppy-disk and/or hard-disk storage. The speed of the Turbocharger is achieved by multilevel buffering of disk input/output, using an LRU (least-recently-used) buffer-

assignment algorithm. The use of larger physical sector sizes, the elimination of the reserved system tracks required by standard CP/M, and the storing of the operating system as a relocatable module in an ordinary disk file allow more data to be stored on each disk. The Turbocharger package includes CP/M version 2.0, the source code for sample BIOS and bootstrap program-mable read-only memory (PROM), and documentation. It is priced at \$300 from Info 2000 Corp, 20620 S Leapwood Ave, Carson CA 90746, (213) 532-1702. Circle 478 on inquiry card.

### A CP/M Inventory-Control System for Businesses

Structured Systems Group has announced an inventory-control software package for small to medium businesses. The program can support up to 32,767 inventory item records. The program provides quick access to file records by item number. It creates a hard-copy record of stock additions, stock depletions, or both. The system also generates such reports as item list, stock activity report, and a reorder report. The system incorporates a full-screen formatting utility. The Inventory Control System requires CBASIC2 and will run on most CP/M systems with dual floppy-disk drives and 48 K bytes of programmable memory.

For details, contact Structured Systems Group, 5204 Claremont Ave, Oakland CA 94618, (415) 547-1567.

Circle 480 on inquiry card.

### Some Common BASIC Programs for Heath Computers

The JE Brancheau Engineering Co, POB 67, Trenton MI 48183, is offering Heath cassette system owners the 76 programs presented in the book *Some Common BASIC Programs* by Lon

Poole and Mary Borchers of Osborne/McGraw-Hill. This collection includes business, finance, math, statistics, plotting, and other general interest applications programs. Most programs will run with any version of Heath BASIC; only four require Extended BASIC. The price is \$15 for the cassette tape.

Circle 479 on inquiry card.

### Z80 Softcard for the Apple II

Microsoft Consumer Products has developed a Z80 card, the Softcard, that plugs into the Apple II and allows the Apple to run software written for Z80-based computers. The Softcard package includes the CP/M operating system and Microsoft disk BASIC. The Softcard allows either the Apple's 6502 processor or the Z80 processor to run a program. It is compatible with existing Apple software and peripherals. CP/M software written for Z80 computers can run on the Apple with minimal alteration. The Z80 Softcard will run on all configurations of the Apple at a clock rate of 2 MHz. The version 5.0 Microsoft BASIC that comes with the package includes PRINT USING for formatted output; long variable names; random disk input/output (I/O) with variable-length records; WHILE/WEND conditional statement; 16-bit precision; and AUTO and RENUM for numbering and renumbering lines. Graphics capabilities are expanded with the statements LINE, PUT and GET. The Z80 Softcard with CP/M and Microsoft BASIC will run on the Apple II with 48 K bytes of programmable memory and a single disk drive. The package includes the card, CP/M and BASIC on floppy disk and documentation. The suggested retail price is \$349. For the name of the nearest dealer, contact Microsoft Consumer Products, 10800 NE 8th, Suite 507, Bellevue WA 98004, (206) 454-1315.

Circle 482 on inquiry card.

### Medical Office Business System

A Medical Office Business System (MOBS) is now available for 6800/6809 computer systems. MOBS will maintain patient account records; prepare billing statements, insurance forms, and routine correspondence; and present reports for the management and control of a medical office for one or many doctors. Reports are obtained at the close of the business day, summarizing daily activity and account status. Other reports list appointments for the next day or any

specified day, still other lists report on distribution of credits among doctors and accounts receivable. The system includes a text editor and text processor which can be used as a word processor independently of the business application software. MOBS is designed to run on a 40 K-byte 6800/6809 computer with a minimum of one dual 5-inch disk system. SSB DOS and Computerware Random BASIC are required. MOBS is priced at \$1000. Contact Computerware, 1512 Encinitas Blvd, POB 668, Encinitas CA 92024, (714) 436-3512.

Circle 481 on inquiry card.

### Enhanced COBOL Packages from MCBA

MCBA (Mini-Computer Business Applications Inc) has announced the completion and availability of enhanced versions of its accounting packages in CS (Commercial Systems) COBOL for Data General CS/30, CS/40, and CS/60s. Included are MCBA's accounts receivable with sales analysis, order entry/invoicing, accounts payable, payroll, and general ledger. Data General's ICOS (Interactive COBOL Operating System) is required to run MCBA's CS COBOL packages. Source code and documentation are provided. The single microprocessor license is \$1500 for the accounting packages and \$2500 for the Client Write-Up Package. Contact MCBA, 117 S Brand Blvd, Glendale CA 91204, (213) 247-9050.

Circle 483 on inquiry card.

### LISP/80

LISP/80 is a LISP interpreter which runs on an 8080 or an equivalent microprocessor. LISP/80 runs under CP/M versions 1.4 and 2.0. It includes MAPCAR, MAPLIST, PROG, TRACE, and UNTRACE functions; string data types and subatomic pattern matching functions; garbage collection and list storage format; and it has editing commands for console input. Input may be loaded from a disk file; and definitions, properties, and values may be saved on a disk file in editable form. LISP/80 is supplied on an 8-inch, single-density, soft-sectored floppy disk. It comes with a manual for \$75 from T W Yonkman, 4182 Caminito Islay, San Diego CA 92122.

Circle 484 on inquiry card.

# MEMOREX Floppy Discs

Lowest prices. **WE WILL NOT BE UNDERSOLD!!** Buy any quantity 1-1000. Visa, Mastercharge accepted. Call free (800)235-4137 for prices and information. All orders sent postage paid.



**PACIFIC EXCHANGES**  
100 Foothill Blvd.  
San Luis Obispo, CA  
93401. (In Cal. call  
(805) 543-1037.)

Circle 217 on inquiry card.



## SOFTWARE BY KEY-TRONICS FOR TRS-80 LEVEL II COMPUTERS

\*Earn \$\$\$\$\$ with **COMPUTER DATING**  
single disc holds 1000 entries  
disc #1 — \$49.00 disc #2 — \$39.00

\***GASOLINE ENGINE SERIES**  
4 cycle and 2 cycle engines  
3 cassetts — \$9.95 each or all 3 — \$19.95  
**EDUCATIONAL**

\***STATIC DISCHARGE KIT**  
Helps eliminate accidental disc start up  
easy installation  
a must for computer buffs  
just \$16.95

**KEY-TRONICS**  
P.O. BOX 1097  
HAGERSTOWN, MARYLAND 21740  
301-790-0547  
TRS-80 is a product  
of the TANDY corporation

# OHIO SCIENTIFIC

..... With This Ad .....

HAZELTINE 1420 ..... \$780  
CENTRONICS 779 W/TRACTOR \$969  
NEC SPINWRITER ..... \$2250

..... Get the Catalog .....

&  
Our Low Prices

**DATA PRODUCTS  
MAINTENANCE CORP.**  
**OHIO SCIENTIFIC**

9460 Telstar Avenue (213) 573-5991  
El Monte, CA 91731 (714) 994-4180

Circle 218 on inquiry card.

# What's New?

## SOFTWARE

### AlphaMicro Introduces a Word-Processing System

This word-processing system consists of two components: a screen editor (AlphaVUE) and a text formatter (TXTFMT). AlphaVUE is a high-speed, two-dimensional editor capable of editing large files by displaying a single page at a time. It includes local and global search and replace commands. TXTFMT is used in conjunction with AlphaVUE to produce formatted documents, which can then be written to an output file.

The word processor features automatic page numbering, table of contents, index production, backup file protection, and left and right justification.

The system hardware requirements are an AlphaMicro AM 100 computer system and a video display with direct cursor addressing and erase-to-end-of-line capability. The word-processing software is available as a standard feature of all AlphaMicro computer systems. For details, contact AlphaMicro, 17881 Sky Park N, Irvine CA 92714, (714) 957-1404.

Circle 485 on inquiry card.

### 6809 Diagnostics and Disk Repair

This memory-diagnostic and disk-repair package is for the Motorola MC6809 microprocessor. The utility programs in the package are designed to run under the 6809 FLEX operating system. Included in the memory diagnostics portion of the package are 0s and 1s test, random pattern test, walking bit tests, dynamic programmable-memory dropout test, and convergence test. All memory tests are position independent. Among the diagnostic utilities are three that report unreadable sectors and structural inconsistencies among the files on the disk. Other utilities remove bad or intermittent sectors from the free chain. The manual includes descriptions of the diagnostics, some information on types of errors, and troubleshooting guides. The price is \$75 on 5- or 8-inch floppy disks. Contact Technical Systems Consultants Inc, POB 2570, West Lafayette IN 47906, (317) 463-2502.

Circle 486 on inquiry card.

### TRS-80 Model II CP/M

Lifeboat Associates, 2248 Broadway, New York NY 10024, is offering CP/M 2.0 for the TRS-80 Model II. The package makes it possible to run existing CP/M programs for business accounting, word processing, scientific, and special application programming. The system has nearly 500 K bytes of storage per disk with double-density formatting, but will read and write standard single-density disks. The serial ports and parallel printer port are easily configured for use with the CP/M system. The printer port has complete format and page-control implemented in software for the standard Radio Shack printer. The CP/M 2.0 system with documentation is \$170.

Circle 487 on inquiry card.

### North Star BASIC Utility Set

N•BUS is a North Star BASIC utility set featuring an editor; BPAK, a program pack utility; BPRT, a program formatted list and cross-reference utility; RE, a file rename utility; and a manual for \$69. The editor encompasses commands including global locate and change, line insert and append, copy, move, erase columns, delete, print and line scrolling, and more. N•BUS is delivered with a BASIC program that personalizes the machine code of the editor to any version of North Star BASIC version 4 or later. For details, contact SZ Software Systems, 1269 Rubio Vista Rd, Altadena CA 91001.

Circle 488 on inquiry card.

### Z8000 Floating-Point Package

This package provides a set of floating-point support subroutines for Z8002 microcomputers. Using a 32-bit binary floating-point format, these subroutines provide fast arithmetic operations, integer-float and float-integer conversions, float-ASCII string representation, ASCII string-float conversions, and give between six and seven digits of precision. These subroutines run in 200 to 400 microseconds on a

Z8002 with a 3.9 MHz clock. Each subroutine is reentrant and interruptible. The package requires 1.4 K bytes of memory and may use up to 50 bytes of stack memory. Some of the subroutines included in the package are FADD, FSUB, FMUL, FDIV, and FTOA (float-to-ASCII string).

The package costs \$99.95 and is available from Hemenway Associates Inc, 101 Tremont St, Suite 208, Boston MA 02108.

Circle 489 on inquiry card.

## TRS-80 SERIAL I/O

- Can input into basic
- Can use LLIST and LPRINT to output, or output continuously
- RS-232 compatible
- Can be used with or without the expansion bus
- On board switch selectable baud rates of 110, 150, 300, 600, 1200, 2400, parity or no parity odd or even, 5 to 8 data bits, and 1 or 2 stop bits. O.T.R. line
- Requires +5, -12 VDC
- Board only \$19.95 Part No. 8010, with parts \$59.95 Part No. 8010A, assembled \$79.95 Part No. 8010C. No connectors provided, see below.

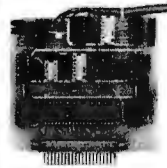

EIA/RS-232 connector Part No. DB25P \$6.00, with 9', 8 conductor cable \$10.95 Part No. DB25P9



3' ribbon cable with attached connectors for TRS-80 and our serial board \$19.95 Part No. 3CAB40

## COMPUCRUISE



\$129.95, with cruise controller \$169.95

## THE TELESIS VAR-80 INTERFACE UNIT

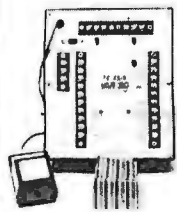

For the TRS-80 with Level II Basic • Provides 8 outputs • Provides 8 inputs • 2 ft. of interconnecting cable w/ connector • Plugs directly into TRS-80 • Power supply provided • Assembled and tested. Part No. VAR80, introductory price \$109.95.

## GAME PADDLES & SOUND



Includes: 2 game paddles, interface, software, speaker, power supply, full documentation including: schematics, theory of operation, and user guide; plus 2 games on cassette (Pong and Starship War). \$79.95 Complete Part No. 7922C

## DIGICOM DATA PRODUCTS INC. Series 312 Acoustic Coupler



300 BAUD Originate, Part No. AC3122, \$219.95. 300 BAUD Answer, Part No. AC3122, \$219.95. 300 BAUD Answer/Originate, Part No. AC3123, \$229.95

## LIGHT-PEN For Your TRS-80



Your TRS-80 Light-Pen is a carefully engineered instrument and with the proper care will give satisfactory use and many years of service. Part No. TRS80LP \$24.95.

## SYSTEM EXPANSION from LNW Research

- Serial RS232C/20 mA I/O
- Floppy controller
- 32K bytes memory
- Parallel printer port
- Dual cassette port
- Real-time clock
- Screen printer bus
- Onboard power supply
- Software compatible
- Solder mask, silk screen. PC board and user manual. Part No. LNW80, \$69.95.

## DISKETTES



Box of 10, 5" \$29.95, 8" \$39.95. Plastic box, holds 10 diskettes, 5" - \$4.50, 8" - \$6.50.

## 16K RAMS

For the Apple, TRS-80 or Pet \$8 each Part No. 4116/2117.

## LEEDIX MONITOR



12" Black and White • 12 MHz Bandwidth • Handsome Plastic Case • \$139.00

## S-100 INTERFACE



AN S-100 bus Adapter—Motherboard for the TRS-80, Kit, Part No. HUH81DLXK, \$295.95. Assembled, Part No. HUH81DLXA, \$375.95.

## NOW! A FULL SUPPORT SYSTEM FOR TRS-80

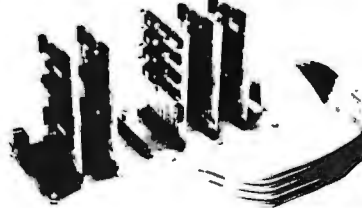

- 32K of RAM
- EPROM firmware
- Disk control
- Data acquisition
- Parallel I/O
- Serial I/O
- Plug into GPA's Motherboard. GPA's quality design includes: 6-44 pin edge connectors • +5V, -5V, +12V, -12V external power supply required • Active termination. The Motherboard, Part No. GPA80, is only \$149.95.

## TAKE ADVANTAGE OF GPA-EXPANSION CARDS FOR THE GPA80

**Memory cards:** Now with Fortran compilers available for your TRS-80, additional expansion memory is a must! Card with sockets only, Part No. GPA801, \$119.95. Card with 16K of 4116 Dynamic Ram, Part No. GPA802, \$224.95. Card with 32K of 4116 Dynamic Ram, Part No. GPA803, \$329.95. All cards come equipped with sockets to accommodate 32K of Ram.

**EPROM firmware card.** Put those valuable subroutines in firmware. Don't waste time loading and unloading tapes and disks. For 2708 or 2716 EPROMS, Part No. GPA806, \$79.95.

**Serial I/O card.** Here's what you've been asking for, a full serial terminal interface, with RS-232C or 20 mA. Current loop. Input/output capabilities. Part No. GPA807, \$79.95.

**Parallel I/O Card.** Control functions in the outside world, monitor and store real time events. Two parallel output ports. Dip switches select ports (0-254). Part No. GPA808, \$79.95.

## FLOPPY DISK STORAGE BINDER

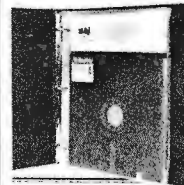

Three-ring binder comes with ten transparent plastic sleeves which accommodate either twenty, five-inch or ten, eight-inch floppy disks. Binder & 10 holders \$14.95 Part No. 8800; Extra holders 95¢ each, Part No. 800.

## DISK JACKET™

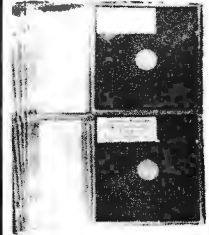

Holds two 5-1/4 inch diskettes and will fit any standard three-ring binder. \$9.95/10 Pack.

## TRENDCOM PRINTER



- 40 characters per second
- 4-7/16 inch wide thermal paper
- Graphics (TRENDCOM 100): 480 sevendot print positions per line. TRENDCOM 100, Part No. TRC0100, \$495.95. TRENDCOM 200, Part No. TRC0200, \$375.95.
- Interface for TRS-80,** Part No. T80A \$45.95. For Apple II, Part No. TRCAII, \$75.95. For PET, NO. TRCP2, \$79.95. For Scroccer, TRCSA1 \$45.95.

## DIGITAL CASSETTE



5 min. each side. Box of 10 \$9.95. Part No. C-5.

## SARGON: A Computer Chess Program

Features the complete program that won the 1978 West Coast Computer Faire Tournament. Part No. 00603 — TRS-80 Level II; Part No. 00604 — Apple II (24K). \$19.95

## SOUND EFFECTS AND MUSIC FOR YOUR COMPUTER



PET TRS-80 CompuColor II ADD SOUND TO YOUR BASIC PROGRAM

**SOUNDWARE** is a complete system. It includes a speaker/amplifier unit with volume control, earphone jack, and connectors. It boasts excellent tone quality yet is small and convenient to use. Add batteries, plug it in, and play. One year warranty. **SOUNDWARE** package (includes INTRO to **SOUNDWARE** programs) PET (8K), Part No. 20003, \$29.95. TRS-80 Level II (16K), Part No. 20002, \$29.95. CompuColor II (8K), Part No. 20001, \$39.95. **INTRO to SOUNDWARE** programs only PET and TRS-80, Part No. 20005, \$14.95. CompuColor II Part No. 20006, \$19.95.

## To Order:

Mention part no., description, and price. In USA shipping paid by us for orders accompanied by check or money order. We accept C.O.D. orders in the U.S. only, or a VISA or Master Charge no., expiration date, signature, phone no., shipping charges will be added. CA residents add 6.5% for tax. Outside USA add 10% for air mail postage and handling. Payment must be in U.S. dollars. Dealer inquiries invited. 24 hour order line (408) 448-0800



Send for FREE Catalog... a big self-addressed envelope with 41¢ postage gets it fastest!

**ELECTRONIC SYSTEMS** Dept. B P. O. Box 21638, San Jose, CA USA 95151

### HEX ENCODED KEYBOARD

Four onboard LEOs indicate the HEX code generated for each key depression. The board requires a single +5 volt supply. Board only \$15.00 Part No. HEX-3, with parts \$49.95 Part No. HEX-3A. 44 pin edge connector \$4.00 Part No. 44P.

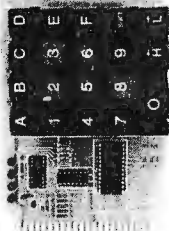

HEX ENCODED KEYBOARD

### T.V. TYPEWRITER

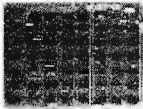

- Stand alone TVT
- 32 char/line, 16 lines, modifications for 64 char/line included
- Parallel ASCII (TTL) input
- Video output
- 1K on board memory
- Output for computer controlled cursor
- Auto scroll
- Non-destructive cursor
- Cursor inputs: up, down, left, right, home, EDL, EOS
- Scroll up, down
- Requires +5 volts at 1.5 amps, and -12 volts at 30 mA
- All 7400, TTL chips
- Char. gen. 2513
- Upper case only
- Board only \$39.00 Part No. 106, with parts \$145.00 Part No. 106A

### UART & BAUD RATE GENERATOR

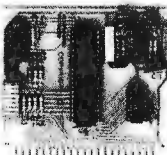

- Converts serial to parallel and parallel to serial
- Low cost on board baud rate generator
- Baud rates: 110, 150, 300, 600, 1200, and 2400
- Low power drain +5 volts and -12 volts required
- TTL compatible
- All characters contain a start bit, 5 to 8 data bits, 1 or 2 stop bits, and either odd or even parity.
- All connections go to a 44 pin gold plated edge connector
- Board only \$12.00 Part No. 101, with parts \$35.00 Part No. 101A, 44 pin edge connector \$4.00 Part No. 44P

### 44 BUS MOTHER BOARD



Has provisions for ten 44 pin (.156) connectors, spaced 3/4 of an inch apart. Pin 20 is connected to X, and 22 is connected to Z for power and ground. All the other pins are connected in parallel. This board also has provisions for bypass capacitors. Board cost \$15.00 Part No. 102. Connectors \$3.00 each Part No. 44WP.

### RS-232/20mA INTERFACE



This board has two passive, opto-isolated circuits. One converts RS-232 to 20mA, the other converts 20mA to RS-232. All connections go to a 10 pin edge connector. Requires +12 and -12 volts. Board only \$9.95, part no. 7901, with parts \$14.95 Part No. 7901A.

### ASCII TO CORRESPONDENCE CODE CONVERTER

This bidirectional board is a direct replacement for the board inside the Trendata 1000 terminal. The on board connector provides RS-232 serial in and out. Sold only as an assembled and tested unit for \$249.95. Part No. TA 1000C

### ASCII KEYBOARD

53 Keys popular ASR-33 format • Rugged G-10 P.C. Board • Tri-mode MOS encoding • Two-Key Rollover • MOS/DTL/TTL Compatible • Upper Case lockout • Data and Strobe inversion option • Three User Definable Keys • Low contact bounce • Selectable Parity • Custom Keycaps • George Risk Model 753. Requires +5, -12 volts. \$59.95 Kit.

### ASCII KEYBOARD

TTL & DTL compatible • Full 67 key array • Full 128 character ASCII output • Positive logic with outputs resting low • Data Strobe • Five user-definable spare keys • Standard 22 pin dual card edge connector • Requires +5VDC, 325 mA. Assembled & Tested. Cherry Pro Part No. P70-05AB. \$119.95.



### COMPRINT PRINTER

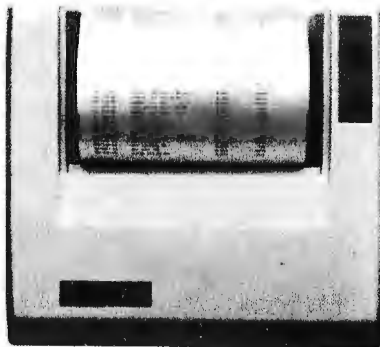

**Printing Characteristics:** 225 characters/second (170 lines/minute) throughput • 9 horizontal x 12 vertical matrix • 96 ASCII character set with upper and truelower case • 80 characters/line • 5.8 lines/inch

**Buffer Memory:** standard 256 bytes; • optional; 2,048 bytes (buffer memory option designated as Model 912-2K), add \$149.95.

**Paper Requirements:** electrosensitive type (aluminum coated) • 8-1/2 inch width • 3.7 inch max. (300 ft.) roll diameter.

**Model 912-S Interfacing:** serial interface RS232 and 20 mA current loop • BAUD rates 110, 150, 300, 600, 1200, 2400 and 4800 are strap selectable.

**Model 912-P Interfacing:** parallel interface, IEEE-488 and 8 bit parallel (strobe/acknowledge). Model 912-S, Part No. CPIA, 32118, \$579.95. Model 912-P, Part No. CPIA, 32117, \$559.95.

### T.V. INTERFACE



- Converts video to AM modulated RF. Channels 2 or 3. So powerful almost no tuning is required. On board regulated power supply makes this extremely stable. Rated very highly in Doctor Dobbs' Journal. Recommended by Apple
- Power required is 12 volts AC C.T., or 15 volts DC
- Board only \$7.60 part No. 107, with parts \$13.50 Part No. 107A

### SOROC IQ 120



Upper/lower case display • Numeric keypad & cursor keys • Protected fields, 1/2 intensity display • RS 232 interface & aux. port. IQ120—\$799.95 • IQ140 Detachable keyboard—\$1199.95

### RS-32/TTL INTERFACE

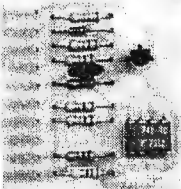

- Converts TTL to RS-232, and converts RS-232 to TTL
- Two separate circuits
- Requires -12 and +12 volts
- All connections go to a 10 pin edge connector, kit \$9.95 Part No. 232A10P, 10 pin edge connector \$3.00 part No. 10P.

### DC POWER SUPPLY

- Board supplies a regulated +5 volts at 3 amps., +12, -12, and -5 volts at 1 amp.
- Power required is 8 volts AC at 3 amps., and 24 volts AC C.T. at 1.5 amps.
- Board only \$12.50 Part No. 6085, with parts excluding transformers \$42.50 Part No. 6085A

### TAPE INTERFACE

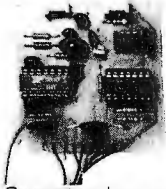

- Converts a low cost tape recorder to a digital recorder
- Works up to 1200 baud
- Digital in and out are TTL serial
- Output of board connects to mic. in of recorder
- Earphone of recorder connects to input on board
- No coils
- Requires +5 volts, low power drain
- Board only \$7.60 Part No. 111, with parts \$29.95 Part No. 111A

### MODEM



- Type 103
- Full or half duplex
- Works up to 300 baud
- Originate or Answer
- Serial TTL input and output
- connect 8 Ω speaker and crystal mic. directly to board
- Requires +5 volts
- Board only \$7.60 Part No. 109, with parts \$29.95 Part No. 109A.

### COMPUCOLOR II



With reg. keyboard MOD3 8K \$1595.95 MOD4 16K \$1695.95 MOD 5 32K \$1995.95 Now includes \$250 more, worth of software and accessories with 101 key option add \$134.95 with 117 key option add \$179.95

**To Order:** Mention part no. description, and price. In USA shipping paid by us for orders accompanied by check or money order. We accept C.O.D. orders in the U.S. only, or a VISA or Master Charge no., expiration date, signature, phone no., shipping charges will be added. CA residents add 6.5% for tax. Outside USA add 10% for air mail postage and handling. Payment must be in U.S. dollars. Dealer inquiries invited. 24 hour order line (408) 448-0800



Send for FREE Catalog . . . a big self-addressed envelope with 41¢ postage gets it fastest!

**ELECTRONIC SYSTEMS** Dept. B P. O. Box 21638, San Jose, CA USA 95151

## apple II Or APPLE II PLUS



16K \$975.95, Extra 16K E.S. RAM installed \$74.95, extra 32K E.S. RAM installed \$148.95.

**APPLE II HOBBY/  
PROTOTYPING CARD**  
Part No. 7907 \$14.95

## REAL TIME 100,000 DAY CLOCK

**MT. HARDWARE** Double the utility of your S-100 bus computer with a real-time clock that keeps time in 100µS increments for over 273 years. Program events for the entire period with real time interrupts...without de-railing the system. Maintain a log of computer usage, time and date transaction printouts, call up lists...virtually any activity where time is a factor. On-board battery backup. MHPX004—\$249.95

## SUPER MODEM

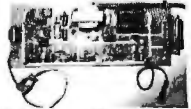

Originate, RS-232 and 20mA compatible. Full duplex, and half duplex, direct connect or acoustic coupled, on board power supply, carrier detect light, DB25 plug, 300BAUD, Type 103 compatible frequencies. Bare board Part No. 2000, \$19.95, Kit, Part No. 2000A, \$99.95.

## 16K EPROM

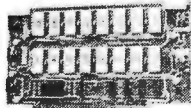

Uses 2708 EPROMS, memory speed selection provided, addressable anywhere in 65K of memory, can be shadowed in 4K increments. Board only \$24.95 part no. 7902, with parts less EPROMS \$49.95 part no. 7902A.

## PET COMPUTER



With 16K & monitor - \$795. Dual Disk Drive - \$10.95

## OPTO-ISOLATED PARALLEL INPUT BOARD FOR APPLE II

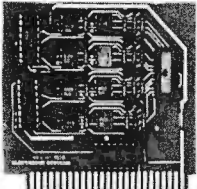

There are 8 inputs that can be driven from TTL logic or any 5 volt source. The circuit board can be plugged into any of the 8 sockets of your Apple II. It has a 16 pin socket for standard dip ribbon cable connection. Board only \$15.00, Part No. 120, with parts \$69.95, Part No. 120A.

## VIDEO TERMINAL

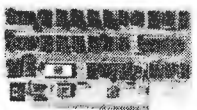

16 lines, 64 columns • Upper and lower case • 5x7 dot matrix • Serial RS-232 in and out with TTL parallel keyboard input • On board baud rate generator 75, 110, 150, 300, 600, & 1200 jumper selectable • Memory 1024 characters (7-21L02) • Video processor chip SFF96364 by Neculonic • Control characters (CR, LF, →, ←, ↑, ↓, non destructive cursor, CS, home, CL • White characters on black background or vice-versa • With the addition of a keyboard, video monitor or TV set with TV interface (part no. 107A) and power supply this is a complete stand alone terminal • also S-100 compatible • requires +16, & -16 VDC at 100mA, and 8VDC at 1A. Part No. 1000A \$199.95 kit.

## PARALLEL TRIAC OUTPUT BOARD FOR APPLE II



This board has 8 triacs capable of switching 110 volt 6 amp loads (660 watts per channel) or a total of 5280 watts. Board only \$15.00 Part No. 210, with parts \$119.95 Part No. 210A.

## APPLE II\* SERIAL I/O INTERFACE

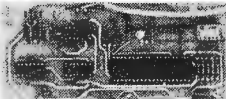

Baud rate is continuously adjustable from 0 to 30,000 • Plugs into any peripheral connector • Low current drain, RS-232 input and output • On board switch selectable 5 to 8 data bits, 1 or 2 stop bits, and parity or no parity either odd or even • Jumper selectable address • SOFTWARE • Input and Output routine from monitor or BASIC to teletype or other serial printer • Program for using an Apple II for a video or an intelligent terminal. Also can output in correspondence code to interface with some selectrics. • Also watches OTR • Board only \$15.00 Part No. 2, with parts \$42.00 Part No. 2A, assembled \$62.00 Part No. 2C

## 8K EPROM PIGEON

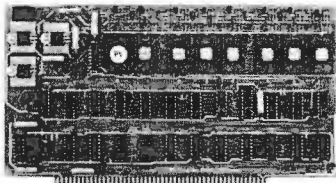

• Programs 2708's address relocation of each 4K of memory to any 4K boundary • Power on jump and reset jump option for "turnkey" systems and computers without a front panel • Program saver software in 1 2708 EPROM \$25. Bare board \$35 including custom coil, board with parts but no EPROMS \$139, with 4 EPROMS \$179, with 8 EPROMS \$219.

## WAMECO PRODUCTS

With ELECTRONIC SYSTEMS parts

- FDC-1** FLOPPY CONTROLLER BOARD will drive shugart, pertek, remex 5" & 8" drives up to 8 drives, on board PROM with power boot up, will operate with CPM (not included). PCBD ..... \$42.95
- FPB-1** Front Panel, (Finally) IMSAI size hex displays. Byte or instruction single step. PCBD ..... \$42.95
- MEM-1A** 8Kx8 fully buffered, S-100, uses 2102 type RAMS. PCBD ..... \$24.95, \$168 Kit
- GMB-12** MOTHER BOARD, 13 slot, terminated, S-100 board only ..... \$34.95
- CPU-1** 8080A Processor board S-100 with 8 level vector interrupt PCBD ..... \$89.95 Kit
- RTC-1** Realtime clock board. Two independent interrupts. Software programmable. PCBD ..... \$25.95, \$60.95 Kit
- EPM-1** 1702A 4K EPROM card PCBD ..... \$25.95
- ..... \$49.95 with parts less EPROMS
- EPM-2** 2708/2716 16K/32K EPROM card PCBD ..... \$24.95
- ..... \$49.95 with parts less EPROMS
- GMB-9** MOTHER BOARD. Short Version of GMB-12. 9 Slots PCBD ..... \$30.95
- ..... \$67.95 Kit
- MEM-2** 16Kx8 Fully Buffered 2114 Board PCBD ..... \$25.95, \$269.95 Kit

## D.C. HAYES MICROMODEM



Fully S-100 bus compatible including 16-bit machines and 4 MHz processors. • Two software selectable Baud rates—300 Baud and a jumper selectable speed from 45 to 300 Baud. (110 standard). Supports originate and answer modes. • Direct-connect Microcoupler. This FCC-registered device provides direct access into your local telephone system, with none of the losses or distortions associated with acoustic couplers and without a telephone company supplied data access arrangement. • Auto-Answer/Auto-Call. The MICROMODEM 100 can automatically answer the phone and receive input; it can also dial a number automatically. • Automatic Reset and Disconnect. • Software compatible with the D.C. Hayes Associates 80-103A Data Communications Adapter. Micromodem-DCHA32625—\$379.95

## TIDMA



Tape Interface Direct Memory Access • Record and play programs without bootstrap loader (no prom) has FSK encoder/decoder for direct connections to low cost recorder at 1200 baud rate, and direct connections for inputs and outputs to a digital recorder at any baud rate • S-100 bus compatible • Board only \$35.00 Part No. 112, with parts \$110.00 Part No. 112A.

## SYSTEM MONITOR

8080, 8085, or Z-80 System monitor for use with the TIOMA board. There is no need for the front panel. Complete with documentation \$12.95.

## RS-232/TTY INTERFACE

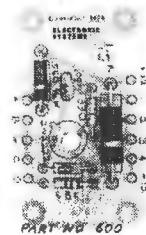

This board has two active circuits, one converts RS-232 to 20mA, the other converts 20mA to RS-232. Requires +12 and -12 volts. \$9.95 Part No. 600A Kit.

## SERIAL I/O



Four Serial I/O RS-232 ports. S-100 Bus, Software or jumper selectable baud rate (110, 300, 600, 1200, 2400, 4800, 9600, 19.2K), on board Xtal baud rate generator. Addressing, switch selectable, Parity or no parity (odd or even) switch selectable, 1 or 2 stop bits, 5 to 8 bits/character. Board only \$29.95, Part No. 7908. With parts (kit) \$199.95, Part No. 7908A.

## S-100 BUS ACTIVE TERMINATOR

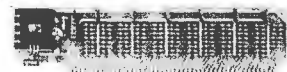

Board only \$14.95 Part No. 900, with parts \$24.95 Part No. 900A

**To Order:** Mention part no. description, and price. In USA shipping paid by us for orders accompanied by check or money order. We accept C.O.D. orders in the U. S. only, or a VISA or Master Charge no., expiration date, signature, phone no., shipping charges will be added. CA residents add 6.5% for tax. Outside USA add 10% for air mail postage and handling. Payment must be in U. S. dollars. Dealer inquiries invited. 24 hour order line (408) 448-0800



Send for FREE Catalog... a big self-addressed envelope with 41¢ postage gets it fastest!

**ELECTRONIC SYSTEMS** Dept. B P. O. Box 21638, San Jose, CA USA 95151

# SD SYSTEMS

# Factory Rebate Sale



When you purchase any S.D. SYSTEMS Computer Board, either kit or A&T from PRIORITY 1 ELECTRONICS you will receive a COUPON FOR A \$25.00 CASH REBATE Direct from the Manufacturer SD SYSTEMS. Combine the Rebate with our already low prices, and you can hardly afford to pass up this special offer.

## SD EXPANDORAM The Ultimate S-100 Memory

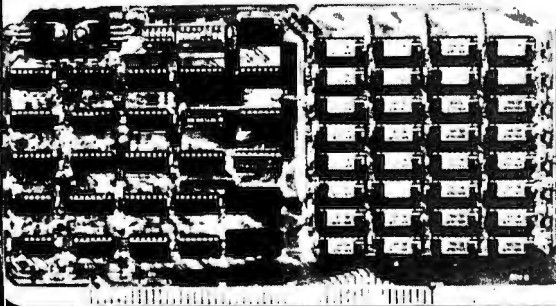

### EXPANDO 64 KIT (4116)

16K	\$189.00
32K	\$239.00
48K	\$289.00
64K	\$339.00

The EXPANDORAM is available in versions from 16K up to 64K, so for a minimum investment you can have a memory system that will grow with your needs. This is a dynamic memory with the invisible on-board refresh, and IT WORKS!

- Interfaces with Altair, IMSAI, SOL-8, Cromenco, SBC-100, and others.
- Bank Selectable
- Phantom
- Power 8VDC, ± 16VDC, 5 Watts
- Lowest Cost Per Bit
- Uses Popular 4116 RAMS
- PC Board is doubled solder masked and has silk-screen parts layout.
- Extensive documentation clearly written
- Complete Kit includes all Sockets for 64K
- Memory access time: 375ns, Cycle time: 500ns
- No wait states required.
- 16K boundaries and Protection via Dip Switches
- Designed to work with Z-80, 8080, 8050 CPU's

### VERSAFLOPPY II

DOUBLE DENSITY, DOUBLE SIDED, DISC CONTROLLER

**GENERAL DESCRIPTION**  
Versafloppy II is a flexible disk drive controller that incorporates a wide range of capabilities into one board. It operates with double density soft sector format which provides 800,000 bytes of storage on a double sided 8 inch diskette and 125,000 bytes per side on a five inch mini diskette. The Versafloppy II directly controls many popular disk drives. These include Shugart SA400 and SA450 Shugart SA80 and SA850 Mayhew MFC300 and MFE700 Per Se 70 and 277, and Siemens 951 105.

- S-100 Bus IEEE Standard Compatible
- IBM 3740 Compatible Soft Sector Format for Single Density Drives
- Operates with both Standard 8" and Mini 5" Drives Simultaneously
- Provides Control for Double Sided Operation
- Operates with Z80, 8080 and 8085 Central Processing Unit
- Controls up to four drives
- Vectored Interrupts Operation Optional
- Control and Diagnostic Software Available in PROM
- SDS Disk Operating System Compatible



NEW

SDS-VERSAFLOPPY II KIT.....\$299.00  
SDS-VERSAFLOPPY II KIT.....\$425.00

### DISC CONTROLLER

SD"VERSAFLOPPY" KIT  
The Versatile Floppy Disk Controller

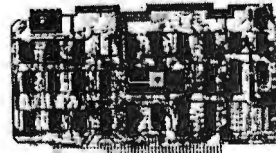

**FEATURES:** IBM 3740 Soft Sector Compatible, S-100 Bus Compatible for Z80 or 8080, Controls up to 4 D-type single or double sided soft sector floppy disk drives, Single Standard 8" Floppy, Single 5" Floppy, Single 5" and 277, MFE 200740, CDS, 8080/85, 8088/86, 8010/15, 8012/18, 8013/19, 8014/20, 8015/21, 8016/22, 8017/23, 8018/24, 8019/25, 8020/26, 8021/27, 8022/28, 8023/29, 8024/30, 8025/31, 8026/32, 8027/33, 8028/34, 8029/35, 8030/36, 8031/37, 8032/38, 8033/39, 8034/40, 8035/41, 8036/42, 8037/43, 8038/44, 8039/45, 8040/46, 8041/47, 8042/48, 8043/49, 8044/50, 8045/51, 8046/52, 8047/53, 8048/54, 8049/55, 8050/56, 8051/57, 8052/58, 8053/59, 8054/60, 8055/61, 8056/62, 8057/63, 8058/64, 8059/65, 8060/66, 8061/67, 8062/68, 8063/69, 8064/70, 8065/71, 8066/72, 8067/73, 8068/74, 8069/75, 8070/76, 8071/77, 8072/78, 8073/79, 8074/80, 8075/81, 8076/82, 8077/83, 8078/84, 8079/85, 8080/86, 8081/87, 8082/88, 8083/89, 8084/90, 8085/91, 8086/92, 8087/93, 8088/94, 8089/95, 8090/96, 8091/97, 8092/98, 8093/99, 8094/100, 8095/101, 8096/102, 8097/103, 8098/104, 8099/105, 8100/106.

DISC CONTROLLER SD "VERSAFLOPPY" KIT  
The Versatile Floppy Disk

LIST 250.00  
SALE 220.00

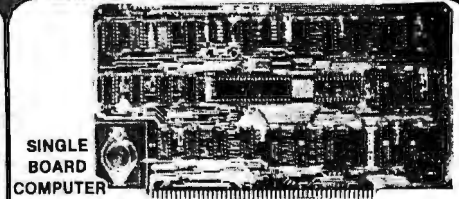

SINGLE BOARD COMPUTER

With On-Board RAM, PROM, CTC

- S-100 Bus Compatible
  - Z80 Central Processing Unit
  - 1024 Bytes of Random Access Memory
  - 8K Bytes of PROM using 2716
  - Parallel Input and Output Ports
  - Four Channel Counter/Timer (Z80-CTC)
  - Software Programmable Baud Rate Generator
  - No Front Panel Required for Operation
- SDS-SBC-100 2MHZ KIT ..... 265.00  
SDS-SBC-100 2MHZ A&T ..... 350.00  
SDS-SBC-200 4MHZ KIT ..... 289.00  
SDS-SBC-200 4MHZ A&T ..... 369.00

Sale Price

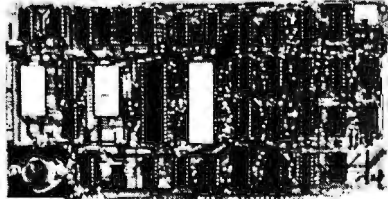

### VDB-8024 VIDEO DISPLAY BOARD

With on-board Z80 Microprocessor

- S-100 bus Compatible
- Full 80 Characters by 24 Lines Display
- Characters Displayed by High Resolution 7 x 10 Matrix
- Composite or TTL Video Output
- Keyboard Power and Interface
- Forward and Reverse Scrolling Capability
- Blinking, Underlining, Field Reverse, Field Protect and Combinations
- Full Cursor Control
- 96 Upper and Lower Case Characters
- 32 Special Character Set
- 128 Additional User Programmable Characters (Optional)
- On-Board Z80 Microprocessor
- 2K Bytes Independent On-Board RAM Memory Display
- Glitch-Free Display

SDS-VDB-8024 KIT ..... \$320.00  
SDS-VDB-8024 A&T ..... \$469.00

Sale Price

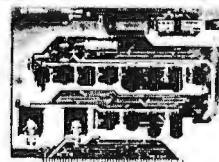

### PROM-100

Programming Board for PROM Development

NEW

SD SYSTEMS' PROM-100 is a versatile PROM programming board offering complete EPROM programming capability. The board operates on the industry standard S-100 Bus. Support software verifies the erasure of EPROM and verifies the loaded program. SD SYSTEMS' PROM-100 offers a support-software listing with its operations manual.

- S-100 Bus Compatible
- Programs the Following EPROMs: Intel 2758, 2716, 2732 and Texas Instruments 2516
- Dip Switch Selection of EPROM type
- 25 VDC Programming Pulse Generated On Board
- Maximum Programming time: 16,384 Bits in 100 Seconds
- Power Requirement: +8VDC at 300 ma.; +16 VDC at 100 ma.; -16 VDC at 60 ma.
- TTL compatible
- Software Provides for Reading of Object File from SDSOS, CP/M or PROM and Programming into EPROM
- Program Verification • Verification of Erasure
- Zero Insertion Force Socket

SDS-PROM-100 KIT ..... \$175.00  
SDS-PROM-100 A&T ..... \$225.00

Sale Price

BEST BUY

### Z80 STARTER KIT

A Complete Microcomputer On A Board

- Z80 CPU with 158 Instructions
- On-Board Keyboard and Display
- On-Board PROM Programmer for Single Voltage PROMS (2716, 2758, 12516)
- Kansas City Standard Cassette Interface
- Simple Key Controlled Audio Cassette Load and Dump
- Expansion Provision for Mounting Two S-100 Connectors (Sockets Not Included)
- Wire Wrap Area for Custom Circuitry
- Single Step through RAM or PROM
- Memory Examine and Change
- Port Examine and Change
- Z80 CPU Register and Change
- 2K Byte ZBUG Monitor in ROM
- 1K Bytes of RAM (Expandable to 2K Bytes)
- A 4 Channel Hardware Counter/Timer (Z80-CTC)
- Two Bi-Directional 8-Bit I/O Ports (Z80-P10)
- Up to 5 Programmable Breakpoints
- Switch Selectable PROM or Monitor Restart
- Vectored Interrupts provided by Z80-CTC and

SDS-Z80 STARTER KIT ..... \$299.00  
SDS-Z80 STARTER A&T ..... \$439.00

Sale Price

ORDER TOLL FREE  
1-800-423-5633  
except CA, AK, HI, CALL  
(213) 894-8171



## PRIORITY ONE ELECTRONICS

16723K Roscoe Blvd. Sepulveda, CA 91343

Terms: Visa, MC, BAC, Check, Money Order, U.S. Funds Only. CA residents add 6% sales tax. Minimum order \$10.00 Prepaid U.S. orders less than \$75.00 include 5% shipping and handling. MINIMUM \$2.50. Excess refunded. Just in case... please include your phone no. Prices subject to change without notice. We will do our best to maintain prices thru JULY 1980. \*SOCKET and CONNECTOR prices based on GOLD, not exceeding \$500 per oz.

\*Sale Prices are for prepaid orders only credit card orders will be charged appropriate freight



FOR MORE INFORMATION SEE OUR 52 PAGE AD IN JANUARY BYTE OR SEND \$1.00 FOR CATALOG

• Sale Prices are for prepaid orders only • Quantities are limited, subject to prior sale • CREDIT CARD ORDERS WILL BE CHARGED APPROPRIATE FREIGHT

ORDER TOLL FREE (800) 423-5633

Circle 221 on inquiry card.



# PRIORITY ONE ELECTRONICS

## CENTRONICS 730 Dot Matrix Printer

SAVE \$100.00

**STANDARD FEATURES:** • 50 Character/second • Character/line • 10 characters/inch • 3 way paper handling system • 7 x 7 dot matrix • 96 character ASCII • microprocessor electronics • unidirectional print at 5.0 ips • high speed return approximately 10 ips • 21 ips • 18 columns printed • 58 lpm with 20 columns printed • 80 character buffer • 6 vertical • Centronics Colors and logo

**FORMS HANDLING:** Real Paper 8 1/2 x 11, 5 1/2 dia. with 1 in. hole max. dimensions 3.5 in. wide with 36 in. core minimum dimensions: Fan Fold 9 1/2 in. x 22 3/4 in. add 1/2 in. per 9 1/2 in. x 24 in. wide or 11 in. x 1 1/2 in. with 2 carbon copies (total thickness not to exceed) 0.12 inches Cut Sheet: Maximum width 6 5/8 inches

**RIBBON SYSTEM:** Continuous ribbon 9 1/8 (14mm) wide 20 yards (18.3 meters) long Mobius Loop allows printing on upper and lower portion on alternate passes

**OPERATOR CONTROLS:** Power on/off, Reset Switch, allows disabling of printer without dropping AC

**DATA INPUT:** 7 or 8 bit ASCII parallel TTL levels with strobe. Acknowledge pulse in indicates that data was received

**PHYSICAL DIMENSIONS:** Weight less than 10 lbs 5 kg Width 14.5 inches 37 cm Depth 11 0 inches 28 cm Height 4 89 inches 13 cm Dimensions exclusive of roll paper holder

**SHIPPING WEIGHT:** 14 lbs

CEN-730-1 (Parallel Int.) ..... LIST PRICE: \$795.00



WOW  
PRICE  
\$695.00  
WOW

## TRS-80/APPLE MEMORY EXPANSION KITS

4116's RAMS  
from Leading Manufacturers  
(16Kx1 200/250ns)

1,000's SETS SOLD  
100% GUARANTEED

8 for \$50.00

ADD \$3.00 FOR PROGRAMMING JUMPERS  
FOR TRS-80 KEYBOARD  
4116's 100 pcs & UP \$5.20 each  
1000 pcs & UP \$4.45 each

## STARS & STRIPES SPECIAL



LIST PRICE  
199.00

OUR CORNER  
THE MARKET PRICE  
\$139.00

FEATURE  
FITS GTE HANDSETS!

The STAR modem from Livormore represents a significant breakthrough in the development of acoustic modems. The small, lightweight case houses a high-performance modem that competes with the highest quality standard-sized couplers available. Yet, because of its cost effective design, the STAR has become the price/performance leader in the industry.

**CIRCUITRY**  
The switchable, four-section bandpass filter provides the user with excellent out-of-band rejection to assure accurate processing of the received carrier, even at signal levels of less than -47 dBm. Further, the proven soft limiter and phase lock loop discriminator yields data that is essentially jitter free.

The oscillator is built using highly stable, state-variable circuitry that delivers a nearly harmonic free, phase coherent sine wave to the telephone network, assuring compatibility with all other 103 type modems. Because of the purity of the sine wave,

the STAR modem exceeds even the stringent harmonic requirements of all CCITT countries.

**CARRIER DETECT**  
To assure accurate teleprocessing connections, the carrier detect circuitry prevents the modem from attempting to operate when excessive noise would produce errors or cause marginal operation. The circuitry also has a special amplitude sensor that prevents chatter when the received signal fades.

**EXCLUSIVE ACOUSTIC CHAMBERS**  
The exclusive triple seal of Livormore's new flat mounted cups locks the handset into the acoustic chamber yielding superior acoustic isolation and mechanical cushioning. Designed to adapt to most common handsets used throughout the world, the STAR offers the utmost in flexibility and transmission reliability.

**SELF TEST**  
The self test feature on the STAR allows the user to verify total operation of the acoustic modem by using the terminal in the full duplex mode. No need to remote

assistance in diagnosing terminal or modem problems.

Utilizing the experience gained from building high quality couplers for over twelve years, Livormore has designed a coupler superior to any in its class for cost efficiency in industrial, commercial, business or home situations. You can see why we call it the STAR!

**SPECIFICATIONS**  
Data Rate: 0 to 300 baud  
Compatibility: Bell 103 and 113, CCITT  
Transmit Frequencies: \* Originate - 1070 Hz/Space, 1270 Hz/Mark, Answer - 2025 Hz/Space, 2225 Hz/Mark  
Receive Frequencies: \* Originate 2025 Hz/Space, 2225 Hz/Mark, Answer 1070 Hz/Space, 1270 Hz/Mark  
Frequency Stability: ± 0.3 percent  
Receiver Sensitivity: 50 uBrn ON, - 53 dBm OFF  
Transmit Level: - 15 dBm  
Modulation: Frequency shift keyed (FSK)  
Carrier Detect Delay: 1.2 seconds ON, 120 msec OFF

EIA Terminal Interface. Compatible with RS 232 specifications  
Teletype Interface, 20 milliampere current loop  
Optional Interfaces: IEEE 488, TTL, TTY, 43

\*International (CCITT) frequencies available  
Switches: Originate/Off/Answer Full Duplex/Test/Half Duplex  
Indicators: Carrier Ready, Data, Receive Data, Carrier Ready, Test  
Environmental: Ambient operating temperature 5°C to 50°C Relative humidity 10 to 90 percent (non-condensing)  
Power: Supplied by 24 VAC/150 MA UL/CSA listed wall-mount transformer input 115 VAC, 2.5 watts (A 220 VAC, 50 Hz adaptor is available upon request).  
Dimensions: 10" x 4" x 2"  
Weight: 1.75 lbs (2.2 lbs. shipping weight including AC adaptor)  
Warranty: Two years on parts and labor, excluding the AC adaptor which carries its manufacturer's warranty.

## STAR MODEM

## 4 MHZ EXPANDORAM II KIT The S-100 Memory Board for the 80's

SD SYSTEMS ExpandoRAM II is a state-of-the-art dynamic RAM board with capacities from 16K bytes (4116) to 256K bytes (4164). It operates on the industry S-100 Bus. The ExpandoRAM II's design allows eight boards to operate from the same S-100 Bus. Page mode operation provides the system with the capability of servicing multiple users without RAM interference. Invisible refresh and synchronization with wait states provide greater reliability, and processing speeds up to 4 Mhz.

- S-100 Bus Compatible
- Up to 4Mhz Operation
- Expandable Memory from 16K to 256K
- DIP Switch Selectable Boundaries
- Uses 16K (4115) or 64K (4164) Memory Devices
- Page Mode Operation Allows up to 8 Memory Boards on Bus
- Operates with Z80 CPU's
- Phantom Output Disable
- Invisible Refresh (Synchronized with Wait States)

The ExpandoRAM II is compatible with some S-100 CPU's based on the Z80 microprocessor. When other SD SYSTEMS 200 series boards are combined with the ExpandoRAM II, they create a microcomputer with exceptional capabilities and features.

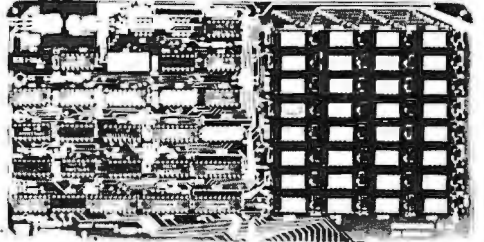

NEW

DON'T FORGET  
YOUR REBATE

SDS - EXPANDOPRAM II KIT (4116)	
	Sale Price
16K...	\$280.00
32K...	\$340.00
48K..	\$399.00
64K..	\$459.00

## LOBO 8" DISK DRIVE CABINET



New from Lobo, a dual Cabinet with power supply, and internal data cable hook-up

- Cabinet accepts 2 801R, 800R, FD120, or FD200 style disk drives
- Power Supply for 2 drives
- Assembled, tested and guaranteed by Lobo Drives
- Shipping Weight 30 lbs.

LBO - DUAL 8 PCS. .... \$329.00

**BUY CABINET AND DRIVES AND SAVE**

WITH 1 DRIVE	WITH 2 DRIVES
LBO-801R-1PSC \$775.00	LBO-801R-2PSC \$1250.00

**DISC DRIVE ONLY**

SHU-801R.....\$499.00

**EXTERNAL DATA CABLES**

CARDEDGE TO CARDEGE	CARDEDGE TO SOCKET
PRI-50CE-CE ..... \$19.95	PRI-50CE-SKT ..... \$19.95

## Hitachi V302

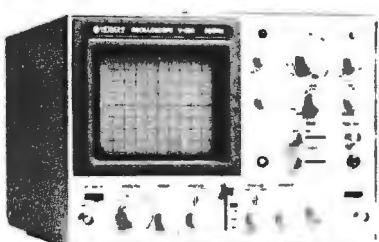

**30MHZ DUAL TRACE  
OSCILLOSCOPE**

- LIST 945.00 - SALE \$798.00
- TV sync-separator circuit
  - High-sensitivity 1mV/div
  - Sweep-time magnifier (5MHz)
  - 10 times
  - Z-axis input (intensity modulation)
  - Signal delay line
  - X-Y operation
  - Trace Rotation
  - Complete with 2 probes
  - CH1, CH2, DUAL, ADD, DIFF.
  - Vertical Deflection Modes
  - V152 Dual Trace
  - 15MHZ - no delay sweep
- LIST 695.00

SALE \$595.00

## MEMORY HEADQUARTERS

- 2716 16K 5 Volt only EPROM. . \$22.00 ea.
- 10/200.00
- 2708 8K 450ns EPROM. .... 8/55.00
- 8/50 ea.
- 2114-3L 1Kx4 300ns Low Power. 8 \$45.00
- 100 + \$4.95 ea.
- 5257-3L 4Kx1 300ns Low Power . . 8/55.00
- 100 + \$5.95 ea.
- 2102AL-2 L/P 250ns in lots of 20, 1.25 ea.
- 100 + 1.10 ea.

**THE FAMOUS  
GODBOUT  
ECONORAM II  
8K 450ns RAM  
UNKIT CLOSE OUT  
\$109.00ea. 2/\$200.00**

ORDER TOLL FREE  
1-800-423-5633  
except CA., AK., HI., CALL  
(213) 894-8171



## PRIORITY ONE ELECTRONICS

16723K Roscoe Blvd. Sepulveda, CA 91343

Terms: Visa, MC, BAC, Check, Money Order, U.S. Funds Only. CA residents add 6% sales tax. Minimum order \$10.00 Prepaid U.S. orders less than \$75.00 include 5% shipping and handling. MINIMUM \$2.50. Excess refunded. Just in case ... please include your phone no. Prices subject to change without notice. We will do our best to maintain prices thru JULY 1980.

\*SOCKET and CONNECTOR prices based on GOLD, not exceeding \$500 per oz.

\*Sale Prices are for prepaid orders only credit card orders will be charged appropriate freight



FOR MORE INFORMATION SEE OUR 52 PAGE AD IN JANUARY BYTE OR SEND \$1.00 FOR CATALOG

- Sale Prices are for prepaid orders only • Quantities are limited, subject to prior sale • CREDIT CARD ORDERS WILL BE CHARGED APPROPRIATE FREIGHT

**ORDER TOLL FREE (800) 423-5633**

Circle 221 on inquiry card.

SEND \$1.00 FOR 52 PAGE CATALOG

SEND \$1.00 FOR 52 PAGE CATALOG



## STRUCTURAL ANALYSIS SOFTWARE

For TRS-80 and North Star Computers

**SPACE FRAME** (Finite Element - Stiffness Method)  
includes Space Frame, Plane Frame, Space Truss & Floor Grids  
Disk Version \$150.00 Cassette Version \$50.00  
TRS-80 Model II \$200.00 Documentation Only \$25.00  
plus postage

**TRUSS FORCE** (Method of joints solution of Common Trusses)

Disk Version \$50.00 Cassette Version \$25.00  
Documentation Only \$5.00 plus postage

**LINEAR PROGRAMMING** (Simplex Method)

Disk Version \$80.00 Cassette Version \$25.00  
Documentation Only \$5.00 plus postage

## ENGINEERING ANALYSIS SOFTWARE

P.O. Box 26206  
Fort Worth, Texas 76116  
Phone (214) 298-1248

In California Contact:

**MICOPS INC.**  
421 Royale Park Dr.  
San Jose, Ca. 95136  
Phone (408) 629-5716

Circle 223 on inquiry card.

APPLE II PLUS WITH 48K RAM	\$1340.
TEXAS INSTRUMENT 99/4 COMPUTER	\$ 989.
71 810 PRINTER	\$1590.
CENTRONIC PRINTERS:	
730-1 PARALLEL PRINTER	\$ 715.
737-1 PARALLEL INTERFACE	\$ 879.
SPINURITERS FROM NEC	
5510 R/O SERIAL INTERFACE	\$2690.
5520 KSR SERIAL WITH KEYBOARD	\$2890.
5530 PARALLEL INTERFACE	\$2690.
COMPRINT 912 APPLE, TRS-80, PET	\$ 559.
912 SERIAL	\$ 599.
PAPER TIGER 440	\$ 929.
440/G	\$ 990.
BASE-2 800 S.T. PRINTER	\$ 559.
COMMODORE BUSINESS MACHINES:	
PET 2001-8K COMPUTER	\$ 495.
PET 2001-32K	\$1090.
PET 8032 80 CHAR. SCREEN	\$1595.
PET 2022 TRAC. FEED PRINTER	\$ 749.
PET 2023 FRIC. FEED PRINTER	\$ 679.
PET 2040 DUAL FLOPPY DISK DRIVE	\$1090.
PET 8050 1 MEG STORAGE	\$1499.
ATARI 800	\$ 889.
INTERTEC SUPERBRAIN (32K)	\$2595.
NORTH STAR COMPUTERS	
NR7-2-32K-D-ASH	\$3490.
HRZ-2-32K-D-ASH	\$2849.
DISPLAY TERMINALS:	
INTERTRU II	\$ 775.
HAZELTINE 1410	\$ 785.
1420	\$ 899.
1500	\$ 999.

IMMEDIATE DELIVERY FROM STOCK.

MULTI-BUSINESS COMPUTER SYSTEMS  
28 HARBOROUGH STREET  
PORTLAND, CONN. 06480  
(203) 342-2747

Circle 224 on inquiry card.



## 6800 DEVELOPMENT PAC II

- 6800 MICRO COMPUTER
- 48K RAM
- ROM PROGRAMMER
- RS-232 INTERFACE
- CASSETTE INTERFACE
- MONITOR DEBUG ROM
- EDITOR/ASSEMBLER
- 4K INDUSTRIAL BASIC
- RACK, BACK PLANE, SUPPLY
- \$1895

**WINTEK** Corp.

317-742-8428  
801 South St., Lafayette, IN 47904

Circle 225 on inquiry card.

## MINI FLOPPY SALE

TRS-80 OWNERS

SINGLE SIDED \$365.00

DOUBLE SIDED \$485.00

READY TO GO-CABINET-  
POWER SUPPLY-CABLE  
ASSEMBLED & TESTED

ADD ON DRIVES

SINGLE SIDED \$225.00

DOUBLE SIDED \$345.00

INTERFACE, INC.  
20932 CANTARA STREET  
CANOGA PARK, CA. 91304  
(213) 341-7914

MASTER CHARGE & VISA

Circle 226 on inquiry card.

## 16 K RAMS & RAM CONTROLLERS

- 16 K X 1 DYNAMIC RAMS MK4115P3
- 200 NSEC ACCESS/375 NSEC CYCLE TIMES
- 16 PIN/TTL COMPATIBLE
- ALL CHIPS BURNED IN AND FULLY TESTED
- PRICE WITH DATA SHEET
- \$68.00 IN QTY OF 8/THAT'S \$8.50 EACH

6800/6502 64K BYTE RAM & CONTROLLER SET

MAKE 64K BYTE MEMORY FOR YOUR 6800 OR 6502

THIS SET INCLUDES:

- 32 MSK 4116-3, 16K X 1, 200 NSEC RAMS
- 1 MC3480 MEMORY CONTROLLER
- 1 MC3242A MEMORY ADDRESS MULTIPLEXER AND COUNTER
- DATA & APPLICATION SHEETS, PARTS TESTED AND GUARANTEED.

\$295.00 PER SET

DYNAMIC MEMORY CONTROLLER MC3480

- GENERATES RAS/CAS & REFRESH TIMING FOR 16K TO 64K BYTE MEMORIES
- PRICE WITH DATA SHEET: \$13.95 EACH

MEMORY ADDRESS MUX/COUNTER MC3242AP

- MUX ADDRESS & REFRESH COUNTER FOR 16K TO 64K BYTE MEMORIES
- PRICE WITH DATA SHEET: \$12.50 EACH

QUANTITY DISCOUNTS AVAILABLE  
ALL ORDERS POSTPAID U.S. FUNDS ON INTERNATIONAL  
ORDERS. CHECK OR MONEY ORDER. VISA/MC/AMC ALSO AC  
CEPTED SEND ACCT. NO. EXPIRATION DATE & INTERBANK  
NO WITH SIGNED ORDER. CALIF. RESIDENTS PLEASE ADD  
6% SALES TAX. PHONE ORDERS (714) 633-4660

MEASUREMENT SYSTEMS & CONTROLS, INC.  
MEMORY DEVICES DIVISION  
867 NORTH MAIN ST., ORANGE, CA 92668

Circle 227 on inquiry card.



## SUPER SALE

### 16K Apple II or Apple II Plus \$995.00

- Apple Disk II w/controller \$529.95
- Apple Soft or Integer Cards \$159.95
- Pascal Language Card \$459.95
- 10 Megabyte Disk for Apple \$4695.00
- DC Hayes Modems \$339.95
- Graphics Tablet \$695.00

**UCATAN COMPUTER STORE**  
P.O. BOX 1000 DESTIN FL 32541  
ACROSS FROM RAMADA INN  
904-837-2022

Credit Cards Accepted

Circle 227 on inquiry card.

## 12" BLACK & WHITE LOW COST VIDEO TERMINAL

\$139.00 LIST  
Add \$5 for shipping and handling  
Texas residents add 5% sales tax.

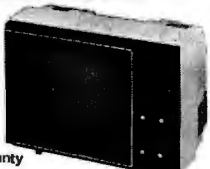

One year limited warranty

- Ideal for home, personal and business computer systems; surveillance monitors • 12" diagonal video monitor • Composite video input • Compatible with many computer systems • Solid-state circuitry for a stable & sharp picture • Video bandwidth—12 MHz ± 3 DB • Input impedance—75 Ohms • Resolution—650 lines Minimum IN Central 80% of CRT; 550 Lines Minimum beyond central 80% of CRT • EIA RS-375 • Dimensions—11.375" high; 16.250" wide; 11.250" deep (exclude video input connector) • Weight—6.5 KG (14.3 lbs) net

Use Master Charge/Visa or send money order.

**Micro Products Unlimited**  
P.O. Box 1525, Arlington, TX 76010  
817/461-8043  
Dealer Inquiries welcome

Circle 228 on inquiry card.

## COMPUTER EQUIPMENT & SOFTWARE BARGAINS



EVERY MONTH

BUY, SELL OR TRADE ALL TYPES OF COMPUTER EQUIPMENT AND SOFTWARE (pre-owned and new) among 20,000 readers nationwide in BIG (11x14") pages. Classified ads are only 10¢ per word and are indexed for easy and fast location. Subscription: \$10 a year/12 issues. Bank cards accepted. Money back guarantee.

**COMPUTER SHOPPER**  
P.O. Box F-14  
Titusville, FL 32780  
(305) 269-3211

Circle 229 on inquiry card.

## FAST A/D FOR MICROS



At last: Scientific quality data acquisition in real time for microcomputers. A/D Section: 12 bits (1 part in 4096 resolution) in 25 microseconds. 5 channels input (expandable to 21) unipolar or bipolar, software selected full-scale range for each channel. D/A Section: 2 (up to 6) 12 bit double-latched fast analog outputs, selectable ranges. Rugged, modular construction with internal supplies. Ready to operate, includes extensive software package. Customized to your needs, applications consulting. Interface card for Apple II and TRS-80. Please write for information.

**das**  
DATA ACQUISITION SYSTEMS, INC.  
1534 Cambridge Street, Suite 2  
Cambridge, Massachusetts 02139

Circle 230 on inquiry card.

7400

Table listing various 7400 series integrated circuits with part numbers and prices.

74LS00

Table listing various 74LS00 series integrated circuits with part numbers and prices.

BECKMAN Digital Multimeters

Advertisement for Beckman Digital Multimeters, featuring a price of \$1000 and a list of models.

ADVANCED COMPUTER PRODUCTS

Advertisement for Apple II 16K and Apple II Plus \$990, including a 16K Apple Upgrade Kit for \$62.95.

ATARI 800 & 400 Personal Computer System

Advertisement for Atari 800 and 400 personal computer systems, listing prices and included software.

PROTECTION AGAINST TRANSIENT OVER VOLTAGE SAVINGS ON ENERGY COSTS

Advertisement for surge protectors, including Power Sentry and Interceptor Surge-Less Socket.

THE BONE FONE

Advertisement for 'The Bone Fone' AM/FM stereo surround system, featuring a price of \$65.95.

Advertisement for Texas Instruments 99/4 Personal Computer, priced at \$1099.00.

CMOS

Table listing various CMOS integrated circuits with part numbers and prices.

LINEAR

Table listing various linear integrated circuits with part numbers and prices.

FLOPPY DISK DRIVES

Advertisement for floppy disk drives, listing various models and prices.

MONITORS

Advertisement for various computer monitors, listing models and prices.

CONTINENTAL SPECIALTIES

Advertisement for Continental Specialties, listing various electronic components and their prices.

Advertisement for Commodore PET computer system, priced at \$775.00.

COMPUWISOR

Advertisement for Compuvisor computer system, listing models and prices.

TEXAS INSTRUMENTS LANGUAGE TRANSLATOR THAT SPEAKS

Advertisement for Texas Instruments language translator, listing features and prices.

HOME BURGLAR ALARM

Advertisement for home burglar alarm system, listing features and prices.

PROGRAMMABLE TEMPERATURE CONTROLLER

Advertisement for programmable temperature controller, listing features and prices.

SINGLE BOARD COMPUTER SELECTION GUIDE

Table providing a selection guide for single board computers, listing board, processor, ACP price, and enclosure options.

STORE 1310 'B' E. Edinger Santa Ana, CA 92705 Showrooms, Retail, Warehouse

# ADVANCED COMPUTER PRODUCTS

GET YOUR 1980 CATALOG

FIRST TO OFFER PRIME PRODUCTS TO THE HOBBYIST AT FAIR PRICES!

1. Proven Quality Factory tested products only.
  2. Guaranteed Satisfaction
  3. Over \$1,000,000 Inventory
- ## 1980 CATALOG NOW AVAILABLE.

Send \$2.00 for your copy of the most complete catalog of computer products. A must for the serious computer user.

### STATIC RAM BOARDS

• S-100 32K (uses 2114)  
 ASSEMBLED Kit  
 450ns \$48.00 450ns. 469.00  
 250ns. 539.00 250ns. 499.00  
 Bare Board 49.95  
 Bare Board w/all parts less mem. 99.95

• S-100 16K (S-100 Compatible)  
 • Low Power  
 • 2 MHz or 4 MHz  
 • Assembled & Tested  
 2 MHz ..... \$250.00  
 4 MHz ..... \$265.00

**WOW!**

• LOGOS 18K ASSEMBLED  
 450 ns 149.95 KIT 450ns. 125.95  
 250ns. 169.95 250ns. 149.95  
 Bare PC Board w/Data \$21.95  
 \*Special Offer\* Buy (4) 8K 450ns. Kits \$117.00

### The VISTA V-80 Disk Drive System

• 23% more storage capacity than V75-80  
 • 120 day warranty  
 • 40 track patch at NO CHARGE

Single drive system ..... \$385.00  
 Two drive system ..... \$770.00  
 Fourdrive system ..... \$1450.00  
 Two drive cable ..... \$29.95  
 Four drive cable ..... \$39.95

### THE VISTA V-200 FOR EXIDY

Price Starting as low as \$1199.00

Item	Qty	Drives	Capacity	Weight	Price
V200-E-200	400	2 Drive	75 in.	1199.00	
V200-E-200	2 Drive	75 in.	1549.00		
V200-E-300	600	3 Drive	32 in.	1524.00	
V200-E-32	12 MHz	3 Drive	32 in.	1999.00	

• Apple II • Cromemco (S-100)  
 • TRS 80 • Others soon

HARD DISK SUBSYSTEM I - 8000.00  
 Includes: Dual Channel 16 Bit Drive  
 - Interface of Your Choice  
 - Includes of Two Heads

### LOW COST FLOPPY DISK SUBSYSTEM

Shugart 801R Drives (2)  
 VISTA Floppy Controller (S-100)  
 Case, Power Supply & Cable  
 CP/Trk Operating System  
 Assembled & Tested ..... \$1499.00  
 SAVE \$300.00 (\$1799.00 Value)

### WATANABE MILOPT

Max print speed 50 mm/sec  
 resolution 10 mm typically  
 05 mm built-in character generator with 8 alpha-numeric character sizes & degrees of rotation available. d, relative draw, alpha printing done with simple commands

**\$1195.00**

### IMS STATIC RAM BOARDS

250 ns. 450 ns.  
 8K Static \$209.00 \$189.00  
 16K Static \$449.00 \$399.00  
 32K Static \$729.00 \$629.00

### ANADEK PRINTER NEW APPLE VERSION

Model DP-8000 compact, inline, parallel or serial. Sprinklet feed, 80 cols. 84 lines/min., bi-directional.  
 New only ..... \$875.00  
 DP-8000AP (for Apple) \$875.00

### SALE! SD SYSTEMS BOARDS

TAKE 10% OFF! KIT ASSEM

MODEL NO.	DESCRIPTION	PRICE
9600A	Single Board Microcomputer	\$495.00
9609	Advanced Single Bit Comp (6809)	\$59.00
9601	16 Slot Mother Board	175.00
9602	Card Cage	74.00
9603	8 Slot Mother Board	100.00
9605	Power Supply	325.00
9606	DC Input Power Supply	39.00
9611	Anti-Protection Module	49.00
9612	Anti-Protection Module	49.00
9616	32K EPROM/RAM Module	250.00
9617	EPROM Programming Head	25.00
9620	16 Channel Parallel I/O Module	295.00
9622	Serial/Parallel I/O Module	325.00
9627	16K Static RAM Module 470ns	395.00
9628	32K Static RAM 450ns	685.00
9629A	32K Static RAM 200ns	895.00
9630	Card Extender	68.00
9640	Multiple Programmable Timer	395.00
9650	8 Channel Duplex Serial I/O Mod	395.00
9655	Interrupt Priority Controller	395.00
9670	32/32 I/O Module	275.00
9670Z	Context Closure Module	350.00

UNPOPULATED BOARDS (Also Available)

### APPLE/EXIDY/EXPANDO TRS 80 16K-UPGRADE KIT

**\$54.95 TRS-80/APPLE \$54.95**

MEMORY EXPANSION KITS, 4116's, 16K (200/250 ns.), 8 pcs for \$54.95 w/instructions & Jumpers

Call For Volume Pricing

\* Special: TRS80 Schematic ..... \$ 4.95  
 \* Expansion Interface Schematic ..... \$ 4.95  
 \* Expansion Interface Connector ..... 7.95

### EXPANDRAM II MEMORY KITS

\* Bank Selectable • Uses 4116 200 ns.  
 • Write Protect • Power 8VDC, ±16VDC  
 • Phantom NEW LOW PRICES • Up to 4 MHz

Expando 64 Kit (4116) Assem. & Tested Add \$50

16K \$269.00 48K \$435.00  
 32K \$349.00 64K \$505.00

### HAZELTINE TERMINALS SALE \$749.00

Model 1400 \$749.00 Model 1500 \$1065.00  
 Model 1410 \$825.00 Model 1510 \$1245.00  
 Model 1420 \$945.00 Model 1520 \$1495.00

### UV "Eprom" Eraser

Model UVs-11E \$69.95  
 Holds 4 Eprom's at a time  
 Backed by 45 years experience

Model S-52T...\$265.00  
 Professional Industrial Model

### EMAKO-20... Reg. \$777.00 \$599.00

UNBELIEVABLE!  
 125 Caps, 60 Pin - Vertical Format Unit - 95 Characters - Upper/Lower Case - 4.5" to 9.5" Adjustable - 80 col/40 col double width - Full 98 char. ASCII

### EMAKO-22... \$799.00

Prints a 132 col/line. Available with parallel or serial output at same price.

### MIKA 20... \$1280.00

9x7, 125 cps 136 characters/line  
 Full 15" width Super for business applications requiring large IBM format paper.

### BASE II PRINTER

80 Column Impact Printer  
 • 60 Lines Per Minute  
 • 115/232 VAC, 50/60 Hz  
 • 72, 90, 96, 120 or 150 cps  
 • Self-Test Switch

Reg. \$649.00

### Z-80/Z-80A/8080 CPU BOARD

• On board 2708 • 2708 included (450ns.)  
 • Power on jump • completely socketed  
 • Z-80 Assembled and Tested ..... \$185.00  
 • Z-80 Kit ..... \$129.95  
 • Z-80 Bare PC Board ..... \$ 34.95  
 • For 4MHz Speed Add \$15.00

8080A Kit ..... \$ 99.95  
 80UDA Assembler ..... \$149.95

### S-100 MOTHERBOARD SPECIAL

8 slot expandable/w/9 conn. reg \$69.95..... NOW \$52.95

### SIEMENS'S FLOPPY

• Special buy while supply lasts.  
 • B' Drive with Double-ensity  
 • 90 Day Warranty

SALE \$429.00  
 \$499.00  
 \$475.00

### ACOUSTIC MODEM NOVATION CAT™

O-300 Baud  
 100 Cps  
 Answer, Originate \$169.00

### DATA BOOKS • COMPUTER BOOKS

1980 IC Master	59.95	Intel MCS 80 Manual	7.95
NSC TTL Data	3.95	Intel MCS 40 Manual	4.95
NSC Linear	4.95	AMD 8080A Manual	5.95
NSC Linear App Notes II	3.95	AMD Schematic Databook	4.95
NSC CMOS	3.95	AMD MOS/LSI Data	3.95
NSC Microprocessor	3.95	Intel MCS 85 Manual	7.95
Intel Outsource	7.50	Harris Analog Databook	4.95
Intel: MCS 85 Manual	7.50	Ti Linear Control Data	3.95

### SALE • OSBORNE BOOKS • SALE

Intro to Micros Vol I	7.95
Intro to Micros Vol II	7.95
8080A Programming	7.95
8080A Programming	7.95
8080 Programming	7.95
Z80 Programming	7.95
Vol II Some Real Microprocessors w/boards	30.00
Vol II Some Real Support Devices w/boards	30.00
Intro to Micros Vol III	7.95

### SALE • DILITHUM COMPUTER BOOKS • SALE

Understanding Computers	7.95
8080/Microcomputer Experiments	7.95
Beginning BASIC	7.95
Beginners Glossary & Guide	6.95
Personal Buyer & Jelly Guide to Computers	7.95
8080 Machine Language Programming	7.95
Home Computers Vol I Hardware	7.95
Home Computers Vol II Software	7.95
Starburst Simulator	6.95

### MICROPROCESSORS

2800 16 bit to 8 bit	\$189.00
2801 16 bit to 6.5 KHz <td>149.00</td>	149.00
2802	10.75
280A	14.50
1613B50	18.95
2650	18.95
IC1802	13.95
8080A	5.50
8080A-MHz	19.95
SALE 8085	19.95
8088A	14.95
2901	14.95
2901A	9.95
2903 4 bit Supericde	9.95
TM59900UL	49.95
CM1500	39.95
AMD3130 41	11.50
AMD3130 31	11.50
6502A	16.95
14630	19.95
BB800	11.75
6800B 2.0 MHz	19.95
6800C	19.95
8035	19.95
8755	49.95
8748	69.95
6809	69.95
8086	69.95

### ADVANCED SUPPORT

AM9511 Arith. Processor 175.00  
 9512 Arith. Processor 175.00  
 9513 Univ. Timer 79.00  
 AM9517 DMA Controller 18.95  
 AM9519 Universal Interrupt. 18.95

### Z-80 SUPPORT CHIPS

280-PIO 2.5 MHz	8.75
280-PIO 4.0 MHz	12.95
280-CTC 2.5 MHz	8.75
280A-CTC 4.0 MHz	12.95
280-DMA 2.5 MHz	29.95
280-DMA 4.0 MHz	36.95
280-SIO/IO 2.5 MHz	35.95
280-SIO/IO 4.0 MHz	39.40
280-SIO/IO 2.5 MHz	39.95
280-SIO/IO 4.0 MHz	39.40

### 8080/8085 SUPPORT

8155/8156 I/O	64.95
8755 I/O w/EPROM	24.95
8752 Dyn. Ram Cont.	34.95
8207/7438 138 Decoder	3.95
828 2 bit I/O	2.75
8284 8MHz	2.95
8216 Bus Driver	2.75
8218 Clock Gen.	2.95
8226 Bus Driver	3.95
8228 Bus Driver	3.95
8229 Sys. Control	2.95
8238 Sys. Control	5.00
8253 Univ. Timer	16.95
8255 Prog. I/O	6.50
8255 DMA	16.95
8259 Prog. I/O	17.95
8275 CRT Controller	59.95
8278 DMA Controller	18.95

### 8080 SUPPORT CHIPS

6810 2 x 8 Ram	4.75
6820 16 Ram	5.95
6821 16 Ram	6.50
6828 32 Ram	9.95
6831 512 x 8 Eprom	16.95
6845/HD68505 CRT Cont.	36.95
6847 8MHz	24.95
6850A ACIA	5.95
6862 Serial Adapter	5.95
6863 DMA	10.95
6864 Modem	11.95
6871A 10MHz OSC	25.95
6880 Bus Driver	2.95
6885-6888	19.95
6889 Bus Driver	19.95

### 1802 SUPPORT CHIPS

1821 SCD Z8RAM	25.00
1822 SCD Z85 x 4 RAM	16.95
1824 CD 32 x 8 RAM	10.95
1825 CD 16 x 8 I/O	10.95
1884 I/O	19.95
1855 CD I/O	8.95
1871 CD I/O	12.95

### 6502 SUPPORT CHIPS

6502A	7.50
6502B <td>11.95</td>	11.95
6502C	11.95
6502D	11.95
6551	19.95

### PROMS

2708 450 ns	8.25
2708 650 ns <td>8.25</td>	8.25
1702A	7.95
2732	7.95
2716 5V	29.95
2716 5V 12V	29.95
2758 5V	29.95
2764 5V	13.50
2904A	14.95
IM 5610	3.90
8251 1512 x 8 (1T5)	16.95
8252 1512 x 8	4.30
8253 256 x 4	4.30
8253 256 x 4 (1T5)	4.90
8253 512 x 4 (10C)	16.95
8253	16.95
8253 1	16.95
8253 2	16.95
8253 3	16.95

### NOTE: WE PROGRAM PROMS

### CHARACTER GEN.

2513-001 15V Upper	8.50
2513-002 15V Lower	10.95
2513-003 15V Lower	14.95
CM6571A	11.75
CM6571B	11.75
CM6571C	11.75
CM6571D	11.75
CM6571E	11.75
CM6571F	11.75
CM6571G	11.75
CM6571H	11.75
CM6571I	11.75
CM6571J	11.75
CM6571K	11.75
CM6571L	11.75
CM6571M	11.75
CM6571N	11.75
CM6571O	11.75
CM6571P	11.75
CM6571Q	11.75
CM6571R	11.75
CM6571S	11.75
CM6571T	11.75
CM6571U	11.75
CM6571V	11.75
CM6571W	11.75
CM6571X	11.75
CM6571Y	11.75
CM6571Z	11.75

### UARTS/BAUD RATE

11H1602B5V 12V	3.95
AY51013 15V 12V	4.95
AY51014 15V 12V	4.95
AY51015 15V 12V	4.95
AY51016 15V 12V	4.95
AY51017 15V 12V	4.95
AY51018 15V 12V	4.95
AY51019 15V 12V	4.95
AY51020 15V 12V	4.95
AY51021 15V 12V	4.95
AY51022 15V 12V	4.95
AY51023 15V 12V	4.95
AY51024 15V 12V	4.95
AY51025 15V 12V	4.95
AY51026 15V 12V	4.95
AY51027 15V 12V	4.95
AY51028 15V 12V	4.95
AY51029 15V 12V	4.95
AY51030 15V 12V	4.95
AY51031 15V 12V	

# The Supermarket for TRS-80\* Add-on Components (and other computers, too)

In stock now. Immediate delivery.

## The VISTA V-80 Disk Drive System

- 23% more storage capacity than TRS-80
- 120 day warranty
- 40 track patch at NO CHARGE

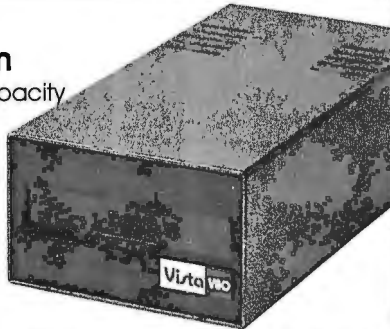

Single drive system ..... \$ 395.00  
 Two drive system ..... \$ 770.00  
 Four drive system ..... \$1450.00  
 Two drive cable ..... \$ 29.95  
 Four drive cable ..... \$ 39.95

## The VISTA V-80 Expansion Module

- Provides double density modification to your current Radio Shack interface (lets you format diskettes in either single or double density).
- Increases storage capacity up to 204K bytes (on single 40 track drive).
- Includes all hardware and software.



**\$239.00**

## The VISTA Model II

- Provides one, two or three drives.
- Adds up to 1.5 million bytes of on-line storage.
- 120 day warranty
- Does everything Radio Shack's expansion system will do...for less!

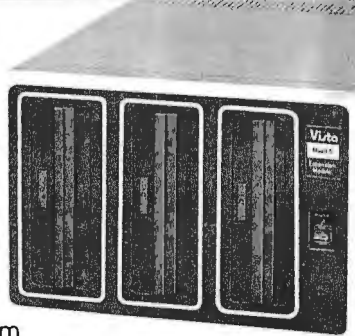

**\$1000.00** Single drive Expansion System  
**\$1550.00** Two drive Expansion System  
**\$2100.00** Three drive Expansion System  
**\$ 525.00** Additional drives alone

## The TRS-80 Printers

Centronics 730... **\$945.00**  
 7x7 dot matrix-80 column

Anadex DP8000... **\$895.00**  
 9x7 dot matrix-80 column

VISTA Printer... **\$745.00**  
 5x7 dot matrix-80 column

Cables ..... **\$27.50 each**



## Other Products

1. VISTA Verbatim diskettes (hard or soft sector) Certified 40 track ..... **\$ 38.95**
2. 16K RPM upgrade kits, guaranteed for 120 days.  
**PRIME PRODUCT** ..... **\$ 74.50**
3. NEW! DOS + ..... **\$ 110.00**
4. LNW expansion bare board ..... **\$ 66.95**
5. H.C. Pennington book, **TRS-80 Disk and Other Mysteries** ..... **\$ 18.95**
6. DDT Disco-Tech disk drive timer ..... **\$ 19.95**
7. Cryptext (An Encryption Module). ..... **\$299.00**

## Add On Drives

- |         |                                       |                       |
|---------|---------------------------------------|-----------------------|
| MPI B51 | 40 Track, Double Density-204K         | ..... <b>\$275.00</b> |
| MPI B52 | Dual Head, Double Density-408K        | ..... <b>\$375.00</b> |
| Siemens | FDD100-5 40 Track Double Density 204K | ..... <b>\$275.00</b> |
| Siemens | FDD100-5 Flippy, records both sides   | ..... <b>\$290.00</b> |
| Siemens | FDD100-8 8" Single Sided Drive        | ..... <b>\$448.00</b> |

## The VISTA V-200 for Exidy

- Completely packaged system, tested and ready to plug in, includes: power supply, two 40 track drives, case, controller, all cabling and total CPM documentation.
- Storage capacity from 400K to 1.2 meg.
- System software-VISTA CP/M Disk Operating System and BASIC-E Compiler recorded on 5-1/4" diskettes.

Price: Starting as low as **\$1199.00**



CALL TOLL-FREE 800-854-8017

\*TRS-80 is a registered trademark at Radio Shack.

The Vista Computer Company 1401 Borchard Street • Santa Ana, California 92705 • 714/953-0523

## NORTH STAR BUSINESS SOFTWARE

Very comprehensive software now available in BASIC.

- Job costing
- Payroll
- General Ledger
- Accounts Payable
- Inventory
- Interfaces to GL
- Veterinarian
- Questionnaire: Survey/Polling
- Other Misc. Software
- Also Corvus Hard Disc

WE ACCEPT MASTER CHARGE/VISA

### THE COMPUTER PLACE INC.

2718 COLONIAL AVENUE S.W.  
ROANOKE, VA. 24015  
(703)982-3661

Circle 233 on inquiry card.

## GET Paid for using your Computer

FUN!

Easy

RUSH COUPON FOR FREE FACTS

GREAT SPARE TIME

Send today to — DAR-B7  
3110 Fulton Ave, Sacramento CA 95821

<b>CASH</b>	
NAME	
STREET	
CITY	
STATE	ZIP

Circle 234 on inquiry card.

## SPECIAL PRICES

HARDWARE, SOFTWARE, PERIPHERALS

FOR

**apple computers**  
**OHIO SCIENTIFIC**  
*Vector Graphics*

Most items in stock for immediate delivery. VISA/MC.

For Our Catalog, Contact

**Computer Distributors**  
PO BOX 9194  
AUSTIN, TX 78766  
(512) 345-9729

Circle 235 on inquiry card.

## DISCOUNT PRICES

NORTH STAR  
APPLE II  
MICROTEK  
ANADIX  
TREND/COM  
CENTRONICS  
SOROC  
INTERTUBE  
THINKER TOYS  
SOLID STATE MUSIC  
& OTHERS  
Call for Prices  
(301) 694-8884

### FREDERICK COMPUTER PRODUCTS

Municipal Airport  
Frederick, MD. 21701

Circle 236 on inquiry card.

4180 44th Street S.E.  
Grand Rapids, MI 49508

\* PERSCI DISK REPAIR \*  
MINIMIZE DOWN TIME  
BY CALLING

(616) 698-8700  
CROMEMCO Dealer



**JEPSAN, Group K**  
Incorporated  
Sales Installation Service of Computers

## STATIC RAM CHIPS

FACTORY PRIME From the same shipment we use in our professional quality boards

2114L 450 ns. **\$5.90** 200 ns. \$6.90  
4044 450 ns. **\$5.90** 250 ns. \$6.90  
Add \$5.00 Handling on Orders Under \$200.00

### 32K STATIC RAM BOARD

FOR THE \$550 AND \$550C BUS (SWTP etc.)  
• SS50C Extended Addressing (can be disabled).  
• 4 separate 8K blocks.  
• Low power 2114L RAMS  
• Socketed for 32K  
• Write Protect  
• Gold Bus Connectors

16K ..... \$328.12  
24K ..... \$438.14  
32K ..... \$548.15

Phone, write, or see your dealer for details and prices on our broad range of Boards and Systems for the SS50/SS50C bus including our **UNIQUE 8024 VIDEO BOARD**, and our AC Power Control Products for all computers.

**GIMIX inc.**  
1337 W. 37th Place • Chicago, IL 60609  
(312) 927-5510 • TWX 910-221-4055

**The Company that delivers.**  
Quality Electronic products since 1975.

GIMIX® and GHOST® are Registered Trademarks of GIMIX INC.

Circle 237 on inquiry card.

## interactive video

- Index and access multiple frames or segments of videotape by name or by frame number from the Apple® keyboard or from within a program
- Develop a comprehensive picture and text information storage and retrieval system
- Interfaces any VCR having a control pulse or search capability with the Apple Computer®
- Uses the same screen for computer and video
- Utilize extensive authoring software to easily write CAI

A complete package of all interfacing hardware, software, and connectors available from

**Cavri**  
SYSTEMS

26 Trumbull Street, New Haven, CT 06511  
or call (203) 562-9873

TM - Apple Computer Co

Circle 238 on inquiry card.

Dial: 402-987-3771

## HOT LINE

YOU NEED CRISP, HIGH CONTRAST BLACK-WHITE and VIVID COLOR ALPHA-NUMERICS/GRAPHICS CAPABILITIES FROM YOUR VIDEO MONITOR IF YOU WANT REALLY SUPER-LOOKING IMAGES FROM YOUR COMPUTER!!

AS SPECIALISTS IN VIDEO IMAGING...we think we have the right monitor or modulator for your system. Our product line includes the popular "Micro-Verter" (OSI) and Apple Inc. approved UHF color modulators, a variety of color and B-W monitors, color cameras, B-W cameras, Audio subcarrier kits and parts. FREE CATALOG UPON REQUEST. Dealers welcomed. Well established program with over 400 dealers.

GET FREE DETAILS VIA OUR HOTLINE!!!

ATV Research 13-B BROADWAY DAKOTA CITY, NE. 68731

## SURPLUS ELECTRONICS

ASCII

ASCII

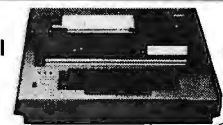

**IBM SELECTRIC**  
**BASED I/O TERMINAL**  
**WITH ASCII CONVERSION**  
**INSTALLED \$645.00**

- Tape Drives
  - Cable
  - Cassette Drives
  - Wire
  - Power Supplies 12V15A, 12V25A, 5V35A Others.
  - Displays
  - Cabinets
  - XFMRs
  - Heat Sinks
  - Printers
  - Components
- Many other items. SEND \$1.00 FOR CATALOG REFUNDABLE FIRST ORDER  
WORLDWIDE ELECT. INC.  
130 Northeastern Blvd.  
Nashua, NH 03060  
Phone orders accepted using VISA or MC  
Call 603-889-7661

Circle 239 on inquiry card.

# IT'S KID JADE'S SURPLUS SALE.

## S-100 Boards

### THE BIG Z - Jade

2 or 4 MHz switchable Z-80 CPU with serial I/O

CPU-30201K Kit	\$135.00
CPU-30201A A & T	\$199.00
CPU-30200B Bare board	\$35.00

### SBC-100 - SD Systems

2.5 MHz Z-80 CPU with serial & parallel I/O ports

CPC-30100K Kit	\$257.50
CPC-30100A A & T	\$325.00

### SBC-200 - SD Systems

4 MHz Z-80 CPU with serial & parallel I/O ports

CPC-30200K Kit	\$399.95
CPC-30200A A & T	\$475.00

### CB2 - S.S.M.

2 or 4 MHz switchable Z-80 CPU with RAM, ROM, & I/O

CPU-30300K Kit	\$185.00
CPC-30300A A & T	\$249.95

### ExpandoRAM I - SD Systems

2.5 MHz RAM board expandable from 16K to 64K

MEM-16130K 16K kit	\$199.95
MEM-16130A 16K A & T	\$249.95
MEM-32131K 32K kit	\$254.95
MEM-32131A 32K A & T	\$304.95
MEM-48132K 48K kit	\$309.95
MEM-48132A 48K A & T	\$359.95
MEM-64133K 64K kit	\$364.95
MEM-64133A 64K A & T	\$414.95

### ExpandoRAM II - SD Systems

4 MHz RAM board expandable from 16K to 256K

MEM-16630A 16K kit	\$249.95
MEM-16630A 16K A & T	\$299.95
MEM-32631K 32K kit	\$309.95
MEM-32631A 32K A & T	\$359.95
MEM-48632K 48K kit	\$369.95
MEM-48631A 48K A & T	\$409.95
MEM-64633K 64K kit	\$429.95
MEM-64633A 64K A & T	\$479.95

### 32K STATIC RAM - Jade

2 or 4 MHz expandable static RAM board uses 2114L's

MEM-16150K 16K 2 MHz kit	\$249.95
MEM-16150A 16K 2 MHz A & T	\$299.95
MEM-16151K 16K 4 MHz kit	\$259.95
MEM-16151A 16K 4 MHz A & T	\$309.95
MEM-32150K 32K 2 MHz kit	\$399.95
MEM-32150A 32K 2 MHz A & T	\$449.95
MEM-32151K 32K 4 MHz kit	\$409.95
MEM-32151A 32K 4 MHz A & T	\$459.95

### 16K STATIC RAM - Cal Comp Sys

2 or 4 MHz 16K static RAM - a real memory bargain

MEM-16160K 16K 2 MHz kit	\$249.95
MEM-16160A 16K 2 MHz A & T	\$279.00
MEM-16162K 16K 4 MHz kit	\$279.95
MEM-16162A 16K 4 MHz A & T	\$309.00
MEM-16160B Bare board	\$29.95

### PB-1 - S.S.M.

2708, 2716 EPROM board with built-in programmer

MEM-99510K Kit	\$119.95
MEM-99510A A & T	\$169.95

### PROM-100 - SD Systems

2708, 2716, 2732, 2758, & 2516 EPROM programmer

MEM-99520K Kit	\$175.00
MEM-99520A A & T	\$225.00

### 32K BYTESAVER - Cromemco

32K EPROM board with on-board 2716 programmer

MEM-32550A A & T	\$295.00
------------------	----------

Call for your free 1980 catalog

## DOUBLE-D - Jade

Double density controller with the inside track

IOD-1200K Kit	\$299.95
IOD-1200A 8" A & T	\$389.95
IOD-1205A 5 1/4" A & T	\$389.95
IOD-1200B Bare board	\$65.00

### VERSAFLOPPY I - SD Systems

Versatile floppy disk controller for 8" or 5 1/4"

IOD-1150K Kit	\$219.95
IOD-1150A A & T	\$269.95

### VERSAFLOPPY II - SD Systems

New double density controller for both 8" & 5 1/4"

IOD-1160K Kit	\$309.95
IOD-1160A A & T	\$369.95

### I/O-4 - S.S.M.

2 serial I/O ports plus 2 parallel I/O ports

IOI-1010K Kit	\$129.95
IOI-1010A A & T	\$189.95
IOI-1010B Bare board	\$29.95

### BIT STREAMER II - Vector Graphic

3 serial I/O ports plus 2 parallel I/O ports

IOI-1025A A & T	\$259.00
-----------------	----------

### CB-1 - Mullen

S-100 controller for up to 8 external devices

IOC-1100K Kit	\$119.95
IOC-1100A A & T	\$169.95

### 100K DAY CLOCK - Mtn Hardware

Crystal controlled S-100 clock with NiCad backup

IOK-1400A A & T	\$329.95
-----------------	----------

### SB1 - S.S.M.

15 Hz to 25K Hz music synthesizer for S-100

IOS-1005K Kit	\$189.95
IOS-1005A A & T	\$269.95

### TB-4 - Mullen

Extremely versatile extender board with logic probe

TSX-180K Kit	\$55.00
TSX-180A A & T	\$75.00

### TERMINATOR & EXTENDER - C.C.S.

Can be used as both an S-100 extender and terminator

TSX-150K Kit	\$39.95
--------------	---------

### S-100 EXTENDER - Cal Comp Sys

Puts problem boards within easy reach

TSX-160A A & T	\$24.95
----------------	---------

### VDB-8024 - SD Systems

80 x 24 I/O mapped video board with keyboard I/O

IOV-1020K Kit	\$324.95
IOV-1020A A & T	\$379.95

### VB3 - S.S.M.

80 x 24 or 80 x 51 memory mapped with graphics

IOV-1090K Kit, 2 MHz	\$299.95
IOV-1090A A & T, 2 MHz	\$385.00
IOV-1095K Kit, 4 MHz	\$339.95
IOV-1095A A & T, 4 MHz	\$399.00
IOV-1091K 80 x 51 upgrade, 2 MHz	\$69.00
IOV-1096K 80 x 51 upgrade, 4 MHz	\$89.00

### VIDEO BOARD - Jade

64 x 16 assembled & tested S-100 video board

IOV-1050A A & T sale price	\$135.00
----------------------------	----------

## Modems

### NOVATION CAT

300 baud, auto answer/originate acoustic modem

IOM-5200A Special sale price	\$149.95
------------------------------	----------

Call for your free 1980 catalog

## Single Board Computer

### AIM-65 - Rockwell

6502 computer with printer, display, & keyboard

CPK-50165 1K AIM	\$374.95
CPK-50465 4K AIM	\$449.95
SFK-74600008E 8K BASIC ROM	\$99.95
SFK-64600004E 4K assembler ROM	\$84.95
PSX-030A Power supply	\$59.95
ENX-00002 Enclosure	\$49.95
4K AIM, 8K BASIC, power supply, & enclosure	
Special package price	\$599.00

### 32K RAM - for AIM-65

Dynamic memory board to expand your AIM-65

MEM-99170A A & T w/out RAM	\$275.00
MEM-16170A A & T w/16K	\$325.00
MEM-32170A A & T w/32K	\$375.00
MEM-99170B Bare board	\$49.00

### DISK CONTROLLER - for AIM-65

Add 5 1/4" or 8" disk drives to your AIM-65

IOD-3013A A & T	\$575.00
-----------------	----------

### VISIBLE MEMORY - for AIM-65

Video board with 8K memory & graphics for AIM-65

IOV-3011A A & T	\$239.95
-----------------	----------

### MEMORY-MATE - for AIM-65

The master-mater with 48K RAM, I/O, PROM, & music

MEM-52301A A & T w/16K	\$475.00
------------------------	----------

### Z-80 STARTER KIT - SD Systems

Z-80 computer with RAM, ROM, I/O, & keyboard

CPS-30010K Kit	\$289.95
CPS-30010A A & T	\$349.95

## Accessories for Apple

### 16K MEMORY UPGRADE

Add 16K of RAM to your TRS-80, Apple, or Exidy

MEX-16100K TRS-80 kit	\$49.95
MEX-16101K Apple kit	\$49.95
MEX-16102K Exidy kit	\$49.95

### DISK DRIVE for APPLE

5 1/4" disk drive with controller for your Apple

MSM-12310C with controller	\$495.00
MSM-123101 w/out controller	\$425.00

### 8" DRIVES for APPLE

Controller, DOS, two 8" drives, cabinet, & cable

Special package price	\$1475.00
-----------------------	-----------

### AIO - S.S.M.

Parallel & serial interface for your Apple

IOI-2050K Kit	\$115.00
IOI-2050A A & T	\$155.00

### SUP'R'TERMINAL - M & R Assoc

80 x 24 video display board for your Apple

IOV-2100A A & T	\$359.00
-----------------	----------

### SUPERTALKER - Mtn Hardware

Speech recognition/synthesizer w/speaker & mike

IOS-2015A A & T	\$275.00
-----------------	----------

### Z-80 CARD for APPLE

Z-80 CPU card with CP/M for your Apple

CPX-30800A A & T	\$345.00
------------------	----------

### MICROMODEM - D.C. Hayes

Auto answer/dial modem card for Apple or S-100

IOM-2010A Apple modem	\$349.95
IOM-1100A S-100 modem	\$375.00

### SUP'R'MOD II - M & R Assoc

Color or B & W TV interface recommended for Apple

IOR-5050A A & T	\$29.95
-----------------	---------



# SUMMER '80 ROUND #4.

**KNOCKOUT  
PRICES**

## Printers

### BASE 2 - Impact Printer

132 cps, bi-directional, tractor feed, & graphics  
PRM-13100 ..... \$625.00

### DP-9500 - Anadex

9 x 9 dot matrix, 176 column, 200 cps, & graphics  
PRM-10500 Standard DP-9500 .... \$1395.00  
PRM-10510 with graphics & 2K .. \$1495.00

### LP-80 - Matchless

9 x 7 matrix, 132 column, 125 cps, bi-directional  
PRM-37204 ..... \$775.00

### PAPER TIGER - Integral Data

132 column, parallel & serial, 150 cps, graphics  
PRM-33440 IDS-440 ..... \$950.00  
PRM-33441 IDS-440 w/graphics .. \$1050.00

### MILOT - Watanabe Instruments

Intelligent graphics plotter uses 7 bit ASCII code  
PRP-10800 ..... \$1075.00

### SPINWRITER - NEC

65 cps, bi-directional, letter quality with tractor  
PRD-55510 with 2K buffer ..... \$2995.00

## Motherboards

### ISO-BUS - Jade

Silent, simple, and on sale - a better motherboard

6 Slot (5 1/4" x 8 1/2")  
MBS-061B Bare board ..... \$19.95  
MBS-061K Kit ..... \$39.95  
MBS-061A A & T ..... \$49.95

12 Slot (9 1/4" x 8 1/2")  
MBS-121B Bare board ..... \$29.95  
MBS-121K Kit ..... \$69.95  
MBS-121A A & T ..... \$89.95

18 Slot (14 1/4" x 8 1/2")  
MBS-181B Bare board ..... \$49.95  
MBS-181K Kit ..... \$99.95  
MBS-181A A & T ..... \$139.95

## Mainframes

### MAINFRAME - Cal Comp Sys

12 slot S-100 mainframe with 20 amp power supply  
ENC-112105 Kit ..... \$309.95  
ENC-112106 A & T ..... \$349.95

### DISK MAINFRAME - NNC

Dual 8" drive cutouts with 8 slot motherboard  
ENS-112320 with 30 amp p.s. .... \$699.95

## Video Monitors

### VIDEO 100 - Leedex

12" B & W video monitor with 12 MHz bandwidth  
VDM-801210 ..... \$139.95

### VIDEO 100-80 - Leedex

81 x 24 version of Video 100 with metal cabinet  
VDM-801230 ..... \$189.95

### B & W MONITOR - Sanyo

High quality, high resolution video monitors  
VDM-700901 9" monitor ..... \$209.95  
VDM-701501 15" monitor ..... \$279.95

### 13" COLOR MONITOR - Zenith

The hi res color you've been promising yourself  
VDC-201301 ..... \$449.00

**Call for your free 1980 catalog**

## Disk Drives

### JADE DISK PACKAGE

Double-D controller kit, two 8" double density  
disk drives, cabinet, power supply, & cables  
Special package price ..... \$1295.00

### DUAL 8" DRIVES - Lobo

A pair of double density Shugarts in a cabinet  
MSF-12800R 2 single sided ..... \$995.00  
MSF-125202 2 double sided ..... \$1425.00

### HARD DISK - Lobo

10 Megabyte capacity for TRS-80 or Apple systems  
MSH-12771C Apple hard disk .... \$4395.00  
MSH-12772C TRS-80 hard disk ... \$4395.00

### DISKETTES - Jade

Bargain prices on magnificent magnetic media  
5 1/4" single sided, single density, box of 10  
MMD-5110103 Soft sector ..... \$27.95  
MMD-5111003 10 sector ..... \$27.95  
MMD-5111603 16 sector ..... \$27.95

5 1/4" double sided, double density, box of 10  
MMD-5220103 Soft sector ..... \$39.95  
8" single sided, single density, box of 10  
MMD-8110103 Soft sector ..... \$33.95

8" single sided, double density, box of 10  
MMD-8120103 Soft sector ..... \$55.95  
8" double sided, double density, box of 10  
MMD-8220103 Soft sector ..... \$57.95

### FLOPPY SAVERS - Tri-Star

Protect your valuable software from spindle damage  
MMA-205 5 1/4" kit ..... \$13.95  
MMA-208 8" kit ..... \$15.95

## Software

### CP/M 2.2 - Digital Research

Latest & most powerful release of CP/M  
SFC-52506000D Manual set ..... \$24.95  
SFC-52506000M 5 1/4" disk & manual \$149.95  
SFC-52506000F 8" disk & manual \$149.95

### MP/M - Digital Research

Multi-user operating system for Z-80 computers  
SFC-52507000F 8" disk & manual \$295.00

### PASCAL/MT - MetaTech

A powerful language for CP/M systems  
SFC-73301001F 8" disk & manual .. \$99.95

### SDOS - SD Systems

DOS, CBASIC-2, Z-80 assembler/editor/linker  
SFX-55001000D Manual set ..... \$24.95  
SFX-55001002M 5 1/4" disks & man \$149.95  
SFX-55001006F 8" disk & manual \$149.95

### WORDSTAR - MicroPro Intl

The finest word-processing package for CP/M  
SFC-13600100F 8" disk & manual \$395.00

### VISICALC - Personal Software

Visible business/accounting calculator for Apple  
SFA-24101005M 5 1/4" disk & manual \$145.00

### SINGLE DRIVE COPY - for Apple

Make back-up disks with just a single Disk II  
SFA-51150010M 5 1/4" disk & manual \$19.95

### SUPER-TEXT - Muse

Professional word-processing package for Apple  
SFA-13800085M 5 1/4" disk & manual \$99.95

### EPROM ERASER - L.S. Engineering

UV eraser for up to 48 EPROMs  
XME-3200 A & T ..... \$39.95

### MICROPROCESSORS

Z-80 ..... \$10.95  
Z-80A ..... \$14.95  
6502 ..... \$11.50  
6800 ..... \$11.95  
6802 ..... \$17.95  
6809 ..... \$39.95  
8035 ..... \$24.00  
8035-8 ..... \$24.00  
8080A ..... \$ 6.59  
8085 ..... \$15.95  
TMS9900JI ..... \$39.95

### PROMS

2708 (450ns) \$ 8.95  
2716 (450ns) \$34.95  
2716 (5v) ..... \$34.95  
2732 (5v) ..... \$95.00  
2758 (5v) ..... \$34.95

### RAMS

21102 (2 MHz) ... \$ 1.25  
21102 (4 MHz) ... \$ 1.50  
21141 (2 MHz) ... \$ 5.75  
21141 (4 MHz) ... \$ 5.95  
4116 ..... \$ 4.80  
4127 (70ns) ... \$ 39.95  
4164 (64K x 1) ..... \$175.00  
5257 (2 MHz) ... \$ 6.75  
5257 (4 MHz) ... \$ 7.25

### SUPPORT DEVICES

8212 ..... \$ 4.95  
8214 ..... \$ 4.65  
8216 ..... \$ 2.95  
8224 ..... \$ 3.25  
8224-4 ..... \$10.95  
8226 ..... \$ 3.85  
8228 ..... \$ 4.95  
8238 ..... \$ 4.95  
8243 ..... \$ 8.00  
8250 ..... \$14.95  
8251 ..... \$ 6.50  
8253 ..... \$13.95  
8255 ..... \$ 6.50  
8257 ..... \$19.95  
8259 ..... \$17.95  
8275 ..... \$49.95  
8279 ..... \$15.95

### UARTS

AYS-1013A ... \$5.25  
AY3-1014A ... \$8.25  
TR1602B ... \$5.25  
TMS6011 ... \$5.95  
IM6403 ..... \$9.00

### BAUD RATE GENERATORS

MCH4411 .. \$10.00  
CRYSTAL .. \$ 4.95

### Z80 SUPPORT

3881 (PIO) ..... \$ 9.50  
3881-4  
(PIO-4 MHz) .. \$14.50  
3882 (CTC) ..... \$ 9.50  
3882-4  
(CTC-4MHz) .. \$14.95  
3883 (SIO) ..... \$29.50  
3884 (SIO) ..... \$49.50

### 6800 SUPPORT

6821P .. \$ 5.95  
6828P .. \$11.95  
6834P .. \$12.95  
6840P .. \$18.75  
6850P .. \$ 4.80  
6852P .. \$ 5.79  
6875L .. \$ 7.40  
68488P \$25.00

## PLACE ORDERS

### TOLL FREE

Inside California Continental U.S.  
800-262-1710 800-421-5500

For customer service

or technical inquiries call 213-973-7707

Write for our FREE 1980 catalog

## JADE

### COMPUTER PRODUCTS

4901 W. Rosecrans, Hawthorne, CA 90250

TERMS OF SALE: Cash, checks, credit cards  
money orders or from recognized institutions  
Purchase orders accepted. Minimum order \$10.00  
California residents add 6% sales tax. Minimum  
shipping and handling charge \$2.50. Prices are for  
U.S. and Canadian delivery only and are subject  
to change without notice. For export prices and  
information send for a JADE INTERNATIONAL

CATALOG.

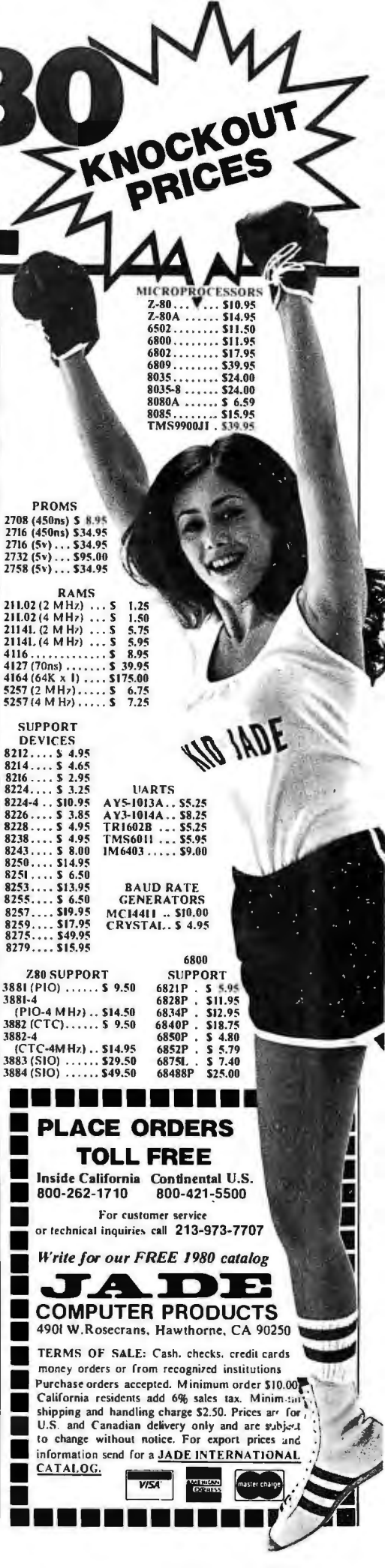



### MINIATURE SCREWDRIVER



4 1/4" RUGGED CONSTRUCTION 1000'S OF USES - 1/8" TIP ..... 2/\$1.00

### MAGNETIC RETRIEVER TOOL



Picks up elusive metal parts or tools in hard-to-reach places. EXTENDS TO 26 3/4" - ROTATES 360° STRONG, LIFETIME MAGNET

MRT-2281 ..... \$3.95

### CSC CONTINENTAL SPECIALTIES

#### LOGIC PROBE KIT



**SPECIFICATIONS**  
Input Impedance: 300,000 Ohms.  
Thresholds: "Lo" 30%Vcc - "Hi" 70%Vcc  
Maximum Speed: 300 nsec., 1.5MHz  
Input Protection: ±50VDC continuous 117VAC for 15 sec.  
Power: 30mA @5V - 40mA @ 15V - 25V max. reverse voltage protected; 36" cable with color coded clips included.  
Operating Temp.: 0-50°C.  
Dimensions: 5.8L x 1.0W x 0.7D in. (147 x 25 x 18mm)  
Weight: 30 oz. (85 gm)

LPK-1 ..... \$21.95/Kit

### Proto Clips



14-PIN CLIP	PC-14	.....	\$ 4.50
16-PIN CLIP	PC-16	.....	\$ 4.75
24-PIN CLIP	PC-24	.....	\$10.00
40-PIN CLIP	PC-40	.....	\$16.00

### Proto Boards



PB-6	.....	\$17.95
PB-100	.....	19.95
PB-101	.....	22.95
PB-102	.....	26.95
PB-103	.....	44.95
PB-104	.....	55.95
PB-203	.....	99.95
PB-203A	.....	155.00
PB-203A-Kit	.....	131.00

### Jumbo 6-Digit Clock Kit



- Four .630"ht. and two .300"ht. common anode displays
- Uses MM5314 clock chip
- Switches for hours, minutes and hold functions
- Hours easily viewable to 30 feet
- Simulated walnut case
- 115 VAC operation
- 12 or 24 hour operation
- Includes all components, case and wall transformer
- Size: 6 1/2" x 3 1/2" x 1 1/2"

JE 747 ..... \$29.95

### JE701



- Bright .300 ht. comm. cathode display
- Uses MM5314 clock chip
- Switches for hours, minutes and hold modes
- Hrs. easily viewable to 20 ft.
- Simulated walnut case
- 115 VAC operation
- 12 or 24 hr. operation
- Incl. all components, case & wall transformer
- Size: 6 3/4" x 3 1/8" x 1 3/4"

6-Digit Clock Kit \$19.95

### Regulated Power Supply



Uses LM309K. Heat sink provided. PC board construction. Provides a solid 1 amp @ 5 volts. Can supply up to ±5V, ±9V and ±12V with JE205 Adapter. Includes components, hardware and instructions. Size: 3 1/2" x 5" x 2 1/4"

JE200 ..... \$14.95

### ADAPTER BOARD

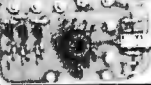

Adapts to JE200 - ±5V, ±9V and ±12V

DC/DC converter with +5V input. Toroidal hi-speed switching XMF8. Short circuit protection. PC board construction. Piggy-back to JE 200 board. Size: 3 3/4" x 2" x 9/16" H

JE205 ..... \$12.95

### MICROPROCESSOR COMPONENTS

8080A/8080A SUPPORT DEVICES		MICROPROCESSOR MANUALS		
8080A CPU	\$ 7.95	M-280 User Manual	\$7.50	
8212 8-Bit Input/Output	3.25	M-CDP802 User Manual	7.50	
8214 Priority Interrupt Control	5.95	M-2650 User Manual	5.00	
8216 8i-Directional Bus Driver	3.49			
8224 Clock Generator/Driver	3.95			
8226 Bus Driver	3.95			
8228 System Controller/Bus Driver	4.95			
8238 System Controller	4.95			
8251 Prog. Comm. I/O (USART)	7.95			
8253 Prog. Interval Timer	9.95			
8255 Prog. Periph. I/O (PPI)	9.95			
8257 Prog. DMA Control	19.95			
8259 Prog. Interrupt Control	19.95			
8800/8800 SUPPORT DEVICES		ROM'S		
MC6800 MPU	\$14.95	2513(2140) Character Generator(uppercase)	\$9.95	
MC6802CPU MPU with Clock and Ram	24.95	2513(3021) Character Generator(lower case)	9.95	
MC6810API 128K Static Ram	5.95	2516 Character Generator	10.95	
MC6821 Periph. Inter. Adapt (MC6820)	7.49	MMS230A 2048-Bit Read Only Memory	1.95	
MC6828 Priority Interrupt Controller	12.95			
MC6830L8 1024X8 Bit ROM (MC6830-8)	14.95			
MC6850 Asynchronous Comm. Adapter	7.95			
MC6852 Synchronous Serial Data Adapt.	9.95			
MC6860 0-600bps Digital MODEM	12.95			
MC6862 2400 bps Modulator	14.95			
MC6880A Dual 5-State Bus. Trans. (MC6870)	2.25			
MICROPROCESSOR CHIPS - MISCELLANEOUS				
Z80(780C) CPU	\$13.95	745200 256K1	Dynamic	4.95
Z80A(780-1) CPU	19.95	UPD416 4K	Dynamic 16 pin	4.95
CDP802 CPU	19.95	UPD416 16K	Dynamic 16 pin 250ns	7.95
2650 MPU	11.95	(M4K416)		
6502 CPU	19.95	TMS044 4K	Static	14.95
8035 8-Bit MPU w/block, RAM, I/O lines	19.95	49L		
P8085 CPU	19.95	TMS045 1024X4	Static	14.95
TMS9900UL 16-Bit MPU w/hardware, multiply & divide	49.95	2117 16.384X1	Dynamic 350ns	9.95
SHIFT REGISTERS				
MMS500H Dual 25 Bit Dynamic	\$ 5.50	MMS262 2XK1	Dynamic	4/1.00
MMS503H Dual 50 Bit Dynamic	5.50			
MMS504H Dual 16 Bit Static	5.50			
MMS505H Dual 100 Ohm Static	5.50	1702A 2048	FAMOS	55.95
MMS506H Dual 64 Bit Accumulator	5.50	2716INTEL 16K	EPROM	59.95
MMS5016H 500/512 Bit Dynamic	3.95	TMS2516 16K	EPROM	24.95
2504T 1024 Dynamic	3.95	(2716) *Requires single +5V power supply		
2518 Hex 32 Bit Static	4.95	TMS2532 4KX8	EPROM	89.95
2522 Dual 132 Bit Static	2.95	2708 8K	EPROM	10.95
2524 512 Static	2.95	2716 I	EPROM	29.95
2525 1024 Dynamic	2.95	**Requires 3 voltages -5V, +5V, +12V		
2527 Dual 256 Bit Static	2.95	5203 2048	FAMOS	14.95
2528 Dual 250 Static	4.00	6301-1/7611 1024	Tristate Bipolar	3.49
2529 Dual 240 Bit Static	4.00	6330-1/7602 256	Open C Bipolar	2.95
2532 Dual 80 Bit Static	2.95	82523 32X8	Bipolar	3.95
3341 Hfo	6.95	82S115 4096	Bipolar	19.95
74LS670 4X4 Register File (TriState)	2.49	82S123 32X8	Tristate	3.95
		74186 512	TTL Open Collector	9.95
		74188 256	TTL Open Collector	3.95
		74S287 1024	TTL Open Collector	2.95
UART'S				
A-Y-5-1013 30K BAUD	5.95			

### Function Generator Kit



Provides 3 basic waveforms: sine, triangle and square wave. Freq. range from 1 Hz to 100K Hz. Output amplitude to over 6 volts (peak to peak). Uses a 12V supply or a ±6V split supply. Includes chip, P.C. Board, components & instructions.

JE2206B ..... \$19.95

### DIGITAL THERMOMETER KIT



Dual sensors-switching control for indoor/outdoor or dual monitoring  
Continuous LED 8"ht. display  
Range: 40°F to 199°F / 40°C to 100°C  
Accuracy: ±1° nominal  
Set for Fahrenheit or Celsius reading  
Sim. walnut case - AC wall adapter incl.  
Size: 3-1/4" H x 6-5/8" W x 1-3/8" D

JE300 ..... \$39.95

### DESIGNERS' SERIES

#### Blank Desk-Top Electronic Enclosures

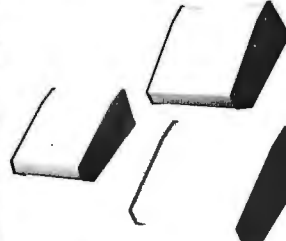

- High strength epoxy molded end pieces in mocha brown finish.
- Sliding rear/bottom panel for service and component accessibility.
- Top /bottom panels .080 thk alum. Alodine type 1200 finish (gold tint color) for best paint adhesion after modification.
- Vented top and bottom panels for cooling efficiency.
- Rigid construction provides unlimited applications.

CONSTRUCTION:  
The "DTE" Blank Desk Top Electronic Enclosures are designed to blend and complement today's modern computer equipment and can be used in both industrial and home. The end pieces are precision molded with an internal slot (all around) to accept both top and bottom panels. The panels are then fastened to 3/4" thick tabs inside the end pieces to provide maximum rigidity to the enclosure. For ease of equipment servicing, the rear/bottom panel slides back on slotted tracks while the rest of the enclosure remains intact. Different panel widths may be used while maintaining a common profile outline. The molded end pieces can also be painted to match any panel color scheme.

Enclosure Model No.	Panel Width	PRICE
DTE-8	8.00"	\$29.95
DTE-11	10.65"	\$32.95
DTE-14	14.00"	\$34.95

\$10.00 Min. Order - U.S. Funds Only  
Calif. Residents Add 6% Sales Tax  
Postage-Add 5% plus \$1 Insurance (if desired)

Spec Sheets - 25¢  
1980 Catalog Available - Send 41¢ stamp

### Jameco ELECTRONICS

PHONE ORDERS WELCOME  
(415) 592-8097

MAIL ORDER ELECTRONICS - WORLDWIDE  
1355 SHOREWAY ROAD, BELMONT, CA 94002  
PRICES SUBJECT TO CHANGE

### The Incredible "Pennywhistle 103"



**\$139.95 Kit Only**

The Pennywhistle 103 is capable of recording data to and from audio tape without critical speed requirements for the recorder and is able to communicate directly with another modern and terminal for telephone "barring" and communications. In addition, it is free of critical adjustments and is built with non-precision, readily available parts.

Data Transmission Method ..... Frequency Shift Keying, full-duplex (half-duplex selectable).  
Maximum Data Rate ..... 300 Baud.  
Data Format ..... Asynchronous Serial (return to mark level required between each character).  
Receive Channel Frequencies ..... 2225 Hz for space, 2225 Hz for mark.  
Transmit Channel Frequencies ..... Switch selectable: Low (normal) = 1070 space, 1270 mark. High = 025 space, 2225 mark.  
Receive Sensitivity ..... 46 dbm acoustically coupled.  
Transmit Level ..... 15 dbm nominal. Adjustable from -8 dbm to +20 dbm.  
Receive Frequency Tolerance ..... Frequency reference automatically adjusts to allow for operation between 1800 Hz and 2400 Hz.  
Digital Data Interface ..... EIA RS-232C or 20 mA current loop (receiver is optional and non-polar).  
Power Requirements ..... 120 VAC, single phase, 10 Watts.  
Physical ..... All components mount on a single 5" by 9" printed circuit board. All components included.  
Requires a VOM, Audio Oscillator, Frequency Counter and/or Oscilloscope to align

### TRS-80 16K Conversion Kit

Expand your 4K TRS-80 System to 16K.  
Kit comes complete with:  
\* 8 each UPD416-1 (16K Dynamic Rams) 250NS  
\* Documentation for conversion

TRS-16K ..... \$59.95

### JUST WRAP™



- 30 AWG wire
- Daisy chain or point-to-point
- No stripping or slitting required - just wrap
- .025" square posts
- Built-in cut off
- Includes 50 ft. wire

Part No.	Wire Color	Price
JW-1B	Blue	\$14.95
JW-1W	White	14.95
JW-1Y	Yellow	14.95
JW-1R	Red	14.95

### JUST WRAP™ Replacement Wire

Part No.	Color	50 ft. roll	Price
R-JW-B	Blue	.....	\$2.98
R-JW-W	White	50 ft. roll	2.98
R-JW-Y	Yellow	50 ft. roll	2.98
R-JW-R	Red	50 ft. roll	2.98

### JUST WRAP™ Unwrap Tool \$3.49

### Vacuum Vise

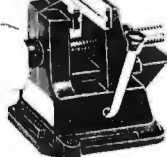

Vacuum-based light-duty vise for small components and assemblies. ABS construction. 1 1/2" jaws, 1 1/4" travel. Can be permanently installed.

VV-1 ..... \$3.49

### ADJUSTABLE WRENCH

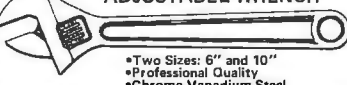

- Two Sizes: 6" and 10"
- Professional Quality
- Chrome Vanadium Steel

6"- AW-6 ..... \$4.95 10"- AW-10 ..... \$6.95

### JOYSTICK VIDEO CONTROLLER



IDEAL FOR ALL VIDEO GAMES OR REMOTE CONTROL PROJECTS

- SMALL CASE SIZE: 1-1/2" H x 2-3/8" W x 4-5/16" L
- 2 MINIATURE POTENTIOMETERS - 40K OHM EACH
- SPST PUSH BUTTON CONTROL
- 5-WIRE CONNECTION CABLE - 5 FEET LONG
- RUGGED PLASTIC CASE

JVC-40 ..... \$4.95 each



COMPUTER SYSTEMS INC.

15335 South Hawthorne Boulevard  
Lawndale, California 90260  
(213) 970-0952

# Look to QT for the **BIG +**

## TELEVIDEO SMART (CRT) TERMINAL

- Reverse Video • Blinking/blank fields
- Upper/lower case character • Protected fields
- Non-glare screen • Underlining • 12 x 10 character resolution • Single stroke editing keys • Function keys • Blinking cursor • TTY keyboard • Numeric pad • 9 Baud rates (75-9600 Baud) • Self-test
- Printer port

912B .....	\$750.00
920B .....	\$850.00
920C .....	\$900.00

OPTION:

2nd Page Memory ..... \$ 24.95

Freight Charge ..... \$ 15.00

Nationwide Field Service available from General Electric Instrumentation and Communication Equipment Service Shops.

## APPLE PRODUCTS

MICRO-MODEM II ..... \$350.00

SORRENTO CONTROLLER

for 8" Apple Disk Drive ..... \$360.00

INTROL X-10 SYSTEM

(turns appliances on/off) ..... \$275.00

MICRO-MUSIC (Software) ..... \$180.00

AIO/Serial-Parallel Board A&T SSM ..... \$155.00

INTEGER Firmware Card ..... \$179.00

PARALLEL INTERFACE CARD ..... \$ 90.00

VISICALC (Business Software

Package) ..... \$124.95

SUPER-MOD II (connects Apple to TV) ... \$ 29.00

ROM WRITER (Epromburner)

Mountain Hardware ..... \$175.00

PROGRAMMER AID #1 ..... \$ 50.00

APPLE CLOCK ..... \$280.00

SANYO 15" MONITOR ..... \$295.00

SWITCHABLE 2 or 4 MHz

## THE QT Z+80 REV 1

Z-80A CPU with Serial I/O Port

This CPU can accommodate a 2708, 2716, or 2732 EPROM in SHADOW mode, allowing you to use a full 64K of RAM. The MWRITE signal is generated automatically if you use the board without a front panel. There's also an independent on-board USART to control the RS232 serial port at baud rates from 110 to 9600.

CPU-Z+80K (KIT) ..... \$132.00

CPU-Z+80AT (A&T) ..... \$189.00

CPU-Z+80BB (BARE BOARD) ..... \$ 33.00

## VERBATIM

Part No.	Sectoring	Pkg. of 2	Box of 10
QTMO 525 01	Soft Sector	\$ 8.95	\$29.95
QTMO 525 10	Hard 10 Sector	\$ 8.95	\$29.95
QTMO 525 18	Hard 16 Sector	\$ 8.95	\$29.95
QTF032 1000	Hard Sector	\$11.95	\$34.95
QTF034 1000	Soft Sector	\$11.95	\$34.95

## KASSETTE/10 LIBRARY

Part No.			
CAS-10-8	Grey	8" Diskette Holder	\$4.50
	Black	..... or 3/	\$10.00
	Blue		
	Beige		
CAS-10-5	Grey	5" Diskette Holder	\$4.25
	Black	..... or 3/	\$10.00
	Blue		
	Beige		

## SPECIAL PACKAGE PRICE

1 Male DB-25, 1 Female DB-25, 1 Cover  
RS-232 SET ..... \$6.50

## QT MEMORY EXPANSION KITS FOR TRS-80 APPLE EXIDY 4116-200 ns

Expansion Kit (8 pcs) .....	\$49.50 ea.
100 pcs .....	\$ 5.00 ea.
1,000 pcs .....	\$ 4.50 ea.

## 16 X 64 VIDEO BD BY ITHACA AUDIO

ASSEMBLED & TESTED

- Full upper/lower case ASCII character set, numbers, symbols and Greek letters
- 7 x 9 Dot matrix in 8 x 10 field
- Selectable display modes, normal & reverse video, blinking characters
- Memory addressable to any 1K page
- Software driver simulates TTY, provides full cursor control, scrolling & paging

A&T PRICE ONLY ..... \$138.95

## NOVATION CAT

ACOUSTIC COUPLER/MODEM

\$156.00

Let your computer talk to other computers! Bell Systems 103 compatible 300 baud, answer or originate

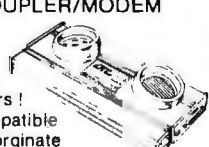

## EPROMS

1702A .....	\$ 4.95
2708 .....	\$ 6.75
2516 .....	\$22.00
2716 (TI) (5V-12V) .....	\$20.00
2716 (5 VOLT) .....	\$22.00
2758 .....	\$27.00
2532 .....	\$75.00
2732 .....	\$75.00

## TRS-80 DISK DRIVE (CABLES INCLUDED)

TRS-80 I (5 1/4") .....	\$395.00
TRS-80 II (8") .....	\$1095.00
APPLE II .....	\$1550.00

## DISK DRIVE SYSTEMS S-100

MS-800-1 (Drive with case, cables & power supply) .....	\$1095.00
MS-800-2 (2 Drives with case, cables & power supply) .....	\$1595.00

## 5 1/4" DISK DRIVES

MPI B-51 .....	\$295.00
SHUGART SA400 .....	\$295.00

## 8" DISK DRIVES

SHUGART 8" 801R .....	\$450.00
REMEX RFD 4000 .....	\$635.00

## TEXTTOOL ZIP\* DIP II SOCKETS

16 PIN ZIP* DIP II .....	\$ 5.50
24 PIN ZIP* DIP II .....	\$ 7.50
40 PIN ZIP* DIP II .....	\$10.25

\*ZERO INSERTION PRESSURE

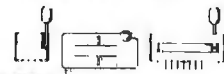

## MATCHLESS PRINTER

- FEATURES:
- 132/80 Columns, 63 LPM, Bi-Directional, Nominal Thruput
  - 100% Heavy Duty Cycle - High Reliability, 100 Million Character Print Head Life
  - Sprocket Feed; Variable Forms Width, 4.5" - 9.5"
  - Double Width Characters
  - 9 x 7 Dot Matrix Character Font
  - 12-Channel Electronic Vertical Format Unit
- SALE PRICE WITH CABLE
- FOR TRS-80 I ..... \$795.00
- FOR TRS-80 II ..... \$795.00
- FOR APPLE ..... \*\*\$849.00
- FOR S-100 (parallel interface) ..... \$795.00
- \*\*Includes parallel interface with documentation. Add freight \$20.00

## PAPER TIGER

- 132/80 Columns; 6 or 8 lines per inch
- 1.75"-9.5" Adjustable Tractor and Friction Feed
- Parallel and Serial Interface
- 98 Character ASCII Set
- 8 Software Selectable Character Sizes
- 110, 300, 600 or 1200 Baud

### QT PRICES

PT-132 .....	\$ 950.00
PT-132G (Graphics & 2K Buffer) .....	\$1050.00

## STATIC RAM BOARDS

SR-8K BARE BD (Ithaca Audio) 21L02 .....	\$ 19.00
SR-16K BARE BD (Problem Solvers) 2114 .....	\$ 19.00
SR-16K A&T (Cal. Comp Sys) .....	
2114L 4MHz .....	\$269.95
SR-32K KIT (Uses 2114L) 4MHz .....	\$475.00
SR-32K A&T (Uses 2114L) 4MHz .....	\$500.00

## PARTS

MICROPROCESSORS	USRT
Z80 (2 MHz) .....	\$10.95
Z80A (4 MHz) .....	\$12.95
6502 .....	\$11.25
6800 .....	\$12.50
8802 .....	\$19.50
8035 .....	\$20.00
8080A .....	\$ 3.95
8085A .....	\$20.00
8088-4 .....	\$80.00
8748-8 .....	\$70.00
BOBOA SUPPORT	
6212 .....	\$ 3.50
8214 .....	\$ 4.50
8216 .....	\$ 2.95
8224 .....	\$ 4.00
8228 .....	\$ 8.00
8238 .....	\$ 6.00
8243 .....	\$ 5.00
8251 .....	\$ 7.00
8253 .....	\$19.00
8253-5 .....	\$27.00
8255 .....	\$ 8.25
8257 .....	\$17.95
8257-5 .....	\$19.00
8259 .....	\$19.95
8275 .....	\$69.95
8279 .....	\$17.50
8279-5 .....	\$18.00
8295 .....	\$16.50
MISCELLANEOUS OTHER COMPONENTS	
N8T20 .....	\$ 3.25
N8T28 .....	\$ 2.50
N8T97 .....	\$ 2.00
N8T98 .....	\$ 2.00
1488 .....	\$ 1.25
1489 .....	\$ 1.25
D3205 .....	\$ 3.00
D3242 .....	\$10.15
D3245 .....	\$ 5.60
P3404 .....	\$ 8.75
TMS5501 .....	\$19.00
DM8131 .....	\$ 3.00
CRT CONTROLLER	
MC6845P .....	\$18.00
STATIC RAMS	
21L02 (450 ns) .....	\$4/ea./\$1.20 ea.
..... 100 ea./	\$1.10 ea.
2114L (450 ns) .....	\$5.25 ea.
..... 100 ea./	\$4.50 ea.
2114L (300 ns) .....	\$5.50 ea.
..... 100 ea./	\$4.75 ea.
KEYBOARD CHIPS	
AYS-2378 88 .....	\$13.75
AYS-3600 90 .....	\$13.75
BAUD RATE GENERATORS	
MC14411 .....	\$11.00
1.8432 XTAL .....	\$ 4.95
BR1941L .....	\$14.00
DISC CONTROLLER	
1771B01 .....	\$24.95
1791B01 .....	\$39.95
UARTS	
TR1602B .....	\$ 3.75
CHARACTER GENERATORS	
2513 (Upper case) .....	\$10.95
2513 (Lower case) .....	\$10.95
2513 Upper (5 v) .....	\$ 9.75
2513 Lower (5 v) .....	\$10.95

# EXPANDORAM I

EXPANDABLE TO 64K USING 4116 RAMS

Interfaces with most popular S-100 boards  
Bank selectable: PHANTOM provision  
Draws only 5 watts fully populated  
Designed to work with Z-80, 8080, and 8085 systems  
No wait states required  
16K boundaries & protect via dip switches  
Kits come with sockets for full 64K  
Invisible refresh

MEM-16K (16K KIT) .....	\$198.00
MEM-16AT (16K A&T) .....	\$268.00
MEM-32K (32K KIT) .....	\$260.00
MEM-32AT (32K A&T) .....	\$329.00
MEM-48K (48K KIT) .....	\$315.00
MEM-48AT (48K A&T) .....	\$378.00
MEM-64K (64K KIT) .....	\$370.00
MEM-64AT (64K A&T) .....	\$439.00

# EXPANDORAM II

THE RANDOM ACCESS MEMORY

S-100 Bus Compatible  
Up to 4Mhz Operation  
Expandable Memory from 16K to 256K  
Dip Switch Selectable Boundaries  
Uses 16K (4116) or 64K (4164) Memory Devices  
Page Mode Operation Allows up to 8 Memory Boards on Bus  
Operates with Z80 CPU's  
Phantom Output Disable  
Invisible Refresh (Synchronized with Wait States)

MEMII-16K (KIT) .....	\$250.00
MEMII-16AT (A&T) .....	\$300.00
MEMII-32K (KIT) .....	\$325.00
MEMII-32AT (A&T) .....	\$375.00
MEMII-48K (KIT) .....	\$395.00
MEMII-48AT (A&T) .....	\$475.00
MEMII-64K (KIT) .....	\$475.00
MEMII-64AT (A&T) .....	\$539.00

**QT LOW PRICES!**

# Z-80 STARTER KIT

COMPLETE Z-80 MICROCOMPUTER

On-board keyboard, display, EPROM programmer, and cassette interface  
On-board S-100 interface  
Wire-wrap area and room for 2 S-100 connectors  
Two 8-bit parallel I/O ports, 4-channel CTC, 5 programmable breakpoints  
Examine and change memory, I/O ports, or register

Z-80K (KIT) .....	\$310.00
Z-80AT (A&T) .....	\$369.95

# SD SYSTEMS

## VERSAFLOPPY I

SINGLE DENSITY DISK DRIVE CONTROLLER

S-100 Bus Compatible  
IBM 3740 Compatible Soft-Sector Format  
Operates with both Standard (8") and Mini (5 1/4") Drive  
Provides Control for Single or Double-Sided Operation  
Controls up to Four Drives Simultaneously  
Operates with SDOS or CP/M Disk Operation System  
Operates with Z80, 8080, and 8085 Central Processing Units  
Utilizes FD 1771B-1 Controller Device  
Control and Diagnostic Software Available in PROM  
Interrupt Operation Optional

VF-1K (KIT) .....	\$235.00
VF-1AT (A&T) .....	\$295.00

## VERSAFLOPPY II

DOUBLE DENSITY DISK CONTROLLER

Single or double density floppy disk controller  
985600 bytes on 8" double sided diskettes  
259840 bytes on double sided 5 1/4" diskettes  
S-100 bus (IEEE) standard compatible  
IBM 3740 format in single density  
8" and 5 1/4" drives controlled simultaneously  
Operates with Z-80, 8080, and 8085 CPU's  
Controls up to 4 drives  
Vectored interrupt operation optional

VF-2K (KIT) .....	\$335.95
VF-2AT (A&T) .....	\$385.95

## SBC-100/200

OR 4 Mhz SINGLE BOARD COMPUTER

S-100 bus compatible Z-80 CPU  
1K of on-board RAM  
4 EPROM sockets accommodates 2708, 2716, or 2732  
One parallel and one serial I/O port  
4-channel counter timer chip (Z-80 CTC)  
Software programmable serial baud rates

SBC-100K (2 Mhz KIT) .....	\$280.00
SBC-100AT (2 Mhz A&T) .....	\$340.00
SBC-200K (4 Mhz KIT) .....	\$299.00
SBC-200AT (4 Mhz A&T) .....	\$359.00

VDB-8024

# VIDEO DISPLAY BOARD

WITH ON-BOARD Z80 MICROPROCESSOR

S-100 Bus Compatible  
Full 80 Characters by 24 Lines Display  
Characters Displayed by High Resolution 7 x 10 Matrix  
Composite or TTL Video Output  
Keyboard Power and Interface  
Forward and Reverse Scrolling Capability  
Blinking, Underlining, Field Reverse, Field Protect and Combinations  
Full Cursor Control  
96 Upper and Lower Case Characters  
32 Special Character Set  
128 Additional User Programmable Characters (Optional)  
On-Board Z80 Microprocessor  
2K Bytes Independent On-Board RAM Memory  
Glitch-Free Display

VDB-K (KIT) .....	\$365.00
VDB-AT (A&T) .....	\$440.00

# PROM-100

PROGRAMMING BOARD FOR PROM DEVELOPMENT  
S-100 Bus Compatible  
Programs the Following EPROMs:  
2708, Intel 2758, 2716, 2732 and Texas Instruments 2516

Dip Switch Selection of EPROM type  
25 VDC Programming Pulse Generated On Board  
Maximum Programming Time: 16,384 Bits in 100 Seconds  
Power Requirement: +8VDC at 300 ma; +16 VDC at 100 ma; -16VDC at 60 ma  
TTL Compatible

Software Provides for Reading of Object File from SDOS, CP/M or PROM and Programming into EPROM  
Program Verification  
Verification of Erasure  
Zero Insertion Force Socket

PROM-100K (KIT) .....	\$175.95
PROM-100AT (A&T) .....	\$235.00

PLACE ORDERS TOLL FREE

1-800-421-5150

Continental U.S. only  
Except California

## S-100 BARE BOARDS

CB1A 8080 CPU .....	\$30.95
VB1B Memory Mapped Video Interface .....	\$26.95
VB2 I/O Mapped Video Interface .....	\$29.95
I02 Parallel I/O Interface .....	\$34.00
I04 2P + 2S I/O Interface .....	\$26.95
SB1 Music Synthesizer .....	\$39.95
OB1 Vector Jump & Prototyping Board .....	\$29.95
MB6B 8K Static RAM .....	\$25.95
MB7 Low Power 16K Static RAM .....	\$26.95
MB8 4K 1702 EPROM Board .....	\$29.95
MB8A 16K 2708 EPROM Board .....	\$34.95
T1 Terminator .....	\$26.00
MT1 15 Slot Motherboard .....	\$45.00
XB1 Extender Board .....	\$13.50

## S-100 KITS & ASSEMBLED BOARDS

I04 2P + 2S I/O Interface Kit .....	\$129.95
Assembled & Tested .....	\$199.95
PB1 2708/2716 EPROM Programmer Kit with Textool sockets .....	\$124.95
Assembled & Tested with Textool sockets .....	\$174.95
VB1B Memory Mapped Video Interface Kit .....	\$125.00
Assembled & Tested .....	\$180.00

# SSM PRODUCTS

VB2 I/O Mapped Video Interface Kit .....	\$150.00
Assembled & Tested .....	\$195.00
VB3 80 Character Video Interface 80x24 Display, 2 Mhz Kit .....	\$299.95
Assembled & Tested .....	\$389.95
80x24 Display, 4 Mhz Kit .....	\$324.95
Assembled & Tested .....	\$410.00
Upgrade Kit for 80x24 Display 2 Mhz .....	\$ 69.00
4 Mhz .....	\$ 89.00
I02 Parallel I/O Interface Kit .....	\$ 59.00
Assembled & Tested .....	\$ 89.00
CB1A 8080 CPU Kit .....	\$129.95
Assembled & Tested .....	\$189.95
SB1 Music Synthesizer (4) Kit .....	\$199.00
Assembled & Tested .....	\$279.00
OB1 Vector Jump & Prototyping Board Kit .....	\$ 55.00
Assembled & Tested .....	\$ 85.00

MB6B 8K Static RAM 450 ns RAM Kit .....	\$129.95
Assembled & Tested .....	\$149.95
250 ns RAM Kit .....	\$159.95
Assembled & Tested .....	\$224.95
MB7 Low Power 16K Static RAM Kit .....	\$269.96
Assembled & Tested .....	\$375.00
CB2 Z-80 CPU Kit .....	\$185.95
Assembled & Tested .....	\$250.00
MB3 4K 1702 EPROM Board Kit - without EPROMs .....	\$ 65.00
Assembled & Tested .....	\$125.00
MB8A 16K 2708 EPROM Board Kit - without EPROMS .....	\$ 85.00
Assembled & Tested .....	\$139.00
T1 Active Terminator Kit .....	\$ 34.00
Assembled & Tested .....	\$ 64.00
MT1 15 Slot Motherboard Kit (with Connectors) .....	\$129.95
Assembled & Tested .....	\$149.95
XB1 Extender Board Kit (with Connector) .....	\$ 19.95
Assembled & Tested .....	\$ 29.95



COMPUTER SYSTEMS INC.

15335 South Hawthorne Boulevard  
Lawndale, California 90260  
(213) 970-0952

PLACE ORDERS TOLL FREE  
1-800-421-5150  
(CONTINENTAL U.S. ONLY)  
(EXCEPT CALIFORNIA)

TERMS OF SALE: Cash, checks, money orders, credit cards accepted. Also C O D orders under \$100.00. Minimum order \$10.00. California residents add 6% sales tax. Minimum shipping and handling charge \$2.50. Prices subject to change without notice. International sales in American dollars only.



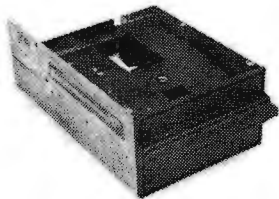

## Qume Datatrak 8

Double sided floppy with NO HEADACHES. Although many think this an impossibility, seeing is believing, and this drive is really something! Shugart compatible, fully optioned, reliable, and rapidly becoming the standard in double-sided diskdom.

\$599. Two/\$549.

## Cal Disk 142 M

A sleeper in the floppy drive industry: built like the proverbial tank and

chosen for use by Motorola and DEC, this drive features single/double density, write protect and much more. With Electrolabs' special cabling, it magically becomes Shugart compatible. . . . \$439 Two/\$419

The following 5 1/4" mini-floppies share most features with their 8" cousins, so without further ado...

Siemens FDD 100-5D. . . . . \$279.  
 Cal Disk Mini. . . . . 279.  
 Qume Datatrak 5 (double sided). . . . 399.  
 BASF Mini mini. . . . . 279.  
 SA 400. . . . . 299.

All the above mini-floppies are fully SA400 compatible.



## Disk Accessories

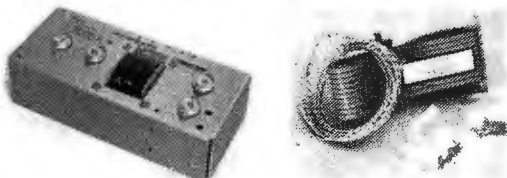

Cable kits for 8" drives with 10' 50 cond. flat cable, power cable, and all connectors. Assembled if desired. One drive 27.50, two 33.95, three 38.95 for mini floppies (34 cond): one 24.95, two, 29.95

CP-206 Power-one power supply. Powers two drives more than adequately, top quality. 2.8A/24V, 2.5A/5V, 5A/5V. . . . . \$99.

Delta Products double density disk controller Operate at 2 or 4MHZ, with 8 or 5" drives \$399  
 Micromation doubler w/programmable UART RS-232 port \$495  
 Sorrento Valley single density for Apple \$399  
 Again, purchase price of manuals (\$5) is applicable towards future purchase price.

Subtract 15% OFF any Controller with Purchase of 2 Drives



## Electrolabs

POB 6721, Stanford, CA 94305

415-321-5601      800-227-8266

Telex. 345567 (Electrolab Pla)

Visa   MC   Am. Exp.

Tarbell floppy disk controller, A & T \$325  
 Tarbell floppy disk controller, A & T \$225  
 Tarbell double density, DMA A & T \$425  
 Tarbell double density, DMA, kit \$325

## Hard Disk



CII HB 10 MBY fully REMOVEABLE cartridge drive. Complete with controller, personality card, media, power supply, cabling, connectors and documentation. Highlighted by stylish & modern cabinetry. \$6995.

Shugart SA4008 20MBY fixed disk system. S-100, includes controller, power supply, and all that is necessary to run \$6995.

Manuals for all drives are \$10, refundable against future purchase of drives. Also, all 8" drives can be ordered with 220 v/50 hz for world-wide use. Moving on to the realm of floppy disk controllers... although we still feel that single density is more reliable, there are many excellent double density disk controllers available, so choose your weapons carefully.



## ENCLOSURES

Rackmount Mainframe MT-200. This gorgeous beast is so appealing that it can easily function also as stand-alone mainframe. Very modern styling with fully actively terminated S-100 bus. With two 8" single-sided disk drives. . . \$1899.  
 With two 8" double sided disk drives in place of single-sided variety. . . . . \$2499.

Desktop Mainframe MT-100. Contemporary styling, a handsome cabinet coated with durable epoxy finish colors (blue, beige, off-white & silver). Easy to fit into an office environment. The proper way to start your system.

Above plus two 8" single sided disk drives. . . . . \$1599.  
 Above with two 8" double sided disk drives in place of single-sided variety. . . . . \$2199.

## Electrolabs' Monthly Special!!!

Incredible!! - Two 8" Shugart compatible single sided floppy disk drives (double density), CP-206 power supply, in handsome color coordinated cabinet, with full cabling, connectors, and documentation, plus one box diskettes!!! All for an unprecedented \$1295. Up to one MBY of storage.



## Media



8" ....\$39.93/10 single-sided/single density  
 8" ....\$55.00 single sided/double density  
 8" ....\$55.00 double sided/single density  
 8" ....\$60.00 double sided  
 8" ....specify hard or soft  
 5 1/4" ....\$34.95 single sided  
 5 1/4" ....\$60.00 double sided  
 Verbatim, Memorex, Scotch, or equivalent name brand  
 Diskette head cleaning kit for 5 1/4" or 8" \$28.75 includes everything for 1 drive for 1 year. Alignment Diskette for Floppy Drives. . . . . \$39.00



## Keyboard Special 1 !!

CHERRY "PRO" Keyboard  
..... \$119.00  
Streamlined Custom Enclosure  
..... 34.95  
BOTH only ..... \$134.95

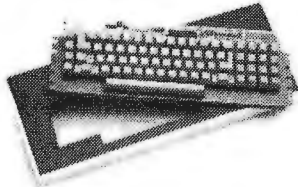

## Keyboard Special 2 !!

Keytronics 1660 .... \$149.00  
Hard Plastic enclosure 49.00  
BOTH only ..... \$152.00

## June Bonanza!!

### 4116 dynamic RAM, 16K

Set of 8, 16K, for Apple, TRS-80, Exidy, Heath & more. 200 Ns., prime parts, at the unheard of \$49/8.

Large discounts available for quantity & dealers (500 & up). Offer limited while supply lasts, as these will vanish quickly!!!

## Daisy Wheel Printers

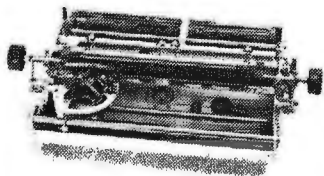

### Qume Sprint 3/45

PRINTER (factory warr.) \$1499.  
POWER SUPPLY (Borschert) 349.  
(Shown mounted on rear of printer)  
COMBINATION SPECIAL 1699.  
Cases available 200.  
S-100 interface card 149.  
SPRINT 5/45 RO, RS-232  
Complete, assembled, in case, plug-in &  
print, hence, no muss & no fuss \$2699.  
NEC Spinwriter ..... \$2899,



### ESAT 200B

### BI-LINGUAL 80x24 Communicating Terminal

Scrolling, full cursor, bell, 8x8 matrix, 110-19,200 baud, Dual Front Applications. Arabic & Hebrew, Multilingual Data Entry Forms Drawing, Music, & Switchyards.  
Alone ..... \$279.  
with Cherry Pro keyboard &  
custom metal case ..... \$399.

## Disk Subsystem

### Matchmaker Technology TURNKEY DISK SUBSYSTEMS

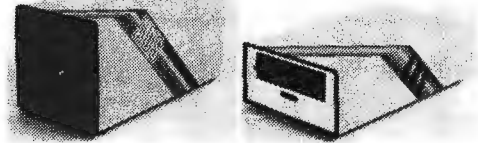

APPLE ..... Single density disk controller. Expanded Apple DOS  
TRS-80 ..... Single or double density. Expansion interface necessary. Space for 48K dynamic RAM on controller card RS232 port  
SORCERER .. Full RS-232 Interface. One S-100 slot for memory expansion. Single or double density  
All above units come as follows: Complete, assembled and tested, with two 8" floppy disk drives (Apple available in one drive model). Includes all cabling, connectors and documentation in a stunning color coordinated cabinet with power supply. Ready to go, plug in and run!!!

When ordering specify single or double sided drives

Software available for above disk add-ons

TRS-80 & Sorcerer operate on all CP/M compatible software

## Data Display Monitors

Please call us for particulars

### Electrolabs

POB 6721, Stanford, CA 94305  
415-321-5601 800-227-8266  
Telex: 345567 (Electrolab Pla)  
Visa MC Am. Exp.

## Software

CP/M 1.4 ..... \$ 99  
CP/M 2.0 ..... 149  
OS-1 (incl. 1st yr. update) .. 249  
Spellbinder (Exc. secretarial type  
word-processor) ..... 350

## Peripheral Sale!!

Hiplot Plotter .....	\$875.
Hipad Digitizer .....	715.
Televideo 912C .....	760.
Televideo 920C .....	860.
IDS 440 Paper tiger .....	899.
SD Expandoram II (A&T, 64K) .....	560.
Imesai 65K dynamic RAM III	399.
DC Hayes Micromodem 100 ..	399.
Super switcher power for hard disk & more .....	349.
CII HB 10 MBY .....	3300.
SA 4008 .....	2799.
<hr/>	
C-Basic .....	99.
Fortran Compiler .....	100.
C Compiler .....	600.
Basic compiler .....	350.

## NEW "UNIX-like" Operating System for Z-80

### OS-1

OS-1 is truly a breakthrough in the micro world! OS-1 is NOT a "control program for micros" but is, instead a large, professional operating system designed to lower the cost and improve the quality of programming efforts. OS-1 provides a "friendly" human interface for both system programmers and users. Finally, with OS-1, the capability of a Z-80 system is vastly expanded.

OS-1 appears exactly like UNIX to the user, and includes virtual i/o, "set tty" and "login" commands, a shell, a hierarchical "tree" type file structure with 16Mby file size and an unlimited no. of files and devices. OS-1 allows the extremely useful "pipes" and "filters" to be implemented. OS-1 also provides for up to 1024 users and 64 groups and security for users, groups, files and devices. OS-1 occupies 12Kby and comes with a 4Kby "enhanced" cp/m adapter which runs ALL cp/m and most CDOS programs. Source code is supplied with adapter.

OS-1 (Including Debugger, "UNIX-type" editor, Linker-Loader & 1 Yr. update)  
\$249

"C" Compiler (Whitesmiths') \$600

Microsoft Compiler Interface (Interfaces MS Fortran & Cobal compilers directly to OS-1. This allows compiler output to "Command" OS-1 Routines. The Electrolabs' Software Group considers this interface indispensable. Contains over 100 separate routines) \$49

#### Manuals:

(price applies to OS-1 purchase)

Introduction to OS-1 (60pg)	\$15
OS-1 Users' Guide (150pg)	\$35
Sys-Gen Manual for OS-1 (40pg)	\$10
SET	\$45

## DEAL #1

### Hobby Wire Wrap Starter Package



BW2630 WW Tool .....	\$19.95
BT30 #30 Bit .....	3.95
BC1 Batteries & Charger .....	14.95
*Kit #1 Wire Kit .....	9.95

Regular Price .... \$48.80

**\$39<sup>95</sup>**

\*Kit #1 Contains 900 pcs. of precut wire in asst. sizes.

Choose from Red, Blue, White, Black, Green, Orange, Violet, Yellow, or assortment.

## DEAL #2

### Industrial Wire Wrap Starter Package

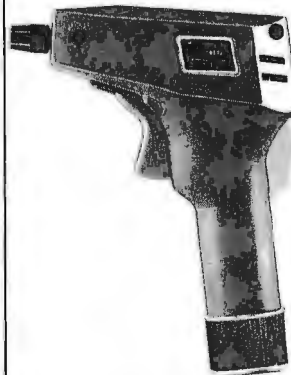

BW928BF WW Tool .....	\$52.95
BT30I #30 Bit & Sleeve ..	29.50
BC1 Batteries & Charger .....	14.95
*Kit #3 Wire Kit .....	32.95

Regular Price ... \$130.35

**\$119<sup>95</sup>**

\*Kit #2 Contains 4000 pcs. of precut wire in asst. sizes.

Choose from Red, Blue, White, Black, Green, Orange, Violet, Yellow or assortment.

# ★ ★ BIG DEAL ★ ★

## RN IC Sockets by the Tube

RN HIGH RELIABILITY eliminates trouble. "Sidewipe" contacts make 100% greater surface contact with the wide, flat sides of your IC leads for positive electrical connection.

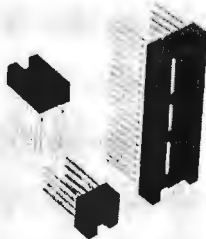

### WIRE WRAP SOCKETS

Size	Quantity/Tube	Price ea.*	Price/Tube
08 pin	52	.39	\$20.28
14	30	.46	\$13.80
16	26	.50	\$13.00
3-level Gold			
Closed Entry	18	.23	\$6.84
Design	20	.21	\$7.85
	22	.18	\$16.56
	24	.17	\$15.95
	28	.15	\$18.45
	40	.10	\$16.00

\*Sockets sold at these prices by the tube only.

Above prices include gold up to \$800/oz.

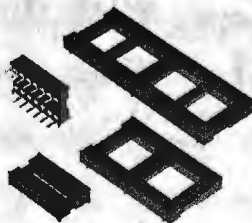
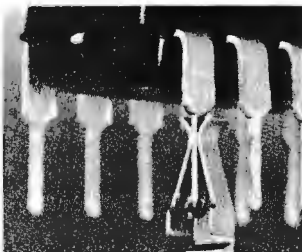

### SOLDER TAIL

Low Profile Tin  
Closed Entry  
Design

**1¢/pin**  
**(over 5 tubes)**

**3/4¢/pin**  
**(over 100 tubes)**

\*Sockets sold at these prices by the tube only.

See tube quantities above.

### ORDERING INFORMATION

- Orders under \$25 include \$2 handling
- All prepaid orders shipped UPS Ppd.
- Visa, MC & COD's charged shipping
- All prices good through cover date
- Most orders shipped next day.

Limited to products Page Digital stocks. All discounts are off of list price.  
Call or write for list prices.

- 10% off on all OK hobby products!**
- 10% off on all Bishop Graphics products!**
- 5% off on all Vector products!**



# California Digital

Post Office Box 3097 B • Torrance, California 90503

## NEW

from  
**INTEGRAL DATA**  
**460**  
**Paper Tiger**



\*\*\*\* All the features of the 440 and more \*\*\*\*  
The 460 uses a dot matrix character formation technique in which the placement of the dots overlap both horizontally and vertically to achieve a correspondence-quality printing.  
The printer's nine-wire print head uses staggered needle rows to create the vertically overlapping dots. The head is driven bidirectionally under microprocessor control by a stepper motor driven mechanism with logic-seeking look ahead capability.  
Standard "Two-K Byte" buffer allows the printer to accept the entire content of a 1,920-character CRT screen. Weight 27 lbs. suggested list price \$1,295. Calif. Digital price **\$1,076**

## S-100 Mother Board

**Quiet Buss**

**\$2995**  
8803-18  
18 slot  
1MSAI

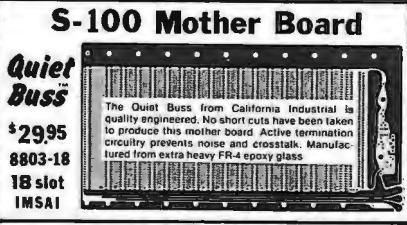

The Quiet Buss from California Industrial is quality engineered. No short cuts have been taken to produce this mother board. Active termination circuitry prevents noise and crosstalk. Manufactured from extra heavy FR-4 epoxy glass.

## WESTERN UNION ENCLOSURE

These enclosures were manufactured for Western Union by Universal Technology. The exact purpose of the product is still a mystery, but the enclosure is ideally suited for an S-100 motherboard with shielded power supply. Removable hood and plastic front make this enclosure an attractive home for any hobby product. New surplus in factory boxes supplied with three 22/4 edge connectors. D1255 communications connector; six foot grounded power cord and more. Inside dimensions: 10" x 10 1/2" x 5 7/8". Shipping weight 8 lbs. **\$24.95**



## TELETYPE MODEL 43

**4320 KEYBOARD**

TTL ..... AAA \$ 950  
RS 232 .... AAK 1050  
Friction ... AA 1100 plus shipping  
103 Modem AAB 1575

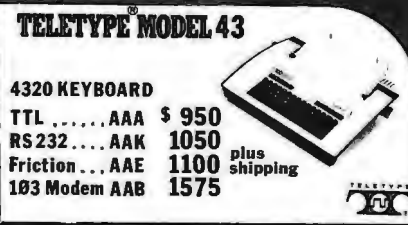

## DB25

each 10+  
male \$2.50 195  
female 325 305  
hood-2p 125 98  
Centronic 695

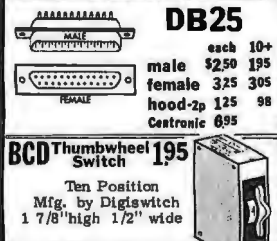

## Edge Connectors

**GOLD 100 PIN**  
MSAI/ALTAIR

Im sai solder 125x.250 \$2.95 3/4 7.50  
Im sai w/w .125 centers \$4.95 3/4 13.00  
Altair solderail 140row \$5.95 3/4 15.00

**SPECIALS**

22/44 Kim eyelet .156" \$1.95 3/4 5.00  
25/50 solder tab .156" \$1.09 3/4 2.00  
36/72 wide post w/w .156" \$1.95 3/4 5.00

## BCD Thumbwheel 195 Switch

Ten Position  
Mfg. by Digiswitch  
1 7/8" high 1/2" wide

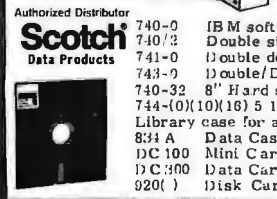

## COMPUTERS

Apple II standard 16K	588
Apple II Plus 128K	990
Altair 1000	850
Altair 8800	450
Vector 512	2985
Telex Instruments 50/4	1305
Northern Quad 32 bit octopus	2985
Compaq 101 Model 2	1205
Rockwell Altair 811A	375

## KEY TERMINALS

ADDIS Recent 35 five key pad	850
ADDIS Recent 40	1100
ADDIS Recent 50	1400
Hastings 1120	850
Headline 1500	695

## MONITORS

Sanyo 9" black & white monitor	175
Leadtek Video 100 12"	329
Leadtek Video 100-30 12"	172

## PRINTERS

MS1400 Tiger with Graphics	595
Petricom P-200 (300 LPI)	400
Periprint P-600	400
Teletype Model 43 (MS232)	1150
Teletype Model 40 (300 LPI)	1150
NEC printer 5010 B/O	2300
Telex Instruments 810	1450
Centronics 7510	895
Centronics 770-1 tractor	905
Centronics 781	1010
Altek 80 8000	225
Altek 101/500	225
Altek 101/501	225
Digital 1040 E/O plastic wheel	3750
Digital 1140 K/O plastic wheel	3750

## DISK DRIVES

Shugart SA800 R floppy	490
Shugart SA800 R hard sec.	850
Labo / Two Shugart 801 w/ power supply and enclosure	1195
Two Shugart 801 with power supply and enclosure	795
Labo hard drive for Apple II	2995
Labo hard drive for TRS80	3000
Labo 100-1 5 1/4" for TRS80	3000
Labo V-80 for TRS80 (40K)	3000
Labo V-80 for TRS80 (40K)	3000

## DISK PRODUCTS

Godbout Back Enclosure	320
Godbout Disk Enclosure	320
Electronic Controls ECT 100P	250
Ca. Digital 18 slot motherboard	30
S-100 B/O A1115	210
Trink/Tera Switchboard L/O	210
Godbout Enclosure Products	49
Shulin 72-2 Extent. ALcode	49
A see W1000 Wre/Wrp Price	25
80 Disk Random Access Memory	49
80 Disk 18 Slot 10/11/15	30

## APPLIC COMPATIBLE PRODUCTS

Apple disk drive with controller	495
Apple drive without controller	495
Apple IIe Interface	190
Ten Key Data Pad for Apple	110
Monoman Hardware Simulator	270
Monoman / Imro-X10 For IBM	220
8" soft sector diskettes 100	21
8" double density for TRS80	30

## FREE PLASTIC LIBRARY CASE

with purchase of each box of ...  
Memorex mini-diskettes. \$5 value.

# \$24.95

BOX of 10  
**DISKETTES**

## Authorized Distributor

### Scotch Data Products

740-0	IBM soft format.	\$39.00	\$3.50
740-2	Double side soft	65.00	6.00
741-0	Double density	54.00	4.90
743-0	Double/Double	70.00	6.60
740-32	8" Hard sector	39.00	3.50
744-0(10/18) 5 1/4" mini		39.00	3.50

Library case for any above: Add \$3.00

834 A	Data Cassette	5.50
13C100	Mint Cartridge	16.00
13C300	Data Cartridge	20.00
920(1)	Disk Cartridge	89.00

## Shugart Associates

### SA800-R Floppy Disk Drive

The most cost effective way to store data processing information, when random recall is a prime factor. The SA800 is fully compatible with the IBM 3740 format. Write protect circuitry, low maintenance & Shugart quality.

# \$449.50

## XEROX 800 WORD PROCESSING KEYBOARD

ASCII ENCODED

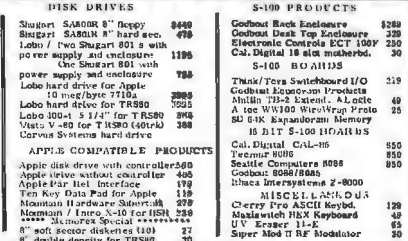

This 77 key word processing keyboard was manufactured by Xerox which for use in the Xerox 800 word processing system. The keyboard outputs a seven bit ASCII code along with an eight bit that allows most keys to shift and double function as special characters. Extra large "Tab & Return" keys are designed into the layout of the keyboard to emulate the IBM Selectric. 17 illuminated keys serve for special word processing codes. The keyboard is equipped with two thumbwheel switches for defining line width.

Original Xerox acquisition over \$100.00  
California Digital USED price only \$110.00  
Excellent cond. Documentation included.

## MEMORY

### TRS-80 \$49

### APPLE II \$49

16k memory (8) 4116's

Installation is simple. Anyone who has ever changed a spark plug should be able to up-grade his microcomputer.

How can California Digital offer these memory up-grade sets at 25% below our competition? Simple. We buy in volume, wholesale to dealers and sell the balance directly to owners of personal micro-systems. These 16K dynamic memory circuits are factory prime and unconditionally guaranteed for one full year. NOW, before you change your mind, pick up the telephone and order your up-grade memory from California Digital. Add \$3 for TRS80 jumpers.

### STATIC

21L02 450ns.	1.19	.99	.95	.90	.85
21L02 250ns.	1.49	1.39	1.25	*	*
2114 1Kx4 450	5.95	5.50	5.25	4.75	4.50
2114 1Kx4 300	8.95	8.50	8.00	*	*
4044 4Kx1 450	5.95	5.50	5.25	*	*
4044 4Kx1 250	9.95	9.50	9.00	*	*
4045 1Kx4 450	8.95	8.50	8.00	*	*
4045 1Kx4 250	9.95	9.50	9.00	*	*
5257 low pow.	5.95	5.50	5.00	4.80	4.60

## DATA INPUT TERMINAL

This Revolution terminal was recently acquired from the CMC division of the Peritek Corporation. The unit was originally designed for inputting data directly onto magnetic tape.

The system is comprised of a premium cast aluminum and fiberglass enclosure, along with a fluorescent / microswitch half effect keyboard. Thirty display lamps advise the operator of the systems status. Four high load speaker acknowledges acceptance of data and alerts the operator of pending problems.

But most of all this "USER" terminal, with a little imagination, can be engineered to make the perfect home for an S-100 computer and video display; or with slight modification will accept the Rockwell AIM-85 micro computer.

Five volt regulated power supply is available for an additional \$20. (see June Byte) All units are in excellent condition. Original acquisition over \$700. \$2 lab.

## MINIATURE SWITCHES

your choice

\$ .98	10	50
\$ .88	100	500

SPDT Miniature Toggles

7101 C&K	ON-NONE-ON
7102 C&K	ON-OFF (mom.) ON
7103 C&K	ON (moment) ON
7103 C&K	ON OFF ON
Rotary	3P-4-Pos.
Rotary	3P-6-Pos.
Push B (N.O.)	\$ .39 ea. 4/51

## DIP Switch

\$129	10	25	100	16
ea.	\$119.109	.97	.83	

specify 4 for 8 pos.

## SPST

## 2716 EPROM SALE \$13

\*\*\* THOUSANDS \*\*\*

We have slashed price in an effort to reduce our over stocked inventory. These are Single Five Volt Eproms, manufactured by one of the Worlds largest producers of semiconductors. Please phone for volume pricing.



## direct connect MODEM

### Universal Data 103

Connects directly to the new modular phone jack. Fully powered from your existing telephone line. No need to locate external AC power. Crystal control prevents frequency drift. Direct connect feature eliminates loss of information due to carbon compression that is associated with acoustic modems. Runs circles around those other "Domesticated" modems.



**\$169**

## PORTABLE DATA ENTRY SYSTEM

These used data terminals were originally designed for chain store inventory control and order entry systems. The operator enters the inventory control number, merchandise on hand and the unit price. After all pertinent data has been entered into the recorder, the main warehouse is telephoned, the hostess is placed in the acoustic coupler and all the recorded information is transmitted back to the master computer. With a little imagination and one of these portable entry systems, you should be able to exchange programs and computer information with associates across the country. All units were removed from service in working condition. Original cost \$2,500.

- Portable Cassette Drive Unit
- Removable Entry Keyboard with LED Display
- Five Word "TP" N/Calls
- Acoustical Coupler
- Battery Charger
- 10125 Cable
- Shoulder strap
- Full Documentation

**\$1395.00**

## New Regent 30

**\$895**



Through years of research the ADDS Corporation has evolved a low maintenance, extremely durable CRT terminal capable of withstanding an average 24 hour duty cycle. The Regent 35 features Intel 6885 microprocessor controlled circuitry along with the Cherry Swallow line-art computer keyboard.

18 key cursor and numeric pad devices to allow for user definable special functions. True decreasing lower case characters along with a fully addressable cursor make the Regent 35 the ideal word processing terminal.

11 soft-resolution screen is capable of displaying 80 upper and lower case ASCII characters and 32 control codes. This terminal is suitable to display as European languages.

At \$895 (plus optional terminal) the Regent 35 offers the best value in usage till terminal market. Additional data upon request.

## DISCOUNT Wire Wrap Center

### IC SOCKETS

pin	Wire wrap ea.	low profile ea.	25	50	ea.	25	50
8		17	16	15			
14	37	36	35	18	17	16	
16	38	37	36	19	18	17	
24	99	93	85	36	35	34	
40	169	155	139	63	60	58	

50th \$ .98

**KYNAR WIRE WRAP**

500	1,000	11,000
\$9.	\$15.	\$105.

**\$545**

ON HOBBY WRAP-3D wire wrap & strip tool

New  
Summer 1980  
**SEND FOR OUR FREE CATALOG**

**CompuMart  
lets you  
put 'em on trial**

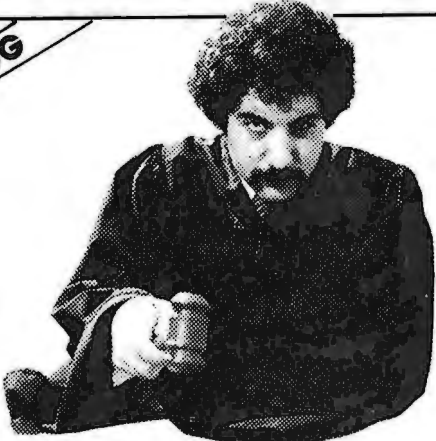

CompuMart has been selling computers by mail since 1971. Our thousands of satisfied customers rely on CompuMart for services not generally available from the others. Namely:

- Product Selection/Each product advertised by CompuMart has been evaluated by our in-house staff for best price, performance, and supplier reliability
- Return Privilege/After receipt of our products, you are protected by CompuMart's exclusive, 10-day return privi-

ledge- good for all products except software.

- Support/Our Customer Service Dept. and expert technicians are always there to assist you by phone or at CompuMart's outlets. Our knowledgeable phone sales force can provide you with detailed information and complete product specifications.
- Phone Ordering/For added convenience, CompuMart maintains a toll-free ordering number. 1-800-343-5504.

**with 10 day  
free return**

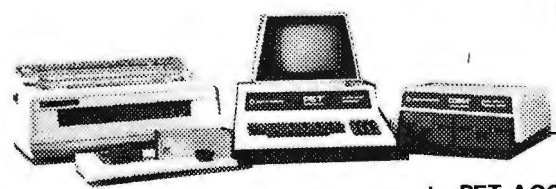

**Computers**

Buy Direct from the largest Commodore dealer in the country, and the very first Commodore distributor in the U.S. Buy from the experts- Buy from CompuMart.

**NEW! FROM COMMODORE**

The CBM 8000 Business Computer is Here! This is a true Business Computer. Features include:

- 80 column
- Responsive Business Style Keyboard
- BASIC 4.0 - with disk commands built in
- 12" monitor - green screen standard. Excellent resolution.
- New screen editor functions

<b>NEW!</b> 8016 (16K Business Computer)	\$1,495
<b>NEW!</b> 8032 (32K Business Computer)	\$1,795
8K- Keyboard N	\$ 795
16K- Keyboard B	\$ 995
16K- Keyboard N	\$ 995
32K- Keyboard B	\$1,295
32K- Keyboard N	\$1,295

**\$100 IN FREE ACCESSORIES**

WITH 16K or 32K Commodore Computer  
When you buy a 16K or 32K Commodore Computer apply \$100 toward Commodore Accessories FREE. Choose from the accessories listed below.

**Educators! Commodore 3 for 2 is back! But, this may be your last chance .**  
☆ . Offer expires August 15, 1980. ☆

Any bona fide school or educational institution will receive one CBM/PET Computer FREE (direct from Commodore) for every two CBM/PET Com-

puters purchased at retail. Call CompuMart for details and ordering information. (All Commodore computers qualify except the new 8016 & 8032.)



We have a complete inventory of Apple computers, peripherals & software. In-stock for immediate delivery- Call us for prices.

**\$200 in FREE accessories with the purchase of a 48K Apple II reg. or Apple II plus**

- 16K Apple reg. or plus- \$1,195 (\$100 in free acces)
- 32K Apple reg. or plus- \$1,295 (\$150 in free acces)
- 48K Apple reg. or plus- \$1,395 (\$200 in free acces)

**PET ACCESSORIES**

**NEW! CBM 8050 DUAL DRIVE FLOPPY DISK**  
All the features of the intelligent CBM 2040 Disk Drive but more powerful software capabilities, and nearly one megabyte of online storage capacity. \$1,695.

**NEW! CBM MODEM**  
High performance 300 BAUD IEEE interfaced modem features accurate teleprocessing communication for your CBM system. **\$395**

**NEW! CBM VOICE SYNTHESIZER**  
Features phoneme synthesis for vocabulary construction. Easy installation. Via user port. **\$395**

PET Accessories (Continued)

Commodore Dual Floppy Disk Drive	\$1,295
Second Cassette from Commodore	\$95
Commodore PET Service Kit	\$30
Beeper-Tells when tape is loaded	\$24.95
Petunia- Play music from PET	\$29.95
Video Buffer- Attach another CRT	\$29.95
Combo- Petunia and Video Buffer	\$49.95
TNW Bi-Dir RS-232 printer x-face	\$229.00
KIM 1 (A Single Board Computer from Commodore)	\$179.00
PET to IEEE Cable	\$39.95
IEEE to IEEE Cable	\$49.95
KIM 1 & Power Supply Package Special	\$200.00

Apple Accessories

PASCAL	\$495
Micromodem	\$379
VisiCalc	\$150
The Controller (Business Package)	SALE \$550
The Cashier (POS System)	SALE \$200
Integer BASIC ROM Card	\$200
Centronics Printer Interface	\$225
Disk and Controller	\$595
Parallel Printer Card	\$180
Communications Card	\$225
Hi-Speed Serial Card	\$195
Firmware Card	\$200
NEW! AppleWriter Text Editor	\$75
Apple Graphics Tablet	\$795

**ATARI 800  
PERSONAL COMPUTER SYSTEM**

**INTRODUCTORY SPECIALES**

To celebrate our commitment to Atari, we are offering the following Atari Specials: note (You must buy an Atari)

- (1) Buy additional memory for your computer, 8K or 16K, and we will double the amount of memory FREE! (A potential savings of \$200)
- (2) Buy the Atari 800 Computer and take \$100 off the purchase price of the Atari 810 Disk Drive or the Atari 820 printer

**Comes with:**

- Computer Console
- BASIC Language Cartridge
- Education System Master Cartridge
- BASIC Language Programming Manual
- 800 Operator's Manual
- ATARI 410 Program Recorder
- Invitation to Programming™ Cassette
- 8K RAM Memory Module™
- 10K ROM Operating System
- Power Supply
- TV Switch Box



**SPECIFICATIONS**

High resolution color graphics  
57 key full stroke keyboard  
Built-in RF modulator for channel 3/4 operation with standard TV set  
Composite video output for use with monitor  
Internal Speaker  
Two cartridge slots for rapid program insertion  
Four internal slots for expansion up to 48K RAM  
6502B Microprocessor  
High speed serial I/O port

**Atari 800 Computer System . . . . . SUPER SALE \$789**

**ATARI 820 PRINTER**

Atari 820 Printer . . . . . \$599.95

**ATARI 810 DISK DRIVE**

Atari 810 Disk Drive . . . . . \$699.95

Upgrade your computer with additional memory. (Note that the Atari 800 Computer comes with 8K of RAM memory and will accept up to 48K).  
Atari 8K RAM Memory Module . . . . . \$124.95  
Atari 16K RAM Memory Module . . . . . \$199.95

**Additional Peripherals**

Paddle Controller (Pair) . . . . . \$19.95  
Joystick Controller (Pair) . . . . . \$19.95

**Atari Software**

Basketball (Uses Joystick Controllers) . . . . . \$39.95  
Video Easel (Uses Joystick Controllers) . . . . . \$39.95  
Super Breakout (Uses Paddle Controllers) . . . . . \$39.95  
Star Raiders (Uses Joystick Controllers) . . . . . \$39.95

**FREE 9" Sanyo Monitor with purchase of any Exidy Sourcerer Computer. \$169 VALUE!**

The Magicians Have Done It Again with the Sorcerer II . . . Expandable to 48K! - Greatly enhanced word processing capabilities.

Z-80 Microprocessor, Full-sized keyboard, ROM PAC Programs • Microsoft BASIC • Powerful Graphics • Serial and Parallel I/O • Dual Cassette I/O Memory • Internally Expandable • S-100 Expansion Option • Plus: Greatly enhanced word processing capabilities.

16K Sorcerer II	\$1,245
32K Sorcerer II	\$1,395
48K Sorcerer II	\$1,495



Single dual-density floppy disk and controller	\$1,100
Second Drive	\$760
S-100 Expansion Unit	\$419
Video Display Disk	\$2,895
Micromodem 100 from D.C. Hayes	\$379



**COMPU MART NOW OFFERS THE ENTIRE DEC LSI-11 PRODUCT LINE CALL FOR PRICES & DELIVERY.**

**THE SINGLE BOARD DEVELOPMENT**



**ROCKWELL AIM 65**

6502 Microprocessor • 20-character, alpha-numeric LED display • Full-size 54-key keyboard with 3 user-defined functions • Fast, on-board 20-column thermal printer • 8K Advanced Interactive Monitor program • Dual cassette interface board • On-board timer • On-board ROM expansion to 12K • 4K on-board RAM • On-board TTY interface • 16 parallel I/O lines • One serial I/O port • KIM compatible edge connectors for even further memory or I/O expansion.

The CompuMart AIM System combines all of our options for the AIM to give you the capabilities of development systems costing 5 to 10 times as much. This system includes a 4K AIM 65 with BASIC and Assembler, and MTU power supply, a Sanyo tape recorder and an EGI Enclosure for the AIM.

CompuMart Aim System ..... \$850.00  
 4K AIM-65 ..... \$515.00  
 Paper for the AIM ..... \$4.75

**The remarkable TI-99/4 Home Computer. Compare it.**

Dollar for Dollar. Feature for feature. Superior color, music, sound & graphics- and a powerful extended BASIC- all built in. Plus a unique new Solid State Speech™ Synthesizer and TI's special Solid State Software.™ Comes complete with the Features you want:

- Powerful TI-BASIC
- Up to 72K total memory capability- 16K RAM, 26K ROM plus up to 30K ROM in TI's Solid State Software Command Modules.
- 16 - color graphics capability
- Music & sound effects
- Built-in equation calculator
- High quality 13" color monitor

Call our Sales Department for Complete Description & Specs.

TI-99/4 Home Computer w/Monitor ..... **SUPER SALE \$899**  
 TI-99/4 Home Computer w/o Monitor ..... \$895  
 TI User Reference Manual ..... \$9.95



**Calculators**

**A CALCULATOR, A SYSTEM, A WHOLE NEW STANDARD.**

The finest calculators available for Science, Engineering & Business.

**HEWLETT-PACKARD'S HP-41C**

HP-41C Calculator ..... \$288.00

The System

Memory Modules. For storing programs or up to 2,000 lines of program memory ..... \$45.00

"Extra Smart" Card Reader. Records programs and databack onto blank mag-cards ..... \$199.00

The Printer. Upper and Lower case, High resolution plotting, Portable Thermal operation ..... \$355.00

Application Modules ..... \$45.00 EACH

Standard pac:

- Statistics,
- Math,
- Financial & Surveying

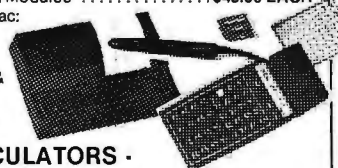

**TI CALCULATORS -**

Three of the finest from the first.

Programmable 59 ... **SUPER SALE \$229**

TI-58c Programmable Calculator (W/continuous memory) ..... \$104.00

TI Programmer ..... \$59.00

Add convenient versatile printing capabilities to your TI Programmable 58C or 59 calculator with the PC-100C thermal printer, plotter.

TI PC-100C ..... \$168.00

TI Talking Translator. The calculator actually speaks! ..... \$300.00

**Printers**

**CENTRONICS PRINTERS**

New! The incredible Model 737- Correspondence and Draft Quality Printing for Under \$1,000. This is the first printer in its class to offer print quality suitable for text processing, plus the performance and application flexibility required for data processing. **\$995**

Tractor Feed Printer- Centronics' Most Popular Model. Perfect for the needs of a small business system. Recommended by Apple and Radio Shack. **\$1,079**

**The Paper Tiger Printer From Integral Data**

Uses standard 1/2 inch roll paper and ribbon  
 40 characters per line  
 Speed: 40 characters per second  
 UL approved

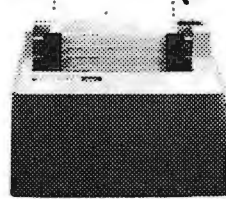

**CompuMart STOCKS THE COMPLETE LINE OF MATROX PRODUCTS. CALL FOR SPECS.**

**The Omni 810 Printer From Texas Instruments**

This Receive-Only printer is very compact and features the 150 cps performance you'd expect from more costly printers. Call for complete specs. **\$1,795.**

High resolution dot matrix impact printer

Standard features include: 4 character 8.3 to 16.5 cpi • 56 cps at 10 char. per in. • Selectable line spacing • 8 switch-selectable form sizes.

The IDS Graphics Option for the Paper Tiger allows full dot pattern control and includes and expanded 2048-byte buffer (a 256-type buffer is standard).

IDS Paper Tiger Printer ..... \$995  
 IDS Graphics Paper Tiger Printer ..... \$1,094

**Terminals**

**Lear Siegler Terminals - Printers at Tremendous Savings- Call CompuMart for Special Sales Prices.**

**ADM-3A**  
 Industries' favorite dumb terminal for some very smart reasons. 12" diagonal screen • Full or half duplex operation at 11 selectable data rates • 1,920 easy-to-read characters in 24 rows of 80 letters • RS-232C interface extension port • Direct cursor addressing  
 Reg. Price \$895 ..... **SALE! CALL US**

**ADM-31**  
 A terminal that's too smart to be considered dumb. Comes complete with keyboard, control logic, character generator, refresh memory & interface • Displays two pages of text instead of one • Field protect mode • Factory installed selected parameters.  
 Reg. Price \$1,450 ..... **SALE! CALL US**

**ADM-42**  
 The semi-intelligent terminal that provides you with flexibility of format, security, and editing, interface, and transmission. Two-page display standard. (Originally expandable to eight) • Blank-ing, blinking, and reverse fields • three ways to TAB • 16 Function keys do the work of 32 • Detachable keyboard.  
**ADM-42 with keyboard. Reg. Price \$1,795 SALE! CALL US**  
**ADM-42 without keyboard. Reg. Price \$1,595 SALE! CALL US**



**HAZELTINE TERMINALS AT SPECTACULAR SAVINGS!**

**Hazeltine 1410**-TTY-style keyboard, 8 baud rates from 110 to 9600, 12" screen, 24x80 display, 5x7 dot Matrix Upper Case, ASC11 character set, 12-key numeric keypad.  
 List Price \$895 ..... **SALE! \$749**

**Hazeltine 1500**- 8 baud rates from 110 to 19,200, and ANSI Standard Keyboard, EIA RS-232, All 94 Upper/Lower Case characters in a high resolution, 7x10 matrix dot display. Much more.  
 List Price \$1,145 ..... **SALE! \$979**

**HAZELTINE 1520** - Take advantage of this huge savings while it lasts! The Hazeltine 1520 is a powerful multi-processor terminal  
 List Price \$1,585 ..... **SALE! \$1,269**

**Monitors**

**EXCLUSIVE FROM COMPUMART! SPECIAL OFFER**

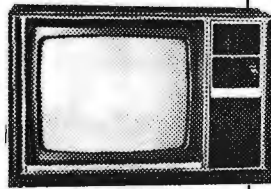

**ZENITH COLOR VIDEO MONITOR**

Beautiful Display Capabilities. Excellent for use with Apple, Atari & Sorcerer Computers.  
 Zenith Color Monitor ..... \$379.00

**SANYO MONITORS**

9-inch reg. \$199 ..... **SALE! \$169**  
 16-inch reg. \$299 ..... **SALE! \$269**  
 Perfect for Apple users ...  
 Sanyo Cassette Recorder \$55

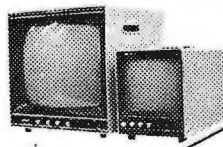

**Peripherals**

**NOVATION CAT™**

**ACCOUSTIC MODEM**

- Answer Originate
- 300 Baud
- Looks good, works great!
- Bell 108
- Low Profile Design
- \$179.00

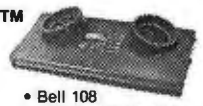

**IMPORTANT ORDERING INFORMATION**

All orders must include 4% shipping and handling. Mass. residents add 5% sales tax; Mich. residents 4%, for sales tax.

**Buy direct from CompuMart and get more than you pay for**

Phones open from 8:30 a.m. to 5:30 p.m. EST, Mon.-Fri. • P.O.'s accepted from D&B rated companies—shipment contingent upon receipt of signed purchase order

- All prices are subject to change without notice
- Most items in stock for immediate shipment—call for delivery quotation • In the Ann Arbor area? Our retail store is open 11:00 a.m. to 7:00 p.m. Tues.-Fri., 10:00 a.m. to 5:00 p.m. Saturdays (closed Sun. and Mon.)

**TO ORDER CALL: 1-800-343-5504**  
 IN MASS 617-491-2700



Member Computer Dealers Assoc.

**COMPUMART**

We've had a reputation for dependability since 1971



**270 THIRD ST. DEPT 107 CAMBRIDGE, MA. 02142**

# MICRO MART

16K UPGRADE KIT FOR TRS-80, APPLE, PET, SORCERER \$70  
MICROPOLIS 8" Hard Disk DRIVE with

Power, S-100 controller  
9 Megabyte \$3995  
27 Megabyte \$4495  
45 Megabyte \$4995

TI 994 \$1050.00  
Without Monitor \$895.00

DISCOUNTS on EXIDY SORCERER, PET, most other systems, peripherals, and software.

MICROCOMPUTERS,  
PERIPHERALS AND SOFTWARE

1015 NAVARRO SAN ANTONIO, TEXAS 78205  
512/272 1427

Circle 247 on inquiry card.

# Hard Copy Printer For Your Computer

## COMPLETELY REFURBISHED

Model 33, Friction Feed  
Receive only, Table Model, 110  
Baud, 8 level ASCII Code, 20  
MA Loop

### \$279.95

Complete line of options available. Check  
or M.O. \$50 Deposit on C.O.D. orders. N.J.  
Residents add 5% Sales Tax

## RED ARROW ELECTRONICS CORP.

1217 Summit Ave.,  
Union City, N.J. 07087  
(201) 863-7916

Circle 248 on inquiry card.

# T-SHIRTS

If you're not  
part of the  
solution



Then you're part of  
the precipitate

The computer  
is only a tool  
There will always  
be room for  
unbridled avarice

HAUTE COUTURE for the specialist. At last!  
Technical tee shirts with subjects from the fore-  
front of science — and elsewhere — based on  
findings from the I.S. R & D labs.  
Extensive catalog of titillating topics and tan-  
talizing technical tidbits to tickle your tastes —  
and outrage your colleagues 30¢ (stamps O.K.)

"RESEARCH IS WHAT  
I AM DOING WHEN  
I DON'T KNOW  
WHAT I AM DOING"

QUALITY HANES 50-50  
lt. blue, tan, gold, yellow  
Sizes: S-M-L-XL  
\$7.25-2/\$14-3/\$20.  
4/\$25-5+/\$46.00 @

## INTELLECTUAL SMARTTEES

Star Rt. Box 38, Winthrop, WA 98862  
Mastercharge Visa (509) 996-2576

Circle 249 on inquiry card.

For Your TRS-80  
DISK SYSTEM  
**ElectraSketch**  
Add Animation to your  
TRS-80 Programs

- Animation Compiler and Graphics Editor Package
- Add smooth, fast action to basic programs
- Create ad layouts, newsletter covers, posters

**\$14.95**

Write or call for complete catalog

## MACROTRONICS, inc.

1125 N. Golden State Blvd. / Suite G  
Turlock, CA 95380 (A)  
(209) 667-2888 / 634-8888

We are experiencing telephone difficulties,  
please keep trying.

California residents add 6% tax

VISA or MC

Circle 250 on inquiry card.

# Acoustic Coupler Sale



- 1 Yr Warranty (RTN to Factory)
- Latest Technology (Phose Lock Loop)
- Up to 300 Baud
- EIA and/or 20 MIL

Technology Design 300

**\$145.00\***

\*Texas Residents Add 5% Sales Tax

Please Rush: Qty. \_\_\_\_\_ TD300 Coupler

To: \_\_\_\_\_

Check Enclosed zip code \_\_\_\_\_

Master Charge No. \_\_\_\_\_

Visa No. \_\_\_\_\_

Exp. Date \_\_\_\_\_

Signature \_\_\_\_\_

Mail to:

TBI 11332 Mathis Ave. / Suite 109  
Dallas, Texas 75229 / 214-247-1053

Circle 251 on inquiry card.

# CONSULTANT'S BILLING SYSTEM

An automated client/project billing system designed for use by the professional consultant.

- Client/Project Files
- Labor Distribution
- Daily Time & Expenses
- Posts Payments/Adjustments
- Aged Accounts Receivable
- Monthly Invoices
- Project Summary
- Fixed and T&M Projects

Requires CBASIC-2 and 32K CP/M®

Distributed on 8" CP/M compatible diskette. Includes CBASIC-2 Source Code and a 25 page User's Manual including installation procedures.

\$79.00 check with order

## CEDAR HILL SOFTWARE

P.O. BOX 652  
STAFFORD, VA 22554  
(703) 659-2890

® CP/M is a registered trademark of Digital Research

# COLOR SOFTWARE

**ROAD RACE:** Race around 2.25 mile course. 1 or 2 players. \$15. Apple II or Atari 16K.

**3-D STARTREK:** Discover new planets, fight Klingons. \$15. Apple II, Atari 16K, TI 99/4.

**BLACKJACK:** Popular card game for 1 to 3 players. \$15. Atari 16K, TI 99/4.

**MAJOR LEAGUE BASEBALL:** Manage Major League teams and make all strategic decisions. \$25. For Apple II 48K, Apple-soft ROM, Disk.

All the above programs use  
hi-resolution color graphics.

## COLOR SOFTWARE

5410 W. 20th St.  
Indianapolis, IN 46224

Circle 252 on inquiry card.

# A-STAT 79

A Statistical Package and File Management System  
For the Apple II Computer™

A subset language of P-STAT 78™

Computes:  
Frequencies

Bivariate Tables - Chi Squares  
Correlation Matrices  
Multiple Regressions

Complete Variable Transformations

Uses standard DOS text files and EXEC's

A-STAT 79 on disk with manual ... \$100.00  
32K or 48K versions - all programs in Applesoft™

Rosen Grandon Associates  
296 Peter Green Road  
Tolland, Connecticut 06084  
(203) 875-3541

Apple II is a trademark of Apple Computer, Inc.  
P-STAT 78 is a trademark of P-STAT Inc. Princeton, N.J.  
A-STAT 79 is copyrighted by Gary M. Grandon

# 80X24 VIDEOTERM™ 7X9 MATRIX DISPLAY FOR

LOWER CASE W/ DESCENDERS **APPLE II®**



\* REGISTERED TRADE MARK OF APPLE COMPUTER INC.

80 columns by 24 lines with easy to read 7x9 dot matrix, upper and lower case with descenders using shift lock feature • 1K firmware incorporates PASCAL and BASIC protocols so user is not required to enter machine language programs or change PASCALS. Misc. info. or Gotoxy files • Compatible with all APPLE II peripherals so user won't need new software patches for future software products • Crystal controlled dot clock for excellent character stability • VIDEOTERM is the same size as the Apple language card and power consumption is held to a minimum through the use of CMOS and lower power devices • Character set can be user definable up to a maximum of 128 symbols of 8x16 dot matrix font • Display control character mode and four standard display formats controlled by escape sequences • Built in light pen capability • Inverse display mode • 50/60 HZ operation • Sockets on all IC's.

PRICE: Without graphic EPROM \$345

OPTIONS: Graphics EPROM (Incdwg) \$25  
VIDEO SWITCH PLATE (Incdwg)  
In case slot to choose between  
APPLE II® and VIDEOTERM \$12  
MANUAL: \$15



VIDEX, 3055 N.W. Tristite Pl., Corvallis, OR 97330 Phone (503) 750-5521

Circle 254 on inquiry card.

# WE WILL NOT BE UNDERSOLD

## 16K MEMORY UPGRADE KITS

for TRS-80\* Apple II, Sorcerer (specify)

\$59

## PRINTERS

### NEC Spinwriter



#### Letter Quality High Speed Printer

Includes TRS-80\* interface software, quick change print fonts, 55 cps, bidirectional, high resolution plotting, graphing, proportional spacing

\$2689

With Tractor Feed \$2889

### DIABLO 1650

#### Letter Quality High Speed Printer

Prints at 40 cps, using 88, 92, or 96 char. Metalized printwheels. Vertical resolution  $\frac{1}{8}$ " ; Horizontal  $\frac{1}{20}$ ". Capable of proportional spacing, bidirectional printing, and graphics under software control. Bidirectional normal and direct tabs. Left, right, top and bottom margins. Friction and tractor feed. R.O. \$2890 KSR \$3285

### 779 CENTRONICS TRACTOR FEED PRINTER

\$969

Same as Radio Shack line printer I

### 737 CENTRONICS FRICTION & PIN FEED PRINTER

\$849

9 x 7 matrix

### 730 CENTRONICS FRICTION & PIN FEED PRINTER

\$639

7 x 7 matrix Same as Radio Shack line printer II

### P1 CENTRONICS PRINTER

\$269

Same as Radio Shack quick printer

### PAPER TIGER (IP440)

\$948

Includes 2K buffer and graphics option

### TI-810 Faster than Radio Shack line printer III

\$1575

Parallel and serial w/TRS-80\* interface software with upper and lower case and paper tray

\$1665

### OKIDATA Microline 80 Friction and pin feed

\$639

Tractor Feed, friction, and pin feed

\$739

### EATON LRC 7000 + 64 columns, plain paper

\$349

### CAT MODEM Originate and answer same as

\$156

Radio Shack Telephone Interface II

### LEEDEX MONITOR Video 100

\$135

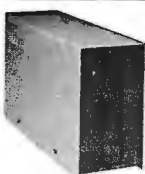

## DISK DRIVES

\$299

More capacity than Radio Shack 35 Track (80 K Bytes) drives. Fully assembled and tested. Ready to plug-in and run the moment you receive it. Can be intermixed with each other and Radio Shack drive on same cable. TRS-80\* compatible silver enclosure.

90 DAY WARRANTY. ONE YEAR ON POWER SUPPLY.

### FOR TRS-80\*

CCI-100 5 1/4", 40 Track (102K Bytes) for Model I \$299

CCI-200 5 1/4", 77 Track (197K Bytes) for Model I \$549

CCI-800 8" Drive for Model II (1/2 Meg Bytes) \$795

### For Zenith Z89

CCI-189 5 1/4", 40 Track (102K Bytes) add-on drive \$394

Z-87 Dual 5 1/4" add-on drive system \$995

DISKETTES — Box of 10 (5 1/4") — with plastic library case \$24.95

8" double density for Model II (box of 10) \$36.49

## COMPLETE SYSTEMS

TRS-80\* LEVEL II-16K with keypad \$699

TRS-80\* Expansion Interface \$249

ZENITH Z89, 16K expands to 48K, all-in-one computer \$1949

ZENITH Z19 \$740

ATARI 400 \$492 ATARI 800 \$839 TI 99/4 \$894

MATTEL INTELLIVISION \$249

NORTH STAR Horizon 1 32K, Double Density \$2149

Horizon 2 32K, Double Density \$2609

64K, Double Density \$3229

## DISK OPERATING SYSTEMS

PATCHPAK #4 by Percom Data \$ 8.95

CP/M for Model I, Zenith \$145.00

CP/M for Model II, Altos \$170.00

NEWDOS Plus — with over 200 modifications 35track \$ 89.00

and corrections to TRS-DOS 40 or 77 Track \$ 99.00

## SOFTWARE FOR THE TRS-80\*

Software / Manual  
w/Manual / Alone

**CCI-INVESTMENT PORTFOLIO MANAGER:** This is what investors have been waiting for! This powerful program was developed by security analysts working with software designers. It comes on one cassette—16K LEVEL II BASIC on one side, 32K DISK BASIC on the other. Store and report data; Review your portfolio; Produce detailed status, value, gain, and security analysis; Compare alternatives \$49.95/\$10

**INTELLIGENT TERMINAL SYSTEM ST-80-III BY LANCE MIKLUS:** Enables a TRS-80\* to act as a dial-up terminal on any standard time sharing network. Provides a TRS-80\* with control key, ESC Key, Repeat Key, Rub Out Key, Break Key, full upper and lower case support, selectable printer output and program selectable transmission rates \$139/\$10

**CC-A-DATA MANAGEMENT SYSTEM:** Automate your information processing tasks. You can create a file of customer information; quickly and easily add, delete or update records; search a file; keep a file in order of the value in any field; and print records and labels in any desired sequence or from just a part of a file. Requires 32K TRS-80 and one drive. \$74.95/\$10

**CSA-MAILIST SYSTEM:** Creates, maintains and efficiently utilizes a name, address and telephone number file. 400 individual name/address entries can be maintained on a single density mini-floppy, and are manipulated directly by record number (direct access file method). Sorts can be performed, name + address combinations can be coded. Listing-directories and labels can be printed. A conversion facility is provided to convert most sequential name, address file formats into direct. Requires 32K TRS-80 and one drive. \$49.95/\$10

### S & M SYSTEMS

**INSEQ-80™:** Indexed Sequential Access Method (ISAM) for the TRS-80 Model I. A must for any writing business programs. Eliminates wasted disk space from direct record processing. Split second access to any record. Access data records instantly via alpha/numeric "key" eg. Part NR, zip code or sequentially in ascending key sequence. Add/modify records in any order. Access up to three files per program—Files may be spread over multiple disks. Machine language processing from your basic program. Utility program to convert direct files to INSEQ-80 format. \$49.95/\$10

**FULLY INTERACTIVE ACCOUNTING PACKAGE:** ISAM (INSEQ-80) based. Includes General Ledger, Accounts Payable, Accounts Receivable and Payroll. System runs "stand alone" or "co-ordinated G/L" at users option. Based on Osborne accounting method. Requires 32K, TRS-80, 2 or 3 drives. N/A CA.

**General Ledger \$99/\$10**  
**Accounts Receivable \$99/\$10**  
**Accounts Payable \$99/\$10**  
**Payroll \$99/\$10**

Osborne books: Req'd as additional documentation \$20 ea

**INVENTORY** Requires 32K, TRS-80, 1 drive \$125/\$10

**INSERT-80:** Callable form BASIC via USR. Sorts "Random" Disk Files. "Disk" to "Disk" sort times—350 records in 35 secs, 1000 records in 6 minutes, 3500 records in 12 minutes. Machine language processing. Up to 35 sort keys ascending/descending. Utility to build BASIC program. Runs under NEWDOS \$49.95/\$40

## CP/M BASED SOFTWARE for Zenith, Altos, Radio Shack, Apple

Software / Manual  
w/Manual / Alone

**MICROSOFT BASIC-80:** Disk Extended BASIC ANSI compatible with long variable names, WHILE/WEND, chaining, variable file records. \$325/\$25

**BASIC COMPILER:** Language compatible with BASIC-80 and 3-10 times faster execution. Produces standard Microsoft relocatable binary output. Includes MACRO-80 Also linkable to FORTRAN-80 or COBOL-80 code modules. \$350/\$25

**FORTRAN-80:** ANSI 66 (except for COMPLEX) plus many extensions. Includes relocatable object compiler, linking loader, library with manager. Also includes MACRO-80 (see below) \$425/\$25

**COBOL-80:** Level 1 ANSI '74 standard COBOL plus most of Level 2. Full sequential, relative and indexed file support with variable file names. STRING, UNSTRING, COMPUTE, VARYING/UNTIL, EXTEND, CALL, COPY, SEARCH, 3-dimensional arrays, compound and abbreviated conditions, nested IF. Powerful interactive screen-handling extensions. Includes compatible assembler, linking loader, and relocatable library manager as described under MACRO-80. \$700/\$25

**MACRO-80:** 8080/Z80 Macro Assembler. Intel and Zilog mnemonics supported. Relocatable linkable output. Loader, Library Manager and Cross Reference List utilities included. \$149/\$15

**EDIT-80:** Very fast random access text editor for text with or without line numbers. Global and in-line commands supported. File compare utility included. \$89/\$15

**Z-80 SOFTCARD FOR APPLE:** Your key to future software expansion. Get the best of both worlds, Apples 6502 and CP/M Z-80. Plug in the card and get a Z80. Supports Apple language card and all Apple peripherals. Comes with set of three manuals. \$338/\$75

**muSIMP/muMATH-79:** At last, a sophisticated math package for microcomputers. muMATH performs mathematical operations efficiently and accurately. Use it to solve equations and simplify formulas; or perform exact arithmetic and symbolic matrix inversion. muMATH is an invaluable tool for engineering and scientific applications involving lengthy, analytical computations. It is also an ingenious teaching method for all levels of math from arithmetic to calculus. muMATH is implemented in muSIMP, a highly structured language for complex symbolic manipulation. muSIMP/muMATH Package, CP/M versions. \$235/\$25

**CCI-TELNET VERSION 5:** A communication Package which enables microcomputer users to communicate both with Large Mainframes and other microcomputers. Extensive commands make it useful in many applications where communication between computers is necessary. Powerful terminal mode enabling user to save all data from a session on disk. Completely CP/M compatible. Multiple communication protocols supported. Able to transfer files in both directions without protocol where the other machine does not support any protocol. Extensive ON-SCREEN help. Source code provided. \$149/\$15

**MICROPRO-WORD-STAR:** Menu driven visual word processing system for use with standard terminals. Text formatting performed on screen. Facilities for text pagination, page number, justify, center and underscore. User can print one document while simultaneously editing a second. Edit facilities include global search and replace. Read/Write to other text files, block move, etc. Requires CRT terminal with addressable cursor positioning. \$445/\$40

DEALER (NATIONAL/INTERNATIONAL) INQUIRIES INVITED

Send for FREE Catalogue

# The CPU SHOP

TO ORDER CALL TOLL FREE 1-800-343-6522

Massachusetts residents call (617) 242-3361

For detailed technical information, call 617/242-3361

Hours: 10AM-6PM (EST) M-F (Sat. till 5)

\*TRS-80 is a Tandy Corporation Trademark

5 Dexter Row, Dept. B7M  
Charlestown, Massachusetts 02129

Massachusetts residents add  
5% sales tax

Quantities on some items are limited





GO DIGITAL!

ZEMCO'S COMPUCRUISE

A 22 FUNCTION DIGITAL CRUISE-CONTROL, FUEL/DISTANCE/MILEAGE MONITOR, IN-DOOR/OUTDOOR TEMPERATURE MONITOR, BATTERY VOLTAGE MONITOR, ENGLISH OR METRIC READOUT, AND MORE. EASY TO INSTALL AND OPERATE. MODEL 44 WITH CRUISE IS \$159.95. MODEL 41 WITHOUT CRUISE IS \$129.95. A SPORTY VERSION WITH NO CRUISE AND 12 ENGLISH/METRIC FUNCTIONS IS \$89.95.

OTHER LINES CARRIED ARE: 1) NEW APF (6800 BASED) PERSONAL COMPUTER (MODEL IM-1) WITH DIGITAL TAPE STORAGE, GRAPHICS, PROGRAMMABLE AUDIO. OUR LOW PRICE IS \$549.00. 2) BASE 2 PRINTERS WITH 2K MEMORY AND TRACTOR FEED FOR \$575.00.

MAKE CHECK PAYABLE TO:

BEAR ESSENTIALS, INC.  
5300 LK. WOUSSICKET RD.,  
WALNUT COVE, N.C. 27052.

FOR INFORMATION OR COD ORDERS CALL (919) 595-4124. (NC RESIDENTS ADD 4% SALES TAX.)

Circle 256 on inquiry card.

DISK DRIVE/CAT

★SALE★

Shugart  
SA801R  
for  
RS MOD. II  
ONLY

\$485

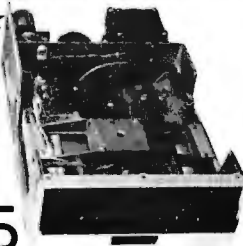

Hazeltine 1000 (unused) . . . . . \$ 499  
Shugart SA400 . . . . . 279  
Pertec FD200 . . . 279—FD250 . . . 359  
MPI B51 . . . . . 279—B52 . . . 349  
SA801R w/PS/Cab. . . . . 750  
Dual Drives w/PS/Cab. . . . . 1640

LIMITED QUANTITIES

MTI

3304 W. MacArthur Blvd.  
Santa Ana, CA 92704

(714) 979-9923

Circle 257 on inquiry card.

THE BIT BUCKET  
(617) 783-3144

ITEM	PRICE	SAVE
ATARI 800	810.00	25%
ATARI 400	504.00	25%
RECORDER	63.00	30%
810 DISK	525.00	25%
16K RAM	150.00	25%

ALL ROM CARTRIDGES 20% OFF  
ALSO

CAT MODEMS 156.00  
10-12% OFF ALL PETS!

SEND FOR A COMPLETE LIST  
OF OUR PRODUCT LINE.

TO ORDER:

SEND CHECK OR MONEY ORDER TO:

THE BIT BUCKET

168 NORTH BEACON ST.

P.O. BOX 365

NEWTON HIGHLANDS, MA 02161

PERSONAL CHECKS TAKE 2 WEEKS TO

CLEAR. ALL EQUIPMENT INCLUDES

FACTORY WARRANTY. WE SHIP COLLECT

BY UPS. MASS RESIDENTS ADD 5% TAX.

"A MICROBUCK SAVED IS

A MICROBUCK EARNED."

Circle 258 on inquiry card.

MEMOREX  
DISKETTES  
VERBATIM

MINI Soft Sector \$325 Ea. in boxes of 10  
10 Sector  
16 Sector

STANDARD \$340 Ea. in boxes of 10  
Soft or Hard Sector

PLASTIC BOX for Standard \$390  
10 Diskettes

Visa, MasterCharge, Cash, C.O.D.

Dealer Inquiries Invited  
MANCHESTER EQUIPMENT CO., Inc.  
30 Midland Ave. • Hicksville, N.Y. 11801  
Call Collect: (516) 433-0613

Circle 259 on inquiry card.

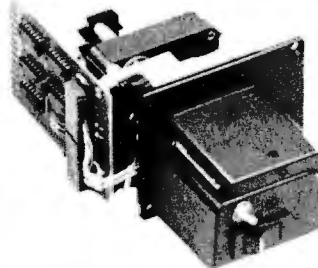

350 Char/Sec Low Cost Loader

Solid state photoelectronic components read all standard 5, 6, 7 or 8-level tapes. Smooth, quiet AC drive. Reliable high-speed paper tape data entry. Data amplifiers and "character ready" output available for CMOS or TTL interfaces. Standard interface or to your interface specifications. Fanfold boxes available.

Addmaster Corporation, 416 Junipero Serra Drive, San Gabriel, CA 91776, Telephone: (213) 285-1121, Telex: 674770 Addmaster SGAB

Circle 260 on inquiry card.

Factory Direct  
Products for Your  
NEW! Computer & Your Home NEW!  
the BRUTES™

Heavy duty solid-state AC switches control your water heater or other heavy loads. Opto-isolated - 1500VAC isolation. All units pretested & baked in oven. TTL logic level compatible - 5V @ 20-50 ma.

TA-4020	120/240VAC@40A	\$49.95
TA-8020	480 VAC @ 40A	\$49.95
TA-2030	120 VAC @ 60A	\$99.95
TA-4030	240 VAC @ 60A	\$99.95

the WATCHDOG™ \$29.95

Power failure plugs into standard outlet. Audible buzzer lets you know immediately when power fails. Alerts you to check your freezer, compressors, alarm clock, and other critical devices you depend on.

the SPIKE-SPIKER™ \$44.95

Power console w/solid-state transient absorber plus conducted RF "hosh" filters. Compact desktop unit comes complete with integral on-off switch, fuse, pilot light, and 8 120 VAC protected & individually switched convenience outlets. Helps protect valuable equipment from lightning, power line transients and other interference. Makes it easy to turn off all your equipment at one time. No more unplugging & replugging a zillion power cords.

Kalglo Electronics Co. Inc.

Colony Drive I.P., Box 2062, Bethlehem, PA 18001

215-865-0006

Out of state call toll free 1-800-523-9685

Master Charge, VISA, Check w/order or COD

Circle 261 on inquiry card.

PET<sup>®</sup> TRS 80<sup>®</sup> THE SANYO<sup>®</sup> LEEDEX<sup>®</sup>  
GREEN  
SCREEN

- IMPROVE IMAGE CONTRAST
- REDUCE EYE FATIGUE
- ENHANCE SCREEN LEGIBILITY
- PROVIDE A MORE PLEASING DISPLAY
- GIVE A DISTINCTIVE PROFESSIONAL LOOK TO YOUR SYSTEM

The GREEN SCREEN is custom molded to fit nicely over the picture tube. It ingeniously mounts in seconds without any tools.

\*\*\*\*\*

CALL: (212) 296-5916

or send \$12.50 + \$2 S&H



ALPHA product co.

85-71, 79th St., Woodhaven, N.Y. 11421

Circle 262 on inquiry card.

ALTAIR-PRODUCT CLOSEOUT  
AT COST!!

8800B FRONT PANEL CPU'S  
8800BT TURNKEY CPU'S  
3202 DUAL DISC DRIVES  
SYSTEMS DESKS  
1312 TURNKEY W/DUAL MINI DRIVES  
QUIME DAISEY WHEEL PRINTERS  
CENTRONICS PRINTERS  
ICOM 3712 DUAL DISC DRIVE  
ICOM 3812 DUAL DISC DRIVE  
8800 TURNKEY BOARDS  
4P 10 PARALLEL INTERFACE  
16K STATIC RAM  
FLOPPY CONTROLLERS  
MINI-DISC CONTROLLERS  
A/D BOARDS  
COMPLETE LINE OF ALTAIR INTERFACE BOARDS  
STOCK - IMMEDIATE DELIVERY

The Computer Systems Store, Inc.

40 East 52nd Street

New York, NY 10022

212-832-2161

CASH/MONEY ORDER, U.S. FUNDS

PASCAL

For programmers learning or desiring to learn PASCAL for the APPLE computer.

LEARN BY  
EXAMPLE

Three practical-useful PASCAL programs (Text & Code) are now available on minidisk for only \$55.00. Filecreate, fileupdate, and filesearch will help you produce in just a very short time. Order today from:

Personal Programs By Victor

P.O. Box 60034

Sunnyvale, CA 94086

(CA Residents add \$3.57 Tax)

CUSTOM PROGRAMS UPON  
REQUEST

Circle 263 on inquiry card.

# Precision Engineered Drives...

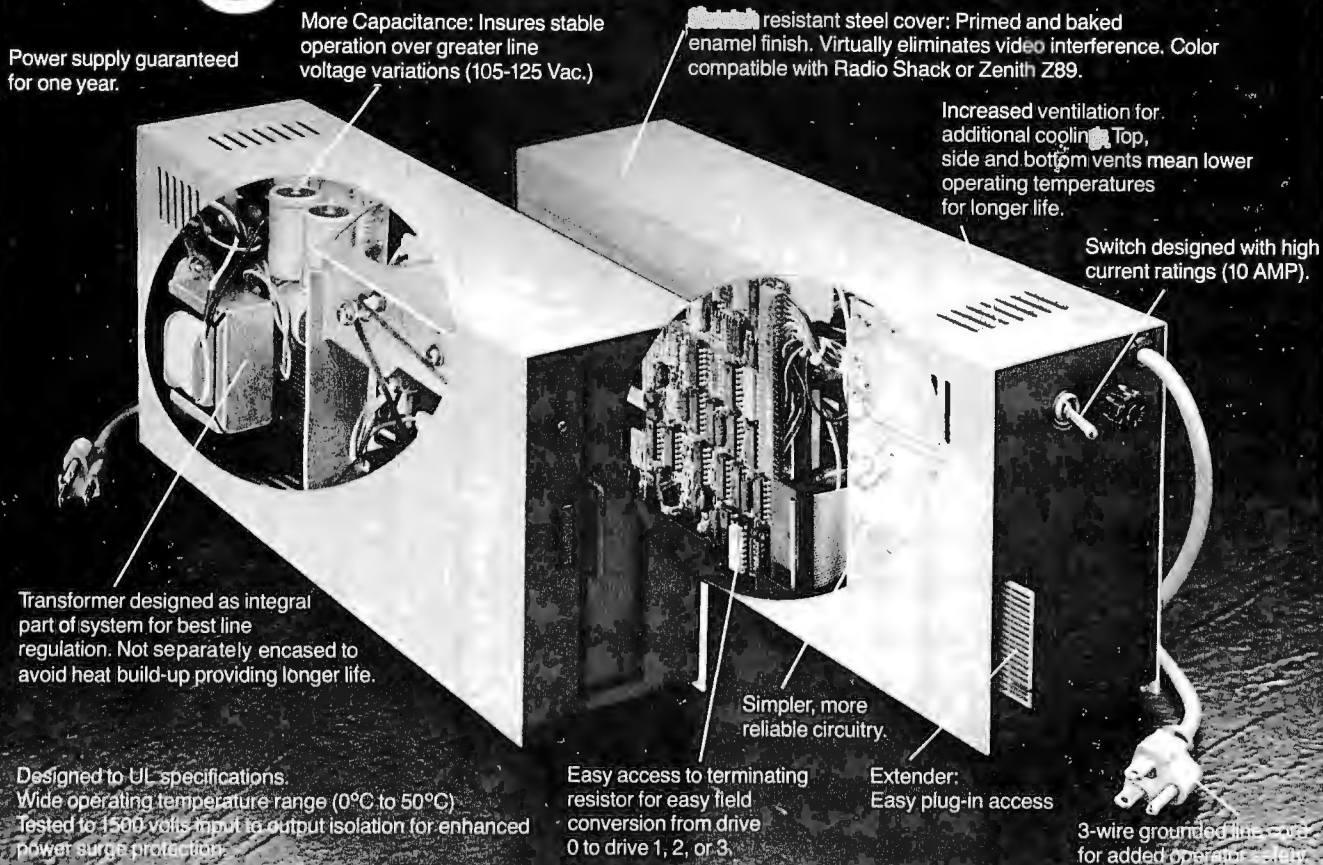

Power supply guaranteed for one year.

More Capacitance: Insures stable operation over greater line voltage variations (105-125 Vac.)

Resistant steel cover: Primed and baked enamel finish. Virtually eliminates video interference. Color compatible with Radio Shack or Zenith Z89.

Increased ventilation for additional cooling. Top, side and bottom vents mean lower operating temperatures for longer life.

Switch designed with high current ratings (10 AMP).

Transformer designed as integral part of system for best line regulation. Not separately encased to avoid heat build-up providing longer life.

Designed to UL specifications. Wide operating temperature range (0°C to 50°C). Tested to 1500 volts input to output isolation for enhanced power surge protection.

Easy access to terminating resistor for easy field conversion from drive 0 to drive 1, 2, or 3.

Simpler, more reliable circuitry.

Extender: Easy plug-in access

3-wire grounded line cord for added operator safety.

With the number of disk drives on the market increasing, more and more people are beginning to ask what's underneath that cover.

The CCI™ series of disk drives have been designed for long life and ease of operation. The features shown above are what set our CCI drives apart from the rest. With a CCI drive you get an integrated professional design!

If you're still not convinced that you get the most for your money with a CCI drive, just ask for our complete specifications sheet. Then, compare our disk drives to anyone else's.

## 5 1/4" DRIVES

CCI-100	40 Track (102K Bytes) for TRS-80* Model I	\$399.00
CCI-189	40 Track (102K Bytes) for Zenith Z89	\$499.00
CCI-200	77 Track (197K Bytes) for TRS-80* Model I	\$675.00

## 8" DRIVES

CCI-800	77 Track (1/2 Meg Bytes) for TRS-80* Model II	\$895.00
---------	---	----------

All CCI drives are also available for 220 Vac (50Hz) operation.

## Operating Systems

NEWDOS Plus for 5 1/4", 40 and 77 Track Drives—with over 200 modifications and corrections to TRSDOS	\$110.00
CP/M for Model I, Zenith	\$150.00
CP/M for Model II, Altos	\$199.00

## Software by S&M Systems

INSEQ-80™—Indexed Sequential Access Method (ISAM) for the TRS-80 Model I.

Four machine language programs that can be called from your BASIC program via ISR functions to access records either sequentially or randomly. The INSEQ-80 programs maintain all indexes and chains for you. Includes reorganization utility to consolidate files. **\$49.95**

Professional Business Software using INSEQ-80 for the TRS-80\* Model I and Zenith Z89.

Accounts Payable, Accounts Receivable,	per package \$99.00
General Ledger, Payroll	per package \$125.00
Inventory	

# ComputerCity™

175 Main Street, Dept. B-7, Charlestown, MA 02129  
Hours: 10AM-6PM (EST) Mon.-Fri. (Sat. till 5).

**TO ORDER CALL**  
**TOLL FREE 1-800-343-6522**  
**TWX: 710-348-1796**

Massachusetts residents call 617/242-3350  
For detailed technical information, call 617/242-3350.  
Freight Collect, F.O.B. Charlestown.

\*TRS-80 is a trademark of the Tandy Corporation

Products also available from: Radio Shack, NEC, Centronics, Paper Tiger, TI, Altos, MPI, Zenith, ATARI, Mattel, PET, OKIDATA, Apple, Eaton/LRC.

**FRANCHISE AND DEALER (NATIONAL/INTERNATIONAL) INQUIRIES INVITED**

**Retail Stores: MA: Burlington, Charlestown, Framingham, Hanover NH: Manchester RI: Providence**





Keepers—Finders

## FILING SYSTEM FOR COMPUTER DISKETTES



Clear, non-glare vinyl holders with pockets on both sides to hold standard 8" diskettes plus a center pocket to hold standard 8 1/2 x 11 sheets of paper or print-outs. Holders fit standard 3-ring binders. Write for FREE sample or send \$8.95 for a package of 10 holders plus \$1.75 for shipping and handling.

Try one FREE!

Just send 50¢ to cover postage & handling.



BUSINESS INFORMATION SYSTEMS

BIS, INC., P.O. BOX 969, BRENTWOOD, TN 37027  
(615) 373-2380

Circle 265 on Inquiry card.

CP/M → IBM  
Compatibility with

## REFORMATTER™

For \$195 you can now transfer data between large and small systems.

REFORMATTER™, a Diskette Utility Program, enables you now to transfer textual data files in either direction between Z-80 or 8080 based micros operating under CP/M and IBM systems using 3741 diskettes.

For detailed information contact  
MicroTech Exports  
912 Cowper Street  
Palo Alto, CA 94301

TWX: 910-370-7457 MUH-ALTOS

Dealer & OEM discounts available

Circle 266 on inquiry card.

## H9 OWNERS!

Upgrade your video terminal with one of these long overdue kits:

**GRAFIX** — Graphical display capabilities assembled and tested \$69.95. Kit \$59.95.

**CURSOR CONTROL** — A total of 8 functions assembled and tested \$34.95. Kit \$29.95.

**FLICKER FREE** — 4800 baud operation assembled and tested \$79.95. Kit \$69.95.

All have a full 6 month warranty.

**NORTHWEST COMPUTER SERVICES, INC.**

8503 N.E. 30th Avenue  
Vancouver, WA 98665

Circle 267 on inquiry card.

## S-100 VOICE

The ARTICULATOR board allows you to record, store, and playback any vocabulary on your S-100 computer. Input speech is digitized by the ARTICULATOR and sent to the computer via an on-board port for storage at 1K to 2K bytes/sec. This data is then sent back from the computer to the ARTICULATOR for very high quality playback. On-board VOX switching minimizes memory storage requirements.

PRICE — \$289 A&T  
AVAILABLE NOW

Quintrex, Inc., 9185 Bond  
Overland Park, Ks. 66214  
(913) 888-3353

Circle 268 on inquiry card.

## OHIO SCIENTIFIC SYSTEMS

CALL TOLL FREE  
(800) 558-0870

or

WRITE FOR CATALOG

**FARAGHER & ASSOCIATES**

7635 BLUEMOUND  
MILWAUKEE, WI 53213  
(414) 258-2588  
In Wisconsin

Circle 269 on inquiry card.

**LOOK!** For the best buy in the West...  
Buy from Kenabco Sales

...GET THE PROOF, GET A QUOTE!

Example:

Cromenco C-S-3 64K List \$6,990 Sale \$5,395

Cromenco Hard Disk List \$6,995 Sale \$5,995

Cromenco 11 Meg. Byte List \$9,995 Sale \$7,695

Cromenco Z-2H 64K 11 Meg. Byte List \$9,995 Sale \$7,695

Comparable discounts on Complete Systems and other brands of equipment.

159 Catherine Lane • Grass Valley, CA 95945  
(916) 273-4453

Circle 270 on inquiry card.

## ATTENTION: S-50 BUS-USER S-100 INTERFACE

Open up your computer system to the real world. Now at last there is an S-50 to S-100 interface available that allows you to be compatible with any S-100 Bus Interface system, I/O media or memory system. This third generation S-50 Bus interface, which is chosen by professionals and experts features:

- Selectable memory addressability
- Selectable I/O Device Addressability
- Up to 64K addressability
- Assembled, tested, and guaranteed for the low price of \$129.95

**AL NOBLE**  
COMPUTER CORPORATION

P.O. BOX 7035  
PORTSMOUTH  
VIRGINIA 23701

PHONE: (804) 465-1814

Circle 271 on inquiry card.



**Dysan**  
CORPORATION

Solve your disc problems, buy 100% surface tested Dysan diskettes. All orders shipped from stock, within 24 hours. Call toll FREE (800) 235-4137 for prices and information. Visa and Master Card accepted. All orders sent postage paid.

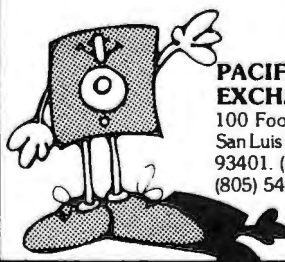

**PACIFIC EXCHANGES**  
100 Foothill Blvd.  
San Luis Obispo, CA  
93401. (In Cal. call  
(805) 543-1037.)

Circle 271 on inquiry card.

## Floppys & Systems Repair

### DRIVES

- Per Sci - Shugart
- Pertec - Micropolis

### COMPUTERS

- Apple - TRS-80

**Computer Service Center**

1023 N. La Brea  
Hollywood, CA 90038  
(213) 851-2226

Circle 272 on inquiry card.



# Try to beat our prices!

## SUPERBRAIN<sup>®</sup> by Intertec

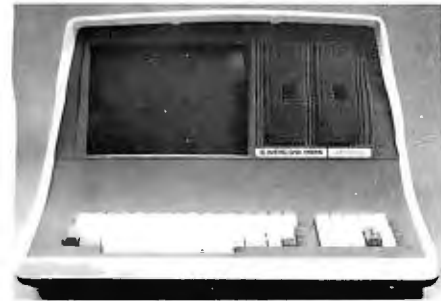

Self-contained computer with dual disks and two RS232C ports. Complete with CP/M<sup>®</sup> 2.2 and BASIC.

32K Double Density, List \$2995 . **\$2685**

64K Double Density, List \$3345 . . . . . \$2883

64K MiniMicroMart-upgraded to Quad Density . . . . . **SPECIAL \$3395**

## VIDEO TERMINALS

INTERTUBE II, List \$995 . . . . . **ONLY \$ 799**

SOROC 120, List \$995 . . . . . **SPECIAL \$ 729**

1Q140, List \$1495 . . . . . **SPECIAL \$1149**

PERKIN-ELMER 550, List \$997 . . . . . \$ 799

with anti-glare screen, \$1027 . . . . . \$ 829

HAZELTINE 1410, List \$900 . . . . . \$ 749

1420 . . . . . \$ 849

1500, List \$1225 . . . . . \$ 879

1510, List \$1395 . . . . . \$1089

1520, List \$1650 . . . . . \$1389

ADDS R-20, List \$995 . . . . . \$ 945

LEAR SIEGLER ADM3A, Assembled . . \$ 849

TELEVIDEO 912 B or C . . . . . \$ 789

920 B or C . . . . . \$ 849

## PRINTERS

ANADEX DP-8000 . . . . . **SPECIAL \$ 749**

INTEGRAL DATA IP-125 **NOW ONLY \$ 689**

IP-125 w/1210 option, \$838 . . . . . **NOW \$ 724**

IP-225 w/1210 & 1250 op., List \$988 . . . \$ 834

IP-225 w/tractor, 1210, 1250, 1221

(2K Buffer), 1241 (graphics) . . **NOW \$ 899**

PAPER TIGER IDS-440, List \$995 . . . . . \$ 895

w/graphics op., incl. buffer, \$1195 . . . \$ 989

NEC Spinwriters . . . . . **Call for Price**

TELETYPE 43 KSR . . . . . \$1087

**CENTRONICS**

730-1 parallel interface . . . . . **NEW LOW \$679**

737 parallel interface . . . . . **SUPER VALUE \$849**

779 w/Tractor, List \$1350 . . . . . \$1049

702 w/Tractor, VFU, List \$2480 . . . . . \$1995

703 w/Tractor, VFU, List \$2975 . . . . . \$2395

704 w/Tractor, VFU, List \$2350 . . . . . \$1995

T.I. 810 Basic, List \$1895 . . . . . \$1695

810/serial & Centronics-style

parallel interface, List \$1940 . . . . . \$1735

810 w/full ASCII (U/LC), Vertical

Forms Control, Compressed Print . . \$1895

COMPRINT 912 w/parallel interface . . \$ 559

912 w/serial interface, List \$699 . . . . . \$ 589

AXIOM IMP I . . . . . **Call for Price**

MICROTEK, List \$750 . . . . . \$ 675

OKIDATA Microline 80, List \$949 . . . . . \$ 649

Tractor Feed Option . . . . . \$ 109

## NORTH STAR HORIZON

### HORIZON 1 KITS

16K, Double Density, List \$1749 . . . . \$1474

32K, Double Density, List \$1999 . . . . \$1684

32K, Quad Density, List \$2199 . . . . . \$1869

### HORIZON 1 ASSEMBLED & TESTED

32K, Double Density, List \$2695 . . . . \$2279

32K, Quad Density, List \$2995 . . . . . \$2539

### HORIZON 2 KITS

16K, Double Density, List \$2149 . . . . \$1824

32K, Double Density, List \$2399 . . . . \$2034

32K, Quad Density, List \$2779 . . . . . \$2359

### HORIZON 2 ASSEMBLED & TESTED

32K, Double Density, List \$3095 . . . . \$2619

32K, Quad Density, List \$3595 . . . . . \$3049

48K, Double Density, List \$3590 . . . . \$3039

48K, Quad Density, List \$4090 . . . . . \$3469

64K, Double Density, List \$3830 . . . . \$3239

64K, Quad Density, List \$4330 . . . . . \$3669

## FLOPPY DISK SYSTEMS

### NORTH STAR MDS-A

Assembled, List \$899 . . . . . **SPECIAL \$ 719**

Kit Version, List \$799 . . . . . \$ 669

### MORROW THINKER TOYS<sup>®</sup> Discus 2D,

List \$1199 . . . . . **OUR PRICE \$1019\***

Discus 2D, dual-drive, List \$1994 . . . . \$1694\*

Discus 2+2, A&T, List \$1549 . . . . . \$1319\*

Dual Discus 2+2, A&T, List \$2748 . . . . \$2335\*

\*Now includes CP/M<sup>®</sup> 2.2

### MICROMATION Megabox, DD w/

8" drives, 1-megabyte, List \$2295 . . . . \$1949

2-megabyte, List \$3095 . . . . . \$2629

### MICROPOLIS 1041 MacroFloppy<sup>®</sup>

w/enclosure (no P.S.), List \$695 . . . . \$ 625

1042 MacroFloppy w/case & AC P.S. . . \$ 709

1053 Dual MetaFloppy<sup>®</sup>, List \$1895 . . . \$1695

## VIDEO BOARDS

### I/O Mapped

SD COMPUTER VDB-8024,kit,List \$370 \$299

Assembled, List \$470 . . . . . \$ 399

XITEX SCT-100K, Kit . . . . . **ONLY \$154.95**

SCT-100A Assembled . . . . . \$174.95

SSM VB2 I/O, Kit, List \$169 . . . . . \$ 144

Assembled & Tested, List \$234 . . . . . \$ 199

### Memory Mapped

SSM VB1B, 16x64, Kit, List \$155 . . . . \$ 132

Assembled & Tested, List \$210 . . . . . \$ 178

SSM VB3, 80-Char., 4MHz, Kit, List \$399 \$ 339

4 MHz, A&T, List \$464 . . . . . \$ 394

INTERSYSTEMS, 16x64, A&T, List \$165 \$149

## ESCON CONVERSION FOR IBM SELECTRIC

Complete w/microprocessor controller and power supply. Factory built. User installs solenoid assembly or it can be done at Escon factory at nominal cost.

Parallel (TRS-80, Sorcerer, etc.), \$575 \$514

RS232 Standard Serial, List \$599 . . . . 534

IEEE-488 (for PET), List \$660 . . . . . 584

TRS-80 Cable . . . . . 25

## CPU BOARDS

(assembled unless noted)

**NORTH STAR Z80A (ZPB-A/A), \$299 \$254**

**CROMEMCO 4 MHz (ZPU-W), List \$395 \$335**

4 MHz (SCC-W), List \$450 . . . . . \$382

**INTERSYSTEMS (formerly Ithaca Audio)**

new Series II Z-80, 4 MHz, List \$395 . . . \$349

**SSM CB1 8080 A&T, List \$219 . . . . . \$186**

CB1A Kit, List \$159 . . . . . \$135

CB2 Z-80, A&T, List \$275 . . . . . \$234

CB2 Kit, List \$210 . . . . . \$179

**DELTA Z-80, with I/O . . . . . \$289**

**SD SBC-100, List \$350 . . . . . \$298**

SBC-100 Kit, List \$295 . . . . . \$250

SBC-200, List \$400 . . . . . \$332

SBC-200 Kit, List \$320 . . . . . \$272

## MEMORY BOARDS

### IMAGINE!

32K SD ExpandoRAM Kit

**ONLY \$249**

\$159 without RAM chips

**NORTH STAR 16K Dynamic RAM Board,**

A&T (RAM-16-A/A), List \$499 . . . . . \$420

16K Kit Version, List \$449 . . . . . **SPECIAL \$299**

32K A&T (RAM-32/A), List \$739 . . . . . \$620

32K Kit, List \$669 . . . . . **SPECIAL \$499**

**CROMEMCO (16KZ-W), List \$595 . . . . . \$495**

64KZ-W, List \$1795 . . . . . 1485

### MEASUREMENT SYSTEMS & CONTROLS

(Guaranteed performance, incl. labor/parts 1 yr)

DM6400 64K Board w/all 64K, \$795 . . . \$659

DM4800 with 48K, List \$695 . . . . . \$589

DM3200 with 32K, List \$595 . . . . . \$509

DMB6400 64K Board w/all 64K . . . . . \$859

DMB4800 with 48K . . . . . \$789

**MORROW SuperRAM** — all static, all A&T

16K, 4 MHz or 2 MHz, List \$349 . . . . . \$299

32K, 4 MHz, List \$699 . . . . . \$629

16K Memory Master, List \$399 . . . . . \$339

24K Memory Master, List \$549 . . . . . \$465

**INTERSYSTEMS (formerly Ithaca Audio)**

8K Static 2 MHz, A&T, List \$165 . . . . \$149

8K Static 4 MHz, A&T, List \$195 . . . . \$176

16K Static 2 MHz, A&T, List \$475 . . . . \$427

16K Static 4 MHz, A&T, List \$495 . . . . \$445

64K Dynamic, List \$995 . . . . . \$895

### CALIFORNIA COMPUTER

16K Static, A&T, List \$349.95 . . . . . \$259

## FLOPPY DISK CONTROLLER BOARDS

**MORROW Disk Jockey 1, A&T (\$213) . \$189**

Disk Jockey 2D, A&T, List \$479 . . . . \$429

**SD Versafloppy 1, Kit, List \$250 . . . . \$212**

Versafloppy II, DD Kit, List \$350 . . . . \$278

Versafloppy II, DD, A&T, List \$430 . . . \$360

**DELTA double density A&T (\$385) . . . \$345**

**CONDUCTOR, double density A&T . . . \$269**

**INTERSYSTEMS FDC-2, A&T, \$495 . . . \$439**

**MICROMATION Doubler, DD, A&T . . . \$399**

**TARBELL Floppy Disk Interface Kit . . \$199**

double density, A&T, List \$495 . . . . \$444

SHIPPING AND INSURANCE: Add \$2.50 for boards, \$6 for Selectric converter, \$7.50 for Floppy Disk Systems, \$15 for Horizons. SHIPPED FREIGHT COLLECT: SuperBrain, Centronics and T.I. printers. Contact us for shipping information on other terminals and printers.

Advertised prices are for prepaid orders. Credit card and C.O.D. 2% higher. Deposit may be required on C.O.D. All prices subject to change and all offers subject to withdrawal without notice.

— WRITE FOR FREE CATALOG —

# MiniMicroMart, Inc.

1618 James Street, Syracuse NY 13203 (315) 422-4467 TWX 710-541-0431 Circle 273 on inquiry card.

<b>DIGITAL MULTIMETERS</b> Sinclair PDM35 Reg. \$69.95 <b>\$49.95</b> Hickok LX303 Reg. \$69.50 <b>\$69.50</b> Beckman TECH310 Reg. \$140. <b>\$140.</b> Model 2800	<b>MURAPHONE Cordless Telephone System</b> Reg. \$89.95 <b>\$74.95</b> GTE Flip-Phone Reg. \$37.95 <b>\$37.95</b>	<b>Portable VOM Multitester</b> Model #1995 Reg. \$89.95 20 KΩ VDC • 10 KΩ VAC <b>\$1995</b>	<b>100 MHz 8-Digit Counter</b> Model MAX100 Reg. \$150.00 range • LED display Fully automatic <b>\$12750</b>	<b>6" x 9" 3-Way Speaker</b> • 20 oz. ceramic magnet Model BP2000-6STR <b>\$1495 ea.</b>
<b>3 1/2-Digit Portable DMM</b> Model 2800 <b>\$140.</b>	<b>HICKOK Digital CB In-Line Tester</b> Model 388 Reg. \$399.00 <b>\$169.95</b>	<b>Logic Monitor</b> • Automatically displays static and dynamic logic Model LM-1 Works with DTL, TTL, TTL, and CMOS • 16 LED display <b>\$59.95</b>	<b>Telephone Answering</b> Model 1500 \$249.95 Call Control Reg. \$349.95 Model 1400 \$199.95	<b>FREE</b> 8 pc. Tool Set (value \$14.95) with \$200.00 purchase from this ad.
<b>Portable Oscilloscopes</b> 15 MHz Dual Trace Triggered Miniscope Model MS-15 Reg. \$465.45 <b>\$389.95</b> 15 MHz Triggered Miniscope Model MS-15 Reg. \$349.80 <b>\$289.95</b> 30 MHz Dual Trace Triggered Miniscope Model MS-230 Reg. \$598.15 <b>\$499.95</b>	<b>Function Generator</b> Model 2001 Reg. \$185.95 <b>\$157.95</b> • Sine-, square-, triangle- and separate TTL square wave output • Frequency range: 1Hz-100KHz	<b>Attache Style Tool Case</b> Model TC100-ST Reg. \$499.95 <b>\$299.95</b> <b>Service Master Tool Kit</b> Model 99-SM Reg. \$79.95 <b>\$49.95</b>	<b>Weller Xcelite Meter</b> Model 820 • Measures capacitance from 0.1pF to 1 Farad • Resolves to 0.1pF • 10 ranges for accuracy and resolution • 4 digit easy-to-read LED display • 0.5% accuracy <b>\$170</b>	<b>Miniature High Fidelity 3-Way Stereo Speakers</b> Model HF-9 Reg. \$149.95 <b>\$69.50 PR</b>
<b>Logic Probe</b> • Compact circuit powered • Detects pulses as short as 50 μsec • DTL/TTL/HTL/CMOS compatibility Model LP-1 <b>\$44.95</b>	<b>Proto Preassembled Boards</b> Model PB-104 Fully assembled breadboard contains four QT-59S sockets, seven QT-59B bus strips and four 5-way binding posts <b>\$49.95</b>	<b>Proto Board with Built-in Power Supplies</b> Model PB-203A • Regulated • Short-proof Reg. \$154.95 <b>\$129.95</b>	<b>3 1/2-Digit 0.1% Digital Capacitance Meter</b> Model 3001 • 9 ranges from 1999 pF to 199.9 μF • 0.1% of reading accuracy Reg. \$190.00 <b>\$170</b>	<b>Wahl Cordless Soldering Iron</b> Model 7800 <b>\$29.95</b> <b>Thermal-Spot Circuit Tester</b> Model 5800 <b>\$29.95</b>
<b>RC Circuit Box</b> • 36 resistors (15 Ω to 10 MΩ) • 18 capacitors (100 pF to 0.22 μF) Reg. \$49.95 <b>\$42.</b> includes test leads vtz Model WC 412A	<b>Magnifier Lamp</b> Precision ground and polished magnification lens Model MG10A <b>\$49.50</b>	<b>30 MHz LEADER Dual Trace with Delay Line</b> Model L80-520 <b>\$899.95</b>	<b>DIGITAL MULTIMETER Simpson 461</b> Complete with nickel-cadmium batteries, AC charger/adaptor, test leads <b>\$149.95</b>	<b>In-Dash Car Stereos</b> 8-Track Tape Player with AM/FM/MPX Radio Model C-777 <b>\$52.50</b> <b>Cassette Tape Player with AM/FM/MPX Radio</b> Model CAS-888 <b>\$57.50</b>
<b>Chess Challenger 7</b> Reg. \$110.00 <b>\$79.95</b>	<b>Weller Controlled Output Soldering Station</b> Model WTCPN Reg. \$77.50 <b>\$54.95</b>	<b>BSR X-10 Remote Control for Lights &amp; Appliances</b> 4 Pc Standard Starter Kit • One (1) Standard Command Console • Two (2) Lamp Modules • One (1) Appliance Module Reg. \$87.95 <b>\$79.50</b> 5 Pc Ultrasonic Starter Kit • One (1) Deluxe Ultrasonic Command Console • One (1) Hand Held Remote Unit • Two (2) Lamp Modules • One (1) Appliance Unit Reg. \$112.95 <b>\$99.95</b> Lamp Modules \$14.50 Standard Command Console \$36.00 Appliance Modules \$14.50 Ultrasonic Command Console \$59.95 Wall Switch Modules \$14.50 with Hand Held Remote	<b>Stereo Power Booster</b> Model POW-40 • 40W stereo <b>\$24.95</b>	

# FORDHAM

855 Conklin St. Farmingdale, N.Y. 11735

ADD FOR SHIPPING AND INSURANCE

Master Charge	\$ 3.50
BankAmericard	\$ 3.50
VISA • COD	\$ 2.50
Money Order	\$ 2.50
Check	\$ 2.50
N.Y. State residents add appropriate sales tax	\$ 12.00
CDTS extra	\$ 2.00

**TOLL FREE (800) 645-9518**  
 in N.Y. State call (516) 752-0050



## apple computer

# \$975 <sup>16K</sup>

The APPLE II is a completely assembled and tested computer system. The system includes a rugged molded case, typewriter-style keyboard with N-key rollover, high-efficiency switching power supply, two hand controllers, demonstration programs on tape cassettes, AC power cord, cassette cable, reference manuals.

APPLE II has ROM-resident Integer BASIC interpreter, monitor, mini-assembler and disassembler & BASIC Programming Manual.

APPLE II PLUS has ROM-resident Applesoft Extended BASIC interpreter, Auto-Start ROM, disassembler & Applesoft Tutorial Manual.

APPLE II & APPLE II PLUS SOFTWARE

FORTRAN for use with LANGUAGE SYSTEM	\$429
CP/M for use with MICROSOFT Z-80 SOFTCARD	169
THE CONTROLLER General Business System	299
THE CASHIER Retail Management & Inventory	519
APPLE WRITER Word Processor	199
APPLEPOST Mailing List System	65
APPLEPOST Graph & Plot System	85
DOW JONES PORTFOLIO EVALUATOR	45
CONTRIBUTED VOLUMES 1 THRU 5 w/ MANUALS	125
VISI CALC by PERSONAL SOFTWARE	35
DESKTOP/PLAN by DESKTOP COMPUTERS	85
CCA DATA MANAGEMENT by PERSONAL SOFTWARE	85
PIMS Personal Information Management System	23
ADVENTURE by MICROSOFT	27
SUB-LOGIC FS-1 Flight Simulator	23
SARGON II Chess by HAYDEN (Cass.)	27
SARGON II Chess on Diskette	32
Bill Budgets TRILOGY of GAMES	27
Bill Budgets SPACE GAME ALBUM	32
SPACE INVADER on cassette	18
SPACE INVADER on Diskette	23
SYBEX APPLE-80 ROM SIMULATOR	17

FORTH II by PROGRAMMA SOFTWARE 45  
 SINGLE DISK COPY ROUTINES 17  
 APPLEBUG ASSEMBLER/DISASSEMBLER 79  
 APPLEBUG DEBUGGER 27  
 APPLESOFT UTILITY PROGRAMS BY HAYDEN 27  
**PRINTERS, TERMINALS & MONITORS**  
 PRINTERS, TERMINALS & MONITORS  
 ANADEX OP8000 or OP8000AP \$795  
 ANADEX OP9500 or OP9501 1395  
 BASE 2 w/ TRACTOR & BUFFER 599  
 CENTRONICS 700 1099  
 CENTRONICS 737 849  
 MPI 881 699  
 PAPER TIGER IDS 440 895  
 W/GRAPHICS OPTION 995  
 NEC SPINWRITER 5530 or 5510 2595  
 TRENDON 100 329  
 TRENDON 200 529  
 LEXOX VIDEO 100 139  
 SANYO 9 INCH B&W MONITOR 159  
 SANYO 15 INCH MONITOR 249  
 11 1/2 INCH COLOR MONITOR 429  
 SOROC IQ 120 729  
 SOROC IQ 140 1199  
 HAZELTINE 1500 979  
 HAZELTINE 1510 1079  
 HAZELTINE 1520 1379  
 HAZELTINE 1410 1749  
 HAZELTINE 1420 829

DISK II-DRIVE ONLY \$429	PROGRAMMABLE TIMER MODULE No 7440A 145
DISK II-DRIVE & CONTROLLER CARD 489	3 1/2 DIGIT BCD ANALOG IO 135
MODEM IIB w/INTERFACE 339	DITGALCONVERTER GP1B IEEE 488(1978) INTERFACE No 7490A 259
MODEM IIB ONLY (Novation Cat) 159	ASYNCHRONOUS SERIAL INTERFACE No 7710A 145
GRAPHICS TABLET 659	SYNCHRONOUS SERIAL INTERFACE No 7712A 145
SILENTYPE PRINTER w/Apple Interface 519	PARALLEL INTERFACE No 7720A 109
APPLE COMPUTER INTERFACE CARDS	ARITHMETIC PROCESSOR CARD NO 7811B 339
PROTOTYPING/HOBBY CARD \$72	WIRE WRAP BOARD 20
PARALLEL PRINTER INTERFACE CARD 145	SOLDER TAIL BOARD 20
COMMUNICATION CARD & DB25 Connector Cable 185	EXTENDER BOARD 24
HI-SPEED SERIAL INTERFACE CARD 155	PCB ETCH BOARD 20
LANGUAGE SYSTEM WITH PASCAL CENTRONICS PRINTER INTERFACE CARD 185	CORVUS ORVUS I/O MEGABYTE HARD DISK DRIVE SYSTEM \$4495
APPLESOFT II FIRMWARE CARD w/Auto-Start ROM 149	CORVUS MIRROR (VTR Required) 695
INTEGER BASIC FIRMWARE CARD w/Mon & Prog. Amd ROMS 149	CORVUS MIRROR2 (VIR Required) 795
ADD-ONS	CORVUS CONSOLE/ATION 595
16K MEMORY UPGRADE (TRS-80, Apple Sorcerer) 569	DAN PAYMAR LOWER CASE ADAPTER 44
ABT NUMERIC INPUT KEYPAD (Old or New Kybrd.) 119	DC HAYES MICROMODEM II 319
ALF MUSIC SYNTHESIZER 239	HUERISTICS SPEECHLINK 2000 (64 Word Vocabulary) 219
ALF TYPING MODE INPUT BOARD 19	SPEECHLAB 20A (Cassette) 169
BRIGHTPEN LIGHTPEN FROM SOFTAPE CALIFORNIA COMPUTER SYSTEMS 32	SPEECHLAB 20A (Diskette) 189
12K ROM/PRGM ASSEMBLED BOARD NO 7114A \$69	MODEL TO CONTROLLER 75
	M&R SUP-R MOD IV MODULATOR ADAPTER 77

**ORDERING INFORMATION:** Phone orders may be placed using Visa, Mastercard or bank wire transfer. Mail orders may send charge card number (include expiration date), cashiers check, money order or personal check (allow 2 weeks to clear). Please include telephone number with all orders. Foreign orders (excluding Military PO's) add 10% for shipping and funds must be in U.S. dollars. Shipping, handling and insurance in U.S. is 50c per lb surface, \$1.00 per lb air. No COD's or purchase orders. All prices subject to change and availability. Equipment is new and complete with manufacturer warranty.

**"WE WILL NOT BE UNDER SOLD!"**

## BUDGET COMPUTER PRODUCTS

4878 RONSON COURT, SUITE A  
 SAN DIEGO, CA. 92111 (714) 698-0260

# DIGITAL RESEARCH COMPUTERS

(214) 271-3538

## 32K S-100 EPROM CARD

**NEW!**

**\$74.95**  
KIT

USES 2716's  
Blank PC Board - \$34  
ASSEMBLED & TESTED  
ADD \$30

SPECIAL: 2716 EPROM's (450 NS) Are \$19.95 EA. With Above Kit.

**KIT FEATURES:**

1. Uses +5V only 2716 (2Kx8) EPROM's.
2. Allows up to 32K of software on line!
3. IEEE S-100 Compatible.
4. Addressable as two independent 16K blocks.
5. Cromemco extended or Northstar bank select.
6. On board wait state circuitry if needed.
7. Any or all EPROM locations can be disabled
8. Double sided PC board, solder-masked, silk-screened.
9. Gold plated contact fingers.
10. Unselected EPROM's automatically powered down for low power.
11. Fully buffered and bypassed.
12. Easy and quick to assemble.

## 8K LOW POWER RAM KIT-S 100 BUSS

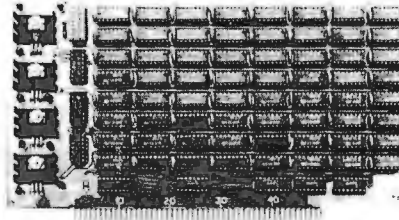

21L02  
(450 NS RAMS!)

**\$119.50**  
KIT

ASSEMBLED & FULLY  
BURNED IN ADD \$35

Thousands of computer systems rely on this rugged, work horse, RAM board. Designed for error-free, NO HASSLE, systems use.

ADD \$10  
FOR 4 MHZ

Blank PC Board w/Documentation - \$29.95  
Low Profile Socket Set - \$13.50  
Support IC's (TTL & Regulators) - \$9.75  
Bypass CAP's (Disc & Tantalums) - \$4.50

**FOR SALE!** **LOW POWER - 300NS** **8 FOR \$44'**  
**2114 RAM SALE!**  
4K STATIC RAM'S. MAJOR BRAND, NEW PARTS.  
These are the most sought after 2114's, LOW POWER and 300NS FAST.  
**8 FOR \$44**

## 16K STATIC RAM KIT-S 100 BUSS

PRICE CUT!

**\$225** KIT

FOR 4MHZ  
ADD \$10

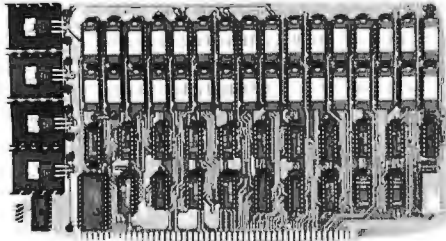

**KIT FEATURES:**

1. Addressable as four separate 4K Blocks.
2. ON BOARD BANK SELECT circuitry. (Cromemco Standard!). Allows up to 512K on line!
3. Uses 2114 (450NS) 4K Static Rams.
4. ON BOARD SELECTABLE WAIT STATES
5. Double sided PC Board, with solder mask and silk screened layout. Gold plated contact fingers
6. All address and data lines fully buffered.
7. Kit includes ALL parts and sockets.
8. PHANTOM is jumpered to PIN 67.
9. LOW POWER: under 1.5 amps TYPICAL from the +8 Volt Buss
10. Blank PC Board can be populated as any multiple of 4K.

BLANK PC BOARD W/DATA-\$33  
LOW PROFILE SOCKET SET-\$12  
SUPPORT IC'S & CAPS-\$19.95  
ASSEMBLED & TESTED-ADD \$35

**OUR #1 SELLING  
RAM BOARD!**

## 16K STATIC RAM SS-50 BUSS

PRICE CUT!

**\$229** KIT

FULLY STATIC!

FOR 2MHZ  
ADD \$10

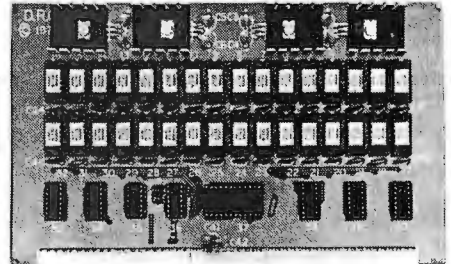

FOR SWTPC  
**6800 BUSS!**

ASSEMBLED AND  
TESTED - \$35

**KIT FEATURES:**

1. Addressable on 16K Boundaries
2. Uses 2114 Static Ram
3. Fully Bypassed
4. Double sided PC Board Solder mask and silk screened layout
5. All Parts and Sockets included
6. Low Power: Under 1.5 Amps Typical

BLANK PC BOARD-\$26 COMPLETE SOCKET SET-\$12  
SUPPORT IC'S AND CAPS-\$19.95

## NEW! S-100 SOUND COMPUTER BOARD NEW!

At last, an S-100 Board that unleashes the full power of two unbelievable General Instruments AY3-8910 NMOS computer sound IC's. Allows you under total computer control to generate an infinite number of special sound effects for games or any other program. Sounds can be called in BASIC, ASSEMBLY LANGUAGE, etc.

**KIT FEATURES:**

- \* TWO GI SOUND COMPUTER IC'S.
- \* FOUR PARALLEL I/O PORTS ON BOARD
- \* USES ON BOARD AUDIO AMPS OR YOUR STEREO.
- \* ON BOARD PROTO TYPING AREA.
- \* ALL SOCKETS, PARTS AND HARDWARE ARE INCLUDED.
- \* PC BOARD IS SOLDERMASKED, SILK SCREENED, WITH GOLD CONTACTS.
- \* EASY, QUICK, AND FUN TO BUILD. WITH FULL INSTRUCTIONS.
- \* USES PROGRAMMED I/O FOR MAXIMUM SYSTEM FLEXIBILITY.

Both Basic and Assembly Language Programming examples are included

**SOFTWARE:**

SCLT™ is now available! Our Sound Command Language makes writing Sound Effects programs a SNAP! SCLT™ also includes routines for Register-Examine, Modify, Memory-Examine-Modify, and Play-Memory. SCLT™ is available on CP/M™ compatible diskette of 2708 or 2716. Diskette - \$24.95 2708 - \$19.95 2716 - \$29.95 Diskette includes the source EPROM'S are ORG at E000H.

COMPLETE KIT!

**\$84.95**

(WITH DATA MANUAL)

BLANK PC  
BOARD W/DATA  
**\$31**

## 16K EPROM CARD-S 100 BUSS

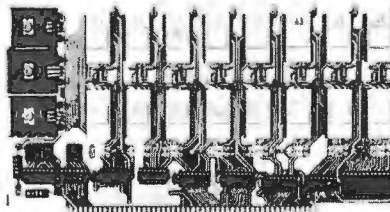

**\$59.95**  
KIT

BLANK PC BOARD - \$28

USES 2708's!

Thousands of personal and business systems around the world use this board with complete satisfaction. Puts 16K of software on line at ALL TIMES! Kit features a top quality soldermasked and silk-screened PC board and first run parts and sockets. Any number of EPROM locations may be disabled to avoid any memory conflicts. Fully buffered and has WAIT STATE capabilities

ASSEMBLED AND FULLY  
TESTED - ADD \$30

OUR 450 NS 2708'S  
ARE \$8.95 EA. WITH  
PURCHASE OF KIT

## RCA CMOS COMPUTER CHIP SET

**INCLUDES:**

- |                         |                        |
|-------------------------|------------------------|
| 1-CDP1802CD CPU         | 1-CDP1861CD VIDEO IC   |
| 2-CDP1822CE 256 x 4 RAM | 1-CDP1862CE COLOR GEN. |
| 1-CDP1858CE 4 BIT LATCH | 1-CDP1863CE SOUND GEN. |

COMPLETE SET \$45 LIMITED QTY

## NEW! G.I. COMPUTER SOUND CHIP

AY3-8910 As featured in July, 1979 BYTE! A fantastically powerful Sound & Music Generator. Perfect for use with any 8 Bit Microprocessor. Contains: 3 Tone Channels, Noise Generator, 3 Channels of Amplitude Control, 16 bit Envelope Period Control, 2-8 Bit Parallel I/O, 3 D to A Converters, plus much more! All in one 40 Pin DIP. Super easy interface to the S-100 or other busses

SPECIAL OFFER: \$14.95 each Add \$3 for 60 page Data Manual.

**Digital Research Computers**  
(OF TEXAS)

P.O. BOX 401565 • GARLAND, TEXAS 75040 • (214) 271-3538

TERMS: Add \$1.00 postage, we pay balance. Orders under \$15 add 75¢ handling. No C.O.D. We accept Visa and MasterCard. Tex. Res. add 5% Tax. Foreign orders (except Canada) add 20% P & H. 90 Day Money Back Guarantee on all items. Orders over \$50. add 85¢ for insurance.

## BUILD YOUR OWN LOW COST MICRO-COMPUTER POWER SUPPLIES FOR S-100 BUS, FLOPPY DISCS, ETC.

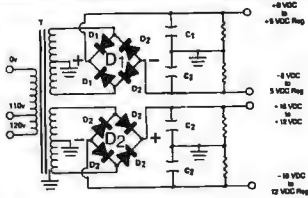
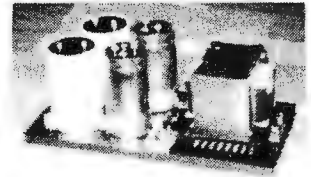

### POWER TRANSFORMERS (WITH MOUNTING BRACKETS)

ITEM NO.	USED IN KIT NO.	PRI. WINDING TAPS	SECONDARY WINDING OUTPUTS			SIZE W x D x H	UNIT PRICE
			2x8 Vac	2x14 Vac	2x24 Vac		
T1	1	0V, 110V, 120V	2x7.5A	2x2.5A	—	3 3/4" x 3 5/8" x 3 1/8"	21.95
T2	2	0V, 110V, 120V	2x12.5A	2x3.5A	—	3 3/4" x 4 3/8" x 3 1/8"	27.95
T3	3	0V, 110V, 120V	2x9A	2x2.5A	2x2.5A	3 3/4" x 4 3/8" x 3 1/8"	29.95
T4	4	0V, 110V, 120V	2x4A	(28V, CT)	48V, CT, @3A	3 3/4" x 3 5/8" x 3 1/8"	22.95

### POWER SUPPLY KITS (OPEN FRAME WITH BASE PLATE, 3 HRS. ASSY. TIME)

ITEM	USED FOR	@+8 Vdc	@-8 Vdc	@+16 Vdc	@-16 Vdc	@+28 Vdc	SIZE WxDxH	UNIT PRICE
KIT 1	15 CARDS SOURCE	15A	—	2.5A	2.5A	—	12" x 6" x 4 7/8"	51.95
KIT 2	SYSTEM SOURCE	25A	—	3A	3A	—	12" x 6" x 4 7/8"	58.95
KIT 3	DISC SYSTEM	15A	1A	2A	2A	4A	14" x 6" x 4 7/8"	66.95
KIT 4	DISC SOURCE	8A	1A	*(SEE OPTION BELOW)		5A	10" x 6" x 4 7/8"	49.95

EACH KIT INCLUDES: TRANSFORMER, CAPACITORS, RESIS., BRIDGE RECTIFIERS, FUSE & HOLDER, TERMINAL BLOCK, BASE PLATE, MOUNTING PARTS AND INSTRUCTIONS. \*OPTION OF KIT 4: SUBSTITUTE ±16V, @4A, FOR +28V, @5A.

### DISC DRIVE POWER SUPPLY "R3" ASSY. & TESTED, OPEN FRAME, SIZE: 9" (W) x 5" (D) x 5" (H) ..... 64.95

SPECS: +5V @ 5A REGULATED, -5V @ 1A REG., +24V @ 5A REG., SHORTS PROTECT. OPTION: SUBSTITUTE ±12V @ 4A IDEAL FOR 2 SHUGART 801/851 OR SIEMANS FDD 100-8/200-8 DISK DRIVES & ROCKWELLAIM-65. FOR -5V & +24V.

SHIPPING FOR EACH TRANSFORMER: \$4.75. FOR EACH POWER SUPPLY: \$5.00 IN CALIF. \$7.00 IN OTHER STATES. CALIF. RESIDENTS ADD 6% SALES TAX. OEM WELCOME.

## SUNNY INTERNATIONAL

(TRANSFORMERS MANUFACTURER)

Telephone: (213) 633-8327

STORE:

7245 E. ALONDRA BLVD.  
PARAMOUNT, CA 90723  
STORE HOURS: 9 AM - 6 PM

MAIL ORDER:  
P.O. BOX 4296  
TORRANCE, CA 90510

VISA



**Z-80**  
\*  
\$1250

**APPLE GAME PORT REMOTE PLUG-IN EXPANDER with SELECTOR!**

Allows continuous connection of any three of the Apple game port options. **\$3995**

**90-COLUMN IMPACT PRINTER**  
LOWEST IN PRICE—HIGHEST IN PERFORMANCE  
\$599.00  
base2, inc.

**4116**  
Dynamic RAM  
MEMORY ADD-ON FOR THE TRS-80 OR APPLE II™  
to 450ms  
8 for \$4995

**8038C**  
VCO Waveform Gen.  
w/sine **\$265**

**78H05**  
**\$595**

**video 100**  
12" BLACK & WHITE LOW COST VIDEO MONITOR **\$129.00**

**CSC**  
8216 BUS DRIVER **\$199**

**LOGIC PROBE KIT**

**I.C. MASTER**  
NEW  
"1980" **\$5995**

**2708**  
1024X8 EPROM  
**\$745**  
450ns AMD, SGS

**SOROC IQ120**  
**\$74900**

**DustCover**  
for Apple keyboard **\$895**  
disk **\$395**

T.I./M.M.I.  
74LS240 **\$245**  
74LS241  
74LS243  
74LS244  
74LS373  
74LS374  
LIMIT 10 EACH  
IN STOCK

**2716** 16K EPROM  
**\$2795**  
450ns single+5V  
TI, HIT, INT, SGS

**8212**  
I/O PORT  
**3.95**

**ULN2001**  
High-Current Drivers.  
Darlingtons **69c**

**RESISTOR NETWORKS**  
values  
270, 4.7K, & 15K  
OHMS  
1.5K & 10K  
**.89 EA**  
100/49c

**MH0026CJ**  
DUAL CLOCK DRIVER **\$100**

74S373  
74S374  
**\$325**

**S-100 16K ADD-ON BARE BOARD**  
WITH DOCUMENTATION AND DETAILED INSTRUCTION BOOK. **\$2895**

**16K STATIC RAM**  
S-100 MEMORY ADD-ON

**EPROM ERASER** BY SPECTOLINE  
UP TO 6 EPROMS IN 19 MINUTES **\$4995**  
6000 HOUR BULB LIFE

**CONCORD COMPUTER COMPONENTS**  
1971 SOUTH STATE COLLEGE · ANAHEIM, CA. 92806  
VISA-MASTER CHARGE (714)937-0637 MINIMUM ORDER-\$10.00  
CHECK OR M.O. ADD \$1.50 FOR FR. CAL. RES. ADD 6%  
NO C.O.D. We stock and sell over 12,000 types of semi-conductors

\*\* FULLY STATIC OPERATION  
\*\* USES 2114 TYPE STATIC RAMS  
\*\* +8 VDC INPUT AT LESS THAN 2 AMPS  
\*\* BANK SELECT AVAILABLE BY BANK PORT AND BANK BYTE  
\*\* PHANTOM LINE CAPABILITY  
\*\* ADDRESSABLE IN 4K BLOCKS IN 4K INCREMENTS  
\*\* LED INDICATORS FOR BOARD/BANK  
\*\* SOLDER MASK ON BOTH SIDES OF BOARD  
**ASSEMBLED & TESTED \$26900**  
California Computer Systems

# 10 Megabyte Hard Disk \$3,495\*

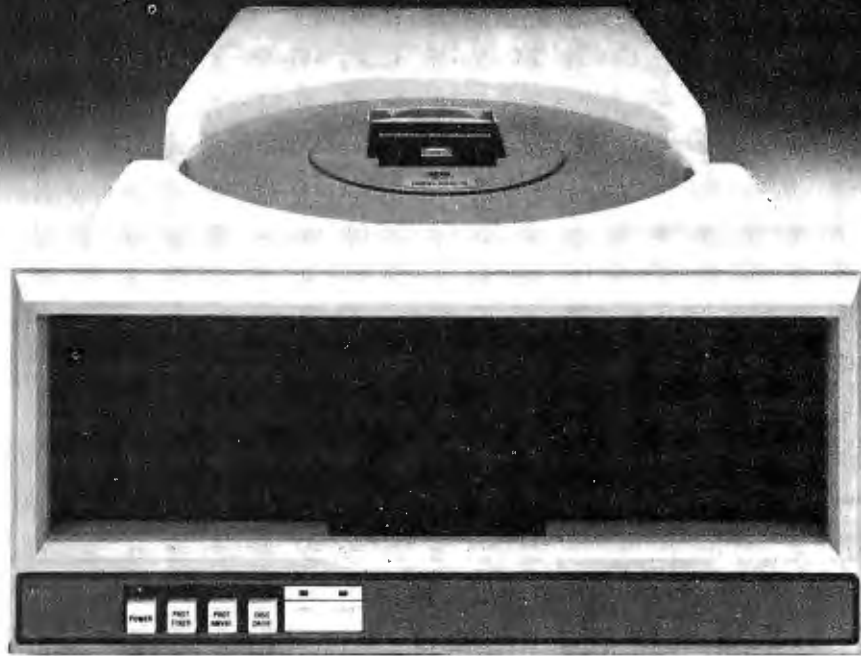

5440-12 Top Load Drive

\* Factory rebuilt 10MB cartridge disk drive only  
A new Cameco Data Systems controller is available for \$1,495  
\$4,495 for a brand new Ampex 10MB drive only



We are the CP/M\*\* and MP/M\*\* specialist of Southern California. We can supply you with the latest CP/M (\$150) or MP/M (\$300) and with Standard BIOS (\$150) or Custom BIOS (\$300). Immediate delivery worldwide. Domestic and foreign inquiries invited...dealers too.

\*\*CP/M and MP/M are Trademarks of Digital Research

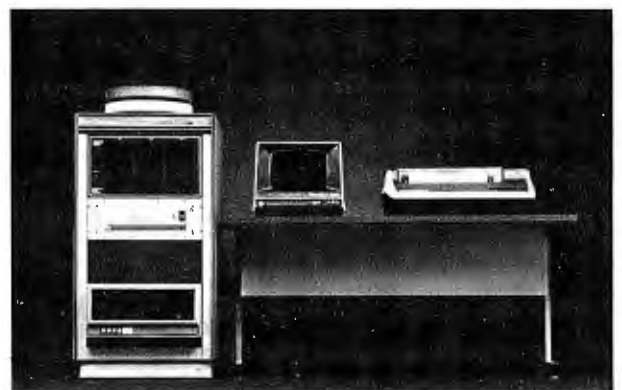

We are a full service computer retailer. We totally integrate hardware and software into high quality, high reliability systems. Systems for use in development, process control and general business. Word processing naturally, multi tasking and multi processing too.

## COMPUTER COMPONENTS



**Dual Trace Oscilloscope  
HITACHI 30 MHz**

- TV sync-separator circuit
- High-sensitivity 1mV/div (5MHz)
- Sweep-time magnifier (10 times)
- Z-axis input (Intensity modulation)
- Signal delay line
- X-Y operation
- Trace Rotation

**\$945.00**

**More sensitive to your input**

**SD SYSTEMS**

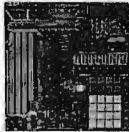

**Z-80 STARTER SYSTEM**

The Z80 Starter Kit by SD Systems uses the powerful Z80 microprocessor as the heart of the complete micro-computer on a single board. Learn a step-by-step Introduction to micro-computers with a keyboard and display, audio cassette interface, PROM programmer, wire-wrap expansion area, 4-channel Counter Timer and on Board RAM and PROM. Complete Operation and Instruction Manual included. Z80 Monitor in ROM.

27004 kit .... \$340 38007 a/t .... \$450

**SBC-100 SINGLE BOARD COMPUTER KIT**

27003 kit ..... \$295

**PROM-100 BOARD KIT PROM Programmer**

27014 kit ..... \$200

**LOOK - MORE SD**

**VERSAFLOPPY I FLEXIBLE DISK DRIVE Controller**



27002 kit ..... \$250  
38005 a/t ..... \$335

**VDB-8024 VIDEO DISPLAY BOARD**



38013 a/t ..... \$470

**8080A MICRO-PROCESSOR \$595**

**AP PRODUCTS**



923101... \$ 79.95  
923102... 124.95  
923103... 124.95

**PLESSEY**



Metallized Polyester Capacitors  
Series 160 MINIBOX SAMPLER  
\$26.00

**SD Systems EXPANDO RAM**

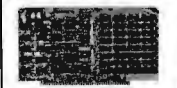

27001 kit ..... \$220  
38001 a/t ..... \$480

**Add-On RAM Kit**  
27010 (16K, 8 devices) \$165

**FUNCTION GENERATOR KIT**

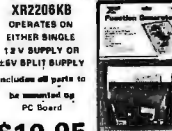

**\$19.95**

**NEW HICKOK LX 304**



**DIGITAL MULTIMETER**

Compact Accurate Dependable

**\$89.95**

ALSO - STILL AVAILABLE  
LX303 ..... \$74.95

**32K**  
Part No. DP1000-2  
**\$1295**

**SORCERER COMPUTER** SPEAKS YOUR LANGUAGE  
FEATURES: 28K - 4K ROM - 32K RAM - Dual Counter I/O - 20 Lines of 84 Characters - 84 User Characters and 84 User Defined Characters - 312 x 240 Graphical Resolution - Edge Card Connection to 8-100 Bus - Serial and Parallel I/O.

**LIQUID CRYSTAL DISPLAY**  
\$18.88  
● High Contrast Ratio  
● Wide Viewing Angle  
● 0.5 in. Digit Height

● **ULTRA Low Power Consumption**  
LCD106 ..... \$14.50

**SYM-1 NEW LOW PRICE**



**\$239.00**  
KTM-2 CRT/TV Kybd Term 8349

**EPROM**

2708 **\$10.50**

**EPROM**

(5 Volt) **\$29.90**  
2716

**POWER SUPPLY**



**5 Volt 3 Amp  
APS 5-3**

1-9 ..... \$37.25  
10 up ..... \$35.55  
25 up ..... \$34.05

**★ 15% ★  
DISCOUNT  
COUPON**

Bring this **COUPON** into one of our stores or mail to our Mail Order address shown below and receive a **15% DISCOUNT** on purchases from this Ad of \$100.00 or more. **Offer EXPIRES on July 31, 1980**

NAME.....  
ADDRESS.....  
CITY..... STATE.....  
ZIP..... PHONE NO.....  
Coupons accepted only with full name and address filled in.

**ANCRONA**

Send check or Money Order to: P.O. Box 2208Y, Denver City, CA 90230. California residents add 6% sales tax. Minimum Order, \$10.00. Add \$1.00 to cover postage and handling. Master Charge and Visa welcomed. Please include your charge card number, Interbank number and expiration date. **PHONE ORDERS: (213) 641-4064**

<b>MAIL ORDER</b> P.O. Box 2208R Denver City, CA 90230 (213) 641-4064	<b>PORTLAND</b> 1125 N.E. 82nd Ave. Portland, OR 97220 (503) 254-3641	<b>SANTA ANA</b> 1300 E. Edinger Ave. Santa Ana, CA 92705 (714) 547-9824	<b>CULVER CITY</b> 11080 Jefferson Blvd. Culver City, CA 90230 (213) 330-3555
<b>TUCSON</b> 4518 E. Broadway Tucson, AZ 85711 (602) 881-2348	<b>HOUSTON</b> 2848 Richmond Houston, TX 77098 (713) 528-3488	<b>ATLANTA</b> 3330 Piedmont Rd, N.E. Atlanta, GA 30305 (404) 281-7100	<b>SUNNYVALE</b> 1054 E. El Camino Real Sunnyvale, CA 94087 (408) 243-4121

**INTRODUCING the DG-80 Z80 CPU!**

Z80 BASED CPU FOR H8®!



The most exciting H8® development yet! Compatible with Heath H8® hardware and software and DG-32D • Z80 CPU Enhanced Instruction Set • Operational at 2 MHz or 4 MHz • On board provisions for RAM and PROM • Wait States available for any or all 8K Memory blocks • Many advanced features that give the H8® users power to spare.

**DG-80 CPU \$249** MANUAL ONLY \$25

**16K CHIP SETS** (8-4116 Type Dynamic RAMS) for DG-32D, Apple®, TRS-80®, H88/89®, and Pet® (Tested) ..... \$ 64.00  
(Programming jumpers available at additional cost)

**BY POPULAR DEMAND**

**OUR POPULAR DG-32D**  
Dynamic RAM Board  
(fully populated)  
Regularly ..... \$479.00  
**OUR POWERFUL NEW DG-80 CPU**  
Regularly ..... \$249.00

**NOW** thru July, 1980 **BOTH FOR \$625**

**32K/DG-32D** ..... \$479.00  
**HALF POPULATED 16K/DG-32D** ..... \$415.00  
**Documentation only (DG-32D)** ..... \$ 12.00  
Heath, H8, TRS-80, Apple, Mostek & Pet are Registered Trademarks.

Ordering Information: Products listed available from D-G Electronic Developments Co., P.O. Box 1124, 1827 South Armstrong, Denison, Tx. 75020. Check, Money Order, VISA or Master Charge accepted. Phone orders (charge only) call (214) 465-7805. No COD's. Freight prepaid. Allow 3 weeks for personal checks to clear. Texas residents add 5%. Foreign orders add 30%.

**D.G. ELECTRONIC DEVELOPMENTS CO.**

**ATTENTION HEATH® H8 OWNERS**

# DAL - COMP



## THE STAR MODEM FROM LIVERMORE

0 to 300 baud data rate. Compatible with Bell 103 and 113. CCITT. Answer/Originate. Full/Half Duplex. Special self test features.

**\$169.00**

## VERBATIM

Box of 10

VER-MD 525-01	Soft Sector for TRS-80 Apple	\$29.95
VER-MD 525-10	Hard 10 Sector for North Star	\$29.95
VER-MD 525-16	Hard 16 Sector for Micropolis	\$29.95
VER-FD32-1000	Hard Sector for Shugart 801R	\$37.00
VER-FD34-1000	Soft Sector for IBM 3740	\$37.00



## EPROM ERASER

Compact, durable quality UV Lamp for erasing EPROM's. Features a special safety lock to prevent accidental exposure. Erases up to four devices (2708, 2716, 2732, 1702A, 52030, 5304Q, etc.) simultaneously.

**UV S-11E \$68.95**

## DYNAMIC RAMS

**4116 — 250 NS OR FASTER  
8 FOR \$48.00**

### STATIC RAMS

2114 — 450 NS	4.50
2114L — 450 NS	5.25
2114L — 300 NS	5.50

### 8080/8085 SUPPORT

8212	\$3.75	8251	6.95
8214	4.50	8253	19.50
8216	2.50	8253-5	20.25
8224	3.50	8255	6.25
8228	5.95	8257	17.95
8238	6.25	8279-5	18.50
8243	7.95	8295	16.50
3881 PIO 2 MHZ		8.75	

### DIP SWITCHES

3 Pos.	\$1.00	6 Pos.	\$1.10
4 Pos.	1.00	7 Pos.	1.15
5 Pos.	1.00	8 Pos.	1.20

### ZIP DIP II SOCKETS

16 Pin	\$5.50
24 Pin	7.50
40 Pin	10.25

### RS-232 CONNECTORS

DB25P — Male Plug	\$2.95
DB25S — Female Socket	3.60
DB25C — Cover	1.50
RS232 SPECIAL	\$6.45
1-DB25P — 1-DB25S — 1 Cover	

### USRT

S 2350	\$7.95
--------	--------

### UARTS

TR 1602 B	\$3.95
TR 1863/AY5 1015	5.95

### DISC CONTROLLER

1771	\$26.95
1791	37.95

### MICROPROCESSORS

Z80A	\$13.95	8035	19.95
6502	11.95	8080A	4.95
8008	15.95	8085A	21.95
		8086	89.95

### CHARACTER GENERATOR

2513 (2140) Upper	9.95
2513 (3021) Lower	9.95

### MOTHER BOARDS

6 Slot Bare Board	\$19.00
6 Slot Kit	36.00
8 Slot Bare Board	24.00
8 Slot Kit	47.00
12 Slot Bare Board	29.00
12 Slot Kit	62.00

## CONTROL DATA 9406-3WL 8" DISK DRIVE

COMPATIBLE WITH SA850R

Double sided, double density. Max. capacity 1.6 megabytes, +24 and +5 VDC, ceramic heads, RETMA rack mounting, access time 3 milliseconds, activity indicator, write protect, high performance band stepper.

CDC-9406-3WL \$675.00

## CONTROL DATA 9408 5 1/4" DISK DRIVE

Single sided, 5.25 inch, single (FM) or double (MFM) density, K Byte capacity, SA 400 size, SA 400 interface, die cast aluminum base. DC power +12V, +5V, no AC required, hard or soft sectoring, precompensation recommended for double density (250 NS all tracks), ceramic read/write heads, 34 pin board edge I/O connector (gold), IBM compatible heads (tunnel erase), 8000 hours MTBF (assumes drive motor duty cycle is 25% of POH), 30 minutes MTTR, media life 3 x 10<sup>6</sup> wear revolutions, may be mounted in any orientation, daisy chain provisions, DC band positioner, write protect, activity indicator light, increased throughput, options - none.

CDC-9408 \$275.00

### PROMS

1702	\$4.95
2708	6.25
2716 — 5 Volt	21.95
2716 — TI +5 -5 +12V	17.00
2732	85.00

### LO-PRO SOCKETS

14 PIN	.15	16 PIN	.17
18 PIN	.19	20 PIN	.26
24 PIN	.33	28 PIN	.37
40 PIN	.45		

(ALL SOCKETS ARE TIN)

# CALIFORNIA COMPUTER SYSTEMS

7712

Synchronous Serial Interface  
For Apple

7440

Programmable Timer Module  
For Apple

7720

Parallel Interface  
For Apple

7470

3 3/4 Digit BCD Ad Converter

## SD SYSTEMS EXPANDORAM I & II

## SD SYSTEMS VERSAFLOPPY I & II

## SD SYSTEMS SBC-100 & SBC-200

## SD SYSTEMS VDB-8024 VIDEOBOARD

**PRICES TOO LOW TO PUBLISH — CALL TOLL FREE FOR BARGAIN QUOTES**

### I04 2 PARALLEL & 2 SERIAL I/O BOARD

SSM — I04 — KIT	\$124.95
SSM — I04 — A&T	\$197.95

### VB3 80 CHARACTER VIDEO BOARD

SSM — VB3 — KIT	\$297.95
SSM — VB3 — A&T	\$387.95

### PB1 2708/2716 PROGRAMMER & 4K/8K EPROM BOARD

SSM — PB1 — KIT	\$124.95
SSM — PB1 — A&T	\$174.95

### CB2 Z-80 CPU BOARD

SSM — CB2 — KIT	\$184.95
SSM — CB2 — A&T	\$249.95

### A10 APPLE SERIAL/PARALLEL INTERFACE

KIT	\$115.00
ASSEMBLED & TESTED	\$155.00

### VB2 I/O MAPPED VIDEO INTERFACE

KIT	\$150.00
ASSEMBLED & TESTED	\$195.00

### I02 PARRALLEL I/O INTERFACE

KIT	\$59.00
ASSEMBLED & TESTED	\$89.00

### XB1 EXTENDER BOARD

KIT (W/CONNECTOR)	\$19.95
ASSEMBLED & TESTED	\$29.95

**CALL TOLL FREE 800-527-5310**

TEXAS RESIDENTS  
CALL COLLECT (214) 350-6898

**DAL - COMP**  
MAIL ORDER DIV.

TERMS OF SALE: Cash, checks, money orders, VISA, Master Charge. Minimum Order \$10.00. Texas residents add 5% sales tax. Minimum shipping and handling charge \$3.00. COD orders add \$2.00 COD fee. U.S. funds only. PRICES SUBJECT TO CHANGE WITHOUT NOTICE. SOME ITEMS SUBJECT TO PRIOR SALE. WE RESERVE THE RIGHT TO LIMIT QUANTITIES. 90 DAY GUARANTEE.

DAL-COMP M/O DIV. 2560 ELECTRONIC LANE, SUITE 108, DALLAS, TEXAS 75220 • (214) 350-6895

# BECKIAN ENTERPRISES

ALL PRIME QUALITY — NEW PARTS ONLY  
SATISFACTION GUARANTEED.

## EDGE CARD CONNECTORS: GOLD PLATED:

Abbreviations: S/E Solder Eye, S/T Sold Tail: W/W Wire Wrap.

PART # DESCRIPTION.	Row Sp.	1-9pc.	10-24pcs.	25pcs. Up.
<b>BRAND: TEXAS INST.</b>				
4070 50/100 Imaei/Crom.	.250	\$3.95ea.	\$3.55ea.	\$3.15ea.
4090 50/100 Imaei W/W	.250	4.30ea.	3.85ea.	3.45ea.
<b>BRAND: SULLINS: U.L. Reg.</b>				
129865 50/100 Solder Eye	.140	8.00ea.	6.10ea.	5.45ea.
129870 50/100 S/T Imaei	.250	4.50ea.	4.10ea.	3.70
129875 50/100 W/W Imaei	.250	5.25	4.75	4.20
129885 50/100 S/T Altair	.140	4.95	4.45	3.95
129990 50/100 S/T Cromam.	.250	4.75	4.25	3.80

<b>OTHER .125" CONTACT CTR CONNECTORS:</b>				
12305 22/44 S/E No Ears	.140	4.15	3.75	3.35
12759 36/72 S/T	.140	5.40	4.85	4.35
12790 40/80 W/W	.250	6.30	5.65	5.00

<b>.100" CONTACT CTR CONNECTORS:</b>				
10048 13/26 S/E No Ears	.140	3.40	3.05	2.15
10280 25/50 S/E TRS 80	.140	4.50	4.05	3.60
10175 20/40 S/E TRS 80	.140	5.85	5.35	4.75
10180 20/40 W/W TRS 80	.200	3.30	3.00	2.15
10190 20/40 S/T TRS 80	.140	3.20	2.90	2.55
10485 36/72 S/E Vector	.140	5.50	4.90	4.40
10490 36/72 W/E Vector	.200	5.80	5.25	4.65
10500 36/72 S/T Vector	.140	5.70	4.20	4.60
10535 40/80 S/E PET	.140	5.85	5.35	4.75
10540 40/80 W/W PET	.200	6.00	5.40	4.80
10550 40/80 S/T PET	.140	5.80	5.25	4.65
10585 43/86 S/E COS/ELF	.140	6.95	6.25	5.55
10605 43/86 S/T COS/ELF	.140	8.60	5.95	5.30
10595 43/86 W/W COS/ELF	.200	6.90	6.20	5.95
10615 43/86 S/T COS/ELF	.200	6.80	6.10	5.40

<b>.158" CONTACT CENTER CONNECTORS.</b>				
15105 6/12 S/E PET/NSC	.140	\$1.80	\$1.65	\$1.45
15110 8/12 S/T PET/NSC	.140	1.85	1.65	1.50
15137 8/12 S/T PET/NSC	.200	1.80	1.54	1.45
15175 6/ S/E Sgle Row	-	1.70	1.50	1.30
15270 10/20 S/E	.140	2.15	1.95	1.70
15275 10/20 S/T	.140	2.00	1.85	1.60
15435 12/24 S/E PET	.140	2.80	2.35	2.10
15440 12/24 S/T PET	.140	2.85	2.40	2.15
15445 12/24 S/T PET	.200	2.75	2.50	2.20
15505 15/30 S/E GRI Key	.140	2.50	2.25	2.00
15510 15/30 S/T GRI Key	.140	2.40	2.15	2.95
15600 18/36 S/E	.140	3.35	3.05	2.70
15610 18/36 S/T	.140	3.00	2.70	2.40
15615 18/36 W/W	.200	3.60	3.20	2.90
15700 22/44 S/E KIM/VEC	.140	2.98	2.90	2.75
15705 22/44 S/T KIM/VEC	.140	3.98	3.30	3.00
15710 22/44 W/W KIM/VEC	.200	3.49	3.20	2.85
15875 25/50 S/E	.140	4.65	4.20	3.75
15880 25/50 S/T	.140	4.55	4.10	3.65
15885 25/50 W/W	.200	4.85	4.35	3.90
16115 36/72 S/E	.140	6.50	5.85	5.20
16120 36/72 S/T	.140	6.55	5.90	5.25
16125 36/72 W/W	.200	6.75	6.10	5.40
16145 36/72 S/T	.200	6.50	5.85	5.20
16235 43/86 S/T Mot 6800	.140	6.60	5.95	5.30
16240 43/86 W/W Mot 6800	.200	7.80	7.05	6.25
16260 43/86 S/T Mot 6800	.200	8.50	5.85	5.20
16725 43/86 S/E Mot 8800	.140	7.20	6.50	5.75
K-1 Pol-Keys		.15	.12	.10

<b>'D' TYPE SUBMINIATURE CONNECTORS.</b>				
PART NUMBER	DESCRIPTION.	1-9pcs.	10-24pcs.	25-99pcs.
DE 9P	Male	\$1.60ea.	\$1.40ea.	\$1.30ea.
DE 9S	Female	2.25ea.	2.00ea.	1.90ea.
DE 110983-1	2 pc. Gray Hood.	1.50ea.	1.35ea.	1.20ea.
DA 15P	Male	2.35ea.	2.15ea.	2.00ea.
DA 15S	Female	3.25ea.	3.10ea.	2.90ea.
DA 51211-1	1 pc. Gray Hood	1.40ea.	1.20ea.	1.15ea.
DA 51226-1	2 pc. Black Hood	2.50ea.	2.25ea.	2.00ea.
DA 110983-2	2 pc. Gray Hood	1.60ea.	1.35ea.	1.30ea.
DB 25P	Male	2.80ea.	2.60ea.	2.40ea.
DB 25S	Female	3.60ea.	3.40ea.	3.20ea.
DB 51212-1	1 pc. Gray Hood	1.50ea.	1.30ea.	1.10ea.
DB 51226-1	2 pc. Black Hood	1.90ea.	1.65ea.	1.45ea.
DB 110983-3	2 pc. Gray Hood	1.75ea.	1.50ea.	1.35ea.
DC 37P	Male	4.20ea.	4.00ea.	3.70ea.
DC 37S	Female	6.00ea.	5.75ea.	5.50ea.
DC 110983-4	2 pc. Gray Hood	2.25ea.	2.00ea.	1.75ea.
DD 50P	Male	5.50ea.	5.10ea.	4.75ea.
DD 50S	Female	9.40ea.	8.60ea.	8.00ea.
DD 51216-1	1 pc. Gray Hood	2.40ea.	2.20ea.	2.00ea.
DD 110983-5	2 pc. Gray Hood	2.60ea.	2.40ea.	2.10ea.
D 20418-2	Hardware Set (1 Hood Set)	.90ea.	.80ea.	.70ea.

<b>I.C. SOCKETS GOLD. W/WRAP 3 TURN</b>	
14 pin	\$0.40 ea.
16 pin	0.44 ea.
<b>8080A PRIME. \$5.00 ea.</b>	
<b>EIA 8 CONDUCTOR CABLES 8ft. Long. CLASS #1 Type Cables.</b>	
1. to 4 pcs.	\$22.00
5 to 9 pcs.	19.00

<b>I.C. SOCKETS TIN.</b>	
14 pin	\$0.15 ea.
16 pin	0.17 ea.
<b>CONNECTORS FOR CENTRONICS 700 SERIES. Amphenol 57-30360</b>	
1 to 4 pcs.	\$8.00 ea.
5 to 9 pcs.	6.00 ea.

<b>COOLING FANS. Extra Quiet.</b>	
1 to 4	\$18.00 ea.
5 to 9	17.00 ea.

TERMS: MINIMUM ORDER: \$15.00 ADD \$1.35 For Handling & Shipping. Orders over \$30.00 in the U.S.A. We Pay the Shipping. CALIF. RESIDENTS: Please Add 6% Sales Tax.  
NOTE: NO C.O.D. OR CREDIT CARD ORDERS WILL BE ACCEPTED.

PHONE: 213-988-6196

MAIL ORDERS TO:

**BECKIAN ENTERPRISES**  
P.O. BOX #3089  
SIMI VALLEY, CA 93063

## TRS-80™ MODEL II 64K 3626<sup>00</sup>

IN STOCK • FULLY GUARANTEED  
ORDER NOW (1) 800-345-8102

### MODEL II DISK DRIVES

- SINGLE DRIVE, SINGLE ENCLOSURE \$ 899.00
- SINGLE DRIVE, MULTIPLE ENCLOSURE \$1050.00
- ADDITIONAL DRIVES FOR MULT. ENCL. \$ 540.00

IMMEDIATE DELIVERY

## DISK DRIVES 350<sup>00</sup>

- OVER \$149.00 LESS THAN RADIO SHACK
- TRS-80 MODEL I COMP. DRIVES

## INTERTEC SUPERBRAIN

32K \$2995.00 • 64K \$3170.00

ORDER NOW (1) 800-345-8102

EXPANSION INTERFACES • IMMEDIATE DELIVERY

0 K \$ 278.10 • 16 K \$ 376.10 • 32 K \$ 474.10

	LIST PRICE	OUR PRICE		OUR PRICE
TRS-80 4K LEVEL II	\$619.00	\$ 575.70	NEC 5510 (IN STOCK)	\$2995.00
TRS-80 16K LEVEL II	\$849.00	\$ 789.60	CENTRONICS 730	\$ 695.00
TELEPHONE MODEM	\$199.00	\$ 185.10	CENTRONICS 737	\$ 950.00
KEY PADS	\$79.00	\$ 73.40	CITOH LETTER QUALITY	\$2195.00
RS 232	\$19.00	\$ 92.10	PRINTER	

## VR DATA

1-800-345-8102  
(215) 461-5300

777 HENDERSON BLVD.  
FOLCROFT INDUSTRIAL PARK  
FOLCROFT, PA 19032

AD'S PRICES ARE CASH DISCOUNTED

## V R DATA'S TRS-80™ SWEEPSTAKES

Celebrating V. R. DATA's 8th Anniversary

OVER \$1700.00 in PRIZES

GRAND PRIZE - 16K LII TRS-80

TWO SECOND PRIZES - DISK DRIVES

FOUR THIRD PRIZES - \$50.00 Gift Certificates

### SWEEPSTAKES RULES

- 1 ALL ENTRIES MUST BE SUBMITTED ON ORIGINAL ENTRY BLANK
- 2 ONE ENTRY PER PERSON
- 3 WINNERS SELECTED BY RANDOM DRAWING. NOTIFIED BY MAIL
- 4 ENTRIES MUST BE RECEIVED BY 10 31 80
- 5 VOID WHERE PROHIBITED BY LAW NO PURCHASE NECESSARY

MAIL NOW TO ENTER V. R. DATA'S SWEEPSTAKES

NAME \_\_\_\_\_  
ADDRESS \_\_\_\_\_  
CITY \_\_\_\_\_ STATE \_\_\_\_\_ ZIP \_\_\_\_\_  
TELEPHONE \_\_\_\_\_ OCCUPATION \_\_\_\_\_  
COMPUTER EQUIPMENT OWNED \_\_\_\_\_

INTENDED USE \_\_\_\_\_

B

SEND FOR CATALOG





**NEW PRODUCTS!**

**Super Color S-100 Video Kit \$129.95**  
Expandable to 256 x 192 high resolution color graphics. 6847 with all display modes computer controlled. Memory mapped. 1K RAM expandable to 6K. S-100 bus 1802, 8080, 8085, 280 etc. Delivery January '80.

**1602 16K Dynamic RAM Kit \$149.00**  
Expandable to 32K. Hidden refresh w/clocks upto 4 MHz w/no wait states Addl. 16K RAM \$63

**Quest Super Basic**

Quest, the leader in inexpensive 1802 systems announces another first. Quest is the first computer worldwide to ship a full size Basic for 1802 systems. A complete function Super Basic by Ron Kenner including floating point capability with scientific notation (number range ± 17E<sup>99</sup>), 32 bit integer ±2 billion; Multi dim arrays; String arrays; String manipulation; Cassette I/O, Save and load, Basic, Data and machine language programs; and over 75 Statements, Functions and Operators.

Easily adaptable on most 1802 systems. Requires 12K RAM minimum for Basic and user programs. Cassette version in stock now. ROM versions coming soon with exchange privilege

**Elf II Adapter Kit \$24.95**

Plugs into Elf II providing Super Elf 44 and 50 pin plus S-100 bus expansion. (With Super Expansion). High and low address displays, state and mode LED's optional \$18.00.

**Gremlin Color Video Kit \$69.95**

32 x 16 alpha/numerics and graphics; up to 8 colors with 6847 chip; 1K RAM at E000. Plugs into Super Elf 44 pin bus. No high res. graphics.

allowing some credit for cassette version. New improved version with improved speed and accuracy now avail. Source list for I/O now incl.

**Super Basic on Cassette \$40.00**

**Tom Pittman's 1802 Tiny Basic Source** listing now available. Find out how Tom Pittman wrote Tiny Basic and how to get the most out of it. Never offered before. \$19.00.

**S-100 4-Slot Expansion \$9.95**

**Super Monitor VI.I. Source Listing \$15.00**

Coming Soon: Assembler, Editor, Disassembler, DA/AD, Super Sound/Music, EPROM programmer, Stringy Floppy System.

Same day shipment. First line parts only. Factory tested. Guaranteed money back. Quality IC's and other components at factory prices.

**INTEGRATED CIRCUITS**

7400RTL	1.50	LM323K-5	5.95	CD4026	2.50
7414N	1.19	LM323K-15	5.95	40M5111	5.50
7420N	1.20	LM320K-15	1.50	4116 200ns	9.50
7404N	25	LM320T-5	1.35	40M5312	3.00
7410N	23	LM320T-15	1.35	40M5320	3.00
7410N	20	LM320T-12	1.35	40M5328	3.00
7414N	70	LM320T-15	1.35	40M5330	3.00
7410N	20	LM320N	1.35	40M5332	3.00
7422N	39	LM333N	1.00	40M5334	3.00
7432N	20	LM340K-5	1.35	40M5336	3.00
7432N	58	LM340K-12	1.35	40M5338	3.00
7445N	74	LM340K-12	1.35	40M5340	3.00
7447N	59	LM340K-15	1.35	40M5342	3.00
7448N	77	LM340K-24	1.35	40M5344	3.00
7450N	20	LM340T-5	1.25	40M5346	3.00
7424N	35	LM340T-12	1.25	40M5348	3.00
7475N	49	LM340T-12	1.25	40M5350	3.00
7495N	88	LM340T-15	1.25	40M5352	3.00
7495N	105	LM340T-15	1.25	40M5354	3.00
7490N	43	LM340T-24	1.25	40M5356	3.00
7492N	43	LM350	2.50	40M5358	3.00
7498N	43	LM350	2.50	40M5360	3.00
7495N	69	LM379	5.00	40M5362	3.00
7410N	120	LM360N	1.00	40M5364	3.00
7414N	35	LM381	1.60	40M5366	3.00
7412N	34	LM382	1.60	40M5368	3.00
7412N	59	LM703N	65	40M5370	3.00
7412N	45	LM703N	65	40M5372	3.00
74145N	77	LM7232N	50	40M5374	3.00
74150N	120	LM723N	85	40M5376	3.00
74150N	89	LM7414N	38	40M5378	3.00
74145N	2.00	LM7414N	38	40M5380	3.00
74157N	89	LM7417N	75	40M5382	3.00
74157N	89	LM7417N	75	40M5384	3.00
74157N	87	LM7417N	75	40M5386	3.00
74162N	125	LM1303N	1.75	40M5388	3.00
74163N	87	LM1304	1.10	40M5390	3.00
7414N	35	LM2901B	1.25	40M5392	3.00
74190N	1.15	LM2901B	1.25	40M5394	3.00
74190N	87	LM1458	47	40M5396	3.00
74193N	85	LM1480	3.75	40M5398	3.00
7422N	2.65	LM1480	3.75	40M5400	3.00
74260N	67	LM1899	3.00	40M5402	3.00
74265N	89	LM2111	1.75	40M5404	3.00
74265N	89	LM2111	1.75	40M5406	3.00
74367N	89	LM3900N	50	40M5408	3.00
74367N	89	LM3900N	50	40M5410	3.00
74367N	89	LM3900N	50	40M5412	3.00
74367N	89	LM3900N	50	40M5414	3.00
74367N	89	LM3900N	50	40M5416	3.00
74367N	89	LM3900N	50	40M5418	3.00
74367N	89	LM3900N	50	40M5420	3.00
74367N	89	LM3900N	50	40M5422	3.00
74367N	89	LM3900N	50	40M5424	3.00
74367N	89	LM3900N	50	40M5426	3.00
74367N	89	LM3900N	50	40M5428	3.00
74367N	89	LM3900N	50	40M5430	3.00
74367N	89	LM3900N	50	40M5432	3.00
74367N	89	LM3900N	50	40M5434	3.00
74367N	89	LM3900N	50	40M5436	3.00
74367N	89	LM3900N	50	40M5438	3.00
74367N	89	LM3900N	50	40M5440	3.00
74367N	89	LM3900N	50	40M5442	3.00
74367N	89	LM3900N	50	40M5444	3.00
74367N	89	LM3900N	50	40M5446	3.00
74367N	89	LM3900N	50	40M5448	3.00
74367N	89	LM3900N	50	40M5450	3.00
74367N	89	LM3900N	50	40M5452	3.00
74367N	89	LM3900N	50	40M5454	3.00
74367N	89	LM3900N	50	40M5456	3.00
74367N	89	LM3900N	50	40M5458	3.00
74367N	89	LM3900N	50	40M5460	3.00
74367N	89	LM3900N	50	40M5462	3.00
74367N	89	LM3900N	50	40M5464	3.00
74367N	89	LM3900N	50	40M5466	3.00
74367N	89	LM3900N	50	40M5468	3.00
74367N	89	LM3900N	50	40M5470	3.00
74367N	89	LM3900N	50	40M5472	3.00
74367N	89	LM3900N	50	40M5474	3.00
74367N	89	LM3900N	50	40M5476	3.00
74367N	89	LM3900N	50	40M5478	3.00
74367N	89	LM3900N	50	40M5480	3.00
74367N	89	LM3900N	50	40M5482	3.00
74367N	89	LM3900N	50	40M5484	3.00
74367N	89	LM3900N	50	40M5486	3.00
74367N	89	LM3900N	50	40M5488	3.00
74367N	89	LM3900N	50	40M5490	3.00
74367N	89	LM3900N	50	40M5492	3.00
74367N	89	LM3900N	50	40M5494	3.00
74367N	89	LM3900N	50	40M5496	3.00
74367N	89	LM3900N	50	40M5498	3.00
74367N	89	LM3900N	50	40M5500	3.00
74367N	89	LM3900N	50	40M5502	3.00
74367N	89	LM3900N	50	40M5504	3.00
74367N	89	LM3900N	50	40M5506	3.00
74367N	89	LM3900N	50	40M5508	3.00
74367N	89	LM3900N	50	40M5510	3.00
74367N	89	LM3900N	50	40M5512	3.00
74367N	89	LM3900N	50	40M5514	3.00
74367N	89	LM3900N	50	40M5516	3.00
74367N	89	LM3900N	50	40M5518	3.00
74367N	89	LM3900N	50	40M5520	3.00
74367N	89	LM3900N	50	40M5522	3.00
74367N	89	LM3900N	50	40M5524	3.00
74367N	89	LM3900N	50	40M5526	3.00
74367N	89	LM3900N	50	40M5528	3.00
74367N	89	LM3900N	50	40M5530	3.00
74367N	89	LM3900N	50	40M5532	3.00
74367N	89	LM3900N	50	40M5534	3.00
74367N	89	LM3900N	50	40M5536	3.00
74367N	89	LM3900N	50	40M5538	3.00
74367N	89	LM3900N	50	40M5540	3.00
74367N	89	LM3900N	50	40M5542	3.00
74367N	89	LM3900N	50	40M5544	3.00
74367N	89	LM3900N	50	40M5546	3.00
74367N	89	LM3900N	50	40M5548	3.00
74367N	89	LM3900N	50	40M5550	3.00
74367N	89	LM3900N	50	40M5552	3.00
74367N	89	LM3900N	50	40M5554	3.00
74367N	89	LM3900N	50	40M5556	3.00
74367N	89	LM3900N	50	40M5558	3.00
74367N	89	LM3900N	50	40M5560	3.00
74367N	89	LM3900N	50	40M5562	3.00
74367N	89	LM3900N	50	40M5564	3.00
74367N	89	LM3900N	50	40M5566	3.00
74367N	89	LM3900N	50	40M5568	3.00
74367N	89	LM3900N	50	40M5570	3.00
74367N	89	LM3900N	50	40M5572	3.00
74367N	89	LM3900N	50	40M5574	3.00
74367N	89	LM3900N	50	40M5576	3.00
74367N	89	LM3900N	50	40M5578	3.00
74367N	89	LM3900N	50	40M5580	3.00
74367N	89	LM3900N	50	40M5582	3.00
74367N	89	LM3900N	50	40M5584	3.00
74367N	89	LM3900N	50	40M5586	3.00
74367N	89	LM3900N	50	40M5588	3.00
74367N	89	LM3900N	50	40M5590	3.00
74367N	89	LM3900N	50	40M5592	3.00
74367N	89	LM3900N	50	40M5594	3.00
74367N	89	LM3900N	50	40M5596	3.00
74367N	89	LM3900N	50	40M5598	3.00
74367N	89	LM3900N	50	40M5600	3.00
74367N	89	LM3900N	50	40M5602	3.00
74367N	89	LM3900N	50	40M5604	3.00
74367N	89	LM3900N	50	40M5606	3.00
74367N	89	LM3900N	50	40M5608	3.00
74367N	89	LM3900N	50	40M5610	3.00
74367N	89	LM3900N	50	40M5612	3.00
74367N	89	LM3900N	50	40M5614	3.00
74367N	89	LM3900N	50	40M5616	3.00
74367N	89	LM3900N	50	40M5618	3.00
74367N	89	LM3900N	50	40M5620	3.00
74367N	89	LM3900N	50	40M5622	3.00
74367N	89	LM3900N	50	40M5624	3.00
74367N	89	LM3900N	50	40M5626	

**SAVE TRS-80's**



# #1 IN TRS-80 SALES!!!

DISCOUNTS of 10%, 15% and More available.

WE PAY Domestic U.P.S. shipping and insurance on minimum orders.

NO TAXES are collected on out-of-state shipments.

TOLL FREE Order Number 800/531-7466.

OPEN 8:00 a.m. to 6:00 p.m., Central Time, Monday through Friday;  
9:00 a.m. to 6:00 p.m., Saturday.

## Pan American Electronics

Incorporated

A **Radio Shack**

AUTHORIZED SALES CENTER

1117 CONWAY MISSION, TEXAS 78572

TOLL FREE ORDER NUMBER 800/531-7466

TEXAS AND PRINCIPAL TELEPHONE NUMBER 512/581-2765



6502	7.45	10 @	6.95	50 @	6.55	100 @	6.15
6502A	8.40	10 @	7.95	50 @	7.35	100 @	6.90
6520 PIA	5.15	10 @	4.90	50 @	4.45	100 @	4.15
6522 VIA	7.15	10 @	6.95	50 @	6.45	100 @	6.00
6532	7.90	10 @	7.40	50 @	7.00	100 @	6.60
2114-L450			4.75	20 @	4.45	100 @	4.15
2114-L300			5.95	20 @	5.45	100 @	5.10
2716 EPROM			27.00	5 @	25.00	10 @	23.00
4116-200 ns RAM			7.00		8 @		6.25
6550 RAM (PET 8K)							12.70
21L02							.90
S-100 Wire Wrap					2.85	10 @	2.65
S-100 Solder Tail					2.35	10 @	2.15

### CASSETTES—AGFA PE-611 PREMIUM

High output, low noise, 5 screw housing, labels.

C-10 10/5.65 50/25.00 100/48.00

C-20 10/6.45 50/29.50 100/57.00

C-30 10/7.30 50/34.00 100/66.00

All other lengths available. Write for price list.

### SALE

(write for quantity prices)



SCOTCH 8" Disks		10/\$31.00
SCOTCH 5.25" Disks		10/ 31.50
Verbatim 5.25" Disks		10/ 25.50
Diskette Storage Pages		10/ 3.95
Disk Library Cases	8" - 2.95	5" - 2.15
BASF 5.25" Disks		10/ 28.00
BASF 8" Disks		10/ 29.00

### ATARI—INTRODUCTORY SPECIAL

Atari 400, Atari 800, all Atari Modules 20% OFF

### Commodore CBM-PET SPECIALS

**FREE**—Up to \$235 free merchandise with purchase of one of following CBM-PET items:



8032 32K-80 column CRT	\$1795	235
8016 16K-80 column CRT	1495	205
8050 Dual Disk Drive-950,000 bytes	1695	220
CBM Modem-IEEE Interface	395	50
CBM Voice Synthesizer	395	50
8N full size graphics keyboard	795	100
16N full size graphics keyboard	995	135
32N full size graphics keyboard	1295	170
16B full size business keyboard	995	135
32B full size business keyboard	1295	170
2040 Dual Disk Drive-343,000 bytes	1295	170
2022 Tractor Feed Printer	795	100
2023 Pressure Feed Printer	695	90
C2N External Cassette Deck	95	12
Used 8K PETs (limited quantities)	495	

### \*\*\*\* EDUCATIONAL DISCOUNTS \*\*\*\*

Buy 2 computers, get 1 FREE

CBM Full Size Graphics Keyboard	\$ 74
CBM WordPro I-for 8K PET	25
CBM WordPro II-16 or 32K, 2040, Printer	88
CBM WordPro III-32K, 2040, Printer	178
VISICALC for PET (CBM/Personal Software)	\$128
CBM Assembler/Editor (disk)	89
CBM General Ledger, A/P, A/R NEW!	270
Programmers Toolkit-PET ROM Utilities	\$ 44.90
PET Spacemaker Switch	22.90
Dust Cover for PET	7.90
IEEE-Parallel Printer Interface for PET	79.00
IEEE-RS232 Printer Interface for PET	149.00

Centronics 737 Proportional Spacing Printer	\$ 845
NEC Spinwriter-parallel	2450

SYM-1 \$209 with 4K RAM	\$ 238
SYM BAS-1 BASIC in ROM	85
SYM RAE-1/2 Assembler in ROM	85
MDT 1000 Synertek Development System	1345
KTM-2/80 Synertek Video Board	349
KIM-1 (add \$34 for power supply)	159
Seawell Motherboard-4K RAM	195
Seawell 16K Static RAM-KIM, SYM, AIM	320
S-100 Static RAM kit SALE	198
Leedex Video 100 12" Monitor	129
Zenith Z19 Terminal (factory asm.)	770

KL-4M Four Voice Music Board for PET	\$34.90
Visible Music Monitor (4 Voice) for PET	29.90
SPECIAL—KL-4M with Visible Music Monitor	59.90

MICROHELLO for PET by Michael Riley	\$9.95
Machine language version—you can't win at Level 5.	

PAPER MATE 60 Command PET Word Processor	\$29.95
Full-featured version by Michael Riley	

All Book and Software Prices are Discounted

PET Personal Computer Guide (Osborne)	\$12.75
PET and the IEEE-488 Bus (Osborne)	12.75
6502 Assembly Language (Osborne)	9.45
Hands on BASIC with a PET	10.15
Programming the 6502 (Zaks)	10.45
6502 Applications Book (Zaks)	10.45
6500 Manuals (MOS)	Each 6.45
Programming a Microcomputer: 6502	7.75
6502 Software Bookbook (Scelbi)	9.45

115 E. Stump Road  
Montgomeryville, PA 18936

215-699-5826

**A B Computers**

### WRITE FOR CATALOG

Add \$1 per order for shipping. We pay balance of UPS surface charges on all prepaid orders.

**IMSAI CONN.**  
100 PIN GOLD  
SOLDERTAIL  
\$ **2.50** ea.  
or  
10 for \$2.30 ea.

**CAPACITORS**  
1 @ 12 Volts  
**CERAMIC**  
11¢ ea.  
or  
100/\$10<sup>00</sup>

**MICROBYTE**

**16K** STATIC  
RAM BOARD  
• S-100 Compatible  
• 4K Bank Addressable  
• Extended Memory  
Management  
• No DMA Restrictions  
• Assembled & Tested  
• 4MHz Operation

\$ **240**<sup>00</sup>

**4116's - 200NS**

Add-On Memory for:  
Apple, TRS-80, Heath, Exidy,  
SD Expandoram, etc.

8 for \$**55**<sup>00</sup>  
16 for \$**105**<sup>00</sup>

**MICROBYTE**

**32K** STATIC  
RAM BOARD

- IEEE/S-100
- 4K Bank Addressable  
to any 4K Slot within  
a 64K Boundary
- On-board 8-Bit  
Output Port
- No DMA Restrictions
- Assembled & Tested
- 4MHz Operation

\$ **475**<sup>00</sup>

CATALOG  
AVAILABLE  
CALL  
OR  
WRITE

**LO-PRO SOCKETS**

14 PIN	1-99	100 UP
16 PIN	.10	.09
18 PIN	.12	.11
20 PIN	.15	.13
24 PIN	.23	.21
28 PIN	.26	.24
40 PIN	.30	.28
	.42	.40

**LOBO INT'L**

**SA800**

Shugart 8''  
Single-Sided/  
Double Density  
Floppy Disk  
Drive, Cabinet &  
Power Supply  
(1) Drive Installed  
\$**775**<sup>00</sup>  
(2) Drives Installed  
\$**1250**<sup>00</sup>

**APPLE II**

DISK DRIVE INTERFACE  
• SA400, Cabinet,  
Power Supply & Cable

\$ **395**<sup>00</sup>

\*WITH OPTIONAL  
INTERFACE CARD  
\$**495**<sup>00</sup>

**ATARI 400 & 800**

- |                                     |                                       |
|-------------------------------------|---------------------------------------|
| <b>MODEL 400</b>                    | <b>MODEL 800</b>                      |
| • Computer Console                  | • Computer Console                    |
| • Basic Language Cartridge          | • Basic Language Cartridge            |
| • Basic Language Programming Manual | • Education System Master Cartridge   |
| • Operators Manual                  | • Basic Language Programming Manual   |
| • Power Supply                      | • Operators Manual                    |
| • TV Switch Box                     | • Atari 410 Program Recorder          |
|                                     | • Guide to Basic Programming Cassette |
|                                     | • 8K Ram Module                       |
|                                     | • Power Supply                        |
|                                     | • TV Switch Box                       |

**CALL FOR PRICE**

AVAILABLE FROM STOCK

**2708's**  
(450 NS)

\$**800** ea.  
or  
8/\$**58**<sup>00</sup>

**2716's**

5-VOLT ONLY  
(450 NS)

\$ **2800** ea.

TEXAS INST., FUJITSU

**STATIC & DYNAMIC RAM CHIPS**

2104 (4K Dynamic)	\$ <b>225</b> ea.
4108/4115 (8K Dynamic)	\$ <b>450</b> ea.
5257-3L (4K Static)	\$ <b>600</b> ea.
250 NS	

INTEL's \$**3200** ea.

**74LS244**

\$**175** ea.

QTY. PRICES AVAILABLE

**8080A**

CERAMIC  
\$**250** ea.

**SHUGART**

**SA801R**

Bare Drives  
Single Sided/  
Sgl/ Dbl Density

CALL FOR PRICE  
AND  
DELIVERY

**SANYO**

B & W  
MONITORS  
9" MODEL  
\$**175**<sup>00</sup>  
15" MODEL  
\$**250**<sup>00</sup>

**CENTRONICS PRINTERS (MODEL # 703)**

- 180 CPS B1-Directional
- Logic Seeking Printer
- 132 Column Carriages
- VFU & Centronics Standard Parallel Interface

\$ **1995**<sup>00</sup>

MODEL #704 (Serial) \$**1895**<sup>00</sup>

**SHUGART SA400**

- Enclosed in Metal Case
- Cutouts for Data Cable, Switch, Fuse & Pwr Cord

\$ **315**<sup>00</sup>

**LINEAR COMPONENTS**

LM 348	.....75
LM 377	.....90
LM 555	.....35
LM 3900	.....42

**COMMODORE SOFTWARE**

- Basic/Basic
- Mortgage
- Stock Portfolio
- Basic Finance
- Statistics Pkg.
- Checkbook
- Basic Math
- Alphabetizing
- Guess A Sentence
- Spelling

CALL FOR PRICES

**TRS-80 DISK DRIVES**

**REGULATORS**

Shugart SA400, Single or Double Density, Soft Sector, up to 218K Bytes, 25 MSec. Access Time, Software Compatible.

\$ **395**<sup>00</sup>

320T-5	.....90
320T-12	.....80
340T-5	.....75
340T-12	.....65
78HO5	.....5.25

**ORDERING INFO**

Name, Address, Phone  
Ship by: UPS or Mail  
Shipping Charges, Add  
\$2.00 up to (5) lbs.

**TERMS**

We Accept Cash,  
Check, Money Order,  
Visa & Master Charge.  
C.O.D.'s on Approval.  
(U.S. Funds Only)  
Tax: 6% Calif. Res.



**CALIFORNIA COMPUTER SYSTEMS**

- 16K RAM BOARD.** Fully buffered addressable in 4K blocks. IEEE standard for bank addressing 2114's. PCB .....\$27.95 Kit 450 NSEC .....\$249.95
- PT-1 PROTO BOARD.** Over 2,600 holes 4" regulators. All S-100 buss functions labeled, gold fingers. PCB .....\$26.95
- PT-2 PROTO BOARD.** Similar to PT-1 except set-up to handle solder tail sockets. PCB .....\$26.95
- CCS MAIN FRAME.** Kit (S-100) .....\$339.95
- APPLE EXTENDER.** Kit .....\$22.95
- APPLE IEEE INSTRUMENTATION INTERFACE KIT 7490.** Kit .....\$275.00
- ARITHMETIC PROCESSOR FOR APPLE 7811A.** Kit .....\$350.00
- APPLE ASYNCHRONOUS SERIAL INTERFACE 7710A.** Kit .....\$89.95
- APPLE SYNCHRONOUS SERIAL INTERFACE 7712A.** Kit .....\$89.95
- ALL OTHER CCS PRODUCTS AVAILABLE**
- SSM**
- PB-1 2708 & 2716 Programming Board** with provisions for 4K or 8K EPROM. No external supplies required. Textool sockets. Kit .....\$129.95
- CB-1A 8080 Processor Board.** 2K of PROM 256 BYTE RAM power on/rest Vector Jump Parallel port with status. Kit .....\$129.95 PCB .....\$27.95
- VB-3 80 x 55 VIDEO BOARD.** Graphic included. 4 MHz .....\$379.95
- IQ-4 Two serial I/O ports with full handshaking 20/60 ma current loop: Two parallel I/O ports.** Kit .....\$130.00 PCB .....\$27.95
- VB-1B 64 x 16 video board, upper lower case Greek composite and parallel video with software, S-100.** Kit .....\$125.00 PCB .....\$27.95
- CB-2 Z80 CPU BOARD.** Kit .....\$185.95
- AIO APPLE SERIAL/PARALLEL** .....\$125.95
- ALL OTHER SSM PRODUCTS AVAILABLE**

**WMC inc. WAMECO INC.**

- FDC-1 FLOPPY CONTROLLER BOARD** will drive shugart, pertek, remic 5" & 8" drives up to 8 drives, on board PROM with power boot up, will operate with CPM™ (not included). PCB .....\$42.95
- FPB-1 Front Panel.** IMSAI size, hex displays. Byte, or instruction single step. PCB .....\$47.50
- MEM-1A 8K x 8** fully buffered, S-100, uses 2102 type rams. PCB .....\$25.95
- QM-12 MOTHER BOARD,** 13 slot, terminated, S-100 board only .....\$38.95
- CPU-1 8080A Processor board S-100** with 8 level vector interrupt. PCB .....\$27.95
- RTC-1 Realtime clock board.** Two independent interrupts. Software programmable. PCB .....\$24.95
- EPM-1 1702A 4K Eprom card.** PCB .....\$25.95
- EPM-2 2708/2716 16K/32K EPROM CARD.** PCB .....\$25.95
- QM-9 MOTHER BOARD.** Short Version of QM-12. 9 Slots. PCB .....\$32.95
- MEM-2 16K x 8 Fully Buffered 2114 Board.** PCB .....\$27.95
- PTB-1 POWER SUPPLY AND TERMINATOR BOARD.** PCB .....\$27.95
- IOB-1 SERIAL AND PARALLEL INTERFACE.** 2 parallel, one serial and cassette. PCB .....\$27.95
- 2708.....\$ 9.49 2114 450 NSEC .....\$5.99  
2716.....\$35.95 2114 200 NSEC .....\$6.99

**JULY SPECIAL SALE ON PREPAID ORDERS**

(Charge cards not included on this offer)

- FPB-1 with MIKOS #14 all parts for front panel** .....\$129.95
- MIKOS PARTS ASSORTMENT WITH WAMECO AND CYBERCOM PCBDS**
- MEM-2 with MIKOS #7 16K ram** with L2114 450 NSEC .....\$249.95
- MEM-2 with MIKOS #13 16K ram** with L2114 250 NSEC .....\$279.95
- CPU-1 with MIKOS #2 8080A CPU** .....\$ 94.95
- QM-12 with MIKOS #4 13 slot mother board** .....\$ 95.95
- RTC-1 with MIKOS #5 real time clock**.....\$ 59.95
- EMP-1 with MIKOS #10 4K 1702 less EPROMS** .....\$ 49.95
- EMP-2 with MIKOS #11 16-32K EPROMS less EPROMS** .....\$ 59.95
- QM-9 with MIKOS #12 9 slot mother board** .....\$ 89.95
- FPB-1 with MIKOS #14 all parts for front panel** .....\$144.95

MIKOS PARTS ASSORTMENTS ARE ALL FACTORY MARKED PARTS. KITS INCLUDE ALL PARTS LISTED AS REQUIRED FOR THE COMPLETE KIT. LESS PARTS LISTED. ALL SOCKETS INCLUDED.

VISA or MASTERCHARGE. Send account number, interbank number, expiration date and sign your order. Approx. postage will be added. Check or money order will be sent post paid in U.S. If you are not a regular customer, please use cash, cashier's check or postal money order. Otherwise there will be a two-week delay for checks to clear. Calif. residents add 6% tax. Money back 30-day guarantee. We cannot accept returned IC's that have been soldered to. Prices subject to change without notice. \$10 minimum order. \$1.50 service charge on orders less than \$10.00.

**MIKOS**

NOTE: NEW ADDRESS AND PHONE (415) 726-7593 P. O. Box 955 • El Granada, CA 94018 Please send for IC, Xistor and Computer parts list

**C/MOS (DIODE CLAMPED)**

4001	-35	4023	-35	4066	-40	74C73	-75
4002	-35	4024	-35	4067	-40	74C74	-75
4006	-110	4026	-35	4071	-35	74C83	-130
4007	-27	4027	-45	4072	-35	74C86	-50
4029	-45	4028	-45	4073	-35	74C87	-95
4010	-45	4029	-35	4074	-35	74C151	-175
4011	-35	4030	-35	4075	-35	74C157	-176
4002	-35	4032	-35	4076	-35	74C160	-176
4013	-40	4035	-37	4014	-1.86	74C161	-115
4014	-1.20	4040	-1.80	4516	-1.00	74C163	-110
4015	1.50	4041	-1.80	4517	-1.20	74C165	-125
4016	-45	4045	-45	4520	-1.00	74C173	-130
4017	-1.05	4046	-1.95	74C200	95	74C174	-120
4018	80	4048	-78	74C201	27	74C175	-120
4019	-45	4050	-46	74C202	-27	74C192	-130
4020	-1.10	4091	-1.10	74C206	-30	74C193	-140
4021	-1.10	4052	-1.10	74C210	-27	74C201	90
4022	-1.00	4053	-1.10	74C214	-120	74C202	50
				74C220	-27	74C214	-130

**DATL'S DAC-08BC - 8 bit DAC - \$9.95**

**8" DISKETTES - HARD SECTOR**  
\$1.75, 10/\$16.00

**CRYSTALS \$3.45 ea.**

2.000 MHz	6.144 MHz
4.000 MHz	12.288 MHz
3.5715 MHz	10.000 MHz
5.000 MHz	18.000 MHz
6.000 MHz	20.000 MHz

**RIBBON CABLE**  
FLAT (COLOR CODED)  
#30 WIRE

26 cond. - .50/par foot  
40 cond. - .75/par foot  
50 cond. - .90/par foot

**RS232 CONNECTORS**

DB 25P male	.....\$3.25
DB 25S female	.....\$4.25
HOOGS	.....\$1.50

**LED READOUTS**

CCS 8024 - 4 digit C.C. 8" display	.....\$5.95
FD 503 C.C. 5"	.....\$6.50
FD 510 C.C. 5"	.....\$6.50
DL 704 - 3" C.C.	.....\$8.95
DL 707 C.A. 3"	.....\$7.75
DL 747 C.A. 6"	.....\$1.50
HP3400 C.C.	.....\$1.95
HP3405 8" CC	.....\$1.95

**PRINTED CIRCUIT BOARD**

4" x 6" DOUBLE SIDED EPOXY BOARD 1/16" thick \$60.00 .....\$182.50

EPOXY glass vector board 1/16" thick with 1/10" spacing 4 1/2" x 6 1/2" .....\$1.95

74500	-30	74S15	-40	74S151	-125
74502	-30	74S32	-40	74S157	-125
74505	-45	74S112	-85	74S158	-125
74506	-40	74S153	-110	74S174	-140
74S11	-35			74S257	-150

**7 WATT LD-65 LASER DIODE IR \$8.95**

25 watt Infra Red Pulse (SG 2008 equiv.) Laser Diode (Spec sheet included) .....\$24.95

**MINIATURE MULTI-TURN TRIM POTS**  
100K, 5K, 10K, 20K, 250K, 1 Meg, 8.75 each .....\$3/2.00

**2N3820 P FET** .....\$ .45  
**2N3457 N FET** .....\$ .45  
**2N2646 UJT** .....\$ .45  
**ER 800 TRIGGER DIODES** .....\$481.00  
**2N 6028 BTR UJT** .....\$ .65

**FP 100 PHOTO TRANS.** .....\$ .50  
**RED, YELLOW, GREEN LARGE LED's 2"** .....\$61.00  
**RED/GREEN BIPOLAR LED's 2"** .....\$ .95  
**TIL-118 OPTO-ISOLATOR** .....\$ .75  
**IL-5 OPTO-ISOLATOR** .....\$ .80

**1 WATT ZENERS: 3.3, 4.7, 5.1, 5.6, 9.1, 10, 12, 15, 18, or 22V** .....\$61.00

**TTL REED RELAY - 8PST 5V 20ma \$1.00**

**Silicon Power Rectifiers**

PRV 1A	3A	12A	50A	125A	240A
100	.06	.14	.35	.90	3.70
200	.07	.20	.40	1.30	4.25
400	.09	.25	.65	1.50	6.50
600	.11	.30	.80	2.00	8.50
800	.15	.35	1.00	2.50	10.50
1000	.20	.45	1.25	3.00	12.50

**SILICON SOLAR CELLS**

4" diameter .4V at 1 AMP .....\$10.00  
IN 4148 (IN814) .....\$15/81.00  
.1 or .01 uF 25V ceramic disc. caps. 16/\$1.00, 100/\$50.00

**REGULATORS**

LM317T	.....\$2.50
323K - 5V3A	.....\$5.75
79H 60C - 5V at 5A	.....\$6.95
723	.....\$6.50
320T - 5, 12, or 15V	.....\$1.30
LM305H	......75

**TRANSISTOR SPECIALS**

2N1303 PNP GE TO 18	.....\$3/81.00
2N1307 PNP GE TO 5	.....\$4.40
2N404 PNP GE TO 5	.....\$3/81.00
2N2232 NPN SWITCHING POWER	.....\$1.95
MJE-9004 C-B R F Transistor NPN	.....\$1.75
2N372 NPN Si TO 3	.....\$1.00
2N4508 PNP Si TO 3	.....\$1.00
2N6869 PNP Si TO 9A	.....\$4/81.00
2N3137 NPN Si RF	.....\$ .55
2N2819 NPN Si TO 3 RF	.....\$1.50
2N4200 NPN Si TO 5	.....\$3/81.00
2N3767 NPN Si TO 56	.....\$ .70
2N2222 NPN Si TO 18	.....\$5/81.00
2N2906 NPN Si TO 3	.....\$1.00
2N3904 NPN Si TO 32	.....\$6/81.00
2N3906 PNP Si TO 20	.....\$6/81.00
2N1308 PNP GE TO 5	.....\$ .40
2N2907 NPN Si TO 22	.....\$ .80
TIP 32B PNP Si TO 220	.....\$ .65

**TTL IC SERIES**

7400	-17	7448	-75	74155	-75
74101	-17	7450	-17	74157	-65
7402	-17	7472	-65	74160	-80
7403	-17	7473	-35	74162	-82
7404	-24	7474	-42	74163	-82
7405	-34	7475	-49	74165	-85
7406	-33	7476	-45	74166	-105
7407	-36	7480	-45	74167	-135
7408	-27	7483	-60	74170	-160
7409	-24	7486	-75	74171	-85
7410	-17	7488	-42	74172	-75
7411	-22	7489	-160	74173	-100
7412	-22	7490	-50	74174	-75
7413	-42	7491	-55	74175	-75
7414	-90	7492	-55	74176	-75
7415	-33	7493	-50	74177	-75
7416	-37	7494	-60	74178	-120
7417	-17	7495	-50	74179	-120
7418	-35	7496	-60	74180	-75
7419	-35	7497	-35	74181	-120
7420	-35	7498	-60	74182	-79
7421	-35	7499	-35	74183	-79
7422	-35	74101	-36	74184	-65
7423	-17	74123	-39	74185	-65
7424	-27	74125	-45	74186	-65
7425	-27	74126	-45	74187	-65
7426	-17	74145	-75	74188	-65
7427	-85	74148	-110	74189	-65
7428	-50	74150	-110	74190	-65
7429	-75	74151	-65	74191	-65
7430	-75	74154	-110	74192	-105
7431	-75	74155	-110	74193	-105
7432	-27	74123	-39	74194	-65
7433	-27	74125	-45	74195	-65
7434	-27	74126	-45	74196	-65
7435	-17	74145	-75	74197	-65
7436	-85	74148	-110	74198	-65
7437	-50	74150	-110	74199	-65
7438	-75	74151	-65	74200	-65
7439	-65	74154	-110	74201	-65
7440	-1.05	74155	-110	74202	-65
7441	-85	74154	-110	74203	-65
7442	-50	74155	-110	74204	-65
7443	-75	74156	-110	74205	-65
7444	-75	74154	-110	74206	-65
7445	-75	74155	-110	74207	-65
7446	-75	74156	-110	74208	-65
7447	-75	74154	-110	74209	-65
7448	-75	74155	-110	74210	-65

**14 pin headers** .....\$3/81.00

**MM5387AA** .....\$6.95  
**MM5314** .....\$4.75

**NO. 30 WIRE WRAP WIRE SINGLE STRAND 100'** .....\$1.40

**ALCO MINATURE TOGGLE SWITCHES**

MTO 106 SPDT	.....\$1.05
MTO 206 DPDT	.....\$1.70
MTO 206 DPDT CENTER OFF	.....\$1.85
MTO 206 DPDT CENTER OFF LEVER SWITCH	.....\$1.85

**Full Wave Bridges**

PRV	2A	6A	25A	8 PIN .17	22 PIN .30
100	1.00	1.40	1.40	14 PIN .20	24 PIN .35
200	80	1.30	2.20	16 PIN .22	28 PIN .40
400	1.00	1.65	3.30	18 PIN .25	28 PIN .40
600	1.30	1.90	4.40	18 PIN .25	40 PIN .60

**SANKEN AUDIO POWER AMPS**

SI 1010 G10 WATTS	.....\$ 7.50
SI1020 G20 WATTS	.....\$13.75
SI 1050 G50 WATTS	.....\$26.50

**TANTULUM CAPACITORS**

.22UF 35V	5/81.00	4.7UF 15V	5/81.00
.47UF 35V	5/81.00	6.8UF 35V	4/81.00
.68UF 35V	5/81.00	22UF 25V	\$ .40
1UF 35V	5/81.00	300UF 6V	5/81.00
2.2UF 20V	5/81.00	33UF 20V	\$ .60
3.3UF 20V	4/81.00	100UF 15V	\$ .70
		150UF 15V	\$ .95

**74LS SERIES**

74LS00	-28	74LS163	-119
74LS01	-28	74LS164	-119
74LS02	-28	74LS165	-119
74LS03	-28	74LS166	-119
74LS04	-28	74LS167	-119
74LS05	-28	74LS168	-119
74LS06	-35	74LS169	-110
74LS07	-35	74LS170	-110
74LS08	-35	74LS171	-120
74LS09	-35	74LS172	-120
74LS10	-35	74LS173	-120
74LS11	-35	74LS174	-120
74LS12	-35	74LS175	-120
74LS13	-35	74LS176	-120
74LS14	-35	74LS177	-120
74LS15	-35	74LS178	-120
74LS16	-35	74LS179	-120
74LS17	-35	74LS180	-120
74LS18	-35	74LS181	-120
74LS19	-35	74LS182	-120
74LS20	-35	74LS183	-120
74LS21	-35	74LS184	-120
74LS22	-35	74LS185	-120
74LS23	-35	74LS186	-120
74LS24	-35	74LS187	-120
74LS25	-35	74LS188	-120
74LS26	-35	74LS189	-120
74LS27	-35	74LS190	-120
74LS28	-35	74LS191	-120
74LS29	-35	74LS192	-120
74LS30	-35	74LS193	-120
74LS31	-35		

# DELTA IS READY . . .

Call For  
DEALER  
In Your Area

## Z-80 CPU



Two serial ports, three parallel ports. 2/4 MHz, on board Prom Monitor Phantoms. (Less cable and Monitor). A & T \$325.00

## DOUBLE/SINGLE DISK CONTROLLER



Two stage phase lock loop circuitry for greatest reliability, data transfer at maximum rate. Transparent density selection. 8" or 5" operation 2 or 4 MHz (Some restrictions on DMA).  
DMA — \$425.00  
STD. — \$385.00

## 16K, 32K STATIC RAM



World's most reliable memory, responds to extended address lines A16, A17, cool running, fast.  
16K-\$395.00 32K-\$650.00

## 32K, 48K, 64K DYNAMIC RAM



Basic dynamic board tested to run at 4MHz with our Z-80 board. 4116 chips at 200 nanosecond speed insures most reliable data storage. Double density and DMA compatible.  
32K-\$580.00 48K-\$640.00  
64K-\$750.00

## 32K, 48K, 64K ERROR DETECTING Cromenco/Alfa Micro



State of the art development. Parity generation and error detection. Compatible with 16 bit CPU designs. 16K bank, select under software control. 4MHz Z-80, 8086, Cromenco, Alpha Micro compatible.  
32K-\$650.00 48K-\$725.00  
64K-\$850.00

## FLOPPYS



8" Shugart . . . . \$550.00  
8" Siemans . . . . \$525.00  
5" Siemans . . . . \$350.00  
(Double Sided)  
8" CDC . . . . . \$675.00  
8" Remex . . . . . \$645.00

## TELEVIDEO 912



80 x 24—Lower case descenders. Teletype or typewriter keyboard 110/220 VAC. 50 to 19.2K Baud Hex entry pad. Similar to SOROC but better looking with NO FAN NOISE

## TELEVIDEO 920



Similar to TV 912 but has programmable functions keys across top. Excellent for WORDSTAR Text Editing.

## WINCHESTER/SHUGART SA 1000



5 megs now expandable to 10, works alongside floppy disk drive for expanded storage. Use with controller below.  
\$1950.00

## WINCHESTER/CENTURY DATA SYSTEM (Hunter Shown)



20 megs expandable to 40—Marksman series, plugs into our CPU parallel port or MP/M board drive, cabinet, power supply, 2.0 Bios.  
\$4850.00

## FLOPPY DISKS

### DYSAN Quality



8" SSSD . . . . . \$4.25  
8" SSDD . . . . . \$5.50  
8" DSDD . . . . . \$7.60  
5" SSDD . . . . . \$4.10  
(Boxes of 10 only)

## MPM<sup>®</sup> I/O TIMER



Designed for MP/M<sup>®</sup> software of Digital Research. 6 users serial port, three 8 bit parallel ports for hard disk. Timer and vectored interrupt.  
©TM Digital Research

## 80 x 24 VIDEO

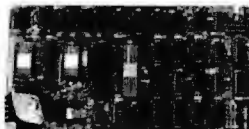

Keyboard input, Z-80 Processor, on board RAM makes this a non-memory mapped substitute for a terminal when mated with a keyboard.  
\$430.00

## WINCHESTER/FLOPPY INTERFACE



Allows mixing of Shugart Winchester and floppy drives on same cable when used with DP-DSK. Supplied with software Bios for MP/M<sup>®</sup> and 2.0  
©TM Digital Research

## SOFTWARE/CABLES/PROMS

CP/M<sup>®</sup> 2.2 . . . . \$150.00  
MP/M<sup>®</sup> . . . . . \$350.00  
2708 Monitor . . . \$ 25.00  
2716 Monitor . . . \$ 40.00  
Disk 50 Pin . . . \$ 22.00  
RS-232 . . . . . \$ 15.00  
CPU to Back . . . \$ 32.00  
Disk DC . . . . . \$ 4.50  
Disk AC . . . . . \$ 2.50  
Winchester . . . . \$ 28.00

# COMPLETELY NEW FROM DELTA PRODUCTS

## S-100 MAINFRAME



- Twin Vertical Drive Mounting, Fits Shugart, Siemans, Etc.
- Key-Lock Switch
- Detachable Power/Mother Module
- Detachable Drive Platform
- 12-Slot Motherboard, Fully Terminated

LESS DRIVES

**\$849.00**

INTRODUCTORY SPECIAL

• INCLUDES S-100 MODULE SHOWN AT RIGHT.

## S-100 MODULE

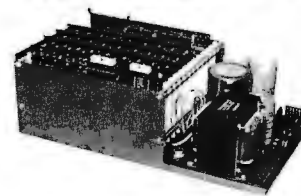
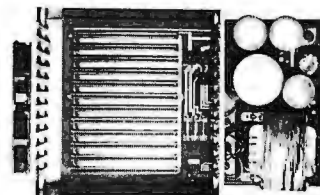

- 30A of +8V  
6A of ±16V
- Disc Power Supply  
6A of +24V  
5A of +5V  
1A of -5V
- 220V or 110V AC  
50 or 60 Cycle Operation
- Connectors Supplied For Up To 4 Drives
- OPTIONAL Fans Mount Neatly On 1 Side For Forced Air Cooling

**\$249.00**

INTRODUCTORY SPECIAL

West:  
**DELTA PRODUCTS**  
15392 Assembly Lane, Unit A  
Huntington Beach, CA 92649  
TELEPHONE: (714) 898-1492



East:  
**DELTA PRODUCTS**  
11 Edison Drive  
New Lenox, IL 60451  
TELEPHONE: (815) 485-9072

Circle 291 on inquiry card.

TELEX: 681-367 DELTMAR HTBH

# WAMECO

## THE COMPLETE PC BOARD HOUSE EVERYTHING FOR THE S-100 BUSS

### INTRODUCTORY SPECIAL

#### IOB-1 SERIAL/PARALLEL INTERFACE BOARD

- \* TWO PARALLEL DATA PORTS PROGRAMMABLE USING AN 8255 WITH SEPARATE HANDSHAKING.
  - \* ONE SERIAL PORT USING AN 8251 WITH PROVISIONS FOR PARITY, STOP BIT AND CHARACTER LENGTH. BAUD RATES 110 TO 9600 BAUD. OUTPUTS RS232, TTL AND CURRENT LOOP.
  - \* KANSAS CITY STANDARD CASSETTE INTERFACE, 300 BAUD FOR USE WITH THE SERIAL INTERFACE.
  - \* STATUS MAY BE POLLING SOFTWARE OR VECTURED INTERRUPTS.
- PCBD .....\$31.95  
KIT TO BE ANNOUNCED LATER.

FUTURE PRODUCTS: 80 CHARACTER VIDEO BOARD.

Z-80 CPU BOARD WITH ROM, 8 PARALLEL PORT I/O BOARD.

**DEALER INQUIRIES INVITED, UNIVERSITY DISCOUNTS AVAILABLE  
AT YOUR LOCAL DEALER**

MOST PRODUCTS FOR IMMEDIATE SHIPMENT. NO 4-8 WEEK DELAYS REQUIRED FOR OTHERS.

NOTE:  
NEW ADDRESS AND PHONE



WAMECO, INC., P. O. BOX 877 • 455 PLAZA ALHAMBRA • EL GRANADA, CA 94018 • (415) 726-6378

# The DATA-TRANS 1000

A completely refurbished  
**IBM Selectric Terminal** with  
built-in **ASCII** Interface.

## \$1495

### Features:

- 300 Baud
- 14.9 characters per second printout
- Reliable heavy duty Selectric mechanism
- RS-232C Interface
- Documentation included
- 60 day warranty - parts and labor
- High quality Selectric printing
- Off-line use as typewriter
- Optional tractor feed available
- 15 inch carriage width

### HOW TO ORDER DATA-TRANS 1000

1. We accept Visa, Master Charge. Make cashiers checks or personal check payable to:

### DATA-TRANS

2. All orders are shipped F.O.B. San Jose, CA
3. Deliveries are immediate



For orders and information

## DATA-TRANS

2154 O'Toole St.

Unit E

San Jose, CA 95131

Phone: (408) 263-9246

**SUMMER SALE!**

**Now a complete OHIO SCIENTIFIC mini-floppy system for just \$797!**

**Here's what you get:**



**Ohio Scientific Superboard II**

The first complete computer system on a board! Includes keyboard, video interface and audio cassette interface. BK BASIC-in-ROM, 4K RAM. Requires power supply of +5V @ 3 amps . . . . .

**\$299**

**"We heartily recommend Superboard II for the beginner who wants to get into microcomputers with a minimum cost. A real computer with full expandability."**

—POPU AR ELECTRONICS, MARCH, 1979

**"The Superboard II is an excellent choice for the personal computer enthusiast on a budget."**

—BYTE, MAY, 1979

**Buy OHIO SCIENTIFIC's 610 Expander Board and get \$99 off reg. \$299 price of mini-floppy disk drive (including connector cable). ONLY \$200!**

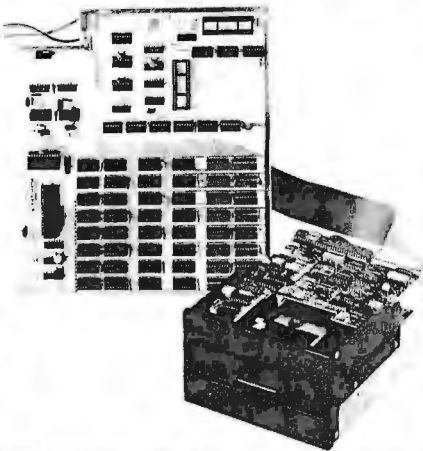

**610 Expander Board**

For use with Superboard II and Challenger 1P. BK static RAM expandable to 24K or 32K system total. Accepts up to two mini-floppy disk drives. Requires +5V @ 4.5 amps . . . . .

**\$298**

**Mini-Floppy Disk Drive**

Includes Ohio Scientific's PICO DOS software and connector cable. Compatible with 610 Expander Board. Requires +12V @ 1.5 amps and +5V @ 0.7 amps.

**Reg. \$299 . . . . . SALE! \$200**  
**TOTAL \$797**

- 4KP 4K RAM chip set \$ 79
- PS003 Mini-floppy power supply each \$ 29
- PS005 5V 4.5 amp open frame power supply \$ 35
- SAMS manual C1P/Superboard II \$ 8
- SAMS manual C4P \$ 16
- OS-65D V3.2 Disk Operating System with 9-digit extended BASIC, random access from sequential files \$ 49
- C4P computer 8K RAM expandable to 32K RAM \$ 750
- C4P MF computer Mini-floppy, 24K RAM \$1795
- CBP computer 8K RAM expandable to 32K and dual 8-inch floppies \$ 950
- CBP DF computer 32K RAM expandable to 48K, dual 8-inch floppies \$2895

**NEW! SAMS manual for the Challenger III Series \$ 40**

**Attention Superboard II and C1P owners:**

You can still take advantage of our summer sale. Purchase the 610 Expander Board for the regular price and get \$99 off on the mini-floppy and cable.

**Step up to mini-floppy operation for only \$498.**

**COMING SOON! Color Video Adaptor for Superboard II and C1P!**

**Freight Policies**

All orders of \$100 or more are shipped freight prepaid. Orders of less than \$100 please add \$4.00 to cover shipping costs. Ohio Residents add 5.5% Sales Tax.

**Guaranteed Shipment** Cleveland Consumer Computers & Components guarantees shipment of computer systems within 48 hours upon receipt of your order. **Our failure to ship within 48 hours entitles you to \$35 of software, FREE.**

**To Order:**

Or to get our free catalog **CALL 1-800-321-5805 TOLL FREE.**

Charge your order to your **VISA** or **MASTER CHARGE ACCOUNT** Ohio Residents Call: (216) 464-8047. Or write, including your check or money order, to the address listed below.



**Hours:** Call Monday thru Friday 8:00 AM to 5:00 PM E.O.T.

**CLEVELAND CONSUMER COMPUTERS & COMPONENTS**  
P.O. Box 46627  
Cleveland, Ohio 44146

**TO ORDER: CALL 1-800-321-5805 TOLL FREE**

# Unclassified Ads

**NEED:** Integrated circuit, type #SW-10667 pt #14027 used in 1622 Diablo keyboard, micro switch #75SD12-4. Also, KB timing diagrams. Jim Jamison, 2304 Tucker, Rt 6 NE, North Fort Myers FL 33903.

**FOR SALE:** Century Data Systems Model CDS230 dual-disk drive (IBM 3330 equivalent). 100 megabytes each spindle. Good condition; documentation included. Best offer, shipping additional. Bill Volz, 2229 Vickers, Plano TX 75075, (214) 596-7282.

**WANTED:** IMSAI 8048 single-board control computer. R Williams, 341 S Gordon St, Ridgecrest CA 93555.

**FOR SALE:** 10-megabyte Western Dynex moving head drive. Stored since new due to scored Position Transducer Scale (glass graticule). Works to 1/4 capacity. Perfect for "spares kit." Will sell, buy good graticule/carriage assembly (#10D000180G2 or G1), or trade for floppy with controller board/chip. Model 82015-24-101, 24 sector, 200 TPI, 1500 rpm, with one fixed platter, one 5440 cartridge, and complete manual. A Du Rea, 101 Indian Ln, Oak Ridge TN 37830.

**FOR SALE:** Teletype Model 33 computer terminal, 20 mA loop or RS-232. Complete with all power supplies, 20 mA and RS-232 interfaces, paper-tape reader/punch, keyboard, printer, and stand. \$499. Chuck Fricano, 2113 Admiral St, Alliquippa PA 15001, (412) 375-1446.

**FOR SALE:** Printer and video display terminal. Heath H14 dot-matrix printer fully assembled and operating, \$650. Micro Term ACT IV-b intelligent video display terminal, 24 by 80 format with numeric keypad on standard keyboard, excellent condition, \$675. Both units with RS-232 interfaces and complete technical manuals. Bob McBride, Rt 1, POB 1171, Benton City WA 99320, (509) 588-3895.

**WANTED:** A used Shugart SA-400 or SA-800 disk drive. Or a Commodore single- or dual-disk drive for my PET. I also want a used printer that will handle all of the PET graphics. Scott Summer, 27 Leicester Way, Pawtucket RI 02860, (401) 728-4678.

**FOR SALE:** Xitan mainframe (8 slots), factory-assembled S-100 unit with power supply; Xitan video display board, also factory assembled. Both work fine. Also have GRI keyboard kit (assembled), Z80 processor kit (assembled), and Xitan SMB-1 kit (assembled), one which does not work. Xitan Alpha-1 software on cassette and full documentation are included. Total cost over \$1000. Best offer takes. M W Williams, 111 Kempsey Ct, Slidell LA 70458, (504) 643-1995.

**FOR SALE:** Intel D8086-4 16-bit microprocessor and October 1979 *Family User's Manual* for \$50. I decided to try the 68000 instead. Unit never used/in original foam. R Rowe, c/o A H P, POB 1032, Ridgecrest CA 93555.

**FOR SALE:** Complete set of *Kilobaud Microcomputing* magazine thru December 1979 (issues 1 thru 36), in excellent condition. \$120. Arthur Granville, 5515 Crane Rd, Ypsilanti MI 48197, (313) 434-1586.

**WANTED:** College student desires ASR33 or similar Teletype terminal with paper-tape reader/punch and modem. Must be in working order. Reasonable, please. Tony Sgarlatti, 10717 Northglenn Dr, Northglenn CO 80233.

**FOR SALE:** Altair 8800a computer system. All MITS except Lear-Siegler ADM-3A. Includes 24 K programmable memory, programmable read-only memory board, 2-port serial board, one floppy disk, and disks. All schematics and user manuals included. \$2000. Steve Walker, 6175 E Mineral Pl, Englewood CO 80112, (303) 741-0632.

**WANTED:** VDP-80 IMSAI documentation needed. I will gladly pay reasonable charges for duplication of all or part documentation. David F Smith, Rt 7, POB 265, Ashland KY 41101, (606) 928-6318 evenings (collect).

**FOR SALE:** First four issues of *onComputing* magazine at cover price (\$2.50 each) plus \$1 postage. B Schweber, 58 Pleasant St, Sharon MA 02067.

**FOR SALE:** I am changing systems. I have an assembled and working SwTPC 6800 system; 12 K static memory; serial input/output (I/O); AC-30 cassette interface (all integrated circuits socketed on above equipment); ACT-1 professional terminal. All documentation and schematics. Asking \$850 or best offer within thirty days. John Sherwood, Rt 1, POB 114B, Mt Hope WV 25880.

**FOR SALE:** Cromemco Z-2D computer with two 16 K programmable-memory cards and 16 K CP/M-compatible BASIC software. Used less than twenty hours; \$2650. M Zonoun, 1493 Flicker Way, Sunnyvale CA 94087.

**FOR SALE:** TASA touch-activated, solid-state keyboard. 128-position, 8-bit ASCII. Brand new with stand, asking \$75. Hewlett-Packard 3476B (ni-cad model) digital multimeter. Autorange/polarity/zero. Well cared for, asking \$225. F Sears, Rush Rd, Henniker NH 03242, (603) 428-7034.

**WANTED:** A good used HP97 calculator. Will pay \$350 to \$400 cash. David Sloan, 218 W 20th Ave, Vancouver British Columbia V5Y 2C6, CANADA, (604) 874-2171.

**FOR SALE:** TMS 9900-based floppy-disk controller boards with complete schematic and parts list. \$20. Steven Jacob, 612 Bocowood Cir, Eutaw TX 76039, (817) 571-0722.

## The Book That Takes Students From Novice Computer Users To Sophisticated Programmers

by Thomas Dwyer and Margot Critchfield



From the leading authors of computer education material, **You Just Bought a Personal What** presents an educational experience which is guaranteed to excite and interest students, while carefully developing sound programming practices. It takes them through the steps necessary to write their own computer programs, and shows how to use structured design techniques to tackle a variety of larger projects. The book contains over 60 ready-to-use programs written in Microsoft and Level II BASIC in the areas of educational games, financial record keeping, business transactions, disk-based data files, and word processing.

Price \$11.95 ISBN 0-07-018492-5

This and other BYTE/McGraw-Hill books are available from BYTE Books or your local computer store.

Please send  \_\_\_\_\_ copies of *You Just Bought a Personal What?*

Name \_\_\_\_\_ Title \_\_\_\_\_ Company \_\_\_\_\_

Street \_\_\_\_\_ City \_\_\_\_\_ State/Province \_\_\_\_\_ Code \_\_\_\_\_

Check enclosed in the amount of \$ \_\_\_\_\_

Bill Visa  Bill Master Charge

Card No. \_\_\_\_\_ Exp. Date \_\_\_\_\_

Add 75c per book to cover postage and handling.

**BYTE BOOKS**

70 Main Street  
Peterborough, New Hampshire 03458

B7

**McGraw Hill**



**UNCLASSIFIED POLICY:** Readers who are soliciting or giving advice, or who have equipment to buy, sell or swap should send in a clearly typed notice to that effect. To be considered for publication, an advertisement must be clearly noncommercial, typed double spaced on plain white paper, contain 75 words or less, and include complete name and address information.

These notices are free of charge and will be printed one time only on a space available basis. Notices can be accepted from individuals or bona fide computer users clubs only. We can engage in no correspondence on these and your confirmation of placement is appearance in an issue of BYTE.

Please note that it may take three or four months for an ad to appear in the magazine.

**FOR SALE:** Compucolor 8001 system with expanded graphics software, eight high-resolution colors, 11 K read-only memory, BASIC 8001, 16 K programmable memory, user workspace, 19-inch color monitor, keyboard, floppy-tape storage device. Make an offer. Rick Missimer, 2102 Cannon Cir, Grissom AFB IN 46971, (317) 689-7440.

**FOR SALE:** Tektronix TM500 equipment consisting of: TM504 power supply 4-bay; PS503A dual-tracking 120 V lamp, 5 V lamp power supply; DM502 3 1/2 DMM with temp probe; FG501 7-function, 0.0001 Hz to 1 MHz generator; DC502 DC to 550 MHz frequency counter with OPT #1; blank module; cover and pouch; manuals; probes. Cost over \$2900; \$1950 or best offer. Charles D Eichorn, 136 Roberta Dr, Hendersonville TN 37075, (615) 824-2693 between 6 thru 9 PM CT.

**FOR SALE:** SC/MP demonstration and keyboard kit. Assembled and tested, 256 bytes programmable memory. Two 1/2 K monitors for teletypewriter and keyboard. Cost \$200, sell for \$125 or reasonable offer. Great learning aid. Greg Vines, 25 University Cir, Charlottesville VA 22903, (804) 977-1509.

**FOR TRADE:** Fairchild OCM-1 one-card microcomputer with 1 K bytes programmable memory, 2 K bytes 2708 erasable-programmable read-only memory; includes Fairbug monitor, four input/output (I/O) ports expandable to eight, RS-232C and teletypewriter interfaces. With all documentation. Want letter-quality printer. Preferably with tractor feed and daisy-wheel print font. Send description of what you have. Steve Swift, 15302 5th Ave NE, Seattle WA 98155.

**FOR SALE:** Like new printer. Integral Data Systems IP225 with dot matrix, tractor (pin) feed, 2 K buffer, full graphics, software, and selection of eight print sizes. Wired for both serial and parallel. Comes with all original documentation, serial and parallel cables, and software (assembled to your specified starting addresses) for the Apple II that dumps text and contents of high-resolution graphics displays onto the printer. \$850. Ross M Tonkens, 733 N Kings Rd #253, Los Angeles CA 90069, (213) 658-6741 evenings.

**FOR SALE:** Jade Z80 board, assembled, tested, \$125 or best offer. With 6-slot backplane, ASR33, working, with coupler. \$350 plus freight, \$300 plus freight without coupler. Or best offer. Joe Heck, 101 Wachusett St, Jamaica Plain MA 02130, (617) 437-2335 days.

**FOR SALE:** Complete SwTPC 6800 microsystem. 20 K bytes primary, input/output (I/O) card (serial), I/O card and SwTPC 40-column printer, Smoke Signal dual floppy, Lear-Siegler ADM3A, spike protectors, and full documentation. \$3000 or trade for HP-85. Terry Floyd, Rt 1, Kyle TX 78640, (512) 295-6761.

**FOR SALE:** SYM-1; 4 K low-power programmable memory; 8 K BASIC read-only memory; Revised Monitor V 1.1; ASCII keyboard with case; 5 V, 3 A power supply; with manuals. \$450 includes shipping. Ronnie Schanzer, 1917 Lauderdale, Houston TX 77030, (713) 475-4266.

**FOR SALE:** GE Termet 300 printer. Prints at 30 cps. RS-232 interface. Reliable letter quality, 9-inch tractor feed. \$500. M W Basch, POB 344, Harvard MA 01451.

**FOR TRADE:** Intel SKD 8086 with extra memory for 8 K Challenger IP. Allan Musser, 6514 El Nido #4, Isla Vista CA 93017, (805) 685-4202.

**WANTED:** Plastic card edge guides for IMSAI 8080 mother board case. Three IMSAI Cable As with matching plugs and one Cable M for an MIO board. Len Tower, POB 29 MIT Branch, Cambridge MA 02139, (617) 253-1541.

**FOR SALE:** 165 cps printer, uses regular paper, same as the Paper Tiger, almost new; \$499. S-100 bus video display board, 16 by 64 characters; \$100. Speech Technology voice generator; \$300. Stan Levine, 1802 Melville St, Ocean NJ 07712, (201) 531-8305.

**FOR SALE:** Datatype Corp DFR-100 optical page reader with maintenance/operation manuals; best offer. Anyone interested in a Digital Computer Controls Inc D-116 minicomputer, Remex optical tape reader, Remex tape punch, spare boards for interfacing Mohrtext (Omni-lex Inc) 1200 editing proofing terminal? Ken Cazakoff, RR #2, Nelson British Columbia, CANADA V1L 5P5.

**FOR SALE:** OSI Challenger C2-4P with 8 K read-only memory BASIC, 8 K programmable memory, graphics, and polled keyboard. \$500 or best offer. Also, OSI minifloppy owners, are any newsletters or clubs in existence? Al Casper, 3632 CTH, I, Saukville WI 53080, (414) 675-6946.

**FOR SALE:** SYM BASIC read-only memories (BAS-1) for \$65. Send check and SASE. Ken Henrich, 14 Meadow Pl, Northport NY 11768, (516) 754-1677.

**WANTED:** TRS-80 Level II system or comparable system with business operating software. Also needed: Heathkit electronics courses and microcomputer course with training units or comparable home-study course material. Also interested in print-quality printer with interface. Mike McColligan, 7341 West Chester Pike, Upper Darby PA 19082, (215) 352-8110.

**FOR SALE:** 6802 system with 4 K programmable memory and BASIC in read-only memory. Keyboard and video with modulator and cassette interface, \$250. 16 K Econoram IV S-100, \$150. Visible Memory (graphics for KIM) and Music Card with all software, \$175 and \$25 respectively. System above with homemade expansion and power supply, \$600. (SwTPC power supply free, all parts included.) Also, sell separately or swap for Apple stuff. Mark Siebert, 2599 Caulfield, San Diego CA 92154, (714) 423-0609.

**FOR SALE:** 8 K PET computer with BETSI S-100 interface, joystick, and many tapes, including Microchess. \$600 or best offer. Mark Poeschl, 1065 Witte B, Madison WI 53706.

# BOMB

## BYTE's Ongoing Monitor Box

Article #	Page	Article	Author
1	22	Handheld Remote Control for Your Computerized Home	Ciarcia
2	46	The 1980 West Coast Computer Faire: A Watershed Year for Personal Computing	Morgan
3	56	Simulating Human Decision-Making on a Personal Computer	Frey
4	74	Education Forum: Books as an Antidote to the CAI Blues	Dwyer
5	86	Education Forum: The Personal Computer—Last Chance for CAI?	Frenzel
6	98	Education Forum: Computer Illiteracy: A National Crisis and a Solution for It	Luehrmann
7	116	Interactive Control of a Videocassette Recorder with a Personal Computer	Hallgren
8	138	A Personal Computer on a Student's Budget	Johnson
9	154	PILOT/P: Implementing a High-Level Language in a Hurry	Mundie
10	175	The Microcomputer in the Undergraduate Science Curriculum	Hubin
11	198	The User's Column: Omikron TRS-80 Boards, NEWDOS+ and Sundry Other Matters	Pournelle
12	210	Creating a Fantasy World on the 8080	Nicholson
13	236	MICRO8: Using BASIC to Learn Assembly Language	Pickett

### Ciarcia's First Place BOMBs Defused

Steve Ciarcia's April article "Ease Into 16-Bit Computing" did not place first in the BOMB; thus, his four-month streak was ended with a second place finish. Hal Chamberlin's "Advanced Real-Time Music Synthesis Techniques" was rated best by BYTE readers who responded to the April BOMB. Hal will receive a \$100 bonus for his work, and Steve will be awarded \$50. Congratulations to both authors for their efforts. ■

# Reader Service

To get further information on the products advertising in BYTE, fill out the reader service card with your name and address. Then circle the appropriate numbers for the advertisers you select from the list. Add a 15-cent stamp to the card, then drop it in the mail. Not only do you gain information, but our advertisers are encouraged to use the marketplace provided by BYTE. This helps us bring you a bigger BYTE. \*Correspond directly with company.

Inquiry No.	Page No.	Inquiry No.	Page No.	Inquiry No.	Page No.	Inquiry No.	Page No.
287	AB Computers 296	218	Data Prod Maintenance Corp 258	206	MICAH 245	285	Quest 295
153	ABM Products 219	51	Datasouth Comp Corp 78	223	Micops Inc 265	268	Quintrex Inc 286
215	AEON Electronics 249	101	Data Speed 151	93	Microamerica Distributing 136	165	Racet Computes 227
260	Addmaster Corp 284	293	Data Trans 300	95	Microamerica Distributing 137	117	Radio Shack 172
231	Adv Computer Prod 266, 267	291	Delta Products 299	104	Microamerica Distributing 155	140	Radio Shack 206
36	Altos 59	281	DG Electronics 292	71	Micro Ap 105	*	Rainbow Marketware 62
262	Alpha Products Co 284	100	Diablo (Div of Xerox) 149	160	Micro Appl Grp (MAG) 223	248	Red Arrow Elect Corp 282
129	American Micro Prod Inc 191	151	Digiac 217	*	Micro Computer Discount 247	305	RITAM Int'l 66
15	American Square Comp 26	64	Digital Marketing 94	89	Microcomputer Tech Inc 131	113	RNB Enterprises 168
280	Ancrona 292	118	Digital Graphic Systems 172	257	Microcomputer Tech Inc 284	202	Rochester Data 243
112	Anderson Jacobson 166	99	Digital Pathways 147	4	MicroDaSys 8	*	Rosen Grandon Assoc 282
172	Anderson Jacobson 230	143	Digitus 208	49	MicroDaSys 75	209	S-100 Inc 245
26	APF Electronics 43	276	Digital Research Comp (TX) 289	79	Micro Data Base Systems 113	130	Howard W. Sams Co 193
88	Apparat 131	133	Digital Research Corp (CA) 197	162	Micromail 224	180	Sara-Tech 233
7	Apple Computer 12, 13	193	Discount Software Group 239	106	Micro Management Sys 158	167	SC Digital 227
39	Applied Digital Data Sys (ADDS) 63	163	Dynacomp 225	247	Micro Mart 282	33	SD Systems 55
21	Artec Electronics 36	144	Dynamic Microprocessor Assoc 213	150	Micro Mikes 217	9	Scion Corp 5
288	ASAP 297	198	Ecosoft 241	203	Micro Music 243	2	Scitronics 140
*	ATV Research 269	243	Electrolabs 276, 277	*	Micro Pro Int'l 143	156	Selinar 221
188	Avionic Enterprises Inc (AEI) 237	159	Electronic Control Tech 223	228	Micro Products Unltd 265	148	Service Technologies 215
52	Base 2 Inc 41	219	Electronic Systems 259, 260	306	Microsette 204	205	Shepardson Microsystems 244
256	Bea Essentials 284	220	Electronic Systems 261	68	Microsoft 99	191	Michael Shryayer Software 239
283	Beckian 294	10	Emtrol Sys Inc 16	20	Microsoft (Cons Prod Div) 35	75	Shugart 7
168	John Bell Engineering 228	223	Engineering Analysis Software 265	26	Microtech Exports 286	127	Siemens Electronics 109
*	Beta Comp Devices 221	192	Escon 239	18	Microtek Inc 31	8	Sigma Int'l 187
11	Bishop Graphics 17	35	Essex Publishing 58	141	Microtek Inc 79	127	Siliconix 14
14	Bishop Graphics 25	187	Excom 237	174	Microware Systems 232	60	Sirius Systems 89
23	Bishop Graphics 39	152	Executive Business Sys 218	142	The Micro Works 208	200	SMA 204
29	Bishop Graphics 51	30	EXO Electronics Co. 51	84	Micro World 121	69	Small Business Appl 103
258	The Bit Bucket 284	207	FAIRCOM 245	289	Mighty Micros 210	189	Small Sys Design 237
155	BIZCOMP 220	269	Faragher & Assoc 286	211	Mikos 298	41	Smoke Signal Broadcasting 65
275	Budget Computer Prod 288	197	Farnsworth Computer 241	114	Mini Micro Mart 169	42	Smoke Signal Broadcasting (Dealers Only) 65
265	Business Info Systems 286	301	FMG Corp 201	213	Mini Micro Mart 248	54	Softech 81
208	Buss/Charles Floto 245	274	Fordham Radio Supply 288	273	Mini Micro Mart 287	177	Software Concepts 233
*	BYTE Back Issues 232	274	Frederick Computer Prod 269	298	Mini Micro Mart 171	178	Software Concepts 233
*	BYTE Books 205, 211, 302	237	Gimix 269	87	Mittendorf Engineering 130	131	The Software Exchange 195
*	BYTE Subscriber 249	109	Godbout 163	25	Morrow/Thinker Toys CV III	290	Solid State Sales 298
190	C & S Electronics 237	58	Guardian Electronics 87	12	Mountain Hardware 19	116	Sonex Systems 172
13	California Comp Sys 20, 21	169	GW Computers 299	37	Mountain Hardware 60	43	Sorcim 60
245	Calif Digital 279	73	H & E Computronics 107	128	mpi 189	216	Sorrento Valley Assoc 249
171	Cambridge Dev Labs 229	59	Hardhat Software 88	105	MT Microsystems 157	229	Southwest Tech Prod Corp CVII
238	Cavri Sys Inc 269	19	Heath Co 33	224	Multi Business Comp Sys 265	181	Spectrum Software 234
*	Cedar Hill Software 282	72	High Technology Inc 106	34	National CSS Inc 57	6	SSM 11
120	Central Data 175	46	Houston Instruments 71	92	NEECO 136	212	The StackWorks 247
204	CFR Assoc Inc 243	76	IBC 110	94	NEECO 137	98	Stroke 145
90	Christlin Industries 133	22	Image Resource Corp 37	103	NEECO 155	149	Structured Systems Group 216
294	Cleveland Consumer Computers & Components 301	50	Independent Business Sys 77	110	Netronics 165	145	SubLOGIC 214
252	COLOR Software 282	45	Industrial Micro Sys 69	111	Netronics 165	277	Sunny Int'l 290
157	Compas Microsystems 221	122	Integrand 178	135	Netronics 200	5	SuperSoft 10
24	Complete Business Systems 40	249	Intellectual Smartees 282	*	Noble Computer Corp 286	107	SuperSoft 159
246	CompuMart 280, 281	28	Intel Seminar 123	267	North Star 29	138	SuperSoft 203
183	CompuMax 234	226	Interface Inc 265	297	Northwest Comp Services 286	173	SuperSoft 231
125	CompuServe (MicroNET) 185	123	Int'l Data Sys (IDS) 179	81	Okidata 117	56	Sybox 83
264	ComputerCity 285	137	Int'l Prod Dev Inc 202	31	OK Machine & Tool 52	170	Synchro Sound 111
166	Computer Camp Inc 227	16	Intertec Data Sys 27	199	Olympic Sales Co Inc 241	196	Synergetic Comp Prod 229
279	Computer Components 291	32	Intertec Data Sys 53	53	Omega Research 80	158	SZ Software Sys 241
235	Computer Distributors 269	47	Ithaca Intersystems 9	136	Omikron 201	102	3-G Co, Inc 222
3	Computer Enhancements Co (CECO) 6	240	Jade Comp Prod 270, 271	*	OnComputing 209	251	Tarbell Electronics 153
*	Computer Factory 181	241	Jameco Electronics 272, 273	62	Orange Micro 92	67	TBI 282
147	Computer Marketing Corp 215	185	Javelin Electronics 235	80	Oregon Software 115	66	Tech Sys Consultants (TSC) 97
233	The Computer Place 269	236	Jepsan Group K Inc 269	85	Osborne/McGraw-Hill 127	64	Tec-Mar Inc 96
175	Computer Products Int'l 232	307	Jini Microsystems 204	182	OSM Computer Corp 234	44	Texas Instruments 67
272	Computer Service Center 286	210	JRT Sys Inc 246	*	Owens Associates 18	194	Texas Instr Inc 239
229	Computer Shopper 265	261	Kalglo Electronics 284	*	Oxford University Press 90	*	Robert Tinney Graphics 167
154	Computer Specialties 219	63	Kemco Ltd 93	217	Pacific Exchanges 258	161	TransNet 223
*	Computer Systems Store 284	270	Kenabco Sales 286	271	Pacific Exchanges 286	227	Ucatan Computer Store 265
184	Computers Wholesale 235	179	Key Bits Inc 233	244	Page Digital 278	*	United Software of America 125
40	Computex 64	91	Konac Corp 135	286	Pan American Elec 296	27	Universal Data 44, 45
124	Computique 183	108	Lifeboat 100, 101, 235	139	(A Radio Shack Auth Sales Ctr) PCD Systems Inc 242	146	US Robotics 215
278	Concord Computer Components 290	86	Lobo Drives Int'l 129	9	Percom Data 15	132	Vector Electronics 196
38	Corvus Systems 61	164	Lomas Data Prod 226	83	Percom Data 119	254	Videx 282
57	Cover Craft 84	78	Macrotronics 112	195	Personal Computers 240	214	The Viking Press 249
255	The CPU Shop 283	250	Macrotronics 282	263	Personal Progs by Victor 284	232	Vista Computers 268
1	Cromemco 1, 2	115	Malibu Electronics Corp 207	134	Personal Computing '80, 199	284	VR Data 294
186	Crown Publishers 236	259	Manchester Equipment 284	65	Phase One Systems 173	292	Wameco 300
*	Cybernetics Inc 213	300	Marway Products 201	70	Pickles & Trout 104	292	Whitesmith's Ltd 85
282	Dal-Comp 293	126	Marymac Industries 186	55	Power One Inc 82	225	Wintek Corp 265
234	DAR Sales 269	97	Maxell Data Products 141	221	Priority One 262, 263	239	Worldwide Electronics 269
230	Data Acquisition Sys Inc 265	*	Meas Sys & Controls 23, 265	222	Priority One 264	82	XCOMP, Inc 118
*	Data Access 247			48	QT Comp Systems 73	119	Zs Systems 172
*	Data Discount Center 177			242	QT Comp Systems 274, 275		
201	Datadisk Systems 243			61	Quasar Data Products 91		

For fastest service transfer mailer label from wrapper to coupon provided at the right. Requests cannot be honored unless zip code is given. This card valid for 90 days only.

NOTE—If label is missing or defaced fill out coupon carefully —PLEASE PRINT—this is only way to get requested material to you.

Name \_\_\_\_\_  
 (Title) \_\_\_\_\_  
 (Company) \_\_\_\_\_  
 Address \_\_\_\_\_  
 City \_\_\_\_\_ State \_\_\_\_\_ Zip \_\_\_\_\_

1	21	41	61	81	101	121	141	161	181	201	221	241	261	281	301	321	341	361	381	401	421	441	461	481	501	521	541	561	581	601	621	641
2	22	42	62	82	102	122	142	162	182	202	222	242	262	282	302	322	342	362	382	402	422	442	462	482	502	522	542	562	582	602	622	642
3	23	43	63	83	103	123	143	163	183	203	223	243	263	283	303	323	343	363	383	403	423	443	463	483	503	523	543	563	583	603	623	643
4	24	44	64	84	104	124	144	164	184	204	224	244	264	284	304	324	344	364	384	404	424	444	464	484	504	524	544	564	584	604	624	644
5	25	45	65	85	105	125	145	165	185	205	225	245	265	285	305	325	345	365	385	405	425	445	465	485	505	525	545	565	585	605	625	645
6	26	46	66	86	106	126	146	166	186	206	226	246	266	286	306	326	346	366	386	406	426	446	466	486	506	526	546	566	586	606	626	646
7	27	47	67	87	107	127	147	167	187	207	227	247	267	287	307	327	347	367	387	407	427	447	467	487	507	527	547	567	587	607	627	647
8	28	48	68	88	108	128	148	168	188	208	228	248	268	288	308	328	348	368	388	408	428	448	468	488	508	528	548	568	588	608	628	648
9	29	49	69	89	109	129	149	169	189	209	229	249	269	289	309	329	349	369	389	409	429	449	469	489	509	529	549	569	589	609	629	649
10	30	50	70	90	110	130	150	170	190	210	230	250	270	290	310	330	350	370	390	410	430	450	470	490	510	530	550	570	590	610	630	650
11	31	51	71	91	111	131	151	171	191	211	231	251	271	291	311	331	351	371	391	411	431	451	471	491	511	531	551	571	591	611	631	651
12	32	52	72	92	112	132	152	172	192	212	232	252	272	292	312	332	352	372	392	412	432	452	472	492	512	532	552	572	592	612	632	652
13	33	53	73	93	113	133	153	173	193	213	233	253	273	293	313	333	353	373	393	413	433	453	473	493	513	533	553	573	593	613	633	653
14	34	54	74	94	114	134	154	174	194	214	234	254	274	294	314	334	354	374	394	414	434	454	474	494	514	534	554	574	594	614	634	654
15	35	55	75	95	115	135	155	175	195	215	235	255	275	295	315	335	355	375	395	415	435	455	475	495	515	535	555	575	595	615	635	655
16	36	56	76	96	116	136	156	176	196	216	236	256	276	296	316	336	356	376	396	416	436	456	476	496	516	536	556	576	596	616	636	656
17	37	57	77	97	117	137	157	177	197	217	237	257	277	297	317	337	357	377	397	417	437	457	477	497	517	537	557	577	597	617	637	657
18	38	58	78	98	118	138	158	178	198	218	238	258	278	298	318	338	358	378	398	418	438	458	478	498	518	538	558	578	598	618	638	658
19	39	59	79	99	119	139	159	179	199	219	239	259	279	299	319	339	359	379	399	419	439	459	479	499	519	539	559	579	599	619	639	659
20	40	60	80	100	120	140	160	180	200	220	240	260	280	300	320	340	360	380	400	420	440	460	480	500	520	540	560	580	600	620	640	660

### MENTION **BYTE** WHEN WRITING TO ADVERTISERS

#### BYTE SUBSCRIPTIONS

4170

For a subscription to BYTE, please complete this card.

Name \_\_\_\_\_  
 Address \_\_\_\_\_  
 City \_\_\_\_\_  
 State \_\_\_\_\_ Zip \_\_\_\_\_ Country \_\_\_\_\_

USA Canada  
Mexico

- 1 year  \$18  \$20
- 2 years  \$32  \$36
- 3 years  \$46  \$52

- \$32 Europe (air freight) payment enclosed
- \$32 Elsewhere (surface mail) payment enclosed (Air mail rates available upon request)

**Please remit in US funds drawn on a US bank. Thank you.**

- Check enclosed (Bonus: one EXTRA issue — receive 13 issues for the price of 12)

    Bill me (North America only)

Card No. \_\_\_\_\_  
 Expiration date \_\_\_\_\_  
 Four digits above name — Master Charge only \_\_\_\_\_  
 Signature \_\_\_\_\_ Date \_\_\_\_\_

Please allow eight weeks for processing.

Thank you

#### BOMB: BYTE's Ongoing Monitor Box

4170

BYTE's BOMB is your direct line to the editor's desk. Each month, the two top rated authors receive bonuses based on your votes. To use this card, refer to the list of authors, titles, and corresponding BOMB article numbers located in the Unclassified Ads section. Then rate each article on a scale from 0 to 10 below by circling the appropriate rating number to the right of each BOMB article number. Your feedback helps us produce the best possible magazine each month.

BOMB Article Number	Rating										
	Poor	Fair	Good	Very Good	Excellent						
1	0	1	2	3	4	5	6	7	8	9	10
2	0	1	2	3	4	5	6	7	8	9	10
3	0	1	2	3	4	5	6	7	8	9	10
4	0	1	2	3	4	5	6	7	8	9	10
5	0	1	2	3	4	5	6	7	8	9	10
6	0	1	2	3	4	5	6	7	8	9	10
7	0	1	2	3	4	5	6	7	8	9	10
8	0	1	2	3	4	5	6	7	8	9	10
9	0	1	2	3	4	5	6	7	8	9	10
10	0	1	2	3	4	5	6	7	8	9	10
11	0	1	2	3	4	5	6	7	8	9	10
12	0	1	2	3	4	5	6	7	8	9	10
13	0	1	2	3	4	5	6	7	8	9	10
14	0	1	2	3	4	5	6	7	8	9	10
15	0	1	2	3	4	5	6	7	8	9	10
16	0	1	2	3	4	5	6	7	8	9	10
17	0	1	2	3	4	5	6	7	8	9	10
18	0	1	2	3	4	5	6	7	8	9	10
19	0	1	2	3	4	5	6	7	8	9	10
20	0	1	2	3	4	5	6	7	8	9	10

Comments \_\_\_\_\_  
 \_\_\_\_\_  
 \_\_\_\_\_  
 \_\_\_\_\_

PLACE  
FIRST  
CLASS  
POSTAGE  
STAMP  
HERE

**BYTE** READER SERVICE

PO Box 2114 GPO  
New York NY 10001  
USA

PLACE  
STAMP  
HERE

**BYTE** SUBSCRIPTIONS

PO Box 590  
Martinsville NJ 08836  
USA

PLACE  
STAMP  
HERE

**BYTE** Publications Inc

70 Main St  
Peterborough NH 03458  
USA

BOMB  
BYTE's Ongoing Monitor Box

# There are two sides to our story.

## Side One

### The DISCUS™ 2+2 Quad-Density Hardware

Now you can use your S-100 system to tackle big jobs. Because the DISCUS™ 2+2 Quad-Density Disk System puts 1.2 megabytes of fast-access memory on your side for just \$1545.00 complete.

With the DISCUS™ 2+2 System, complete means complete.

You get a full-size (IBM-compatible 8") double-sided/double-density disk drive,

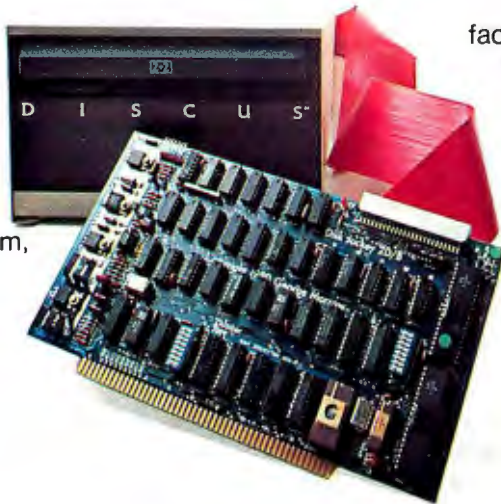

factory mounted in a cabinet with power supply, fully-buffered S-100 single-board controller, and interconnecting cables. All fully assembled, system-tested and fully warranted.

You get the speed and efficiency of 1.2 megabyte-per-diskette memory... and you get it for 0.13¢ per byte.

## Side Two

### The DISCUS™ 2+2 Quad-Density Software

1.2 megabyte quad-density hardware is only one side of the story. The DISCUS™ 2+2 System price includes all the fully-interfaced, high-performance software you need to take full advantage of your quad capacity.

The system includes our exclusive BASIC-V™ virtual disk BASIC, which allows you to address your quad-density diskettes as easily as main memory. The operating system you get is the widely accepted CP/M\* 2.1. And you get our powerful DISK-ATE text editor/assembler; The most advanced software



development tool available.

Micro-Soft BASIC 5.1 and Micro-Soft FORTRAN are available as options. Both run under CP/M\* 2.1.

Check out the full system price of DISCUS™ 2+2 Quad against any other floppy disk system at your local computer store. At \$1545.00, we think you'll take sides with DISCUS™ 2+2.

If your dealer doesn't carry THINKER TOYS products, write MORROW DESIGNS Inc., 5221 Central, Richmond, CA 94804. Or call (415) 524-2101 9-5 weekdays (Pacific Time).

MORROW DESIGNS™ /  Thinker Toys™

# Ohio Scientific: The leader in Winchester based micro- computers.

Ohio Scientific produced the first Winchester based microcomputer in 1977. Since then, we have shipped more of these systems than the rest of the industry combined. Among them are our C3-B and our C3-C microcomputers.

## **The C3-C. 23 Megabytes. Under \$10,000.**

The C3-C computer has been designed and engineered to fill the void that existed between floppy disk systems and larger hard disk systems.

In its normal configuration, the C3-C includes the Challenger III processors, 52K RAM, the 23 Megabyte Winchester drive and dual floppy drives for file system back up. And the cost is less than \$10,000.

The CPU employs three micro-processors, the 6502, the Z-80 and the 6800. And the processor bus has been designed so new, more powerful micros (like 16 bit CPU's) can be added to the system later on.

There are also 10 open slots in the basic C3-C. The system supports up to 768K bytes of memory, in a multi user configuration.

## **The C3-B. 74 Megabytes. Under \$13,000.**

For those who require even more hard disk storage, Ohio Scientific offers another microcomputer in the C3



Series, the C3-B. Its specifications are the same as those of the C3-C. However, the C3-B offers a 74 Megabyte Winchester drive.

For those who do not need hard disk capacity now, but in all probability will need it in the future, Ohio Scientific offers the C3-A. It is like the C3-B and the C3-C in all respects but two. 48K RAM is standard in the C3-A, and it offers 12 open slots. When more storage is needed, the C3-A is easily expandable to either a 23 Megabyte or 74 Megabyte hard disk system. The C3-A is priced at less than \$6,000.

**For literature and the name of your local dealer, CALL 1-800-321-6850 TOLL FREE.**

**OHIO SCIENTIFIC**  
1333 SOUTH CHILLICOTHE ROAD  
AURORA, OH 44202 • (216) 831-5600