



GSA prices effective October 4, 2021
(based on June 7, 2021, commercial price list)
Published October 2021

Workspaces

Public Office Landscape®

General Services Administration Federal Supply Service Authorized Federal Supply Schedule Price List

Online access to contract ordering information, terms and conditions, up-to-date pricing, and the option to create an electronic delivery order is available through GSA Advantage!, a menu-driven database system. The Internet address for GSA Advantage! is www.gsaadvantage.gov.

Office Furniture
FSC Group 71, Part 1
Contract Number: GS-03F-036DA
Contract Period: December 21, 2015—December 20, 2025

Herman Miller, Inc.
855 East Main Avenue
Zeeland, Michigan 49464
(616) 654 3000 Phone
(616) 654 8278 Fax
www.HermanMiller.com/government

Business Size: Large

Contract Information

1a. Special Item Numbers (SIN)

SIN 33721

Furniture Systems, Computer Furniture, Filing and Storage, Tables and Accessories, Upholstered Seating and Multi-Purpose Seating, Project Management, Reconfiguration and Relocation Services, Design/Layout and Installation Services

SIN 33721P

Packaged Offices

SIN 337127

Modular Laboratory Furniture Systems

SIN NEW

New Product Introductions

SIN OLM

Order-Level Materials (OLMs)

This SIN is only for products and/or services used in direct support of the purchase of new furniture. It requires approval from the ordering Contract Officer. Please contact your local Herman Miller representative to discuss the appropriate use of this SIN.

SIN 532289

Leasing

Contact Herman Miller participating government dealer for current leasing information.

1b. Lowest Priced Model

SIN 33721: G9999.B \$10

1c. Not applicable

2. Maximum Order

SIN 33721, 337127, NEW, OLM

\$250,000 net product value

SIN 33721P

\$5,000,000 net value

3. Minimum Order

\$100 net

4. Geographic Coverage

Continental U.S.

Orders for Alaska, Hawaii, and Puerto Rico will be shipped F.O.B. inland carrier point of exportation.

5. Point of Production

Zeeland, Ottawa County, Michigan

Spring Lake, Ottawa County, Michigan

6. Pricing

Prices shown are list. Discounts include Industrial Funding Fee.

SIN 33721

Standard Lead Time, Single Order Net Purchase \$100 - 250,000, includes approved Herman Miller Options Products.

Product Line	Discount From List
Action Office 1	73.8%
Action Office 2	73.8%
Aeron	64.5%
Aside	64.2%
C-Style Overhead Storage	73.8%
Canvas Office Landscape Channel	74.8%
Canvas Office Landscape Dock	74.8%
Canvas Office Landscape Group	74.8%
Canvas Metal Desk	74.8%
Canvas Office Landscape Metal Storage	74.8%
Canvas Office Landscape Private Office	74/8%
Canvas Office Landscape Wood Storage	74.8%
Canvas Office Landscape Vista	74.8%
Canvas Office Landscape Wall	74.8%
Caper	61.5%
Celle	59.7%
Cosm	61.7%
Eames® Conference & Dining Tables	73.6%
Embody	59.7%
Embody Gaming	37.5%
Ethospace System	73.8%
Everywhere™ Tables	73.8%
Headway™ Tables	73.8%
Keyn	57.7%
Layout Studio®	60.7%
Lino	63.7%
Meridian Laterals	67.3%
Meridian Pedestals	64.2%
Meridian Towers	62.7%
Meridian Storage	62.7%
Mirra 2	61.7%
Motia Tables	73.8%
Nevi™ Tables	73.8%
Nevi Link	73.8%
OE1 Boundary	72.8%
OE1 Micro Packs	73.8%
OE1 Storage	72.8%
OE1 Tables and Benching	73.8%
Overlay™	62.7%
Plex® Lounge Furniture	59.5%
Renew™ Tables	73.8%
Renew Link	73.8%
Sayl	62.2%
Setu	59.7%
Swoop Lounge Furniture	60.7%
Thrive Portfolio	62.0%
Tu Lateral Files	74.3%
Tu Pedestals	73.8%
Tu Storage	74.3%
Tu Towers	74.3%
Tu Wood Cases	74.3%
Tu Wood Cubbies	74.3%
Tu Wood Credenzas	74.3%
Tu Wood Pedestals	74.3%
Tu Wood Towers	74.3%
Valor™ Family	54.91%
Verus	63.7%
Whisk	54.91%

Contract Information

continued

Services

Please refer to section 19 for Terms and Conditions of Installation/ Reconfiguration and Relocation Services.

Project Management

Services under this SIN may be used only in conjunction with the purchase of new furniture. Please contact your local Herman Miller rep representative to discuss the available labor categories (listed below). The hourly rates listed are "Not To Exceed" or "NTE" values.

Furniture Project Manager: \$64.75 per hour
 Furniture Project Coordinator: \$49.00 per hour
 Build-Out Project Manager: \$80.00 per hour

Reconfiguration and Relocation Services

Reconfiguration and Relocation Services will be provided by Herman Miller, Inc., or its participating dealer based on a fee not to exceed \$55 per hour.

See * Additional Notes for Installation & Reconfiguration and Relocation Services.

Design/Layout

Design service will be provided by Herman Miller, Inc., or its participating dealer based on a fee not to exceed \$65 per hour.

Installation Services

Installation Services will be provided by Herman Miller, Inc., or its participating dealer based on a fee not to exceed \$55 per hour (\$82.50 per hour for after-hours Installation).

See * Additional Notes for Installation & Reconfiguration and Relocation Services.

SIN 337127

Standard Lead Time, Single Order Net Purchase \$100 - 250,000, includes approved Herman Miller Options Products.

Product Line	Discount From List
Action Lab	58.5%
Compass System	58.5%
Co/Struc System	58.5%
Mora System	58.5%
Bedside Cabinets	58.5%

SIN NEW

Standard Lead Time, Single Order Net Purchase \$100 - 250,000, includes approved Herman Miller Options Products.

Product Line	Discount From List
Commend™ Nurses Station	73.3%
Exclave	61.7%
Intent Solution	58.7%
Public Office Landscape	61.7%

SIN 33721P

Packaged Office Furniture - Maximum Order \$5,000,000 (net).

Includes packaged furniture solutions for customers needing to furnish an office.

7. Quantity Discounts

Reference item #6.

8. Payment Terms

Net 30 days

9. Government Commercial Credit Card

- Government commercial credit cards are accepted below the micropurchase threshold.
- Government commercial credit cards are accepted above the micropurchase threshold.

10. Foreign Items

None

11. Time of Delivery

- 90 day ARO
- Expedited delivery: Items listed in the 10-Day section of the catalogs are available for expedited delivery.
- Overnight/2-day delivery: Select items may be available for overnight or 2-day delivery. Contact Herman Miller or a participating dealer for availability and rates.
- Urgent requirements: Agencies may contact contractor or participating dealer to request faster delivery.

12. F.O.B.

F.O.B. destination except Alaska, Hawaii, and Puerto Rico, which will be shipped F.O.B. inland carrier point of exportation.

13. Ordering Address

- Herman Miller, Inc.,
 Government Customer Care 0161
 855 East Main Avenue
 Zeeland MI 49464.
- For supplies and services, the ordering procedures information on Blanket Purchase Agreements (BPA's) are found in Federal Acquisition Regulation (FAR) 8.405-3.

14. Payment Address.

Herman Miller, Inc.
 22764 Network Place
 Chicago, IL 60673-1227

15. Warranty

Herman Miller, Inc., commercial warranty applies.

Contract Information

continued

16. Export Packing Charge

Prices supplied on request.

17. Terms and Conditions of Government Purchase Card Acceptance

Accepted above and below the micropurchase level.

18. Rental Maintenance and Repair Terms

Not applicable

19. Terms and Conditions of Installation/Reconfiguration and Relocation Services

* Additional Notes for Installation & Reconfiguration and Relocation Services:

FOB Destination (Drop Ship): Price includes product delivery to the site, brought to the tailgate of the truck. The purchaser is responsible for unloading.

Prices effective up to the maximum order by SIN only. Above the MO, pricing shall be negotiated on a case-by-case basis between the client and local dealer.

Standard Services are Subject to the Following Conditions:

Installation will be performed during normal weekday working hours.

Adequate facilities for delivery, unloading, moving and staging/storing the product during the installation process shall be provided.

Service work will not be hindered by other trades.

Electric, heat, and adequate elevator service will be furnished without charge.

The immediate installation area shall be complete and free of debris including the carpet/flooring before installation commences.

Any work requiring a licensed electrician is the responsibility of the buyer.

Additional Charges May Apply For:

Major Metro Markets and any non-ground floor installation.

Major Metro Markets include large population centers and urban environments.

Installation in a clinical/medical environment.

Special restrictions or limits established by local laws, ordinances or the directions of the buyer, including but not limited to restrictions on transportations of materials, street access to the job site and/or dock facilities.

Installations outside of a 50 mile radius of the servicing dealer.

Local Prevailing Wage and/or Union Labor Rates.

Any additional charges shall be quoted by the dealer and approved by the buyer prior to performance of the work.

20. Terms and Conditions of Repair Parts

Not applicable

21. Service and Distribution Points

For service and distribution points nearest you, call (800) 851 1196.

22. Participating Dealers

Access Herman Miller web site for current list of participating dealers: www.HermanMiller.com/where-to-buy/contact-a-dealer/. Select your market by using the filter.

23. Preventive Maintenance

Not applicable

24a. Special Attributes.

2019

TIME Magazine names Cosm to its list of the 100 Best Inventions of 2019.

Working Mother Magazine names Herman Miller one of the 100 Best Companies for Working Mothers in 2019.

Herman Miller named #12 Overall and #2 in Manufacturing on Investor's Business Daily Best ESG (Environmental, Social, Governance) Companies.

Herman Miller named Silver Level Employer in the Michigan Veterans Affairs Agency Veteran-Friendly Employer Program.

Herman Miller named "Frontrunner" in Chemical Footprint Project by Clean Production Action for our chemical management policies and practices.

Herman Miller receives International Interior Design Association and Contract's best showroom design award in the "Large Showroom" category at NeoCon.

Herman Miller earns its 12th consecutive perfect score in Human Rights Campaign (HRC) Foundation's 2019 Corporate Equality Index.

Geiger One Casegoods receives a Best of NeoCon Silver in the "Case Goods" category.

Cosm receives a Red Dot Best of the Best Product Design Award in the "Office Chairs" category.

Cosm receives Gold at the New York DRIVENxDESIGN Award in the Product Design—Office category.

Lino receives an iF Design Award in the Product Design category.

2018

Herman Miller receives the Corporation of the Year—Consumer Products award from the Michigan Minority Supplier Development Council.

Herman Miller achieves the Advanced Excellence in Supplier Diversity Award from the Great Lakes Women's Business Council for doing business with women-owned suppliers.

Contract Information

continued

As one of the top-scoring companies in the industry for the fourteenth consecutive year, Herman Miller has qualified for inclusion in RobecoSAM's 2018 Sustainability Yearbook and received the Silver Class distinction for excellent sustainability performance—economic, environmental, and social.

Aeron receives Good Design Award from The Chicago Athenaeum Museum of Architecture and Design.

The Cosm Chair won the 2018 Best of NeoCon Gold Award in the Ergonomic Seating Category, the Interior Design HiP Award in the Ergonomic Seating Category, and a #MetropolisLikes Award. Cosm also won Mix Interiors "Product of the Year—Task" award.

For the 11th consecutive year, Herman Miller received a perfect score on the Corporate Equality Index and we were designated as Best Place to Work for LGBT equality. This report evaluates U.S. companies in terms of diversity, particularly their LGBT-related policies and practices.

2017

Herman Miller was named the 2017 "Corporation of the Year" in the consumer products sector by the Michigan Minority Supplier Development Council (MMSDC).

Herman Miller has received a 2017 SEAL (Sustainability, Environmental Achievement and Leadership) Business Sustainability Award.

Herman Miller has earned the 4 Star Diversity Visionary Award. This award celebrates the diversity, equality, and inclusion work of Herman Miller. The award is presented at the annual Diversity Equity Inclusion Summit, held by the Grand Rapids Area Chamber of Commerce.

Herman Miller named one of the Best and Brightest in Wellness for the fifth year in a row.

Working Mother magazine has recognized Herman Miller as one of the 2017 Working Mother 100 Best Companies.

Herman Miller earned our tenth consecutive perfect score in Human Rights Campaign (HRC) Foundation's 2017 Corporate Equality Index.

As one of the top-scoring companies in our industry for the thirteenth consecutive year, Herman Miller has qualified for inclusion in RobecoSAM's 2017 Sustainability Yearbook and received the Bronze Class distinction for our excellent economic, environmental, and social sustainability performance.

Herman Miller has once again earned the WorldatWork Seal of Distinction, a unique standard of excellence in work-life effectiveness that shows we provide a distinct, mutually beneficial workplace experience.

2016

Herman Miller was recognized as the Business of the Year at the Annual Meeting of the West Michigan Environmental Action Council (WMEAC). This award goes to the business with the greatest depth and breadth of support, unwavering dedication to environmental action in West Michigan, and a strong corporate commitment to environmental advocacy.

The 101 Best and Brightest Sustainable Companies once again (fifth consecutive year) recognized Herman Miller as an organization in Michigan (and for the first time, in the nation) that exhibits leadership and innovation in its approach to sustainability.

Herman Miller has been recognized by the Michigan Minority Supplier Development Council (MMSDC), as a "Corporation of the Year", and we also received a "2016 Excellence in Supplier Diversity Award" from the Great Lakes Women's Business Council. Additionally, we are the only West Michigan company this year to receive an "Ambassadors Championing Excellence" Award from the MMSDC.

Plex Lounge Furniture from Herman Miller receives #MetropolisLikes award at NeoCon 2016.

Plex Lounge Furniture from Herman Miller receives Interior Design HiP Award for Workplace Seating/Lounge at NeoCon 2016.

Spot Stools from Herman Miller Collection receive Interior Design HiP Award for Hospitality Seating at NeoCon 2016.

Herman Miller has been named a 2020 Women on Boards Winning Company. Companies selected for this recognition are considered champions of board diversity as 20 percent or more of their board seats are occupied by women.

Herman Miller selected for inclusion in the 2016 RobecoSAM Sustainability Yearbook for twelfth consecutive year.

Herman Miller again earns the WorldatWork Work-Life 2016 Seal of Distinction. This award identifies organizations that focus on programs that promote work-life balance and overall well-being.

2015

Herman Miller earns ninth consecutive perfect score in Human Rights Campaign (HRC) Foundation's 2016 Corporate Equality Index and we were designated as Best Place to Work for LGBT equality.

This is the fourth consecutive year that Herman Miller was named one of Michigan's Best and Brightest Sustainable Companies.

Herman Miller has received the Best and Brightest in Wellness Award for the third year in a row. This program is an innovative initiative that recognizes and celebrates quality and excellence in health awareness.

Contract Information

continued

Herman Miller received the Forest Stewardship Council® (FSC®) Leadership Award for longstanding commitment to manufacturing with wood sourced from responsibly managed forests, which reduces environmental impacts by protecting against deforestation and forest degradation.

Herman Miller accepted its second Excellence in Reusable Packaging Award from the Reusable Packaging Association.

Herman Miller has once again been recognized for its commitment to best-in-class economic, environmental, and societal sustainability, earning a spot on the prestigious Dow Jones Sustainability Index (DJSI) for the twelfth consecutive year. We are the only contract furniture company recognized globally for its corporate sustainability leadership.

Herman Miller selected for inclusion in the 2015 RobecoSAM Sustainability Yearbook; awarded Bronze Class distinction for excellent sustainability performance for the second consecutive year.

Herman Miller received a Michigan Business Pollution Prevention (MBP₃) Certificate – a recognition given by the Michigan Department of Environmental Quality (MDEQ) to organizations committed to environmental stewardship, conservation, and sustainable operations. This basic partnership with the MDEQ, which we've maintained since 1998, makes us eligible for our Clean Corporate Citizen (CCC) status that began in 2004 and our Environmental Leader status, which we received for the first time this past year.

MedAssets named Herman Miller Healthcare as Platinum Suppliers. MedAssets, a large group purchasing organization, helps providers enhance operational and financial performance so they can sustainably serve the needs of their community.

Herman Miller honored with five of 20 spots for the Michigan Environmental Leaders Award by the Michigan Department of Environmental Quality for our outstanding, voluntary environmental stewardship.

Renew Sit-to-Stand tables recognized on Record Products 2014 list by Architectural Record.

Herman Miller was again awarded a perfect score in the 2015 Corporate Equality Index. This is the eighth consecutive year we received a perfect score.

2014

Herman Miller has received the Best and Brightest in Wellness Award for the second year in a row. This program is an innovative initiative that recognizes and celebrates quality and excellence in health awareness.

Herman Miller's Locale wins International Design Excellence Awards (IDEA) Gold in the Office & Productivity category.

Herman Miller achieves eleventh consecutive listing on Dow Jones Sustainability World Index, an international stock portfolio that evaluates the annual performance of the world's largest 2500 companies using economic, environmental, and social criteria, known as the "triple bottom line" of sustainability.

2013

Herman Miller achieves tenth consecutive listing on Dow Jones Sustainability World Index.

Herman Miller has received the Best and Brightest in Wellness Award. This program is an innovative initiative that recognizes and celebrates quality and excellence in health awareness.

Herman Miller Earns Perfect Score on the Corporate Equality Index. We are one of only 303 major U.S. businesses to receive a perfect score in 2013, an achievement we have now obtained seven years in a row.

Herman Miller is listed in Forbes Magazine inaugural "Platinum List" of America's 400 best managed, large companies.

For the second consecutive year, Herman Miller is honored as one of West Michigan's "101 Best and Brightest Sustainable Companies".

2012

Herman Miller accepted its first Excellence in Reusable Packaging Award from the Reusable Packaging Association.

Herman Miller is named "Corporation of the Year" in the commercial products sector by the Michigan Minority Supplier Development Council.

In July 2012 Herman Miller was inducted into the Made in the USA Hall of Fame. Herman Miller is one of only 20 companies across the nation to receive this distinction.

Herman Miller achieves ninth consecutive listing on Dow Jones Sustainability World Index.

Herman Miller is honored as one of West Michigan's 101 Best and Brightest Sustainable Companies.

The Sustainable Asset Management (SAM) group selected Herman Miller for inclusion in "The Sustainability Yearbook 2012" and has awarded Herman Miller both the "SAM Sector Leader" and "SAM Sector Mover" distinctions.

Herman Miller was named one of 16 Section Leaders on Climate Counts 2011-2012 Scorecard Report, making us the industry leader for Home and office Furnishings.

SGS International Certification Services, Inc., recognizes Herman Miller's manufacturing sites, Midwest Distribution Center, and Design Yard for initial certification to the OHSAS 18001 standard as well as re-certification to ISO 14001.

Contract Information

continued

24b. Section 508 Compliance

Not applicable

25. Data Universal Numbering System (DUNS): 00-601-2801

26. Registered in System for Award Management (www.SAM.gov) Database

27. Cancellation

Prior to production, no cancellation charge will apply. After production, only actual cost incurred that the contractor can demonstrate if items are sold after 3 months.

28. Restocking Charges

Agencies must notify the contractor for authorization prior to returning any items. The customer agency will be required to pay all packaging and return freight charges. A restocking fee of 50% for Systems Furniture and 35% for all other product lines will be charged for any returned items.

Returns and restocking policy is not applicable to products under SIN 337127.

Herman Miller Miscellaneous Information:

Federal ID Number: 38-0837640

Commercial and Government Entity Code (CAGE): 40636

Data Universal Numbering System (DUNS) 00-601-2801

Commercial Entity Code (CEC): 00702290J

Introduction	page 2
Public Office Landscape®	3
Seating	5
Desking and Storage	12
Power	26
Tables	43
Space Delineation	53
Indices	59
By Name	59
By Number	61
Appendices	
20-Day or Less/Assigned Lead-Time Order Information	
Proprietary Textiles Application Chart-Workspaces	
Proprietary Textile Colors-Workspaces	
Proprietary Textiles Application Chart-Seating	
Proprietary Textile Colors-Seating	
Maharam® Application Chart-Seating	
Maharam Colors-Seating	
For the latest materials information, refer to the Materials pages on HermanMiller.com.	

Introduction

A Note on the Organization of This Book

There are a few signals that will help you understand the organization of this book. Once you know them, you should be able to find your way around easily.

Like a newspaper, this book is formatted with columns of text and illustrations that run vertically.

Information wraps from one column to the next and continues for as many pages as it needs to.

Black bars are clues.

A black bar at the top of a page signals the start of information about a product.

This information is divided into two sections, each signaled by a black bar. Product Information includes a description, additional notes, and dimensional drawings. Specification Information, which always begins at the top of a column, includes a series of steps. Each step represents a decision you need to make in order to complete your product number. Steps must be followed sequentially. The number of pages needed to complete information on a product varies; some will be complete in one page; others may fill three or four pages. Just continue going through the steps until you run into the next product, signaled by the black bar at the top of the page.

Black tabs running along the outside edge of the page help you locate what section you are in or what section you want to go to. You can thumb forwards or backwards to find a section; tabs and text appear on both sides of the page.

The additional pages in the back of the book include the appendices and indices. They are signaled by a long black bar running along the outside edge of the page.

The index is presented two ways.

The first index is in alphabetical order by product name. It can be helpful if you are new to the products and numbering scheme or if you are looking for a type of product, such as work chair or round table.

The second index is by product number. It lists, in alphanumeric order, the base product number, typically a five-digit number.

This book is effective October 4, 2021, subject to change without notice. Products may be purchased from authorized Herman Miller dealers who will quote prices upon request. For more information about our products and services or to see a list of dealers, visit www.HermanMiller.com.

All prices are list prices in US Dollars. Additional services, such as planning services, design, storage, and installation, are not included and must be added to these prices when the additional services are requested.

Illustrations, specifications, and prices are based on the latest information at the time of publication. The right is reserved to make changes at any time without notice in prices, fabrics, finishes, materials, specifications, and models, and also to discontinue models and finishes.

Dimensions shown in the drawings are engineering drawing dimensions rounded up to the nearest $\frac{1}{8}$ ". Product is shipped set up or knocked down. Products that include "Shipped knocked down" in the description require some assembly. If this statement does not appear in the description, the product is shipped assembled.

Service problems are normally handled by a Herman Miller authorized dealer. Where this cannot be accomplished on a local level, service problems should be referred to the Customer Care Representative for your region, Herman Miller, Inc., Zeeland, Michigan 49464.

20-Day or Less/Assigned Lead-Time Shipments

All products and options in this price book not designated by an Assigned Program icon  will ship in **20 business days or less** after being acknowledged by Herman Miller.

Products and options designated by an  are on the assigned lead-time program and may ship in 20 days, less than 20 days, or more than 20 days from order acknowledgement.

Seating

Desking and Storage

Power

Tables

Space Delineation

Social Chair

BVS1N.

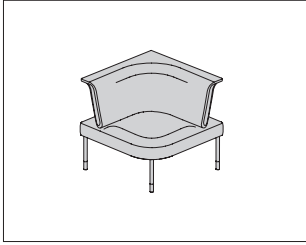

Product Information

Description

This chair has an upholstered foam seat on an expanded polypropylene base, with a Network-wrapped suspension back. The chair can be freestanding next to a desk or connected to other social chairs or café tables. It accepts the attachment of screens. It comes with legs for freestanding applications or without legs when attached to other chairs. Legs have glides that provide up to 2" of adjustment.

Notes

- Chair supports attachment of 2 screens.
- When specified without legs, order seating legs (BVS3.) separately.
- When specifying leg (L) option, legs are welded to seat frame and are not reconfigurable.
- Network color and back loop frame color will match.
- Seat fabric is railroaded.
- Customers Own Material can only be specified for seat fabric. See Customers Own Material Order Information in appendices.
- Seat accepts Customer's Own Material (COM). Yardage is estimated for nondirectional 54"-wide fabrics. Order 2.16 yards of fabric per cushion.
- For information on multiple quantities or directional fabrics, contact COM Department. See Order Information in Appendices.

Dimensions

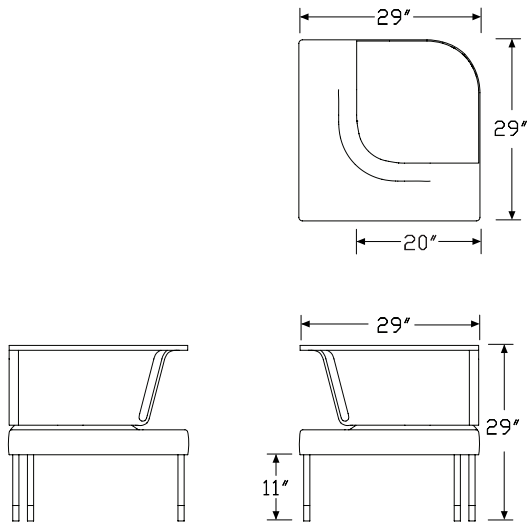

Specification Information

Step 1.

BVS1N.

Step 2. Seat Style

- L** left
- R** right

Step 3. Leg Option

- L** legs
- N** no legs

Step 4. Fire Retardancy

For not fire retardant (*), skip this step.
not fire retardant

Prices for Steps 1-4.

		*
BVS1N. L	L	\$2077
	N	\$2077
	R L	\$2077
	N	\$2077

Step 5. Glide Option

For legs (L)

- C** nylon glide, carpet floors + \$0

Step 6. Leg Finish

For legs (L)

- G1** graphite + \$0
- 91** white + \$0
- MS** metallic silver + \$0

Step 7. Glide Finish

For graphite (G1)

- BK** black + \$0

For white (91)

- 8Q** folkstone grey + \$0

For metallic silver (MS)

- 63** fog + \$0

Step 8. Back Frame Finish		
91	white	+\$0
G1	graphite	+\$0
RO	red	+\$0
97	twilight	+\$0
63	fog	+\$0
79	green apple	+\$0
WBY	wild berry	+\$0

Step 9. Back Knit Color		
-------------------------	--	--

<i>For white (91)</i>		
1A901	warm white	+\$0

<i>For graphite (G1)</i>		
1A907	graphite	+\$0

<i>For red (RO)</i>		
1A903	red	+\$0

<i>For twilight (97)</i>		
1A906	twilight blue	+\$0

<i>For fog (63)</i>		
1A902	fog	+\$0

<i>For green apple (79)</i>		
1A905	green apple	+\$0

<i>For wild berry (WBY)</i>		
1A904	wild berry	+\$0

Step 10. Seat Fabric		
	Price Category 1	+\$0
	Price Category 10	+\$572
	Price Category 2	+\$25
	Price Category 3	+\$46
	Price Category 4	+\$90
	Price Category 5	+\$134
	Price Category 7	+\$288
	Price Category 8	+\$379
	Price Category 9	+\$421
	Price Category C	+\$107
	Price Category F	+\$211
	Price Category I	+\$532

Sectional Seating

BVS2N.

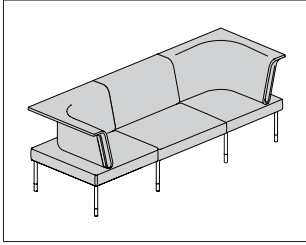

Product Information

Description

The sectional seat comes in straight, right-corner, and left-corner styles. It has an upholstered foam seat on an expanded polypropylene base, with a Network-wrapped suspension back. Sectional seats connect to other sectional seats and social chairs and accept the attachment of screens.

Notes

Order seating legs (BVS3.) separately.

Corner-style seats support 2 screens. Straight-style seats support 1 screen.

Network color and back loop frame color will match.

Seat fabric is railroaded.

Customers Own Material can only be specified for seat fabric. See

Customers Own Material Order Information in appendices.

Seat accepts Customer's Own Material (COM). Yardage is estimated for nondirectional 54"-wide fabrics.

Seat style—Yardage

CR—2.16

CL—2.16

29—2.21

For information on multiple quantities or directional fabrics, contact COM Department. See Order Information in Appendices.

Dimensions

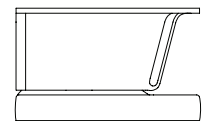
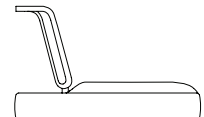
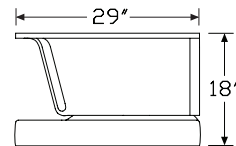
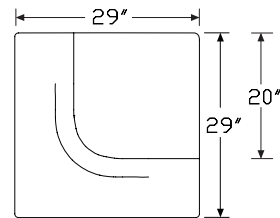
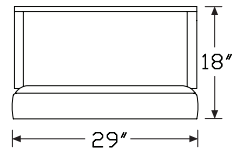
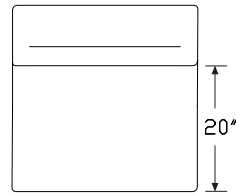

Sectional Seating *continued*

Specification Information	
Step 1.	
BVS2N.	
Step 2. Seat Style	
CR	corner right
CL	corner left
29	straight, 29"
Step 3. Fire Retardancy	
<i>For not fire retardant (*), skip this step.</i>	
not fire retardant	
Prices for Steps 1-3.	
*	
BVS2N.CR	\$2077
CL	\$2077
29	\$2077
Step 4. Back Frame Finish	
91	white +\$0
G1	graphite +\$0
RO	red +\$0
97	twilight +\$0
63	fog +\$0
79	green apple +\$0
WBY	wild berry +\$0
Step 5. Back Knit Color	
<i>For white (91)</i>	
1A901	warm white +\$0
<i>For graphite (G1)</i>	
1A907	graphite +\$0
<i>For red (RO)</i>	
1A903	red +\$0
<i>For twilight (97)</i>	
1A906	twilight blue +\$0
<i>For fog (63)</i>	
1A902	fog +\$0
<i>For green apple (79)</i>	
1A905	green apple +\$0

<i>For wild berry (WBY)</i>	
1A904	wild berry +\$0
Step 6. Seat Fabric	
Price Category 1	+\$0
Price Category 10	+\$572
Price Category 2	+\$25
Price Category 3	+\$46
Price Category 4	+\$90
Price Category 5	+\$134
Price Category 7	+\$288
Price Category 8	+\$379
Price Category 9	+\$421
Price Category C	+\$107
Price Category F	+\$211
Price Category I	+\$532

Legs

BVS3.

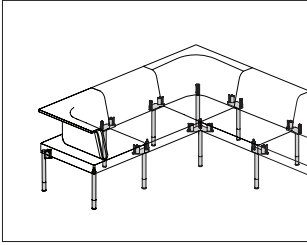

Product Information

Description

Seating legs provide 4 attachment options to accommodate the various configurations of social chairs and sectional seats. Legs have glides that provide up to 2" of adjustment.

Notes

When specifying trivalent chrome (47) finish option, glide color must be specified separately.

Dimensions

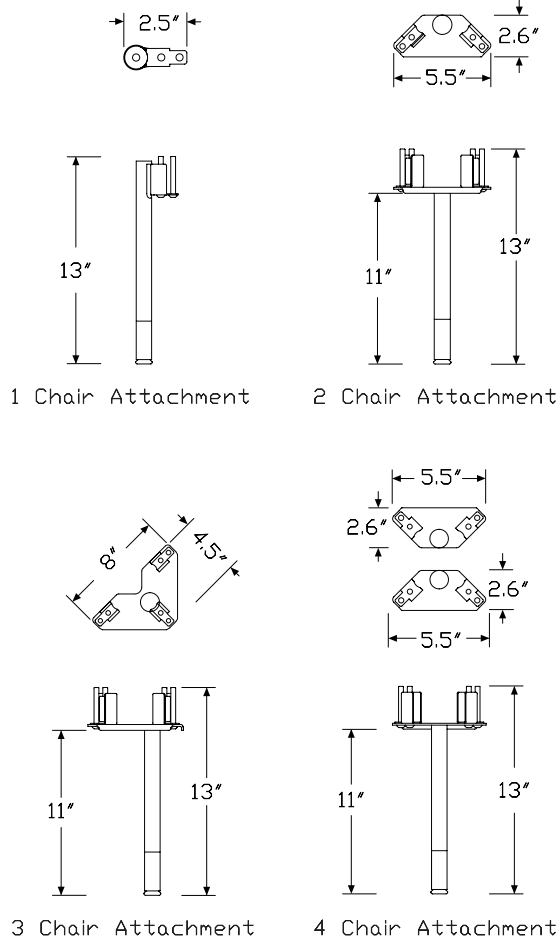

Specification Information

Step 1.

BVS3.

Step 2. Leg Option

- 1 attaches to one chair
- 2 attaches to two chairs
- 3 attaches to three chairs
- 4 attaches to four chairs

Prices for Steps 1-2.

BVS3. 1	\$62
2	\$90
3	\$126
4	\$179

Step 3. Glide Option

C	nylon glide, carpet floors	+\$0
----------	----------------------------	------

Step 4. Leg Finish

91	white	+\$0
G1	graphite	+\$0
MS	metallic silver	+\$0
47	trivalent chrome	+\$10

Step 5. Glide Finish

For graphite (G1)

BK	black	+\$0
-----------	-------	------

For white (91)

8Q	folkstone grey	+\$0
-----------	----------------	------

For metallic silver (MS)

63	fog	+\$0
-----------	-----	------

For trivalent chrome (47)

BK	black <input type="checkbox"/>	+\$0
8Q	folkstone grey <input type="checkbox"/>	+\$0
63	light grey <input type="checkbox"/>	+\$0

Seat Back Ganging Kit

BVS4.

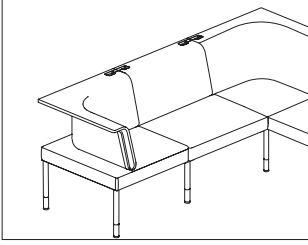

Public Office Landscape® Seating

Product Information

Description
This seat back ganging kit aligns 2 sectional seats that are side-by-side.

Dimensions

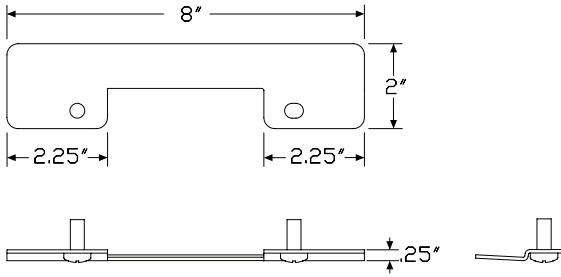

Specification Information

Step 1.	
BVS4.	\$34
Step 2. Leg Option	
2 ganging kit for 2 seats	+\$0

Seat Back Alignment Clip

BVS5.

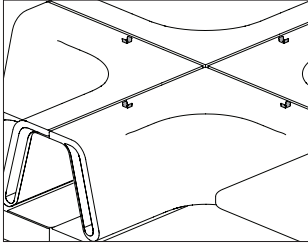

Product Information

Description

This seat back alignment clip aligns 2 chairs that are back-to-back.

Dimensions

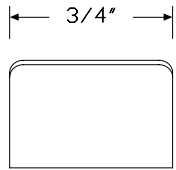
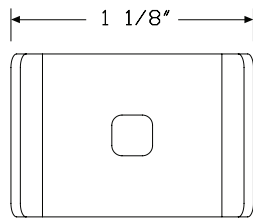

Specification Information

Step 1.

BVS5.1

\$18

Desk

BVD1.

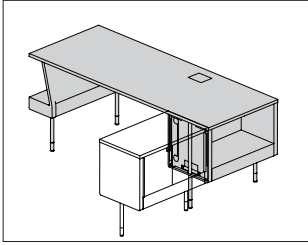

Product Information

Description

Desks have 4 legs and are intended to connect with other desks and connecting bins. Desks have a laminate or veneer squared-edge work surface with a painted steel understructure bin on 1 side and a steel shelf with a bag hook on the other side. Desks will support a screen on the shelf side, and on the bin side when the bin does not have doors, and will accommodate desktop dividers. Understructure bins come in left or right orientation, with or without doors. Bin divider included. Legs have glides that provide up to 2" of adjustment.

Power bridge desk allows power to be run from desk-bin side to L-shelf side of the desk to accommodate powering other desks or café surfaces from a single power entry point. The desk bin and L-shelf have internal structures and components to support power across the desk.

Notes

To connect desk to a connecting bin (BVD2.) or another desk (BVD1.), order desk and bin ganging plate (BVD5.C) separately.

All connecting bins (BVD2.) require the use of both bin-to-bin and desktop-to-desktop ganging plates. Order desk and bin ganging plate (BVD5.C) separately.

The exposed end of the understructure bin requires a desk and bin finishing kit (BVD4.), ordered separately.

Desk accepts modular power (BVEo1., BVEo2.) through the bottom of the understructure bin.

To bring power to the surface of a desk, order Logic Mini, Grommet Mount (Y1414.) separately.

Bin divider is field installed and can be specified in a complementary color.

Grommet color is either graphite or white, matched to the work surface color.

Bag hook color is matched to shelf color.

When specifying trivalent chrome (47) leg finish, glide color is predetermined to coordinate with specified desk finish:

- Graphite (G1) desk will have black (BK) glides
- Metallic silver (MS) desk will have fog (63) glides
- White (G1) desk will have folkstone grey (8Q) glides

Power bridge desk includes cable management channel and L-shelf cover for beam connection.

Power bridge desk can only be ordered without doors, to accommodate the power bridge components.

See Planning Guide for more information about settings.

Dimensions

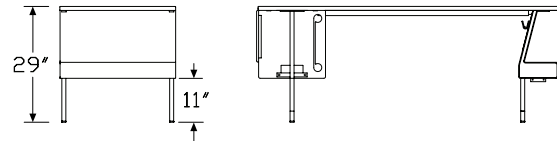
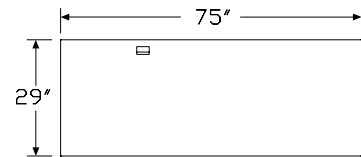

Specification Information

Step 1.

BVD1. A

Step 2. Depth

29 29" deep

Step 3. Width

75 75" wide

Step 4. Power Access

B power bridge desk A

Step 5. Bin Orientation

R bin right

L bin left

Step 6. Bin Doors

For power bridge desk (B)

N no doors

Step 7. Top Material

L laminate top/thermoplastic edge

W veneer

Prices for Steps 1-7.

	BRNL	BRNW	BLNL	BLNW
BVD1. 29 75	\$2366	2803	2366	2803

Step 8. Top Finish

For laminate top/thermoplastic edge (L)

76 light brown walnut	+\$0
8Q folkstone grey	+\$0
91 white	+\$0
98 studio white	+\$0
CL cool grey neutral	+\$0
HF inner tone light	+\$0
HM natural maple	+\$0
HP light anigre	+\$0
HX aged cherry	+\$0
HY walnut on cherry	+\$0
LA light ash	+\$0
LBA clear on ash	+\$0
LBR phantom ecru	+\$0
LBS phantom cocoa	+\$0
LBU medium matte walnut	+\$0
LBV warm grey teak	+\$0
LBB oak on ash	+\$0
LBC walnut on ash	+\$0
LBD dark brown walnut	+\$0
LBF neutral twill	+\$0
LBG sarum twill	+\$0
LBH earthen twill	+\$0
LBJ graphite twill	+\$0
LBM crisp linen	+\$0
LBN classic linen	+\$0
LBP casual linen	+\$0
LBQ white twill	+\$0
LT light tone	+\$0
LU soft white	+\$0
WL sandstone	+\$0
WN warm grey neutral	+\$0

For veneer (W)

2U light brown walnut	+\$0
40 dark brown walnut	+\$0
ET clear on ash	+\$0
EU oak on ash	+\$0
EV walnut on ash	+\$0
EW medium matte walnut	+\$0

Step 9. Edge Finish

For laminate top/thermoplastic edge (L)

76 light brown walnut	+\$0
8Q folkstone grey	+\$0

Desk *continued*

8Z	neutral grey	+\$0
91	white	+\$0
98	studio white	+\$0
BU	black umber	+\$0
CL	cool grey neutral	+\$0
HF	inner tone light	+\$0
HM	natural maple	+\$0
HP	light anigre	+\$0
HX	aged cherry	+\$0
HY	walnut on cherry	+\$0
LA	light ash	+\$0
LBA	clear on ash	+\$0
LBR	phantom ecru	+\$0
LBS	phantom cocoa	+\$0
LBU	medium matte walnut	+\$0
LBV	warm grey teak	+\$0
LBB	oak on ash	+\$0
LBC	walnut on ash	+\$0
LBD	dark brown walnut	+\$0
LBF	neutral twill	+\$0
LBG	sarum twill	+\$0
LBH	earthen twill	+\$0
LBJ	graphite twill	+\$0
LBK	pewter mesh	+\$0
LBL	steel mesh	+\$0
LBM	crisp linen	+\$0
LBN	classic linen	+\$0
LBP	casual linen	+\$0
LBQ	white twill	+\$0
LU	soft white	+\$0
WL	sandstone	+\$0
WN	warm grey neutral	+\$0

Step 10. Leg Finish		
91	white	+\$0
G1	graphite	+\$0
MS	metallic silver	+\$0
47	trivalent chrome	+\$150

Step 11. Bin/Bin Doors/Shelf Finish		
<i>For metallic silver (MS)</i>		
MS	metallic silver	+\$0

<i>For graphite (G1)</i>		
G1	graphite	+\$0

<i>For white (91)</i>		
91	white	+\$0

<i>For trivalent chrome (47)</i>		
91	white	+\$0
G1	graphite	+\$0
MS	metallic silver	+\$0

Step 12. Bin Divider Color		
MS	metallic silver	+\$0
G1	graphite	+\$0
91	white	+\$0
RO	red	+\$30
79	green apple	+\$30
TRQ	turquoise	+\$30
MY3	yellow oxide	+\$30
SG	slate grey	+\$0

Step 13. Grommet Selection		
91	white	+\$0
G1	graphite	+\$0

Connecting Bin

BVD2.

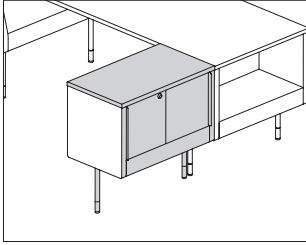

Product Information

Description

Connecting bins have 2 legs and are intended to connect with desks and other connecting bins. Connecting bins have a laminate or veneer top surface with a painted steel understructure bin. They come with or without doors, and allow power pass-through. Connecting bin will support a screen when the bin does not have doors. Bin divider included. Legs have glides that provide up to 2" of adjustment.

Notes

Connecting bins are not freestanding and will not support screens.

All connecting bins require the use of both bin-to-bin and desktop-to-desktop ganging plates. Order desk and bin ganging plate (BVD5.C) separately.

For stability when connecting to a desk (BVD1.) or another connecting bin (BVD2.), use both desktop-to-desktop and bin-to-bin ganging plates (BVD5.C), ordered separately.

The exposed end of the connecting bin requires a desk and bin finishing kit (BVD4.), ordered separately.

Bin divider is field installed and can be specified in a complementary color.

When specifying trivalent chrome (47) leg finish, glide color is predetermined to coordinate with specified bin finish:

- Graphite (G1) bin will have black (BK) glides
- Metallic silver (MS) bin will have fog (63) glides
- White (91) bin will have folkstone grey (8Q) glides

See planning guide for more information about settings.

Dimensions

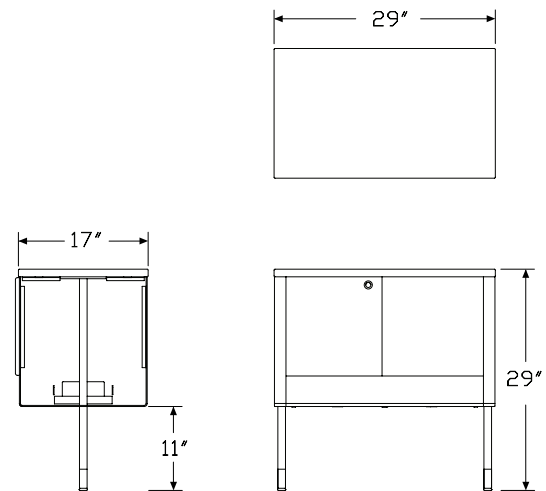

Specification Information			
Step 1.			
BVD2.			
Step 2. Width			
29	29" wide		
Step 3. Bin Doors			
D	doors		
N	no doors		
Step 4. Top Material			
L	laminate top/thermoplastic edge		
W	veneer		
Prices for Steps 1-4.			
		L	W
BVD2.	29 D	\$1141	1369
	N	\$978	1173

Step 5. Top Finish

For laminate top/thermoplastic edge (L)		
76	light brown walnut	+\$0
8Q	folkstone grey	+\$0
91	white	+\$0
98	studio white	+\$0
CL	cool grey neutral	+\$0
HF	inner tone light	+\$0
HM	natural maple	+\$0
HP	light anigre	+\$0
HX	aged cherry	+\$0
HY	walnut on cherry	+\$0
LA	light ash	+\$0
LBA	clear on ash	+\$0
LBR	phantom ecru	+\$0
LBS	phantom cocoa	+\$0
LBU	medium matte walnut	+\$0
LBV	warm grey teak	+\$0
LBB	oak on ash	+\$0
LBC	walnut on ash	+\$0
LBD	dark brown walnut	+\$0
LBF	neutral twill	+\$0
LBG	sarum twill	+\$0
LBH	earthen twill	+\$0
LBJ	graphite twill	+\$0
LBM	crisp linen	+\$0
LBN	classic linen	+\$0
LBP	casual linen	+\$0
LBQ	white twill	+\$0
LT	light tone	+\$0
LU	soft white	+\$0
WL	sandstone	+\$0
WN	warm grey neutral	+\$0

For veneer (W)		
2U	light brown walnut	+\$0
40	dark brown walnut	+\$0
ET	clear on ash	+\$0
EU	oak on ash	+\$0
EV	walnut on ash	+\$0
EW	medium matte walnut	+\$0

Step 6. Edge Finish

For laminate top/thermoplastic edge (L)		
76	light brown walnut	+\$0
8Q	folkstone grey	+\$0

8Z	neutral grey	+\$0
91	white	+\$0
98	studio white	+\$0
BU	black umber	+\$0
CL	cool grey neutral	+\$0
HF	inner tone light	+\$0
HM	natural maple	+\$0
HP	light anigre	+\$0
HX	aged cherry	+\$0
HY	walnut on cherry	+\$0
LA	light ash	+\$0
LBA	clear on ash	+\$0
LBR	phantom ecru	+\$0
LBS	phantom cocoa	+\$0
LBU	medium matte walnut	+\$0
LBV	warm grey teak	+\$0
LBB	oak on ash	+\$0
LBC	walnut on ash	+\$0
LBD	dark brown walnut	+\$0
LBF	neutral twill	+\$0
LBG	sarum twill	+\$0
LBH	earthen twill	+\$0
LBJ	graphite twill	+\$0
LBK	pewter mesh	+\$0
LBL	steel mesh	+\$0
LBM	crisp linen	+\$0
LBN	classic linen	+\$0
LBP	casual linen	+\$0
LBQ	white twill	+\$0
LU	soft white	+\$0
WL	sandstone	+\$0
WN	warm grey neutral	+\$0

Step 7. Leg Finish

91	white	+\$0
G1	graphite	+\$0
MS	metallic silver	+\$0
47	trivalent chrome	+\$75

Step 8. Bin/Bin Doors Finish

For metallic silver (MS)

MS	metallic silver	+\$0
-----------	-----------------	------

For graphite (G1)

G1	graphite	+\$0
-----------	----------	------

For white (91)

91	white	+\$0
-----------	-------	------

For trivalent chrome (47)

91	white	+\$0
G1	graphite	+\$0
MS	metallic silver	+\$0

Step 9. Bin Divider Color

MS	metallic silver	+\$0
G1	graphite	+\$0
91	white	+\$0
RO	red	+\$30
79	green apple	+\$30
TRQ	turquoise	+\$30
MY3	yellow oxide	+\$30
SG	slate grey	+\$0

Step 10. Lock

For doors (D)

KA	keyed alike, black	+\$0
KC	keyed differently, chrome	+\$0
KD	keyed differently, black	+\$0
KQ	keyed alike, chrome	+\$0
NL	no lock	+\$0

Upper Bin

BVD3.

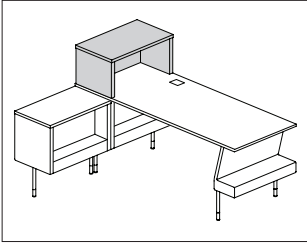

Public Office Landscape® Desking and Storage

Product Information

Description
 The upper bin sits on top of a desk, connecting bin, or freestanding bin. Upper bins have a laminate or veneer top surface with a painted steel frame.

Notes
 Upper bin does not require a desk and bin finishing kit.
 Bin divider is field installed and can be specified in a complementary color.

Dimensions

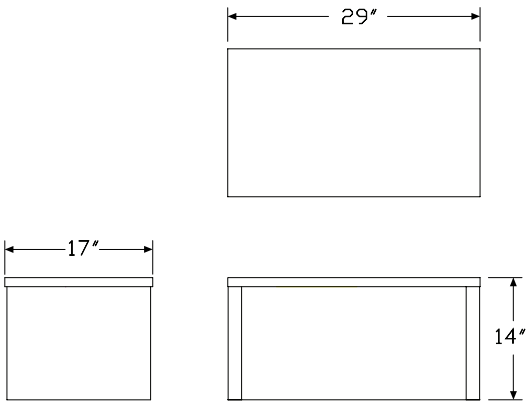

Specification Information

Step 1.

BVD3.

Step 2. Width

29 29" wide

Step 3. Top Material

L laminate top/thermoplastic edge

W veneer

Prices for Steps 1-3.

	L	W
BVD3. 29	\$755	906

Step 4. Top Finish

For laminate top/thermoplastic edge (L)

76	light brown walnut	+\$0
8Q	folkstone grey	+\$0
91	white	+\$0
98	studio white	+\$0
CL	cool grey neutral	+\$0
HF	inner tone light	+\$0
HM	natural maple	+\$0
HP	light anigre	+\$0
HX	aged cherry	+\$0
HY	walnut on cherry	+\$0
LA	light ash	+\$0
LBA	clear on ash	+\$0
LBR	phantom ecru	+\$0
LBS	phantom cocoa	+\$0
LBU	medium matte walnut	+\$0
LBV	warm grey teak	+\$0
LBB	oak on ash	+\$0
LBC	walnut on ash	+\$0
LBD	dark brown walnut	+\$0
LBF	neutral twill	+\$0
LBG	sarum twill	+\$0
LBH	earthen twill	+\$0
LBJ	graphite twill	+\$0
LBM	crisp linen	+\$0
LBN	classic linen	+\$0
LBP	casual linen	+\$0
LBQ	white twill	+\$0
LT	light tone	+\$0
LU	soft white	+\$0
WL	sandstone	+\$0
WN	warm grey neutral	+\$0

For veneer (W)

2U	light brown walnut	+\$0
40	dark brown walnut	+\$0
ET	clear on ash	+\$0
EU	oak on ash	+\$0
EV	walnut on ash	+\$0
EW	medium matte walnut	+\$0

Step 5. Edge Finish

For laminate top/thermoplastic edge (L)

76	light brown walnut	+\$0
8Q	folkstone grey	+\$0

8Z	neutral grey	+\$0
91	white	+\$0
98	studio white	+\$0
BU	black umber	+\$0
CL	cool grey neutral	+\$0
HF	inner tone light	+\$0
HM	natural maple	+\$0
HP	light anigre	+\$0
HX	aged cherry	+\$0
HY	walnut on cherry	+\$0
LA	light ash	+\$0
LBA	clear on ash	+\$0
LBR	phantom ecru	+\$0
LBS	phantom cocoa	+\$0
LBU	medium matte walnut	+\$0
LBV	warm grey teak	+\$0
LBB	oak on ash	+\$0
LBC	walnut on ash	+\$0
LBD	dark brown walnut	+\$0
LBF	neutral twill	+\$0
LBG	sarum twill	+\$0
LBH	earthen twill	+\$0
LBJ	graphite twill	+\$0
LBK	pewter mesh	+\$0
LBL	steel mesh	+\$0
LBM	crisp linen	+\$0
LBN	classic linen	+\$0
LBP	casual linen	+\$0
LBQ	white twill	+\$0
LU	soft white	+\$0
WL	sandstone	+\$0
WN	warm grey neutral	+\$0

Step 6. Bin Finish

MS	metallic silver	+\$0
G1	graphite	+\$0
91	white	+\$0

Step 7. Bin Divider Color

MS	metallic silver	+\$0
G1	graphite	+\$0
91	white	+\$0
RO	red	+\$30
79	green apple	+\$30
TRQ	turquoise	+\$30
MY3	yellow oxide	+\$30
SG	slate grey	+\$0

Freestanding Bin

BVB1.

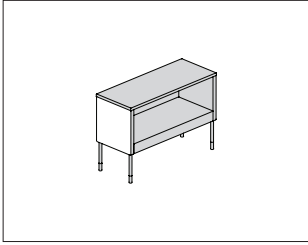

Public Office Landscape® Desking and Storage

Product Information

Description

This freestanding bin has 4 legs and provides shared storage. It has a laminate or veneer work surface with a painted steel understructure bin. It is available with or without power access, with or without doors, and accepts screen attachment. Legs have glides that provide up to 2" of adjustment. Bin divider included.

Notes

The exposed end of the understructure bin requires a desk and bin finishing kit (BVD4), ordered separately.

To connect to other freestanding bins, order desk and bin ganging plate (BVD5) separately.

Freestanding bins do not allow power pass-through, but can be ordered with grommets to accommodate power at the top surface.

To bring power to the surface of a freestanding bin with power access, order Logic Mini, Grommet Mount (Y1414) separately.

Bin divider can be specified in a complementary color.

Grommet color is either graphite or white, matched to the work surface color.

When specifying trivalent chrome (47) leg finish, glide color is predetermined to coordinate with specified bin finish:

- Graphite (G1) bin will have black (BK) glides
- Metallic silver (MS) bin will have fog (63) glides
- White (g1) bin will have folkstone grey (8Q) glides

Dimensions

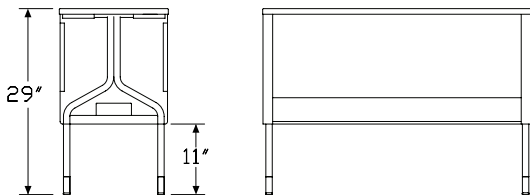
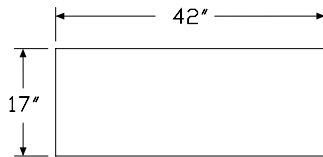

Specification Information

Step 1.

BVB1.

Step 2. Width

- 29** 29" wide
- 42** 42" wide

Step 3. Power Access

- P** power access
- N** no power access

Step 4. Bin Doors

- D** doors
- N** no doors

Step 5. Top Material

- L** laminate top/thermoplastic edge
- W** veneer

Prices for Steps 1-5.

		DL	DW	NL	NW
BVB1.	29 P	\$1239	1486	1077	1291
	N	\$1141	1369	978	1173
	42 P	\$1402	1682	1239	1486
	N	\$1305	1564	1141	1369

Freestanding Bin *continued*

Step 6. Top Finish

For laminate top/thermoplastic edge (L)

76	light brown walnut	+\$0
8Q	folkstone grey	+\$0
91	white	+\$0
98	studio white	+\$0
CL	cool grey neutral	+\$0
HF	inner tone light	+\$0
HM	natural maple	+\$0
HP	light anigre	+\$0
HX	aged cherry	+\$0
HY	walnut on cherry	+\$0
LA	light ash	+\$0
LBA	clear on ash	+\$0
LBR	phantom ecru	+\$0
LBS	phantom cocoa	+\$0
LBU	medium matte walnut	+\$0
LBV	warm grey teak	+\$0
LBB	oak on ash	+\$0
LBC	walnut on ash	+\$0
LBD	dark brown walnut	+\$0
LBF	neutral twill	+\$0
LBG	sarum twill	+\$0
LBH	earthen twill	+\$0
LBJ	graphite twill	+\$0
LBM	crisp linen	+\$0
LBN	classic linen	+\$0
LBP	casual linen	+\$0
LBQ	white twill	+\$0
LT	light tone	+\$0
LU	soft white	+\$0
WL	sandstone	+\$0
WN	warm grey neutral	+\$0

For veneer (W)

2U	light brown walnut	+\$0
40	dark brown walnut	+\$0
ET	clear on ash	+\$0
EU	oak on ash	+\$0
EV	walnut on ash	+\$0
EW	medium matte walnut	+\$0

Step 7. Edge Finish

For laminate top/thermoplastic edge (L)

76	light brown walnut	+\$0
8Q	folkstone grey	+\$0

8Z	neutral grey	+\$0
91	white	+\$0
98	studio white	+\$0
BU	black umber	+\$0
CL	cool grey neutral	+\$0
HF	inner tone light	+\$0
HM	natural maple	+\$0
HP	light anigre	+\$0
HX	aged cherry	+\$0
HY	walnut on cherry	+\$0
LA	light ash	+\$0
LBA	clear on ash	+\$0
LBR	phantom ecru	+\$0
LBS	phantom cocoa	+\$0
LBU	medium matte walnut	+\$0
LBV	warm grey teak	+\$0
LBB	oak on ash	+\$0
LBC	walnut on ash	+\$0
LBD	dark brown walnut	+\$0
LBF	neutral twill	+\$0
LBG	sarum twill	+\$0
LBH	earthen twill	+\$0
LBJ	graphite twill	+\$0
LBK	pewter mesh	+\$0
LBL	steel mesh	+\$0
LBM	crisp linen	+\$0
LBN	classic linen	+\$0
LBP	casual linen	+\$0
LBQ	white twill	+\$0
LU	soft white	+\$0
WL	sandstone	+\$0
WN	warm grey neutral	+\$0

Step 8. Leg Finish

91	white	+\$0
G1	graphite	+\$0
MS	metallic silver	+\$0
47	trivalent chrome	+\$150

Step 9. Bin/Bin Doors Finish

For metallic silver (MS)

MS	metallic silver	+\$0
-----------	-----------------	------

For graphite (G1)

G1	graphite	+\$0
-----------	----------	------

Freestanding Bin *continued*

For white (91)

91 white +\$0

For trivalent chrome (47)

91 white +\$0

G1 graphite +\$0

MS metallic silver +\$0

Step 10. Bin Divider Color

MS metallic silver +\$0

G1 graphite +\$0

91 white +\$0

RO red +\$30

79 green apple +\$30

TRQ turquoise +\$30

MY3 yellow oxide +\$30

SG slate grey +\$0

Step 11. Lock

For doors (D)

KA keyed alike, black +\$0

KC keyed differently, chrome +\$0

KD keyed differently, black +\$0

KQ keyed alike, chrome +\$0

NL no lock +\$0

Desk and Bin Finishing Kit

BVD4.

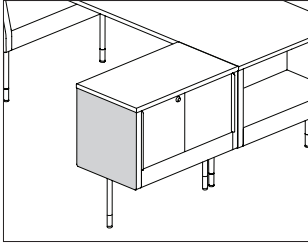

Product Information

Description

This finishing kit is painted steel and covers the exposed end of a desk, peninsula table, connecting bin, or freestanding bin.

Notes

Specify kit color to match color of corresponding desk, peninsula table, connecting bin, or freestanding bin.

Dimensions

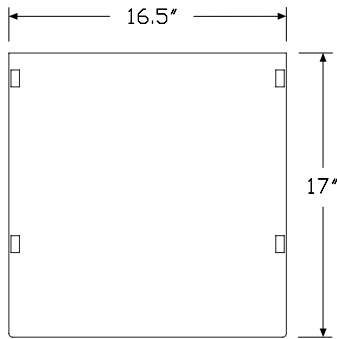

Specification Information

Step 1.

BVD4.

Step 2. Kit Application

- 1 bin finishing kit, single
- 2 bin finishing kit, double

Prices for Steps 1-2.

BVD4. 1	\$59
2	\$100

Step 3. End Cap Material Finish

G1	graphite	+\$0
91	white	+\$0
MS	metallic silver	+\$0

Desk and Bin Ganging Plate

BVD5.

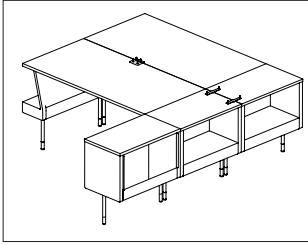

Product Information

Description

These ganging plates provide attachment between bins, desks, and peninsula tables. Attachment hardware included.

Notes

Desk (BVD1.) requires ganging plates (BVD5.C) to attach to other desks or connecting bins.

Connecting bin (BVD2.) requires ganging plates (BVD5.C) to attach to other connecting bins or desks.

Peninsula table (BVT4.) requires ganging plates (BVD5.B) to attach to freestanding bins.

Freestanding bin (BVB1.) requires ganging plates (BVD5.B) to attach to peninsula table or other freestanding bins.

See Planning Guide for more information about settings.

Public Office Landscape® Desking and Storage

Dimensions

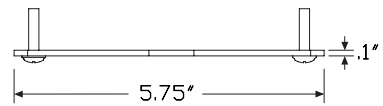

Peninsula table & freestanding bin ganging plates (B)

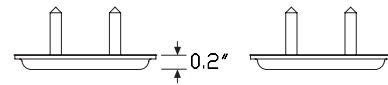
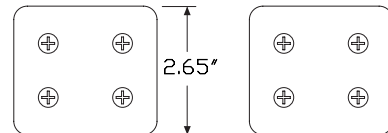
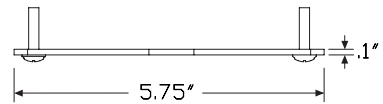

Desk & connecting bin ganging plates (C)

Desk and Bin Ganging Plate

continued

Specification Information

Step 1.

BVD5.

Step 2. Application

B bin-to-bin

C connecting bin ganging kit

Prices for Steps 1-2.

BVD5. B	\$72
C	\$142

Modular Power Entry

BVE01.

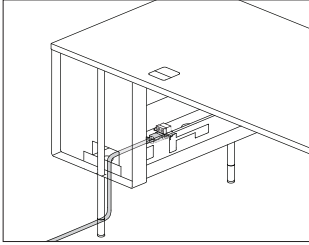

Public Office Landscape® Power

Product Information

Description
 This power entry connects a buildings electrical supply from a wall, floor, or column to a desk or connecting bin. It enters through the bottom of the desk or bin. The power entry plugs into any of the ports on the power block and includes a cable that can be field cut to the appropriate length. Cord comes in 6', 10', and 20' lengths. UL listed and Canadian UL listed.

Notes
 A licensed electrician must wire power entry.

Dimensions

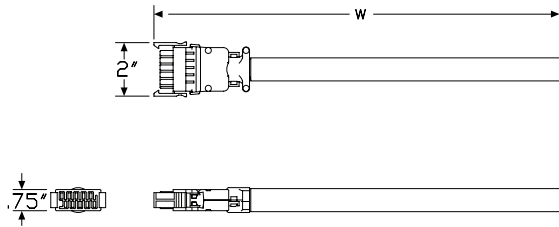

Specification Information

Step 1.

BVE01.

Step 2. Wire Configuration

08 8 wire

Step 3. Cord Length

06 6' long

10 10' long

20 20' long

Prices for Steps 1-3.

	06	10	20
BVE01. 08	\$209	291	404

Modular Power Entry, New York BVE02.

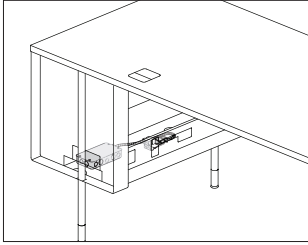

Product Information

Description

This power entry connects a buildings electrical supply from a wall, floor, or column to a desk or connecting bin. It includes a junction box with 8" of wire and a harness. The junction box can be located in the desk or connecting bin. The power entry plugs into any of the ports on the power block. UL listed and Canadian UL listed.

Notes

A licensed electrician must wire power entry.

Dimensions

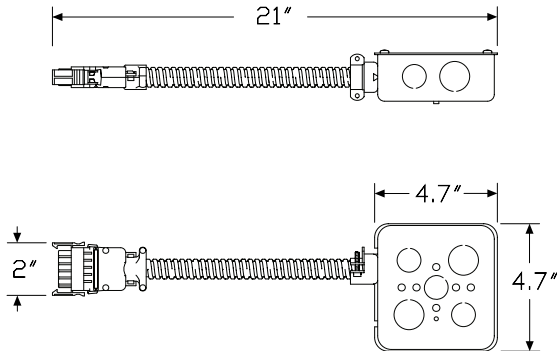

Specification Information

Step 1.

BVE02.

Step 2. Wire Configuration

08 8 wire

Prices for Steps 1-2.

BVE02. 08

\$273

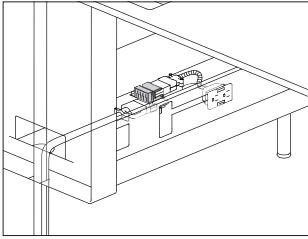

Product Information

Description
 This power block has electrical ports for connecting modular power to receptacles and jumpers. It can be located in a desk, preinstalled into the connecting bin, and for power bridge access desk applications can be located in the L-shelf bin. UL listed and Canadian UL listed.

Notes
 When using the power bridge desk (BVD1.xxxxB) to power a café table, order the 4 port with receptacle harness (4R) configuration to be installed underneath the L-shelf.
 When connecting modular power within connecting bins and desk bins, order the 4 port (04) configuration.
 When using the power bridge desk (BVD1.xxxxB) to bring power across desks without a café table configuration between the desks, order the 4 port (04) configuration.
 See Planning Guide for more information about power.

Dimensions

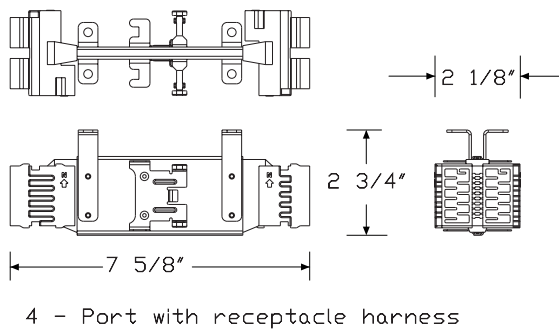
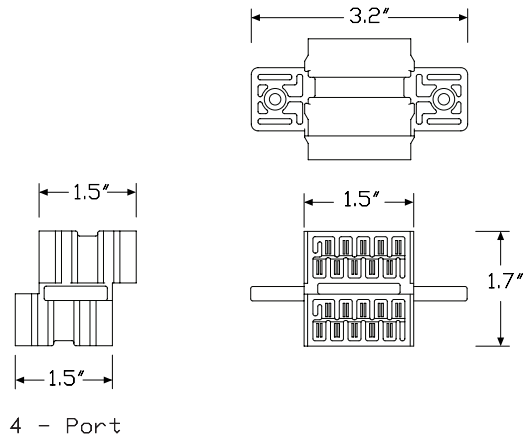

Specification Information

Step 1.

BVE03.

Step 2. Wire Configuration

08 8 wire

Step 3. Block Configuration

04 4 port

4R 4 port with receptacle harness A

Prices for Steps 1-3.

	04	4R
BVE03. 08	\$50	91

Modular Power Duplex

BVE04.

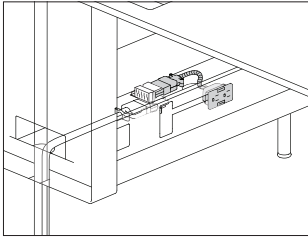

Product Information

Description

This receptacle connects to a power block and provides power to a desk. Package contains 1 duplex receptacle. UL listed and Canadian UL listed.

Notes

When using the power bridge desk (BVD1.xxxxB) to power a café table, order the 8 wire duplex receptacle (FW152) separately.

Dimensions

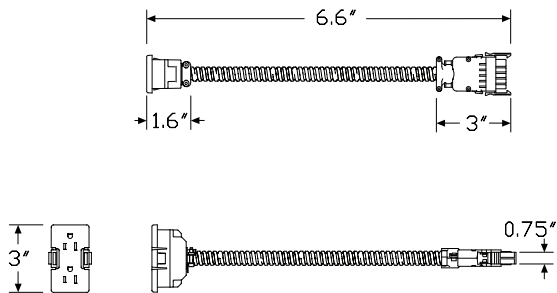

Specification Information

Step 1.

BVE04.

Step 2. Wire Configuration

08 8 wire

Step 3. Duplex Type

For 8 wire (08)

- AN** circuit a - shared neutral, 8 wire
- BN** circuit b - shared neutral, 8 wire
- CN** circuit c - shared neutral, 8 wire
- DN** circuit d - shared neutral, 8 wire
- AG** circuit a - shared neutral isolated ground, 8 wire
- BG** circuit b - shared neutral isolated ground, 8 wire
- CG** circuit c - shared neutral isolated ground, 8 wire
- DG** circuit d - shared neutral isolated ground, 8 wire

Prices for Steps 1-3.

	AN	BN	CN	DN	AG	BG
BVE04. 08	\$113	113	113	113	113	113
					CG	DG
BVE04. 08					\$113	113

Step 4. Duplex Color

- 91** white +\$0
- BK** black +\$0

Modular Power Controlled Duplex BVE04M

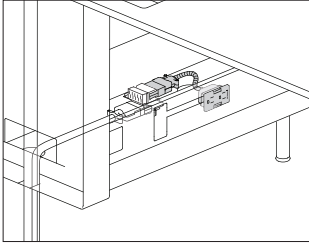

Product Information

Description

This receptacle is to be used for ASHRAE90.1 and Title 24 compliance. A controlled receptacle should be used for any receptacles that are under automated control by the energy management system. The receptacle connects to a power block and provides power to a desk. Package contains 1 duplex receptacle. It is UL listed and Canadian UL listed.

Dimensions

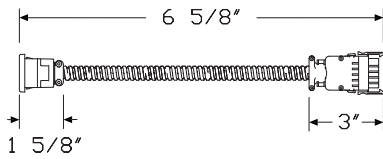

Public Office Landscape® Power

Specification Information

Step 1.

BVE04M.

Step 2. Wire Configuration

08 8 wire

Step 3. Duplex Type

For 8 wire (o8)

- AN** circuit a - shared neutral, 8 wire
- BN** circuit b - shared neutral, 8 wire
- CN** circuit c - shared neutral, 8 wire
- DN** circuit d - shared neutral, 8 wire
- AG** circuit a - shared neutral isolated ground, 8 wire
- BG** circuit b - shared neutral isolated ground, 8 wire
- CG** circuit c - shared neutral isolated ground, 8 wire
- DG** circuit d - shared neutral isolated ground, 8 wire

Prices for Steps 1-3.

	AN	BN	CN	DN	AG	BG
BVE04M. 08	\$113	113	113	113	113	113
					CG	DG
BVE04M. 08					\$113	113

Step 4. Duplex Color

- 91** white +\$0
- BK** black +\$0

Power Block-to-Power Block Jumper

BVE05.

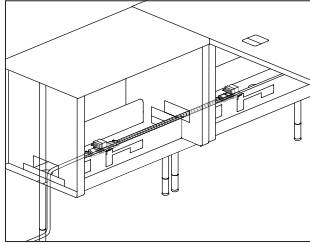

Product Information

Description

This power jumper connects power block to power block in desks and connecting bins. UL listed and Canadian UL listed.

Notes

The 29" jumper distributes power through adjacent desk bin and connecting bin raceways. It connects power blocks in desk back-to-back and offset back-to-back configurations with side-to-side desk bins.

The 52" jumper distributes power through back-to-back desk bin or connecting bin raceways. This jumper includes cover to house jumper outside of the bin.

The 116" jumper distributes power between the power bridge desk (BVD1.xxxxB) in applications where the social chair and/or café table configuration is used in conjunction with the desk.

The 134" jumper distributes power underneath the desk surface of the power bridge desk (BVD1.xxxxB).

See Planning Guide for more information about settings.

Dimensions

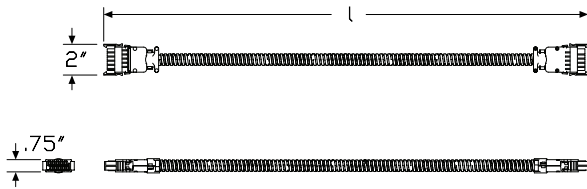

Specification Information

Step 1.

BVE05.

Step 2. Wire Configuration

08 8 wire

Step 3. Jumper Length

29 29" wide

30 52" wide

116 116" wide

134 134" wide

Prices for Steps 1-3.

	29	30	116	134
BVE05. 08	\$113	170	180	202

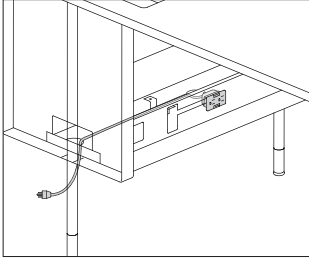

Product Information

Description
 This corded power receptacle provides a plug-in solution in lieu of the modular power system. It plugs directly into a wall or floor outlet. Cord comes in 6', 10', and 20' lengths. Package contains 1 duplex receptacle. UL listed and Canadian UL listed.

Dimensions

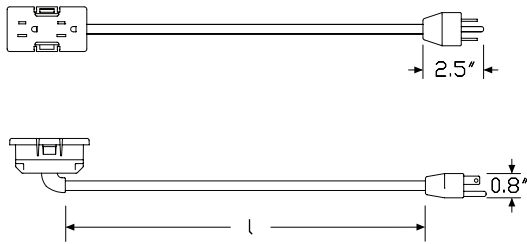

Public Office Landscape® Power

Specification Information

Step 1.

BVE06.

Step 2. Duplex Configuration

1 single duplex

Step 3. Cord Length

06 6' long

10 10' long

20 20' long

Prices for Steps 1-3.

	06	10	20
BVE06. 1	\$102	124	186

Step 4. Duplex Color

91 white +\$0

BK black +\$0

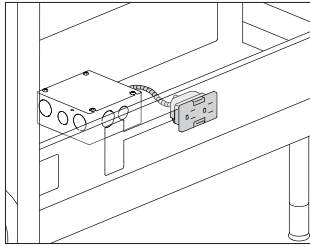

Product Information

Description

This hardwired receptacle connects to the Chicago Power Junction Box and provides power to the desk. Package contains 1 duplex receptacle. UL listed and Canadian UL listed.

Notes

A licensed electrician must wire the receptacle to the junction box (BVEo8.), ordered separately.

Dimensions

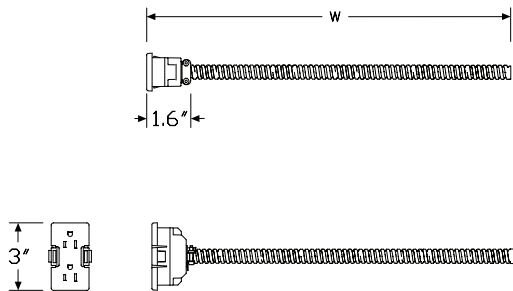

Specification Information

Step 1.

BVE07.

Step 2. Configuration

- A** circuit a
- B** circuit b

Prices for Steps 1-2.

BVE07. A	\$113
B	\$113

Step 3. Duplex Color

91 white	+\$0
BK black	+\$0

Chicago Power - Controlled Duplex

BVE07M

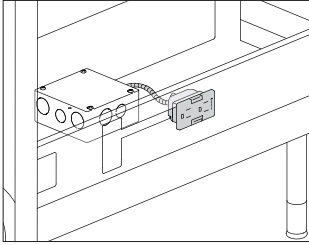

Public Office Landscape® Power

Product Information

Description

This receptacle is to be used for ASHRAE90.1 and Title 24 compliance. A controlled receptacle should be used for any receptacles that are under automated control by the energy management system. This hard-wired receptacle connects to the Chicago power junction box and provides power to a desk. Package contains 1 duplex receptacle. It is UL listed and Canadian UL listed.

Notes

A licensed electrician must wire the receptacle to the junction box (BVEo8.), ordered separately.

Dimensions

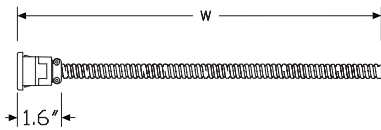

Specification Information

Step 1.

BVE07M. A

Step 2. Configuration

A circuit a A

B circuit b A

Prices for Steps 1-2.

BVE07M. A	\$113
B	\$113

Step 3. Duplex Color

91 white <input type="checkbox"/> A	+ \$0
BK black <input type="checkbox"/> A	+ \$0

Controlled Receptacle Decal
(12 per sheet)

G9999.

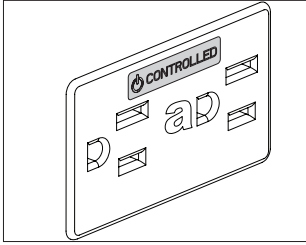

Product Information

Description

This decal is to be used for ASHRAE90.1 and Title 24 compliance. The decal is used to mark standard receptacles (new or existing) that are under automated control by the energy management system. 1 sheet includes 12 clear decals with white or black print.

Dimensions

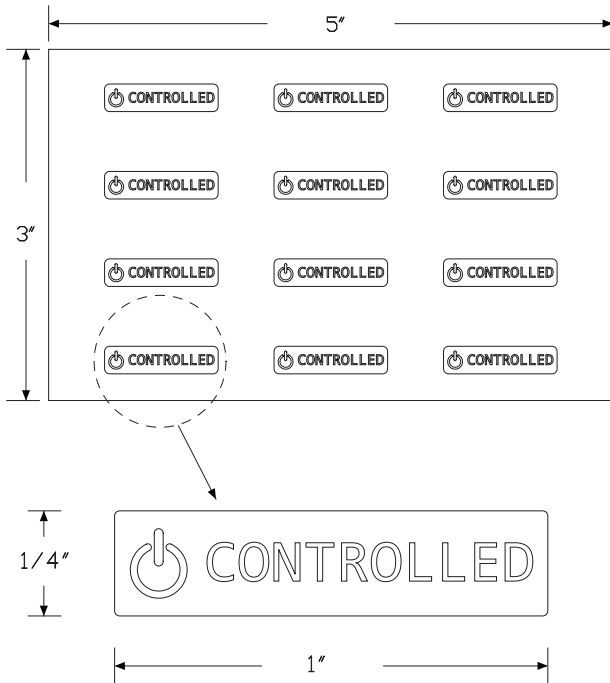

Specification Information

Step 1.

G9999. A

Step 2. Color

B black print A

W white print A

Prices for Steps 1-2.

G9999. B	\$11
W	\$11

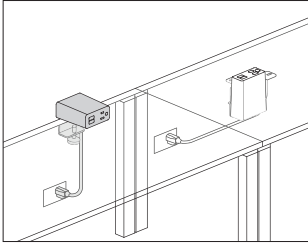

Product Information

Description

This electrical distributor plugs directly into floor, wall, or ceiling drop outlets. Each module configuration presents the same visual appearance. Cable clips and attachment hardware included. Product is UL listed.

Notes

Cable clips for cord management are intended for a 1-time installation. Clamp versions can be reoriented in the field by a technician. USB ports provide a combined 20 watts of power to charge most devices and tablets at full speed. USB-C provides 15 watts of power and USB-A provides 10 watts of power individually. When using the USB-C and USB-A ports simultaneously, USB-C remains at 15 watts and USB-A reduces to 5 watts. Cord color is predetermined. For white (g1) finish cords will be white. For graphite (G1) finish cords will be black. Grommet mount attachment (Y1414.xxxG) does not come with the mini grommet. Order Logic mini grommet (Y1412.) separately, as needed.

Public Office Landscape® Power

Dimensions

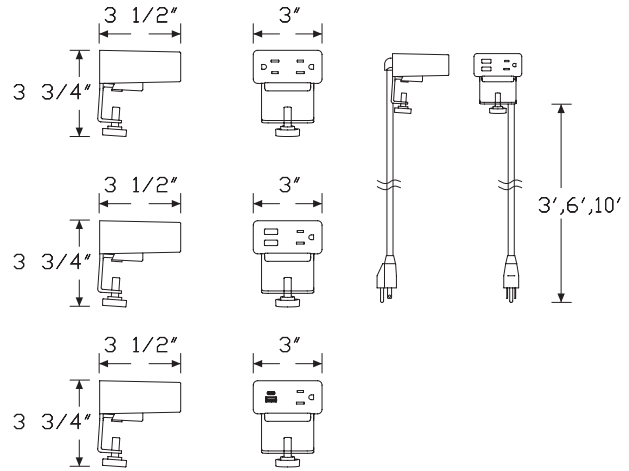

Surface Clamp

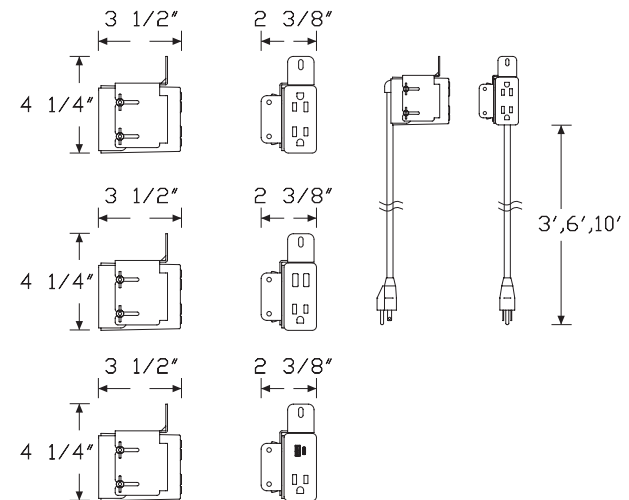

Grommet Mount

Specification Information

Step 1.

Y1414.

Step 2. Configuration

- J** 1 simplex receptacles, 2 powered USB A
- L** 1 simplex receptacles, 1 powered USB A/C Combo
- K** 2 simplex receptacles

Step 3. Cord/Conduit Length

- 03** 3' cord/conduit
- 06** 6' cord/conduit
- 10** 10' cord/conduit

Step 4. Attachment

- G** grommet mount
- S** surface clamp

Prices for Steps 1-4.

		G	S
Y1414. J	03	\$383	383
	06	\$383	383
	10	\$393	393
L	03	\$383	383
	06	\$383	383
	10	\$393	393
K	03	\$214	214
	06	\$214	214
	10	\$225	225

Step 5. Finish

- BK** black **A** +\$0
- 91** white **A** +\$0
- 98** studio white **A** +\$0
- G1** graphite **A** +\$0

Logic G1200 Grommet Pass Thru Y1420.

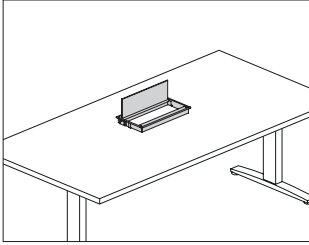

Product Information

Description

This Logic Power Access Solutions™ grommet mounted metal enclosure provides access to cords kept beneath the surface. The unit has an integrated cord keeper.

Notes

Unit size is based on the grommet mounted electrical distributor (Y1425.) with simplex receptacles.

Dimensions

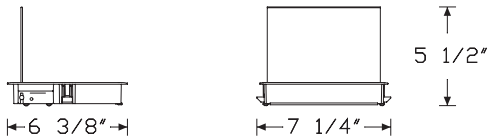

3 outlet opening (T)

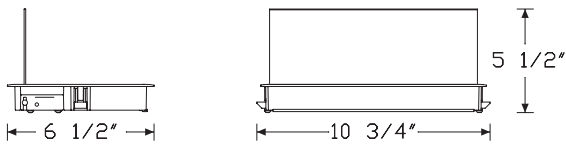

5 outlet opening (V)

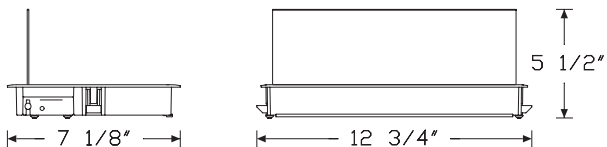

6 outlet opening (X)

Specification Information

Step 1.

Y1420.

Step 2. Configuration

- T** three outlet opening
- V** five outlet opening
- X** six outlet opening

Prices for Steps 1-2.

Y1420. T	\$246
V	\$270
X	\$294

Step 3. Finish

91	white <input type="checkbox"/>	+\$0
98	studio white <input type="checkbox"/>	+\$0
BK	black <input type="checkbox"/>	+\$0
G1	graphite <input type="checkbox"/>	+\$0
MS	metallic silver <input type="checkbox"/>	+\$0

Chicago Power - Junction Box

BVE08.

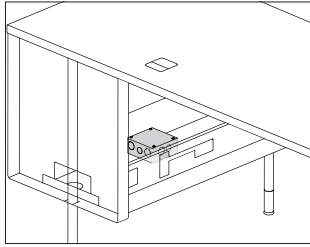

Product Information

Description

This hardwired junction box provides power for up to 2 hardwired Chicago Power Receptacles. UL listed and Canadian UL listed.

Notes

A licensed electrician must wire the junction box to the Chicago power receptacle (BVE07.), ordered separately.

Dimensions

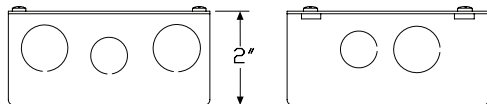
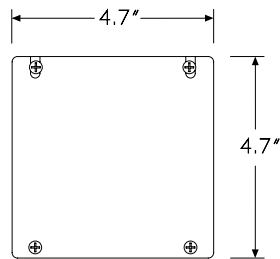

Specification Information

Step 1.

BVE08.

\$81

Logic HD Cable Manager

Y1424.

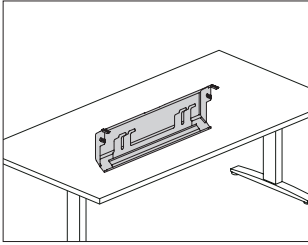

Product Information

Description

This Logic Power Access Solutions™ stand-alone cable management tray mounts to the underside of most surfaces. It can be used with a Logic unit for cord storage, or used alone with cords routed through the back side of the unit. Tray drops down and holds cords in place while working and can be easily stowed back in place.

Dimensions

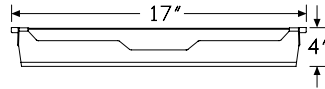
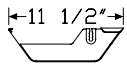

Specification Information

Step 1.

Y1424.

Step 2. Size

17 17" wide tray

Prices for Steps 1-2.

Y1424. 17 \$270

Step 3. Finish

SNA	satin aluminum	+\$0
SNB	satin bronze	+\$0
SNC	satin carbon	+\$0
91	white <input type="checkbox"/>	+\$0
98	studio white <input type="checkbox"/>	+\$0
BK	black <input type="checkbox"/>	+\$0
G1	graphite <input type="checkbox"/>	+\$0
MS	metallic silver <input type="checkbox"/>	+\$0

Power Bridge

BVE09.

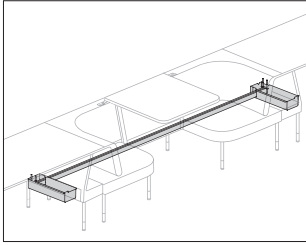

Product Information

Description

This kit includes beam to route power jumper and data between power bridge access desks positioned L-shelf-to-L-shelf with or without social chairs and café table between desk configurations. Attachment hardware included. Power components must be ordered separately.

Notes

Receptacle over only option (NB) supports desk back-to-back configurations with a single or double café and power bridge desk located on left or right side.

Jumper tray only option (00) covers the power block and desk jumper in back-to-back L-shelf configurations with the power bridge desk.

Short bridge option (29) connects L-shelf-to-desk bin configurations with a single social chair between desks. At least 1 desk must be the power bridge desk.

Long bridge option (87) connects L-shelf-to-L-shelf in desk side-to-side configurations with a café table between the power bridge desks.

See Planning Guide for more information about settings.

Dimensions

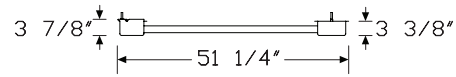
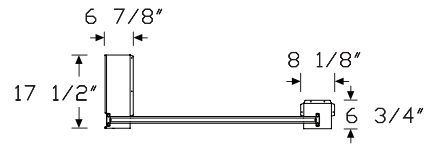

Short Bridge (29)

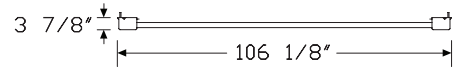

Long Bridge (87)

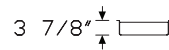
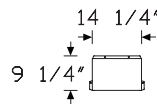

Jumper Tray (00)

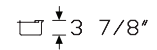
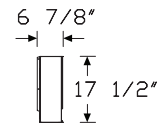

Receptacle Cover (NB)

Specification Information

Step 1.

BVE09.

Step 2. Length

- NB** receptacle cover only
- 00** jumper tray only
- 29** short bridge
- 87** long bridge

Step 3. Desk Bin Orientation

For receptacle cover only (NB)

- L** left bin
- R** right bin

For jumper tray only (00), short bridge (29), or long bridge (87)

- B** left bin and right bin

Prices for Steps 1-3.

	B	L	R
BVE09. NB	—	\$136	136
00	\$113	—	—
29	\$504	—	—
87	\$728	—	—

Step 4. Finish

- 91** white +\$0
- G1** graphite +\$0
- MS** metallic silver +\$0

Single Café Table

BVT1.

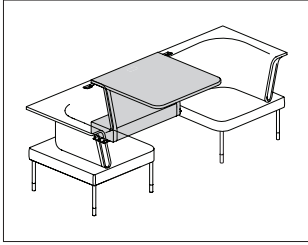

Product Information

Description

This single café table comes with a laminate or veneer squared-edge work surface. It has a painted steel shelf, accepts a single 29"-wide screen, and is available with or without power access. Café table includes bag hook. Attachment hardware included.

Notes

Single café table cannot stand alone and must attach between 2 social chairs (BVS1N.).

Power access comes with single grommet to accommodate power at the surface. Grommet color is either graphite or white, matched to the work surface color.

To bring power to the surface of a single café table with power access, order Logic Mini, Grommet Mount (Y1414.) separately.

Bag hook color is matched to shelf color.

Dimensions

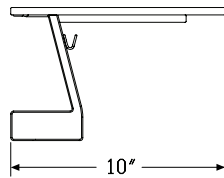
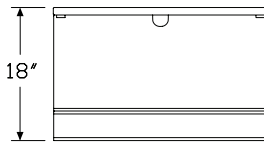
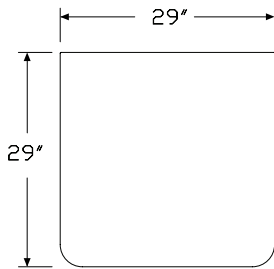

Specification Information

Step 1.

BVT1.

Step 2. Depth

29 29" deep

Step 3. Power Access

P power access

N no power access

Step 4. Top Material

L laminate top/thermoplastic edge

W veneer

Prices for Steps 1-4.

		L	W
BVT1.	29 P	\$1025	1231
	N	\$966	1160

Single Café Table *continued*

Step 5. Top Finish

For laminate top/thermoplastic edge (L)

76	light brown walnut	+\$0
8Q	folkstone grey	+\$0
91	white	+\$0
98	studio white	+\$0
CL	cool grey neutral	+\$0
HF	inner tone light	+\$0
HM	natural maple	+\$0
HP	light anigre	+\$0
HX	aged cherry	+\$0
HY	walnut on cherry	+\$0
LA	light ash	+\$0
LBA	clear on ash	+\$0
LBR	phantom ecru	+\$0
LBS	phantom cocoa	+\$0
LBU	medium matte walnut	+\$0
LBV	warm grey teak	+\$0
LBB	oak on ash	+\$0
LBC	walnut on ash	+\$0
LBD	dark brown walnut	+\$0
LBF	neutral twill	+\$0
LBG	sarum twill	+\$0
LBH	earthen twill	+\$0
LBJ	graphite twill	+\$0
LBM	crisp linen	+\$0
LBN	classic linen	+\$0
LBP	casual linen	+\$0
LBQ	white twill	+\$0
LT	light tone	+\$0
LU	soft white	+\$0
WL	sandstone	+\$0
WN	warm grey neutral	+\$0

For veneer (W)

2U	light brown walnut	+\$0
40	dark brown walnut	+\$0
ET	clear on ash	+\$0
EU	oak on ash	+\$0
EV	walnut on ash	+\$0
EW	medium matte walnut	+\$0

Step 6. Edge Finish

For laminate top/thermoplastic edge (L)

76	light brown walnut	+\$0
8Q	folkstone grey	+\$0

8Z	neutral grey	+\$0
91	white	+\$0
98	studio white	+\$0
BU	black umber	+\$0
CL	cool grey neutral	+\$0
HF	inner tone light	+\$0
HM	natural maple	+\$0
HP	light anigre	+\$0
HX	aged cherry	+\$0
HY	walnut on cherry	+\$0
LA	light ash	+\$0
LBA	clear on ash	+\$0
LBR	phantom ecru	+\$0
LBS	phantom cocoa	+\$0
LBU	medium matte walnut	+\$0
LBV	warm grey teak	+\$0
LBB	oak on ash	+\$0
LBC	walnut on ash	+\$0
LBD	dark brown walnut	+\$0
LBF	neutral twill	+\$0
LBG	sarum twill	+\$0
LBH	earthen twill	+\$0
LBJ	graphite twill	+\$0
LBK	pewter mesh	+\$0
LBL	steel mesh	+\$0
LBM	crisp linen	+\$0
LBN	classic linen	+\$0
LBP	casual linen	+\$0
LBQ	white twill	+\$0
LU	soft white	+\$0
WL	sandstone	+\$0
WN	warm grey neutral	+\$0

Step 7. Shelf Finish

MS	metallic silver	+\$0
G1	graphite	+\$0
91	white	+\$0

Step 8. Grommet Selection

For power access (P)

91	white	+\$0
G1	graphite	+\$0

Focus Café Table

BVT2.

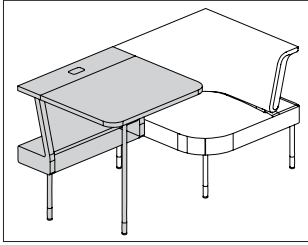

Product Information

Description

The focus café table comes with a laminate or veneer squared-edge work surface. It has a painted steel shelf, accepts a single 29"-wide screen, accepts power accessories, and is available with or without power access. Stiffeners, and attachment hardware included.

Notes

Focus café table cannot stand alone and must attach to 1 social chair (BVS1N).

Power accessories in this application will comply with UL 962A.

Power access comes with single grommet to accommodate power at the surface. Grommet color is either graphite or white, matched to the work surface color.

To bring power to the surface of a focus café table with power access, order Logic Mini, Grommet Mount (Y1414.) separately.

Dimensions

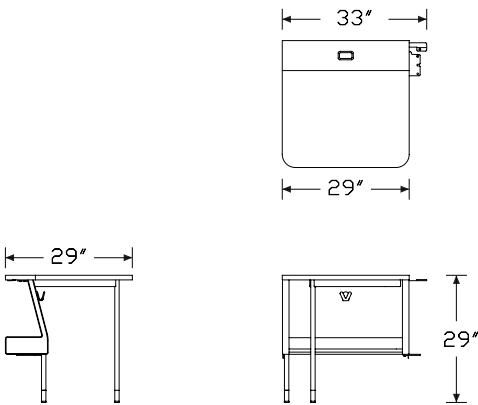

Specification Information

Step 1.

BVT2.

Step 2. Depth

29 29" deep

Step 3. Power Access

P power access

N no power access

Step 4. Surface Application

L table left

R table right

Step 5. Top Material

L laminate top/thermoplastic edge

W veneer

Prices for Steps 1-5.

		LL	LW	RL	RW
BVT2.	29 P	\$1412	1694	1412	1694
	N	\$1327	1592	1327	1592

Step 6. Top Finish

For laminate top/thermoplastic edge (L)

76	light brown walnut	+\$0
8Q	folkstone grey	+\$0
91	white	+\$0
98	studio white	+\$0
CL	cool grey neutral	+\$0
HF	inner tone light	+\$0
HM	natural maple	+\$0
HP	light anigre	+\$0
HX	aged cherry	+\$0
HY	walnut on cherry	+\$0
LA	light ash	+\$0
LBA	clear on ash	+\$0
LBR	phantom ecru	+\$0
LBS	phantom cocoa	+\$0
LBU	medium matte walnut	+\$0
LBV	warm grey teak	+\$0
LBB	oak on ash	+\$0
LBC	walnut on ash	+\$0
LBD	dark brown walnut	+\$0
LBF	neutral twill	+\$0
LBG	sarum twill	+\$0
LBH	earthen twill	+\$0
LBJ	graphite twill	+\$0
LBM	crisp linen	+\$0
LBN	classic linen	+\$0
LBP	casual linen	+\$0
LBQ	white twill	+\$0
LT	light tone	+\$0
LU	soft white	+\$0
WL	sandstone	+\$0
WN	warm grey neutral	+\$0

For veneer (W)

2U	light brown walnut	+\$0
40	dark brown walnut	+\$0
ET	clear on ash	+\$0
EU	oak on ash	+\$0
EV	walnut on ash	+\$0
EW	medium matte walnut	+\$0

Step 7. Edge Finish

For laminate top/thermoplastic edge (L)

76	light brown walnut	+\$0
8Q	folkstone grey	+\$0

8Z	neutral grey	+\$0
91	white	+\$0
98	studio white	+\$0
BU	black umber	+\$0
CL	cool grey neutral	+\$0
HF	inner tone light	+\$0
HM	natural maple	+\$0
HP	light anigre	+\$0
HX	aged cherry	+\$0
HY	walnut on cherry	+\$0
LA	light ash	+\$0
LBA	clear on ash	+\$0
LBR	phantom ecru	+\$0
LBS	phantom cocoa	+\$0
LBU	medium matte walnut	+\$0
LBV	warm grey teak	+\$0
LBB	oak on ash	+\$0
LBC	walnut on ash	+\$0
LBD	dark brown walnut	+\$0
LBF	neutral twill	+\$0
LBG	sarum twill	+\$0
LBH	earthen twill	+\$0
LBJ	graphite twill	+\$0
LBK	pewter mesh	+\$0
LBL	steel mesh	+\$0
LBM	crisp linen	+\$0
LBN	classic linen	+\$0
LBP	casual linen	+\$0
LBQ	white twill	+\$0
LU	soft white	+\$0
WL	sandstone	+\$0
WN	warm grey neutral	+\$0

Step 8. Leg Finish

MS	metallic silver	+\$0
G1	graphite	+\$0
91	white	+\$0

Step 9. Shelf Finish

For metallic silver (MS)

MS	metallic silver	+\$0
-----------	-----------------	------

For graphite (G1)

G1	graphite	+\$0
-----------	----------	------

Focus Café Table *continued*

For white (G1)

91 white +\$0

Step 10. Grommet Selection

For power access (P)

91 white +\$0

G1 graphite +\$0

Double Café Table

BVT3.

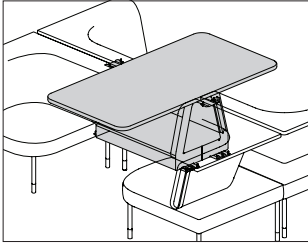

Product Information

Description

This double café table comes with a laminate or veneer squared-edge work surface. It has a painted steel shelf and is available with or without power access. Attachment hardware included.

Notes

Double café table cannot stand alone and must attach between 4 social chairs (BVS1N.).

Power access comes with 2 grommets to accommodate power at the surface. Grommet color is either graphite or white, matched to the work surface color.

To bring power to the surface of a double café table with power access, order Logic Mini, Grommet Mount (Y1414.) separately.

Dimensions

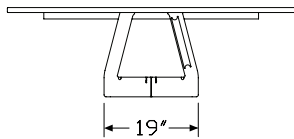
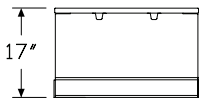
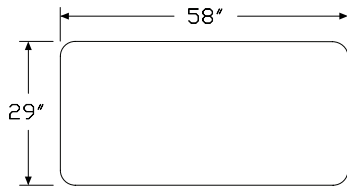

Specification Information

Step 1.

BVT3.

Step 2. Depth

29 29" deep

Step 3. Power Access

P power access

N no power access

Step 4. Top Material

L laminate top/thermoplastic edge

W veneer

Prices for Steps 1-4.

		L	W
BVT3.	29 P	\$1215	1459
	N	\$1119	1343

Double Café Table *continued*

Step 5. Top Finish

For laminate top/thermoplastic edge (L)

76	light brown walnut	+\$0
8Q	folkstone grey	+\$0
91	white	+\$0
98	studio white	+\$0
CL	cool grey neutral	+\$0
HF	inner tone light	+\$0
HM	natural maple	+\$0
HP	light anigre	+\$0
HX	aged cherry	+\$0
HY	walnut on cherry	+\$0
LA	light ash	+\$0
LBA	clear on ash	+\$0
LBR	phantom ecru	+\$0
LBS	phantom cocoa	+\$0
LBU	medium matte walnut	+\$0
LBV	warm grey teak	+\$0
LBB	oak on ash	+\$0
LBC	walnut on ash	+\$0
LBD	dark brown walnut	+\$0
LBF	neutral twill	+\$0
LBG	sarum twill	+\$0
LBH	earthen twill	+\$0
LBJ	graphite twill	+\$0
LBM	crisp linen	+\$0
LBN	classic linen	+\$0
LBP	casual linen	+\$0
LBQ	white twill	+\$0
LT	light tone	+\$0
LU	soft white	+\$0
WL	sandstone	+\$0
WN	warm grey neutral	+\$0

For veneer (W)

2U	light brown walnut	+\$0
40	dark brown walnut	+\$0
ET	clear on ash	+\$0
EU	oak on ash	+\$0
EV	walnut on ash	+\$0
EW	medium matte walnut	+\$0

Step 6. Edge Finish

For laminate top/thermoplastic edge (L)

76	light brown walnut	+\$0
8Q	folkstone grey	+\$0

8Z	neutral grey	+\$0
91	white	+\$0
98	studio white	+\$0
BU	black umber	+\$0
CL	cool grey neutral	+\$0
HF	inner tone light	+\$0
HM	natural maple	+\$0
HP	light anigre	+\$0
HX	aged cherry	+\$0
HY	walnut on cherry	+\$0
LA	light ash	+\$0
LBA	clear on ash	+\$0
LBR	phantom ecru	+\$0
LBS	phantom cocoa	+\$0
LBU	medium matte walnut	+\$0
LBV	warm grey teak	+\$0
LBB	oak on ash	+\$0
LBC	walnut on ash	+\$0
LBD	dark brown walnut	+\$0
LBF	neutral twill	+\$0
LBG	sarum twill	+\$0
LBH	earthen twill	+\$0
LBJ	graphite twill	+\$0
LBK	pewter mesh	+\$0
LBL	steel mesh	+\$0
LBM	crisp linen	+\$0
LBN	classic linen	+\$0
LBP	casual linen	+\$0
LBQ	white twill	+\$0
LU	soft white	+\$0
WL	sandstone	+\$0
WN	warm grey neutral	+\$0

Step 7. Shelf Finish

MS	metallic silver	+\$0
G1	graphite	+\$0
91	white	+\$0

Step 8. Grommet Selection

For power access (P)

91	white	+\$0
G1	graphite	+\$0

Peninsula Table

BVT4.

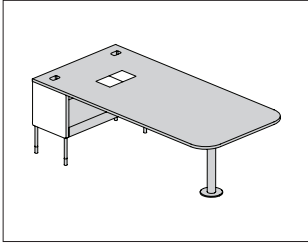

Public Office Landscape® Tables

Product Information

Description
 This peninsula table comes with a laminate or veneer squared-edge work surface. It has a painted steel understructure bin, a column leg, 2 grommets in the back of the surface, and an additional cutout for power access. It accepts a single 42"-wide screen. Legs have glides that provide up to 2" of adjustment. Bin divider included.

Notes
 To connect peninsula table to other freestanding bins, order desk and bin ganging plate (BVD5.) separately.
 Bin divider color is specified separately.
 The exposed end of the understructure bin requires a desk and bin finishing kit (BVD4.), ordered separately.
 Grommet color is either graphite or white, matched to the work surface color.
 To bring power to the surface of a peninsula table with power access, order Logic Mini, Grommet Mount (Y1414.) separately.
 Doors are not available for the peninsula table understructure bin.

Dimensions

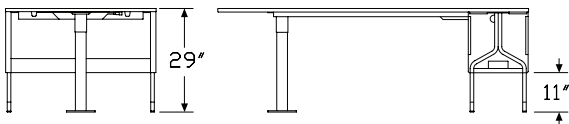
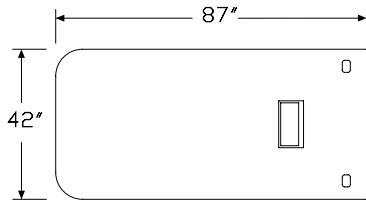

Specification Information

Step 1.	
BVT4.	
Step 2. Depth	
42	42" deep
Step 3. Width	
87	87" wide
Step 4. Power Access	
P	power access
Step 5. Doors	
N	no doors
Step 6. Top Material	
L	laminate top/thermoplastic edge
W	veneer

Prices for Steps 1-6.

		PNL	PNW
BVT4.	42 87	\$2717	3259

Step 7. Top Finish

For laminate top/thermoplastic edge (L)

76	light brown walnut	+\$0
8Q	folkstone grey	+\$0
91	white	+\$0
98	studio white	+\$0
CL	cool grey neutral	+\$0
HF	inner tone light	+\$0
HM	natural maple	+\$0
HP	light anigre	+\$0
HX	aged cherry	+\$0
HY	walnut on cherry	+\$0
LA	light ash	+\$0
LBA	clear on ash	+\$0
LBR	phantom ecru	+\$0
LBS	phantom cocoa	+\$0
LBU	medium matte walnut	+\$0
LBV	warm grey teak	+\$0
LBB	oak on ash	+\$0
LBC	walnut on ash	+\$0
LBD	dark brown walnut	+\$0
LBF	neutral twill	+\$0
LBG	sarum twill	+\$0
LBH	earthen twill	+\$0
LBJ	graphite twill	+\$0
LBM	crisp linen	+\$0
LBN	classic linen	+\$0
LBP	casual linen	+\$0
LBQ	white twill	+\$0
LT	light tone	+\$0
LU	soft white	+\$0
WL	sandstone	+\$0
WN	warm grey neutral	+\$0

For veneer (W)

2U	light brown walnut	+\$0
40	dark brown walnut	+\$0
ET	clear on ash	+\$0
EU	oak on ash	+\$0
EV	walnut on ash	+\$0
EW	medium matte walnut	+\$0

Step 8. Edge Finish

For laminate top/thermoplastic edge (L)

76	light brown walnut	+\$0
8Q	folkstone grey	+\$0

8Z	neutral grey	+\$0
91	white	+\$0
98	studio white	+\$0
BU	black umber	+\$0
CL	cool grey neutral	+\$0
HF	inner tone light	+\$0
HM	natural maple	+\$0
HP	light anigre	+\$0
HX	aged cherry	+\$0
HY	walnut on cherry	+\$0
LA	light ash	+\$0
LBA	clear on ash	+\$0
LBR	phantom ecru	+\$0
LBS	phantom cocoa	+\$0
LBU	medium matte walnut	+\$0
LBV	warm grey teak	+\$0
LBB	oak on ash	+\$0
LBC	walnut on ash	+\$0
LBD	dark brown walnut	+\$0
LBF	neutral twill	+\$0
LBG	sarum twill	+\$0
LBH	earthen twill	+\$0
LBJ	graphite twill	+\$0
LBK	pewter mesh	+\$0
LBL	steel mesh	+\$0
LBM	crisp linen	+\$0
LBN	classic linen	+\$0
LBP	casual linen	+\$0
LBQ	white twill	+\$0
LU	soft white	+\$0
WL	sandstone	+\$0
WN	warm grey neutral	+\$0

Step 9. Leg Finish

MS	metallic silver	+\$0
G1	graphite	+\$0
91	white	+\$0

Step 10. Bin/Bin Doors Finish

For metallic silver (MS)

MS	metallic silver	+\$0
-----------	-----------------	------

For graphite (G1)

G1	graphite	+\$0
-----------	----------	------

Peninsula Table *continued*

For white (91)

91 white +\$0

Step 11. Bin Divider Color

MS metallic silver +\$0

G1 graphite +\$0

91 white +\$0

RO red +\$30

79 green apple +\$30

TRQ turquoise +\$30

MY3 yellow oxide +\$30

SG slate grey +\$0

Step 12. Grommet Selection

91 white +\$0

G1 graphite +\$0

Flat Edge Screen, Single Material BVP1.

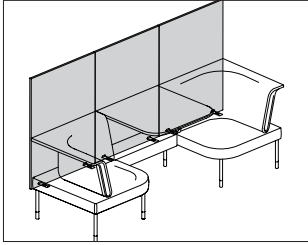

Product Information

Description

Screens attach to social chairs, sectional seats, desks, single café tables, peninsula tables, and freestanding bins. They are tackable, have a single fabric covering the entire screen, and come in 2 widths and 3 heights. Attachment is by a push-button mechanism.

Notes

For attachment to a social chair (BVS1N.), sectional seat (BVS2N.), single café table (BVT1.) and 29" freestanding bin (BVB1.29), specify 29"-wide screen. For attachment to peninsula table (BVT4.) and 42" freestanding bin (BVB1.42), specify 42"-wide screen.

Applications with adjacent screens in a line or at a corner require alignment clip (BVP3.), ordered separately.

Screens accept whiteboard overhang (BVP4.), ordered separately.

Screen accepts Customer's Own Material (COM). Yardage is estimated for nondirectional 54"-wide fabrics.

Height—Yardage

42—2.33

54—3.09

68—3.97

For information on multiple quantities or directional fabrics, contact COM Department. See Order Information in Appendices.

Dimensions

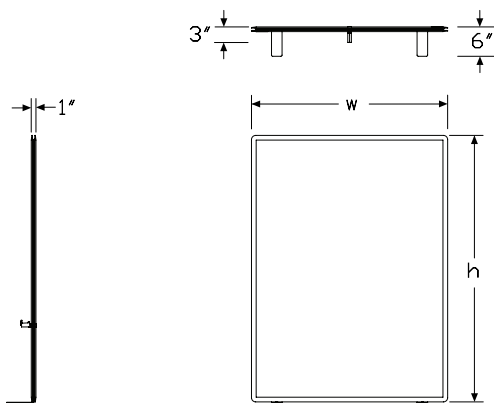

Specification Information

Step 1.

BVP1.

Step 2. Width

29 29" wide

42 42" wide

Step 3. Height

42 42" high

54 54" high

68 68" high

Step 4. Screen Material

F fabric

Prices for Steps 1-4.

	F
BVP1. 29 42	\$707
54	\$910
68	\$1082
42 42	\$926
54	\$1130
68	\$1223

Step 5. Fabric

For 42" high (42) with fabric (F)

Price Category 1	+\$0
Price Category 2	+\$22
Price Category 3	+\$50
Price Category 5	+\$134
Price Category B	+\$69
Price Category C	+\$114

For 54" high (54) with fabric (F)

Price Category 1	+\$0
Price Category 2	+\$28
Price Category 3	+\$66
Price Category 5	+\$187
Price Category B	+\$94
Price Category C	+\$157

Flat Edge Screen, Single Material

continued

For 68" high (68) with fabric (F)

Price Category 1	+\$0
Price Category 2	+\$36
Price Category 3	+\$86
Price Category 5	+\$234
Price Category B	+\$118
Price Category C	+\$196

Screen and Desktop Divider Alignment Kit

BVP3.

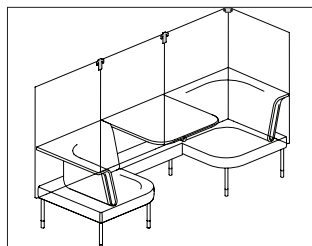

Product Information

Description

This clip comes in 2 types to align screens and desktop dividers either in a line or at a corner. Clip finish is metallic silver (MS).

Notes

For use with the flat edge screen, desktop divider (BVP5.), only the straight alignment clip is recommended.

Dimensions

Specification Information

Step 1.

BVP3.

Step 2. Application

S straight

C corner

Prices for Steps 1-2.

BVP3. S	\$14
C	\$26

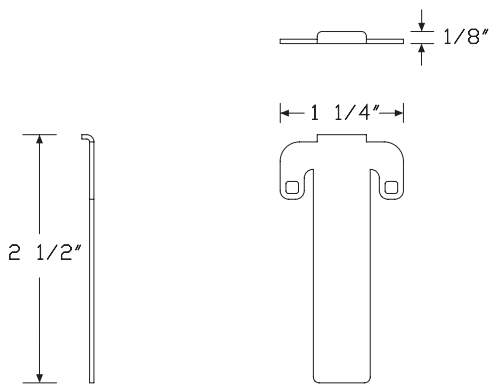

Straight

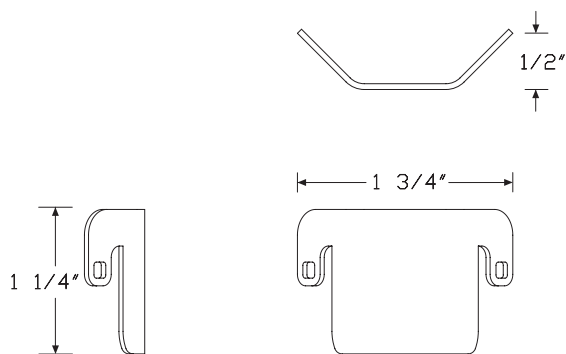

Corner

Whiteboard Overhang

BVP4.

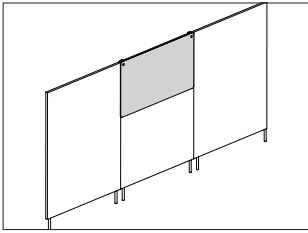

Product Information

Description
 This whiteboard hangs over a screen. It is 25" high when used on 54"-high screens, and 39" high when used on 68"-high screens. Available in 29" and 42" widths to match screen width. Bracket finish is metallic silver (MS).

Notes
 Available for 54"-high and 68"-high screens only.
 A screen can support only a single whiteboard overhang.

Dimensions

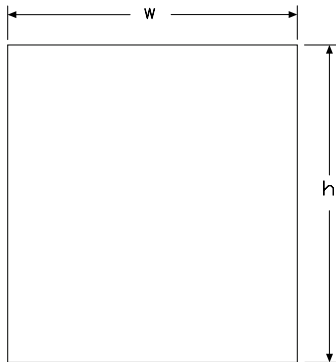

Specification Information

Step 1.

BVP4.

Step 2. Width

- 29** 29" wide
- 42** 42" wide

Step 3. Height

- 54** 54" high
- 68** 68" high

Prices for Steps 1-3.

		54	68
BVP4.	29	\$480	640
	42	\$640	800

Flat Edge Screen, Desktop Divider BVP5.

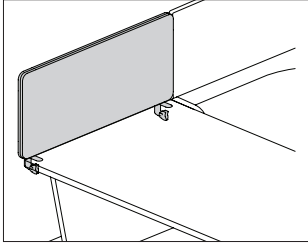

Product Information

Description

This 13"-high fabric-covered divider is mounted to, or freestanding on, desks, tables, and connecting bins. Attachment hardware is included and comes standard in metallic silver (MS) finish.

Notes

Applications with adjacent dividers in a line require alignment clip (BVP3.S), ordered separately.

Divider accepts Customer's Own Material (COM). Yardage is estimated for nondirectional 54"-wide fabrics.

Width—Yardage

29—1.10

58—1.92

For information on multiple quantities or directional fabrics, contact COM Department. See Order Information in Appendices.

Dimensions

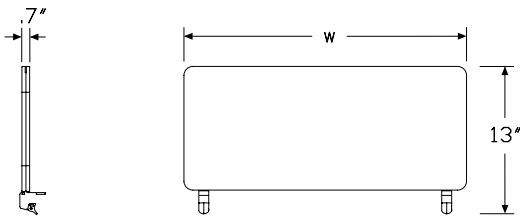

Specification Information

Step 1.

BVP5.

Step 2. Height

13 13" high

Step 3. Width

29 29" wide

58 58" wide

Step 4. Material

F fabric

Step 5. Attachment Location

F freestanding base

S side clamp

Prices for Steps 1-5.

		FF	FS
BVP5.	13 29	\$404	404
	58	\$557	557

Step 6. Fabric

Price Category 1	+\$0
Price Category 2	+\$11
Price Category 3	+\$28
Price Category 5	+\$88
Price Category B	+\$44
Price Category C	+\$73

Index by Product Name

Public Office Landscape®	
Chicago Power - Controlled Duplex	page(s) 34
Chicago Power - Duplex	33
Chicago Power - Junction Box	39
Connecting Bin	15
Controlled Receptacle Decal (12 per sheet)	35
Corded Power Solution	32
Desk	12
Desk and Bin Finishing Kit	23
Desk and Bin Ganging Plate	24
Double Café Table	48
Flat Edge Screen, Desktop Divider	57
Flat Edge Screen, Single Material	53
Focus Café Table	45
Freestanding Bin	20
Legs	9
Logic G1200 Grommet Pass Thru	38
Logic HD Cable Manager	40
Logic Mini	36
Modular Power Controlled Duplex	30
Modular Power Duplex	29
Modular Power Entry	26
Modular Power Entry, New York	27
Peninsula Table	50
Power Block	28
Power Block-to-Power Block Jumper	31
Power Bridge	41
Screen and Desktop Divider Alignment Kit	55
Seat Back Alignment Clip	11
Seat Back Ganging Kit	10
Sectional Seating	7
Single Café Table	43
Social Chair	5
Upper Bin	18
Whiteboard Overhang	56



Index by Product Number

BVB1. Freestanding Bin	page(s) 20
BVD1. Desk	12
BVD2. Connecting Bin	15
BVD3. Upper Bin	18
BVD4. Desk and Bin Finishing Kit	23
BVD5. Desk and Bin Ganging Plate	24
BVE01. Modular Power Entry	26
BVE02. Modular Power Entry, New York	27
BVE03. Power Block	28
BVE04M Modular Power Controlled Duplex	30
BVE04. Modular Power Duplex	29
BVE05. Power Block-to-Power Block Jumper	31
BVE06. Corded Power Solution	32
BVE07. Chicago Power - Duplex	33
BVE07M Chicago Power - Controlled Duplex	34
BVE08. Chicago Power - Junction Box	39
BVE09. Power Bridge	41
BVP1. Flat Edge Screen, Single Material	53
BVP3. Screen and Desktop Divider Alignment Kit	55
BVP4. Whiteboard Overhang	56
BVP5. Flat Edge Screen, Desktop Divider	57
BVS1N. Social Chair	5
BVS2N. Sectional Seating	7
BVS3. Legs	9
BVS4. Seat Back Ganging Kit	10
BVS5. Seat Back Alignment Clip	11
BVT1. Single Café Table	43
BVT2. Focus Café Table	45
BVT3. Double Café Table	48
BVT4. Peninsula Table	50
G9999. Controlled Receptacle Decal (12 per sheet)	35
Y1414. Logic Mini	36
Y1420. Logic G1200 Grommet Pass Thru	38
Y1424. Logic HD Cable Manager	40



20-Day or Less/Assigned Lead-Time Order Information

20-Day or Less and Assigned Lead-Time Programs

20-day or less and assigned lead-time products are designed for established Herman Miller dealers with pre-approved credit.

Products are distributed from multiple manufacturing facilities across the United States. All products and options not designated by an Assigned Lead-Time icon **A** will ship in 20 business days or less after being acknowledged by Herman Miller. Products and options designated by an **A** are on the assigned lead-time program and will ship in 20 days, less than 20 days, or more than 20 days from order acknowledgement.

Ordering Procedure

Please place orders through Order Manager. If this is not available to you, place orders through mail or fax. Verbal purchase orders will not be accepted.

Order Entry fax number for Passage®, 5000 Series, and Meridian® Filing and Storage: (616) 846 9236.

Order Entry fax number for all other products:
(616) 654 3085.

For more information, contact your Customer Care representative at:
(866) 854 3048 EXT 3400.

Shipments and Delivery

Per Herman Miller Terms and Conditions.

Changes and Cancellation

Per Herman Miller Terms and Conditions.



Customer's Own Material Order Information — Workspaces

Customer's Own Material

Program Overview

The Customer's Own Material (COM) program gives you the option of using textiles other than those listed. Herman Miller will test textiles for application to Herman Miller products and will process orders for those with approved COM textiles only. COM textiles are on assigned lead times.

Omni lists an overview of fabrics that have been tested and indicates whether or not they were approved for application to Herman Miller products.

Specific information on the terms and conditions, testing, approval, and ordering process for COM is listed below. Questions about the COM program and requests for assistance may be directed to your COM representative at:

(616) 654 3400

(866) 854 3048 EXT 6543400

Customer's Own Material Warranty

Herman Miller does not warrant COM textiles. COM textiles are tested for application only; they are not tested for performance. The Herman Miller warranty does apply to the underlying products.

Suppliers of COM textiles are responsible for color consistency within commercial tolerances, UV stability, and resistance to soiling and perspiration.

Customer's Own Material Pricing

COM is a Category 1 fabric. There are no application charges for COM fabrics.

Ordering and payment for COM textile yardage are the responsibility of the customer and the textile supplier.

If desired, Herman Miller will purchase COM textiles directly from Maharam, Camira, C.F. Stinson, Guilford of Maine, Luna Textiles, Momentum Textiles and Ultrafabrics to simplify ordering and shipment. For this service, refer to the Supplier Connection program.

Application Note

Herman Miller does not guarantee that Customer's Own Material (COM) fabric patterns will align across panels/tiles or from one screen to the next. We also do not guarantee that COM fabric designs will be positioned consistently in the same location across several panels, tiles, or screens.

COM is not available on panels.

Textile Approval

1. Select a COM textile and a Herman Miller product.
2. If your textile does not show as tested in Omni, submit a request. You will be required to select a specific color of the textile and feature of the product to test, i.e., seat, back, etc.
3. Herman Miller will notify you of approval or disapproval within 4 days from receipt of the test yardage.

Customer's Own Material Order Information — Workspaces

continued

Ordering Products with COM

1. Refer to the specific products to determine the yardage required for COM textiles.

Note: Yardage requirements are based on nondirectional, 54"-wide textiles. 66"-wide textiles are needed for application on 60"-wide products. Additional yardage may be needed due to the unique characteristics of a textile.

2. Obtain the COM ID# in Omni. If the color you are ordering does not have a COM ID# assigned, click "Create ID".
3. Enter your order on Order Manager in Omni.
4. Upon receipt of your purchase order, Herman Miller will send you a PO acknowledgment.
5. Arrangements must be made for the textiles to be shipped from the supplier to Herman Miller for application to the Herman Miller products. Textiles must be tagged with the assigned identification number and the roll yardage quantity. See Omni for shipping procedures and current shipping addresses or contact a COM representative at (616) 654 3400 or (866) 854 3048 EXT 6543400.

Products will be scheduled for production when COM textiles are received at Herman Miller. Standard lead times in effect at that time will apply.

Note: If textiles are to be purchased directly by Herman Miller through the Supplier Connection program, Herman Miller will handle the ordering and shipping process and will schedule your order for production upon receipt of your purchase order (dependent on textile availability). Refer to the Supplier Connection program for more information.

Supplier Connection

Program Overview

The Supplier Connection program is a service offered by Herman Miller to purchase approved COM textiles directly from Maharam, Camira, C.F. Stinson, Guilford of Maine, Luna Textiles, Momentum Textiles and Ultrafabrics. When you select a textile through this program, Herman Miller will facilitate the ordering, scheduling, and shipment of the textile directly with the supplier.

Suppliers included in the Supplier Connection program keep an active inventory of textiles that are pre-approved for application to Herman Miller products. Pre-approval applies only to the suitability of a textile for manufacturing and application to a Herman Miller product. Omni provides an overview of fabrics that have been tested and indicates whether or not they were approved for application to Herman Miller products.

Specific information on the terms and conditions, testing, approval, and ordering process for the Supplier Connection program is listed below. Questions and requests for assistance may be directed to your COM representative at:

(616) 654 3400
(866) 854 3048 EXT 6543400

Supplier Connection Warranty

Textiles purchased by Herman Miller through the Supplier Connection program are COM and are not warranted by Herman Miller. COM textiles are tested for application only; they are not tested for performance. The Herman Miller warranty does apply to the underlying products.

Suppliers of COM textiles are responsible for color consistency within commercial tolerances, UV stability, and resistance to soiling and perspiration.

Supplier Connection Pricing

Textiles purchased by Herman Miller through the Supplier Connection program are COM. COM is a Category 1 fabric. There are no application charges for COM fabrics.

Payment for textiles purchased by Herman Miller through the Supplier Connection program is the responsibility of the customer or dealer. Herman Miller will invoice the order at the supplier's prices published at the time of the order.

Customer's Own Material Order Information — Workspaces

continued

Textile Approval

1. Select a COM textile and a Herman Miller product.
2. If your textile does not show as tested in Omni, submit a request.
You will be required to select a specific color of the textile and feature of the product to test, i.e., seat, back, etc.
3. Herman Miller will notify you of approval or disapproval within 4 days from receipt of the test yardage.

Ordering Products with Supplier Connection COM

1. Identify and include the following information on your purchase order:
 - Product number and option
 - Herman Miller's COM identification number
2. Enter your order on Order Manager in Omni.
3. Upon receipt of the purchase order, Herman Miller will process your order and send you a PO acknowledgment. Herman Miller will determine the yardage required to produce your product and will order and schedule for delivery the required textile. Standard lead times in effect at the time the textile is allocated at the supplier will apply to products ordered through this program.



Customer's Own Material/Customer's Own Leather Order Information — Seating

Packaging

Packaging varies according to individual product. A surcharge may be added for special packaging requests. Contact Customer Care for specific information.

Customer's Own Material/Customer's Own Leather

Program Overview

The Customer's Own Material (COM) and Customer's Own Leather (COL) program gives you the option of using textiles other than those listed. Herman Miller will test textiles for application to Herman Miller products and will process orders for those with approved COM/COL textiles only. COM/COL are assigned lead-time textiles.

Omni lists an overview of fabrics and leathers that have been tested and indicates whether or not they were approved for application to Herman Miller products.

Specific information on the terms and conditions, testing, approval, and ordering process for COM/COL is listed below. Questions about the COM/COL program and requests for assistance may be directed to your COM representative at:

(616) 654 3400

(866) 854 3048 EXT 6543400

Customer's Own Material/Customer's Own Leather Warranty

Herman Miller does not warrant COM/COL textiles. COM/COL textiles are tested for application only; they are not tested for performance. The Herman Miller warranty does apply to the underlying products.

Suppliers of COM/COL textiles are responsible for color consistency within commercial tolerances, UV stability, and resistance to soiling and perspiration.

Customer's Own Material/Customer's Own Leather Pricing

COM is a Category 1 fabric. There are no application charges for COM fabrics. COL is a Category 7 textile; refer to prices on specific products to determine the application charge.

Ordering and payment for COM/COL textile yardage are the responsibility of the customer and the textile supplier.

If desired, Herman Miller will purchase COM textiles directly from Maharam, Camira, C.F. Stinson, Guilford of Maine, Luna Textiles, Momentum Textiles and Ultrafabrics to simplify ordering and shipment. For this service, refer to the Supplier Connection program.

Customer's Own Material/Customer's Own Leather Order Information — Seating

continued

Textile Approval

1. Select a COM textile and a Herman Miller product.
2. If your textile does not show as tested in Omni, submit a request. You will be required to select a specific color of the textile and feature of the product to test, i.e., seat, back, etc.
3. Herman Miller will notify you of approval or disapproval within 4 days from receipt of the test yardage.

Ordering Products with COM/COL

1. Refer to the specific products to determine the yardage required for COM/COL textiles.
Note: Additional yardage may be needed due to the unique characteristics of a textile.
2. Obtain the COM ID# in Omni. If the color you are ordering does not have a COM ID# assigned, click “Create ID”.
3. Enter your order on Order Manager in Omni.
4. Upon receipt of your purchase order, Herman Miller will send you a PO acknowledgment.
5. Arrangements must be made for the textiles to be shipped from the supplier to Herman Miller for application to the seating products. Textiles must be tagged with the assigned identification number and the roll yardage quantity. See Omni for shipping procedures and current shipping addresses or contact a COM representative at (616) 654 3400 or (866) 854 3048 EXT 6543400.

Products will be scheduled for production when COM/COL textiles are received at Herman Miller. Standard lead times in effect at that time will apply.

Note: If textiles are to be purchased directly by Herman Miller through the Supplier Connection program, Herman Miller will handle the ordering and shipping process and will schedule your order for production upon receipt of your purchase order (dependent on textile availability). Refer to the Supplier Connection program for more information.

Supplier Connection

Program Overview

The Supplier Connection program is a service offered by Herman Miller to purchase approved COM textiles directly from Maharam, Camira, C.F. Stinson, Guilford of Maine, Luna Textiles, Momentum Textiles and Ultrafabrics. When you select a textile through this program, Herman Miller will facilitate the ordering, scheduling, and shipment of the textile directly with the supplier.

Suppliers included in the Supplier Connection program keep an active inventory of textiles that are pre-approved for application to Herman Miller products. Pre-approval applies only to the suitability of a textile for manufacturing and application to a Herman Miller product. Omni provides an overview of fabrics that have been tested and indicates whether or not they were approved for application to Herman Miller products.

Specific information on the terms and conditions, testing, approval, and ordering process for the Supplier Connection program is listed below. Questions and requests for assistance may be directed to your COM representative at:

(616) 654 3400
(866) 854 3048 EXT 6543400

Supplier Connection Warranty

Textiles purchased by Herman Miller through the Supplier Connection program are COM and are not warranted by Herman Miller. COM textiles are tested for application only; they are not tested for performance. The Herman Miller warranty does apply to the underlying products.

Suppliers of COM textiles are responsible for color consistency within commercial tolerances, UV stability, and resistance to soiling and perspiration.

Customer's Own Material/Customer's Own Leather Order Information — Seating

continued

Supplier Connection Pricing

Textiles purchased by Herman Miller through the Supplier Connection program are COM. COM is a Category 1 fabric. There are no application charges for COM fabrics.

Payment for textiles purchased by Herman Miller through the Supplier Connection program is the responsibility of the customer or dealer. Herman Miller will invoice the order at the supplier's prices published at the time of the order.

Textile Approval

1. Select a COM textile and a Herman Miller product.
2. If your textile does not show as tested in Omni, submit a request.
You will be required to select a specific color of the textile and feature of the product to test, i.e., seat, back, etc.
3. Herman Miller will notify you of approval or disapproval within 4 days from receipt of the test yardage.

Ordering Products with Supplier Connection COM

1. Identify and include the following information on your purchase order:
 - Product number and option
 - Herman Miller's COM identification number
2. Enter your order on Order Manager in Omni.
3. Upon receipt of the purchase order, Herman Miller will process your order and send you a PO acknowledgment. Herman Miller will determine the yardage required to produce your product and will order and schedule for delivery the required textile. Standard lead times in effect at the time the textile is allocated at the supplier will apply to products ordered through this program.



Proprietary Textiles Application Chart — Workspaces

• Available

A Assigned lead-time textile.

See following page for exception notes.

	Action Office® Panels/Connectors	Action Office/Ethospace® B-Style Storage	Action Office B-Style Tackboards	Action Office/Ethospace E-Style Storage	Ethospace Tiles/Connectors	Ethospace/Canvas Office Landscape® Privacy Doors	Canvas Tiles/Extended Width Tiles/Channel Tiles	Canvas B-/E-Style Storage	Canvas Standing Screen and Team Wall Infill	Canvas Tackboards	Canvas Metal Desk Hutch Back Panel	Canvas Vista™ Movable Insert and Display Unit	Layout Studio® Framed Screen	OE1 Boundary Agile Wall Tile	OE1 Boundary Project Board and Screens	OE1 Nook Liner/Felt Screen Liner/Storage Trolley Liner	Overlay™ Performance Wall Cladding	Pari™ Screens/Flat Edge Screens/Channel Screens	Public Office Landscape® Screen/Desk Top Divider	Renew™ Link Screens	Exclave® Tackable Boards and Stowage Tackable Backdrop	Exclave Video-Friendly Tackable Boards and Stowage Tackable Backdrop	Personal Side Screen	Tu® Wood Storage Cubby Tackboard	Seating
Price Category 1																									
COM	Customer's Own Material A																								
2V__ Chain	•	•	•	•	•	•	22	•	•	•	•	•	•	•	•	•	•	•	•	•	•	•	•	•	•
8T__ Crossing (85__)	2	2	2	•	•	•	•	2	•	•	•	•	•	•	•	•	•	•	•	•	•	8	•	•	18
3DE__ Dex	6	2	2	•	•	•	•	•	•	•	•	•	•	•	•	•	•	•	•	•	•	•	•	•	•
95__ Gem	2	2	2	•	•	•	•	2	•	•	•	•	•	•	•	•	•	•	•	•	•	•	•	•	•
2I__ Grasscloth	•	•	•	•	•	•	•	•	•	•	•	•	•	•	•	•	•	•	•	•	•	•	•	•	•
1MN__ Monologue	2	2	2	•	•	•	•	2	•	•	•	•	•	•	•	•	•	•	•	•	•	•	•	•	•
5T__ Resonance	•	•	•	•	•	•	•	•	•	•	•	•	•	•	•	•	•	•	•	•	•	•	•	•	•
2M__ Silkworm	•	•	•	•	•	•	•	•	•	•	•	•	•	•	•	•	•	•	•	•	•	•	•	•	•
22F__ Slant	6	•	•	•	•	•	•	•	•	•	•	•	•	•	•	•	•	•	•	•	•	•	•	•	•
235__ Tailored	•	•	•	•	•	•	8	•	•	•	•	•	•	•	•	•	•	•	•	•	•	•	•	•	•
1WS__ Whisper	2	2	2	•	•	•	•	2	•	•	•	•	•	•	•	•	•	•	•	•	•	•	•	•	•
Price Category 2																									
3AR__ Aristo	2	2	2	•	•	•	•	2	•	•	•	•	•	•	•	•	•	•	•	•	•	•	•	•	•
1CD__ Code	•	•	•	•	•	•	•	•	•	•	•	•	•	•	•	•	•	•	•	•	•	•	•	•	•
51__ Cord	•	•	•	•	•	•	•	•	•	•	•	•	•	•	•	•	•	•	•	•	•	•	•	•	•
92__ Crepe	2	•	•	•	•	•	•	•	•	•	•	•	•	•	•	•	•	•	•	•	•	8	•	•	•
3EP__ Epic	2	2	2	•	•	•	•	2	•	•	•	•	•	•	•	•	•	•	•	•	•	•	•	•	•
22Q__ Fish Net	•	2	2	•	•	•	•	2	•	•	•	•	•	•	•	•	•	•	•	•	•	•	•	•	•
57__ Frost	•	•	•	•	•	•	•	•	•	•	•	•	•	•	•	•	•	•	•	•	•	•	•	•	•
84__ Grosgrain	4	•	•	•	•	•	8	•	•	•	•	•	•	•	•	•	•	•	•	•	•	•	•	•	•
4N__ Horizon	2	2	2	•	•	•	•	•	•	•	•	•	•	•	•	•	•	•	•	•	•	•	•	•	•
1LM__ Loom	2	2	2	•	•	•	•	•	•	•	•	•	•	•	•	•	•	•	•	•	•	•	•	•	•
1HA__ Medley	2	2	2	•	•	•	•	•	•	•	•	•	•	•	•	•	•	•	•	•	•	8	•	•	•
3RA__ Rain	•	•	•	•	•	•	•	•	•	•	•	•	•	•	•	•	•	•	•	•	•	•	•	•	•
1RV__ Rivet	2	2	2	•	•	•	•	2	•	•	•	•	•	•	•	•	•	•	•	•	•	•	•	•	•
3SL__ Sequel	•	G2	G2	G2	•	•	•	G2	•	•	•	•	•	•	•	•	•	•	•	•	•	•	•	•	•
8R__ Twist (5S__)	5	2	2	•	•	•	•	2	•	•	•	•	•	•	•	•	•	•	•	•	•	•	•	•	18
Price Category 3																									
70__ Bento	2	2	2	•	•	•	•	2	•	•	•	•	•	•	•	•	•	•	•	•	•	•	•	•	•
1FC__ Current	•	•	•	•	•	•	•	•	•	•	•	•	•	•	•	•	•	•	•	•	•	•	•	•	•
8Z__ Glaze	•	•	•	•	•	•	•	•	•	•	•	•	•	•	•	•	•	•	•	•	•	•	•	•	•
47__ Ground Cloth®	•	•	•	•	•	•	•	•	•	•	•	•	•	•	•	•	•	•	•	•	•	8	•	•	•
5D__ Kira 2	2	2	2	•	•	•	•	2	•	•	•	•	•	•	•	•	•	•	•	•	•	•	•	•	•
8L__ Savannah	•	20	•	•	•	•	•	•	•	•	•	•	•	•	•	•	•	•	•	•	•	•	•	•	•
8W__ Strands	•	•	•	•	•	•	•	•	•	•	•	•	•	•	•	•	•	•	•	•	•	•	•	•	•
22V__ String Plaid	2	2	2	•	•	•	•	2	•	•	•	•	•	•	•	•	•	•	•	•	•	•	•	•	•

continued on next page

Proprietary Textiles Application Chart — Workspaces

continued

	Action Office® Panels/Connectors	Action Office/Ethospace® B-Style Storage	Action Office B-Style Tackboards	Action Office/Ethospace E-Style Storage	Ethospace Tiles/Connectors	Ethospace/Canvas Office Landscape® Privacy Doors	Canvas Tiles/Extended Width Tiles/Channel Tiles	Canvas B-/E-Style Storage	Canvas Standing Screen and Team Wall Infill	Canvas Tackboards	Canvas Metal Desk Hutch Back Panel	Canvas Vista™ Movable Insert and Display Unit	Layout Studio® Framed Screen	OE1 Boundary Agile Wall Tile	OE1 Boundary Project Board and Screens	OE1 Nook Liner/Felt Screen Liner/Storage Trolley Liner	Overlay™ Performance Wall Cladding	Pari™ Screens/Flat Edge Screens/Channel Screens	Public Office Landscape® Screen/Desk Top Divider	Renew™ Link Screens	Exclave® Tackable Boards and Storage Tackable Backdrop	Exclave Video-Friendly Tackable Boards and Storage Tackable Backdrop	Personal Side Screen	Tu® Wood Storage Cubby Tackboard	Seating
Price Category 4																									
2X__ Glisten	•	•	•	•	•	•	•	•	•	•	•	•								•				•	
6S__ Quilty	2	2	2	•	•	•	•	2	•	•	•	•	•												•
Price Category 5																									
14A__ Hopsak	2	2	2	•	•	•	•	2	•	•	•	•	•	•		•					•			•	•
Price Category 6																									
No fabrics available at this time.																									

- G2 Sequel fabric only available on flipper doors.
- 1 Refer to price book appendices and Omni for COM information.
- 2 Available on all products except 54" and 60" wide.
- 4 Not available on Action Office (AO) acoustical panels.
- 5 (8R__), (8T__), (85__), and (5S__) not available on AO acoustical panels and not available on 54"- or 60"-wide products.
- 6 Not available on Action Office (AO) connectors, cable management, and spacers.
- 8 Available in select colors. See the "Proprietary Textile Colors — Workspaces" appendix.
- 18 Available on seating products in select colors. See the "Proprietary Textile Colors — Seating" appendix.
- 19 Not available in Grosgrain (84__) fabric colors 8401, 8405, and 8413.
- 20 Available only on Ethospace B-Style.
- 22 Not available as railroaded application option for Chain and Moire on Canvas extended width tiles.

Application Note: Herman Miller cannot guarantee material/pattern alignment in adjacent products. For example, a fabric's pattern may not align from one screen to the next, or from one panel to the next.

Proprietary Textile Colors — Workspaces

Price Category 1

Customer's Own Material

See Order Information in Appendices.
Assigned lead-time textile. A

Chain

66" wide	
100% recycled polyester	
2V01	Pearl
2V02	Oyster
2V03	Wheat
2V04	Linen
2V05	Wicker
2V06	Bamboo
2V07	Sage
2V08	Spring Wood
2V09	Iceberg

Crossing

54" wide	
86% antimony-free polyester	
14% polyester	
8T03	Wicker *
8T04	Porcelain *
8T05	Warm Grey *
8T06	Sepia
8T07	Pumpkin
8T08	Copper
8T09	Cranberry
8T10	Tomato
8T11	Mulberry
8T12	Plum
8T13	Green Apple
8T14	Loden
8T15	Spruce
8T16	Periwinkle
8T17	Cerulean
8T18	Indigo
8T19	Shale *
8T20	Brownstone
8T21	Bark
8T22	Tin *
8T23	Graphite
8T24	Black

Crossing

For systems products only.
54" wide
86% antimony-free polyester
14% polyester
8501 Ivory *
8502 Oyster *

* Crossing colors available on Exclave® Video-friendly Tackable Boards and Stowage Tackable Backdrop

Dex

54" wide	
50% recycled polyester	
50% polyester	
3DE01	Frost
3DE02	Silver Pine
3DE03	Stone
3DE04	Shale
3DE05	Charcoal

Gem

54" wide	
100% antimony-free polyester	
9502	Tangerine
9503	Red
9507	Twilight
9508	Bayou
9510	Berry Blue
9511	Aqua Green
9512	Green Apple
9514	Black
9515	Slate Grey
9516	Fog

Grasscloth

66" wide	
100% recycled polyester	
2I01	Silver Birch
2I02	Pampas
2I03	Sedge
2I07	Lea
2I08	Taro
2I09	Steam Grey
2I10	Cayenne
2I11	Bottle Green
2I12	Surf
2I13	Gravel

Monologue

54" wide	
56% recycled polyester	
44% polyester	
1MN01	Linen
1MN02	Alabaster
1MN03	Truffle
1MN04	Folkstone
1MN05	Silver Pine
1MN06	Slate
1MN07	Seed
1MN08	Yellow Oxide
1MN09	Persimmon
1MN10	Tundra
1MN11	Meadow
1MN12	Blue Sky
1MN13	Blue Spruce
1MN14	Deep Sea

Resonance

66" wide	
100% polyester	
5T04	Greige
5T05	Porcelain
5T06	Alabaster
5T15	Iris
5T28	Sugar
5T47	Tobacco
5T54	Saltbush
5T57	Seed
5T58	Sepia
5T60	Iceberg
5T65	Red
5T67	Boysenberry
5T68	Pistachio
5T69	Green Apple
5T71	Jade
5T72	Blue Green
5T74	Twilight

Silkworm

66" wide	
58% recycled polyester	
42% polyester	
2M01	Cocoon
2M02	Pongee
2M03	Saffron
2M04	Tussah
2M05	Ceylon
2M06	Jasmine
2M07	Shale
2M08	Monsoon

Slant

66" wide	
51% polyester	
49% recycled polyester	
22F04	Pesto
22F06	Neptune
22F07	Blueberry
22F10	Pumpkin
22F12	Silver Birch
22F13	Bluestone
22F15	Shale

Price category 1 continued on next page

Proprietary Textile Colors — Workspaces

continued

Appendix: Proprietary Textile Colors — Workspaces

Price Category 1

continued

Tailored	
54" wide	
56% polyester	
44% recycled polyester	
23501	Studio White *
23502	Sugar
23503	Tomato
23504	Orchid
23505	Boysenberry
23506	Chive
23507	Bluegrass
23508	Cobalt
23509	Cadet
23510	Fog
23511	Graphite
23512	Black
23513	Coffee

* Color not available on Canvas Tiles.

Whisper	
54" wide	
73% recycled polyester	
27% polyester	
1WS01	Sand Dollar
1WS02	Pebble
1WS03	Silver Birch
1WS04	Iceberg
1WS05	Silver Pine
1WS06	Carbon
1WS07	Cumin
1WS08	Adobe
1WS09	Strawberry
1WS10	Blush
1WS11	Eggplant
1WS12	Willow
1WS13	Sea Grass
1WS14	Pool
1WS15	Blueberry

Price Category 2

Aristo	
54" wide	
88% recycled polyester	
12% polyester	
Acrylic backing	
3AR01	Forest Moss
3AR02	Light Brindle
3AR03	Mink
3AR04	Copper
3AR05	Adobe
3AR06	Cherry
3AR07	Lilac
3AR08	Green Apple
3AR09	Surf
3AR10	Waterfall
3AR11	Cadet
3AR12	Tin
3AR13	Pewter
3AR14	Grey Brindle
3AR15	Grey Black

Code	
66" wide	
100% Repreve recycled polyester	
1CD01	Linen
1CD02	Khaki
1CD03	Iceberg
1CD04	Zinc
1CD05	Blue Black

Cord	
66" wide	
51% antimony-free polyester	
49% polyester	
5101	Ivory
5102	White Ash
5103	Linen
5104	Bamboo
5105	Sepia
5106	Wicker
5107	Sesame
5108	Kiwi Green
5109	Bayou
5110	Shade
5111	Spring Wood
5112	Summer White

Crepe	
54" wide	
100% recycled polyester	
9201	Licorice
9203	Smoke
9207	Cherry
9209	Claret
9212	Raisin
9218	Aquamarine
9223	Cadet
9241	Beachglass
9243	Midnight
9244	Artichoke
9248	Warm White *
9249	Stone *
9250	Earth
9251	Fog *
9252	Slate Grey
9253	Yellow Dark
9254	Coral
9255	Blush Grey *
9256	Wild Berry
9257	Clover
9258	Caribbean
9259	Cerulean
9260	Brownstone
9261	Shale
9262	Graphite
9263	Tomato
9264	Green Apple

* Crepe colors available on Exclave® Video-friendly Tackable Boards and Stowage Tackable Backdrop

Epic	
54" wide	
56% recycled polyester	
44% polyester	
Acrylic backing	
3EP01	Alabaster
3EP02	Smoke
3EP03	Falcon
3EP04	Citrus Spring
3EP05	Copper

Epic continued	
3EP06	Urban Orange
3EP07	Poppy
3EP08	Wild Plum
3EP09	Sugar Plum
3EP10	Clover
3EP11	Loden
3EP12	Everglade
3EP13	Mist
3EP14	Peacock
3EP15	Cadet
3EP16	Indigo
3EP17	Spring Wood
3EP18	Grey Brindle
3EP19	Seed
3EP20	Carbon Dark

Fish Net	
55" wide	
100% recycled polyester	
22Q01	Oyster
22Q02	Stone
22Q03	Citrus
22Q04	Curry
22Q05	Chipotle
22Q06	Cherry
22Q07	Fuschia
22Q08	Claret
22Q09	Purple
22Q10	Clover
22Q11	Pesto
22Q12	Peacock
22Q13	Lagoon
22Q14	Twilight
22Q15	Bluestone
22Q16	Storm
22Q17	Black
22Q18	Cocoa

Price category 2 continued on next page

Proprietary Textile Colors — Workspaces

continued

Price Category 2

continued

Frost

66" wide	
100% recycled polyester	
5703	Porcelain
5704	Honey
5705	Iceberg
5706	Sage
5710	Sable Grey

Grosgrain

66" wide	
100% recycled polyester	
8401	Pearl * **
8402	White Ash
8403	Warm Grey
8404	Khaki
8405	Oyster *
8406	Celadon
8407	Chamois
8408	Spa Blue
8409	Bud
8410	Kiwi Green
8411	Bayou
8412	Tin
8413	Iceberg *

* Grosgrain colors not available on Canvas Dock Mounted Screens, Public Office Landscape® Screen/Desk Top Divider, and Thrive® Personal Side Screen.
 ** Color not available on Canvas tiles.

Horizon

54" wide	
65% antimony-free polyester	
35% polyester	
4N01	Rye Grass
4N02	Sugar Pine
4N03	Silver Pine
4N04	White Ash
4N05	Spring Wood
4N06	Tamarack
4N07	Mushroom
4N08	Haystack
4N09	Oat Grass
4N10	Forest Moss
4N11	Hickory
4N12	Beech Nut
4N13	Pine Cone
4N14	Poplar
4N15	Elderberry

Loom

54" wide	
100% polyester	
1LM01	Linen
1LM02	Brown Sugar and Spice
1LM03	Brick and Mortar
1LM04	Salt and Pepper
1LM05	Black
1LM06	Lemongrass
1LM07	Poppy
1LM08	Wild Berry
1LM09	Loden
1LM10	Jade
1LM11	Deep Sea

Medley

54" wide	
100% polyester	
1HA01	Stone *
1HA02	Trail
1HA03	Charcoal
1HA04	Cinder
1HA05	Citrus
1HA06	Papaya
1HA07	Chutney
1HA08	Tundra
1HA09	Feather Grey *
1HA10	Chartreuse
1HA11	Loden
1HA12	Peacock
1HA13	Bayou *
1HA14	Blue Grotto
1HA15	Blueberry
1HA22	Khaki
1HA23	Pewter
1HA24	Yellow Oxide
1HA25	Vintage Rose
1HA26	Raspberry
1HA27	Acai Berry

* Colors available on Exclave®
 Stowage Video-friendly
 Tackable Backdrop

Rain

66" wide	
100% recycled polyester	
3RA01	Iceberg
3RA02	Frost
3RA03	Pewter
3RA04	Graphite
3RA05	Warm White
3RA06	Linen
3RA07	Rye
3RA08	Light Brindle

Rivet

54" wide	
100% recycled polyester	
1RV01	Twig
1RV02	Deep Clay
1RV03	Woodrose
1RV04	Otter
1RV05	Hemlock
1RV06	Olive
1RV07	Lagoon
1RV08	Deep Sea
1RV09	Charcoal
1RV10	Grey Brindle

Sequel

54" wide	
100% vinyl	
100% polyester knit backing	
Resilience® finish	
3SL01	White
3SL02	Pebble
3SL03	Mushroom
3SL04	Stone
3SL05	Chestnut
3SL06	Rattan
3SL07	Black Cherry
3SL08	Tundra
3SL09	Seal
3SL10	Blue Fog
3SL11	Folkstone
3SL12	Shale
3SL13	Slate Grey
3SL14	Charcoal
3SL15	Carbon Dark

Price category 2 continued on next page

Proprietary Textile Colors — Workspaces

continued

Price Category 2

continued

Appendix: Proprietary Textile Colors — Workspaces

Twist	
54" wide	
80% antimony-free polyester	
13% recycled polyester	
7% polyester	
8R05	Wicker
8R10	Poppy
8R14	Tin
8R15	Shale
8R16	Graphite
8R17	Birch
8R18	Sepia
8R22	Blueberry
8R23	Green Apple
8R26	Gunmetal
8R27	Cinder
8R28	Citrus
8R29	Pekoe
8R30	Tangerine
8R31	Red Plum
8R32	Wisteria
8R33	Forest
8R34	Jade Dark
8R35	Waterfall
8R36	Midnight Blue
8R37	Carbon Dark

Twist	
For systems products only.	
54" wide	
80% antimony-free polyester	
13% recycled polyester	
7% polyester	
5S01	Pearl
5S02	Ivory
5S03	Oyster

Price Category 3

Bento	
54" wide	
100% antimony-free polyester	
7001	Frost
7002	Linen
7003	Khaki
7004	Truffle
7005	Grey Black
7006	Pumpkin
7007	Cranberry
7008	Everglade
7009	Cobalt

Current	
66" wide	
100% antimony-free polyester	
1FC1	Oyster
1FC2	Linen
1FC3	Iceberg
1FC4	Silver Pine
1FC5	Apricot
1FC6	Cumin
1FC7	Green Apple
1FC8	Slate Blue
1FC9	Metal

Glaze	
66" wide	
100% recycled polyester	
8Z01	Wicker
8Z02	Honey
8Z03	Porcelain
8Z04	Celadon
8Z05	Spearmint
8Z06	Rye
8Z07	Frost
8Z08	Silver Birch

Ground Cloth®	
66" wide	
100% polyester	
4701	Vapor Grey
4721	Warm White *
4722	Fog *
4723	Straw *
4724	Red Orange *
4725	Wild Berry *
4726	Green Apple *
4727	Caribbean *
4728	Midnight *
4729	Cappuccino *

* Colors available on Exclave®
Video-friendly Tackable
Boards and Stowage Tackable
Backdrop

Kira 2	
54" wide	
100% recycled polyester	
5D11	Flaxen
5D12	Papyrus
5D13	Oasis
5D14	Incense
5D15	Ash
5D16	Falcon

Savannah	
66" wide	
76% recycled polyester	
24% polypropylene	
8L01	Pearl
8L02	Oyster
8L03	Wheat
8L04	Jute
8L05	Bamboo
8L06	Metal
8L07	Linen
8L08	Celadon
8L09	Moss
8L10	Frost
8L11	Shale
8L12	Pewter

Strands	
66" wide	
100% recycled polyester	
8W01	Pebble
8W02	Porcelain
8W03	Taupe
8W04	Honey
8W05	Khaki
8W06	Rye
8W07	Wicker
8W08	Tin
8W09	Cool Grey

String Plaid	
54" wide	
100% recycled polyester	
22V01	Warm White on Khaki
22V02	Mint on Yellow Green
22V03	Mist on Blue Grey
22V04	Sky Blue on Red
22V05	Lime on Magenta
22V06	Bright Green on Green
22V07	Aqua Blue on Cerulean
22V08	Ivory on Black

Proprietary Textile Colors — Workspaces

continued

Price Category 4

Glisten

66" wide
84% polyester
16% recycled polyester

2X02	Rye
2X05	Iceberg
2X07	Celadon
2X09	Pewter
2X10	Ash

Quilty

56" wide
100% antimony-free polyester
GreenShield

6S03	Khaki
6S04	Straw
6S07	Brick
6S10	Mink
6S11	Green Apple
6S13	Indigo
6S14	Zinc
6S15	Slate
6S16	Beachwood
6S17	Paprika
6S18	Plum
6S19	Juniper
6S20	Grey Black

Price Category 5

Hopsak

56" wide
100% recycled polyester

14A20	Black
14A22	Raw Umber Dark
14A26	Grey Blue Dark
14A30	Sepia Dark
14A38	Emerald Dark
14A39	Yellow Dark
14A40	Orange
14A41	Sienna
14A42	Olive Green Dark
14A43	Crimson
14A44	Crimson Dark Dark
14A45	Violet Dark
14A46	Pink Dark Dark
14A47	Ultramarine Dark
14A48	Cobalt Blue
14A49	Terra Cotta
14A50	Ochre Dark

Price Category 6

No fabrics available at this time.



Proprietary Textiles Application Chart — Seating

• Available

[A] Assigned lead-time textile.

See following page for exception notes.

[N] Non-woven textile.

	Aeron® Chairs	Cosm™ Chairs	Mirra® 2 Chairs/Stools	Celle® Chairs/Stools	Embody® Chairs	Sayl® Work Chairs/Stools	Sayl Side Chairs	Setu® Chairs/Stools	Setu Lounge Chair/Ottoman	Verus™ Work Chairs/Stools Back	Verus Work Chairs/Stools Seat	Verus Side Chairs Back	Verus Side Chairs Seat	Verus Plus Chairs	Aside® Chairs	Caper® Chairs/Stools	Keyn Chair Group Back	Keyn Chair Group Seat	Lino™ Chairs Back	Lino Chairs Seat	Locale® Bench Cushion	Public® Office Landscape Back	Public Office Landscape Seat	Plex™ Lounge Furniture	Swoop™ Lounge Seating - Fully Upholstered	Swoop Lounge Seating - Plywood	Valor™ Seating	Nemschoff® Whisk™ Chairs	Cushion Tops	Workspaces				
Price Category 1																																		
COM Customer's Own Material [A]				14	1	1				1	1	1	1	1	1			1		1	1				1	1	1		1	1	1			
231__ 8Z Pellicle®	•																																	
1A7__ AireWeave 2			•																															
8T__ Crossing				•				•	•																									
3DE__ Dex			14		•	•				•	•	•	•	•	•			•						•	19	•	•		•	•				
4RM__ Duo																																		
6V__ Flexnet™																	•																	
95__ Gem			14					•	•																									
845__ Intercept		•																																
65__ Interweave										•		•																						
4W__ Lyris 2™								•	•																									
1MN__ Monologue			14		24	22		•	•		•	•	•				•	•			•	•		•	•	•	•	•						
3DK__ Stretch Knit					21																													
235__ Tailored				•	•	•	•	•	•	•	•	•	•	•	•		•	•																
1WS__ Whisper			14		24	•	•	•	•	•	•	•	•	•	•		•	•													7	•		
Price Category 2																																		
3AR__ Aristo			14		•	•	•	•	•	•	•	•	•	•	•		•	•													9	•	•	
92__ Crepe				•	•	•	•	•	•	•	•	•	•	•	•		•	•														•	•	
3EP__ Epic			14		•	•	•	•	•	•	•	•	•	•	•		•	•														7	•	
22Q__ Fish Net				•	•	•	•	•	•	•	•	•	•	•	•		•	•														7	•	
1LM__ Loom			14		•	•				•	•	•	•	•	•		•	•																
1MV__ Marvel [N]										21	22							•														•	•	
1HA__ Medley				15	•	•	22			•	•	•	•	•	•		•	•															•	
30__ Rhythm				•	23	•	•			•	•	•	•	•	•		•	•															•	
1RV__ Rivet			14														•	•															•	
3SL__ Sequel [N]				15	•	•	•	•	•	•	•	•	•	•	•		•	•															•	
8R__ Twist				•	•	•	•	•	•	•	•	•	•	•	•		•	•															•	
Price Category 3																																		
3AC__ Ace					21	•				•	•	•	•	•	•	8		•	•					•	19			•				•		
70__ Bento			14		•	•	•	•		•	•	•	•	•	•	8		•															•	
8M__ Latitude™				23		•	•																											
22V__ String Plaid			14		•	•				•	•	•	•	•	•		•	•															•	
Price Category 4																																		
3DM__ Daydream			14		21	•	•	•		•	•	•	•	•	•		•	•															•	
213__ Mercer			14		21	22				•	•	•	•	•	•		•	•																•
1A9__ Network																																		
6S__ Quilty			14		•	•				•	•	•	•	•	•		•	•																•
22P__ Strata					•	•	•			•	•	•	•	•	•		•	•																•
3SY__ Sync				•	•	•	•	•	•	•	•	•	•	•	•		•	•																•

Continued on next page

Appendix: Proprietary Textiles Application Chart — Seating

Proprietary Textiles Application Chart — Seating

continued

	Aeron® Chairs	Cosm™ Chairs	Mirra® 2 Chairs/Stools	Celle® Chairs/Stools	Embody® Chairs	Sayl® Work Chairs/Stools	Sayl Side Chairs	Setu® Chairs/Stools	Setu Lounge Chair/Ottoman	Verus™ Work Chairs/Stools Back	Verus Work Chairs/Stools Seat	Verus Side Chairs Back	Verus Side Chairs Seat	Verus Plus Chairs	Aside® Chairs	Caper® Chairs/Stools	Keyn Chair Group Back	Keyn Chair Group Seat	Lino™ Chairs Back	Lino Chairs Seat	Locale® Bench Cushion	Public® Office Landscape Back	Public Office Landscape Seat	Plex™ Lounge Furniture	Swoop™ Lounge Seating - Fully Upholstered	Swoop Lounge Seating - Plywood	Valor™ Seating	Nemschoff® Whisk™ Chairs	Cushion Tops	Workspaces			
Price Category 5																																	
3CY__ Cozy			14		•	•	•	•	•	•	•	•	•	•	•		•	•			•	•		•	•	•	•	•	•	•	•	•	•
14A__ Hopsak			14		•	•	•	•	•	•	•	•	•	•	•		•	•			•	•		•	•	•	•	•	•	•	•	•	•
3SU__ Summit			15		•	•				•	•	•	•							•	•		•	•	•	•	•	•	•	•	•	•	
Price Category 6																																	
35__ Balance					•			•																									
Price Category 7																																	
COL Customer's Own Leather [A]	1		14												8																		1
Price Category 8																																	
No fabrics available at this time																																	
Price Category 9																																	
21__ Leather [N]	23		14												8					•							•					•	

All foam and Proprietary Textiles on HermanMiller seating comply with California TB 117-2013.

Application Note: Herman Miller cannot guarantee material/pattern alignment in adjacent products. For example, a fabric's pattern may not align from one pedestal cushion top to the next, or from one chair to the next.

- 1 Refer to price book appendices and Kiosk for COM/COL information.
- 7 Available on 1" Cushion Tops only.
- 8 Only available on non-upholstered outer back (PB) option.
- 9 Available on Valor upholstered seat only.
- 14 Available on Celle UC (upholstered seat) and Celle UF (upholstered seat) Chairs.
- 15 Available only on Celle HC (upholstered seat with protective edge) and Celle HF (upholstered seat) Chairs.

- 19 Available on Plex seat only.
- 21 Not available on Sayl upholstered back work chairs.
- 22 Not available on Sayl side chairs with upholstered backs.
- 23 Available in select colors. Refer to "Proprietary Textile Colors - Seating" for color offering.
- 24 Not available on Sayl upholstered High-Back Work Chairs.

Proprietary Textile Colors — Seating

Price Category 1

Customer's Own Material
See Order Information in
Appendices.
Assigned lead-time textile. A

8Z Pellicle®
For New Aeron® Chairs
56% elastomeric
44% polyester
23101 Mineral
23102 Carbon
23103 Graphite

AireWeave™ 2
For Mirra® 2 Chairs
67% elastomeric
33% antimony-free polyester
1A701 Alpine
1A702 Slate Grey
1A703 Graphite
1A704 Lime Green
1A705 Cappuccino
1A706 Urban Orange
1A707 Dark Turquoise
1A708 Twilight

Crossing
54" wide
86% antimony-free polyester
14% polyester
8T03 Wicker
8T04 Porcelain
8T05 Warm Grey
8T06 Sepia
8T07 Pumpkin
8T08 Copper
8T09 Cranberry
8T10 Tomato
8T11 Mulberry
8T12 Plum
8T13 Green Apple
8T14 Loden
8T15 Spruce
8T16 Periwinkle
8T17 Cerulean
8T18 Indigo
8T19 Shale
8T20 Brownstone
8T21 Bark
8T22 Tin
8T23 Graphite
8T24 Black

Dex
54" wide
50% recycled polyester
50% polyester
3DE01 Frost
3DE02 Silver Pine
3DE03 Stone
3DE04 Shale
3DE05 Charcoal

Duo
For Lino™ Chairs
52% polyester
48% elastomeric
4RM01 Mineral
4RM02 Poppy
4RM03 Green Leaf
4RM04 Jade
4RM05 Shadow
4RM06 Graphite

Flexnet™
For Caper® Chairs
69% elastomeric
31% polyester
6V01 Black
6V02 Silver Grey

Gem
54" wide
100% antimony-free polyester
9502 Tangerine
9503 Red
9507 Twilight
9508 Bayou
9510 Berry Blue
9511 Aqua Green
9512 Green Apple
9514 Black
9515 Slate Grey
9516 Fog

Interweave
For Verus™ Chairs
71% elastomeric
29% polyester
6504 Pewter
6505 Charcoal
6506 Black

Lyris 2™
For Setu® Chairs
74% elastomeric
26% polyester
4W21 Alpine
4W22 Mango
4W23 Chartreuse
4W25 Berry Blue
4W26 Slate Grey
4W28 Chino
4W29 Rattan
4W30 Java
4W31 Graphite

Monologue
54" wide
56% recycled polyester
44% polyester
1MN01 Linen
1MN02 Alabaster
1MN03 Truffle
1MN04 Folkstone
1MN05 Silver Pine
1MN06 Slate
1MN07 Seed
1MN08 Yellow Oxide
1MN09 Persimmon
1MN10 Tundra
1MN11 Meadow
1MN12 Blue Sky
1MN13 Blue Spruce
1MN14 Deep Sea

Stretch Knit
Assigned lead-time textile. A
Available only on Sayl®
Suspension Back Work Chairs
97% polyester, 3% spandex
3DK01 Fog
3DK02 Slate Grey
3DK03 Java
3DK04 Black
3DK05 Red
3DK06 Green Apple
3DK07 Berry Blue

Price category 1 continued on
next page

Proprietary Textile Colors — Seating

continued

Price Category 1

continued

Price Category 2

Tailored	
54" wide	
56% polyester	
44% recycled polyester	
23501	Studio White *
23502	Sugar *
23503	Tomato
23504	Orchid
23505	Boysenberry
23506	Chive
23507	Bluegrass
23508	Cobalt
23509	Cadet
23510	Fog
23511	Graphite
23512	Black
23513	Coffee

* Colors not available on Plex™ Lounge Furniture.

Whisper	
54" wide	
73% recycled polyester	
27% polyester	
1WS01	Sand Dollar
1WS02	Pebble
1WS03	Silver Birch
1WS04	Iceberg
1WS05	Silver Pine
1WS06	Carbon
1WS07	Cumin
1WS08	Adobe
1WS09	Strawberry
1WS10	Blush
1WS11	Eggplant
1WS12	Willow
1WS13	Sea Grass
1WS14	Pool
1WS15	Blueberry

Aristo	
54" wide	
88% recycled polyester	
12% polyester	
Acrylic backing	
3AR01	Forest Moss
3AR02	Light Brindle
3AR03	Mink
3AR04	Copper
3AR05	Adobe
3AR06	Cherry
3AR07	Lilac
3AR08	Green Apple
3AR09	Surf
3AR10	Waterfall
3AR11	Cadet
3AR12	Tin
3AR13	Pewter
3AR14	Grey Brindle
3AR15	Grey Black

Crepe	
54" wide	
100% recycled polyester	
9201	Licorice
9203	Smoke
9207	Cherry
9209	Claret
9212	Raisin
9218	Aquamarine
9223	Cadet
9241	Beachglass
9243	Midnight
9244	Artichoke
9248	Warm White
9249	Stone
9250	Earth
9251	Fog
9252	Slate Grey

Crepe continued	
9253	Yellow Dark
9254	Coral
9255	Blush Grey
9256	Wild Berry
9257	Clover
9258	Caribbean
9259	Cerulean
9260	Brownstone
9261	Shale
9262	Graphite
9263	Tomato
9264	Green Apple

Epic	
54" wide	
56% recycled polyester	
44% polyester	
Acrylic backing	
3EP01	Alabaster
3EP02	Smoke
3EP03	Falcon
3EP04	Citrus Spring
3EP05	Copper
3EP06	Urban Orange
3EP07	Poppy
3EP08	Wild Plum
3EP09	Sugar Plum
3EP10	Clover
3EP11	Loden
3EP12	Everglade
3EP13	Mist
3EP14	Peacock
3EP15	Cadet
3EP16	Indigo
3EP17	Spring Wood
3EP18	Grey Brindle
3EP19	Seed
3EP20	Carbon Dark

Fish Net	
55" wide	
100% recycled polyester	
22Q01	Oyster
22Q02	Stone
22Q03	Citrus
22Q04	Curry
22Q05	Chipotle
22Q06	Cherry
22Q07	Fuschia
22Q08	Claret
22Q09	Purple
22Q10	Clover
22Q11	Pesto
22Q12	Peacock
22Q13	Lagoon
22Q14	Twilight
22Q15	Bluestone
22Q16	Storm
22Q17	Black
22Q18	Cocoa

Loom	
54" wide	
100% polyester	
1LM01	Linen *
1LM02	Brown Sugar and Spice
1LM03	Brick and Mortar
1LM04	Salt and Pepper
1LM05	Black
1LM06	Lemongrass
1LM07	Poppy
1LM08	Wild Berry
1LM09	Loden
1LM10	Jade
1LM11	Deep Sea

* Color not available on Valor Seating

Price category 2 continued on next page

Proprietary Textile Colors — Seating

continued

Price Category 2

continued

Marvel	
54" wide	
100% pvc-free polyurethane	
1MV01	Summer White
1MV02	Sand Dollar
1MV03	Espresso
1MV04	Folkstone Grey
1MV05	Graphite
1MV06	Onyx
1MV07	Polar Blue
1MV08	Blush Grey
1MV09	Woodrose
1MV10	Citrus
1MV11	Adobe
1MV12	Red
1MV13	Kiwi Green
1MV14	Pine
1MV15	Teal Green
1MV16	Twilight

Medley	
54" wide	
100% polyester	
1HA01	Stone
1HA02	Trail
1HA03	Charcoal
1HA04	Cinder
1HA05	Citrus
1HA06	Papaya
1HA07	Chutney
1HA08	Tundra
1HA09	Feather Grey
1HA10	Chartreuse
1HA11	Loden
1HA12	Peacock
1HA13	Bayou
1HA14	Blue Grotto
1HA15	Blueberry
1HA22	Khaki
1HA23	Pewter
1HA24	Yellow Oxide
1HA25	Vintage Rose
1HA26	Raspberry
1HA27	Acai Berry

Rhythm	
54" wide	
100% polyester	
3001	Kiwi Green *
3002	Green Apple *
3003	Peacock *
3004	Bayou *
3005	Berry Blue
3006	Iris *
3007	Twilight
3008	Pumpkin *
3009	Poppy *
3010	Molasses *
3011	Mulberry *
3012	Khaki *
3013	Mink *
3014	Black
3015	Charcoal

* Colors not available on Embody Chair

Rivet	
54" wide	
100% recycled polyester	
1RV01	Twig
1RV02	Deep Clay
1RV03	Woodrose
1RV04	Otter
1RV05	Hemlock
1RV06	Olive
1RV07	Lagoon
1RV08	Deep Sea
1RV09	Charcoal
1RV10	Grey Brindle

Sequel	
54" wide	
100% vinyl	
100% polyester knit backing	
Resilience® finish	
3SL01	White
3SL02	Pebble
3SL03	Mushroom
3SL04	Stone
3SL05	Chestnut
3SL06	Rattan
3SL07	Black Cherry

Sequel continued	
3SL08	Tundra
3SL09	Seal
3SL10	Blue Fog
3SL11	Folkstone
3SL12	Shale
3SL13	Slate Grey
3SL14	Charcoal
3SL15	Carbon Dark
3SL28	Navy

Twist	
54" wide	
80% antimony-free polyester	
13% recycled polyester	
7% polyester	
8R05	Wicker
8R10	Poppy
8R14	Tin
8R15	Shale
8R16	Graphite
8R17	Birch
8R18	Sepia
8R22	Blueberry
8R23	Green Apple
8R26	Gunmetal
8R27	Cinder
8R28	Citrus
8R29	Pekoe
8R30	Tangerine
8R31	Red Plum
8R32	Wisteria
8R33	Forest
8R34	Jade Dark
8R35	Waterfall
8R36	Midnight Blue
8R37	Carbon Dark

Price Category 3

Ace	
54" wide	
100% polyurethane	
Polyester knit backing	
Stain resistant finish	
3AC01	Summer White
3AC02	White Ash
3AC03	Rye
3AC04	Metal
3AC05	Clay
3AC06	Chestnut
3AC07	Citrus
3AC08	Camelback
3AC09	Chipotle
3AC10	Claret
3AC11	Slate Purple
3AC12	Artichoke
3AC13	Sepia Dark
3AC14	Aloe
3AC15	Flint
3AC16	Blue Sky
3AC17	Oceanside
3AC18	Midnight
3AC19	Spring Wood
3AC20	Frost
3AC21	Lead
3AC22	Black

Bento	
54" wide	
100% antimony-free polyester	
7001	Frost
7002	Linen
7003	Khaki
7004	Truffle
7005	Grey Black
7006	Pumpkin
7007	Cranberry
7008	Everglade
7009	Cobalt

Price category 3 continued on next page

Proprietary Textile Colors — Seating

continued

Price Category 3

continued

Latitude™

61" wide	
100% polyester	
8M01	Graphite
8M02	Shadow
8M10	Alpine
8M17	Black
8M21	Slate Grey
8M22	Lime Green
8M23	French Press
8M24	Urban Orange
8M25	Dark Turquoise
8M26	Twilight

String Plaid

54" wide	
100% recycled polyester	
22V01	Warm White on Khaki
22V02	Mint on Yellow Green
22V03	Mist on Blue Grey
22V04	Sky Blue on Red
22V05	Lime on Magenta
22V06	Bright Green on Green
22V07	Aqua Blue on Cerulean
22V08	Ivory on Black

Price Category 4

Daydream

54" wide	
48% wool	
41% recycled polyester	
9% nylon	
2% polyester	
3DM01	Rye Grass
3DM02	Silver Birch
3DM03	Pewter
3DM04	Graphite
3DM05	Black
3DM06	Lemongrass
3DM07	Permission
3DM08	Juniper
3DM09	Sea Grass
3DM10	Nightfall

Mercer

54" wide	
50% solution dyed recycled nylon	
50% solution dyed nylon	
BLOCKaide	
21301	Stone
21303	Cayenne
21305	Pesto
21306	Teal Blue
21307	Ultramarine
21310	Charcoal

Network

For Public Office Landscape® sectional back/social chair. knit to size	
100% polyester	
1A901	Warm White
1A902	Fog
1A903	Red
1A904	Wildberry
1A905	Green Apple
1A906	Twilight
1A907	Graphite

Quilty

56" wide	
100% antimony-free polyester	
GreenShield	
6S03	Khaki
6S04	Straw
6S07	Brick
6S10	Mink
6S11	Green Apple
6S13	Indigo
6S14	Zinc
6S15	Slate
6S16	Beachwood
6S17	Paprika
6S18	Plum
6S19	Juniper
6S20	Grey Black

Strata

54" wide	
50% solution dyed recycled nylon	
50% solution dyed nylon	
BLOCKaide	
22P04	Pesto
22P05	Peacock
22P06	Blue Jay
22P07	Blueberry
22P09	Mango
22P10	Paprika
22P12	Wheat
22P13	Brownstone
22P14	Bayou

Sync

55" wide	
100% polyester	
3SY01	Pine Cone
3SY02	Citron
3SY03	Canyon
3SY04	Truffle
3SY05	Wild Berry
3SY06	Everglade
3SY07	Glacier
3SY08	Nightfall
3SY09	Dark Mineral
3SY10	Slate Grey
3SY11	Dark Carbon
3SY12	Black

Price Category 5

Cozy

54" wide	
100% wool	
3CY01	Heathered Warm Grey
3CY02	Heathered Rye Grass
3CY03	Heathered Cool Grey
3CY04	Heathered Blue Grey
3CY05	Heathered Black
3CY06	Heathered Persimmon
3CY07	Heathered Loden
3CY08	Heathered Jade
3CY09	Heathered Lagoon
3CY10	Heathered Twilight

Hopsak

56" wide	
100% recycled polyester	
14A20	Black
14A22	Raw Umber Dark
14A26	Grey Blue Dark
14A30	Sepia Dark
14A38	Emerald Dark
14A39	Yellow Dark
14A40	Orange
14A41	Sienna
14A42	Olive Green Dark
14A43	Crimson
14A44	Crimson Dark Dark
14A45	Violet Dark
14A46	Pink Dark Dark
14A47	Ultramarine Dark
14A48	Cobalt Blue
14A49	Terra Cotta
14A50	Ochre Dark

Summit

54" wide	
100% silicone	
Polyester knit backing	
3SU01	Bright White
3SU02	Oyster
3SU03	Zinc
3SU04	Sparrow
3SU05	Taupe
3SU06	Java
3SU07	Black
3SU08	Cherry
3SU09	Beachglass
3SU10	Midnight

Proprietary Textile Colors — Seating

continued

Price Category 6

Balance

100% polyester

3512 Carbon

3513 Black

Price Category 7

Customer's Own Leather

See Order Information in Appendices. Assigned lead-time textile. A

Price Category 8

No fabrics available at this time.

Price Category 9

Leather

approx. 50 sq. ft. per hide

100% leather

2101 Ivory

2109 Black *

2110 Smoke

2111 Graphite

2112 Khaki

2113 Rattan

2114 Truffle

2115 Alpine

2116 Haze

2117 Sable Grey

2118 Dark Mineral **

2119 Dark Carbon ***

2120 Cranberry

2121 Deep Sea

* Armpad color available on Aeron® Chair, Graphite.

** Armpad color available on Aeron Chair, Mineral.

*** Armpad color available on Aeron Chair, Carbon.



Maharam Application Chart — Seating

• Available

[A] Maharam textiles are on assigned lead times.

[N] Non-woven textile.

	Mirra® Chairs/Stools	Celle® Chairs	Say® Work Chairs	SayL Side Chairs	Setu® Chairs	Setu Lounge Chair/Ottoman	Verus™ Work Chairs/Stools Back	Verus Work Chairs/Stools Seat	Verus Side Chairs Back	Verus Side Chairs Seat	Verus Plus Chairs	Aside® Chairs	Cape® Chairs/Stools	Keyn Chair Group Back	Keyn Chair Group Seat	Lino™ Chairs Seat	Locate® Bench Cushions	OE1 Storage Trolley Cushion Top	Public Office Landscape® Seat	Plex® Lounge Furniture	Swoop™ Lounge Seating - Fully Upholstered	Swoop Lounge Seating - Plywood	Valor™ Seating	Nemschoff® Whisk™ Chairs	Cushion Tops	
Price Category 1																										
No fabrics available at this time.																										
Price Category 2																										
811__ Muse - Maharam		14	16	16			•		•						•	•	•		•							26
Price Category 3-4																										
No fabrics available at this time.																										
Price Category 5																										
ZNC__ Nico - Maharam		14	•	•			•	•	•	•	•	•		•	•	•	•		•	•	•	•	•	•	•	•
Price Category 6-8																										
No fabrics available at this time.																										
Price Category 9																										
ZGE__ Gemma - Maharam		14	•	•	•	•	•	•	•	•	•	•		•	•	•	•		•	•	•	•	•	•	•	•
ZJA__ Jasper - Maharam		14	16	16			•		•	•	•	•		•	•	•	•		•				•	•	7	
Price Category 10																										
ZGF__ Gemma Multi - Maharam		14	•	•	•	•	•	•	•	•	•	•		•	•	•	•		•	•	•	•	•	•	•	•
ZGF__ Gemma Multi Reverse - Maharam		14	•	•	•	•	•	•	•	•	•	•		•	•	•	•		•	•	•	•	•	•	•	•
ZP4__ Petra - Maharam		14	16	16			•		•	•	•	•		•	•	•	•		•	•	•	•	•	•	•	•
Price Category A																										
No fabrics available at this time.																										
Price Category B																										
TI__ Messenger - Maharam *		14	•	•	•	•	•	•	•	•	•	•		•	•	•	•		•	•	•	•	•	•	•	26
Price Category C																										
887__ Merit - Maharam		14	•	•			•	•	•	•	•	•		•	•	•	•		•	•	•	•	•	•	•	•
Z27__ Manner - Maharam		14	•	•			•		•		•			•	•	•	•		•	•	•	•	•	•	•	•
Z3__ Metric - Maharam		14	•	•			•	•	•	•	•	•		•	•	•	•		•	•	•	•	•	•	•	•
8EY__ Murmur - Maharam		14	•	16			•		•		•			•	•				•	•	•	•	•	•	•	•
Price Category D																										
818__ Bluff - Maharam			16	16			•		•	•	8			•					•	21		•	•	•	•	•
Price Category E																										
896__ Dwell - Maharam		14	16	16			•		•		•			•	•				•				•	•	7	
ZR2__ Roster - Maharam		15	16	16			•		•	•	•			•	•	•			•		•			•	•	•
Price Category F																										
82T__ Apt [N] - Maharam			18	•			•	•	•	•				•					•	21	•		•	•	7	
74M__ Instill [N] - Maharam		15	18	16			•	•	•	•				•	•	•			•	•		•	•	•	•	
89N__ Keen - Maharam		15	16	16			•		•	•	•			•	•				•	•	•	•	•	•	•	
V9G__ Ledger - Maharam		15	18	16			•	•	•	•				•	•	•			•				•	•	•	
ZLL__ Loop - Maharam		15	16	16			•		•		8			•	•				•				•	•	•	
8LW__ Pepper - Maharam		14	16	16			•		•		•			•	•	•			•	21	•		9	•		
Z32__ Skein - Maharam		14	16	16	•		•	•	•	•				•	•				•				•	•	•	
Z33__ Strum - Maharam [N]				16										•									•	•	7	

* Available in select colors on 20-day lead-time.
Refer to "Maharam Colors - Seating" for 20-day colors.

Continued on next page

Maharam Application Chart — Seating

continued

	Mirra® Chairs/Stools	Celle® Chairs	Sayl® Work Chairs	Sayl Side Chairs	Setu® Chairs	Setu Lounge Chair/Ottoman	Verus™ Work Chairs/Stools Back	Verus Work Chairs/Stools Seat	Verus Side Chairs Back	Verus Side Chairs Seat	Verus Plus Chairs	Aside® Chairs	Caper® Chairs/Stools	Keyn Chair Group Back	Keyn Chair Group Seat	Lino™ Chairs Seat	Locale® Bench Cushions	OE1 Storage Trolley Cushion Top	Public Office Landscape® Seat	Plex® Lounge Furniture	Swoop™ Lounge Seating - Fully Upholstered	Swoop Lounge Seating - Plywood	Valor™ Seating	Nemschoff® Whisk™ Chairs	Cushion Tops	
Price Category G																										
ZBU__ Bushel by Lisa Scull - Maharam		15	16	16			•		•	•	•				•	•			•			•				
8GI__ Chassis - Maharam		15	16	16			•		•	•	•				•	•			•			•				•
ZC2__ Compound - Maharam [N]			16	16			•	•	•	•	•	8			•	•				•		•	•			•
8AR__ Gild - Maharam				16			•	•	•	•					•	•				•	21	•	•	•		
82N__ Quay - Maharam		14	16	16			•	•	•	•	•				•	•			•	20	•		•			
8DW__ Waver - Maharam		14	16	16			•	•	•	•	•				•	•			•			•	•			
Price Category H																										
ZT__ Circles - Maharam		14	16	16											•											•
ZK__ Dot Pattern - Maharam		14	•	•	•							•			•									•		•
ZP3__ Pocket - Maharam															•	•										•
ZL__ Small Dot Pattern - Maharam		14	•	•	•	•		•		•		•			•									•		•
Price Category I																										
7CW__ Cursive - Maharam		14	14	16			•	•	•	•	8				•	•	•		•		•	•	•			•
Price Category J-V																										
No fabrics available at this time.																										

7 Available on 1" Cushion Tops only.

8 Only available on the Aside nonupholstered outer back option (PB).

9 Available on Valor upholstered seat.

14 Available on Celle UC (upholstered seat) chairs and Celle UF (upholstered seat) chairs.

15 Available only on Celle HC (upholstered seat with protective edge) chairs and Celle HF (upholstered seat) chairs.

16 Available on Sayl Chair seat.

18 Available on Sayl Chair seat and upholstered mid-back.

20 Not available on Plex Club Chair with Headrest.

21 Available on Plex seat and on ottoman.

26 Available in select colors. Refer to "Maharam Colors - Seating" for color offering.

Maharam Colors — Seating

Price Category 1 Price Category 2 Price Category 3-4 Price Category 5

No fabrics available at this time.

Muse – Maharam	
54" wide	
100% post-consumer recycled polyester	
8I101/466487-001	Crescendo
8I102/466487-002	Resonate
8I103/466487-003	Runway
8I104/466487-004	Ascend
8I105/466487-005	Veil *
8I106/466487-006	Refresh *
8I107/466487-007	Clear *
8I108/466487-008	Fantasy
8I109/466487-009	Miso
8I110/466487-010	Compass
8I111/466487-011	Bergamot *
8I112/466487-012	Grasshopper
8I113/466487-013	Goal
8I114/466487-014	Mistletoe
8I115/466487-015	Seaglass *
8I116/466487-016	Frigid
8I117/466487-017	Riverbend
8I118/466487-018	Noble
8I119/466487-019	Pulsar
8I120/466487-020	Verella
8I121/466487-021	Sailboat
8I122/466487-022	Sparse
8I123/466487-023	Vase
8I124/466487-024	Haven
8I125/466487-025	Mead
8I126/466487-026	Neat
8I127/466487-027	Jovial
8I128/466487-028	Theater
8I129/466487-029	Poinsetta
8I130/466487-030	Celebrate
8I131/466487-031	Spectacle

* Colors not available on Valor Seating.

No fabrics available at this time.

Nico - Maharam	
54" wide	
63% wool	
21% polyester	
16% solution-dyed nylon	
ZNC01/466564-001	Alcazar
ZNC02/466564-002	Ironclad
ZNC03/466564-003	Tune
ZNC04/466564-004	Bridegroom
ZNC05/466564-005	Diode
ZNC06/466564-006	Jest
ZNC07/466564-007	Sanctuary
ZNC08/466564-008	Aquarius
ZNC09/466564-009	Houseboat
ZNC10/466564-010	Olympian
ZNC11/466564-011	Tennis
ZNC12/466564-012	Dressage
ZNC13/466564-013	Zing
ZNC14/466564-014	Bitterroot
ZNC15/466564-015	Gemini
ZNC16/466564-016	Posh
ZNC17/466564-017	Sizzle
ZNC18/466564-018	Cheerful
ZNC19/466564-019	Watermelon
ZNC20/466564-020	Toucan
ZNC21/466564-021	Rosin
ZNC22/466564-022	Jousting
ZNC23/466564-023	Jojoba
ZNC24/466564-024	Dromedary
ZNC25/466564-025	Toasty
ZNC26/466564-026	Casaba
ZNC27/466564-027	Greenhouse
ZNC28/466564-028	Sibyl
ZNC29/466564-029	Spearmint
ZNC30/466564-030	Pothos
ZNC31/466564-031	Calathea
ZNC32/466564-032	Landscape
ZNC33/466564-033	Espalier
ZNC34/466564-034	Gecko
ZNC35/466564-035	Meditation

Appendix: Maharam Colors — Seating

- Maharam textiles are on assigned lead times ^A unless otherwise noted.
- Fabric numbers are listed as Herman Miller fabric number/Maharam fabric number.

Maharam Colors — Seating

continued

Price Category 6-8

No fabrics available at this time.

Price Category 9

Gemma – Maharam	
55" wide	
85% wool	
15% nylon	
ZGE01/466568-001	Crinoline
ZGE02/466568-002	Angelic
ZGE03/466568-003	Savory
ZGE04/466568-004	Honeycomb
ZGE05/466568-005	Gilded
ZGE06/466568-006	Paddleboat
ZGE07/466568-007	Stagecoach
ZGE08/466568-008	Waterbuck
ZGE09/466568-009	Earnest
ZGE10/466568-010	Auric
ZGE11/466568-011	Carmine
ZGE12/466568-012	Serape
ZGE13/466568-013	Ferric
ZGE14/466568-014	Canyon
ZGE15/466568-015	Alembic
ZGE16/466568-016	Patio
ZGE17/466568-017	Sorrel
ZGE18/466568-018	Root
ZGE19/466568-019	Mansion
ZGE20/466568-020	Buff
ZGE21/466568-021	Starch
ZGE22/466568-022	Dawn
ZGE23/466568-023	Countryside
ZGE24/466568-024	Dewy
ZGE25/466568-025	Reliquary
ZGE26/466568-026	Deluge
ZGE27/466568-027	Overlay
ZGE28/466568-028	Electron
ZGE29/466568-029	Sheath
ZGE30/466568-030	Quietude
ZGE31/466568-031	Jargon
ZGE32/466568-032	Powder
ZGE33/466568-033	Tide
ZGE34/466568-034	Outwash
ZGE35/466568-035	Enamored
ZGE36/466568-036	Smitten
ZGE37/466568-037	Revere
ZGE38/466568-038	Mangosteen
ZGE39/466568-039	Allium
ZGE40/466568-040	Immense
ZGE41/466568-041	Chamber

Gemma continued	
ZGE42/466568-042	Cosmos
ZGE43/466568-043	Inkling
ZGE44/466568-044	Rainwater
ZGE45/466568-045	Shade
ZGE46/466568-046	Pendant
ZGE47/466568-047	Axial
ZGE48/466568-048	Fervent
ZGE49/466568-049	Legacy
ZGE50/466568-050	Caliber
ZGE51/466568-051	Temple
ZGE52/466568-052	Evenfall

Jasper - Maharam	
53" wide	
55% wool	
27% solution-dyed nylon	
18% cotton	
ZJA01/466563-001	Thrill
ZJA02/466563-002	Anise
ZJA03/466563-003	Grapefruit
ZJA04/466563-004	Lifeguard
ZJA05/466563-005	Heartfelt
ZJA06/466563-006	Corsage
ZJA07/466563-007	Earthenware
ZJA08/466563-008	Bear
ZJA09/466563-009	Firelight
ZJA10/466563-010	Dreamcatcher
ZJA11/466563-011	Bobcat
ZJA12/466563-012	Glacial
ZJA13/466563-013	Vaporize
ZJA14/466563-014	Trapdoor
ZJA15/466563-015	Halcyon
ZJA16/466563-016	Observatory
ZJA17/466563-017	Steamboat
ZJA18/466563-018	Aquathlon
ZJA19/466563-019	Cloudless
ZJA20/466563-020	Briny
ZJA21/466563-021	Magical
ZJA22/466563-022	Picnic
ZJA23/466563-023	Herbage
ZJA24/466563-024	Pasture
ZJA25/466563-025	Courtyard
ZJA26/466563-026	Leapfrog

Price Category 10

Gemma Multi – Maharam	
55" wide	
85% wool	
15% nylon	
ZGF01/466569-001	Andromeda
ZGF02/466569-002	Dappled
ZGF03/466569-003	Lyra
ZGF04/466569-004	Flaunt
ZGF05/466569-005	Celluloid
ZGF06/466569-006	Hydrozoa
ZGF07/466569-007	Firefly
ZGF08/466569-008	Pisces
ZGF09/466569-009	Strath
ZGF10/466569-010	Erosion
ZGF11/466569-011	Cabaret
ZGF12/466569-012	Candytuft
ZGF13/466569-013	Juice
ZGF14/466569-014	Fairground
ZGF15/466569-015	Copperplate
ZGF16/466569-016	Sunbird
ZGF17/466569-017	Cinematic
ZGF18/466569-018	Clairvoyant
ZGF19/466569-019	Crocus
ZGF20/466569-020	Memoir
ZGF21/466569-021	Roulette
ZGF22/466569-022	Voltaic
ZGF23/466569-023	Compote
ZGF24/466569-024	Lambent
ZGF25/466569-025	Twister
ZGF26/466569-026	Chronicle
ZGF27/466569-027	Sidereal
ZGF28/466569-028	Tanzanite
ZGF29/466569-029	Crystalize
ZGF30/466569-030	Chromium
ZGF31/466569-031	Pallium
ZGF32/466569-032	Spectre
ZGF33/466569-033	Courgette
ZGF34/466569-034	Viper
ZGF35/466569-035	Sunlit
ZGF36/466569-036	Heavenly
ZGF37/466569-037	Vernal
ZGF38/466569-038	Cress
ZGF39/466569-039	Limn
ZGF40/466569-040	Horseradish

- Maharam textiles are on assigned lead times **A** unless otherwise noted.
- Fabric numbers are listed as Herman Miller fabric number/Maharam fabric number.

Price category 10 continued on next page

Maharam Colors — Seating

continued

Price Category 10

continued

Gemma Multi continued	Gemma Multi Reverse continued	Gemma Multi Reverse continued	Gemma Multi Reverse continued
ZGF41/466569-041 Shandy	ZGF68/466569-111 Cabaret	ZGF90/466569-133 Courgette	ZGFB2/466569-155 Eiderdown
ZGF42/466569-042 Granary	Reverse	Reverse	Reverse
ZGF43/466569-043 Percolate	ZGF69/466569-112 Candytuft	ZGF91/466569-134 Viper	ZGFB3/466569-157 Tanager
ZGF44/466569-044 Motor	Reverse	Reverse	Reverse
ZGF45/466569-045 Unicorn	ZGF70/466569-113 Juice	ZGF92/466569-135 Sunlit	
ZGF46/466569-046 Lobster	Reverse	Reverse	
ZGF47/466569-047 Rhododendron	ZGF71/466569-114 Fairground	ZGF93/466569-136 Heavenly	
ZGF48/466569-048 Taffy	Reverse	Reverse	
ZGF49/466569-049 Rishi	ZGF72/466569-115 Copperplate	ZGF94/466569-137 Vernal	
ZGF50/466569-050 Backcountry	Reverse	Reverse	
ZGF51/466569-051 Buckthorn	ZGF73/466569-116 Sunbird	ZGF95/466569-138 Cress	
ZGF52/466569-052 Coniferous	Reverse	Reverse	
ZGF53/466569-053 Delphic	ZGF74/466569-117 Cinematic	ZGF96/466569-139 Limn	
ZGF54/466569-054 Hieroglyph	Reverse	Reverse	
ZGF55/466569-055 Eiderdown	ZGF75/466569-118 Clairvoyant	ZGF97/466569-140 Horseradish	
ZGF56/466569-056 Sandbar	Reverse	Reverse	
ZGF57/466569-057 Tanager	ZGF76/466569-119 Crocus	ZGF98/466569-141 Shandy	
	Reverse	Reverse	
	ZGF77/466569-120 Memoir	ZGF99/466569-142 Granary	
	Reverse	Reverse	
	ZGF78/466569-121 Roulette	ZGFA0/466569-143 Percolate	
	Reverse	Reverse	
	ZGF79/466569-122 Voltaic	ZGFA1/466569-144 Motor	
	Reverse	Reverse	
	ZGF80/466569-123 Compote	ZGFA2/466569-145 Unicorn	
	Reverse	Reverse	
	ZGF81/466569-124 Lambent	ZGFA3/466569-146 Lobster	
	Reverse	Reverse	
	ZGF82/466569-125 Twister	ZGFA4/466569-147 Rhododendron	
	Reverse	Reverse	
	ZGF83/466569-126 Chronicle	ZGFA5/466569-148 Taffy	
	Reverse	Reverse	
	ZGF84/466569-127 Sidereal	ZGFA6/466569-149 Rishi	
	Reverse	Reverse	
	ZGF85/466569-128 Tanzanite	ZGFA7/466569-150 Backcountry	
	Reverse	Reverse	
	ZGF86/466569-129 Crystalize	ZGFA8/466569-151 Buckthorn	
	Reverse	Reverse	
	ZGF87/466569-130 Chromium	ZGFA9/466569-152 Coniferous	
	Reverse	Reverse	
	ZGF88/466569-131 Pallium	ZGFB0/466569-153 Delphic	
	Reverse	Reverse	
	ZGF89/466569-132 Spectre	ZGFB1/466569-154 Hieroglyph	
	Reverse	Reverse	

Gemma Multi Reverse – Maharam

55" wide
85% wool
15% nylon

ZGF58/466569-101 Andromeda	Reverse
ZGF59/466569-102 Dappled	Reverse
ZGF60/466569-103 Lyra	Reverse
ZGF61/466569-104 Flaunt	Reverse
ZGF62/466569-105 Celluloid	Reverse
ZGF63/466569-106 Hydrozoa	Reverse
ZGF64/466569-107 Firefly	Reverse
ZGF65/466569-108 Pisces	Reverse
ZGF66/466569-109 Strath	Reverse
ZGF67/466569-110 Erosion	Reverse

Petra - Maharam

55" wide
70% wool
19% linen
11% nylon

ZP401/466580-001 Hieroglyph
ZP402/466580-002 Interior
ZP403/466580-003 Samovar
ZP404/466580-004 Calcite
ZP405/466580-005 Silversmith
ZP406/466580-006 Rivet
ZP407/466580-007 Carpolite
ZP408/466580-008 Bonbon
ZP409/466580-009 Dreamy
ZP410/466580-010 Bejewel
ZP411/466580-011 Sashimi
ZP412/466580-012 Spirula
ZP413/466580-013 Chalet
ZP414/466580-014 Reindeer
ZP415/466580-015 Nostalgia
ZP416/466580-016 Trove
ZP417/466580-017 Narcissus
ZP418/466580-018 Yurt
ZP419/466580-019 Congee
ZP420/466580-020 Genepy
ZP421/466580-021 Herbaceous
ZP422/466580-022 Paddock
ZP423/466580-023 Precious
ZP424/466580-024 Biome
ZP425/466580-025 Tinted
ZP426/466580-026 Pelagic
ZP427/466580-027 Bluebill
ZP428/466580-028 Chicory
ZP429/466580-029 Eaglet
ZP430/466580-030 Permafrost
ZP431/466580-031 Atlantic
ZP432/466580-032 Airstream
ZP433/466580-033 Debonair

Appendix: Maharam Colors — Seating

- Maharam textiles are on assigned lead times ^A unless otherwise noted.
- Fabric numbers are listed as Herman Miller fabric number/Maharam fabric number.

Maharam Colors — Seating

continued

Price Category A

No fabrics available at this time.

Price Category B

Messenger — Maharam

54" wide	
78% recycled polyester	
15% polyester	
7% nylon	
TI07/458640-007	Shadow *
TI08/458640-008	Bayou *
TI24/458640-024	Poppy
TI25/458640-025	Mao
TI29/458640-029	Onyx
TI31/458640-031	Cloud *
TI38/458640-038	Depth *
TI40/458640-040	Nile
TI41/458640-041	Azure *
TI45/458640-045	Cactus *
TI46/458640-046	Ice *
TI48/458640-048	Neon *
TI50/458640-050	Hydrangea *
TI53/458640-053	Tangelo
TI54/458640-054	Lumine *
TI58/458640-058	Snow **
TI60/458640-060	Peridot *
TI61/458640-061	Capri
TI62/458640-062	Ultramarine
TI63/458640-063	Squall
TI66/458640-066	Cassis
TI67/458640-067	Aster

Messenger continued

TI69/458640-069	Cherry
TI70/458640-070	Vibrant
TI71/458640-071	Satsuma *
TI72/458640-072	Maize
TI76/458640-076	Fossil
TI77/458640-077	Ash
TI78/458640-078	Tusk
TI79/458640-079	Oyster
TI81/458640-081	Husk
TI84/458640-084	Robust
TI85/458640-085	Beyond
TI86/458640-086	Voyage
TI87/458640-087	Everglade
TI89/458640-089	Blanch
TI90/458640-090	Longspur
TI91/458640-091	Vireo
TI92/458640-092	Dipper
TI93/458640-093	Gale
TI94/458640-094	Hunter
TI95/458640-095	Lime
TI96/458640-096	Apple
TI97/458640-097	Krill
TI98/458640-098	Catalyst

* Colors available on
20-day lead time.

** Color not available on
Valor Seating.

Price Category C

Manner - Maharam

54" wide	
100% recycled polyester	
Z2701/466177-001	Magic
Z2702/466177-002	Carob
Z2703/466177-003	Porpoise
Z2704/466177-004	Flint
Z2705/466177-005	Hush
Z2706/466177-006	Nuance
Z2711/466177-011	Ember
Z2712/466177-012	Wagon
Z2713/466177-013	Ablaze
Z2714/466177-014	Peel
Z2716/466177-016	Butterscotch
Z2717/466177-017	Harvest
Z2720/466177-020	Parakeet
Z2722/466177-022	Aquatic
Z2723/466177-023	Cottage
Z2724/466177-024	Dahlia
Z2725/466177-025	Vivid
Z2726/466177-026	Basin
Z2727/466177-027	Schooner
Z2728/466177-028	Slope
Z2729/466177-029	Silverpoint
Z2730/466177-030	Lattice
Z2731/466177-031	Smoky
Z2732/466177-032	Magnetic
Z2733/466177-033	Woad
Z2734/466177-034	Resolute
Z2735/466177-035	Cruise
Z2736/466177-036	Atmospheric
Z2737/466177-037	Cloudburst
Z2738/466177-038	Tidewater
Z2739/466177-039	Firth
Z2740/466177-040	Oceanside
Z2741/466177-041	Grandeur
Z2742/466177-042	Comfort
Z2743/466177-043	Dill
Z2744/466177-044	Poplar
Z2745/466177-045	Citronella
Z2746/466177-046	Passerine

Price category C continued on
next page

- Maharam textiles are on assigned lead times A unless otherwise noted.
- Fabric numbers are listed as Herman Miller fabric number/Maharam fabric number.

Maharam Colors — Seating

continued

Price Category C

continued

Manner continued

Z2747/466177-047	Southwest
Z2748/466177-048	Roseate
Z2749/466177-049	Charisma
Z2750/466177-050	Siltstone
Z2751/466177-051	Kimono
Z2752/466177-052	Valiant
Z2753/466177-053	Baroness

Merit - Maharam

54" wide	
76% post-industrial recycled polyester	
24% polyester	
PFOA-Free stain resistant	
88Z01/466444-001	Trickle
88Z02/466444-002	Beluga
88Z03/466444-003	Gunmetal
88Z04/466444-004	Blackout
88Z05/466444-005	Superior
88Z06/466444-006	Ocean
88Z07/466444-007	Highborn
88Z08/466444-008	Immersed
88Z09/466444-009	Rainfall
88Z10/466444-010	Blizzard
88Z11/466444-011	Poolside
88Z12/466444-012	Steel
88Z13/466444-013	Zircon
88Z14/466444-014	Ripple
88Z15/466444-015	Aegean
88Z16/466444-016	Armada
88Z17/466444-017	Hedera
88Z18/466444-018	Rainforest
88Z19/466444-019	Gator
88Z20/466444-020	Vineyard
88Z21/466444-021	Pine
88Z22/466444-022	Kiwi
88Z23/466444-023	Kookaburra
88Z24/466444-024	Bellini
88Z25/466444-025	Sunflower
88Z26/466444-026	Sandstorm

Merit continued

88Z27/466444-027	Mudder
88Z28/466444-028	Lynx
88Z29/466444-029	Farro
88Z30/466444-030	Manila
88Z31/466444-031	Starfish
88Z32/466444-032	Brass
88Z33/466444-033	Arrow
88Z34/466444-034	Gelato
88Z35/466444-035	Nectarine
88Z36/466444-036	Macaron
88Z37/466444-037	Alert
88Z38/466444-038	Goji
88Z39/466444-039	Cabernet
88Z40/466444-040	Eggplant
88Z41/466444-041	Hawk
88Z42/466444-042	Stag
88Z43/466444-043	Overcast

Metric - Maharam

54" wide	
51% recycled polyester	
49% polyester	
Z302/466014-002	Fog
Z303/466014-003	Fleece
Z312/466014-012	Cardinal
Z313/466014-013	Lava
Z318/466014-018	Pollen
Z320/466014-020	Alligator
Z323/466014-023	Tar
Z324/466014-024	Anchor
Z326/466014-026	Admiral
Z327/466014-027	Seaport
Z328/466014-028	Scuba
Z329/466014-029	Skate
Z330/466014-030	Hopscotch
Z331/466014-031	Film
Z332/466014-032	Whale
Z333/466014-033	Downpour
Z334/466014-034	Midday
Z335/466014-035	Talisman
Z336/466014-036	Hedgerow
Z337/466014-037	Snorkel

Metric continued

Z338/466014-038	Highway
Z339/466014-039	Canary
Z340/466014-040	Sunny
Z341/466014-041	Aztec
Z342/466014-042	Fruit
Z343/466014-043	Galah
Z344/466014-044	Kiln
Z345/466014-045	Moth

Murmur - Maharam

55" wide	
100% polyester	
PFOA-Free stain resistant	
8EY01/466446-001	Gust
8EY02/466446-002	Harmonica
8EY03/466446-003	Canopy
8EY04/466446-004	Dim
8EY05/466446-005	Peppercorn
8EY06/466446-006	Cauldron
8EY07/466446-007	Conquer
8EY08/466446-008	Rapids
8EY09/466446-009	Seawater
8EY10/466446-010	Baby
8EY11/466446-011	Elderberry
8EY12/466446-012	Iceberg
8EY13/466446-013	Tallgrass
8EY14/466446-014	Underground
8EY15/466446-015	Biome
8EY16/466446-016	Cask
8EY17/466446-017	Argan
8EY18/466446-018	Sundown
8EY19/466446-019	Ignite
8EY20/466446-020	Sultry
8EY21/466446-021	Sangria

Price Category D

Bluff - Maharam

54" wide	
100% polyurethane	
Ink-resistant protective top coat	
Polyester backing	
8I801/466489-001	Loom
8I802/466489-002	Helm
8I803/466489-003	Cruller
8I804/466489-004	Folklore
8I805/466489-005	Beguile
8I806/466489-006	Sherpa
8I807/466489-007	Teleport
8I808/466489-008	Annex
8I809/466489-009	Lorimer
8I810/466489-010	Cinema
8I811/466489-011	Zip
8I812/466489-012	Coach
8I813/466489-013	Supernova
8I814/466489-014	Pirate
8I815/466489-015	Academy
8I816/466489-016	Disco
8I817/466489-017	Equator
8I818/466489-018	Brink
8I819/466489-019	Scene
8I820/466489-020	Petrichor
8I821/466489-021	Exotic
8I822/466489-022	Fauna
8I823/466489-023	Calabash
8I824/466489-024	Fuscous
8I825/466489-025	Wildling
8I826/466489-026	Blitz
8I827/466489-027	Allspice
8I828/466489-028	Lumos
8I829/466489-029	Pilot
8I830/466489-030	Jukebox
8I831/466489-031	Dugout
8I832/466489-032	Claret
8I833/466489-033	Flamenco

- Maharam textiles are on assigned lead times ^A unless otherwise noted.
- Fabric numbers are listed as Herman Miller fabric number/Maharam fabric number.

Maharam Colors — Seating

continued

Appendix: Maharam Colors — Seating

Price Category E

Dwell - Maharam	
54" wide	
66% post-industrial recycled polyester	
32% post-consumer recycled polyester	
PFOA-Free stain resistant	
Latex backing	
89601/466419-001	Sesame
89602/466419-002	Summit
89603/466419-003	Freeze
89604/466419-004	Poolside
89605/466419-005	Teal
89606/466419-006	Mojito
89607/466419-007	Lizard
89608/466419-008	Thunder
89609/466419-009	Foil
89610/466419-010	Wine
89611/466419-011	Firecracker

Roster - Maharam	
54" wide	
68% post-consumer recycled polyester	
32% polyester	
PFOA-Free stain resistant	
Acrylic backing	
ZR201/466445-001	Jacana
ZR202/466445-002	Wythe
ZR203/466445-003	Grosgrain
ZR204/466445-004	Ceremony
ZR205/466445-005	Breton
ZR206/466445-006	Frigate

Price Category F

Apt - Maharam	
54" wide	
100% polyurethane/silicone	
Ink-resistant protective top coat	
Polyester backing	
82T12/466392-012	Iris
82T13/466392-013	Nocturnal
82T14/466392-014	Fluid
82T15/466392-015	Eden
82T16/466392-016	Galactic
82T17/466392-017	Shoreline
82T18/466392-018	Jade
82T19/466392-019	Garden
82T20/466392-020	Botanic
82T21/466392-021	Chartreuse
82T23/466392-023	Lytic
82T24/466392-024	Turmeric
82T25/466392-025	Bengal
82T26/466392-026	Core
82T27/466392-027	Mantle
82T28/466392-028	Sorbet
82T32/466392-032	Oak
82T33/466392-033	Castle
82T34/466392-034	Follow
82T35/466392-035	Elixir
82T36/466392-036	Charm
82T37/466392-037	Descend
82T38/466392-009	Sketch
82T39/466392-010	Glacier
82T40/466392-031	Fortress
82T41/466392-030	Lotus
82T42/466392-001	Coconut
82T43/466392-011	Cobblestone
82T44/466392-029	Bloom
82T45/466392-022	Crepe
82T46/466392-006	Hickory
82T47/466392-007	Constellation
82T48/466392-008	Labyrinth
82T49/466392-002	Vibe
82T50/466392-003	Stampede
82T51/466392-004	Lumber
82T52/466392-005	Gingerbread

Instill - Maharam	
54" wide	
100% polyurethane	
Ink-resistant protective top coat	
Polyester backing	
74M01/466351-001	Page
74M02/466351-002	Limestone
74M03/466351-003	Bobwhite
74M04/466351-004	Loafer
74M05/466351-005	Moor
74M06/466351-006	Barley
74M07/466351-007	Shaker
74M08/466351-008	Doe
74M09/466351-009	Ride
74M10/466351-010	Squire
74M11/466351-011	Tannin
74M12/466351-012	Vitis
74M13/466351-013	Sonar
74M14/466351-014	Quail
74M15/466351-015	Brittanic
74M16/466351-016	Narwhal
74M17/466351-017	Synth
74M18/466351-018	Stowaway
74M19/466351-019	Koala
74M20/466351-020	Dorsal
74M21/466351-021	Stealth

Keen - Maharam	
54" wide	
61% polyester	
39% polyolefin	
PFOA-Free stain resistant	
Acrylic backing	
89N01/466433-001	Gaur
89N02/466433-002	Lock
89N03/466433-003	Elk
89N04/466433-004	Oatmeal
89N05/466433-005	Lakefront
89N06/466433-006	Argent
89N07/466433-007	Coyote
89N08/466433-008	Eventide
89N09/466433-009	Canal
89N10/466433-010	Rosemary
89N11/466433-011	Herb
89N12/466433-012	Ruby
89N13/466433-013	Loganberry

Ledger - Maharam	
54" wide	
100% polyurethane	
V9G1/463770-001	001
V9G2/463770-002	002
V9G3/463770-003	003
V9G4/463770-004	004
V9GG/463770-017	017
V9GQ/463770-025	025
V9GS/463770-026	026
V9GU/463770-028	028
V9GV/463770-029	029
V9GW/463770-030	030
V9GX/463770-031	031
V9GY/463770-032	032
V9G13/463770-037	037
V9G17/463770-041	041
V9G18/463770-042	042
V9G19/463770-043	043
V9G20/463770-044	044
V9G21/463770-045	045
V9G22/463770-046	046

Loop - Maharam	
57" wide	
48% post-industrial recycled polyester	
26% polyester	
26% post-consumer recycled polyester	
PFOA-Free stain resistant	
Acrylic Backing	
ZLL01/466469-001	Opossum
ZLL02/466469-002	Foundation
ZLL03/466469-003	Naval
ZLL04/466469-004	Buoyant
ZLL05/466469-005	Mockingbird
ZLL06/466469-006	Dynasty
ZLL07/466469-007	Zori
ZLL08/466469-008	Wildfire
ZLL09/466469-009	Floral
ZLL10/466469-010	Penguin

Price category F continued on next page

- Maharam textiles are on assigned lead times **A** unless otherwise noted.
- Fabric numbers are listed as Herman Miller fabric number/Maharam fabric number.

Maharam Colors — Seating

continued

Price Category F

continued

Pepper - Maharam	
58" wide	
49% polyester	
41% post-industrial recycled polyester	
10% post-consumer recycled polyester	
PFOA-Free stain resistant	
Acrylic Backing	
8LW01/466486-001 Dojo	
8LW02/466486-002 Marengo	
8LW03/466486-003 Harlequin	
8LW04/466486-004 Pavlova	
8LW05/466486-005 Sedona	
8LW06/466486-006 Achiote	
8LW07/466486-007 Essence	
8LW08/466486-008 Genome	
8LW09/466486-009 Myriad	
8LW10/466486-010 Terrarium	

Skein - Maharam	
54" wide	
56% recycled polyester	
44% polyester	
Z3201/466170-001 Burrow	
Z3204/466170-004 Sumac	
Z3206/466170-006 Cavern	
Z3207/466170-007 Bitter	
Z3208/466170-008 Cinder	
Z3209/466170-009 Dock	
Z3210/466170-010 Cadet	
Z3211/466170-011 Marsh	

Strum - Maharam	
54" wide	
100% polyurethane	
with silver-based antimicrobial	
Z3301/466122-001 Overcast	
Z3302/466122-002 Ridge	
Z3304/466122-004 Pigeon	
Z3307/466122-007 Bur	
Z3308/466122-008 Abalone	
Z3311/466122-011 Wheat	
Z3312/466122-012 Lemongrass	

Price Category G

Bushel by Lisa Scull - Maharam	
54" wide	
45% solution-dyed nylon	
45% solution-dyed post-industrial recycled nylon	
9% polyester	
1% polyolefin	
Acrylic backing	
ZBU01/466490-001 Enchant	
ZBU02/466490-002 Flurry	
ZBU03/466490-003 Oxygen	
ZBU04/466490-004 Vortex	
ZBU05/466490-005 Loon	
ZBU06/466490-006 Maverick	
ZBU07/466490-007 Hadron	
ZBU08/466490-008 Spirulina	
ZBU09/466490-009 Environ	
ZBU10/466490-010 Rotunda	
ZBU11/466490-011 Caraway	

Chassis by Lisa Scull - Maharam	
54" wide	
50% solution-dyed nylon	
50% solution-dyed post-industrial recycled nylon	
PFOA-Free stain resistant	
Acrylic backing	
8GI01/466458-001 Locomotive	
8GI02/466458-002 Owl	
8GI03/466458-003 Minuet	
8GI04/466458-004 Galax	
8GI05/466458-005 Stratus	
8GI06/466458-006 Cape	
8GI07/466458-007 Cirrus	
8GI08/466458-008 Inlet	
8GI09/466458-009 Petrol	
8GI10/466458-010 Peppermint	
8GI11/466458-011 Hemic	

Compound - Maharam	
54" wide	
100% polyurethane	
silane-based antimicrobial	
ZC201/466196-001 001	
ZC203/466196-003 003	
ZC204/466196-004 004	
ZC205/466196-005 005	
ZC206/466196-006 006	
ZC207/466196-007 007	
ZC208/466196-008 008	
ZC209/466196-009 009	
ZC210/466196-010 010	
ZC211/466196-011 011	
ZC212/466196-012 012	
ZC213/466196-013 013	
ZC214/466196-014 014	
ZC215/466196-015 015	
ZC216/466196-016 016	
ZC217/466196-017 017	
ZC218/466196-018 018	
ZC219/466196-019 019	

Gild - Maharam	
54" wide	
100% non-phthalate vinyl	
Ink-resistant protective top coat	
Polyester backing	
8AR01/466432-005 Grapevine	
8AR02/466432-009 Frosting	
8AR03/466432-007 Smokey	
8AR04/466432-003 Skylight	
8AR05/466432-011 Sandstone	
8AR06/466432-004 Hurricane	
8AR07/466432-002 Wreath	
8AR08/466432-001 Rainforest	
8AR09/466432-012 Fudge	
8AR10/466432-010 Lantern	
8AR11/466432-006 Planet	
8AR12/466432-008 Reflection	

Quay - Maharam	
54" wide	
73% post-industrial recycled cotton	
18% polyester	
9% solution-dyed polyester	
PFOA-Free stain resistant	
82N01/466390-001 Winter	
82N03/466390-003 Chapelle	
82N04/466390-004 Heather	
82N05/466390-005 Federal	
82N06/466390-006 Swan	
82N07/466390-007 Granite	
82N10/466390-010 Seafoam	
82N11/466390-011 Wedgewood	
82N12/466390-012 Parrot	
82N13/466390-013 Persian	
82N14/466390-014 Dawn	
82N15/466390-015 Cerulean	
82N17/466390-017 Cascade	
82N18/466390-018 Pastel	
82N20/466390-020 Spectrum	
82N21/466390-021 Nile	
82N23/466390-023 Leaf	
82N25/466390-025 Oxford	
82N30/466390-030 Cardinal	
82N31/466390-031 Shrimp	
82N32/466390-032 Abode	

Waver - Maharam	
54" wide	
50% solution-dyed nylon	
50% solution-dyed post-industrial recycled nylon	
PFOA-Free stain resistant	
Acrylic backing	
8DW01/466459-001 Mingle	
8DW02/466459-002 Numinous	
8DW03/466459-003 Gale	
8DW04/466459-004 Dual	
8DW05/466459-005 Azure	
8DW06/466459-006 Wash	
8DW07/466459-007 Magpie	
8DW08/466459-008 Steller	
8DW09/466459-009 Peony	
8DW10/466459-010 Kermes	
8DW11/466459-011 Oar	

- Maharam textiles are on assigned lead times ^A unless otherwise noted.
- Fabric numbers are listed as Herman Miller fabric number/Maharam fabric number.

Maharam Colors — Seating

continued

Appendix: Maharam Colors — Seating

Price Category H

Circles — Maharam	
55" wide	
70% cotton	
30% polyester	
ZT01/458310-001	Khaki
ZT02/458310-002	Fatigue
ZT03/458310-003	Document
ZT04/458310-004	Engine
ZT05/458310-005	Charcoal

Dot Pattern — Maharam	
55" wide	
71% cotton	
29% polyester	
ZK01/458300-001	Document
ZK02/458300-002	Taupe
ZK04/458300-004	Red
ZK05/458300-005	Navy

Pocket - Maharam	
54" wide	
76% recycled polyester	
24% nylon	
ZP301/466243-001	001
ZP303/466243-003	003
ZP305/466243-005	005
ZP306/466243-006	006
ZP307/466243-007	007

Small Dot Pattern — Maharam	
55" wide	
71% cotton	
29% polyester	
ZL01/458320-001	Document
ZL02/458320-002	Sand
ZL03/458320-003	Khaki
ZL04/458320-004	Taupe
ZL05/458320-005	Charcoal
ZL06/458320-006	Document Reverse
ZL07/458320-007	Red
ZL08/458320-008	Yellow
ZL09/458320-009	Green

Price Category I

Cursive — Maharam	
54" wide	
67% solution-dyed acrylic	
33% solution-dyed polyester	
PFOA-Free stain resistant	
7CW01/466335-001	Fast
7CW03/466335-003	Beachcomb
7CW05/466335-005	Swift
7CW06/466335-006	Jetstream
7CW07/466335-007	Inkwell
7CW08/466335-008	Rubber

Price Category J-V

No fabrics available at this time.

- Maharam textiles are on assigned lead times A unless otherwise noted.
- Fabric numbers are listed as Herman Miller fabric number/Maharam fabric number.

For more information about our products and services or to see a list of dealers, please visit us at HermanMiller.com or call (800) 851 1196.

© 2021 Herman Miller, Inc., Zeeland, Michigan

Distribution Rights

Working together since 1956, Herman Miller and Vitra are the authentic sources of designs by Charles and Ray Eames, Alexander Girard, and George Nelson. All the designs shown in this book are protected by law. Herman Miller has obtained all rights to make and sell these designs. Also, Herman Miller holds exclusive worldwide manufacturing and distribution rights for these products with the following exceptions:

Charles and Ray Eames, George Nelson, and Alexander Girard—Worldwide distribution rights for furniture in all areas except Europe and the Middle East. For those areas, please contact Vitra.

Isamu Noguchi—Worldwide distribution rights for the Noguchi Rudder Table. Distribution rights for the Noguchi Table in North America and Central America only. For all other areas, please contact Vitra.

Magis—Exclusive distribution rights in the US and Canada. For all other areas, please contact Magis.

® **HermanMiller**, , Action Office, Aeron, Aside, Canvas Office Landscape, Caper, Celle, Cosm, Co/Struc, Eames, Embody, Ethospace, Exclave, Fine-Tune, FlexFront, Formcoat, Ground Cloth, Herman Miller Healthcare, Layout Studio, Lino, Maharam, Meridian, Mirra, Motia, Nelson, Pellicle, Perspectives, Plex, PostureFit, PostureFit SL, Resolve, Sayl, Setu, Tu, Verus, Y-Tower, and Z-Axis are among the registered trademarks of Herman Miller, Inc., and its owned subsidiaries.

™ AireWeave, Bubbletack, Cellular Suspension, Commend, Compass, Connect, DOT, Durawrap, Everywhere, Flex-Edge, Headway, Hopsak 2, Intent, Iota, Keyless Entry, Latitude, Lyris 2, Mora, Multiscrim, Nevi, Overlay, Pedastools, Renew, Stackable, Swoop, Thrive, TriFlex, Twist, Valor, and Vista are among the trademarks of Herman Miller, Inc., and its owned subsidiaries.

5Chemsurf® is a registered trademark of Wilsonart International.

Corian® is a registered trademark of E.I. du Pont de Nemours and Company Corporation.

FLEXNET™ is a trademark of Milliken & Company.

Floor Saver Glide® is a registered trademark of Carpin Manufacturing, Inc.

Forest Stewardship Council® is a registered trademark of the Forest Stewardship Council A.C. (FSC). We are FSC® certified (FSC® C102895).

FSC® is a registered trademark of the Forest Stewardship Council A.C. (FSC).

Geiger® is a registered trademark of Geiger International.

MicrobeCare™ is a trademark of Parasol Medical LLC.

Microsoft® and Natural® Keyboard are registered trademarks of Microsoft Corporation.

Place Textiles® is a registered trademark of Place Textiles.