

Electronic Design 14

VOL. 14, NO.

THE MAGAZINE OF ESSENTIAL NEWS, PRODUCTS AND TECHNOLOGY

JUNE 7, 1966

Build your own IC with this easy-to-use breadboard. A ball- or wedge-bonder is all that's needed to interconnect any of eight transistors, five zener di-

odes, or 44 individual resistors that are available on the chip. The interconnection pattern eliminates the need for unreliable bird's-nest wiring (page 66).

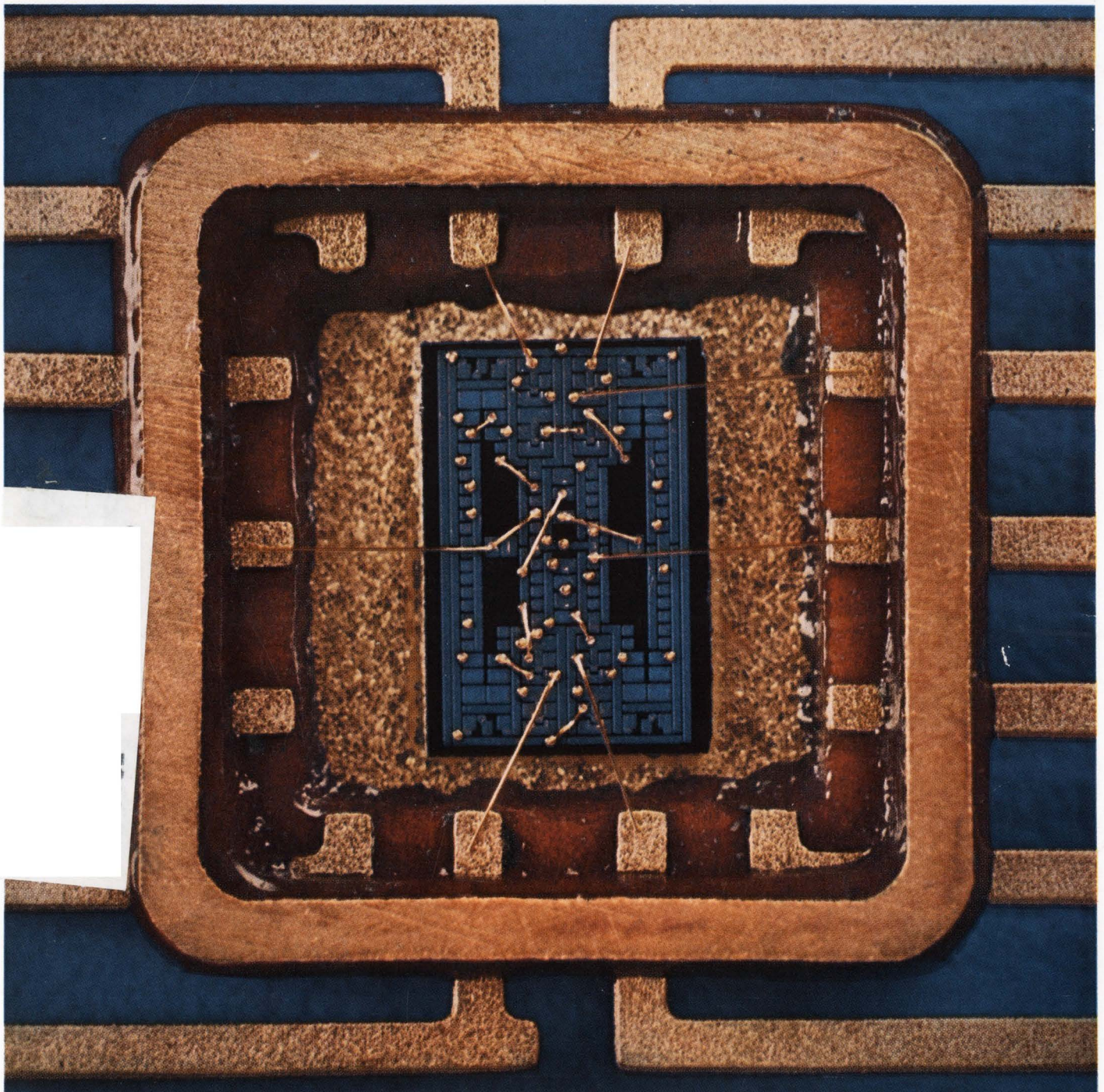

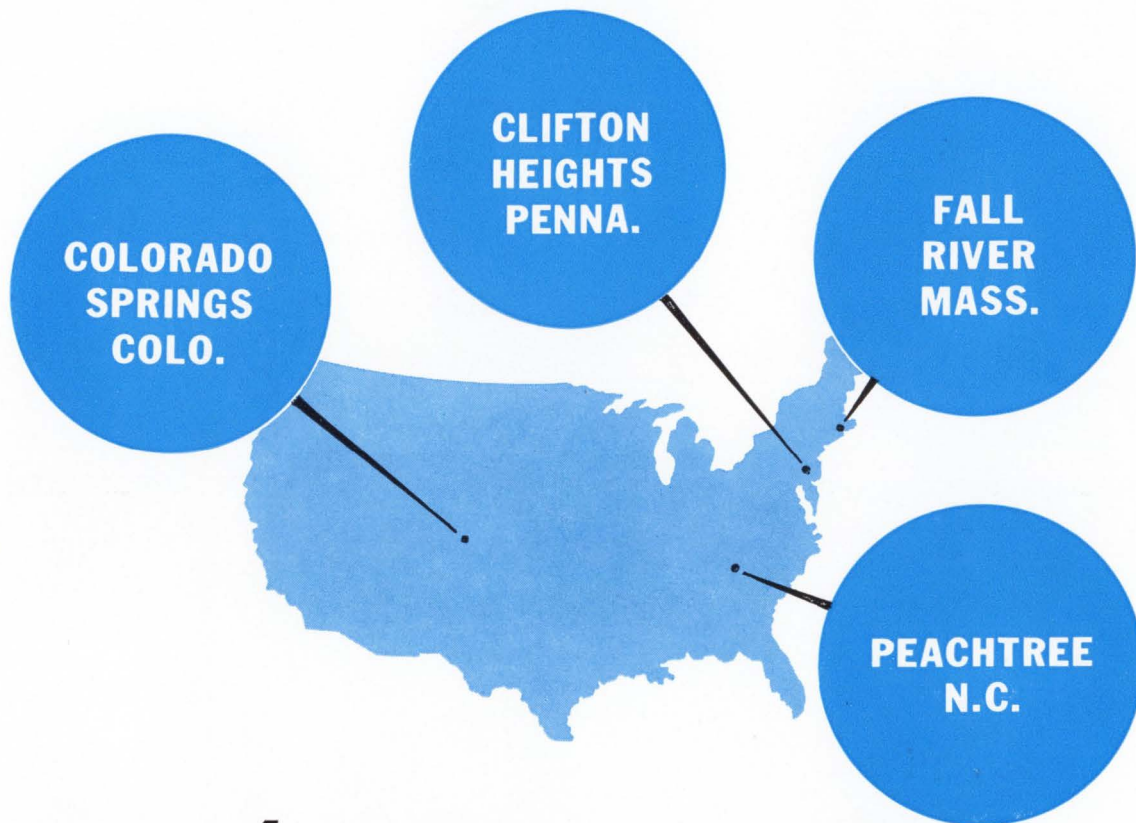

Now 4 Clifton Plants for Greater Synchro Production



Last winter we expanded into a modern 40,000 sq. ft. facility in Fall River, Mass. It is already helping significantly to increase our synchro production.

This summer, construction of our newest synchro plant will be under way in Peachtree, North Carolina. Peachtree will be a 30,000 sq. ft. plant expandable to 100,000 sq. ft. It will further increase our synchro capacity.

Meanwhile, in nearby Murphy, N.C. where we have been doing synchro work for the past two years in temporary quarters, production is being pushed and expanded as rapidly as is feasible. This is true also at Clifton Heights and Colorado Springs.

Our every effort is toward increased production from all 4 plants.





Just
add a
scope . . .

and you have everything you need for **Quantitative Frequency-Response Measurements**

The Type 1025-A Standard Sweep-Frequency Generator is both a sweep generator and a CW generator, with a marker generator, attenuator, and output meter . . . all wrapped up in a single package • it can be switched instantly from swept to CW mode without readjusting, recalibrating, or reconnecting • it covers 0.7 to 230 Mc/s in 10 overlapping octave ranges • has two bandspread ranges (400 to 500 kc/s and 10.4 to 11 Mc/s) • has a "perfect marker" . . . continuously adjustable and accurately calibrated both in frequency and amplitude, which allows you to take accurate quantitative data *directly* from a scope display • output is calibrated, 0.3 μ V to 1 V behind 50 ohms • frequency can be monitored by an external counter through a connector provided specifically for that purpose • price is \$3450, far less than the total cost of the separate instruments you would need for comparable performance.

Write for complete information or a demonstration.

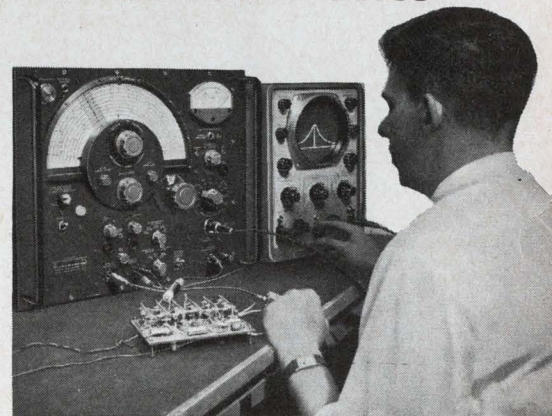

An experimental 5-stage, single-tuned, 30-Mc i-f strip with 1-Mc bandwidth being aligned with the Type 1025-A Standard Sweep-Frequency Generator. Data measured includes center frequency, 6- and 60-dB bandwidths, and gain. The generator can be accurately set to both the 10 μ V signal level at the front end as well as to 100 mV at the last stage.

GENERAL RADIO COMPANY
WEST CONCORD, MASSACHUSETTS

BOSTON • NEW YORK • CHICAGO • PHILADELPHIA • WASHINGTON, D.C. • SYRACUSE • DALLAS • SAN FRANCISCO • LOS ANGELES • ORLANDO • CLEVELAND — TORONTO • MONTREAL
GENERAL RADIO COMPANY (overseas), ZURICH, SWITZERLAND; GENERAL RADIO COMPANY (U.K.) Ltd., BOURNE END, ENGLAND

ON READER-SERVICE CARD CIRCLE 215

instant systems

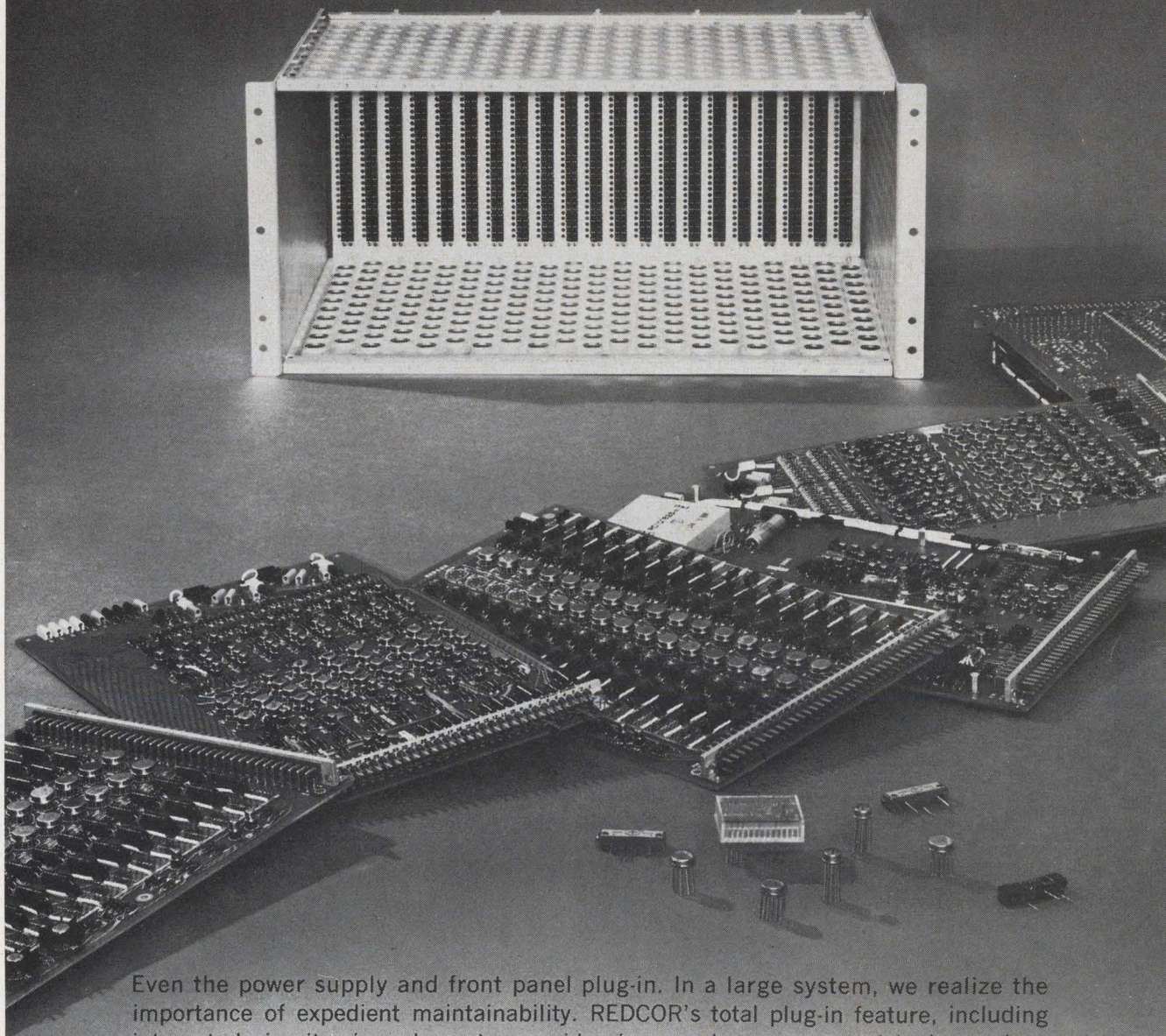

Even the power supply and front panel plug-in. In a large system, we realize the importance of expedient maintainability. REDCOR's total plug-in feature, including integrated circuit micro-elements, provides inexpensive spares provisioning and reduces "mean-time-to-repair" to seconds which minimizes troubleshooting costs. Total plug-in capability also provides proven reliability, optimum performance and prompt delivery.

ANALOG-TO-DIGITAL-TO-ANALOG DATA ACQUISITION SYSTEMS

Engineers: If your field is analog/digital data systems or component design, a career opportunity awaits you at REDCOR. Write to Personnel Director.

RC **REDCOR**[®]
CORPORATION

P. O. Box 1031 / CANOGA PARK, CALIFORNIA 91304 / PHONE: (213) 348-5892 / TWX: 213-348-2573

Speed Inquiry to Advertiser via Collect Night Letter
ON READER-SERVICE CARD CIRCLE 2

Electronic Design 14

VOL. 14, NO.

THE MAGAZINE OF ESSENTIAL NEWS, PRODUCTS AND TECHNOLOGY

JUNE 7, 1966

NEWS

- 13 News Report
- 17 **Design deficiencies cited in medical electronics**
Communications gap between engineer and physician discussed at biomedical symposium.
- 21 **New process boosts gallium arsenide devices**
Vapor phase growth makes possible GaAs devices that cannot easily be produced by other processes.
- 22 Telephone system uses time-sharing.
- 24 Microwaves study rocket plumes.
- 27 Washington Report
- 31 **Editorial:** What's happening in computer-aided design?

TECHNOLOGY

- 34 **Use ferrite phase-shifters** for high-power phased arrays. The latching types operate without holding current and are efficient even at 1 GHz.
- 40 **Gain insight into FET amplifiers.** Learn which parameters govern performance and how to handle the design of low-noise and high-frequency circuits.
- 48 **D/A converter uses thin-films** to get high precision and maintain the flexibility needed for low-volume production.
- 58 NASA Tech Briefs
- 60 Ideas for Design

PRODUCTS

- 66 **Cover Feature:** IC breadboard allows bench assembly with the drop of a dot.
- 68 Components
- 78 Microwaves
- 82 Systems
- 84 Semiconductors
- 87 Test Equipment

Departments

- 88 Application Notes
 - 90 New Literature
 - 94 Advertisers' Index
 - 96 Designer's Datebook
-

ELECTRONIC DESIGN is published bi-weekly by Hayden Publishing Company, Inc., 850 Third Avenue, New York, N. Y., 10022. James S. Mulholland, Jr., President. Printed at Poole Bros., Inc., Chicago, Ill., Controlled-circulation postage paid at Chicago, Ill., and New York, N. Y. Copyright © 1966, Hayden Publishing Company, Inc. 61,114 copies this issue.



Planar is a patented Fairchild process.

FAIRCHILD SEMICONDUCTOR / A Division of Fairchild Camera and Instrument Corporation ■ 313 Fairchild Drive, Mountain View, California (415) 962-5011 ■ TWX: 910-379-6435



Planar and power are no longer contradictory terms. You can now buy Fairchild Planar power devices with up to 60W power dissipation, up to 12A current, with voltages up to 300V. Here's why: we deposit nickel-chromium resistors in series with the emitters, right on the chip. This technique inhibits secondary breakdown and keeps all the inherent advantages of Planar devices:

Greater temperature stability due to lower leakage currents. Passivated junctions which prevent surface degradation. And higher yields, which mean that Fairchild Planar power costs you less. Prove it to yourself. We've prepared two sample kits which are available through Fairchild Distributors: Sample Kit No. 1 contains 14 power transistors with $V_{CE0} = 80$ Volts and IC up to 10 Amps (\$300 value for \$49.50); Sample Kit No. 2 contains 12 SCR's with ranges up to 200 Volts and 10 Amps (\$120 value for \$29.50). Fairchild reserves the right to limit quantities. This offer expires July 30, 1966.

PLANAR POWER **FAIRCHILD** SEMICONDUCTOR

June 7, 1966

ON READER-SERVICE CARD CIRCLE 3



**Syntron has a pond full of the
best avalanche silicon rectifiers**

... and they are the best—the result of intensive research—a complete, performance proven line of Avalanche Silicon Rectifiers which give assured protection against voltage transients.

The Avalanche Silicon Controlled Rectifiers give you the same protection plus the dependability and efficiency to help you meet the highest standards of reliability.

There is a Syntron Avalanche Silicon or Avalanche Silicon Controlled Rectifier for your every requirement.

Write for Detailed Information



SYNTRON

SYNTRON COMPANY

283 LEXINGTON AVENUE • HOMER CITY, PA.

66R21

An oscilloscope picture in 10 seconds: any longer is a waste of time.

Polaroid Land films don't make you wait to see if your trace zigged when it should have zagged.

They let you know in ten seconds.

They give you an oscilloscope picture you can study, attach to a report, send as a test record with a product shipment, or file for future reference.

You have a choice of 5 films for oscilloscope recording.

The standard film has an A.S.A.

equivalent rating of 3000. It comes in both roll film [Type 47] and pack film [Type 107]. They both give you 8 pictures $3\frac{1}{4} \times 4\frac{1}{4}$ inches. This emulsion is also available in 4×5 sheets [Type 57].

For extremely high-speed recording, there's Polaroid PolaScope Land film [a roll film, Type 410]. It has an A.S.A. equivalent rating of 10,000.

It can take pictures of traces too fleeting for the human eye: such as a scintillation pulse with a rise time of less than 3 nanoseconds.

One thing all these films have in common is a sharp, high-contrast image that's easy to read. Because the films are so sensitive, you can use small camera apertures and low-intensity settings.

To put these films to work on your scope, you need a camera that will take a Polaroid Land Camera Back.

Most oscilloscope camera manufacturers have one. For instance: Analab, Beattie-Coleman, BNK Associates, Fairchild, EG&G, General Atronics, Hewlett-Packard, and Tektronix.

You can get complete information by writing to Polaroid Corporation, Technical Sales Department, Cambridge, Massachusetts 02139, or by writing to one of the manufacturers mentioned above.

It will probably take a little longer than 10 seconds, but we promise the information won't be a waste of time.

"Polaroid" and "PolaScope"®

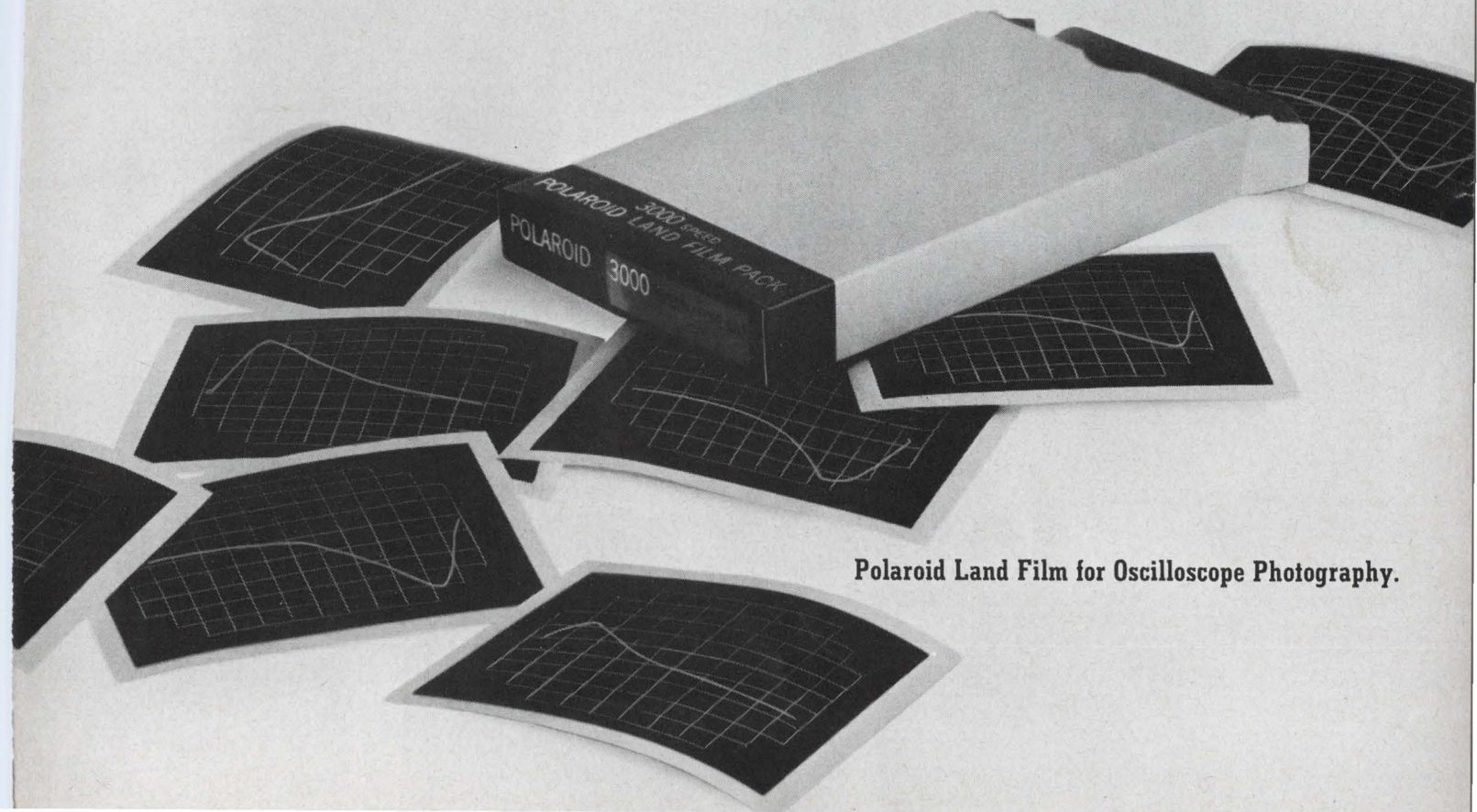

Polaroid Land Film for Oscilloscope Photography.

KILLS SNIVETS INSTANTLY

How would you like an anti-snivet tube for your color TV horizontal deflection circuits? That's right—an anti-snivet tube would eliminate the need for snivet-suppression circuitry with its extra components and extra costs.

The new Amperex 6KG6 output pentode is your tube! It was specifically developed to eliminate Barkhausen oscillations and achieves its snivet-free performance through the use of a Cavitrap anode and other unique design characteristics. The 6KG6 can be operated with grounded suppressor at B+ supply voltages from 240 to 400 volts and still remain snivet-free.

Life-expectancy and reliability of the 6KG6 is far above that of ordinary output pentodes in similar service due to its lower bulb temperature at maximum operating conditions; it operates about 50°C. cooler than comparable tubes in similar service. But in spite of its low operating temperature, the 6KG6 packs plenty of reserve power and added safety factors. It has a max. 7,000 V peak plate voltage, 34 watts max. plate dissipation and 1.4 amps peak anode current.

The 6KG6 is but one of the growing family of new Amperex tubes for color TV that make possible lower costs, higher quality and more reliable performance. Other new tubes in this family include the 6EC4 damper diode, a matching companion to the 6KG6 for horizontal deflection circuits, the 3BH2 high voltage rectifier diode and the ED500 shunt stabilizer.

For data and applications information, write to the company *still doing new things with receiving tubes*: Amperex Electronic Corporation, Semiconductor and Receiving Tube Division, Dept. 371, Slatersville, Rhode Island, 02876.



Amperex®

Speed Inquiry to Advertiser via Collect Night Letter
ON READER-SERVICE CARD CIRCLE 232

This Wilcox Model 914 ATC transponder uses Allen-Bradley Type CB 1/4-watt and Type EB 1/2-watt fixed resistors, Type G variable resistors, and Type R adjustable fixed resistors. The Model 914 transponder is for aircraft operating under ground control radar.

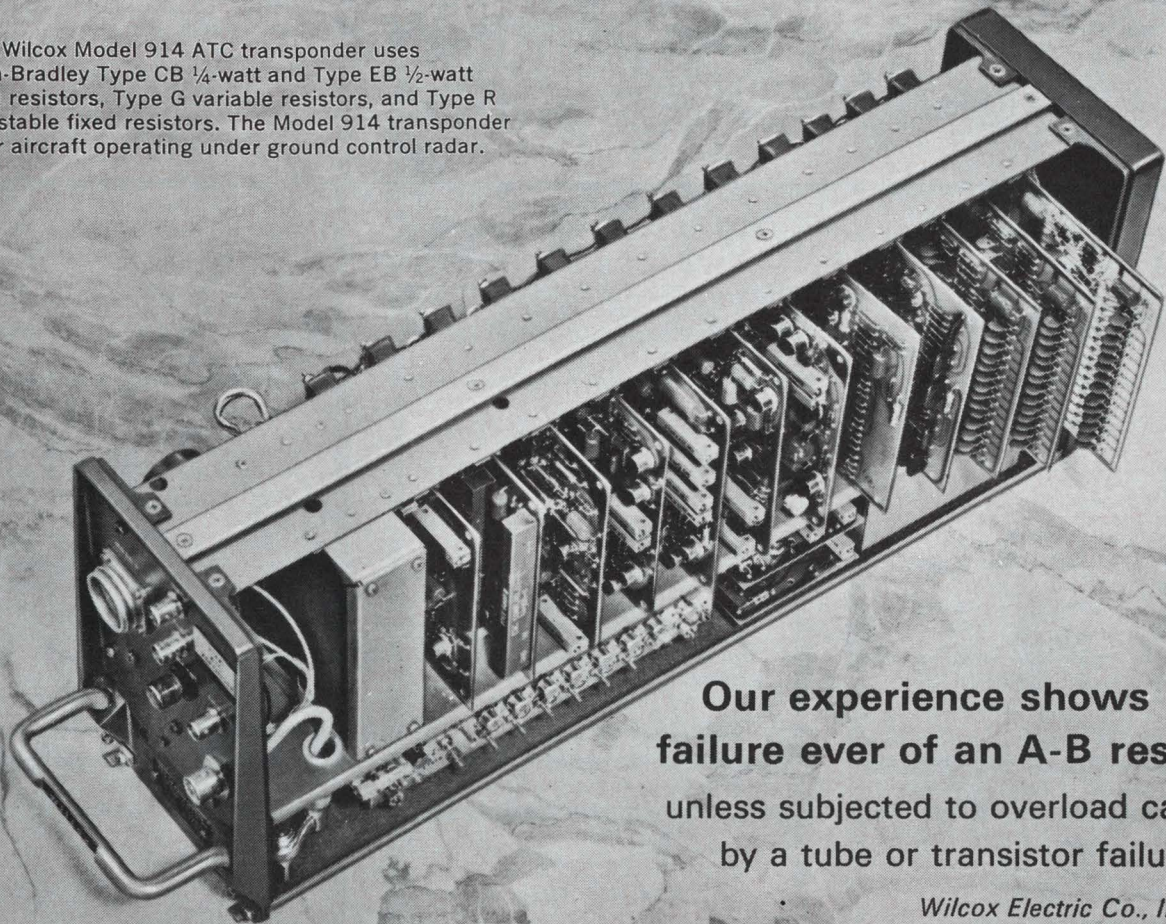

Our experience shows no failure ever of an A-B resistor unless subjected to overload caused by a tube or transistor failure

Wilcox Electric Co., Inc.

Prompt shipment of **HOT MOLDED FIXED RESISTORS** in all standard EIA and MIL-R-11 resistance values and tolerances. Values above and below standard limits can be furnished. Resistors are shown actual size.

TYPE BB 1/8 WATT		MIL TYPE RC 05
TYPE CB 1/4 WATT		MIL TYPE RC 07
TYPE EB 1/2 WATT		MIL TYPE RC 20
TYPE GB 1 WATT		MIL TYPE RC 32
TYPE HB 2 WATTS		MIL TYPE RC 42

Type R Hot Molded Adjustable Fixed Resistors are rated 1/4 watt at 70°C. Supplied in resistance values from 100 ohms to 2.5 megohms.

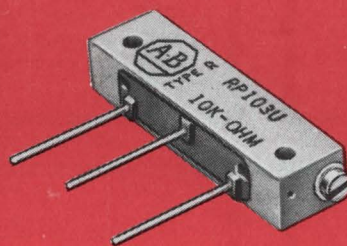

Type G Hot Molded Variable Resistors are rated 1/2 watt at 70°C. Resistance values from 100 ohms to 5.0 megohms.



“No failure ever” is an impressive record, especially since Allen-Bradley fixed and variable resistors have been used in Wilcox transponders for around ten years.

The reason for this consistently high performance is the unique hot molding process developed and used only by Allen-Bradley. In fixed resistors, it produces such complete uniformity that long term A-B resistor performance can be accurately predicted. Catastrophic failures don't occur with Allen-Bradley hot molded resistors.

Use of the hot molded resistance element in the Allen-Bradley Type G variable resistors assures very smooth operation—there are never any abrupt changes in resistance during adjustment. The Type G controls have

a very low initial noise factor, becoming lower with use.

Type R adjustable fixed resistors also have a solid molded resistance track. Adjustment of resistance is so smooth, it approaches infinite resolution. Settings will remain fixed under severe vibration or shock. The Type R molded enclosure is dustproof and watertight—it can be potted after adjustment.

For more complete details on the full line of A-B quality electronic components, please write for Publication 6024: Allen-Bradley Co., 1344 S. Second Street, Milwaukee, Wisconsin 53204. In Canada: Allen-Bradley Canada Ltd. Export Office: 630 Third Ave., New York, New York, U.S.A. 10017.



ALLEN-BRADLEY
QUALITY ELECTRONIC COMPONENTS

1065-10APB

ON READER-SERVICE CARD CIRCLE 5

June 7, 1966

9

You Can Get All These Microcircuits from Sprague Electric:

SERIES SU300, LU300 UTILOGIC



K Package

For use in commercial, industrial, ground support applications. Available in two operating temperature ranges, -20 C to $+85\text{ C}$, and $+10\text{ C}$ to $+55\text{ C}$. Propagation delay of 15 to 40 nanoseconds.

*Trademark of Signetics Corp.

ON READER-SERVICE CIRCLE 182

*SERIES SE400, NE400 LOW POWER LOGIC

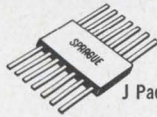

J Package

Operating temperature ranges: -55 C to $+125\text{ C}$, and 0 C to $+70\text{ C}$. For use in Aerospace and other applications where low power drain is required. Optimized speed, noise margin.

ON READER-SERVICE CIRCLE 183

*SERIES SE500 LINEAR AMPLIFIERS



K Package

Operating temperature range: -55 C to $+125\text{ C}$. Two linear circuits available in 10-lead low silhouette TO-5 case. SE501K is a video amplifier, SE505K is a general purpose differential amplifier.

ON READER-SERVICE CIRCLE 184

UNICIRCUIT® RCTL LOGIC

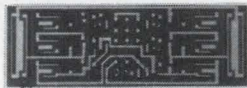

(8x actual size)

Sprague Series US-0100 . . . a complete line of silicon monolithic digital building blocks featuring low power consumption (2 mW typ.)

ON READER-SERVICE CIRCLE 185

UNICIRCUIT® mW RTL LOGIC



TO-5 Case

Types US-0908 through US-0921 . . . Fully interchangeable mW digital building blocks featuring power consumption of 4 mW/node and propagation delay of 40 nsec.

ON READER-SERVICE CIRCLE 186

UNICIRCUIT® CUSTOM HYBRID CIRCUITS

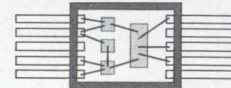

Combine monolithic silicon circuits with tantalum or Ni-Cr alloy resistors. Close resistance tolerances, low temperature coefficient. Resistor matching, $\pm 1/2\%$.

ON READER-SERVICE CIRCLE 187

DIGITAL-TO-ANALOG CONVERSION CIRCUITS



UT-1000—Four-bit ladder network
UT-4001—Ladder switch for driving resistor ladder networks
UT-4024—Buffer amplifier

ON READER-SERVICE CIRCLE 188

***Series SE100, NE100,
CS700, SU300, LU300,
SE400, NE400, SE500
are all available
from Sprague Electric
under technology interchange
with Signetics Corp.**

For data sheets on the microcircuits in which you are interested, write to:

Technical Literature Service
Sprague Electric Company
347 Marshall Street
North Adams, Mass. 01247

SPRAGUE COMPONENTS

INTEGRATED CIRCUITS
THIN-FILM MICROCIRCUITS
TRANSISTORS
CAPACITORS
RESISTORS

PULSE TRANSFORMERS
INTERFERENCE FILTERS
PULSE-FORMING NETWORKS
TOROIDAL INDUCTORS
ELECTRIC WAVE FILTERS

CERAMIC-BASE PRINTED NETWORKS
PACKAGED COMPONENT ASSEMBLIES
BOBBIN and TAPE WOUND MAGNETIC CORES
SILICON RECTIFIER GATE CONTROLS
FUNCTIONAL DIGITAL CIRCUITS

SPRAGUE®
THE MARK OF RELIABILITY

*Sprague' and '®' are registered trademarks of the Sprague Electric Co.

ED News

Communications gap exists in medical electronics PAGE 17

New process boosts gallium arsenide devices PAGE 21

Microwaves used to study rocket plumes PAGE 24

Data and voice time-share a telephone system PAGE 22

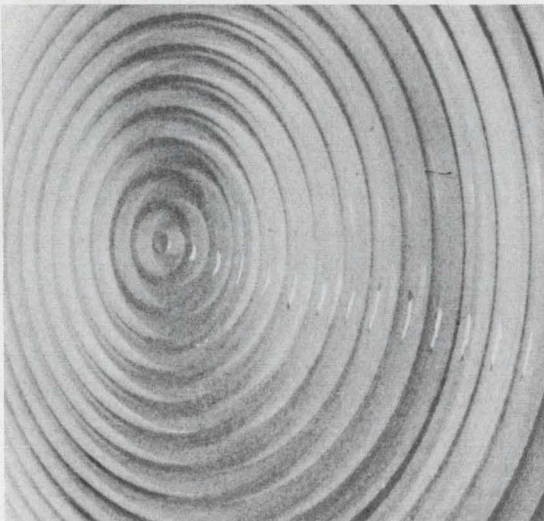

Focusing in on rocket exhaust ... 24



Gallium arsenide—a "growing" business ... 21

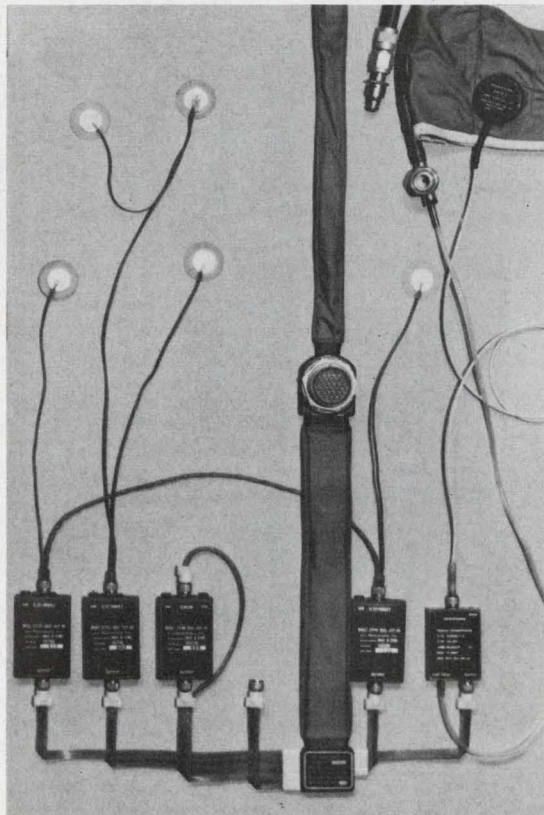

Long-distance blood pressure ... 17



Plug in to the Industry's Most Advanced Counter Line



15 GHz Plug-in
Model 1292

50 & 100 MHz Counters

(Models 1037, 1017/1038, 1018)

Fully Automatic to 12.4 GHz

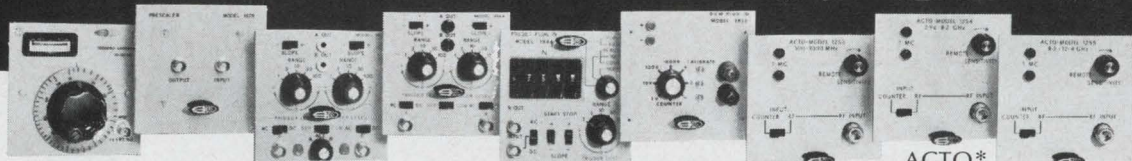

- 512 MHz Converter
Model 1291
- 100 MHz Prescaler
Model 1979
- Dual Measurement
Model 1924
- Time Interval
Model 1926A
- Preset
Model 1944
- DVM
Model 1936
- ACTO*
500-3000 MHz
Model 1253
- ACTO*
2.96-8.2 GHz
Model 1254
- ACTO*
8.2-12.4 GHz
Model 1255

Systron-Donner's system for *direct readout* of microwave frequencies from 0-15 GHz provides an unprecedented simple and low cost solution — features no other Gc counting system offers. Further, S-D's "think ahead" design provides even greater flexibility. As you can see, an ever-growing number of plug-ins can be used interchangeably in the basic 50 and 100 MHz counters. When your digital measuring needs change, you change plug-ins, not counters. That way you always have a state-of-the-art-counter.

EXCEPTIONAL STABILITY—Another exclusive feature of S-D's counter line is a high stability oscillator with an aging rate of better than

1 part in 10⁹ per 24 hours!

NEW INSTRUMENT STYLING—In addition to unmatched performance and flexibility in counting instrumentation, new styling refinements have been added to the entire line of S-D counters: die cast front panel, wrap-around cabinetry, tilt stand, and a simplified method for bench or rack installation.

*ACTO: Automatic Computing Transfer Oscillator plug-ins. For fully automatic microwave measurements with counter accuracy and instantaneous direct readout.



10 MHz Counter
Model 1034



5 MHz Counter
Model 1033



300 kHz Counter
Model 1013

SYSTRON DONNER CORPORATION

888 Galindo Street, Concord, California 94520 • Phone: (415) 682-6161, TWX: 415-687-3200
Speed Inquiry to Advertiser via Collect Night Letter

ON READER-SERVICE CARD CIRCLE 6

Adding fuel to fuel cell

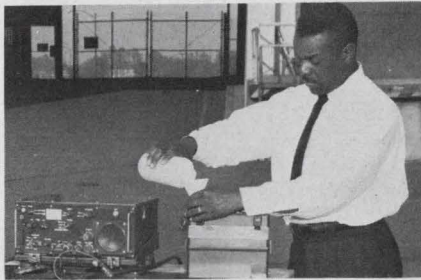

Army develops air-breathing fuel cell

An air-breathing fuel cell for use by front-line troops was demonstrated by the Army at the recent Annual Power Sources Conference at Atlantic City, N. J. The cell uses the nitrogen-hydrogen compound hydrazine for fuel and extracts its oxygen directly from the atmosphere.

The new power source was built by Monsanto Research Corp. under the technical direction of the U.S. Army Electronics Command. It weighs less than 12 pounds, has an output of 60 watts and can operate for 12 hours on one pound, or pint, of fuel.

According to Army spokesmen, the cell's introduction into field use is expected to have a major impact on military portable electrical power equipment. This is because of the fuel cell's silent operation, simple maintenance, low operating temperature and high efficiency for converting fuel into current. In demonstrations, the cell has powered an Army AN/VRC-12 vehicular radio, an Army AN/PPS-4 ground surveillance radar and a Marine Corps manpack radio AN/PRC-47.

Northeast Corridor may acquire branch line

The state of Pennsylvania is investigating the feasibility of a high-speed ground transportation system that would link up with the Federally-sponsored Northeast Corridor high-speed rail system. An \$80,000 contract has been signed with the Westinghouse Air Brake Company to study the possibility of creating a Keystone Corridor, as the east-west rail link would be called.

Westinghouse will investigate and analyze the effect of the various systems under consideration for the Northeast Corridor (ED 6, March 15, 1966, pp. 22-26) on a Keystone Corridor. The company will also study possible routes for 150-mph and 300-mph service across the state, as well as possible rates and schedules for both 150- and 300-mph service.

The Westinghouse contract represents only part of the \$200,000 that Pennsylvania has made available for transportation studies under the Urban Mass Transportation Assistance Act. According to Pennsylvania

News Report

Secretary of Commerce John K. Tabor, "This is a unique Pennsylvania accomplishment, and marks the first such state sponsored program in the nation."

Thick-film transistor announced

A new technique for manufacturing solid-state active devices has been announced by the National Aeronautics and Space Administration. The exploratory work, performed jointly at NASA's Langley Research Center and RCA's Defense Microelectronics Activity, involves the use of deposited thick films to produce majority-carrier field-effect transistors (FETs).

An array of 50 individual FETs, manufactured at RCA's Sommerville plant by this process, was recently evaluated at Langley. NASA physicist Robert Stermer reported that, though the devices did not have the performance of diffused FETs, the practicality of the process had been demonstrated and further research would be undertaken. Stermer indicated that the measured transconductance was greater than 800.

He said that the devices were at present being made with a "wet spray" technique. Powdered cadmium sulfide is first doped and then made into a slurry with water. The slurry is sprayed on to an insulating substrate and deposition of insulating material and aluminum metallization follow. Stermer pointed out that the devices are actually formed by applying voltages to the metal electrodes and accumulating charge carriers along the surface. The cadmium sulfide's inherently high impedance was what made the technique possible, he said. The original idea was jointly conceived by Stermer and Dr. Franz Huber, Group Leader at the RCA Activity, but it was the RCA group that did much of the actual work. As a result, RCA was awarded a \$35,000 contract to continue the materials investigation and further refine the fabrication technique.

The first phase of the contract, Stermer said, will concentrate on study of the doping method (consistency, predictability, etc.) and the possibility of screening the semiconductor material into the substrate, rather than spraying it on.

High-speed logic slows IBM production

Production difficulties with their advanced solid-logic technology (ASLT) circuit packages will delay initial delivery of IBM's super-computer, the System/360, Model 90. Deliveries of the Model 90, which is the largest and fastest member of the System/360 family, were planned to begin in 1967. According to the company, earliest shipments will now be delayed two to three months because of a "production bottleneck".

The ASLT circuit packages (ED, Nov. 8, 1965, pp. 12-15) have delay-time speeds of 1.5 ns, compared with 5 to 30 ns for the solid logic technology (SLT) circuit packages used in the other models of the System/360. The increase in speed is achieved by use of current-steering circuitry and high packaging density. The ASLT packages are designed to be produced on the same automated production line used for the SLT packages.

Klystron amplifier delivers 21 kW cw

The most powerful klystron amplifier known to date has been successfully tested at Varian Associates. The tube puts out 21 kW cw at 18 GHz over a band of 50 MHz with a gain of 60 dB.

"I don't know what the power limitations of the tube are," designer senior engineer Bill A. James said. "100 kW cw seems extremely difficult, but not impossible, with present-day technology". He explained that cryogenic cooling and other improvements could boost the output power considerably. "There is no magic in the design. We simply optimized the well-known design of the beam optics and the electron gun," he added.

The tube's power capabilities are especially important in plasma research, in space communications and in radio astronomy, James claimed.

Nimbus II scores several firsts

The Nimbus II experimental weather satellite, launched recently by NASA, embodies several features not included in any of the other weather satellites now in operation. The two most significant are its capacity for transmitting night-time infrared pictures to simple ground stations, and its inclusion of a code on each transmitted picture to allow ground stations to

determine the time it will be in position and angle to beam in the station's antenna.

Besides photographing the Earth's cloud cover, Nimbus II will measure for the first time the heat balance budget (albedo) of the entire 200-million-square-mile area of the Earth every day. Although the primary purpose of Nimbus II is research and development, data collected will be forwarded to the Commerce Department's Environmental Services Administration for operational weather-forecasting purposes.

Sylvania will light up stamps

A phosphor that has particles of unusually minute size has been developed by Sylvania Electric Products, Inc., and will soon be incorporated in the ink used to print all U.S. postage stamps. The phosphor will make it possible for machines to differentiate between regular stamps and air-mail stamps and thus facilitate the automatic processing of mail.

Six different phosphors were tried during a two-year test by the Post Office Department at Dayton, Ohio. On the basis of this test, two of the phosphors were chosen for nationwide use: an orange-red phosphor for airmail stamps and a green phosphor for regular stamps. There are 204 machines, currently in use in 40 cities, capable of identifying the "tagged" stamps.

Mariner IV back in range

The Mariner IV spacecraft, which took the world's first close-up pictures of Mars last year, is again in contact with Earth, reporting on the space environment and its own operating performance after 18 months of flight. On October 1, 1965 telemetry contact with the spacecraft in its orbital path around the sun was lost at the then unprecedented distance of 191 million miles. Since then NASA has put into operation its new 210-foot diameter antenna at Goldstone, California, and on May 21, 1966 the 210-foot dish began receiving Mariner telemetry signals from a distance of 197.5 million miles.

The new signals indicate that all spacecraft systems are operating properly. Mariner IV is now transmitting over its low-gain antenna, since the high-gain antenna used during the Mars flyby is no longer pointing towards the Earth.

A preliminary analysis of the signals received by the Goldstone antenna indicate that Mariner IV has exceeded its designed life by more than 100 per cent.

An updated "Who's who" in electronics manufacturing in the western states has been published by the Western Electronic Manufacturers Association (WEMA). Copies can be obtained for \$5 from WEMA, 3600 Wilshire Blvd., Los Angeles, California 90005.

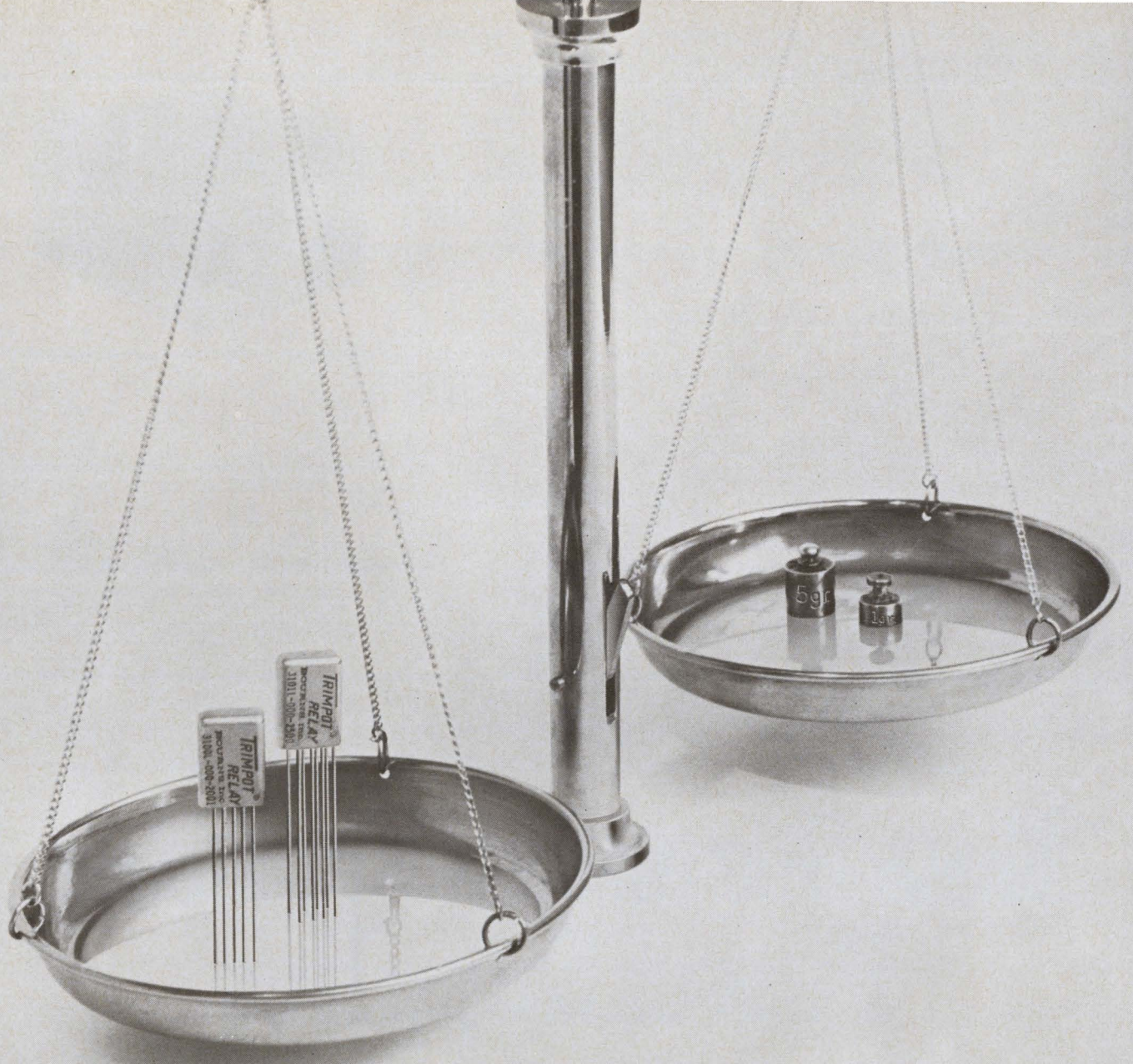

Relay Reliability in 3-Gram Packages

You can cut problems down to size with the Bourns TRIMPOT® Model 3100 SPDT and Model 3101 DPDT relays. These proven units give you MIL-Spec reliability and 160 mw sensitivity in a package size of less than 1/20 cubic inch. Punish them with 150G shock or 40G, 3000 cps vibration, and you still get the performance that's on the published data sheet. Features include highly efficient magnetic circuit, rotary balanced armature, hermetically sealed case and self-cleaning contacts. Environmentally they exceed requirements of MIL-R-5757D.

With these relays, there is little chance of "infant mortality" in your circuits. Bourns double-checks each unit with a 5000-operation run-in followed by 100% final inspection for all important characteristics, including mass-spectrometer leak testing. Furthermore, Bourns tests samples quarterly in the famous Reliability Assurance Program that it created for TRIMPOT potentiometers. In short, you can trust the name TRIMPOT in relays, too.

Other TRIMPOT relay products available from Bourns: Model 3105 subminiature AC DPDT and a full line of miniature adjust-

able time-delay and voltage-sensing relays and modules. Delivery is immediate. Write today for complete technical data.

Size:	0.2" x 0.4" x 0.6"
Max. operating temp.:	125°C
Contact rating:	1.0 amp resistive, 26 VDC
Pickup sensitivity:	100 mw (Model 3100) 160 mw (Model 3101)
Standard coil resistances:	50 to 2000Ω (Model 3100) 65 to 2000Ω (Model 3101)



Model 3100 (SPDT)



Model 3101 (DPDT)

units shown actual size



BOURNS, INC., TRIMPOT DIVISION, 1200 COLUMBIA AVE., RIVERSIDE, CALIF.
PHONE 684-1700 • TWX: 714-682 9582 • CABLE: BOURNSINC.

TRIMPOT means BOURNS—BOURNS means QUALITY
TRIMPOT is a registered trademark of Bourns, Inc.

TRIMPOT® AND PRECISION POTENTIOMETERS — RELAYS — MICROCOMPONENTS: TRANSFORMERS, INDUCTORS, RESISTORS AND CAPACITORS

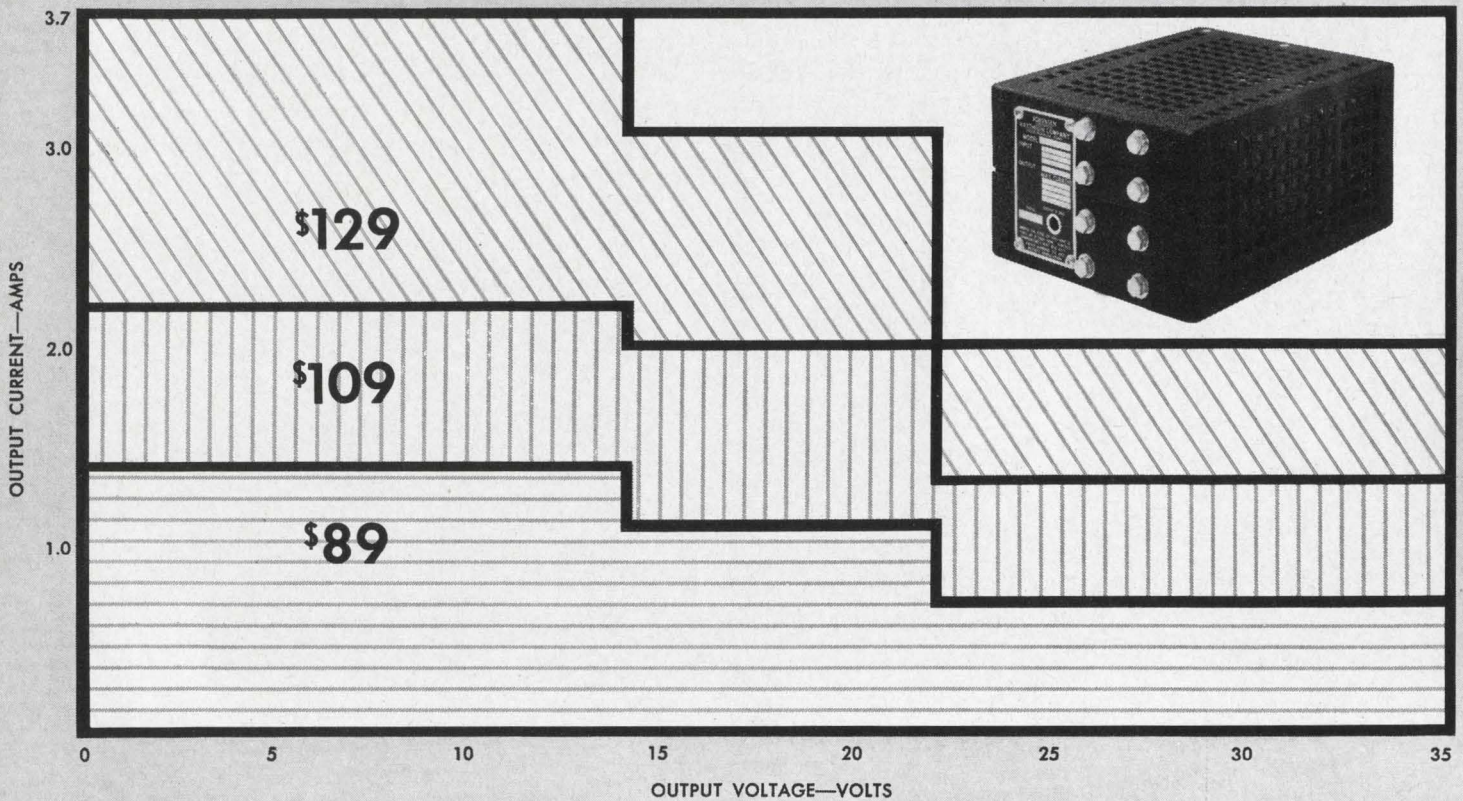

All-silicon QSA Series: 12 models; regulation $\pm .005\%$; response time 20 μs .

New Sorensen Modular Power Supplies

The new Sorensen QSA Series offers the only modular power supply line in the 0 to 35 volt range that combines $\pm .005\%$ regulation line and load, 20 μs response time, 71°C operating temperatures, 300 μV ripple—all at prices below other lines having lesser performance specifications. Sorensen's QSA Series modules are ideal for OEM, lab or system applications. They can be used as bench models (mounted in any position) or mounted in combinations of 3 or 4 in an optional 19" (3½" high) rack adapter. Other design features include: Load current vs. temperature, 110% @ 40°C—100% @ 50°C—85% @ 60°C—66% @ 71°C • Temperature coefficient 0.01%/°C • Stability

0.025%/8 hrs. • Models QSA10-1.4, QSA10-2.2 and QSA10-3.7 permit operation of up to 20 units in series; other units permit operation of 2 units in series; All models permit operation of 4 units in parallel • No turn-on/turn-off overshoots • Remote sensing • Remote programming • Ripple voltage peak to peak 3mV. All Sorensen power sources conform to proposed NEMA standards. For additional QSA Series details or for data on other standard/custom DC power supplies, AC line regulators or frequency changers, call your local Sorensen representative, or write: Raytheon Company, Sorensen Operation, Richards Avenue, Norwalk, Conn. Tel: 203-838-6571, TWX: 710-468-2940.

SPECIFICATIONS

MODELS (RANGES)	QSA10-1.4 (0-10V, 1.4A) QSA12-1.4 (8-14V, 1.4A) QSA18-1.1 (14-22V, 1.1A) QSA28-.7 (22-35V, .7A)	QSA10-2.2 (0-10V, 2.2A) QSA12-2.2 (8-14V, 2.2A) QSA18-2.0 (14-22V, 2.0A) QSA28-1.3 (22-35V, 1.3A)	QSA10-3.7 (0-10V, 3.7A) QSA12-3.7 (8-14V, 3.7A) QSA18-3.0 (14-22V, 3.0A) QSA28-2.0 (22-35V, 2.0A)
SIZES (IN.)	7 x 3-5/16 x 3-7/8	7 x 3-5/16 x 5-1/8	10 x 3-5/16 x 5-1/8
PRICES (U.S. List)	\$89	\$109	\$129

RAYTHEON

Medical electronics: design deficiencies cited

Communications gap between engineer and physician discussed at biomedical symposium

Ralph Dobriner
West Coast Editor

Though the role of electronics in medicine continues to grow apace, so too does the communications gap between physicians and electronic designers.

This apparent contradiction was evident at the recent Biomedical Sciences Symposium in Anaheim, Calif. There, a variety of new bio-electronic monitoring systems, sensory devices and specialized computer systems to aid in medical diagnosis and research were discussed. Yet, many of those present felt that much of the equipment—such as the large automated physiological monitoring systems—are expensive, rather complex to operate and often designed by engineers unfamiliar with medical requirements.

Only 1% of patients benefit

Dr. David Davis, Professor of Surgery at the University of North Carolina School of Medicine, said: "In spite of fantastic improvements in instrumentation and considerable publicity attending the use of such instrumentation in patient care, it is doubtful that more than 1% of patients deserving this 'improved' care actually receive it."

"What could be done has not been done," he observed, adding that the number of people that benefit from modern instrumentation was questionable. The principal cause for this lack of clinical application of instrumentation, according to Dr. Davis, has been the failure of the clinician and designer to get together on the design requirements.

It is simply a lack of education, he said, noting that physicians, physical scientists and engineers simply do not speak the same language: they don't think alike and there is no contact in the literature of each profession.

The surgeon said that the average practicing physician, no matter how

skillful and successful, is absolutely unfamiliar with such terms as strain gauge, spectrophotometer, analog or rectifier. On the other hand, the physical scientist and engineer has usually had no exposure to biological systems, and, for example, the variable responses of a cell, Dr. Davis said.

Reasons for lack of use

Why have so-called monitoring systems not become widely used? Dr. Davis gave the following reasons:

- *The instrumentation is incompatible with clinical situations.* The designers of medical instruments have no place to go to test their prototypes. Mostly their hospital connections are few and the family physician may be their only source of friendly advice. For example, many transducers function beautifully in

aqueous solutions. Blood is principally an aqueous solution, but it also possesses the important and life-saving property of clotting. A surprising number of designers have neglected this well-known fact.

- *The instrument does not present information in an intelligible or useful manner to the physician.* The well-known electrocardiogram, for example, provides the instrument designer with a signal relatively easy to obtain, being essentially nothing more than a low-frequency series of pulses in the millivolt range. But the recording represents only a brief period in the patient's life and marked and significant changes may take place in seconds as well as over years.

Techniques for the continuous display of the electrocardiogram on oscilloscopes have been developed and many devices are on the market. The information, however, is significant only if observed and interpreted in a patient who is under constant surveillance by a physician



Microminiature temperature transmitter, designed to be implanted in a human body, is said to be capable of detecting temperature changes of 1/100 to 1/1000°C. Developed by NASA's Ames Research Center, the transmitter contains four hybrid integrated-circuit chips mounted inside a hermetically sealed can for protection from body fluids. The circular portion contains the battery and antenna and is usually left outside the body.

(biomedical, continued)

trained in electrocardiographic interpretation.

What this means, then, is that, regardless of improved data collection techniques, better means of data storage and recall are needed and, more important, methods of cross-correlation data. Attempts have been made to use large multi-purpose computers for this, but little has been done with small, specialized computers.

■ *The information presented is not particularly important to the existing clinical situation.* Many instruments have been developed which display information in which the physician is not particularly interested. For example, few physicians require minute-by-minute measurements of body temperature in clinical situations. Also, many monitoring devices are developed around a physiological function that is easy to measure but which may mean little.

■ *Many medical monitoring instruments are unreliable.* The requirements of instrumentation used in clinical care may exceed even those imposed by military specifica-

tions. Any instrument the size of a cigarette package is surely, within a week, dropped on the floor, sent to the laundry or steam-sterilized. An instrument that cannot withstand these stresses is useless.

Equipment must meet needs

Drs. Stewart Wilber and William Derrick of the University of Texas cited the great need for reasonably priced instrumentation for simple, straightforward monitoring of patients in critical care areas, including all major operating rooms. Apparently, the only way to get this type of equipment, they said, is through a joint effort by the whole electronic industry and medical profession to establish standards.

They referred to studies that show that there would be buyers for equipment that met the biological, clinical and economic needs of doctors and hospitals. The medical-care dollar will be spent on purchasing instrumentation that is basic in function and adaptable to several uses. Hospitals and research institutes are not willing to pay large sums of money for equipment that does not fill medical needs, they said.

Another important consideration mentioned by the doctors is simplicity and ruggedness of design.

"There is not time for calibration and setting of the base lines and plate currents, especially in what is considered the minimum monitoring equipment required for clinical critical-care use. If this is necessary, the cause is lost and the equipment is not used," the physicians said.

They also stressed the need for explosion-proof miniature electronic systems that are compatible with all types of biological signals and free from interference from X-rays, cauteries and ground loops of numberless variety.

This includes telemetering systems for data-acquisition in the operating room. The doctors suggested that wireless telemetry of data directly from the patient into the computer would be useful.

The toughest instrument problem in clinical investigation, they felt, was that of transducers. These simple and sometimes delicate devices may be affected by noise created by the subject or the instrument itself.

"The confounding noise created by modulation of the desired signal by other biological activity of similar frequencies creates severe problems," the doctors said.

Army studies biological armor

Among the newest and most unusual applications of medical electronics discussed at the symposium was a current program sponsored by the Army Medical Material Div. to develop a transportable type of biological equipment.

The instrumentation, referred to as "biological armor" by Moses Berlin of Sylvania Electronic Systems, Needham, Mass., is designed to help the soldier to combat the exotic condition he is liable to encounter in various parts of the world, such as weather extremes and endemic diseases.

Instead of using medical equipment originally designed for fixed hospital uses—and therefore bulky and fragile—the Army is focusing on the design of special-purpose, compact transducer and telemetry gear. Equipment carried by the soldier would constantly radio back to a central computer the soldier's physiological responses to varying

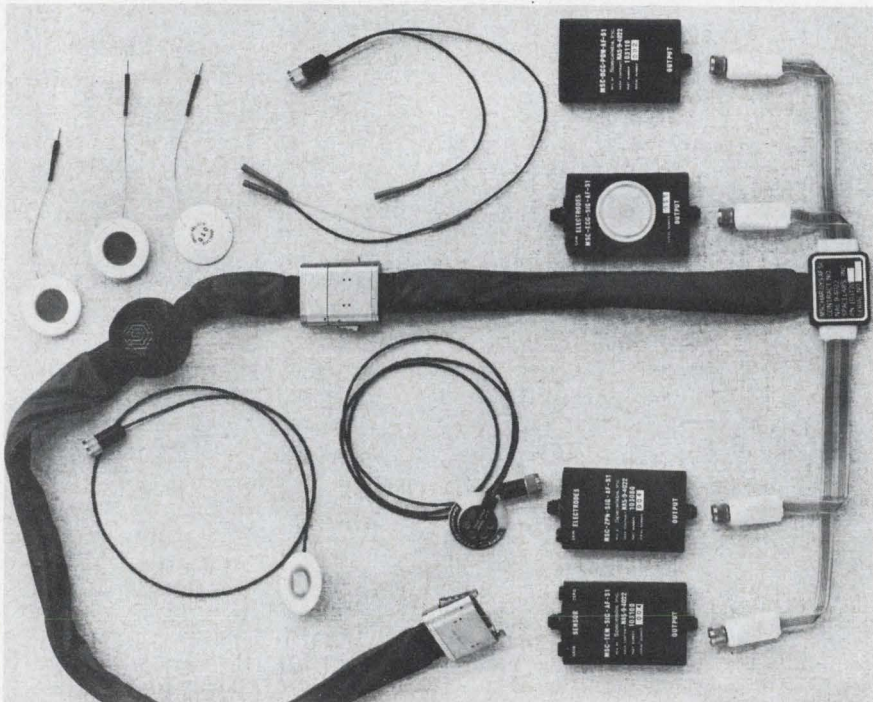

Apollo bioinstrumentation system to be worn by astronauts records and radios back to earth physiological measurements, such as body temperature, respiration and heart rate. Developed by Spacelabs Inc., Van Nuys, Calif., the system is now undergoing qualification tests.

in meters



SPRING-BACKED



CUSHION-BACKED

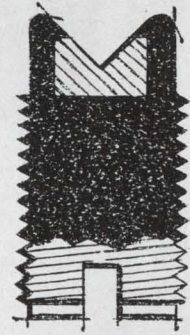

FIXED

look for this

watch out for this

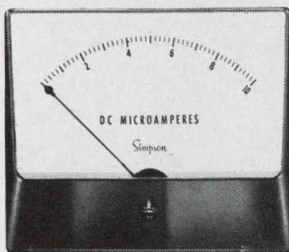

SPRING-BACKED JEWELS (left above) dissipate much of the shock energy on a movement's moving part. This prevents damage to the jewel and avoids subsequent "stickiness" or inaccuracy. In contrast are the two constructions shown above right... so-called cushion-backed and fixed jewels. The fixed absorbs no shock at all. The cushion-backed protects a little, but still won't do the job under the rugged use to which most of us put meters and test equipment. ■ On the other hand, a spring-backed jewel permits full deflection with less than 20% increase in pivot pressure. Simpson makes a complete selection of spring-backed meter movements as well as fixed. The spring-backed type costs only about 20¢ more than a cushion-back, and 40¢ more than a fixed jewel. Is the spring-backed jewel worth the small extra amount? You bet it is, say most of our customers. ■ Write for Stock Catalog No. 2073 which lists 1400 sizes and types. It may well be the cure for meter headaches and complaints in your equipment.



Simpson
INSTRUMENTS THAT STAY ACCURATE

SIMPSON ELECTRIC COMPANY
5202 W. Kinzie Street, Chicago, Ill. 60644 • Phone: (312) ESTebrook 9-1121
Representatives in Principal Cities See Telephone Yellow Pages
Export Dept.: 400 W. Madison St., Chicago, Ill. 60606 Cable, Simelco
In Canada: Bach-Simpson Ltd., London, Ontario
In India: Ruttonsha-Simpson Private Ltd., Vikhroli, Bombay

WORLD'S LARGEST MANUFACTURERS OF ELECTRONIC TEST EQUIPMENT

ON READER-SERVICE CARD CIRCLE 7

6 Reasons Why SPRAGUE is a Major Resistor Supplier

FILMISTOR® PRECISION FILM RESISTORS



metal-film, molded case

Distinct limited temperature coefficients and low tolerances to meet exacting application requirements. Rugged end cap construction for long-term stability and reliability. Superior resistance to humidity and mechanical damage. Surpass MIL-R-10509E requirements. Send for Bulletin 7025B.



deposited-carbon, molded case

Approach precision wirewounds in reliability and stability, yet are smaller in size and have lower self-inductance. Low, controlled temperature coefficient. Dense molded case provides outstanding humidity protection. Send for Bulletin 7000A.



deposited-carbon, conformal coated

Full rated load operation at 70 C with no wattage derating. Assured uprated loads at lower operating temperatures. Ideal for circuitry where small size, humidity resistance, and close tolerance ($\pm 1\%$) are required. Send for Bulletin 7005A.

ON READER-SERVICE CARD CIRCLE 891

ACRASIL® PRECISION/POWER WIREWOUND RESISTORS



silicone-encapsulated

Combine the best features of both precision and power wirewound types. Resistance tolerances to $\pm 0.05\%$. Unusually tough encapsulation protects against shock, vibration, moisture, fungus. Meet MIL-R-26C requirements. Smaller than conventional wirewounds, yet greater in stability. Send for Bulletin 7450.

ON READER-SERVICE CARD CIRCLE 892

BLUE JACKET® VITREOUS ENAMEL POWER WIREWOUND RESISTORS



All-welded end cap construction with special vitreous coating for long-term dependability. Axial-lead style for conventional wiring or on printed boards. Tab terminals for higher wattage applications. Meet MIL-R-26C requirements. Send for Bulletins 7400B, 7410D, 7411A.

ON READER-SERVICE CARD CIRCLE 893

KOOLOHM® CERAMIC-SHELL POWER WIREWOUND RESISTORS



Exclusive ceramic-insulated resistance wire permits "short-proof" multilayer windings for higher resistance values. Standard and non-inductive designs. Non-porous ceramic shell for moisture protection and electrical insulation. Axial-lead, axial-tab, and radial-tab styles. Send for Bulletins 7300B, 7305, 7310.

ON READER-SERVICE CARD CIRCLE 894

GLASS-JACKETED POWER WIREWOUND RESISTORS

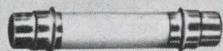

Ferrule terminals soldered to metallized ends of glass casing for true hermetic seal. Virtually failure-proof, even in extremely corrosive industrial and salt atmosphere. Standard and non-inductive windings. External meter-multiplier types also available. Send for Bulletins 7350, 7420, 7421.

ON READER-SERVICE CARD CIRCLE 895

STACKOHM® POWER WIREWOUND RESISTORS



Flat silhouette permits stacking of resistor banks in close quarters. Aluminum thru-bar simplifies mounting and conducts heat from resistance element. Vitreous enamel protective coating. Meet MIL-R-26C performance requirements. Send for Bulletin 7430.

ON READER-SERVICE CARD CIRCLE 896

For complete technical data, write for engineering bulletins on the resistors in which you are interested to: Technical Literature Service, Sprague Electric Company, 347 Marshall Street, North Adams, Massachusetts.

45R-166-63 R1



Sprague and *®* are registered trademarks of the Sprague Electric Co.

NEWS

(biomedical, continued)

conditions in the field. The computer would analyze and interpret the information to help predict the soldier's performance and to improve self-aid and first aid.

Astronaut behavior monitored

Berlin also described an unusual application of a computer that would determine the psychological reactions and behavior of astronauts during long space voyages and so prevent failures that might jeopardize the trip.

A preprogrammed digital computer would be put aboard the spacecraft and, with adequate inputs derived from previous experience and known psychological behavior patterns, help to predict the astronauts' reactions. The psychological environment can then be programmed to make the pilot's adaptation easier and his performance more reliable, Berlin said.

For example, he observed it may be necessary to provide a diurnal-nocturnal cycle to simulate night and day in the space vehicle so that the pilot could sleep. The computer would program the duration of each phase of the cycle and control the conditions which constitute night: darkness, less humidity, cooler temperature, lower noise.

The occurrence of fatigue in the astronaut could be determined by measurement of blood sugar content and periods of rest scheduled optimally. If more than one spaceman was aboard, the relative psychological condition of each could be evaluated and an alternating assignment of command established. ■ ■

Accuracy

The author points out that in "Bootstrap action yields high Z_{in} wideband amplifier" (ED 10, Apr. 26, 1966, p. 93) the last line of the third paragraph should read: "... The 1.1- μ F and 33- μ F (not 3- μ F) capacitors."

The two photographs appearing on pp. 21 & 22 of ED 11, May 10, 1966, were wrongly captioned. The caption under photograph 1 applied to 2 and vice versa.

New process boosts gallium arsenide devices

Vapor phase growth makes possible GaAs devices that cannot be easily produced by other processes.

René Colen
Microelectronics Editor

"Vapor phase growth will do for gallium arsenide what alloying did for germanium and diffusion did for silicon," said Dr. Fred D. Rosi, associate director of the Materials Research Program at RCA Laboratories, as he announced RCA's development of a practical process for manufacturing gallium arsenide solid-state devices.

He added that experimental devices had already been made by this process that could not be made by any other. These devices are: an extremely bright photoemitting diode (red); a visible-light laser operating at room temperature; a high frequency Gunn-effect oscillator (up to 40 GHz); an electro-optical modulator for visible laser beam communications; and varactor diodes possessing high voltage and high cut-off frequency ratings.

Process uses gaseous sources

Rosi, speaking at an RCA news conference late last month, stated that this development involves the use of gaseous sources to form complete semiconductor devices in crystals of gallium arsenide and its alloys.

Rosi pointed out that both the impurity doping and the crystal growth is accomplished simultaneously in a single continuous operation. Beside being inherently simple, he said, this process avoids the contamination that is often found in alloying and diffusion technologies, where processing is accomplished in a number of discrete steps.

Describing the process, Rosi said that a gallium arsenide substrate is placed in a glass tube through which the various vapors are passed. Connected to this tube are a set of gated inlets that provide any combination of gases desired. The accompanying table summarizes Rosi's description of the

gases used and their purpose.

He pointed out that by adjusting the gas flows, any sort of growth may be accomplished: phosphide may be grown on gallium arsenide and doping may be changed from n-type to p-type. In addition, he noted, it is possible to control the crystal concentrations very accurately as a function of time, and thus form graded impurity concentrations and alloy growths.

This is highly desirable, he explained, since, in the former case, any sort of junction types may be made, and, in the latter case, the two crystal structures can be closely matched at their interface to prevent any crystal strain.

Dr. James Tietjen, developer of the vapor-phase process, claimed that hyper-abrupt junctions, where the impurity concentration goes from high to low to high, could theoretically be manufactured by this process. He wistfully added, however, that such work had not been performed yet.

Experimental devices produced

Tietjen, and his supervisor, Dr. Leonard Weisberg, demonstrated and showed a number of the devices built by this process. Among these were some of the photo-diodes, mounted in a standard pocket flashlight case, which emitted a bright red light, even in the presence of a high ambient incandescent light. RCA specifications on these devices indicate that the measured brightness at room temperature is over 500 foot-lamberts (@6000Å) with a current density of 1 amp/mm². Weisberg pointed out that a number of these devices had been made and that by varying the dopant gradient, a continuous improvement in efficiency had been achieved.

Also shown were some cut-away samples of the varactor diodes that were made by this process. Weisberg pointed out that 1000 of these diodes had been made and that the

over-all yield, including handling, had been about 40%. The diodes, composed of a 5-mil heavily doped (selenium) N⁺ region, a 0.2-mil undoped N region, and a 0.5-mil heavily doped (zinc) P⁺ region, have a breakdown voltage rating of 60-to-100 volts, a cut-off frequency of 120-to-220 GHz, and a junction capacitance of 0.3-to-0.7 pF.

Rosi described the laser device as the first injection laser ever to emit visible light at room temperature. He claimed that the laser had a peak power output (@7260 Å) during a 20-ns current pulse of 60 amperes. He noted that the device was made from a gallium arsenide-phosphide alloy with a 33% phosphorus concentration.

According to Rosi, the opto-electronic modulator has one basic advantage over already existing types of optical modulators: it can be transversely modulated. Since the quality of modulation varies inversely with length, the longer the crystal is, the better it is, he pointed out. By being able to modulate transversely, an extremely long crystal can be used without the need for inordinately high driving voltages. Aside from this advantage, the device is also claimed to be rugged, insensitive to temperature and moisture, and to have a rela-

Chemicals used in growth process

Chemical & use	How formed
Gallium (Ga)- Ga growth.	Passing HCl vapor over molten Ga.
Arsenic (As)- GaAs growth.	Cracking arsine gas (AsH ₃).
Phosphorous (P)- GaP growth.	Cracking gaseous phosphine (PH ₃).
Selenium (Se)- n-dopant.	Cracking gaseous selenide (H ₂ Se).
Zinc (Zn)- p-dopant.	Cracking zinc vapor.
Hydrogen (H ₂)- carrier.	(ultra-pure)

(gallium arsenide, *continued*)

Get immediate delivery on Vector **2N3866** and **2N4012** RF power transistors

Vector's 2N3866 NPN silicon power transistor is available now in production quantities. This unit can also be ordered in a TO-18 alumina channel or stripline package.

Also, Vector's new 2N4012 transistor is in stock for immediate delivery in quantities up to 1,000 units. The 2N4012 features a JEDEC TO-60 package with isolated electrodes, and stud mounting for maximum thermal capability.

Vector offers a wide range of RF power transistors with guaranteed performances as shown in this chart.

PERFORMANCE OF RF POWER TRANSISTORS

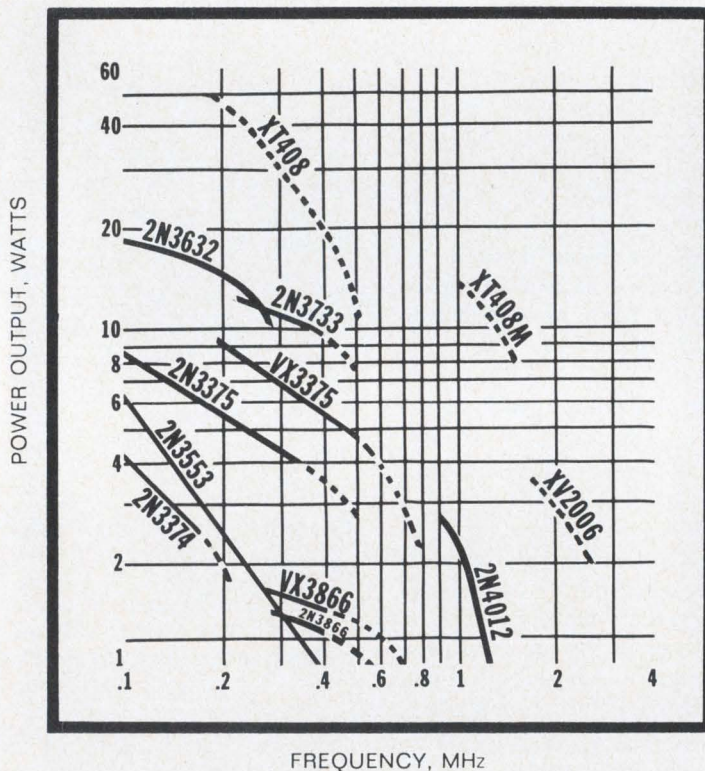

For additional information, price quotations, or immediate delivery, call Vector Solid State Laboratories (215) 355-2700. TWX 510-667-1717.

Vector DIVISION OF UNITED AIRCRAFT CORPORATION
SOUTHAMPTON, PENNSYLVANIA 18966

U
A

tively low dielectric constant.

Rosi indicated that the answer to making high-frequency Gunn-effect devices is to make the middle layer of the three-layered device as thin as possible. He supported this by describing RCA's measurements on the devices they made: with a 10- μ thickness, the diode oscillated at 14 GHz; with a 5- μ thickness, the diode oscillated at 25 GHz; and with a 1- μ layer it went to 40 GHz. He added that these diodes had been pulse-operated with a 40% duty cycle and that he expected to have a continuous-wave device soon.

Dr. Joseph Donahue, manager of RCA's Industrial Semiconductor Operations Dept., announced that a group of 15 people had been formed to handle the development work on these devices. He expects that the photo-emitting diodes will be made available on the market by next fall. ■ ■

Data fits into lulls in telephone talk

A new system stores data, compresses it and then transmits it at high speed over telephone lines during the pauses and silences in normal conversation.

Studies have shown that lines carry signal only 36% of the time in ordinary conversation. The remaining 64% is dead time. Silence between speakers accounts for 48% of total transmission time, and normal speech pauses comprise 16%, according to ITT, New York, creators of the system.

They call it Automatic Alternate Voice/Data. Its heart is a rotating magnetic drum. The telephone conversation is actually recorded and played back in transit between talker and listener, but this takes place so rapidly that an utterance is delayed only a small fraction of a second.

The device detects an utterance during this delay and switches the line from its data channel to its speech channel. As soon as the speaker pauses, the data transmission is resumed. Speech is always given priority over data. ■ ■

3 ways you can use the Raysistor[®] to improve your product, cut costs

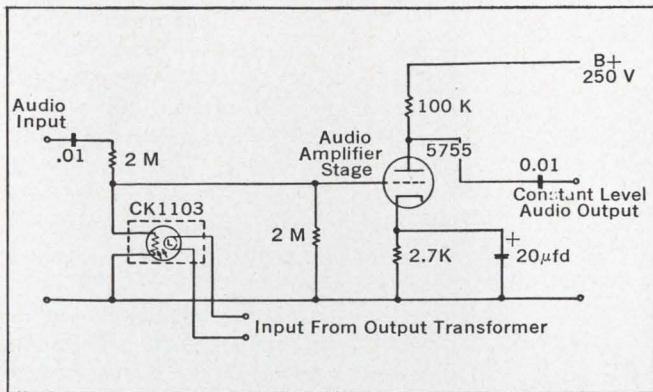

1. Use the Raysistor[®] as a simple remote or automatic volume control in SSB suppressed carrier receivers. Feeding part of the audio output into the control light source varies the resistance of the Raysistor's photocell, making it usable in place of a normal volume control.

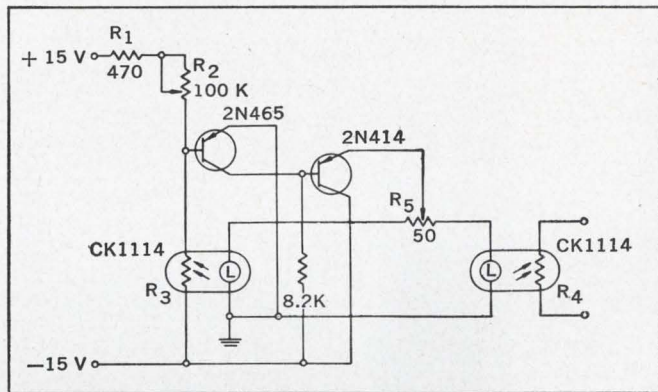

2. As a remotely controlled linear potentiometer. The Raysistor can be used as a remotely controlled linear potentiometer when used in the circuit shown above. Here the Raysistor forms a voltage divider between the positive and negative voltages.

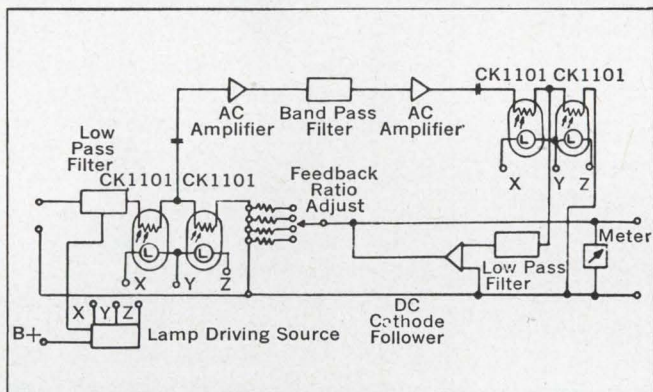

3. As a photochopper stabilized D-C microvoltmeter. Raysistors, used as photochoppers in both modulator and demodulator circuits, enable d-c levels to be measured to a fraction of a microvolt. They facilitate synchronous detection and demodulation with simple electrical coupling, have less noise than transistor choppers, while avoiding maintenance problems of mechanical choppers. Other photochopper applications: photochopper relay, series or shunt chopper, modulator circuit, and as a stabilizer to reduce long-term drift.

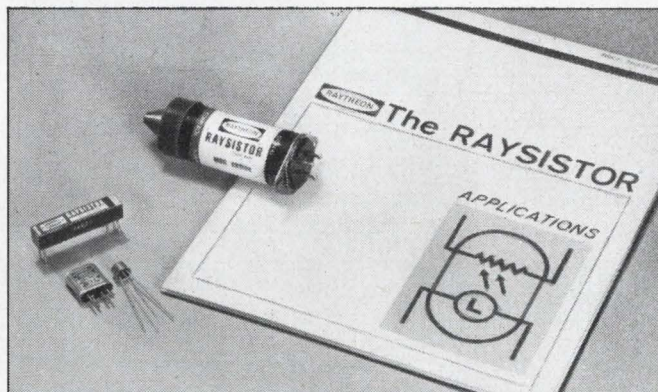

Many more ways you can use the Raysistor. Send for *The Raysistor Applications Manual* which describes ways you can use this unique optoelectronic component as a photochopper, variable resistor, solid-state switch, relay, voltage or signal isolator, nonlinear potentiometer, etc. For complete specifications and prices, call your Raytheon distributor or regional sales office. For a copy of this 28-page manual, circle the reader service card or write *Raytheon Company, Components Division, 141 Spring Street, Lexington, Mass. 02173.*



Raytheon Components Division—A single source for Transistors/Diodes/Integrated Circuits/Industrial Tubes/Control Knobs/Panel Hardware/Raysistors/Circuit Modules/Display Devices

ON READER-SERVICE CARD CIRCLE 9

VOLTMETER WITH A MEMORY ...DC TO 20 MEGACYCLES

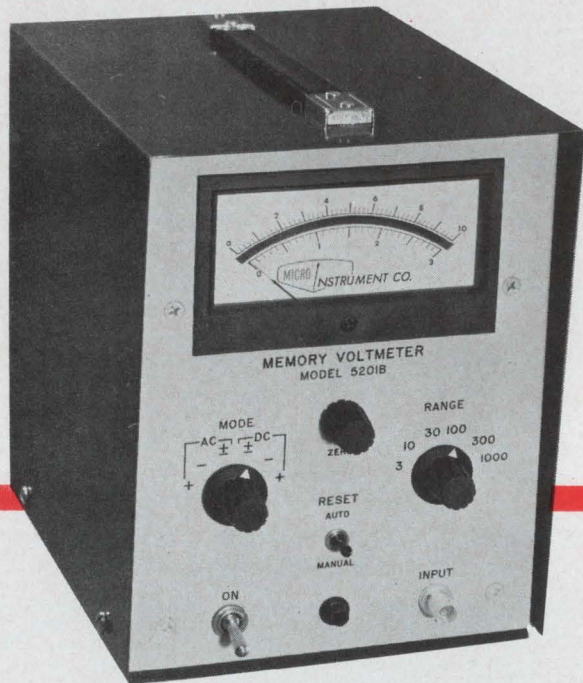

The Model 5201 memory voltmeter is a dc to 20 mc instrument which measures and stores indefinitely the maximum peak voltage applied, including continuous or one shot pulses as short as 50 nanoseconds. A memory reset-switch on the front panel allows the 5201 to monitor peak values of a varying waveform, either positive or negative going.

The solid-state 5201 is also available with a 4-digit in-line Nixie® tube readout. The voltage range may be extended to 30 kv with optional high voltage probes. For complete technical information, contact the Micro Instrument representative near you or write directly to us.

Specifications

VOLTAGE RANGE	0-3, 10, 30, 100, 300, 1000 volts. Can be operated up to 1000 volts above ground.
INPUT IMPEDANCE	100 k-10 megohms (depending on range).
PULSE WIDTH	DC to 50 (typically 30) nanoseconds.
OPERATING MODES	+, -, ± (DC or AC coupled).
READOUT	5" mirror-backed 1% meter.
PRICE	\$695.00.



13100 CRENSHAW BLVD., GARDENA, CALIFORNIA 90249
PHONES: (213) 323-2700 & 321-5704 / TWX (213) 327-1312

ON READER-SERVICE CARD CIRCLE 10

NEWS

Microwaves used to study rocket plumes

Microwaves are being employed to measure the intensity of radio interference and noise generated by rocket-motor exhaust combustion by-products.

The work is being conducted at the new Microwave Interference Test Facility at Lockheed Propulsion Corp., Redlands, Calif.

Interference caused by combustion by-products may interrupt communications between a missile or spacecraft and ground control stations, according to a Lockheed spokesman.

Two lens-corrected horn antennas, built by DeMornay-Bonardi, Inc., Pasadena, Calif., focus the microwaves through the heart of the rocket exhaust plumes.

The horns are mounted on opposite sides of an equipment ring through which the exhaust is passed. One of the horns transmits the energy, concentrating it within a selected area, while the other horn acts as a receiver. The difference between the signal transmitted and that received is detected by an interferometer. The effect of the exhaust upon the microwave signal helps to determine the degree of ionization of the exhaust plume.

Other antennas, high-speed cameras and infrared detectors are mounted on a movable cart and propelled down the length of the plume. ■ ■

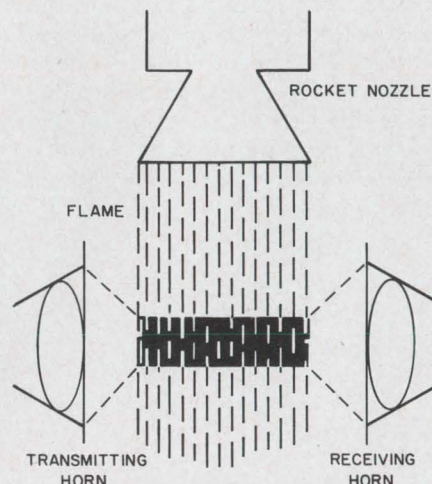

Lens-corrected horns focus microwaves through solid rocket exhaust plume.

in stock...in quantity 6x8 monolithic diode matrices

Exclusive dielectrically isolated circuits and fusing techniques provide unlimited matrix designs

Radiation's highly flexible 6 x 8 matrix is available for immediate shipment in quantity. These circuits contain 48 active devices per chip. A fusible link in series with each diode permits unlimited matrix patterns to be formed. In addition, matrices can be combined to provide an infinite variety of matrix sizes and configurations—6 x 8, 6 x 16, 12 x 8, 12 x 16 ... $n_1 \times n_2$!

In addition to *flexibility*, Radiation matrices provide other important benefits: *System reliability* is increased by monolithic construction. *Space requirements* and weight are slashed through use of fewer packages. And, assembly of discrete diodes is eliminated.

Only Radiation supplies monolithic diode matrices. Write or phone for our detailed data sheets which include worst-case limits and all information required by design engineers. Radiation Incorporated, Physical Electronics, Department ED-05, Melbourne, Florida 32901. Phone: (305) 723-1511, extension 554.

flexibility ↑
reliability ↑
size & weight ↓

All Radiation integrated circuits are dielectrically isolated.

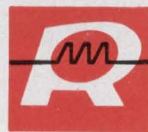

**RADIATION
INCORPORATED**

Radiation RM-30 Diode Matrix*

CHARACTERISTIC	TYP LIMITS	TEST CONDITIONS
Forward drop $V_f(20)$ $V_f(1)$	1.0 v 0.7 v	$(T_A = +25^\circ\text{C})$ $I_F = 20 \text{ ma}$ $I_F = 1 \text{ ma}$
Reverse breakdown BV_R	60 v	$I_R = 100 \mu\text{a}$
Reverse current I_R	7 na	$V_R = 25 \text{ v}$
Reverse recovery t_{rr}	7 nsec	$I_F = 10 \text{ ma}$ $I_R = 10 \text{ ma}$ Recover to 1 ma
Crosspoint capacitance C_{cp}	1.9 pf	$V_R = 5 \text{ v}, f = 1 \text{ Mc}$
Coupling coefficient I_{cl}	20 na	

*Supplied in TO-84 packages.

Sales offices: Suite 622, 650 North Sepulveda Blvd., El Segundo, Calif. (213) 772-6371—Suite 438, 600 Old Country Road, Garden City, N. Y. (516) 747-3730—P.O. Box 37, Melbourne, Florida (305) 723-1511.

Speed Inquiry to Advertiser via Collect Night Letter

ON READER-SERVICE CARD CIRCLE 11

A BRUTE

THE SIZE OF A MIDGET!



READ HOW IT CAN SOLVE
YOUR SPACE PROBLEMS

THIS 4 AMP, 100 AMP SURGE RECTIFIER
HAS CONTROLLED AVALANCHE TOO

CASE HISTORY

Bob has the job of designing power supplies for his company, an electronic equipment manufacturer. Requirements vary considerably from one piece of equipment to the next, with ratings all the way from 1 to 10 amps in both single and three phase configurations. He had a dilemma--what should the physical arrangement of his bridges be:

This

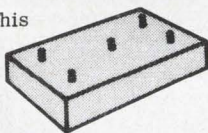

or this

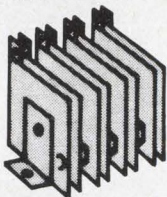

Both were bulky, and--worse yet--each was a custom design requiring long vendor lead times, not to mention the expense. One day, a Compar salesman suggested that if Bob used Unitrode UT 4000 series diodes, he could make his own bridges with only this comparative space required...

... TO GET 10 AMPS AT 500 VOLTS
without additional heat sinking.



ACTUAL
SIZE

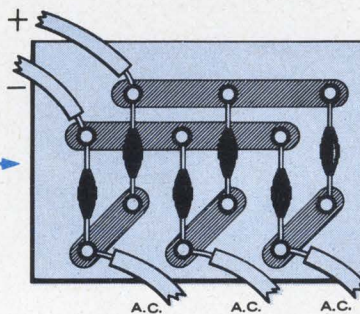

vendors were charging for special bridge assemblies ... and the work stayed in-house.

Also Bob could supplement his small laboratory stock by drawing on Compar's substantial inventory of Unitrode semi-conductors. No more weeks of waiting. Now he could instantaneously breadboard any bridge he needed.

There were other bonuses from the Unitrode rectifiers: reliability, stability, ruggedness and ... the controlled avalanche feature ensuring the diodes' ability to absorb reverse transient surges as high as 0.8 joules. And Bob's regulation problems were solved as well--with Unitrode 5 watt zeners in the same small package.

YOU CAN SAVE SPACE AND TIME ON YOUR BRIDGE DESIGNS TOO

Contact the factory, call your local Compar office, Daniel and Company office, or circle the reader service number on the magazine reply card. You will receive technical data and samples of Unitrode UT 4000 series rectifiers plus a complete catalog on other Unitrode devices immediately.



NEW 32 PAGE DIODE CATALOG

- Technical Specifications
- Mounting Data
- Applications Information
- Physical Drawings
- Derating Information
- Multiple Surge Ratings

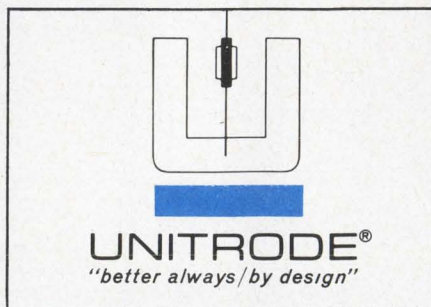

UNITRODE CORPORATION

580 PLEASANT STREET • WATERTOWN, MASS. 02172 • TELEPHONE (617) 926-0404 • TWX (710) 327-1296

REPRESENTATIVES IN PRINCIPAL CITIES THROUGHOUT THE WORLD

Speed Inquiry to Advertiser via Collect Night Letter
ON READER-SERVICE CARD CIRCLE 12

Electronic system brings help



Maryland tests Hoffman road alarm

Hoffman Electronics is supplying equipment for an experiment that may lead to installation of a motorist-in-distress alarm system along all 41,000 miles of federal interstate highways within five years.

The Commerce Department's Bureau of Public Roads has contributed 90% of the \$379,298 awarded by Maryland's State Roads Commission to set up the Hoffman Highway Emergency Call System and Safety Satellite alarm system.

A total of 324 of the coded-signal transmitters will be erected along the 43-mile section of the Washington, D.C., Capital Beltway, I-495, that lies in Maryland. The post-mounted, spherical, aluminum call boxes are powered by storage batteries recharged by solar cells. They each contain a transmitter that registers on a central emergency switchboard as soon as a distressed motorist touches a clearly labeled button. The signals are coded according to the type of aid needed, the location of the box and the side of the median on which it is located.

The Highway Emergency Call System contains buttons for police, ambulance, fire or maintenance service. About 100 will be installed. The boxes of the Safety Satellite system contain only police and fire buttons. They will form the bulk of the call boxes, which are to be set up and operational by September.

Hoffman also received a \$96,000 contract to conduct a program of research into traffic patterns and the response time of the emergency equipment. The Baltimore Beltway, an interstate circumferential highway very similar to the Capital Beltway, will be used as a control. No automatic emergency devices will be erected on the Baltimore loop.

Industry will bid for federal contracts

A Department spokesman said the Maryland experiment may well be the forerunner of similar systems to be set up nationwide. He pointed out that, while Hoffman has an edge in this field, it will have to be opened up for competitive bidding from other firms. The Commerce Department or a new Department of Transportation will have to set standards and

Washington Report

S. DAVID PURSGLOVE,
WASHINGTON EDITOR

specify the system to be used.

The Chairman-Director of Maryland's State Roads Commission, John B. Funk, said that highway alarm systems will have to be a government responsibility. "Private enterprise, operating on uncertain schedules and without public control, could make a farce of a motorist distress call system," he said. He also believes that, "states rights" notwithstanding, this is a field that must be governed by the Federal Government. The Federal Bureau of Public Roads would act jointly with state roads units: the Bureau to set standards, the states to award contracts.

Hoffman outlines details of systems

Hoffman has been circumspect about technical side of its systems, but some detail was revealed at the time that the Maryland contract was announced.

The Satellite system boxes have no transmitters, but are wired to the nearest Highway Emergency Call System boxes. These generally use HCA-1 non-directional antennas; their silicon solar cells are HCS-1 models.

Under the contract, Hoffman will provide a service engineer on 24-hour duty for one year and will train state maintenance engineers.

Nike-X raises MOL issues

As everyone in Washington except the Administration pushes for establishment of a missile defense system, the question of the real status of the Air Force manned orbiting laboratory (MOL) has again come up. In the competition for the limited funds available for military missile and space programs, the Army—developers of the Nike-X missile defense system—has won out over the Air Force—rather uncommitted developers of a military MOL.

The White House and Defense Department still insist that they do not want the money that Congress is pressing on them for missile defense. But they will probably spend more on engineering development and long-lead production than was planned when the budget for fiscal 1967 was originally taking shape.

Washington Report

CONTINUED

A modified Nike-X system to cope with an accidentally fired ICBM or a small-scale attack from an "Nth Country" is beginning to look attractive to Administration advisers who a year ago opposed deployment of any system. If for budgetary reasons a choice has to be made, the MOL is the clear loser, they say. There is far wider popular and political support for a system that is billed as protection for the citizens than there is for a surveillance satellite, the mission of which seems ill-defined to the public. Defense Department officials concede that this is all the more true when an MOL looks as though it duplicates the work of NASA and the unmanned Samos reconnaissance satellites.

Administration thinking is that a further advantage of an anti-missile system over the MOL is that development of the former would channel money into a much broader segment of the electronic industry than the MOL would.

Yet despite the current upsurge of interest in a Nike-type system, the MOL was obviously in difficulties, despite assurances to the contrary from the White House.

What of MOL's future?

It would be facile to say that only the President or Secretary McNamara know what the future holds for MOL. But it would be misleading, for even they do not know. There is no question that MOL has already been greatly downgraded in size and mission. The next step depends upon the vagaries of war and the economy. But MOL appears to be heading for a merger with NASA post-Apollo projects and some other programs.

The Office of the Director of Defense, Research and Engineering, an influential Pentagon power center, is on record as favoring a "multipurpose satellite" system. It would combine communications, navigation, early ICBM warning, weather surveillance and nuclear test detection. Daniel J. Fink, deputy DDR&E director for strategic and space systems, recently said: "We have concluded that these functions are compatible and could be married into a single, newly proposed satellite, thereby increasing the cost-effectiveness of any one alone. Consequently, during the past year we have reoriented each of these programs toward such a common goal."

Fink did not mention intelligence-reconnaissance in the list of functions that an all-purpose

satellite would carry out, but it is understood to be included. Neither did he state whether the satellite would be manned or unmanned, nor whether it would substitute for MOL. Many observers believe, however, that it will initially be unmanned and use existing sensors. Later, they believe, any Defense Department manned space program may take the shape of a manned multipurpose satellite program.

New DOD agency in the air?

Yet another blow for the Air Force may come out of this sort of Defense Department thinking: "An Army company is pinned down and needs support from a missile battalion 85 miles to the rear. The C.O. radios his request via tactical communications satellite."

Whose should such a satellite be? Air Force because it is in space? Or Army because it answers an Army need? Is it a strategic system because it was originally launched half a world away by a large booster? Or is it tactical because it supports front-line elements?

DOD is beginning to say it is both and belongs to neither. The Department has begun to take a very preliminary look at the possibility of a new DOD agency to serve all the services, rather as the Defense Communications Agency, Defense Intelligence Agency and Defense Supply Agency do. It would control intelligence-weather-communications-navigation satellites, launch them and design them. The nucleus of such an agency would likely draw on major elements of the Air Force as well as some elements of the Army and Navy technical organizations.

DOD publicly denies that this is in the offing, but officials privately admit that it is in the thinking stage. A high DOD official commented: "Some years ago I said categorically, but in good faith on my part, that the Army would never lose the von Braun team."

Airlines communicate by satellite

An airplane can now communicate to distant ground stations even while flying over open ocean. The transmission is received and rebroadcast by the Syncom satellite.

The system was recently displayed by its manufacturer, the Bendix Corp., at a Communications Satellite Seminar held at the U.S. Department of State.

The simple, light equipment carried aboard the plane is powerful enough to reach ground stations directly if it is in direct line of sight with them.

For only **\$1.75***



you can buy
this silicon
power transistor

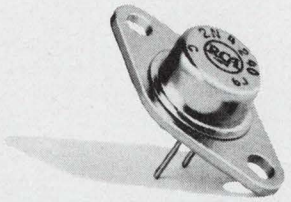

with **400 V** $V_{CER(sus)}$
5 A $I_C(peak)$
15 Mc/s $f_T(min)$

probably the most "electrifying" offer you've had today

Check into RCA-2N4240 further. It gives you big performance with real economy... and it's in a quantity price class that's just right for mass-production applications. In high-current, high-voltage, high-frequency designs, 2N4240 improves circuit reliability—each transistor is 100 per cent tested to assure freedom from second breakdown in both forward- and reverse-bias conditions.

Evaluate the new 2N4240 and its companion types 2N3583, 2N3584 and 2N3585 for use in:

- High voltage inverters and switching regulators
- Line-operated or high-voltage amplifiers
- Operational amplifiers
- Electrostatic or magnetic deflection circuits

		2N3583	2N3584	2N3585	2N4240
h_{fe}	@ $I_C = 100 \text{ mA}$, $V_{CE} = 10 \text{ V}$ @ $I_C = 1 \text{ A}$, $V_{CE} = 10 \text{ V}$ @ $I_C = 0.75 \text{ A}$, $V_{CE} = 10 \text{ V}$	40 Min 10 Min	40 Min 25-100	40 Min 25-100	40 Min 30-150
$h_{fe} @ 5 \text{ Mc/s}$	@ $I_C = 200 \text{ mA}$, $V_{CE} = 10 \text{ V}$	3 Min	3 Min	3 Min	3 Min
I_{sb}	@ $V_{CE} = 100 \text{ V}$	350 mA Min	350 mA Min	350 mA Min	350 mA Min
$V_{CER(sus)}$	@ $I_C = 200 \text{ mA}$ @ $R_{BE} = 50 \text{ ohms}$	250 V Min	300 V Min	400 V Min	400 V Min
$V_{CE(sat)}$	@ $I_B = 125 \text{ mA}$, $I_C = 1 \text{ A}$ @ $I_B = 75 \text{ mA}$, $I_C = 0.75 \text{ A}$		0.75 V Max	0.75 V Max	1.0 V Max
I_C		5 A peak 2 A continuous	5 A peak 2 A continuous	5 A peak 2 A continuous	5 A peak 2 A continuous

For full price and delivery information, check with your RCA Representative. For technical data on specific types, write: RCA Commercial Engineering, Section IG6-1 Harrison, N.J.

Also available through your RCA Distributor

*\$1.75 each in quantities of 1000 and up.



RCA ELECTRONIC COMPONENTS AND DEVICES
The Most Trusted Name in Electronics

WHO PINNED A MEDAL ON THIS TINY TRW CAPACITOR?



...nearly everybody!

For your next design where there's too little room for components and *no room for compromise*...turn to "tiny but tough" TRW Type 608 Mylar* capacitors.

Excellent electrical characteristics and exceptionally small size make the Type 608 ultra-miniature a good capacitor for exacting military and instrument applications. Add the remarkable record of space-proven reliability and TRW Type 608 becomes a great capacitor!

Look at these outstanding features!

- 50% smaller than MIL-C-27287
- 4½ lb lead pull capability
- Mylar-foil, tape-wrapped construction
- Exceeds characteristics of many larger units
- MIL-C-27287 performance
- 50V and 100V, .001 to 2.0 mfd
- Temp. range -55 to +85°C; to 125°C with derating
- Tolerance to ±1% available

Contact TRW Capacitor Division, Box 1000, Ogallala, Nebraska, or phone (308) 284-3611. TWX: 910-260-0321

*DuPont's trademark for polyester film.

TRW CAPACITORS

ON READER-SERVICE CARD CIRCLE 13

Co-Publishers

James S. Mulholland, Jr.
Robert E. Ahrens Dorf

Editorial Director

Edward E. Grazda

Editor

Howard Bierman

Managing Editor

Robert C. Haavind

Technical Editors

Joseph J. Casazza
Rene Colen
Maria Dekany
Richard Harnar
Mark B. Leeds

News Editors

Frank Egan
Roger K. Field

East Coast Editor

Neil Sclater

West Coast Editors

Ralph Dobriner
Peer Fossen

Copy Editor

Peter Beales

New Products Editor

David Surgan

Washington Editor

S. David Pursglove

Editorial Production

Dollie S. Viebig
Anne T. Lombardi

Art Director

Clifford M. Gardiner

Art Assistant

William Kelly

Technical Illustrators

Lewis D. Hill
Cheh Nam Low

Production Manager

Thomas V. Sedita

Asst. Production Manager

Helen De Polo

Production Assistants

Carl Merkin
Bernard Wolinsky

Circulation Manager

Nancy L. Merritt

Reader Service

Diane Pellechi

E|D EDITORIAL



What's happening in computer-aided design?

The digital computer promises to become one of the most powerful tools available to the electronic design engineer. Like any other tool, however, its functions, capabilities and limitations must be understood before the prospective user can employ it effectively and intelligently.

Only a small proportion of the design community has made extensive use of this design aid to date, and as a consequence there is a paucity of general information about it. The designer looking for material written about it will not have an easy time.

Why this lack of information? There are several reasons. For one, computer-aided circuit design—unlike circuit *analysis*—is still in its infancy. For another, many organizations engaged in research and experimentation are unwilling to publicize their work in this field. And perhaps most important, there has been no common meeting ground for engineers using the computer as a design tool.

Time alone should take care of the first of these as the use of computers for designing becomes more widespread. To solve the second problem, we can only urge those organizations involved to bear in mind the crying need for some hard facts to be published on the successes—and failures—of computer-aided design.

Happily, the first steps have already been taken toward eliminating the third reason for lack of data. An initial exchange of ideas and experience took place at the Conference on Computer-Aided Solid-State Circuit Design held at the University of Wisconsin in early May. Dr. William W. Happ, Chief of the Design Criteria Branch at NASA's Electronic Research Center, Cambridge, Mass., stressed to the delegates the need to discuss common problems and compare ideas. Happ believes that this engineer-to-engineer communication is one of the most useful means of spreading knowledge of semiautomated design techniques. And to help foster and supplement person-to-person exchanges, NASA is conducting a survey of available computer programs used for electronic design. The results of this survey can't come too soon.

We believe it is time for engineering schools and institutions to follow the lead given by the University of Wisconsin and NASA. The continuing professional-studies courses of engineering schools would fill a great need by adding computer-aided circuit design to their curriculums. Industry, for its part, should boost in-house training in this field.

The rapid pace of modern technology demands more effectual and accessible dissemination of information than has hitherto been the case.

JOSEPH J. CASAZZA

THIS NEW COMPUTER QUALITY TRANSISTORIZED DIGITAL READOUT COSTS YOU

30% LESS!

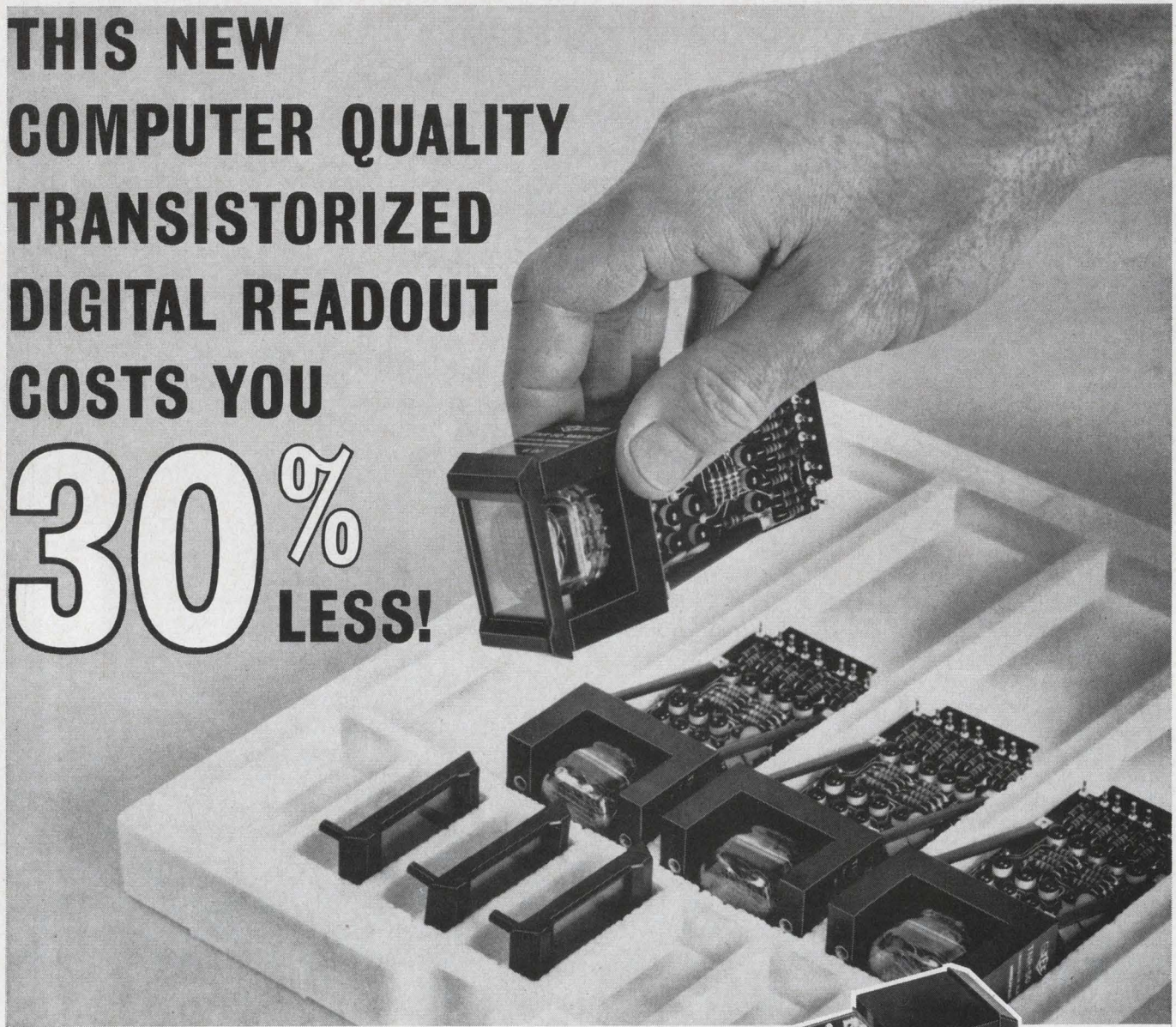

FOR INTEGRATED OR DISCRETE COMPONENT CIRCUITS

■ Identical electrical characteristics, identical driver-decoder functions, identical 1-inch mounting centers—yet these new digital readouts using NIXIE® tubes cost you 30% less than fully enclosed (with metal case transistors) TEC-LITE TNR-10 and TNR-30 Series models. New simplified single board design and use of plastic encased silicon transistors substantially reduce assembly time, allowing this far lower price.

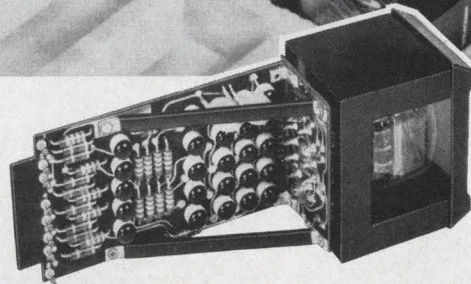

TNR-40 Series—Provides decimal readout from decimal input signals of low level. Internal circuits of four standard models are controlled by input signals as small as 3.5 volts. Special versions can be controlled with signals as small as 2 volts or less. High voltage to fire the neon tube's numeral elements is confined to the unit and to the panel area.

Price (0-9 display) in 100-299 quantities: \$18.85 less tube.
For fully enclosed readout, request data on TEC-LITE TNR-10 Series.

TNR-50 Series—Decimal readout is available in 8 standard models to handle 8-wire and 4-wire binary coded decimal input as small as 3.5 volts. A variety of other input codes and signal levels can be accommodated on special order. All-transistor circuitry eliminates diode decoders to reduce the number of components and increase reliability.

Price (0-9 display) in 100-299 quantities: \$24.90 less tube.
For fully enclosed readout, request data on TEC-LITE TNR-30 Series.



INDICATING DEVICES

Transistor Electronics Corporation

Box 6191 • Minneapolis, Minnesota 55424



INDICATORS



DATA PANEL



READOUTS

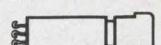

TEC-SWITCH

ON READER-SERVICE CARD CIRCLE 14

ON READER-SERVICE CARD CIRCLE 250 thru 261 ▶

SIGNETICS

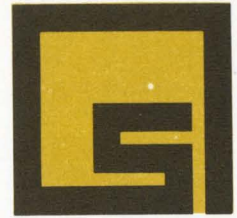

INTEGRATED CIRCUIT NEWS AND APPLICATIONS

SIGNETICS USER-ORIENTED PACKAGING

All integrated circuit users face the problem of reliably testing, sorting, and handling these products during assembly without incurring damage to the leads of the device. Endeavoring to ease this problem, Signetics provides device carriers which are designed with the user in mind. Ease of test, storage, and minimum carrier cost to provide the "throw away" feature are all part of this program.

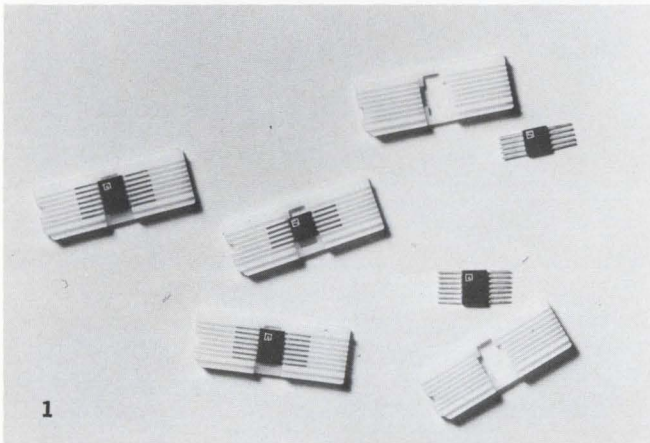

The outcome of this program is a group of throw-away plastic carriers designed for each type of circuit package. The flat package carrier, Figure 1, will accommodate either the $\frac{1}{4}$ by $\frac{1}{4}$ -inch 10-lead flat package, (TO-91), or the $\frac{1}{4}$ by $\frac{3}{8}$ -inch 14-lead flat package (TO-88). The package body opening in this carrier is under-cut so that the package snaps in and is retained even if the carrier is accidentally turned over. The flat, ribbon-like leads are fully protected within the grooves of the carrier body which also serve to guide the wipers of a multi-point test head into contact with them.

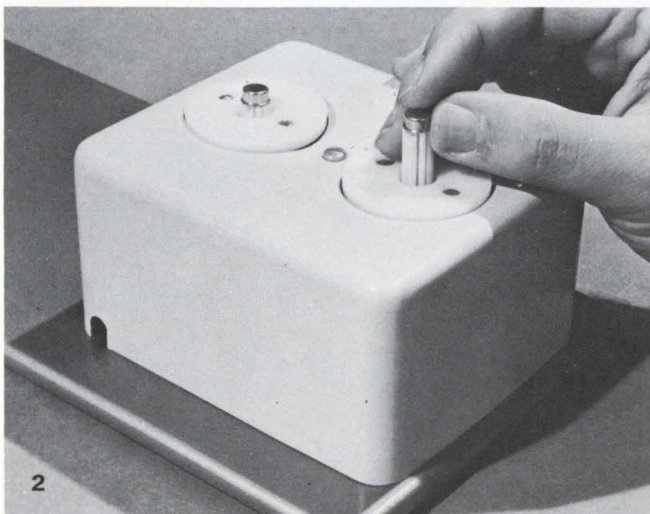

A similar approach was taken in designing the carrier for the familiar modified JEDEC TO-5 can. In this case the carrier is a grooved plastic cylinder. Carrier and circuit plug into a Signetics-designed test socket as shown in Figure 2.

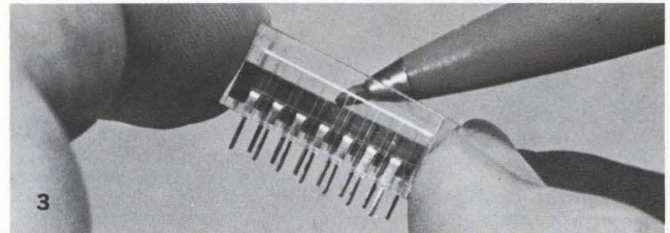

The carrier designed for Signetics' new "A" package, a solid plastic 14-lead dual in-line type, serves, as do the others, to protect the leads and guide the test head. It has one additional outstanding feature. This new carrier also serves as a throw-away alignment jig for insertion of the circuit into a PC board. As indicated in Figure 3 a slight downward pressure on the package body is used to extend the leads slightly beyond the bottom of the hole in the carrier. The leads can then be easily registered in the hole pattern in the PC board. A final downward push seats the circuit in the board, Figure 4. The carrier is then discarded.

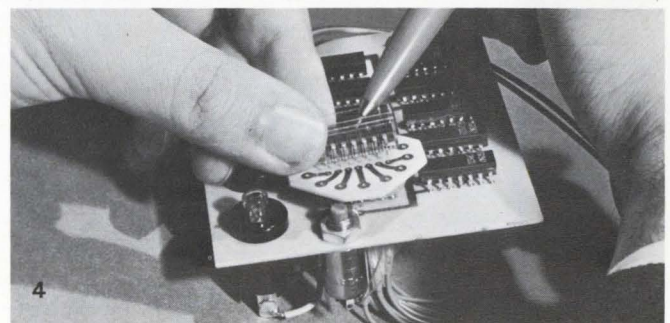

This carrier is equally useful whether hand or machine insertion is involved. It should be noted that for machine insertion, the normal shipping box for Signetics dual in-line packages serves as a throw-away magazine for loading automatic machinery.

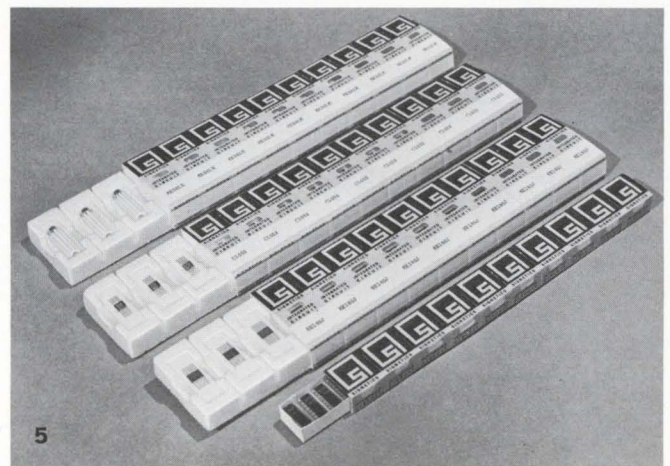

Shipping containers for each type of circuit package are shown in Figure 5.

Signetics Data Circle 250

NEW SAGE I ELECTRONIC CALCULATOR USES SIGNETICS INTEGRATED CIRCUITS

A new, low-priced electronic desk-top calculator designed for general purpose business and engineering use has recently been introduced by Dero Research and Development Corporation of Huntington, New York. Called Sage I, the 12-pound portable typewriter-sized unit performs computations in fractions of a second, in complete electronic silence. Featuring a simplified 10-key keyboard, the machine has a 20-digit capacity and displays results in $\frac{7}{8}$ -inch high numerals on a brightly illuminated screen.

The self-contained Memory of Sage I permits storage and recall of entries and results, facilitating continuous calculations and the accumulation of products and quotients. A number need only be entered once for raising to powers or for repetitive use. The device has four registers—entry, answer, memory and accumulate—and its typical speed is 0.008 seconds for addition and subtraction, and 0.25 seconds for multiplication and division.

Sage I operates in the same sequence in which a normal problem is expressed and thus no special instructions are required to learn how to operate the machine. The unit "remembers" both the last number and command entered, permitting an automatic repeat of either or both. Sub-totals are automatically indicated and any result may be further operated upon without re-entry. Automatic reciprocal division is also possible.

A special "double precision" feature of Sage I permits calculation capacity to 20 digits on its 10-digit display, with the 10 most significant digits presented first, and the remaining least significant digits presented when the "D" key is pressed. A second press of the "D" key returns the most significant digits to the display.



This advanced electronic desk calculator uses Signetics integrated circuits in the new easy-to-handle dual in-line plug-in package. The low cost of these units and the manufacturing economies they permit have helped keep the price of Sage I below \$1000, which makes it less than the cost of many conventional mechanical calculators.

Signetics Data Circle 251

Sage Data Circle 252

SIGNETICS 8-BIT MEMORY ELEMENT IN SDS SIGMA 7 COMPUTERS

The remarkably high Input/Output rate of Scientific Data Systems' new Sigma 7 family of computers (up to 160 million bits per second) can be attributed in large measure to the liberal use of very high speed scratch pad memories assembled from Signetics 8-bit memory elements. These new monolithic I/C's incorporate 8 flip-flops, decoding and write networks, and an output buffer all on a single chip.

The principle function of the scratch pad memories is to speed up system response to multiple inputs by reducing dependence on the much larger and slower main memory. The basic scratch pad building block is a PC board carrying 16 of the 8-bit memory elements, and drive circuitry to form a 16 byte module of 8 bits per byte.

Sigma 7 features a total capability for both business and scientific data processing and is uniquely designed for real time computation while operating in time sharing, multiprocessing and multiprogramming environments. Because of its extensive use of monolithic integrated circuits, Sigma 7 is considered a third generation computer.

A 12-page reprint of an article describing the SDS Sigma 7 and the function of the Signetics 8-bit memory element in it is available on request.

Signetics Data Circle 253

SDS Data Circle 254

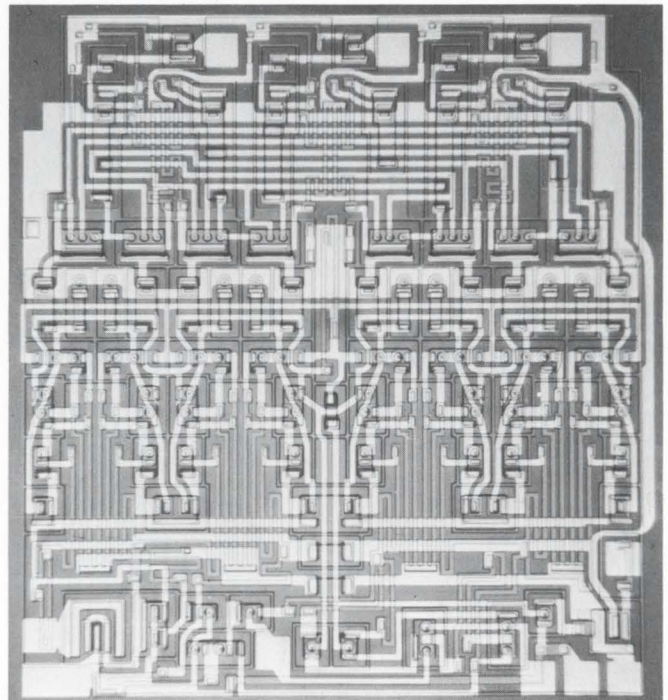



VITRO LABS TIMING AND CONTROL SYSTEM FEATURES SIGNETICS DTL IC'S

High reliability, compactness and low cost are the major advantages of a new Event Control Sequencer manufactured by Vitro Laboratories of West Orange, New Jersey. Designated model 3219, this device was designed by Vitro to fill the need for more reliable data timing and control systems. It provides means for separate on-off control of three independent events to a resolution of 0.1 sec., operating on a time base of one hour. A seven-segment incandescent display indicates elapsed time in minutes, seconds and tenths of seconds. Outputs consist of three independent relay closures. These have mercury-wetted contacts rated at 28 volts, two amperes DC.

The 5 1/4" x 19" x 17" 30-pound unit, designed for rack mounting, is assembled using Signetics DTL integrated circuits in the new dual in-line plastic package on standard Vitro micro-circuit board assemblies. All components are mounted on one side of 3x5-inch epoxy-glass plug-in printed-wiring boards for standardization and ease of manufacture and maintainability.

Signetics Data Circle 255

Vitro Data Circle 256

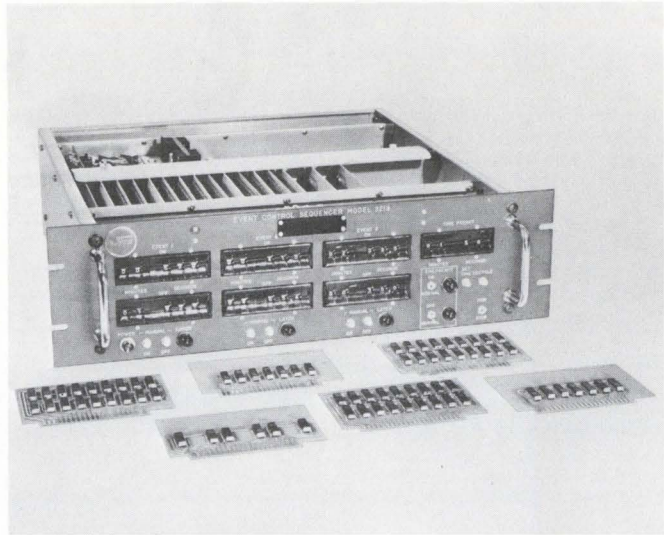

INTEGRATED CIRCUITS REDUCE SIZE OF MINUTEMAN PORTABLE TEST SET

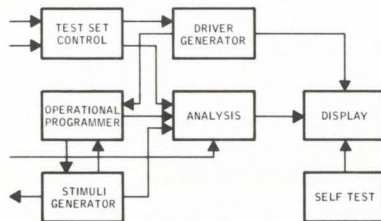

A portable automatic digital test set using Signetics integrated circuits has been designed by Sylvania Electronic Systems Division for part of the Minuteman ground electronic system. By using IC's, a volume reduction of 30 times and a weight reduction of 6 times has been achieved. If the test set were designed for conventional solid state printed circuit construction it would weigh 90 pounds and occupy 5 cubic feet of space. At 14 pounds, this set is light enough to be plugged directly into a rack connector, eliminating the need for cables.

Designed to limit operator decision-making (and thus minimize personnel training requirements) the test set is an automatic go/no-go readout unit capable of isolating a malfunction in a communications subsystem to one of seven drawers by simple indicator lamps. The unit automatically tests itself and then proceeds to program a series of tests on the subsystem. It is capable of performing the self test plus analysis of 42 test points required to check the subsystem in 20 seconds.

Two techniques are used for subsystem analysis. One is direct comparison of digital type signals from the subsystem with similar signals generated by the test set. The second technique is the checking of analog signals with a threshold level detector which indicates a no-go condition if signal voltages fall below a minimum preset level.

A block diagram of the test set is shown in the accompanying figure. Test start and stop signals, gating functions and synchronization are provided by the "Test Set Control." Clock pulses and pulse rates are developed in the "Driver Generator," and the "Operational Programmer" provides duplicating and controlling of the subsystem operations. The "Self Test" function checks for proper basic timing rates in the test set and assures that all analysis and readout circuits are capable of a no-go indication.

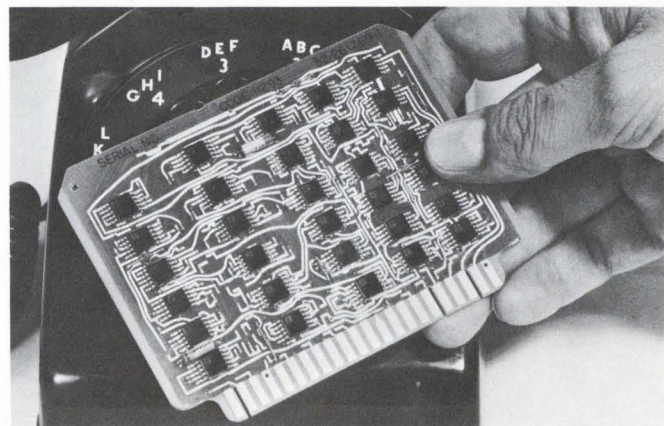
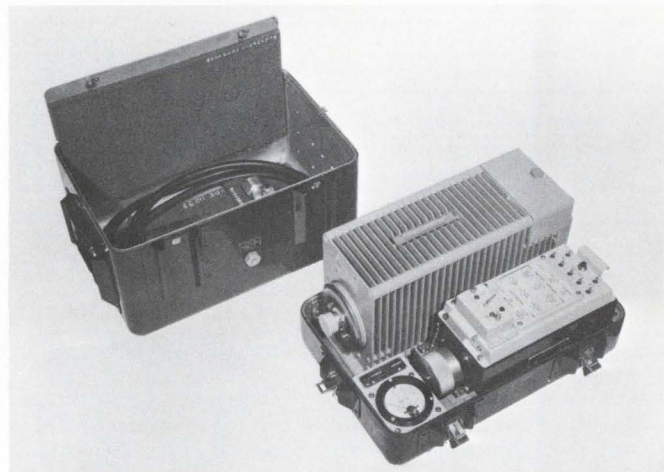

Signetics SE100-Series DTL circuits in "G"-type package are used extensively in this test set, and are shown on a typical circuit board in the accompanying photograph.

Signetics Data Circle 257

Sylvania Data Circle 258

DUAL J-K FLIP-FLOP ADDED TO SE800-SERIES TTL FAMILY

Signetics has added a 35 Mc dual J-K flip-flop to its TTL family. Introduced at the IEEE convention in March, the new monolithic element, designated SE826 provides opportunities for greatly reducing can counts in TTL systems. Each of the two flip-flops has independent Preset, J, K, Q, \bar{Q} , and clock inputs. Average power dissipation is 40 mW per flip-flop, and 1.0-Volt noise margins are typical.

The 800 series also includes six different NAND gate configurations, single, dual, triple and quad; a gate expander, an Exclusive-OR, and a 30 Mc single J-K Binary Element that offers unusually great input logic flexibility.

The series is offered in Signetics glass-Kovar 14-lead TO-88 flat package, and is available in two temperature ranges: the SE800 series for -55°C to $+125^{\circ}\text{C}$ application, and the NE800 series for a range of 0°C to 70°C .

800 SERIES TTL

Element Catalog Number	Description	Package Type	Available In 0°C to 70°C Range
SE806	DUAL 4-INPUT EXPANDER	J	X
SE808	8-INPUT NAND GATE	J	X
SE816	DUAL 4-INPUT NAND GATE	J	X
SE825	MASTER-SLAVE J-K FLIP-FLOP	J	X
SE826	DUAL HIGH SPEED J-K FLIP-FLOP	J	X
SE840	EXCLUSIVE-OR GATE	J	X
SE855	DUAL 4-INPUT POWER GATE	J	X
SE870	TRIPLE 3-INPUT NAND GATE	J	X
SE880	QUAD 2-INPUT NAND GATE	J	X

Signetics Data Circle 259

SIGNETICS LINEAR FUNCTION SET

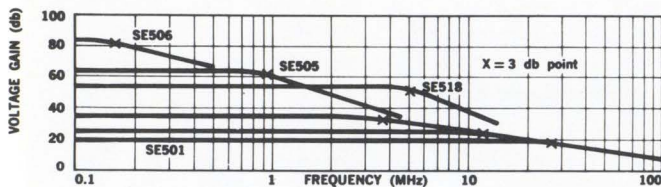

As shown in the accompanying graph, Signetics SE500-Series Linear Function Set provides all of the most frequently required circuit functions over a broad spectrum of gain and bandwidth combinations. The most recent additions to Signetics linear family are the SE506 Differential Operational Amplifier featuring an open loop gain of 17,000 and bandwidth of 170 KHz and the SE518 Analog Comparator which provides 5 MHz bandwidth and an open loop gain of 1700. All SE500 series elements are available in two temperature ranges (-55°C to $+125^{\circ}\text{C}$ and 0°C to 70°C).

Signetics Data Circle 260

CALL A HELPFUL SIGNETICS DISTRIBUTOR—THE ONE NEAREST YOU:

AUTHORIZED SIGNETICS REPRESENTATIVES AND DISTRIBUTORS: **ALA.** Compar Southern, Huntsville, 539-8476; **ARIZ.** Compar Rocky Mountain, Scottsdale, 947-4336; **CALIF.** Compar Los Angeles, Glendale, 245-1172; Compar San Francisco, Burlingame, 697-6244; Jack Pyle Company, San Mateo, 349-1266; Wesco Electronics, Pasadena, 684-0880; **COLO.** Compar Rocky Mountain, Denver (Englewood), 781-0912; **CONN.** Compar New England, Hamden, 288-9276; **DISTRICT OF COLUMBIA** (see Baltimore, Md.); **FLA.** Compar Florida, Orlando, 855-3964; **ILL.** Compar Chicagoland, Chicago, 775-5300; Semiconductor Specialists, Chicago, 622-8860; **MD.** Compar Chesapeake, Baltimore, 484-5400; **MASS.** Compar New England, Newtonville, 969-7140; Cramer Electronics, Newton, 969-7700; **MINN.** Compar Twin Cities, Minneapolis, 922-7011; **MO.** Compar Ozark, St. Louis, 428-5313; **N.J.** Compar Philadelphia, Haddonfield, 429-1526; **N.M.** Compar Rocky Mountain, Albuquerque, 265-1020; **N.Y.** Compar Albany, Albany, 436-8536; Compar Albany, Endwell, 723-8743; Compar Albany, Depew, 684-5731; Compar New York, Clifton, N.J., 471-6090; Terminal Hudson Electronics (Distributors), New York, 243-5200; **N.C.** Compar Southern, Winston Salem, 724-0750; **OHIO** Compar Ohio, Fairview Park, 333-4120; Compar Ohio, Fairborn, 878-2631; **PENN.** Philadelphia (see Haddonfield, N.J.); Western Pennsylvania (see Compar Ohio, Fairborn); **TEXAS** Compar Southwest, Dallas, 327-4551; Compar Southwest, Houston, 926-4160; **WASH. and ORE.** Compar Northwest, Seattle, 622-0622.

SIGNETICS SALES OFFICES: Eastern Regional Sales Office, 591 North Avenue, Wakefield, Mass., (617) 245-8200; TWX (617) 245-8367. Middle Atlantic Regional Office, 129 W. Mount Pleasant Ave., Livingston, N.J., (201) 992-3980. Southeastern Regional Sales Office, 1761 Martha Lane, Clearwater, Fla. Mid-Western Regional Sales Office, 212 Skyline Drive, Barrington, Ill., (312) 463-5105. Western Regional Sales Office, 8820 Sepulveda Blvd., Los Angeles 45, Calif., (213) 776-2295/2296; TWX (213) 670-4303. Northwestern District Sales Office, 811 E. Arques Ave., Sunnyvale, Calif., (408) 738-2710.

SIGNETICS INTERNATIONAL SALES REPRESENTATIVES: **FRANCE, GERMANY, ITALY, BELGIUM, HOLLAND, LUXEMBOURG, SPAIN** Sovcor Electronique, 11, Chemin de Ronde, Le Vesinet S.-&O., France. **UNITED KINGDOM, IRELAND, SWEDEN, DENMARK, NORWAY, SWITZERLAND, AUSTRIA, PORTUGAL** Electrosil Ltd., Lakeside Estate, Colnbrook By-Pass, Slough, Buckinghamshire, Great Britain. **CANADA** Corning Canada, 135 Vanderhoof Ave., Toronto, Ontario. (416) 421-1500. TWX: (610) 492-1300. **AUSTRALIA** Corning Australia, 1202 Plaza Building, Australia Square, Sydney N.S.W. TWX: "Cornglas" Sydney, 27-3692. **JAPAN** Corning Electronic Products, Dow Corning International Ltd., Sanno Dai-ichi Bldg., Akasaka Enokizaka, Ninato-Ku, Tokyo, Japan.

For further information on the Signetics products discussed in this insert, please circle the appropriate reader service number. For information on the products which use Signetics Integrated Circuits, please circle the reader service number indicated.

SIGNETICS CORPORATION, 811 East Arques Avenue, Sunnyvale, California
Subsidiary of Corning Glass Works

TEL.: (408) 739-7700 TWX: (910) 339-9220

ED Technology

Ferrite phase-shifters are best for high power PAGE 34

Select the right FET for low-noise and hf applications PAGE 40

Use thin-films for a D/A converter PAGE 48

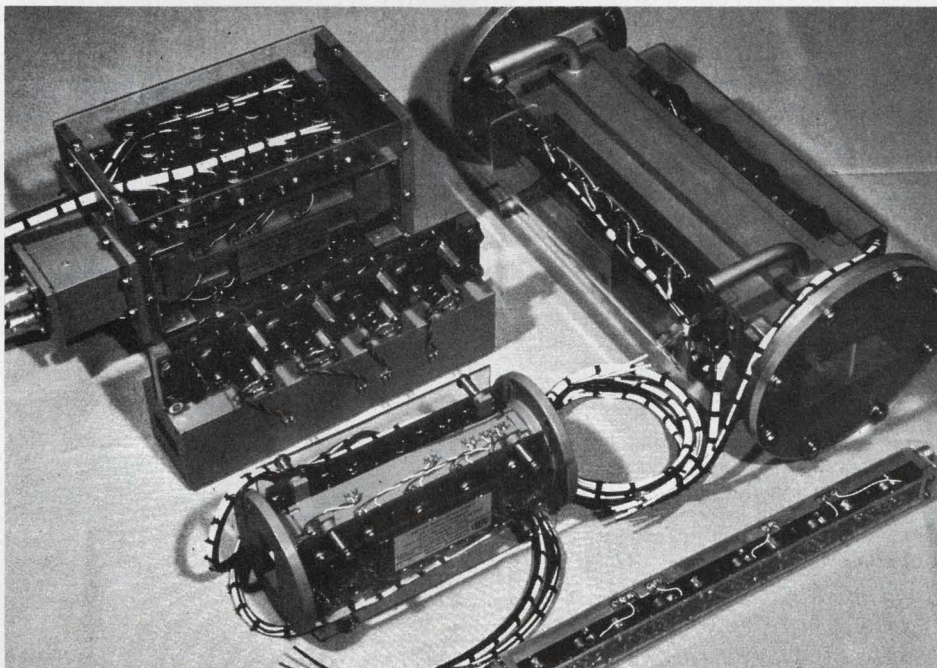

Ferrite phase-shifters on display . . . 34

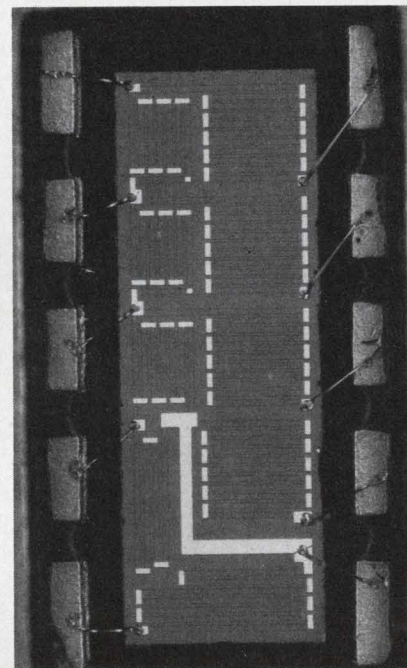

Thin-film ladder network . . . 48

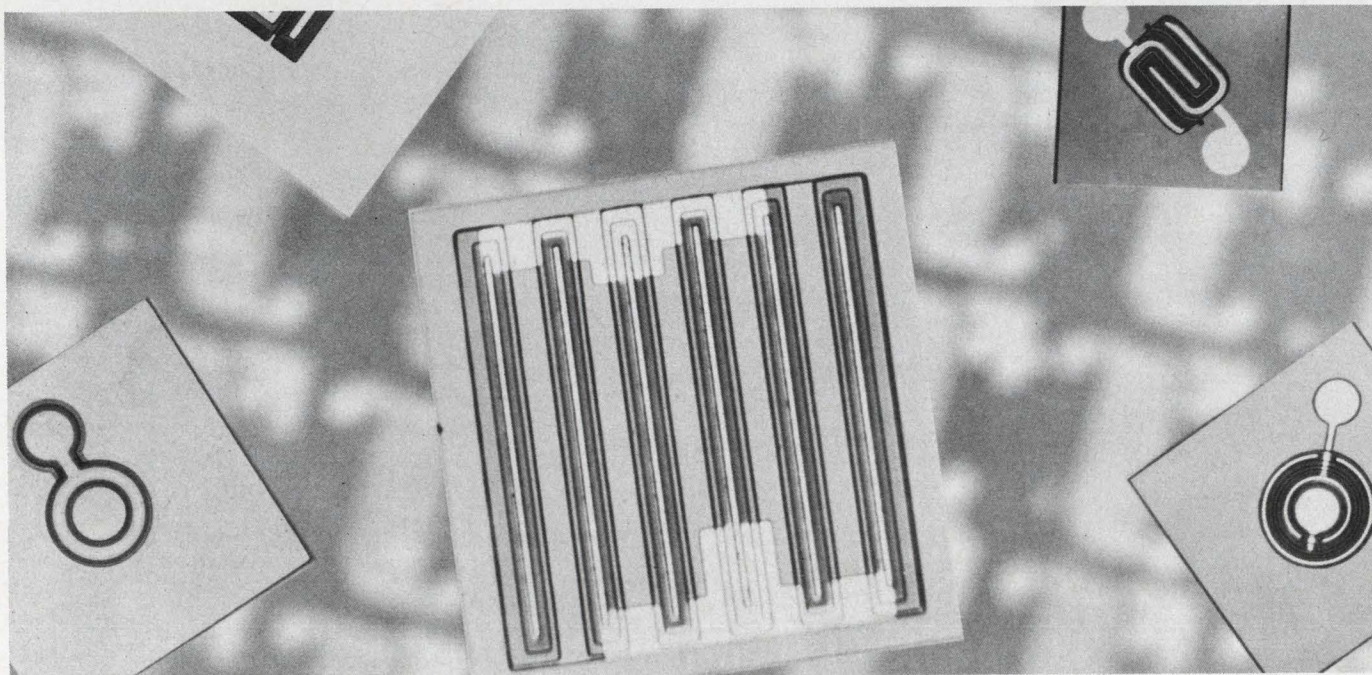

A feast of FETs for hf design . . . 40

Use ferrite phase-shifters for high-power phased arrays. The latching types operate without holding current and are efficient even at 1 GHz.

For powerful, long-range phased-array radars, ferrite phase-shifters are a must. The efficiency of ferrite phase-shifters is greatly improved with latching, or digital, design. This approach does not use holding currents and makes possible efficient operation at frequencies above 1 GHz.

The power levels of ferrite phase-shifters can be as high as 1000-W average and 100-kW peak. Diode phase-shifters do not even approach these power levels yet (ED13, May 24, 1966, p. 46). Another point favoring ferrites at higher frequencies is the fact that the insertion loss of diodes increases with frequency. However, there is no firm demarcation line between diode and ferrite types—careful consideration must be given to each application.

There are two ways to obtain phase shifts from magnetized ferrites in the geometry being considered:

- Keep the direction of the magnetic field fixed and change the direction of the propagating RF.
- Change the direction of the magnetic field and keep the RF field in the same direction.

In each case, the phase shift is nonreciprocal, or differential.

Nonreciprocity limits the speed of operation. Switching time between transmit and receive states is limited by the time needed to change the direction of magnetization. Recognizing this limitation, many companies are working on reciprocal ferrite phase-shifters. Some success has been reported, but insertion loss of reciprocal types is still about double that of the nonreciprocal.

Only nonreciprocal types will be discussed, since reciprocal types have not achieved practical performance yet.

The external magnetic fields may be eliminated by forming a ferrite toroid. The toroidal geometry^{1,2,3} reduces the demagnetizing fields of the slabs in the direction of the magnetization and preserves the desired direction of magnetization for a phase shifter (Fig. 1).

The operation of a ferrite phase-shifter is based on the ability of the ferrite or garnet to “remember” its past magnetization. The memory, defined as $B_{\text{remanent}}/B_{\text{max}}$ (the remanent magnetic moment divided by the maximum moment), is typically 0.80 to 0.50 for a toroid.

A portion of the magnetized toroid sees a circularly or elliptically polarized magnetic field resulting from the incident RF signal. The field is either positive or negative for one direction of

magnetization of the toroid. Switching the direction of this magnetization reverses the sense of the polarized magnetic field and thus produces a differential phase shift. The switching field is generated by a current pulse in the wire that threads each core.

The two remanent states of magnetization, represented by the top and bottom of the loop, are the normal operating positions. The difference in the RF permeability of the two states determines the amount of differential phase shift.

To obtain digital phase shift, the toroids must be composed of good microwave materials, with square or nearly square hysteresis loops.

Design with proper core-lengths

By cascading appropriate lengths of toroids, each individually switched by current pulses, one can assemble a phase-shifter that has as many discrete values as required. For example, assume that a phase-shifter is needed to cover 360° in 11.25° steps. One toroidal core, or bit, is required for each phase shift of 180, 90, 45, 22.5 and 11.25° . Each successive core is one-half the length of the previous one, since the length is proportional to the phase shift:

$$\Delta\phi = K 4 \pi M_s R_r L, \quad (1)$$

where the symbols represent the following:

FERRITE SLAB, SHOWING ORIENTATION OF ITS MAGNETIZATION

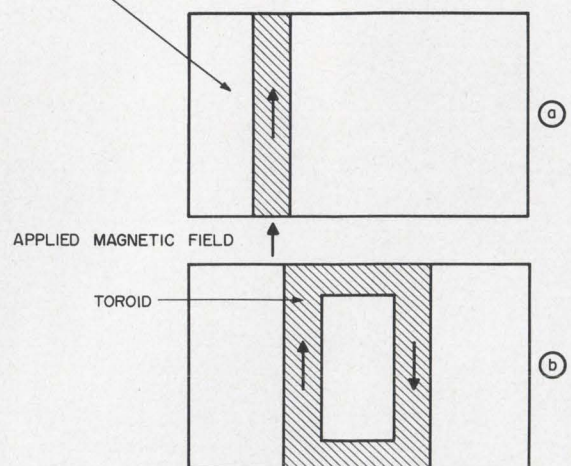

1. A single-slab ferrite, when magnetized, shifts the phase of an incoming RF field if either the direction of the magnetic field or the RF field is changed (a). Toroidal geometry does not need external magnetic field (b) to provide phase shift.

Julian Brown, Jr., engineering section head, Sperry Microwave Div., Clearwater, Fla.

$\Delta\phi$ = differential phase shift,

K = a constant of proportionality for a given geometry,

$4\pi M_s$ = saturation magnetization,

R_r = remanent ratio = $4\pi M_r/4\pi M_s$,

L = length of core, and

M_r = remanent magnetization.

Since the toroidal core exhibits a nearly square hysteresis loop, the switching current must produce a magnetic field greater than the coercive field of the material (Fig. 2). After the current pulse, the magnetization falls into the remanent state and holds. It is essential to drive the toroid beyond point 4 in Fig. 2. Otherwise the resulting remanent flux depends too much on the exact value of the peak current.

With this latching design, a command signal can establish a new phase state in 1 to 5 μ s, and no holding current is required for either state.

The short switching time and absence of holding current ensure low average power consumption and low heating. Nevertheless, the materials must provide good phase-shift accuracy over a moderate temperature range and with a moderate variation in average power.

Loss depends on material

The ferrimagnetic materials used in the toroids determine the loss, the switching time and switching power, and the power-handling ability of the phaser.

Insertion loss in the digital phase-shifter comes primarily from three mechanisms: magnetic loss, dielectric loss and wall losses in the RF structure. The first two can be minimized by proper material selection. In general, the dielectric loss tangent of the material should be as low as possible. Values less than 0.0005 have been achieved and these materials are acceptable for most applications.

Since the operating point in the digital phase shifter is one of the two stable remanent points of the hysteresis loop, the material is never completely saturated (single domain); therefore, the toroidal material is composed of a number of domains separated by domain walls. (Experimental results indicate that circular domains predominate.) In an unmagnetized, domain-filled ferrimagnetic material, so-called low-field magnetic losses have been predicted, and it has been experimentally verified that they occur up to a maximum frequency given by:

$$\omega_{max} = \gamma(H_{anis} + 4\pi M_s), \quad (2)$$

where:

γ = gyromagnetic ratio in MHz/Oe, and
 H_{anis} = anisotropy field in Oe.

The gyromagnetic ratio is nearly constant and equal to about 2.8 MHz/Oe. The anisotropy field is due to the fact that it is easier to magnetize the crystal along certain directions than others. Along these so-called easy axes, the magnetization requires the smallest amount of magnetic field. The hard axes are those directions that require the largest fields for magnetization. The anisotropy field is essentially the difference in the fields in the easy and in the hard directions.

Magnetic losses in ferrimagnetic materials are generally confined to a narrow band of frequencies which is related to the linewidth of the material.

Phase shifters operate off-resonance and in the case of most remanent phasers, above the resonant frequency. Sharpening linewidth cuts losses. To overcome linewidth broadening resulting from such factors as composition and porosity of the sample and the anisotropy field, operating frequency should be well above the value given by Eq. 2.

Magnetization is usually chosen so that the ratio

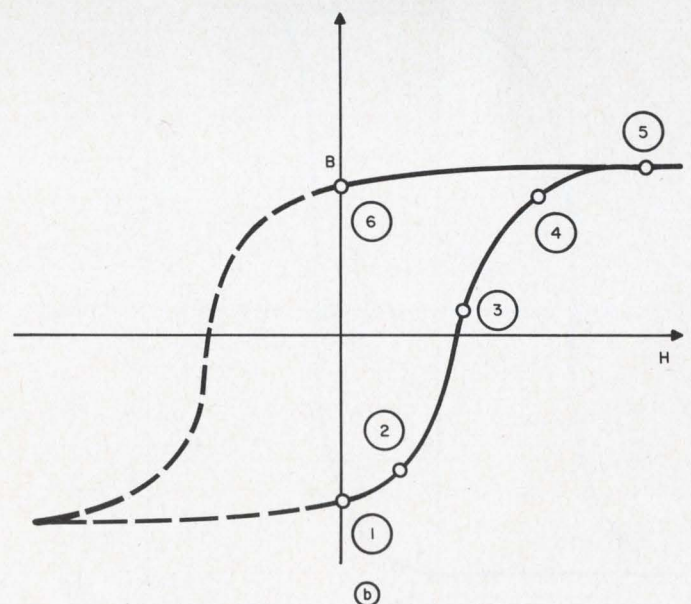
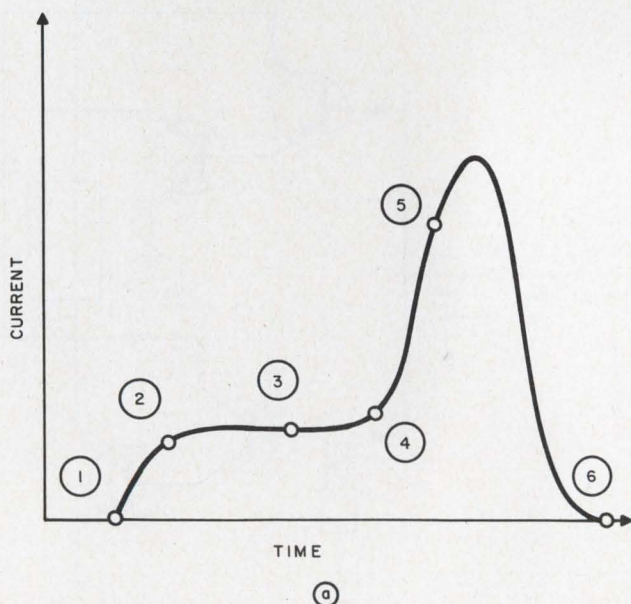

2. Switching current changes with time (a) as one-half of the hysteresis loop (b) is transversed. The current must be large enough to drive the toroid beyond point 4. to

make the value of the remanent flux somewhat independent of the exact value of the peak current. With this design, no holding current is needed for either state.

$\gamma 4 \pi M_s / \omega$ is between 1/3 and 3/4 where ω is the operating frequency. The phase shifter's high-power limits must also be considered.

Spin waves limit power

As power increases, spin waves are beginning to oscillate at both the fundamental operating frequency and at one-half of this frequency.

Instabilities appear in the precessing motion of the electrons. The result is an exponential coupling of energy to the spin-waves and a concurrent linewidth-broadening and decrease in output power. Since the half-frequency waves have greater effects, the material should be selected to eliminate their influence. The power-handling capability can be increased and stabilized by selecting the ratio of $\gamma 4 \pi M_s / \omega$ to be less than about 0.4 by doping the garnet material with rare-earth substitutions. The latter step increases the resonant linewidth and the spin-wave linewidth. This also increases insertion loss of the device. Therefore, peak power can best be controlled by adjusting $4 \pi M_s$.

A high remanence ratio is desired in the material, because it reduces the magnetic losses and allows the use of a larger saturation magnetization.

The squareness of the hysteresis loop, S_D , is the ratio of $4 \pi M_{RD}$ and $4 \pi M_D$ (Fig. 3). $4 \pi M_{RD}$ is the remanent magnetization at the drive field, and $4 \pi M_D$ is the magnetization at the drive field, as shown in Fig. 3.

Typical S_D values for better materials are in the 0.85 to 0.9 region, and typical values for R_r range from 0.5 to 0.8.

The switching time and the needed switching energy also depends on the drive field and on the ferrimagnetic material. Switching, or reversal, time, in μs , is given by:

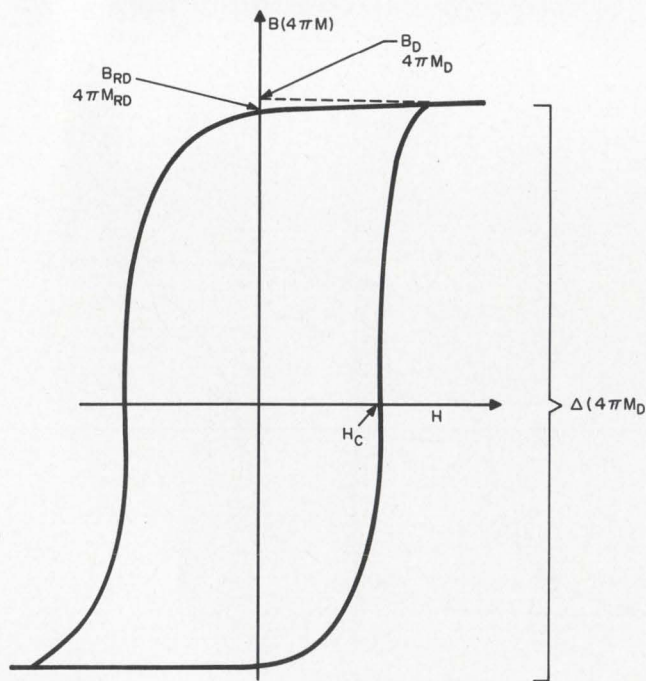

3. Hysteresis loop of typical ferrimagnetic material shows the magnetization, $4\pi M_R$, and the remanent magnetization, $4\pi M_{RD}$, at the drive field.

$$t \approx \frac{6.4d \lambda (10^{-2})}{\delta g^2 M_s (H_m - H_o)}, \quad (3)$$

where the symbols represent the following:

- d = mean distance from one domain wall to another, in cm,
- λ = damping parameter of material, in sec^{-1} ,
- δ = domain-wall thickness in cm,
- g = g-factor of material [$g = \gamma / (e/2mc)$], and

H_m, H_o = drive and threshold fields in Oe.

The threshold field is approximately equal to the coercive field of the material.

The inverse switching time is a linear function of the applied switching field.⁴

$$S_\omega = t(H_m - H_o), \quad (4)$$

where S_ω is the switching coefficient, a constant at a given temperature; and $H_m - H_o$ is the actual drive field in oersteds. Typical values of S_ω range from 0.1 to 1.0 Oe- μs .

To show how switching power depends on the magnetic properties of the material, assume that the magnetic material has a square hysteresis loop, is toroidal in shape, and is threaded with a single switching coil of N turns. (In many applications, the coil has only a single turn.) During the switching of such a core, its impedance is almost entirely resistive.⁵ The needed switching current I is:

$$I = \left(\frac{S_\omega}{t} + H_o \right) \frac{5D}{N}, \quad (5)$$

where D is the average diameter of the core in centimeters. Typical switching currents range from 5 to 15 A. Using this expression for I , the average resistance of the core can be computed. With all other characteristics the same, the fastest

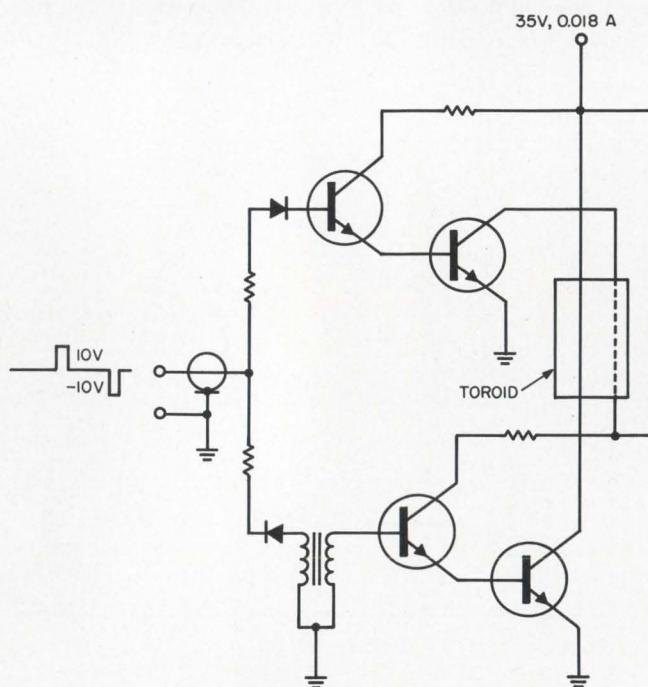

4. Typical transistor driver can best satisfy switching requirements of 1 to 5 μs and switching rates of about 5 kHz. Energy required depends on square of wavelength.

switching material will be the one having the highest resistance.

The average power P dissipated by the core is given by:

$$P = \frac{DA\Delta B}{t} r(S_{\omega} + H_{\omega}t)10^{-1}, \quad (6)$$

where

A is the cross-sectional area of the core in square cm,

B is the change in flux density (similar to ΔM_r), and

r is the switching rate of the material in Hz.

Equation 6 covers one complete trip around the hysteresis loop, which involves two switching actions. For a given core size and switching time, the driving power can be reduced only by choosing a material with a low S_{ω} and small flux density. The energy dissipated in the core can become very high for large cores that require fast switching time or high repetition rates, and the resulting heat can change the properties of the material. The typical core loss should be less than one watt.

Too many materials—be careful!

For square hysteresis loops and low coercive fields, the particle size should be large. Large remanent magnetization usually requires thin-walled toroids.

A wide range of saturation magnetization values is available in good square-loop materials. Following are some general guidelines for selection of the proper materials.

Aluminum substitution in yttrium iron garnets (YIG) produces a family of compositions having magnetization values from 1780 gauss (for YIG) down to 200 gauss (for 25% aluminum substituted YIG). Gadolinium substitutions produce compositions having stable magnetization as a function of temperature. For increased peak power dysprosium substitution is helpful in garnet materials, however lowering $4\pi M_s$ with aluminum is the preferred way.

Nickel zinc ferrites may have saturation magnetizations as high as 5000 gauss.

Lithium ferrites that exhibit square hysteresis properties have been compounded. These materials are particularly inviting because they have high Curie temperatures—in the neighborhood of 680°C. (Beyond the Curie temperature, ferrite materials lose their magnetic properties). Although their dielectric loss tangents are extremely high, they can be used for temperature compensation in composite toroids. Here, the active portion of the core is composed of a good microwave material, while the legs completing the toroidal geometry (outside the RF fields) are lithium ferrite. Nickel ferrites, too, have remanence ratios markedly lower than those of the garnets.

In applications where mechanical loads are expected, the selected material should have zero, or near zero, magnetostrictive constants. Otherwise mechanical loads can alter the hysteretic properties of the material and affect the reproduc-

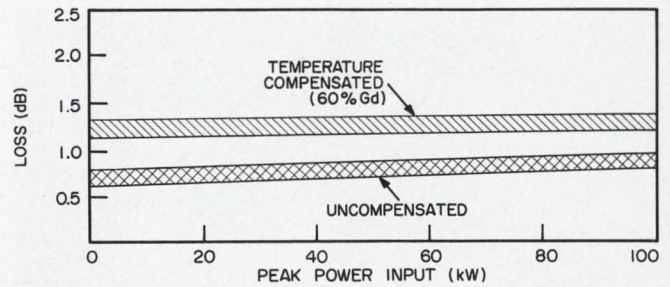

5. Insertion losses of ferrites increase with increasing peak powers. Temperature-compensated materials show somewhat higher losses.

ibility of the digital phase-shifter. In these areas some ferrite materials, in particular the magnesium manganese ferrites, are usually preferred over garnet types.

Efficiency depends on switching current

The toroid can be switched in a short time by applying a high voltage, or in a longer time with lower voltage. The energy delivered to the toroid is essentially the same, but the difference in driver efficiency is proportional to the square of the current ratio. Typical energy, time, and rate requirements are best satisfied with a transistor driver (Fig. 4). The toroid energy requirements are approximately proportional to the wavelength squared. The magnitude of the current is related to the variable permeability of the toroid during switching. A large portion of the energy is consumed during the last half of the switching cycle (mostly in the driver), but it is this part that contributes least to the total amount of differential phase shift.

Although most phasers will handle 10-kW peak power and work with average power levels from near zero to 100 W, some requirements will be as high as 100-kW peak and 1000-W average. In spite of these levels, each phaser must be insensitive to burn-out. Operation at higher power levels increases the inherent insertion loss (Fig. 5). The compensated curve in Fig. 5 represents the loss from a 60% gadolinium material that provides maximum temperature stability. The designer must choose between lowest possible loss accompanied by phase-shift variations as a function of temperature, or higher loss with relatively constant phase shift as a function of temperature. The usual compromises lead to a material with a moderate amount of temperature-compensation characteristics and a loss of 1 dB or less.

The presence of several objects—ferrimagnetic cores, dielectrics, and charging wires—in the waveguide can cause E-field arc-over if proper precautions are not observed. Arc-over is most likely to occur at the interface between the toroid and the waveguide walls and around the charging wires.

How to build a phase-shifter

The essential features of a ferrite phase-shifter

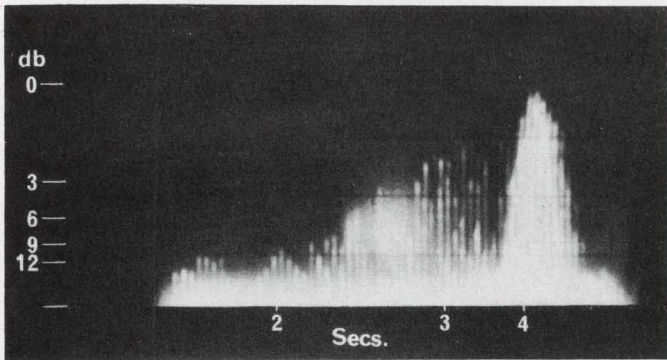

**A clean spectrum within 5 secs.
at a temperature of -65°C .**

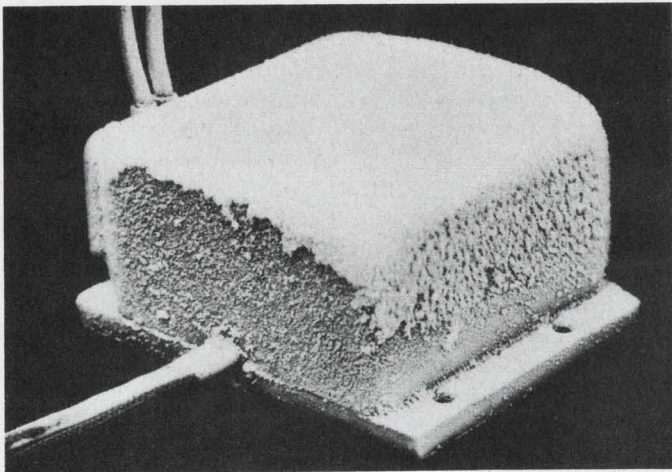

Just one of the characteristics of the outstanding range of GENALEX X-Band Rugged Magnetrons. The MAG 12 and MAG 15 are designed to operate through a wide range of adverse acceleration, vibration, pressure and temperature conditions and are, therefore, ideal devices for all military environments.

	MAG 12	MAG 15	
Missing pulse rate	%	0.01	0.01
Rate of rise of voltage	kV/uS	90	150
Frequency range	Gc/S	9-10	9-10
Va (pulse) (max)	kV	2.5	6.1
P out (pulse)	kW	2.0	8.0
Connectors	—	WG16	WG16
Weight (max)	1lb	2	4

**GENALEX X-BAND RUGGED MAGNETRONS
PERFORM ANYWHERE**

Genalex
THE M-O VALVE CO. LTD.

North American Sales Manager:
David LaFrenais · 9 Codeco Court
Don Mills · Ontario · Canada · Phone: 416-447-5511
ON READER-SERVICE CARD CIRCLE 16

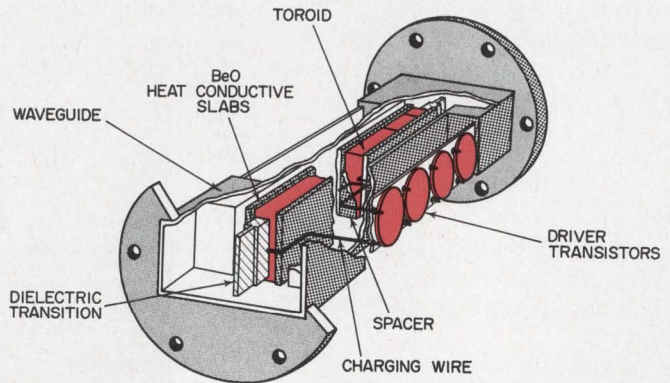

S BAND, 4-BIT, DIGITAL PHASE SHIFTER

6. **Typical S-band 4-bit phase-shifter** uses dielectric transitions to match the ferrite section to the waveguide. A dielectric load may be placed inside the toroid, to increase the phase shift.

are shown in Fig. 6. The dielectric spacers between toroids eliminate magnetic interactions. Dielectric impedance transformers (steps) match the waveguide impedance to the ferrite-loaded section. Either two charging wires are used in this case for each toroid so that only positive current pulses are needed from the driver, or a single wire and a driver capable of supplying both positive and negative pulses is required. Although these wires are at right angles to the E-field of the RF signal, some RF energy leaks on to them and must be removed by radiation suppressors or absorbers.

Use a square waveguide

The most efficient waveguide size, when loaded with toroids, is approximately square, measuring about one-third wavelength on each side. This small size makes it possible to contain the entire phaser, including the driver, in a square whose edge dimension is one half the free-space wavelength of the operating frequency. Thus the phaser can be mounted in the array in line with the radiating elements—all about a half-wave-length apart. Present drivers are too large to implement this optimum size above 6 GHz, but only slight miniaturization of the drivers and microwave housings is required to reach the higher-frequency range. It is expected that it will be possible to fabricate a microminiaturized driver from integrated circuits to allow half-wavelength stacking in the X-band or beyond. ■ ■

References:

1. B. N. Enander, "A New Ferrite Isolator," *Proceedings of the IRE*, XLIV, No. 10 (Oct., 1956), 1421.
2. L. Levey and L. M. Silber, "A Fast-Switching X-band Circulator Utilizing Ferrite Toroids," *1960 IRE International Convention Record*, Part 1, p. 21.
3. J. B. Birks and J. Hart, *Progress in Dielectrics*, V (New York: Academic Press, 1963).
4. H. Rubinstein, *Switching Properties of Ferrites and Garnets*, (Scientific Report No. 6, Series 2, [Cambridge, Mass.: Gordon McKay Laboratory of Applied Science, Nov. 30, 1962].

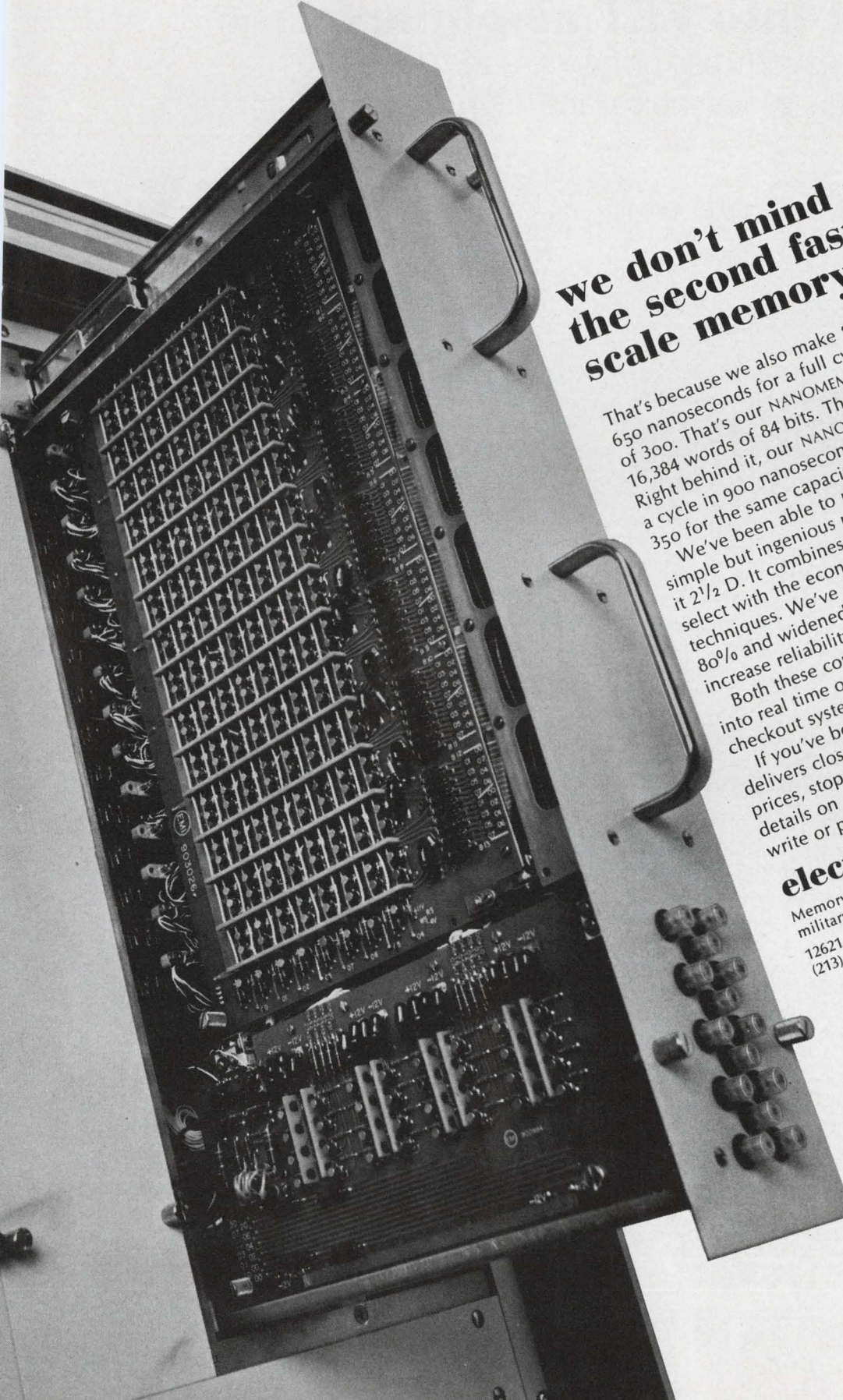

**we don't mind making
the second fastest large
scale memory system.**

That's because we also make the fastest. How fast? 650 nanoseconds for a full cycle with an access time of 300. That's our NANOMEMORY™ 650. It handles up to 16,384 words of 84 bits. They don't come any faster. Right behind it, our NANOMEMORY 900 completes a cycle in 900 nanoseconds with an access time of 350 for the same capacity.

We've been able to reach these speeds by using a simple but ingenious magnetic organization. We call it 2½ D. It combines the speed potential of linear select with the economy of coincident current techniques. We've also reduced stack connections by 80% and widened operating margins to increase reliability.

Both these compact memory systems fit perfectly into real time or high speed computers and checkout systems. If you've been looking for a memory system that delivers close to thin film speeds at magnetic core prices, stop looking. We've got two. For complete details on our NANOMEMORY 650 or 900, write or phone

Electronic memories

Memory systems, stacks and cores for commercial, military and space applications
12621 Chadron Avenue, Hawthorne, California
(213) 772-5201

Gain insight into FET amplifiers.

Learn which parameters govern performance and how to handle the design of low-noise and high-frequency circuits.

Part 2 of a three-part article.

Filling an amplifier need with a field-effect transistor (FET) no longer need be difficult or time-consuming. In all FET-amplifier applications just a few parameters are critical. Consult these first and you quickly determine both the FET's suitability for the job and the major portion of the circuitry required.

Four major FET-application categories* remain in this theme of segregating governing parameters to facilitate selection. They are:

- Low-noise amplifiers (where signal levels are a few millivolts or less).
- High-frequency amplifiers (video and RF types).
- Differential amplifiers (conventional and low-drift types).
- Low-drift, single-ended amplifiers (including zero temperature coefficient operation).

We will now consider the first two application classes. Part 3 will cover the final two circuits, which are generally lower frequency applications.

The order of treatment for each application class will be first to consider the important characteristics peculiar to it; then to call out and use the key design parameters; finally to give the step-by-step design procedure for a typical circuit.

FET source for low-noise amplification

A low-noise amplifier is but a variation of the general-purpose amplifier. Dc and ac design procedures are the same, except that amplifier noise becomes a paramount consideration. Signal levels are typically in the range below a few millivolts. A FET amplifier (shown at right) will be used to consider the audio- and sub-audio applications.

The FET may be described by the noise-equivalent circuit of Fig. 1a; it is characterized by an equivalent short-circuit noise voltage and an equivalent open-circuit noise current referred to the input.² Both \bar{e}_n and \bar{i}_n are functions of frequency as shown in Fig. 1b. The specified i_n includes the effect of gate-source capacitance in the equivalent

circuit. Thus, when making noise calculations due to \bar{i}_n , C_{iss} is not included in the path of \bar{i}_n (See Table 1).

Noise figure (NF) measurements include the effects of both \bar{e}_n and \bar{i}_n , although the effect of \bar{i}_n is usually insignificant when the generator resistance is below several megohms. NF measurements must always include a generator resistance (R_{gen}) specification, as well as frequency and bandwidth. Either \bar{e}_n or \bar{i}_n need include only frequency and bandwidth specifications. NF should always be specified with an R_{gen} low enough to give an $NF > 1$ dB; otherwise, the NF measurement is not of sufficient accuracy to be meaningful.

The fact that the FET exhibits a minimum NF with a specific $R_{gen}(R_{opt})$ at a given frequency does not mean circuit output noise is a minimum under these conditions. It simply means that for the specified R_{opt} the FET contributes a minimum percentage of the total noise; the remainder is generated by the signal source and its internal re-

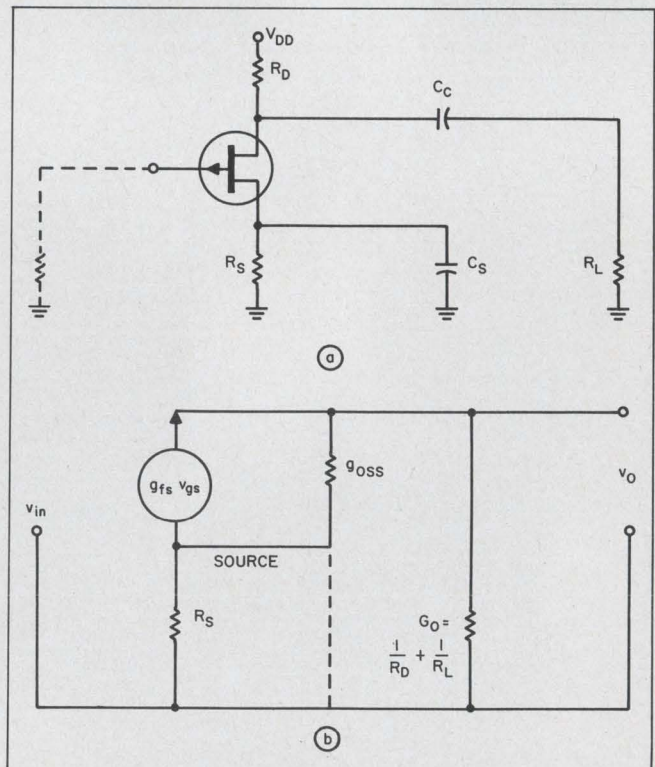

A FET RC-coupled amplifier (a) and its equivalent circuit (b) are analyzed for noise sources in text.

*Consult ED 11, May 17, 1966, Semiconductor reference issue, pp. 94 ff., for a detailed background treatment of field-effect parameters. Part 1 of this article, "Take the fog out of FET design," appeared in ED 12, May 24, 1966, pp. 38 ff. It covered three other major types of FET and MOS switching and amplifying applications.

James S. Sherwin, Senior Applications Engineer, Siliconix Inc., Sunnyvale, Calif.

sistance (R_{opt}). In fact, it is axiomatic that output noise increases with generator resistance.

The important FET parameters for low-noise applications are NF , \bar{e}_n , \bar{i}_n , C_{iss} , g_{fs} and C_{rss} . Any two of the three noise characteristics will describe FET noise performance. However, it is best that \bar{e}_n be specified in the excess noise region for applications below several hundred Hertz. An additional specification at or above 1 KHz is important for audio-frequency applications. For the high-frequency region, we take note of the curves of Fig. 1b. At high frequencies, \bar{e}_n becomes independent of frequency. In the excess noise region below a few hundred Hertz, the noise power increases as $1/f$, hence the name $1/f$ noise. It is to be noted, although not the rule, that the noise power of FETs manufactured by some processes increases as $1/f^2$ over a significant portion of the spectrum. A single-frequency noise specification does not, therefore, necessarily provide adequate noise-performance information. It is only from curves of typical performance, such as those shown in Fig. 1b, that the FET devices can be adequately described.

In the $1/f$ region, \bar{e}_n increases as $1/\sqrt{f}$, and the equivalent noise resistance increases as $1/f$. FET noise voltage at any given frequency may also be expressed as an equivalent noise resistance, R_N . This is because the noise produced by a FET may be equated to the thermal noise produced in a resistor. Thermal noise is plotted as a function of resistance in Fig. 2a and is expressed by the relationship

$$\bar{e}_n^2 = kTRB \text{ or } \bar{e}_n = \sqrt{kTRB}, \quad (1)$$

where k is Boltzman's constant, T is the temperature in degrees Kelvin (usually 298°K or 25°C),

Table 1. FET Noise Parameters

Parameter	Test conditions (must be specified)	Meaning of specification
\bar{e}_n	V_{DS} V_{GS} or I_D frequency bandwidth	Common-source equivalent short-circuit input noise voltage. Measured at the output with the input shorted, and referred to the input. Expressed as rms volts per root cycle, $\mu\text{V}/\sqrt{\text{Hz}}$. A function of frequency, so frequency value must be stated.
\bar{i}_n	V_{DS} V_{GS} or I_D frequency bandwidth	Common-source equivalent open-circuit input noise current. Expressed as $\text{pA}/\sqrt{\text{Hz}}$, a function of frequency.
NF	V_{DS} V_{GS} or I_D $R_{generator}$ frequency bandwidth	Noise figure. This represents a ratio between input signal to noise and output signal to noise. NF is a function both of frequency and of generator resistance R_s . Both must be stated or the specification is meaningless. When properly qualified, NF includes the effects of both \bar{e}_n and \bar{i}_n .

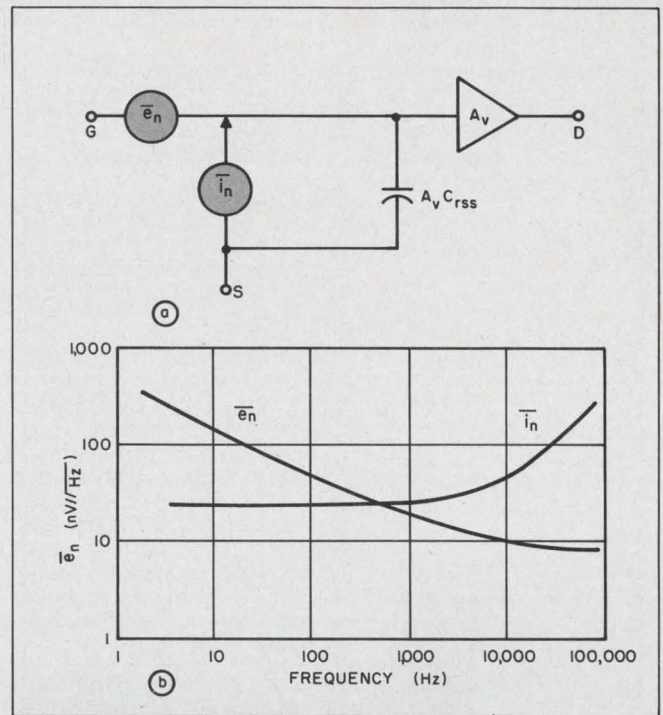

1. When FETs are used for low-noise amplifier applications, the noise equivalent circuit (a) must be consulted. The equivalent short-circuit noise voltage (\bar{e}_n) and equivalent open-circuit noise current (\bar{i}_n), as referred to the input, are functions of frequency (b).

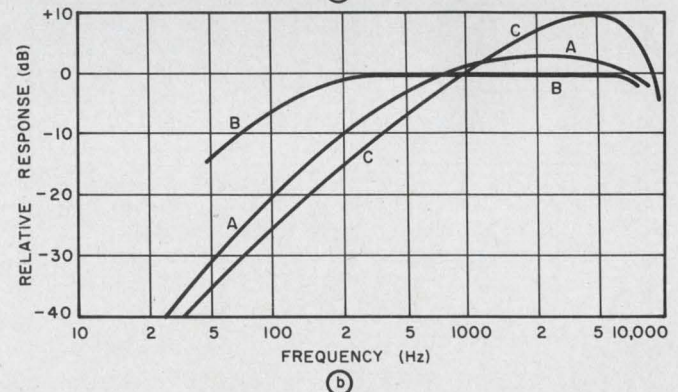
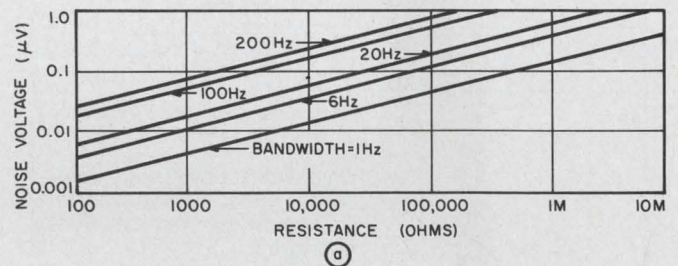

2. Thermal noise in FETs can be plotted as a function of resistance (a) according to the relationship $\bar{e}_n^2 = kTRB$. To obtain a specified noise-response characteristic, filters are used (b), particularly in measurements of sound-reproduction equipment. Curve A is an ASA recommendation; Curve B is a standard used by the Radio Manufacturers' Association; curve C is a German standard (DIN #45-405). All three display filter characteristics for noise measurements.

Table 2. Small Signal Characteristics of FETS

Parameter	Test Conditions (must be specified)	Meaning of specification
$r_{ds(on)}$	V_{GS} $V_{DS} = 0$ or I_s frequency	Drain-to-source resistance when biased to full ON condition (max operating I_D).
$ y_{fs} $		Magnitude of common-source forward transfer admittance. Sometimes the magnitude signs are omitted. Measured at $V_{GS} = 0$, unless otherwise specified.
$ g_{fs} $		Magnitude of common-source forward transfer conductance. Sometimes the magnitude signs are omitted. This is perhaps a more informative term than y_{fs} . At 1kHz, $y_{fs} \approx g_{fs}$. However, at high frequencies y_{fs} includes the effect of gate-drain capacity, hence may be misleadingly high. The term g_{fs} should be used for all high-frequency measurements.
g_{fsx}	V_{DS} & V_{GS} or V_{DG} & I_D frequency	Same as g_{fs} but a particular set of operating conditions is implied.
g_{fs1} g_{fs2}		Match in g_{fsx} for differential pairs. Expressed as a fraction.
g_{fsx1} g_{fsx2}		Match in g_{fsx} for differential pairs.
g_{fsz}		Same as g_{fsx} but often used to denote g_{fs} when biased for zero temperature coefficient operation.
g_m		Mutual conductance. Sometimes used in lieu of g_{fs} .
g_{m0}		Same as g_m , but specifically at $V_{GS} = 0$.
y_{iss}		Common-source input admittance with output shorted. Important for high-frequency operation.
g_{iss}	V_{DS} V_{GS} $v_{ds} = 0$ frequency	Common-source input conductance with output shorted. This must be specified for high-frequency applications as $g_{iss} \propto 1/\omega^2$.
$Re y_{iss} $		Real part of y_{iss} . Identically equal to g_{iss} . Sometimes used instead of g_{iss} .

Parameter	Test Conditions (must be specified)	Meaning of specification
g_{is}		Same as g_{iss} .
y_{oss}		Common-source output admittance with input shorted.
g_{oss}		Common-source output conductance with input shorted.
$Re y_{oss} $	V_{DS} & V_{GS} V_{DG} & I_D $v_{gs} = 0$ frequency	Real part of y_{oss} . Identically equal to g_{oss} . Sometimes used instead of g_{oss} .
g_{os}		Same as g_{oss} .
$Im y_{oss} $		Imaginary part of y_{oss} . Output susceptance b_{oss} . Identically equal to $1/\omega C_{oss}$. Sometimes used in lieu of C_{oss} .
C_{iss}	V_{DS} V_{GS} $v_{ds} = 0$ frequency	Common-source input capacitance, output shorted. $C_{iss} = C_{dg} + C_{gs}$. (Fig. 6).
C_{is}		Same as C_{iss} if $v_{ds} = 0$.
C_{gss}		Same as C_{iss} .
C_{rss}	V_{DS} V_{GS} $v_{gs} = 0$ frequency	Reverse transfer capacitance, input shorted.
C_{rs}		Same as C_{rss} .
C_{dg}		Same as C_{rss} , actual value of drain-gate capacitance.
C_{gs}		Values in equivalent circuit not measurable directly.
C_{ds}		Actual value of drain-source capacitance, essentially header capacitance.
C_{oss}	V_{DS} V_{GS} $v_{gs} = 0$ frequency	Common-source output capacitance, input shorted. $C_{oss} = C_{rss} + C_{ds}$. However, C_{ds} is essentially header capacitance.
C_{os}		Same as C_{oss} if $v_{gs} = 0$.
C_{dgs}		Same as C_{oss} .
C_{ngs}	V_{DS} V_{GS} $v_{dg} = 0$ frequency	Source-to-gate capacitance, gate and drain shorted. $C_{ngs} = C_{gs} + C_{ds}$.
C_{dgo}	V_{DG} V_{GS} or $I_s = 0$ $i_s = 0$ frequency	Drain-to-gate capacitance with source open. $C_{dgo} = C_{rss} + \frac{C_{gs} C_{ds}}{C_{gs} + C_{ds}} > C_{rss}$, but $< C_{dgs}$.
C_{sgo}	V_{GS} V_{DS} or $I_D = 0$ $i_d = 0$ frequency	Source-to-gate capacitance with drain open. $C_{sgo} = C_{gs} + \frac{C_{dg} C_{ds}}{C_{dg} + C_{ds}} > C_{gs}$, but $< C_{sgs}$.

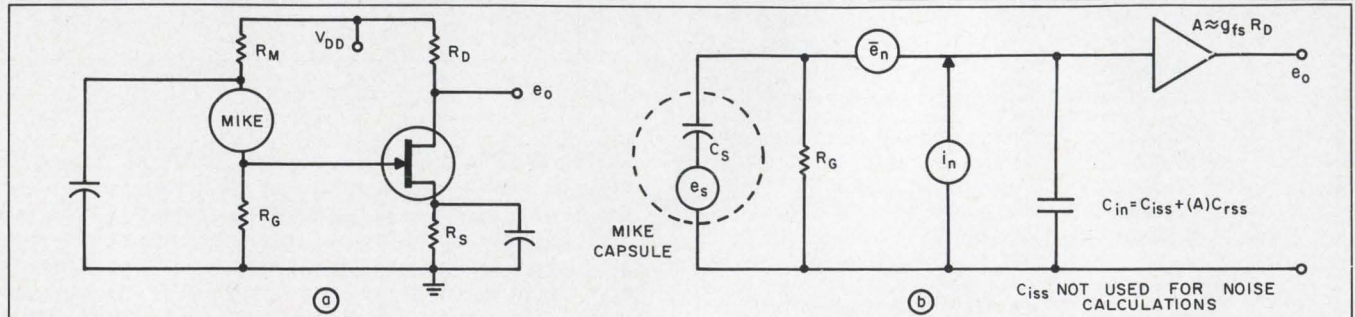

3. The FET can be put to advantage in capacitor microphone preamplifier applications (a). Referring to the equiv-

alent circuit (b). C_{in} (across mike) must be minimized to provide high S/N ratios. Capacitance at R_S is C_S .

R the resistance in ohms and B the bandwidth in Hertz.

As \bar{e}_n is proportional to \sqrt{B} , the units used are $\mu\text{V}/\sqrt{\text{Hz}}$. The conversion from \bar{e}_n to R_N becomes an easy one with Fig. 2a. The characterization of a FET by R_N is equivalent to specifying a NF . Thus, when a FET is said to have an equivalent noise resistance of 20 k Ω at 1 kHz, this is tantamount to saying $NF=3$ dB at 1 kHz with $R_{gen}=20$ k Ω .

How to spot noise in narrow bands

Narrow-band NF , \bar{e}_n , and \bar{i}_n are usually specified either as NB-noise or spot-noise measurements. This means simply that the bandwidth is sufficiently small for a change in bandwidth not to affect the NF of $\bar{e}_n/\sqrt{\text{Hz}}$. In a wide-band measurement, over a frequency range of 0.1 to 5 kHz for instance, this may not be true. From Fig. 1b it is seen that the integral of \bar{e}_n in this band is a function of bandwidth. On the other hand, from 1 to 50 Hz or from 10 to 100 kHz, the integral of \bar{e}_n is essentially independent of bandwidth. For this reason, it is important to note the bandwidth specified for any noise measurement. Alternatively, it must be stated that the parameter is a spot noise measurement.

When selecting a FET for use in sound-reproduction equipment, a noise specification at or above 1 kHz is desirable. A noise specification at 20 or 100 Hz for audio equipment will most often result in over-specification and will increase component cost. As the ear is progressively less sensitive to frequencies below a few kilohertz, noise measurements on sound-reproduction equipment are ordinarily carried out with wide-band equipment possessing a certain specified response characteristic.

The characteristics of several filters used for this purpose appear in Fig. 2b. Curve A is recommended by the American Standards Association for low-level noise measurements.^{2,3} Curve B is most useful for noise analysis in offices and factories, although it is recommended by the Radio Manufacturers' Association for noise measurement on sound reproduction equipment.⁴ Neither of these two curves is *universally* applicable as each was generated from single-frequency measurements. Curve C, a standard (DIN 45-405) used for this purpose in Germany, appears to be more applicable, as it includes the effect of the high frequency's masking of low frequencies.

It is most meaningful, therefore, to specify noise measurement for sound-reproduction equipment at a frequency from 1 to 5 kHz or over a broad band, regardless of whether one of the weighting curves (A, B or C) is used.

C_{iss} affects signal-to-noise ratio

Although NF , \bar{e}_n , and \bar{i}_n specify noise performance of the FET, there are those applications

where C_{iss} can significantly affect circuit signal-to-noise ratio (S/N). For a given \bar{e}_n and \bar{i}_n it is desirable to have a high g_{fs} so that the output S/N is high enough to reduce the effect of second-stage noise. Consider, for example, the capacitor microphone preamplifier, of Fig. 3. As the signal source is a small capacitor, C_{in} of the amplifier and the microphone capacitance become a voltage divider. It is thus important to minimize C_{in} for a high S/N . Also, the gate-return resistor R_G should be as high as practical to extend the low-frequency cut-off; therefore, \bar{i}_n should be low to minimize current noise in R_G and C_s . Assuming a noiseless microphone, the noise performance of the preamplifier may be determined by a step-by-step procedure.

Referring to Fig. 3, we use the following circuit characteristics:

- $g_{fs} = 1000 \mu\text{mhos}$ at operating point.
- $\bar{e}_n = 0.05 \mu\text{V}/\sqrt{\text{Hz}}$ at 1 kHz.
- $\bar{i}_n = 0.001 \text{ pA}/\sqrt{\text{Hz}}$ at 1 kHz.
- $C_{iss} = 4.5 \text{ pF}$;
- $C_{rss} = 1.5 \text{ pF}$;
- $C_s = 27 \text{ pF}$;
- $R_G = 100 \text{ M}\Omega$
- $R_D = 10 \text{ k}\Omega$
- $e_s = 1 \text{ mV}$ at 1 kHz

Note that R_G is negligible in comparison to the 1-kHz reactance of the C_{in} and C_s combination. Also, the correlation between \bar{e}_n and \bar{i}_n is neglected.

Now for the design:

1. Determine amplifier gain:

$$A = g_{fs} R_D = 10.$$

2. Determine the input capacitance:

$$C_{in} = C_{iss} + A C_{rss} = 19.5 \text{ pF}.$$

3. Determine the input signal level at the frequency of interest:

$$e_{in} = e_s \left(\frac{C_s}{C_s + C_{in}} \right) \approx 0.6 \text{ mV at 1 kHz.} \quad (4)$$

4. Determine the total equivalent input noise, total \bar{e}_n . Observe that \bar{e}_n divides between Z_{gen} and Z_{in} in the same manner as does e_s . Thus,

$$\text{Total } \bar{e}_n^2 = \left[\bar{e}_n \frac{C_s}{C_s + C_{in}} \right]^2 + \left[\frac{\bar{i}_n}{\omega (C_s + A C_{rss})} \right]^2, \quad (5a)$$

and

$$\text{Total } \bar{e}_n \approx 9.77 \text{ nV}/\sqrt{\text{Hz}} \text{ at 1 kHz.} \quad (5b)$$

5. Determine S/N in the bandwidth 1-10 kHz. Assume \bar{e}_n and \bar{i}_n to be constant with frequency. Use no weighting function. Note that total \bar{e}_n is due principally to \bar{e}_n and not \bar{i}_n . One may then assume total \bar{e}_n is constant with frequency in the range of interest. Thus,

$$S/N = 20 \log \frac{e_{in}}{\text{total } \bar{e}_n \sqrt{9000}} \approx 76 \text{ dB.} \quad (6)$$

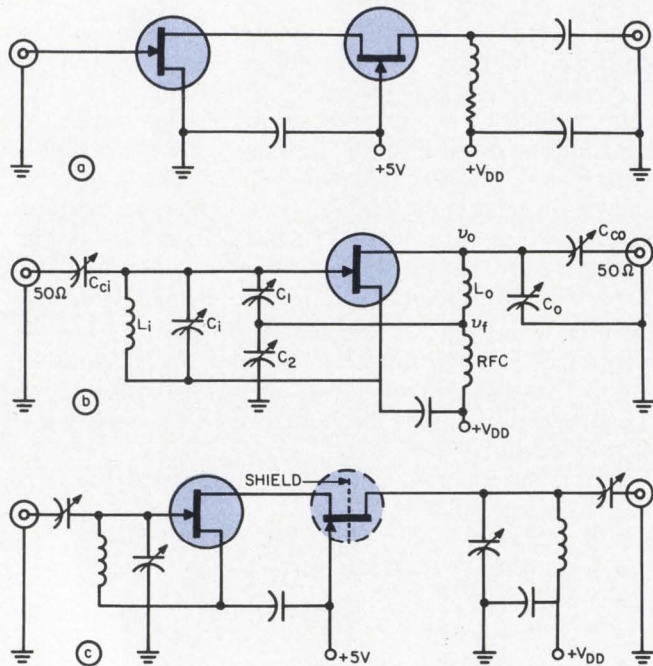

4. FETs are suitable for high-frequency amplifying applications. A cascode video amplifier (a), a 100-MHz neutralized amplifier (b) and a 30-MHz cascode amplifier (c) all exhibit good gain, low noise and little harmonic distortion.

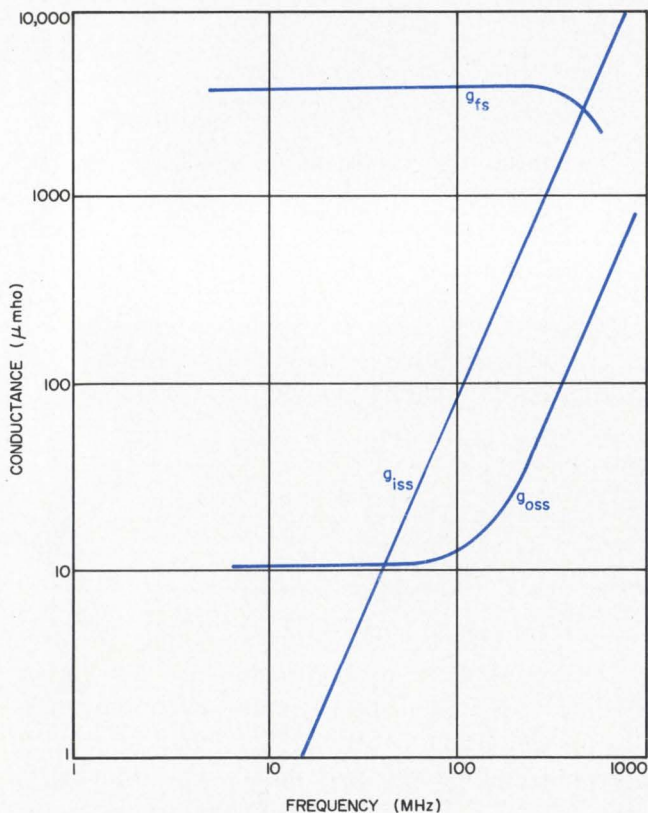

5. Maximum available gain (MAG) in FET high-frequency amplifiers is calculated from the master chart. It exhibits the conductance vs frequency relationship of FET devices now on the market. Shown are the input (g_{iss}), output (g_{oss}) and transfer (g_{fs}) conductances.

This completes the low-noise amplifier class of FET applications. We now turn to the high-frequency type (FETs operated above 1.0 MHz).

FETs suitable for RF operation

A high-frequency amplifier is arbitrarily defined as one which is operating at frequencies above 1 MHz. Included in this definition are both video and RF amplifiers (Fig. 4). The small-signal FET characteristics are of prime importance (See Table 2). They establish the suitability of a particular FET and govern design of FETs in high-frequency amplifiers.

For the video designs the major parameters are g_{fs} , C_{iss} , C_{rss} and C_{oss} . Each of these terms is critical in RF amplifier design, where the values of g_{iss} , g_{oss} and NF also exert a major influence. The video amplifier is characterized by its gain-bandwidth (GB) product. This is expressed as

$$GB = \frac{g_{fs}}{\omega [C_{in} + C_{out}]} = \frac{g_{fs}}{\omega [C_{iss} + (1 + A)C_{rss}]} \quad (7)$$

For the cascode connection this becomes⁵

$$GB = \frac{g_{fs}}{\omega [C_{iss} + 2C_{rss}]} \quad (8)$$

Note that $C_{oss} \approx C_{rss}$ and $C_{iss} = C_{gs} + C_{rss}$.

The GB is important for RF amplifiers; however bandwidth is ordinarily limited to a few megahertz at most, rather than the tens of megahertz required of a video amplifier. An RF amplifier is limited in power gain by the real part of its input and output impedances. When these are matched to source and load, maximum available gain (MAG) is realized. For the FET

$$MAG = \frac{|y_{fs}|^2}{4g_{iss}g_{oss}} \quad (9)$$

FET performance as a small-signal RF amplifier is also limited by its high-frequency noise characteristics. The value of C_{rss} is important, as its effect must be neutralized for stable amplifier operation.

An important advantage of the FET in RF circuitry is its almost perfect square-law transfer characteristic. Because of this, amplifier cross-modulation figures are at least an order of magnitude better than those of bipolar transistor designs. In most cases a substantial improvement is obtained even over vacuum-tube circuits.^{2,3}

FET transconductance remains essentially constant to several hundred MHz. Both g_{iss} and g_{oss} increase with a nearly square relationship to frequency. With available FETs, MAG is less than unity at that frequency where g_{fs} begins to decrease. MAG can be calculated from the curves in Fig. 5—which represent the characteristic obtainable with current FETs.

Recent improvements in the control of device input and output impedances at high operating frequencies has made possible the production of both MOS and FET units with acceptable per-

formance to 500 MHz.⁶ The MOS has a very low value of g_{iss} at high frequencies, thus permitting excellent hf operation. However, its output conductance rises in the same manner as that of the FET, limiting the MAG obtainable.

FET high-frequency noise figure (NF) for properly designed practical circuits is 2 dB or better at 10 MHz (with an $R_{gen} = 1 \text{ k}\Omega$), and good noise performance extends to the vicinity of 500 MHz. In contrast to bipolars, these same FETs exhibit a typical NF of 5 dB at 10 Hz (with an $R_{gen} = 1 \text{ M}\Omega$). MOS high-frequency noise performance is approaching that of the FET, with at least one available unit specified with a NF of 4.5 dB at 450 MHz.

Designing a 100-MHz cascode amplifier

FET amplifier circuits resemble the triode-vacuum-tube types. Practical use of the cascode circuit is limited to about 100 MHz for good noise performance with maximum gain, unless cumbersome circuitry is added. Here is the step-by-step design procedure for a 100-MHz amplifier. We will use a FET with the following parameters:

- $g_{fs} = 3500 \mu\text{mho}$ at 100 MHz
- $C_{iss} = 4.5 \text{ pF}$
- $g_{iss} = 100 \mu\text{mho}$ at 100 MHz
- $C_{rss} = 1.5 \text{ pF}$
- $g_{oss} = 15 \mu\text{mho}$ at 100 MHz
- $f_o = 100 \text{ MHz}$

The procedure refers to the circuit of Fig. 4b.

1. Calculate output-circuit component values. The network $C_{oss} + C_o$ and C_{co} match the output conductance to the load conductance. The output conductance is the sum of g_{oss} plus the tuned-circuit conductance, $1/Z_p$. As $1/g_{oss} = 67 \text{ k}\Omega$, and the 100-MHz tuned-circuit Q is such that $Z_p \approx 5 \text{ k}\Omega$, the latter determines the actual output conductance at 100 MHz. Then, $R_o = 5 \text{ k}\Omega$ and $R_L = 50 \Omega$. If $C_o = 1.2 \text{ pF}$, the matching capacitor value are determined by

$$C_{oss} + C_o \approx C_{rss} + C_o = 2.7 \text{ pF}, \quad (10)$$

$$C_{co} = \frac{1}{\omega \sqrt{R_o R_L}} \approx 3 \text{ pF}, \quad (11)$$

$$L_o = \frac{1}{\omega^2 (C_{oss} + C_o + C_{co})} \approx 0.45 \mu\text{H}. \quad (12)$$

2. Input circuit calculations are similar. Assume input circuit Q is such that $R_i = 1 \text{ k}\Omega$ to achieve optimum noise figure. With $R_{gen} = 50 \Omega$ and $C_i = 1.2 \text{ pF}$, C_{rss} is subtracted from C_{iss} to obtain actual FET input capacitance because C_{rss} is neutralized. Thus,

$$C_{iss} - C_{rss} + C_i = 4.7 \text{ pF}, \quad (13)$$

$$C_{ci} = \frac{1}{\omega \sqrt{R_i R_{gen}}} \approx 1.3 \text{ pF}, \quad (14)$$

$$L_i = \frac{1}{\omega^2 (C_{iss} - C_{rss} + C_i + C_{ci})} \approx 0.42 \mu\text{H}. \quad (15)$$

3. The circuit is neutralized using the "sloppy bypass" technique as follows: The fraction of v_o appearing out of phase on C_2 is

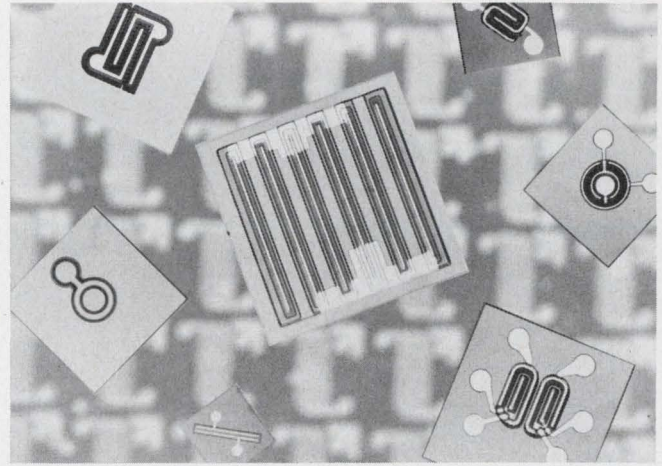

FET geometries vary from unit to unit. Knowing which of the many parameters best reflect device suitability for high-frequency applications simplifies FET selection.

$$v_f = v_o \frac{C_{out}}{C_2} \quad (16)$$

where C_{out} is the sum of C_{oss} , C_o and C_{co} . The fraction of v_f appearing at the gate is approximately

$$v_g = \left[\frac{1/j\omega C_1}{R_{in} + 1/j\omega C_1} \right] v_f. \quad (17)$$

This must be set equal to the fraction of v_o appearing in phase at the gate. Note that the fraction is due to the feedback function of C_{rss} . The latter term is given by

$$v_{fb} = \frac{1/j\omega C_{rss}}{R_{in} + 1/j\omega C_{rss}} (v_o). \quad (18)$$

Equating (16) and (17) and using Eq. 18 yield

$$\frac{1/j\omega C_{rss}}{R_{in} + 1/j\omega C_{rss}} = \frac{C_{out}}{C_2} \left[\frac{1/j\omega C_1}{R_{in} + 1/j\omega C_1} \right], \quad (19a)$$

$$1 + j\omega C_1 R_{in} = \frac{C_{out}}{C_2} (1 + j\omega C_{rss} R_{in}). \quad (19b)$$

For all practical purposes, it is only the imaginary terms which must be set equal. Doing this establishes the relationship,

$$C_1 C_2 = C_{out} C_{rss}. \quad (20)$$

This wraps up the higher-frequency FET amplifier applications. In Part 3 (ED 15, June 21) we will take up the low drift, single-ended and differential FET circuits. ■ ■

References:

1. A. van der Ziel. "Thermal Noise in Field-Effect Transistors," *Proc. IEEE*, L (Aug., 1962), 1808.
2. *American Standard for Noise Measurement* (American Standards Assn., Z24.2 [1942]).
3. *American Standard for Sound Level Meters* (American Standards Assn., Z24.3 [1944]).
4. *Amplifiers for Sound Equipment* (American RMA Standard SE-101-A [July 1949]).
5. *FET Cascode Circuits Reduce Feedback Capacitance*, Application Tip (Siliconix Inc., Feb. 1, 1966).
6. George Pierson, "A FET Operating at UHF?," *ELECTRONIC DESIGN*, XIV, No. 7 (March 29, 1966), 48-53.

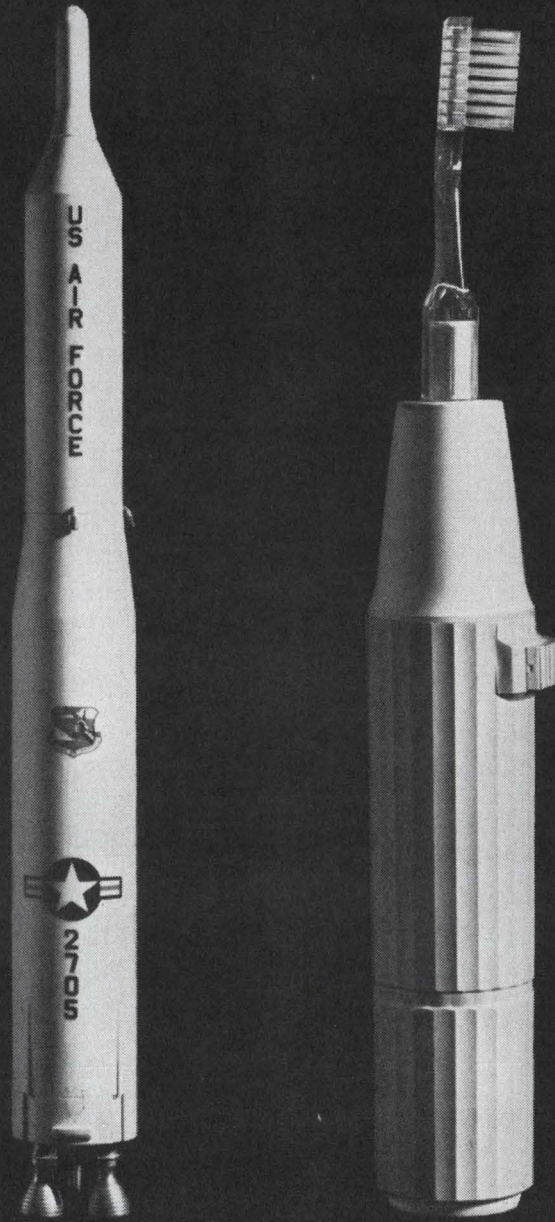

from Titan to Toothbrush

Sonotone batteries spark portable power to action!

Mite or might—if it's portable, the chances are it relies on Sonotone rechargeable sintered-plate, nickel-cadmium cells and batteries. That goes for everything from space satellites and missiles to cordless razors and toothbrushes, and even to small, delicate medical instruments. The reason is this: Sonotone pioneered in the development of high-power/low-weight rechargeable batteries. With more years of experience in this field than any other American company, Sonotone has built up an unmatched record of reliability...and an unmatched reputation for cooperation with design engineers. What new product are

you working on? Let Sonotone help you solve your power problem. Write today for technical data, stating your application requirements...and we'll be happy to lend you a hand.

Sonotone Batteries MM-13 have been used in U.S. ICBM Titan I and Sonotone Batteries MM-14 have been used in the emergency ground support. Many electric toothbrushes use Sonotone Sealed Battery S-113. These are just three of more than 300 Sonotone rechargeable sintered-plate, nickel-cadmium cells and **Sonotone Batteries**  portable power for progress

Semiconductor Report



NEW PRODUCTS, DESIGN AND APPLICATION INFORMATION FROM MOTOROLA

Motorola EPICAP Diodes 1N5139-48 & 1N5139A-48A

TYPE†	CAPACITANCE VALUE (pF) (1 MHz & 4V Typ.)	FIGURE OF MERIT (Q) (50 MHz & 4V dc Min.)	PRICE (100-up)
1N5139	6.8	350	\$3.90
1N5140	10	300	3.90
1N5141	12	300	3.90
1N5142	15	250	3.90
1N5143	18	250	3.90
1N5144	22	200	3.90
1N5145	27	200	3.90
1N5146	33	200	3.90
1N5147	39	200	3.90
1N5148	47	200	3.90

† "A" versions are priced at \$4.30 (100-up)

NEW MOTOROLA EPICAP* DIODES GREATLY SIMPLIFY ELECTRONIC TUNING

If you've been struggling with cumbersome mechanical assemblies, or low Q electric tuning devices, and "living with" limited reliability in your tuning circuits — RELAX!

Now, you can enjoy all the advantages of automatic, electronic tuning — at about half the price you might expect to pay — with new, high Q EPICAP diodes from Motorola.

For example, in Electronic Countermeasures (ECM) equipment, the EPICAP diode can be used with a "saw-tooth wave" design to automatically sweep a broad frequency range (200 to 400 MHz); and, in the process, eliminate the need for a clumsy sweep generator motor. (Drop a note to our applications group if you'd like more information on this one.)

You'll also find EPICAPS well-suited for difficult tuning jobs in other RF applications such as FM tuning, aircraft radio, etc. In fact, in every application above 200 MHz, you'll get faster, more reliable performance — the highest performance/lowest cost combination in the industry, for applications up to 500 MHz.

These new voltage-variable capacitors feature improved fabrication techniques which yield a low leakage and a Figure of Merit (Q) that's specified at a minimum of 200 at 50 MHz and a bias of 4 volts dc. In addition, EPICAPS boast a 20 nanoamp reverse leakage current, due to the good, "clean" surfaces you'd expect in a high quality diode — your assurance of maximum reliability. And, the rugged, new Ramrod* (straight-through) DO-7 glass diode package adds another measure of increased reliability.

ON READER-SERVICE CARD CIRCLE 162

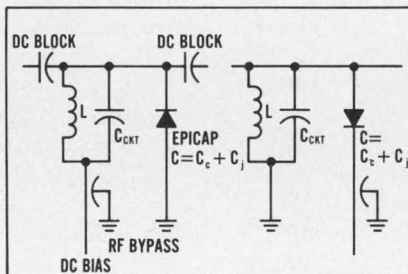

FIGURE 1 — TWO EPICAP TUNED PARALLEL RESONANT CIRCUITS

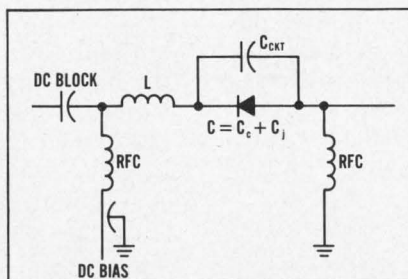
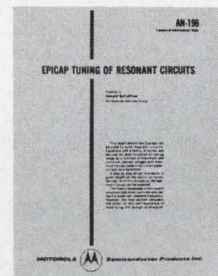

FIGURE 2 — EPICAP TUNED SERIES RESONANT CIRCUIT

*Trademarks of Motorola Inc.



"HOW TO TUNE RESONANT CIRCUITS" COVERED IN NOTE

A comprehensive report that details a step-by-step design procedure and helps you select the optimum EPICAP for your specific application is the subject matter of Motorola Application Note 196. Circuit schematics, equations and a family of curves are used for determination of tuning range as a function of maximum EPICAP capacity to circuit capacity as a parameter.

Figures 1 and 2 (left) show the most common forms taken by EPICAP resonant circuits. The equations and graphs of the report apply to both. For example, a graph has been developed to predict tuning range, using the voltage tunable capacitance and external circuit parameters. The discussion and use of that graph is the major thesis of AN 196. You're sure to find this well-written technical report a valuable addition to your semiconductor library. Write for it today, to Technical Information Center, Motorola Semiconductor Products Inc., P. O. Box 955, Phoenix, Arizona 85001.

ON READER-SERVICE CARD CIRCLE 161



MOTOROLA Semiconductors

Call your nearby Motorola Franchised Distributor for "off-the-shelf" delivery.

Speed Inquiry to Advertiser via Collect Night Letter

D/A converter uses thin-films to get high precision and maintain the flexibility needed for low-volume production.

If your microelectronics application calls for high accuracy, look beyond the popular monolithic integrated circuits. Hybrid thin-film circuits offer greater advantages.

One such application is in the digital-to-analog converter, where hybrid circuits provide the following:

- High resistance accuracy.
- Wide selection of active devices.
- Well matched resistance values.
- Improved temperature coefficients.
- Design flexibility.
- Economical low-volume production.

Four-bit D/A converter requires three ICs

An integrated digital-to-analog (D/A) converter can be made by connecting three integrated circuits (a buffer amplifier, a ladder switch and a ladder network) in series. If each of the integrated circuits is designed to handle 4 bits, the complete circuit will perform as a 4-bit D/A converter. Two sets of each will form the 8-bit D/A converter shown in Fig. 1, and three sets can be used to form a 12-bit converter. All the circuits are mounted in flat-packs, and their leads are arranged as shown to facilitate assembly.

The converter interprets a set of digital input pulses and converts it to an analog output signal. The buffer amplifier (normally ON) is turned OFF by a positive input signal. As the output of the buffer amplifier goes more negative, a turn-on drive current is supplied to the pnp transistor of the next stage, the ladder switch. The complementary npn transistor is simultaneously biased off and the output of the ladder switch goes to the reference voltage level. This negative reference voltage feeds the ladder network where it is divided down to the correct analog output. The output of the ladder network represents the sum of the various input signals.

With no input signals to the converter, the buffer amplifier is ON. This in turn sets the output of the ladder switch at zero volts (the offset voltage can be made extremely low) by driving the pnp transistor OFF and the npn transistor ON. With zero volts into the ladder network, the output of this stage also remains at zero volts.

Richard D. Tatro, Applications Engineer, Semiconductor Div., Sprague Electric Co., Concord, N. H.

The circuits described here are available as standard catalog items (buffer amplifier-UD4025; ladder switch-UD4001; ladder network-UT1000), and thus do not necessarily represent the best approach to D/A conversion for all applications. They do, however, show a practical method of designing microelectronic converters that are compatible with present-day silicon microcircuits.

Buffer uses individual transistor chips

The buffer amplifier is used to convert the digital input signal (0 to V_{CC}) into positive and negative current drives to the ladder switch. Though the buffer is designed for a rather restricted range of applications, the inherent design flexibility of thin-film circuits makes modifications simple to achieve when low-volume quantities are involved. Where large-volume use of a particular buffer circuit is indicated, a monolithic approach may be more practical.

The typical buffer circuit, shown in Fig. 2a, drives the complementary-transistor-pair ladder switch. When the buffer transistor is turned OFF, the pnp-transistor-side of the ladder switch is turned ON. With V_{CC} set to -20 volts, approximately 1 mA of current will flow into this transistor. To guarantee turn-off, the input signal must be at least as positive as the V_{EE} supply; if an input high level of 4 to 6 volts is anticipated, the V_{EE} supply should be set at +4 volts. If the input signal is lower than V_{EE} , the buffer amplifier will remain turned ON and thus drive the npn-transistor-side of the ladder switch also ON. With V_{EE} equal to +4 volts, approximately 1 mA of current will flow into this transistor. The circuit can handle input high levels as low as 1.5 volts if the V_{EE} supply is correspondingly lowered. Base drive to the pnp transistor when $V_{EE} = 1.5$ volts is reduced to approximately 0.25 mA.

A photograph of the actual buffer circuit is shown in Fig. 2b. The four input resistors and eight output resistors are nickel-chromium (NiCr) material deposited on silicon substrates. The use of two separate chips facilitates the internal wiring and allows for greater flexibility. These particular resistors were specified with a tolerance of $\pm 10\%$ and a temperature coefficient (TC) of ± 100 ppm/ $^{\circ}$ C. However, NiCr resistors are available with a $\pm 5\%$ tolerance and a ± 50 ppm/ $^{\circ}$ C TC, in resistance values from 15 ohms to 150 kilohms.

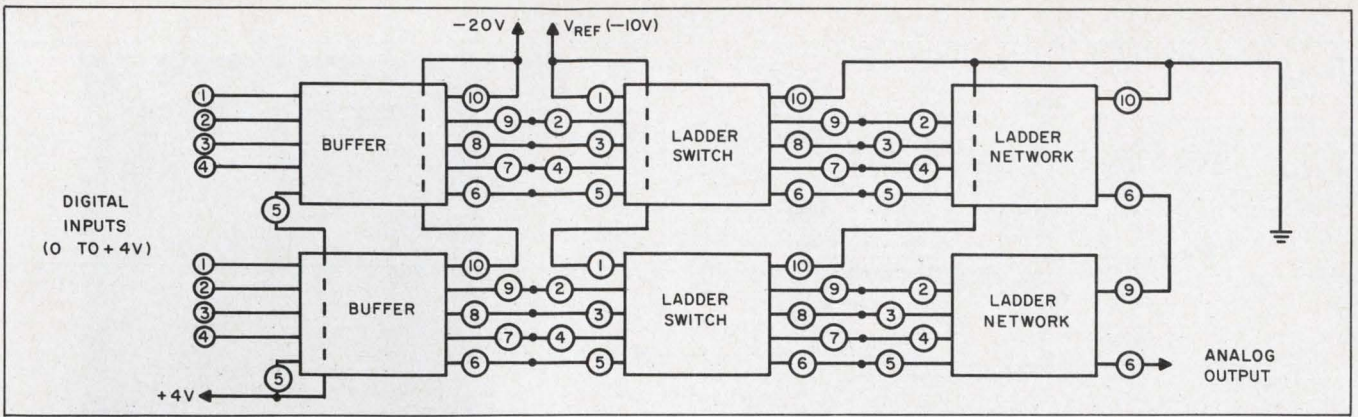

1. Eight-bit digital-to-analog converter uses three different types of integrated circuits: a buffer amplifier, a ladder

switch and a ladder network. Note that the circled numbers refer to the pins on each individual package.

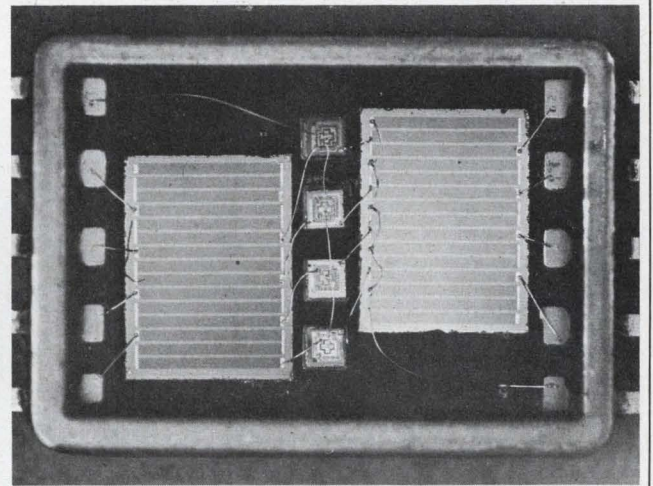
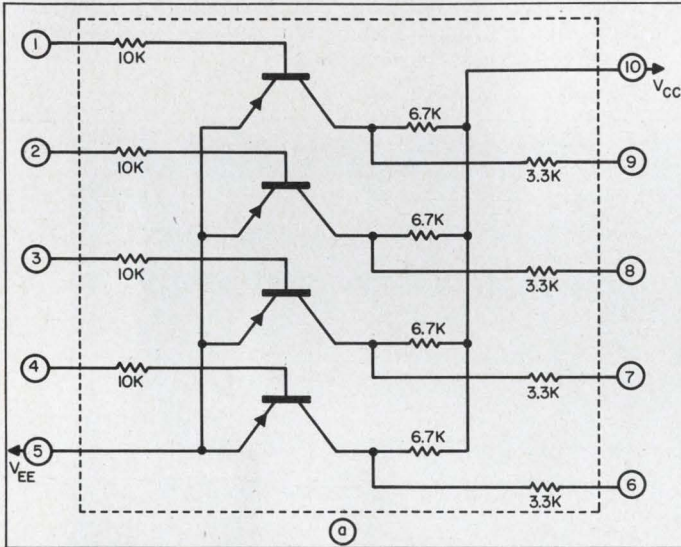

2. The buffer amplifier (a) converts the digital input signals to driving currents for the next stage, the ladder

switch. The base resistor network is the large block at the left in the photograph (b).

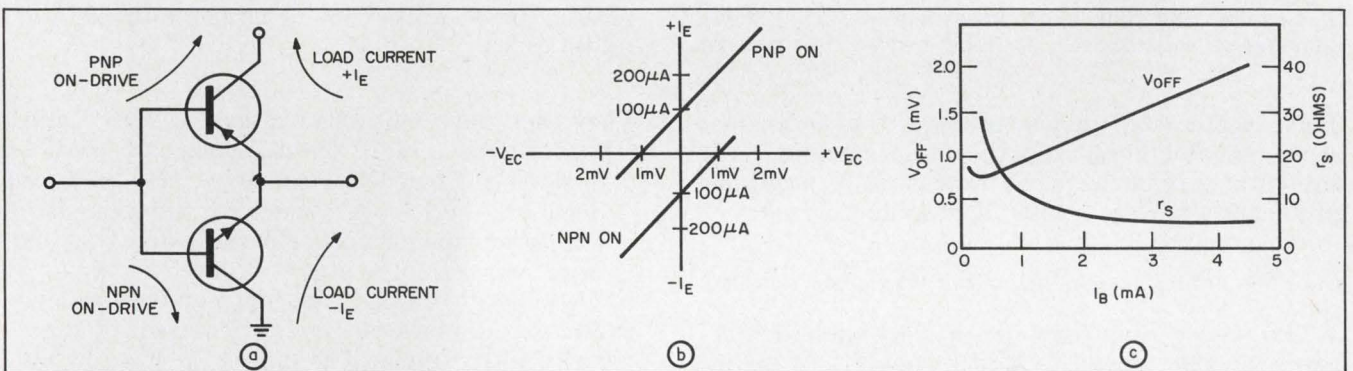

3. Complementary transistor switch (a) is used to provide extremely low offset voltages. With the base drive at 1 mA, both the pnp and npn transistors have an

voltage of about 1 mV at cutoff (b). If the base current is increased (c), the offset voltage will also increase and the series resistance r_s will decrease.

This buffer circuit was designed to accept inputs from most present digital monolithic circuits, and also to:

- Accept low level input signals as high as +0.5 volts.
- Accept a high level from 1.5 to 5 volts. Larger inputs could be tolerated but a new design would be required in order to limit power consumption.
- Require only low levels of drive current or

sink current from the driving circuit.

- Supply approximately ± 1 mA of base drive to the ladder switch.

With the hybrid thin-film approach, it is easy to change either the base resistors or both collector resistors, or to change from a pnp to an npn stage. A circuit designer can make breadboard circuits with conventional discrete components knowing that the hybrid version will behave similarly.

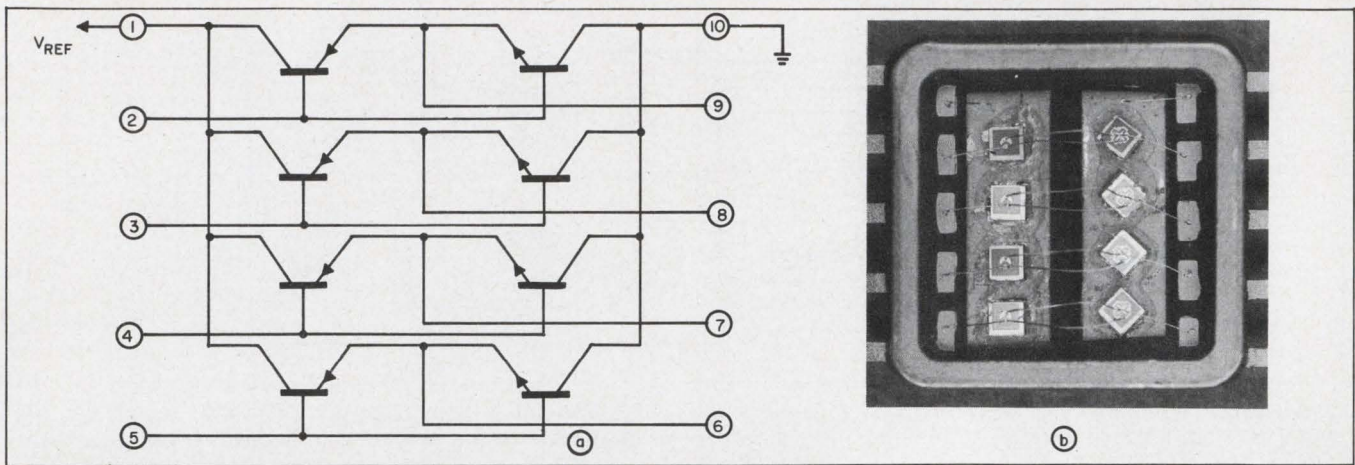

4. **Four-bit ladder switch** uses four pairs of complementary transistors (a). The circuit is actually made up of eight individual transistor chips (b). The two sets of transistors

(pnps are on the left) are each bonded to a conductive substrate to achieve a common collector connection with a low collector series resistance.

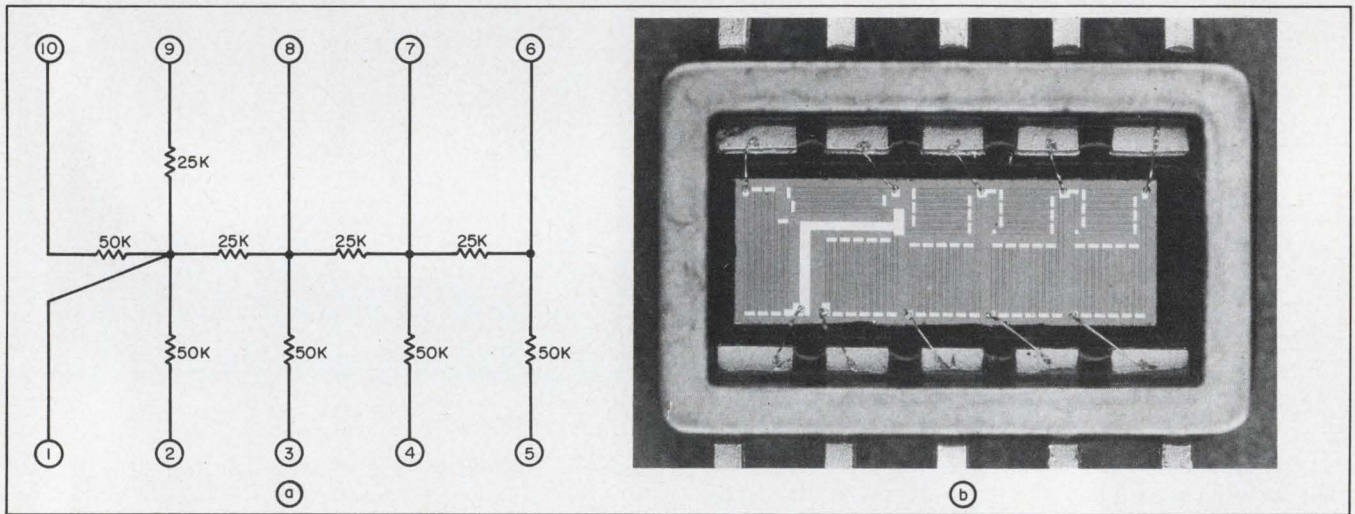

5. **Tantalum thin-film ladder network** uses highly stable and precise resistors (a). An 8-bit network is made by

connecting the output of one circuit (pin 6) to pin 9 of a second circuit.

This relationship holds because the individual semiconductor chips and the tantalum and NiCr resistors do not have the parasitic capacitance problems associated with monolithic devices.

Complementary transistors make up ladder switch

The ladder switch acts as a single-pole double-throw switch, since the ladder converter-network requires inputs which are at ground potential or at the reference voltage. The ladder switch must have negligible voltage errors in both the ON and OFF conditions. To do this a complementary transistor switch, shown in Fig. 3a, is used. The complementary transistor approach is highly desirable, since both sides of the switch can be operated in the inverted mode, thereby providing a low offset voltage. In this arrangement the voltage-drop contribution of $I_B r_s$ (where r_s is the ON series resistance) is of opposite polarity to that of the offset voltage, and offset errors are minimized. The output emitter characteristics of the npn and pnp devices are shown in Fig. 3b.

They each have an offset voltage of 1 mV and a series resistance of 10 ohms, which is typical for both devices when the base drive (I_B) is 1 mA.

Since the series resistance of the transistors varies as an inverse function of I_B and the offset voltage varies as a direct function of I_B , it is possible to choose the optimum base drive currents to the switches in anticipation of the required load currents. The curves in Fig. 3c show the typical variations of V_{OFF} and r_s with I_B for the transistors used. The characteristics of the npn and pnp transistors are similar enough for the curve to represent both. By adjustment of I_B it is possible to restrict the error of the ladder switches to ± 2 mV, which in turn holds the error at the output to less than ± 1 mV. For a 12-bit converter operating from a 10-volt reference voltage, this is equivalent to $\pm 1/2$ least significant bit (LSB), since

$$1 \text{ LSB} = \frac{1}{4096} (V_{REF}).$$

A 4-bit ladder switch is schematically shown in

Fig. 4a. Figure 4b is a photograph of the actual integrated circuit. Both the pnp and the npn sets of transistors have their collectors tied in common, each set on a single land area. The common emitters and bases of the npn-pnp pairs are interconnected and then brought out of the package.

Ladder network has well-matched resistances

The ladder network, shown in Fig. 5a, consists of five 50-K Ω and four 25-K Ω tantalum resistors deposited on a silicon substrate. Figure 5c is a photograph of the actual circuit. The network is mounted in a 0.160 in. x 0.265 in. flat pack by standard thermocompression bonding techniques. Each resistor is adjusted to a tolerance of $\pm 0.5\%$ and can be matched within a 0.5% spread. As a result, the maximum analog output error, due to the resistors, is $\pm 0.25\%$. In terms of least significant bits this would be somewhat less than one LSB for an 8-bit converter. (The LSB in an 8-bit converter is 1/256, or 0.39% of the reference voltage.) This maximum error, however, occurs only when the resistor at pin 5 is high and all other resistors are low, or vice versa. In actual practice, the resistors are randomly off tolerance and the bit accuracy is much better than this worst-case situation. Bit accuracy is typically 10 to 11 bits (1/1024 to 1/2048) and results in approximately 0.05% to 0.1% error in the analog output signal. Twelve-bit accuracy devices are available on a selection basis.

Ladder networks constructed in this configuration with values as low as 10 K Ω and 5 K Ω perform nearly identically. The difference that exists is related to the temperature coefficient of the resistances. The circuit in Fig. 5 has a typical TC of -150 ppm/ $^{\circ}\text{C}$, while the 10 K Ω and 5 K Ω networks, made with thicker tantalum, have a typical TC of -20 ppm/ $^{\circ}\text{C}$. Temperature-coefficient matching for the former is guaranteed to be within a spread of 25 ppm/ $^{\circ}\text{C}$.

In actuality, the effective match of temperature coefficients for the entire circuit is much better, as in the case of resistance value matching, often reaching a few parts per million per degree centigrade; often, the steps in the output of the ladder network will vary less than 1 mV over the -55°C to $+125^{\circ}\text{C}$ temperature range for a 10 volt reference input.

The settling time of the D/A converter is approximately 4 to 5 μs . Unfortunately, since the storage time of good chopper transistors, such as the ones used in the ladder switch, is relatively long, it is difficult to construct a fast converter with low switching errors. As a result, both the npn and pnp transistors in the ladder switch will be ON at the same time for an interval of about 1 μs . During this time the switch may be at ground instead of V_{REF} or vice versa, and causes spike at the output. Though these spikes are largely the result of this "storage time" error, some of this error is also due to the RC time constant of the ladder resistors and their distributed capacity. ■ ■

June 7, 1966

**WE CUT THE SIZE ...
WE CUT THE COST ...
WE KEPT THE PERFORMANCE**
to give you the best value in
LAB POWER SUPPLIES



Deltron

**ED SERIES (12 automatic crossover models)
EA SERIES (12 current limiting models)**

You won't find a better value in lab power supplies (voltage ratings up to 100 V . . . current ratings up to 2 A) . . . with these important features.

- 0.01% regulation
- ED units feature DUET twin amplifier system for continuous voltage or current control with automatic electronic crossover.
- EA units have continuously adjustable current limiting
- Completely protected and automatic recovery from overload and short circuit conditions.
- PLUS floating output . . . no overshoot . . . remote sensing . . . remote programming . . . automatic series and parallel operation . . . and many other advanced features.

FOR COMPLETE INFORMATION WRITE TO . . .

Deltron inc.

WISSAHICKON AVE., NORTH WALES, PA. 19454
PHONE: (215) 699-9261 TWX: (510) 661-8061

ON READER-SERVICE CARD CIRCLE 19

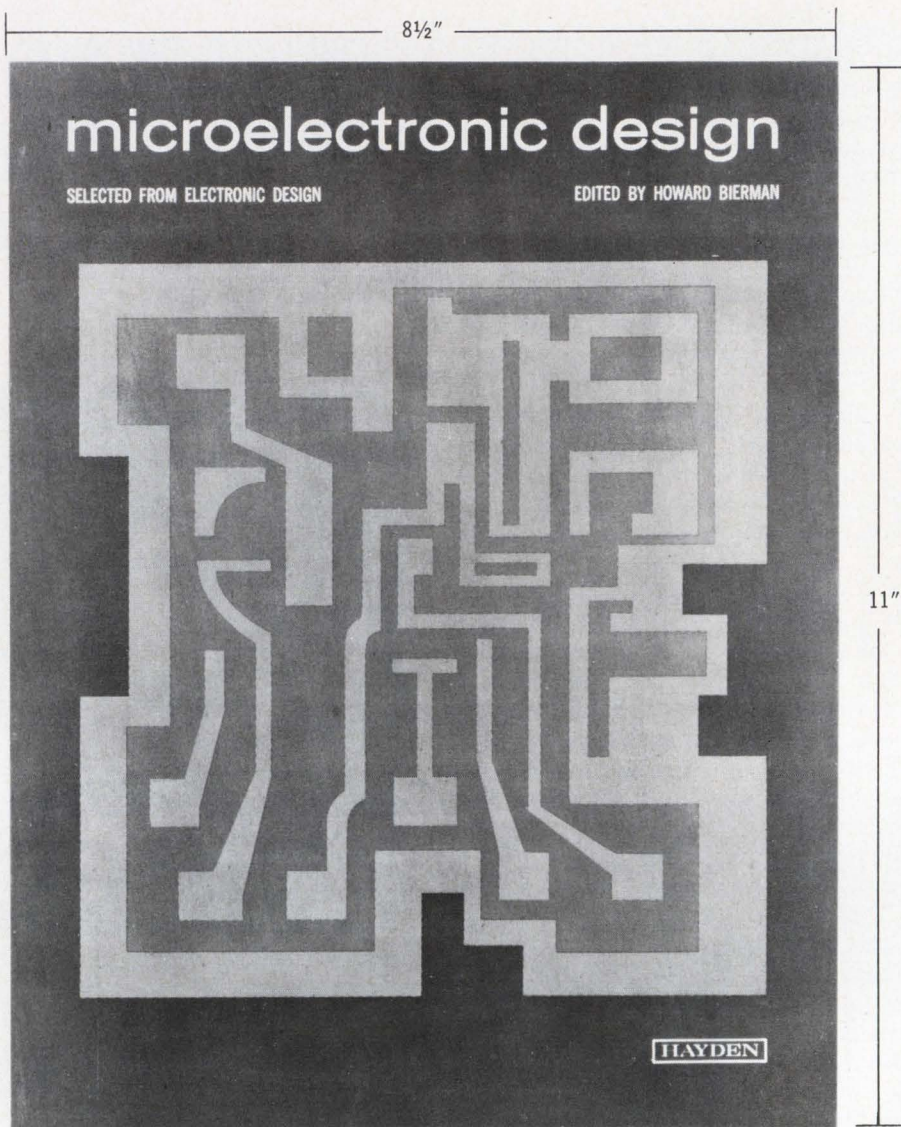

Little things do come in big packages.

The circuits may be microscopic, but there's nothing undersized about this comprehensive and convenient reference book. Its 320 *big* pages offer you almost 90 outstanding articles on all aspects of microelectronic design, compiled from the pages of Electronic Design magazine.

MICROELECTRONIC DESIGN gives a thorough overview of the field in six sections: Theory and Basic Concepts; Fabrication and Interconnection; Circuit Conversion; Prototype Planning and Fabrication; Testing Techniques; Bibliography and Data Charts (covering over 500 devices). #5762, clothbound, \$11.50.

HAYDEN BOOK COMPANY, INC., NEW YORK

also selected from electronic design
400 IDEAS FOR DESIGN
 All tested and proved award-winners, written by and for electronic design engineers, #5537, clothbound, \$8.50

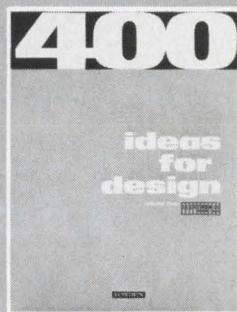

HAYDEN BOOK COMPANY, INC. 116 W. 14 St., New York 10011
 Department ED-42

Please send the book(s) checked below and bill me. At the end of 30 days, I will remit payment plus a few cents postage, or return the book(s).

5762 5537 Free 1966 Catalog

Name _____

Company _____

Address _____

City _____ State _____ Zip _____

You pay the postage. I enclose \$ _____.
 Same return privilege.

Opportunities for

Design & Development Engineers in Electronic Signal Processing and Display Systems

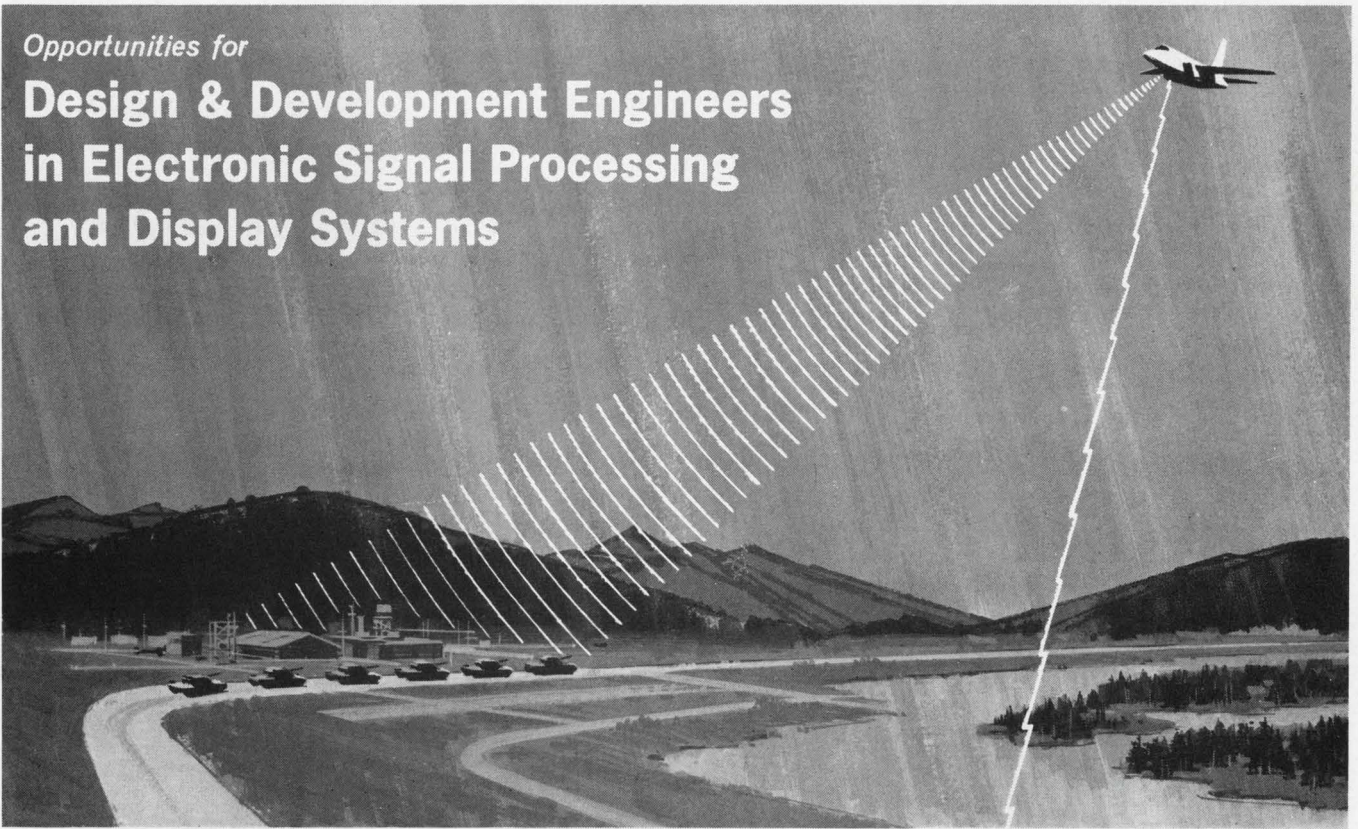

Design and Development activities in the field of Electronic Signal Processing and Display are rapidly expanding today at HUGHES Aerospace Divisions.

Advanced development is being accelerated on **high resolution pulse doppler radars** and other sensors utilizing matched filter, synthetic array, pattern recognition and other exotic correlation techniques.

Specialists will be interested in the many challenging and rewarding assignments now available in Project Engineering, Radar System Design, Performance Analysis, Signal Processing with emphasis on synthetic array, Information Display, System Simulation and Human Factors; in Circuit, Mechanical and Packaging Design.

Stimulating assignments are immediately available for graduate Engineers with accredited degrees and several years of applicable, professional experience in one or more of the following areas:

1. Highspeed Timing & Sampling Circuits
2. Optical & Electronic Moving Maps
3. Ultrahigh Speed Film Development
4. Wideband Video & IF Amplifiers
5. Mixers & Balanced Modulators
6. High Precision CRT Circuitry
7. Scan Converters Storage Tubes
8. Aerospace System Simulation
9. Multisensor Data Display
10. Precision Film Transport

All interested persons are invited to submit resumes in confidence.

For immediate consideration
please write:

Mr. Robert A. Martin
Head of Employment
HUGHES Aerospace Divisions
11940 W. Jefferson Blvd.
Culver City 9, Calif.

Creating a new world with electronics

HUGHES

HUGHES AIRCRAFT COMPANY
AEROSPACE DIVISIONS

An equal opportunity employer

U. S. CITIZENSHIP REQUIRED

3C

Interesting opportunities open for **Circuit Design Engineers** with experience in integrated circuits, high speed switching circuits, and A/D-D/A circuitry. Each of these positions offers considerable responsibility and growth potential. Your interest is invited. Send resume in confidence or call collect: **Martin Dorfman (617) 235-6220.**



COMPUTER CONTROL COMPANY, INC.
OLD CONNECTICUT PATH, FRAMINGHAM, MASSACHUSETTS 01702

An Equal Opportunity Employer
ON CAREER-INQUIRY FORM CIRCLE 901

Looking for a New Job?

- Fill out one application . . .
- Check off the companies that interest you . . .
- We do the rest

Contacting the job market takes only ten minutes with ELECTRONIC DESIGN's Career Inquiry Service. To put Career Inquiry Service to work for you, fill in the attached resume. Study the employment opportunity ads in this section. Then circle the numbers at the bottom of the form that correspond to the numbers of the ads that interest you.

ELECTRONIC DESIGN will be your secretary, type neat duplicates of your application and send them to any number of companies you select—the same day the resume is received.

Career Inquiry Service is a fast, efficient way to present your job qualifications to companies recruiting engineering personnel—as confidentially and discreetly as you would in person. This service is the first of its kind in the electronic field, and one that engineers have used effectively since its inception in 1959.

We take the following precautions to ensure that your application receives complete, confidential protection

- All forms are delivered unopened to one reliable specialist at ELECTRONIC DESIGN.
- Your form is kept confidential and is processed only by this specialist.
- The "circle number" portion of the form is detached before the application is sent to an employer, so that no company will know how many numbers you circled.
- All original applications are placed in confidential files at ELECTRONIC DESIGN and after a reasonable lapse of time they are destroyed.

After completing, staple, fold and mail career form to ELECTRONIC DESIGN, 850 Third Avenue, New York, N. Y. Our Reader Service Department will forward copies to the companies you select below.

(Please print with a soft pencil or type.)

Name _____ Telephone _____

Home Address _____ City _____ Zone _____ State _____

Date of Birth _____ Place of Birth _____ Citizenship _____

Position Desired _____

Educational History

College	Dates	Degree	Major	Honors

Recent Special Training _____

Employment History

Company	City and State	Dates	Title	Engineering Specialty

Outstanding Engineering and Administrative Experience _____

Professional Societies _____

Published Articles _____

Minimum Salary Requirements (Optional) _____

Use section below instead of Reader Service Card. Do not write personal data below this line. This section will be detached before processing.

Circle Career Inquiry numbers of companies that interest you

- 900 901 902 903 904 905 906 907 908 909 910 911 912 913 914 915 916 917 918 919 920 921 922 923 924
- 925 926 927 928 929 930 931 932 933 934 935 936 937 938 939 940 941 942 943 944 945 946 947 948 949

Fold here, staple and Mail.

FIRST CLASS
Permit No. 725
New York, N.Y.

BUSINESS REPLY MAIL

No Postage Stamp Necessary if Mailed in the United States

POSTAGE WILL BE PAID BY

ELECTRONIC DESIGN

READER SERVICE
850 THIRD AVENUE
NEW YORK, NEW YORK 10022



The Future Is At MCDONNELL

MCDONNELL AIRCRAFT CORPORATION

ST. LOUIS, MISSOURI 63166

PERSONAL: *McDonnell*
 Name *St. Louis, Missouri*
 Address *27 years*
 Age *Billion Dollar Aerospace Backlog.*
 Health *Complete, Modern Aerospace*
 Physical Appearance *Engineering, Research Laboratories and*
Production Facilities.
 Size *Over 35,000.*
 MILITARY SERVICE: *Contracts with U.S. Navy, U.S. Air Force,*
U.S. Army and the NASA.

ACHIEVEMENTS:
 FH-1 Phantom *First Navy jet to take off and*
land on a carrier.
 F2H Banshee *Saw extensive combat in Korea.*
 F-101 Voodoo *Set 10 world records.*
 F3H Demon *Served with the Navy in the Lebanon Crisis.*
 Aeroballistic *Lifting body research craft.*
 Quail GAM-72 *U.S.A.F. Pecos Missile.*
 Mercury *America's First Manned Orbital Spacecraft.*
 ASSET *Lifting Reentry Research Spacecraft.*
 Talos *Airframes and Engines.*

CURRENT ASSIGNMENTS:
 Phantom II *Fighter, Attack, and Reconnaissance aircraft*
for U.S. Navy, Marines and Air Force.
 Gemini *Two-man Spacecraft for Extended*
Missions and Orbital Rendezvous.
 F-111 *Crew Module.*
 TORS *Systems utilizing Precise Time Reference.*
 Automation *Data Services for Business, Govern-*
ment and Industry.
 Model 204 *Data Retrieval and Access Systems.*
 BGRV *Boat Glide Reentry Vehicle.*
 MAW *Medium Anti-tank Weapon for the Army.*
 MOL *Gemini B for the Air Force MOL.*

IN DESIGN FOR THE FUTURE: *Jet Fighters, Manned and Unmanned*
Spacecraft, Data Retrieval Systems, Collision
Avoidance Systems, Advanced Missile Systems -
both Tactical and Long Range, and a host of
related basic system application studies.

LET'S SWAP RESUMES

These vital programs in the national interest, now underway at McDonnell, have created exceptional opportunities for engineers, scientists, physicists, mathematicians, and other specialists in aerospace design, human factors, electronics, and data handling. For more information, complete the resume form below. For a comprehensive, immediate review of your qualifications, include your complete resume.

Mail This Form To: W. R. Wardle, McDonnell Employment, Dept. R-66, Box 516, St. Louis, Mo. 63166

Name _____ Phone _____ Age _____

Home Address _____ City & State _____ Zip _____

Education: BS _____ MS _____ PhD _____ Major Field: _____
 Date _____ Date _____ Date _____

Primary Experience Area: _____

Present Position: _____

_____ Number of Years _____ I would like to receive application form

Openings now exist in the following areas:

Aerodynamics, Automation, Control and Structural Dynamics, Design, Electronics, Engineering Planning, Ground Support Equipment, Liaison, Materials, Mathematics, Metallurgy, Operations Analysis, Propulsion, Reliability, Research, Space Medicine, Structures, Systems Management, Thermodynamics.

An Equal Opportunity Employer

MCDONNELL

ON CAREER-INQUIRY FORM CIRCLE 902

Mount improves transducer accuracy

Problem: Measure transient pressures in a hostile environment, such as the thrust chamber of a rocket motor. Such cases require remote transducers. Complicating factors are introduced, i.e., length, diameter and configuration of the passage leading to the transducer. Heat transfer to the transducer and its connecting passage and clogging by combustion products are common problems in such systems.

Solution: A new mount.

The transducer is mounted in a body with a sleeve designed to provide precise volume between the transducer diaphragm and a small diameter passage leading

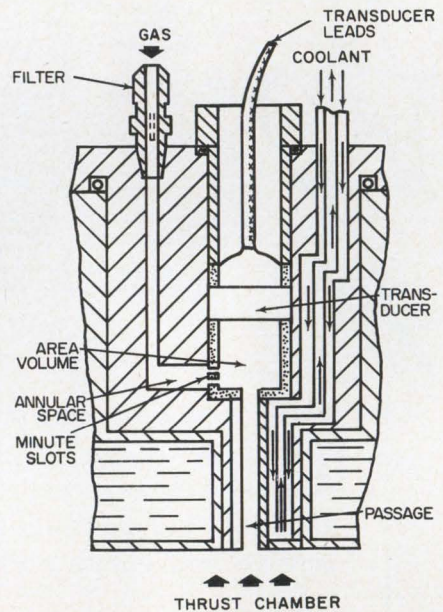

to the chamber where pressure transients occur. A control gas is fed through a filter into an annular space that leads through four minute slots to the volume and small passage.

Thermal equilibrium is maintained by conditioning fluid circulated through an external pipe next to the transducer. Conditioning fluid exits by an internal pipe to compensate for heat passing through the chamber wall, or to obtain the chilling effect of a cryogenic regenerative coolant.

Contact: James Preston Layton, Princeton University, P.O. Box 172, Princeton, N. J.

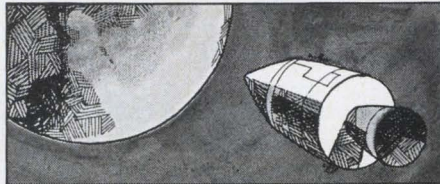
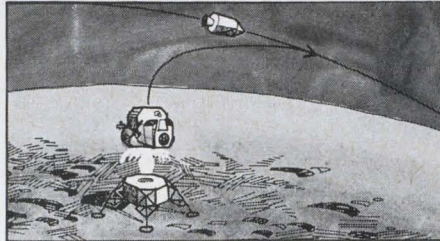
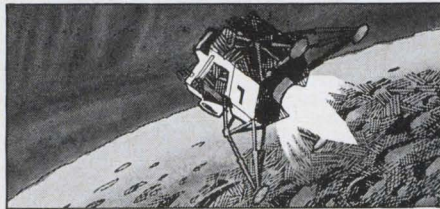
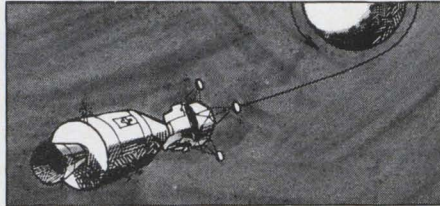
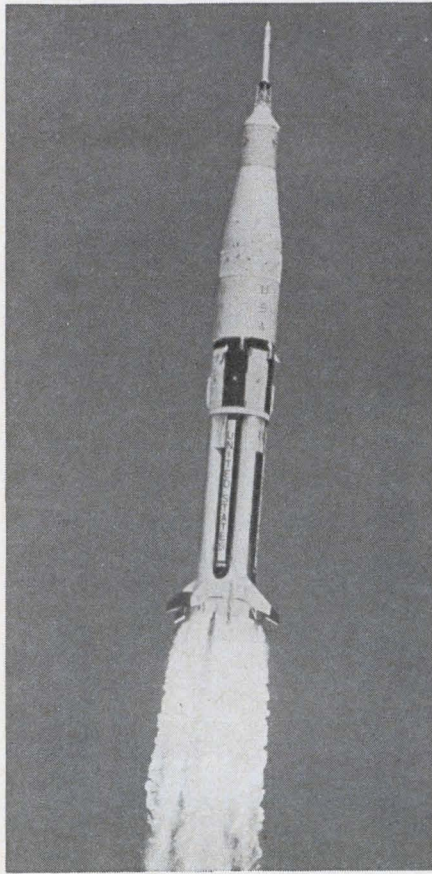

Challenge:

Develop guidance, navigation and control systems for earth orbit, lunar orbit, lunar landing, lunar-orbit rendezvous, and return to earth.

Our assignment for the Apollo program includes not only participation in completing these major goals, but added responsibilities for the Apollo optical and computer subsystems as well. A tall order? True. But it's typical of the long-range challenges you'll meet every day in a career at AC Electronics. For instance, AC supplies the guidance/navigation systems for Titan II and III-C. In addition, we're working on a low-level navigation system for strategic aircraft... a fire-control system for a new battle tank... on SABRE, the new self-aligning boost and reentry guidance system... and on a new self-contained navigation system for ships.

That's our business—guidance, navigation and control—and the career opportunities have never been greater. Interested? Check the list below for job openings at all three AC locations—Milwaukee, Boston and Los Angeles. Then write to: R. W. Schroeder, Dir. of Scientific & Professional Employment, Dept. #5753 J3, AC Electronics Div., Milwaukee, Wis. 53201. Minimum of B.S. degree required.

MECHANICAL ENGINEERS
STRESS/VIBRATION ANALYSTS
CIRCUIT DESIGN ENGINEERS
OPTICS SYSTEM DESIGN ENGINEERS
SEMICONDUCTOR & MICRO-CIRCUIT SPECIALISTS
DIGITAL COMPUTER ENGINEERS
DIGITAL SYSTEMS ENGINEERS
HYDRAULIC SERVO DESIGN ENGINEER
TECHNICAL WRITERS

SCIENTIFIC PROGRAMMERS
SYSTEMS ANALYSIS ENGINEERS
SYSTEMS MECHANIZATION ENGINEERS
GUIDANCE TRAJECTORY ANALYSTS
GUIDANCE/NAVIGATION EQUATION ANALYSTS
DIGITAL FLIGHT CONTROL ENGINEERS
SYSTEMS PROGRAMMER
SYSTEMS ENGINEERS
SR. PROGRAMMER ANALYST
SR. MATERIALS ENGINEER

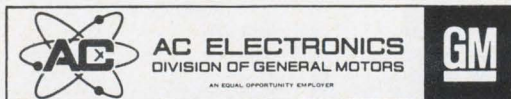

Electronic Engineers:

Instant Careers

A vast array of assignments has opened at Boeing's Commercial Airplane and Supersonic Transport divisions in Seattle. Partly because unprecedented jetliner sales have created the largest backlog in the history of commercial aviation. And because the next generation of jets is on drawing boards and in the wind tunnels. Also because of the new \$250 million facilities expansion in the Seattle area.

If your present spot is static, the challenge and advancement opportunities of new Boeing programs will warrant your immediate investigation. And be well worth your while.

Life in the great Pacific Northwest is living at its finest. The Seattle area is famous for a climate so mild you can golf, fish or boat (both fresh and salt water) year-round. It's but an hour's drive from sea-level to ski-level.

There's more. Seattle's Opera House, Repertory Theater, Pacific Science Center (next to the Space Needle on the World's Fair grounds) and Symphony have gained national acclaim. Seattle-area schools, too, are ranked among the finest.



Typical assignments include: electrical/electronic design, electrical/electronic development, electro-optical systems, flight test instrumentation, navigation & guidance systems, radar technology, operations research analysis, systems research analysis, mathematical statistics and research, analog & hybrid flight simulation, and programming & systems analysis incorporating commercial, manufacturing support, and engineering and scientific applications.

Salaries are competitively commensurate with your experience and education. **ON CAREER-INQUIRY FORM CIRCLE 904**

national background. Moving and travel allowances are paid to newly hired personnel. Boeing is an equal opportunity employer.

Please telephone (collect) or send a resume to the Boeing Employment Office nearest you:

Chicago: (312) 726-8955, 120 South LaSalle St., Dept. CDB, Chicago, Ill. 60603. **Phoenix:** (602) 264-1238, Suite 1012, The Del Webb Bldg., Dept. CDB, Rosenzweig Center, Phoenix, Ariz. 85012. **Minneapolis:** (612) 338-5896, 404 Roanoke Bldg., 109 South 7th St., Dept. CDB, Minneapolis, Minn. 55402. **San Francisco:** (415) 434-0438, Suite 304, 16 California Street, Dept. CDB, San Francisco, Calif. 94111. **Houston:** (713) RI 8-0305, Houston Siteman Bldg., Holcumbe & Fannin Blvds., Dept. CDB, Houston, Tex. 77025. **Detroit:** (313) 962-5850, Suite 1157, The Guardian Bldg., 500 Griswold St., Dept. CDB, Detroit, Mich. 48226. **New York:** (212) 697-8838, Suite 1604, Dept. CDB, 535 5th Ave., New York City, N.Y. 10017. **Seattle:** (206) 237-4659, Mr. Thomas Sheppard, Commercial Airplane Division, P.O. Box 707-CDB, Renton, Wash. 98055.

Join the
world leader in
jet transportation

BOEING

COMMERCIAL AIRPLANE DIVISION
SUPERSONIC TRANSPORT DIVISION

Vacuum photo-diode constitutes simple, accurate current source

A vacuum photo diode, excited by a variable-intensity light source, makes an excellent current source with almost perfect isolation between input and output. The system shows a negligible temperature coefficient.

A simple and accurate (5%) current source was needed, for a neuro-physiological application, to deliver a variable 0.1 to 3 μA dc current to a stainless steel microelectrode for plating out iron onto neural tissue. Consideration had to be given to the load impedance, which might range from 1.0 to 100 M Ω during application of the current (5 s), owing to metal-tissue interface changes.

The type 922 cartridge photo-diode used in the circuit (see schematic) exhibits a plate resistance on the order of 10^9 ohms over an anode-to-cathode voltage range of 40 to 400 volts. The unit has a maximum dark current of 0.005 μA (at 25°C) and a maximum average current rating of 5 μA . R_s is a current-sensing resistor used to set the initial value of i with S_1 (low-leakage reed switch) closed. With S_1 open, current i is diverted into the probe. Less than a 5% change in a 2- μA current is observed when S_1 is opened into a 100 M Ω resistor placed across the probe terminals. Thus, no

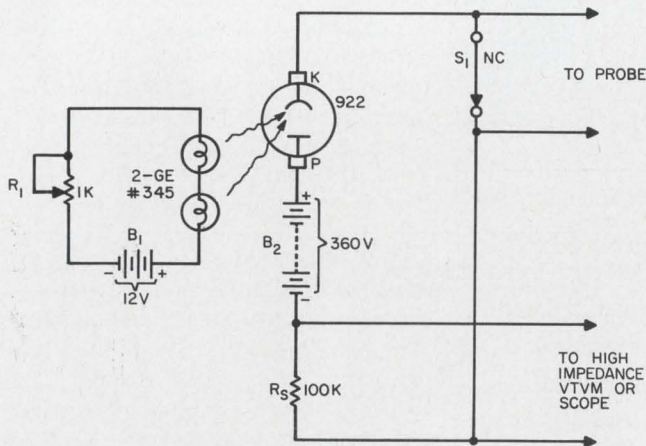

Vacuum photo-diode is used to form a current source. Excited by lamps, the diode has a negligible temperature coefficient and features excellent isolation.

feedback system is required to achieve the accuracy desired.

The exciting lamps (GE #345) are mounted in a light-tight box with the 922 and their intensity is controlled with series rheostat R_1 . Battery B_1 is a nickel-cadmium type chosen for its flat discharge characteristic, portability and noise isolation.

Once a current-intensity calibration curve is obtained, R_s may be eliminated and the entire photo-tube side of the two-port floated. Or, R_s may be used in an operational amplifier circuit with the exciting lamps in the feedback loop for either precise current control or modulation.

Many optical modulation techniques can also be implemented with this photo-diode current source. The frequency response of the system is mainly limited by stray capacity rather than transit time, as far as the impedance levels discussed here are concerned.

Julius M. J. Madey, Research Engineer, California Institute of Technology, Pasadena, Calif.

VOTE FOR 110

Diodes ensure start of astable multivibrator

A simple, inexpensive diode arrangement prevents an astable multivibrator from "locking-up" when starting power is applied.

It is applicable to both silicon and germanium circuits, and is far less involved than competitive logic circuitry schemes designed to detect the lock-up. The design (Fig. 1a) uses the diodes to force the multivibrator into an unstable condition.

Given a collector current level at which the astable is to work, the value of R_E is chosen, so that the sum of the V_{R_E} drop caused by the emitter current of one saturated transistor only and the base-to-emitter voltage of that transistor is slightly less than the forward drop of the silicon diode, CR , in its region of low conduction. $V_{BE} = 0.3\text{V}$ for a 2N404 where the base current does not exceed 0.5 mA. Hence, V_{R_E} is to be 0.2 to 0.25 V.

At start-up time, if both Q_1 and Q_2 were to saturate, V_{R_E} would jump to 0.4 or 0.5 volt, and the base potentials of Q_1 and Q_2 above ground would be near 0.7 volts, a region where the diodes CR would sustain a current of several milliamperes. Hence, the base currents of Q_1 and

IDEAS FOR DESIGN: Submit your idea for Design describing a new or important circuit or design technique, the clever use of a new component, or a cost-saving design tip to our Ideas for Design editor. If your idea is published, you will receive \$20 and become eligible for an additional \$30 (awarded for the Best of Issue Idea) and the grand prize of \$1000 for the Idea of the Year.

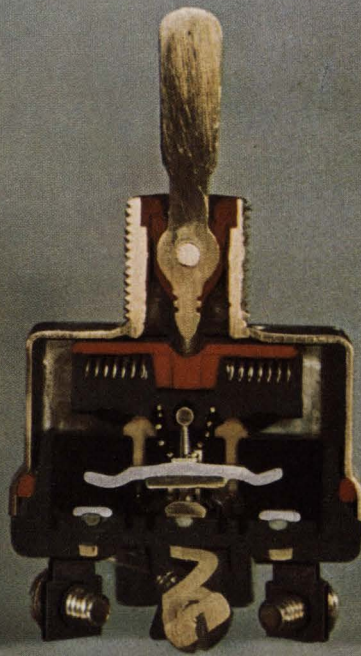

You can have Cutler-Hammer positive action switches in all standard pole configurations, in miniature and standard sizes.

No "in between"
action here.
It's positive.

We designed and built this line of military switches to give you the positive make-and-break you must have. There's no "maybe" about the way they work. They've proven themselves. In projects Mercury and Gemini.

You get butt-wiping contact action, too. Great for low-level switching circuits where the action wipes the contact clean first.

There's more. High shock, high vibration, better arc tracking resistance. And better sealing.

Cutler-Hammer military switches give you the truly "big" reliability you must have in aerospace and ground support. The kind you can't get in standard MIL-S-3950 switches. Our positive actions are built to MIL-S-8834.

You can choose exactly the military switch you need from the thousands we make. Just call your local stocking distributor or local Cutler-Hammer sales office. Or write us for a catalog.

Cutler - Hammer

Milwaukee, Wis. 53201



ON READER-SERVICE CARD CIRCLE 221

VERSATILE SERVO TESTERS

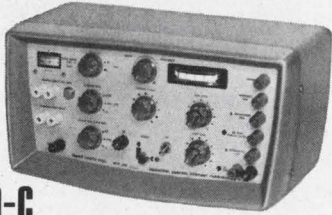

100-C

- Measures transient and frequency response
- Checks carrier and DC servos
- For lab & development work



103-A AN/TPM-8

- Military-standard
- Go, no-go test
- Production test, Q.C. and field maintenance

INDUSTRIAL CONTROL COMPANY
CENTRAL AVENUE FARMINGDALE, L. I., N. Y.
AT PINELAWN 516-694-3000

ON READER-SERVICE CARD CIRCLE 21

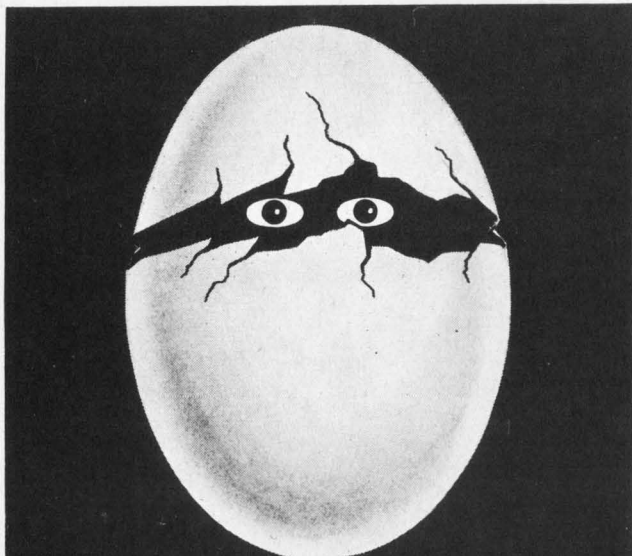

**LOOK WHAT'S HATCHED AT
LITTELFUSE**

The world's smallest fuse—Picofuse.
1/8 thru 5 amps... 1/6 grain... 125 v.

LITTELFUSE

DES PLAINES, ILLINOIS

ON READER-SERVICE CARD CIRCLE 22

IDEAS FOR DESIGN

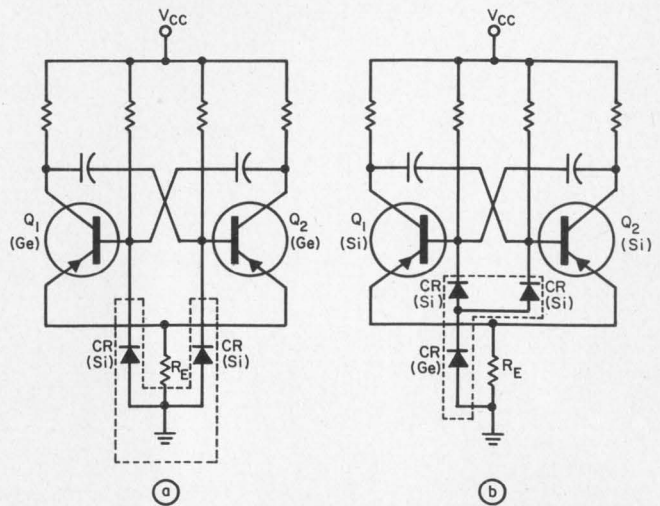

Simple diode arrangement prevents astable multivibrator from "locking-up." Two diodes are required for germanium circuits (a); three diodes for silicon networks (b).

Q_2 would be mostly diverted in the CR diodes until the current contribution of Q_1 and Q_2 through R_E would reduce V_{RE} to a point where an equilibrium exists between base current, CR diode current and emitter current. However, this equilibrium point is out of saturation for Q_1 and Q_2 , and so is unstable. Therefore, oscillations are guaranteed to start.

The same concept can be extended to a pair of silicon transistors by the addition of a germanium diode to compensate for the increase in V_{BE} in these devices (Fig. 1b).

R. Couturier, Senior Project Engineer, STELMA, Inc., Stamford, Conn.

VOTE FOR 111

ICs for bounceless push-button switching

The effect of the mechanical bounce of push-button switches can be eliminated from a system through the use of a portion of a readily available, inexpensive IC. This is achieved by isolating the output from the input during the interval when bounce occurs.

Using positive logic and NAND/NOR gates (see schematic), construct a "latch" flip-flop with two 2-input gates (many IC manufacturers put four 2-input gates in a 14-lead flat pack).

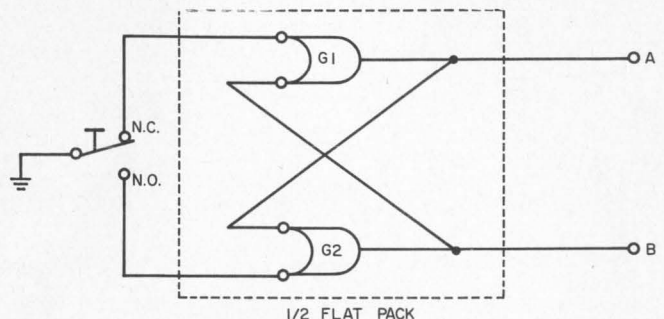

IC gates form flip-flop to establish a bounceless, push-button switching action.

When the switch is positioned as shown, the G_1 input is held at ground. When the button is depressed, the G_2 input is held at ground, switching the flip-flop. However, when the contacts bounce from the NO position to an open-circuit condition, the flip-flop does not change state. This action provides a bounce-free switching action at either output (A or B).

D. R. McTaggart, Consulting Engineer, D. Brown Associates, Inc., Eau Gallie, Fla.

VOTE FOR 112

Tunnel-diode generator calibrates frequency counter

A common method for calibrating frequency counters is to beat a harmonic of the 100 kHz timing-crystal output with a WWV (often at 15 MHz) carrier. A simple tunnel-diode generator circuit can be used to generate the necessary harmonics

The circuit (see schematic) generates strong harmonics to at least 30 MHz when connected to the 100-kHz output of the frequency counter. The result is much more reliable reception of easily discernible beat notes.

The harmonics are the product of a cyclic series of pulses generated by D_1 . These pulses occur

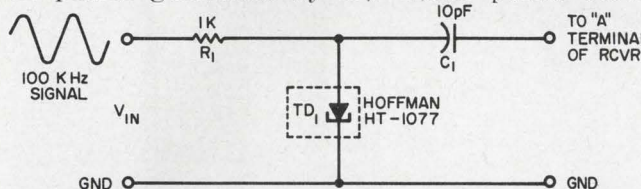

Tunnel diode harmonic generator uses 100-kHz frequency counter input to produce beat-frequency notes for calibrating receivers.

once for each cycle of the input frequency as tunnel diode D_1 switches from a low- to a high-impedance state. The higher-frequency components of these pulses are coupled to the receiver antenna terminals through C_1 .

Resistor R_1 must be small enough to allow the input current to exceed I_{peak} of the tunnel diode. R_1 must also be large enough to prevent the continuous current rating of D_1 from being exceeded. D_1 here has an I_{peak} of 0.47 mA. For this value, a R_1 of 1000 Ω works well for signal inputs between 0.5 and 1 volt.

Tunnel diodes with larger values of I_{peak} may be used, providing the signal source can deliver pulse currents in excess of I_{peak} of the diode. In most cases, the network may be left permanently attached to either the receiver or the counter.

Kenneth G. Holmes, Chief Engineer, Magnetic Circuit Elements Inc., Montrose, Calif.

VOTE FOR 113

IFD Winner for March 1, 1966

Larry Blaser, Senior Engineer, Fairchild Semiconductor, Mountain View, Calif.

His idea, "Dual MOS-FET simplifies FM multiplex decoder," has been voted the \$50 Most Valuable of Issue Award.

Cast Your Vote for the Best Idea in this Issue.

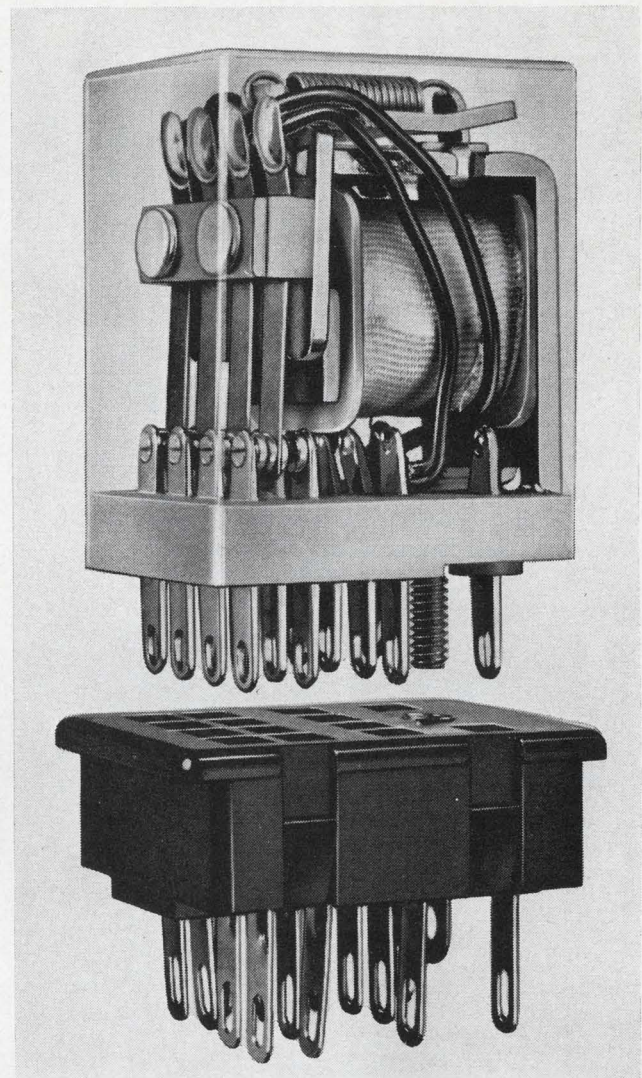

This is our Miniature 4-Pole Relay but we magnified it 2½ times to show you the kind of quality you can buy for \$4.10.

The Series JA is in all respects a high quality miniature 4 PDT relay for AC or DC operation. This is borne out by the fact that our customers have reported 40,000,000 mechanical operations without a single failure. The JA is excellent for computer, logic system and data processing applications. We could write an essay about its virtues but prefer to let the features and specifications speak for themselves.



Complete information including specifications and prices available in Bulletin #45.

LINE ELECTRIC COMPANY
Division of Industrial Timer Corporation
205 U.S. Highway 287, Parsippany, N.J.
In Canada: Sperry Gyroscope Ottawa Ltd., Ont.

ON READER-SERVICE CARD CIRCLE 23

3 Tektronix Portable Oscilloscopes

Choose one for your own measurement requirements

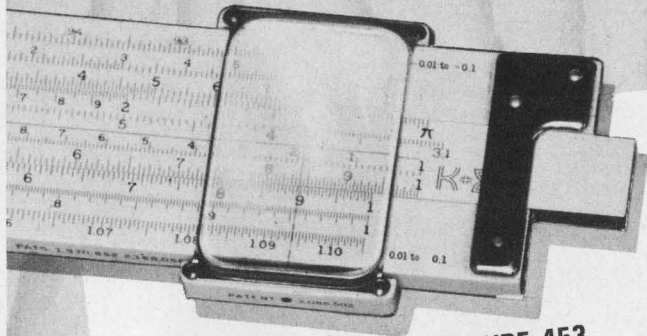

	<input type="checkbox"/> TYPE 453	<input type="checkbox"/> TYPE 422	<input type="checkbox"/> TYPE 321A
Bandwidth	DC-50 MHz	DC-15 MHz	DC-6 MHz
Deflection Factor	5 mV/div to 10 V/div	10 mV/div to 20 V/div	10 mV/div to 20 V/div
Channels	Dual	Dual	Single
Delay Line	Yes	Yes	No
Sweep Delay	Yes	No	No
Size	Height	7 $\frac{1}{4}$	8 $\frac{1}{4}$
	Width	12 $\frac{1}{2}$	5 $\frac{1}{4}$
	Depth	20 $\frac{1}{2}$	16
Weight (pounds)	28 $\frac{3}{4}$	22	14
Power Requirements	AC	AC, DC or Battery	AC, DC or Battery
Rack Mount Available	Yes (7" Rack Height)	Yes (7" Rack Height)	No
Probes and Accessories Included	Yes	Yes	Yes
Price	\$2050	\$1400 (AC Model) *\$1750 (AC/DC Model)	*\$900 *without batteries



U.S. Sales Prices f.o.b. Beaverton, Oregon

A TEKTRONIX PORTABLE will fit your specific requirements. Your Tektronix field engineer will be happy to demonstrate any of these oscilloscopes at your location. Just call him, or write Tektronix, Inc., P. O. Box 500, Beaverton, Oregon 97005.

Tektronix, Inc.

ED Products

Breadboard brings IC assembly to the bench PAGE 66

Plotter programs 127 steps with single command PAGE 82

Pnp switches in $20 \mu\text{s}$ in the $10 \mu\text{A}$ region PAGE 84



One instruction, 127 increments . . . 82

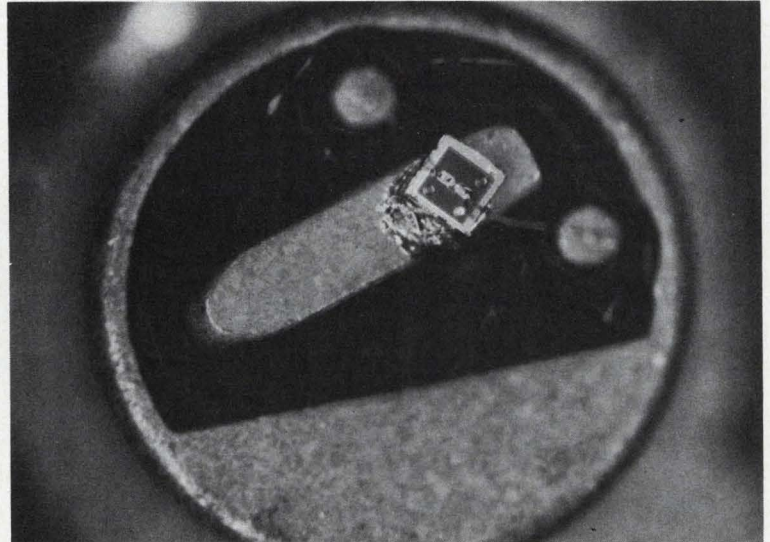

Swift-switching pnp . . . 84

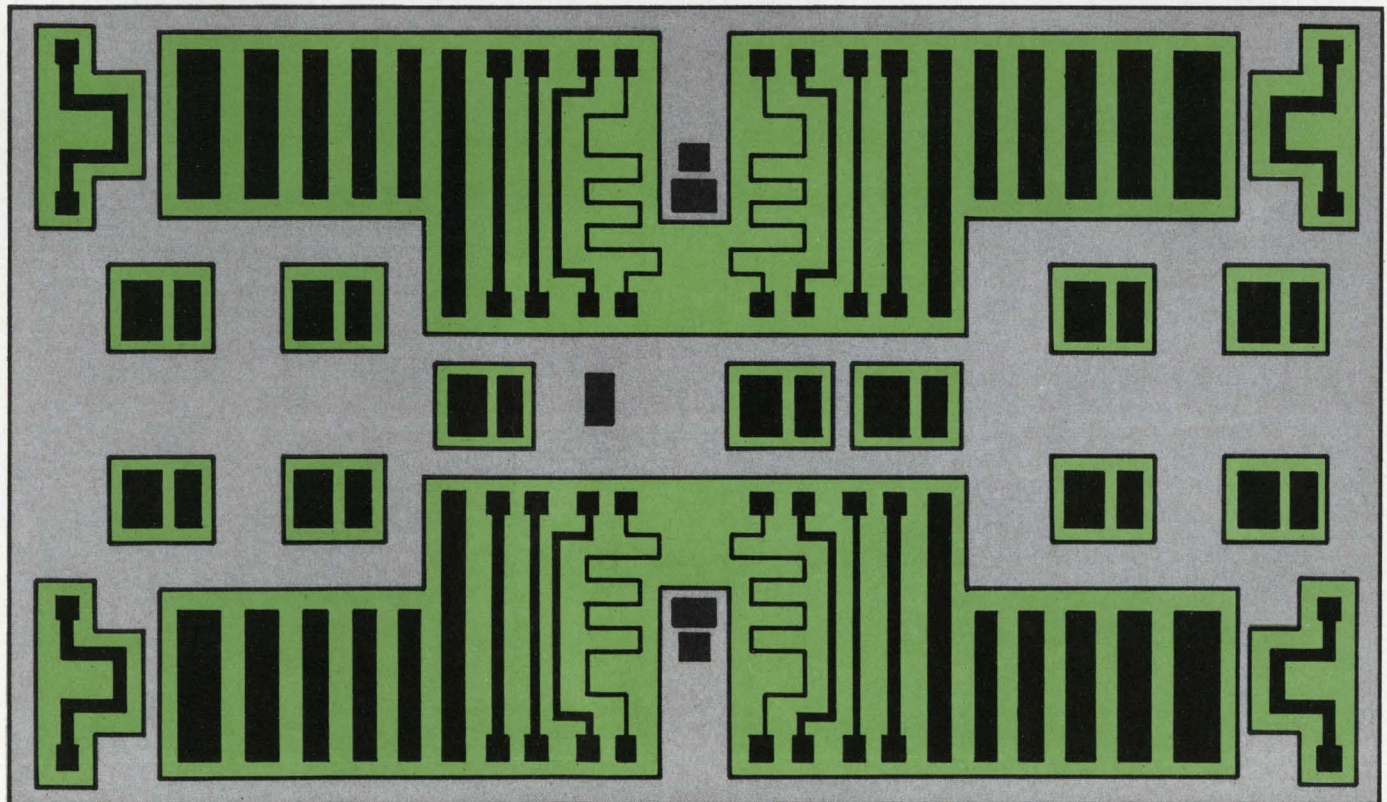

Instant, inexpensive ICs . . . 66

IC breadboard allows simple bench assembly of custom circuits with the drop of a dot

Integrated circuit design and evaluation need no longer be expensive and involved. Custom or prototype units can be produced right on the bench with the WS177 Insta-Circuit. The Insta-Circuit is a monolithic 124- x 86-mil silicon die, packaged in an open 1/4- x 1/4- inch, 14-lead (TO-86) flat-pack. It contains eight planar transistors, five zener diodes and four sets of 11 diffused silicon resistors. A "road map" with keyed call-outs and values is supplied to ease component selection.

On the surface of the chip is a set of aluminum conductors and component bonding pads. This interconnection pattern has a constant 1-mil separation. A single ball or wedge bond acts as the shorting bar across appropriate pairs of conductors and components to complete the desired circuit. This technique holds jumper bonds to a minimum, thus eliminating the conventional unreliable bird's-nest wiring. The bond is made with a pigtail attached. Removal of this unwanted pigtail does not impair the bond's solidity.

All that is required in the way of capital equipment is a ball or wedge bonder. The relative economy of the bonder (\$2000 and up) provides a quick, cheap technique for IC design and production.

Insta-Circuits are supplied in open packages

with a solder preform and lid. Lid sealing may be accomplished with a simple hot plate or soldering iron in the absence of commercial sealing equipment. For production runs, the dice should be cleaned with alcohol or similar agent, baked in an inert gas atmosphere at 200°C for eight hours and held in a desiccator until sealed.

Each set of resistors ranges from 20 Ω to 20 k Ω in a binary-coded relationship. Appropriate series connections yield any resistance value from 20 Ω to 46 k Ω in 100- Ω increments and parallel combinations provide intermediate values. Absolute values vary less than 20% and temperature coefficients are approximately 2000 ppm/°C. Tracking between two resistors over the normal temperature range is 0.2%. Capacity to substrate of the 20-k Ω resistor does not exceed 7 pF.

The eight transistors are non-gold doped npn epitaxial planar types. Beta is typically 40 to 120 at 25°C. Cut-off frequency exceeds 200 MHz.

The remaining components are five zener diodes. Two 5.8-V zeners are connected to the substrate, and two are floating. The fifth is a floating 8.2-V zener. All are rated less than $\pm 5\%$ at 25°C. The entire die dissipates no more than 250 mW.

The flexibility of the die is typified by the design of a summing amplifier circuit (see below).

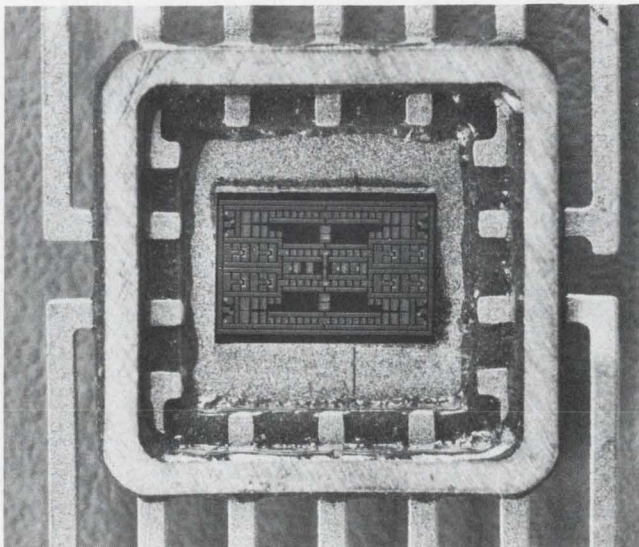

Component/conductor geometry and design are shown on the basic Insta-Circuit die. The aluminum interconnection pattern has a constant 1-mil separation.

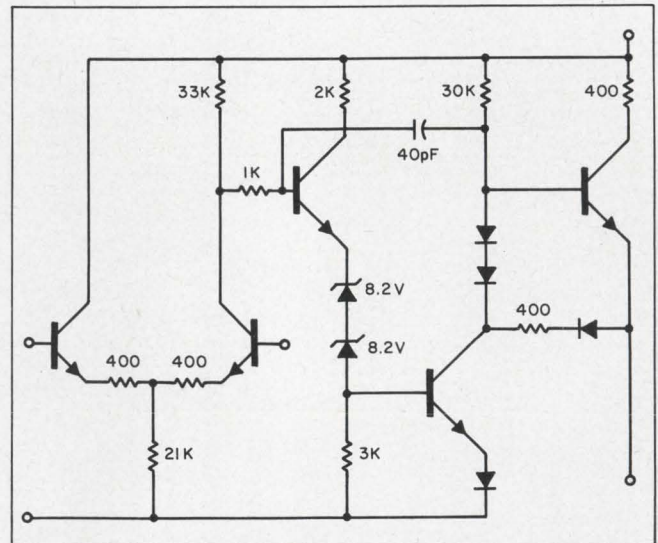

The capacitor and diodes for the summing amplifier are formed from a parallel resistor combination and transistor base-emitter junctions.

Component characteristics (25°C)

Resistors ($\pm 20\%$ +5% match)	
4 - 50 Ω (tapped at 20 Ω)	
4 - 100 Ω	4 - 2000 Ω
4 - 200 Ω	4 - 4000 Ω
4 - 400 Ω	4 - 8000 Ω
4 - 800 Ω	4 - 10,000 Ω
4 - 1000 Ω	4 - 20,000 Ω
Transistors	
$\beta = 40 - 120$	$V_{CE\ SAT} = 0.25\ V$
$V_{CEO} > 30\ V$	$C_{OBO} < 3\ pF$
$V_{CBO} > 60\ V$	$f_T > 200\ MHz$
$V_{EBO} = 8.2\ V \pm 5\%$	$\beta_{pnp} = 0.05$ (parasitic)
Zener diodes ($\pm 5\%$)	
2 - 5.8 V (to substrate)	
2 - 5.8 V (floating)	
1 - 8.2 V (floating)	

Two 8.2-V zeners are required and only one is available. A ball bond shorts the collector-to-base junction of an unused transistor and utilizes its 8.2-V emitter-to-base voltage. Signal diodes to 60 V may be obtained by the same techniques. The turn-on characteristics of every diode are the same. The designer's limits are stretched well past those seemingly imposed.

Using the Insta-Circuit, the designer may now evolve an IC from schematic to prototype in a few hours, with the inherent advantages of in-house design.

The devices are also available in a 12-pin modified TO-5 header with the same price structure.

P&A: \$39.50 (1 to 9), \$29 (50 to 499); stock. Westinghouse Electric Corp., Molecular Electronics Div., P. O. Box 7377, Elkridge, Md. Phone: (301) 796-3666.

Circle No. 350

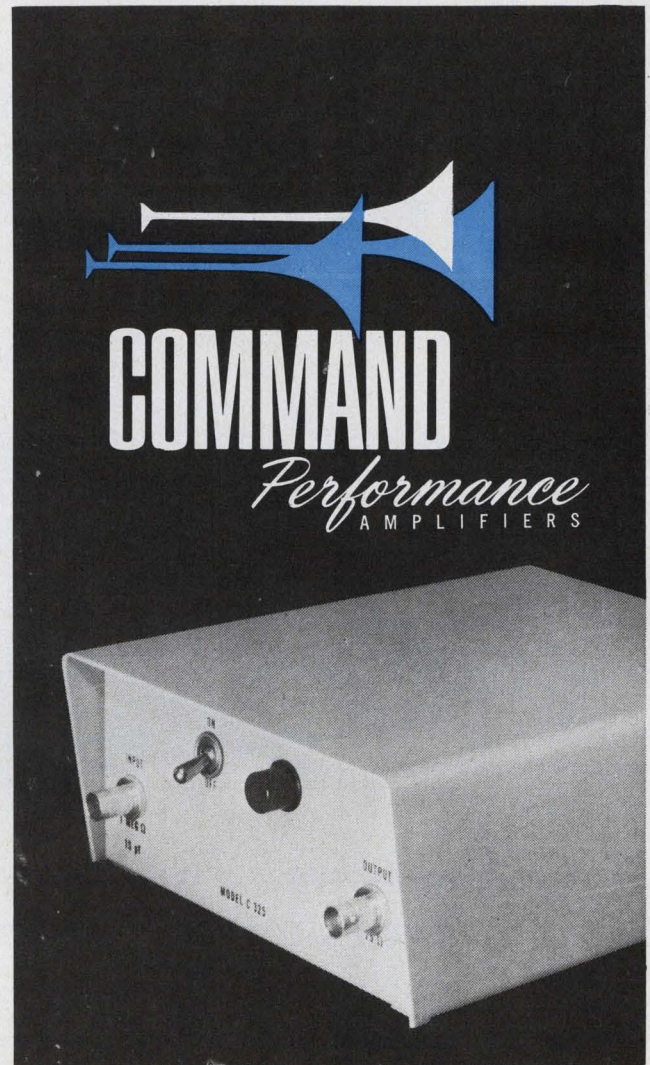

yours to command!

Specify COMMAND PERFORMANCE by Conducon: wide bandwidth/low power consumption/fast rise time/solid state/integrated power supply/pulse operation/high voltage output. Broaden your display capabilities either for test purposes or for reliable long-term continuous use.

	C-300-15	C-401
Ripple	$\pm .5\ db$ (200 cps—50 mcs)	$\pm .5\ db$ (200 cps—160 mcs)
Bandwidth @ 3 db	50 cps—50 mcs, minimum	100 cps—200 mcs
Voltage Gain	50 db	30 db
Impedance—in	50 ohms	50 ohms
Impedance—out	50 ohms	100 ohms
Voltage—out	15.0v p-p	1.0v p-p
Noise—rms	70 microvolts	40 microvolts
Rise time	6.5 nanoseconds	< 2.5 nanoseconds
Weight	4½ lbs.	3.5 oz.
Dimensions	3" x 6.5" x 8"	1.75" x 2.75" x 2.75"
Power Required	105-125v @ 60-400 cps	12.0v dc @ 60 ma

Specifications for two of the many types of amplifiers available.

Conducon's line of wideband amplifiers are another product of its MRC Division, long a recognized leader in the development and production of magnetic modulators. Conducon invites inquiries. For your particular Wideband/Pulse Amplifier requirements write to Conducon-MRC Division, 2311 Green Road, Box 614, Ann Arbor, Michigan 48107 or call (313) 665-9741.

an equal opportunity employer



CONDUCON - MRC Division



ON READER-SERVICE CARD CIRCLE 25

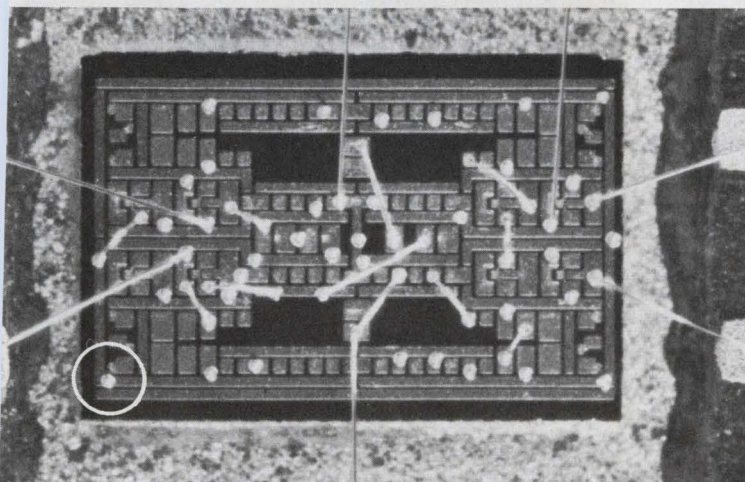

Typical ball bond is circled in completed amplifier. The bond may short a component and conductor or component pairs.

June 7, 1966

67

ANOTHER "ADVANCED" CONCEPT FROM DSE

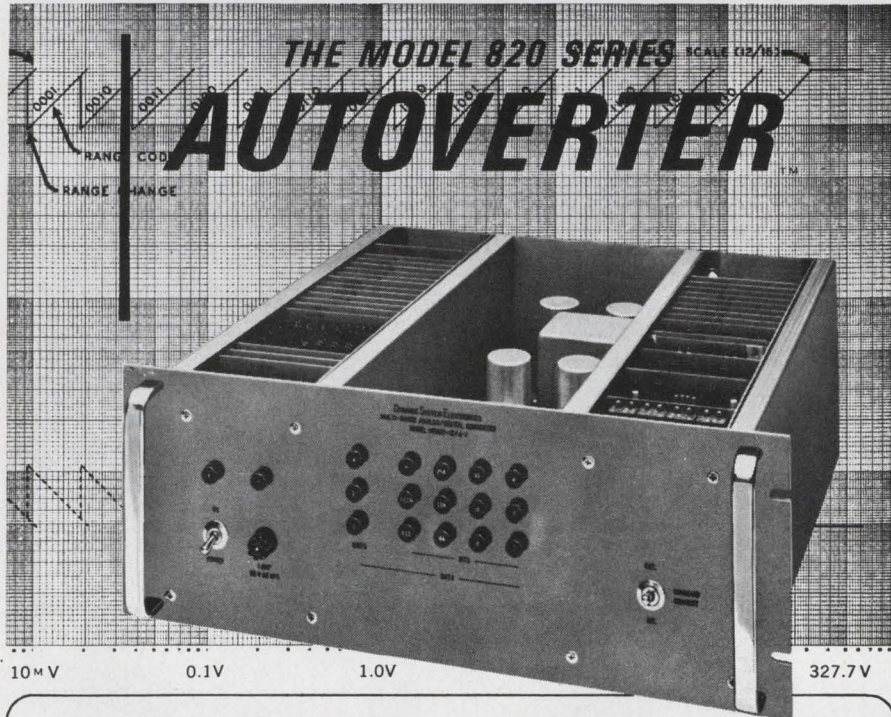

ANNOUNCING... A NEW MULTIRANGE ANALOG-TO-DIGITAL CONVERTER

The Model 820 Series AUTOVERTER—designed and developed by DSE—is an automatic ranging, general purpose, solid state, analog-to-digital converter. It is especially ideal for a broad spectrum of applications requiring the conversion of raw information into computer input data. Application requirements of wide dynamic ranges, such as, testing and checking out laboratory equipment, monitoring aircraft on the flight-line, measuring public utility system data, converting geophysical field expedition data, on-board airborne telemetry systems, and others.

The DSE AUTOVERTER exhibits an input dynamic range in excess of 160 db. Providing an actual reading accuracy and resolution $\pm 0.1\%$, over a dynamic range in excess of 100 db, the Model 820 Series offers the equivalent range and resolution of a 26 binary bit converter—using only 16 bits of data.

Available in four models, with a dynamic range from ± 10 mv to ± 327.7 V, the DSE AUTOVERTER is convenient for measuring a single test parameter which has a wide dynamic range, or measuring many channels of analog data which together have an extremely wide range.

The AUTOVERTER is another "state of the art" original concept from DSE to add to its data conversion capabilities in the GSE and airborne fields. Complete information and specifications are available upon request. Simply write, wire or telephone today.

Engineers: If your field is data conversion, an exceptional opportunity is available at DSE. Write to personnel director. An equal opportunity employer.

'performance'

DSE

2321 East Washington Street

Phoenix, Arizona 85034 | (602) 275-6229

DYNAMIC SYSTEM ELECTRONICS

COMPONENTS



Power divider

HHP-50 power hybrids handle up to 500 W cw and up to 1500 W peak envelope power. Four ports with type N connectors exhibit 25-dB min isolation between the two input arms and between the sum and difference arms. Insertion loss is 0.5 dB max, phase balance between input arms is 5° max, amplitude balance is 0.2 dB max and vswr is 1.3.

P&A: \$325; stock. Adams-Russell Co., 280 Bear Hill Rd., Waltham, Mass. Phone: (617) 899-3145.

Circle No. 262

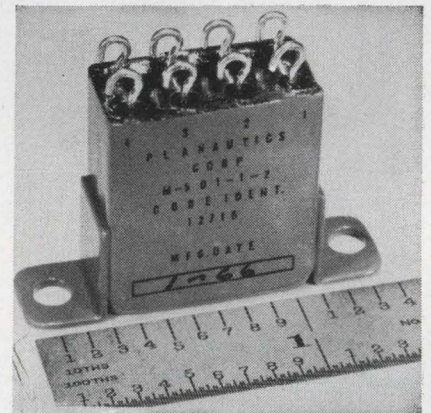

Time-delay switch

A 2-oz, hermetically sealed time-delay switch provides 150 ms delay at 22 to 36 Vdc and up to 0.5 A. The model M-501-1-2 functions on the first event at the specified time interval.

Time interval may be modified from 0.01 to 10 s. The 2-pole device features line-transient protection and built-in suppression for inductive loads.

Planautics Corp., 410 S. Cedros Ave., Solano Beach, Calif. Phone: (714) 755-1181.

Circle No. 263

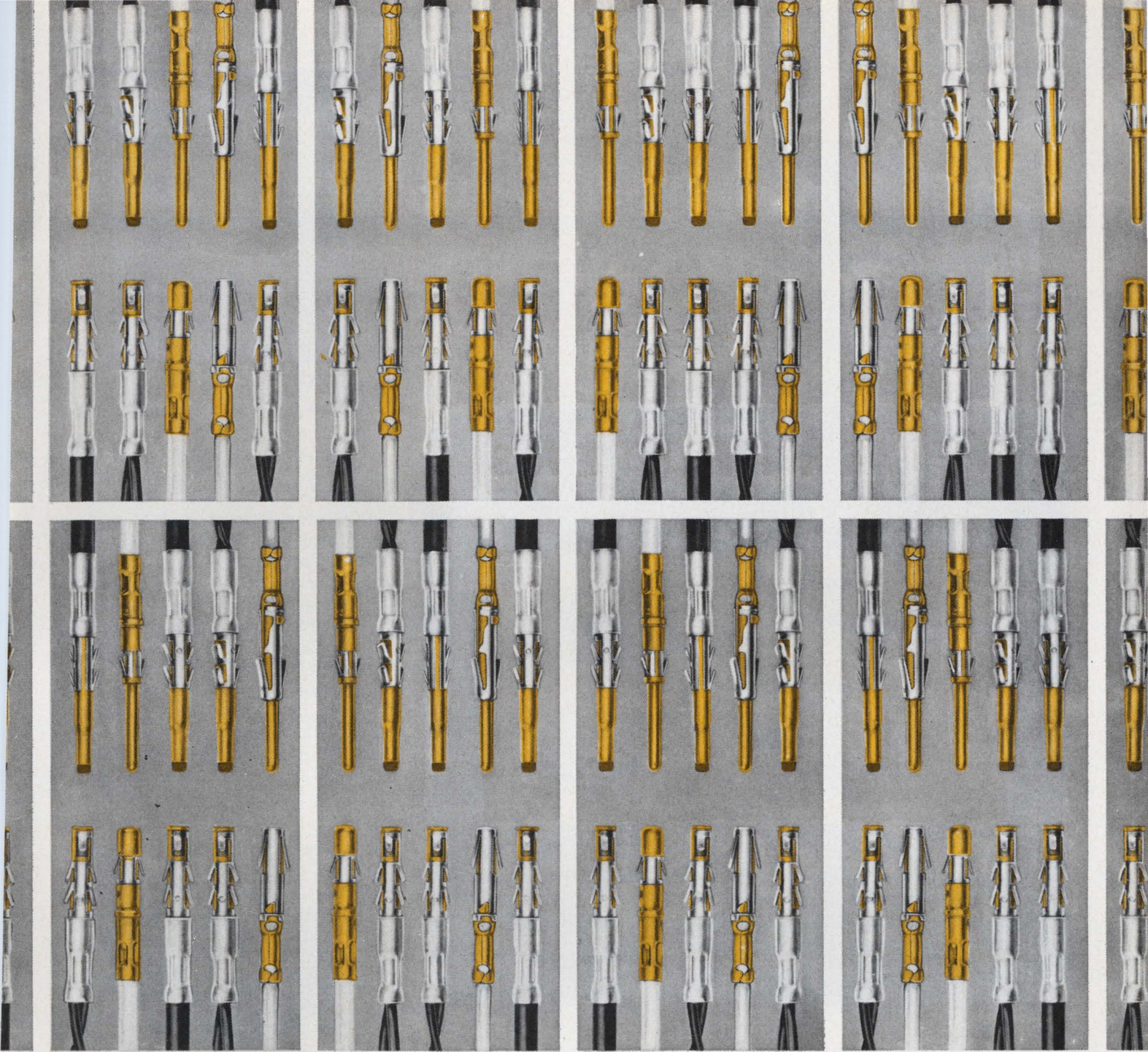

Mix these signal, power and coax leads in any combination.

Burndy Trim Trio Connectors—available in many shapes—accept three contact styles, all crimp-removable, for signal and power leads #16 thru #24, twisted pair #24 and #26, and subminiature coaxial cables.

Changing conductors is fast and simple, whether for lower voltage drop or better shielding or mechanical reasons. This makes Trim Trio Connectors ideal for breadboard and prototype work as well as

production. For large production runs you can take advantage of the economies offered by the automatic Burndy Hyfematic™ with a crimp rate of up to 3000 contacts per hour.

Get more details on how you can take advantage of the Burndy Trim Trio System—THE ACCEPTED METHOD OF INTERMIXING CONTACTS.

 **BURNDY**
Norwalk, Connecticut

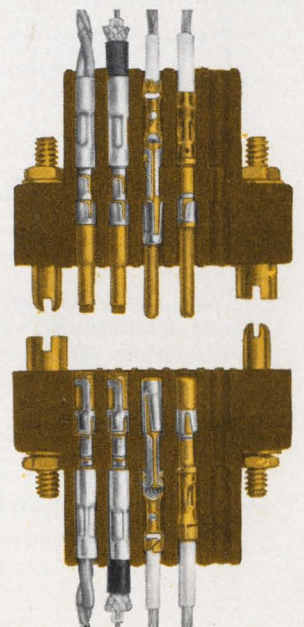

COMPONENTS

Digital readout

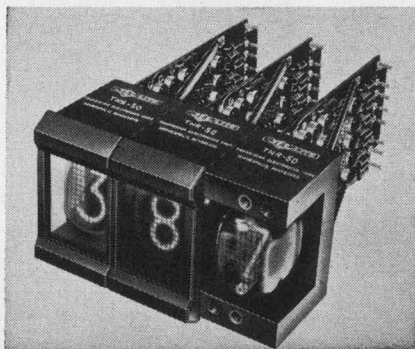

Series TNR-50 digital readouts consists of 8 models handling 8-wire BCD input in 1, 2, 4, 8 code with input signals of 3.5 V. Supply voltage of 180 ± 10 Vdc at 2 to 12 mA is confined to the panel areas. The transistorized decoder-driven circuitry eliminates diode decoders. Nixie tubes have a 100,000- to 200,000-hour life expectancy. Other input codes and a variety of signal voltages are available.

Transistor Electronics Corp., P. O. Box 6191, Minneapolis. Phone: (612) 941-1100. *Circle No. 264*

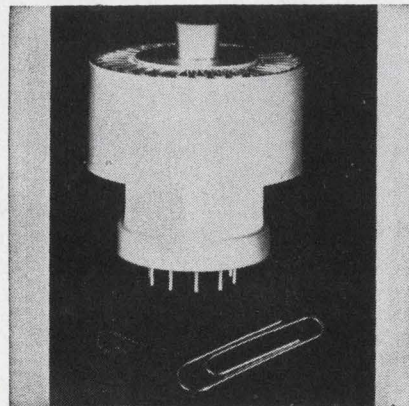

Pentode

The PL-8582/267 ceramic beam pentode has a third-order intermodulation distortion level of at least -40 dB at 350 W useful power output. Plate dissipation rating is 300 W. The external-anode, forced-air cooled tube is 2.16-in. long by 1.75-in. in diameter and uses a vane-type suppressor grid and an oxide-coated unipotential cathode. Required filament voltage is 26.5 V at 1.0. Plate voltage is 200 V max and plate current is 350 mA max. Transconductance is 0.04 mhos.

Price: \$87 (1 to 5). Machlett Labs., 312 N. Nopal St., Santa Barbara, Calif. Phone: (805) 965-4581.

Circle No. 265

RFI/EMI FILTERS
FOR COMMUNICATIONS AND DATA LINES

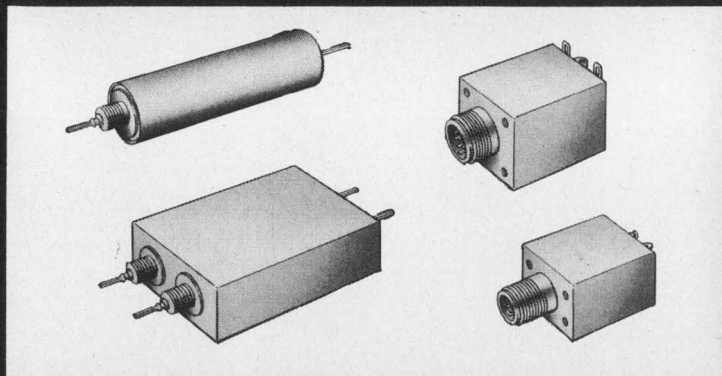

Reliability is the key word in literally thousands of filters currently in use on telephone, teletype, digital and audio transmission lines. ■ Your requirements for custom filter designs as well as standard products, can be met by Potter's extensive engineering capability and high performance criteria.

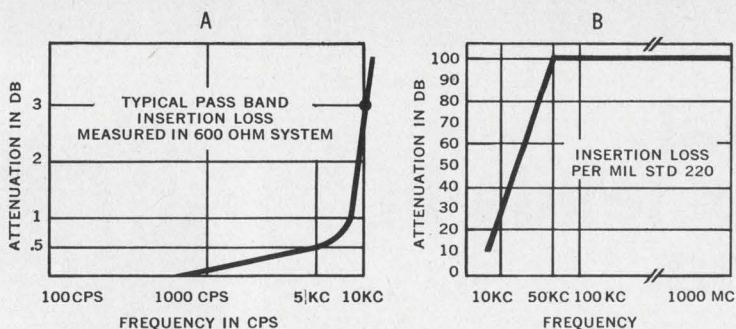

Graphs A and B show typical characteristics of Potter signal line filters. These filters are used on systems which must meet Defense Communications Agency criteria and provide maximum attenuation above the pass band with less than 1/2 db attenuation in the pass band. ■ Write for further information on these and other Potter filters.

THE POTTER COMPANY
Pioneering in Imagination Since 1925
7351 North Lawndale Avenue ■ Skokie, Illinois
ON READER-SERVICE CARD CIRCLE 27

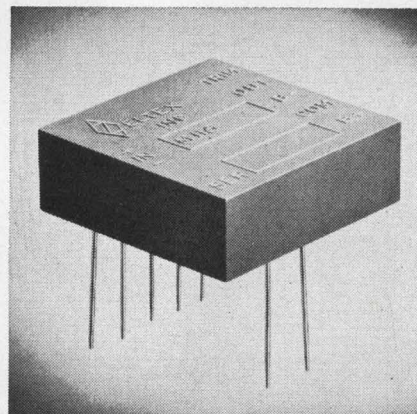

Operational amplifier

Model 115D differential op-amp is designed as an amplifying black-box for PC cards with 0.1-in. hole spacing. Output is ± 10 V at 4 mA and unity gain bandwidth is 1 MHz. Voltage drift is $25 \mu\text{V}/^\circ\text{C}$ and current drift is $5 \text{ nA}/^\circ\text{C}$. Narrow band input noise is $10 \mu\text{V}$ peak. Package is 0.8-in.³ molded epoxy.

P&A: \$19 (1 to 9); stock. Zeltex, Inc., 1000 Chalomar Blvd., Concord, Calif. Phone: (415) 686-6660.

Circle No. 266

IF YOU CAN'T AFFORD TO DESIGN WITH FAIRCHILD DT μ L, YOU CAN'T AFFORD TO DESIGN.

Industrial IC's at about \$1.00 per Function: Fairchild Diode-Transistor Micrologic® Integrated Circuits are now available at prices you can afford. Take your pick of dual in-line packaging for production line use (at about \$1.00 per function at distributor quantities) or Mil spec rated 1/4" x 1/4" Cerpaks. Either way you get high performance monolithic logic elements for a wide variety of applications.

Complete, versatile line: Fairchild DT μ L circuits offer unique design features: A complete line which includes both binary and gate elements, completely compatible with one another./

Gates may be wire OR'ed at the output./Expander inputs can be used with 930, 932, and 944 elements./Low input current leakage./High noise immunity.

We can deliver: Fairchild DT μ L circuits are available now, in production quantities, on distributors' shelves. You can get immediate delivery on virtually any number. Don't take our word for it. Call any Fairchild Distributor, now. Or, ask for our complete data sheets.

MICROLOGIC: A FAIRCHILD TRADEMARK SEMICONDUCTOR

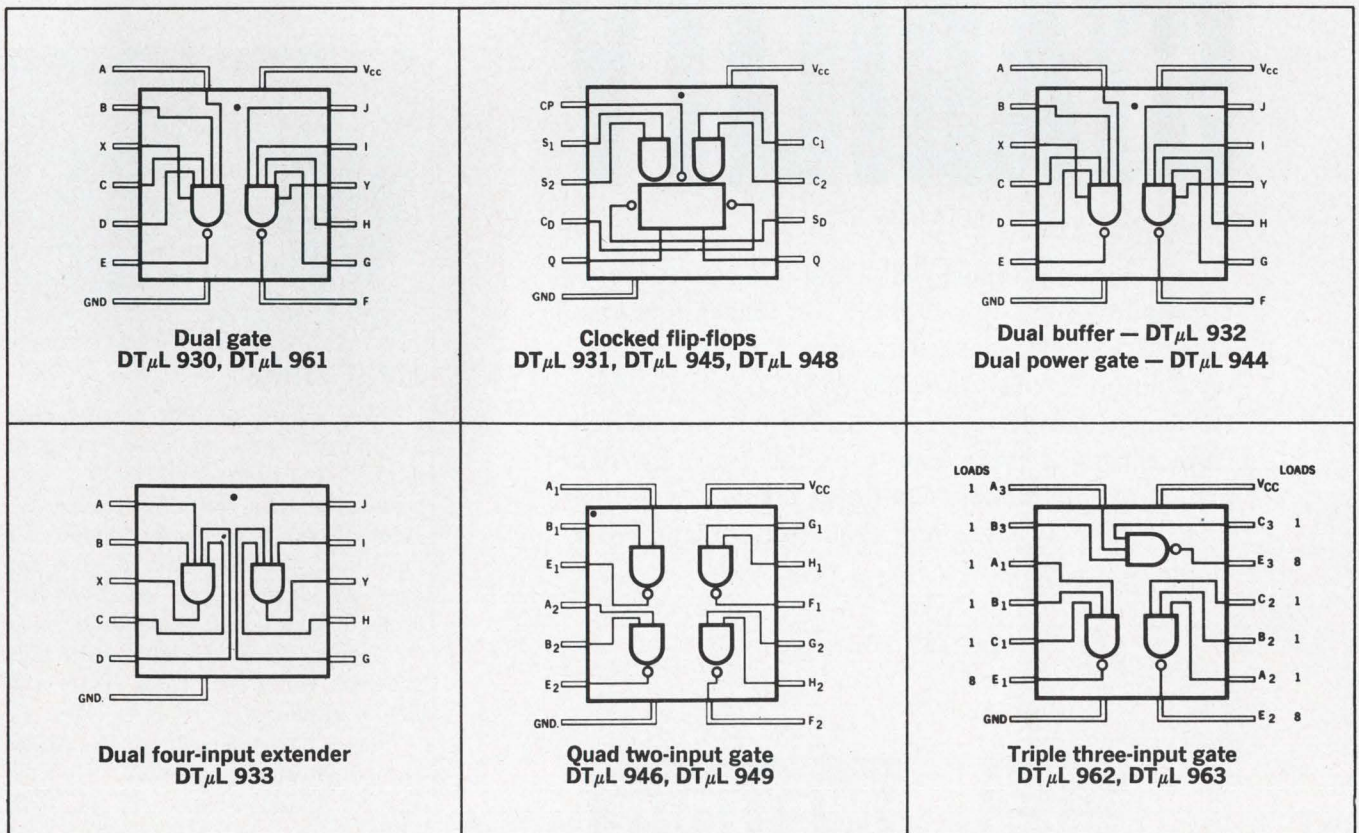

MOL Resistors

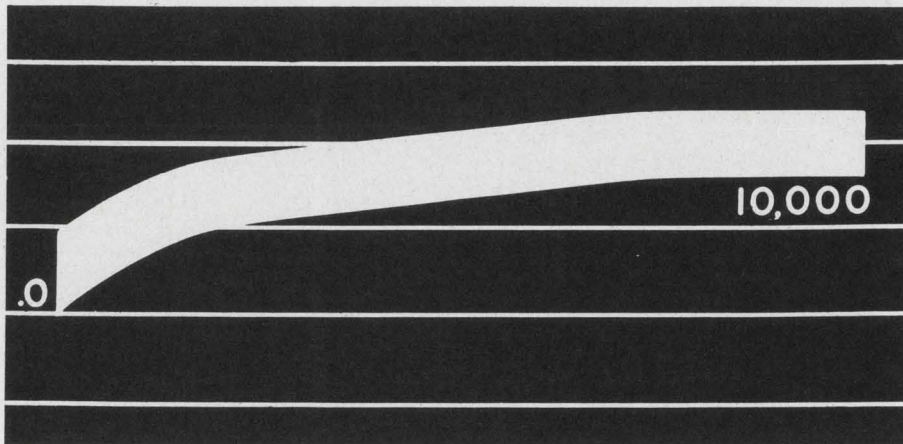

STABILITY

... is just one reason why all major TV manufacturers use Mallory MOL film resistors. On 10,000-hour load-life test, resistance changed less than 5%. Other reasons: temperature coefficient of 250 PPM/°C; proved flame resistance, stability in humidity. *Plus* prompt delivery from expanded production capacity. Write for data and quotation. Mallory Controls Company, a division of P. R. Mallory & Co. Inc., Frankfort, Indiana 46041.



ON READER-SERVICE CARD CIRCLE 29

COMPONENTS

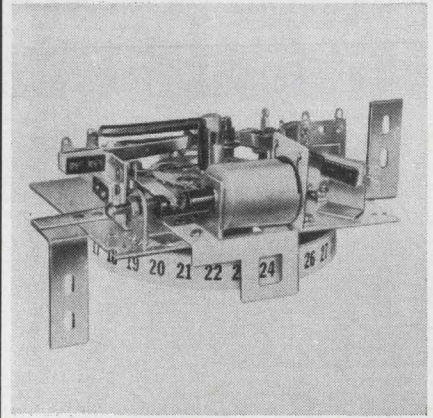

Accumulator

A lifetime of 10^6 cycles is claimed for this 28-position numerical accumulator. Series 130-2532 adds and subtracts by single counts from 0 to 28. Count may be stopped at any number and reset one step at a time or completely reset to zero. Pulsing rate is 350 to 400 counts/minute. Solenoid operating voltages are 12 to 115 Vac or dc.

P&A: \$7.50 (1 to 9); stock to 3 wks. Chicago Dynamic Industries, 1725 Diversey Blvd., Chicago. Phone: (312) 935-4600.

Circle No. 267

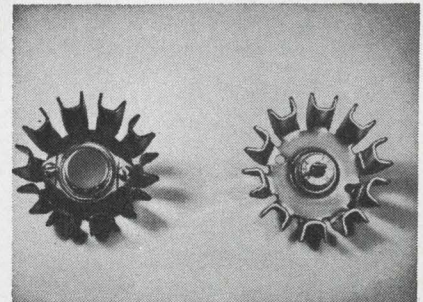

Heat sinks

Two series of low-profile heat dissipators accommodate press-fit diodes, rectifiers and SCRs, and transistor cans. Both feature a 10-sided, formed-fin configuration for max heat transfer. Series 606 for press-fit devices has a controlled press-fit aluminum expansion jacket. Series 600 is available with hole patterns for TO-3, TO-6, TO-8 and TO-36 cans.

P&A: From \$0.42; stock. Alpha Components Corp., 4222 Glencoe, Venice, Calif. Phone: (213) 398-7773.

Circle No. 268

ON READER-SERVICE CARD CIRCLE 223 ➤

Answers to CRT needs . . . ? You bet!



ETC[®] has them . . . already developed . . . already de-bugged

Designing and fabricating cathode ray tubes for out-of-the-ordinary requirements is a specialty at ETC. We thrive on challenges.

Each of the different tube types that make up our "standard" line was designed to answer a specific customer need. They range from small electrostatic CRT's to a twelve-gun multiple-display model, from fibre optic screens to distortionless rear windows. And they're all deliverable, saving you the expense of prototype development and de-bugging.

The same design ingenuity that turned these custom-engineered tubes into standard items can be applied to the

modification of an existing tube, or the development of an entirely new one, if a stock answer doesn't fill the bill. Whatever it takes, we've got the know-how and skills to do it . . . including over three decades of experience in multi-layer phosphors, multi-gun structure, non-linear spiral bandings, hybrid deflection, shielding and potting.

Whether your needs involve data display, radar, mapping, or any other exacting application, you can be certain that an ETC tube will give you light output, deflection sensitivity and spot size criteria equaling or exceeding those available elsewhere. And you'll find our service to

be prompt, efficient, courteous—no matter how simple or complex the assignment.

We can't promise you a scientific breakthrough. But we *will* provide you with the right tube for the job . . . even if we have to stretch the current art boundaries to do it. Find out why this kind of "total CRT capability" is your assurance of the greatest value in display. Write today for our latest catalog.

**GENERAL
ATRONICS**
ELECTRONIC TUBE DIVISION
PHILADELPHIA • PENNSYLVANIA 19118





When you demand maximum temperature stability in a miniature size...

PAKTRON[®]
FILM/FOIL
POLYCARBONATE
 capacitors
 are your answer!

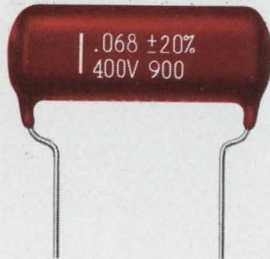

When your design calls for stability in a capacitor operating temperature range of -65°C , to $+105^{\circ}\text{C}$, then PAKTRON polycarbonate film/foil capacitors are your answer. Hot or cold, the inherent stability of polycarbonate will provide you with consistent reliability over the entire temperature range. PAKTRON polycarbonate capacitors are tough, too. You'll find them highly resistant to moisture, shock, vibration and contamination. Available in two lines. The epoxy dipped (shown above) line for values up to 0.5 mfd. and 400 WVDC and the molded line (not shown) for values to 0.1 mfd. and 200 WVDC.

PAKTRON dimensions are precise. Capacitance ranges are broad and tolerances exacting. See for yourself, ask for full details and free samples—no obligation.

"Remember, you're never more than a few feet away from a product of ITW"[®]

it **PAKTRON**
 DIVISION ILLINOIS TOOL WORKS INC.
 1321 LESLIE AVENUE • ALEXANDRIA, VIRGINIA 22301

ON READER-SERVICE CARD CIRCLE 30

COMPONENTS

Differential preamp

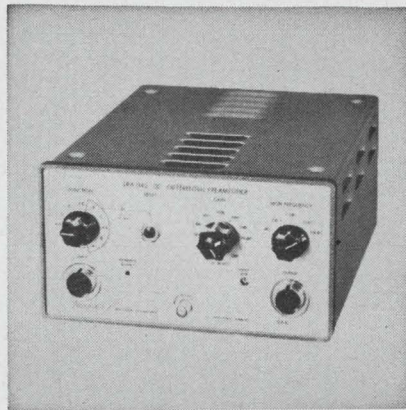

A hybrid solid-state/nuvistor preamplifier, LRA 045, has a dc to 100-kHz bandwidth. The driven common-mode circuitry in the input stage provides independence of common mode rejection from source impedance variations. Common mode rejection at 1 kHz is 140 dB and noise is less than $8\ \mu\text{V}$ p-p. Input impedance is 20 M Ω and gain is 10,000.

Price: \$265. Argonaut Associates, Inc., P. O. Box 273, Beaverton, Ore. Phone: (503) 292-3149.

Circle No. 269

Servo/differential relay

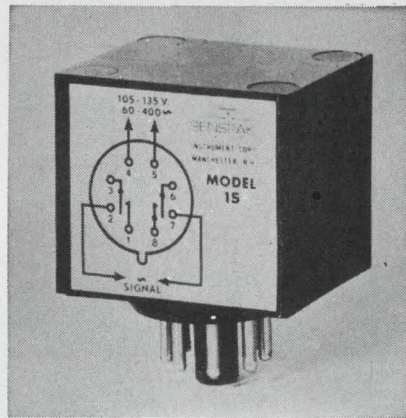

Model 15 servo/differential relay incorporates a high-gain silicon amplifier requiring a primary power source and a derived phase sensing signal source. The relay output consists of dry reeds with 15-W ac or dc switching capacity. Current amplification factor is 10^8 . Signal input impedance is 20 k Ω .

Price: \$31.95. Sensitak Instrument Corp., 531 Front St., Manchester, N. H. Phone: (603) 627-1432.

Circle No. 270

Department ED-01
HAYDEN BOOK COMPANY, INC.
 116 W. 14 St., New York, N. Y. 10011

Gentlemen:

I don't need a lengthy sales talk to realize the idea-provoking reference values of almost 90 articles on microelectronics, compiled from **Electronic Design**. All

I need is this coupon to order a 30-day approval copy. After 30 days, I'll either pay \$11.50 plus a few cents postage, or return the book. Send my copy of MICROELECTRONIC DESIGN, Edited by Howard Bierman, to:



Name _____

Company _____

Address _____

City _____ State _____ Zip _____

Enclosed is a check for \$11.50. You pay the postage. I'll retain the same return guarantee.

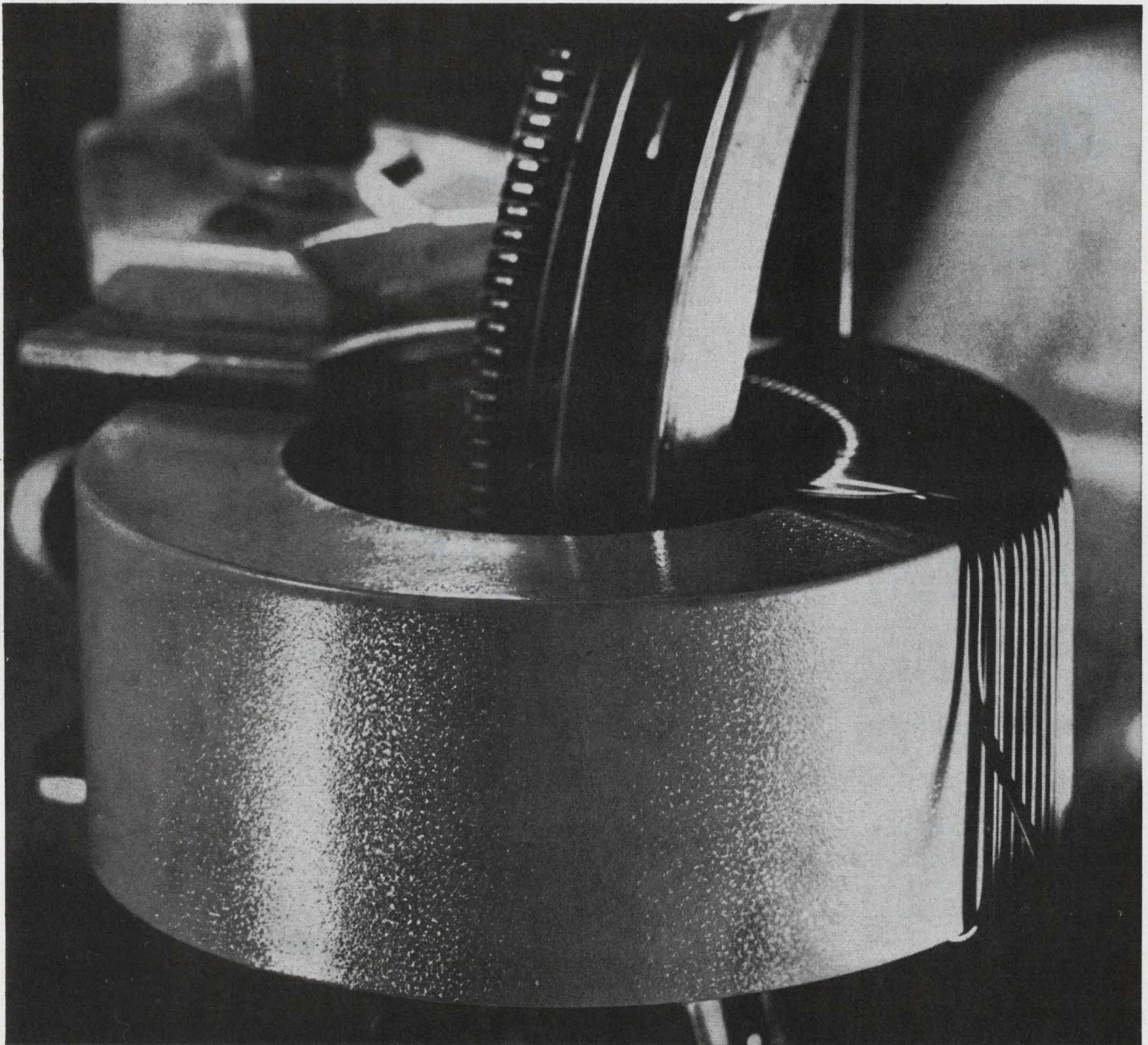

ROUGH WITH A REASON

Unique GVB finish cuts core winding costs

GVB encased cores mean fewer production delays because GVB does much more than seal the core box against potting material. Its matte finish provides a resilient, non-slip base for winding, and the tough epoxy skin prevents the wire from cutting through to the core box. Guaranteed not to fail, even when wound with heavy #6 wire, GVB surface also eliminates abraded wire problems. No prior taping of the core is required, so another winding operation is wiped out.

Magnetics doubles the normal guarantee on core box finishes by expressing it in this unique way: The guaranteed voltage breakdown (GVB) finish seals the box

and is capable of withstanding at least 1,000 volts at 60 cycles *between a bare winding and the aluminum case*. Quality control monitors the application and curing of GVB to assure dimensional and voltage breakdown fidelity. Performance characteristics are maintained between -65 and 200 degrees C.

To reduce production costs on your winding operations, try Magnetics' tape wound cores with GVB. Eight material types, in a wide range of sizes from $0.375''$ to $4.0''$ inside diameter, are stocked for immediate delivery. More information? Write *Magnetics Inc.*, Dept. ED-27, Butler, Pa.



Speed Inquiry to Advertiser via Collect Night Letter
ON READER-SERVICE CARD CIRCLE 31



When your specifications call for quality performance at a modest price...

PAKTRON[®]
HI-WHITE-50[®]
 capacitors
 are your answer!

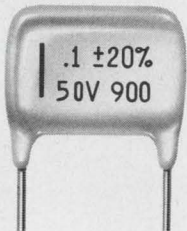

Do your design specifications call for low voltage capacitors that are really miniature in size, perform with consistent reliability under rugged application conditions, and are modest in price? PAKTRON HI-WHITE-50 capacitors are your answer. Demanding industrial applications have proven PAKTRON HI-WHITE-50 capacitors are the perfect subminiature, economy capacitors for circuits requiring up to 50 WVDC. Standard values through .5 mfd. available. Special PAKTRON construction techniques assure smallest size, superior moisture resistance and exacting tolerances. See for yourself, ask for full details and *free* samples —no obligation.

"Remember, you're never more than a few feet away from a product of ITW"[®]



ON READER-SERVICE CARD CIRCLE 32

COMPONENTS

Control transformers

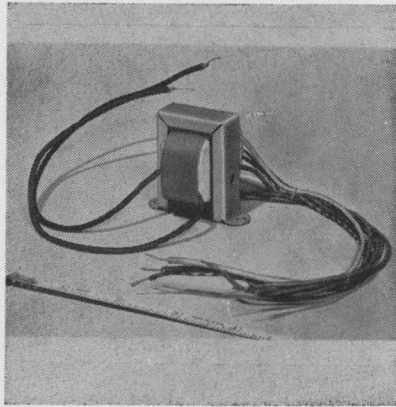

These "Versatile" control transformers are designed for multi-voltage and/or current requirements. Transformers have 117 V 50/60 Hz primary and 3 isolated 12-V secondaries, one with center tap. Four sizes are available with secondaries of 100, 150, 250 and 500 mA. Secondaries of 6, 12, 18, 20, 24 and 36 V may be obtained.

Essex Wire Corp., 3501 W. Addison St., Chicago. Phone: (312) 463-7400.

Circle No. 271

Plastic pot

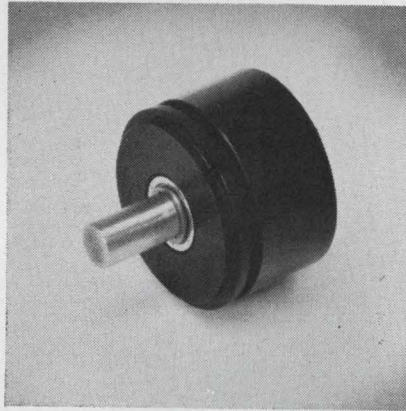

A conductive plastic track is integrally molded with the Model CP-36's slip rings, terminal and case for improved reliability over wire-wound pots. Linearity is better than 1% with essentially infinite resolution. Standard resistance range is 500 Ω to 100 Ω. Multi-gang cups and servo mounts can be provided.

Keltron Corp., 223 Crescent St., Waltham, Mass. Phone: (617) 894-0525.

Circle No. 272

THUMBWHEEL SWITCHES



- COMPACT
- POSITIVE OPERATION
- SIMPLE, CLEAN INSTALLATION
- ECONOMICAL
- MODULAR
- WIDE RANGE OUTPUT
- EDGE LIGHTING AVAILABLE

Send for further information

TECH LABORATORIES, INC.

Palisades Park, New Jersey
 Phone: 201 — 944-2221 • TWX: 201 — 947-4730

ON READER-SERVICE CARD CIRCLE 33

ON READER-SERVICE CARD CIRCLE 224 ➤

Infinite resistance at null to 1100 volts is one feature of our new solid state differential voltmeter. Accuracy to $\pm 0.0025\%$ of dial setting is another. Price of \$1095 doesn't hurt our cause either. Ratio measurement lets you compare two external sources with a resolution of 0.0001%. In the TVM mode, input resistance is 100 megohms. Reference regulation is 0.0002%. Stability is 13 ppm peak-to-peak per 60 days.

Of course, that's not the whole story. Other features include 6 digit inline readout with a dial resolution of 1 ppm. The recorder output is well isolated and linear to within 0.5% of end scale. Ten percent overranging minimizes range changing and offers increased resolution on the lower end of each range. A continuously adjustable last digit allows exact null and eliminates meter interpolation for resolution.

The half-rack Model 895A weighs 16 pounds.



FLUKE • Box 7428, Seattle, Washington 98133 • Phone: (206) 776-1171 • TWX: (910) 449-2850

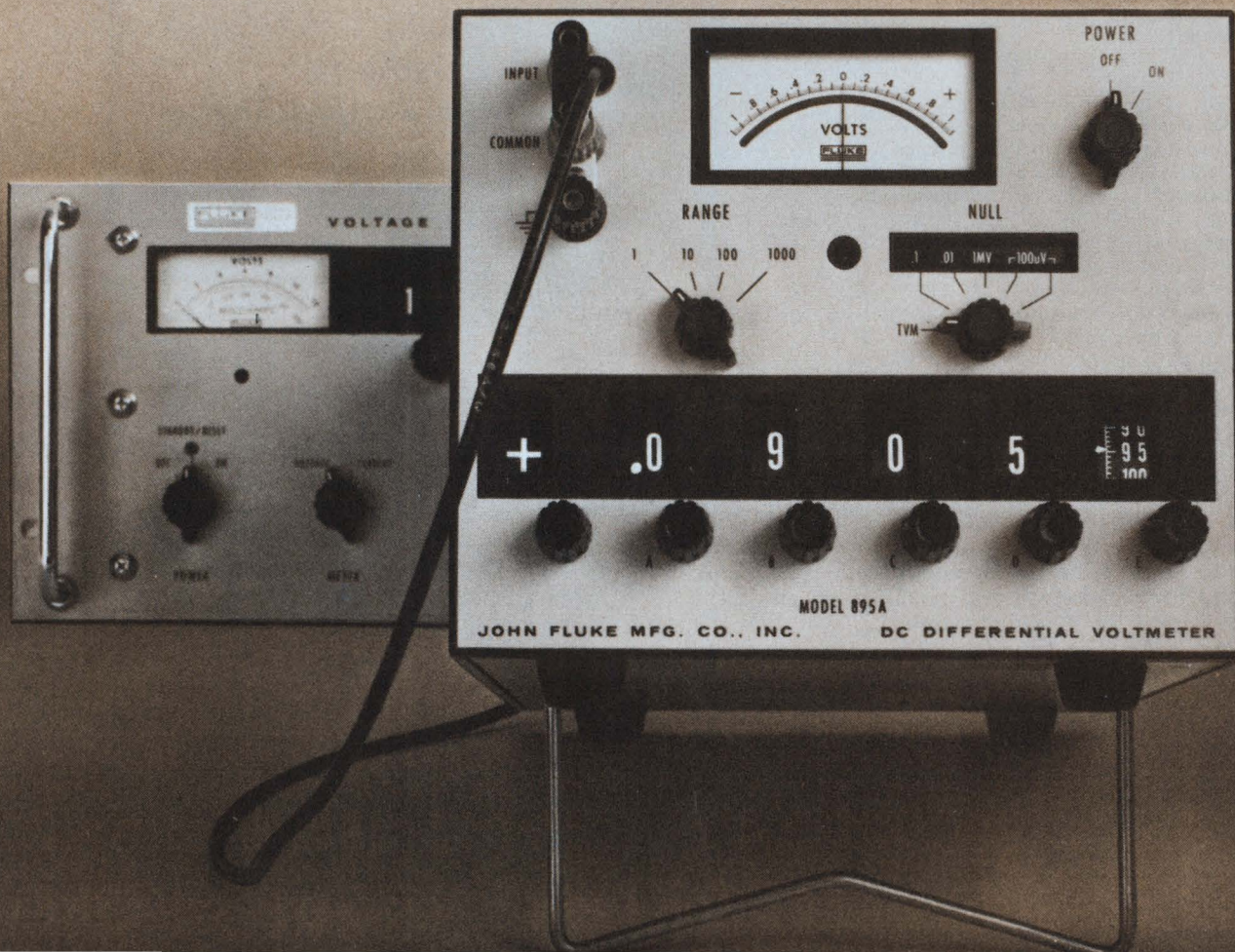

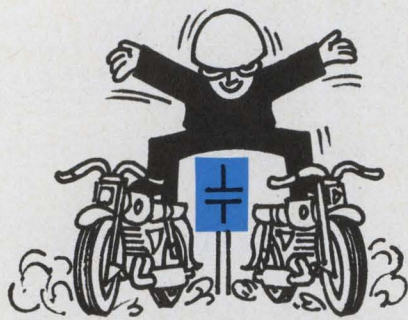

When you need a wide capacitance range and high performance in a small size...

PAKTRON[®]
MOLDED AND DIPPED
CAPACITORS OF
MYLAR
are your answer!



When your capacitor needs require you to think broadly in relation to capacitance and voltage range, then PAKTRON epoxy molded (shown above) and dipped capacitors of MYLAR* film/foil are your answer. They are designed to provide the widest possible capacitance range and most useful voltage ratings in the smallest practical sizes.

The PAKTRON molded line (shown) offers values through 0.1 mfd. and voltage ratings through 200 WVDC. The dipped line (not shown) provides values through 0.5 mfd. and voltage ratings through 600 WVDC.

Unique PAKTRON construction techniques and high grade epoxy coatings insure stability under severe environmental conditions including shock and vibration.

See for yourself, ask for full details and free samples—no obligation.

*A DuPont Registered Trademark

"Remember, you're never more than a few feet away from a product of ITW[®]"



ON READER-SERVICE CARD CIRCLE 34

MICROWAVES

Dual TR-limiter



The MA-3813Z combines a gas TR tube and a solid-state limiter to provide protection from spike leakage energy for crystal receivers and tunnel diode amplifiers. The device operates up to 16-to-17 GHz with a peak power of 40 kW max. Vswr is 1.3 max and insertion loss is 1.0 dB. Recovery time is 2 μ s and spike leakage is less than 0.05 ergs/pulse.

Microwave Associates, Inc., South St., Burlington, Mass. Phone: (617) 272-3000.

Circle No. 273

Rotary joints

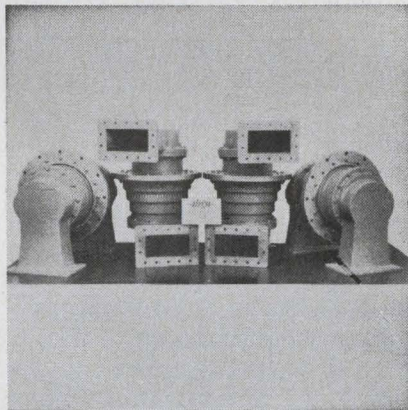

A new family of circular waveguide rotary joints is designed for L, S, C, X, Xb, Ku and Ka band operation.

The joints handle full waveguide power over a 7% band with a max vswr less than 1.15 and an insertion loss less than 0.1 dB. Typical waveguide sizes used are in the category of WR770 through RG-96/U.

Diamond Antenna & Microwave Corp., 35 River St., Winchester, Mass. Phone: (617) 729-5500.

Circle No. 274

GLOBE **low-cost bi-directional variable speed device**

100 RPM CLOCKWISE THROUGH 0 TO 100 RPM COUNTER-CLOCKWISE

Globe a.c. and d.c. differentials offer torques up to 1000 oz. in. with top speeds of from 10 to 100 rpm in either direction. Smooth transitions from top speed in one direction through 0 rpm to top speed in the opposite direction at full torque are possible. Motor options: to 115 v.d.c.; to 230 v.a.c., 50/60 and 400 cps. Antenna drives, tracking devices, positioning or servocontrol systems are typical applications. For further information, request Bulletin DI.

Globe Industries, Inc., 2275 Stanley Ave., Dayton, Ohio 45404. Tel.: 513 222-3741

ON READER-SERVICE CARD CIRCLE 35

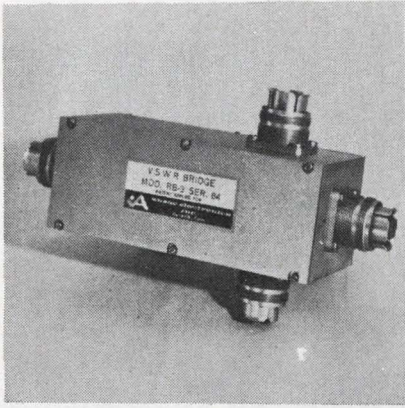

Vswr bridges

Two bridges enable vswr and return loss measurement in fixed or swept set-ups. Model RB-1 covers 0.5 to 50 MHz and RB-3 covers 3 to 1500 MHz. Accuracy of the RB-1 is 1% for vswr to 1.5 and 2% at vswr of 2. Max vswr error of the RB-3 is 1.5% below 1 GHz, and 2.5% at 1.5 GHz for vswr up to 1.5. Both have a short-circuit termination and a table converting return loss to vswr.

P&A: \$360; stock to 4 wks. Anzac Electronics Inc., Moody's Lane, Norwalk, Conn. Phone: (203) 838-8451.

Circle No. 275

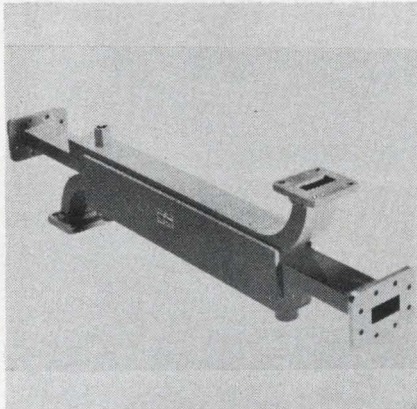

Top wall coupler

DBH-S-879 dual top wall waveguide coupler handles 30 kW cw with a 0.05-dB insertion loss. It is designed for water-cooled operation and pressurization to 60 psig. Forward coupling is 65 dB and reverse coupling is 35 dB. Directivity is typically 35 dB across the band. Vswr is 1.05 max in the main arm and 1.03 max in the coupling arms.

P&A: \$595; stock to 4 wks. DeMornay-Bernardi Div. of Datapulse, Inc., 780 S. Arroyo, Pasadena, Calif. Phone: (213) 681-7416.

Circle No. 276

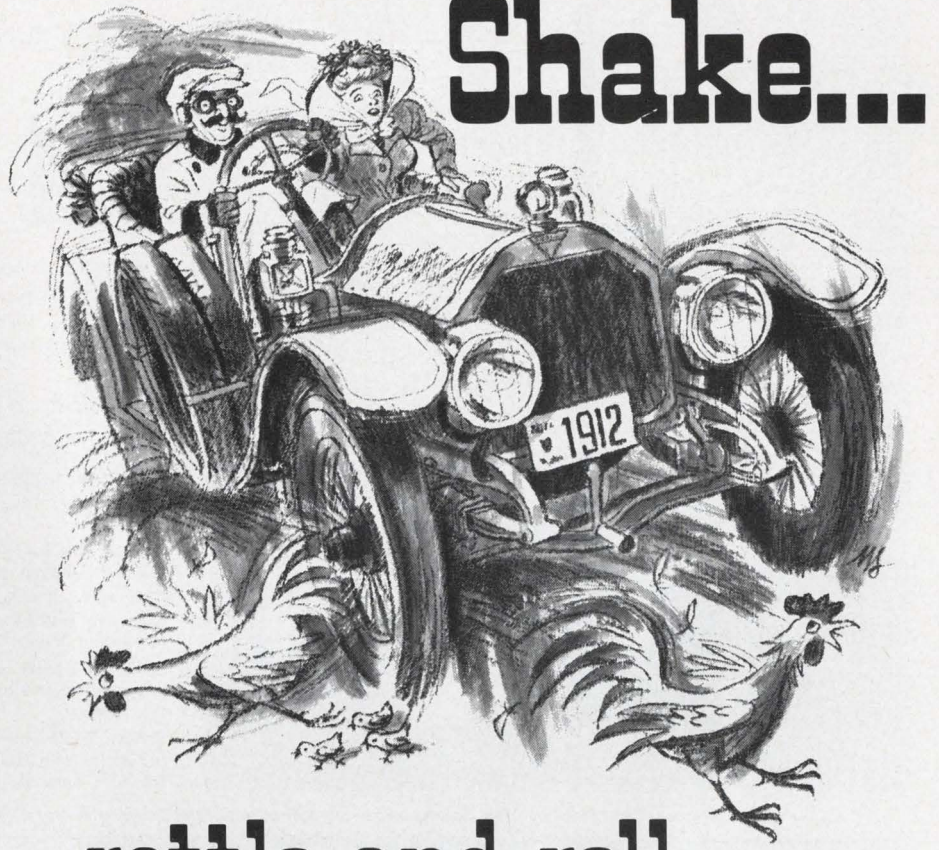

Shake...

rattle and roll...

When they made the 1912 Simplex, the art of vibration control was virtually unexplored — if you go by the theory of what you don't know can't hurt you, fine! Today's engineers are a little different (thank heavens) they design every shock and vibration problem possible out of a product. A good example is Rolls-Royce, they just installed 16 of our all-metal Met-L-Flex mounts. They will now become a production standard.

Rolls-Royce chose Met-L-Flex because it's the only mount that completely resists all elements—extreme high or low temperatures, oils, chemicals, fuels etc. You see Met-L-Flex mounts are all-metal—they incorporate a resilient cushioning material of fabricated, knitted stainless steel wire. It isolates your product from vibration and shock and we're the only ones that make it!

We also have a complete line of elastomeric mounts to meet vibration and shock problems—so whether you're mounting engine and exhaust systems, electronic gear, industrial equipment, or computer systems, we have the mount to solve the problem.

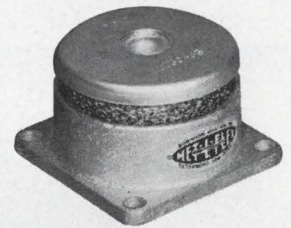

Met-L-Flex unit isolator for Airborne, Vehicular and Industrial applications.

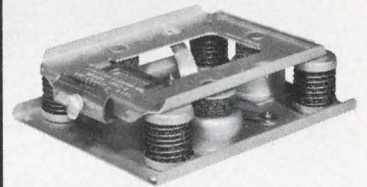

High Frequency engineered mounting systems for missile applications.

VibraShock

ROBINSON TECHNICAL PRODUCTS, INC.
3310 Vanowen Street, Burbank, California 91504
Teterboro, New Jersey
(213) 849-7181 TWX 910-498-2217

ON READER-SERVICE CARD CIRCLE 36

STANCOR

STANDARD TRANSFORMERS

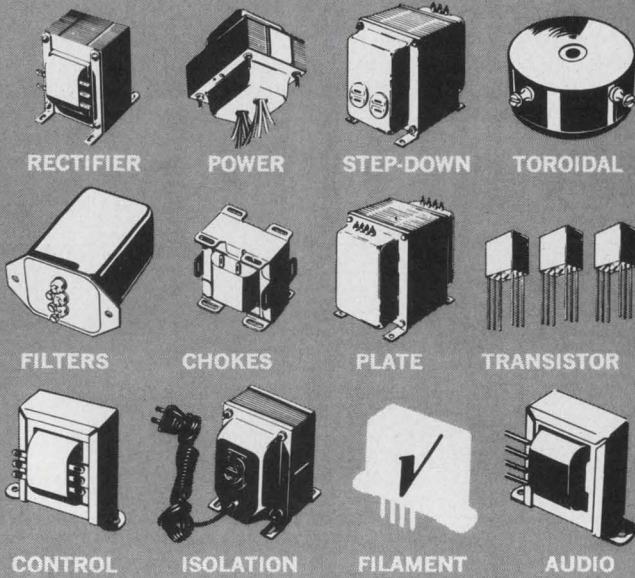

* Write for 1966 catalog and information on variations from standard transformers.

SOLD NATIONALLY THROUGH ELECTRONIC DISTRIBUTORS BY
ELECTRONIC MARKETING DIVISION

3501 W. Addison Street • Chicago, Illinois 60618
 ON READER-SERVICE CARD CIRCLE 37

STANCOR STANDARD FILAMENT TRANSFORMERS

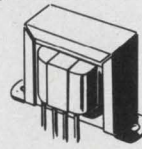

Over 75,000 in stock ranging from 100 to 10,000 of over 100 types.

Specification Ranges

- Primary Voltage 115-230 volts 50/60 cycle and 400 cycles
- Secondary Voltage 2.5 to 25.2 volts
- Secondary Current 0.6 to 51 amperes

USE STANCOR STANDARDS* AND BE ASSURED OF . . .

Immediate Availability: Sold by Industrial Electronic Distributors in major marketing areas — AT OEM PRICES IN ANY QUANTITY.

Highest Quality: Millions of standard transformers, time-tested and field-proven for over 35 years.

Competitive Prices: Mass production facilities — to supply its extensive distributor organization — enable Stancor to manufacture at lowest costs.

Stock In Depth: Over 300,000 transformers stocked in our warehouses strategically located throughout the country.

Service Replacement: Available from over 1,000 Industrial and Service Parts Electronic Distributors located in over 500 cities.



ARNOLD/TOROIDAL COIL WINDER

*sets up quickly...easy to operate...
 takes wide range of wire sizes*

SPECIFICATIONS:

- Min. finished hole size: .18 in.
- Max. finished toroid O.D.: 4.0 in.
- Winding speed: 1500 turns/min.
- Wire range: AWG 44 to AWG 26
- Dual, self-checking turns counting system
- Loading (wire length) counter
- Core range: 9/32" I.D. to 4" O.D. to 1 1/2" high

LABORATORY USE

- Change wire and core size in 45 sec.

PRODUCTION USE

- 1500 turns per minute
- Insert core and load in 20 sec.

\$890.00 includes all rings, counters and accessories

immediate delivery. literature on request

ARNOLD MAGNETICS CORP.

6050 W. Jefferson Blvd., Los Angeles, Calif. 90016
 (213) 870-6284

ON READER-SERVICE CARD CIRCLE 38



SOLDERLESS TERMINALS

now!

from
ZIERICK

**INSULATED &
 NON-INSULATED**

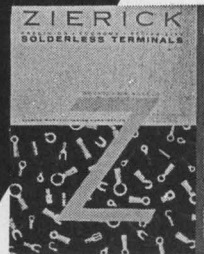
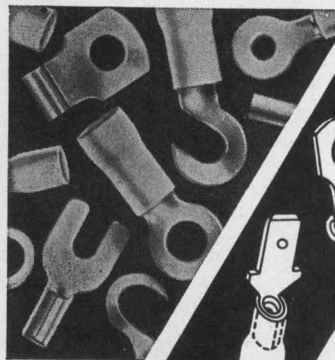

**STANDARD ELECTRICAL
 PARTS
 delivered FAST**

Lugs • Clips • Terminals.
 Send for your copy of the
 new Zierick Solderless Terminal Brochure TODAY!

All metals, sizes, varieties, uses. Immediate delivery from stock

ZIERICK MANUFACTURING CORP.

96 Beechwood Ave., New Rochelle, N. Y. • (914) NEW Rochelle 6-8520

ON READER-SERVICE CARD CIRCLE 39

MICROWAVES

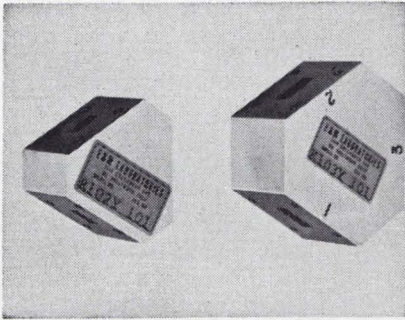

Waveguide circulators

Waveguide circulators covering a 20.0 to 36.0 GHz range are offered in 3 models in RG-53/U and RG-96/U waveguide. Featured are 2.0 GHz bandwidths with 20 dB min isolation, 0.5 dB max insertion loss and 1.2 max vswr. The millimeter-region units are designed for duplexing and paramp systems.

They can be modified for use as low-loss terminated circulators and switches.

E & M Labs., 7419 Greenbush Ave., North Hollywood, Calif. Phone: (213) 875-1484.

Circle No. 277

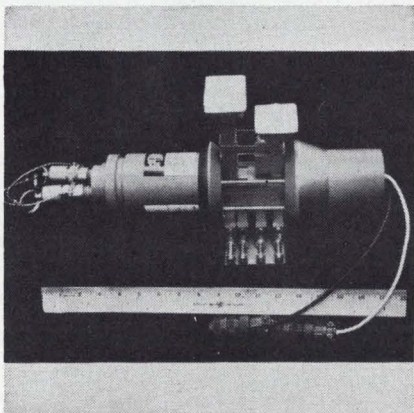

X-band amplifier

Series SAX-4700 X-band cw amplifier tunes over 500 MHz and has a 1-dB bandwidth of 40 MHz. The bellows-type tuners allow remote-gang tuning. The 8-kW cw unit covers 7.9 to 8.4 GHz with a gain of 45 dB. Beam voltage is 14 kV and beam current is 1.7 A. Heater voltage is 10 V and heater current is 5 A. Solenoid power required is 1.1 kW.

Electronic Tube Div. of Sperry Rand Corp., Gainesville, Fla. Phone: (305) 372-0411.

Circle No. 278

June 7, 1966

5% TIME DELAY RELAYS

Shown here is one of a family of Beta-mite solid state time delay relays. The RT-175 pictured waits from 0.050 second to 22 minutes after application of B+ to the input. Timing accuracy is $\pm 5\%$. Fixed or adjustable delay models are available, with either relay or solid state contacts. The unique termination header shown features insertable/removable environment-free crimp contact terminals. Send for details on this and other Betamite solid state devices.

- PHASE SEQUENCE DETECTORS
- VOLTAGE LIMIT DETECTORS
- TIME DELAY RELAYS
- FREQUENCY LIMIT DETECTORS



BETAMITE ELECTRONIC DEVICES

7001 W. Imperial Highway • Los Angeles, Calif. 90009
(213) 673-5080 • TWX 213-673-1000
Airport Station P. O. Box 90920



A Division of The Deutsch Company — ECD

ON READER-SERVICE CARD CIRCLE 40

Digital plotting system

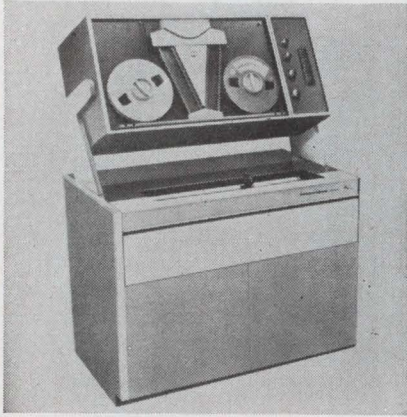

The "Delta" digital incremental plotter is designed to self-program up to 100 steps from a single input command via punched cards. One command from computer or tape will also produce up to 127 incremental plotting steps. The control unit is available with IBM 360 software. Either a magnetic tape or a card reader is included.

Benson-Lehner Corp., 14761 Califa, Van Nuys, Calif. Phone: (213) 781-7100.

Circle No. 279

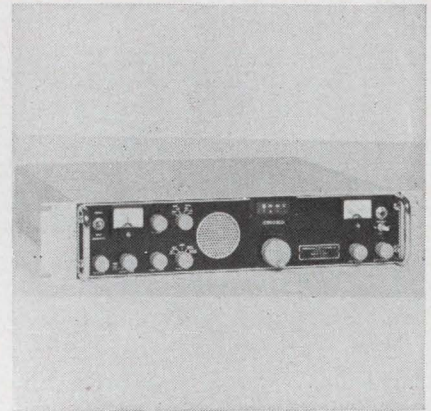

Vhf receivers

Series 500 vhf receivers cover AM, FM and cw in the 54- to 260-MHz range and are tunable in a single band. A tape dial, a 115/230-Vac power supply and built-in BFO are standard. IF bandwidth of 10 or 300 kHz is front-panel selectable. Video bandwidth is adjustable to 1, 3, 10, 30 or 150 kHz.

P&A: \$1600 to \$1750; stock to 30 days. Communication Electronics Inc., 6006 Executive Blvd., Rockville, Md. Phone: (301) 933-2800.

Circle No. 280

GENTAPE — where great ideas are generated

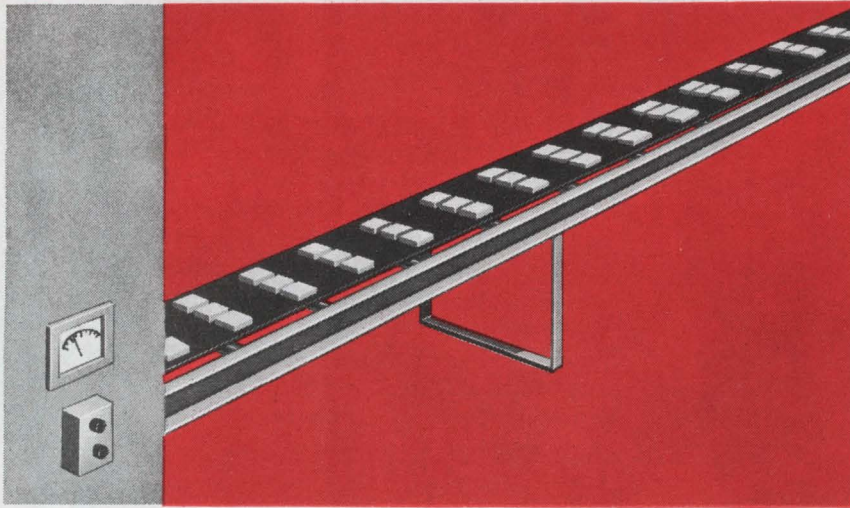

When Moving Miniature Parts is a Particular Problem . . . or Driving Fine Instruments Demands Dimensional Stability,

GENTAPE

CONVEYOR and DRIVE BELTS DELIVER REMARKABLE QUALITY and FLEXIBILITY

Highly sophisticated electronic components seemingly become more minuscule by the minute — while precision standards soar. And assembly line methods and materials must keep pace.

Gentape's TO-412 Series of conveyor and drive belts fully take the measure of today's demanding miniaturization. They're available in widths as meager as $\frac{1}{8}$ " up to 6" — in any color — with or without sprocket holes.

Highly flexible, dimensionally stable, they're more accurate and last longer.

SPLICE — AND GO!

In addition, TO-412 Series loops may be quickly, easily spliced — cuts downtime — secures the exact loop length right on the job.

Have we conveyed to you why you should check into Gentape without delay?

GENTAPE CORPORATION

A DIVISION OF GENERAL PLASTICS CORPORATION
51A LA FRANCE AVE., BLOOMFIELD, N. J. (201) 748-5506

Mfrs. of Precision Printed Tapes, Lighted Dials, Masks and Other Critical Instrumentation Parts

ON READER-SERVICE CARD CIRCLE 41

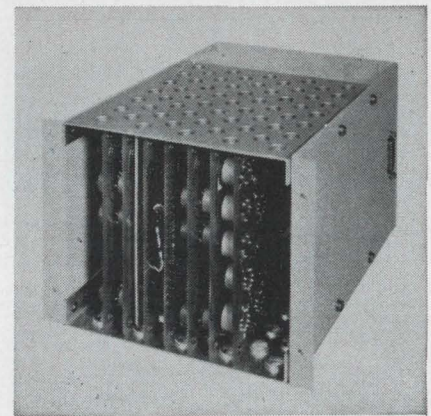

Communications buffer

Series MCDL sequential access buffer, designed as a magnetic core delay line, has a 1386-bit capacity. The basic bit serial in/bit serial out unit contains the 1386-bit array selected on 4 coordinates by mutually prime ring counters. Each stage provides the shift and core drive function in each circuit. A bit serial in/bit parallel out model is obtained by adding a magnetic core rope card which will accommodate up to 16 parallel bits.

Di/An Controls Inc., 944 Dorchester Ave., Boston. Phone: (617) 288-7700.

Circle No. 281

New value-priced sweeper...

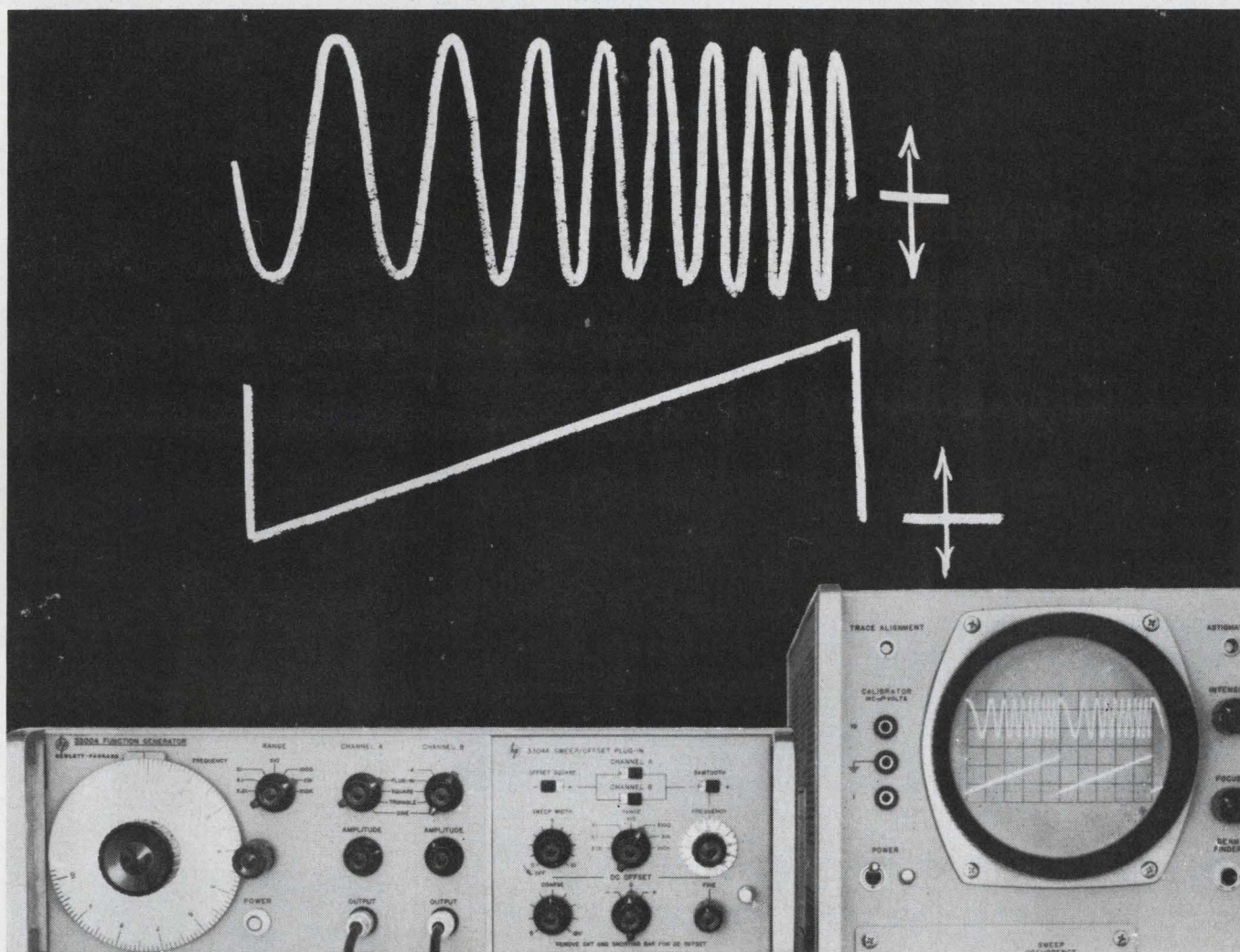

with a dc offset plug-in for your Hewlett-Packard 3300A Function Generator

Here's a low cost (\$210) plug-in, 3304A, for the Hewlett-Packard 3300A Function Generator that provides internal sweeping, up to ± 16 v of dc offset on all functions, plus sawtooth and offset square-wave outputs.

This is an instrument package you need to use on your bench... it provides more flexibility than words can describe. The new plug-in sweeps internally over a decade. The sweep starts at the main frame frequency setting and is controlled at the top end by the "Sweep Width" control. Any function can be offset with stability of ± 50 mv over 24 hours. The 3304A plug-in sawtooth is independent of the 3300A main frame frequency and can be used for driving external systems. The offset square wave clamps the top or bottom of the waveform either to the dc offset voltage or to ground potential.

The plug-in provides the offset with coarse and vernier control, a 15 v sawtooth (adjustable) and the square wave over the same frequency range as the main frame. The main frame, the 3300A itself, is the first plug-in function generator to offer variable phase, phase-lock capability with accurate sine, square, triangular output, amplitude controlled, 0.01 Hz to

100 kHz. It offers linear voltage programmability, single-cycle, multi-cycle, free-run operation, external trigger capability. It provides isolated dual output amplifiers, plus a sync pulse output for oscilloscope or recorder.

All this for just \$570, plus the cost of one of these plug-ins: 3301A Operational Plug-in, \$20; 3302A Trigger/Phase-Lock Plug-in, \$190; 3304A Offset Plug-in, \$210.

Ask for a demonstration. Have your Hewlett-Packard field engineer turn it on and show you what this remarkably versatile instrument can give you. Or write for a special chart showing all the outputs available from this instrument and its plug-ins: Hewlett-Packard, Palo Alto, California 94304, Tel. (415) 326-7000; Europe: 54 Route des Acacias, Geneva.

Data subject to change without notice. Prices f.o.b. factory.

HEWLETT  **PACKARD**
An extra measure of quality

ON READER-SERVICE CARD CIRCLE 42

MAGNETIC SHIELDING MADE EASY

APPLIED IN SECONDS

**Cut to any size or outline
with ordinary scissors**



Co-Netic and Netic foils are ideal for initial laboratory or experimental evaluation... also for production applications and automated operations. Dramatically enhance component performance by stopping degradation from unpredictable magnetic fields. When grounded, foils also shield electrostatically. They are not significantly affected by dropping, vibration or shock, and do not require periodic annealing. Available in thicknesses from .002" in rolls 4", 15", and 19-3/8" wide. High attenuation to weight ratio possibilities. Every satellite and virtually all guidance devices increase reliability with Netic and Co-Netic alloys, saving valuable space, weight, time, and money.



MAGNETIC SHIELD DIVISION

Perfection Mica Company

1322 N. ELSTON AVENUE, CHICAGO 22, ILLINOIS

ORIGINATORS OF PERMANENTLY EFFECTIVE NETIC CO-NETIC MAGNETIC SHIELDING

ON READER-SERVICE CARD CIRCLE 43

SEMICONDUCTORS

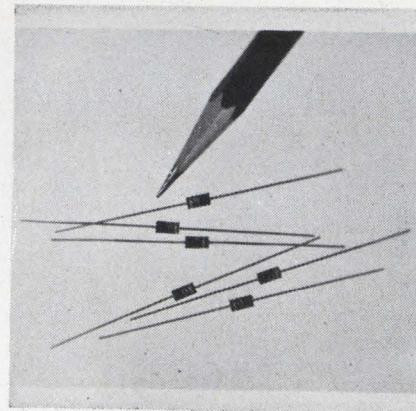

Capacitance diodes

Ratings of 80 and 100 Vdc are combined with a 50-MHz Q as high as 300 in these voltage-variable capacitance diodes. The SV-4500 to SV-4800 and SV-5500 to SV-5700 series utilize an abrupt junction epitaxial structure to achieve minimum capacitance ratios of 5.6 and 6.4 for 80 and 100 V. Capacitance ranges from 10 to 47 pF at 4-V bias with 10% tolerance.

P&A: From \$5.00; stock to 2 wks. Somerset Electronics Corp., P.O. Box 115, Manville, N. J. Phone: (201) 722-2340.

Circle No. 282

WHICH DEFLECTION YOKE FOR YOUR DISPLAY ?

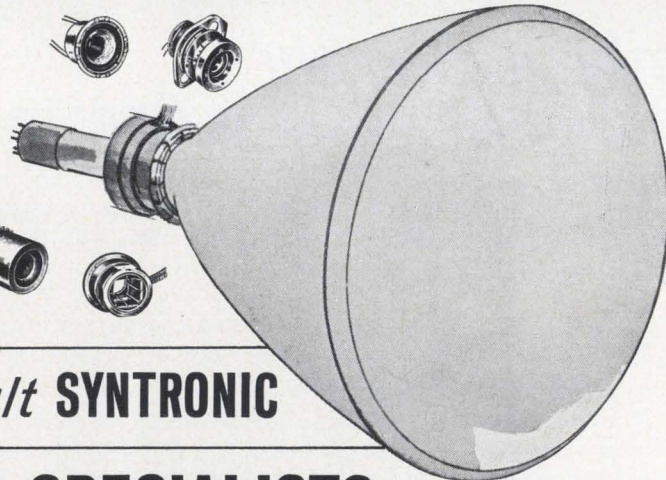
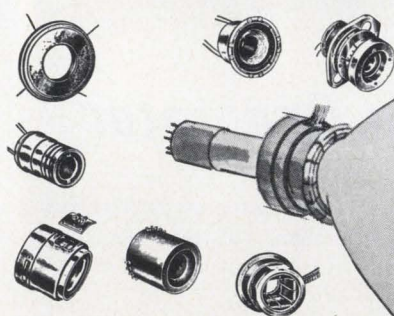

Consult **SYNTRONIC**

YOKE SPECIALISTS

Syntronic's team of experts knows more about yoke design, engineering and quality control than anyone else. A solid 10-year record of leadership—acknowledged throughout the industry. Benefit from it.

syntronic INSTRUMENTS, INC.
100 Industrial Road, Addison, Illinois
Phone: Kingswood 3-6444

ON READER-SERVICE CARD CIRCLE 44

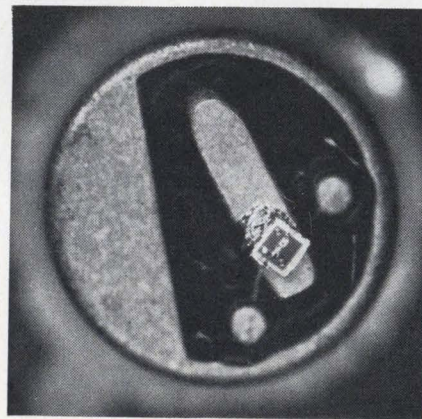

Pnp transistor

Typical switching time of the TW-300 pnp silicon planar transistor is better than 20 μ s at a collector current of 1 μ A. Switching speed stems from the small geometry epitaxial base. Collector-to-base breakdown voltage of the single emitter device is 45 V and emitter-to-base breakdown voltage is 30 V. Beta is greater than 30 at 1 μ A and V_{ce} of 0.5 V.

P&A: \$13.50 (1 to 99), stock. Sprague Electric Co., 347 Marshall St., North Adams, Mass.

Circle No. 283



Fast 4-way relief for inventory headaches...mix your own!

Ordering and stocking a different connector configuration for each new product design requirement can be a real headache. If this is your problem, aspirin won't help you. But, our pin and socket connector housings will—four ways!

These housings, available with or without die-cast aluminum shells, now accept four types of size 16 contacts—including coaxial. Which means you can bring both **power and shielded circuits** through the same connector in **any desired combination**, up to 160 positions.

All four contacts are crimp snap-in types for fast, dependable termination with AMP's matched application tools. Three types of pin and socket contacts are available; type II is a precision screw-machined contact meeting applicable requirements of MIL-C-8384, types III and III(+) are continuous strip formed contacts for high production at lowest installed cost.

For your low-level signal lines, our new subminiature COAXICON* contact is ideal. It's applied by

AMP's exclusive **single-stroke crimping technique** which simultaneously crimps center conductor, braid and cable support. And, it snaps into any connector cavity just like the pin and socket contacts.

So take a tip, not a pill. Minimize your inventory problems by selecting A-MP* Series M, D, DD, W or WW connector housings in the materials and sizes you'll need. Then, mix your own contacts in whatever configuration the application calls for. Sound good? Write today and get the complete story.

*Trademark of AMP INCORPORATED

AMP
INCORPORATED
 Harrisburg, Pennsylvania

A-MP* products and engineering assistance available through subsidiary companies in: Australia • Canada • England • France • Holland • Italy • Japan • Mexico • Spain • West Germany

Speed Inquiry to Advertiser via Collect Night Letter
 ON READER-SERVICE CARD CIRCLE 45

Silicon rectifiers

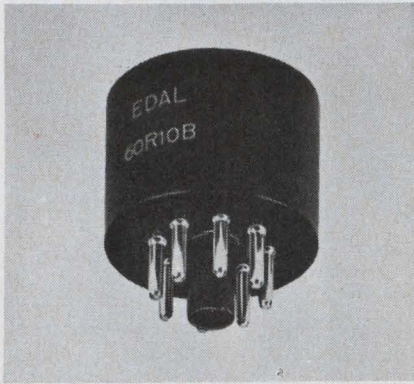

Series R plug-in silicon rectifiers are available in full- and half-wave, doubler, center-tap, open-bridge and three-phase types.

The octal socket devices contain double diffused passivated controlled avalanche junctions in a cold case configuration. Voltage ratings range from 50 to 5,000 V PIV and currents from 100 mA to 6 A.

Edal Industries, Inc., 4 Short Beach Rd., East Haven, Conn. Phone: (203) 467-2591.

Circle No. 284

High-gain amplifier

The TQN-0030 transistor amplifier operates at 30 MHz with a 2-MHz bandwidth and provides a gain of 100 dB min. Actual noise figure is 2.5 dB max and quiescent current drain is 6 V at 1.5 mA. The gain characteristic has a stability of ± 3 dB at an operating range of -25 to $+75^\circ\text{C}$. Input and output both have 50- Ω connectors.

Micro State Electronics Corp., 152 Floral Ave., Murray Hill, N. J. Phone: (201) 464-3000.

Circle No. 285

Another First by Weston-Rotek:
Wideband True RMS To DC Converter



Model PR840

True
RMS to 0.05%
from your DVM

For use with existing DVM's and other precision dc measuring instruments, this unit provides accurate, reliable and automatic true rms measurements of sinusoids, square, triangular and other complex wave forms. It eliminates errors caused by distortion in "average computing" precision voltmeters.

Features: .05% Accuracy 10 volts dc full scale
.01% Repeatability output
30 mv to 1000 volts 7:1 Crest Factor
full scale All Silicon
10 Hz to 100 KHz Guarded and Isolated

Ask for Bulletin 840. Weston Instruments, Inc., Rotek Division, 11 Galen Street, Watertown, Mass. 02172

WESTON[®]

prime source for precision... since 1888

Switching diode

A subminiature high-speed germanium gold alloy junction switching diode is 1/3 the volume of comparable units. The hermetically sealed diode is 0.07-in. in diameter and 0.16-in. in length. Characteristics include a 100-ps reverse recovery time with resistance load of 120 Ω . PIV is 1 V to -25 V at 50 μA . Forward current is over 200 mA at 1 V.

P&A: \$0.85; 2 wks. International Diode Corp., 90 Forrest St., Jersey City, N. J. Phone: (201) 432-7151.

Circle No. 286

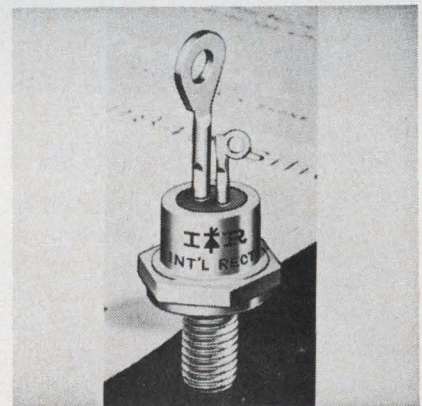

SCRs

Series 22RC of SCRs has PRV ratings from 25 to 700 V (800 V non-repetitive transient rated). Maximum current rating is 22.3 A average, 25 A rms at up to 70 $^\circ\text{C}$ case temperature. Junction temperature capability is 150 $^\circ\text{C}$. The SCRs are packaged in TO-48 cans.

P&A: \$10.80 to \$51 (1 to 9); 2 to 4 wks. International Rectifier, 233 Kansas St., El Segundo, Calif. Phone: (213) 678-6281.

Circle No. 287

RFI/EMI

TEST, MEASUREMENT, ANALYSIS, & CONTROL SERVICES



F&M SYSTEMS CO. can dispatch an RFI/EMI Test Crew to your job-site within 24 hours to provide . . .

- MILITARY SPECIFICATION TESTING
- INTEGRITY MEASUREMENTS OF SHIELDED ENCLOSURES
- RFI/EMI SOURCE LOCATION
- INTEGRITY MEASUREMENTS OF SECURE COMMUNICATIONS SYSTEMS
- GENERAL RFI/EMI CONSULTATION SERVICES



Measurements and analyses over the RF spectrum of 30 cps to 15 gc are accomplished by F&M . . . even under the most undesirable field conditions. Write for F&M Systems' RFI/EMI Services Brochure.



F&M SYSTEMS CO.

■ A DIVISION OF FISCHBACH AND MOORE, INCORPORATED

P. O. BOX 20778 DALLAS, TEXAS 75220

Career opportunities for competent engineers . . . with an equal opportunity employer

ON READER-SERVICE CARD CIRCLE 47

TEST EQUIPMENT



Impulse noise counter

Noise pulses on voice frequency circuits are counted by the 74258-A impulse noise counter. An internal register records all pulses exceeding a pre-set amplitude between 0 and -60 dB. Counting time can be adjusted in steps up to 60 minutes with max count of 9999. All pulses separated by 125 ms or more will record. The instrument operates from dry cells or a dc supply.

Standard Telephones & Cables Ltd., Newport, Monmouthshire, England. Phone: NE: 72281.

Circle No. 288

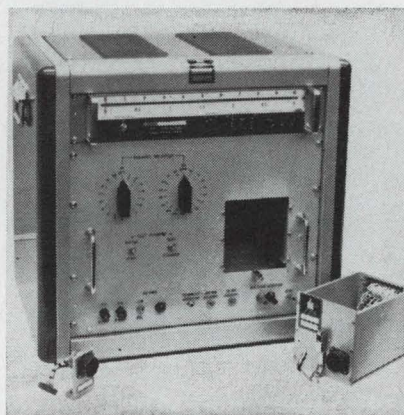

Resistance test set

Model UTS-4 takes low-range dc resistance measurements from 2-terminal or complex multi-position devices. A constant 10 or 100 mA passes through the test resistance and the drop is measured with a high-resistance volt-meter. Constant currents are regulated at $\pm 1\%$ over an ambient temperature range of 60° to 90°F.

Sparton Corp., P.O. Box 1784, Albuquerque, N. M. Phone: (505) 898-1150.

Circle No. 289

ON READER-SERVICE CARD CIRCLE 226 ➤

Quality Product of
SIGMUND COHN CORP.

Platinum Potentiometer Wire Alloy No. 479*

*Trade Mark/Patented

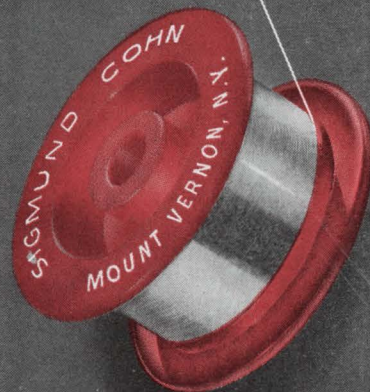

No. 479 Platinum Alloy Wire is manufactured exclusively in the Sigmund Cohn Corp. plant, specifically for low-noise, precision potentiometers . . . This high tensile strength, long-life potentiometer alloy wire contains 92% Platinum, 8% Tungsten . . . It is exceptionally round . . . linear . . . bright . . . strong and corrosion-resistant. Potentiometers wound with it have very low noise limits — shelf life unlimited . . .

SIGMUND COHN CORP.

121 South Columbus Avenue
Mount Vernon, N. Y. 10553



Sigmund Cohn Corp. of California, Burbank, Calif.
Sigmund Cohn-Pyrofuzze, Inc., Dallas, Texas

Need a small 1, 5 or 10 mc crystal oscillator for use in synthesizers, timing systems, counters, communication systems, time-code generators, tape systems, or some other small black box?

Think **TRACOR**®

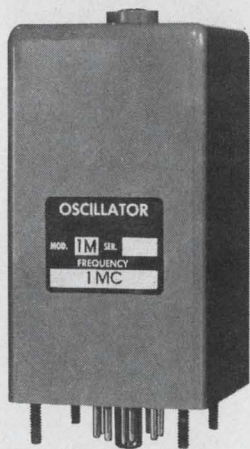

Shown half actual size

TFA 766

Volume 19.1 in.³
That's about the size of it.

For further information:
TRACOR, Inc.
General Sales Office
6500 Tracor Lane
Austin, Texas 78721
Phone: 512-926-2800



**SULZER
DIVISION**

REPRESENTATIVES IN PRINCIPAL CITIES

We are looking for EE's, ME's and Physicists for design consultation or systems development in ASW and undersea problems—experience in penetrations aids—design studies, tests, analysis and reports on electronic and mechanical systems. Your reply strictly confidential.

ON READER-SERVICE CARD CIRCLE 48

TEST EQUIPMENT

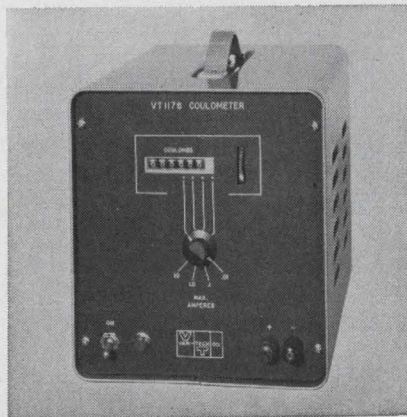

Coulometer

The VT-1176 coulometer incorporates a 6-digit counter with manual reset and a front-panel switch. Any of four scales may be dialed with the last counter digit set to read in 0.01, 0.1, 1.0 or 10 coulombs. Accuracy of 1% ± one digit is not affected by over-ranging up to 250%. The coulometer can be adapted with appropriate transducer to measure any physical parameter which can be converted to a varying voltage.

P&A: \$350; stock. Vari-Tech Co., 546 Leonard St., N.W., Grand Rapids, Mich. Phone: (616) 459-7281.

Circle No. 290

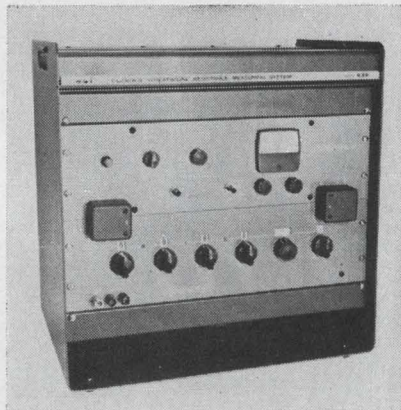

Resistance system

A guarded Wheatstone resistance measuring system, model 232, has ±0.01% accuracy. The 5-dial bridge has 6-place resolution on 11 ranges from 1.2 Ω to 12,000 MΩ full scale. The null-detector has 5-μV sensitivity, 70-dB ac rejection and 5-s overload recovery. The completely guarded generator provides up to 200 V at a variable 0 to 1 W.

P&A: \$1045; stock to 30 days. Electro Scientific Industries, 13900 N.W. Science Park Dr., Portland, Ore. Phone: (503) 646-4141.

Circle No. 291

VECO THINISTORS®

THIN
FILM



THERMISTORS

SUBSTRATE BACKED THINISTORS are available with a standard film thickness of 5 microns on substrates of nickel foil, silicon, barium titanate, beryllium oxide, quartz and commercial alumina.

FREE STANDING THINISTORS have a standard thickness of 20 microns for lead mounting.

LOW HEAT CAPACITY

FAST THERMAL RESPONSE

LARGE SURFACE-TO-MASS RATIO

SENSITIVITY PLUS ACCURACY

STANDARD NEGATIVE TEMPERATURE

COEFFICIENTS OF RESISTANCE

THINISTOR® APPLICATIONS

- Microcircuitry — Micromodule, integrated circuitry and circuit chip techniques. Temperature compensation of semiconductor devices, microminia-ture temperature control, monitoring and telemetry.
- Pulse Circuitry — Fast response and high thermal sensitivity make Thinistors suitable for pulse circuitry and in computer elements such as multipliers, amplifiers, oscillators, flip-flops, triggers, counters and shift registers.
- Gas Chromatography — Low heat capacity of Thinistors permits small volume samples. Rapid response provides detector possibilities previously unobtainable.
- Micro Calorimetry — Thermal energy determinations where minute amounts of heat are involved and low heat capacity and fast, thermal response are essential.
- Vacuum Manometry — High surface-to-mass ratio, low heat capacity and high sensitivity permit extension of thermal conductivity techniques for low pressure gas measurements.
- Medical Electronics — Low heat capacity, rapid response, high dissipation constant and extreme sensitivity for temperature and flow measurements. Clinical thermometers, thermal dilution studies and area skin temperature measurements.
- Infrared Energy Detection — Thinistors permit an intimate bond by sintering the thermistor film directly to its substrate eliminating distortion and attenuation properties of cement normally used in bonding.

Write for Technical Bulletin MFN171

VECO First in Progress • First in Service

J-6904

VECO VICTORY ENGINEERING CORP.

124 Springfield Ave., Springfield, N.J. 07081
Tel: 201 • 379-5900 TWX: 710-983-4430

ON READER-SERVICE CARD CIRCLE 49

ELECTRONIC DESIGN

New standard of performance

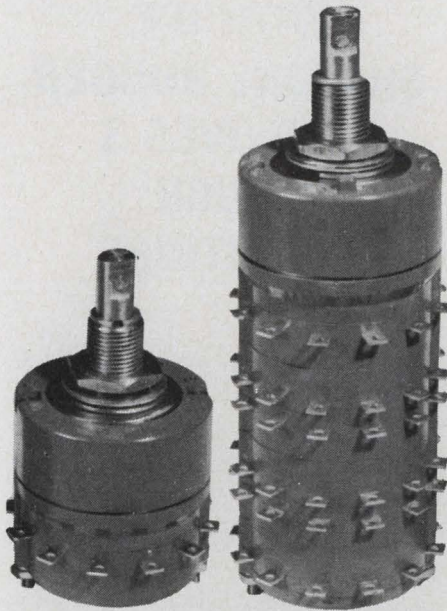

- Contact resistance 0.0015 ohm—change less than 0.001 after life, rotational and salt spray tests
- Low thermal emf
- Space-age performance . . . designed to MIL specs

The low contact resistance means you can even switch microvolts without signal loss. So if you have a problem of switching at low signal levels, this is the answer. There's no other switch in this class.

Low stable contact resistance and long life go side by side in the design. Switch body constructed of diallyl phthalate. Gold-plated terminals. Solid silver alloy brush and contact design. Stainless steel hardware. Unique hex shaft for multiple positioning of brushes.

The switches have long life under difficult conditions of temperature, vibration and shock—100,000 rotations minimum at 125 C. Exceptionally low thermal emf—less than 0.01 microvolt per degree C change in temperature.

They're a smooth-acting series of switches, available in a large number of configurations to meet your exact needs. We build them with 1 to 6 poles, each pole with 12 terminals (11 active, 1 collector). Price: moderate for a switch of this quality.

To learn more about the switches and how to order, write or call Components Division, Leeds & Northrup, North Wales, Pa. 19454. (215) 699-5353.



LEEDS & NORTHRUP
Philadelphia 44 • Pioneers in Precision

ON READER-SERVICE CARD CIRCLE 50

June 7, 1966

Application Notes

Current integration

"Using the Electrometer Voltmeter as a Current Integrating or Charge Measuring Instrument" is a 6-page application note discussing circuit considerations for these measurements. This technique is used in measurements of capacitors, random current pulses, laser energy, ion and electron beams, current integration as a timing device and dosimetry. Circuits and equations involved in these applications are given. Two techniques are described. Keithley Instruments.

Circle No. 292

Af amplifier design

A 12-page application note details design of a 4-output af amplifier. The circuit uses germanium transistors in the push-pull output stage and silicon transistors in the input and driver stages. Complete with schematics, charts and graphs, the bulletin gives power supply data and a modified battery-operated circuit. American Elite Inc.

Circle No. 293

Generator calibration

A 12-page application note 19 describes the IF substitution technique for attenuation measurement as applied to calibration of signal generator controls. Procedures for calibration of cw and pulse-modulated signal generators to accuracies of ± 1 dBm are given. The method of measurement, operation of the manufacturer's substitution receiver, error summation and equipment necessary to perform the measurement in a +10 to -110 dBm range are discussed. PRD Electronics.

Circle No. 294

SCR motor controls

Open-chassis SCR motor controls for OEM applications are described in a 4-page bulletin. Complete specifications, configurations and dimensions are given. Also included are typical performance curves and a list of standard and optional accessories. Gerald K. Heller Co.

Circle No. 295

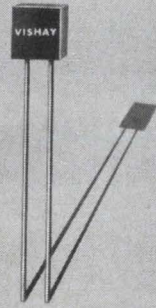

*this is not a
CAPACITOR!*

It is available with all these standard specs:

- 0.01% Tolerance
- 0 ± 1 ppm/°C TC (0° to +60° C.)
- Guaranteed 25 ppm shelf life stability for one year
- Non-measurable noise
- Non-measurable inductance

With these standard specs, it could only be a Vishay Precision Resistor . . . not wire-wound . . . not conventional evaporated metal film . . . but a totally new kind of resistor, with a totally new order of precision!

How it got its unique small size . . . how it delivers its unequalled performance without parameter trade-offs . . . and where it can solve problems for you, are explained in this new, complete DATA CATALOG. Send for your free copy today.

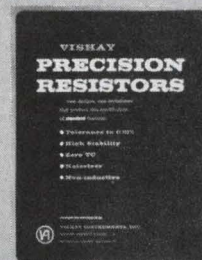

VISHAY RESISTOR PRODUCTS

a division of
Vishay Intertechnology, Inc.
63 Lincoln Highway
Malvern, Pa. 19355

ON READER-SERVICE CARD CIRCLE 51

What is really important when evaluating crystal frequency standards?

How much can you find out from aging-rate data?

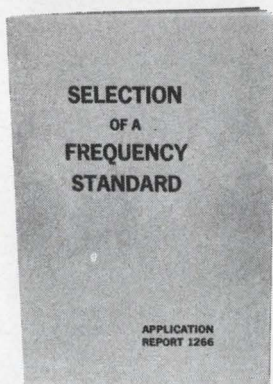

TFA-1166

Two reports will be of special help if you want to know the fine points in evaluating a crystal frequency standard.

One is "Selection of a Frequency Standard", Application Report 1266.

The other is a National Bureau of Standards report on a specific oscillator of this type.

Both are yours via the reader-service card in this magazine — or for faster response write directly to:

TRACOR, Inc.
General Sales Offices
6500 Tracor Lane
Austin, Texas 78721

Phone: 512-926-2800



**SULZER
DIVISION**

® REPRESENTATIVES IN PRINCIPAL CITIES

New Literature

Stator winder

A two-page, two-color bulletin describes the Link-Possis automatic stator winder, model ST-W-4B. Model ST-W-4B winds one to five coils per pole for 2, 4, or 6 pole stators. It winds 2, 3, or 4 poles simultaneously. Possis Machine Corp.

Circle No. 296

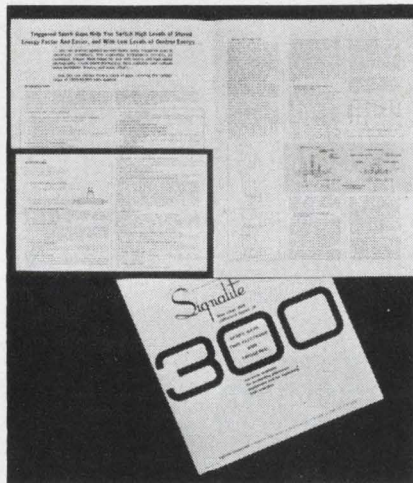

Spark gaps

A 20-page brochure discusses almost 300 types of 2-electrode and triggered spark gaps. Drawings, curves and application notes aid in presenting operation and performance data on both types. Catalog information and mounting methods are given. Signalite Inc.

Circle No. 297

Force transducer

Major features, specifications and typical applications of the "micro-probe" are detailed in a new data sheet. The transducer is fully described as a force probe comprising a rigid mechanical system acting on a pair of semiconductor strain gages. Endeveco Corp.

Circle No. 298

Infrared detector

A 2-page bulletin covers the manufacturer's infrared detector. Test conditions, electrical characteristics, application notes, dimensions and a general description are included. Borg-Warner.

Circle No. 299

HIGH-VOLTAGE CABLE INSULATED WITH G-E SILICONE RUBBER SURVIVES 3 TOUGH CONDITIONS

One, it carries high currents at 7,000 volts rms. in an airborne power supply.

Two, it withstands temperatures that continuously fluctuate between -55°C and 125°C .

Three, it operates at altitudes as high as 70,000 feet.

Of all the cable insulating materials checked by the manufacturer, G-E silicone rubber proved reliable under every condition. Resisting ozone and corona, it extended cable life to at least 1,000 hours.

Saves \$2.00 per unit

By using silicone rubber as both a dielectric and a potting sealant for a standard connector, the manufacturer got a bonus — a void-free, all silicone system with a minimum of labor.

Compared to installation of individual insulating sleeves for connector contacts, cost savings amounted to \$2.00 a unit. And reliability was improved.

FREE NEW DATA BOOK

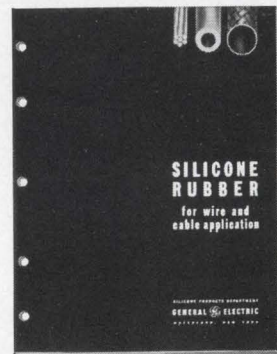

For more ways on how G-E silicone rubber can save money, get Technical Data Book CDS-592, a comprehensive 36-page guide to high performance wire and cable.

Write to Sect. L6204, Silicone Products Dept., General Electric Co., Waterford, N. Y. 12188.

GENERAL  ELECTRIC

ON READER-SERVICE CARD CIRCLE 53
ELECTRONIC DESIGN

Test equipment

A review of scientific and test instruments is the subject of catalog PD-602. The 20-page brochure concentrates on strain gage devices and high-speed strip chart recorders. The catalog encompasses photographs of each unit, as well as drawings, specifications, dimensions and graphs. Baldwin-Lima-Hamilton Corp.

Circle No. 300

Photo-sensitive FET

A 12-page brochure explains the operation of the photo-sensitive FET. Examples of circuits using this FET as a light amplifier and as a switch are provided. Applications described include chopper, modulator, multiplexer, servo, relay, logical and computer uses. Performance data for these and other applications are supplied. Teledyne Inc, Crystalonics Div.

Circle No. 301

Photo choppers

Bulletin PC-118 provides information on ac and dc drive photo choppers. Internal schematics and a typical application of a photo chopper in a modulator circuit are provided. The bulletin includes scope traces of output waveforms and dimensional drawings. Airpax Electronics Inc.

Circle No. 302

Tunnel diode amplifiers

Low noise figure tunnel-diode amplifiers are listed with principal specifications in a short form catalog folder. The two-color brochure lists 68 standard models ranging from 250 MHz to 20 HGz in the uhf, L, S, C, X and K bands. Micro State Electronics.

Circle No. 303

Potentiometer catalog

The 60-page potentiometer catalog P-3 provides detailed engineering information and includes 15 different resistance curves, nomenclature, test methods, attenuator circuits and attenuator calculations. Quick reference charts list seven basic pots from 0.1 to 4 W. Centralab, Div. of Globe-Union Inc.

Circle No. 304

America's Foremost
COMPACT
HIGH VOLTAGE POWER SUPPLIES



Unregulated—Series "S"
Output: 1 KV to 50 KV up to 10 MA DC
input: 115 V, AC—60/400 cycles
From Stock

Regulated—Series "TRHV"
Output: 1 KV to 30 KV up to 5 MA DC
Input: 115 V, AC—60/400 cycles
From Stock

Both Del models represent the ultimate in quality. Their design and manufacture incorporate only the finest materials and workmanship to assure reliable and dependable service.

Other instrumented power supplies available up to 250 KV ratings.

WRITE FOR DATA



Applications

- Missile Ground Support Equipment
- Radar Displays
- Image Intensifiers
- Storage Tubes
- Electron Optical Devices
- Nuclear Applications
- CRT Applications
- Electrostatic Precipitation Equipment

DEL ELECTRONICS CORPORATION

250 E. SANDFORD BLVD., MOUNT VERNON, N.Y. • (914) 699-2000

ON READER-SERVICE CARD CIRCLE 54

AUGAT

Low Cost • High Performance • Wide Application
14 CONTACT DUAL-IN-LINE SOCKET
for testing and packaging Monolithic Circuits

Accepts packages with flat or round leads. Has large contoured entry holes for easy insertion. Gentle wiping action of spring contacts prevent lead damage.

Can be used in panel mount or printed circuit applications. Wire-wrap® termination also available.

Fast, easy, damage-free release of circuit. Unique ejector key, as integral part, speeds up testing programs. Simple extractor tool facilitates handling in close packaging production.

Unit has molded diallyl pythalate body with gold-plated, beryllium copper contacts. Dimensions: .8L x .5W x .37H. 16 and 20 DIL sockets under development.

Write for Data Sheet 166.

® Trade Mark Gardner-Denver Co.

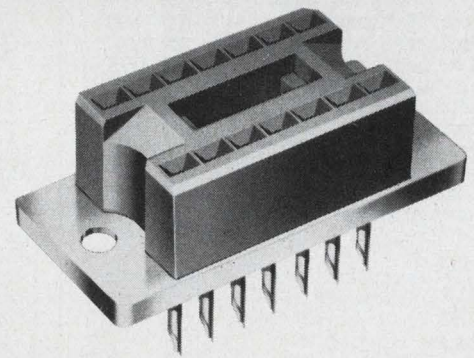

AUGAT inc.

31 PERRY AVE., ATTLEBORO, MASS. 02703

ON READER-SERVICE CARD CIRCLE 55

Fluidics

An explanation of fluidics technology is given in a new 12-page folder. In an applications section, the illustrated pamphlet cites such typical fluidic functions as binary logic, computing, counting, timing, digital switching, amplification, information handling, sensing and other control techniques. A page of symbols for use by designers is also contained.

Devices covered include flip-flops, an OR/NOR gate, an AND gate, single and staged binary counters, proportional amplifiers, a pneumatic timer and fluid resistors. A language section includes 39 definitions of terms, including functions, uses and operating principles of various types of fluid amplifiers. Corning Glass Works.

Circle No. 305

Vibratory systems

"How to Analyze Vibratory Systems" is the title of the 4-page, 2-color design monograph No. 5. Essential information to classify and analyze linear single-degree-of-freedom system vibrations is given. Formulas with definitions, charts and graphs are used. Lord Corp.

Circle No. 306

Subscription Policy

ELECTRONIC DESIGN is circulated free of charge to qualified design engineers in the U.S., Western European Continent and Britain. To establish your qualifications, send ELECTRONIC DESIGN the following information on your company's letterhead: Your name, engineering title, description of your design duties and a list of your company's major products. The letter must be signed by you personally.

Subscription rates for nonqualified subscribers—\$25 a year in the U.S., \$35 in all other countries. Single copy, \$1.50.

Change of Address

An address change for a subscriber requires a restatement of his qualifications. To expedite the change, and to avoid missing any issues, send along a label from a back copy.

Microfilm copies of all 1961, 1962, 1963, 1964 and 1965 issues of ELECTRONIC DESIGN are available through University Microfilms, Inc., 313 N. First Street, Ann Arbor, Mich.

Design Data from

New Continuous Plating Saves 40%!

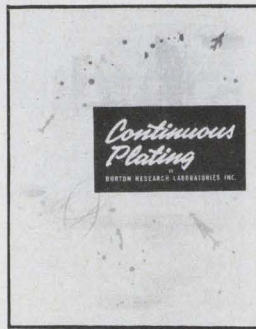

New continuous reel-to-reel precious metal plating (gold, silver, Rhodium, etc.) on strip reduces materials cost up to 40%. Provides extremely accurate depositing to specifications, allows selection of plated area (i.e.: 20 microinches one side, 100 microinches on opposite side).

Process also permits plating of pre-die cut integrated circuits for semi-conductors, etc., and allows forming after plating.

Burton Research Laboratories, Inc.

Division of
Burton Silverplating Co.

171

Reliable Fastener Seals Described

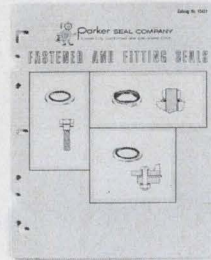

Parker Seal Company's Fastener Seals are well-known for their superior reliability in mechanical sealing. These famed "seal-for-sure" designs are described in a new catalog-handbook containing sizes, dimensions, engineering data, etc. It includes their new Thredseal, an extremely reliable, easy-to-use seal for sealing directly against threads as well as information on Stat-O-Seals, Lock-O-Seals, etc.

Parker Seal Company

10567 Jefferson Blvd.
Culver City, California 90230

173

Rotary Power Tap Switches

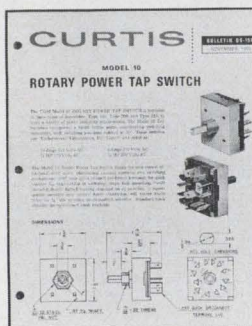

Bulletin DS-158 describes the Model 10 Rotary Power Tap Switches, which are available in three types to meet a variety of switching requirements. The Model 10 Tap Switches incorporate a break before make, non-shortening switching movement, with switching positions indexed at 30°. The switches are "Underwriters' Laboratories, Inc. Listed." The bulletin fully describes these three different types and furnishes all specifications, dimensions, ratings, and prices.

Curtis Development & Mfg. Co.

3236 North 33rd Street
Milwaukee, Wisconsin 53216

175

Manufacturers

Advertisements of booklets, brochures, catalogs and data sheets. To order use Reader-Service Card.

Electronic Design

White Noise Loading Tests Systems

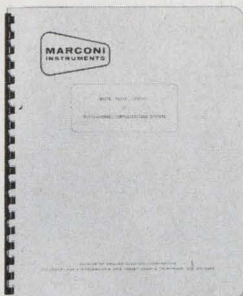

A new paper entitled "White Noise Loading of multi-channel Communications Systems" by W. Oliver is available from Marconi Instruments. Under a number of general headings, the paper deals with Noise Power Ratio measurement, measurement of intermodulation distortion and crosstalk together with other noise and distortion criteria of multi-channel systems.

MARCONI INSTRUMENTS

111 Cedar Lane
Englewood, New Jersey

172

The Multireed Relay



This highly explicit pamphlet provides full technical data on Thermosen's Multireed Relay. The Multireed Type A has 4 to 8 contact groups controlled by a single coil; Type B has up to 3 independent DPDT relays; and Type C has up to 5 SPDT relays. True Form C switching and individual contact adjustment make this unit adaptable in a wide variety of applications. For further information write:

Thermosen, Inc.
375 Fairfield Avenue
Stamford, Conn.

174

Complete Line of Non-Linear Resistors

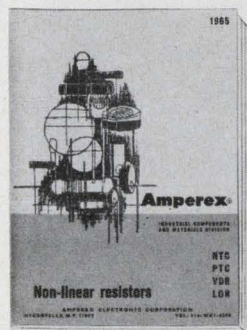

This 110-page engineering guide covers the most complete line of heat-, light-, and voltage-sensitive resistors available today. Prepared by the Components Division of Amperex, the book describes physical principles, measurement techniques and the electrical and mechanical properties of the non-linear resistors in the Amperex line. These fall into four broad categories: negative temperature-coefficient thermistors, positive temperature-coefficient thermistors, voltage-dependent resistors, and light-dependent resistors. Applications data, including circuits and selection criteria, are given for each type.

Amperex Electronic Corporation
Components Division
Hicksville, Long Island, N. Y. 11802

Advertising Representatives

New York 10022
Robert W. Gascoigne
Thomas P. Barth
Samuel M. Deitch
Richard W. Nielson
850 Third Avenue
(212) PLaza 1-5530
TWX: 867-7866

Philadelphia 19066
Fred L. Mowlds, Jr.
P. O. Box 206
Merion Station, Pa.
(215) MO 4-1073

Marblehead 01945
Richard Parker
7 Redstone Lane
(617) 742-0252

Chicago 60611
Thomas P. Kavooras
Berry Conner, Jr.
720 N. Michigan
(312) 337-0588

Cleveland 44107
Robert W. Patrick
8410 Treetower Drive
Chagrin Falls, Ohio
(216) 247-7670

Los Angeles 90303
Stanley I. Ehrenclou
Terrence D. Buckley
W. James Bischof
2930 W. Imperial Highway
Inglewood, Calif.
(213) 757-0183

San Francisco 94306
Ashley P. Hartman
541 Del Medio
Suite #301
Mountain View, Calif.
(415) 327-6536

Southwestern 75206
Tommy L. Wilson
6200 North Central Expressway
Dallas, Tex.
(214) EMerson 1-2311

London W. 1
Brayton C. Nichols
44 Conduit Street

Tokyo
Yoshihiro Takemura
International Planning
Service, Inc.
Room No. 512 Nikkoh
Mita Building
1, Nishidaimachi, Shiba-
Takanawa
Minato-ku, Tokyo



Advertisers' Index

*PARTICIPANTS IN NIGHT LETTER PROGRAM

*AMP, Incorporated	85
Allen-Bradley Co.	9
*Amperex Electronic Corporation	8, 93
Arnold Magnetics Corp.	80
Augat, Inc.	91
Beta Mite Electronic Devices	81
*Bourns, Inc.	15
Burndy Corporation	69
Burton Research Laboratories	92
*Clifton Precision Products, Division of Litton Industries	Cover II
Cohn Corp., Sigmund	87
Conductron Corporation	67
Curtis Development & Mfg. Co.	92
Cutler-Hammer, Inc.	61
*Dale Electronics, Inc.	Cover III
Del Electronics Corp.	91
Deltron, Inc.	51
Dialight Corporation	94
Dynamic System Electronics	68
Electronic Marketing Division, Essex Wire Corporation	80
*Electronic Memories	39
F&M Systems Co.	87
Fairchild Semiconductor, A Division Fairchild Camera and Instrument Corporation	4, 5, 71
*Fluke Mfg. Co., Inc., John	77
General Atronic, Electronic Tube Division	73
General Electric Company, Silicone Products Department	90
General Radio Company	1
Genatape Corporation	82
Globe Industries, Inc.	78
Gore & Associates, W. L.	96
Hayden Book Company, Inc.	52, 74
Hewlett-Packard	83
Industrial Control Company	62
Leeds & Northrup	89
Line Electric Company	63
Littelfuse	62
M-O Valve Co., Ltd.	38
*Magnetics, Inc.	75
Mallory Controls Company	72
Marconi Instruments	93
Micro Instrument Co.	24
*Motorola Semiconductor Products, Inc.	47
Paktron Division, Illinois Tool Works Inc.	74, 76, 78
Parker Seal Company	92
Perfection Mica Company	84
Polaroid Corporation	7
Potter Company, The	70
RCA Electronic Components and Devices	29, Cover IV
*Radiation, Incorporated	25
Raytheon Company, Components Division	23
*Redcor Corporation	2
Robinson Technical Products Inc.	79
Signetics Corporation	32A-B-C-D
Simpson Electric Company	19
*Sonotone Corporation	46
Sorensen Operation, Raytheon Company	16
Sprague Electric Company	10, 20
Syntron Company	6
Syntronic Instruments, Inc.	84
*Systron-Donner Corporation	12
TRW Capacitors	30
Tech Laboratories, Inc.	76
Technical Information Corp.	95
Tektronix, Inc., Oscilloscopes	64
Thermosen, Inc.	93
Tracor, Inc.	88, 90
Transistor Electronics Corporation	32
*Unitrode Corporation	26
Vector Division of United Aircraft Corporation	22
Victory Engineering Corporation	88
Vishay Resistor Products	89
Wakefield Engineering, Inc.	94
Weston Instruments, Inc.	86
Zierick Manufacturing Corp.	80
Regional Advertising	
*Arnold Engineering Company, The	64C
*Brush Instrument Division of Cleveite	64D
*JFD Electronics Corporation	64A
*Leach Corporation	64B
Career Advertising	
AC Electronics	58
Boeing Company, The	59
Computer Control Company Inc.	54
Hughes Aircraft Company	53
McDonnell	57

Subminiature ILLUMINATED PUSH BUTTON SWITCHES and matching Indicator Lights

Switch Form A or B with 3/4" sq. cap

Switch Form C with 1/2" rnd. cap

Matching Indicator with 3/4" rnd. cap

Matching Indicator with 1/2" sq. cap

DIALCO Switches and Indicator Lights provide almost limitless applications—are flexible in arrangement—economical in price—and feature high reliability.

Switches are the silent, momentary type—requiring 24 oz. (approx.) operating force. Contact arrangements are: S.P.S.T., normally open or normally closed; S.P.D.T. two circuit (one normally open, one normally closed). Ratings: 3 amps, 125V A.C.; 3 amps, 30V D.C. (non-inductive). The switch is completely enclosed and independent of the lamp circuit. The light source is the T-1 3/4 incandescent lamp, available in voltages from 1.35 to 28V. Units are made for single hole (keyed) mounting in panels up to 3/16" thick and mount from back of panel in 1/2" clearance hole. Switch forms for dry circuits are also available.

Other features include: 1/2" or 3/4" interchangeable caps, round or square, rotatable or non-rotatable, in a choice of 7 color combinations.

For complete data, request current Catalog.

Illust. approx. 75% actual size

DIALCO®

FOREMOST MANUFACTURER OF PILOT LIGHTS

DIALIGHT CORPORATION

60 STEWART AVENUE, BROOKLYN, N.Y. 11237 212 HYACINTH 7-7600

ON READER-SERVICE CARD CIRCLE 56

INTRODUCING DELTA BOND 152 THERMALLY CONDUCTIVE ADHESIVE

... To be used:

- For bonding thermally, yet isolating electrically, semiconductors to anodized or hard-coated chassis heat sinks.
- As a general adhesive. i.e. fabricating thermal links.
- For bonding when a thermally conductive interface is required.

Being 100% solid adhesive, it is effective on porous and non-porous surfaces. Features ... high thermal conductivity, excellent dielectric strength, a coefficient of thermal expansion similar to Al and Cu, and produces a rigid high strength bond to most materials when cured.

Available in 4 oz. kits or 15 lb. cans ... from authorized WAKEFIELD Electronic Distributors.

Write for BULLETIN 152.

WAKEFIELD
ENGINEERING, INC.



139 FOUNDRY ST. / WAKEFIELD, MASS. (617) 245 5900 • TWX 617 245 9213

ON READER-SERVICE CARD CIRCLE 57

The Standard Reference For Electronic Test Instruments

DIRECTORY OF TECHNICAL SPECIFICATIONS

5

FREQUENCY METERS

upper frequency limit 1 - 15Mc

Photo See Page	MANUFACTURER	MODEL	FREQUENCY					Stability		SENSITIVITY		Interpolation	OUTPUT		Calibration	Operating Power Required	Circuit Type	Connector Type
			Min Mc	Max Mc	Number of Bands	Meas Acc %	Long Term	Short Term	Min @ Freq	Max @ Freq	Main		Aux					
29	MILLEN (A)	90619	350kc	1	1	1.5	N/A	N/A	N/A	N/A	N/A	*	N/A	direct	none	re-		
	SELL-TRONIC	401A	10cps	1	9	ina	ina	ina	100mv	200mv	ina	phone jack	none	direct				
	GENERAL RADIO (A)	1142-A	3cps	1.5	5	*±0.2 full scale	0.2% warm up	0.2% warm up	*20mv rms	*200mv rms	0.64V 4800Hz	*1-5m						
	GENERAL RADIO (A)	1106-A	100kc	2	9	±0.1	ina	ina	15uv	0.1mv								
	MILLEN (A)	90611		1.5	3.5	1	* 1.5	N/A	N/A									
	MEASUREMENTS (A)	59LF		100kc	4.5	4	±2											
	AIRCRAFT RADIO	H-37A	1															
	MILLEN (A)	90625																
	MILLEN (A)	90612																
	TECHNICAL MATERIEL (A)	PMO-5 PMO-6	61															
	MILLEN (A)	90682																
	MILLEN	90605	3															

6
1 - 15Mc

FREQUENCY METERS

Type	Width Inches	MECHANICAL Height Inches	Depth Inches	Weight Pounds	Price Dollars
	2 1/2	3 3/4	1 1/2	1/2	22.50
	3	3 3/4	1 1/2	1/2	249.00
	5 7/8	7 5/8	16	16	525.00
	5 7/8	12	47 3/4	1/2	1050.00
	12 3/4	12 3/4	1/2	1/2	15.00

NOTES
 10. Neon indicator. 16. Dimensions are of contour fitting cover.
 ACCEPTABLE WAVE FORM: pulse square sawtooth, sine, etc.
 DUTY CYCLE: 1% to 100% 2% above 100kc. INPUT IMPEDANCE:
 10kΩ @ 100kc. TRANSISTORIZED.
 1% of reading above 10% of full scale. 7.8. From 20cps-150kc.
 100mv @ 5cps & 1.5Mc. 10. 1ma @ 2.7kc maximum, to 5ma @ 190kc.
 maximum. 15. Back adapter available.
 14. Also transfer oscillator. CALIBRATION: 10kc @ highest frequency; 1kc @ lowest frequency.
 4. Straight line frequency. 16. Dimensions are of contour fitting cover.
 special order. 4. 1 part in whatever range selected.
 100 GRID CURRENT METER: 100ua, 50 divisions.
 100. Dimensions are of contour fitting cover.
 100. 4Mc

- SYMBOLS
- C - Cabinet
 - R - Rack
 - P - Portable
 - ina - information not available
 - N/A - not applicable
 - ccc - cross over counter
 - (A) - This manufacturer has cooperated by checking the accuracy of this compilation prior to final typesetting and printing.
 - * - See NOTES following column numbers.
 - q - Photo of similar instrument appears on page noted.

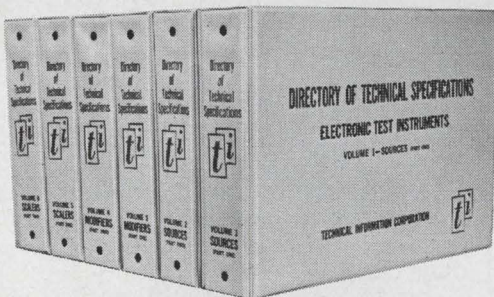

CONVENIENT TABULAR FORMAT PROVIDES QUICK AND EASY MODEL-TO-MODEL COMPARISONS

One look at the specimen pages will show you—better than words—the extent of the information furnished by the DIRECTORY OF TECHNICAL SPECIFICATIONS and the comparative arrangement of the data. These convenient tables are designed for rapid and accurate point-by-point comparison of instruments having similar functional capabilities. By providing a thorough across-the-market analysis, all alternatives can be considered in selecting the right instrument for any application.

SAVE HOURS OF ENGINEERING TIME

The Directory eliminates once and for all the necessity of searching catalogs, sales literature and periodicals to find suppliers, specifications, performance characteristics and prices. It provides in one comprehensive source, arranged and indexed for convenient use, all the information you need to keep completely up-to-date on available instruments, to evaluate competitive products and to select the best instrument at the best price.

NO NEED FOR CATALOG FILES

Keeping and maintaining your own files of manufacturers catalogues, brochures and loose data sheets is completely unnecessary. The DIRECTORY OF TECHNICAL SPECIFICATIONS

gives you all the required data to select and specify electronic test instruments—all in one compact and easy to use reference. No other reference source is as complete or efficiently organized. The six-volume Directory lists approximately 14,000 instruments of more than 500 manufacturers and comprises 46 sections, each covering a different type of instrument.

ALWAYS COMPLETE AND UP-TO-DATE

The constant changes in specifications and performance of electronic test instruments is making it increasingly difficult to keep abreast of the latest developments. The Directory is kept continuously up-to-date by the mailing of section revisions to subscribers at the rate of approximately one each week. The information in the entire Directory is completely revised in less than a year.

AVAILABLE ON FREE 30-DAY TRIAL

The DIRECTORY OF TECHNICAL SPECIFICATIONS may be obtained on a FREE 30-DAY TRIAL BASIS for your examination and use. A one-year subscription includes the six-volume set of 46 sections plus the up-dating service to keep all information complete and current.

PRICE... \$300. per year

For further information write or telephone ...

TECHNICAL INFORMATION CORP.

P. O. Box 514, Smithtown, N. Y. (516 234-0100)



ON READER-SERVICE CARD CIRCLE 225

for people like you...

GORE RIBBON CABLES

solve problems

like this!

CHALLENGE

Carry 140 RG/196/U coaxial cables across a hinge point then along the inner wall of a cabinet in a space only 1/4" deep.

SOLUTION!

Fourteen MULTI-TET[®] ribbon cables were used by Burroughs engineers to solve this packaging problem in their D-825 computer. Each cable contains ten coaxial leads. Besides meeting the space and flexibility requirements, the ribbon cables made lead identification easy and accurate. Since the ribbon cables were self supporting in the short lengths used, the only extra hardware required was a clamp at each end.

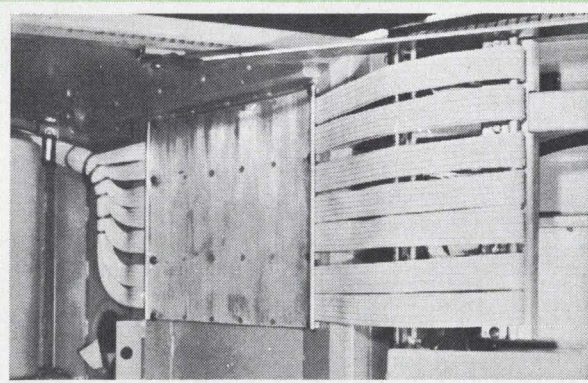

Write for a sample of this MULTI-TET[®] cable and information on other Gore products.

Challenge our cableability with your packaging problem.

W.L. GORE & ASSOCIATES, INC.

555 PAPER MILL ROAD NEWARK, DEL. 19711
PHONE (302) 368-0651 TWX (302) 737-1060

ON READER-SERVICE CARD CIRCLE 59

Designer's Datebook

JUNE						
S	M	T	W	T	F	S
			1	2	3	4
5	6	7	8	9	10	11
12	13	14	15	16	17	18
19	20	21	22	23	24	25
26	27	28	29	30		

JULY						
S	M	T	W	T	F	S
					1	2
3	4	5	6	7	8	9
10	11	12	13	14	15	16
17	18	19	20	21	22	23
24	25	26	27	28	29	30
31						

June 13-14

Filmed Data & Computers Seminar (Boston, Mass.) Sponsor: United States Air Force, Electronic System Div.; Dr. H. L. Kasnitz & G. M. Shannon, MIT Lincoln Lab., Lexington, Mass.

June 15-17

1966 IEEE Communications Conference (Philadelphia, Pa.) Sponsor: IEEE, Philadelphia Section; William H. Forster, Philco Corp., Communication Electronics Div., Philadelphia, Pa.

June 15-17

1966 IEEE Solid-State Device Research Conference (Evanston, Ill.) Sponsor: IEEE; Dr. B. J. Rothlein, National Semiconductor Corp., P. O. Box 443, Danbury, Conn.

June 15-20

XIIIth International Scientific Congress on Electronics (Rome, Italy); Secretariat of the Congress, Via Crescenzo 9, Rome, Italy.

June 21-23

Conference on Precision Electromagnetic Measurements (Boulder, Colo.) Sponsor: Institute for Basic Standards of the National Bureau of Standards; John Cronland, University of Colorado, 328 University Memorial Center, Boulder, Colo.

June 27-29

2nd Annual Conference & Exhibit on "Exploiting the Ocean" (Wash., D. C.) Sponsor: Dr. James H. Wakelin Jr., Scientific Engineering Institute, Waltham, Mass.

July 6-9

Annual Meeting of the National Society of Professional Engineers (Minneapolis, Minnesota) Sponsor: National Society of Professional Engineers; Kenneth E. Trombley, 2029 K Street, N.W., Washington, D.C.

**When it comes
to color-TV
receiving tubes**



**... it's
amazing
what RCA's
"problem-
shrinkers"
can do for
you.**

Take THE CASE OF VERTICAL DEFLECTION. IT WAS A MAJOR PROBLEM—UNTIL THE PROBLEM-SHRINKERS AT RCA DESIGNED THE A40607C. THIS NEW DEVELOPMENTAL BEAM POWER TUBE HAS AN INTEGRAL DIODE, AND WITH ITS RECOMMENDED CIRCUITRY PROVIDES A MINIMUM OF INTERACTION BETWEEN THE HEIGHT AND LINEARITY CONTROLS IN THE VERTICAL DEFLECTION CIRCUIT.

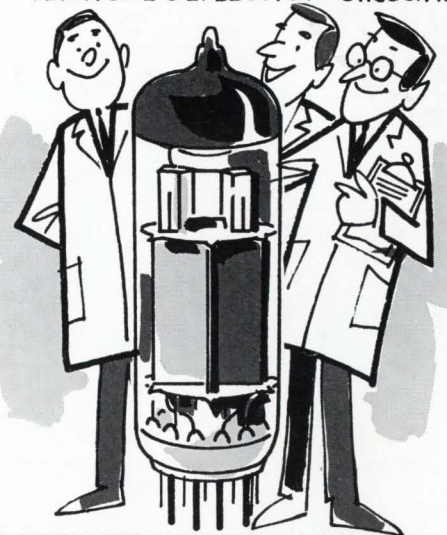

More PROBLEM-SHRINKERS — THE APPLICATION-ASSISTANCE PEOPLE AT RCA — WENT ON TO DEVELOP AND PROVE NEW VERTICAL DEFLECTION CIRCUITS, MADE POSSIBLE BY THE A40607C, FOR BOTH LOW B+ AND HIGH B+ OPERATION.

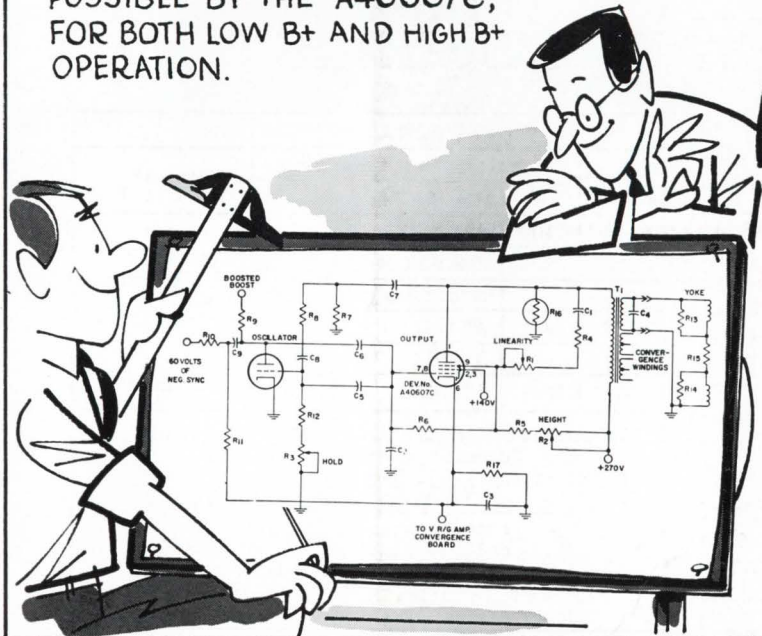

Shrink? THE PROBLEM VIRTUALLY EVAPORATED WITH THE A40607C IN A FEEDBACK-STABILIZED VERTICAL-OUTPUT CIRCUIT DEVELOPED BY RCA APPLICATION ENGINEERS. THIS CIRCUIT CAN DELIVER PERFORMANCE FEATURES NOT FOUND IN CONVENTIONAL CIRCUITS USING MORE COMPONENTS:

- EXCEPTIONALLY GOOD LINEARITY
- TRUE HEIGHT CONTROL (EQUAL EFFECT ON TOP AND BOTTOM OF PICTURE)
- GREATER INDEPENDENCE FROM VARIATIONS IN TUBE CHARACTERISTICS
- OUTPUT STAGE DEVELOPS ITS OWN BIAS
- NO LONG RC TIME DELAY DURING ADJUSTMENT OF HEIGHT AND LINEARITY

Take advantage of RCA's complete package—dependable products and painstaking service—when choosing your color-TV receiving tube components. Get in touch with your nearest RCA District Office or, for technical information on RCA Receiving Tubes, write to RCA Commercial Engineering, Harrison, N. J. 07029.

RCA DISTRICT OFFICES—OEM SALES: EAST, 2075 Millburn Ave., Maplewood, N. J. 07040, (201) 485-3900 • MID-ATLANTIC, 605 Marlton Pike, Haddonfield, N. J. 08034, (609) 428-4802 • MID-CENTRAL, 2511 East 46th St., Bldg. Q2, Atkinson Square, Indianapolis, Ind. 46205, (317) 546-4001 • CENTRAL, 446 East Howard Ave., Des Plaines, Ill. 60018, (312) 827-0033 • WEST, 6363 Sunset Blvd., Hollywood, Cal. 90028, (213) 461-9171 • INTERNATIONAL OPERATIONS, RCA International Division: Central and Terminal Aves., Clark, N. J. 07066, (201) 382-1000 • 118 Rue du Rhone, Geneva, Switzerland, 35 75 00.

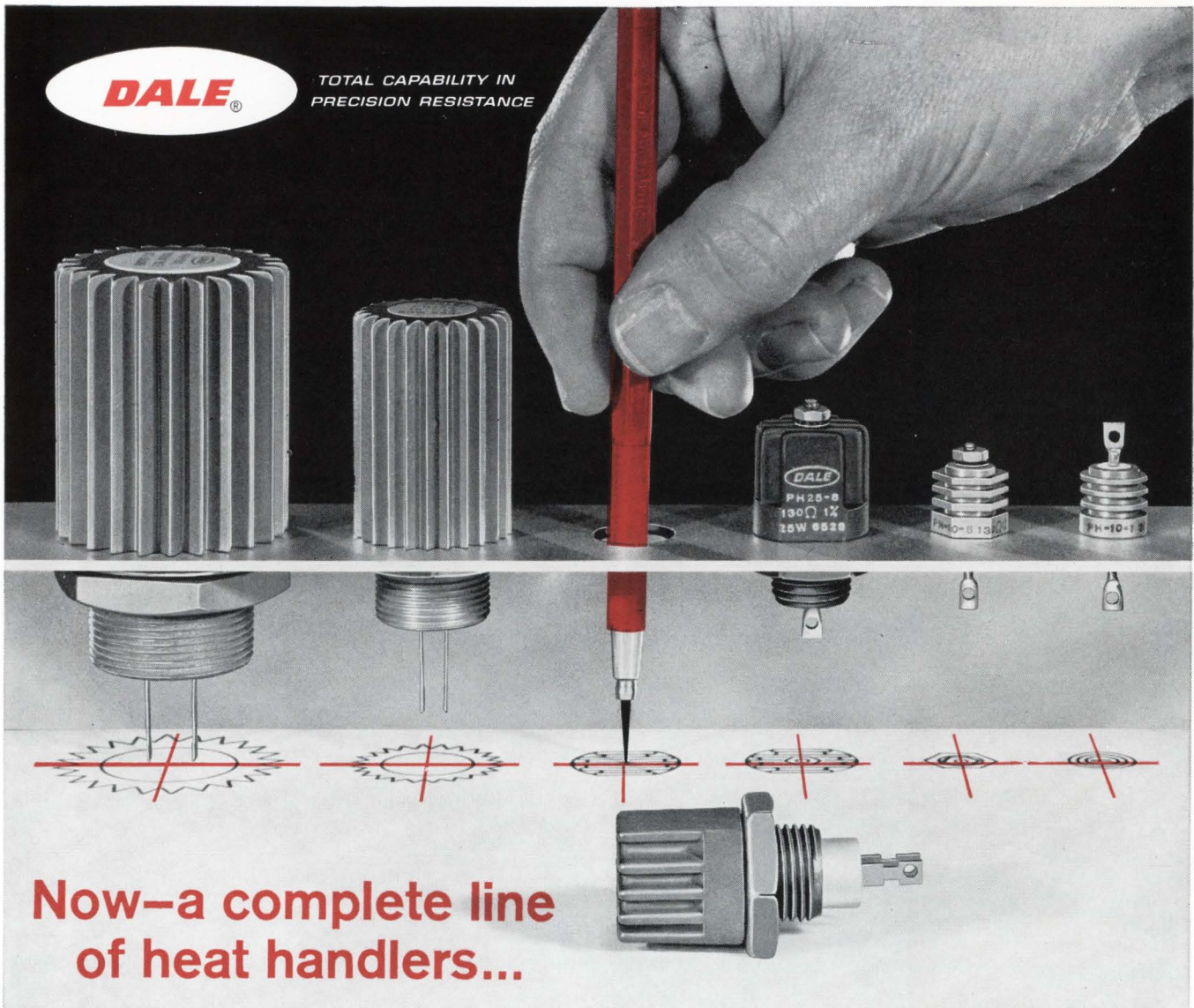

The Most Trusted Name in Electronics

DALETOTAL CAPABILITY IN
PRECISION RESISTANCE

**Now—a complete line
of heat handlers...**

Dale thru-chassis PH wirewounds

When you see design advantages in mounting *through* the chassis—specify Dale PH Housed Precision Wirewounds. They handle more power—up to 100 watts—and give you exceptional stability plus other important design features.

NON-INDUCTIVE/SINGLE TERMINATION

Dale's expanded PH line includes the new PH-10-5 and PH-25-8, both non-inductively wound and designed to ground the housing to the chassis. This combination provides both reduced assembly time and faster cycle time. It makes these PH models extremely valuable in high speed core memory systems where they are used as drive line resistors in modules of up to 256 units.

NAME YOUR SPECIAL

Built to the electrical and environmental requirements of MIL-R-18546, PH Wirewounds can be quickly adapted to your special requirements. Special terminals, resistances, tolerances and matching are only a few of the modifications readily available.

For complete information on thru-chassis and chassis-mounted housed resistors, write for Catalog A or call Dale: 564-3131, Area Code 402.



PH RESISTOR SPECIFICATIONS				
DALE TYPE	DALE RATING WATTS	RESISTANCE RANGES (OHMS)		STANDARD HEAT SINK
		.05%, .1%, .25%	.5%, 1%, 3%	
PH-10-1	10	1 to 12.7K	.1 to 47.1K	4x6x2x.040 aluminum chassis
PH-10-5	10	.5 to 6.3K	.1 to 23.5K	4x6x2x.040 aluminum chassis
PH-25	25	.5 to 25.7K	.1 to 95.2K	5x7x2x.040 aluminum chassis
PH-25-8	25	.25 to 12.8K	.1 to 47.7K	5x7x2x.040 aluminum chassis
PH-50	50	3 to 52K	.1 to 75K	12x12x.125 aluminum panel
PH-100	100	5 to 35K	.1 to 50K	12x12x.125 aluminum panel

Temperature Coefficient: ±50 PPM, ±30 PPM, ±20 PPM, depending on value and tolerance
Operating Temperature: -55° C to + 275° C
Construction: Extruded aluminum housing with steatite or alumina core and tinned copperweld or 180 alloy terminals, depending on physical size. Covered by U.S. Patents.
*Power Rating based on 275°C max. internal hotspot temperature with resistor mounted on standard heat sink.

DALE ELECTRONICS, INC.

 1328 28th Avenue, Columbus, Nebraska
 In Canada: Dale Electronics, Canada, Ltd.

 Speed Inquiry to Advertiser via Collect Night Letter
 ON READER-SERVICE CARD CIRCLE 103