



MASERATI

*Ghibli*



Owner's manual





**WARNING:**

Operating, servicing and maintaining a passenger vehicle or off-road vehicle can expose you to chemicals including engine exhaust, carbon monoxide, phthalates, and lead, which are known to the State of California to cause cancer and birth defects or other reproductive harm. To minimize exposure, avoid breathing exhaust, do not idle the engine except as necessary, service your vehicle in a well-ventilated area and wear gloves or wash your hands frequently when servicing your vehicle.

For more information go to: [www.P65Warnings.ca.gov/passenger-vehicle](http://www.P65Warnings.ca.gov/passenger-vehicle).





MASERATI

**Ghibli**

**Owner's Manual**





Dear Customer,

Thank you for choosing a Maserati.

This vehicle represents the result of Maserati's great experience in the design and production of sports, touring and racing vehicles.

With this manual you will acquaint yourself with the equipment and options of your Maserati in order to take advantage of its full potential.

Before driving your vehicle for the first time, we suggest reading the printed Quick Guide carefully in order to quickly acquaint with commands and functions of your vehicle. You can consult this Owner's Manual and the Maserati Touch Control Plus guide directly from the dashboard touchscreen display of your vehicle.

The updated version of the onboard documentation can be consulted by accessing the section "Services" on the website [www.maserati.com](http://www.maserati.com).

In a dedicated section of this manual you will also find instructions for basic maintenance procedures, in order to ensure steady levels of performance, quality and safe driving.

Keep in mind that proper maintenance is an essential factor to help preserve the value of the vehicle over time and protect the environment.

For "Scheduled Maintenance" or any other operation, contact your **Authorized Maserati Dealer**: you can trust our trained technical staff, who is constantly updated and provided with the required equipment in order to ensure that all service operations are performed properly and reliably.

The Quick guide and other documents contained in onboard documentation kit are integral part of the vehicle and should always be kept on board.

You can purchase a printed copy of the documents visible on dashboard touchscreen display at your dealer of your **Authorized Maserati Dealer**.





**WARNING!**

**CALIFORNIA proposition 65.**

Operating, servicing and maintaining a passenger vehicle or off-road vehicle can expose you to chemicals including such as, engine exhaust, carbon monoxide, phthalates and lead, that which are known to the State of California to cause cancer and birth defects or other reproductive harm. To minimize exposure, avoid breathing exhaust, do not idle the engine except as necessary, service your vehicle in a well-ventilated area and wear gloves or wash your hands frequently when servicing your vehicle. For more information go to: [www.P65Warnings.ca.gov/passenger-vehicle](http://www.P65Warnings.ca.gov/passenger-vehicle)









Introduction	1
Before Starting	2
Understanding the Vehicle	3
Dashboard Instruments and Controls	4
Driving	5
In an Emergency	6
Maintenance and Care	7
Features and Specifications	8
Index	9







## **1 – Introduction**

Consulting the Manual .....	8
Abbreviations .....	8
Updating .....	9
Service and Warranty .....	10
Suggestions for Obtaining Service for Your Vehicle .....	10
If You Need Assistance .....	11
Warranty Information .....	12
Reporting Safety Defects .....	12
Parts Service .....	13
Aftermarket Parts & Accessories Statement .....	13
Symbols .....	14
Warnings when Driving .....	15
Maserati Roadside Assistance Program (available for USA and Canada only) .....	16
Vehicle Identification Data .....	18





1

## Consulting the Manual

For an easy identification of the topics, this Manual is divided into sections and chapters: each chapter can have more paragraphs.

Within the text, important warnings and notes are also easily identifiable through icons.



### WARNING!

**California Proposition 65**  
**Operating, servicing and maintaining a passenger vehicle or off-road vehicle can expose you to chemicals including such as, engine exhaust, carbon monoxide, phthalates and lead, that which are known to the State of California to cause cancer and birth defects or other reproductive harm. To minimize exposure, avoid breathing exhaust, do not idle the engine except as necessary, service your vehicle in a well-ventilated area and wear gloves or wash your hands frequently when servicing your vehicle. For more information go to:**  
**[www.P65Warnings.ca.gov/passenger-vehicle](http://www.P65Warnings.ca.gov/passenger-vehicle)**



### WARNING!

**Failure to comply with the instructions could cause HAZARDOUS SITUATIONS involving personal and vehicle safety.**



### ENVIRONMENTAL!

**This note indicates the correct behavior when using the vehicle to protect the environment.**



### CAUTION!

**Aimed at preventing any damage to the vehicle and thus hazards involving the safety of persons.**

### NOTE:

*Additional information regarding the subject and/or the operation described.*

- “Left” and “right” in this manual, always refer to the driving direction.
- All indications and images in this Manual refer to a vehicle with left-hand drive. On right-hand drive vehicles, some controls are ordered differently than shown in the illustrations.

## Abbreviations

Some descriptions and terms with particular meanings are found in this manual in abbreviated form.

A/C	Air-Conditioning system.
ABA	Advanced Brake Assist.
ABS	Anti-Lock Braking System.
ABSA	Active Blind Spot Assist.
ACC	Adaptive Cruise Control.
ADAS	Advanced Driver Assistance Systems.
ALR	Automatic Locking Retractor.
AQS	Air Quality Sensor.
ATC	Automatic Temperature Control.
AWD	All-Wheel Drive.
BAS	Brake Assist System.
BSA	Blind Spot Assist.
BTO	Brake Throttle Override.
CAN	Controller Area Network.
CC	Cruise Control.
CRS	Child Restraint System.
DRL	Daytime Running Lights.
EBD	Electronic Brake-force Distribution.



<b>ECU</b>	Electronic Control Unit.	<b>RCP</b>	Rear Cross Path.
<b>EDR</b>	Event Data Recorder.	<b>RKE</b>	Remote Keyless Entry.
<b>EPB</b>	Electric Parking Brake.	<b>SAB</b>	Side Air Bag.
<b>ESC</b>	Electronic Stability Control.	<b>SABIC</b>	Supplemental Side Air Bag Inflatable Curtains.
<b>ETC</b>	Electronic Throttle Control.	<b>SBR</b>	Seat Belt Reminder.
<b>FCW</b>	Forward Collision Warning.	<b>SRS</b>	Supplemental Restraint System.
<b>HAS</b>	Highway Assist.	<b>TCS</b>	Traction Control System.
<b>HSA</b>	Hill Start Assist.	<b>TFT</b>	Thin Film Transistor.
<b>HBA</b>	Hydraulic Brake Assistance.	<b>TPMS</b>	Tire Pressure Monitoring System.
<b>I.C.E.</b>	Increased Control and Efficiency.	<b>TSA</b>	Traffic Sign Assist.
<b>LATCH</b>	Lower Anchors and Tether for Children.	<b>VIN</b>	Vehicle Identification Number.
<b>LDW</b>	Lane Departure Warning (LaneSense).		
<b>LKA</b>	Lane Keeping Assist.		
<b>MIL</b>	Malfunction Indicator Light.		
<b>MTC+</b>	Maserati Touch Control Plus.		
<b>OBD</b>	On Board Diagnostics.		
<b>ORC</b>	Occupant Restraint Controller.		
<b>PDC</b>	Park Distance Control.		
<b>PEB</b>	Pedestrian Emergency Braking.		
<b>RAB</b>	Ready Alert Braking.		



## Updating

Constant improvements are being performed to maintain this vehicle's high level of quality. Therefore, there may be differences between this manual and your vehicle.

Maserati reserves the right to carry out design and functional changes and to provide updates or improvements.

This Owner's Manual illustrates and describes all versions of the current vehicle model. Therefore, some of the equipment and accessories in this publication may not appear on your vehicle; please only consider the information related to your vehicle. All specifications and illustrations contained in this manual are as of the Manual publishing date.

### **NOTE:**

*The updated version of the on-board documentation can be consulted by accessing the section "Services" on the website [www.maserati.com](http://www.maserati.com).*



### 1 Service and Warranty

The information provided in this manual is limited to instructions and indications that are strictly required for vehicle use and proper maintenance.

By following these instructions carefully, the vehicle will meet the owner's satisfaction and best results. We advise to have all service and inspections completed only by an **Authorized Maserati Dealer**, where you will find a specially trained staff and the proper equipment to repair your vehicle.

Please visit the [www.maserati.com](http://www.maserati.com) to find the nearest **Authorized Maserati Dealer**.

All features and accessories installed on the vehicle have been designed by Maserati engineers and have successfully passed rigorous tests, submitted in all conditions of use.

Installing aftermarket components or accessories not approved by Maserati may interfere with the vehicle electronics and compromise driving safety and possibly voiding the warranty coverage.

Nor do the warranties cover the costs of repairing damage or conditions caused by any changes to your vehicle

that do not comply with Maserati's specifications.

An **Authorized Maserati Dealer** is at your complete disposal for any information and questions you may have.

### Suggestions for Obtaining Service for Your Vehicle

#### **Prepare for the Appointment**

If warranty work is required, be sure to have the right papers with you and take your warranty folder. Not all work being performed may be covered by the warranty; therefore discuss additional charges with the service manager. It is advisable to keep a maintenance log of your vehicle's service history, as this can often provide a clue to the current problem.

#### **Prepare a List**

Make a written list of your vehicle's problems or the specific work you wish to be performed. If the vehicle has had an accident or work done that is not indicated on the maintenance log, please communicate this to the service advisor.

#### **Optimize the Requests**

If there are a number of items needing attention, it is advisable to discuss this with your service advisor to agree on the order of priorities.

At many **Authorized Dealers/Service Centers**, it is possible to obtain a loaner vehicle or a rental vehicle at a





minimal daily charge. If you need a rental vehicle, it is advisable to make these arrangements prior to the visit, for example when you call to set the appointment.

## If You Need Assistance

The manufacturer/Maserati and its Authorized Dealers/Service Network set highest priority to the client's satisfaction with the products and services.

Warranty service must be performed by an **Authorized Maserati Dealer/Service Center**.

Should there be any issues, please keep in mind that most matters can be resolved with the following process.

- If for some reason you are still not satisfied, please contact the general manager or owner of the Service Center, it is their responsibility to assist you.
- If a Service Center is unable to resolve the issue, you may contact **Maserati Customer Center**.

Any communication to the **Maserati Consumer Affairs** should include the following information:

- Owner's name and address.
- Owner's telephone number (home and office).
- Maserati Service Center name.
- Vehicle Identification Number (VIN).
- Vehicle delivery date and mileage.

DEALER ePROCESS

Contact:

**MASERATI North America, Inc.**

One Chrysler Drive

Auburn Hills,

MI 48326

Phone:

**Maserati Customer Care**

1-877-MY-MASERATI (877-696-2737) or

1-201-510-2369



### Warranty Information

Please refer to the Warranty booklet, included in the Owner's documentation kit, for the terms and provisions of Maserati warranties applicable to this vehicle and market.

### Reporting Safety Defects

#### NHTSA's Toll-free Auto Safety Hotline

If you believe that your vehicle has a defect which could cause a crash, injury or death, immediately inform the National Highway Traffic Safety Administration (NHTSA) in addition to notifying Maserati North America, Inc. If NHTSA receives similar complaints, it may open an investigation, and if it finds that a safety defect exists in a group of vehicles, it may order a recall and remedy campaign. However, NHTSA cannot become involved in individual problems between you, your dealer, or Maserati North America, Inc. To contact NHTSA, you may call the Vehicle Safety Hotline toll-free at 1-888-327-4236 (TTY: 1-800-424-9153), go to <http://www.nhtsa.gov/parents-and-caregivers>; or write to: Administrator, NHTSA, Washington, D.C. 20590. You can also obtain other information about motor vehicle safety from <http://www.nhtsa.gov/parents-and-caregivers>.

#### Reporting safety defects in Canada

If you believe your vehicle has a defect that could cause a crash or could cause injury or death, you should

immediately inform Transport Canada in addition to notifying Maserati North America, Inc.

#### *Transport Canada can be contacted at:*

1-800-333-0510

Teletypewriter (TTY): 613 990-4500

Fax: 1-819-994-3372

Mailing Address: Transport Canada - Road Safety, 80 rue Noël, Gatineau, (Quebec) J8Z 0A1.

#### In Canada

If you believe that your vehicle has a safety defect, contact the Customer Service Department immediately. Canadian customers who wish to report a safety defect to the Canadian government should contact Transport Canada, Motor Vehicle Defect Investigations and Recalls at 1-800-333-0510 or go to <http://www.tc.gc.ca/roadsafety/>





distributed by Maserati North America, Inc.

## Parts Service

---

Genuine Maserati parts keep the reliability, comfort and performance of your new car unchanged throughout its life.

For service and scheduled maintenance Maserati suggests you to ask for genuine parts since they are the result of constant research and development, reliability test and new technologies, as well as they are specifically designed for this vehicle.

## Aftermarket Parts & Accessories Statement

---

Modification of the vehicle or installation of any accessory or components attached to the vehicle which alters the original engineering and/or vehicle operating specifications, or which result in damage to the other original components, electrical interference, electrical short(s), radio static, water leaks and wind noise may result in damage to genuine components, compromise the safety of the vehicle and affect the validity of the new car warranty on the vehicle.

### Non-genuine Maserati Parts

Non-genuine Maserati Parts (while you may elect to use non-genuine Maserati parts for maintenance or repair services), Maserati North America, Inc. is not obligated to pay for repairs that include non-genuine Maserati parts or for any damage resulting from the use of non-genuine parts.

Maserati will not accept any liability for any parts and accessories not approved by Maserati, including Dealer-installed accessories not

**DEALER ePROCESS**



1

## Symbols

There are specific colored plates on or near some of the components on your Maserati designed to attract user's attention. Important warnings concerning all specific devices that the user must consider, are reported on the internal hood cover central label (see "Vehicle Identification Data" in this section).

All symbols reported on the plate and inside the vehicle, as well as the component for which the symbols stand, are summarized in the following list. These symbols are divided into categories according to their meaning.

### Danger Symbols



**Battery**  
Corrosive liquid.



**Battery**  
Explosion.



**Blower**  
May start automatically even with engine off.



**Coolant expansion reservoir**  
Do not open cap with engine warm.



**Coil - headlights**  
High voltage.



**Belts and pulleys**  
Moving parts, keep body and clothing clear.



**Air-conditioning lines**  
High pressure gas, do not open.

### Symbols of Prohibitions and Compulsory Measures



**Battery**  
Keep away from flames.



**Battery**  
Keep out of children's reach.



**Heat guards - belts - pulleys - fans**  
Do not touch.



**Battery**  
Wear eye protection.



**Battery - jack**  
Refer to the owner manual.



### WARNING!

**California Proposition 65**  
Operating, servicing and maintaining a passenger vehicle or off-road vehicle can expose you to chemicals including such as, engine exhaust, carbon monoxide, phthalates and lead, that which are known to the State of California to cause cancer and birth defects or other reproductive harm. To minimize exposure, avoid breathing exhaust, do not idle the engine except as necessary, service your vehicle in a well-ventilated area and wear gloves or wash your hands frequently when servicing your vehicle. For more information go to: [www.P65Warnings.ca.gov/passenger-vehicle](http://www.P65Warnings.ca.gov/passenger-vehicle)





## Warning Symbols



### **Engine - Engine Oil Filler Cap**

Engine oil. We recommend using an oil with the characteristics indicated in chapter "Refillings" in section "Features and Specifications".



### **Brake fluid reservoir**

Brake fluid type DOT 4. Do not exceed max. level. We recommend using a fluid with the characteristics indicated in chapter "Refillings" in section "Features and Specifications".



### **Radiator coolant expansion reservoir**

Use antifreeze liquid for radiators. We recommend using a liquid with the characteristics indicated in chapter "Refillings" in section "Features and Specifications".



### **Windshield washer fluid reservoir**

Windshield washer. We recommend using a liquid with the characteristics indicated in chapter "Refillings" in section "Features and Specifications".



### **WARNING!**

**California Proposition 65  
Operating, servicing and maintaining a passenger vehicle or off-road vehicle can expose you to chemicals including such as, engine exhaust, carbon monoxide, phthalates and lead, that which are known to the State of California to cause cancer and birth defects or other reproductive harm. To minimize exposure, avoid breathing exhaust, do not idle the engine except as necessary, service your vehicle in a well-ventilated area and wear gloves or wash your hands frequently when servicing your vehicle. For more information go to:**

**[www.P65Warnings.ca.gov/passenger-vehicle](http://www.P65Warnings.ca.gov/passenger-vehicle)**

**DEP**  
DEALER ePROCESS

## Warnings when Driving

Always comply with local traffic regulations wherever you drive. Failure to operate this vehicle correctly may result in loss of control or a collision.

Operating this vehicle at excessive speed or in an altered state or while intoxicated may result in loss of control, going off the road, or overturning. In all these situations a collision with other vehicles or objects is more likely to happen with the risk to cause an accident that may lead to serious injury.

In case of an accident, failure to use seat belts causes the driver and passengers a greater risk of injury or death. Use your seat belt at all times. This Owner's Manual contains warnings against operating procedures that could result in a collision or injury or damage to the environment. It also contains cautions against procedures that could damage the vehicle.

If you do not read this manual in its entirety, you may miss important information. Consider carefully all warnings and cautions.



1



## WARNING!

- It is the driver's responsibility to operate the vehicle in a safe way: if you are distracted while driving you can lose control and cause serious accidents.
- Maserati strongly recommends you use particular care when operating the features and tools that may distract you.
- Mobile phones, PC, portable audio device or other features operated while the vehicle is moving can be very dangerous and can cause serious accidents, and in some states is against the law.
- It is very dangerous to send text messages while driving; do so only when the vehicle is not moving.
- In some Countries/States the use of mobile phones when driving is forbidden: it is the driver's sole responsibility to respect local regulations.



## CAUTION!

If battery charge is too low, proper function of some electric/electronic components may not be guaranteed. It

is necessary to recharge the battery in order to allow all vehicle's components and systems to function correctly.

## Maserati Roadside Assistance Program (available for USA and Canada only)

Welcome to Maserati and the benefits and security of the Maserati Roadside Assistance Program. Please take a moment to review the benefits listed below and available to you through the Maserati Roadside Assistance Program.

### Emergency Roadside Services

In the event you require Roadside Assistance, please call 1-888-371-1802, 24 hours a day, 365 days a year. You will be connected with a Roadside Assistance representative who will dispatch a local towing vendor.

### Information needed for when you call

When you call, please be prepared to provide the following information:

- Your Name.
- Vehicle Identification Number (VIN).
- Location of your vehicle.
- Nature of your call (for example; you require a tow, vehicle will not start, out of gas, tire service, etc.).





## Summary of Program Benefits and Services

- Towing of a disabled registered Maserati vehicle. In the event a registered vehicle becomes disabled in connection to a warranty related concern it will be transported to the nearest **Authorized Maserati Dealership**. You may request that the vehicle be taken to a different **Authorized Maserati Dealer**, as long as it is no more than 50 miles further away from the nearest authorized dealer (one tow per disablement).
- Battery jump start.
- Flat tire change providing the vehicle is equipped with a spare tire.
- Fuel delivery (up to 2 gallons).
- Lockout Services.
- Service Loaner Vehicle: For warranty repairs, your dealer may provide you with a Maserati Service Loaner Vehicle (if available) or provide you with Rental Car allowance: in the event your vehicle is disabled due to a warranty related concern, we will reimburse you up to \$50 per day. A five (5) day or \$250 maximum applies. In order to receive reimbursement, you must supply the following information within 20

days of the rental car transaction to the address listed below; the original pre-printed rental car receipt, which must include your name, address, telephone number, VIN, rental dates and the corresponding warranty repair order.

Maserati Roadside Assistance ATTN:  
Maserati Rental Car Claims Dept.  
P.O. Box 8140 Ft.  
Washington, PA 19034

### **NOTE:**

*An authorized licensed driver must be driving at the time of the disablement.*

Items excluded from coverage:

- Parts, labor, tire repair, rental of towing equipment, storage fees, or any labor performed at the service facility.
- Any form of impound towing, or towing by someone other than a licensed service station or garage.
- Assistance from a private citizen.

### **NOTE:**

*Membership is intended to cover emergencies and is not intended to be a substitute for proper vehicle maintenance or repair. Repeated calls which are considered by Maserati North America, Inc. Signature Motor Club, Inc. or Signature Motor Club of California, Inc. to be excessive may, at our discretion, result in cancellation of the membership.*

Emergency road service providers are independent contractors and are not employees, agents or representatives of Maserati North America, Inc. Signature Motor Club, Inc. or Signature Motor Club of California, Inc.

### **Under this Agreement**

- You will not be required to pay any sum for services up to the mileage limit on towing.
- Your registered Maserati vehicle is the vehicle covered. The Vehicle Identification Number (VIN) that appears on the vehicle represents your identification number with Signature Motor Club, Inc. or Signature Motor Club of California, Inc.





- **NEW VEHICLES:** Your membership begins on the date the Registered Vehicle was originally sold (in service date) and continues until the expiration date of the New Car Limited Warranty or unless terminated by Maserati North America, Inc. for cause.
- **PRE OWNED VEHICLES:** Your membership begins on the date the registered vehicle was sold (in service date) and continues until the expiration date of the Maserati Certified Pre-Owned Limited Warranty or unless terminated by Maserati North America, Inc for cause.

### Address Inquiries to

#### **General Inquiries:**

Maserati Roadside Assistance  
P.O. Box 968008  
Schaumburg, IL 60173

#### **Rental Car Reimbursements:**

Within 20 days of your rental car transaction, the original pre-printed rental car receipt, which must include your name, address, telephone number, VIN, rental dates and the corresponding warranty repair order should be submitted to:

Maserati Roadside Assistance ATTN:  
Maserati Rental Car Claims Dept.  
P.O. Box 8140  
Ft. Washington, PA 19034

## Vehicle Identification Data

### Vehicle Identification Number

The vehicle's identification number (VIN) is punched on the foot platform, in front of the right-hand front seat.

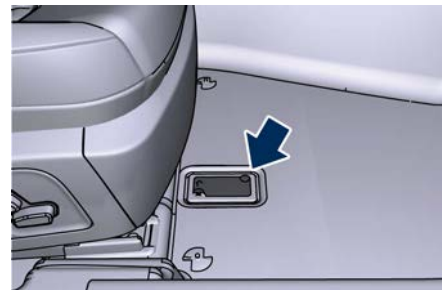

To read the number, lift the mat and rotate the guard.

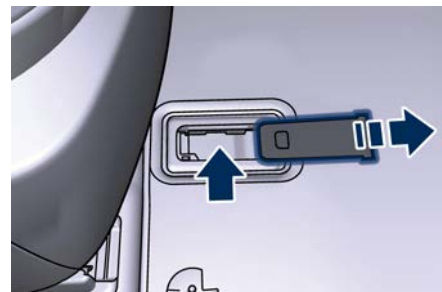

The VIN Number is also visible from the outside through the windshield on the front left corner of the dashboard.



**NOTE:**

*When ordering spare parts or making inquiries, always quote the vehicle identification number.*

## Warning and Identification Labels

### Overview label with cautions and warning notes

The centrally attached label placed inside the engine hood cover displays cautions, warnings, and symbols. For further information refer to "Symbols" in this section.



### Vehicle Emission Control Information (VECI) Label

The label is applied on the lower right side of the hood.



### California Proposition 65 Warning Label

The labels are applied on the upper left corner of the windshield and in the engine compartment on the left headlight crossbar.

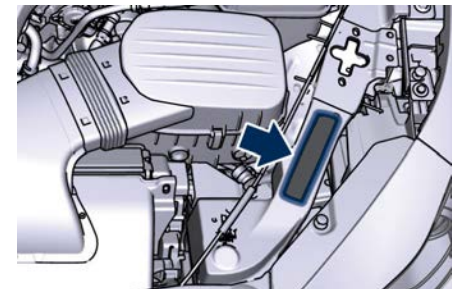
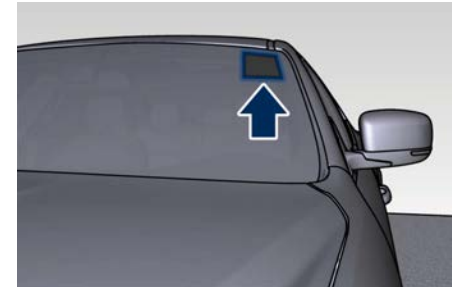



1

## Passenger Air bag Labels

The labels are applied on the external side of sun visors and behind it, on the dome.

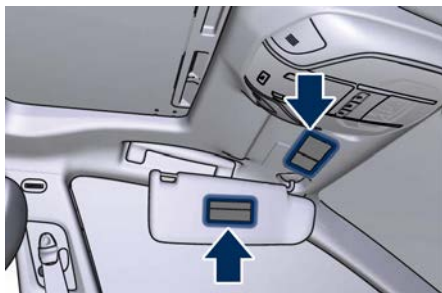
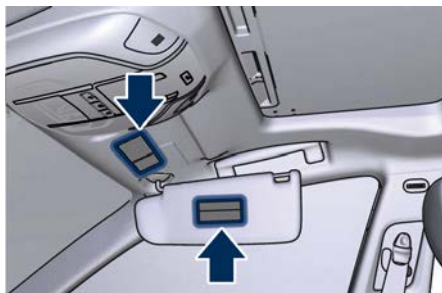

Another label is applied on the dashboard to indicate that air bag system is installed.



## Loading Information Label

This label applied on the driver's side rear door pillar attests the compliance with safety standards.



## Tire Information Label

This paper label is applied on the driver's side rear door pillar.



### NOTE:

For further informations see "Tire Safety Information" in section "Driving".

## Paint Identification Label

The label is applied on the lower left side of the hood.







## Fuel Warning Label

The label is applied inside the fuel filler door.

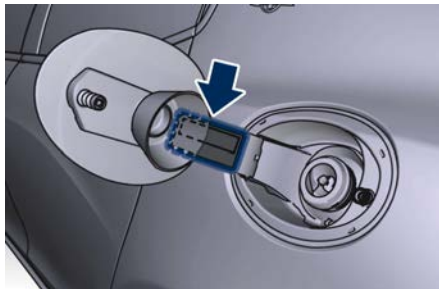

### **NOTE:**

*To ensure optimum performance and fuel economy, please ensure to refill your vehicle using Premium Unleaded Fuel ONLY, with a minimum of 91 AKI.*





## 2 – Before Starting

Keys . . . . .	24
Sentry Key Immobilizer System . . . . .	26
Vehicle Security Alarm . . . . .	27
Illuminated Entry/Exit . . . . .	30
Unlock the Vehicle with Key fob . . . . .	33
Requiring and Setting Additional Key fobs . . . . .	34
Remote Start System . . . . .	36
Doors Locking . . . . .	39
Passive Entry System . . . . .	41
Power Windows . . . . .	45
Rear Window . . . . .	47
Trunk Lid Operation . . . . .	49
Trunk Safety . . . . .	54
Hood Operation . . . . .	54
Occupants Restraint Systems . . . . .	55
Supplemental Restraint System (SRS) — Air Bags . . . . .	64
Child Restraint Systems . . . . .	72
Transporting Pets . . . . .	78
Rear Parking Camera . . . . .	78
Surround View Camera System (optional) . . . . .	80
Safety Tips . . . . .	82
Park Assist (if equipped) . . . . .	85





## Keys

The vehicle is equipped with a Remote Keyless Entry transmitter and a Keyless Ignition Node, to enter, start and protect the vehicle.

2



### Keyless Ignition Device

This device allows the driver to operate the ignition switch with the push of a button, as long as the

Remote Keyless Entry (RKE) transmitter is inside the vehicle.

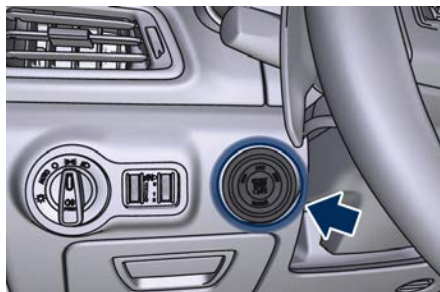

The Keyless Ignition Node (KIN) has three operating setups indicated on the outer ring. Pressing and releasing the middle button, you can switch from one setup to the next without starting the engine, the switched on indication will turn amber. The engine will start by pushing the center button **START/STOP** with the brake pedal pressed and the device set in any of the three operating setups.

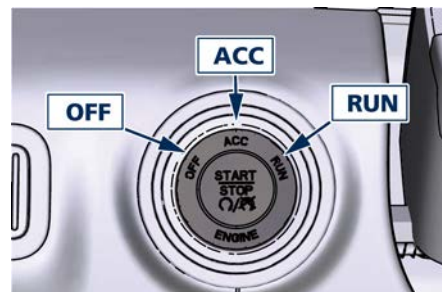

In case the ignition switch does not change by pushing a button, the RKE transmitter (key fob) may have a low or discharged battery. If this occurs it is necessary to replace the battery in order to operate the ignition switch (see "Requiring and Setting Additional Key fobs" in this section). It is still possible to operate the ignition device using the key fob RKE transmitter with discharged battery by pressing the nose side (side opposite of the emergency key) of the key fob on the **START/STOP** button.



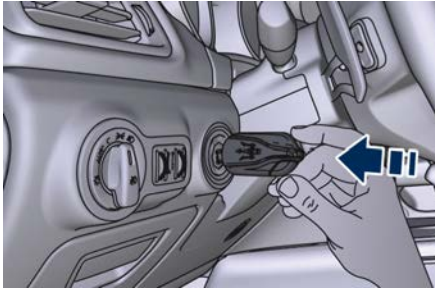

## Key fob

This vehicle is provided with two programmed key fobs.

The key fob contains a Remote Keyless Entry (RKE) transmitter and an emergency key that is inserted into the lock of the opening handle on the driver's door, in case the battery of the vehicle or the key fob go dead.



You can keep the emergency key with you when using valet parking. To remove the emergency key:

- hold the mechanical latch on the back of the key fob sideways;
- simultaneously remove the emergency key by sliding laterally towards the end of the key fob.



### NOTE:

You can insert either side of the emergency key into the lock cylinder.

## Shift Ignition Device to OFF Alert

Opening the driver's door to exit the vehicle when the ignition device is set in **ACC** or **RUN** (engine not running), a beep will remind you to cycle the ignition to **OFF**.

DEP  
DEALER ePROCESS

In addition to the acoustic signal a dedicated message is displayed on the instrument cluster.

If the ignition device is left in the **ACC** or **RUN** position, when vehicle is locked the system will turn off the instrument cluster and automatically set ignition device to **OFF**.

With the MTC+ System, the power window switches, radio, power sunroof (optional), and power outlets will remain active for up to 10 minutes after the ignition switch is cycled to the **OFF** position. Opening either front door will cancel this feature, it is possible to set the timing of this feature.

### NOTE:

Refer to "MTC+ Settings" in Section "Dashboard Instruments and Controls" for further information.



### WARNING!

- When leaving the vehicle, always remove the key fob and lock your vehicle.
- Do not allow children to be in a vehicle unattended or with access to an unlocked vehicle. A child or

(Continued)



*(Continued)*  
others could be seriously or fatally injured. Children should be warned not to touch the parking brake trigger, brake pedal or the shift lever.

- Do not leave the key fob in or near the vehicle, and do not leave the ignition switch in the ACC or RUN mode. A child could operate power windows, other controls, or move the vehicle.
- Do not leave children or animals inside parked vehicles in hot weather. Interior heat build-up may cause serious injury or death.
- An unlocked car is an invitation to thieves. Always remove the key fob from vehicle, cycle the ignition switch to OFF and lock all doors when leaving the vehicle unattended.

## Sentry Key® Immobilizer System

The Sentry Key® Immobilizer System prevents unauthorized vehicle operation by disabling the engine. The system does not need to be armed or activated. Operation is automatic, regardless of whether the vehicle is locked or unlocked.

The system uses a key fob with Remote Keyless Entry (RKE) transmitter, an ignition switch and a RF (Radio Frequency) receiver to prevent unauthorized vehicle operation.

Therefore, only key fobs expressly programmed can be used to start and operate the vehicle.

After placing the ignition in the RUN position, the Vehicle Security Light (see picture) will light up for a three seconds bulb check.

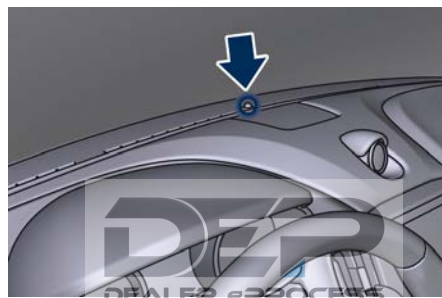

If the light remains on after the bulb check, it indicates that there is a problem with the electronics: this condition will result in the engine being shut off after two seconds. If the Vehicle Security Light turns on during normal vehicle operation (engine running for longer than 10 seconds), an electronic fault is detected. Should this occur, contact the **Authorized Maserati Dealer** as soon as possible for assistance.



### CAUTION!

The Sentry Key® Immobilizer system is not compatible with some remote starting systems that can be installed in after-market.

Use of these systems may result in vehicle starting problems and loss of security protection.

All key fobs provided with the new vehicle have been updated with the vehicle electronics and are therefore able to guarantee correct functioning and protection.



## Radio Frequency RKE Transmitter - Regulatory Information

The “Regulatory Information” for all the radio and radar frequency devices can be consulted by accessing the “Services” section on the website [www.maserati.com](http://www.maserati.com).

## Replacement Key fobs

### NOTE:

*Only key fobs that are updated with the vehicle electronics can be used to start and operate the vehicle.*



### WARNING!

- Always remove the key fobs from the vehicle and lock all doors when leaving the vehicle unattended.
- Always remember to cycle the ignition switch to OFF.

Duplication of key fobs may be performed by an **Authorized Maserati Dealer** only.

This procedure consists of programming a key fob that has never been programmed to the vehicle's electronics.

### NOTE:

- *When having the Sentry Key® Immobilizer System serviced, bring all key fobs provided with the vehicle with you to the **Authorized Maserati Dealer**.*
- *When selling the vehicle, it is necessary to provide the new owner with all key fobs.*



## Vehicle Security Alarm

The vehicle security alarm monitors the vehicle doors and trunk for unauthorized entry and the **START/STOP** button for unauthorized operations.

The system includes a dual function anti-intrusion sensor and vehicle anti-lift sensor. The anti-intrusion sensor monitors the vehicle interior for motion.

The vehicle anti-lift sensor monitors the vehicle for any lifting or tilting actions (tow away, tire removal, ferry transport, etc). A siren with battery backup which senses interruptions of power and communications is also included.

While the vehicle security alarm is enabled, interior door locks switches, trunk lid and fuel filler door release are disabled. If something triggers the alarm, the vehicle security alarm will provide the following audible and visible signals: intermittent buzzer, position lights and/or turn signals and the vehicle security light on the dashboard will flash.

This light will fast flash for approximately 15 seconds, when the vehicle security alarm is being armed,



and will then flash slowly until the vehicle is disarmed.



located on the driver door trim panel with the driver and/or passenger door open.

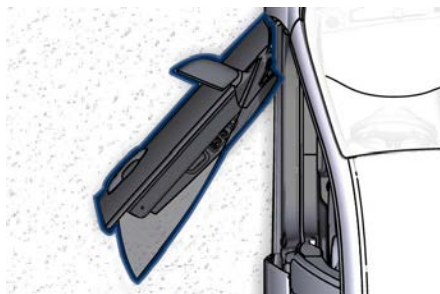

- Press the  lock button on the key fob RKE transmitter.

### Rearming the System

If something triggers the security alarm, and no quick action is taken to disarm it, the vehicle security alarm will turn off the beeper after 29 seconds, and turn off all of the visual signals after 31 more seconds; the vehicle security alarm will then rearmed itself.

### Arming the System

Follow these steps to arm the vehicle security alarm.

- Make sure the vehicle ignition switch is **OFF**.
- Perform one of the following methods to lock the vehicle:
  - Press the  lock button on the interior power door lock switch



- Press the button on the exterior "Passive Entry" door handle having a valid key fob RKE transmitter in the same exterior zone (see "Passive Entry System" in this section for further information).

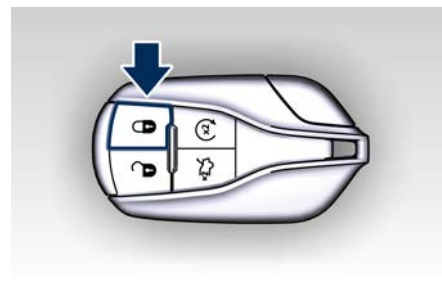

- If any door is open, close it. In any of these situations, if one or more windows are open, they will remain open. To close the windows press again the  lock button and hold it until their closure. If vehicle is equipped with Power Trunk Lid/Hands Free, when arming the alarm system in any of the described ways, the power trunk lid







will remain open if it was left open. In this condition, it will be necessary to first close the trunk lid as described under "Trunk Lid Operation" in this section, and repeat the arming operation, to be able to arm the alarm system.

Vehicles equipped with Power Trunk Lid/Hands Free option a button - located at the bottom of the trunk lid and indicated in the figure - that can be used to completely close and lock the trunk lid, lock all the doors and arm the alarm system if all the doors and trunk lid are closed.

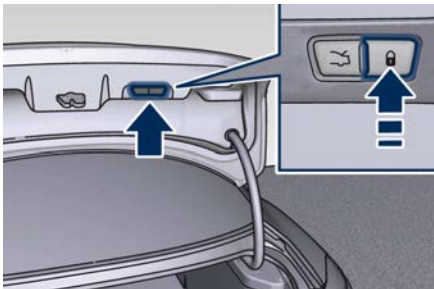
See chapter "Trunk Lid Operation" in this section for further information.



Each time the vehicle security alarm is armed, the anti-intrusion and anti-lift sensors actively monitor the vehicle. When arming the security alarm, it is possible to disable these sensors by

pressing the  button on the key fob three times within 5 seconds from the moment the system has been armed (meanwhile the security alarm light flashes rapidly).

## To disarm the System

Use any of the following steps to disarm the vehicle security alarm.

- Press the  button on key fob RKE transmitter.
- Grasp the "Passive Entry" unlock door handle (see "Passive Entry System" in this section for further information).
- Press the **START/STOP** button so as to release the **OFF** position.

### NOTE:

- *When the vehicle security alarm is armed, the interior power door lock switch will not allow unlocking of the doors.*
- *The use of the emergency key into the driver door lock and the use of the button  on the key fob cannot arm or disarm the security alarm of the vehicle.*
- *The vehicle security alarm remains engaged while accessing the power trunk lid. Pressing the button between the license plate lights will*

*not disarm the vehicle security alarm. If anyone enters the vehicle through the trunk lid and opens a door, the alarm will trigger.*

The vehicle security alarm is designed to protect your vehicle; however, you can create conditions where the system will give you a false alarm. If one of the previously described arming sequences has occurred, the vehicle security alarm will arm regardless of whether you are in the vehicle or not. If you remain in the vehicle and open a door, the alarm will activate. If this occurs, disarm the vehicle security alarm. If the vehicle security alarm is armed and the battery becomes disconnected, the vehicle security alarm will remain armed when the battery is reconnected; the exterior lights will flash, the buzzer will activate. If this occurs, disarm the vehicle security alarm.

## Tamper Alert

If something has triggered the vehicle security alarm in your absence, the horn will sound three times when you disarm the vehicle security alarm. Check the vehicle for tampering.



## Illuminated Entry/Exit

Lights will turn on and off when you enter/exit the vehicle and operate the buttons on the key fob RKE transmitter and/or on the "Passive Entry" system as follows:

- If the unlock command is enabled by pressing the specific  button on the key fob RKE transmitter or by the "Passive Entry" system, the "illuminated entry" mode will activate. Courtesy & dimmable internal lighting, night front seats lighting, and approach lighting will stay on for 27 seconds.

2



- If the lock command of the car is enabled by pressing the specific  button on the key fob RKE transmitter or by the "Passive Entry" system, when the key fob RKE transmitter is moved out of range, all the lights will turn off within 3 seconds, if they were previously on.

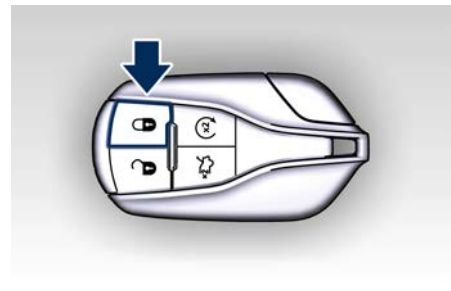
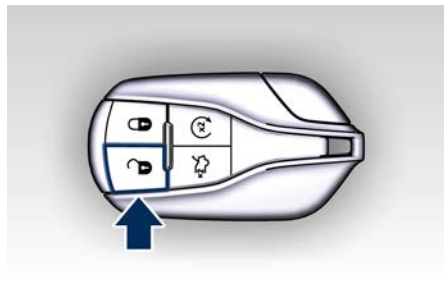

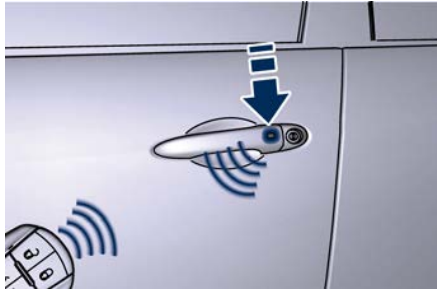

- After activating the trunk lid opening command in the possible modes (see “Trunk Lid Operation” in this section), the inner trunk light will turn on and will stay on for 10 minutes before turning off. The light will immediately turn off if you lock the trunk lid before 10 minutes.

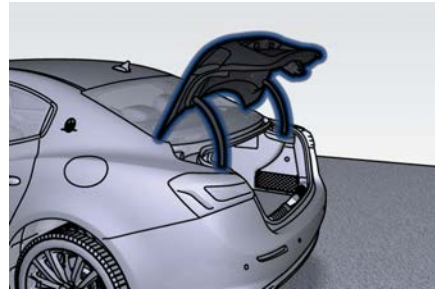
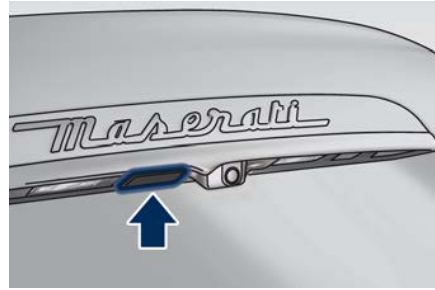
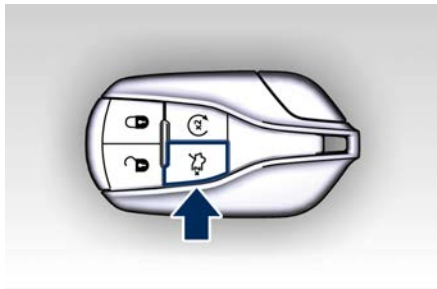

## Vehicle Lighting with Open/Closed Doors

- If one or more doors are open, the central light, front/rear domelights (main and spot light), the instrument cluster, the MTC+ display, the night front seats lighting and the ignition switch backlight will turn on and will light up for 27 seconds.
- If the doors are closed, all lights will turn off (within 3 seconds) with the exception of the console display and the ignition switch backlight, which will turn off after 27 seconds.

## Use of Light Switch for Vehicle Lighting



Vehicle lighting can be operated from the key fob RKE transmitter, the “Passive Entry” system and from the light switch on the left side of the dashboard (refer to “Lights” in section “Understanding the Vehicle” for further information).



2



- If the light switch is in the "0" (OFF) mode all switch backlights and the front seats lighting will turn off.
- If the light switch is in the  position and the ignition switch is in **OFF** position, the front low intensity LEDs of the external light and rear position light guide LED will turn on and will turn off automatically after 8 minutes to preserve the battery charge.

- If the light switch is in  position and the ignition switch is in **RUN** position, no lighting feature will be available.
- If the light switch is in  position (Low beam mode) the front domelight LED (if enabled), the switches backlighting, the instrument cluster's display, the night front seats lighting will turn on. The front domelight LED and the night lighting of the front seats will light up with the intensity set by the right-hand regulator. If the regulator is in "0" (OFF) position, the night lighting will turn off.
- If the light switch is turned in "AUTO" position (on/off AUTO mode) and the ignition is switched in **RUN** position, as in "low beam mode" all lights turn on either in "DAY" or "NIGHT" mode according

to the twilight sensor. In "DAY" mode the switches backlighting will be at 100% intensity, in "NIGHT" mode they will be as set by the left dimmer control switch.

### NOTE:

*In "DAY" mode, the switches are not backlit, except the windows and steering switches.*

## Light Dimmer Controls

The light dimmer controls are part of the headlight switch and are positioned beside the switcher itself (see "Lights" in section "Understanding the Vehicle" for further information).

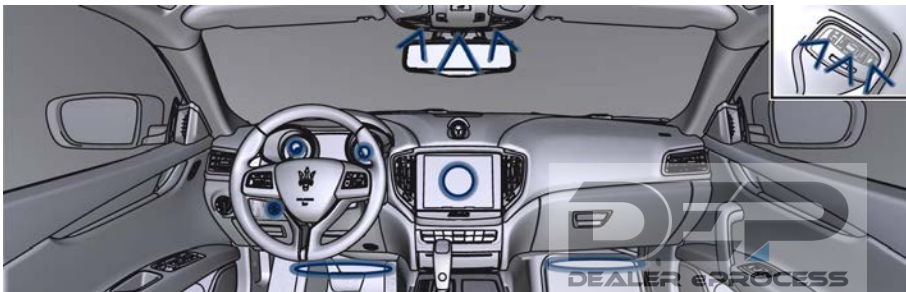



## Unlock the Vehicle with Key fob

The RKE system allows you to unlock the doors and the fuel filler door, open the trunk and turn the approach and courtesy lights on from a distance up to approximately 33 ft (10 m). The key fob RKE transmitter does not need to be pointed at the vehicle to activate the system. See “Illuminated Entry/Exit” in this section for further information.

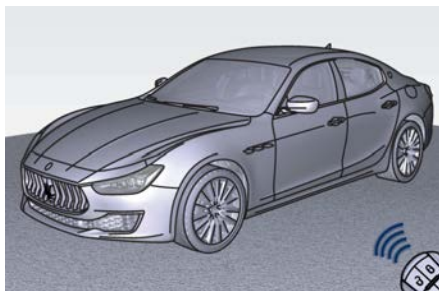

### NOTE:

*Driving at speeds of 5 mph (8 km/h) and above disables the system from responding to all key fobs RKE transmitter buttons.*

## Unlock the Doors, Fuel Filler Door and Trunk

Press and release the unlock button  on the key fob RKE transmitter once to unlock the driver's door or twice within five seconds to unlock all doors, the fuel filler door and the trunk lid. The turn signal lights will flash for the unlock signal recognition. The illuminated entry/exit system will also turn on. See “Passive Entry System” in this section for further information.

### Unlock Driver Door/All Doors with Remote Key 1<sup>st</sup> Press

This feature allows you to program the system to unlock either the driver's door or all doors, the fuel filler door and the trunk lid, by the first press of the unlock button  on the key fob RKE transmitter. To change the current setting, see “MTC+ Settings” in section “Dashboard Instruments and Controls”.

### Lock/Unlock Doors Flash Lights

This feature will cause the flash of the turn signal lights when the doors are locked or unlocked with the key fob RKE transmitter. This feature can be turned on or turned off. To change the current setting, see “MTC+

Settings” in section “Dashboard Instruments and Controls”.

### Turn Headlights On with Remote key

This feature activates the headlights for up to 90 seconds when the doors are unlocked with the key fob RKE transmitter. The duration can be set as desired. To change the current setting, see “MTC+ Settings” in section “Dashboard Instruments and Controls”.

## Locking Doors Sound Alarm

This feature will cause the alarm to activate when the doors are locked with the key fob RKE transmitter. This feature can be enabled or disabled. To change the current setting, see “MTC+ Settings” in section “Dashboard Instruments and Controls”.

## Unlatch the Trunk Lid

Press the button  on the key fob RKE transmitter two times within five seconds to unlatch the manual trunk lid.

If the vehicle is equipped with Power Trunk Lid/Hands Free, besides unlocking the trunk lid, the control will fully open it.



See chapters “Passive Entry System” and “Trunk Lid Operation” in this section for further information.

## Requiring and Setting Additional Key fobs

Provide your **Authorized Maserati Dealer** the following when ordering additional key fob RKE transmitters:

- all key fobs RKE transmitters in your possession;
- a personal ID;
- the identification and registration documents proving ownership of the vehicle.

Setting new key fobs or re-setting the original ones can only be performed at an **Authorized Maserati Dealer**.

### NOTE:

*Codes of any key fob RKE transmitters that are not present when the new setting procedure is done will be deleted from the memory to prevent lost or stolen key fobs transmitters being used to disarm the electronic alarm system.*



## Key fob Battery Replacement

### NOTE:

*A low charge level of the key fob battery will be indicated on the instrument cluster display.*

The recommended replacement battery type is: CR2032.

To replace the battery proceed as follows:

- Remove the emergency key as indicated in “Keys” chapter of the current section.
- Loosen the lateral screw that connects the two side covers with a torx T6 screwdriver.



- Separate the two lateral covers from the key fob case.



minimize exposure, avoid breathing exhaust, do not idle the engine except as necessary, service your vehicle in a well-ventilated area and wear gloves or wash your hands frequently when servicing your vehicle. For more information go to: [www.P65Warnings.ca.gov/passenger-vehicle](http://www.P65Warnings.ca.gov/passenger-vehicle)



- Separate both parts of the key fob case.



- Remove the card with PCB (Printed Circuit Board).



- Remove the battery from its seat and replace with a new recommended type of battery.

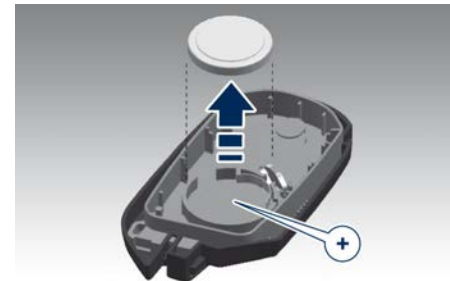

**WARNING!**

California Proposition 65 Operating, servicing and maintaining a passenger vehicle or off-road vehicle can expose you to chemicals including such as, engine exhaust, carbon monoxide, phthalates and lead, that which are known to the State of California to cause cancer and birth defects or other reproductive harm. To



**ENVIRONMENTAL!**

Batteries contain dangerous materials that could harm the environment. Please dispose of them according to local regulations or at an Authorized Maserati Dealer.





### WARNING!

**California Proposition 65**  
**Operating, servicing and maintaining a passenger vehicle or off-road vehicle can expose you to chemicals including such as, engine exhaust, carbon monoxide, phthalates and lead, that which are known to the State of California to cause cancer and birth defects or other reproductive harm. To minimize exposure, avoid breathing exhaust, do not idle the engine except as necessary, service your vehicle in a well-ventilated area and wear gloves or wash your hands frequently when servicing your vehicle. For more information go to: [www.P65Warnings.ca.gov/passenger-vehicle](http://www.P65Warnings.ca.gov/passenger-vehicle)**

### NOTE:

*Avoid touching the new battery with your fingers. Skin oils may cause battery deterioration. If you touch a battery, clean with alcohol.*

- Match the + sign on the battery to the + sign on the inside of the battery clip, located on the back cover.

- Replace the printed circuit board by using the indicated pin for the sealing of the two covers.
- Assemble the key fob case and reassemble the two lateral covers: a click will indicate successful sealing.
- Combine the disassembled parts with clamping screw and reassemble the emergency key.

### Radio Frequency RKE Transmitter - Regulatory Information

The “Regulatory Information” for all the radio and radar frequency devices can be consulted by accessing the “Services” section on the website [www.maserati.com](http://www.maserati.com).

### Remote Start System

This system enables the key fob RKE transmitter to start the engine conveniently from outside the vehicle while still maintaining security. The system has a range of approximately 300 ft (91 m). Obstructions between the vehicle and the key fob may reduce this range.

### NOTE:

*Changes or modifications not expressly approved by the party responsible for compliance could void the user's authority to operate the equipment.*

If your RKE transmitter fails to operate from a normal distance, check for these conditions:

- A weak battery in the RKE transmitter. The expected life of the battery is a minimum of three years.
- Closeness to a radio transmitter such as a radio station tower, airport transmitter, and some mobile or CB radio.
- Obstructions between the vehicle and the Key Fob.







## How to use Remote Start

All of the following conditions must be met before the engine will remote start:

- System not disabled from previous remote start event.
- Vehicle theft alarm not active.
- Doors closed.
- Hood closed.
- Trunk lid closed.
- Hazard lights switched off.
- Brake pedal not pressed.
- Battery at an acceptable charge level.
- The shift lever is in P (Park) position.
- The vehicle transmission is in automatic mode.
- The remote start has not been activated yet two consecutive times. If EPB (Electric Parking Brake) is not selected, at key-off in some conditions the remote start system may not allow engine to start. We suggest to set "Auto Apply On" function through the switch on the right-side of the steering wheel (refer to "Instrument Cluster" in section "Dashboard Instrument and Controls").



### WARNING!

- **Do not start or run an engine in a closed garage or confined area. Exhaust gas contains Carbon Monoxide (CO) which is odorless and colorless**
- **Keep key fobs RKE transmitter away from children. Operation of the Remote Start System, windows, door locks or other controls could cause serious injury or death.**

## Engine Remote Start Abort Message on Instrument Cluster

The following messages will display on the instrument cluster if the vehicle fails to remote start or exits remote start prematurely:

- "Remote Start Canceled Door Open".
- "Remote Start Canceled Trunk Open".
- "Remote Start Canceled Fuel Low".
- "Remote Start Canceled Time Expired".
- "Remote Start Disabled Start Vehicle to Reset".



The message on the instrument cluster stays active as long as the ignition switch is in **RUN** position.

## To enter Remote Start Mode

Press and release the button (Ⓜ) on the key fob RKE transmitter twice within five seconds. The vehicle doors will lock, position lights will flash and the horn will ring twice (if this function is set using the MTC+ System, refer to "MTC+ Settings" in section "Dashboard Instruments and Controls"). Then, the engine will start and the vehicle will remain in the "Remote Start" mode for a 15-minute cycle.



### WARNING!

**California Proposition 65**  
**Operating, servicing and maintaining a passenger vehicle or off-road vehicle can expose you to chemicals including such as, engine exhaust, carbon monoxide, phthalates and lead, that which are known to the State of California to cause cancer and birth defects or other reproductive harm. To minimize exposure, avoid breathing engine exhaust, do not idle the engine except as necessary, service your vehicle in a**

*(Continued)*



**(Continued)**  
 well-ventilated area and wear gloves or wash your hands frequently when servicing your vehicle. For more information go to:  
[www.P65Warnings.ca.gov/passenger-vehicle](http://www.P65Warnings.ca.gov/passenger-vehicle)



### NOTE:

- In case of an engine fault or low fuel level, the vehicle will start and then shut down in 10 seconds.
- The position lights will turn on and remain lighted up during "Remote Start" mode.
- For security reasons, power window and power sunroof operation are disabled when the vehicle is in the "Remote Start" mode.
- The engine can be started two consecutive times (two 15-minute cycles) with the key fob RKE

transmitter. However, the ignition must be cycled to the **RUN** position before you can repeat the start sequence for a third cycle.

### To exit Remote Start Mode without Driving the Vehicle

Press and release the button  one time or allow the engine to run for the entire 15-minute cycle.

### NOTE:

To avoid unintentional shutdowns, the system will disable the one time press of the button  for two seconds after receiving a valid "Remote Start" request.

### To exit Remote Start Mode and Drive the Vehicle

Before the end of the 15-minute cycle, press and release the button  on the key fob RKE transmitter to unlock the doors and disarm the vehicle security alarm. Then, prior to the end of the 15-minute cycle, press and release the **START/STOP** button.

### NOTE:

The message "Remote Start Active Push Start Button" will display in the instrument cluster until you push the **START/STOP** button.

### Auto-On Comfort with Remote Start

The driver's heated and ventilated seat and the heated steering wheel (if equipped) can be programmed to come on during a remote start. Refer to "Auto-On Comfort & Remote Start" function in chapter "MTC+ Settings", section "Dashboard Instruments and Controls", for further information.

### Radio Frequency RKE Transmitter - Regulatory Information

The "Regulatory Information" for all the radio and radar frequency devices can be consulted by accessing the "Services" section on the website [www.maserati.com](http://www.maserati.com).





## Doors Locking



### WARNING!

- For personal security and safety, always lock the vehicle doors before you drive as well as when parking and leaving the vehicle unattended.
- When leaving the vehicle, always remove the key fob RKE transmitter and lock your vehicle.
- Never leave children alone in a vehicle, or with access to an unlocked vehicle.
- Do not allow children to be in a vehicle unattended. A child or others could be seriously or fatally injured. Children must not touch the parking brake trigger, brake pedal or the shift lever.
- Do not leave the key fob in or near the vehicle, and do not leave ignition switch in the ACC or RUN mode.

## Doors Manual Lock

To lock each door, push the door lock knob on each door trim panel downward.

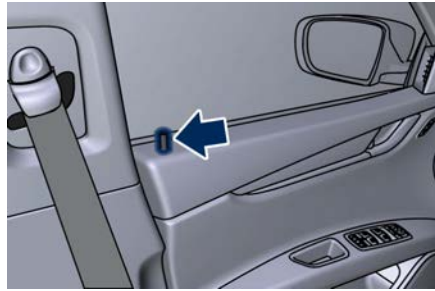

To unlock the front doors, pull the inside door handle to the first detent.

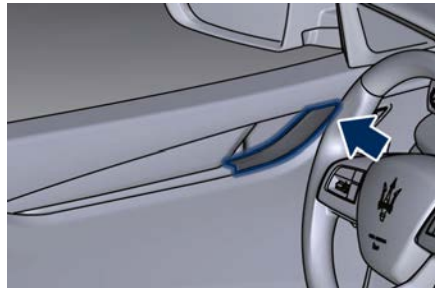



To unlock the rear doors, pull the door lock knob on the door trim panel upward.

If the door lock knob is down when you shut the door, the door will lock. Therefore, make sure the key fob RKE transmitter is not inside the vehicle before closing the door.

**DEP**  
DEALER ePROCESS

## Power Doors Locking/Unlocking

A power door lock switch  and a power door unlock switch  are positioned on the front door trim panel. Use this switches to lock or unlock the doors.



If the vehicle has been locked from inside with the above-figured switches, the fuel filler flap remains unlocked.



If Power Trunk Lid/ Hands Free (if equipped) has been left open, it will stay open when you press lock button , and the locking feature will only occur after the closing of the power trunk lid.

The doors can also be locked and unlocked with the “Passive Entry” system. For further information, see “Passive Entry System” in this section. If you press the power door lock switch while the ignition switch is in the **ACC** or **RUN** position, and any front door is open, the power locks will not operate. This prevents you from accidentally locking the key fob RKE transmitter in the vehicle. Cycling the ignition to the **OFF** position or closing the door will allow the locks of the doors and fuel filler door to operate. If a door is open with the key fob RKE transmitter inside the cabin and the ignition is in the **ACC** or **RUN** position, a beep will draw the driver's attention.

### Automatic Locking Doors

The auto door lock feature default condition is disabled. When enabled, the door locks will lock automatically when the vehicle's speed exceeds 15 mph (24 km/h). The auto door lock feature can be enabled or disabled by

an **Authorized Maserati Dealer** only which can also service the vehicle.

### Automatic Door Unlock on Exit

The doors will unlock automatically on vehicles with power door locks if:

- The automatic unlock doors on exit feature is enabled.
- The transmission is in gear and the vehicle speed is 0 (mph - km/h).
- The transmission is in N (Neutral) or P (Park).
- The driver door is open.
- The doors were not previously unlocked.
- The vehicle speed is 0 (mph - km/h).

### Set Automatic Door Unlock on Exit

To change the current setting, see “MTC+ Settings” in section “Dashboard Instruments and Controls”.

#### NOTE:



*Use the automatic door unlock on exit feature in accordance with local regulations.*



## Child-Protection Door Lock System — Rear Doors

To provide a safer environment for small children sitting in the rear seats, the rear doors are equipped with a child-protection door lock system.

### Engage or Disengage the Child-Protection Door Lock

- Open the rear door.
- Insert the tip of the emergency key into the lock and rotate to the lock  or  unlock position.
- Repeat the first two steps on the opposite rear door.



#### WARNING!

**Avoid trapping anyone in a vehicle in a collision. Remember that the rear doors can only be opened from the**



**outside when the child-protection locks are engaged (locked).**

**NOTE:**

*For emergency exit from the rear seats when the child-protection door lock system is engaged, manually raise the door lock knob to the unlocked position, roll down the window, and open the door using the outside door handle.*

### Soft Door Close System (if equipped)

This system makes doors easier to shut without having to slam if you do not get it closed the first time. It increases the vehicle's safety and comfort, in particular for children in the back seat, it is not necessary to slam the door and it also prevents the risk of traveling with the door ajar.

The system uses a sensor to detect the door ajar and an electric actuator to close it. The sensor detects your attempt to close the door and once the latch catches the handle the electric actuator pulls the door firmly bringing the door to the fully closed position.

During the soft closing phase operated by the system, it is possible

to intervene manually by opening or closing the door. If you are pushing the door hard enough to close just like a regular one, the system still works, but only to check whether the door is properly closed.



**WARNING!**

**The system works properly if the ajar door has a gap , between exterior door panel surface and exterior bodyshell surface in the latch area , of max 0.23 in (6 mm). In the presence of higher gap, the system is not able to close the door with the risk of travelling with the door not completely closed.**



## Passive Entry System

The "Passive Entry" system is an enhancement to the vehicle's Remote Keyless Entry (RKE) system. This feature allows you to lock and unlock the vehicle's door(s) without having to press the key fob RKE transmitter lock or unlock buttons.

**NOTE:**

- "Passive Entry" may be programmed to on/off; see "MTC+ Settings" in section "Dashboard Instruments and Controls" for further information.
- If wearing gloves, or if it has been raining on the "Passive Entry" door handle, the unlock sensitivity can be affected, resulting in a slower response time.
- Access to the vehicle using "Passive Entry" system may not work properly in case of interference caused by external sources such as metal objects, mobile phones, overhead power lines, antennas, etc. In these cases, use the buttons of the key fob RKE transmitter to open and close the vehicle or the emergency key, inserting it into the driver side door lock.

**(Continued)**



(Continued)

- The "Passive Entry" system does not lock and unlock the doors directly and immediately but with a slight delay (about 2 seconds).

2

## Unlock Door from the Driver Side

With a valid key fob RKE transmitter within 3.3 ft (1 m) of the driver's door handle, grip the driver's door outside handle to unlock the door automatically. The interior door panel lock knob will rise when the door is unlocked.



### NOTE:

If "1st Press of Key Fob Unlocks" is selected, all doors will unlock when you grip the front driver's door handle. To select between "Driver Door" and "All Doors", see "MTC+ Settings" in section "Dashboard Instruments and Controls".

## Unlock Door from the Passenger Side

With a valid key fob RKE transmitter within 3.3 ft (1 m) of the passenger door handle, grip the front passenger outside door handle to unlock all four doors automatically.

The interior door panel lock knob will rise when the door is unlocked.

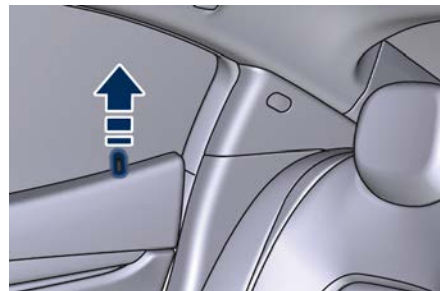

### NOTE:

All doors will unlock when you grip the front passenger door handle regardless of the driver's door unlock preference setting ("Driver Door" or "All Doors").





## Preventing Inadvertent Locking of the Key fob RKE Transmitter inside the Vehicle

To minimize the possibility of unintentionally locking a key fob RKE transmitter inside your vehicle, the "Passive Entry" system is equipped with an automatic door unlock feature which will function if the ignition switch is in the **OFF** position. If one of the vehicle doors is open and the door panel switch  is used to lock the vehicle, once all open doors have been closed, the system checks the inside and outside of the vehicle for any valid key fobs RKE transmitter. If one of the vehicle's key fobs RKE transmitters is detected inside the vehicle, and no other valid key fobs RKE transmitters are detected outside the vehicle, the "Passive Entry" system automatically unlocks all vehicle doors and chirps the horn fourteen times (on the fifteenth attempt ALL doors will lock and the key fob RKE transmitter will be locked in the vehicle). This will happen even on vehicles equipped with Power Trunk Lid/Hand Free pressing RH button on its right lower part to close and lock the trunk lid.

### NOTE:

The vehicle unlocks the doors under any of the following conditions:

- the doors are manually locked using the door lock knob positioned on the door panel;



- there is a valid key fob RKE transmitter inside the vehicle;
- there is not a valid key fob RKE transmitter outside the vehicle.

### NOTE:

The vehicle will not unlock the doors under any of the following conditions:

- the doors are locked using the key fob RKE transmitter;
- the doors are locked using the button on the "Passive Entry" door handles;

**DEP**  
DEALER ePROCESS



- there is a valid key fob RKE transmitter outside the vehicle and within 3.3 ft (1 m) of either "Passive Entry" door handle;
- fifteen attempts are made to lock the doors using the door panel switch and/or the RH button  (on the vehicles equipped with Power Trunk Lid/Hands Free) and then close the doors.

If the key fob RKE transmitter is inside the passenger compartment and one of the doors locked only to the first detent of lock pawl (hence it is not fully closed), when the vehicle lock function with alarm system for trunk lid and doors is being activated by means of RH button  at the bottom of the trunk lid, said function will be activated all the same. In this condition, any attempt to duly close the door that is partially open



will cancel vehicle lock and alarm system arming thus leaving vehicle unlocked.

Since when the doors are locked, the "Passive Entry" system waits for about 16 seconds before verifying if a key fob RKE transmitter is present inside the vehicle.

### Release the Lid and Enter the Trunk

For vehicles equipped with manual trunk lid, with the key fob within 3.3 ft (1 m) of the lid, press the button located between the licence plate lights and lift it manually.

For vehicles equipped with Power Trunk Lid/Hands Free, with the key fob within 3.3 ft (1 m) of the lid, press the button located between the license plate lights, the power trunk lid will automatically open until it has reached its maximum height; if the same button is not pressed again to stop it (for more information, see chapter "Trunk Lid Operation" in this section).

If the vehicle had already been unlocked through key fob or "Passive Entry", the presence of the key fob is not required; simply use the button located between the license plate lights to open the trunk lid manually or automatically.



### Manual Door Lock from Outside

With one of the vehicle's key fobs RKE transmitters within 3.3 ft (1 m) of the driver or passenger front door handles, press the external door handle button to lock all four doors.

#### NOTE:

- After pressing the outside door handle button, you must wait two seconds before you can lock or unlock the doors using this door handle. By pulling the external door handle, you can check if the car remains locked, without "Passive Entry" system reacting and unlocking the doors.
- The "Passive Entry" system will not operate if the key fob RKE transmitter battery is dead.
- If Power Trunk Lid/Hands Free (if equipped) has been left open, it will stay open when you press the button on door external handle, and the locking feature will only occur after the closing of the power trunk lid.



The vehicle doors can also be locked by using the key fob RKE transmitter lock button  or the lock button  located on the vehicle's inner door panel.

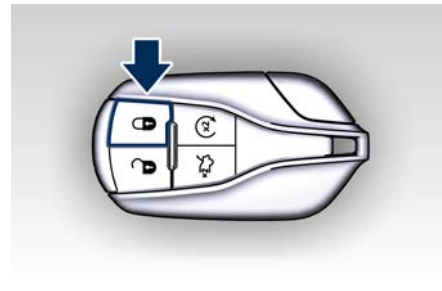





## Radio Frequency RKE Transmitter - Regulatory Information

The "Regulatory Information" for all the radio and radar frequency devices can be consulted by accessing the "Services" section on the website [www.maserati.com](http://www.maserati.com).



## Power Windows

The window controls on the driver's door panel govern all the door windows.

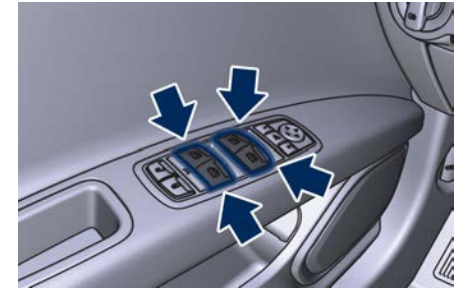

There are single window controls on each passenger door trim panel, which operate the corresponding window. The window controls will operate only when the ignition switch is in the **ACC** or **RUN** position.

**DEP**  
DEALER ePROCESS



### NOTE:

- The power window switches will remain active for up to 10 minutes after the ignition switch is turned to the **OFF** position. Opening either front door will cancel this feature. The time lapse can be set. See “MTC+ Settings” in section “Dashboard Instruments and Controls” for further information.
- Frequent activations of the power windows could result in a temporary lock out of the motors. In this case, wait a moment before a new activation.



### WARNING!

**Improper use of the power windows and the sunroof (if equipped) can however be dangerous, even with the anti-pinch prevention system. Before and during activation of the power window, always check that the passengers are not exposed to the risk of injury both by the moving window and by personal objects that could be dragged or hit by it. Do not leave unattended children in a vehicle with a key fob RKE transmitter inside. When getting out the vehicle, always remove the key fob RKE transmitter to**

**prevent the windows being accidentally activated, posing a risk to passengers remaining onboard.**

### Auto-Down Feature

The driver door power window switch and some model passenger door power window switches have an auto-down feature.

Press the window switch to the second detent, release, and the window will go completely down automatically. To open the window part way, press the window switch to the first detent and release it when you want the window to stop.

To stop the window from going all the way down during the auto-down operation, pull up on the switch briefly.

### Auto-Up Feature with Anti-Pinch Protection

Lift the window switch to the second detent, release, and the window will go all the way up automatically. To stop the window from going all the way up during the auto-up operation, push down on the switch briefly. To close the window part way, lift the window switch to the first detent and

release it when you want the window to stop.

### NOTE:

- If the window runs into any obstacle during auto-closure, it will reverse direction and then go back down. Remove the obstacle and use the window switch again to close the window.
- Any impact due to rough road conditions may trigger the auto reverse function unexpectedly during auto-closure. If this happens, pull the switch lightly to the first detent and hold to close the window manually.
- Frequent activations of the anti-pinch function could disable the auto-down and auto-up function of the windows. In order to re-activate this function proceed with a reset cycle as described in the next paragraph.



### WARNING!

**There is no anti-pinch protection when the window is almost closed. Be sure to clear all objects from the area before closing the window.**





## Reset Auto-Up/Down

Should the auto-up/down feature stop working, the window probably needs to be reset.

To reset auto-up/down, pull the window switch up to close the window completely and push the window switch down to open the window completely.

## Open the Windows and Sunroof with RKE Transmitter and Ignition Off

When the ignition switch is in **OFF** position, windows can be opened by pressing the  button on the RKE transmitter.

- Press the  button and release it;
- Press a second time the  button and keep it pressed until complete opening of the windows, if they were closed.

## Rear Window and Sunshade Lockout Button

The window lockout button on the driver's door trim panel allows to disable the window and sunshade control on the rear doors by pressing the window lockout button (setting it in the down position).

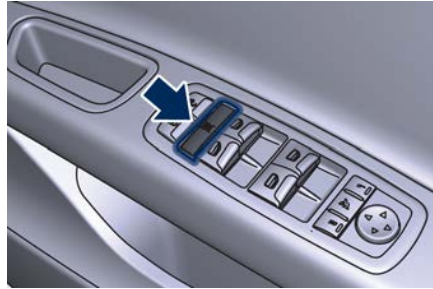

To enable the controls previously described, press the window lockout button again (setting it in the up position).

## Wind Buffeting

Wind buffeting can be described as the perception of pressure or a helicopter-type sound. Your vehicle may exhibit wind buffeting with the windows down, or the sunroof in open or partially open positions. This is a normal occurrence and can be minimized. If the buffeting occurs with the rear windows open, open the front and rear windows together to minimize the buffeting. If the buffeting occurs with the sunroof open, then adjust the sunroof opening to minimize the buffeting.



## Rear Window

### Rear Window Defroster

The rear window defroster button is located on the climate control panel. See "Air Conditioning Controls" in section "Dashboard Instruments and Controls".

### Power Sunshade (optional)

Your vehicle can be equipped on request with a power sunshade that will reduce the amount of sunlight that will enter through the rear window.

The sunshade is rolled in and stored inside the cover behind the rear seats; when activated, it rolls out upwards. The power sunshade can be operated using the MTC+ System.

- Touch the "Controls" soft-key.
- Within 15 seconds, touch the "Rear Sunshade" soft-key to raise the power sunshade.
- Within 15 seconds, touch the "Rear Sunshade" soft-key a second time to lower the sunshade.



2

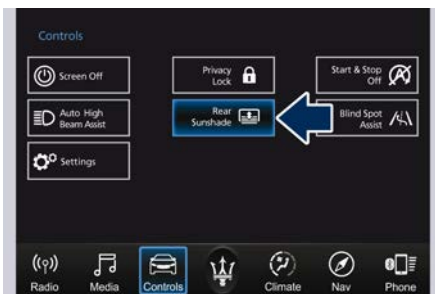

Without ADAS



With ADAS

If the sunshade is in the raised position and the transmission lever is positioned in R (Reverse), the sunshade will automatically fully lower.

When the transmission lever is shifted out of R (Reverse) the sunshade will automatically return to the fully raised position after approximately five seconds.

On versions equipped with heated rear seats are available the curtain buttons of the rear sunshade, positioned at the rear of the central console, which can be operated from the rear passengers.

- Press the left button to fully raise the sunshade.
- Press the right button to fully lower the sunshade.

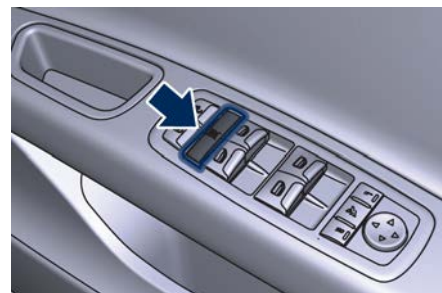

**NOTE:**

*The rear sunshade control and rear power windows switches, can be locked by pressing the window lockout button on the driver side door panel.*







## Trunk Lid Operation

The manual trunk lid can be unlocked from inside the vehicle by pressing the button on the front dome console. This command will fully open the Power Trunk Lid/Hands Free (if equipped). Pressing this button in sequence, if the power trunk lid stops in intermediate position, it resumes his opening movement.

### NOTE:

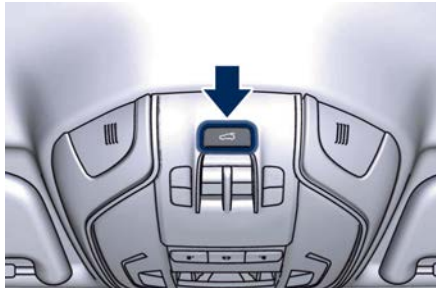
*The shift lever must be in P (Park) before the button can operate.*



The manual trunk lid can be released from outside the vehicle by pressing the  button on the key fob with RKE transmitter twice within five seconds or by using the external release button located on the lower side of the trunk lid ledge, between

the license plate lights, when the vehicle has been unlocked using the key fob or the "Passive Entry" system.

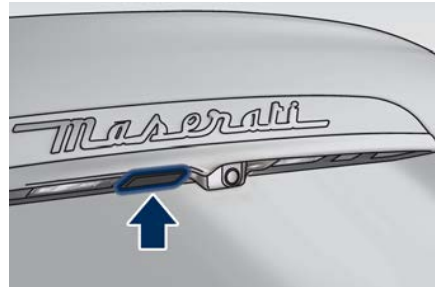
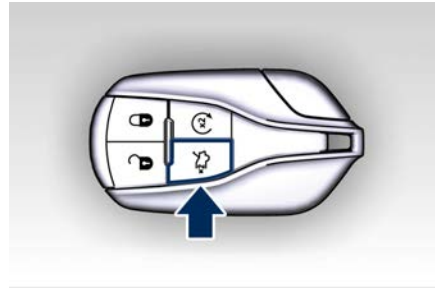

When the button  on the key fob is pressed twice within five seconds, the direction indicators flash twice to indicate the opening or closing of the trunk lid, if the light flashing function at closing is activated on MTC+ (for more information, see the chapter "MTC+ Settings" in section

DEALER ePROCESS

"Dashboard Instruments and Controls").

To manually close the trunk lid use the handle as indicated beside the closing device.



With the ignition switch in **RUN** position, the red symbol  will display on the instrument cluster with the message indicating that the trunk lid is open. Once the trunk is closed both symbol and message will disappear from the display.







2

With the ignition device in the **OFF** position, the trunk open symbol and message will display until closure. See "Passive Entry System" in this section for more information on trunk lid operation with the "Passive Entry" feature.

### Power Trunk Lid/Hands Free (optional)

Automatic opening and closing movement of the trunk lid is driven by electric actuators and a motorized latch ensuring lid locking upon closing. Power Trunk lid can be opened using button  on the key fob RKE transmitter and the button on the front dome console used also for non-power version.

The  on key fob and button on dome console not only allows user to completely open the Power Trunk Lid/Hands Free, but also to stop it at any intermediate position by pressing the button again at anytime you wish to stop and resume the opening process.

In addition to these commands, it is possible open and close the Power Trunk Lid/Hands Free by simply moving your foot under the rear bumper, if the vehicle is so equipped with the kick sensor option, as specified in the

paragraph "Hands Free Power Trunk Release and Closing". In this latter case, the lid will be opened and closed only if the "Passive Entry" system acknowledges the presence of the key fob RKE transmitter within 3.3 ft (1 m) of the trunk lid.

Power Trunk Lid/Hands Free uses the button in between the license plate lights, indicated in figure, to activate the opening once the car has been unlocked by the key fob or by the "Passive Entry" function.

By pressing this button when the Power Trunk Lid/Hands Free is closed you can open it completely or by pressing the button again stop the opening process, or by pressing the button again invert the movement and close it completely.



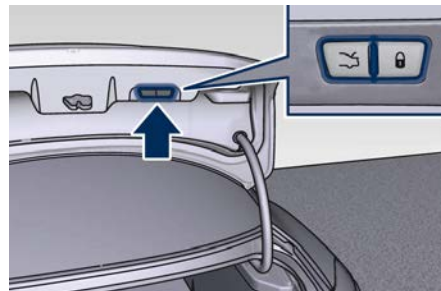

When the Power Trunk Lid/Hands Free is open, to move it there are two

buttons positioned on its right lower part as indicated in figure.



When the power trunk lid is completely open if you press and release the LH button , the power trunk lid will be completely closed unless it is stopped;



- if instead the power trunk lid is in an intermediate position and you press and release the LH button  during the closing or opening stroke, it will be stopped;
- if instead the power trunk lid is stopped in an intermediate position and you press and release the LH button , it will reverse its previous movement and it will be completely opened or closed unless it is stopped again.

In any case, when you press the LH button , the doors will not be



locked and the alarm system will not be armed.

When the power trunk lid is completely open if you press and release the RH button , the power trunk lid will be completely closed unless it is stopped;

- if instead the power trunk lid is in an intermediate position and you press and release the RH button  during the closing or opening stroke, it will be stopped;
- if instead the power trunk lid is stopped in an intermediate position and you press and release the RH button , it will reverse its previous movement and it will be completely opened or closed unless it is stopped again.

In any case, when you press the RH button , the doors will not be locked and the alarm system will not be armed immediately, but only when the power trunk lid will have reached the totally closed position as effect of every movement commands received from every other available inputs.

#### NOTE:



- *The order of the functions shown does not represent the sequence in which they can be performed.*

- *The buttons of the Power Trunk Lid/Hands Free do not work if a gear is engaged or if the vehicle speed is higher than 0 (km/h - mph).*
- *The Power Trunk Lid/Hands Free does not work with temperatures lower than -22°F (-30°C) or higher than 150°F (65°C).*
- *If the opening buttons or the handles are operated while the Power Trunk Lid/Hands Free is closing, the stroke of lid stops. Pressing another time the same command it reverses movement and fully open.*
- *If the opening buttons or the handle are operated while the Power Trunk Lid/Hands Free is opening, the motor of the lid is disabled to allow manual operation.*
- *If the Power Trunk Lid/Hands Free finds several obstacles during the same operating cycle, it will stop automatically and must be opened or closed manually.*
- *If the Power Trunk Lid/Hands Free is closing and a gear is engaged, the lid will continue closing. In this condition, it is possible that, during the closing stroke, it may find an obstacle and stop.*

DEALER ePROCESS

### Set the Position of Maximum Power Trunk Lid Opening

The maximum opening position of the trunk lid can be modified using the previously described buttons on its right lower side.

1. Activate the trunk lid and stop it in the new maximum opening position to be set, by pressing the LH  button.
2. Press the LH  and RH  buttons at the same time and keep them pressed for 3 seconds.
3. Release both buttons. Upon the following opening controls, the trunk lid will stop in the stored position.

If you want to reset the maximum possible opening position of the power trunk lid, proceed as described below starting from the previously set opening position.

1. Manually push the trunk lid to the maximum possible opening position.
2. Repeat the previously performed steps 2 and 3.

### Power Trunk Lid/Hands Free Automatic Safe Movement

Power Trunk Lid/Hands Free safe opening and closing is ensured by a



protection system able to stop its movement when an obstacle is detected along the path: when opening or closing, it stops automatically and then slightly moves back.

After the closing command, when Power Trunk Lid/Hands Free starts closing, all the indicators will blink to warn anyone within range. Apart from activating indicators blinking when power trunk lid is operated, it is also possible to activate a sound warning by selecting the relevant function within MTC+ user settings (see "MTC+ Settings" in section "Dashboard Instruments and Controls"). When Power Trunk Lid/Hands Free edge reaches the car body, the motor locking the latch is activated automatically.

If necessary, the Power Trunk Lid/Hands Free can also be opened or closed manually. This operation could be required when the trunk lid remains open for a long period of time.



### WARNING!

- **Activate Power Trunk Lid/Hand Free only when vehicle is at a standstill.**

- **Always pay utmost attention when opening and closing Power Trunk Lid/Hand Free.**
- **After the closing command, always make sure that Power Trunk Lid/Hand Free is completely closed.**



### CAUTION!

- **Under extreme weather conditions, trunk lid seal could freeze and compromise Power Trunk Lid/Hand Free automatic opening and closing.**
- **Before opening Power Trunk Lid/Hand Free, make sure that no objects or snow are set on trunk lid or might jam or prevent its opening.**

### Hands Free Power Trunk Release and Closing

This mode is controlled by the "Passive Entry" system (see paragraph "Passive Entry System" in this section), which automatically releases and closes the Power Trunk Lid/Hands Free when you place your foot in the area under the rear bumper.

The system will only operate if the system acknowledges the presence of the key fob RKE transmitter within 3.3 ft (1 m) of the Power Trunk Lid/Hands Free. **DEALER ePROCESS**

The range of the sensors that detect your foot movement extends along and underneath the central portion of the rear bumper.

To activate the Power Trunk Lid/Hands Free, stand behind the vehicle, near the trunk lid, and move your foot under the bumper as if to kick something. Do not place your foot too close to the bumper or touch the underbody.



### WARNING!

- **Pay careful attention to the exhaust tailpipes as they can reach high temperatures and, in case of contact, they can cause severe burns.**
- **When it is not necessary to open the Power Trunk Lid/Hand Free with the Hands Free mode, make sure the key fob results outside the range of use (3.3 ft/1 m). Otherwise, the Power Trunk Lid/Hand Free can be opened accidentally by an unintentional movement of the foot.**



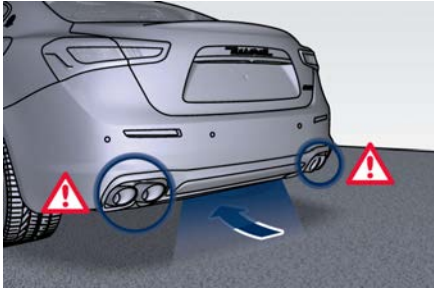

In order for the sensors to detect your foot movement, move your foot towards the vehicle rather than sideways and immediately pull it back: from this moment, the Power Trunk Lid/Hands Free will activate within two seconds.

If closed, with the foot movement the Power Trunk Lid/Hands Free will:

- unlock and completely open;
- after another kick, will stop;
- after another kick, will reverse its movement and completely close unless stopped again.

If open, with the foot movement the Power Trunk Lid/Hands Free will:

- completely close but not lock;
- another kick before the completed closing can stop the movement;

- if the movement was stopped another kick operation will invert a complete opening.

#### NOTE:

- *If your foot movement fails to activate the Power Trunk Lid/Hands Free movement, wiggling your foot under the bumper will not help. Repeat the whole kick movement.*
- *In particular situations, external factors affecting the sensor area may trigger the Hands free power trunk lid release feature. For example, when washing the vehicle, a water jet aimed at the sensor area may trigger the "Hands free" power trunk release feature. Keep the key fob RKE transmitter away from the sensing range of the sensors (10 ft/3 m) or disable the Hands free feature from the MTC+ menu (see "MTC+ Settings" in section "Dashboard Instruments and Controls"). A key fob RKE transmitter located in the front seat passenger area is considered out of range of the "Hand free" trunk release sensor.*
- *If somebody or something knocks against the Power Trunk Lid/Hands Free while it is moving, the safety*

*system might stop lid opening or closing movement.*

## Trunk Lid Emergency Release

If accessing the trunk compartment from the rear seats, operate the emergency release lever (see the chapter "Trunk Safety" in this section) in order to lower the rear seat backrest (see "Cargo Area" in section "Understanding the Vehicle"). If the power release control operated by pressing the button on the dome console fails, it may be that the battery is critical. In this case, it is possible to temporarily power the system by using the battery remote poles located inside the engine compartment (see "Auxiliary Jump-Start Procedure" in section "In an Emergency"). Then it is possible to normally open the trunk lid by using the key fob RKE transmitter. Have the vehicle subsequently serviced by an **Authorized Maserati Dealer** center in order to solve the failure.



## Trunk Safety



### WARNING!

**Do not allow children to have access to the trunk. Always close the trunk lid when your vehicle is unattended. Once in the trunk, young children may not be able to escape. If trapped in the trunk, children can die from suffocation or heat stroke.**

### Trunk Lid Emergency Release from inside the Trunk

As a security measure, an internal trunk emergency release lever is built into the trunk latching mechanism. In the event of a person trapped inside the trunk, the trunk lid can be simply opened by pulling on the phosphorescent handle shown in figures.



With Power Trunk Lid/Hand Free Option

## Hood Operation

### Opening

Two latches must be released to open the hood.

- From inside the vehicle, pull the hood release lever located under the left lower side of the dashboard.

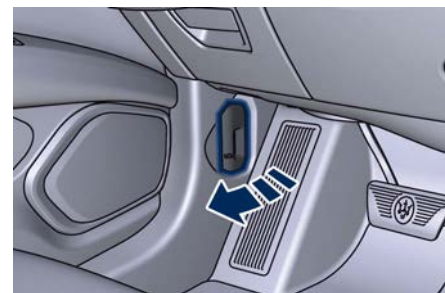

- Move to the outside and stand in front of the vehicle front grille.

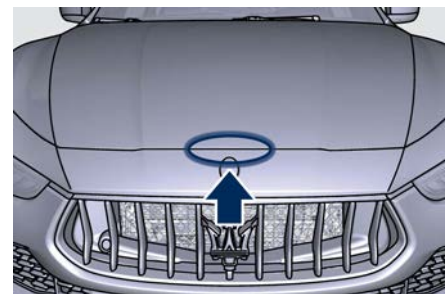



- Slightly lift the hood and push the safety catch as indicated by the arrow. The safety catch is located in the center of the hood.

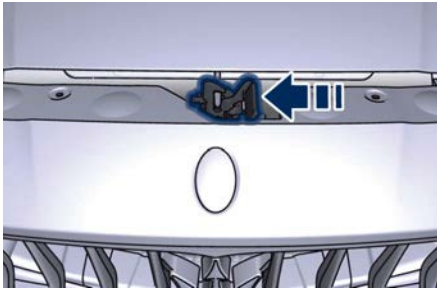

- Lift the hood completely: this operation is facilitated by two gas struts keeping the hood in the fully open position.

With the ignition switch in **RUN** position, the red symbol  will display on the instrument cluster with the message indicating that the hood is open.

## Closing

Lower the hood, and then drop it. This should secure the inclusion of both latches.



### CAUTION!

To prevent possible damage, do not

slam the hood to close it.



### WARNING!

- **Be sure the hood is fully latched before driving your vehicle. If the lid is not fully latched, it could open when the vehicle is in motion and block your vision. Failure to follow this warning could result in serious injury or death.**
- **Gear shifting is always active and may be performed even when one or more doors, the hood or the trunk lid are open. Therefore, in these conditions, take great care to avoid moving the transmission shift lever and so accidentally engage gears.**



## Occupants Restraint Systems

The listed occupants restraint systems are some of the most important safety features in your vehicle:

- Three-point seat belts (also called lap and shoulder belts) for the driver and all passengers.
- Advanced front air bags for driver and passenger.
- Supplemental Side Air Bag Inflatable Curtains (SABIC) for the driver and passengers seated next to a window.
- Supplemental driver side knee air bag.
- Supplemental seat-mounted side air bags.
- An energy-absorbing steering column and steering wheel.
- Front seat belts incorporate dual pretensioners that may enhance occupant protection by managing the energy created during an impact.
- All seat belt systems (except the driver's) include Automatic Locking Retractors (ALR), which lock the seat belt webbing into position by extending the belt all the way out and then adjusting the belt to the



desired length to restrain a child seat or secure a large item in a seat. Please pay close attention to the information in this section. It tells you how to use your restraint system properly, to keep you and your passengers as safe as possible. If you are carrying children too small for adult-sized seat belts, the seat belts or the Lower Anchors and Tether for Children (LATCH) feature also can be used to hold infant and child restraint systems. For more information on LATCH, refer to “Lower Anchors and Tether for Children (LATCH)” in this section.



### WARNING!

To help provide maximum protection, you are advised to keep the seatback in the most upright position possible and the seat belt close to your chest and pelvis. If the seat belt is loose, in the event of an accident you could move too far forward and could be injured. Travelling with the seatback too far reclined could also be dangerous: even if the seat belts are fastened, they may not work correctly. In fact, the belt itself may not be close enough to your body and, if it is in front of you, it could cause neck

wounds or other injuries in an accident. Additionally, in an accident, the lower section of the belt could press against the upper part of your stomach rather than the pelvic area, causing serious internal injuries.

### NOTE:

*The advanced air bags have a multi stage inflator. This allows the air bag to have different stages of inflation based on the severity and type of collision.*

Here are some simple steps you can take to minimize the risk of harm from a deploying air bag:

- Children 12 years old and under should always ride buckled up in a rear seat.



### WARNING!

Infants in rear facing child restraints should never ride in the front seat of a vehicle with a passenger Advanced Front Air Bag. An air bag deployment can cause severe or fatal injury to infants in that position. Do not use child seats or child booster cushions/backrests in the front passenger seat. Occupants in the front

passenger seat must never sit on the edge of the seat, leaning toward the dashboard or otherwise sit out of position. The occupants' back must be as upright as comfort allows, and must rest against the seatback with the seat belt properly fastened. Feet must be on the floor (i.e. not on the dashboard, seat or out of the window).

Children that are not big enough to wear the vehicle seat belt properly (see “Child Restraints System” in this section) should be secured in the rear seat in child restraints seats or belt-positioning booster seats. Older children who do not use child restraints seats or belt-positioning booster seats should ride properly buckled up in the rear seat. Never allow children to slide the shoulder belt behind them or under their arm. The safest place for a child that has outgrown the child safety seat is in the rear seat using the standard seat belt in combination with a suitable booster seat if needed so the seat belt is properly located on the child. You should read the instructions provided with your child restraint system to make sure that you are using it properly.



- All occupants should always wear their lap and shoulder belts properly.
- The driver and front passenger seats should be moved back as far as possible to allow the Advanced Front Air Bags room to inflate.
- Do not lean against the door or window. Your vehicle has Supplemental Side Air Bag Inflatable Curtains (SABIC) and Supplemental Seat-Mounted Side Air Bags (SAB), and if deployment occurs, the SABIC and SAB air bags will inflate forcefully into the space between you and the door.
- If the air bag system in this vehicle needs to be modified to accommodate a disabled person, contact an Authorized Maserati Dealer.

**WARNING!**

- Relying on the air bags alone could lead to more severe injuries in a collision. The air bags work with your seat belt to restrain you properly. In some collisions, the air bags won't deploy at all. Always wear your seat belt even though you have air bags.

- In a collision, you and your passengers can suffer much greater injuries if you are not properly buckled up. You can strike the interior of your vehicle or other passengers, or you can be thrown out of the vehicle. Always be sure you and others in your vehicle are buckled up properly.
- Be sure everyone in your vehicle is in a seat and using a seat belt properly. Occupants, including the driver, should always wear their seat belts whether or not an air bag is also provided at their seating position to minimize the risk of severe injury or death in the event of a crash.
- Buckle up even though you are an excellent driver, even on short trips. Someone on the road may be a poor driver and cause an accident that includes you. This can happen far away from home or on your own street.

Statistics report that seat belts save lives and help reduce the seriousness of injuries in an accident. Some of the worst injuries happen when people are thrown from the vehicle. Seat belts reduce the possibility of ejection

DEALER ePROCESS

and the risk of injury caused by striking the inside of the vehicle. Everyone in a motor vehicle should be belted at all times.

## Three-Point Seat Belts

All seating positions in your vehicle are equipped with combination lap and shoulder belts.

The belt retractor is designed to lock during very sudden stops or impacts. This feature allows the shoulder part of the belt to move freely with you under normal conditions, conforming to the body of the occupants. However, in an accident, the belt will lock and reduce your risk of striking the inside of the vehicle or being thrown out.

The driver is responsible for respecting, and ensuring that all the other occupants of the car also observe the local regulations concerning the use of seat belts. Always fasten the seat belts before starting the vehicle.

Seat belts are designed to be used by persons whose physical characteristics (age, height, weight) are provided for by established legislation in each country. Anyone who does comply with these provisions may not travel in the front passenger seat. This also



applies to children. Their heads are proportionally heavier and larger than those of adults, while their bones and muscles are relatively undeveloped. To help protect them in case of a collision, they must use special restraint or safety systems, even in the rear seat area.



### WARNING!

- It is forbidden and dangerous to ride in a cargo area. In an accident, people riding in these areas are more likely to be seriously injured or killed.
- Do not allow any person to ride in any area of your vehicle that is not equipped with seats and seat belts.
- Be sure all passengers are in a seat and using a seat belt properly.
- Wearing your belt improperly could make your injuries in an accident much worse. You might suffer internal injuries, or you could even slide out of part of the belt. Follow these instructions to wear your seat belt properly and to keep your passengers safe, too.
- Two people should never be belted into a single seat belt. People belted

together can crash into one another in an accident, hurting one another severely. Never use a lap/shoulder belt for more than one person.

- Remember that, in the event of an accident, the rear seat passengers not wearing the seat belts are not only subject to personal injuries but also represent a serious danger for the front seat occupants.

### Three-Point Seat Belts Use Instructions

- Enter the vehicle and close the door. Sit back and adjust the seat.
- The seat belt latch plate is on the rear door pillar, above the seat on the external side.
- Hold the latch plate and pull the belt across you, make the belt go around your body and when the belt is long enough to fit, insert the latch plate into the buckle until you hear a "click."

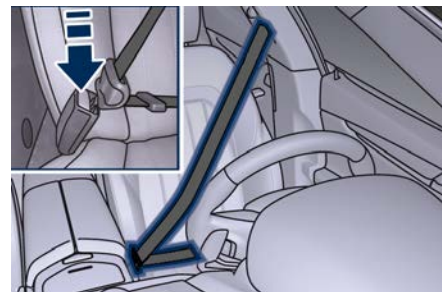

### WARNING!

- The seat belts height must be adjusted only with the vehicle stationary.
- Do not bring sharp edges in contact with a seat belt. This could reduce their initial strength and cause them to tear in the event of a crash.
- If a seat belt has been brought in contact with a sharp edge, or has been used to pin something to it, have it immediately replaced by our Authorized Maserati Dealer.
- A belt that is latched into the wrong buckle will not protect you properly. The lap portion of the belt could ride too high on your body, possibly causing internal injuries. Always





latch your belt into the corresponding buckle.

- A seat belt that is too loose will not protect you properly. In a sudden stop, you could move too far forward, increasing the possibility of injury. Wear your seat belt snugly.
- A belt that is worn under your arm is dangerous. Your body could strike the inside surfaces of the vehicle in an accident, increasing head and neck injury. A belt worn under the arm can also cause internal injuries.
- Position the lap belt so that it is snug and lies low across your hips, below your abdomen. To fasten the lap belt pull slightly up the diagonal portion of the shoulder belt. To loosen the lap belt if too tight, tilt the latch plate and pull on the lap belt. A snug belt reduces the risk of sliding under the belt in an accident.



### WARNING!

- A lap belt worn too high can increase the risk of internal injury in an accident. The belt forces won't impact on the strong hip and pelvic bones, but across your abdomen. Always wear the lap belt as low as

possible and keep it comfortable.

- A twisted belt will not protect you properly. In a collision, it could even cut into you. Be sure the belt is straight. If you can't straighten a belt in your vehicle, take it to a Service Center immediately.
- Do not use devices (clips, fastenings etc.) that prevent the seat belts from laying close to the occupants bodies.
- Never carry children on a passenger's lap.
- Position the shoulder belt on your chest so that it is comfortable and not resting on your neck. The retractor will withdraw any slack in the belt.
- To release the belt, push the red button on the buckle. The belt will automatically retract to its stowed position. If necessary, guide the seat belt with your hand while it is rewinding, to prevent it from twisting.



### WARNING!

A frayed or torn belt could break in an accident and leave you with no protection. Inspect the belt system periodically, checking for cuts, frays,

or loose parts. Damaged parts must be replaced immediately. Do not disassemble or modify the system. Seat belt/retractor assemblies must be replaced by an Authorized Maserati Dealer after an accident if they have been damaged (bent retractor, torn belt, etc.).

### Three-Point Seat Belt Height Adjustment



### WARNING!

- Wearing your seat belt incorrectly could make your injuries in a collision much worse. You might suffer internal injuries, or you could even slide out of the seat belt. Follow these instructions to wear your seat belt safely and to keep your passengers safe, too.
- Position the shoulder belt across the shoulder and chest with minimal, if any slack so that it is comfortable and not resting on your neck. The retractor will withdraw any slack in the shoulder belt.
- Misadjustment of the seat belt could reduce the effectiveness of the safety belt in a crash.

(Continued)



2

*(Continued)*

- Always make all seat belt height adjustments when the vehicle is stationary.

The vehicle has a shoulder belt height adjuster for the driver and front passenger seating positions.

Adjust the guide so that the shoulder portion of the belt is on the shoulder and not falling off of it. The belt should be close to, but not contacting, the neck.

Push the indicated button above the shoulder belt guide to release the anchorage, then move the belt slider up or down to the fixed position that fits you best.



### WARNING!

After the adjustment, always check that the slider to which the oscillating ring is fixed, is locked into one of the positions provided. With the handgrip released, push again downward to allow the anchoring device to click into place, in the event that it has not been released in one of the positions provided.



When you release the anchorage try to move the belt slider up and down to make sure that it is locked in position.

### Three-Point Seat Belt Untwisting Procedure

Use the following procedure to untwist a twisted three point belt.

- Position the latch plate as close as possible to the anchor point.
- At about 0.5 to 1 ft (15 to 30 cm) above the latch plate, grasp and twist the belt 180 degrees to create a fold that begins immediately above the latch plate.
- Slide the latch plate upward over the folded belt. The folded belt must enter the slot at the top of the latch plate.
- Continue to slide the latch plate up until it clears the folded belt.



### Passengers Seat Belts

All passengers seat belts are equipped with Automatic Locking Retractors (ALR) and can be used to secure a child restraint system. For additional information, see "Installing Child Restraint Systems using the Vehicle Seat Belt equipped with ALR" under "Child Restraint Systems" in this section.

If the passenger seat position should not be used to accommodate a child restraint system, only pull the belt out far enough to comfortably wrap around the occupant so as to not activate the ALR. If the ALR is activated, you will hear a ratcheting sound as the belt retracts. In this case, allow the belt to retract completely and then carefully pull out only the amount of belt necessary to comfortably wrap around the seat occupant.

Slide the latch plate into the buckle until you hear a "click".



### WARNING!

- Remember that, in the event of a violent impact, the passengers in the rear seats who are not wearing the seat belts are not only subject to





personal injury but also represent a danger for passengers sitting in the front seats.

- Always fasten the seat belts.
- Traveling without the seat belts fastened significantly increases the risk of serious injury in the event of a collision, even with the air bags.
- In the event of a collision, the seat belts help reduce the possibility of the vehicle's occupants being thrown against the structures of the passenger compartment or out of the vehicle.
- The air bags are designed to work together with the seat belts, not to substitute them. The front air bags only deploy in the event of certain head-on collisions of sufficient intensity. They may not be activated if the vehicle rolls over, or in the event of rear bumps or minor frontal collisions, or non-frontal collisions.

### Seat Belt for Rear Central Seat

The rear central seat belt has two buckles and two metal latch plates; in this way it is possible to release it from the seat and fold down the long part (60) of the seatback (refer to "Cargo Area" in section "Understanding the Vehicle" for further information). To

buckle the seat belt proceed as follows:

- Take place in the central seat and pull out the belt from the upper retractor in a normal manner, without twisting it.
- Insert the first latch plate located at the end of the shoulder portion of the belt inside the left buckle (this is the one without the red unlatch button on the top of the slot).



- Insert the latch plate located at the end of the lap portion of the belt inside the right buckle.

To unlatch the seat belt, release the right plate of the lap portion by clicking on the red button.

### Using Seat Belt in Automatic Locking Retractor Mode (ALR)

Use the seat belt automatic locking mode anytime a child safety seat is

installed in a seating position that has a belt with this feature.

Children under 5 ft (1.50 m) in height, should be properly buckled up in a child restraint system.

### Automatic Locking Mode Setting

- Buckle the lap and shoulder belt.
- Grasp the shoulder portion and pull downward until the entire belt is extracted.
- Allow the belt to retract. As the belt retracts, you will hear a clicking sound. This indicates the safety belt is now in the automatic locking mode.

### Automatic Locking Mode Unsetting

Unbuckle the three point seat belt and allow it to retract completely to disengage the automatic locking mode and activate the vehicle emergency locking mode.



### WARNING!

- The belt and retractor assembly must be checked by an Authorized Maserati Dealer and must be replaced if the Automatic Locking Retractor (ALR) feature or any other seat belt function is not working

(Continued)



(Continued)  
properly.

- Failure to replace the belt and retractor assembly could increase the risk of injury in collisions.

## Seat Belt Pretensioners

The car is equipped with front seat belt pretensioners, that reduce slack in the belts in the event of a severe frontal impact. This guarantees the perfect adherence of the seat belts to the occupants bodies before the restraining action begins.

This car is also equipped with a second pretensioner in the kick plate area. Its activation is signalled by the shortening of the metal cable and curling of its protective sheath.

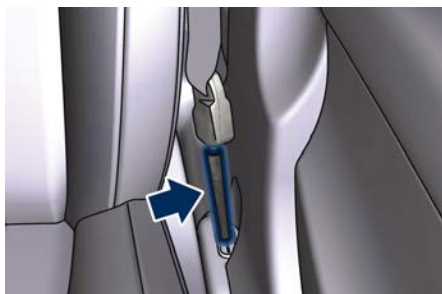

Pretensioners work for all size occupant restraint systems, including the child restraint systems.

### NOTE:

*To obtain the highest degree of protection from the action of the pretensioning device, wear the seat belt tight to the chest and pelvis.*

Pretensioners are triggered by the Occupant Restraint Controller (ORC). A pretensioner may be used only once because it is a pyrotechnic device. Pretensioners do not require any maintenance or lubrication: any changes to its original conditions will invalidate its efficiency. If, due to unusual natural events (floods, sea storms, etc.), the device has been affected by water and mud, it must be replaced.



**WARNING!**  
It is strictly forbidden to remove or tamper with the pretensioner components. Any service intervention must be carried out only by qualified and authorized personnel. Always contact an Authorized Maserati Dealer.

**DEP**  
DEALER ePROCESS





### CAUTION!

Operations which lead to impacts, vibrations or localized heating (over 212°F/100°C for a maximum of 6 hours max.) in the area around the pretensioners may damage or deploy them erroneously. These devices are not affected by vibrations caused by uneven road surfaces or low obstacles. Contact the **Authorized Maserati Dealer** for any intervention that may be required.

## Enhanced Seat Belt Use Reminder System (BeltAlert®)

BeltAlert® is a feature intended to remind the driver and front passenger to fasten their seat belts. The feature activates with engine running. If the driver or front seat passenger is unbelted, the seat belt reminder light  and the related message will turn on in the instrument cluster. Message remains on for 5 seconds.



The BeltAlert® warning sequence begins after the vehicle speed is over 5 mph (8 km/h) for more than 19 seconds, by blinking the seat belt reminder light  and message and by sounding an intermittent chime. Once the sequence starts, it will continue for the entire duration. After the sequence completes, the seat belt reminder light  remains illuminated until the respective seat belts are fastened and the message remains on for 5 seconds. If the opened front door on the driver or passenger side is closed and the occupant presence sensor detects a status change from occupant not present to occupant present the system will repeat the warning sequence. The driver should instruct all other occupants to fasten their seat belts.

If a front seat belt is unbuckled while traveling at speeds greater than 5 mph (8 km/h), BeltAlert® will provide both audio and visual notification on the instrument cluster. The front passenger seat BeltAlert® is not active when the front passenger seat is not occupied. BeltAlert® may be triggered when an animal or heavy object is on the front passenger seat. It is recommended to restrain pets in the rear seat, in pet harnesses or pet carriers that are secured by seat belts, and properly stow cargo.

### Seat Belts and Pregnant Women

Seat belts should be worn by pregnant women: the risk of injury in the event of an accident is greatly reduced for them and the unborn child if they are wearing a seat belt. The best way to protect the fetus is to protect the mother. Pregnant women must position the lower part of the belt below the belly so that it passes over the pelvis and under the abdomen (see figure).



When a safety belt is worn properly, it is more likely that the baby will not be hurt in a crash. For pregnant women, as for anyone, the key to making safety belts effective is wearing them properly.



#### **WARNING!**

**Pregnant women should observe the above indications, as well as local regulation concerning the use of seat belts.**





### Supplemental Restraint System (SRS) — Air Bags

This vehicle has front air bags and lap/shoulder belts for both the driver and front passenger. The front air bags are a supplement to the seat belt restraints systems.

The driver's advanced front air bag is mounted in the center of the steering wheel in the area shown in the picture. On this area is embossed the word "SRS AIRBAG" for easier recognition.

The passenger's advanced front air bag is mounted in the dashboard, above the glove compartment in the area shown in the picture. On this area is embossed the word "AIRBAG" for easier recognition.

In addition, the vehicle is equipped with a supplemental driver side knee air bag mounted in the dashboard below the steering column.

#### NOTE:

*These air bags are designed to the advanced air bag regulatory requirements.*



The advanced front air bags have a multistage inflator design. This allows the air bag to have different rates of inflation based on the severity and type of collision.

This vehicle is equipped with driver and front passenger seat track position sensors that may adjust the inflation level of the advanced front air bags based upon seat position.

This vehicle is also equipped with a front passenger seat belt buckle sensor that detects whether the front passenger seat belt is fastened. The seat belt buckle sensor may adjust the inflation rate of the advanced front air bag.

This vehicle is equipped with Supplemental Side Air Bag Inflatable Curtains (SABIC) to protect the heads of front and rear outer occupants. The SABIC air bags are located above the

side windows and their covers are also labeled "AIR bag".

This vehicle is also equipped with Supplemental Seat-Mounted Side Air Bags (SAB) for driver and passenger pelvis-chest-shoulder protection during a side impact. The Supplemental Seat-Mounted Side Air Bags are mounted on front seats and are located in the outboard side of the front seats.

#### NOTE:

*After any accident, the vehicle should be taken to the **Authorized Maserati Dealer** immediately.*

### Air Bag System Components

Your vehicle may be equipped with the following air bag system components:

- Occupant Restraint Controller (ORC);
- Air bag warning light on the instrument cluster;
- Steering wheel and column;
- Instrument cluster;
- Driver advanced front air bag;
- Passenger advanced front air bag;
- Supplemental driver side knee air bag.
- Supplemental Seat-Mounted Side Air Bags (SAB);



- Supplemental Side Air Bag Inflatable Curtains (SABIC);
- Front and side impact sensors;
- Front seat belt pretensioners;
- Seat belt buckle switch;
- Seat track position sensors;
- Pyrotechnical charge to cut power from the battery; it is located on the positive battery terminal.

**WARNING!**

The air bag is not a substitute for the seat belts. Correct use of the seat belts, in combination with the air bag, will offer protection for the driver and passenger in the front seat in the event of a head-on collision.

## Advanced Front Air Bags Properties

The advanced front air bag system has multistage driver and front passenger air bags. This system provides air bag inflation rates which are appropriate to the severity and type of collision as determined by the Occupant Restraint Controller (ORC), which may receive information from the front impact sensors.

The first stage inflator is triggered immediately during an impact that requires air bag deployment. This inflation rate is used in less severe collisions. A higher energy output, inflation rate, is used for more severe collisions.

**CAUTION!**

• The airbag system must be ready to protect you in a collision. The Occupant Restraint Controller (ORC) monitors the internal circuits and interconnecting wiring associated with electrical Air Bag System Components listed below:

- Occupant Restraint Controller (ORC)
- Airbag Warning light on the instrument cluster
- Steering Wheel and Column Instrument Cluster
- Driver advanced front air bag
- Passenger advanced front air bag
- Supplemental Seat-Mounted Side Air Bags (SAB) Air Bags
- Supplemental Side Air Bag Inflatable Curtains (SABIC)
- Front and side Impact Sensors
- Front seat belt pretensioners
- Seat Belt Buckle Switch

- Seat Track Position Sensors
- Pyrotechnical charge to cut the power from the battery: it is located on the positive battery terminal

- The electronic control unit provides for the activation of the pretensioners, front air bags or side air bags (front and rear) based on different criteria, according to the type of impact. Failure of one or more systems to activate is not indicative of a system malfunction.
- The front and/or lateral air bags may inflate if the vehicle suffers a violent impact involving the underbody area, for example in case of violent impacts against steps, sidewalks, speed bumps, or when the vehicle falls into potholes, or similar.

**WARNING!**

- No objects should be placed over or near the air bag on the instrument panel or steering wheel because any such objects could cause harm if the vehicle is in a collision severe enough to cause the air bag to inflate.

*(Continued)*



*(Continued)*

- Do not place anything on or around the air bag covers or attempt to open them manually. You may damage the air bags and you could be injured because the air bags may no longer be functional. The protective covers for the air bag are designed to open only when the air bags are inflating.
- Always drive with your hands on the steering wheel rim, so that the air bag can inflate freely if required. During the drive your back must be as upright as comfort allows and be against the seat back with the seat belt properly fastened.
- Do not apply stickers or other objects on the steering wheel, on the dashboard in the passenger's side air bag area, on roof side trims or on the seats.
- Do not travel with objects in your lap, in front of your chest or especially with a pipe, pencil or other objects in your mouth. In the event of a collision, the intervention of the air bag could result in serious injury.
- **EXTREME HAZARD!** Do not place a rearward-facing infant seat onto the front seat (see warning plate on the

dashboard and above and behind the sun visors). Deployment of the air bag in an accident could cause fatal injuries to the baby regardless of the severity of the collision.

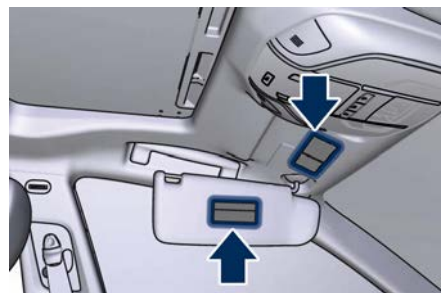
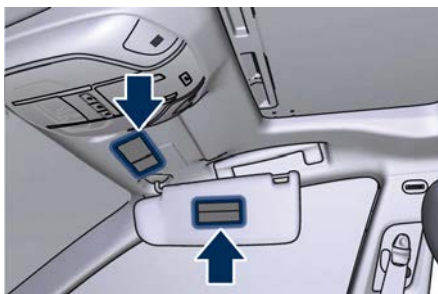

### Supplemental Air bags

#### Supplemental Seat-Mounted Side Air Bags (SAB)

Supplemental Seat-Mounted Side Air Bags (SAB) protect the pelvis, chest and shoulder area of the occupants in the event of a side impact of medium/high severity. The SAB is marked with "AIRBAG" label sewn into the outboard side of the front seats.





When the air bag deploys, it opens the seam between the front and side of the seat's trim cover. Each air bag deploys independently; a left side impact deploys the left air bag only and a right side impact deploys the right air bag only.

### Supplemental Side Air Bag Inflatable Curtain (SABIC)

SABIC air bags are designed to protect the head of front and rear occupants in the event of a side impact, thanks to the wide cushion inflation surface. Each air bag features inflated chambers placed adjacent to the head of each outboard occupant that reduce the potential for side-impact head injuries. The SABICs deploy downward, covering both windows on the impact side.



#### WARNING!

- Side air bags also need room to inflate. Do not rest your head, arms or elbows on the door, windows or the area in which the window bag is located to avoid possible injury during air bag inflation. Sit upright in the center of the seat.
- Do not cover the front seatbacks with clothes or covers. Do not use

accessory seat covers or place objects between you and the side air bags; the performance could be adversely affected and/or objects could cause serious injury.

- Do not add roof racks that require permanent attachments (bolts or screws) for installation on the vehicle roof. Do not drill into the roof of the vehicle for any reason.

### Supplemental Driver Side Knee Air bag

The supplemental driver side knee air bag provides enhanced protection and works together with the driver advanced front air bag during a frontal impact.

### Air Bag Deployment Sensors and Controls

#### Occupant Restraint Controller (ORC)

The Occupant Restraint Controller (ORC) determines if deployment of the front air bags and/or side air bags in a frontal or side collision or rollover event is required. Based on the impact sensor's signals, a central electronic ORC deploys the advanced front air bags, SABIC and SAB air bags, and front seat belt pretensioners, as

DEALER ePROCESS

required, depending on the severity and type of impact.

On top of what previously described, the characteristics of the collision registered by the sensors and sent to the control unit of the ORC can also cause a sudden cut of the power from the battery, "blowing" the pyrotechnical charge located on the positive battery terminal.



#### CAUTION!

After a collision that has caused the ignition of the pyrotechnical charge, this must be replaced at an Authorized Maserati Dealer.

Advanced front air bags are designed to provide additional protection by supplementing the seat belts in certain frontal collisions depending on the severity and type of collision.

Advanced front air bags are not expected to reduce the risk of injury in rear, side, or rollover collisions.

The advanced front air bags will not deploy in all frontal collisions, including those that may produce substantial vehicle damage, for example, some pole collisions, truck under rides, and corner impacts. On the other hand, depending on the type and location of impact, advanced



front air bags may deploy in crashes with little vehicle front-end damage but that produce a severe initial deceleration.

The side air bags will not deploy in all side collisions. Side air bag deployment will depend on the severity and type of collision. Because air bag sensors measure vehicle deceleration over time, vehicle speed and damage merely are not good indicators of whether or not an air bag should have deployed.

Seat belts are necessary for your protection in all accidents, and also are needed to help keep you in position, away from an inflating air bag. The ORC monitors the readiness of the electronic parts of the air bag system whenever the ignition switch is in the **RUN** position. If the ignition switch is in the **OFF** position, in the **ACC** position, or not active, the air bag system is not activated and the air bags will not inflate.

The ORC contains a backup power supply system that may deploy the air bags even if the battery has low power or it becomes disconnected prior to deployment. When starting the vehicle, ORC turns on the air bag warning light  on the instrument

cluster for approximately 4 to 8 seconds for a test.

After the test, the air bag warning light will turn off. If the ORC, during the diagnosis phase detects a malfunction that could affect the air bag system, it turns on the air bag warning light and the "Service Airbag System" message either momentarily or continuously. The diagnostics also record the nature of the malfunction. A beep will sound if the light illuminates again after initial startup.



The air bag warning light monitors the internal circuits and interconnecting wiring associated with air bag system electrical components.



**WARNING!**  
• If the ignition switch is in RUN position, the engine is off and the

**vehicle is in complete stop, the air bags can be deployed in case of collision. For this reason, children must never occupy the front seat in a rearward facing seat even if the car is not moving. Deployment of the air bag following an impact could cause fatal injuries to the child. Please note that when the ignition switch is in the OFF or ACC position or is turned off, the air bag will not deploy in case of collision. Therefore, in these cases, lack of air bag deployment is not an indication of a system malfunction.**

- Ignoring the air bag warning light and message in your instrument cluster could mean you won't have the air bags to protect you in the event of a collision. If the light does not come on as a bulb check when the ignition is first turned on, stays on after you start the engine, or if it comes on as you drive, have an **Authorized Maserati Dealer service the air bag system immediately.**

### Front Air Bag Inflator Units

When the ORC detects a collision requiring the advanced front air bags, it signals the inflator units. A large





quantity of nontoxic gas is generated to inflate the advanced front air bags. The steering wheel hub trim cover and the upper right side of the dashboard separate and fold out of the way as the air bags inflate to their full size. The air bags then quickly deflate while helping to restrain the driver and front passenger. The advanced front air bag gas is vented through the vent holes in the sides of the air bag. In this way, the air bags do not interfere with your control of the vehicle.

#### **Supplemental Driver Side Knee Air Bag Inflator Unit**

The supplemental driver side knee air bag unit is located in the dashboard trim beneath the steering column. When the ORC detects a collision requiring the air bag, it signals the inflator units. A large quantity of non-toxic gas is generated to inflate the supplemental driver side knee air bag. The trim cover separates and folds out of the way allowing the air bag to inflate to the full size.

#### **Supplemental Seat-Mounted Side Air Bag (SAB) Inflator Units**

The ORC unit determines if a side collision requires the side air bags to inflate, based on the severity and type of collision. Based on the severity and

type of collision, the side air bag inflator on the crash side of the vehicle may be triggered, releasing a quantity of nontoxic gas. The inflating SAB exits through the seat seam into the space between the occupant and the door. The side air bag moves at a very high speed and with such a high force that it could injure you if you are not seated properly, or if items are positioned in the area where the side air bag inflates. This especially applies to children.

#### **Supplemental Side Air Bag Inflatable Curtain (SABIC) Inflator Units**

During collisions where the impact is confined to a particular area of the side of the vehicle, the ORC may deploy the SABIC air bags, depending on the severity and type of collision. In these events, the ORC will deploy the SABIC only on the impact side of the vehicle. A quantity of non-toxic gas is generated to inflate the side curtain air bag.

The inflating side curtain air bag pushes the head/s of the occupant/s seating in the outside seats from the edge of the headliner out of the way and covers the window. The air bag inflates with enough force to possibly

injure you if you are not belted and seated properly, or if items are positioned in the area where the side curtain air bag inflates. This especially applies to children. The SABICs may also help reduce the risk of partial or complete ejection of vehicle occupants through side windows in certain rollover events (because equipped with rollover sensing).

#### **Front and Side Impact Sensors**

In front and side impacts, impact sensors can aid the ORC in determining appropriate response to impact events.

#### **Enhanced Accident Response System**

In the event of an impact causing air bag deployment, if the communication network and the power remains intact, depending on the nature of the accident, the ORC will determine whether the enhanced accident response system will have to perform the following functions:

- cut off fuel to the engine;
- turn hazard lights and interior lights on as long as the battery has power or until the ignition switch is turned off;
- unlock the doors automatically;



- disconnect the battery with a pyrotechnic charge.

### Air Bag Deployment Result

The advanced front air bags are designed to deflate immediately after deployment.

If you do have a collision which deploys the air bags, any or all of the following may occur:

- The nylon air bag material may sometimes cause abrasions and/or skin reddening to the driver and front passenger as the air bags deploy and unfold.
- As the air bags deflate, you may see some smoke-like particles. The particles are a normal by-product of the process that generates the non-toxic gas used for air bag inflation. These airborne particles may irritate the skin, eyes, nose, or throat. If these particles settle on your clothing, follow the garment manufacturer's instructions for cleaning. Do not drive your vehicle after the air bags have deployed. If you are involved in another collision, the air bags will not be in place to protect you.



### ENVIRONMENTAL!

Air bag inflation releases a small amount of powder. This powder is not harmful to the environment.



### WARNING!

**California Proposition 65 Operating, servicing and maintaining a passenger vehicle or off-road vehicle can expose you to chemicals including such as, engine exhaust, carbon monoxide, phthalates and lead, that which are known to the State of California to cause cancer and birth defects or other reproductive harm. To minimize exposure, avoid breathing exhaust, do not idle the engine except as necessary, service your vehicle in a well-ventilated area and wear gloves or wash your hands frequently when servicing your vehicle. For more information go to: [www.P65Warnings.ca.gov/passenger-vehicle](http://www.P65Warnings.ca.gov/passenger-vehicle)**



### WARNING!

- Deployed air bags and seat belt



pretensioners cannot protect you in another collision. Have the air bags, seat belt pretensioners, and the front seat belt retractor assemblies replaced by a Maserati Service Center. Also, have the Occupant Restraint Controller (ORC) system serviced as well.

- Have the air bag checked, serviced and replaced only by an Authorized Maserati Dealer.

### Air Bag System Maintenance



### WARNING!

- Modifications to any part of the air bag system could cause it to fail; thus you could be injured if the air bag system is not there to protect you. Do not modify the components or wiring. Do not modify the front bumper, vehicle body structure, or add aftermarket side steps or running boards.
- It is dangerous to try to repair any part of the air bag system without the necessary know-how.
- Do not attempt to modify any part of your air bag system. The air bag may inflate accidentally or may not



function properly if modifications are made. Take your vehicle to an Authorized Maserati Dealer for any air bag system service. If your seat including your trim cover and cushion needs to be serviced in any way (including removal or loosening/tightening of seat attachment bolts), take the vehicle to an Authorized Maserati Dealer.

- Only Maserati manufacturer approved seat accessories may be used. If it is necessary to modify the air bag system for persons with disabilities, contact an Authorized Maserati Dealer.
- If the speedometer, Rev Counter, or any engine related gauges are not working, the Occupant Restraint Controller (ORC) may also be disabled. The air bags may not be ready to inflate for your protection. Promptly check the fuse block for blown fuses. To identify the air bag fuse see "Fuse Replacement" in section "Maintenance and Care". See an Authorized Maserati Dealer if the fuse does not fix the problem.

## Transport of persons with disability

If it is necessary to modify the advanced air bag system of your vehicle to accommodate a person with disabilities, contact an **Authorized Maserati Dealer**.



### WARNING!

- The advanced air bag system of your vehicle is not designed to protect adults with disabilities that require deactivation of the passenger or driver air bag.
- If you or another occupant is an adult with a medical condition that requires air bag deactivation, please contact an Authorized Maserati Dealer. For further information on disabled driver or passengers see <http://www.safercar.gov>.
- As long as the air bag is activated, persons with disabilities are advised not to travel in the front seat in order to avoid the risk of serious injuries or death, even in minor crashes.



## Event Data Recorder (EDR)

This vehicle is equipped with an event data recorder (EDR). The main purpose of an EDR is to record, in certain crash or near crash-like situations, such as an air bag deployment or hitting a road obstacle, data that will assist in understanding how a vehicle's systems have performed.

The EDR is designed to record data related to vehicle dynamics and safety systems for a short period of time, typically 30 seconds or less. The EDR in this vehicle is designed to record such data as:

- how various systems in your vehicle were operating;
  - whether or not the driver and passenger safety belts were buckled/fastened;
  - how far (if at all) the driver was depressing the accelerator and/or brake pedal; and
  - how fast the vehicle was traveling.
- These data can help provide a better understanding of the circumstances in which crashes and injuries occur.



### NOTE:

EDR data are recorded by your vehicle only if a non-trivial crash situation occurs; no data are recorded by the EDR under normal driving conditions and no personal data (e.g., name, gender, age, and crash location) are recorded. However, other parties, such as law enforcement, could combine the EDR data with the type of personally identifying data routinely acquired during a crash investigation.

To read data recorded by an EDR, special equipment is required, and access to the vehicle or the EDR is needed.

In addition to the vehicle manufacturer, other parties, such as law enforcement, that have the special equipment, can read the information if they have access to vehicle or the EDR.

## Child Restraint Systems

### NOTE:

A child restraint system can help protect a child in a vehicle so ensure that the child restraint selected has a certification label applicable to FMVSS 213 in the U.S., or CMVSS 213 in Canada.

Everyone in your vehicle must be buckled up all the time, including babies and children. Every state in the United States and all Canadian provinces require that small children ride in proper restraint systems. Please be reminded that you can be prosecuted for ignoring this law. Children 12 years or younger should ride properly buckled up in a rear seat, if available. According to crash statistics, children are safer when properly restrained in the rear seats rather than in the front.



### WARNING!

**In a collision, an unrestrained child, even a baby, can become a projectile inside the vehicle. The force required to hold even an infant on your lap could become so great that you could**

**not hold the child, no matter how strong you are. The child and others could be badly injured or killed. Any child riding in your vehicle should always be in a proper restraint system suitable for the child's size.**

There are different sizes and types of restraint systems for children from newborn size to the child almost large enough for an adult safety belt. Always refer to the manual provided with child seat to ensure it is the proper type according the travelling child. Use the restraint system that is correct for your child.

### Infants and Child Restraints

Safety experts recommend that children ride rearwardfacing in the vehicle until they are two years old or until they reach either the height or weight limit of their rear facing child seat.

Two types of child restraint systems can be used rearward-facing: infant carriers and convertible child seats. The infant carrier is only used rearward-facing in the vehicle. It is recommended for children from birth until they reach the weight or height limit of the infant carrier.



Convertible child seats can be used either rearward-facing or forward-facing in the vehicle. Convertible child seats often have a higher weight limit in the rearward-facing direction than infant carriers do, so they can be used rearward-facing by children who have outgrown their infant carrier but are still younger than at least two years old.

Children should remain rearward-facing until they reach the highest weight or height allowed by their child seat. Both types of child restraint systems are fixed to the car by the lap/shoulder belt or the LATCH child restraint anchor system. Refer to “Lower Anchors and Tether for CHildren (LATCH)” in this section.



### **WARNING!**

- **Never place a rear facing infant seat in front of an air bag. A deploying Passenger Advanced Front Air Bag can cause death or serious injury to a child 12 years or younger, including a child in a rearward facing infant seat.**

- **Only use a rearward-facing child restraint in a vehicle with a rear seat.**

## **Older Children and Child Restraints**

Children who are two years old or who have outgrown their rear-facing child seat can ride forward-facing in the vehicle. Forward-facing child seats and convertible child seats used in the forward-facing direction are for children who are over two years old or who have outgrown the rear-facing weight or height limit of their rear-facing child seat.

Children should remain in a forward-facing child seat with a harness for as long as possible, up to the highest weight or height allowed by the child seat. These child seats are also fixed to the car by the lap/shoulder belt or the LATCH child restraint anchorage system. Refer to “Lower Anchors and Tether for CHildren (LATCH)” in this section. All children whose weight or height is above the forward-facing limit for the child seat should use a belt-positioning booster seat until the vehicle’s seat belts fit properly. If the child cannot sit with knees bent over

the vehicle’s seat cushion while the back is against the seatback, they should use a belt-positioning booster seat.

The child and belt-positioning booster seat are fixed to the car by the lap/shoulder belt.

## **Children Too Large for Booster Seats**

Children who are large enough to wear the shoulder belt comfortably and whose legs are long enough to bend over the front of the seat when their back is against the seatback should use the lap/shoulder belt in a rear seat.

- Make sure that the child is upright in the seat.
- The lap portion should be low on the hips and as snug as possible.
- Check belt fit periodically. A child’s squirming or slouching can move the belt out of position.
- If the shoulder belt contacts the face or neck, move the child closer to the center of the vehicle. Never allow a child to put the shoulder belt under an arm or behind their back.



### NOTE:

For additional information, refer to "<http://www.safercar.gov/parents/index.htm>" [www.safercar.gov/parents/index.htm](http://www.safercar.gov/parents/index.htm) or call 1-888-327-4236.

Canadian residents should refer to Transport Canada's website for additional information: [http://www.tc.gc.ca/eng/motorvehicle\\_safety/safedrivers-childsafety-index-53.htm](http://www.tc.gc.ca/eng/motorvehicle_safety/safedrivers-childsafety-index-53.htm)



### WARNING!

- **Improper installation can lead to failure of an infant or child restraint. It could come loose in a collision. The child could be badly injured or killed. Follow the restraint manufacturer's directions exactly when installing an infant or child restraint.**
- **A rearward-facing child restraint should only be used in a rear seat. A rearward-facing child restraint in the front seat may be struck by a deploying passenger air bag, which may cause severe or fatal injury to the infant.**

## Here are some tips on getting the most out of your child restraint

- Before buying any restraint system, make sure that it has a label certifying that it meets all applicable Safety Standards. Maserati also recommends that you make sure that you can install the child restraint in the vehicle where you will use it before you buy it.
- The restraint system must be appropriate for your child's weight and height.
- Check the label on the restraint system for weight and height limits.
- Carefully follow the instructions that come with the restraint system.
- If installed improperly, it may not work when needed.
- Fit the child into the seat according to the child restraint manufacturer's directions.



### WARNING!

**When your child restraint system is not in use, secure it in the vehicle with the seat belt or remove it from the vehicle. Do not leave it loose in the vehicle. In a sudden stop or accident, it**

**could strike the occupants or seatbacks and cause serious personal injury.**

## Installing Child Restraint Systems using the Vehicle Seat Belt equipped with ALR

Child restraint systems are designed to be secured in vehicle seats by lap belts or the lap belt portion of a lap/shoulder belt.

All the passenger seat belts are equipped with an Automatic Locking Retractor (ALR) to secure child protection through a Child Restraint System (CRS). These types of seat belts are designed to keep the lap portion of the seat belt tight around the child restraint seat avoiding to use a locking clip.

The ALR will make a ratcheting noise if the entire belt is pulled out of the retractor in order to enable the belt to retract subsequently. For additional information on ALR, see "Using Seat Belt in Automatic Locking Retractor (ALR) Mode" in "Occupants Restraint Systems" in this section.

To install a Child Restraint System with ALR, pull enough of the belt out of the retractor leading it through the belt path of the protection device. Slide the



latch into the buckle until it clicks, then remove the entire safety belt from the retractor in order to rewind. While rewinding a click will indicate the safety belt is now in Automatic Locking mode. Exert then a traction on the exceeded lap section of the belt in order to tighten it around the child restraint seat. All seat belts will loosen over time, it is therefore necessary to check them periodically and set them properly.

### Lower Anchors and Tether for Children (LATCH)

Your vehicle's rear outboard seats are all equipped with the child restraint anchorage system called LATCH. The LATCH system allows the child restraint systems to be fixed without using the vehicle's seat belts, instead fixing the child restraint system to the vehicle structure, using lower anchorages **A** and upper tether strap **B**.

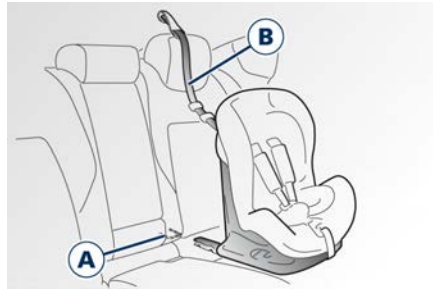

LATCH-Compatible child restraint systems are now available. You should never install LATCH child seats so that two seats share a common lower anchorage. If your child restraints are not LATCH-Compatible, install the restraints using the vehicle's seat belts.

### Installing a LATCH- Compatible Child Restraint System

The lower LATCH anchorages are “U-shaped” metal rings located on the rear seat where the cushion meets the seatback just below the symbol shown in the picture, but are not visible. You will find them if you run your finger along the intersection of the seatback and seat cushion surfaces.



In addition, there are tether strap anchorages behind each rear seat.

#### **NOTE:**

*The top tether strap anchorage behind the central rear seat should be used to secure a child restraint system with the vehicle's seat belts.*



2

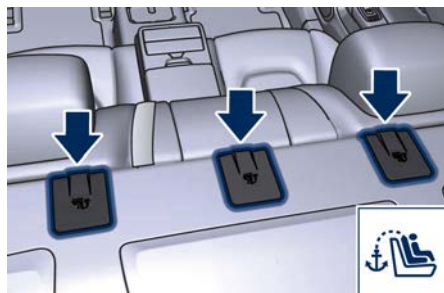

To install a LATCH-Compatible child restraint seat proceed as follows.

- Secure the child seat to the “U-shaped” lower metal rings positioned on the rear seat.
- Fix the top tether strap (provided with the child seat), to the anchor located in the panel between the rear seat back and the rear window.
- Lift the plastic cover located behind the seat where you want to install the child restraint system.



- Route the top tether strap to provide the most direct path between the anchorage and the child restraint passing it over the headrest.
- Attach the hook of the top tether strap (provided with the child restraint system) to the anchor.



- Tighten the upper strap until you reach the tension level recommended by the restraint system manufacturer.

DEALER ePROCESS

To install a child restraint system in the center seating position route the hook end of the tether strap between the seatback and adjustable headrest (with the headrest in the full up position) then attach the hook to the anchor located in the panel between the rear seatback and the rear window.



**NOTE:**

*For any further details on installation and/or use of child restraint system, refer to the instructions provided with the child seat.*



**WARNING!**

- **A child seat should be fitted only when the car is stationary. Follow the instructions for assembly, disassembly and positioning that the**





manufacturer must supply with the child restraint system.

- An incorrectly anchored tether strap could lead to increased head motion and possible injury to the child. Use only the anchor position directly behind the child seat to secure a child restraint top tether strap.

#### NOTE:

- Ensure that the tether strap does not slip into the opening between the seatbacks as you remove slack in the strap.
- When using a LATCH-Compatible child restraint system, please ensure that all seat belts not being used for occupant restraints are stowed and out of reach of children.



#### WARNING!

- Improper installation of a child restraint system to the LATCH anchorages can lead to failure of an infant or child restraint. The child could be badly injured or killed. Follow the child restraint manufacturer's directions exactly when installing an infant or child restraint system.

- Child restraint anchorages are designed to withstand only those loads imposed by correctly fitted child restraints. Under no circumstances are they to be used for adult seat belts, harnesses, or for attaching other items or equipment to the vehicle.

### Important Safety Notice for Transporting Children

- Install the child seat on the rear seat as this is the safest position in case of collisions.
- Keep the instructions in the vehicle together with the documents and this owner's manual. Do not use a child restraint system which does not contain instructions for use.
- Every child has to use one child restraint system; never carry two children using only one child seat.
- If using the vehicle seat belt, always check that the belt does not restrain the child's throat.
- Firmly pull the seat belt to check that it is correctly buckled.
- Never allow a child to seat improperly or to unbuckle the seat belt while driving.

- Never allow a child to wear the shoulder portion of the belt under the arms or behind the back.
- Never carry children on your lap, not even newborns. No one can restrain a child in the event of an accident.
- In case of accident, replace the child seat with a new one.





### Transporting Pets

Air bags deploying in the front seat could harm your pet. An unrestrained pet will be thrown about and possibly injured, or injure a passenger during panic braking or in an accident.

Pets should be restrained in the rear seat in pet harnesses or pet carriers that are secured by vehicle seat belts.

### Rear Parking Camera

Your vehicle is equipped with a rear parking camera that allows you to see an image on the MTC+ screen of the rear surroundings of your vehicle whenever the shift lever is put into R (Reverse).

When "Parkview Camera Off Delay" mode is enabled, the rear view image shall be displayed for up to 10 seconds after shifting out of R (Reverse).

When "Rearview Camera Delay" mode is enabled, the rear view image shall be displayed for up to 10 seconds after shifting out of R (Reverse).

To assist the driver during maneuvers on dead-ends/roads and on intersections, the vehicle may be equipped with an optional surround view camera system. In this case, the rear parking camera is integrated into the surround view camera system. In both configurations (rear parking camera only or surround view camera system), you can monitor the rear view. For more details on this option, see chapter "Surround View Camera System (optional)" in this section.

The image will be displayed along with a caution note to "Check Entire Surroundings" across the top of the

screen. After five seconds this note will disappear.

The rear parking camera is located on the rear of the vehicle above the rear license plate.



When the shift lever is shifted out of R (Reverse), the rear camera mode is exited and the navigation or audio screen appears again.

When displayed, dynamic grid lines (if the function is set to "MTC+ Settings") will illustrate the width of the vehicle to assist with parking or aligning to a hitch/receiver. The dynamic grid lines will show separate zones in different color that will help indicate the distance to the rear of the vehicle.



The following table shows the approximate distances for each zone and color:

Zone	Distance to the rear of the vehicle
Red	11 - 12 in (28 - 30 cm)
Yellow	12 - 78 in (30 cm - 2 m)
Green	78-157 in (2-4 m) or greater

**reversing. Failure to do so can result in serious injury or death.**

**NOTE:**

*If snow, ice, mud, or any other substance builds up on the camera lens, clean the lens, rinse with water, and dry with a soft cloth. Do not cover the lens.*

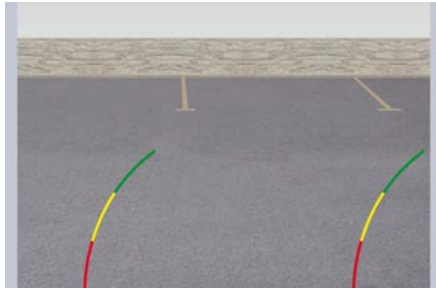

**CAUTION!**

- To avoid vehicle damage, the rear camera should only be used as a parking aid, as the rear camera is unable to view every obstacle or object in your drive path.
- To avoid vehicle damage, the vehicle must be driven slowly when using the rear camera to be able to stop in time when an obstacle is seen. It is recommended that the driver looks frequently over his/her shoulder when using the rear camera.



**WARNING!**

**Drivers must be careful when reversing even when using the rear view camera. Always check carefully behind your vehicle, and be sure to check for pedestrians, animals, other vehicles, obstructions, or blind spots before reversing. You are responsible for the safety of your surroundings and must continue to be careful while**





## Surround View Camera System (optional)

### System components

The system uses four cameras to monitor the area around the vehicle, placed on the front grid, under the side rearview mirrors and on the trunk lid, between the number plate lights.

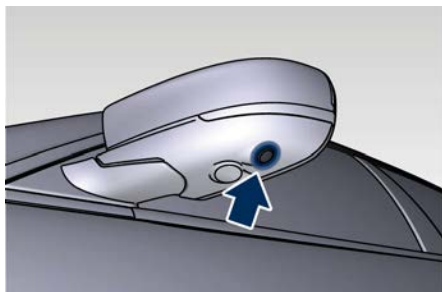

When the shift lever is shifted to R (Reverse) position, the top view and the rear view of the surrounding area will be automatically displayed on MTC+ display.

Instead, when the shift lever is shifted to P (Park), N (Neutral) or D (Drive) position, it is possible to activate/deactivate the system by pressing "Surround Camera" softkey in "Controls" screen of MTC+ display.



Once the "Surround Camera" screen is displayed, it is possible to choose which images to display according to 4 possible settings.



Rear view and top view



Rear cross path view



Front cross path view



Front view and top view

In any shift lever condition, when "Surround Camera" screen is displayed, a pop-up message will appear in the upper part for 5 seconds to advise the driver to check the surrounding area before any manoeuvre.

With transmission in P (Park), N (Neutral) or D (Drive), the upper right corner of the screen will show the "X" key: touch it to go back to the previous screen of MTC+ display, before entering in "Controls". The deactivation of the rear visualization via "X" soft-key is not



possible when the transmission is in R (Reverse) position.

Choose the most suitable setting for the situation and the maneuver you are performing or going to perform, by touching the relevant button present under the images: the edges of the pressed button will highlight. The button will highlight and the type of setting will appear on each image.



In the top view, the vehicle is represented as it is during the maneuver (see example in the figure), therefore any open doors will be visible in the image.

To display also the dynamic lines of the area you are setting, it is necessary to set this function by accessing the "Settings" menu on MTC+, at "Safety & Driving Assistant" item, by using the dynamic gridlines action menu. Once this menu is displayed, it is also

possible to set the function that delays the exit from this screen in special situations when the transmission lever is in D (Drive) position by using the surround view camera delay menu. For further information, see "MTC+ Settings" in section "Dashboard Instruments and Controls".

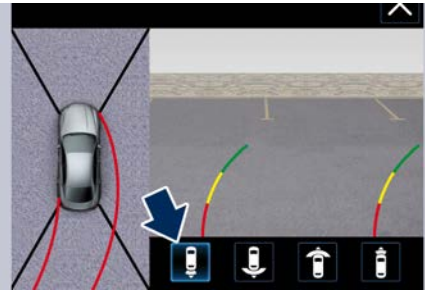

### WARNING!

Failure to follow the precautions below might result in serious injury or even death.

- Drivers must be careful during maneuvers also when using the camera system with surround view.
- Always check carefully the areas around your vehicle, before proceeding forward or backward.

DEALER ePROCESS

- Be sure to always check for any pedestrians, animals, other vehicles, obstructions, or blind spots.
- The driver must use the utmost caution while using the system to avoid damage to property or personal injury.
- The camera system with surround view is designed for use during the day or under good lighting conditions. Do not use and rely on the system under poor lighting conditions.
- Distance lines and directional lines must be used only as a reference and only when vehicle is on a flat ground. The distance shown on MTC+ display must be interpreted as a reference and might be different from the distance actually present between the vehicle and any displayed objects.
- Any obstacles present above the cameras cannot be detected.



### CAUTION!

- To avoid vehicle damage, the camera system with surround view should only be used as a parking aid, as the

(Continued)



**(Continued)**

cameras are unable to view every obstacle or object in your drive path.

- To avoid vehicle damage, the vehicle must be driven slowly when using the camera system with surround view, to be able to stop in time when an obstacle is seen. It is recommended that the driver looks frequently over his/her shoulder when using this system.

**NOTE:**

*If snow, ice, mud, or any other substance builds up on the camera lens, clean the lens, rinse with water, and dry with a soft cloth. Do not cover the lens.*



**WARNING!**

**California Proposition 65**

Operating, servicing and maintaining a passenger vehicle or off-road vehicle can expose you to chemicals including such as, engine exhaust, carbon monoxide, phthalates and lead, that which are known to the State of California to cause cancer and birth defects or other reproductive harm. To minimize exposure, avoid breathing exhaust, do not idle the engine except

as necessary, service your vehicle in a well-ventilated area and wear gloves or wash your hands frequently when servicing your vehicle. For more information go to:  
[www.P65Warnings.ca.gov/passenger-vehicle](http://www.P65Warnings.ca.gov/passenger-vehicle)

## Safety Tips

### Transporting Passengers



**WARNING!**

- Do not leave children or animals inside parked vehicles in hot weather. Interior heat build-up may cause serious injury.
- Never ride in a cargo area, inside of a vehicle.
- Do not allow people to ride in any area of your vehicle that is not equipped with seats and seat belts.
- Be sure everyone in your vehicle is in a seat and using a seat belt properly.





## Exhaust Gas



### WARNING!

Exhaust gases can injure. They contain carbon monoxide (CO), which is colorless and odorless. Breathing it can make you unconscious and can eventually poison you. To avoid breathing (CO), follow these safety tips:

- Do not run the engine in a closed garage or in confined areas any longer than needed to move your vehicle in or out of the area.
- If it is necessary to sit in a parked vehicle with the engine running, adjust your heating or cooling controls to force outside air into the vehicle. Set the blower at high speed.
- If you are required to drive with the trunk open, make sure that all windows are closed and the climate control blowers switch is set at high speed. DO NOT use the recirculation mode.

The best protection against carbon monoxide entry into the passenger compartment is a properly maintained engine exhaust system.

Whenever detecting a change in the sound of the exhaust system or eventual exhaust fumes inside the vehicle have the **Authorized Maserati Dealer** inspect the complete exhaust system and adjacent body areas for broken, damaged, deteriorated, or mispositioned parts.

Open seams or loose connections could permit exhaust fumes to seep into the passenger compartment.



### WARNING!

**California Proposition 65**  
Operating, servicing and maintaining a passenger vehicle or off-road vehicle can expose you to chemicals including such as, engine exhaust, carbon monoxide, phthalates and lead, that which are known to the State of California to cause cancer and birth defects or other reproductive harm. To minimize exposure, avoid breathing exhaust, do not idle the engine except as necessary, service your vehicle in a well-ventilated area and wear gloves or wash your hands frequently when servicing your vehicle. For more information go to:  
[www.P65Warnings.ca.gov/passenger-vehicle](http://www.P65Warnings.ca.gov/passenger-vehicle)





## Vehicle Safety Checks

### Seat Belts

- Inspect the belt system periodically, checking for cuts, frays, and loose parts. Damaged parts must be replaced immediately.
- Do not disassemble or modify the system.
- If the belt has been sharply pulled, for example as the result of an accident, the safety belt, together with the anchoring devices, the anchoring device mounting screws and the pretensioner must be completely replaced. Even if the belt does not present any exterior signs of wear or damage, it may have lost its restraining properties.

### Air Bag Warning Light

The  light should illuminate and remain lit for a few seconds bulb checking when the ignition switch is pushed in **RUN** position (see “Supplemental Restraint System (SRS) — Air Bags” chapter in this section).

- If the light  does not illuminate while starting, contact the **Authorized Maserati Dealer**.
- If the light stays on, flickers, or comes on while driving, have the



system checked by the **Authorized Maserati Dealer**.



### **WARNING!**

**Certain components of this vehicle such as air bag modules, seat belt pretensioners, adaptive steering columns, and button cell batteries may contain Perchlorate material. Special handling may apply for service or vehicle end of life disposal. See [www.dtsc.ca.gov/hazardouswaste/perchlorate](http://www.dtsc.ca.gov/hazardouswaste/perchlorate).**

### **Defroster**

Check operation by selecting the defrost mode and place the fan system on high speed (see "Air Conditioning Controls" chapter in section "Dashboard Instruments and Controls").

You should be able to feel the air directed against the windshield and front side windows. Contact **Authorized Maserati Dealer** for service if your defroster is inoperable.

### **Floor Mat**

Always use floor mats designed to fit the footwell of your vehicle. Use only floor mats that leave the pedal area unobstructed and that are firmly

secured so that they cannot slip out of position and interfere with the pedals or impair safe operation of your vehicle.

### **NOTE:**

*The **Authorized Maserati Dealer** can provide you with any information about the available Maserati floor mats included in the "Genuine Accessories" range.*



### **WARNING!**

**Pedals that cannot move freely can cause loss of vehicle control and increase the risk of serious personal injury.**

- **Always make sure that floor mats are properly attached to the proper fasteners.**
- **Never place or install floor mats or other floor coverings in the vehicle that cannot be properly secured to prevent them from moving and interfering with the pedals.**
- **Never put floor mats or other floor coverings on top of already installed floor mats. Additional floor mats and other coverings will reduce the size of the pedal area and interfere with**

**the pedals.**

- **Check mounting of mats on a regular basis. Always properly reinstall and secure floor mats that have been removed for cleaning.**
- **Always make sure that objects cannot fall into the driver footwell while the vehicle is moving. Objects can become trapped under the brake pedal and accelerator pedal causing a loss of vehicle control.**
- **Mounting posts must be properly installed, if not equipped from the factory. Failure to properly follow floor mat installation or mounting can cause interference with the brake pedal and accelerator pedal operation causing loss of control of the vehicle.**

### **Tires**

- Examine tires for excessive tread wear and uneven wear patterns.
- Check for stones, nails, glass, or other objects lodged in the tread or sidewall.
- Inspect the tread for cuts and cracks.
- Inspect sidewalls for cuts, cracks and bulges.
- Check the wheel nuts for tightness.





- Check the tires (see “Tire Inflation Pressure” chapter in section “Features and Specifications”) for proper cold inflation pressure.

### Lights and Indicator Lights

- Have someone observe the operation of exterior lights while you operate the controls (see “Lights” chapter in section “Understanding the Vehicle”).
- Check turn signal and high beam indicator lights on the instrument cluster (see “Instrument Cluster” chapter in section “Dashboard Instruments and Controls”).

### Door Latches

- Check for positive closing, latching, and locking of doors and trunk lid (see “Unlock the Vehicle with Key fob” chapter in this section).

### Fluid Leaks

- Check area under vehicle after overnight parking for recent fluid leaks (oil, fuel, etc.).
- If gasoline fumes are detected or fluid leaks are suspected, contact the **Authorized Maserati Dealer**.



### WARNING!

**California Proposition 65**  
**Operating, servicing and maintaining a passenger vehicle or off-road vehicle can expose you to chemicals including such as, engine exhaust, carbon monoxide, phthalates and lead, that which are known to the State of California to cause cancer and birth defects or other reproductive harm. To minimize exposure, avoid breathing exhaust, do not idle the engine except as necessary, service your vehicle in a well-ventilated area and wear gloves or wash your hands frequently when servicing your vehicle. For more information go to:**  
[www.P65Warnings.ca.gov/passenger-vehicle](http://www.P65Warnings.ca.gov/passenger-vehicle)



## Park Assist (if equipped)

The Park Assist (also called “ParkSense”) system provides visual and audible indications of the distance between the rear and/or front bumper and a detected obstacle when backing up or moving forward, e.g. during a parking maneuver.

Besides the use of the sensors available on the bumpers and of the rear parking camera, the vehicle may be equipped with surround view cameras (optional) to assist the driver during maneuvers on dead-ends/roads and on intersections. For more details on this option, see chapter “Surround View Camera System (optional)” in this section.

Refer to “Park Assist System Usage Precautions” for limitations of this system and recommendations.

Park Assist system will retain the last system state (enabled or disabled) from the last ignition cycle when the ignition is changed to the **RUN** position.

Park Assist system can be active only when the shift lever is in R (Reverse) or D (Drive).

If Park Assist is enabled at one of these shift lever positions, the system will remain active until the vehicle



speed is increased to approximately 7.5 mph (12 km/h) or above. The system will become active again if the vehicle speed is decreased to speeds less than approximately 6.2 mph (10 km/h).

### Park Assist Sensors

The four Park Assist sensors, located in the rear bumper, monitor the area behind the vehicle that is within the sensors' field of view. The sensors can detect obstacles up to approximately 78 in (200 cm) from the rear bumper in the horizontal direction, depending on the location, type and orientation of the obstacle.

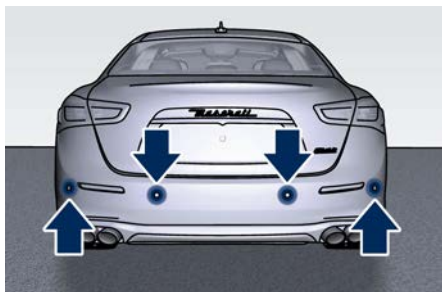

The six Park Assist sensors, located in the front bumper, monitor the area in front of the vehicle that is within the sensors' field of view.

The sensors can detect obstacles up to a distance of approximately 50 in (120 cm) from the front bumper in the horizontal direction, depending on the location, type and orientation of the obstacle.

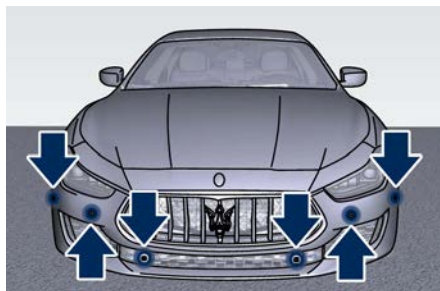

### Park Assist Warning Messages Display

The Park Assist Warning screen will only be displayed if "Sound + Display" is selected from the MTC+ System. Refer to "MTC+ Settings" in section "Dashboard Instruments and Controls" for further information. The Park Assist Warning screen is located on the instrument cluster display. It provides visual warnings to indicate the distance between the rear bumper and/or front bumper and the detected obstacle.

The warning display will turn on indicating the system status (ready or off) when the vehicle is in R (Reverse) or in D (Drive) and an obstacle has been detected.

The detection area in front of the vehicle is divided into two parts with four arcs while the two detection areas behind the car into five arcs.

The system will indicate a detected obstacle by displaying arcs with fixed or flashing light and a characteristic sound according to the obstacle distance. The color indicates the distance and the arc indicates the position of the detected obstacle. The green color of the outer arc indicates the maximum distance, the amber color of the middle arcs indicates the medium distance, while the red color of the nearest arc indicates the minimum distance.





As the vehicle moves closer to the object, the instrument cluster will

display the arc moving towards the vehicle and the sound tone will change from single to slow, to fast and to continuous.

The vehicle is close to the obstacle when the instrument cluster displays one flashing red arc only, combined with a continuous sound.

The following charts show the warning alert visualization when the system is detecting an obstacle.

Front Sensors - Warning Alerts					
Front distance	More than 50 in (120 cm)	50-40 in (120-101 cm)	40-24 in (100-61 cm)	23.6-12.2 in (60-31 cm)	Less than 12 in (30 cm)
Audible Alert	None	None	Slow	Fast	Continuous
Arc in left and right areas	None	4 <sup>th</sup>	3 <sup>rd</sup>	2 <sup>nd</sup>	1 <sup>st</sup> (inner most)
Light type	None	Solid	Solid	Flash	Flash
Arc color	-	Green	Amber	Amber	Red
Radio sound	Active	Active	Mute	Mute	Mute

Rear Sensors - Warning Alerts						
Rear distance	More than 78 in (200 cm)	78-59.4 in (200-151 cm)	60-40 in (150-101 cm)	40-24 in (100-61 cm)	23.6-12.2 in (60-31 cm)	Less than 12 in (30 cm)
Audible Alert	None	Single	Slow	Slow	Fast	Continuous





Arc in left and right areas	None	5 <sup>th</sup>	4 <sup>th</sup>	3 <sup>rd</sup>	2 <sup>nd</sup>	1 <sup>st</sup> (inner most)
Light type	None	Solid	Solid	Solid	Flash	Flash
Arc color	–	Green	Amber	Amber	Amber	Red
Radio sound	Active	Mute	Mute	Mute	Mute	Mute

### NOTE:

- Maserati reserves the right to change specifications without prior notification.
- Park Assist will turn off the front park assist audible alert (chime) after approximately 4 seconds when an obstacle has been detected, the vehicle is stationary, and brake pedal is applied.

## Enabling and Disabling Park Assist

By accessing the submenu “Safety & Driving Assistant” from MTC+ System, the “Park Assist” can be disabled (option “Off”). The available options regarding the warning alerts are: “Sound” or “Sound + Display”. Refer to “MTC+ Settings” in section “Dashboard Instruments and Controls” for further information. The front sensors can be enabled or disabled at any time by pressing the button on the front dome console.



After pressing the button the instrument cluster will display the state of front parking sensors for approximately five seconds. The button LED will be on when the front sensors are disabled. The button LED will be off when the front sensors are enabled. If the button is pressed and the system requires service, the LED

will blink momentarily, and then the LED will be on.

When the shift lever is moved to R (Reverse) or to D (Drive) at a speed of 7 mph (11 km/h) or below and the system is disabled, the instrument cluster will display the “PARK ASSIST Off” message for 5 seconds until the shift lever remains in R (Reverse) or when the shift lever is moved in D (Drive).

## Service the Park Assist System

In case of malfunction of the Park Assist system, the instrument cluster will actuate a single sound, once per ignition cycle. The instrument cluster will display a message when any of the rear or front sensor(s) are blocked by



snow, mud, or ice and the vehicle is shifted into R (Reverse) or D (Drive). The instrument cluster will display a message when any of the rear or front sensors are damaged and require service.

When the shift lever is moved to R (Reverse) or D (Drive) and the system has detected a faulted condition, the instrument cluster will display the corresponding message for the time lapse the vehicle is in R (Reverse) or D (Drive) at speeds less than 7 mph (11 km/h). Under this condition Park Assist will not operate. See "Instrument Cluster" in section "Dashboard Instruments and Controls" for further information. If the instrument cluster displays a message prompting you to clean the sensors, make sure the outer surface and the underside of the rear bumper and/or front bumper is clean and clear of snow, ice, mud, dirt or other obstruction and then cycle the ignition switch. If the message continues to appear contact the **Authorized Maserati Dealer**.



If a failure message is displayed on the instrument cluster, contact the **Authorized Maserati Dealer**.

### Cleaning the Park Assist Sensors

When cleaning the sensors, take special care not to scratch or damage them; therefore, do not use dry, rough or hard cloths.

The sensors must be washed with clean water, possibly adding car shampoo.

Should you need to repaint the bumper or in case of paint touch-ups in the sensor area, please contact exclusively the **Authorized Maserati Dealer**. Incorrect paint application could affect the parking sensors operation.



### Park Assist System Usage Precautions

#### NOTE:

- *Jackhammers, large trucks, and other vibrations could affect the performance of Park Assist.*
- *Objects such as bicycle carriers, trailer hitches, etc., must not be placed within 12 in (30 cm) from the rear bumper while driving the vehicle. Failure to do so can result in the system misinterpreting a close object as a sensor problem, causing the service Park Assist message to be displayed in the instrument cluster.*



#### CAUTION!

- **Park Assist is only a parking aid and it is unable to recognize every obstacle, including small obstacles. Parking curbs might only be temporarily detected or not detected at all. Obstacles located above or below the sensors will not be detected when they are in close proximity.**
- **The vehicle must be driven slowly when using Park Assist in order to be able to stop in time when an**

**(Continued)**



**(Continued)**  
obstacle is detected. When backing up, it is recommended that the driver looks over his/her shoulder when using Park Assist.



### **WARNING!**

**Drivers must be careful when backing up even when using the Park Assist system. Always check carefully behind your vehicle, look behind you, and be sure to check for pedestrians, animals, other vehicles, obstructions, and blind spots before backing up. You are responsible for safety and must continue to pay attention to your surroundings. Failure to do so can result in serious injury or death.**

## Park Assist Volume

The volume of the acoustic signal emitted by the front and rear parking sensors is set to the medium level. Three different levels of volume can be selected via the submenu "Safety & Driving Assistant" from the MTC+ System.

Low level is useful in certain conditions when the parking sensor acoustic signal keeps coming on although there is no actual collision hazard. This may

typically occur when driving in a queue or when the vehicle is overtaken by motorcycles or other vehicles on one or both sides in a queue of traffic. When you set the volume, only the parking sensor acoustic signal will be affected. The radio or any other devices connected to the vehicle sound system will not be affected. Refer to chapter "MTC+ Settings" in section "Dashboard Instruments and Controls" for further information.





### **3 – Understanding the Vehicle**

Interior Components . . . . .	92
Front Power Seats . . . . .	96
Driver Memory Seat . . . . .	99
Rear Seats . . . . .	101
Head Restraints . . . . .	103
Power Steering Wheel Adjustment . . . . .	105
Adjustable Pedals (if equipped) . . . . .	107
Rearview Mirrors . . . . .	107
Lights . . . . .	110
Windshield Wipers and Washers . . . . .	122
Interior Features . . . . .	126
Cargo Area . . . . .	133
Power Sunroof with Sunshade . . . . .	136
HomeLink (optional) . . . . .	138
Air Conditioning Distribution . . . . .	142





## Interior Components

### Dashboard Components

3

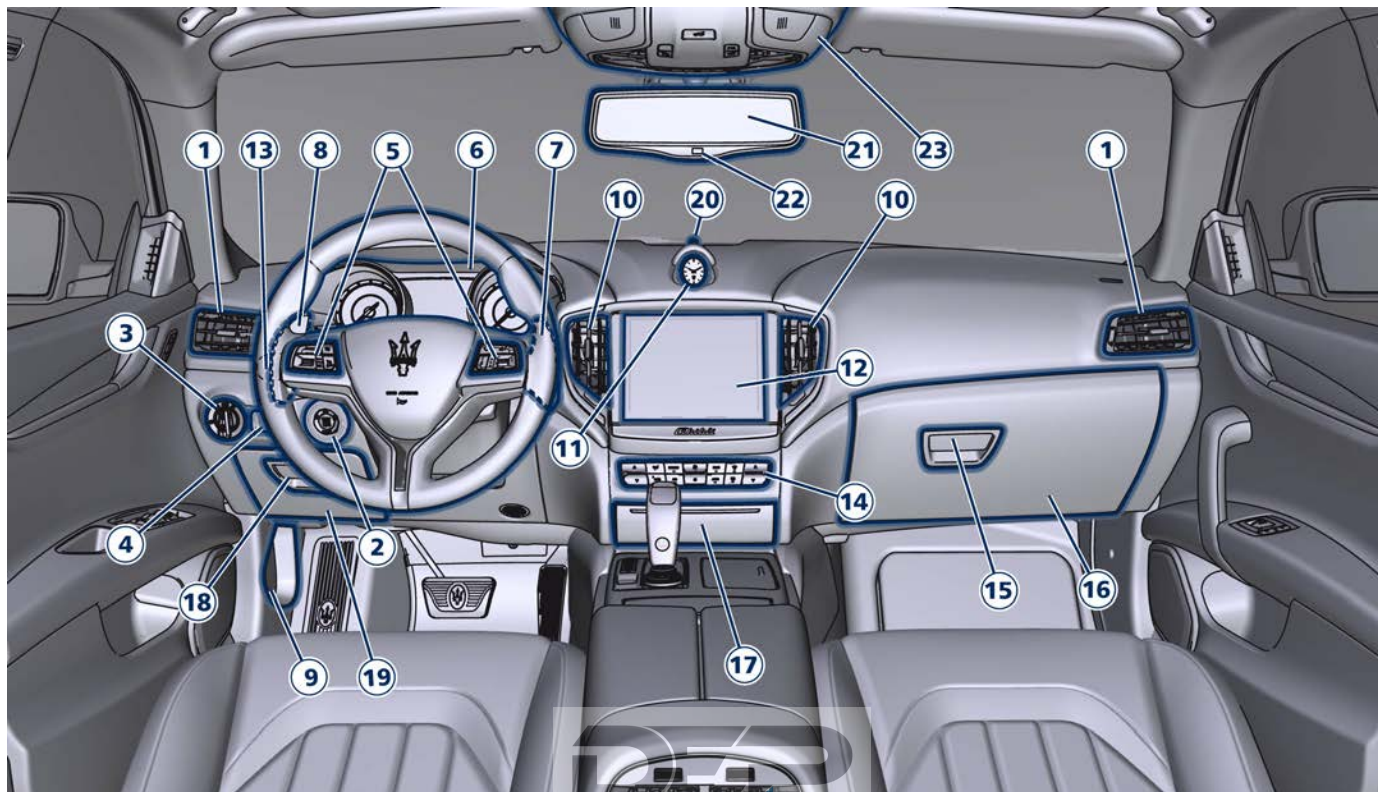

DEALER ePROCESS





- 1 Adjustable side air outlets.
- 2 Engine **START/STOP** button.
- 3 Light switch.
- 4 Light dimmer controls.
- 5 Steering wheel controls.
- 6 Instrument cluster.
- 7\* Right shift paddle +.
- 8\* Left shift paddle -.
- 9 Hood release.
- 10 Adjustable central air outlets.
- 11 Analog clock.
- 12 MTC+ display.
- 13 Multifunction lever (windshield wipers, headlight washer and headlight selection, turn signals).
- 14 Climate controls.
- 15 Dashboard glove box handle.
- 16 Dashboard glove box.
- 17 Cover for compartment with AUX, USB, SD memory card port and slide phone drawer.
- 18 Storage compartment handle.
- 19 Storage compartment.
- 20 Vehicle security light and solar sensor.

- 21 Internal rear view mirror.
  - 22 Auto-dimming on/off button.
  - 23 Front dome console.
- (\* ) If equipped

### Central Console Components

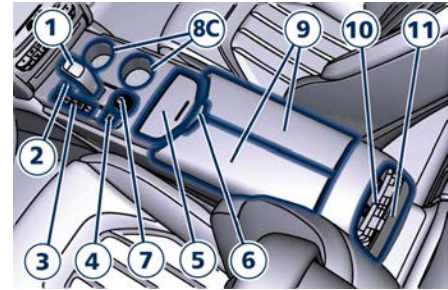
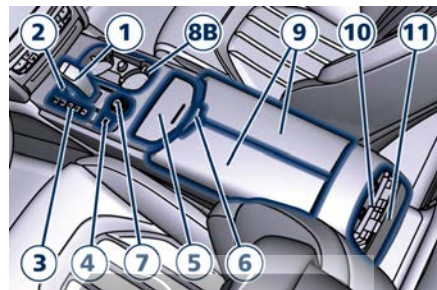
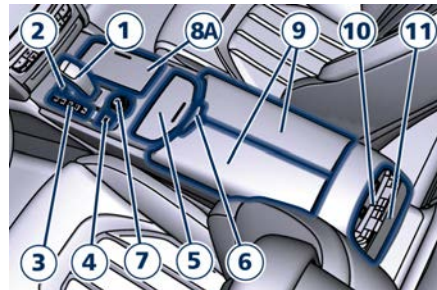

- 1 Automatic transmission shift lever.
- 2 Hazard lights switch.
- 3 Drive mode switches.
- 4 Electric Parking Brake lever.
- 5 Glove compartment.
- 6 Unlock button for central console with cupholder and power outlet.
- 7 Rotary selectors and buttons for the multimedia navigation.
- 8A Cover for cupholder and power socket compartment.
- 8B Cupholder and power socket compartment.
- 8C Cupholder.
- 9 Central console covers with armrest function.
- 10 Air outlets (adjustable).





- 11 Rear power sunshade and rear seats comfort controls panel (if equipped).

## Front Dome Console Components

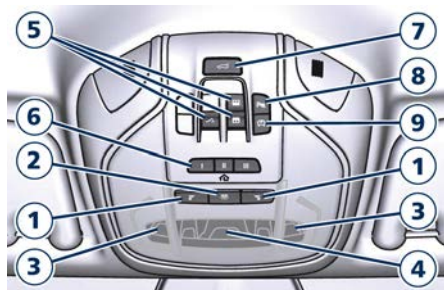

- 1 Reading lights control button.
- 2 Central light control button.
- 3 Reading lights.
- 4 Central light.
- 5 Sunroof controls.
- 6 HomeLink controls (optional).
- 7 Button to release the manual trunk lid or to open fully/partially the power trunk lid (optional).

- 8 Button to enable/disable front sensors of the Park Assist system (if equipped).
- 9 Button to switch off passenger compartment lights.

## Front Doors Components

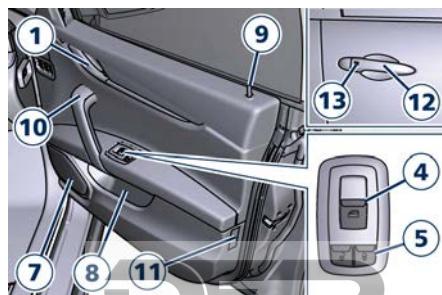
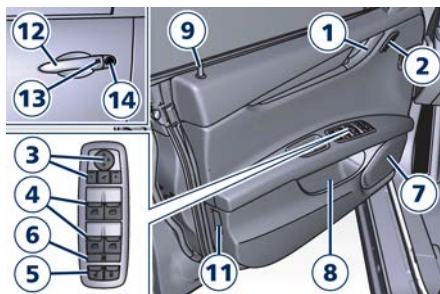

- 1 Internal door handle.

- 2 Driver's seat, steering wheel, adjustable pedals (if equipped) and rear mirrors memory switch.
- 3 Rear view mirrors switches.
- 4 Power window switch.
- 5 Power door unlocks/locks.
- 6 Rear windows and sunshade lockout button.
- 7 Loudspeakers.
- 8 Storage compartment.
- 9 Internal door lock/unlock knob.
- 10 Passenger door panel grip.
- 11 Reflex reflector.
- 12 External door handle.
- 13 Door lock button with "Passive Entry" function.
- 14 Door outboard opening lock.



### Components between the Rear Seats

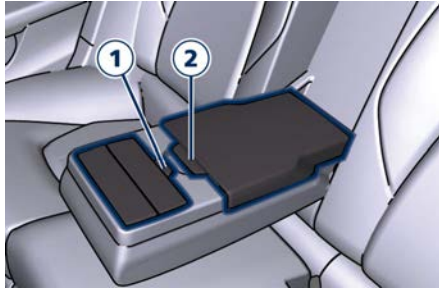

- 1 Armrest cupholder covers unlock button (some versions can have the cupholder visible, without access cover).
- 2 Armrest compartment unlock button with power outlet and USB port (optional).

### Rear Dome Console Components

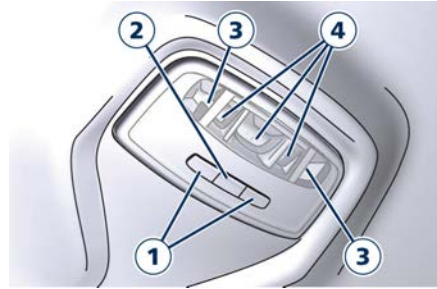

- 1 Reading lights control button.
- 2 Central light control button.
- 3 Reading light LED.
- 4 Central light LEDs.

### Rear Doors Components

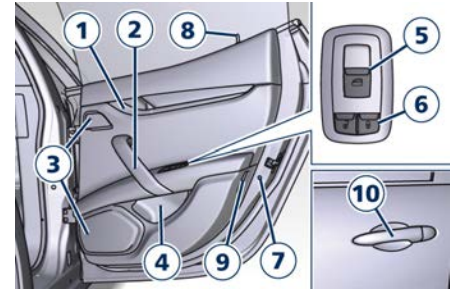

- 1 Internal rear door handle.
- 2 Grip.
- 3 Loudspeaker.
- 4 Door storage pockets.
- 5 Power window switch.
- 6 Power doors lock/unlock buttons.
- 7 "Child protection" door lock system.
- 8 Inside door lock/unlock knob.
- 9 Reflex reflector.
- 10 External door handle.





## Front Power Seats

Seats, head restraints and seat belts are part of the Occupant Restraint System of the vehicle.

For further information, see chapter "Occupant Restraint System" in section "Before Starting" and "Head Restraints" in this section.



### WARNING!

Be sure everyone in your vehicle is in a seat and using a seat belt properly.

Depending on the different markets and versions, the front seats may have different controls for adjustment and optional features. The configurations shown below may differ from the ones in your vehicle.

### Front Power Seat Controls

The power seats switches are located on the outboard side of the seat cushion.

Use the front switch **1** to move the seat up or down, forward or rearward or to recline the seat cushion.

Use the switch **2** to recline the seatback.

Use the rear switch **3** to adjust the lumbar support.

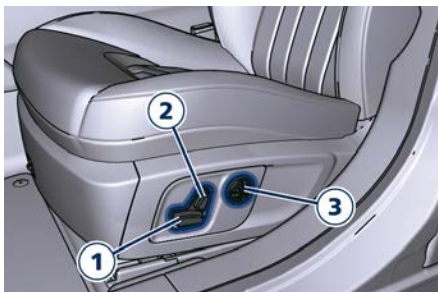

### Seat Forward/Rearward Adjustment

The seat can be adjusted both forward and rearward.

Push the seat switch **1** forward or rearward, the seat will move in the direction of the switch. Release the switch **1** when the desired position is reached.

### Seat Up/Down Adjustment

The height of the seat can be adjusted up- or downward.

Grip switch **1** from the back side and push it down or up. Release the switch **1** when the desired position is reached.



### CAUTION!

If the seat's movement does not work, make sure that the corresponding fuse is not tripped (see chapter "Fuse Replacement" in section "Maintenance and Care").

### Seat Tilt Control (Up/Down)

The angle of the seat cushion can be adjusted in four directions.

Pull upward or push the front of the switch **1**, to move the front cushion seat in the direction of the switch. Release the switch **1** when the desired position is reached.

### Seat Back Tilt Control

The angle of the seatback can be adjusted forward or rearward.

Push the seatback switch **2** forward or rearward, the upper seatback will move in the direction of the switch. Release the switch **2** when the desired position is reached.



## Power Lumbar

Push the switch **3** forward or rearward to increase or decrease the lumbar support.

Push the switch **3** upward or downward to raise or lower the lumbar support.



### WARNING!

- **Never adjust the seat while driving. You could lose control of the vehicle. Moving the seat could distract you or make you press a pedal unintentionally.**
- **Seats should be adjusted before fastening the seat belts and while the vehicle is parked.**
- **Do not ride with the seatback reclined so that the shoulder belt is no longer resting against your chest. In a collision you could slide under the seat belt, which could result in serious injury or death.**



### CAUTION!

Do not place any object under a power seat or obstruct its movement as it may cause damage to the seat controls. Seat movement may become

limited if there is an obstruction in the way.

## Front Heated Seats

The front seats are equipped with heaters in both seat cushions and seatbacks.

The seats comfort commands are in the "Climate" screen of the MTC+. They are present in the "Climate" screen even when the A/C is off. See "Air Conditioning Controls" in section "Dashboard Instruments and Controls" for further details.



### WARNING!

- **Persons with low skin sensitivity because of advanced age, chronic illness, diabetes, spinal cord injury, medication, alcohol use, exhaustion or other physical conditions must be careful when using the seat heater. It may cause irritation even at low temperatures, especially if used for long periods of time.**
- **Do not place anything on the seat that insulates against heat, such as a blanket or cushion. This may cause the seat heater to overheat.**

DEALER ePROCESS

## Front Seats Heat Function

### NOTE:

*The engine must be running for the heated seats to operate.*

- Touch the "Climate" softkey on the lower part of the MTC+ display.
- Starting from the state "OFF", indicated below the respective icon, within 15 seconds touch the driver or passenger seat soft-key once to select HI-level heating.



- Within 15 seconds, touch the driver or passenger seat soft-key a second time to select LO-level heating.



3



- Within 15 seconds, touch the same soft-key a third time to shut off the seat heating.

### NOTE:

Once a heat setting is selected, heat will be felt within 2 to 5 minutes.

When the HI-level setting is selected, the heater will provide a boosted heat level during the first 4 minutes of operation.

Then, the heat output will drop to the normal HI-level.

If the HI-level setting is selected, the system will automatically switch to LO-level after a maximum of 60 minutes of continuous operation.

At that time, the display will indicate the change from HI to LO.

The LO-level setting will turn OFF automatically after a maximum of approximately 45 minutes.

## Front Ventilated Seats (optional)

To enhance occupants comfort by high external temperatures, both the driver and passenger seats, on request, can be ventilated.

Small fans are located in the seat cushion and seatback, they draw air from the seat surface through fine perforations in the seat cover to help keep the driver and front passenger cooler when the temperature is high. The seats comfort commands are in the "Climate" screen of the MTC+.

They are present in the "Climate" screen even when the A/C is off. See "Air Conditioning Controls" in section "Dashboard Instruments and Controls" for further details.

### Front Ventilated Seats Function

#### NOTE:

The engine must be running for the ventilated seats to operate.

- Touch the "Climate" softkey on the lower part of the MTC+ display.
- Starting from the state "OFF", within 15 seconds touch the driver or passenger seat soft-key once to select HI-level ventilation.



- Within 15 seconds, touch the driver or passenger seat soft-key a second time to select LO-level ventilation.



- Within 15 seconds, touch the same soft-key a third time to shut off the seat ventilation.



## Driver Memory Seat

This feature allows the driver to store up to two different memory profiles for easy recall through a memory switch. Each memory profile contains desired position settings for the driver seat, external side mirrors, adjustable pedals (optional), and power tilt and telescopic steering column and a set of programmed radio stations. Your key fob RKE transmitter can also be set to recall the same positions by pressing the  button.

### NOTE:

- Only one key fob RKE transmitter can be linked to each of the memory positions.
- "Passive Entry" door handles cannot be linked to the memory function. Use either the memory recall switch or the key fob RKE transmitter (if linked to the memory feature) to recall memory positions 1 or 2.

The memory seat switch is located on the driver's door trim panel. The switch consists of three buttons:

- The "S" (SET) button, which is used to activate the memory save function.

- The "1" and "2" buttons which are used to recall either of two programmed memory profiles.



## Memory Profiles Setting

### NOTE:

Saving a new memory profile will erase an existing profile from memory.

To create a new memory profile, perform the following:

- Cycle the ignition device to the **ACC** or **RUN** position.
- Adjust all memory profile settings to desired preferences (i.e., seat, side mirrors, adjustable pedals (optional), power tilt and telescopic steering column, and radio station presets).
- Press and release the "S" button on the memory switch.
- Within 5 seconds, press and release the memory button "1" or "2".

- Check on the instrument cluster for the positive response of the actions "Memory 1 (or 2) profile set". After these steps, the profile set will be memorized in the selected position.

### NOTE:

Memory profiles can be set without the vehicle in P (Park), but the vehicle must be in P (Park) to recall a memory profile.

## Pairing Remote Keyless Entry Transmitter to Seats Memory

Your key fob with RKE transmitters can be programmed to recall one of two programmed memory profiles by pressing the  button on the RKE transmitter.



### NOTE:

This feature can be enabled or disabled using the MTC+ System, refer to "MTC+ Settings" in section "Dashboard Instruments and Controls" for further information.

To program your key fobs RKE transmitter, perform the following actions:

- Cycle the ignition device to the **RUN** position.



- Move the seat and/or the other adjustable devices in the position that you wish to memorize, or recall a previously memorized profile, pressing the corresponding memory button "1" or "2".
- Cycle the ignition device to the **OFF** position.
- Press and release the "S" button.
- Within 5 seconds, press and release the memory button "1" or "2".
- Press and release the  button on key fob RKE transmitter.
- Within 3 seconds, press and release the  button on the key fob RKE transmitter.

To check if the system has memorized the correct profile, you can move the seat and press the  button: the seat will move to the memorized position.

### **NOTE:**

Your key fobs RKE transmitter can be unlinked to your memory settings by pressing the "S" button followed by the  button on the key fob RKE transmitter.

## Memory Position Recall

### **NOTE:**

*The vehicle must be in P (Park) to recall memory positions. If a recall is attempted when the vehicle is not in P (Park), a message will display in the instrument cluster.*

To recall the memory settings for driver, press memory button number "1" or "2" on the driver's door trim panel or the  button on the RKE transmitter linked to memory position "1" or "2" with ignition device in the **RUN** position.

A recall can be canceled by pressing any of the buttons ("S", "1", or "2") during a recall. When a recall is canceled, the driver seat, external side mirrors, adjustable pedals (optional), and power tilt and telescopic steering column stop moving.

A delay of at least one second will occur before selecting a new recall.

## Easy Entry/Exit Driver Seat

This feature provides automatic driver seat positioning to enhance driver mobility when entering and exiting the vehicle.

The distance the driver seat moves depends on where you have the driver seat positioned when you place the ignition device to the **OFF** position.

- When you cycle the ignition device to the **OFF** position the driver seat:
  - will move about 2.36 in (60 mm) rearward if the driver seat position is greater than or equal to ca. 5.51 in (140 mm) forward of the rear stop;
  - will move to a position of ca. 3.15 in (80 mm) rearward of the rear stop if the driver seat position is between 5.51 in (140 mm) and 3.15 in (80 mm) forward of the rear stop.
- The seat will return to its previously set position when you place the ignition device into the **ACC** or **RUN** position.
- The Easy Entry/Exit feature is disabled when the driver seat position is less than 3.15 in (80 mm) forward of the rear stop. In this position, there would be no benefit







to the driver by moving the seat for Easy Exit or Easy Entry.

Each stored memory setting will have an associated easy entry/exit position.

#### NOTE:

*The Easy Entry/Exit feature can be enabled or disabled using the MTC+ System, refer to "MTC+ Settings" in section "Dashboard Instruments and Controls" for further information.*

## Rear Seats

Rear seats can fit three passengers. Seats, head restraints and seat belts are parts of the occupant restraint system of the vehicle.

For further information, see chapter "Occupants Restraint Systems" in section "Before Starting" and "Head Restraints" in this section.



#### WARNING!

**Be sure everyone in your vehicle is in a seat and using a seat belt properly.**

## Rear Armrest

The rear armrest is mobile and can be folded up into the seat back.

- To lower it, pull the stripe as indicated.



- To close it, pull it upwards then push it back into its seat.

On the front part of the armrest there are two cupholders (see "Interior Features" in this section).

Inside the armrest there is a glove or document compartment. Pressing the opening button and lifting the cover of the armrest box you access to an illuminated compartment where you can find on request a 12 V power outlet and an USB charging port.





3

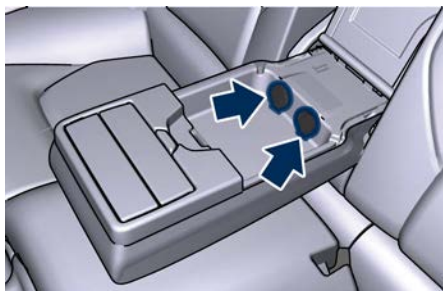

- To close the compartment, lower the cover.



### CAUTION!

The armrest is not designed to support the weight of an adult or a child: please use it only to store beverages, small objects or documents.

## Rear Side Heated Seats (optional)

The side rear seats can be equipped with heaters both in seat cushion and seatback.

Rear seats heating can be adjusted by operating control devices on the panel located on the rear side of the central console. The panel also includes command for the rear window sunshade (see "Rear Windows" in section "Before Starting").



### WARNING!

- Persons with low skin sensitivity because of advanced age, chronic illness, diabetes, spinal cord injury, medication, alcohol use, exhaustion or other physical conditions must be careful when using the seat heater. It may cause irritation even at low temperatures, especially if used for long periods of time.
- Do not place anything on the seat that insulates against heat, such as a blanket or cushion. This may cause the seat heater to overheat. Sitting in a seat that has been overheated could cause irritation due to the increased surface temperature of the seat.

The buttons on the panel with the resistance icon activate the heating on one or both seats.

- Push the button once to select the highest heating level. The two LED beside of the icon will illuminate.
- Push the same button a second time to select the lowest level. Only the lower LED remains illuminate.
- Push the same button a third time to shut the heating elements OFF. The LED will turn off.



### NOTE:

- Once a heat setting is selected, heat will be felt within two to five minutes.
- The engine must be running for the heated seats to operate.

By selecting the HI-level setting, the heater will provide a boosted heat level during the first four minutes of operation. Then, the heat output will drop to the normal HI-level. By setting the HI-level, the system will automatically switch to LO-level after a maximum of 60 minutes of continuous operation. The LO-level setting will turn off automatically after a maximum of approximately 45 minutes.

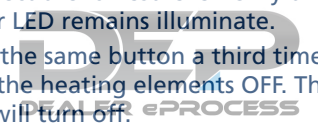



## Head Restraints

### Front Head Restraints (for Comfort Seat only)

Head restraints are designed to reduce the risk of injury by restricting head movement in the event of a rear impact. Head restraints should be adjusted so that the top of the head restraint is located above the top of your ear.

#### NOTE:

*The front head restraints can not be removed.*



#### WARNING!

- A loose head restraint thrown forward in a collision or hard stop could cause serious injury or death to occupants of the vehicle.
- Do not place items over the top of the head restraint, such as coats, seat covers or portable DVD players. These items may interfere with the operation of the head restraint in the event of a collision and could result in serious injury or death.

### Front Head Restraints Adjustment (for Comfort Seat only)

The front head restraints may be height-adjustable. To adjust them, operate as follows:

- Upward adjustment: raise the head restraint until it clicks into place.
- Downward adjustment: push the adjustment button and push downward on the head restraint to lower.

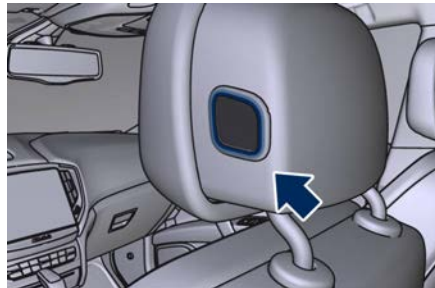

#### WARNING!

- All occupants, including the driver, should not operate a vehicle or sit in a vehicle's seat until the head restraints are placed in their proper positions in order to minimize the

risk of neck injury in the event of a crash.

- Head restraints should never be adjusted while the vehicle is in motion. Driving a vehicle with the head restraints improperly adjusted could cause serious injury or death in the event of a collision.

#### NOTE:

*To allow for maximum visibility for the driver, if a seat is not occupied by a passenger, the head restraint can be lowered to the fully lowered position.*

### Front Head Restraints (for Sport Seat only)

The Sport seat is equipped with non-adjustable head restraint on the seat back. The non-adjustable head restraints consist of a trimmed foam covering over the upper structure of the seat backs and are intended to help protect occupants from neck injury. Adjust the seat backs to their upright, on-road positions so that the head restraint is positioned as close as possible to the back of the occupant's head.



## WARNING!

Be certain that the seat back is locked securely into position. Otherwise the seat will back is not will not provide the proper stability for passengers. An improperly latched seat back could cause serious injury.

3

## Rear Head Restraints

Side seats are endowed with not-adjustable head restraints. The center seat head restraint can be adjusted in two positions, up or down.



## WARNING!

- All occupants, including the driver, should not operate a vehicle or sit in a vehicle's seat until the head restraints are placed in their proper positions in order to minimize the risk of neck injury in the event of a crash.
- Head restraints should never be adjusted while the vehicle is in motion. Driving a vehicle with the head restraints improperly adjusted or removed could cause serious

injury or death in the event of a collision.

## Center Rear Head Restraint Adjustment

When the center seat is being occupied the head restraint should be in the raised position.

When there are no occupants in the center seat the head restraint can be lowered in order to provide the driver for maximum visibility.

- To raise the head restraint, pull upward on the head restraint.



- To lower the head restraint, press the adjustment button, located at the foot of the head restraint on the left side, and push downward on the head restraint.

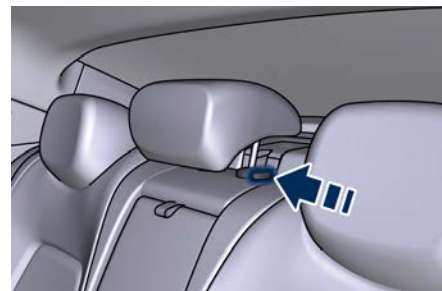

## Center Rear Head Restraint Removal

To remove the head restraint of the center seat is necessary to tilt the long seat back partially (see "Cargo Area" in this section).

To remove the head restraint, proceed as follows:

- Raise the restraint to its upper position.
- Push at the same time the left adjustment button and the right release button at the side of the two supports.



- Remove the head restraint by pulling them upwards.

To reinstall the head restraint, proceed as follows:

- With long seat back partially tilted, hold down both the adjustment button and release button while placing the head restraint post into the holes.
- Tilt the seat back to the upright position (see "CArgo Area" in this section).
- Reposition the head restraint to the appropriate height for the passenger.



### WARNING!

- A loose head restraint thrown forward in a collision or hard stop could cause serious injury or death to occupants of the vehicle. Always

securely stow removed head restraints in a location outside the occupant compartment.

- **ALL the head restraints MUST be reinstalled in the vehicle to properly protect the occupants. Follow the re-installation instructions above prior to operating the vehicle or occupying a seat.**



## Power Steering Wheel Adjustment

This feature allows you to tilt the steering column upward or downward or to lengthen or shorten it in order to adjust the steering wheel to an optimized position.

The power tilt/telescoping steering column/wheel switch is located on the lower left side of the steering column. To adjust the tilt of the steering column/wheel, move the switch up or down as desired.



To lengthen or shorten the steering column/wheel, pull the switch toward you or push the switch away from you as desired.



## NOTE:

You can use your key fob with RKE transmitter or the memory buttons on the driver's door trim panel to return the tilt/telescopic steering column/wheel to programmed positions. See "Driver Memory Seat" in this section.



## WARNING!

**Do not adjust the steering column/wheel while driving. Adjusting the steering column/wheel while driving could cause the driver to lose control of the vehicle. Be sure the steering column/wheel is adjusted before driving your vehicle. Failure to follow this warning may result in serious injury or death.**

## Heated Steering Wheel (optional)

The steering wheel contains a heating element inside the rim that helps warm driver's hands by cold weather. The heated steering wheel has only one temperature setting. Once turned on, this function will operate for approximately 58 to 70 minutes before automatically shutting off.

The heated steering wheel can shut off early or may not turn on when the steering wheel is already warm. The heating steering wheel command is in the "Climate" screen of MTC+. See "Air Conditioning Controls" in section "Dashboard Instruments and Controls" for further details.

## NOTE:

The engine must be running for the heated steering wheel to operate.

- Touch the "Climate" softkey located on the lower part of the MTC+ display.
- When the heating function is in the off state, soft-key is not highlighted.



- Within 15 seconds, touch the heated steering wheel soft-key to turn on the function.



- Within 15 seconds, touch the heated steering wheel soft-key a second time to turn it off.



## WARNING!

- **Persons with low skin sensitivity because of advanced age, chronic illness, diabetes, spinal cord injury, medication, alcohol use, exhaustion or other physical conditions must be careful when using the seat heater. It may cause irritation even at low temperatures, especially if used for long periods of time.**
- **Do not place anything on the steering wheel that insulates against heat, such as a blanket or steering wheel covers of any type and material. This may cause the steering wheel heater to overheat.**



## Adjustable Pedals (if equipped)

The adjustable pedals system is designed to allow greater range of pedals positions enabling driver comfort with regard to the steering wheel tilt and the seat position. This feature allows the brake and accelerator pedals to move toward or away from the driver's feet. The switch is located on the front side of the driver's seat cushion shield.



Press the switch downward to move the pedals forward (toward the front of the vehicle).  
Lift the switch upward to move the pedals rearward (toward the driver).



### WARNING!

Do not adjust the pedals position

**while the vehicle is moving. You could lose control and have an accident. Always adjust the pedals position while the vehicle is parked.**

The following messages will be displayed if the driver is attempting to adjust the pedals when the system is locked out:

- “Adjustable Pedals Unavailable While Reversing”;
- or “Adjustable Pedals Unavailable While Cruise Engaged”.

### NOTE:

*For vehicles equipped with driver memory seat, use your key fob (RKE) transmitter or the memory buttons on the driver's door trim panel to return the adjustable pedals to programmed positions. See “Driver Memory Seat” in section “Understanding the Vehicle” for further information.*



### CAUTION!

Do not place any object under the adjustable pedals or obstruct their movements as it may cause damage to the pedal controls. Pedal movement may become limited if there is an obstruction in the adjustable pedal's path.

DEALER ePROCESS

## Rearview Mirrors

### External Mirrors

External mirrors can be adjusted electrically and are equipped with anti-mist resistors operated by the air conditioning system (see “Air Conditioning Controls” in section “Dashboard Instruments and Controls”).

The mirrors can be closed electrically and will yield in both directions in case of a collision.

The external mirrors are electrochromic, which means, they automatically operate an anti-glare function by gradually shading as the light hitting the mirrors increases. The external rear-view electrochromic mirrors work in conjunction with the internal rear-view electrochromic mirror.

### NOTE:

- The mirrors can be adjusted electrically only with the ignition device in **ACC** and **RUN** position.
- When the vehicle is started, the indicator light shown in the picture will momentarily illuminate in both outside rear-view mirrors to let the driver know that the BSA system is

(Continued)



(Continued)  
operational. For more details see chapter "Blind Spot Assist" in section "Driving".

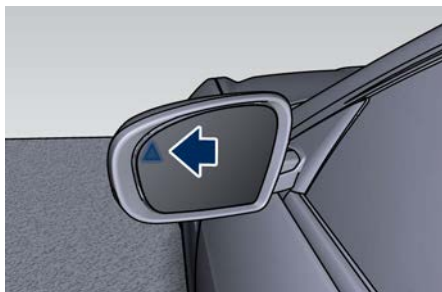

The external of the rear-view mirror support is equipped with LEDs, lighting up when the turn signals and vehicle entry/exit lights are activated. When the surround view camera system is installed, at the external bottom side of the rear-view mirror is the side view camera (refer to "Surround View Camera System (optional)" in section "Before Starting").

### Mirrors Positioning

The power mirror controls are located on the driver's door trim panel. The power mirror controls consist of mirror select buttons and a four-way mirror control switch.

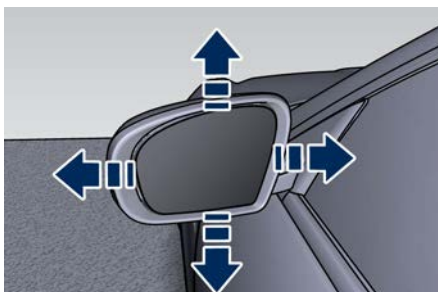

To adjust a rearview mirror, press either the L (left) or R (right) button to select the mirror that you want to adjust. The spin button will illuminate indicating the rearview mirror is activated and can be adjusted. Press the mirror control switch corresponding to the arrow indicating the direction of the desired movement.

For optimal vision orientate the outside(s) mirror(s) in order to frame

the adjacent lane and get a partial overlap with the visible image on the inside rearview mirror. Power mirror preselected positions can be reset by operating the Memory Driver Seat device. Check "Driver Memory Seat" in this section for further information.



### WARNING!

Vehicles and other objects seen in the external side convex mirror will look smaller and farther away than they really are. Relying too much on your passenger side convex mirror could cause you to collide with another vehicle or object. Use the inside mirror to judge the size or distance of a vehicle seen in the external side convex mirror.

### Tilt Side Mirrors In Reverse

This feature provides automatic external rearview mirrors positioning, allowing the driver to view the ground area behind the front doors. The external mirrors will move slightly downward from the current position when the shift lever is shifted into reverse. The external mirrors will then return to the original position when





the lever is shifted out of the reverse position. Each memory set of the driver's seat (see "Driver Memory Seat" chapter in section "Understanding the Vehicle") corresponds to a mirror tilt position in reverse.

#### NOTE:

*The mirrors tilt in reverse can be turned on and off using the MTC+ System, refer to "MTC+ Settings" in section "Dashboard Instruments and Controls".*

#### Folding Mirrors

By selecting this feature on MTC+ the rear-view mirrors automatically fold when the vehicle is locked by the key fob and when the power trunk lid (if equipped) is closed and locked by pressing the  button on the right lower parts of the lid.

When the vehicle and the trunk lid will be unlocked and the ignition device is set in **RUN** position, the rear-view mirrors will automatically open in the position they had before the lock.

The switch for the power folding mirrors is located between the power mirror switches.



Press the switch once and the mirrors will fold in; press the switch a second time to reset the mirrors to the standard position.

There is a way to make external mirrors automatically fold/unfold.

- If the function is available, it need to be activated by MTC+ (refer to "MTC+ Settings" in section "Dashboard Instruments and Controls").

- If the mirrors are automatically folded after the last lock action, then they will automatically unfold when the ignition device is set on **ACC** or **RUN** position.
- If the mirrors were manually folded by the switch on the driver's door panel, before a lock action, they will need to be manually unfolded to reactivate the automatic function.



#### CAUTION!

Never retract or open the mirrors manually: it could damage the power mechanism.

#### Internal Rearview Mirror

The position of internal rearview mirror can be manually adjusted, and is endowed with an accident-prevention release system operating in the event of a collision.

Internal rearview mirror is electrochromic: this glare function is automatically deactivated in reverse to ensure maximum visibility of obstacles.



#### CAUTION!

To avoid damage to the mirror during  
(Continued)



**(Continued)**  
cleaning, never spray any cleaning solution directly onto the mirror. Apply the solution onto a clean cloth and wipe the mirror clean.

## “Mirror Dimmer” Feature

The auto-dimming feature can be disabled or re-enabled by pressing the on/off button on the mirror base. Disabling this feature will increase the reflectance of the internal mirror, increasing visibility at night.



## Lights

### Light Switch

The light switch located on the left side of the dashboard is used for the position/DRL lights, headlights, side marker, license plate lights and rear fog lights operation.

The regulation devices beside the switch may have a different configuration according to type of headlights installed. It can adjust respectively:

- the left one: brightness of the instrument cluster lights, doors controls rear lighting, interior and night lighting (see “Interior Lights” in this chapter).
- the right one: headlights leveling (see “Headlights Leveling” in this chapter) or brightness tuning of night lighting (see “Interior Lights” in this chapter).

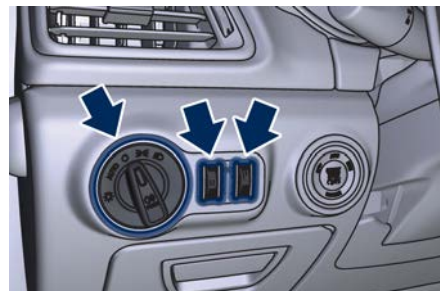

Rotate the light switch to the or to the position: the instrument cluster will display the related telltale.



#### NOTE:

*If the headlights or position/DRL lights are on after the ignition switch is placed in OFF position, a buzzer will alert the driver while opening the driver's door.*





**Lighting Up External Lights according to the Position of the Lights Switch and Ignition Device, and according to the Engine Status and Twilight Sensor Mode**

Ignition Device Position	Engine Status	Twilight Sensor Mode	Lights Switch Position			
			AUTO	0		
OFF	-	-	All lights off.	All lights off.	Position lights (1), side marker and license plate lights on (3).	Low beams, position (1), side marker and license plate lights on.
ACC	Off	-	All lights off.	All lights off.	Position lights (1), side marker and license plate lights on (2).	Low beams, position (1), side marker and license plate lights on (2).
RUN	Off	-	All lights off.	All lights off.	Position lights (1), side marker and license plate lights on (2).	Low beams, position (1), side marker and license plate lights on (2).
RUN	On	DAY	DRL (1) on.	DRL (1) on.	DRL (1), rear position lights, side marker and license plate lights on.	Low beams, position (1), side marker and license plate lights on.
RUN	On	NIGHT	Low beams, position (1), side marker and license plate lights on.	DRL (1) on.	DRL (1), rear position lights, side marker and license plate lights on.	Low beams, position (1), side marker and license plate lights on.

(1) The lighting system uses the same LED for DRL and front position lights with two different levels of intensity: high for DRL and low for position lights.

(2) The lights are powered up for 30 minutes to preserve the charge of the battery.

(3) The lights are powered up for 8 minutes to preserve the charge of the battery.





## Automatic Headlights

This system automatically turns the headlights on or off according to ambient light intensity detected by the twilight sensor positioned on the inner surface of the windshield, over the rear view mirror. To turn the system on, rotate the lights switch clockwise to "AUTO" position.

When the automatic system is activated, the headlight time delay feature is activated as well. This means the headlights will stay on for up to 90 seconds after you place the ignition device into **OFF** position.

To turn the automatic system off, move the lights switch out of "AUTO" position.

### NOTE:

*The engine must be running before the headlights turn on in automatic mode.*



### WARNING!

**The responsibility for turning on the lights, depending on the daylight and regulations in force in the country of use, always lies with the driver. The automatic system for switching on and off the external lights is to be**

**considered as an aid for the driver. If necessary, switch the lights including the rear fog lights on and off manually.**

## Headlights On with Wipers

When this feature is active, the headlights will turn on approximately 10 seconds after activation of the wipers, if the lights switch is placed in the "AUTO" position. The headlights will additionally turn off by deactivation of the wipers if previously activated with this function.

### NOTE:

*The headlights with wipers feature may be turned on and off using the MTC+ System, refer to "MTC+ Settings" in section "Dashboard Instruments and Controls".*

## Headlights Time Delay

This safety feature provides headlight illumination for up to 90 seconds (programmable) when leaving your vehicle in an unlit area. To activate the delay feature, place the ignition switch in the **OFF** or **ACC** position while the headlights are still on. Then turn off the headlights within 45 seconds.

The delay interval begins when the lights switch is turned off (position "0"). If you turn the headlights or position lights on, or place the ignition switch in **RUN**, the system will cancel the delay.

If you turn the headlights off ("0" position) before the ignition, they will turn off in the normal mode.

### NOTE:

- *To activate this feature the lights must be turned off ("0" position) within 45 seconds of placing the ignition switch in the **OFF** or **ACC** position.*
- *Once the delay feature is active, any additional shifting of the light switch will cancel the feature.*
- *The headlight delay time is programmable using the MTC+ System, see "MTC+ Settings" in section "Dashboard Instruments and Controls".*
- *If the low beam bulbs/LEDs are active due to "Headlights with Wipers", then the headlamps delay feature will not be activated when the ignition switch is set in **OFF** position.*



## Daytime Running Lights (DRL)

The lighting system uses the same high or low intensity headlamps LED, respectively, for the DRL lights and front position lights.

DRL lights will turn on when the twilight sensor is in "DAY" mode, the engine is running and the light switch is in  or "AUTO" position.

If a turn signal is activated, the DRL LED on the same side of the vehicle switches in position light function for the duration of the turn signal activation. Once the turn signal is deactivated, the DRL LED will light up again.

### NOTE:

*On Canadian vehicles DRL are always on. On USA vehicles, the DRL lights can be turned on and off using the MTC+ System, see "MTC+ Settings" in section "Dashboard Instruments and Controls" for further information.*

## Bi-Xenon Headlight

The gas-discharge (xenon) headlights operate with an electric arc saturated with Xenon gas under pressure, instead of the incandescent filament. The light produced is assuredly higher compared to traditional light bulbs, in

terms of quality (brighter light) as well as of the span and positioning of the illuminated area.



### WARNING!

**If xenon headlamp replacement is necessary, contact the Authorized Maserati Dealer only: DANGER - RISK OF ELECTRICAL SHOCK.**

## "Full-LED" Headlight with Cornering Function

These headlamps combine the cornering function to the "Full-LED" technology consisting of an additional LED module which turns on when two conditions occurs: the driver turns the steering wheel or the driver activates the turn indicator. The cornering function will illuminate the corner to enhance the visibility to the driver as long as speed will be lower than 25 mph (40 km/h).

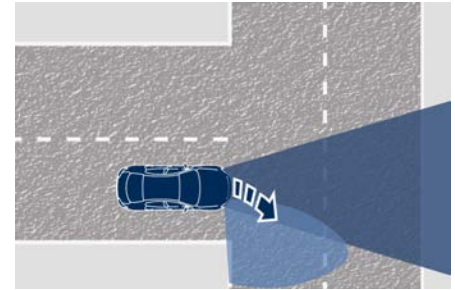

## "Full-LED" Technology

This technology creates headlights with a simpler construction and a more compact size compared to those equipped with traditional or Xenon light bulbs.

Other advantages are:

- a clearer light beam, with a cool white tone that allows a better perception of the contrasts thus making the night vision more efficient and less tiring;
- a longer duration equivalent at least to that of the vehicle;
- a reduced current consumption.

These features positively affect some vehicle management economy aspects by eliminating/reducing the light bulb replacements and help limit fuel consumption.





## Automatic High Beam (for versions/markets, where provided)

The Automatic High Beam headlight control system provides increased forward lighting at night by automating high beam control through the use of the forward-facing digital camera located behind the rear-view mirror, which is the same one used for example by the Lane Keeping Assist - LKA system on vehicles with ADAS systems.

This camera detects the environmental luminosity, the headlamps of oncoming vehicles and the tail lamps of preceding vehicles in the front area. In these cases, the system automatically switches from high beams to low beams until the approaching vehicle is out of view. Furthermore, the digital camera is able to detect the urban areas and the inhabited centers and to turn off the high beams when driving near of one of them.

The properly working for this feature (if all the other conditions are met) is ensured between 21.7 mph (35 km/h) and 155 mph (250 km/h).

### Activation Mode

To activate Automatic High Beam feature:

- Shift the multifunction lever onward .
- Put the light switch in "AUTO" position.
- Touch the "Controls" soft-key in the lower part of the MTC+ display.
- Within 15 seconds, touch the "Auto High Beam Assist" soft-key to turn on the feature.

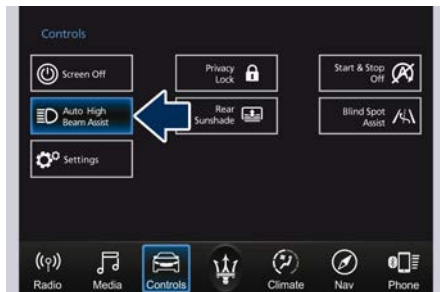

Without ADAS



With ADAS

- Within 15 seconds, touch the "Auto High Beam Assist" soft-key a second time to turn it off.

After these steps, the green indicator on the upper right side of the TFT display comes on.





**NOTE:**

- The function is enabled only if the brightness sensor detects the right lighting conditions and then switch the low beam on.
- Broken, muddy, or obstructed headlights and taillights of vehicles in the field of view will cause headlights to remain on longer (closer to the vehicle). Also, dirt, film, and other obstructions on the windshield or camera lens will cause the system to function improperly.

**Automatic High Beam Failure**

In the event of a failure on high beam system, the related amber warning light will light up on the TFT display. Take your vehicle to the nearest **Authorized Maserati Dealer** as soon as possible avoiding to use this system.

**Fog Lights**

The rear fog lights switch is built into the lights switch. To activate the rear fog lights, turn the headlight switch to the low beam light  or "AUTO" position. Press the lights switch  to turn on the rear fog lights.

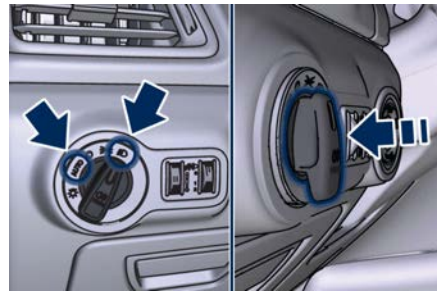

Pressing again the lights switch  will deactivate the rear fog lights. Turning the lights switch off (position "0") will also deactivate the rear fog lights. A dedicated telltale in the instrument cluster illuminates when the rear fog lights are turned on.

**DEP**  
DEALER ePROCESS

**NOTE:**

The rear fog lights will **NOT** activate automatically when turning on the low beam  or "AUTO" headlights if previously deactivated by turning the lights switch off. The rear fog lights will only turn on by operating the switch as previously described.

**Multifunction Lever**

The multifunction lever controls the operation of the turn signals, headlight beam selection, overtaking lights and windshield wiper and washer (for this content see the chapter "Windshield Wipers and Washers" of this section). The multifunction lever is fitted on the left side of the steering column.



## Turn Signals

Move the multifunction lever all the way up or down until the stop triggers.

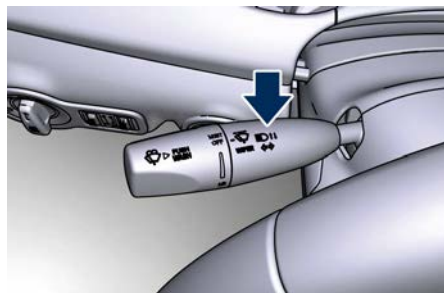

The left or right arrow on the speedometer and tachometer instrument cluster respectively, flashes to show proper operation of the front and rear turn signal lights.

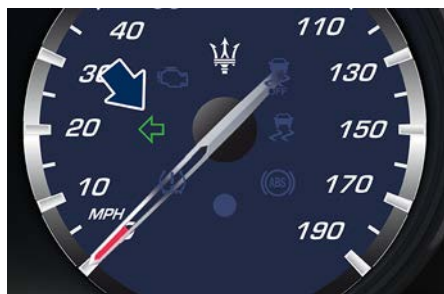



To activate lane change function, tap the lever up or down once, without moving beyond the detent. The turn signals (right or left) will flash three times then automatically turn off. This function is useful when overtaking or changing lanes.

### NOTE:

- If either light remains on and does not flash, or flashes at a fast rate, check for a defective outside light. If an indicator on the instrument cluster fails while moving the lever, then the turn indicator could be defective.
- The message that a turn signal is on will appear in the instrument cluster and a continuous chime will sound if the vehicle is driven more than 1 mile (1.6 km) with either turn signal on.

## High Beams and Flashing

To switch on the high beams with the light switch in headlamp  or "AUTO" position, shift the multifunction lever onward. The blue telltale  will illuminate on the tachometer.



By pulling the lever backward (toward the steering wheel) you switch off the high beams and switch on the low beams.







You can signal another vehicle with your headlights by lightly pulling the multifunction lever toward you. This will turn on the high beams headlights until the lever is released.

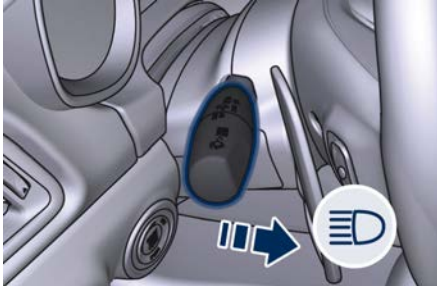

Flashing occurs also with lights off (lights switch in position "0") if the ignition switch is **RUN** position.



### CAUTION!

The high beams can only be switched on manually by pushing the multifunction lever forward.



### WARNING!

If the high beams are activated, they will turn on automatically every time the low beams are switched on either manually or automatically. We recommend therefore that you switch

**them off when they are no longer necessary and every time the twilight sensor deactivates the external lights.**

### Automatic High Beams (if equipped)

The Automatic High Beam headlight control system provides increased forward lighting at night by automating high beam control through the use of the forward digital camera mounted behind the rearview mirror, which is the same one used also by the Lane Departure Warning (LDW) system. This camera detects vehicle specific light and automatically switches from high beams to low beams until the approaching vehicle is out of view. Furthermore, the digital camera is able to detect the urban areas and the inhabited centers and to turn off the high beams when driving near of one of them.

The high beam can be turned back on if there are all the necessary conditions and if the vehicle speed exceed 21.7 mph (35 km/h).

The "Auto High Beam Assist" feature can be turned on or off using the MTC+ System. Refer to "MTC+ Settings" in section "Dashboard Instruments and Controls" for further information.

DEALER ePROCESS

The function is enabled only if the brightness sensor detects the right lighting conditions.

To activate this function:

- Shift the multifunction lever onward .
- Put the headlight switch in "AUTO" position.
- Enable the "Auto High Beam Assist" function on MTC+.

After these steps, the green indicator on the upper right side of the TFT display comes on.





## NOTE:

*Broken, muddy, or obstructed headlights and taillights of vehicles in the field of view will cause headlights to remain on longer (closer to the vehicle). Also, dirt, film, and other obstructions on the windshield or camera lens will cause the system to function improperly.*

If the windshield or Automatic High Beam headlight control mirror is replaced, the mirror must be re-aimed to ensure proper performance. See your local **Authorized Maserati Dealer**.

## Interior Lights

The interior and exterior approach lights turn on and off when entering/exiting the vehicle (see "Illuminated Entry/Exit" in section "Before Starting" for further information).

The brightness of the lights can be manually adjusted with the regulator positioned beside the light switch. To protect the battery, the interior lights will turn off automatically 10 minutes after the ignition switch has been shifted to **OFF**. This occurs if the interior lights were turned on manually or by opening of a door. The glove box light, share the same

characteristics excepting the trunk light.

To adjust interior lights, either turn the ignition switch out of **OFF** or rotate the multifunction lever out of "0" position.

## Courtesy Dimmable Lights

The following dimmable courtesy lights, can be set with the regulation device:

- instrument cluster dials and display;
- dome light (front/rear);
- inside door handle LED;
- doors and steering wheel backlight controls LED;
- front footrest light;
- front seats night lighting.

## Interior Lights Regulator (only with Bi-Xenon Headlights)

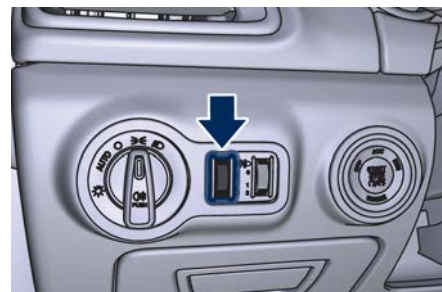

The regulation device rotates from position "0" upward and back downward performing stable and dimmable positions.





This regulator switch has 4 different positions:

- 0 (OFF) Stable position: lower level of the internal and night lighting.
- 1<sup>st</sup> Dimmable position: allows minimum to maximum brightness tuning of the instrument cluster dials, display, control switches and MTC's backlight, including all displayed messages and night lighting.
- 2<sup>nd</sup> Stable position: allows maximum brightness set.
- 3<sup>rd</sup> Stable position: allows to switch on the main and reading lights of the front dome light.

### Interior Lights Regulators (only with Full-LED Headlights)



The regulation devices rotate from position "0" upward and back downward performing stable and dimmable positions.

The left regulator switch has 4 different positions:

- 0 Stable position: lower level of the internal lighting.
- 1<sup>st</sup> Dimmable position: allows minimum to maximum brightness tuning of the instrument cluster dials, display, control switches and MTC's backlight, including all displayed messages and night lighting.
- 2<sup>nd</sup> Stable position: allows maximum brightness set.

- 3<sup>rd</sup> Stable position: allows to switch on the main and reading lights of the front dome light.

#### **NOTE:**

*The left regulator operates only with park lights or low beams lights on.*

The right regulator has 2 different positions:

- 0 Stable position: night lighting off.
- 1<sup>st</sup> Dimmable position: allows minimum to maximum brightness tuning of the front dome light LED and the night lighting.

#### **NOTE:**

*The right regulator is only active if the switch is in "AUTO" or in low beam mode .*



## Headlights Leveling (only with Bi-Xenon Headlights)

A correct headlights leveling is crucial for the safety of the vehicle's occupants and of people in the street. Moreover it is included in the road regulation law.

In order to obtain the best visibility conditions while driving with headlights on, the headlight beam must be properly leveled.

Headlights leveling must be adjusted at every change of the weight and position of the passengers and/or of the load carried.

A heavy load will weigh the vehicle down and, as a consequence, the light beam will be raised. In this case it is important to adjust the beam to a correct level using the right regulator located on the side of the light switch.

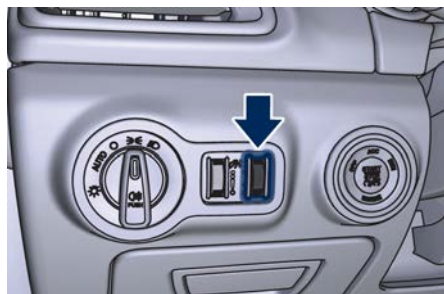

The regulator has 3 different positions:

- 0 One or two people on the front seats.
- 1 Four or five people in the vehicle.
- 2 Four or five people + load in the trunk.

During the regulation, the different positions (0, 1 and 2) are visualized on the TFT display.

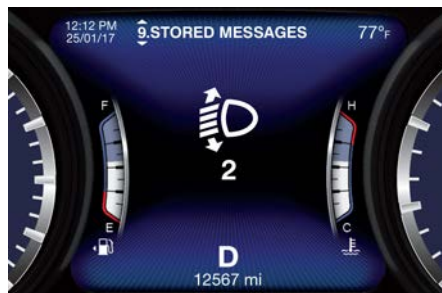

## Dome Lights

The front and rear part of the dome, include each a central and two reading lights.

The central light automatically turns on when one of the doors is opened and turns off when the door is closed (timed switching off). The light may be

DEALER ePROCESS

switched on manually by pressing the central button.

The reading lights are controlled by the respective side buttons. If they are turned on by pressing the button, both central and reading lights will stay on for about 10 minutes after turning the engine off, and will then turn off gradually.

When the exterior lights are switched on, the two night LEDs fitted on the side of the power buttons on the overhead console will light up to facilitate the use of the transmission lever and the central console.



**NOTE:**

The controls of the sunroof, of the HomeLink and the button to switch off Park Assist system can be found on the front dome console.

### Button to Switch off Passenger Compartment Lights

In addition to specific switches to turn on and off the front and rear side dome lights as previously described, on the front console there is a button that allows to turn off and on all these lights.

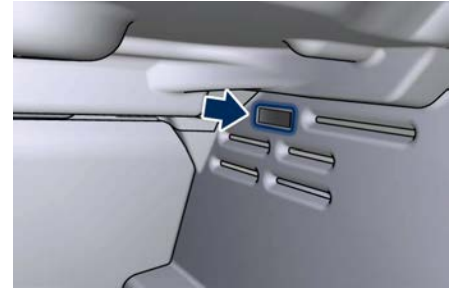

If trunk lid is left open for a long time, lights will turn off after 30 minutes to save battery charge.

### Hazard Warning Flashers



Press the indicated button on the central console to turn on the hazard warning flashers. The operation is independent of the ignition device position.

Press the button again to turn them off.

When these lights are on, the direction indicators, the related arrow indicator on the instrument cluster and the button itself will flash.

If one or more doors are opened, the front and rear dome lights will turn on for 27 seconds. If the door is closed before this time, the lights will dim and subsequently switch off after about 3 seconds.

**NOTE:**

The dome lights will also turn on by pressing the  or  button for centralized doors unlock and lock on the key fob RKE transmitter. See "Illuminated Entry/Exit" section "Before Starting" for further information.

In the event of a collision causing automatic interruption of fuel supply, the dome lights switch on automatically and remain lit for approx. 15 minutes.



### Cargo Lights

To illuminate the cargo area there are two lights inside the trunk compartment, one on each side. These lights turn on when trunk lid is opened and turn off when it is closed.



## Windshield Wipers and Washers

The multifunction lever operates the wipers and washers acting on the windshield when the ignition switch is placed in **RUN** or **ACC** position. The multifunction lever is located on the left side of the steering column. A low fluid level of windshield washers is indicated by the indicator light  and by the message on the instrument cluster.

3

### NOTE:

*When the hazard warning lights are activated, the direction indicator controls are disabled.*

The external mirrors are equipped also with approach and courtesy LEDs, lighting up when the vehicle entry/exit lights are activated.

## Integrated External Rearview Mirror Lights

External mirrors are supplied with LED turn signals integrated on the support. The LED turn signal indicators flash simultaneously with the corresponding turn signal lights in the front and rear of the vehicle. Turning on the hazard warning flashers will also activate these LEDs.



To refill the fluid, see “Maintenance Procedures” in section “Maintenance and Care”.

## Windshield Wipers

- Rotate the end of the multifunction lever to one of the four settings to activate the automatic intermittent





setting (see “Rain Sensing Wipers” paragraph in this chapter).

- For low speed wiper operation (stable position “LO”): rotate the end of the multifunction control lever forward to the first trigger after the intermittent setting.
- Rotate to the second trigger after the intermittent setting for high-speed (stable position HI) wiper operation.
- Rotate the end of the lever downward to the “MIST” position to activate a single wipe cycle.
- The wipers will continue to operate until you release the multifunction lever.
- To turn the wipers off rotate the lever to “OFF”.

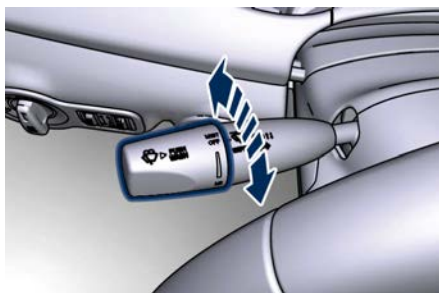

### CAUTION!

- Turn the windshield wipers off when driving through an automatic car wash. The windshield wipers may be damaged if the wiper control is left in any position other than “OFF”.
- In cold weather, always turn off the wiper switch and allow the wipers to return to the park position before turning off the engine. If the wiper switch is left on and the wipers freeze to the windshield, the wiper motor may be damaged when the vehicle is restarted.
- Always remove any buildup of snow that prevents the windshield wiper blades from returning to the off position. If the windshield wiper control is turned off and the blades cannot return to the off position, the wiper motor may be damaged.

## Rain Sensing Wipers

This feature detects moisture on the windshield through an internal rearview mirror integrated sensor, which automatically activates the relative wipers.

Rotate forward the end of the multifunction lever to one of four

settings to adjust the detection system.

First wiper delay position is the least sensitive, and fourth wiper delay position is the most sensitive. Third position should be used for normal rain conditions.

The rain sense wipers will automatically change between an intermittent wipe, slow wipe and a fast wipe depending on the amount of detected moisture sensed by a particular area of the windshield. Place the wiper switch in the “OFF” position when you do not want to use the automatic intermittent system. The rain sensing feature can be turned on and off using the MTC+ System, see “MTC+ Settings” in section “Dashboard Instruments and Controls” for further information.



### CAUTION!

- The rain sensing feature may not function properly by ice or dried salt water on the windshield.
- Use on the windshield of RainX® or products containing wax or silicone may reduce rain sensor performance.

The rain sensing system has protective features for the wiper blades and



arms. It will not operate under the following conditions:

- **Low Temperature Wipe Inhibit:** the rain sensing feature will not operate when the ignition is in **RUN** position, the vehicle is stationary and the outside temperature is below 32°F (0°C). To resume, set the automatic feature on the multifunction lever, start the engine and drive or wait until the outside temperature rises above freezing.
- **Wipe Inhibit with Transmission in Neutral Position:** the rain sensing feature will not operate when the ignition is placed in the **RUN** position, the transmission shift lever is in the N (Neutral) position and the vehicle speed is less than 5 mph (8 km/h). To resume, set the multifunction lever to the automatic function or move the shift lever out of N (Neutral).

### Headlights On with Windshield Wipers

When activating this function, the headlights will light up approximately 10 seconds after the wipers acting on the windshield are turned on if the light switch is placed in "AUTO" position. In addition, the headlights

switch off when the wipers are turned off (position "OFF") if they were previously turned by using this function. Powering on Headlights with wipers can be activated and deactivated with the MTC+ System, see "MTC+ Settings" in section "Dashboard Instruments and Controls" for further information.

### Wiper Blade Maintenance

When the wiper arms acting on the windshield are in the rest position it is not possible to check or replace the blades (Service position) as they are folded under the hood. To service the blades (see paragraph "Wiper Maintenance and Blades Replacement" in chapter "Maintenance Procedures" of section "Maintenance and Care") it is necessary to shift the multifunction lever to "OFF" and the ignition switch to **OFF** position.

Shift the control lever within 15 seconds to the "MIST" position (forward rotation of the end of the multifunction control lever) and release. The blades are brought in a position enabling to open the wiper arms and change the blades.

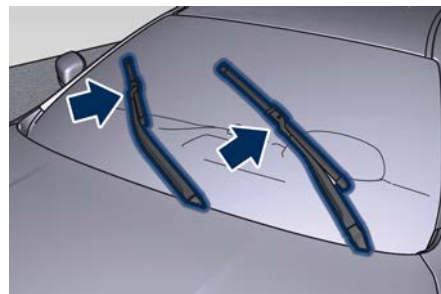

It is possible to use the "MIST" position for a maximum of 3 times within two minutes, corresponding to different three blades positions on the windshield. When completed, bring the ignition switch in **RUN**: the arms will reposition. If necessary move the multifunction lever to other required operating positions.



#### **WARNING!**

**Operate or service the windshield wiper blades without deactivating the wipers ("OFF" position), leaving the ignition switch in RUN can be dangerous for the operator since the rain sensor may suddenly activate the wipers. Always use "Service" position for any intervention on the windshield wiper blades.**





## Windshield Washers

To use the washer on the windshield, push the end of the multifunction lever inward (toward the steering column) and hold it as long as washer spray is desired.

If you activate the washer while the windshield wiper control is in the automatic intermittent range, the wipers will operate for two wipe cycles after releasing the lever and then resume the previously selected intermittent interval.

If you activate the washer while the windshield wiper is turned off ("OFF" position) the wipers will operate for three wipe cycles and then turn off.

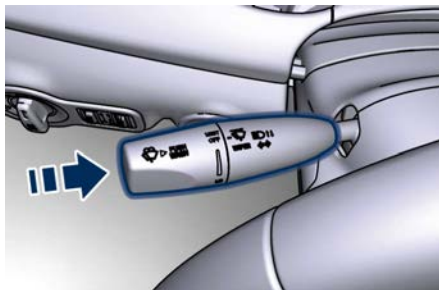

### WARNING!

- Do not start the windshield washer

during the cold months until the windshield has warmed up. If it has not warmed up, the liquid could freeze on the glass and block your view.

- Sudden loss of visibility through the windshield could lead to a collision. You might not see other vehicles or other obstacles. To avoid sudden icing of the windshield during freezing weather, warm the windshield with the defroster before and during windshield washer use.



### WARNING!

California Proposition 65

Operating, servicing and maintaining a passenger vehicle or off-road vehicle can expose you to chemicals including such as, engine exhaust, carbon monoxide, phthalates and lead, that which are known to the State of California to cause cancer and birth defects or other reproductive harm. To minimize exposure, avoid breathing exhaust, do not idle the engine except as necessary, service your vehicle in a well-ventilated area and wear gloves or wash your hands frequently when servicing your vehicle. For more

information go to:  
[www.P65Warnings.ca.gov/passenger-vehicle](http://www.P65Warnings.ca.gov/passenger-vehicle)

### Heated Windshield Washer Nozzles (for version/markets, where provided)

To avoid fluid freezing inside at low external temperatures, the fluid supply nozzles can be heated by internal resistors.



## Interior Features

### Electric Power Outlets

The vehicle is equipped with four 12 Volt (13 Amp) electric power outlets, two available for the front seat passengers, one for rear seat passengers and one fitted in the trunk compartment.

In vehicles equipped with "Smoking Kit" the electric power outlet inside the cupholder is replaced with a cigarette lighter.

All power outlets are supplied only when the engine is started or the ignition device set to **ACC** or **RUN**. Power outlets are protected by a fuse. Insert a cigar lighter or accessory plug into the power outlets to ensure proper operation. Otherwise, check the matching fuse integrity, see "Fuse Replacement" in section "Maintenance and Care" for further information.



#### CAUTION!

- Do not plug in accessories that exceed the maximum power of 160 Watts (13 Amps) at 12 Volts.
- Power outlets are designed for accessory plugs only. Do not insert any other object in the power outlets

as this will damage the outlet and blow the fuse. Damages caused by improper use of the power outlet are not covered by the New Vehicle Limited Warranty.



#### WARNING!

To avoid serious injury or death:

- Only devices designed for use in this type of outlet should be inserted into any 12 Volt outlet.
- Replacing the fuses that protect power outlets with others of higher amperage, there is the risk of fire.
- Do not touch with wet hands.
- Close the lids when the plug is not used and while driving the vehicle.
- If this outlet is mishandled, it may cause an electric shock and failure.

#### Power Outlet inside the Cupholder

To access the power outlet is inside the cupholder beside the transmission lever, press the cover as indicated to open it completely. Remove the cigarette lighter (if equipped) and use its socket as power outlet.



#### WARNING!

High power consumption items plugged into this outlet for long periods may discharge the battery which could prevent the engine from starting.

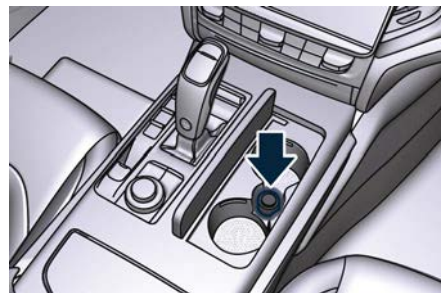

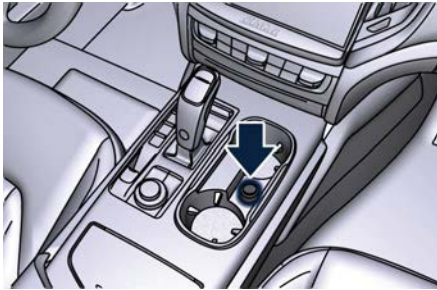

### Power Outlets inside the Central Console

To access the power outlet located inside the glove box of the central console you need to open the half-lids as indicated in the following paragraph.



### Rear Power Outlets

A 12 V power outlet inside the armrest between the rear seats is available

upon request for rear seat passengers (see "Rear Seats" in this section).

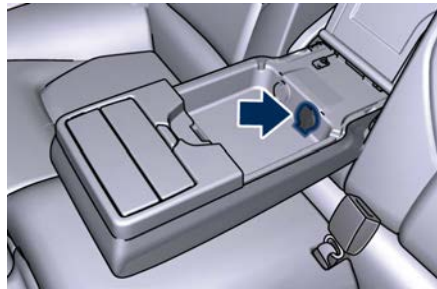

### Power Outlet inside the Trunk

The power outlet is positioned on the right side of the trunk compartment.



### Cupholders

The vehicle is equipped with several cupholders.



- Use light and shatterproof containers.
- Do not forcefully push unsuitable containers into the cupholders to prevent damage to the containers.
- Do not store hot drinks.

### Cupholders for Front Passengers

The front cupholders are located beside the transmission lever and may be at sight or with access cover.

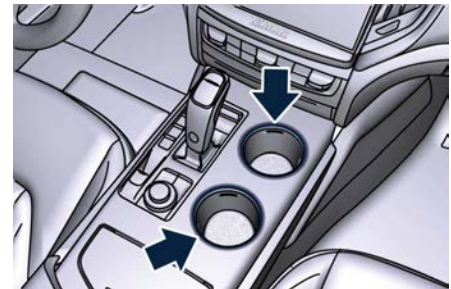

At Sight Version without Power Socket





3

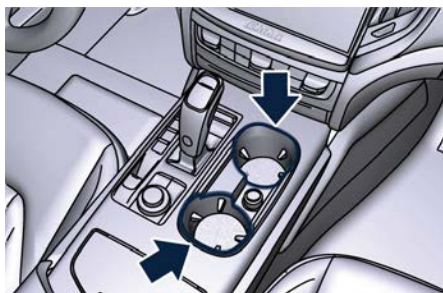

### At Sight Version with Power Socket

To access the cupholder, push the cover (if equipped) as shown in the picture and it will open completely.



Version with Cover

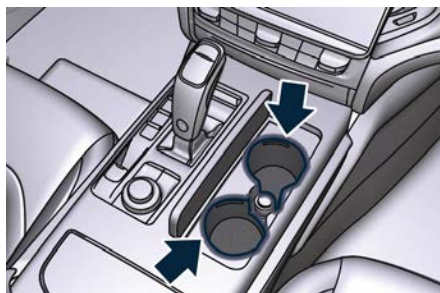

### Version with Cover

By pressing the indicated button on the central console, the half-lids will rise completely enabling access to the inner compartment where the two cupholders are located.



### At Sight Version with Power Socket

The storage and passenger compartment share the same air conditioning even though you may exclude the air conditioning of the

**DEALER ePROCESS**

cupholder compartment by moving the indicated button.



To close one or both of the half-lids, push them down to the locking position.

### Cupholders for Rear Passengers

Two cupholders are available in the front side of the rear seats central armrest.

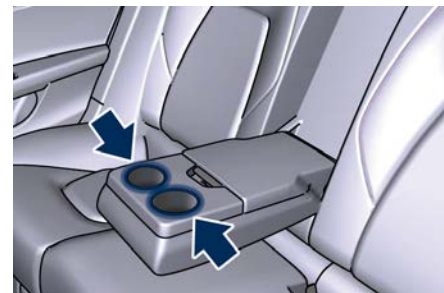

Versions with cupholder visible



On versions with access covers, press the button as shown in the picture to access them.

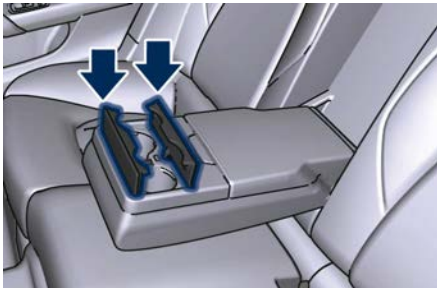

## Multimedia Ports and Phone Housing Compartment

Multimedia ports and the sliding drawer for the phone are located inside the dashboard compartment below the climate control panel. To access this compartment check that cupholder cover (if equipped) is

closed, then push the door as indicated in picture: it will open completely. If needed, gently pull out the drawer until it stops at the very first position. In case of emergency pull out the drawer completely.

### NOTE:

- To prevent damage to the sliding mechanism, do not force the drawer into the extracted position.
- Before closing the compartment door, ensure that the drawer is fully back in its seat.

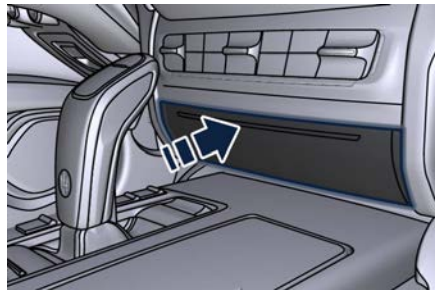

**DEP**  
DEALER ePROCESS

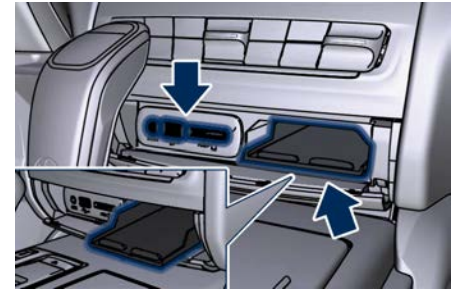

The AUX auxiliary port features:

- typical input impedance between AUX-IN and AUX\_REF: 13 Kohm;
- max. applicable voltage: 0.75 Vrms at 1 kHz;
- input compatible only with 3.5 mm jack connectors (not included).

Any player with these characteristics and analogue audio output (headset output type) can be served by the MTC+ System. The system can recognise the connection to a player outlet autonomously, by enabling access to the audio functions connected to this source.

This USB input  can be used for data exchange and charge of the connected source (refer to the MTC+ guide for further details). Through this USB input is possible to recharge the connected device for about an hour from when the ignition



device is turned **OFF** ("Active Charging" feature). When this feature is enabled, the USB port will be backlit. In the dashboard compartment of the central console there is also a SD memory card input. Once inserted into the slot, to extract it press lightly on the card.

Another USB port can be present for rear seat passengers, inside the armrest between the rear seats. To access the USB port, open the outside cover. This USB port allows charging the connected source.

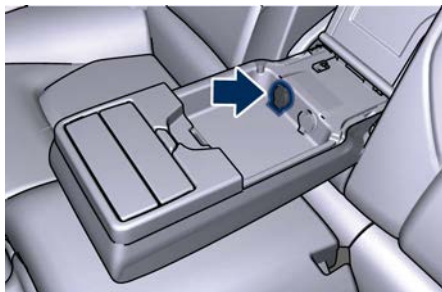

## iPod® Connection

An iPod® can be connected to the system via USB and AUX ports by means of a special cable (optional). The MTC+ will then control the following functions: play, pause, fast forward, rewind, next track, previous track, random or repeat mode,

selection and navigation of playlist/genre/singer/album/Podcast.



### **CAUTION!**

**Do not leave your USB device, iPod® or an external audio source in the vehicle for extended periods of time: extreme temperatures and humidity can occur in the vehicle.**

## Sun Visors

Sun visors can be folded to the front and to the side of the vehicle. To move the visor laterally, lower and release it from its catch as indicated.

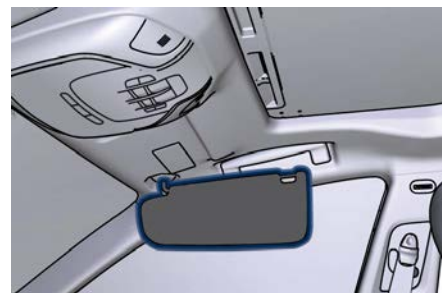
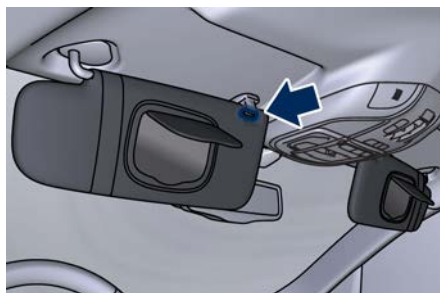

By lowering the visor you can access the courtesy mirror with incorporated light illuminating automatically (with the ignition switch in **RUN**) by raising the mirror protective cover. Before raising the visor, close the mirror cover.

A paper holder is fitted inside each sun visor.

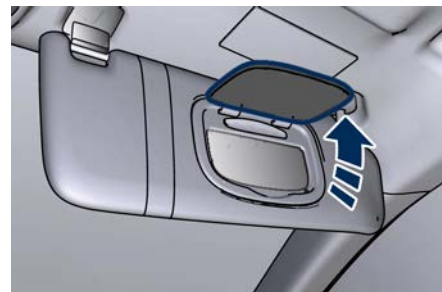



## Removable Ashtray and Lighter (optional)

The removable ashtray with cover for front seats passengers can be inserted inside the front cupholder.

The rear seat passengers can use the removable ashtray by inserting it into the rear door pocket.

### Cigarette Lighter Use

Pressing the central button activates the cigarette lighter. After about 20 seconds the button returns automatically to the initial position and stops the heating: now the cigarette lighter is ready for use.



#### CAUTION!

After use, always make sure that the cigarette lighter is switched off.



#### WARNING!

- The cigarette lighter reaches high temperatures. Handle it carefully and do not allow children to use it.
- The cigarette lighter may not be used as a power outlet.

## Handholds and Cloth Hooks

Handholds are fitted above the passenger doors. Once grabbed, they will lower until the block position. When released, a return spring will bring them back to the original position.

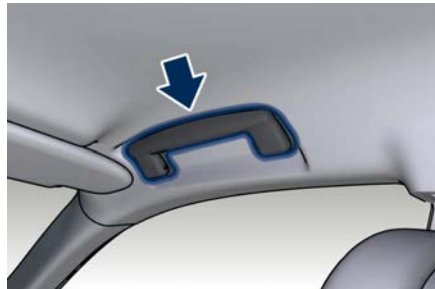

Cloth hook is present on each rear handhold.



DEP  
DEALER ePROCESS

## Mesh Pockets

Front seats are fitted with mesh pockets, on the rear of the seatbacks, and accessible by rear passengers.



The mesh pockets can hold small items, maps and magazines.



#### CAUTION!

Do not put heavy or sharp objects in the mesh pockets.

## iPad Holder (Genuine Accessories)

The Authorized Maserati Dealer can provide you with all information about the "Maserati iPad Holder" mounted on the rear of the front seatbacks, available in the "Genuine Accessories" range.



3



## Wi-fi Connection (optional)

It is possible to install a control unit with router function to access a wi-fi high speed internet connection on board. This enables web navigation and the possibility to connect several devices at the same time.



### WARNING!

**Mobile internet connection is intended for passenger use only. Use of handheld electronic devices while driving can cause an accident due to distraction, resulting in death or injury.**

With this active connection, passengers using smartphone, tablet or pc can navigate the internet, check their emails, download music and films and

share their status major social networks. In order to activate the wi-fi control unit, please provide to your **Authorized Maserati Dealer** your SIM, the relative PIN and the access points (APN) of your provider.



### CAUTION!

**Refer to your Authorized Maserati Dealer to activate the wi-fi control unit and, if necessary, remove or replace it or the SIM card.**

### NOTE:

*To speed up operations of installation and activation, in addition to the above, you'll need to create a new account by accessing the following website of the manufacturer of the system that Maserati has chosen for its models:*

*<https://signup.autonetmobile.com/>*

Wi-fi connectivity covers an area of ca. 100 ft (30 m), in order to avoid intrusions, the router is supplied with WEP or WPA2 cryptography. During activation, to be performed by your dealer, it is recommended to enable the security options available by selecting the cryptographic version

(WPA2 is recommended) and inserting the password. From now on, in order to connect to the wi-fi control unit, it will be necessary to insert this password on each device you intend to use.

After that, you shall complete the authentication process and enable Wireless Security to avoid that not-authorized users can improperly access the wi-fi and cause extra costs charged by the provider on the SIM. To navigate the internet it is now necessary to pair the device you intend to use in the vehicle to the active wi-fi connection; you can do that by searching the available wireless Networks from the "Setting" menu. Select the wireless Network linked to your SIM and select "Connect" to start the connection.

If the auto-search is active for wireless Networks, every time the device will be used inside the vehicle or close to it, it will connect to the set connection.

### NOTE:

- *For further information about the pairing procedure, refer to the instructions given with your mobile device.*
- *For further information about wi-fi connectivity and the control unit,*





please contact Client Service at 1-800-977.2107 or write to: support@autonetmobile.com.



### CAUTION!

When selling the vehicle, you should contact the above mentioned Client Service to have your device removed from the list of activated devices registered in your name. Do not simply give your control unit password to a new owner. To avoid improper internet access in your name and allow new owner registration you must de-register with the service provider. A new owner will not be able to register the device if it still appears registered in the prior owner's name. If you are a subsequent owner, the unit could be improperly monitored (usage and location), if it is still registered to a prior owner.

## Cargo Area



### WARNING!

To help protect against personal injury, passengers must not be seated in the rear cargo area. The rear cargo space is intended for load carrying purposes only, not for passengers, who should sit in seats and use seat belts.

## Vehicle Load Carrying Capacity

The load carrying capacity of your vehicle is shown on the vehicle emission control label positioned on the rear driver door's ledge.



The information indicated on the label concerns passengers and luggage loading operations.

DEALER ePROCESS

Do not exceed the specified Gross Vehicle Weight Rating (GVWR) or the Gross Axle Weight Rating (GAWR), both front and rear. The GVWR is the total allowable weight of your vehicle. This includes driver, passengers, and cargo. The total load must be limited so that you do not exceed the GVWR indicated on the label.

## Vehicle Loading



### WARNING!

- After loading the vehicle, before driving, adjust the headlight beam leveling using the specific regulator (if available) as described in chapter "Lights" in this section.
- Improper weight distribution can have an adverse effect on the way the vehicle steers, handles and the way the brakes operate.
- Never drive with the trunk lid open. Exhaust gases can enter the passenger compartment.
- Do not pile luggage or cargo higher than the top of the seatback. This could impair visibility or become dangerous in a sudden stop or



**(Continued)  
collision.**

The trunk is the most suitable place to load bulky and heavy objects onboard the vehicle. The maximum allowable load on the floor of the trunk is 440 lb (200 kg).

To load your vehicle properly, store heavier items below and be sure you distribute their weight as evenly as possible.

Stow all loose items securely before start driving as they could move during the trip.

Light objects can be stored in the net pocket on the right side of the trunk compartment.

To fasten heavy and bulky luggage inside the compartment a luggage net with hooks anchored to the floor is available upon request. The hooking eyelets of the net are positioned on the floor and on the rear wall of the trunk compartment.

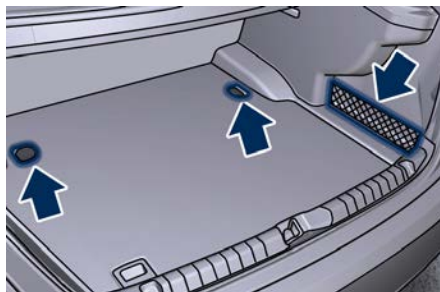

**NOTE:**

*The Authorized Maserati Dealer can provide you with information about the available "Genuine Accessories" for the trunk compartment.*

### Loading with Rear Seatbacks Folded Down

The 60/40 split-folding seatback of the rear seat provides cargo-carrying versatility.

The seatback folded down provides a continuous nearly-flat extension of the load floor able to accommodate large sized equipment and objects (such as the "Maserati Ski and Snowboard Bag") that may not fit within the normal dimensions of the trunk.

**NOTE:**

*Both seat backs can be reclined independently.*

### Folding the Short (40) Seatback Side

The short (40) seatback side fold down easily by pulling tab between the seatback and the side bolster.

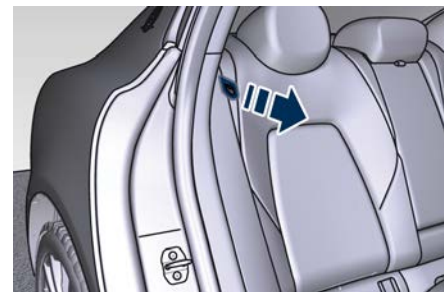



### Ski and Snowboard Bag Housing

To safely store the Ski and Snowboard Bag:

- Tilt forward the short seatback side.
- Secure the rear hook of the bag to the eyelet located on the rear wall of the trunk compartment.
- Wrap the belt around the seat back of the folded seat and fasten the belt buckle.
- Tighten the belt as much as necessary to prevent the bag from moving.

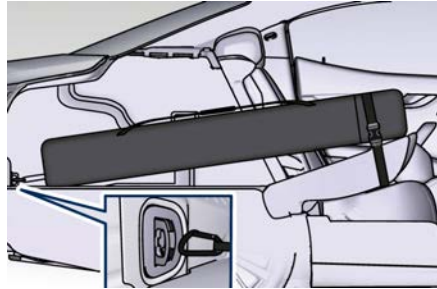

### Folding the Long (60) Seatback Side

- Press the red button located on the front of the buckle using the free latch plate (step 1) and unlatch the plate from the left-side buckle (step 2).

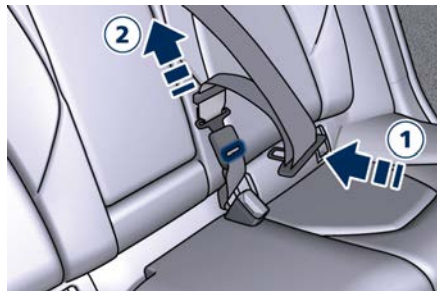

- Allow the belt to retract completely into the retractor seat behind the seatback.
- Unlatch the long (60) seatback side by pulling tab between the seatback and the side bolster.



- Partially fold down the long seatback side and remove the head restraint of the center seat (see "Head Restraints" in this section). In this way it is avoided that the fully reclined seat back touches the edge of the central console.
- Fully fold down the long seatback.

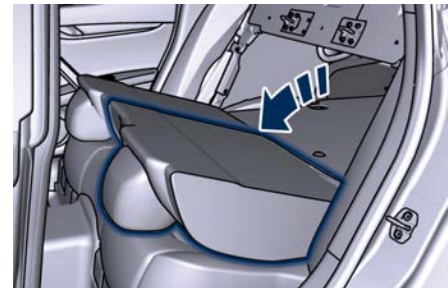

When the short or both seatbacks are tilted to the upright position, make sure they are latched by strongly



pulling on the top of the seatback above the seat strap.

### NOTE:

When the seatback is tilted to the upright position, reassemble the head restraint of the center seat (see "Head Restraints" in this section) make sure the seatbelt of the rear central position is in the proper condition for use.



### WARNING!

- Make sure that the seatback is securely locked into position. If the seatback is not securely locked into position, the seat will not provide the proper stability for child seats and/or passengers. An improperly latched seat could cause serious injury.
- The cargo area in the rear of the vehicle with the rear seatbacks in the folded down position should not be used as a play area by children when the vehicle is in motion. They could be seriously injured in a collision. Children should be seated and use proper restraint system.

## Power Sunroof with Sunshade

The sunroof is power controlled and can only be operated with the ignition switch in **RUN** position. It can slide lengthways and be raised at the rear (tilting).

By opening the sunroof a front flap rises automatically in order to deviate the air flow.



The power sunroof controls are located between the sun visors on the overhead console.

The right two buttons controls the sunroof movement, whereas the left button controls the lifting of the sunroof for venting.



The sunshade can be opened manually. However, the sunshade will open automatically as the sunroof opens. The sunshade cannot be closed if the sunroof is open.



### WARNING!

- Improper use of the sunroof can be dangerous, even if it features a finger-trap prevention system. Before and during the sunroof operation, always make sure that passengers are not exposed to the risk of injuries caused by the moving sunroof or by personal objects dragged or hit by the moving sunroof.
- Never leave children in a vehicle with the key fob RKE transmitter in the passenger compartment.



- In a collision, there is a greater risk of being thrown from the vehicle if the sunroof is open. Always fasten your seat belt properly and make sure all passengers are properly secured too.
- Do not allow small children to operate the sunroof. Never insert fingers, other body parts, or any object through the opening sunroof.



### CAUTION!

- In the event of rain, always close the sunroof to prevent water infiltrations from staining the fabric/leather upholstery.
- Do not open the sunroof if there is ice on it: risk of damage.

## Slide Opening Sunroof

- **Full automatic express opening**

Press the right rear button for more than half second and the sunroof will open automatically regardless of any previous position. The sunroof will open fully and stop automatically. During this operation, if any sunroof button is pressed, the sunroof will stop.

- **Full or partial manual opening**

To open the sunroof manually press the right rear button for less than half second to move step by step the sunroof panel.

## Venting Sunroof

Press and release the left button, and the sunroof will open to the vent position. This is called "Express Vent", and will occur regardless of sunroof position. During this opening operation, any movement of the button will stop the sunroof.

## Pinch Protect Feature

This feature will detect an obstruction in the opening of the sunroof during express close operation. If an obstruction is detected, the sunroof will automatically retract. If this occurs, remove the obstruction then press the right front button and release to express close.

### NOTE:

*If three consecutive attempts to close in express mode the sunroof result in pinch protect reversals, the fourth attempt will be manual, with pinch protect feature disabled.*



## Pinch Protect Override

If any obstruction (ice, debris, etc.) prevents closing the sunroof, press the right front button and hold for two seconds after the reversal occurs. This allows the sunroof to move toward the closed position.

### NOTE:

*Pinch protection is disabled while pressing the right front button.*

## Wind Buffeting

Wind buffeting can be described as the perception of pressure or a helicopter-type sound. Your vehicle may exhibit wind buffeting with the windows down, or the sunroof in certain open or partially open positions. This is a normal occurrence and can be minimised. If the buffeting occurs with the rear windows open, then open the front and rear windows together to minimise the buffeting. If the buffeting occurs with the sunroof open, then adjust the sunroof opening to minimise the buffeting.

## Ignition Off Operation

The power sunroof controls will remain active for up to approximately ten minutes after the ignition switch is



in OFF position. Opening either front door will cancel this feature. The ignition system timing can be set using the MTC+ System (see “MTC+ Settings” in section “Dashboard Instruments and Controls”).

### Sunroof Maintenance

Use only a nonabrasive cleaner and a soft cloth to clean the glass panel.

## HomeLink® (optional)

HomeLink® replaces up to three hand-held transmitters operating the automatic devices that open garage doors and gates, enable/disable the lighting or security systems. The HomeLink® unit is powered by your vehicle's 12 Volt battery. The HomeLink® buttons that are located in the overhead console designate the three different HomeLink® channels. The HomeLink® indicator light is located behind the buttons.



#### NOTE:

HomeLink® is disabled when the vehicle security alarm is active (see “Vehicle security alarm” in section “Before Starting”).



#### WARNING!

- Your motorized door or gate will open and close while you are programming the universal transceiver. Do not program the transceiver if people, pets or other objects are in the path of the door or gate. Only use this transceiver with a garage door opener that has a “stop and reverse” feature as required by Federal safety standards. This includes most garage door opener models manufactured after 1982. Do not use a garage door opener without these safety features. Call toll-free 1-800-355-3515 or, on the Internet at [www.HomeLink.com](http://www.HomeLink.com) for safety information or assistance.
- Vehicle exhaust contains carbon monoxide, a dangerous gas. Do not run your vehicle in the garage while programming the transceiver. Exhaust gas can cause serious injury or death.

### Radio Frequency Transmitter - Regulatory Information

The “Regulatory Information” for all the radio and radar frequency devices can be consulted by accessing the



“Services” section on the website [www.maserati.com](http://www.maserati.com).

## Before You Start Programming HomeLink®

Be sure that your vehicle is parked outside of the garage before you begin programming.

For more efficient programming and accurate transmission of the radio-frequency signal it is recommended that a new battery be placed in the hand-held transmitter of the device that is being programmed to the HomeLink® system.

Before starting programming it is necessary to erase the standard codes memorized on the HomeLink® device during the production phase. To erase such codes:

- place the ignition device in the **RUN** position without starting the engine;
- press and hold the two outside HomeLink® buttons (I and III) until the indicator light starts flashing (after approximately 20 seconds);
- release the buttons.

### NOTE:

- *Erasing the standard codes should only be performed when programming HomeLink® for the first time. Do not perform this operation to program additional buttons.*
- *If you have any problems, or require assistance, please call toll-free 1-800-355-3515 or, on the Internet at [www.HomeLink.com](http://www.HomeLink.com) for information or assistance.*



## System with Devices Provided with Rolling Codes

### Programming the Hand-held Transmitters

Programming garage door/gate openers that were manufactured after 1995.

These devices can be identified by the “LEARN” or “TRAIN” setting button

located where the hanging antenna is attached to the garage door/gate opener. It is NOT the button that is normally used to open and close the door.

The name and color of the button may vary by manufacturer.

- Place the ignition device to the **RUN** position without starting the engine.
- Place the hand-held transmitter 1 to 3 inches (5 - 30 cm) away from the HomeLink® button you wish to program.
- Simultaneously press the HomeLink® button you want to program and the hand-held transmitter button.
- Release immediately the HomeLink® button you want to program.
- Continue holding the hand-held transmitter button until the indicator light starts flashing quickly; then release the button.

The quick flashing light indicates that the channel with the new frequency has been acquired and programmed correctly by the HomeLink® system.



### NOTE:

The distance necessary between the portable hand-held transmitter and the HomeLink® in the vehicle depends on the system you wish to program. Probably it will be necessary to try several times. Upon every attempt, keep the setting position for at least 15 seconds before trying again.

### Synchronizing the Rolling Codes

At the end of the previously-described programming, if the HomeLink® has been programmed for a rolling code system, it will be necessary to synchronize it to ensure its correct operation.

- Locate the “LEARN” or “TRAINING” setting button of the opening motor. Firmly press it and then release it. On some garage door openers/devices there may be a light that blinks when the garage door opener/device is in the LEARN/TRAIN mode.

### NOTE:

You have 30 seconds to initiate the next step after the setting button has been pressed.

- Return to the vehicle and press the programmed HomeLink® button for two seconds and then release it.
- Repeat this operation a second time. If the garage door opening device activates, the programming/synchronization phase is complete.

### NOTE:

If the garage door opening device does not activate, press the button a third time for two seconds and then release it to complete the programming/synchronization phase.

- To program the remaining two HomeLink® buttons, repeat each step for each remaining button. **DO NOT erase the channels.**

### Reprogramming a Single HomeLink® Button

To reprogram a channel that has been previously trained, follow these steps:

- Place the ignition device to the **RUN** position without starting the engine.
- Press and hold the desired HomeLink® button.
- **Without releasing the button** proceed with “Programming the hand-held transmitters” from second step and follow all remaining steps.

## System with Devices Without Rolling Code

### Programming the Hand-held Transmitters

Programming garage door openers manufactured before 1995.

- Turn the ignition device to the **RUN** position without starting the engine.
- Place the hand-held transmitter 1 to 3 inches (5 to 30 cm) away from the HomeLink® button you wish to program.
- Simultaneously press and hold both buttons until the indicator light starts flashing quickly; then release both buttons.

The quick flashing light indicates that the channel with the new frequency has been acquired and programmed correctly by the HomeLink® system.

### NOTE:

The distance necessary between the portable hand-held transmitter and the HomeLink® in the vehicle depends on the system you wish to program. Probably it will be necessary to try several times. Upon every attempt, keep the setting position for at least 15 seconds before trying again.





- Press and hold the programmed HomeLink® button.

If the garage door opener/device activates, programming is complete. To program the remaining two HomeLink® buttons, repeat each step for each remaining button. **Do not erase the channels.**

### Reprogramming a Single HomeLink® Button

To reprogram a channel that has been previously trained, follow these steps:

- Place the ignition device to the **RUN** position without starting the engine.
- Press and hold the desired HomeLink® button.
- **Without releasing the button** proceed with “Programming the hand-held transmitters” from second step and follow all remaining steps.

### Using HomeLink®

To operate, press and release the programmed HomeLink® button. Activation will now occur for the programmed device (i.e., garage door opener, gate operator, security system, entry door lock, home/office lighting, etc.). The hand-held transmitter of the device may also be used at any time.

## Security

It is advisable to erase all channels before you sell or turn in your vehicle. To erase the channels press and hold the two outside HomeLink® buttons (I and III) until the indicator light starts flashing (after approximately 20 seconds).

The HomeLink® Universal Transceiver is disabled when the vehicle security alarm is active (see “Vehicle security alarm” in section “Before Starting”).

## Troubleshooting Tips

If you are having trouble while programming HomeLink®, here are some of the most common solutions:

- Replace the battery in the original hand-held transmitter.
- Press the LEARN button on the garage door opener to complete the training for a rolling code.
- Did you unplug the device for programming and forgot to plug it back in?

If you have any problems, or require assistance, please call toll-free 1-800-355-3515 or, on the Internet at [www.HomeLink.com](http://www.HomeLink.com) for information or assistance.





## Air Conditioning Distribution

3

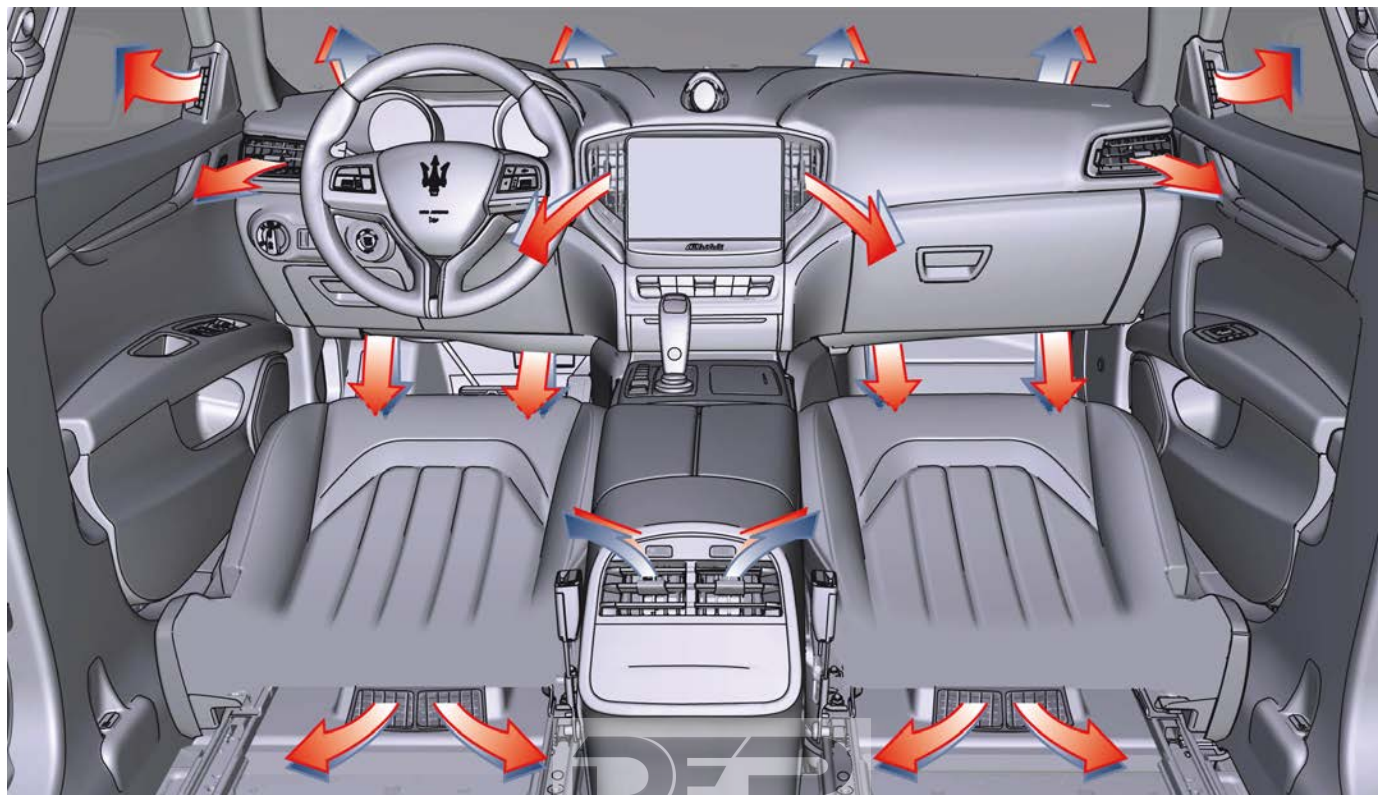

DEALER ePROCESS



Adjustable and fixed air vents allow passengers to achieve the optimal comfort conditions.

### Fixed Air Vents

- The fixed vents, positioned on the upper part of the dashboard, beneath the windshield and above the front part of the front door panels are meant to guarantee the demisting and defrosting of the windshield and the side windows.

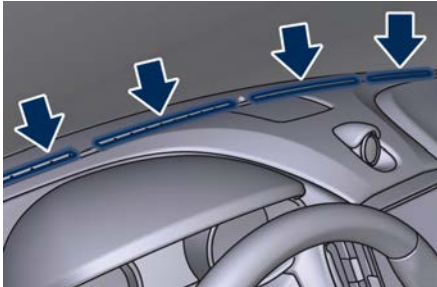

- The fixed vents under the dashboard are aimed at ventilating the lower part of the front passenger compartment.



- The ventilation of the lower part of the rear passengers compartment is made by means of fixed vents positioned under the front seats.

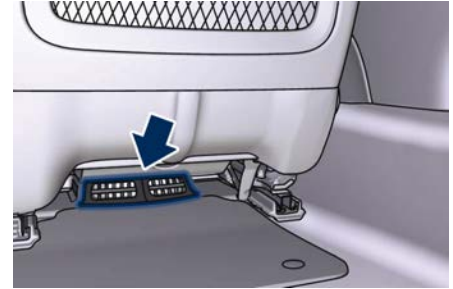

### Adjustable Air Vents

- The adjustable vents are located at the center of the dashboard, to both sides of the MTC+ display, and at the side ends of the dashboard. They have the purpose of ventilating the upper part of the passenger compartment. There are also adjustable vents placed at the rear end of the central console. These vents can be adjusted in vertical and horizontal direction, by operating on the central handle **1**, indicated in the following pictures. The rotor **2**, located near each vent, allows to control the air flow.



3

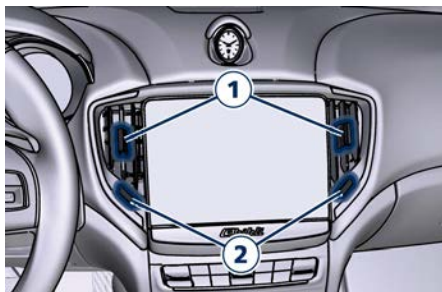

**NOTE:**

*In order not to obstruct the air conditioning inlet, the defrosting or the demisting function of the glass surfaces, avoid covering vents with clothing or other items.*

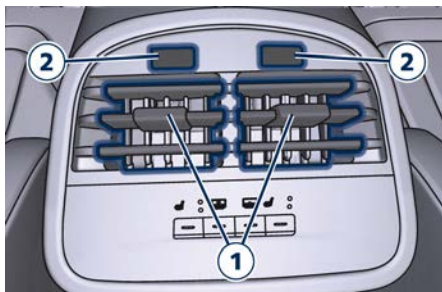
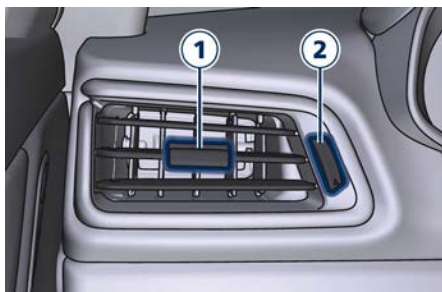



## **4 – Dashboard Instruments and Controls**

Instrument Cluster . . . . .	146
Infotainment System . . . . .	169
Audio Controls . . . . .	176
Audio System . . . . .	177
MTC+ “Controls” Screen . . . . .	179
MTC+ Settings . . . . .	183
Dashboard Compartment . . . . .	194
Analog Clock . . . . .	197
Air Conditioning Controls . . . . .	197
Phone and Voice Controls on Steering Wheel . . . . .	204



## Instrument Cluster

The instrument cluster is divided into three main areas displaying information, signs and text and/or icon messages.

- A** Analogue speedometer. It indicates the vehicle speed.
- B** Rev Counter.
- C** TFT display. In this area the odometer display shows the total distance covered by the vehicle.

U.S. Federal Regulations requires that upon transfer of vehicle ownership, the seller certify to the purchaser the correct mileage that the vehicle has been driven.

If your odometer needs to be repaired or serviced, the repair technician should leave the odometer reading the same as it was before the repair or service. This repair should be performed by an **Authorized Maserati Dealer**.

The odometer setting should be maintained following the repair or service.

Keep a record of the odometer mileage before any repair or service to

ensure that the odometer is properly reset.

Speedometer and Rev Counter display the main warning lights (see “Warning and Indicator Lights on Analogue Instruments” in this chapter).

The other warning and indicator lights are displayed on the TFT display together with mode and drive function indicators (see “TFT Display: Warning/Indicator Lights of Set Modes/Functions” in this chapter).

**NOTE:**

*The image shows the instrument cluster before starting the engine.*

## Warning and Indicator Lights on Analog Instruments

### Telltale on Speedometer

The following telltales are displayed on the speedometer, and related messages are visible for 5 seconds on the central sector of the display, unless otherwise indicated (see “TFT Display” paragraph in this chapter).





### Malfunction Indicator Light (MIL)



The Malfunction Indicator Light (MIL) is part of an onboard diagnostic system that monitors engine and automatic transmission control systems.

Under normal conditions, this indicator light should switch on when the ignition switch is in **RUN** position and switch off soon after the engine is started (the MIL does not shut off immediately).

This is a sign of the indicator light working properly. If the indicator remains lit or switches on while driving, there is a failure in the fuel supply/ignition and emission control systems.

The failure could cause high exhaust emissions, loss of performance, poor vehicle handling and high consumption levels.

Should this occur, proceed with caution to your **Authorized Maserati Dealer** without heavy throttle application or driving at high speeds. Obey all applicable local traffic regulations.

The indicator light will go out if the problem is no longer present. The error will be registered by the system in any case.



### CAUTION!

- When the ignition switch is in the **RUN** position and if the indicator light does not switch on or if it switches on while driving, contact an **Authorized Maserati Dealer** as soon as possible.
- Prolonged driving with the MIL on could cause damage to the engine control system. It also could affect fuel economy and drivability. If the MIL is flashing, severe catalytic converter damage and power loss will soon occur. Immediate service is required. In addition, the OBDII system incorporates a diagnostic connector that can be interfaced using diagnostic equipment. This makes it possible to read the error codes stored in the control unit, together with a set of specific parameters for the engine operation diagnostic cycle, for compliance with CARB & EPA OBDII regulations.

### Left Turn Signal Indicator Light



The indicator lights up when the left turn signals or the hazard flashers are turned on.

DEALER ePROCESS

The indicator light will flash at the same frequency of the turn signals and is controlled by the stalk switch lever.

If the vehicle electronics sense that the vehicle drives for more than 1 mile (1.6 km) with either turn signal on, a continuous sound will alert the driver to turn the signal off.

If the indicator flashes at a rapid rate, check for a defective exterior light bulb.

### Tire Pressure Monitoring Light



This warning light is connected to the Tire Pressure Monitoring System (TPMS).

Under normal conditions, the warning light should illuminate when the ignition switch is in **RUN** and should go off once the engine is started.

If the warning light remains lit or illuminates while driving, the pressure of one or more tires is too low and a message will be displayed.

The TPMS malfunction warning light is connected to the low tire pressure monitoring light.

When the system detects a malfunction, the monitoring light and the related message will flash for

approximately one minute and then remain lit. This sequence will continue upon subsequent vehicle startups as long as the malfunction lasts. When the malfunction warning lights up, the system may not be able to detect or signal low tire pressure correctly. Please refer to “Tire Pressure Monitoring System (TPMS)” in section “Driving” for further information.

### **Anti-Lock Braking System (ABS) Malfunction Warning Light**



This light, and its related message, indicate possible malfunctions of the Anti-Lock Brake System (ABS).

The light will turn on when the ignition switch is in **RUN** position and may stay on for 4 seconds. If the ABS light remains lit or turns on while driving, the Anti-Lock portion of the brake system is not functioning and requires service. However, the conventional brake system will continue to operate normally if the **BRAKE** warning light is switched off. If the ABS light turns on while driving, or if it does not switch on when the ignition switch is in **RUN** position, please visit an **Authorized Maserati**

**Dealer** as soon as possible to restore the Anti-Lock brake function.

### **Electronic Stability Control (ESC) Activation/Malfunction Indicator Light**



The ESC activation/malfunction indicator light on the instrument cluster will display when the ignition switch is in

**RUN** position.

It should switch off by starting the engine.

If the light stays on with the engine running, there is a malfunction in the ESC system.

If the light still stays on after several ignition cycles, and the vehicle has been driven for several miles at more than 30 mph (48 km/h) speed, visit an **Authorized Maserati Dealer** as soon as possible to have the problem diagnosed and serviced.

#### **NOTE:**

*Each time the ignition switch is in **RUN**:*

- *The ESC OFF indicator light  and the ESC activation/malfunction indicator light illuminates temporarily.*
- *When the ESC is functioning, the system will make buzzing or clicking sounds. This is normal. The sounds will stop once ESC becomes inactive*

*and the road conditions that caused the ESC activation no longer persist.*

### **Electronic Stability Control (ESC) OFF Indicator Light**



This indicator notifies that the Electronic Stability Control (ESC) is disabled; the linked message will be displayed.

### **Telltale on Tachometer**

Following telltales are displayed on the tachometer and related messages are visible for 5 seconds on the central sector of the display, unless otherwise indicated (see “TFT Display” in this chapter).



### **Start&Stop Active Indicator**



This telltale indicates that the engine has been switched off automatically by the Start&Stop system.





When the engine starts again, the telltale will switch off.

If the telltale during an automatic engine shutdown (AutoStop) phase starts flashing, it will be necessary to restart the engine normally with the ignition device while holding down the brake pedal.

See chapter “Normal Starting of the Engine” in section “Driving” for further information.

### Rear Fog Light Indicator



This indicator lights up when the rear fog lights are switched on.

### High Beam Indicator



This indicator lights up when the high beams are switched on or when blinking.

### Brake Indicator Light



This light monitors various brake functions, including brake fluid level, brake pads wear and parking brake engagement.

If the brake light illuminates the parking brake may be engaged, the brake pads have reached wear limit, the brake fluid level may be low or a problem with the anti-lock brake

system (ABS) reservoir may have occurred.

In all the above situations, a related message will be displayed.

If the light still illuminates when the parking brake has been disengaged, and the fluid level is at the full mark on the master cylinder reservoir, there could be a brake hydraulic system malfunction or a problem with the brake booster detected by the ABS/ESC system. If this occurs, the light will remain lit until the problem has been solved.

If the problem concerns the brake booster, the ABS master cylinder will run when engaging the brake and a brake pedal pulsation may be felt during each stop of the vehicle.

Inefficiency of one of the dual brake system cycles is indicated by the brake indicator light, which will turn on when the brake fluid level in the master cylinder has dropped below a certain level.

The light will remain lit until the problem has been solved.

If a brake failure occurs, visit an **Authorized Maserati Dealer** as soon as possible in order to check up the brake system.

In the event of an Electronic Brake Force Distribution (EBD) failure, both

the brake indicator light and the ABS light illuminate.

Immediate repair of the ABS system is required.

Functioning of the brake indicator light can be checked by turning the ignition switch from **OFF** to **RUN** position.

The light should illuminate for approximately 2 seconds.

The light should switch off unless the parking brake is engaged or a brake fault is detected. If the light does not illuminate, have the light system repaired by an **Authorized Maserati Dealer**.

The light will also switch on when the parking brake is engaged with the ignition switch in **RUN** position.

This light only indicates the brake is engaged but not the clamping force of the parking brake to the wheels.



### WARNING!

**Driving a vehicle with the red brake light on can be very dangerous and is not recommended. Part of the brake system may have failed, resulting in increased braking distances and the risk of an accident. Have the vehicle**

**(Continued)**  
checked as soon as possible at an Authorized Maserati Dealer.

### Air Bag Indicator Light



This light will illuminate for a few seconds for a bulb check when the ignition switch is in RUN. If the light does not illuminate while starting the engine, stays lit, or switches on while driving, have the system checked at an Authorized Maserati Dealer as soon as possible.

In the latter case, the message will remain displayed: to hide it, press the button ◀ on the steering wheel right side.

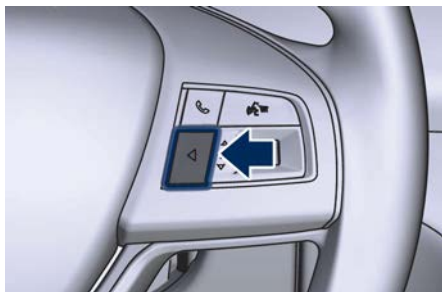

See “Supplemental Restraint System (SRS) – Air bags” in section “Before Starting” for further information.



### WARNING!

**If the warning light remains ON or if it does not illuminate or illuminates while driving, contact your Authorized Maserati Dealer as soon as possible.**

### Right Turn Signal Indicator



This indicator lights up when the right turn signals or the hazard flashers are switched on.

The indicator will flash at the same frequency of the turn signals and is controlled by the turn signal lever. If the vehicle electronics sense that the vehicle drives for more than 1 mile (1.6 km) with either turn signal on, a continuous sound will advise the driver to turn the signal off.

If the indicator flashes at a fast rate, check for a defective outside indicator light bulb.

### Seat Belt Reminder Light



When the ignition switch is in RUN, the seat belt reminder light will light up for a few seconds as a bulb check.

During the bulb check, you will hear an acoustic signal if one or both front seat belts are unbuckled.

After the bulb check or while driving, if a seat belt is unbuckled, together with the acoustic signal the seat belt reminder light will light up and a message will indicate which belt is not fastened.



### WARNING!

**Maserati urges you to use the seat belts correctly fastened and adjusted at all times. Correct use of the seat belts can help reduce the risk of serious injury in the event of an accident. Do not pass seat belts over sharp edges. They could tear. Do not pin anything to the seat belts. This could reduce their initial strength and cause them to tear in the event of a crash.**

Refer to “Occupants Restraint Systems” in section “Before Starting” for further information.

### TFT Display: Menus and Settings

When operating, the TFT Display is divided into sectors including menus and sub-menus, running data, warning/indicator lights and messages. The different sectors of the display layout are rendered in the following



picture.

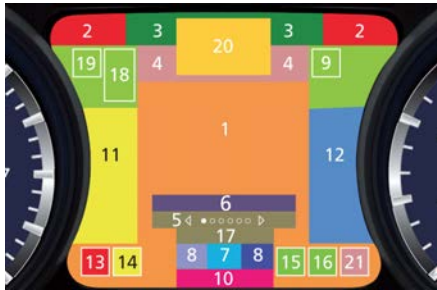

- 1 Main area.
- 2 Selectable information (data, time, outside temperature, compass, etc.). When setting the "Auto High Beam Assist" feature, in the right portion of this area is displayed the respective green indicator.
- 3 Main menu titles with scroll arrows (the number and the main menu title is always visible while scrolling the menu, and for the next five seconds).
- 4 Submenu Titles.
- 5 Position within the submenus and scroll arrows (example: 1 of 5). There can be maximum 9 displayable submenu positions. When the number of submenu points exceeds 9, the points are replaced by a numerical value within the scroll arrows.
- 6 Menu Instruction (hideable).
- 7 Shift lever positions (P, R, N, D, M, 1, 2, 3...) and driving modes.
- 8 Gear shift indicator light and paddles (if equipped).
- 9 Hard/soft suspension indicator light.
- 10 Complete Odometer.
- 11 Fuel Gauge.
- 12 Engine Temperature Gauge.
- 13\* Reconfigurable quadrant for red telltales.
- 14\* Reconfigurable quadrant for amber telltales.
- 15 Low beam headlights/position lights.
- 16 Speed Warning indicator (dynamic text).
- 17 NORMAL, SPORT and I.C.E. modes indicator light.
- 18\* Combined telltale of ACC, LKA and HAS status. They are displayed in the cluster when one (or more) of these systems is enabled and a different menu from "Drive Assist" is displayed in the main area.
- 19\* CC and ACC status function.
- 20\* Traffic Sign Assist icons: conditioned and unconditioned speed limit and/or supplementary signs (time restriction, etc..). See "Traffic Sign Assist - TSA" in section "Driving" for further details. In this area are displayed also the icons of the Seat Belt Reminder (SBR) system that also represent the position of the rear occupants inside the vehicle.
- 21 Electric Parking Brake (EPB) failure warning light.

(\*) See "TFT Display: Warning/Indicator Lights of Set Modes/Functions" in this chapter.

The display background may change according to the type of message displayed.



- Blue color: normal conditions.
- Yellow color: low-critical warning.
- Red color: high-critical warning.

**Main and Submenu**

Operate the controls on the right side of the steering wheel to scroll, modify and program the Main and Submenu.

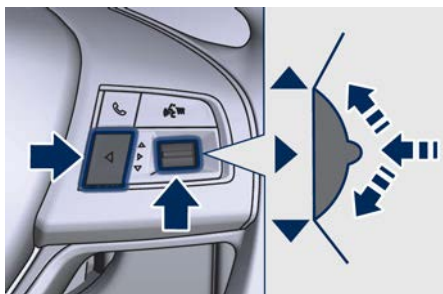

Press and release the multifunction switch in the ▲ and ▼ arrow directions to scroll upwards and downwards the main menu titles.

The screen area in sector 1 (Main Area) will be updated and the selected title will be shown in sector 3 (Main Menu Title).

Press and release the multifunction switch (▶) to enter the information screens or a submenu. Keep the switch (▶) depressed for 2 seconds to restore the selected/visualized functions. The selected sub-menu title selected will be displayed in sector 4 (Submenu Title).



When the driver selects a main menu page and the Traffic Sign Assist (TSA) feature on "Controls" page of MTC+ is set off (see "MTC+ "Controls" Screen" in this section), main menu title, its number and the scroll arrows will disappear after two seconds.

When driver selects a main menu, if the TSA feature is set on and a sign and/or a speed limit icon is displayed in

sector 20, only the main menu number and the scroll arrows remain displayed in sector 3, left side.



Within a submenu, press and release the switch in the ▲ and ▼ arrow directions to scroll the menu. Press the ◀ button to return to the main menu from an item of interest or from an information screen.



## Main Menu & Submenu Content Overview

### 1. MAIN MENU

- View speed in mph or km/h

### 2. VEHICLE INFO

- Tire Pressure
- Transmission Temperature
- Oil Temperature
- Oil Pressure
- Battery Voltage
- Maintenance

### 3. DRIVE MODE

- Drive Mode - Torque Distribution (on AWD version only) - Powertrain status - ESC status - Suspension stiffness status

### 4. Driver Assist (if equipped)

- Shows the status of any active driver assist systems: CC, ACC, LKA and HAS. Graphics in the main area of TFT display only refer to ACC, LKA and HAS systems
- LKA (LaneSense) status

### 5. FUEL ECONOMY

- Average, Range, Current gage

### 6. TRIP

- Trip A: Average, Avg. speed, Elapsed time, Distance

- Trip B: Average, Avg. speed, Elapsed time, Distance

### 7. START&STOP

- Messages relating to the Start&Stop function

### 8. AUDIO

- Information concerning audio status according to current media source, track and station.

### 9. STORED MESSAGES

### 10. VEHICLE SETTINGS

- Speed Warning: enables, disables or sets the speed limit represented in the dynamic icon on the TFT display
- Auto apply Off/On of the Electric Parking Brake
- Screen Setup
  - Upper Left
  - Upper Right
  - Main Menu: Line 1
  - Main Menu: Line 2
  - Main Menu: Line 3
  - MPH km/h Display On/Off
  - Main Menu Navigation
  - Outline Coloring
  - Key-On Display
  - Key-Off Display
  - Defaults



## Messages on Main Display Area

The main display area also displays "pop up" messages. These pop up messages fall into several categories:

### • Five-Second Stored Messages

When the appropriate conditions occur, this type of message appears on the main display area for five seconds and then returns to the previous screen. Most of the messages of this type are then stored (as long as the condition that activated them remains active) and can be reviewed from the "Stored Messages" main menu item. Example of this message type is the one shown in the picture.



### • Unstored Messages

This message type is displayed until the condition that activated the

message is cleared (see example in picture).



**4** • **Unstored Messages with Ignition Switch in RUN**

This message type is displayed until the ignition switch is in **RUN** position. An example of this message type is the one shown in picture.



• **Five-Second Unstored Messages**

When appropriate conditions occur,

this type of message appears on the main display area for five seconds then returns to the previous screen.

• **Five-Second-displayed Navigation Messages**

When the navigation menu is enabled on the MTC+, information pop-ups will be displayed for 5 seconds while changing direction or approaching a turning point.

On highway, the first pop up will be displayed at 2 miles (3.2 km) from the turn, on roadway, at 1 mile (1.6 km).

While approaching the turn, further pop ups will be displayed starting at 437 yd (400 m) from the turning point and the countdown to 0 miles.



While getting closer to a turn, the sections referred to the distance already traveled will switch off while

**DEALER ePROCESS**

the ones referred to the distance yet to be traveled will remain on.

**NOTE:**

- *Popup boxes might take up the space normally used to display main menu items and relevant submenus.*
- *The distance indicated under the road name is expressed in the unit of measure set by the user.*

**1. MAIN MENU**

Press and release the multifunction switch in the ▲ or ▼ arrow directions until this menu item is displayed. Pressing and releasing the switch (▶) will toggle the unit of measure between mph or km/h.



Further to speed, the main area can indicate three lines that can be set to the same options and in the top right or top left area. When these three



lines are present and turn-by-turn navigation is on, main menu area will automatically show navigation information. For further details, please refer to MTC+ guide.

## 2. VEHICLE INFO

Press and release the switch in the ▲ or ▼ arrow directions until this menu item is displayed.

Press and release the switch (▶) to access the submenus.

Press and release the switch in the ▲ or ▼ arrow directions to scroll through the following information displays pressing and releasing the switch (▶) to display the selected information.

### • Tire Pressure

Indicates the pressure of each single tire (see example below). Please refer to "Tire Pressure Monitoring System (TPMS)" in section "Driving" for further information.



### • Transmission Temperature

Displays the current transmission temperature level.

### • Oil Temperature

Displays the current engine oil temperature level.



The gauge fill and telltale (if applicable) are highlighted in red to emphasize that the parameter is at a critical level.

DEALER ePROCESS



### NOTE:

*This strategy is also applicable in the Transmission Temperature and Oil Pressure information screen.*

### • Oil Pressure

Displays the current engine oil pressure level.

### • Battery Voltage

Displays the current battery voltage.

### • Maintenance (service)

Displays mileage and days remaining to the execution of scheduled maintenance service.



Press and release the ◀ button to return to the main menu.

### 3. DRIVE MODE

Press and release the switch in the ▲ or ▼ arrow directions until this menu item is displayed. The screen graphically shows the Drive Mode: I.C.E., NORMAL, SPORT and ⚙️ (Suspension) set by the user through the relevant controls.

The display main area will show vehicle image with parameters and colour-coded components affected by the selected drive mode.

The image will show the following parameters:

- selected drive mode (in the example shown: I.C.E.);
- torque distribution percentage indicated under the arrow in front of the wheels (on AWD version only).

For any color-coded components, color depends on settings of:

- ESC: identified by wheel color.
- PowerTrain: identified by engine + transmission unit color.
- Suspension ⚙️ : identified by the color of the four shock absorbers.



For every drive mode, function (ESC, PowerTrain and Suspension) and color of the components shown are matched as follows:

Drive Mode	ESC	PT	⚙️
NORMAL			
SPORT			S
I.C.E.			

### NOTE:

To set drive parameters according to own needs and path, refer to chapter "Drive Mode" in section "Driving".

Press and release the ◀ button to return to the main menu.

### 4. Driver Assist (if equipped)

Press and release the switch in the ▲ or ▼ arrow directions until this menu item is displayed.

#### • Active Driver Assist System

The screen graphically shows current status of driver assist systems: the figure shows an example with ACC engaged and HAS set.



#### • LKA (LaneSense) Status

Vehicle is delivered with LKA in off state set on MTC+ system, page "Controls".

You can enable LKA in the "Visual"

4





only or “Visual & Haptic” mode by turning on the function via MTC+ system soft-key and by changing your selection in the dedicated submenu. The setting chosen will latch over key cycles.



#### NOTE:

To set these systems, see chapters “Adaptive Cruise Control - ACC”, “Highway Assist - HAS” and “Lane Keeping Assist - LKA” in section “Driving”.

Press and release the ◀ button to return to the main menu.

### 5. FUEL ECONOMY

Press and release the switch in the ▲ or ▼ arrow directions until this menu item is displayed.

The screen will display the following:

- **Current Fuel Economy in MPG (US), MPG (UK) or L/100km**

Shows the instantaneous fuel economy. During AutoStop stage performed by the Start&Stop system (see “Normal Starting of the Engine” in section “Driving”), a dash will be displayed instead of the value.

- **Range in miles or km**

Shows the range since the last fuel average reset.

When the fuel economy is reset, the display will read “Reset” or show dashes for two seconds.

Then, the history information will be erased, and the averaging will continue from the last fuel average reading before the reset.

- **Fuel Economy Average in MPG (US), MPG (UK) or L/100km**

Shows the average fuel economy since the last reset.

Press the multifunction switch (▶) for 1 second and release it to reset the “Fuel Economy Average”.

When the fuel economy is reset, the display will read “Reset” or show dashes for two seconds.

Then, the history information will be erased, and the averaging will

continue from the last fuel average reading before the reset.



Press and release the ◀ button to return to the main menu.

### 6. TRIP

Press and release the switch in the ▲ or ▼ arrow directions until this menu item is displayed.



For each of the “Trip A” and “Trip B” sub-menus the screen will display the following:

- **“Distance”** traveled in miles or km.  
Shows the total covered distance since the last reset.
- **“Average”** consumption in MPG (US), MPG (UK) or l/100km.  
Shows the average fuel consumption since the last reset.
- **“Average”** speed in MPH or km/h.  
Shows the average speed since the last reset.

- **“Elapsed Time”**  
Shows the total time of travel since the last reset in “hours:minutes:seconds.” Elapsed Time will increment when the ignition switch is in the **RUN** or **START** position.

Press the multifunction switch (▶) for 1 second and release to reset “Trip A” or “Trip B”.

“Trip B” is reset after each key on/key off cycle.

Press and release the ◀ button to return to the main menu.

### 7. START & STOP

Press and release the switch in the ▲ or ▼ arrow directions until this menu item is displayed.

With the ignition device in **RUN** position, the screen will display the status of the function (see example in picture). To change the status of the

function, please see chapter “Automatic Start&Stop System” of section “Driving”.



### 8. AUDIO

Press and release the switch in the ▲ or ▼ arrow directions until this menu item is displayed.



The display will show the audio status (source and current audio track) as set on the MTC+. It is possible to display 5

lines of 15 alphanumeric characters. Displays Audio Statuses are:

- **AM:** Station Number, provided with one line of info (frequency);
- **FM:** Frequency, provided with 2 info lines;
- **SXM (SiriusXM Satellite radio):** number and station name, artist, song;
- **BTSA Bluetooth:** folder, album, artist, song;
- **USB (Audio):** USB, album, artist, current track or, if available, previous track, current track and next track;
- **USB:** folder, previous track, current track and next track;
- **SD Card (Audio):** album, artist, previous track, current track and next track;
- **SD Card:** folder, previous track, current track and next track;
- **AUX:** name of source, “Device Connected” text;
- **No Signal:** “No Signal Available” text;
- **Mute:** symbol “Mute”, the lines remain those displayed before the command “Mute”.

The different reception modes are identified by symbols, shown on the



display above the info lines. The chart indicates their meaning.

	AM
	FM
	AUX
	SD
	SXM Satellite Radio
	USB
	<ul style="list-style-type: none"> <li>• Many signals</li> <li>• Signal not available</li> </ul>

	BTSA
	App
	Audio mute

Press and release the ◀ button to return to the main menu.

### 9. STORED MESSAGES

Press and release the central switch in the ▲ or ▼ arrow directions until this menu item is displayed. The system will either display the number of the stored messages (if any available) or “No Stored Messages” as shown in picture.



Press and release the switch in the ▲ or ▼ arrow directions to scroll the stored messages.

When the number of messages exceeds 9, the submenu points will be replaced by a numerical value indicating the message number. Press and release the switch (▶) to view the selected message (see example in the picture).



Press and release the ◀ button to return to the main menu.

### 10. VEHICLE SETTINGS

With ignition switch in **RUN** position and vehicle stopped, press and release the switch in the ▲ or ▼ arrow directions until this menu item is displayed.

Press and release the switch (▶) to access the submenus.

Scroll with the switch in the ▲ or ▼ arrow directions to view the selectable items:

- Speed Warning
- Electric Parking Brake
- Screen Setup

**NOTE:**

*In order to modify the status of electric parking brake, please see chapter "Parking Brake" in section "Driving".*

**Example: How to modify the "Speed Warning" status**

**NOTE:**

*When the vehicle is in motion (above 5 mph – 8 km/h) this function is available and displayed in the list of "Vehicle Settings" menu.*

Scroll with the switch in the ▲ or ▼ arrow directions to view the selectable items.

Press and release the switch (▶) to select "Speed Warning".



Press and release the switch (▶) once again to view the related options: "Off" is the default status.



Scroll with the switch in the ▲ or ▼ arrow directions to view the selectable options. Speed values are in loop, keeping the switch pressed in the ▲ or ▼ arrow directions will increase scroll speed.

Press and release the switch (▶) to select the option. A check mark will remain next to the previously-selected item until a new selection is made.



A setting saved notification appears as a popup for 2 seconds and a white telltale indicating the set speed limit will appear on display.



Then the display will show the last modified item.



When the set speed is exceeded, the driver is alerted by an acoustic signal and the telltale indicating the speed limit becomes amber.

A pop-up message indicating that the limit has been exceeded will appear on display.



The pop-up message and the telltale will be displayed for 5 seconds then system will return to the previous screen.

### SCREEN SETUP

After having entered the "Vehicle Settings" menu, press and release the switch in the ▲ or ▼ arrow directions until this menu item is displayed. Press and release the switch (▶) to access the available items for this submenu.

If the vehicle exceeds 5 mph (8 km/h), this feature is unavailable and the

main screen shows possible options in grey (not activable).

Operate this function with the vehicle stopped and transmission in P (Park) position.

In order to enter a function, press the switch (▶) as shown in the picture.

The following directory shows the items available in the "Screen Setup" submenu:

#### Upper Left

- None
- Compass
- Outside Temperature (default: Upper Right)
- Date
- Time
- Time/Date (default: Upper Left)
- Range to Empty
- Average MPG (or L/100km or km/L)
- Current MPG (or L/100km or km/L)
- Trip A Distance
- Trip B Distance

#### Upper Right

(example in picture)

- None
- Compass
- Outside Temperature (default: Upper Right)
- Date

- Time
- Time/Date (default: Upper Left)
- Range to Empty
- Average MPG (or L/100km or km/L)
- Current MPG (or L/100km or km/L)
- Trip A Distance
- Trip B Distance



#### Main Menu: Line 1

(only displays in Main Menu)

- None (default status)
- Compass
- Outside Temperature
- Date
- Time
- Time/Date
- Range to Empty
- Average MPG (or L/100km or km/L)
- Current MPG (or L/100km or km/L)
- Trip A Distance

- Trip B Distance
- Audio

### Main Menu: Line 2

(only displays in Main Menu)

- Same configurable options as Line 1

### Main Menu: Line 3

(only displays in Main Menu)

- Same configurable options as Line 1

### MPH km/h Display

(instruction line)

- On
- Off

### Main Menu Navigation

- On
- Off

### Outline Coloring

- On
- Off

### Key-On Display

- On
- Off

### Key-Off Display

- On: Trip Summary
- Off: screen with Maserati logo and trident

### Defaults

- Restore
- Cancel

Scroll with the switch in the ▲ or ▼ arrow directions to view the selectable items (in the example “Time” is selected). A check mark will remain next to the previously-selected item until a new selection is made.



Press and release the switch (▶) to select an item. The notification of setting saved appears as a popup for 2 seconds, then the display will show the last-modified item.



Press and release the ◀ button to return to the “Screen Setup” submenu. “Screen Setup” submenu parameters set by the user as the ones to be displayed are also indicated in the top part of the MTC+ (see example in the figures).

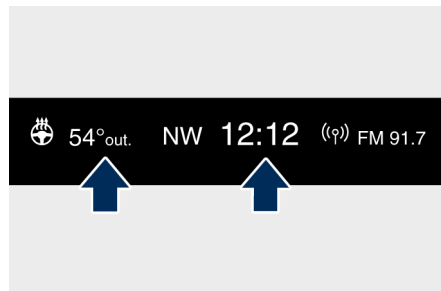

As for the instruction line “MPH km/h Display”, you can either select to display it in sector 6 or not (“Off” option). In the latter case, the function



of changing units remains in any case active.

If the "Main Menu Navigation" is set to "On", navigation information will be displayed in the main area of the display only if a destination has been set on the navigator of the MTC+. If function is set to "Off", the navigation information will not be displayed.

If the "Outline Colouring" is set to "On", the TFT side edge of engine temperature and fuel gauge indicators will change color depending on the selected Drive Mode:

- SPORT: green (example shown in picture);

- I.C.E.: light blue;

If it is set to "Off", the color/Drive Mode combination is not active and the edges will remain "NORMAL" Drive Mode color.



"Key-On Display" and "Key-Off Display" items allow user to set display during vehicle key-on and off.

"Key-On Display" is normally set to "On". When entering the vehicle, after the welcome screen, the display will show the information concerning engine starting sequence. While if it is set to "Off" (example shown in figure), the display will show the information displayed before last vehicle key-off.



When engine is started and ignition device is pressed to stop it, it is possible to set "Key-Off Display", "On" or "Off" to obtain the following display settings:

- "On": Trip summary screen (Trip B is reset after each key-on/key-off cycle);
- "Off": screen with Maserati logo and trident.

The "Defaults" item of "Screen Setup" submenu allows restoring Maserati factory settings.

## TFT Display: Warning/Indicator Lights of Set Modes/Functions

Display sections indicated in the figure show warning/indicator lights concerning all selected driving functions and all set functions/systems. The relevant messages will be indicated within the main area for five seconds, unless otherwise specified. Fault messages will be stored under "Stored messages".

### Charging System Warning Light



This warning light shows the status of the electrical charging system. If the light stays on or comes on while driving, turn off some of the vehicle's non-essential electrical devices or increase engine speed (if at idle). If the charging system warning light remains on, it means that the vehicle is experiencing a problem with the charging system. IMMEDIATELY contact an **Authorized Maserati Dealer** to have the vehicle serviced. If jump starting is required, refer to "Jump Start Procedures" in section "In an Emergency".

### Transmission Temperature Warning Light



This warning light and the related message indicate that the transmission fluid temperature is rising.

If this warning light turns on, safely pull over and stop the vehicle. Then, shift the transmission into P (Park) and run the engine at idle until the temperature drops and the light

switches off. If the problem persists, contact an **Authorized Maserati Dealer**.



#### **CAUTION!**

Continuous driving with the transmission temperature warning light illuminated will eventually cause severe transmission damage or failure.

### Engine Temperature Warning Light



This warning light notifies when the engine is overheated. If the temperature reaches critical

levels and the gauge displayed in sector 12 turns red, this warning light under the engine temperature gauge indicator will illuminate in red color combined with the related message on display. When the temperature is reaching the set threshold an acoustic signal will be heard.

If the warning light switches on while driving, safely pull over and stop the vehicle. If the A/C system is on, turn it off. Also, shift the transmission into N (Neutral) and idle the vehicle. If the temperature does not return to normal, immediately turn the engine off and contact an **Authorized Maserati Dealer**.

Check "Engine Overheating" in section "In an Emergency" for more information.

### Low Oil Pressure Warning Light



Under normal conditions, the warning light illuminates when the ignition device is turned to **RUN** and goes off as soon as the engine is started.







If the warning light stays or turns on while driving, the engine oil pressure is too low. The warning light is combined with a displayed message and an acoustic signal that will last 4 minutes. In this case, turn the engine off immediately and carry out the necessary checks.

Do not operate the vehicle until the problem has been corrected. This light does not indicate the oil level. The engine oil level must be checked with the dipstick located under the hood (see “Maintenance Procedures” in section “Maintenance and Care”). If the problem persists, contact an **Authorized Maserati Dealer**.

### Engine Oil Temperature Warning Light



This light indicates that the engine oil is overheated. The warning light is combined with the related displayed message. In this case, drive carefully until the temperature drops back to normal level and the light warning light turns off.

If the problem persists, contact an **Authorized Maserati Dealer**.

### Low Engine Oil Level Warning Light



This warning light and the related displayed message, indicate a low engine oil level.

The engine oil level must be checked with the dipstick fitted under the hood (see “Maintenance Procedures” in section “Maintenance and Care”).

### Electric Power Steering Failure Warning Light



This warning light, and the related message, illuminate when the electric power steering is not operating and needs service. If the warning light is on, steering assistance may be not available.



**WARNING!**  
After battery disconnection event, the warning light may be on. In this case, start the engine and perform a steering wheel stroke end to end.

If the problem persists, contact an **Authorized Maserati Dealer**.

### Catalyst Over Temperature Warning Light



This warning light, and the related message, light up if the engine runs irregularly with consequent high temperature in the exhaust system.



### WARNING!

- If the warning light is accompanied by the message “Catalyst Temp Getting Hot Reduce Speed”: the temperature of the catalytic converters is too high. The driver must slow down immediately until the warning light turns off.
- If the message “Catalyst Temp Hot Stop Safely Wait To Cool” appears after decelerating: the temperature in the catalytic converters has reached a dangerous level and the catalytic converters could be damaged. Drive slowly to the nearest Authorized Maserati Dealer.
- Maserati declines all responsibility for whatever damage deriving from non-compliance with the above mentioned warnings.

### Door Ajar Indicator



This indicator illuminates when one or more doors are ajar. The indicator will show which door is ajar. When one or more doors are open, a related message will be displayed if the vehicle is running at a speed of 5 mph (8 km/h) or faster.

## Electronic Throttle Control (ETC) Indicator



This indicator light indicates a failure of the Electronic Throttle Control (ETC) system.

If the indicator turns on while driving (a torque decrease is possible), have the system checked by an **Authorized Maserati Dealer**.

When detecting a failure, the light indicator will illuminate while the engine is running.

If the indicator remains lit with the engine running, you can still drive your vehicle. However, contact an **Authorized Maserati Dealer** as soon as possible.

If the indicator is flashing while the engine is running, immediate service is required. You may experience reduced performance, an elevated/rough idle or engine stall and your vehicle may require towing.

## Trunk Lid and Hood Ajar Indicators



These light indicators will illuminate to indicate that the trunk lid and/or the hood are ajar.



When the trunk lid or the hood is open, a related message will be displayed besides the light if the vehicle is

running at a speed of 5 mph (8 km/h) or faster.

## Low Fuel Indicator



When the fuel level reaches approximately 4.2 Gallons (16 litres) this light under the fuel gauge indicator will turn on, and remain on until fuel is added together with the related message. In this condition the color indicating the quantity of fuel in the tank, inside the indicator on display, will go from white to amber.

Refer to "Refueling" in section "Driving" for fuel filling.

## Windshield Washer Low Fluid Indicator



This indicator will illuminate for 5 seconds to indicate a low level of the windshield washer fluid. A related message will be displayed.

See "Maintenance Procedures" in section "Maintenance and Care" for fluid filling.

## Headlight Aiming System Failure Warning Light



This warning light and the related message indicate a failure of the automatic headlight aiming system.

Please contact an **Authorized Maserati Dealer** to check the system.

## Automatic High Beam Failure Warning Light



This warning light and the related message illuminate to report a failure of the automatic high beam headlights.

Contact an **Authorized Maserati Dealer** as soon as possible.

## Suspensions Failure Warning Light



This warning light and the related message turn on while driving if there is a failure of the suspension system (only with optional Skyhook active suspension).

Please contact an **Authorized Maserati Dealer** to check the system.

## Ice Hazard Indicator



When the external temperature falls below 38°F (3°C), the temperature value blinks for a few seconds, the indicator light turns on, a message is displayed and an acoustic signal is triggered to warn the driver of the risk of icy roadbed.

Under such conditions, we recommend using the I.C.E. drive mode (see



“Automatic Transmission” in section “Driving”) drive carefully and slow down as the grip of the tires may be significantly reduced. The indicator light flashes for 5 seconds and switches off when the temperature reaches 43°F (6°C) or higher.

### Electric Parking Brake Failure Warning Light



This warning light and related message illuminate when there is an EPB system failure. The failure could also completely or partially block the vehicle because the parking brake could remain on even after it has been automatically or manually disengaged though its controls. If it is still possible to use the vehicle (parking brake not engaged) drive to the nearest **Authorized Maserati Dealer** and remember to performing each operation/command that the electric parking brake is not functioning.

### Start&Stop Disable Indicator



This indicator illuminates when Start&Stop is turned off through the main menu item “Start&Stop”, via the controls located on the right side of the

steering wheel, or through the button on the central console or through the relevant soft-key of the MTC+. See chapter “Automatic Start&Stop System” of section “Driving” for further information.

### Start&Stop Failure Warning Light



This warning light illuminates when there is a failure in the Start&Stop system. Switch the engine on or off using the normal procedure with the ignition device **START/STOP** and have the vehicle checked at an **Authorized Maserati Dealer**.

### Scheduled Maintenance (Service) Indicator



This indicator illuminates and a message flashes on the display for approximately 5 seconds after an acoustic signal to indicate that the next scheduled maintenance is due or is already overdue. Unless reset, the message will continue to display each time you cycle the ignition to the **RUN** position. To turn off the message temporarily, press and release the ◀ button on the steering wheel. To reset the service indicator system, please visit an **Authorized Maserati Dealer**.

### ADAS Status Indicators (if equipped)



When you are not viewing the “Drive Assist” page, the indicators at the top left-hand side of the display indicate status of individual ADAS system or the combination of them (see examples).



For further details, refer to “Adaptive Cruise Control - ACC”, “Lane Keeping Assist - LKA” and “Highway Assist - HAS” in section “Driving”.

### Forward Collision Warning (FCW) Off (If equipped)



This warning light informs the driver that Forward Collision Warning (FCW) is disabled. If this light occurs together with other specific messages, take your vehicle to an **Authorized Maserati Dealer** for service. This warning light will light even when the activation of another driver assistance feature or drive mode (such as “ESC OFF”) disables the FCW.

### Forward Collision Warning (FCW) Fault (If equipped)



This warning light informs that FCW is in fault state. If this occurred together with other specific messages, could

mean that a system fault requiring servicing at an **Authorized Maserati Dealer**. It is nevertheless possible to drive the vehicle without using this function (for further details, refer to "Forward Collision Warning - FCW" in section "Driving").

### **AWD Failure Warning Light (on AWD version only)**

 This warning light turns on to indicate a fault of the AWD system otherwise a fault or overheating due to excessive wheel spin. Contact an **Authorized Maserati Dealer** as soon as possible, and avoid using the vehicle in heavy duty conditions.

### **Set Passive Speed Limit**

 This indicator light indicates the passive speed limit set via the controls on the RH side of the steering wheel (for further details, refer to "TFT Display: Menus and Settings" in this chapter).

### **Passive Speed Limit Exceeded**

 This indicator light informs the driver that the speed limit that was set has been exceeded.

### **Stiff Suspension Setting Indicator**

 This indicator light indicate that the stiff suspensions program ("S") is on. For further details, refer to "Drive Mode" in section "Driving".

### **Set Drive Mode Indicator**

 Drive mode set by the driver through the controls on central console is displayed above the transmission lever indicator (example in picture: NORMAL). For further details, refer to "Drive Mode" in section "Driving".

### **Cruise Control (CC) Ready or Canceled**

 This white light indicator will illuminate when the CC is ready to be set (with 3 dashes below) and, once it sets, when it is temporarily canceled (set speed in white below). For further information, check "Electronic Cruise Control" in section "Driving".

### **Cruise Control (CC) Set**

 This green light indicator will illuminate with the set speed when the CC is set and in driver override. For further

information, check "Electronic Cruise Control" in section "Driving".

### **Lane Keeping Assist (LKA) Fault**

 This warning light on indicates that the LKA system is in fault. If the warning light and the relevant message do not go off after a few manoeuvres and eventually a key cycle, contact an **Authorized Maserati Dealer**.

### **Adaptive Cruise Control (ACC) Ready or Canceled**

 This white warning light indicates that the ACC is ready to be set (with 3 dashes below) and, once it sets, when it is temporarily canceled (set speed in white below). For further details, refer to "Adaptive Cruise Control - ACC" in section "Driving".

### **Adaptive Cruise Control (ACC) Set**

 This green warning light with below the set speed turns on when the ACC is set (for further details, refer to "Adaptive Cruise Control - ACC" in section "Driving") and vehicle will keep set speed.



### Adaptive Cruise Control (ACC) Fault (if equipped)



This warning light turns on when ACC is not operating or needs servicing. For further details, refer to “Adaptive Cruise Control - ACC” in section “Driving”.

### Blind Spot Assist (BSA) Failure Warning Light



This warning light and related message light on to report a failure of the BSA system.

As consequence, on vehicles equipped with ABSA also this latter will be not working or malfunctioning.

Contact an **Authorized Maserati Dealer** as soon as possible avoiding to use this system.

### Headlight On Indicator



This indicator will illuminate when the position lights or headlights are turned on.

For further details, see “Lights” in section “Understanding the Vehicle”.

### Automatic High Beam On Indicator



This indicator turns on when the “Auto High Beam Assist” feature is set on MTC+ (see

“MTC+ Settings” in this section).

### Gear Shift Indicator Light



This indicator lights up to indicate gear shift change in order to optimize fuel consumption.



See “Drive Mode” in section “Driving” for further information.

### Service AWD System Message (AWD version only)

The message and the warning light on the TFT display will illuminate when all-wheel drive feature requires service. For further information refer to “All-Wheel Drive” in section “Driving”.



**DEP**  
DEALER ePROCESS

## Infotainment System

The vehicle is equipped with the infotainment Maserati Touch Control Plus (MTC+) System, an advanced user interface which combines innovative and exclusive technical features integrating entertainment, user settings, air conditioning, navigation, communication and information features within a single system.

The MTC+ System features an audio system which is acoustically optimized for this specific vehicle.





### WARNING!

The navigation system assists the driver while driving, providing advice and suggestions, by voice guidance and graphic information, for the best route to reach the set destination. The suggestions provided by the navigation system do not relieve the driver from full responsibility for the maneuvers made through traffic while driving, or from compliance with road regulations and other provisions regarding road traffic. The person driving the vehicle is always and in any case responsible for safe driving on the road.

The vehicle is provided with a specific add to the owner's manual, describing the MTC+ System features and listing all warnings and precautions, which are essential for a safe use of the system. Maserati advises you to read this add carefully and thoroughly. The MTC+ display is positioned in the central part of the dashboard and the manual controls and devices for connecting external sources are positioned on the central console.

4

- 1 MTC+ touch display.
- 2 Ports for SD card, AUX and USB (for further details, refer to "Interior features" in section "Understanding the Vehicle").
- 3 "Browse" button  .
- 4 "Back" button  .
- 5 "Enter" button.
- 6 Volume control.
- 7 Tune/scroll control.
- 8 Slide phone drawer.
- 9 Door for access to multimedia ports and phone housing.

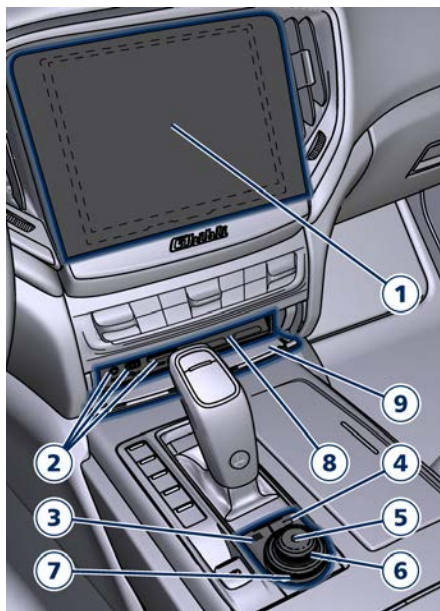

### Manual Controls and Devices

#### SD, AUX and USB Ports

When an SD card is inserted into its housing, the MTC+ is able to read it and select multimedia files (music and images) from the device. By using the AUX and USB ports it is possible to connect external devices to the MTC+ (see chapter "Interior features" in section "Understanding the Vehicle").

After connecting the device, by using the MTC+ display softkeys, knobs on the central console and controls at the steering wheel, user can navigate through the content of the connected device and set its playing mode.

#### Multimedia Navigation Controls on Central Console

The manual controls located on the central console are a further interface for the driver and nearby passenger, that adds to the MTC+ display softkeys. Using the manual controls, the MTC+ display will work as a graphic display of the inputs from the controls.

#### Volume Control

By working this knob in "Radio" or "Media" mode, user can adjust the volume of the radio or audio files, from minimum to maximum and vice versa. Turn knob clockwise to increase the volume, counter-clockwise to decrease it. The volume status will be indicated in the top part of the MTC+ display.

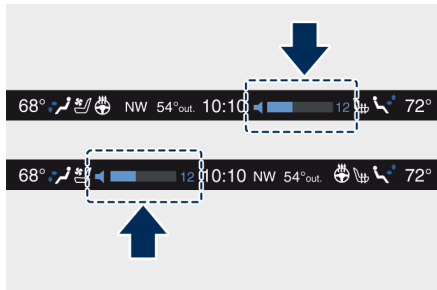

### Tune/Scroll Control

By working this knob in “Radio” or “Media” mode, user can go through the radio stations or scroll the tracks inside connected external devices and confirm the selection by pressing enter button.

In any other mode of the MTC+, use this knob to scroll the list of available options or to manage the cursor movement in the lower bar of the main menus. Then press enter button to confirm the function or setting highlighted on MTC+ display.

### Browse button ☰

After selecting a function, using the tune/scroll knob or softkeys on MTC+ display, press this button to see the detail of the items/options of the selected function. This button is also used as shortcut to display the phone book, when the “Phone” menu is

selected, or the favorites when the “Nav (Navigation)” menu is selected.

### Back button ↶

Press this button to go back to previous menu or previous screen. Press this button to shift the navigation one level backwards on MTC+ screen. If it is pressed and held for at least 2 seconds, it brings the cursor back in the lower bar of the main menus.

### Enter Button

To confirm the function or setting highlighted on MTC+ display. When in “Radio” mode and the ignition switch in **RUN** position, you can save your preset stations.

### Main Menu Bar on MTC+ Display

The softkeys located on the lower part of the MTC+ display represent the main menu modes/functions, which are briefly indicated below.



Main menu bar is set up by Maserati: it can be customized according to personal requirements, as explained in “Customizing the Main Menu Bar” in this chapter.

For further information refer to the dedicated booklet included in the owner documentation.

#### 1. “Radio” softkey

Touch this softkey to enter the Radio mode. The different tuner modes: FM, AM, SXM and “Aha” App (for countries where they are supported) can be selected by touching the related softkeys in the Radio mode.

#### 2. “Media” softkey (if connected)

Touch this softkey to access media sources such as: USB Device, AUX, Bluetooth and SD card as long as the requested media is present.



### 3. "Controls" softkey

Touch this soft-key to access the features of some driver assistance system (ADAS) that can be set up (if equipped). Features can be selected and adjusted or turned on/off by touching the related soft-key (see "MTC+ "Controls" Screen" in this section).

### 4. softkey

Touch this softkey to access Applications / settings screen.

### 5. "Climate" softkey

Touch this soft-key to access the air conditioning settings. In this screen the following controls are also available: Heated Seats, Heated Steering Wheel and Ventilated Seats. See "Air Conditioning Controls" in this section for further details.

### 6. "Nav" softkey

Touch this softkey to access the Navigation feature. Refer to the MTC+ instruction manual for further details.

### 7. "Phone" softkey

Touch one of these softkey to access the MTC+ Phone feature that can be set or monitored via MTC+.

Touch one of these soft-key to access the list of functions that users can set.

### Touchscreen Display Warnings



- Do NOT attach any object to the touchscreen, doing so can result in damage to the touchscreen.
- Do not press the screen with any hard or sharp objects (pen, USB stick, jewelry, etc.) which could scratch the touchscreen surface.
- Do not spray any liquid or caustic chemicals directly on the screen. Use a clean and dry micro fiber lens cleaning cloth in order to clean the touchscreen.
- If necessary, use a lint-free cloth dampened with a cleaning solution, such as isopropyl alcohol, or an isopropyl alcohol and water solution ratio of 50:50. Be sure to follow the solvent manufacturer's precautions and directions.

### Switch OFF Touchscreen Backlight

If the screen backlight becomes annoying when driving, it is possible to switch it off.



Switch off the screen backlight by touching "Screen OFF" softkey in the "Controls" screen of MTC+ display.

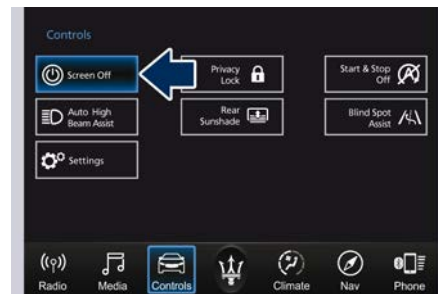

Without ADAS



With ADAS

### Customizing the Main Menu Bar

The softkeys for the main functions of the MTC+ system, indicated at the bottom of the MTC+ display, can be





easily customized to suit user's requirements, as follows:

- touch  button to open applications/settings screen;
- hold depressed and drag the icon corresponding to the selected function until it overlaps the one to be replaced on the bottom bar.



Once it is set in the menu bar, the new connection will be immediately operational.

## Use the MTC+ Display as Projection Device



If your smartphone is properly connected to the vehicle via the USB port, on the MTC+ screen in place of "Phone" soft-key and in the source list of "Media" screen you can find the "Apple CarPlay" (example shown in picture) or the "Android Auto" app soft-key. "Android Auto" app needs to

be downloaded on your mobile device.

















































These applications use the MTC+ display as projector of the functions available on the connected device. "Apple CarPlay" allows the best use of your iPhone® in the car and perfect integration with the MTC + display and with the controls of the car, including Siri voice control. You can make phone calls, access music, send and receive messages, get real-time directions on traffic conditions, all while staying focused on the road. The "Android Auto" app lets you share information while driving and make it easier to access Google. The interface is equipped with Google Maps with voice guided navigation, traffic information in real time, on-demand access to millions of songs in Google Play Music. It also offers the

possibility to make phone calls or send and receive messages without taking your hands off the steering wheel. You can also request Google to make any type of research. Android Auto will give an easier access to applications and content from the MTC+ system display.

The following tables show the "Screen" and "Audio" source (of projection device  or of MTC+ System ) when a smartphone is connected, a session is established and the device (Table A) or the MTC+ System (Table B) is performing an action.



























































**Table A: device is performing an action**

Action 	MTC+ System  : Active Mode				
	 <b>Radio</b>	 <b>Media</b>	 <b>Navigation</b>	 <b>Phone</b>	 <b>Voice Rec.</b>
No App active	Screen:  Audio: 	Screen:  Audio: 	Screen:  Audio: 	Screen:  Audio: 	Screen:  Audio: 
Start Media Player	Screen:  Audio: 	Screen:  Audio: 	Screen:  Audio:  + 		Screen:  Audio: 
Start Navigation	Screen:  Audio:  + Audio priority	Screen:  Audio:  + Audio priority	Screen:  Audio: 		Screen:  Audio:  + Audio priority
Start Phone Call	Screen:  Audio: 				
Start VR 	Screen:  Audio: 	Screen:  Audio: 	Screen:  Audio: 	Screen:  Audio: 	Screen:  Audio: 

**4**



Table B: MTC+ is performing an action

Action 	Device  : Active Mode				
	No App active	 Media	 Navigation	 Phone	 Voice Rec.
Start Radio	Screen:  Audio: 	Screen:  Audio: 	Screen:  Main Audio:  + mix  prompt nav	Screen:  Audio: 	Screen:  Audio: 
Start Media Player	Screen:  Audio: 	Screen:  Audio: 	Screen:  Audio: 	Screen:  Audio: 	Screen:  Audio: 
Start Navigation	Screen:  Audio: 	Screen:  Main Audio:  + Audio priority	Screen:  Audio: 	Screen:  Audio:  + Audio priority	Screen:  Audio:  + Audio priority
Start Phone Call	Screen:  Audio: 				
Start VR 	Screen:  Audio: 	Screen:  Audio:  + Audio priority	Screen:  Audio:  + Audio priority	Cannot start VR during Call	Screen:  Audio: 
Start Rear Parking Camera	Screen:  Audio: 	Screen:  Audio: 	Screen:  Audio: 	Screen:  Audio: 	Screen:  Audio: 



## Audio Controls

The vehicle is equipped with audio controls that allow both driver and front passenger to operate the audio system. These controls can be used to adjust audio volume, change radio station or mode (FM, AM, USB, etc).

### Steering Wheel Audio Controls

These audio controls are rocker-type switches with a button in the center and are located on the rear side of the steering wheel, right behind the front switches.



Press any button to display information on the radio station or track being listened to inside a pop-up for 2 seconds on instrument cluster. The right-hand control manages the volume.

By pressing the top of the rocker switch you can increase the volume and by pressing the bottom of the rocker switch you can lower it. Press the center button to mute the volume. The left-hand control functions depend on the current source. To change source, press the center button.

When in "Radio" mode, pressing the top of the switch will "Seek" up for the previous listenable station and pressing the bottom of the switch will "Seek" down for the previous listenable station.

When an external source is connected to MTC+, a light press on the top of the switch will play the next track on the device connected.

Press the bottom of the switch once to go to the beginning of the current track, or to the beginning of the previous track if it is within one second after the current track begins to play. If you press the switch up or down twice, it plays the second track; three times, it will play the third one, etc.

### Audio Controls on Central Console

In "Radio" mode, turn the volume upper knob to set the audio volume,

or turn the tune/scroll bottom knob to tune station.



For further details, refer to "Infotainment System" in this section. When in App/Settings mode, the tune/scroll bottom knob and the browse  and enter buttons allow you to scroll through the menus and change the user's settings (see "MTC+ Settings" in section "Dashboard Instruments and Controls").





## Audio System

The vehicle is equipped with an audio system that offers superior sound quality, higher sound pressure levels and reduced energy consumption. The system maximises the amplifier and speaker technology delivering substantially higher components and system efficiency.

### Basic System

The basic sound system features 8 speakers and can develop a sound output of 80 W.

The basic system includes:

- Four 6.5 in (165 mm) diameter Woofers, one on each door.
- Four 1 in (25 mm) diameter Tweeters, two on the upper edges of the dashboard and one on each rear door.



Basic System

### Premium System

The vehicle can be equipped with a "Premium" sound system which features 10 speakers and can develop a sound output of 900 W.

This system includes:

- Four 6.5 in (165 mm) diameter Woofers, one on each door.

- One 3.5 in (90 mm) diameter Midrange diameter, on the top of the dashboard.
- Four 1 in (25 mm) diameter Tweeters, two on the upper edges of the dashboard and one on each rear door.
- One 12.4 x 7.9 in (315 x 200 mm) Subwoofer on the rear panel below the rear window.
- 8- channel amplifier in the trunk.

**Premium System****High Premium System**

The vehicle can be equipped with a “High Premium” audio system including 15 speakers and 1280 W of sound power, available upon request.

The “High Premium” system includes:

- Four 6.5 in (165 mm) Woofers: one on each door.
- Five 4 in (100 mm) Midranges: one on center dashboard, one on each

- front door and two on the rear parcel shelf.
- Five 1 in (25 mm) Tweeters: one on center dashboard, two on the upper edges of the dashboard and one on each rear door.
- 12.4 x 7.9 in (315 x 200 mm) Racetrack Sub Dual VC on the rear parcel shelf.
- 16 channel 1280 Watts Class-D amplifier in the trunk.

**High Premium System**



## MTC+ “Controls” Screen

Touch the “Controls” soft-key on the lower part of the MTC+ display to turn on/off some on-board devices and turn on/off and adjust some driver assist systems (ADAS).

Once you enter the “Controls” screen, use the touch soft-keys or turn the tune/scroll knob to scroll and change feature settings and press the enter upper button to confirm the selection. Some of these devices or systems are optional or for a specific model/version and may not be available on your vehicle.

The “Controls” screen is specific to the vehicles that are not equipped with driver assistance systems (Without ADAS) and for those that have them (With ADAS).

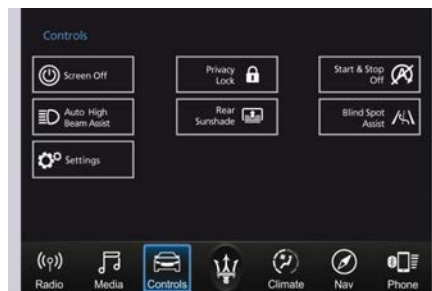

Without ADAS



With ADAS

Some features can be set only on or off touching the corresponding soft-key. The blue colour of the soft-key outline will confirm the state change.

Other features can have one or more instruction/setting pages that are accessed by touching the corresponding soft-key (example: “Privacy Lock”).

The ADAS features have two soft-keys: the first soft-key changes the current setting on or off, the second soft-key on the side shows the current setting. By touching the second soft-key, you will enter the setting page in which all feature options are visible and adjustable.



### NOTE:

- For further details refer also to the “Maserati Touch Control Plus (MTC+)” guide.
- All settings must be edited with ignition device set to **RUN** position.
- Some of the Customer programmable features are optional or for a specific model/version and may not be available on your vehicle.

## Features Common to All Configurations

### • Privacy Lock

The two modes of this feature allows you to enter a 4-digit PIN code to lock and unlock the glove box in the passenger side of the dashboard and, choosing “Valet Mode”, to lock your settings for listening and guidance.

See “Dashboard Compartments” in this section for further details.

### • Rear Sunshade

This feature allows you to open and close the sunshade on the rear window.

See “Rear Window” in section “Before Starting” for further details.

**Start & Stop Off**

This feature allows you to disable the Start & Stop when frequent stops and restarts of the engine may become annoying.

See "Automatic Start&Stop System" in section "Driving" for further details.

**Auto High Beam Assist**

By selecting this feature, when the forward digital camera detects a vehicle that precedes in the direction of travel or in the opposite direction, adjust the high beam in an automatic way not to dazzle.

See "Lights" in section "Understanding the Vehicle" for further details.

**Screen OFF**

This feature allows you to switch off the MTC+ screen backlight if it becomes annoying when driving.

See "Infotainment System" in this section for further details.

**Outlet**

Activating this feature an electrical power converter allows you to use the 115V AC-150W power outlet that may be present on some versions, inside the compartment

between the backrests of the rear seats.



**Without ADAS**

**Settings**

Touch this soft-key you enter the "Settings" page that displays all user - customizable features: see "MTC+ Settings" in this section.

**Features Specific for Vehicle without ADAS**

**Blind Spot Assist**

Activating this feature the BSA and RCP systems assist the driver when changing lanes, overtaking and when parking, by detecting the arrival of other vehicles from a side or rear blind spot. When this happens, a light signal appears in the external rear-view mirror.

When Blind Spot Assist (BSA) is

selected, the feature can be set to "Off", "Lights" or "Lights + Chime" (default mode). When this feature is activated in "Lights" mode, the system will only show a warning light in the outside mirrors.

When "Lights + Chime" mode is activated, the system will show a warning light in the outside mirrors as well as give an audible alert when the turn signal is on. When "Off" is selected, the system is deactivated. For description of this system, see chapter "Blind Spot Assist - BSA" in section "Driving".

**Features specific for Vehicles with ADAS**

**Lane Keeping Assist**

Activating this feature the LKA system will attempt to keep the vehicle in lane and can apply direct input to electric power steering system to change direction of vehicle.

The current system setting is shown in blue on the right side of the LKA soft-key.

Touching this soft-key the set page of LKA system will be displayed (see picture).







Driver warnings can be only "Visual" or "Visual & Haptic" (default mode).

System response can be set to "Early", "Medium" (default mode) and "Late".

System reaction force can be set to "Low", "Medium" (default mode) and "High".

See "Lane Keeping Assist - LKA" in section "Driving" for more details.

- **Active Blind Spot Assist**

Activating this feature the system will try to prevent collision between host vehicle and potential blind spot collision hazard. System applies direct input to electric power steering system to change direction of vehicle to avoid collision.

The current system setting is shown in blue on the right side of the ABSA soft-key. Touching this

soft-key the set page of ABSA system will be displayed (see picture).



Driver warnings can be only "Visual", "Visual & Acoustic" (default mode) or "Visual & Haptic".

System response can be set to "Early", "Medium" (default mode) and "Late".

System reaction force can be set to "Low", "Medium" (default mode) and "High".

See "Active Blind Spot Assist - ABSA" in section "Driving" for more details.

- **Forward Collision Warning** (with active braking)

The FCW feature primarily uses the front radar and forward looking camera for sensing vehicles and pedestrian (if the car is equipped

with Pedestrian Emergency Braking - PEB function) ahead, and will provide warnings to the driver and may perform braking maneuvers.

The current system setting is shown in blue on the right side of the FCW soft-key.

Touching this soft-key the set page of FCW system will be displayed (see picture).



FCW is always active: it is possible to set the sensitivity and the aid of the active braking.

FCW sensitivity can be set to "Near", to "Medium" or to "Far". The default status of FCW is the "Medium" setting. Setting it to "Far" means the system will warn you of a possible collision with the vehicle or pedestrian (if the car is equipped with Pedestrian Emergency Braking - PEB function)

4

in front of you when you are farther away. This gives you the best reaction time, though could lead to some more unwanted warnings. “Medium” gives instead a little less time for reacting compared to “Far”, but at the same time should lead to less not desired warning.

To change the setting for more dynamic driving, select the “Near” setting. This warns you of a possible collision when you are much closer to the vehicle or pedestrian (if the car is equipped with Pedestrian Emergency Braking - PEB function) in front of you.

FCW with active braking can be set to “On” or “Off”.

• **Surround View Camera**

By activating this feature the system uses four cameras to monitor the area around the vehicle when transmission lever is shifted to P (Park), N (Neutral) or D (Drive) position.

When activation occurs by pressing the “Surround Camera” button in the “Controls” screen or moving the shift lever in R (Reverse) position, the initial view will be the default view (associated with current gear state). Image will be displayed with

active guidelines while in that gear as long as vehicle speed remains lower than 8 mph (12 km/h).

When vehicle is shifted into a different gear, the image will remain displayed for 10 seconds, or vehicle is shifted in P (Park), or until vehicle speed exceeds 8 mph (12 km/h), at which point it will immediately cancel and return to the last-viewed screen.

The feature can be set to “On” or “Off”. See “Surround View Camera System (optional)” in section “Understanding the Vehicle” for further details.

• **Traffic Sign Assist**

By activating this feature, the forward-facing digital camera, with the aid of maps on the navigation system, is able to detect speed limits and traffic signs with a restriction indicated by an additional sign (e.g. in snow condition). Those are displayed by the TSA system on the instrument cluster display together with a possible alert when the vehicle exceeds the speed limit.



See "Traffic Sign Assist - TSA" in section "Driving" for further details.



## MTC+ Settings

### Customer Programmable Features

The MTC+ System uses a combination of keys able to access and change the customer programmable features present in the “Settings” and “Controls” page (see also “MTC+ “Controls” Screen” in this section). Access programmable features touching “Settings” soft-key in the “Controls” screen page, or using manual controls on central console (refer to “Infotainment System” in this section).

Turn the tune/scroll knob to scroll through menus and change settings on MTC+ display, touch the enter upper button to confirm the selection.



Without ADAS



With ADAS

#### NOTE:

- For further details refer also to the “Maserati Touch Control Plus (MTC+)” guide.
- All settings must be edited with ignition device set to **RUN** position.

To display the programmable features menu on MTC+, you can also touch soft-key to view all available applications and then select “Settings”.



In this mode the MTC+ System allows you to access the following programmable features (some of them are optional or for a specific model/version and may not be available on your vehicle): Display, Units, Voice Commands, Clock, Safety & Driving Assistant, Lights, Doors & Locks, Auto-On Comfort & Remote Start, Engine Off Options, Audio, Phone/Bluetooth, SiriusXM Setup, Restore Settings and Clear Personal Data.

#### NOTE:

- Only one touchscreen area/softkey may be selected at a time.
- Menu navigation indications refer to the use of softkeys on MTC+ display: the same operations can be performed using the manual controls on central console.

To make a selection, and enter the desired function, touch the corresponding softkey on the menu (the picture shown is “Engine Off Options”).



To scroll through the functions, move the cursor up or down, or touch the arrow ▼ or ▲. Once the desired mode is entered, press and release the touchscreen area of the setting that you wish to modify. The new setting will be highlighted with one or more boxes to indicate status or possible variants of the function status. A check mark in a box indicates the current status of the function. Touch the check mark to cancel, or the empty box to insert the check mark, and change the status of the function.



Once the procedure is completed (for example, Display mode) touch the ← back arrow softkey to return to the previous menu or touch the upper right “X” softkey, to close the settings screen. Touching the ▲ or ▼ softkeys and the cursor on the right side of the screen will allow you to scroll up or down through the available settings.



## Display

After pressing the “Display” soft-key the following mode settings will be available.

- **Display Mode**

When in this display you can select one of the auto display settings. To change mode status, checkmarked “Night”, “Day” or “Auto” cell.

- **Display Brightness with Headlights On (Night)**

When in this display, you can select the brightness with the headlights on. Adjust the brightness from level 0 to 10 with the “+” and “-” setting soft-keys or by selecting any point on the scale between the “+” and “-” soft-keys.

- **Display Brightness with Headlights Off (Day)**

When in this display, you can select the brightness with the headlights off. Adjust the brightness as previously explained for “Night” setting.

- **Set Language**

When in this display, you can select one language for all display descriptions, including the trip functions and the navigation system



(if equipped). The available languages are specific to the target markets.

- **Touchscreen Beep**

When in this display, you can turn on or shut off the sound activated by pressure of a touchscreen soft-key.

- **Controls Screen Time-Out**

When this mode is selected, the “Controls” screen will remain displayed for 5 seconds. If this mode is not selected, the screen will remain displayed until closed manually.



- **Nav Next Turn Pop-ups in Cluster**

By selecting this feature, the next turn direction will appear on the instrument cluster along a programmed route until the desired destination is reached (see picture).



- **AutoShow Smartphone Display Upon Connection**

This feature allows to use the MTC+ display as a projection device connected via USB port in order to browse the Apple CarPlay and Android Auto apps. By setting this feature, automatic switch from native screen to projection device will happen every time you connect your smartphone. For further details refer to the “Maserati Touch Control Plus (MTC+)” guide.

## Units

After pressing the “Units” and then “Custom” softkey on the touchscreen you may select between “Imperial” units and “Metric” of measure. Each unit of measure can be independently displayed in the TFT Display and in the navigation system. The following

selectable units of measure are listed below:

- **Distance unit:**  
select from: “mi” or “km”.
- **Speed unit:**  
select from: “MPH” or “km/h”.
- **Consumption unit:**  
select from: “MPG (US)”, “MPG (UK)”, “L/100km” or “km/L”.
- **Capacity unit:**  
select from: “gal (US)”, “gal (UK)” or “L”.
- **Pressure unit:**  
select from: “psi”, “kPa” or “bar”.
- **Temperature unit:**  
select from: “°F” or “°C”.
- **Power unit:**  
select from: “kW”, “hp (US)” or “hp (UK)”.
- **Torque unit:**  
select from: “lb-ft” or “Nm”.

## Voice Commands

After pressing “Voice” softkey the following modes will be available.

- **Voice Response Length**

When in this display, you can change the voice response length settings. To change the voice

response length, touch the “Brief” or “Detailed” softkey.

**• Show Command List**

When this feature is selected, it is possible to select options during a voice control session. Options for available controls are: “Always”, “w/Help” or “Never”.

**Clock**

Time is always visible on the dashboard analog clock (see “Analog Clock” in this section) and in digital format on the instrument cluster and on the MTC+ display.



With this feature it is possible to view and set the following modes.

**• Sync Time with GPS**

Time is normally automatically synchronised with the radio signal. It is also possible to set automatic synchronisation mode using GPS signal instead.



**• Set Time Hours**

With “Sync Time with GPS” feature unchecked and this mode selected,

you can set the hours manually from 1 to 24. To select, touch the “+” or “-” soft-keys to adjust the hours.

**• Set Time Minutes**

With “Sync Time with GPS” feature unchecked and this mode selected, you can set the minutes manually from 0 to 59. To select, touch the “+” or “-” soft-keys as done for the hours.

**• Time Format**

When in this mode, you can select the time format display. To change the current setting, touch and release the “12 Hrs” or “24 Hrs” soft-key.

**• Show Time In Status Bar**

This feature will allow you to turn on or shut off the digital clock in the status bar.

**• Set Date in Cluster**

When in this mode, you can set the date manually in the status bar of the MTC+ and on the instrument cluster display. Touch the “+” or “-” soft-keys to adjust day, month and year.

4





## Safety & Driving Assistant

Touch this soft-key to set the following modes.

### • ParkSense (Park Assist)

The park assist system will scan for objects behind and in front of the vehicle when the transmission shift lever is in R (Reverse) and the vehicle speed is less than 7.5 mph (12 km/h). The system can be enabled with "Sound" only, "Sound+Display", or turned "Off". See "Park Assist (optional)" in section "Before Starting" for further information.

### • Front Sensors Active in Drive

If this feature is active, when driver takes shift lever from P (Park) or N (Neutral) to D (Drive), front parking sensors are activated. If this feature is not active, when driver takes shift

lever from P (Park) or N (Neutral) to D (Drive), front parking sensors are NOT activated.

### • Front ParkSense Volume

When this feature is selected, the chime volume of front park assist sensors can be set to "Low", "Medium" or "High" level. "Medium" is the default setting. The system will retain its last known configuration state through ignition cycles.

### • Rear ParkSense Volume

When this feature is selected, the chime volume of rear park assist sensors can be set to "Low", "Medium" or "High" level. "Medium" is the default setting. The system will retain its last known configuration state through ignition cycles.

### • Tilt Side Mirrors In Reverse

By selecting this feature the outside side-view mirrors will tilt downward when the ignition is in **RUN** position and the transmission shift lever is in R (Reverse) position. The mirrors will move back to their previous position when the transmission is shifted out of R (Reverse). The feature can be set to "On" or "Off".

### • Auto Folding Side Mirrors

By selecting this feature on MTC+ the rear-view mirrors automatically fold when the vehicle is locked by the key fob and when the power trunk lid (if equipped) is closed and locked by pressing the  button on the right lower parts of the lid.

When the vehicle and the trunk lid will be unlocked and the ignition device is set in **RUN** position, the rear-view mirrors will automatically open in the position they had before the lock.

If the mirrors were manually folded by the switch on the driver's door panel, before a lock action, they will need to be manually unfold to reactivate the automatic behave.

### • ParkView Backup Camera Delay

By selecting this feature, when the shift lever is moved out of R (Reverse), the rear view image with dynamic grid lines will be displayed for up to 10 seconds after shifting unless the forward vehicle speed exceeds 8 mph (12 km/h), or the transmission is shifted into P (Park) or the ignition device is switched to the **OFF** position. The feature can be set to "On" or "Off".

## • Rain Sensing Auto Wipers

By selecting this feature, the system will automatically activate the windshield wipers if it senses moisture on the windshield. The feature can be set to “On” or “Off”.

## • Hill Start Assist

This feature allows you to disable the HSA system. The feature can be set to “On” or “Off”. See “Brake and Stability Control System” in section “Driving” for further details.

## Lights

Press the “Lights” soft-key to set the following modes.

### • Headlight Off Delay

By selecting this feature, the driver can choose to have the headlight off or lit for 30, 60, or 90 seconds when the engine is shut off. To change the current headlight off delay status, touch and release the “0”, “30”, “60” or “90” soft-key to select the desired time range.



### • Headlight Illumination on Approach

By selecting this feature, the driver can choose to have the headlight off or lit for 30, 60, or 90 seconds when the doors are unlocked with the key fob RKE transmitter.

### • Headlights with Wipers

By selecting this feature, while the headlight lever is in “AUTO” position, the headlight will turn on approximately 10 seconds after the wipers are activated. The headlight will also turn off when the wipers deactivate if they were activated in the current mode. The feature can be set to “On” or “Off”.

### • Auto Dim High Beams

By selecting this feature, the high beam headlight will deactivate automatically under certain conditions. See “Lights” in section

“Understanding the Vehicle” for further information.

### • Headlight Dip - Traffic Changeover (if equipped)

By selecting this feature, the headlights will change their light distribution when a left-hand-drive vehicle enter a Country with right-hand-drive system and vice versa. The feature can be set to “On” or “Off”.

### • Daytime Running Lights (DRL)

By selecting and check-mark this feature, the DRL lights will turn on whenever the engine running. The feature can be set to “On” or “Off”.

### • Adaptive Front Light (if equipped)

By selecting this feature, the system turn off the beam shaping and bending. See “Lights” in section “Understanding the Vehicle” for further details.

## Doors & Locks

Press the “Doors & Locks” soft-key to set the following modes.

### • Auto Door Locks

When this feature is selected, all doors will automatically lock when the vehicle is in motion. The feature can be set to “On” or “Off”.





### • Auto Unlock on Exit

By selecting this feature, all doors will unlock when the vehicle is stopped, the transmission is in P (Park) or N (Neutral) position and the driver's door is open. The feature can be set to "On" or "Off".

### • Flash Lights with Lock

By selecting this feature, the headlights will flash when the doors are locked or unlocked with the key fob RKE transmitter or when using the Passive Entry feature.

### • Sound Horn with Lock

When this feature is selected, the horn will sound when the doors are locked with the key fob RKE transmitter. You can choose from the following options: "Off" (no sound), "1st Press" (sound on the first press of the button) and

"2nd Press" (sound on the second press of the button).

### • Sound Horn with Remote Start

When this feature is selected, the horn will sound when you use the key fob RKE transmitter to start the engine. The feature can be set to "On" or "Off". See "Remote Start System" in section "Before Starting" for further details.

### • Remote Unlock Sequence

By selecting this feature you may set up only the driver's door or all doors mode will unlock on the first press of the key fob RKE transmitter button. When "Driver Door" is selected, you must press the key fob RKE transmitter button twice to unlock also the passenger's doors. When unlocking "All Doors" by first press selection mode, all doors will unlock on the first press of the key fob RKE transmitter button.

If the vehicle is programmed on "1st Press of Key Fob Unlocks":

- all doors will unlock no matter which "Passive Entry" equipped door handle is grasped;
- only the driver's door will unlock when the driver's door is grasped;

- with "Passive Entry", touching the handle more than once will only result in the driver's door opening. If driver door first is selected, once the driver door is opened, the interior door lock/unlock switch can be used to unlock all doors (or use key fob RKE transmitter).

### • Passive Entry

This feature allows you to lock and unlock the vehicle door(s) without having to push the key fob RKE transmitter or buttons. By selecting this feature, "Passive Entry" may be set to "On" or "Off". The default status is "On". With "Passive Entry" deactivated, also the "Pre-Short Drop" function is disabled (for further information, refer to "Bodywork Maintenance and Care" in section "Maintenance and Care").

### • Personal Settings Linked to Key Fob

This selected mode enables to combine the key fob to personal driver's position settings. These settings will be implemented when pressing the button on the key fob RKE transmitter with ignition device in **RUN** position.

## • Power Liftgate Alert

When this feature is selected, further to turn indicators flashing, an acoustic warning will also be triggered when opening and closing the liftgate/trunk lid. The feature can be set to "On" or "Off".

## • Hands Free Power Liftgate

To prevent the accidental opening of the Power Trunk Lid/Hands Free (optional) with the movement of the foot, it is possible to disable the "Hands Free" function. The feature can be set to "On" or "Off". This operation is recommended when you have to wash the car (for further information, refer to "Power Trunk Lid Operation" in section "Before Starting").

## Auto-On Comfort & Remote Start

### • Auto-on Driver Heated/Vented Seat & Steering

This feature allows to activate the comfort of the driving seat when equipped starting the engine. If equipped, the driver's heated/vented seat and/or heated steering wheel will automatically activate by temperatures below 40°F (4°C). When temperatures are above

80°F (26°C) the driver vented seat will turn on.



### • Remote Start

You can choose from the following options: "Off", "Remote Start" (activation of this function when you use the key fob RKE transmitter to start the engine) and "All Starts" (activation of this function when you start the engine in all modes).

## Engine Off Options

This feature allows you to set some functions after turning off the engine.

### • Easy Exit Seat

When this feature is selected, the driver's seat will automatically move rearward once the engine is shut off for easy exit of the vehicle. The feature can be set to "On" or "Off".



### • Engine Off Power Delay (Power duration after engine shutdown)

By selecting this feature, the power window switches, radio, MTC+ Phone System, power sunroof (if equipped), and power outlets will remain active for up to 10 minutes after turning off the engine. Opening of one front doors will cancel this feature.

The switch-off delay can be cancelled (0 seconds) you can choose from 45 seconds, 5 minutes or 10 minutes.

### • Headlight Off Delay

By selecting this feature the headlight will stay lit for up to 90 seconds after turning off the engine.

The switch-off delay can be



cancelled (0 seconds) or reduced to 60 or 30 seconds.

## Audio

This feature enables to view and set the available audio modes depending on the type of audio system supplied on the car.

The following modes refer to the "High Premium" audio system.

- **Balance/Fade**

Use this screen to adjust the balance and fade settings. Touch and drag the speaker icon, use the arrows to adjust, or tap the "C" icon to readjust to the centre.



- **Equalizer**

Use this screen is used to adjust the "Bass", "Mid" and "Treb" settings. Adjust the settings with the "+" and "-" setting soft-keys or scroll and

touch the slider in any point on the scale between the "+" and "-" soft-keys.



- **Speed Adjusted Volume**

This feature increases or decreases volume combined to vehicle speed. To change the speed adjusted volume touch the "Off", "1", "2" or "3" soft-key.



- **Surround Sound**

This feature provides simulated

surround sound mode. Available settings: "On" and "Off".



- **Clari-Fi**

This function improves the audio quality by enhancing digitally compressed source files such as MP3 and AAC files and certain music tracks played by radio stations. In case of high-definition source files like the ones on a CD, Clari-Fi shall apply no enhancement. Clari-Fi intervention is completely automatic. The feature can be set "On" or "Off".

- **Auto Play**

When a portable device is connected via USB port to the MTC+ system, it plays automatically the songs if this feature is set to "On".





4

## Phone/Bluetooth

Press this soft-key to select and connect phones and audio sources.

- **Do Not Disturb**

Settings available for this feature:

- **Auto Reply**

To change the mode status, touch the "Text", "Call" or "Both" soft-key.

- **Auto Reply Message**

To change the mode status, touch the "Custom" or "Default" soft-key.

- **Customize Auto Reply Message**

This feature allows you to customise the "Auto Reply Message". Text messages are limited to 160 characters (key pad is not available while vehicle is in motion).

- **Paired Phones**

By selecting this feature you will be notified which phones are combined to the Phone/Bluetooth system.

For each option, you can also add one or more devices: for further information, see the MTC+ guide.



- **Paired Audio Sources**

By selecting this feature you will be notified which audio source are combined to the Phone/Bluetooth system.

For each option, you can also add a device and change the PIN code of the device you wish to connect. For further information, see the MTC+ guide.

- **Phone Pop-ups Displayed in Cluster**

When this mode is selected a pop-up message will appear in case of incoming call. Information associated to call in progress are available by entering to the "Audio" menu using the buttons on the steering wheel RH side.



**NOTE:**

On the Maserati website, at [www.maserati.com](http://www.maserati.com), or through an **Authorized Maserati Dealer** you may consult the list of telephones that are compatible with the MTC+, and their level of compatibility.

## SiriusXM Setup

After pressing the “SiriusXM Setup” soft-key the following settings will be available.

- **Tune Start**

“Tune Start” begins playing the current song from the beginning when you tune to a music channel, so you can enjoy the complete song. “Tune Start” works in the background, so you will not even realize it’s on, except that you will miss the experience of joining your favorite song with only a few seconds left to play.

- **Channel Skip**

SiriusXM can be programmed to designate a group of channels that are the most desirable to listen to or to exclude undesirable channels while scanning. To make your selection, touch the Channel Skip soft-key, select the channels you

would like to skip followed by pressing the arrow ◀ soft-key.

- **Subscription Information**

SiriusXM Satellite Radio requires a user-paid subscription to access these stations.

It will be necessary to access the information on the Subscription Information Screen in order to subscribe.

Touch the Subscription Info soft key to access your receiver ID number. Write down the SiriusXM ID numbers for your radio. To activate SiriusXM service, either call the number listed on the screen or visit SiriusXM online at [www.siriusxm.com/subscriptions](http://www.siriusxm.com/subscriptions) or call the number listed.



**DEP**  
DEALER ePROCESS

## Restore Settings

When this feature is selected, it will reset the “Display”, “Clock”, “Audio”, and “Radio Settings” to their default settings.

Run this feature and a pop-up will appear asking user to confirm default settings resetting. Select “Yes” to restore, or “Cancel” to exit. Once the settings are restored, a pop-up appears confirming that settings have been reset to default and then the MTC+ will restart.

## Clear Personal Data

When this feature is selected, it will remove personal data concerning settings and/or options that have been modified compared to factory settings and will also remove from system memory Bluetooth devices and presets.

To remove personal information, select this feature and a pop-up will appear asking confirmation to delete all personal data. Select “OK” to clear, or “Cancel” to exit. Once the data have been cleared, a pop up appears confirming that personal data have been cleared and then the MTC+ will restart.

## Dashboard Compartment

There are two glove box compartments on the dashboard sides to store small items or documents. In the compartment below the climate control panel, on the slider drawer support can be housed the phone, cards or small items. In this compartment there are also the multimedia ports (see "Interior Features" in section "Understanding the Vehicle" for further information).

4



### **WARNING!**

**Do not operate the vehicle with a glove compartment lid in the open position. Cellular phones, music players, and other handheld electronic devices should be stowed while driving. Use of these devices while driving could cause an accident due to distraction.**



### **CAUTION!**

**Do not place objects weighing over 22 lb (10 kg) in the glove box compartment.**

## Glove Box Driver Side

To open the glove box on the driver side, pull the handle as indicated.



The compartment is ca. 10-12 in (25-30 cm) deep and is lit by two courtesy lights when open (the light automatically switches off when the compartment is closed).



## Glove Box Passenger Side

To open the glove box on the passenger side, pull the handle as shown in the picture.



The compartment is divided into two parts: in the lower part you can find the Owner's documentation, while in the upper part you can fit small items.



The compartment is illuminated by a courtesy light when open (the light



will automatically switch off when the compartment is closed).

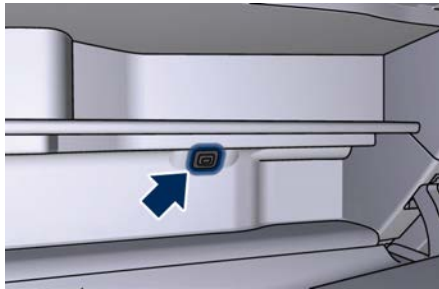

### Privacy Lock Features

The glove box in the passenger side can be equipped with an opening/closing electric actuator that can be locked and unlocked via the "Privacy Lock" menu of the MTC+, by entering a 4-digit PIN code.

When you have to leave the vehicle to another driver (for example, to park it), the "Valet Mode" feature is available in the same menu. This feature, in addition to the glove box, allows you to lock your settings for listening and guidance.

It is important to memorise and take note of the PIN since if it is lost, you must contact the **Authorized Maserati Dealer** that will reset this feature.

**NOTE:**

- "Glove Box Mode" and "Valet Mode" can not be activated at the same time.
- "Glove Box Mode" and "Valet Mode" lock features must be activated when the glove box is already closed. If you activated one of these lock features when the glove box is opened, the glove box will not close properly and will not lock.

**Activation Procedure**

- Open "Controls" screen and touch "Privacy Lock" soft-key.

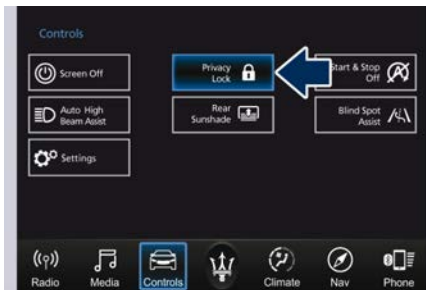

Without ADAS



With ADAS

- Checkmarked one of the two features (the figures shows "Glove Box" feature only) and touch the soft-key to activate the feature.



- Using the keypad, enter the four digits of the PIN and touch "OK". The system prompts you re-enter the PIN code to confirm it.



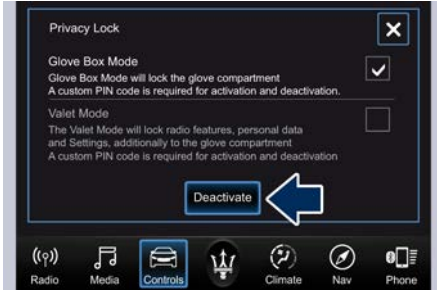

4

**NOTE:**

- If you do not enter all PIN digits, a prompt will indicate that you should do so.
- In case of an incoming call while entering the PIN, the MTC+ system will temporarily stop the release function. As soon as the call is over, the keypad screen will be displayed again so that you can enter the PIN.
- When the next page shown in figure appears, touch "OK".

Glove box is now locked and the MTC+ will go back to "Controls" page. In this condition, system operation is reduced and only "Climate", "Controls" and "Settings" features are active.

**Deactivation Procedure**

To unlock the glove box which it was locked with PIN code, touch "Controls" soft-key on the status bar and then "Privacy Lock" soft-key to enter this page.

- Touch the soft-key to deactivate the feature (the figure shows "Glove Box Mode" feature only).

Unlock glove box by entering the lock code as previously specified.

**Glove Box Manual Unlock**

If battery is dead, it is necessary to manually unlock the actuator on the LH side of the glove box in order to open the glove box that has been locked using the PIN code. To perform this operation you need to remove the lower dashboard moulding to access the actuator unlocking cable. Considering the complexity of this operation, we recommend you to contact an **Authorized Maserati Dealer**.







## Analog Clock

To adjust the analog clock located on the center of the dashboard above the MTC+ display, use the MTC+ System (see "MTC+ Settings" in this section).



The time can be displayed also on the MTC+ status bar and on the instrument cluster display (see "MTC+ Settings" in this section). Clock lighting works in the same way as instrument and controls backlighting (refer to "Lights" in section "Understanding the Vehicle").

## Air Conditioning Controls

The vehicle is equipped with an automatic dual-zone air conditioning system that allows to adjust separately the temperature and the airflow distribution in the left and in the right zone of the passenger compartment, according to the requests of the driver and the front passenger.

A humidity sensor, positioned on the inner surface of the windshield, over the rear view mirror, allows the A/C system to prevent/eliminate fogging of the windshield and side windows. The best efficacy in preventing fogging is obtained by selecting the "AUTO" function, described later. A dual zone solar sensor helps to achieve the best comfort in presence of solar radiation.

## Dual Zone Climate Controls

This system can be operated by using the controls of the automatic climate control panel on the dashboard, or the softkeys on the MTC+ display when "Climate" mode is selected. In the "Climate" screen of the MTC+, the front seats and steering wheel comfort setting soft-keys may be present (optional equipments).

DEALER ePROCESS

The "OFF" state of the front seats comfort setting is shown on their soft-key.



Front seats and steering wheel comfort setting soft-keys are present even when the A/C is off (see "Front Seats" and/or "Steering Wheel Adjustment" in section "Understanding the Vehicle" for further details).



When the MTC+ System is in any mode other than "Climate" ("Radio",

“Media”, “Controls”, etc.) the driver and passenger temperature settings will be indicated on the upper part of the display.

### Description of Controls

All described functions can be set and modified using the climate control panel or the MTC+ display.

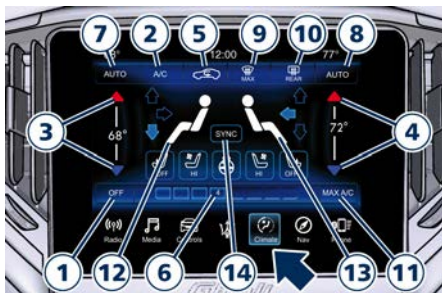
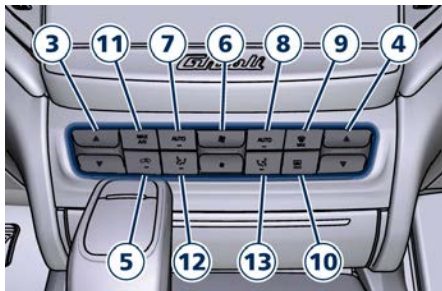

To adjust driver and passenger side temperature and fan speed, climate control panel features rocker switches

that can be pushed up to increase temperature/speed, or down to decrease them. When MTC+ is in any mode other than “Climate”, pressing an air distribution or blower hard control on the climate control panel a small pop-up will appear for three seconds above the “Climate” icon on the main bar.



### 1. Climate control on/off

Once you enter the screen “Climate”, touch the “ON” soft-key to switch the climate control on/off. If the A/C system has been turned off, temperature values in the upper status bar will be obscured in all MTC+ modes.



The “OFF” soft-key will illuminate when the A/C is on.

### NOTE:

*For the vehicles equipped with Remote Start, the Air Conditioning System will not function during Remote Start operation if the climate control is left in “OFF”.*

### 2. A/C

Touch the A/C soft-key to change the current air conditioning setting; the soft-key illuminates when the A/C is on. Operating this function will cause the automatic feature to switch into manual mode and the “AUTO” LED on the buttons and MTC+ soft-key will turn off.

### 3. Driver temperature control

Provides the driver with independent temperature control. Touch the blue



▼ soft-key for cooler temperature. Touch the red ▲ soft-key for warmer temperature. The driver's temperature setting will be displayed on the MTC+ between the soft-key ▲ and ▼. The MTC+ display can also be used to adjust the temperature by touching and sliding the bar towards soft-key ▲, to increase temperature, or towards soft-keys ▼ to decrease it. During this phase, a small pop-up on the side will show the corresponding temperature. You can increase or decrease the temperature using the rocker switch on the climate control panel.

**NOTE:**

*In "SYNC" mode, this control will also automatically and simultaneously adjust the passenger temperature.*

**4. Passenger temperature control**

Provides the passenger with independent temperature control. Touch the ▼ soft-key for cooler temperature. Touch the ▲ soft-key for warmer temperature. The passenger's temperature setting will be displayed on the MTC+ screen between the soft-keys ▲ and ▼. You can increase or decrease the temperature using the

rocker switch on the climate control panel.

**NOTE:**

*Pressing the 4 button/soft-key while in "SYNC" mode will automatically exit "SYNC".*

**5. Recirculation**

Press to change the current setting, the LED indicator on the button and the relevant soft-key illuminates to indicate which recirculation function is activated. For further details, see paragraph "Dual zone Climate Control Functions" in this chapter.

**6. Blower control**

Blower control is used to adjust the amount of air forced through the climate system. Eight levels of blower speed can be selected. Adjusting the blower will cause automatic mode to switch to manual.

On the climate control panel, push the rocker switch up to increase blower speed. Push the rocker switch down to decrease blower speed. Pushing down the rocker switch when set blower is at the first speed, causes the A/C system shutdown (OFF condition).

On the MTC+ display, touch the small icon of the blower to decrease the speed, or the big icon to increase it.

Between the two icons, bars will appear to show the number of the corresponding selected speed. The blower can also be activated/regulated by touching the bars between the two blower icons. When the MTC+ is displayed in any mode other than "Climate", the blower speed is indicated by the bright segments in the climate icon.

**7 - 8. AUTO**

This function automatically controls the interior temperature by adjusting the air flow rate and the air distribution respectively on the driver and on the passenger zone. Press "AUTO" to switch the ATC between manual and automatic mode. The LED on the button and the "AUTO" soft-key illuminates when the "AUTO" function is activated. See "Automatic Temperature Control (ATC)" in this chapter for more information.

**9. MAX defrosting/demisting**

Press the  button or the MTC+ soft-key to switch the airflow setting to the windshield and the front side windows to get quick defrosting/defogging. The LED on the button and the MTC+ soft-key illuminates when this feature is activated. Operating this function will cause the ATC to

switch into manual mode: so the “AUTO” LED on the button and the MTC+ soft-key will turn off. With engine off, the blower will run at minimum speed (1) and can be increased manually: with engine on, the blower speed will gradually increase to the higher speed (8). MAX defrosting/demisting shall also involve REAR defrosting/demisting function. If this function is turned off the climate system will return to the previous setting, switching on the A/C (“A/C” LED on the button and the MTC+ soft-key illuminated).

### 10. REAR defrosting/demisting

Press the  button or the MTC+ soft-key to turn on the rear window defroster and the heated outside mirrors. The LED on the button and the MTC+ soft-key will illuminate when the rear window defroster and the heated external mirrors are on. The rear window defroster and the heated external mirrors automatically turn off after 10 minutes.



### CAUTION!

Failure to observe the following cautions may cause damage to the rear

### windows defroster:

- Use care when washing the inside of the rear window. Do not use abrasive window cleaners on the interior surface of the window. Use a soft cloth and a mild washing solution, wiping parallel to the heating elements. Labels can be peeled off after soaking with warm water.
- Do not use scrapers, sharp instruments, or abrasive window cleaners on the interior surface of the window.
- Keep all objects inside the vehicle at a safe distance from the window.

### 11. MAX A/C

By pressing the “MAX A/C” button or the MTC+ soft-key, the system automatically switches to get the maximum cold air flow in both zones.

### 12 - 13. Air flow distribution modes

The airflow distribution mode, respectively on the driver and on the passenger zone, can be adjusted so air comes from the dashboard vents, vents under the dashboard in direction of the floor, vents under the front seats and demist/defrost vents.

The MTC+ display contains the relevant soft-keys used to set these modes for each zone. The climate

control panel features a single button for each zone: press it several times to select and set the required airflow distribution mode.

Available settings are as follows:

- “Floor” mode 

Air for each zone comes from the front vents, located under the dashboard and under the front seats. A small portion of the airflow is directed through the defrost/demist vents to prevent windows fogging.

- “Dashboard” mode 

Air flows for each zone from four adjustable vents of the dashboard, two vents on the upper part of the dashboard and two positioned at the rear end of the central console. Each of these vents can be singly adjusted. The air grids or vanes of the vents can be moved to adjust air flow direction. A setting wheel, placed near each vent, allows to regulate or close the airflow.

- “Bi-Level” mode 

Air for each zone comes from the dashboard and central console adjustable vents and the fixed floor vents. A small portion of the airflow is directed through the



defrost/demist vents to prevent windows fogging.

**NOTE:**

*Bi-Level mode is designed to let cooler air come in the dashboard and rear part of the central console vents and warmer air from the floor vents.*

• **“Defrost” mode** 

Air for each zone comes from the dashboard defrost/demist vents to prevent windows fogging.

• **“Mix” mode** 

Air for each zone comes from the defrost/demist vent, the vent under the dashboard and from floor vent. This mode is recommended for cold climates, to improve comfort and prevent windows fogging.

• **“Hi-Level” mode** 

Air for each zone comes from the dashboard defrost/demist vents, from the dashboard and central console adjustable vents and the fixed floor vents.

• **“Tri-Level” mode** 

Air for each zone comes from all the adjustable/fixed and defrost/demist vents.

**14. “SYNC” mode**

Touch the “SYNC” soft-key on the MTC+ to switch the Sync feature on/off. The “SYNC” soft-key illuminates when this feature is selected. This function is used to synchronise the passenger temperature setting with the driver temperature setting.

Changing the passenger temperature setting while in “SYNC” will automatically exit this feature.

**Dual Zone Climate Control Functions**

**Air Conditioning (A/C)**

The “A/C” soft-key allows to manually activate or deactivate the air conditioning system. When the air conditioning system is turned on, cool dehumidified air will flow through the vents into the cabin. For improved fuel economy, touch the “A/C” soft-key to turn off the air conditioning and manually adjust the blower and airflow mode settings.

When the “A/C” and “AUTO” functions are switched off it is not possible to have air at a lower temperature than the outside.



**Recirculation  and Air Quality Sensor**

When outside air contains smoke, odours, or high humidity, or if rapid cooling is desired, you may wish to recirculate interior air by pressing the recirculation control button or the relevant soft-key to activate the two different functionalities.



The recirculation function, that allows to open/close the A/C air inlet by operating the  button on the climate control panel or the MTC+ soft key, is integrated with the Air Quality Sensor.

This sensor, positioned upstream of the A/C filter, in front of the air intake of the A/C system, detects the presence of polluting substances and submits an electric signal to the A/C control unit, that closes the intake of the external air by activating the air recirculation.

The  button or the MTC+ soft-key can therefore enable three operating modes, switchable in sequence.

Starting from the outside air condition with LED on the button off and MTC+ soft-key not highlighted, in which the external air is aspirated by the A/C system and treated to be introduced into the passenger compartment, subsequent actuations of the

 button or the MTC+ soft-key change the state as follows.

- First press: the A/C system activates the automatic recirculation control by using the signal transmitted from the AQS. The symbol "A" on the  button and the MTC+ soft-key lights up.
- Second press: the A/C system activates the recirculation, the LED on the  button or the MTC+ soft-key light up. The A/C system will stay this way up to a new actuation, or until the increased humidity could lead to windshield fogging: in this case the recirculation automatically switches to external air.
- Third press: the A/C system switches back to external air (default operating mode).

The next press of the  button and the MTC+ soft-key restarts the operating cycle just described.

**NOTE:**

To avoid the risk of fogging, the AQS is disabled when the external temperature falls below 35°F (2°C).

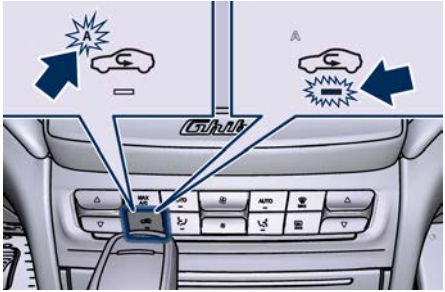

**NOTE:**  
*In cold weather, use of recirculation mode may lead to window fogging. Select the MIX mode  and increase the blower speed to prevent fogging.*

**MAX A/C**  
 Activating this function, the system switches to exit "AUTO", enter "A/C" and recirculation. The minimum temperature (LO) in both zones, the

maximum blower speed and the "Dashboard" air distribution mode  are also selected. The blower speed can be adjusted and the air distribution can be modified without exiting "MAX A/C". To exit "MAX A/C" touch the relevant MTC+ soft-key or exit A/C or recirculation.



Selecting , "AUTO", or "OFF", will also exit "MAX A/C".

**Automatic Temperature Control (ATC)**

**Automatic operation**

- Press the "AUTO" button of driver and/or passenger zone on the climate control panel or the relevant soft-key on the MTC+ screen.
- Set the desired temperature adjusting the driver and/or passenger temperature control buttons or



soft-keys. The system automatically work to maintain the best comfort level inside the passengers compartment.

- When the system is set up for your comfort level, it is not necessary to change the settings anymore, simply allow the system to function automatically.

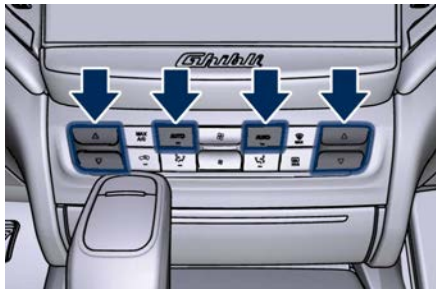

- To provide you with maximum comfort in the automatic mode,

during cold start-ups the blower speed will remain low until the engine warms up.

### Manual operation

The system allows manual selection of blower speed, air distribution mode, A/C status and recirculation control. The blower fan speed can be set to any fixed speed by using the blower control. In this case the blower will operate at a fixed speed until a different speed is selected. This allows the front occupants to control the volume of air circulated in the vehicle exiting the "AUTO" mode.

The user can also choose the direction of the airflow by selecting one of the available mode settings. A/C operation, recirculation control and "SYNC" mode can also be manually selected.

### Operating Tips

- Continuous use of the air recirculation in winter, in rainy weather or humid climate is not recommended because it may cause window fogging.
- Interior fogging on the windshield can be quickly removed by fast defrosting/defogging. The "Mix" mode can be used to maintain a

clear windshield and provide sufficient heating. If side window fogging becomes a problem increase blower speed.

### NOTE:

- *Recirculation mode without A/C should not be used for long periods of time, as fogging may occur.*
- *If inside the passenger compartment there are conditions of high temperature and humidity, when the A/C compressor is switched on (A/C softkey illuminated on MTC+ display or LED on climate control panel A/C button ON) there may be some cold steam at ventilation port outlet: this situation is normal and does not indicate air conditioning system malfunction.*
- *Automatic Temperature Controls (ATC) will automatically adjust the climate control settings to prevent or eliminate window fogging on the front windshield.*
- Make sure the A/C system air intake grille, located under the bonnet directly in front of the windshield, is free of obstructions such as leaves or other objects. Leaves collected in the air intake may reduce airflow, and if they enter the plenum, they could

plug the water drains. In winter make sure the air intake is clear of ice, slush, and snow.

- The temperature can be displayed in U.S. or Metric units by selecting the “Units” customer programmable feature. See “MTC+ Settings” in this section.
- Any time you store your vehicle or keep it stationary (i.e., during vacation) for two weeks or more, run the air conditioning system at idle for about five minutes in the fresh air by high blower setting. This will ensure adequate system lubrication and minimize the possibility of compressor damage when the system is started again.

### A/C Filter

The climate control system filters outside air containing dust, pollen and some odors. Strong odors cannot be totally removed by A/C filter at the entrance of the air climate system. See “Maintenance Procedures” in section “Maintenance and Care” for filter replacement instructions.

## Phone and Voice Controls on Steering Wheel

The commands on the right side of the steering wheel activate/deactivate the phone mode (☎) and the Voice Recognition (🗣️) control functions.

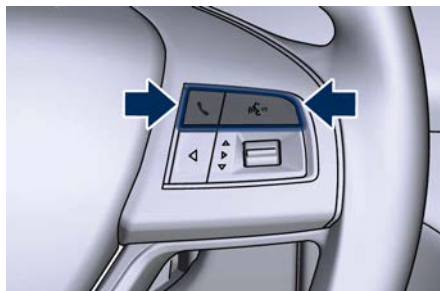

These functions are only available when one or more Bluetooth® compatible mobile phones are paired with the MTC+ System connection: to pair a phone and to learn all available functions refer to the MTC+ guide.

### NOTE:

On the Maserati website, at [www.maserati.com](http://www.maserati.com), or through an **Authorized Maserati Dealer** you may consult the list of telephones that are compatible with the MTC+, and their level of compatibility.

DEALER ePROCESS

The voice command communication system is fully integrated with the vehicle’s audio system.

The volume can be adjusted from the upper knob on the central console (see “Infotainment System” in this section or from the steering wheel radio controls (see “Audio Controls” in this section).

The system will automatically mute the radio when using the phone mode. When activating the phone mode using voice commands with speakerphone, you should talk quietly in a normal conversational tone by keeping the driving position and turning to the microphone of the voice command system located inside of the internal rear-view mirror.

The ability of the system voice control to recognize the user’s voice commands can be invalidated when speaking too quickly or too loudly.



### WARNING!

**Any voice-controlled system should be used only in safe driving conditions following all applicable regulations. Full attention should be kept on driving.**





## Phone Mode

By using the phone button  on the steering wheel it is possible to: activate the phone mode, start a call, show recent incoming and outgoing calls, show contacts list, etc.



All these functions can also be reached by using the touchscreen commands on the MTC+ display in "Phone" mode.



When pressing the phone button  an audible sound will invite you to impart a command.

Information on incoming call is indicated in a pop-up on instrument cluster display main area if this feature is checkmarked on MTC+ (see "MTC+ Settings" in this section). Said information will stay displayed until a control is executed (e.g.: answer, reject, etc.) for the incoming call. The screen will only display the phone number or name of caller (if available) as long as this complies with system specifications in terms of font and number of characters.

Call details can be displayed at any time through "Audio" submenu item. "Phone: call details" using the buttons on steering wheel RH side. On display, said details shall temporarily replace the ones on media source in use.

DEALER ePROCESS

## Voice Commands

By using voice commands, after pressing the VR  button on the steering wheel, it is possible to control the AM, FM radio, SiriusXM satellite radio and all devices connected and managed by the "Media" mode (i.e SD card, USB/iPod player).

When pressing the VR  button an acoustic signal will invite to give a voice command.

### NOTE:

For further details refer to the *Maserati Touch Control Plus (MTC+) guide*.

## Siri Smart Personal Assistant

When a compatible iPhone or iPad that supports Siri voice recognition is paired to the vehicle via Bluetooth®, a long press of the VR  button activates the Siri Smart Personal Assistant.

When you use MTC+ display as projection device (mirroring function) a short press is sufficient.

Siri requires mobile internet access and its functionality might change depending on the geographical area. Through simple voice commands, without taking your eyes off the road,

it may be possible to send messages,  
make phone calls, create notes and  
reminders, etc.

4





## 5 – Driving

Normal Starting of the Engine . . . . .	208
Automatic Start&Stop System . . . . .	210
Automatic Transmission . . . . .	214
All-Wheel Drive (AWD version only) . . . . .	223
Drive Mode . . . . .	224
Active Alternator . . . . .	233
Parking Brake . . . . .	233
Parking . . . . .	236
Brake and Stability Control System . . . . .	238
Using the Brakes . . . . .	241
Use of the Engine . . . . .	242
Electronic Cruise Control . . . . .	244
Adaptive Cruise Control – ACC (optional) . . . . .	247
Forward Collision Warning – FCW . . . . .	258
Lane Keeping Assist - LKA (optional, with ACC only) . . . . .	261
Blind Spot Assist (without ACC) . . . . .	266
Active Blind Spot Assist - ABSA (optional, with ACC only) . . . . .	271
Highway Assist – HAS (optional, with ACC only) . . . . .	274
Traffic Sign Assist – TSA (optional) . . . . .	279
Tires - General Information . . . . .	281
Tire Pressure Monitoring System (TPMS) . . . . .	289
Fuel Requirements . . . . .	294
Refueling . . . . .	296
Driving Conditions . . . . .	298





## Normal Starting of the Engine



### WARNING!

It is dangerous to run the engine in an enclosed area. The engine consumes oxygen and discharges carbon dioxide, carbon monoxide and other toxic gases in the atmosphere.



### WARNING!

**California Proposition 65**  
Operating, servicing and maintaining a passenger vehicle or off-road vehicle can expose you to chemicals including such as, you to chemicals including carbon monoxide, phthalates and lead, that which are known to the State of California to cause cancer and birth defects or other reproductive harm. To minimize exposure, avoid breathing exhaust, do not idle the engine except as necessary, service your vehicle in a well-ventilated area and wear gloves or wash your hands frequently when servicing your vehicle. For more information go to:

[www.P65Warnings.ca.gov/passenger-vehicle](http://www.P65Warnings.ca.gov/passenger-vehicle)

When doors are opened, the instrument cluster displays the Maserati Logo in the center and the complete odometer plus the open doors indicator  in the lower part of the cluster.



Before starting the engine, close the doors, adjust your seat, the inside and outside mirrors, fasten your seat belt and instruct all other occupants to buckle their seat belts.

The shift lever must be in P (Park) or N (Neutral) position before you can start the engine. Apply the brakes before shifting into any driving gear (see "Automatic Transmission" in this section).



### CAUTION!

- Before starting the engine, switch off the electrical devices with a high power consumption (air-conditioning and heating system, heated rear window, headlights, etc.).
- Do not start the engine if the fuel level in the tank is low.

The keyless ignition allows the driver to operate the ignition switch by pushing the center button, as long as the key fob RKE transmitter is within the passenger compartment (check "Keys" in section "Before Starting" for further information).

By pressing the brake pedal and pushing the **START/STOP** button the engine starts. Instrument cluster displays the initial sequence with indicator light and analog instruments test routine and switch-on of the engine temperature indicators and fuel level. This happens if option "On" was set in screen settings for display switch-on (see chapter "Instrument cluster" in section "Dashboard Instruments and Controls").



The current display subsequently sets up with the latest screenshot.



If the engine fails to start, the starter will disengage automatically after 10 seconds. If you wish to stop the cranking of the engine prior to starting it, press the button again.

#### NOTE:

Normal starting of either a cold or a warm engine is obtained without pumping or pressing the accelerator pedal.

If the driver only pushes the **START/STOP** button but does not press the brake pedal, the ignition switch cycles to the **ACC** position (see “Keys” in section “Before Starting”) and the instrument cluster displays the latest screenshot.

At the second press of the **START/STOP** button, the ignition device switches to **RUN** position (see “Keys” in section “Before Starting”) and the instrument cluster displays the latest screenshot.

At the third press of the **START/STOP** button the ignition switch returns to **OFF** position and the display powers down.

At the fourth press of the **START/STOP** button the screen will display the message that invites you to press the brake pedal and push the **START/STOP** button to start the engine.

#### NOTE:

If the ignition switch is left in the **ACC** or **RUN** (engine not running) position and the transmission is in **P** (Park), the system will automatically time out after 30 minutes of inactivity and the ignition will switch to the **OFF** position.

After starting the engine, the idle speed is controlled automatically and will decrease as the engine warms up.

### Engine Start Failure



#### WARNING!

- Do not attempt to push or tow your vehicle to get it started. Vehicles equipped with an automatic transmission cannot be started this way.
- If the vehicle battery is dead, booster cables may be used to obtain a start from a booster battery or the battery in another vehicle. This type of start can be dangerous if done improperly. See “Auxiliary Jump Start Procedure” in section “In an Emergency” for further information.



## Starting with a Cold Engine

Start-off slowly, avoiding sudden acceleration and rev the engine up at low medium speeds. High-performance driving should be avoided until the engine temperature reaches 149-158°F (65-70°C).

## Engine Turn-Off

- With the shift lever in P (Park), D (Drive) or R (Reverse) positions (see “Automatic Transmission” in this section) and vehicle standstill, press and release the **START/STOP** button to switch off the engine. A burst on the accelerator pedal before turning off the engine has no purpose and increases fuel consumption.
- If the shift lever is in N (Neutral) and the **START/STOP** button is pressed once, the instrument cluster will display a “Vehicle Not in Park” message and the engine will remain running.



### **WARNING!**

**Never leave a vehicle out of the P (Park) position, as it could move.**

### **NOTE:**

*If the ignition switch is left in the ACC or RUN (engine not running) position and the transmission is in P (Park), the system will automatically time out after 30 minutes of inactivity and the ignition will switch to OFF position.*

### **Engine Turn Off when in Automatic Start&Stop**

When the engine has been turned off by the Start&Stop system, press and release the **START/STOP** button. The ignition switch will return to the **OFF** position and the vehicle is off.

### **“Panic Stop” Strategy**

In panic conditions, if driver stops engine in any non-standard manner while driving at a speed over 2 mph (3 km/h), the “Panic Stop” strategy can manage the situation by checking gearchange condition upon engine cutting, driver’s action on brakes, road condition (flat or slope) so as to set gearchange to the most suitable condition.

The “Panic Stop” strategy considers that the driver should stop the engine by pressing the ignition switch at least 3 times or holding it depressed for at least 2 seconds.

## Automatic Start&Stop System

The Maserati Start&Stop system allows the engine to automatically switch off when the vehicle stops and to restart when the driver intends to drive. This feature helps reduce fuel consumption. During the “Stop (AutoStop)” phase the ignition is still on and all security features are available.

In order for the Start&Stop to activate, the vehicle must be stationary and the brake pedal adequately pressed.

### **NOTE:**

*If the brake pedal is not sufficiently pressed the Start&Stop may not function even if the vehicle is stopped.*

When the Start&Stop switches off the engine, the related light  illuminates on the instrument cluster. As soon as the brake pedal is released, the engine turns on.

While the vehicle is stopped, the transmission can be placed in P (Park) pressing the “P” button on the shift lever.

In this case it is possible to release the brake pedal and the vehicle will remain in “AutoStop” with engine off.



Pressing the brake pedal and shifting transmission into D (Drive) or R (Reverse) will deactivate the "AutoStop" condition and restart the engine.



## Start&Stop Deactivated

Start&Stop function is deactivated under the following conditions:

- When SPORT drive mode is activated.
- When ESC (ESC OFF) drive mode is activated.
- If it has been disabled through the main menu item "Start&Stop", via the controls located on the right side of the steering wheel, or through the Start & Stop hard button on the central console (see chapter "Drive Mode" in this section) or via the MTC+ in the "Controls" page (see "MTC+ "Controls" Screen" in section

"Dashboard Instruments and Controls") .

## Start&Stop Not Active

For keeping driving safety, interior comfort and a correct functioning of engine and vehicle, the Start&Stop function does not activate under the following conditions:

- When the driver's seat belt is unbuckled (see example).



- When the driver door is open.
- When the fuel level is too low.
- When the vehicle is stopped on a very steep road.
- When the vehicle is stopped with steered wheels (over 135° of steering wheel angle for each part).
- When the vehicle is manoeuvring: shift lever in R (Reverse).

- When the temperature conditions inside the vehicle do not correspond to the air conditioning setting.
- When the front and rear "defroster" function is activated.
- When the engine coolant and the engine oil temperature are not on proper functioning level.
- When the external temperature is too cold.
- When the battery charge is below safety value.
- When the previous stop had just happened (few seconds) and the minimum speed has not yet been achieved.
- Shortly after R (Reverse) has been set or when driving under a certain speed level.
- When the hood is open.
- The sensors managing the Start&Stop have been damaged.
- Start&Stop system faults are present.
- When Adaptive Cruise Control (ACC) and/or Highway Assist (HAS) system are engaged.

## Automatic Restarting of the Engine

The engine may automatically restart, before the brake pedal has been



released, when one of the following conditions occurs:

- The SPORT drive mode or (ESC OFF) drive mode is being activated.
- If the Start&Stop function has been disabled through the main menu voice "Start & Stop" (see chapter "Instrument cluster" in section "Dashboard Instruments and Controls") or through the Start&Stop hard button on the central console (see chapter "Drive Mode" in this section) or via MTC+ in the "Control" page (see "MTC+ "Control" Screen" in section "Dashboard Instruments and Controls").
- If shift lever is moved to R (Reverse).
- If the steering wheel is moved to steer the wheels.
- When the temperature conditions inside the vehicle do not correspond to the air conditioning setting.
- When changing the temperature setting on the air conditioning.
- When the defroster function is being activated.
- When the battery charge is below safety value.
- When the accelerator pedal is being pressed (together with the brake pedal).

- If a long time has passed since the last automatic stop of the engine.

## Occupants Safety Function

To enhance occupants safety, the Start&Stop system monitors if the driver is present and does not allow automatic restarting of the engine if one of the following maneuvers is being performed while in "AutoStop" condition:

- The driver unbuckles his/her seat belt and releases the brake pedal.
- The driver opens the door and releases the brake pedal.
- The driver unbuckles the seat belt and opens the door.
- The driver opens the hood.

All the above-mentioned conditions deactivate the Start&Stop function (the "AutoStart" is deactivated and the engine remains off) and the transmission shifts automatically in P (Park).

The telltale will flash to indicate the Start&Stop function disabling. To restart the engine it is necessary to press the brake pedal and push the **START/STOP** button.

Move the shift lever to D (Drive) to drive away.



## WARNING!

- **Even when the vehicle is stopped in the "Stop (AutoStop)" phase, the driver is responsible for the vehicle and the occupants and shall take care of what happens inside and outside the vehicle.**
- **Even when the vehicle is stopped within the "Stop (AutoStop)" phase, the vehicle driver is responsible for the vehicle, the vehicle's occupants and the vehicle's surrounding area. Never leave the vehicle unattended with the engine running; doing so poses a risk of danger. It is a good practice to always ensure to set the parking brake and place the transmission gear selector lever into the P (Park) position, thereby ensuring the vehicle will not move, when performing any vehicle checks, maintenance and/or service procedures on the vehicle.**

## Start&Stop Function Disabling

Start & Stop enabled is the default status.

Under certain driving conditions, when frequent stops and restarts of the engine may become annoying, it is





possible to disable the Start & Stop function in different ways. Press the Start&Stop hard button on the central console to the disable the function (see instructions in chapter "Drive Mode" in this section). When the Start & Stop function is disabled, in addition to the related message the amber indicator  indicated in the picture will turn on.



Other ways to disable the Start & Stop are via the MTC+ entering the "Controls" or  (Apps) menu.

- Touch the "Controls" soft-key on the lower part of MTC+ display.
- Touch the "Start & Stop Off" soft-key to disable the function.
- Touch a second time the same soft-key to re-enable the function.

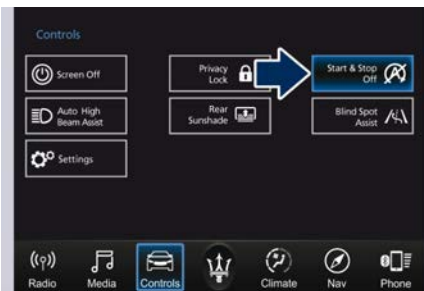

Without ADAS



With ADAS

**NOTE:**

*The highlighted soft-key indicates the disabled status of Start & Stop system and vice versa.*

- Touch the  (Apps) soft-key on the lower part of MTC+ display.
- Touch the "Start & Stop Off" soft-key to disable the function.



To quickly disable the Start&Stop function, you can insert it in the main menu bar, at the bottom of the MTC+ display, as follows:

- press  button to open applications/settings screen;
- hold depressed and drag the "Start & Stop Off" icon until it overlaps the one to be replaced on the bottom bar.





Once it is set in the menu bar, the new menu will be immediately operational.

**NOTE:**

*The yellow LED on the button indicates the disabled status of Start&Stop system and vice versa.*

If the driving conditions allow it, the user can re-enable the Start&Stop function at any time using one of previous ways.

**NOTE:**

*After user intervention, the Start&Stop system will automatically update the status of the function in all contexts where it can be modified.*

## Start&Stop System Failure

When the  indicator light and the related message illuminate on the TFT display (see chapter "Instrument Cluster" in section "Dashboard Instruments and Controls") there is a malfunction in the Start&Stop system and the engine cannot be switched off and restarted automatically. To switch off or restart the engine it is necessary to push the **START/STOP**. Have the vehicle checked at an **Authorized Maserati Dealer**.

## Automatic Transmission

The vehicle is equipped with an electronically controlled 8-speed automatic transmission, which automatically changes gear according to the vehicle's instantaneous usage parameters (vehicle speed, road gradient and accelerator pedal position).

It is possible to change gear manually thanks to the "M +/-" (Manual) position for the shift lever.

The electronic shift lever replaces the conventional mechanical lever and has no mechanical connection to the transmission. The transmission is operated by electrical actuators on the hydraulic system and all commands to the control system are transmitted by the CAN network. The lever itself represents a mere user interface. Gear positions are simulated by solenoids inside the lever body, which are computer-controlled and enable or disable certain positions of the lever. The solenoids inside the shift lever prevent the movement of the lever towards invalid positions.

The electronically-controlled transmission provides a precise shift schedule. The transmission electronics are self-calibrating, therefore the

gearshift behaviour could become perfect as expected after few hundreds of miles/km.



**CAUTION!**

**In order to properly use the automatic transmission, it is essential that you read through the whole chapter, so that you can understand right from the start what the correct and granted operations are.**

**Damage to the transmission may occur if the following precautions are not observed:**

- **Shift into P (Park) only after the vehicle has come to a complete stop: this is the default position of the lever. After engaged P (Park) it is possible set the ignition switch to OFF.**
- **Shift into or out of R (Reverse) only after the vehicle has come to a complete stop and the engine is at idle speed.**
- **Do not shift between P (Park), R (Reverse), N (Neutral) or D (Drive) when the engine is above idle speed**
- **To effect any change from vehicle stop to R (Reverse), D (Drive), 1<sup>st</sup> or**



2<sup>nd</sup> gear, it is necessary to keep the brake pedal fully depressed.



### WARNING!

- It is dangerous to move the shift lever out of P (Park) or N (Neutral) if the engine speed is higher than idlespeed. If your foot is not firmly pressing on the brake pedal, the vehicle could accelerate quickly forward or in reverse. You could lose control of the vehicle and hit someone or something. Only shift into gear when the engine is idling normally and when your foot is firmly pressing on the brake pedal.
- Unintended movement of a vehicle could injure those in or near the vehicle. As with all vehicles, you should never exit a vehicle while the engine is running. Before exiting a vehicle, always apply the electronic parking brake, shift the transmission into P (Park), and turn the engine off.
- Never leave children alone in a vehicle, or with access to an unlocked vehicle. Allowing children to be in a vehicle unattended is dangerous for a number of reasons.

**A child or others could be seriously or fatally injured. Children should be warned not to touch the parking brake, brake pedal or the shift lever.**

- When leaving the vehicle, always remove the key fob and lock your vehicle.
- Do not leave the key fob in or near the vehicle. A child could operate power windows, other controls, or move the vehicle.

This vehicle is equipped with a feature which requires the transmission to be placed in P (Park) before the engine can be turned off. This prevents the driver from inadvertently leaving the vehicle without having placed the transmission in P (Park). This system also locks the transmission in P (Park) whenever the ignition switch is in the OFF position.

### Automatic Transmission Lever

Automatic transmission is operated by a shift lever with unlock button, located on the central console, which can have the following operating positions:

- P (Park): button control;
- R (Reverse);
- N (Neutral);

- D (Drive) automatic forward speed;
- M +/- (Manual): “+” shifting to higher gear or “-” shifting to lower gear in manual mode (see “Drive Mode” in this section).



Transmission status is visible on the lever and on the lower part of the instrument cluster display.



### Shift Lever Movements

Shift lever has two main positions with a single step selection (backward/



forward): two unstable position (2) and (3) and two stable position (1) and (4).

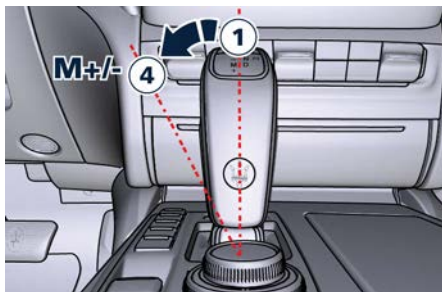
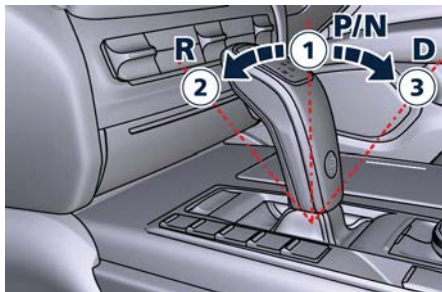

- Automatic lane ("R", "N", "D") as main central position.
- Manual lane ("M +/-") on left position: move forward for "-" and backward for "+".
- "P" is a button on the top of the lever.

## Shift Lever Backlit

- White backlit for "P", "R", "N", "D" and "M +/-": brighter when selected and dimmer when not selected.
  - When P (Park) mode is selected, the letter "P" becomes brighter and "P+" appears brighter near "N".
- Backlit on the shift lever depends on the status of the ignition device.

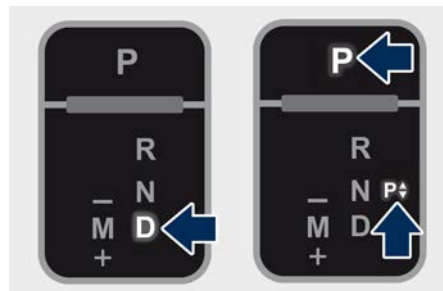

## To Engage a Mode (briefly)

To select one of the operating modes, move the lever as previously indicated and press the brake pedal at the same time.

To engage "P" mode, driver must press the "P" button.

In order to engage "R", "N" or "D" mode, driver have to move the shift lever by pressing the unlock button. If the unlock button is not pressed, the



instrument cluster shows the popup message shows in picture.



The lever functions like a joystick, so releasing it after giving the command, it automatically returns to the two stable positions (vertical in line with "R", "N" and "D" or in line with "-" and "+" when in "M +/-" mode).

- Normally, to engage R (Reverse) mode, press the brake pedal and the unlock button together.
- To pass from P (Park) mode directly to D (Drive) mode, in addition to pressing the brake pedal, it is also necessary to press the unlock button.
- Normally, to pass from R (Reverse) mode directly to D (Drive) mode and vice versa, in addition to pressing the brake pedal, it is necessary to press the unlock button.



- The P (Park) mode can be automatically enabled by pressing the “P” button: if the shift lever was in “M +/-” position, will go to central stable position automatically.
- If using the shift lever in M +/- (Manual) mode, you can activate it by moving the lever from D (Drive) to the left and then forward towards the “-” symbol or back towards the “+” symbol and the gear is shifted.
- To exit P (Park) mode, or to pass from N (Neutral) to D (Drive) or R (Reverse) position when the car is stopped or is moving at a low speed, the brake pedal must also be pressed.



### CAUTION!

- **DO NOT** accelerate while shifting from P (Park) or N (Neutral) to another mode.
- After selecting a transmission mode, wait a few seconds before accelerating. This precaution is particularly important with a cold engine.

### Transmission Status on the Instrument Cluster Display

By pressing the unlock button on the lever, the gear change positions field is displayed: if you release the button without moving the lever, the field disappears after 2 seconds. By operating instead the lever, the new range will be indicated in the field and in the lower part of the display.



DEALER ePROCESS

If the vehicle is in D (Drive) status, in M +/- (Manual) or temporarily in manual drive mode, the gear position is indicated beside the lever status (“D” or “M”), on the lower part of the display.



### Service Shift Lever

In the event of a shift lever malfunction, a message on the instrument cluster will invite to stop the car safely and turn off the engine.



In this way the system moves the transmission in P (Park) position.



## Automatic Transmission Range

### P (Park)

Use this position to park the vehicle. The transmission can be shifted from "P" position only with the brake pedal and the unlock button pressed: then move the shift lever. To move the shift lever from "P" position to any other position, the engine must be switched on. The engine can be regularly started in P (Park) range. Never attempt to use P (Park) while the vehicle is in motion. When parking on a level surface, you may press the "P" button first, and then apply the electronic parking brake by pulling the trigger upwards.



The Instrument cluster will display the related indicator light **BRAKE** and the message for 5 seconds.



When parking on a hill, apply the parking brake before pressing the "P" button.

For enhanced security, turn the front wheels toward the kerb on a downhill and away from the kerb on an uphill grade.



### WARNING!

- Never use the P (Park) mode as a substitute for the electric parking brake. Always apply the parking brake fully when parked to prevent vehicle movement and possible injury or damage.
- Make sure the transmission is in P (Park) before leaving the vehicle.



### CAUTION!

- DO NOT race the engine when shifting from P (Park) or N (Neutral) into another gear range, as this can damage the drivetrain.
- The following indicators should be used to ensure that you have engaged the shift lever into the "P" position:
  - when shifting into P (Park), push the "P" button on the shift lever.
  - with the brake pedal released, verify that "P" position is illuminated on the shift lever and in the instrument cluster display.



## R (Reverse)

This range is used to move the vehicle backward.

Switching to R (Reverse) starting from N (Neutral) is only possible if the vehicle is moving backwards.

We recommend to shift into R (Reverse) only after the vehicle has come to a complete stop.

- Vehicle stationary: switching between R (Reverse) and D (Drive), passing from N (Neutral), requires brake pedal pressed and action on the lever.
- Vehicle moving: the driver can switch from R (Reverse) to N (Neutral) acting on the shift lever without pressing the unlock button and the brake pedal.

## N (Neutral)

- Vehicle stationary and engine started: switching from N (Neutral) to P (Park) requires "P" button pressed only. Switching from N (Neutral) to R (Reverse) and/or D (Drive) requires brake pedal and unlock button pressed and the action on the shift lever.
- Vehicle moving: switching from N (Neutral) to R (Reverse) and/or D (Drive) requires pressing the unlock

button and the action on the shift lever. Switching to R (Reverse) starting from N (Neutral) is only possible if the vehicle is moving backwards, while switching to D (Drive) starting from N (Neutral) is only possible if the vehicle is moving forwards.

Set the parking brake and shift the transmission into P (Park) if you must leave the vehicle.



### WARNING!

**Do not switch to N (Neutral) and/or never turn off the ignition to coast downhill. These are unsafe practices that limit driver's response to changing traffic or road conditions. It is possible to lose control of the vehicle and have a collision.**



### CAUTION!

**Towing the vehicle, coasting, or driving for any other reason with the transmission in N (Neutral) can result in severe transmission damage. See "Towing a Disabled Vehicle" in section "In an Emergency" for further information.**

DEALER ePROCESS

## D (Drive)

This range should be used for most city and highway driving. It provides the smoothest upshifts and downshifts and the best fuel economy. The transmission automatically shifts up and down through all gears. The D (Drive) mode provides optimum driving characteristics under all normal operating conditions of the vehicle.

- Vehicle stationary: to switch from D (Drive) to R (Reverse) requires brake pedal and unlock button pressed and the action on the shift lever: to reach N (Neutral) starting from D (Drive) is possible by only acting on the shift lever.
- To enable special operations while the car is moving at a low speed, such as getting out of marsh or snow, it is possible to run quickly from D (Drive) to R (Reverse), and vice versa, by pressing the unlock button and acting on the shift lever passing from N (Neutral).
- Vehicle moving: switching to N (Neutral) from D (Drive) it is not necessary to press brake pedal.
- From D (Drive) selected mode it is always possible to switch to M +/- (Manual) mode, by move the shift lever to the left (see following



paragraph); to return to "D" position, move the shift lever to the right. It is possible to shift from D (Drive) mode to M +/- (Manual) mode regardless of car speed.

- When in D (Drive) mode, using the paddles behind the steering wheel (if equipped), will cause the system to enter a temporary function and enable the manual shift mode. This range is indicated with the symbols "+/-" above and below "D" letter on the gear range field of the display. The system will then switch back to automatic mode according to time elapsed in "temporary" mode and driving conditions.

At extremely cold temperatures (-23°F / -30°C or below), transmission may be affected by the low temperature of the engine and transmission. Normal operation will resume once the transmission temperature has risen to a normal level.

### M +/- (Manual)

This mode is obtained by moving the shift lever to the left in "M +/-" position.

In this mode, the transmission interacts with the driver in order to allow manual shift and ensure increased control of the vehicle. The current

mode allows the transmission system to optimise the engine brake action, remove undesired shifting into higher and lower gears and improve the overall performance of the vehicle.

This mode allows you to move the shift lever step by step forward "-" or backward "+" without pressing the unlock button. The current transmission gear is displayed on the instrument cluster beside "M".



Manual mode can be activated at any time, with no need to release the brake pedal.

In M +/- (Manual) mode, the transmission will shift up or down (+/-) if manually selected by the driver by using the shift lever, or shift paddles on the steering wheel (if foreseen). The transmission remains in the engaged gear until the driver shifts

into another higher or lower gear, except in the following cases.

- Lack of accelerator pedal activity will cause the transmission to revert to automatic operation. The transmission will also upshift automatically once maximum engine speed is reached.
- If in SPORT mode, the transmission will remain in the selected gear even when maximum engine speed is reached. The transmission will upshift only if enabled by the driver. Manual upshift or downshift will be maintained as long as SPORT mode is selected, even by full stroke pedal press.
- If in "M +/-" or in SPORT mode, the transmission will automatically downshift as the vehicle slows to halt (to prevent engine lugging) and the current gear will display on the instrument cluster. Shifting the shift lever backward "+" or moving the right shift paddle "+" towards the steering wheel when stationary, will cause the vehicle to start in second gear. If the vehicle speed is too low, the system will ignore further upshifts. Avoid using speed control when the M +/- (Manual) mode is engaged.





When the car stops in M +/- (Manual) mode, the transmission automatically moves the shift lever and inserts P (Park).

If you enter the I.C.E. drive mode when the gearshift is in "M +/-" position, the system activates the automatic return of the shift lever in D (Drive) mode.

**Shift Paddles**

The driver can change gears with the shift paddles behind the steering wheel when in D (Drive) and M +/- (Manual) mode.

Using the shift paddles, the corresponding icon will display on the instrument cluster beside the "M" indication and current shifted gear.

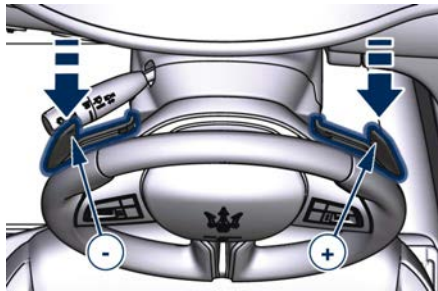

Pull the right shift paddle "+" towards the steering wheel and release it to enter the higher gear; do the same operation with the left shift paddle "-" to enter the lower gear.

- When in D (Drive) mode, by pressing "-" paddle the transmission shifts to "D1 - D2" temporary mode.
- Pull simultaneously both paddles to deactivate the D (Drive) temporary mode.

**Gear Shift Indicator Light**

In order to improve fuel economy, we recommend that you shift gears when the system prompts you to do so. This will help reduce fuel consumption without significantly affecting vehicle performance.

The indicator beside the displayed gear will light up just before reaching the required speed to change

DEALER ePROCESS

downshift or upshift (example in the figures).



When the new gear is engaged, the indicator turns off. If the shift runs late or is not performed at all, the indicator remains lit for a few seconds then turns off. As soon as new conditions requiring further gear change occur, the indicator light will illuminate again.



## NOTE:

The gearshift indicator will only work when the transmission is set in M +/- (Manual) mode.

## Transmission Malfunction and Overheating Conditions

### Transmission Emergency Control

Transmission function is electronically monitored to detect abnormal conditions. If a condition that could result in transmission damage is detected, "Transmission Limp Home Mode" will be activated. In this situation, the transmission may operate only in certain gears, or may not shift at all. In some situations, the transmission system may not re-engage if the engine is turned off and restarted.



A message in the instrument cluster will inform the driver about the more serious transmission conditions, and indicate what actions may be necessary.

### Transmission Oil Overtemperature

If the transmission oil temperature exceeds the operating limit, the red warning light  illuminates on the instrument cluster.



In this case, slow down until temperature returns to normal level (the light will turn off).

If this is not sufficient, we recommend to stop the vehicle, shift the lever to position P (Park) or N (Neutral) and keep the engine idle until the temperature red warning light  turns off and the message disappears from the display. Resume driving without demanding high engine performance. If the red warning light  and the related message turns on again, it is advisable to stop the vehicle, turn off the engine and wait for the engine/transmission assembly to fully cool down.

If the instrument cluster message indicates that the transmission may not re-engage after engine shutdown, perform the following procedure preferably at an **Authorized Maserati Dealer**. 

In the event of a momentary problem, the transmission can be reset to regain all forward gears by performing the following steps.

- Stop the vehicle.
- Shift the transmission into P (Park), if possible.
- Turn the engine off.
- Wait approximately 30 seconds.
- Restart the engine.
- Shift the transmission into D (Drive) and then into the desired gear range. If the problem is no longer detected, the transmission will return to normal operation.

## NOTE:

Even if the transmission can be reset, we recommend that you visit an **Authorized Maserati Dealer** at your earliest possible convenience, which has diagnostic equipment to determine if the problem could recur.

### Transmission Manual Release of P (Park) Position

See chapter "Transmission Manual Release of P (Park) Position" in section "In an Emergency".



## All-Wheel Drive (AWD version only)

The active on-demand All-Wheel Drive (AWD) system provides available optimum traction for a wide variety of road surface and driving conditions. The system minimizes wheel slip by automatically redirecting torque to the front and rear wheels as necessary. To maximise fuel economy, the AWD system automatically disengages torque distribution on front axle when road and environmental conditions are such that wheel slip is unlikely to occur. When specific road and environmental conditions require increased levels of road traction, the AWD system automatically distributes the torque between front and rear axle in order to grant the best driving experience. Torque distribution is displayed on the TFT in the "Drive Mode" main menu. Refer to paragraph "TFT Display: Menus and Settings" in chapter "Instrument Cluster" of section "Dashboard Instruments and Controls" for further information.



### WARNING!

There may be a slight delay for AWD engagement after a wheel slip condition occurs.



### NOTE:

If the AWD system service warning light and message appears after engine start up, or during driving, it means that the AWD system is not functioning properly or is in recovery mode due to overheating caused by the excessive wheel spin. In this condition the vehicle can continue driving but only rear wheel drive is working. If the warning light and message are often activated, it is recommended to have the vehicle serviced at an **Authorized Maserati Dealer**.

DEALER ePROCESS





## Drive Mode

### Controls Preview

Drive modes can be set using the buttons on central console.



#### CAUTION!

**"NORMAL" is the default drive mode, optimized for the best balance between performance, fuel consumption and emissions in the standard conditions use of the car.**

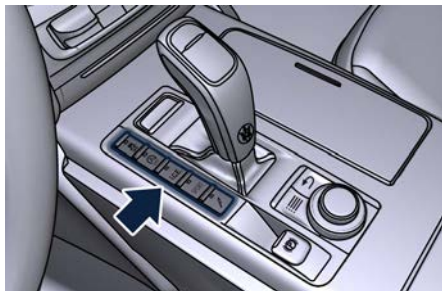

Buttons on the central console have following functions:

- (ESC Off): to exclude/reactivate the ESC system.
- (Start&Stop Off): to deactivate/reactivate the Start&Stop system.

- I.C.E.: to activate/deactivate the drive mode to ensure increased control on slippery surfaces as well as higher energy efficiency.
- SPORT: to activate/deactivate a sportier drive mode. In this mode, the vehicle has a faster throttle response and ESC sport calibration (not recommended on wet/slippy surfaces). Activating this drive mode, will also change the EPS setting.
- (Suspension): to switch between the two suspensions setting modes: soft (LED light off) and hard ("S", LED light on). Activating this drive mode, will also change the EPS setting.

By selecting one of these drive modes, the yellow or white LED on the button illuminates and, for some of these, the vehicle configuration obtained is graphically displayed on instrument cluster. The same screen is also obtained when selecting the "Drive mode" menu using the buttons on steering wheel.

When changing drive mode between I.C.E., NORMAL, SPORT and (Suspension), engine temperature and fuel level indicators inner edge will change color if "Outline Coloring" of submenu "Screen Setup" is set to "On" (see example in the figure).



Refer to chapter "Instrument Cluster" in section "Dashboard Instruments and Controls" for further information.





### Setting the Drive Mode

Drive modes can be set using the buttons on central console. Keys (buttons) only have two statuses: OFF and ON. The OFF status (button released) is the standard function mode. The ON status is activated by pressing the button, the dedicated LED will illuminate. It is necessary to press the (ESC OFF) button for at least 3 seconds. The table shows the different drive modes according to the status of the buttons.



Button	ON – Button pressed (LED ON)
	Electronic Stability Control ESC partially deactivated.
	Start&Stop function deactivated.
<b>I.C.E.</b>	Increase Control and Efficiency mode ON (*).
<b>SPORT</b>	Sportier drive mode (SPORT) ON.
 (**)	Hard/Stiff suspension setting ("S").
<p>(*) I.C.E. (Increase Control and Efficiency) operates on engine supply in order to reduce fuel consumption, exhausts, noisiness (efficiency) by dampening vehicle reactions (control). The current mode is also useful for low-grip surfaces.</p> <p>(**) Only with Skyhook active suspensions.</p>	

The tables below summarise the adjustment of transmission and engine parameters according to set drive mode/s.  (ESC OFF) is the only mode that does not depend on the activation or deactivation of the other modes. The tables show the two configurations with:

-  (ESC OFF) button NOT pressed;
-  (ESC OFF) button pressed.















































## ESC (ESC OFF) Button NOT pressed

<div style="background-color: black; width: 15px; height: 15px; display: inline-block; margin-right: 5px;"></div> Button pressed: LED ON <div style="border: 1px solid black; width: 15px; height: 15px; display: inline-block; margin-right: 5px;"></div> Button not pressed: LED OFF	<div style="border: 1px solid black; width: 20px; height: 15px; display: inline-block;"></div>	<div style="border: 1px solid black; width: 20px; height: 15px; display: inline-block;"></div>	<div style="border: 1px solid black; width: 20px; height: 15px; display: inline-block;"></div>	<div style="border: 1px solid black; width: 20px; height: 15px; display: inline-block;"></div>	<div style="border: 1px solid black; width: 20px; height: 15px; display: inline-block;"></div>	
	<div style="border: 1px solid black; width: 20px; height: 15px; display: inline-block;"></div> OFF	<div style="background-color: black; width: 20px; height: 15px; display: inline-block;"></div> OFF	<div style="border: 1px solid black; width: 20px; height: 15px; display: inline-block;"></div> OFF	<div style="border: 1px solid black; width: 20px; height: 15px; display: inline-block;"></div> OFF	<div style="background-color: black; width: 20px; height: 15px; display: inline-block;"></div> OFF	<div style="background-color: black; width: 20px; height: 15px; display: inline-block;"></div> OFF
	<div style="border: 1px solid black; width: 20px; height: 15px; display: inline-block;"></div> I.C.E.	<div style="border: 1px solid black; width: 20px; height: 15px; display: inline-block;"></div> I.C.E.	<div style="background-color: black; width: 20px; height: 15px; display: inline-block;"></div> I.C.E.	<div style="border: 1px solid black; width: 20px; height: 15px; display: inline-block;"></div> I.C.E.	<div style="border: 1px solid black; width: 20px; height: 15px; display: inline-block;"></div> I.C.E.	<div style="border: 1px solid black; width: 20px; height: 15px; display: inline-block;"></div> I.C.E.
	<div style="border: 1px solid black; width: 20px; height: 15px; display: inline-block;"></div> SPORT	<div style="border: 1px solid black; width: 20px; height: 15px; display: inline-block;"></div> SPORT	<div style="border: 1px solid black; width: 20px; height: 15px; display: inline-block;"></div> SPORT	<div style="border: 1px solid black; width: 20px; height: 15px; display: inline-block;"></div> SPORT	<div style="background-color: black; width: 20px; height: 15px; display: inline-block;"></div> SPORT	<div style="border: 1px solid black; width: 20px; height: 15px; display: inline-block;"></div> SPORT
	<div style="border: 1px solid black; width: 20px; height: 15px; display: inline-block;"></div>	<div style="border: 1px solid black; width: 20px; height: 15px; display: inline-block;"></div>	<div style="border: 1px solid black; width: 20px; height: 15px; display: inline-block;"></div>	<div style="border: 1px solid black; width: 20px; height: 15px; display: inline-block;"></div>	<div style="border: 1px solid black; width: 20px; height: 15px; display: inline-block;"></div>	<div style="background-color: black; width: 20px; height: 15px; display: inline-block;"></div>
	<i>Setup</i>	NORMAL + S&S enabled + Soft suspensions	NORMAL + S&S disabled + Soft suspensions	I.C.E. + S&S enabled + Soft suspensions	SPORT + S&S disabled + Soft suspensions	NORMAL + S&S disabled + Hard suspensions
Stability control	Active	Active	Active	Active-Sport (*)	Active-Sport (*)	
Electric Power Steering (EPS)	Normal	Normal	Normal	Sport	Sport	
Suspensions setup	Normal	Normal	Normal	Normal	Hard	
Engine control	Normal	Normal	Comfort	Performance	Performance	
Engine boost	Normal boost	Overboost	Low boost	Overboost	Overboost	
Exhaust sound	Low (Rev. Threshold)	Low (Rev. Threshold)	Low	Always High	Always High	
Gear shifting point	Normal	-	Comfort	Performance	Performance	
Kick down	Yes	Yes	Yes - Soft	Yes - Strong	Yes - Strong	
Upshift rev. limiter	Yes	Yes	Yes	Yes (No, when in M +/-)	Yes (No, when in M +/-)	





























<p>  Button pressed: LED ON   Button not pressed: LED OFF                 </p>	   	   	   	   	   
	 I.C.E.  I.C.E.	 I.C.E.  I.C.E.	 I.C.E.  I.C.E.		
	 SPORT  SPORT	 SPORT  SPORT	 SPORT  SPORT		
	 	 	 	 	 
	Automatic downshift	Normal	Anti - Stall	Comfort	Performance (Anti - Stall, when in M +/-)
Shifting timing	Normal	Rapid - Normal	Comfort	Sport (Rapid - Sport, when in M +/-)	Sport (Rapid - Sport, when in M +/-)

(\*) In low- and medium-grip conditions (e.g., rain, snow, ice, sand, etc.) it is advisable not to activate SPORT mode, even with the ESC system active (button  (ESC OFF) not pressed).





## 🛑 (ESC OFF) Button pressed

Button pressed: LED ON Button not pressed: LED OFF	 	 	 	 	 
	 	 	 	 	 
	I.C.E.	I.C.E.	I.C.E.	I.C.E.	I.C.E.
	SPORT	SPORT	SPORT	SPORT	SPORT
					
Setup	NORMAL + S&S disabled + Soft suspensions	NORMAL + S&S disabled + Soft suspensions	I.C.E. + S&S disabled + Soft suspensions	SPORT + S&S disabled + Soft suspensions	SPORT + S&S disabled + Hard suspensions
Stability control	OFF	OFF	OFF	OFF	OFF
Electric Power Steering (EPS)	Normal	Normal	Normal	Sport	Sport
Suspensions setup	Normal	Normal	Normal	Normal	Hard
Engine control	Normal	Normal	Comfort	Performance	Performance
Engine boost	Normal boost	Overboost	Low boost	Overboost	Overboost
Exhaust sound	Low (Rev. Threshold)	Low (Rev. Threshold)	Low	Always High	Always High
Gear shifting point	Normal	-	Comfort	Performance	Performance
Kick down	Yes	Yes	Yes - Soft	Yes - Strong	Yes - Strong
Upshift rev. limiter	Yes	Yes	Yes	Yes (No, when in M +/-)	Yes (No, when in M +/-)
Automatic downshift	Normal	Anti - Stall	Comfort	Performance (Anti - Stall, when in M +/-)	Performance (Anti - Stall, when in M +/-)









corresponding button once: the yellow LED on the button will turn on.

To reactivate the Start&Stop function, press the same button again: the LED will turn off.

### Activate/Deactivate I.C.E., SPORT and (Suspension) Drive Mode

To activate one of these drive mode, press the corresponding button once: the white LED on the button will turn on.



To disable the drive mode activated, press the same button again: the LED will turn off.

### Monitoring Settings on Display

By gaining access to "Drive mode" menu through the buttons on steering wheel right-hand side, it is possible to monitor the settings for driving.

The list and figure show vehicle parameters referred to each drive mode. Driving mode and its parameters are identified by a different color (example in the figure: I.C.E.).

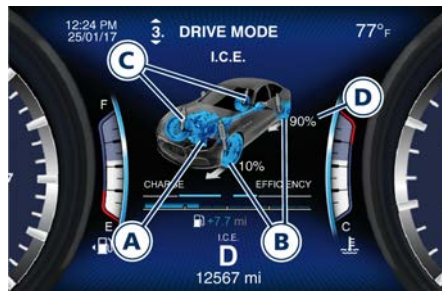

- A Powertrain
- B ESC
- C Suspension stiffness

### D Torque distribution (AWD version only)



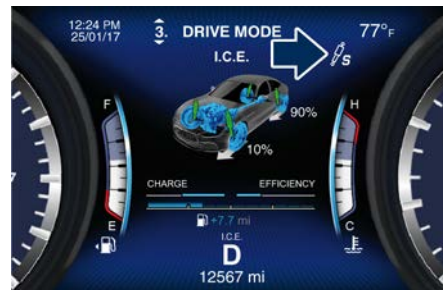

Press "" (Suspension) button, the icon with "S" beside will light up on the upper right side of the TFT display.



The table below specifies the default setting for each drive mode.

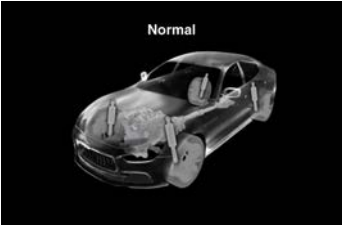

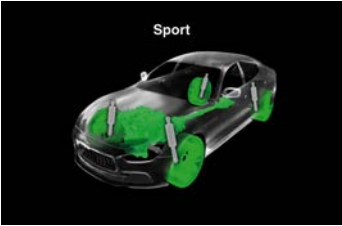



Drive Mode	Default Condition	
<p>I.C.E.</p> 	<p>ESC</p>	<p>I.C.E.</p>
<p>Normal</p> 		<p>Normal</p>
<p>Sport</p> 	<p>ESC</p>	<p>Normal</p>
		<p>Normal</p>
	<p>ESC</p>	<p>Sport</p>
		<p>Sport-Normal</p>



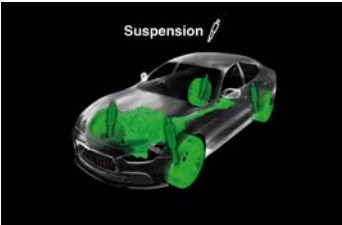

Drive Mode	Default Condition	
	ESC	Sport
		Sport-Firm

### I.C.E. Mode excluding ESC

To release the vehicle in low grip conditions (e.g.: heaps of snow, mud, sand, etc), it is possible to shift the transmission feature in the specific driving mode as required for these situations, by pressing the I.C.E. button and to exclude completely the yaw and spinning control system, by pressing the button for at last three seconds  (ESC Off).

5





## Active Alternator

To improve overall efficiency by reducing the auxiliary loads on the engine, the vehicle is equipped with a smart alternator that is mainly active in the latter energy balance phases (for example, during braking, coasting and overloading).

The alternator becomes active when the battery charge is insufficient and when the vehicle exits from the braking and overload situations.

### Active Alternator Feature (if feature is available)

In the I.C.E. screen, the user can display in the form of dynamic bars some informative parameters on the state of battery charge ("CHARGE"), efficiency of drive style ("EFFICIENCY") and the matured economy (🛢️ bonus range) expressed in miles (mi) or kilometres (km).



The bonus range (about 37 mi/60 km for each full of fuel) is automatically reset every time the vehicle is refueled.

## Parking Brake

The vehicle is equipped with an electric automatic parking brake, also called EPB (Electric Parking Brake).

The EPB braking action on model with "Base" braking system (equipped with rear floating calliper) is ensured by a power actuator directly working on the brake pad inside each calliper of the rear brake system.

All other modes with "Dual Cast" braking system are equipped with a dedicated calliper which acts on each rear brake disc.

It can be automatically engaged when the engine is turned off and disengaged with engine running, driver seatbelt latched and driver door closed, while pressing the brake pedal and operating the shift lever.

Furthermore, EPB can be automatically engaged above a slope threshold with the gearshift in P (Park) to avoid damage to the vehicle. EPB can be disengaged before turning off the vehicle.

When the parking brake is applied, the warning light **BRAKE** lights up on the tachometer display and the related message is displayed on the instrument cluster for 5 seconds (see "Instrument Cluster" in section





“Dashboard Instruments and Controls”).



During engagement and disengagement procedures, the warning light **BRAKE** flashes until the parking brake has reached its maximum activation force and is respectively fully released. In the above-mentioned conditions, the automatic engagement function can be deactivated/activated by selecting the menu item “Vehicle settings” on the main menu (refer to paragraph “Deactivating Automatic Operation” in this chapter).

## Manual Engagement/Disengagement

The parking brake can also be manually engaged or disengaged when the engine is running or the ignition switch is in the **RUN** position,

by pressing the brake pedal and raising the lever located behind the shift lever.

When the parking brake is applied, the warning light **BRAKE** lights up on the tachometer and the related message will be displayed for 5 seconds on the instrument cluster.

If you attempt to engage/disengage the parking brake without having pressed the brake pedal, a message will be displayed, warning you to proceed.

If the engine was turned off when the automatic engagement device was deactivated (see “Deactivating Automatic Operation” in this chapter) it is possible to shift the parking brake simply by pulling the lever upward within 3 minutes after turning off.



**DEP**  
DEALER ePROCESS



### CAUTION!

The main function of the EPB is to allow safe parking of the vehicle, therefore it must only be applied when the vehicle is already stationary. If the EPB is used while the vehicle is moving and decelerating until a speed lower of 3 mph (5 km/h) and, in particular, until complete stop (typically in a sudden brake), it is necessary to have the EPB system checked by an **Authorized Maserati Dealer**.



### WARNING!

- Always hold the brake pedal pressed during engagement or disengagement of the parking brake.
- The EPB command activation while running generates a deceleration of the vehicle with strong deceleration (Dynamic Braking). It is therefore recommended to use this feature only in case of emergency. The stability of the car is guaranteed by the action of the activated ESC system.



- It is advisable to keep the "Auto Apply" function always active (On) so that the vehicle is properly secured with electric parking brake.

## Deactivating Automatic Operation

The automatic engagement function can be deactivated/reactivated by selecting the menu item "Vehicle settings" through the switch on the right side of the steering wheel (refer to "Instrument Cluster" in section "Dashboard Instruments and Controls".)

Press and release the switch toward the arrow (▶) to select "Electric Park Brake".



Press and release the switch once again toward the arrow (▶) to visualize the options connected to this function.

- Auto Apply On (recommended setting);
- Auto Apply Off.



Scroll with the switch toward the arrow ▲ or ▼ through the programmable options. Press and release the switch toward the arrow (▶) to set the selected option. A check mark will remain next to the previously-selected item until a new selection is made.

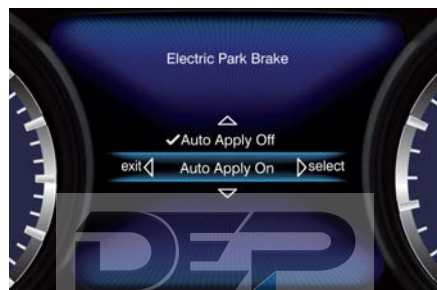

DEALER ePROCESS

"Setting Saved" Selection notification appears as a popup for 2 seconds then the display will show again the modified function.



In order to disable the automatic operation follow the same procedures and select the other option.



### CAUTION!

- Under certain conditions when the battery voltage is low, the electric automatic parking brake system may temporarily be deactivated for safety reasons. Therefore, typically upon starting the engine, when the battery voltage drops, a message may temporarily be displayed, indicating that automatic operation is temporarily disabled.

*(Continued)*



### (Continued)

- In case of repetitive requests to reset the EPB through the messages shown on the TFT display, please contact an **Authorized Maserati Dealer**.

## Failure Indication

In the event of electric parking brake system failure, the warning light  on the display will light up and the related message will show for 5 seconds.



### WARNING!

In the event of an EPB failure, take your vehicle to the nearest **Authorized Maserati Dealer** as soon as possible.



Initialize the EPB System after Re-connecting the vehicle battery

After the detachment and the subsequent connection of the battery, on the instrument cluster display the warning light  will be illuminated. To initialize the EPB system, lift, release and lift again the lever located behind the shift lever.

## Emergency Disengagement

In case of brake lock with complete electrical system failure, it is necessary to force the electric actuator on the rear calipers (see “Emergency Release of the Parking Brake” chapter in section “In an Emergency”).

## EPB Operation with Overheated Brakes

Driving on mountain roads with steep slopes or a sports use of the vehicle could overheat the brake system components. In these conditions, the parking brake must not be used since the push of the power actuator might not be sufficient to ensure vehicle braking, especially on a slope. Drive normally without braking to allow the brakes to cool down a few minutes before stopping. In this way, the automatic or manual activation of the parking brake will ensure vehicle braking.



## Parking

Before leaving the vehicle, **make sure that the parking brake is fully applied** and place the shift lever in the P (Park) position.



### WARNING!

- **Always check that the vehicle is locked before leaving it.**
- **Never leave children unattended in the vehicle.**
- **Do not park the vehicle on paper, grass, dry leaves or other flammable materials.**
- **Do not leave the engine running while the vehicle is unattended.**



### CAUTION!

When you need to park the vehicle on a steep slope, both with the engine on or off, it is recommended not only to engage the parking brake, but also to shift the gearshift lever to P (Park) before leaving the vehicle.

When parking on hill roads, it is important to turn the front wheels toward the curb on a downhill grade





and away from the curb on an uphill grade.

Apply the parking brake before placing the shift lever in P (Park), otherwise the load on the transmission locking mechanism may make it difficult to move the shift lever out of P (Park).

In certain conditions, it is however advisable to disengage the parking

brake manually and slightly apply the service brake for starting off. This is advisable when there are obstacles very close to the vehicle in the direction in which you intend to move.

### “Drive Away Inhibit” strategy

In order to avoid a dangerous condition resulting from leaving the vehicle “not braked” with running

engine and without driver on board, “Drive Away Inhibit” strategy alerts the driver with messages on the instrument cluster display and sounding chimes, then puts the transmission in P (Park).

The table shows the vehicle condition and the action that the system runs to exit the dangerous condition.

Vehicle condition	Action of the driver	
<ul style="list-style-type: none"> <li>• Engine running and speed lower than 1.8 mph (3 km/h).</li> <li>• Transmission in any position other P (Park).</li> <li>• Driver safety belt unlocked.</li> <li>• Driver door opened.</li> <li>• Brake pedal pressed.</li> </ul>	<p>The driver releases the brake pedal to get out of the vehicle.</p>	<p>The system puts the transmission in P (Park) position.</p>
<p><b>Warnings</b></p>	<p><b>Warnings</b></p>	
<ul style="list-style-type: none"> <li>• Slow continuous chime.</li> <li>• The condition of the vehicle not in P (Park) position will be signaled by a message on the display.</li> </ul>	<ul style="list-style-type: none"> <li>• Fast chime.</li> <li>• A message which invites to engage the parking brake to prevent vehicle movement will be displayed on the display.</li> </ul>	





## Brake and Stability Control System

The vehicle is equipped with an Electronic Stability Control System (ESC), which helps to maintain directional control in the event of loss of grip of the tires. The system is able to detect potentially dangerous situations for the stability of the vehicle and automatically sets the brakes on all four wheels in a differentiated manner, in order to provide a torque settlement of the vehicle.

ESC includes the following subsystems:

- ABS (Anti-lock Braking System);
- EBD (Electronic Brake-force Distribution);
- TCS (Traction Control System);
- BAS (Brake Assist System);
- BTO (Brake Throttle Override);
- HSA (Hill Start Assist).



### WARNING!

- **These systems cannot prevent the natural laws of physics from affecting the vehicle, nor can they increase traction, braking or steering efficiency beyond that afforded by**

**the condition of the vehicle brakes and tires.**

- **These systems cannot prevent collisions, including those resulting from excessive speed in turns, following another vehicle too closely, or hydroplaning.**
- **The capabilities of a vehicle equipped with these systems must never be exploited in a reckless or dangerous manner that could jeopardize the driver's and the passenger's safety or the safety of others.**

## Electronic Stability Control (ESC)

This system enhances directional control and stability of the vehicle under various driving conditions. The ESC corrects over steering and under steering of the vehicle by applying the brake to the appropriate wheel. Engine power may also be reduced to assist in counteracting the conditions of instability and maintain the right direction. The system is also able to reduce the engine power.

Through sensors fitted on the vehicle, the ESC system detects the driver's chosen direction comparing it to the one maintained while running. In case

of discrepancy between the required trajectory and the current one, the ESC system brakes the appropriate wheel to counteract over or under steering.

- Oversteer - when the vehicle is turning more than appropriate for the steering wheel position.
- Understeer - when the vehicle is turning less than appropriate for the steering wheel position.

The ESC system has two available operating modes:

### ESC on

This is the normal ESC operating mode. At each start-up of the vehicle, the ESC system is set in this mode and should be used for most driving conditions. The ESC should only be turned off for specific reasons as pointed out in the following paragraphs.

### ESC off

The "ESC off" mode is aimed for a more spirited driving experience but also purposeful for driving in deep snow, sand, or gravel. The current mode disables the TCS portion of the ESC and raises the threshold for ESC activation, allowing higher wheel spin than normally granted by the ESC system. The  (ESC OFF) button is fitted beside the gear shift lever: to



deactivate the system see “Drive Mode” in this section.



### WARNING!

In SPORT mode the ESC control thresholds are higher for maximum performance on dry road surface. To ensure maximum security of the ESC, it is recommended not to activate SPORT mode on surfaces with medium- and low-grip (e.g., wet, snow, dirt, etc..) with ESC system active (ESC OFF button not pressed).

### NOTE:

- When in “ESC off” mode, the TCS functionality of ESC is deactivated (except for the limited slip feature described in the TCS paragraph of this chapter). All other stability features of ESC function regularly.
- To improve the vehicle's traction when driving with snow chains, or when starting off in deep snow, sand, or gravel, it may be desirable to switch to the “ESC off” mode by pressing the ESC OFF button and remain in this operational mode no longer than needed. Once the situation requiring “ESC off” mode is

overcome, turn the ESC on again by pressing the ESC OFF button. This may also be performed while in motion.

## Anti-Lock Braking System (ABS) and Electronic Brake-force Distribution (EBD)

The Anti-Lock Braking System (ABS) provides increased vehicle stability and brake performance under most braking conditions. The system automatically “pumps” the brakes during severe braking to prevent wheel lock-up.

The Electronic Brake-force Distribution (EBD) prevents the rear wheels from over-braking and provides greater control of available braking forces applied to the rear axle.



### WARNING!

The ABS helps prevent the wheels from locking, but it does not increase the physical grip limits between the tires and the road. Therefore, always keep a safe distance from the vehicle in front of yours and reduce your speed when entering a curve.

DEALER ePROCESS

### NOTE:

- When the vehicle's speed is higher than 7 mph (11 km/h), you may hear a slight clicking sound as well as other motor noises. The system is performing a self-check cycle to ensure that the ABS is working properly.
- This self-check occurs each time the vehicle is started and accelerated past 7 mph (11 km/h).

ABS is activated during braking under certain road or stopping conditions. ABS-inducing conditions can include ice, snow, gravel, bumps, railroad tracks, loose debris.

You may also experience the following when the brake system goes into Anti-Lock:

- The ABS motor running (it may continue to run for a short time after the vehicle stops).
- The clicking sound of solenoid valves.
- Brake pedal pulsations.
- A slight drop or fall away of the brake pedal at the end of the stop. These are all normal characteristics of ABS functioning.



## WARNING!

- **The ABS contains sophisticated electronic equipment that may be susceptible to interference caused by improperly installed or high output radio transmitting equipment. This interference can cause possible loss of anti-lock braking capability. Installation of such equipment should be performed by qualified Maserati personnel.**
- **Pumping the Anti-Lock Brakes will diminish their effectiveness. Pumping brakes makes the stopping distance longer. Just press firmly on your brake pedal when you need to slow down or stop. Do not pump brakes.**

## Traction Control System (TCS)

The current device is an integral part of the ESC system. It operates automatically by reducing the power transmitted by the engine in case of slipping, loss of grip on wet floor (aquaplaning), acceleration on slippery snow-covered or frozen surfaces, etc. Activating under slip conditions different control systems:

- if slippage affects both drive wheels, it reduces the power transmitted by the engine;
- if slippage only affects one drive wheel, it brakes the slipping wheel automatically.

## Brake Assist System (BAS)

This system completes the ABS system by optimizing the vehicle braking capacity during emergency brake maneuvers. The system detects an emergency braking situation by sensing the rate and amount of brake application and then applies optimum pressure to the brakes in order to help reduce braking distances. The quick brake coupling is optimal for BAS performances. In order to fully exploit the system, apply continuous brake pedal pressure during the entire vehicle stop sequence. Do not reduce brake pedal pressure earlier than required. Once the brake pedal is released, the BAS is deactivated.

## Brake Throttle Override (BTO)

To complete the range of systems that assist braking, the vehicle is equipped with BTO, which is designed to stop the vehicle even when it is during acceleration. If the brake pedal is depressed together with the

accelerator, the system does not consider as “conflict” the sequence “brake-first-then-accelerator” of pedal application and it will not engage the BTO. When the system recognizes that the accelerator pedal is stuck pressed and the sequence “accelerator-first-then-brake-pressed” (this sequence is recognized as a “conflict”), the engine power should be automatically reduced and, if the driver continues to depress the accelerator and the brake pedal, the system can make the vehicle come to a complete stop. Additionally, if the brake pedal is released when the accelerator is still stuck pressed, the corresponding engine torque increases gradually to a safe value. During this event, the ETC light indicator will illuminate. The system exits from this strategy when the accelerator pedal is completely released.

## Hill Start Assist (HSA)

The HSA system is designed to assist the driver when starting a vehicle uphill. HSA will maintain the level of brake pressure applied for a short period of time also after releasing the brake pedal.



If the driver does not apply the throttle during this short period of time, the system will release brake pressure and the vehicle will start sloping down. The system will release brake pressure proportionally to the amount of throttle/torque applied as the vehicle starts to move in the chosen direction.

### HSA Activation Criteria

The following criteria must be met in order for HSA to activate:

- vehicle is stationary;
- gear selection matches vehicle uphill direction (i.e., vehicle facing uphill is in forward gear; vehicle backing uphill is in reverse gear).

HSA will work in R (Reverse) and all forward gears when the activation criteria have been met.

The system will not activate if the transmission is placed in N (Neutral) or P (Park).

## Using the Brakes



### CAUTION!

To obtain a good performance by brake pads and discs, avoid sudden braking during the first 190 mi (300 km).

The pad wear limit is indicated by the illumination of the warning light **BRAKE** and by a message on the instrument cluster.

In this event, please contact an **Authorized Maserati Dealer**.



### WARNING!

Riding the brakes can lead to brake failure and possibly an accident. Driving with your foot resting or riding on the brake pedal can result in

abnormally high brake temperatures, excessive lining wear, and possible brake damage. In an emergency full braking capacity may be impaired.

## Brake Pads and Brake Discs

Wear on the brake pads and brake discs depends to a great extent on the driving style and the conditions of use and therefore cannot be expressed in actual miles driven on the road.

The brake system is designed for optimal braking effect at all speeds and temperatures.

Certain speeds, braking forces and ambient conditions (e.g. temperature, humidity and long outdoor stopping periods) can therefore cause the brakes to "squeal". This is normal and will cease after a few brakings.

## New Brake Pads and/or Brake Discs

New brake pads have to be "broken in", and therefore only attain optimal friction to the brake disc when the vehicle has covered several hundreds of miles.

During this break-in period, the slightly reduced braking ability must be compensated for by pressing the brake pedal harder. This applies



whenever the brake pads and/or brake discs are replaced.

### Brake Overheating

Driving on mountain roads with steep slopes or a sports use of the vehicle could overheat the brake system components. In these conditions, the parking brake must not be used since the push of the power actuator might not be sufficient to ensure vehicle braking, especially on a slope.

Drive normally without braking to allow the brakes to cool down a few minutes before stopping. The automatic or manual activation of the parking brake will ensure vehicle braking.

Brake overheating could also cause "squeals" and "vibration".

## Use of the Engine

### Breaking-In

Today's most modern production methods are designed to provide extremely precise construction and assembly of components. However, moving parts do undergo a settling process, basically in the first hours of vehicle operation.

Do not drive keeping at a constant high speed rate for a prolonged time. While cruising, brief full-throttle acceleration within the limits of local traffic laws contributes to a good break-in. Wide-open throttle acceleration in low gear can be detrimental and should be avoided.

The engine oil installed in the engine at the factory is a high-quality energy conserving type lubricant. Oil changes should be consistent with anticipated climate conditions under which vehicle operations will occur. For the recommended viscosity and quality grades, see "Refillings" in section "Features and Specifications".

A new engine may consume some oil during its first few thousand miles/kilometers of operation. This should be considered as a normal part

of the break-in and not interpreted as an indication of malfunction.

### Specific Requirements

Avoid exceeding 5000 rpm for the first 620 mi trip (1000 km).

After starting the vehicle, do not exceed 4000 rpm until the engine has warmed up sufficiently (coolant temperature: 149-158°F /65-70°).

### While Driving

Never travel with the tachometer indicator approaching the peak rpm, not even downhill. When the tachometer indicator is approaching the peak rpm (red colored zone), take precautions to avoid exceeding that limit.



Ensure proper operation of different devices checking their respective control telltales.

**CAUTION!**



- Under normal conditions, all red warning lights on the instrument cluster display should be off. When they come on, this indicates a malfunction. Refer to “Instrument Cluster” in section “Dashboard Instruments and Controls”.
- Continuing to drive when a red warning light is on could cause serious damage to the vehicle and affect its performance.

## Onboard Diagnostic System

Your vehicle is equipped with a sophisticated onboard diagnostic system. This system monitors the performance of the emissions, engine, and automatic transmission control systems. When these systems are operating properly, your vehicle will provide excellent performance and fuel economy, as well as engine emissions well within current local regulations of various countries. If any of these systems require service, the system will turn on the  Malfunction Indicator Light (MIL). It will also store diagnostic codes and other information, which your

**Authorized Maserati Dealer** will use to service your vehicle. Although the vehicle will still be driveable and not need towing, contact an **Authorized Maserati Dealer** for service as soon as possible.

**CAUTION!**

- Prolonged driving with the  Malfunction Indicator Light (MIL) on could cause further damage to the emissions control system. It could also affect fuel economy and drivability. The vehicle must be serviced before any emissions tests can be performed.
- If the  Malfunction Indicator Light (MIL) is flashing while the engine is running, severe catalytic converter damage and power loss

will soon occur. Immediate service is required at an **Authorized Maserati Dealer**.

- After the problem has been solved, the **Authorized Maserati Dealer** personnel will perform specific tests for a complete check of the system and, if necessary, road tests.



## Electronic Cruise Control

The electronic Cruise Control (CC) enables the driver to maintain the desired vehicle speed without pressing the accelerator pedal, reducing driving fatigue on highways, especially long trips, as the set speed is automatically maintained. A firm press on the accelerator pedal or the braking pedal will temporarily deactivate the cruise control function.



### CAUTION!

The device can only be switched on at speeds exceeding 18 mph (30 km/h) and it switches off automatically when the brake pedal or the accelerator pedal is pressed.



### WARNING!

The Cruise Control function must only be activated when traffic and the route permit a constant speed to be maintained safely for a sufficiently long distance.

## Controls

The electronic Cruise Control controls are located on the left side of the steering wheel.

Control configuration depends on which driver assist systems are installed to the vehicle.

In the standard configuration there is a specific button to enable and disable the CC.

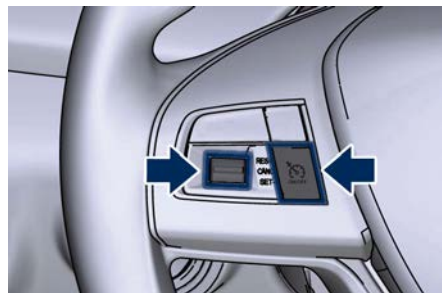

### Standard Configuration

In the optional configuration, there is no specific button to enable and disable the CC, since the driver uses the ACC control buttons.

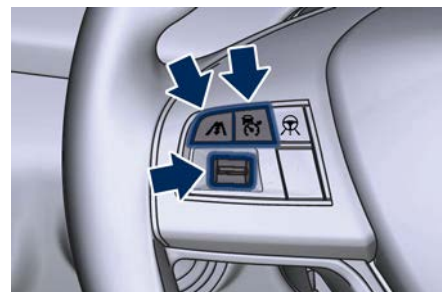

### Optional Configuration

Control buttons have the following functions:

### Standard Configuration



ON/OFF

ON/OFF button to engage/disengage CC system.

### Optional Configuration



Press ACC Gap button and hold it down for 2 seconds to enable the CC system.



Press ACC button to disable the CC system.





## Shared by All Configurations

RES+  
CANC  
SET-

Multifunction switch:

- Press up (indication RES +): increase speed, set current speed or resume previously set speed when system is in "cancelled" status;
- Pushed (indication CANC): deletes the set speed;
- Press down (indication SET -): set speed/decrease speed.

### NOTE:

- *The figures only show the Standard Configuration.*
- *In order to ensure proper operation, the CC system has been designed to shut down if multiple systems are operated at the same time (example: ACC and FCW). When conditions so allow, the CC system can be reactivated by pushing the CC "ON/OFF" button or the ACC Gap button (in the Optional Configuration) and resetting the desired vehicle set speed.*

## Displayed Information

CC conditions are displayed on the instrument cluster after selecting "Driver Assist" menu (see paragraph "TFT Display: Menus and Settings" under "Instrument Cluster" in section "Dashboard Instruments and Controls").

Displayed information depends on system status: ready, disabled, cancelled or set.

Apart from the pop-up messages at the centre of the display, CC system status is represented by icons at the top left. These icons remain displayed even when you exit the "Driver Assist" screen.

The CC screen can be displayed any time the driver changes system status or settings. After 5 seconds of CC inactivity, the display goes back to last screen.

### Activation

To turn the system on, push the ON/OFF button or the ACC Gap button for 2 seconds (in the Optional Configuration). The white light with below 3 dashes on the instrument cluster display will illuminate.



To turn the system off, push the ON/OFF button a second time or the ACC button (in the Optional Configuration). The white light will turn off.



### NOTE:

*The CC system must be turned off when not in use.*

DEP  
DEALER ePROCESS



**WARNING!**

Never leave the electronic Cruise Control system on when not in use. You could accidentally set the system or cause it to go faster than you want. Always leave the system off when you are not using it.

### Speed Range of Use

Speed	mph (km/h)
Minimum	18 (30)
Engaged/activated	18 (30)
Maximum	130 (210)

### Setting Desired Speed

Turn on the CC function. When the vehicle has reached the desired speed (in the example: 60 mph), push downward the multifunction switch (SET -) and release.

The green light below the desired speed will illuminate on the instrument cluster display.



Release the accelerator and the vehicle will operate at the selected speed.

**NOTE:**

*The vehicle should be traveling at a steady speed and on level ground before pushing the switch downward.*

Pressing the "ON/OFF" button or the ACC Gap button for 2 seconds (in the Optional Configuration) or moving the ignition switch in OFF position erases the set speed memory.

### Changing Speed Setting

Pushing the multifunction switch upward (RES +) or downward (SET -) once, or by holding it down, will enable to increase or decrease the set speed by one unit (1 mph or 1 km/h). If the car is equipped with ADAS Systems, the single press of the multifunction switch will increase or

decrease the set speed of 1 mph or 1 km/h; a continuous pressure of the same will increase or decrease the set speed of 5 mph or 10 km/h. Release the switch when the desired speed is reached, and the new set speed will be visualized below the green light.

Each subsequent tap of the multifunction switch will increase or decrease the speed by 1 mph or 1 km/h.

### Temporary Deactivation

A soft tap on the brake pedal, pressing the multifunction switch (CANC), or normal brake pressure while slowing the vehicle will temporarily deactivate the CC without erasing the set speed memory. The white light will appear on the display.

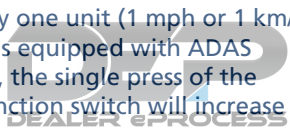





## Driver Override

If the driver presses the accelerator pedal while the CC is on, such as to overtake another vehicle, and exceeds the set speed limit, the system will temporarily deactivate the CC. During the event, the speed indication below the  green light will be blinking.



When the accelerator pedal is released, the vehicle will return to the set speed and the  green light with below the set speed with steady light will be displayed.

## Resume Speed

To resume a previously set speed, push upward the multifunction switch (RES +) and release. The  green light with below the set speed will illuminate on the instrument cluster. Resume can be used at any speed above 18 mph (30 km/h).

## Using Electronic Cruise Control on Hills

The transmission may be downshifted on hills to maintain the vehicle set speed. The CC system maintains set speed up and down hills. A slight speed change on moderate hills is normal. On steep slopes, a greater speed loss or gain may occur so we recommend to drive without CC.



### WARNING!

**Electronic Cruise Control can be dangerous where the system cannot maintain a constant speed. Your vehicle could go too fast for the conditions, and you could lose control and have an accident. Do not use electronic Cruise Control in heavy traffic or on winding, icy, snow-covered or slippery roads.**



## Adaptive Cruise Control – ACC (optional)

### ADAS Equipments

The Adaptive Cruise Control (ACC) is part of ADAS equipments together with:

- Lane Keeping Assist (LKA)
- Active Blind Spot Assist (ABSA)
- Forward Collision Warning (FCW)
- Highway Assist (HAS)
- Traffic Sign Assist (TSA).

FCW is a standard equipment while HAS and TSA are separate functions that may not be present in the ADAS equipment. For more details see "Forward Collision Warning - FCW", "Highway Assist - HAS" and "Traffic Sign Assist - TSA" in this section.

### NOTE:

*LKA and ABSA are described in the relevant chapters of this section.*

### ACC Preview

The Adaptive Cruise Control (ACC) further increases the drive comfort ensured by the Cruise Control when driving on highways and freeways. Always consider that ACC is not a



safety system and is not designed to prevent accidents. The ACC allows driver to keep Cruise Control active in limited or moderate traffic conditions with no need to constantly restore the Cruise Control. The ACC uses a radar sensor, located on the front grille behind the trident, and the forward-facing camera behind the internal rear-view mirror to detect the presence of a vehicle ahead at a close distance and moving in the same direction.



This vehicle, in this chapter, will be indicated as "target vehicle" or "vehicle ahead".

### NOTE:

- If the sensor detects no vehicle ahead, the ACC system will maintain set steady speed.
- If the ACC sensor detects a vehicle

*ahead, the ACC system automatically kicks in by slightly accelerating or braking (to avoid exceeding the initially set speed) so that the vehicle keeps present distance, trying to adapt to the speed of the detected vehicle ahead.*



### WARNING!

- **The Adaptive Cruise Control (ACC) is designed to increase vehicle driving comfort. It must not be considered as a means of replacing the required attention of the driver. The driver is always required to drive carefully. The driver is always required to pay utmost attention to driving conditions (road, traffic, weather) and style (speed, distance from sensed vehicle ahead, brake use). Driver has the full responsibility of the vehicle therefore his attention is crucial to keeping vehicle control, in particular when approaching curves and situations with heavy traffic. Failure to follow these warnings can result in a collision and death or serious personal injury.**
- **In some driving scenarios, the ACC could have detection problems. In such cases, the ACC could kick in late**

**or unexpectedly. The driver must be careful since his/her intervention could be necessary.**

- **It is always the driver's responsibility to obey speed limits and to keep minimum legal distance to the preceding vehicle.**
- **ACC system can decelerate only with limited braking, it cannot execute emergency braking.**

The ACC system:

- Does not activate/react in the presence of pedestrians, bicycles, incoming traffic from the opposite direction and steady objects such as a vehicle stuck in a traffic jam.
- Is meant for the use on highways and well-built roads, not for city traffic or mountain roads.
- May not have enough time to react and/or decelerate sufficiently on vehicles when lane is changed too quickly or the relative speed is too high. In such cases the driver has to react appropriately and without any acoustic/visual and warning.
- Cannot consider road, traffic and weather conditions and might prove limited when visibility is poor.
- Does not always fully recognize complex driving conditions and this



could cause an incorrect assessment of the required safety distance. It is recommended to disable the ACC system in the following instances:

- When driving in the fog, heavy rain, heavy snow, slush, heavy traffic and similar complex situations such as highway construction zones.
- When entering a junction lane or a slip road to leave the highway; when driving on narrow, icy, snowy, slippery roads, or on steep uphill and downhill roads.
- When circumstances do not allow to drive safely at constant speed.

## Displayed information

Adaptive Cruise Control (ACC) condition, as well as the LKA and HAS status, is displayed on instrument cluster after selecting "Driver Assist" menu (see paragraph "TFT Display: Menus and Settings" under "Instrument Cluster" in section "Dashboard Instruments and Controls").

Displayed information depends on system status: ready, set, temporarily cancelled or override.

Apart from the image at the center of the display, CC, ACC, LKA and HAS systems status is represented by icons

at the top left and right. These icons remain displayed even when exiting the "Driver Assist" screen. The vehicle(s) and horizontal bars represent the ACC status as ready (white) or with sensed vehicle ahead (green); the white, grey or yellow lines represent the LKA and HAS systems. The ACC screen can be displayed any time driver changes system status or settings. After 5 seconds of ACC inactivity, the display goes back to last screen.

## ACC Controls and Activation Conditions

The buttons on the RH side of the steering wheel control the ACC operations and the other functions/driver assist systems installed to this vehicle.

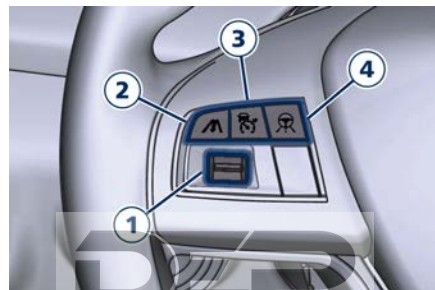

DEALER ePROCESS

- 1 Multifunction control shared by all driver assist functions/systems:
  - Press up (indication "RES +"): increase speed, set current speed or resume previously set speed when system is in "cancelled" status.
  - Pushed (indication "CANC"): cancel the function if it was in "set" status, going in a ready condition but remembering the previous set speed.
  - Press down (indication "SET -"): set speed/decrease speed.
- 2 Two functions button with ACC activated:
  - ACC Gap: pressed and released; set the distance to sensed vehicle ahead as horizontal bars (setting cycle starts to 3 bars).
  - CC On: pressed for 2 seconds activates the CC system.
  - Press it to switch from CC to ACC.
- 3 ACC ON/OFF button. If enabled, pressing this button will disable CC.
- 4 HAS ON/OFF button with ACC set only. See "Highway Assist - HAS" in this section for further details.



## NOTE:

Any change made to tire dimensions affects performance of Adaptive Cruise Control and Front Collision Warning (FCW), if equipped.

The ACC is not activated in the following conditions:

- When braking.
- When parking brake is activated.
- When automatic transmission is in P (Park), R (Reverse) or N (Neutral).
- When vehicle speed is out of preset speed range
- When brakes are overheated.
- When driver door is open.
- When the driver's seat belt is unbuckled.
- When the road is particularly steep (both uphill and downhill) at low speed.
- When drive mode (ESC OFF) is selected.
- When the door is opened at low speed.
- When there has been an ESC event in the last 5 seconds, or is still active.
- When there is an object too close in front of the vehicle.

It is possible that more than one system is active at the same time such

as ACC and ABSA just to mention some.

While activation of ACC and CC at the same time is impossible.

## Speed Range of Use

Speed	mph (km/h)
Minimum	0 (0)
Engaged/activated	18 (30)
Maximum	130 (210)

## Activation/Deactivation

### NOTE:

Pictures show status of ACC and LKA systems.

Press and release ON/OFF button to activate the ACC. The display will show the white symbol with below 3 dashes will illuminate indicating that system is ready to be set.



Driver Assist Page



Non-Driver Assist Page

If a vehicle is detected as being too close, the display will show a message for 5 seconds and trigger a signal to warn the driver that current conditions do not allow enabling of the ACC. At any rate, system will remain in the ready status.





Push the ON/OFF button a second time and release to turn the system off. A pop-up message is displayed for 2 seconds to indicate that ACC was disabled.



### WARNING!

Leaving the Adaptive Cruise Control (ACC) system on when not in use is dangerous. You could accidentally activate the system or cause it to go

faster than you want. Always leave the system off when you are not using it.

## Setting the Speed

When the vehicle reaches the required speed, press down and release the multifunction control (SET -). The display will show set speed corresponding to vehicle current one. Speed value will be indicated below the green symbol and above the distance bars, in the center of the display.



Remove foot from accelerator pedal and vehicle will continue at set speed.

## Driver Override

If the driver accelerates beyond the set speed or faster than the car would do with ACC engaged, the set speed below the green light will blink and

the time gap bars will vanish to indicate that in this condition the system cannot control the distance between vehicle and sensed vehicle ahead. Vehicle speed will be determined only by the accelerator pedal position.

## Changing Speed Setting

Once speed is set, driver can increase or decrease it by respectively pressing multifunction control up (RES +) or down (SET -). Speed can be increased or decreased in two ways:

- Pressing control once, set speed will increase or decrease by one unit corresponding to 1 mph (1 km/h).
- Hold the control to increase or decrease set speed by 5 mph (10 km/h) at a time.

### NOTE:

- When pressing the multifunction control up (RES +) or down (SET -), the new set speed will be the current speed of the vehicle.
- When using (SET -) control to decelerate, if the engine braking power does not slow down the vehicle sufficiently to reach the set speed, the brake system will automatically slow down the vehicle.

(Continued)



## (Continued)

- The ACC system applies the brake down to a full stop when following a target vehicle. If an ACC host vehicle follows a target vehicle to a standstill, after a two or three second delay, the system will not be able to resume driving the car autonomously. At this point it is necessary for the driver to manually reengage the system by either using the multifunction control (press SET- or RES+) or by pressing the accelerator pedal (see "ACC Operation Before and During Stop" in this chapter).
- The ACC system maintains set speed when driving up hill and down hill. However, a slight speed change on moderate hills is normal. In addition, downshifting may occur while climbing uphill or descending downhill. This is normal operation and necessary to maintain set speed. When driving uphill and downhill, the ACC system will cancel if the braking temperature exceeds normal range.

## Temporary Deactivation

A soft tap on the brake pedal, pushing the multifunction control (CANC), or

normal brake pressure while slowing the vehicle will temporarily deactivate the ACC without erasing the set speed memory. The  white light will appear on the display with below the set speed.

## Conditions for Disabling and Deactivation

Besides the cases specified in the previous paragraph, the following conditions will disable the system:

- Anti-Lock Brake (ABS) kicks in.
- Transmission lever is not in D (Drive).
- The Electronic Stability Control and the Traction Control System (ESC/TCS) activate.
- Vehicle parking brake is operated.
- The driver safety belt is unbuckled at low speed.
- The driver door is ajar at low speed.
- The driver disabled the ESC using the  (ESC OFF) button on central console.
- The road is too steep both uphill and downhill at low speed.

The system is deactivated and set speed is deleted from system memory, if the ACC ON/OFF button is pressed or if ignition device is turned to OFF.

## Resuming Speed

If a speed setting is stored in system memory, press the multifunction control (RES +) up and take foot off the accelerator pedal. The last set speed will be displayed.



### WARNING!

**The resume function should be used only when road and traffic conditions allow it. Resuming a too high or too low speed for current traffic and road conditions could cause a harsh vehicle acceleration or deceleration which could increase the risk of collisions and death or serious injury.**

## Setting the ACC Gap

The specified ACC gap can be set by varying the distance setting among the four possible options identified by the number of horizontal bars:

- Maximum (longest) distance: 4 bars.
- Long distance: 3 bars (default distance).
- Medium distance: 2 bars.
- Short distance: 1 bar.

Using this distance setting and the vehicle speed, ACC calculates and sets the gap to the vehicle ahead.





If system does not detect the presence of any vehicles ahead, only the bars referred to set distance will be displayed.

When system detects the presence of a vehicle ahead, it is displayed in front of the bars (see example in the figure).



Driver Assist Page



Non-Driver Assist Page

To increase or decrease the number of bars, corresponding to the gap from

vehicle ahead, press and release the distance setting button.



Each press and release of the button changes the gap starting from 3 bars (default distance) and moving in a sequential way towards the minimum distance: 3→2→1→4→3→2→1→4 and so on.

If there is no vehicle ahead, the vehicle will maintain the set speed. If a slower moving vehicle is detected in the same lane, the system displays the target vehicle icon before the bars. From that moment, the system adjusts the vehicle speed automatically to maintain the distance setting, regardless of the set speed. The vehicle will then maintain the set distance until:

- The vehicle ahead accelerates to a speed above the set speed.

- The vehicle ahead moves out of the lane or view of the sensor.
- The distance setting is changed.
- The driver disables the system.

The maximum braking applied by ACC is limited; however, the driver can always apply the brakes manually, if necessary. Obviously, any time the ACC system automatically operates the brakes, the brake lights will turn on as if the driver was braking.

A Proximity Warning on display will alert the driver if ACC predicts that its maximum braking level is not sufficient to maintain the set distance. If this occurs, a visual alert will flash on the display and a chime will sound while ACC continues to apply its maximum braking capacity.

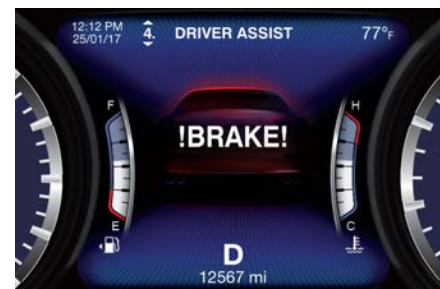



## NOTE:

The displayed warning is a warning for the driver to take action and does not necessarily mean that the Forward Collision Warning (FCW) system is applying the brakes autonomously.

## Overtake Aid

When driving with ACC engaged and following a target vehicle, the system will provide an additional acceleration to assist in passing vehicles in front. This additional acceleration is triggered when the driver utilizes the left turn signal to start overtaking. In locations with left hand drive traffic, overtake aid is active only when passing on the left hand side of the target vehicle.

When a vehicle goes from a location with left hand drive traffic to a location with right hand drive traffic, the ACC system will automatically detect traffic direction. In this condition, overtake aid is active only when passing on the right side of the target vehicle. This additional acceleration is triggered when the driver utilizes the right turn signal to start overtaking. In this condition the ACC system will no longer provide overtake aid on the left side until it

determines that the vehicle has moved back to a location with left hand drive.

## ACC Operation Before and During Stop

If an ACC host vehicle follows a target vehicle to a standstill, after two or three seconds the system will not be able to resume driving the car autonomously. In this condition, TFT displays an instruction message pop up for 5 seconds.

When the ACC system brings the vehicle to a standstill while following a target vehicle, the brakes are released after two-three seconds after the stop and at the same time the system inserts the parking brake. When parking brake engages the ACC deactivates going to ready state.

At this point the driver must reengage the system acting on the multifunction control (RES + or SET -) or alternatively on the accelerator pedal. While ACC with Stop is holding your vehicle at a standstill, if the driver unbuckles the seatbelt or opens the door, the ESC system will activate the EPB. During standstill, ACC system monitors the occupant detection signals: if the driver's seatbelt becomes unbuckled, the ACC system shall be cancelled when the EPB is applied.



## WARNING!

- When the ACC system is resumed, the driver must ensure that there are no pedestrians, vehicles or objects in the path of the vehicle. Failure to follow these warnings can result in a collision and death or serious personal injury.
- During the automatic stopping behind a vehicle in some rare cases it may happen that the system does not recognize the rearmost point of the vehicle ahead but a target under the vehicle ahead (e.g. the back axis of a truck with a high loading edge or a bumper of a vehicle although overhanging load is hanging over the vehicle's rear). In these cases the system cannot guarantee the appropriate stopping distance leading to collision in the worst case. For this reason the driver has to be attentive and ready to brake during automatic stops.



## Display Warnings and Maintenance of ACC and FCW Systems

### Wipe Front Radar Sensor Warning

This warning will display and a signal will indicate when conditions temporarily limit system performance due to sensor poor or failed signal reception. This most often occurs at times of poor visibility, such as in snow or heavy rain. The ACC and FCW systems may also become temporarily blinded due to obstructions, such as mud, dirt or ice on the radar sensor. In these cases, the system will be disabled.

This message can sometimes be displayed while driving in highly reflective areas (i.e. tunnels with reflective tiles, or ice and snow). The ACC and FCW systems will recover operation after the vehicle has left these areas. Under rare conditions, when the radar is not tracking any vehicles or objects in its path this warning may temporarily occur. If weather conditions are not a factor, the driver should examine the sensor. It may require cleaning or removal of an obstruction. The sensor is located in the center of the front grille, behind the Maserati trident.

To keep the ACC System operating properly, it is important to note the following maintenance items:

- Always keep the sensor clean. Carefully wipe the sensor lens with a soft cloth. Be cautious not to damage it.
- Do not remove any screws from the sensor. Doing so could cause an ACC system malfunction or failure and require a sensor realignment.
- If the sensor or front end of the vehicle is damaged due to a collision, see your authorized dealer for service.
- Do not attach or install any accessories near the sensor, including transparent material or aftermarket grilles. Doing so could cause an ACC system failure or malfunction. When the condition that deactivated the system is no longer present, the system will return to the "Adaptive Cruise Control Off" state and will resume function by simply reactivating it.



### NOTE:

*If the radar sensor wipe warning message occurs frequently (e.g. more than once on every trip) without any snow, rain, mud, or other obstruction, have the radar sensor realigned at an Authorized Maserati Dealer.*

### Clean Front Windshield Warning

This warning will display and a signal will indicate when conditions temporarily limit system performance due to failed signal reception. This most often occurs at times of poor visibility, such as in snow or heavy rain and fog. The ACC and FCW systems may also become temporarily blinded due to obstructions, such as mud, dirt, or ice on the windshield and fog on the inside of glass or when driving in bad weather. In these cases, the system will have degraded performance.

The ACC and FCW systems will recover operation after the vehicle has left these areas. Under rare conditions, when the camera is not tracking any vehicles or objects in its path this warning may temporarily occur. If weather conditions are not a factor, the driver should examine the windshield and the camera. They may



require cleaning or removal of an obstruction. When the condition that created limited functionality is no longer present, the ACC and FCW systems will return to full functionality.

### NOTE:

*If the windshield wiper warning message occurs frequently (e.g. more than once on every trip) without any snow, rain, mud, or other obstruction, have the windshield and forward-facing camera inspected at an **Authorized Maserati Dealer**.*

### Service ACC/FCW Warning

If the ACC and FCW systems turn off, and the system displays a service warning, there may be an internal system fault or a temporary malfunction that limits functionality. Although the vehicle is still driveable under normal conditions, ACC and FCW will be temporarily unavailable. If this occurs, try activating ACC and FCW again later, following a key cycle. If the problem persists, contact an **Authorized Maserati Dealer**.



## Precautions while Driving with ACC

### Offset Driving

ACC may not detect a vehicle in the same lane that is offset from your direct line of travel, or a vehicle merging in from a side lane. There may not be sufficient distance to the vehicle ahead. The offset vehicle may move in and out of the line of travel, which can cause your vehicle to brake or accelerate unexpectedly.

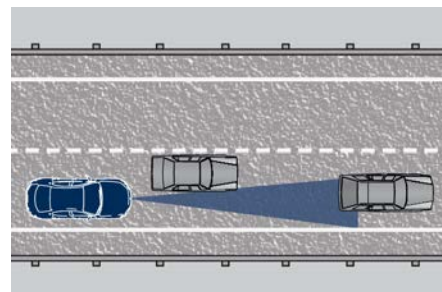

### Turns and Bends

When driving on a curve with ACC engaged, the system may decrease the vehicle speed and acceleration for stability reasons, with no target vehicle detected. Once the vehicle is out of the curve the system will resume your original Set Speed. This is a part of normal ACC system functionality. Moreover, the radar sensor might detect a vehicle on a nearby lane or no longer detect the target vehicle.

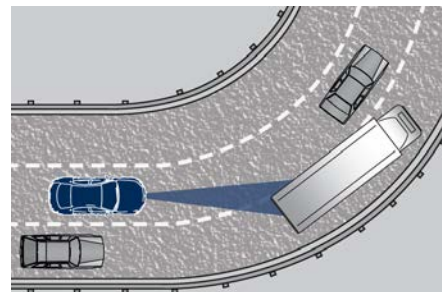



### Using ACC on Hills

When driving on steep hills, ACC may not detect a vehicle in your lane when the vehicle reaches the crest. Depending on the speed, vehicle load, traffic conditions, and the steepness of the hills, ACC performance may be limited.

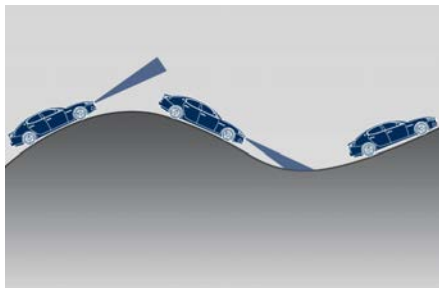

### Lane Changing

ACC may not detect a vehicle until it is completely in the lane in which you are traveling.

In the illustration shown, ACC has not yet detected the vehicle changing lane and it may not detect the vehicle until it is too late for the driver to take action. ACC may not detect a vehicle until it is completely in the lane. There may not be sufficient distance to the lane changing vehicle.

Always be attentive and ready to apply the brakes if necessary.

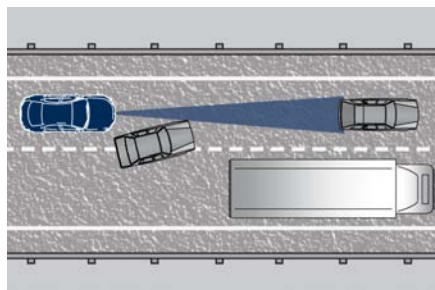

### Narrow Vehicles

Some narrow vehicles (like motorcycles) traveling near the outer edges of the lane or edging into the lane are not detected until they have moved fully into the lane. There may not be sufficient distance to the vehicle ahead.

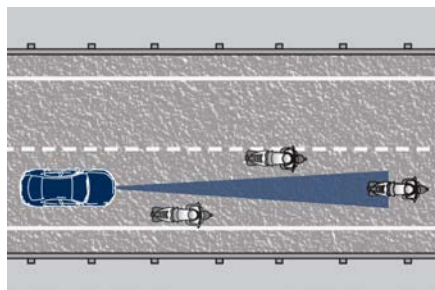

### Stationary Objects and Vehicles

ACC does not react to stationary objects and stationary vehicles. For example, ACC will not react in situations where the vehicle you are following exits your lane and the vehicle ahead is stopped in your lane. Always be attentive and ready to apply the brakes if necessary.

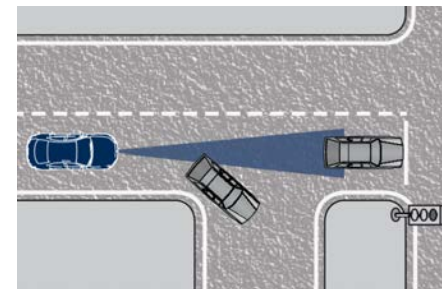

### Radar Device - Regulatory Information

The "Regulatory Information" for all the radio frequency and radar devices can be consulted by accessing the "Services" section on the website [www.maserati.com](http://www.maserati.com).





## Forward Collision Warning – FCW

The Forward Collision Warning (FCW) system with braking action uses the same parts already described for Adaptive Cruise Control (ACC) for sensing vehicle ahead (hereinafter “target vehicle”) as well as part of the warnings/messages on system condition and activation status. Full performance can be reached only when both the sensing parts have detected a vehicle or, if the car is equipped with Pedestrian Emergency Braking (PEB) system, also a pedestrian.



The difference between full and reduced performance is not visible for the driver.

### Pedestrian Emergency Braking (PEB) System (if equipped)

The Pedestrian Emergency Braking (PEB) is a sub-system of FCW and it provides the driver with audible warnings, visual warnings on the instrument cluster display, and may apply automatic braking when it detect a potential frontal collision with a pedestrian.



**WARNING!**  
**Pedestrian Emergency Braking (PEB) is not intended to avoid a collision on its own, nor can PEB detect every type of potential collision with pedestrian. The driver has the responsibility to**

**avoid a collision by controlling the vehicle via braking and steering. Failure to follow this warning could lead to serious injury or death.**

### FCW Operation

The FCW provides audible and visual warnings when a potential collision is detected. Brake jerk and limited braking may also be applied depending on the specific scenario. FCW monitors the information from the forward looking radar sensor as well as the Electronic Brake Controller (EBC), to calculate the probability of a forward collision. When the system determines that a forward collision is probable, the driver will be provided with audible and visual warnings and may provide a warning brake actuation. If the driver does not take actuation based upon these progressive warnings, then the system will provide a limited level of active braking to help slow down the vehicle and mitigate the potential forward collision. If the driver reacts to the warnings by braking and the system determines that the driver intends to avoid the collision by braking but has not applied sufficient brake force, the





system will compensate and provide additional brake force as required. When the system determines a collision with the vehicle in front of you is no longer probable, the warning messages will be deactivated.

#### NOTE:

- *Bad weather conditions, like heavy rain, snow, etc., can lead to reduced system performance. Under these conditions relevant objects will not be detected or detected late by the system.*
- *FCW is designed to react in specific situations in typical traffic scenarios with objects in the same lane driving in the same direction, but under certain conditions it can also react on stationary objects in the same lane. It is not designed to react to oncoming traffic or crossing traffic.*
- *The FCW alerts may be triggered to objects other than vehicles such as guard rails or sign posts based on the course prediction. This is expected and is a part of normal FCW activation and functionality.*
- *It is unsafe to test the FCW system. To prevent such misuse of the system, after four Active Braking events within a key cycle, the Active Braking portion of FCW will be*

*deactivated until the next key cycle. The limit of four events applies to the brake actuation too.*

- *FCW will automatically deactivated when  (ESC OFF) button is pressed (LED light up).*



#### WARNING!

- **Forward Collision Warning (FCW) is not intended to avoid a collision on its own, nor can FCW detect every type of potential collision. The driver has the responsibility to avoid a collision by controlling the vehicle via braking and steering. Failure to follow this warning could lead to serious injury or death. The driver is always in charge to safely drive and to avoid critical situations, and not rely on the support of the FCW system. Driver has to keep in mind that the system and therefore its intervention is always subject to the prevailing physical limits.**
- **Forward Collision Warning (FCW) is not intended either to warn or to apply any brake aid/brake intervention in case of collisions with pedestrians (if not equipped**

**with PEB sub-system), bicycles and not licensable vehicles in general.**

## Speed Range of Use

Speed	mph (km/h)
Minimum	0 (0)
Engaged/activated	1.12 (1.8)
Maximum	155 (250)

When the speed is outside the specified limits, the system automatically disables without turning on the corresponding warning light on the instrument cluster.

## FCW Status

The driver can adjust FCW sensitivity or enable/disable the brake actuation with the other emergency brakings by touching "Controls" soft-key on MTC+ display. The current setting is indicated beside to the "Forward Collision Warning" soft-key. If you want to change the setting, touch the soft-key on the side to enter FCW page.



Setting options are described in the following paragraph.

When FCW status for some reason changes to off, the corresponding amber warning light on instrument cluster will light on.



This warning light informs the driver that FCW is disabled. This warning light will light even when the activation of another driver assistance feature or drive mode (example: ESC OFF) disables the FCW.

### NOTE:

The FCW system setting is kept in memory from one key cycle to the next.

## Changing FCW Sensitivity and Active Braking

The default status of FCW Sensitivity is the "Medium" setting. When the active braking function ("Forward Collision Warning Active Braking") setting is on, the system warns you of a possible collision with the vehicle in front of you when you are farther away and it applies limited braking. This gives you the most reaction time to help avoid a possible collision. Changing the sensitivity status to the "Near" setting, allows the system to warn you of a possible collision with the vehicle in front of you when you are much closer. This setting provides less reaction time than the "Far" sensitivity setting, which allows for a more dynamic driving experience. "Medium" is the intermediate status between the two described above.



### NOTE:

- The default values shall appear at every new ignition cycle: Sensitivity = "Medium" and Active Braking = on.
- FCW may not react to irrelevant objects such as objects not in the path of the car, stationary objects that are far away, oncoming traffic, on cross traffic vehicles, or leading vehicles with the same or higher rate of speed.
- The active braking (autonomous braking/braking aid) will not be provided in case of potential collision with static object such as guard rails, walls, etc..)
- FCW will be disabled like ACC (refer to chapter "Adaptive Cruise Control - ACC" in this section).

Changing the active braking status to "Off" prevents the system from







providing limited autonomous braking or additional brake support if the driver is not braking adequately in the event of a potential frontal collision. In this state the system disables the brake jerk.

### Limited Operation and Service Warning

The messages indicating on display the limited functionality or service at an **Authorized Maserati Dealer** required are the same as for the ACC system. For further details, refer to “Adaptive Cruise Control – ACC” in this section.

#### NOTE:

- *The adjustment of the sensor could be affected by strong shocks or light collisions. This could affect the system by reducing the systems performance or could increase the false positive rate. The adjustment of the radar system has to be proved or a new adjustment has to be performed by an **Authorized Maserati Dealer**.*
- *The radar system requires specific feature to detect objects. The detection could be disturbed/ reduced by environment influences, for example by electrical field or the object itself. Object with small radar*

*reflection properties could not be detected or detected late.*

### Radar Device - Regulatory Information

The “Regulatory Information” for all the radio frequency and radar devices can be consulted by accessing the “Services” section on the website [www.maserati.com](http://www.maserati.com).

### Lane Keeping Assist - LKA (optional, with ACC only)

This system was designed especially for highway or freeway driving, to reduce the risk that the vehicle, under particular circumstances, accidentally departs from the lane in use. When this happens, graphic instructions on instrument cluster display together with steering torque application and steering wheel vibration (depending on the distance to the line) warn the driver that the vehicle is going out of the lane initiates a steering maneuver to try to prevent the lane exit.

To detect lane lines, the system uses the forward-facing camera behind the rear-view mirror, which is the same one used also by the lighting system to manage the automatic high beams. The logic core is in the front radar. LKA system remembers the condition it was in before turning off the vehicle.

Refer to “MTC+ “Controls” Screen” in section “Dashboard Instruments and Controls” for further information.





## NOTE:

In case of wet road or raining conditions the function could be disabled by the system in order to minimize the risks.

## Speed Range of Use

Speed	mph (km/h)
Minimum	37 (60)
Engaged/activated	37 (60)
Maximum	112 (180)

## Customized Settings

LKA is configurable by the driver in order to maximize its efficiency based on the driver driving style and the expectation of the system, reducing at the same time the possible invasiveness.

Entering "Controls" page on MTC+ display the driver can see the current setting beside the "Lane Keeping Assist" soft-key.

Touching "Lane Keeping Assist" soft-key can disable or enable the system.



Touching the soft-key on the side the driver can change the setting. Driver warnings can be only "Visual" or "Visual & Haptic" (default mode). System response can be set to "Early", "Medium" (default mode) or "Late". System reaction force can be set to "Low", "Medium" (default mode) or "High".



## Meanings of Settings

- "Visual" only: the system will not request any steering torque/vibration

to correct the car trajectory. The system will only show on the TFT display when the vehicle is passing the lane.

- "Visual & Haptic": the system will apply steering torque when lane departure is detected while showing at the same time the proper cluster indication, adding to this steering vibration when the departure is very imminent.

When "Visual & Haptic" is selected and LKA is enabled then the following menu will be used by the system.

- "LKA Sensitivity": it tunes the distance to the lane boundary where the system will start to apply steering torque.
- "LKA Strength": it tunes the steering torque value to have a stronger or weaker directional correction/ deviation.



## WARNING!

In rare cases, Lane Keeping Assist (LKA) may make an inappropriate steering torque application. LKA may be interrupted at any time counter steering. Lack of attention may lead to serious injury or death.



## System Availability

The ADAS systems (LKA, CC, ACC, FCW and HAS) help the driver while driving. These systems can be set and monitored simultaneously on the display, after opening “Driver Assist” menu (see paragraph “TFT Display: Menus and Settings” under “Instrument Cluster” in section “Dashboard Instruments and Controls”).

LKA is designed for an attentive driver; therefore the system is available only when his/her hands are on the steering wheel or with hands off for only a limited amount of time. When the system is enabled it will trigger cluster warning in case at least one hand is not detected on the steering wheel.

The torque application as well as the vibration are suppressed/inhibited in case of: high driver torque in the steering wheel, high lateral acceleration, hands not on the steering wheel detected for more than a certain time.

High dynamic driving behaviors, driving on the lane boundary, or driving off course will prevent the function from working. FCW braking and stability system interventions (ESC,

ABS) will also prevent the system from operating. Changing lanes results in system inhibition for a certain time. In addition, the driver must respect some road characteristics such as minimum-maximum width, lanes clearly defined by two lane boundaries and, only in limited cases and for a limited time, at least one lane boundary.

### NOTE:

- *In case of wet road or raining conditions the function could be disabled by the system in order to minimize the risks.*
- *With lane boundaries it is mainly referred to painted lines, nevertheless the system in good conditions might properly recognize as valid lane boundaries also other types (for example road edges, curbs, etc.).*

Being this function used to prevent unintentional lane change/lane drift, it will be temporary suppressed/inhibited by a turn indicator activation, therefore, graphic warning, steering torque application and vibration will be terminated. In this condition in case of a vehicle detected by the Blind Spot Assist (BSA) system

in the covered area on the proper side, there can be the transition from LKA to Active Blind Spot Assist (ABSA) (if this latter is on and properly configured).

## Function Description and Operating Mode

The intent of the function is to prevent the lane departure by warning the driver through indication on the cluster and, if set, applying steering torque and vibration. Whenever the system is enabled there will be graphic on the dedicated screen in the driver assist page and for the others it will be available in the left top corner of the cluster screen. The graphic which intent is to represent at the glance the system knowledge of the lane in front of the car, the system suppression status and warning.

For this reason, a simple colour code has been adopted for each line (of the two presented):

- Both grey lines means system is enabled, not able to operate (suppression condition present or lane detection system not able to properly estimate the lane);



- Left/right grey line: the lane detection system is not able to detect that specific lane boundary;
- Yellow line: there is a steering torque intervention in progress that tries to prevent a departure on that side, in this situation the warning should increase the driver attention requiring him/her to properly handle the situation;
- Yellow flashing line: the graphic is shown whenever the system detects a very imminent lane departure; torque and steering vibration can be added to this warning if configured by the customer.

The white lines (one or both) indicates that the corresponding lane boundary is detected and the system is capable to intervene on it.

An example of these screens can be found in the following figures:

- A:** with only LKA system activated, steering torque in progress to correct the trajectory towards the lane center;

- B:** with LKA and ACC systems activated, car is crossing the lane boundary, steering torque and vibration if configured are in progress when this graphic is shown.



Driver Assist Page  
**DEP**  
 DEALER ePROCESS



### Non-Driver Assist Page

The icons that represent the status of the ADAS systems remain displayed even when you exit the "Driver Assist" screen.

### System Limitations

Because of physical limits, in order to properly operate, the system needs good visibility (it might not work or not properly operate in case of heavy



rain, snow, wet roads, fog, direct sun on the camera, etc.).

#### NOTE:

- *The presence of the hands on the steering wheel is detected by a logic combination of a capacitive sensor installed in the steering wheel and the measured applied torque at the steering column. This leads to a more robust hands detection when hands are actually on the steering wheel (at least one).*
- *The sensors are not able to detect the presence of the hands on the steering wheel areas covered in wood, plastic bezels or carbon inserts (where present).*

Sharp turns, slopes and change in slopes, poor lane boundaries, as well as construction areas and all the scenario described in this paragraph may challenge the system, therefore be always ready to prevent any unexpected behaviour of the car. Damaged front bumper, windshield replaced without proper technical intervention may also lead to system malfunction or system unavailability. Other conditions such as fault, but not explicitly indicated here may also

prevent/interrupt the system intervention.



#### WARNING!

**If the driver fails to adapt his/her driving style, Lane Keeping Assist (LKA) can neither reduce the risk of an accident nor override the laws of physics. It cannot take into account road, weather or traffic conditions. Active LKA is only an aid. Driver is always responsible for the distance to the vehicle in front, for vehicle speed, for braking in good time and for staying in lane.**

#### System in Fault

When the LKA cannot properly operate due to a fault of its components or because the windshield in front of the forward facing camera is dirty, the amber light and/or the corresponding message will be displayed.



If message suggestion does not allow fixing the fault, do not use the system and have the vehicle inspected at an **Authorized Maserati Dealer**.

#### Radar Device - Regulatory Information

The "Regulatory Information" for all the radio frequency and radar devices can be consulted by accessing the "Services" section on the website [www.maserati.com](http://www.maserati.com).





## Blind Spot Assist (without ACC)

### BSA System Operation

The Blind Spot Assist (BSA) system uses two radar-based sensors, located inside the rear bumper fascia, to detect highway licensable vehicles (cars, buses, motorbikes, etc.) that enter the blind spot zones from the rear/front/side of the vehicle.

The example shown in the figure highlights the blind spots on either side of the vehicle when oncoming traffic is approaching from behind.

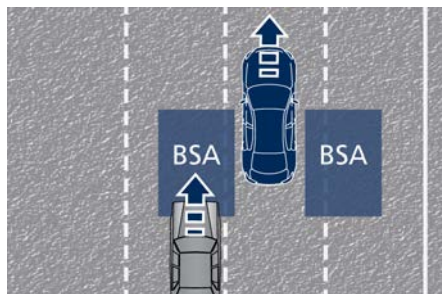

When the vehicle is started, the BSA warning light will momentarily illuminate in both outside rear view mirrors to let the driver know that the system is operational and on. The BSA system sensors operate when the

vehicle is in any forward gear and enters standby mode when the transmission is in (P) Park.

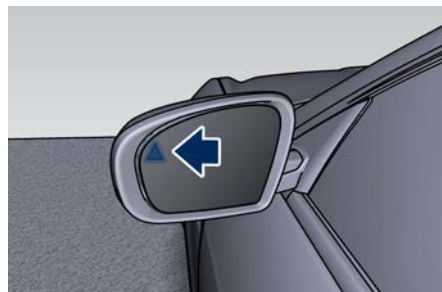

The BSA detection zone shown in figure covers approximately one lane on both sides of the vehicle (approximately 11 ft or 3.3 m). The blind spot area extends from immediately behind the exterior rear-view mirrors up to about 23 ft (7 m) behind the rear bumper.

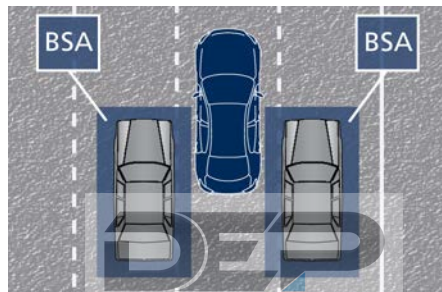

The BSA system monitors the detection zones on both sides of the vehicle when the vehicle speed reaches approximately 6 mph (10 km/h) or higher and will alert the driver of vehicles in these areas.



#### WARNING!

- The BSA system does NOT alert the driver about rapidly approaching vehicles that are outside the detection zones.
- The BSA might alert the driver too late especially in case of rapidly approaching vehicles.



#### WARNING!

Risk of accident despite Blind Spot Assist (BSA).

BSA does not detect/react to the following:

- Overtaking vehicles close on the side, placing them in the blind spot area. As a result, BSA may neither give warnings nor intervene in such situations.



- **Always pay attention to the traffic situation and maintain a safe distance at the side of the vehicle.**

#### NOTE:

If your vehicle has experienced any damage in the area where the sensor is located, even if the fascia is not damaged, the sensor may have become misaligned. Take your vehicle at an **Authorized Maserati Dealer** to verify sensor alignment. Having a sensor that is misaligned will result in the BSA not operating to specification.

The area on the rear bumper fascia where the radar sensors are located must remain free of snow, ice, and dirt/road contamination so that the BSA system can function properly. Do not cover or block the area of the rear bumper fascia where the radar sensors are located with foreign objects (bumper stickers, spoilers, bicycle racks, etc.).

The BSA system notifies the driver of vehicles or objects in the detection zones by illuminating the BSA warning light located in the outside mirrors in addition to sounding an audible (chime) alert and reducing the radio volume (if the radio is on). Refer to

“BSA and RCP Setting” in this chapter for further information. The BSA system monitors the detection zone from three different entry points (side, rear, overtaking traffic) while driving to see if an alert is necessary. The BSA system will issue an alert whenever a vehicle enters any one detection zone as outlined below.

#### Speed Range of Use

Speed	mph (km/h)
Minimum	6 (10)
Engaged/activated	6 (10)
Maximum	– (–)

#### Entering from the Side

Vehicles that move into your adjacent lanes from either side of the vehicle.

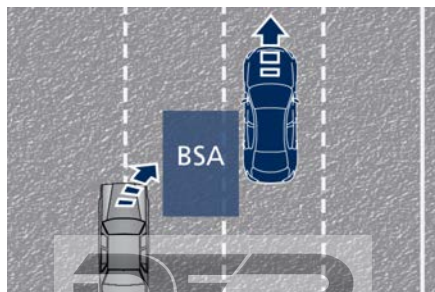

DEALER ePROCESS

#### Entering from the Rear

The alert will turn on when the vehicles that come up from behind your vehicle on either side and enter the rear detection zone with a relative speed of more than 27 mph (43 km/h).

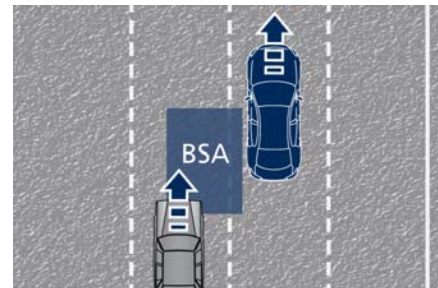

#### Overtaking Traffic

The figures show the vehicle approaching (A) and passing (O) another vehicle in the overtaking lane. If you pass another vehicle slowly, the vehicle remains in the blind spot for approximately 2 seconds, the BSA warning light in the outside mirror will illuminate after 1.5 seconds. If the difference in speed between the two vehicles is greater, the warning light will not illuminate.

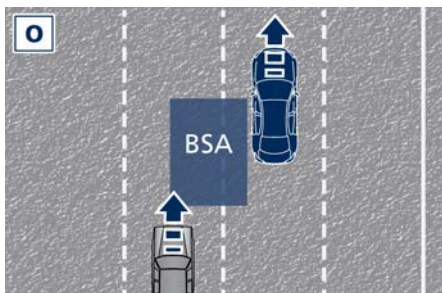
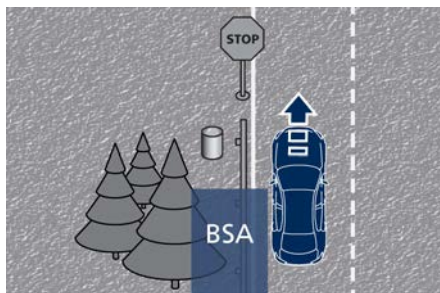
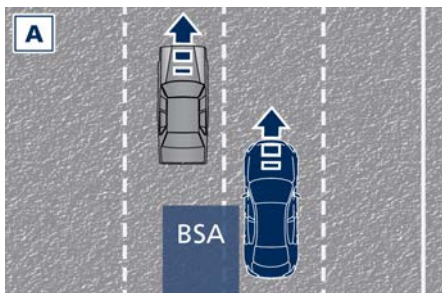

The BSA system will not alert you of objects that are traveling in the opposite direction of the vehicle in adjacent lanes.

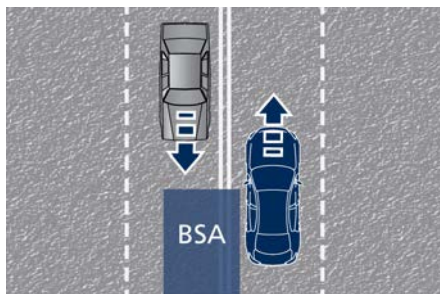

- The BSA system is not designed to detect pedestrians, cyclists, or animals.
- Even if your vehicle is equipped with the BSA system, always check your vehicle's outside and rear-view mirrors for any vehicles approaching from behind or overtaking.
- Use your turn signal before changing lanes.

## RCP - Rear Cross Path

The Rear Cross Path (RCP) feature is intended to aid the drivers when gear in reverse of parking spaces where their vision of oncoming vehicles may be blocked.

The RCP system monitors the rear detection zones on both sides of the vehicle. Using sensors located on either side of the rear bumper, it detects any vehicles or objects that are moving toward the side of the vehicle with a minimum speed of approximately 1 to 2 mph (1 km/h to 3 km/h) to a maximum of approximately 10 mph (16 km/h), such as in parking lot situations.

### Other Cases

The BSA system is not designed to issue an alert on stationary objects such as guardrails, posts, walls, foliage heaps, berms, etc. However, occasionally the system may alert on such objects. This is normal operation and your vehicle does not require service.



- **The BSA system is only an aid to help detect vehicles in the blind spot zones.**





**NOTE:**

*In a parking lot situation, oncoming vehicles can be obscured by vehicles parked on either side. If the sensors are blocked by other structures or vehicles, the system will not be able to alert the driver.*

Proceed slowly and cautiously out of the parking space until the rear end of the vehicle is moderately exposed. The RCP system will then have a clear view of the cross traffic. If an oncoming vehicle is detected, the RCP system will alert the driver using both the visual and audible alarms. If the radio is on, it will also reduce the radio volume.

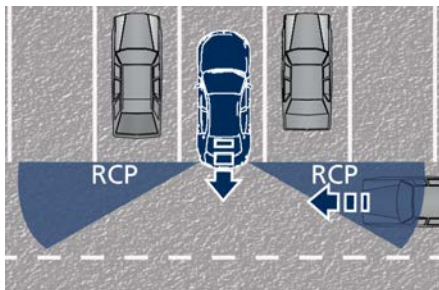
**WARNING!**

**RCP is not a Back Up Aid system. More**

**specifically, it is intended to be used to help a driver detect an oncoming vehicle in a parking lot situation. Drivers must be careful when backing up, even when using RCP. Always check carefully behind your vehicle, look behind you, and be sure to check for pedestrians, animals, other vehicles, obstructions, and blind spots before backing up. Failure to do so can result in serious injury or death.**

### BSA and RCP Setting

Setting modes can be selected from the MTC+ System. Touch “Controls” soft-key and then “Blind Spot Assist” soft-key to enter the setting page.

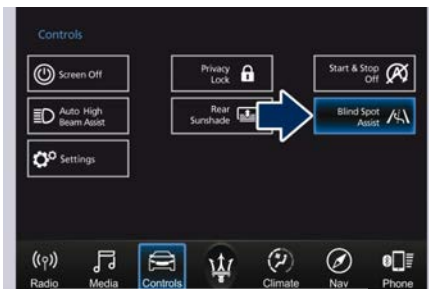

Refer to chapter “MTC+ “Controls” Screen” in section “Dashboard Instruments and Controls” for further information.

### BSA in Visual Mode

When operating in “Visual” mode, the BSA system will provide a visual alert in the appropriate side view mirror when it detects a vehicle or an object in the detection areas monitored by its sensors: depending on the status of the relative turn indicator, the warning light can be fixed or flashing. However, when the system is operating in RCP mode, it will respond with both visual and audible alerts when an oncoming vehicle or an object approaching the rear end side of the vehicle is detected. Whenever an audible alert is requested, the radio is muted (if the radio is on).

### BSA in Visual and Acoustic Mode

When operating in “Visual & Acoustic” mode, the BSA system will provide a visual alert in the appropriate side view mirror based on a detected vehicle or object.



If the turn signal is then activated, and it corresponds to an alert present on that side of the vehicle, an audible chime will also be sounded: in the same moment the warning light will start flashing.

Whenever a turn signal and detected vehicle or object are present on the same side at the same time, both the visual and audio alerts will be issued. In addition to the audible alert, the radio volume will be reduced (if the radio is on).

### NOTE:

*If the hazard flashers are on, the BSA system will issue the appropriate visual alert only.*

When the system is in RCP mode, the system shall respond with both visual and audible alerts when a detected vehicle or object is present. Whenever

an audible alert is requested, the radio (if on) is also muted. Right/left turn/hazard signal status is ignored; the RCP status always requests the chime.

### Blind Spot Assist Off

When this function is turned off from the MTC+, there will be no visual or audible alerts from either the BSA or RCP subsystems.

### NOTE:

*The BSA system will store the current operating mode when the vehicle is shut off. Each time the vehicle is started, the previously-stored mode will be recalled and used.*

### System Temporarily Unavailable

The blind spot system will become temporarily unavailable and the instrument cluster display will show the message "Blind Spot Alert Temporarily Unavailable" when the vehicle enters a radio quiet zone (example the areas around radio telescopes).

The warning light on the outside rear-view mirrors will be lit up and stay lit until the vehicle exits the zone.

### System is Faulty

The BSA system cannot properly operate due to a fault of its components, or because the area on the rear bumper fascia where the radar sensors are located is dirty. In these cases the amber warning light and the related message will be displayed on the instrument cluster.



In these cases do not use the system and have the vehicle inspected at an **Authorized Maserati Dealer**.

### Radar Device - Regulatory Information

The "Regulatory Information" for all the radio frequency and radar devices can be consulted by accessing the "Services" section on the website [www.maserati.com](http://www.maserati.com).





## Active Blind Spot Assist - ABSA (optional, with ACC only)

ABSA system is only available on vehicles equipped with ACC system and represents an addition to the BSA previously described (see chapter "Blind Spot Assist - BSA" of this section).

ABSA adds to the BSA the possibility in certain circumstances to avoid and or mitigate side collisions with vehicles proceeding in the adjacent lanes by changing the car's direction in order to try to keep it inside the detected/estimated lane. A steering wheel vibration is used as further feedback to warn the driver that the lane change is not safe.

The main logic core is the front radar, whereas the sense inputs are the radars on the rear bumper fascia used for sensing the presence of vehicle in the blind spot areas and the forward facing camera placed behind the internal rear-view mirror that instead is used for lane detection and estimation.

ABSA is designed to help the driver to avoid mitigate a collision. Torque and vibration application is however

available in the 37 - 112 mph (60 - 180 km/h) speed interval. All the speed thresholds related to the BSA remain still valid, since ABSA as mentioned is BSA extension.

ABSA is intended as a "hands-on" function meaning that the driver is required to stay engaged in the driving all the time with his/her hands on the steering wheel, in case hands are not on the steering wheel for a certain time there cannot be any steering torque application vibration included.

### System Availability

ABSA is designed for an attentive driver therefore the system is available only when his/her hands are on the steering wheel or with hands off for a very limited amount of time. When the system is enabled, it will trigger cluster warning in case at least one hand is not detected on the steering wheel.

The torque application as well as the vibration are suppressed/inhibited in case of: high driver torque in the steering wheel, high lateral acceleration, hands not on the steering wheel detected for more than a certain time.

Highly dynamic behaviours, driving on the lane boundary, off course will prevent the function from working. FCW braking and stability system interventions (ESC, ABS) will also prevent the system from operating. Changing lane results in system inhibition for a certain time.

In addition the road must respect some characteristics such as minimum-maximum width, lane clearly defined by two lane boundaries and only in limited case for a limited time at least one.

### NOTE:

- *In case of wet road or raining conditions the function could be disabled by the system in order to minimize the risks.*
- *With lane boundaries it is mainly referred to painted lines, nevertheless the system in good conditions might properly recognise as valid lane boundaries also other types (for example road edges, curbs, etc..).*



### Speed Range of Use

Speed	mph (km/h)
Minimum	37 (60)
Engaged/activated	37 (60)
Maximum	112 (180)

### System Limitation

Because of physical limits the system to properly operate needs good visibility (it might not work or not properly operate in case of heavy rain, snow, wet roads, fog, direct sun on the camera, dirty windshield, low illumination etc.)

Sharp turns, slopes and change in slopes, poor lane boundaries, as well as construction areas and all the scenarios described in this paragraph may challenge the system, therefore be always ready to prevent any unexpected behaviour of the car. Damaged front bumper, windshield replaced without proper technical intervention may also lead to system malfunction or system unavailability. Other conditions such as faults, but not explicitly indicated here may also prevent/interrupt the system intervention.

### ABSA Setting

ABSA is configurable by the customer in order to maximize its efficiency based on the driver driving style and his/her expectation of the system, reducing at the same time the possible invasiveness.

Setting modes can be selected from the MTC+ System (see "MTC+ "Controls" Screen" in section "Dashboard Instruments and Controls" for further information). Touch "Controls" soft-key to display the current status of the ABSA system, if it was in the on state.

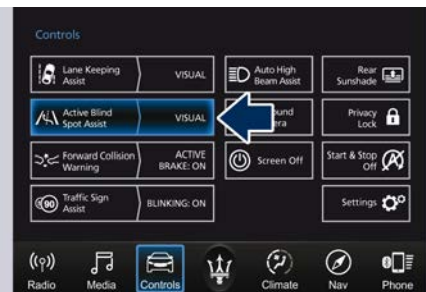

To change status, touch the "Active Blind Spot Assist" soft-key. To change the system setting, touch the soft-key on the side. Driver warnings can be only "Visual", "Visual & Acoustic" (default mode) or "Visual & Haptic".

System sensitivity can be set to "Early", "Medium" (default mode) or "Late". System strength can be set to "Low", "Medium" (default mode) or "High".



### NOTE:

The ABSA system will store the current operating mode when the vehicle is shut off. Each time the vehicle is started, the previously-stored mode will be recalled and used.

### Meanings of Settings

When "Visual & Haptic" is selected and of course ABSA is enabled, then two following menus will be used by the system.

- ABSA "Sensitivity": it tunes the distance to the lane boundary where the system will start to apply steering torque.



- ABSA "Strength": it tunes the steering torque value to have a stronger or weaker directional correction/deviation.

### Blind Spot Assist in "Visual & Haptic" Mode

When the system is on and configured "Visual & Haptic" then the ABSA is enabled and to the conventional visual warnings is added the steering torque and vibration.

When operating in this mode, the system will provide a visual alert in the appropriate outside rear-view mirror when it detects a vehicle or an object in the detection areas monitored by its sensors. In case of turn indicator activation on the appropriate side, the system will react with a torque on the steering wheel to try to prevent the lane change and therefore to avoid/mitigate the collision. The torque on the steering is applied when the car is very close to the lane boundary as a further feedback to warn the driver of the unsafe maneuver.

#### NOTE:

- *The steering torque is not supplied if the system is not able to estimate a lane and if the turn indicator from the appropriate side is not inserted.*

- *The presence of the hands on the steering wheel is detected by a logic combination of a capacitive sensor installed in the steering wheel and the measured applied torque at the steering column. This leads to a more robust hands detection.*



#### WARNING!

- **Risk of accident despite steering torque application of Active Blind Spot Assist (ABSA).**
- **A course-correcting steering torque application cannot always prevent a collision.**
- **The driver is always required to steer, brake or accelerate themselves, especially if ABSA warns or makes a course correcting steer intervention.**
- **Always maintain a safe distance at the sides.**
- **Steering torque application may be interrupted at any time by counter steering by the driver.**

### RCP - Rear Cross Path Operation

RCP operation is the same as described in chapter "Blind Spot Assist - BSA".

When ABSA is turned off from MTC+ "Controls" page, there will be no visual or audible alerts from RCP subsystem.

When ABSA is turned on with any setting, RCP subsystem shall respond with both visual and audible alerts when a detected vehicle or object is present. Whenever an audible alert is requested, the radio (if on) is also muted.

Right/left turn/hazard signal status is ignored; the RCP status always requests the chime.

### System Temporarily Unavailable

The blind spot system will become temporarily unavailable and the instrument cluster display will show the message "Blind Spot Alert Temporarily Unavailable" when the vehicle enters a radio quiet zone (example the areas around radio telescopes).

The warning light on the outside rear-view mirrors will be lit up and stay lit until the vehicle exits the zone.

### System Fault

The ABSA system cannot properly operate either due to a fault of its components, or because the area on



windshield where the forward-facing camera is located or on the rear bumper fascia where the radar sensors are located is dirty. In these cases the amber warning light and the related message will be displayed on the instrument cluster.



In these cases do not use the system and have the vehicle inspected at an **Authorized Maserati Dealer**.

## Radars Device - Regulatory Information

The "Regulatory Information" for all the radio frequency and radar devices can be consulted by accessing the "Services" section on the website [www.maserati.com](http://www.maserati.com).

## Highway Assist – HAS (optional, with ACC only)

The Highway Assist (HAS) is a level 2 Autonomy system (in reference to NHTSA standards) that is designed to aid the driver in the steering, acceleration, and braking functions of the vehicle.

HAS is designed to only function on highways or limited access freeways. HAS centers the vehicle by controlling the EPS system based off of lane line information from the forward-facing camera and data from the front radar sensor.

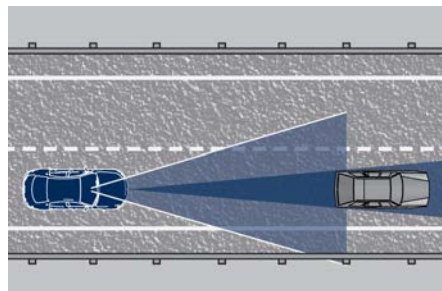

HAS combines ACC and LKA to manage the steering and speed of the vehicle under specific conditions. The conditions to engage HAS are listed in the next paragraph. If a lane line cross is imminent, the steering wheel will

vibrate and a graphic will display on the instrument cluster.



### WARNING!

- **In case the vehicle approaches a curve that is too tight in relation to the current speed the system will disengage, therefore the driver must be prepared to take over control of the vehicle immediately at any time. To avoid this situation it is important that the vehicle speed is not set higher than the current speed limit of the road.**
- **Highway Assist (HAS) is a hands-on feature! You must keep your hands on the steering wheel at all times. The HAS system will disengage and ACC will cancel if your hands are removed from the steering wheels for a set amount of time.**
- **HAS is intended for use only on highways or limited access freeways with a fully attentive driver. When using HAS, hold the steering wheel and be aware of surrounding traffic and road conditions. Always be prepared to immediately take over control of the vehicle from the HAS system. Failure to follow these**



instructions could result in serious injury or death.

- The following list does not fully represent all situations in which HAS may not function as intended. Do NOT solely rely on the HAS system to control the vehicle. It is the driver's responsibility to stay alert and safely control the vehicle at all times.
- If the windshield is replaced, you must have the forward-facing camera remounted and aligned by an Authorized Maserati Dealer.

Many factors can impact the performance of HAS causing the system to be unable to function as intended. These include (but are not limited to):

- Narrow, winding or curvy roads.
- Poor visibility (due to heavy rain, snow, fog, etc.).
- Bright light (oncoming headlights or direct sunlight) or shadows.
- Damage or obstruction caused by mud, ice, snow, etc.
- A damaged or misaligned bumper.
- Interference from other equipment that generates electromagnetic waves.

- Wet roads, roads covered or partially covered by snow.
- Construction zones.

## HAS Operation

With ACC set (see "Adaptive Cruise Control – ACC" in this section), HAS system activates by simply pressing the  button on the steering wheel. Once the conditions are met, HAS will engage.



### CAUTION!

The Highway Assist (HAS) system may take up to 5 seconds to engage once all conditions are met.

The conditions for HAS to engage are as follows:

- HAS must be turned on or enabled.

### NOTE:

*In case of wet road or raining conditions the function could be disabled by the system in order to minimize the risks.*

- The vehicle must be on the highway or limited access freeway.
- Adaptive Cruise Control (ACC) must be engaged.
- Left and right visible lane lines.

- Vehicle speed must be between 0 to 90 mph (0 and 145 km/h).
- No faults in the forward facing camera, radar, EPS, or MTC+.
- Lane width between 3 to 4.6 yd (2.8 and 4.2 m).
- Turn signal not activated.
- No faults related to this system.

## Speed Range of Use

Speed	mph (km/h)
Minimum	0 (0)
Engaged/activated (with ACC engaged)	0 (0)
Engaged/activated (with ACC not engaged)	18 (30)
Maximum	90 (145)

- If set above the maximum speed, HAS will not function after the vehicle speed will reach the maximum speed.
- If set below the maximum speed and the ACC target speed is increased, HAS will function up to the maximum speed and then the system will turn off automatically.
- When the ACC target speed is reduce and speed is lower than the





maximum speed, the system will start automatically.

- If the ACC target speed is set under the maximum speed, HAS is active and vehicle speed increases above the maximum speed due to slope, HAS will continue to function.

## HAS Monitoring on Instrument Cluster

HAS and the other ADAS systems conditions can be monitored on instrument cluster display by accessing the "Driver Assist" page with the buttons on the steering wheel (see "Instrument Cluster" in section "Dashboard Instruments and Controls").

The  symbol in grey indicates that the HAS system is active, but not engaged and is shown at the centre of the TFT display when the "Driver Assist" page is displayed. When exiting the "Driver Assist" page, on TFT display top left corner, the  grey symbol will appear in the multiple light of active ADAS systems.



Driver Assist Page



Driver Assist Page

When exiting the "Driver Assist" page, the attention level colour will always be displayed until the system is disabled by pressing the  button on the steering wheel.



Non-Driver Assist Page

In addition to these symbols, on the TFT top and bottom edge a coloured glow may appear (further referred to as "attention level colour"). Attention level colour together with the outline of the symbol  represent a further indication of the system status.



Non-Driver Assist Page

The HAS system uses sensors in the steering wheel outer crown to detect if the driver's hands are on the steering wheel. If the driver's hands are not detected on the steering







wheel, the instrument cluster will display a series of warnings to alert the driver to return their hands to the steering wheel. There will also be audible chimes. After a set amount of time, HAS will cancel if the driver's hands are not returned to the steering wheel.

When the system does not sense the hands on the steering wheel for a few seconds (3 – 5 seconds) or more (up to 10 seconds), it tries to draw the attention of the driver by showing, even when the display is not in the "Driver Assist" page, the  symbol with the figure of the hands in the centre of the display. According to such time frames, the system will change the attention level colour, silence the audio in the vehicle (if it is active) and emit audible chimes to invite the driver to take the control of the vehicle again. This is the only way to reengage the system.

## Hands Detection on Steering Wheel

The sensors in the steering wheel outer crown are able to detect the presence of the hands on the steering wheel.

In order to be able to use the HAS system, place your hands around the steering wheel outer crown.

### NOTE:

- *The sensors are not able to detect the presence of the hands on the steering wheel areas covered in wood, plastic bezels or carbon inserts (where present).*

HAS is deactivated if the steering wheel is no longer being touched.

## System Statuses

The active status of the HAS system is indicated by the green attention level colour which is maintained even if the driver releases his/her grip from the steering wheel up to 3 seconds.



The yellow attention level colour appears when the driver removes his/her hands from the steering wheel

for 3 to 5 seconds and the  symbol with the figure of the hands will occupy the whole central area of the display.



Driver Assist Page



Non-Driver Assist Page

The red attention level colour appears when the driver releases his/her grip from the steering wheel for 5 and up to 10 seconds: in this case a single audible chime is repeated until he/she



will take the control of the vehicle again.



Driver Assist Page



Non-Driver Assist Page

The red attention level colour remains even when the steering wheel is released for more than 8 to 10 seconds. In this case, if you are travelling at a speed above 25 mph (40 km/h) a sequences of 3 audible chimes will be emitted after 8 seconds

and a message will inform the driver that the HAS system has been disengaged, instructing him/her to grip the steering wheel again. The same will happen after 10 seconds if you travel at a speed below 25 mph (40 km/h). Then the symbol on TFT display will become grey.



If the driver keeps his/her hands away from the steering wheel (for more than 8 to 10 seconds), also the ACC system is deactivated (ACC symbol on the display) and will have to be reset. The aid of LKA system will be disabled as well. In these cases the display will not show the attention level colour anymore and the vehicle will be controlled by the driver only.

## HAS Disengage

To disengage HAS you can do any of the following actions:

- Press the HAS enable button on the steering wheel.
- Begin steering manually.
- Press brake pedal.
- Turn off ACC.
- Unbuckle the driver's seat belt.
- Press ACC Gap button for two seconds to enable CC system.
- Shift out of the (D) Drive gear.
- Enter an Autonomous Emergency Braking (AEB) event (See chapter "Forward Collision Warning - FCW" in this section).
- Turn signal activated.

## System Cancellation

The HAS system will cancel (without driver intervention) if either of the following actions occur:

- Curve that is too tight.
- When leaving the grip of the hands on the steering wheel.
- Vehicle exits the highway or limited access freeway.
- Lane line markers aren't detected by the forward facing camera.
- Any ADAS system faults.
- ACC cancellation.
- Vehicle speed exceeds the maximum limit.





- Lateral accelerations exceeds the limits.

#### NOTE:

- When HAS cancels, the  symbol will turn red then grey.
- The presence of the hands on the steering wheel is detected by a logic combination of a capacitive sensor installed in the steering wheel and the measured applied torque at the steering column. This leads to a more robust hands detection.

### System Limitations

HAS is unable to guide the vehicle when the following conditions occur.

- Lane markings are not clear or visibility is poor (i.e. heavy rain, snow, fog, etc.).
- Obstructed, covered or damaged forward-facing camera or sensor.
- When driving on hills or sharp curves.
- When approaching toll booths.
- When the highway entrance or exit is wider than 20 ft (6 meters).
- Bright light (ex. direct sunlight or glare) facing the forward camera.



#### WARNING!

Many unforeseen conditions can occur that can affect the performance of Highway Assist (HAS). Always keep this in mind and drive attentively. It is the drivers responsibility to keep control of the vehicle at all times.

### Radar Device - Regulatory Information

The “Regulatory Information” for all the radio frequency and radar devices can be consulted by accessing the “Services” section on the website [www.maserati.com](http://www.maserati.com).



### Traffic Sign Assist – TSA (optional)

TSA detects traffic signs through the use of a forward-facing digital camera mounted on windshield, behind the rear-view mirror. TSA assists the driver by displaying on the instrument cluster detected speed limits and traffic signs with a restriction indicated by an additional sign (e.g. in snow conditions). TSA also uses the data of the navigation system, in order to provide information to the driver in all cases in which the camera is not able to detect the traffic signs that are present on the road where the car is travelling.

Some examples of these are: due to low visibility, light reflection, damaged traffic signs, traffic signs in wrong position like rotated or fallen poles.

#### NOTE:

- Overtaking restriction signs are not displayed by the TSA system.
- TSA provides a visual warning to the driver when he/she unintentionally reaches the maximum speed limit allowed or when it exceeds the set “Sensitivity” value.

(Continued)



## (Continued)

- The performance of TSA depends on the update degree of navigation system's maps.

## Customised Settings

TSA is configurable by the customer regarding the display mode on the instrument cluster and the warning sensitivity.

Entering "Controls" page on MTC+ display the driver can see the current setting beside the "Traffic Sign Assist" soft-key.

Touching "Traffic Sign Assist" soft-key can disable or enable the system.



Touching the soft-key on the side the driver can change the setting. The display of the traffic signs can be blinking or static. The system can be set to display the traffic signs when the speed of the

vehicle is equal to the speed limit allowed, or when it is higher than 5 or 10 mph (5 or 10 km/h).



## Signs Monitoring on Instrument Cluster



If TSA feature is set and a sign or a speed limit is detected, the related icons are displayed in the upper area of the instrument cluster beside of the main menu number and scroll arrows.

The display area is divided in three different sectors:

- 1 Conditioned speed limit area.
- 2 Unconditioned speed limit area.
- 3 Overtaking restriction area.



### NOTE:

*Overtaking restriction sign will be displayed only in markets where this is allowed.*

If "Blinking On" warning mode is set, when the visual warning is provided only the unconditioned speed limit (in sector 2) will start blinking when the vehicle speed exceeds to the detected unconditioned speed limit (" +0 mph" or " +0 km/h" option) or when it exceeds the set sensitivity value (" +5 mph" - " +5 km/h" or " +10 mph" - " +10 km/h" options). If the vehicle



speed stays above the unconditioned speed limit for several seconds the unconditioned speed limit sign will stop blinking because the manoeuvre is evaluated as intentional. If the TSA is not able to determine any kind of valid speed limit neither from camera nor from digital maps the following image will be shown in sector 2. Since TSA also uses the data provided by the navigation system, it can update the sector 2 of the display in the following situations without detecting traffic signs:

- When the vehicle changes road.
- Highway enter/exit.
- Urban area stored in the digital map enter/exit.

## System Limitations

TSA may be impaired or may not function in the following situations:

- If there is poor visibility, e.g. due to insufficient illumination of the road, if there are highly variable shade conditions or in rain, snow or fog.
- If there is glare, e.g. from oncoming traffic, direct sunlight or reflections from other vehicles.

- If the windshield in the area of the camera is dirty, or if the camera is fogged up, damaged or covered.
- If the traffic signs are hard to detect, e.g. due to dirt or snow, or because they are covered or because of insufficient lighting.
- If the information in the navigation system's digital map is incorrect or out-of-date.
- If the signs are ambiguous, e.g. traffic signs on construction sites or in adjacent lanes.
- When passing buses or trucks with a speed sticker.



## Tires - General Information

### Tire Safety Information

#### Tire Markings

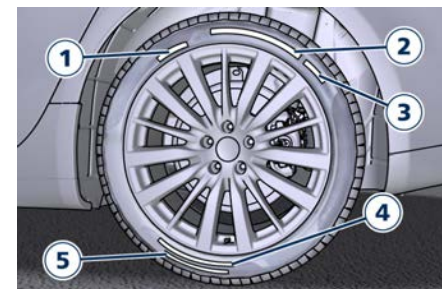

1. U.S. DOT Safety Standards Code (TIN).
2. Size Designation.
3. Service Description.
4. Maximum Pressure and Maximum Load.
5. Treadwear, Traction and Temperature Grades (see "Department of Transportation Uniform Tire Quality Grades" in this section).



## Tire Sizing Chart

**EXAMPLE: P265/50 ZR19 (100Y) XL or 265/50 ZR19 (Y100) XL**

### Size Designation:

**P** = Passenger car tire size based on U.S. design standards  
**"...blank..."** = Passenger car tire based on European design standards

**265** = Section width in millimeters (mm)

**50** = Aspect ratio in percent (%) — Ratio of section height to section width of tire

### ZR = Construction Code

- **Z:** means a tire usable at speeds greater than 150 mph (240 km/h)
- **R:** means radial construction

**19** = Rim diameter in inches (in)

### Service Description:

**100** = Load Index — A numerical code associated with the maximum load a tire can carry

**Y** = Speed Symbol — A symbol indicating the range of speeds at which a tire can carry a load corresponding to its load index under certain operating conditions. The maximum speed corresponding to the speed symbol should only be achieved under specified operating conditions (i.e., tire pressure, vehicle loading, road conditions, and posted speed limits)

### Load Identification:

**"...blank..."** = Absence of any text on the sidewall of the tire indicates a Standard Load (SL) tire

**XL** = Extra Load (or reinforced) tire

**LL** = Light Load tire



### Tire Identification Number (TIN)

The TIN may be found on one or both sides of the tire, however the date code may only be on one side. Tires with white sidewalls will have the full TIN, including the date code, located on the white sidewall side of the tire. Look for the TIN on the outboard side of black sidewall tires as mounted on the vehicle. If the TIN is not found on the outboard side, then you will find it on the inboard side of the tire.



**EXAMPLE: DOT MA L9 ABCD 0313**

**DOT** = Department of Transportation — This symbol certifies that the tire is in compliance with the U.S. Department of Transportation tire safety standards and is approved for highway use.

**MA** = Code representing the tire manufacturing location (two digits).

**L9** = Code representing the tire size (two digits).

**ABCD** = Code used by the tire manufacturer (one to four digits).

**03** = Number representing the week in which the tire was manufactured (two digits). In this case, 03 means the 3<sup>rd</sup> week.

**13** = Number representing the year in which the tire was manufactured (two digits). In this case, 13 means the year 2013.

**Tire Terminology and Definitions**

Term	Definition
<b>B-Pillar</b>	The vehicle B-Pillar is the structural member of the body located behind the front door.
<b>Cold Tire Inflation Pressure</b>	Cold tire inflation pressure is defined as the tire pressure after the vehicle has not been driven for at least three hours, or driven less than 1 mile (1.6 km) after sitting for a minimum of three hours. Inflation pressure is measured in units of PSI (pounds per square inch) or kPa (kilopascals).
<b>Maximum Inflation Pressure</b>	The maximum inflation pressure is the maximum permissible cold tire inflation pressure for this tire. The maximum inflation pressure is molded into the sidewall.
<b>Recommended Cold Tire Inflation Pressure</b>	Vehicle manufacturer's recommended cold tire inflation pressure as shown on the tire placard.
<b>Tire Placard</b>	A label permanently attached to the vehicle describing the vehicle's loading capacity, the original equipment tire sizes and the recommended cold tire inflation pressures.

**Tire and Loading Information Label**

The proper cold tire inflation pressure and the loading information are listed in two labels on the driver's side rear door pillar.



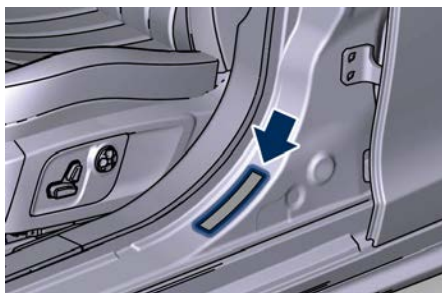

**Tire Information Label**



**Loading Information Label**

This label tells you important information about the:

- Cold tire inflation pressures for the front, rear, and spare tires.
- Number of people that can be carried in the vehicle.
- Total weight the vehicle can carry.
- Tire size designed for the vehicle.

## Loading

The vehicle maximum load on the tire must not exceed the load carrying capacity of the tire on your vehicle. You will not exceed the tire's load carrying capacity if you adhere to the loading conditions, tire size, and cold tire inflation pressures specified on the "Tire and Loading Information Label" and in the "Features and Specifications" section.

### NOTE:

*Under a maximum loaded vehicle condition, gross axle weight ratings (GAWRs) for the front and rear axles must not be exceeded.*

To determine the maximum loading conditions of your vehicle, locate the statement "The combined weight of occupants and cargo should never exceed XXX lbs/XXX kg" on the tire and loading information label. The combined weight of occupants and cargo/luggage should never exceed the weight referenced here.

### Steps For Determining Correct Load Limit

- Locate the statement "The combined weight of occupants and cargo should never exceed XXX lbs/XXX kg" on the vehicle's label.

- Determine the combined weight of the driver and passengers that will be riding in the vehicle.
- Subtract the combined weight of the driver and passengers from XXX lbs/XXX kg.
- The resulting figure equals the available amount of cargo and luggage load capacity. For example, if "XXX amount equals 1,400 lbs/635 kg and there will be five 150 lbs/68 kg passengers in your vehicle, the amount of available cargo and luggage load capacity is 650 lbs/295 kg (since  $5 \times 150/68 = 750/340$ , and  $1,400/635 - 750/340 = 650 \text{ lbs}/295 \text{ kg}$ ).
- Determine the combined weight of luggage and cargo being loaded on the vehicle. That weight may not safely exceed the available cargo and luggage load capacity calculated in previous Step.
- If your vehicle will be towing a trailer, load from your trailer will be transferred to your vehicle. Consult this manual to determine how this reduces the available cargo and luggage load capacity of your vehicle.





## Tires

Driving over rough or damaged road surfaces, as well as debris, curbs and other obstacles can cause serious damage to wheels, tires, and suspension parts.

This is more likely to occur with low-profile tires, which provide less cushioning between the wheel and the road.

Be careful to avoid road hazards and reduce your speed, especially if your vehicle is equipped with low profile tires.



### WARNING!

**Overloading of your tires is dangerous. Overloading can cause tire failure, affect vehicle handling, and increase the stopping distance. Use tires of the recommended load capacity for your vehicle. Never overload them.**

## Department of Transportation Uniform Tire Quality Grades

The following tire grading categories were established by the National Highway Traffic Safety Administration. The specific grade rating assigned by the tire's manufacturer in each category is shown on the sidewall of the tires on your vehicle.

All passenger car tires must conform to Federal safety requirements in addition to these grades.

### Treadwear

The Treadwear grade is a comparative rating, based on the wear rate of the tire when tested under controlled conditions on a specified government test course. For example, a tire graded 150 would wear one and one-half times as well on the government course as a tire graded 100. The relative performance of tires depends upon the actual conditions of their use, however, and may depart significantly from the norm due to variations in driving habits, service practices, and differences in road characteristics and climate.

### Traction Grades

The Traction grades, from highest to lowest, are AAA, A, B, and C. These

grades represent the tire's ability to stop on wet pavement, as measured under controlled conditions on specified government test surfaces of asphalt and concrete. A tire marked C may have poor traction performance.



### WARNING!

**The traction grade assigned to this tire is based on straight-ahead braking traction tests, and does not include acceleration, cornering, hydroplaning, or peak traction characteristics.**

### Temperature Grades

The temperature grades are A (the highest), B, and C, representing the tire's resistance to the generation of heat and its ability to dissipate heat, when tested under controlled conditions on a specified indoor laboratory test wheel. Sustained high temperature can cause the material of the tire to degenerate and reduce tire life, and excessive temperature can lead to sudden tire failure. The grade C corresponds to a level of performance, which all passenger car tires must meet under the Federal Motor Vehicle Safety Standard No.



109. Grades B and A represent higher levels of performance on the laboratory test wheel, than the minimum required by law.



### WARNING!

The temperature grade for this tire is established for a tire that is properly inflated and not overloaded. Excessive speed, under-inflation, or excessive loading, either separately or in combination, can cause heat buildup and possible tire failure.

## Tire Pressure

Proper tire inflation pressure is essential for safety and best performance of your vehicle. The tire pressure monitoring system "TPMS" setup on the vehicle (see "Tire Pressure Monitoring System" in this section) may alert the driver about insufficient tire pressure even though the driver is responsible for regularly checking the tire pressure.

Radial tires fitted on the vehicle may look properly inflated even when they actually are under inflated. Do not make a visual judgment when determining proper inflation.

Three primary driving aspects are affected by improper tire pressure:

### Safety



### WARNING!

- Improperly inflated tires can be dangerous.
- Under-inflation increases tire flexing and can result in tire overheating.
- Over-inflation reduces a tire's ability to cushion shock. Objects on the road and potholes can cause damage that results in tire failure.
- Over-inflated or under-inflated tires can affect vehicle handling and can fail suddenly, resulting in loss of vehicle control.
- Unequal tire pressures can cause steering problems.
- Unequal tire pressures from one side of the vehicle to the other can cause the vehicle to drift to the right or left.
- Always drive with each tire inflated to the recommended cold tire inflation pressure.

### Economy

Improper inflation pressures may cause uneven wear patterns to develop

across the tire tread. These abnormal wear patterns will reduce tread life resulting in a need for earlier tire replacement. Under-inflation also increases tire rolling resistance resulting in higher fuel consumption.

### Ride comfort and vehicle stability

Proper tire inflation contributes to a comfortable ride. Over-inflation produces a jarring and uncomfortable ride.

## Tire Pressure Checkup

The proper cold tire inflation pressure is indicated on the driver's side rear door pillar and on the table "Tire Inflation Pressure" in section "Features and Specifications".

Inflation pressure specified on the table always refers to "cold tire inflation pressure". Cold tire inflation pressure is defined as the tire pressure after the vehicle has not been driven for at least three hours, or driven less than 1 mi (1.6 km) after a three hour period.

Check tire pressures more often in case of significant outside temperature changes, as tire pressure varies according to temperature changes. The pressure should be checked and if necessary adjusted; tire wear and





overall conditions should also be checked monthly. Tire pressures change by approximately 1 PSI (0.07 bar) per 12°F (7°C) of air temperature change. Keep this in mind when checking tire pressure inside a garage, especially in winter.

Example: If garage temperature = 68°F (20°C) and the outside temperature = 32°F (0°C) then the cold tire inflation pressure should be increased by 3 PSI (0.21 bar) for every 12°F (7°C) for this outside temperature condition.

Tire pressure may increase from 2 to 6 PSI (0.13 to 0.4 bar) during operation. DO NOT reduce this normal pressure build-up or your tire pressure will be too low. After inspecting or adjusting the tire pressure, always reinstall the valve stem cap. This will prevent moisture and dirt from entering the valve stem, which could damage the valve stem and the TPMS sensor connected to it.

## Tread Wear Indicators

Tread wear indicators are in the original equipment tires to help you determine when your tires should be replaced.

These indicators are molded into the bottom of the tread grooves.

When the tread is worn to one of the tread wear indicators, the tire should be replaced.



### WARNING!

**The wet performance (aquaplaning resistance) will decrease proportionally to the thickness of the tread.**

## Tires Durability

The service life of a tire depends on various factors including, but not limited to:

- driving style;
- tire pressure;
- distance driven.



### WARNING!

**Tires and the spare tire (if equipped) should be replaced after six years, regardless of the remaining tread. Failure to follow this warning could result in tire failure.**



## Replacement Tires

### NOTE:

*In order to maintain high performance and safety level under all driving conditions, Maserati strongly recommends to use tires equivalent to the originals in size, quality and performance when replacement is needed.*

For the size designation of your tire see the label on the driver's side rear door pillar or see table "Wheels" in section "Features and Specifications". The "Load Index" and "Speed Symbol" for your tire will be found on the original equipment tire sidewall.

### NOTE:

*Maserati recommends Maserati Genuine Tires marked with "MGT" logo specifically designed for its models.*

It is recommended to replace the two front tires or two rear tires as a pair. Replacing just one tire can seriously affect your vehicle's handling. If you ever replace a wheel assembly, make sure that the wheel's specifications (valve, TPMS sensor and tire) match those of the original wheels. Failure to use equivalent



replacement tires may adversely affect the safety, handling, and ride of your vehicle.

Your **Authorized Maserati Dealer** is available to provide suggestions as to the types of tires most suited to the use foreseen by the Customer.



### WARNING!

- Do not use a tire, wheel size or rating other than that specified for your vehicle. Some combinations of unapproved tires and wheels may change suspension dimensions and performance characteristics, resulting in altered steering, handling, and braking operations of the vehicle. This can cause unpredictable handling and stress to steering and suspension components. Use only the tire and wheel sizes with load ratings appointed for your vehicle.
- Never use a tire with a smaller load index or capacity, other than what was originally equipped on your vehicle. Using a tire with a smaller load index could result in tire overloading and failure.
- Always check the maximum speed rating on the tire sidewall on any

### tire on the vehicle.

- **Never exceed the maximum speed rating of the tires. Risk of accident and serious personal injury due to excessive speed.**
- **Failure to equip your vehicle with tires having adequate speed capability can result in tire failure.**



### CAUTION!

Replacing original tires with tires of a different size may result in false speedometer and odometer readings.

## Winter Tires

These tires are specially designed for driving on snow and ice and are fitted to replace the ones supplied with the vehicle. Winter or all-season tires can be identified by the M+S (Mud & Snow) or 3PMSF (3 Peaks Mountain Snow Flake) designation on the tire sidewall.

Before mounting winter tires, contact an **Authorized Maserati Dealer** to receive the technical information necessary to advise you on wheel and tire compatibility.

As to the type of tires to use, inflation pressures and winter tires



specifications, carefully follow the indications as reported in the “Technical Data” and “Tire Inflation Pressure” chapters in section “Features and Specifications”.



### WARNING!

The standard tires profile and rubber mixture are optimized for wet and dry driving conditions. Standard tires may not prove favorable for snow conditions.

### NOTE:

*Snow tires should have the same load capacity as original equipment tires and should be mounted on all four wheels.*

## Snow Chains

Maserati approved traction devices (or snow chains) may be used to improve traction on compacted snow in heavy snow conditions.

The use of snow chains is specified by local regulations of each country.

Use snow chains of reduced dimensions, with a maximum projection of 0.23 in (6 mm) beyond the tire tread.



The chains may be fitted only on 18" and 19" rear wheel tires. Please contact an **Authorized Maserati Dealer** for further information. Check the snow chain tension after driving for a distance of about 55 yd (50 m) with the chains fitted. With the snow chains fitted, it is advisable to deactivate the ESC system (see chapter "Drive Mode" in this section).



### CAUTION!

- The use of non-recommended snow chains may damage the vehicle.
- Broken snow chains can cause serious damage. Stop the vehicle immediately if noise occurs that could indicate snow chain breakage. Replace the damaged parts of the snow chain before further use.
- Do not exceed 30 mph (50 km/h).
- Drive cautiously and avoid severe turns and large bumps, especially with a loaded vehicle.
- Avoid holes in the road, do not drive over steps or sidewalks and do not drive on long stretches without snow. This will prevent damage to the vehicle and the roadbed.

### NOTE:

*The Authorized Maserati Dealer can provide you with all information about the Maserati Snow Chains, available in the "Genuine Accessories" range.*

### Compact Spare Tire

The limited-use spare tire, or compact spare tire, is for temporary emergency use only. This tire is identified by a label indicating the driving speed limitations to comply with when using the spare tire.

Inflate the spare tire to the cold inflation pressure listed on the table "Tire Inflation Pressure" in section "Features and Specifications". Mounting the spare tire affects vehicle handling. Replace (or repair) as soon as possible the original equipment tire and reinstall it on the vehicle. Do not install more than one compact spare tire and wheel on the vehicle at a time.



### WARNING!

**With these compact spare tires, do not drive more than 50 mph (80 km/h). Temporary use spares have limited tread life.**

DEALER ePROCESS

## Tire Pressure Monitoring System (TPMS)

The Tire Pressure Monitoring System (TPMS) will warn the driver of a low tire pressure according to the vehicle recommended cold pressure indicated on the table "Tire Inflation Pressure" in section "Features and Specifications" and on the label applied on the driver's side rear door pillar.

Tire pressure should always be set based on cold inflation tire pressure. The cold tire inflation pressure must not exceed the maximum inflation pressure molded into the tire sidewall. Check "Tires – General Information" in section "Driving" for information on how to properly inflate the tires. The tire pressure will also increase as the vehicle is driven - this is normal and there is no adjustment required when this occurs.

The TPMS will warn the driver of a low tire pressure if the tire pressure falls below the low-pressure warning limit for any reason, including low temperature effects and natural pressure loss of the tire. The TPMS will continue to warn the driver of low tire pressure as long as the condition persists and will not turn



off until the tire pressure is equal or above the recommended cold inflation pressure. Once the low tire pressure warning light (⚠) illuminates, you must increase the tire pressure to the recommended cold inflation pressure in order for the TPMS light (⚠) to turn off. The system will automatically update and the TPMS light (⚠) will turn off once the system acquires the correct tire pressure.

The vehicle may need to be driven for up to 20 minutes above 15 mph (24 km/h) in order for the TPMS to acquire and process the updated setting.



**WARNING!**  
The TPMS warns the driver that the tire pressure has decreased. This warning does not exempt the driver from periodically checking the tires and from complying with the prescribed tire pressure levels.



**CAUTION!**  
The TPMS has been optimized for the original equipment tires and wheels. TPMS pressures and warning have been established for the tire size equipped on your vehicle. Undesirable system operation or sensor damage may occur when using replacement equipment that is not of the same size, type, and/or style. Aftermarket wheels can cause sensor damage. Do not use

aftermarket tire sealants or balance beads if your vehicle is equipped with a TPMS, as damage to the sensors may result.

- The system can temporarily experience radio-electric interference emitted by devices using similar frequencies.
- After inspecting or adjusting the tire pressure, always reinstall the valve stem cap. This will prevent moisture and dirt from entering the valve stem and damage the TPMS internal sensor.

**NOTE:**

- Driving on a significantly underinflated tire causes the tire to overheat and may lead to tire failure. Under-inflation also reduces fuel efficiency and tire tread life, and may affect the vehicle's handling and stopping ability.
- The TPMS is not a substitute for proper tire maintenance, and it is the driver's responsibility to maintain correct tire pressure using an accurate tire pressure gage, even if under-inflation has not reached the level to trigger illumination of the TPMS light (⚠).
- Seasonal temperature changes will affect tire pressure, and the TPMS



will monitor the actual tire pressure in the tire.

## Premium System

The TPMS system uses wireless technology with wheel rim mounted electronic sensors to monitor tire pressure levels. Sensors mounted to each wheel as part of the valve stem transmit tire pressure readings to the receiver module.

The TPMS consists of the following components:

- receiver module;
- four TPMS sensors;
- various TPMS messages, which display on the instrument cluster;
- warning light (⚠).

### Tire Pressure Low Warning

The TPMS light (⚠) will illuminate in the instrument cluster and an acoustic signal will notify that tire pressure is low in one or more of the four tires.



The instrument cluster will also display a screenshot reporting the pressure values of each tire with flashing low pressure value.



Should this occur, you should stop as soon as possible and inflate the tire/s with the low pressure (the one/s flashing in the instrument cluster graphic) to the recommended cold pressure inflation value. Once the system receives the updated tire pressure value, the system will

automatically update, the graphic display in the instrument cluster will stop flashing, and the TPMS light (⚠) will turn off. The vehicle may need to be driven for up to 20 minutes above 15 mph (24 km/h) in order for the TPMS to acquire and process the updated information.

### Tire Pressure System Fault

If a system fault is detected, the TPMS light (⚠) will flash for 75 seconds and then remain lit followed by a beeping sound. Therewith, the instrument cluster will display a "Service Tire Pressure System" message for a minimum of five seconds and then display dashes (--) in place of the pressure value to indicate which sensor is ineffective.

If the ignition switch is cycled, the sequence will repeat, in case the system fault still persists. If the system fault no longer exists, the TPMS light (⚠) will no longer flash, and the "Service Tire Pressure System" message will no longer be displayed, and a pressure value will be displayed in place of the dashes.

A system fault can occur due to any of the following:

- Signal interference due to electronic devices or driving next to facilities



emitting the same radio frequencies as the TPMS sensors.

- Installing aftermarket window tinting that contains materials that may block radio wave signals.
- Accumulation of snow or ice around the wheels or wheel housings.
- Using tire chains on the vehicle.
- Using wheels/tires not equipped with TPMS sensors.

The instrument cluster will also display a "Service Tire Pressure System" message for a minimum of five seconds when a system fault related to an incorrect sensor location fault is detected. In this case, the "Service Tire Pressure System" message is then followed by a graphic display with pressure values still shown. This indicates that the pressure values are still being received from the TPMS sensors but they may not be located in the correct vehicle position. The system still needs to be serviced as long as the "Service Tire Pressure System" message is displayed.



### Vehicles with Compact Spare Tire

- The compact spare tire does not have a TPMS sensor. Therefore, the TPMS will not monitor the pressure of the compact spare tire.
- If you replace a tire having pressure below the low-pressure warning limit, with the compact spare tire, on the next ignition switch cycle, the TPMS light (⚠) will illuminate followed by a beeping sound. In

addition, the graphic in the instrument cluster will still display a flashing pressure value corresponding to the compact tire position.



- After driving the vehicle for up to 20 minutes above 15 mph (24 km/h), the TPMS light (⚠) will flash for 75 seconds and then remain lit. The instrument cluster will then display a "Service Tire Pressure System" message for a minimum of five seconds and then display dashes (--) in place of the pressure value.
- Each subsequent ignition switch cycle will be followed by a beeping sound, the TPMS light (⚠) will flash for 75 seconds and then remain lit. The instrument cluster will then display a "Service Tire Pressure System" message for a minimum of five seconds and subsequently displays

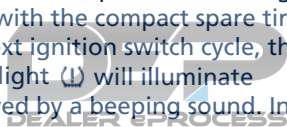





dashes (--) in place of the pressure value.



- Once you repair, replace or reinstall a tire with the compact spare tire, the TPMS will update automatically. The TPMS light (⚠) will turn OFF and the graphic in the instrument cluster will display a new pressure value instead of dashes (--), as long as no tire pressure is below the low-pressure warning limit in any of the four tires. The vehicle may need to be driven for up to 20 minutes above 15 mph (24 km/h) in order for the TPMS to acquire and process the updated information.

## TPMS Deactivation

The TPMS can be deactivated if replacing all four tire rims with wheel and tire assemblies not using of TPMS sensors, such as winter wheel and tire

assemblies. After replacing all four wheel and tire assemblies (road tires) with tires not equipped with Tire Pressure Monitoring System sensors, drive the vehicle for 20 minutes above 15 mph (24 km/h). The TPMS will chime, the TPMS light (⚠) will flash on and off for 75 seconds and then remain on and the instrument cluster will display the "Service Tire Pressure System" message and then display dashes (--) in place of the pressure values. Beginning with the next ignition switch cycle, the TPMS will no longer chime or display the "Service Tire Pressure System" message in the instrument cluster but dashes (--) will remain in place of the pressure values.



To reactivate the TPMS, replace all four wheel and tire assemblies (road tires) with tires equipped with TPMS sensors. Then, drive the vehicle for up

to 20 minutes above 15 mph (24 km/h). The TPMS will chime, the TPMS light (⚠) will flash for 75 seconds and then turn off. The instrument cluster will then display the "Service Tire Pressure System" message.



The instrument cluster will also display pressure values in place of the dashes (--). On the next ignition switch cycle the "Service Tire Pressure System" message will no longer be displayed as long as no system fault exists.

## Radio Frequency Transmitter - Regulatory Information

The "Regulatory Information" for all the radio and radar frequency devices can be consulted by accessing the "Services" section on the website [www.maserati.com](http://www.maserati.com).



## Fuel Requirements

The engines are designed to meet all environmental regulations and provide excellent fuel economy and performance when using unleaded premium gasoline with an AKI octane rating of 91 or above. AKI (Anti Knock Index) is an average on the Research Octane Number, RON, and the Motor Octane Number, MON (RON + MON/2 gives you the AKI).

For vehicle top performance, use unleaded premium gasoline with no less than 93 minimum AKI octane rating.

Poor quality gasoline can cause problems such as hard starting, stalling, and hesitations. If you experience these symptoms, try another brand of gasoline before considering service for the vehicle at an **Authorized Maserati Dealer**. Besides using unleaded gasoline with the proper octane rating, gasoline that contain detergents, anti-corrosion and stability additives are recommended. Using gasoline that have these additives may help improve fuel economy, reduce emissions, and maintain vehicle performance.



- **Maserati strongly recommends the use of Premium unleaded fuel ONLY. Use of lesser grade fuel (other than Premium) will lead to reduced engine performance, and poor fuel economy and can lead to the Malfunction Indicator Light illuminating on the instrument cluster. Continued use of lesser grade fuel (other than Premium fuel) can lead to engine misfire problems and possible catalytic converter damage.**
- **The anti-pollution devices of the vehicle require unleaded fuel to be used at all times. Under no circumstance, not even in an emergency, should leaded fuel be supplied to the fuel tank, not even a minimum quantity. This would irreparably damage the catalytic converters. An inefficient catalytic converter results in noxious exhaust emissions which damage the environment.**

### Reformulated Gasoline

Many areas of the country require the use of cleaner burning gasoline, referred to as "Reformulated

Gasoline". Reformulated gasoline contains oxygenates and are specifically blended to reduce vehicle emissions and improve air quality. Maserati supports the use of reformulated gasoline. Properly blended reformulated gasoline will provide excellent performance and durability of engine and fuel system components.

### Gasoline/Oxygenate Blends

Some fuel suppliers blend unleaded gasoline with oxygenates such as Ethanol. Fuels blended with oxygenates may be used in your vehicle.



**DO NOT use gasoline containing Methanol or gasoline containing more than 10% Ethanol. Use of these blends may result in starting and driveability problems, damage critical fuel system components, cause emissions to exceed the applicable standard, and/or cause the Malfunction Indicator Light to illuminate (see "Instrument Cluster" in section "Dashboard Instruments and Controls". Pump labels should clearly communicate if a fuel contains greater**



than 10% Ethanol.

Problems that result from using gasoline containing Methanol or gasoline containing more than 10% Ethanol are not the responsibility of Maserati and may not be covered under warranty.

## MMT in Gasoline

MMT (Methylcyclopentadienyl Manganese Tricarbonyl) is a manganese containing metallic additive that is blended into some gasoline to increase octane. Gasoline blended with MMT provides no performance advantage beyond gasoline of the same octane number without MMT.

Maserati recommends gasoline **without** MMT to be used in your vehicle. The MMT content of gasoline may not be indicated on the gasoline pump; therefore, you should ask the gasoline station operator whether or not the gasoline contains MMT. It is even more important to look for gasoline without MMT in Canada, because MMT can be used at levels higher than those allowed in the United States. MMT is prohibited in Federal and California reformulated gasoline.

## Materials Added to Fuel

All gasoline sold in the United States is required to contain effective detergent additives. Use of additional detergents or other additives is not needed under normal conditions and they would result in additional cost. Therefore, you should not have to add anything to the fuel.

## Fuel System Warnings



### WARNING!

Follow these guidelines to maintain your vehicle's performance:

- The use of leaded gasoline is prohibited by Federal and Provincial law. Using leaded gasoline can impair engine performance and damage the emissions control system.
- The use of fuel additives, which are now being sold as octane enhancers, is not recommended. Most of these products contain high concentrations of methanol. Fuel system damage or vehicle performance problems resulting from the use of such fuels or additives is not the responsibility of

DEALER ePROCESS

Maserati.

### NOTE:

*Intentional tampering with the emissions control system can result in civil penalties civil penalties and could void the vehicle warranty.*

## Carbon Monoxide Warnings



### WARNING!

Carbon monoxide (CO) in exhaust gases is deadly. Follow the precautions below to prevent carbon monoxide poisoning:

- Do not inhale exhaust gases. They contain carbon monoxide, a colorless and odorless gas, which can kill. Never run the engine in a closed area, such as a garage, and never sit in a parked vehicle with the engine running for an extended period. If the vehicle is stopped in an open area with the engine running for more than a short period, adjust the ventilation system to force fresh, outside air into the vehicle.
- Guard against carbon monoxide

(Continued)



*(Continued)*  
 with proper maintenance. Have the exhaust system inspected every time the vehicle is raised. Have any abnormal conditions repaired promptly. Until repaired, drive with all side windows fully open.





### WARNING!

**California Proposition 65**  
 Operating, servicing and maintaining a passenger vehicle or off-road vehicle can expose you to chemicals including such as, engine exhaust, carbon monoxide, phthalates and lead, that which are known to the State of California to cause cancer and birth defects or other reproductive harm. To minimize exposure, avoid breathing exhaust, do not idle the engine except as necessary, service your vehicle in a well-ventilated area and wear gloves or wash your hands frequently when servicing your vehicle. For more information go to:  
[www.P65Warnings.ca.gov/passenger-vehicle](http://www.P65Warnings.ca.gov/passenger-vehicle)

## Refueling

### Fuel Filler Neck Access

To access the fuel filler neck, the filler door must be unlocked. From outside the vehicle, this can only be done by pressing the unlock  or the lock  button on the key fob RKE transmitter, in the same way as if opening or closing the doors. If any of the door lock controls is pressed from inside the vehicle, the filler door will still remain open to allow refueling.

- Press the indicated area on the filler door, which is located on the rear left side of the vehicle: the filler door will open completely.



### Refill the Tank

The fuel filler is sealed by an internal closing tab, which is opened by the fuel nozzle of the service station when refueling.

Only a nozzle of the suitable size can open the closing tab.

- Insert the fuel nozzle fully into the filler.

#### NOTE:

*Only with a correct size nozzle you can refuel.*



### WARNING!

- To avoid the risk of fire, do not approach the filler with open flames or cigarettes!
- To avoid the risk of inhaling noxious





fumes, do not breathe close to the fuel filler door, when opened.

- Never have any smoking materials lit in or near the vehicle when the fuel filler door is open or the tank is being filled.
- Never add fuel when the engine is running. This violates most fire-prevention regulations and may cause the Malfunction Indicator Light  to turn on (see “Instrument Cluster” in section “Dashboard Instruments and Controls”).

- Fill the vehicle with fuel. Fuel tank capacity is indicated in the “Refillings” table in section “Features and Specifications”. When the fuel nozzle “clicks” or shuts off, the fuel tank is basically full: it is possible to further ensure refueling by enabling the fuel nozzle additional fuel supply until two clicks. After the two additional clicks, the amount of fuel allowed by the system is very low, we recommend therefore not to persist further.
- Wait approximately 10 seconds before removing the fuel nozzle in order to ensure completed supply of

residual fuel and restrict the risk of fouling the fuel filler door area.

- Remove the fuel nozzle.
- Close the fuel filler door.



#### CAUTION!

To avoid fuel spillage and overfilling, do not “top off” the fuel tank after filling.

#### Emergency Refueling Funnel

A funnel is provided (in the trunk in the tool box container) for emergency refueling with a gas can.

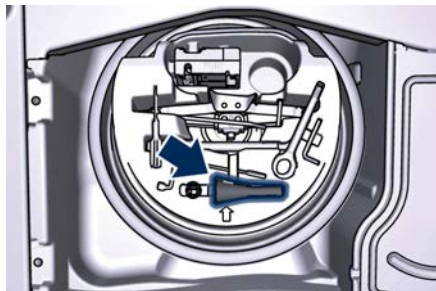

#### WARNING!

A fire may result if fuel is pumped into a portable container that is inside of a vehicle. You could be burned. Always place gas containers outside the vehicle while filling.

#### Emergency Fuel Filler Door Release

If you are unable to unlock the fuel filler door using the key fob RKE transmitter, use the fuel filler door emergency release located in the trunk.

- Open the trunk lid (see “Trunk Lid Operation” in section “Before Starting”).
- Lift the access cover on the left side of the trunk.

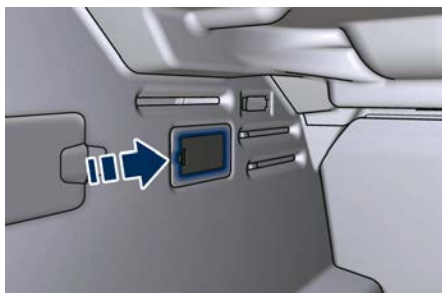

- Pull the release cable moderately to avoid its possible break. It's not possible to feel or hear the unlocking of the fuel filler door actuator.

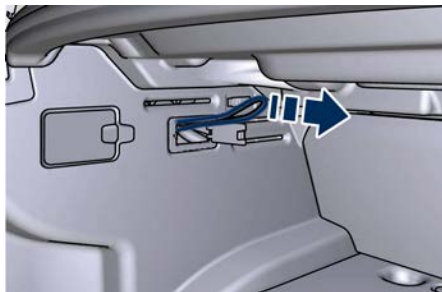

- Then open normally the fuel filler door.

## Driving Conditions

### Before the Trip

Check the following at regular intervals and always before long trips:

- tire pressure and condition;
- levels of fluids and lubricants;
- conditions of the windshield wiper blades;
- clean the glass on the external light and all other glass surfaces;
- proper operation of the indicator lights and of the external lights.



### CAUTION!

It is however advisable to perform these checks at least every 600 mi (1000 km) and always following the maintenance schedule reported in section "Maintenance and Care".

Before you drive:

- adjust seat position, steering wheel, adjustable pedals (if equipped with) and rearview mirrors in order to have the best driving position;
- ensure that nothing (mat covers, etc.) is obstructing the pedals movement;
- carefully arrange and secure any objects in the trunk, to prevent them

from moving forward in case of sudden stops;

- avoid heavy meals before a trip. A light snack helps keep your reflexes sharp. In particular, avoid drinking alcohol.



### WARNING!

Passengers must only travel seated in the vehicle seats, with the seat belts fastened. Always check that the driver and all passengers have the seat belts correctly fastened.

### Safe Driving

Although the vehicle is equipped with active and passive safety devices, the driver's conduct is always a decisive factor for road safety.

Some simple rules for traveling safely in different conditions are listed below. Some of them will probably already sound familiar but, in any case, it would be useful to read them carefully.

#### Driving at Night

The main guidelines to follow when driving at night are set out below.

- Drive carefully. Night conditions demand more focus and attention.



- Reduce your speed, especially on roads with no streetlights.
- Stop at early signs of drowsiness. Continuing to drive would be a risk for yourself and for others. Have a rest before continuing your trip.
- Keep the vehicle at a greater distance from vehicles in front of you than you would during the day: it is difficult to assess the speed of other vehicles when you only see the lights.
- Use the high beams only outside of densely-populated areas and when you are sure that they will not disturb other drivers.
- When another vehicle is approaching, switch from high beams (if on) to low beams.
- Keep lights and headlights clean.
- Outside of densely-populated areas, beware of animals crossing the road.

### Driving in the Rain

Rain and wet roads are dangerous. On a wet road all maneuvers are more difficult since wheel grip on the road is significantly reduced. This means that braking distances increase considerably and road grip decreases. Some advices for driving in the rain are listed below.

- Reduce your speed and keep a greater safety distance from the vehicles in front of you. High speed may result in a loss of vehicle control.
- When driving on wet or slushy roads, it is possible for a wedge of water to build up between the tire and road surface. This is known as aquaplaning and may cause partial or complete loss of vehicle control and stopping ability. To reduce this possibility: slow down if the road has standing water or puddles.
- Heavy rain substantially reduces visibility. In these circumstances, even during the day, turn on the low beams, to be more visible to other drivers.
- Set the air conditioning and heating system controls on the defogging function, in order to avoid any visibility problem.
- Periodically check the conditions of the windshield wiper blades.
- In low grip conditions use "I.C.E." driving mode (see chapters "Drive Mode" in this section).
- Avoid driving with ESC OFF as this will likely cause a loss of control of the vehicle.

DEALER ePROCESS

### Driving in Fog

If the fog is dense, avoid traveling if possible.

When driving in mist, blanket fog or when there is the possibility of banks of fog, please consider some advices listed below.

- Keep a moderate speed.
- Even in daytime, turn on the low beams and rear fog lights. Do not use the high beams.
- Remember that fog creates dampness on the asphalt and thus any type of maneuver is more difficult and braking distances are extended.
- Keep a safe distance from the vehicle in front of you.
- Avoid sudden changes in speed as much as possible.
- Whenever possible, avoid overtaking.
- If you are forced to stop the vehicle (breakdowns, impossibility of proceeding due to poor visibility, etc.), first of all, try to stop off of the travel lane. Then turn on the hazard warning flashers and, if possible, the low beams.



## CAUTION!

Be aware that rear fog lights can bother the drivers following your vehicle: when visibility is back to normal, turn off these lights.

## Driving in the Mountains

Mountain roads usually have many narrow turns and curves, tunnels and steep uphill or downhill slopes: please consider some advices listed below.

- Drive at a moderate speed, avoid "cutting" corners.
- When driving inside a tunnel in daylight turn on the low beams in advance; avoid high beams and be aware of the rapid brightness change. Avoid abrupt maneuvers that could be dangerous for the following vehicle.
- Never coast downhill with the engine off or in neutral.
- Remember that passing other vehicles when driving uphill is slower and thus requires more free distance on the road. If you are being overtaken on a hill, slow down and allow the other vehicle to pass.

## Driving on Snow or Ice

Please consider some general advice for driving in these conditions, listed below.

- Maintain a very moderate speed.
- Fit snow chains or specific tires if the road is covered with snow: see the paragraphs "Tires – General Information" in this section.
- We recommend you to activate the "I.C.E." mode (see chapters "Drive Mode" in this section).
- During the winter season, even apparently dry roads can have icy sections. Be careful when crossing bridges, viaducts and roads that have little exposure to the sun and are bordered by trees and rocks. They may be icy.
- Keep an ample safe distance from the vehicles in front of you.



## WARNING!

- **Rapid acceleration on slippery surfaces is dangerous. Unequal traction can cause sudden pulling of the driving wheels. You could lose control of the vehicle and possibly have a collision. Accelerate slowly and carefully whenever there is**

likely to be poor traction (ice, snow, wet mud, loose sand, etc.).

- **Do not drive on or across a road or path where water is flowing and/or rising (as in storm run-off). Flowing water can wear away the road or path surface and cause your vehicle to sink into deeper water. Furthermore, flowing and/or rising water can carry your vehicle away swiftly. Failure to follow this warning may result in injuries that are serious or fatal to you, your passengers, and others around you.**

Although your vehicle is capable of driving through shallow standing water, consider the following Cautions and Warnings before doing so.



## CAUTION!

- Always check the depth of the standing water before driving through it. Never drive through standing water that is deeper than 47 in (150 mm).
- Determine the condition of the road or the path that is under water and if there are any obstacles in the way before driving through the standing water.





- Do not exceed 5 mph (8 km/h) when driving through standing water. This will minimize wave effects.
  - Driving through standing water may cause damage to your vehicle drivetrain components. After driving through standing water, do not drive if you are not sure about drivetrain condition. Such damage is not covered by the New Vehicle Warranty.
  - Getting water inside your vehicle engine can cause it to lock up and stall out, and cause serious internal damage to the engine. Such damage is not covered by the New Vehicle Warranty.
  - After driving through standing water always have the fluids (engine oil, transmission oil, etc) checked for contamination at an **Authorized Maserati Dealer**.
- limits your vehicle braking capabilities, which increases stopping distances. Therefore, after driving through standing water, drive slowly and lightly press on the brake pedal several times to progressively dry the brakes discs and pads.**
- Getting water inside your vehicle engine can cause it to lock up and stall out.
  - Failure to follow these warnings may result in injuries that are serious or fatal to you, your passengers, and others around you.

**WARNING!**

- Driving through standing water limits your vehicle traction capabilities. Do not exceed 5 mph (8 km/h) when driving through standing water.
- Driving through standing water







## **6 – In an Emergency**

Tool Kit . . . . .	304
Hazard Warning Flashers . . . . .	305
In the Event of an Accident . . . . .	305
In case of a Punctured Tire . . . . .	306
Emergency Release of the Parking Brake . . . . .	311
Transmission Manual Release of P (Park) Position . . . . .	312
Auxiliary Jump-Start Procedure . . . . .	312
Towing a Disabled Vehicle . . . . .	315





### Tool Kit

The tools are located in the trunk inside a preformed container and are available by lifting the ground coverage.

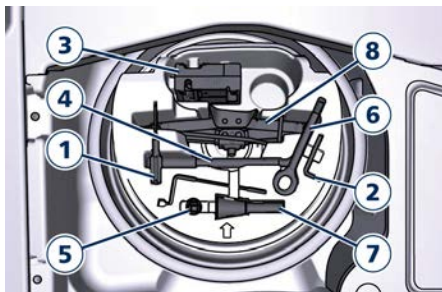

The tools inserted in the container above the compact spare wheel are the following:

Ref.	Description
1	Double torx + cross-head screwdriver
2	8 mm Allen wrench for unscrewing the fastening nut of the reverse light cluster
3	Electric compressor complete with pressure gauge for inflating the compact spare wheel
4	Extended spanner with rubber coated handle for unscrewing/ tightening the wheel nuts
5	Adapter for wheel extended spanner
6	Tow hook
7	Funnel for emergency supply
8	Jack

6



## Hazard Warning Flashers

The hazard warning flashers switch is located in the central console in front of the transmission lever.



Press the switch to turn on the hazard warning flashers to warn oncoming traffic of an emergency. When these lights illuminate, the turn signals, the related warning lights on the instrument cluster and the button start flashing.

Press the switch a second time to turn off the hazard warning flashers.

This is an emergency warning system and it should not be used when the vehicle is in motion. Use it when your vehicle is disabled and it is creating a safety hazard for other motorists.

When you must leave the vehicle to seek assistance, the hazard warning flashers will continue to operate even

though the ignition is placed in the OFF position.



### CAUTION!

- When the hazard warning flashers are activated, the turn signals control is disabled.
- With extended use the hazard warning flashers may wear down your battery.

## In the Event of an Accident

It is important always to keep calm.

- If not directly involved, stop at a safe distance of at least ten yards (meters) away from the accident area.
- If on a highway, stop without obstructing the emergency lane and be especially careful if you need to exit the vehicle.
- Turn off the engine and switch on the hazard warning flashers.
- At night, illuminate the accident area with the headlights.
- Always act with caution to avoid the risk of being crashed into by other drivers.
- Indicate that an accident has occurred by placing the emergency triangle (if equipped) in a well visible position and at the prescribed distance.
- Call the emergency services, providing as much information as possible. On the highway, use the special call boxes.
- Remove the ignition key (if present) from the vehicles involved.





- If fuel or other chemical products can be smelled, do not smoke and ask people around you to put their cigarettes out.
- To extinguish fires, even small ones, use a fire extinguisher, blankets, sand or earth. Never use water.
- In multiple accidents occurred on highways, particularly where visibility is poor, there is a high risk of being involved in other collisions. Leave the vehicle immediately and move away from the area.

### In case of Injured Persons

- Never leave the injured person alone. Persons not directly involved in the accident are also required to give assistance.
- Do not crowd around injured persons.
- Reassure the injured person that help is on the way.



#### **WARNING!**

**California Proposition 65**  
**Operating, servicing and maintaining a passenger vehicle or off-road vehicle can expose you to chemicals including such as, engine exhaust, carbon monoxide, phthalates and lead, that**

**which are known to the State of California to cause cancer and birth defects or other reproductive harm. To minimize exposure, avoid breathing exhaust, do not idle the engine except as necessary, service your vehicle in a well-ventilated area and wear gloves or wash your hands frequently when servicing your vehicle. For more information go to: [www.P65Warnings.ca.gov/passenger-vehicle](http://www.P65Warnings.ca.gov/passenger-vehicle)**

### In case of a Punctured Tire

If the vehicle is equipped with a compact spare wheel.

#### Using the Compact Spare Wheel

##### **NOTE:**

*The compact spare wheel is supplied in aluminium or steel: the pictures show the one in aluminium.*

The compact spare wheel is stored in the trunk and is supplied deflated in order to limit the amount of space occupied. An electric compressor is also provided for inflating. In the event of a tire puncture, proceed as follows.

- Stop the vehicle in a place that does not constitute a danger to traffic and where the wheel can be changed safely.
- Select the P (Park) mode and then engage manually the electric parking brake and move the ignition switch to **OFF** position.
- If necessary, turn the hazard warning flashers on and place the warning triangle (if equipped) at the required distance.





- If provided, the chock can be installed in order to improve vehicle stability.

**WARNING!**

The vehicle must be level and on the firm ground during the vehicle lifting operations. If forced to stop the vehicle on a slope, call the Assistance service and avoid any operation.

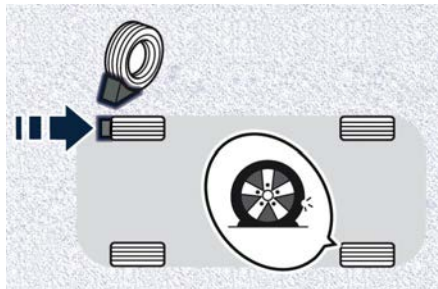

- Before placing the chock, it is necessary to open it like a book as shown in the picture.

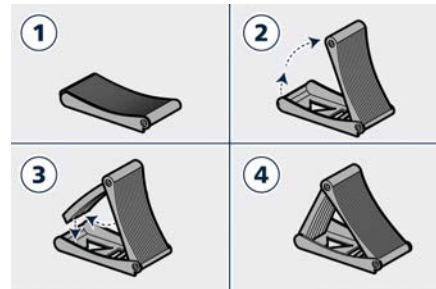

- Lift the ground coverage of the trunk.
- Take the tools for changing the wheel (indicated in picture) from the container.

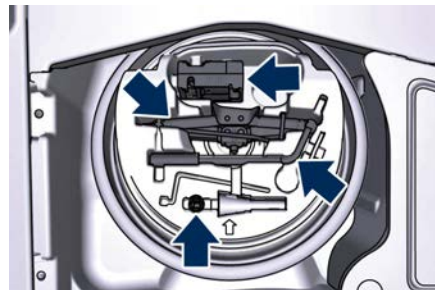

- Unscrew and pull out the locking wheel knob.



- Take the container and the compact spare wheel out of the trunk.
- Remove from the compressor case the inflation hose and the cable with a plug for the power outlet.
- Unscrew the valve cap of the compact spare wheel and screw the fitting of the inflation hose onto the valve.
- Insert the power plug into one of the available power outlets fitted in the trunk or passenger compartment.
- Set the ignition device on **ACC** or **RUN** position.
- Turn the compressor on by pressing the switch.
- Stop the compressor by pressing the switch again, when the pressure indicated by the gauge reaches the recommended level (see "Tire Inflation Pressure" in section

**DEP**  
DEALER ePROCESS



“Features and Specifications”) and screw the cap on the compact spare wheel valve.

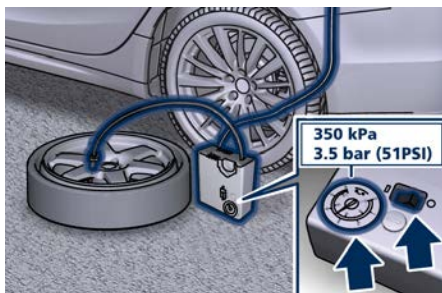

## CAUTION!

- In order to obtain a more accurate reading, the compressor should be switched off when checking the tire pressure of the compact spare wheel on the pressure gauge.
- Do not run the compressor for more than 20 minutes: there is a risk it could overheat. Also, prolonged power absorption may discharge the battery, subsequently preventing the engine from starting.
- The compressor has been designed exclusively to inflate compact spare

wheels; do not use it to inflate air mattresses, floatation devices, etc.

- Remove the center cover of the wheel rim (if equipped) levering into the provided groove on the outer ledge of the cover.
- Fit the adapter on the wrench. Extend the wrench as shown, then loosen by approximately one turn, the five bolts on the wheel to be changed.

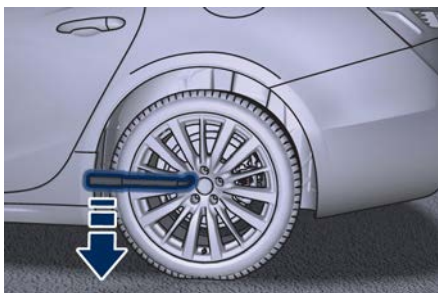

- Place the jack near the wheel to be changed as illustrated.
- Make sure that the head of the jack is correctly inserted in one of the slots beneath the rocker panel.



## WARNING!

- The jack should be used on level firm ground wherever possible.

- It is recommended that the wheels of the vehicle be chocked, and that no person should remain in a vehicle that is being jacked.
- If the vehicle has been stopped on a slope or an uneven surface, place chocks or other suitable items in front of or behind the wheels to stop the vehicle from moving.
- Never start or run the engine with the vehicle on a jack.
- No person should place any portion of their body under a vehicle that is supported by a jack.



## WARNING!

- Never position yourself under a jacked vehicle.
- Never use the jack to carry out maintenance or repairs under the vehicle.
- Turn the jack lever until the wheel is raised a few centimeters off the ground.
- Completely unscrew the five bolts and remove the wheel. In case a wheel security stud bolt is installed, it can only be removed by using the specific fitting wrench provided with





the “Wheel Security Stud Bolt Kit”, available in the “Genuine Accessories” range.

- Fit the compact spare wheel with the valve stem facing outward, securing it with the five bolts previously removed.

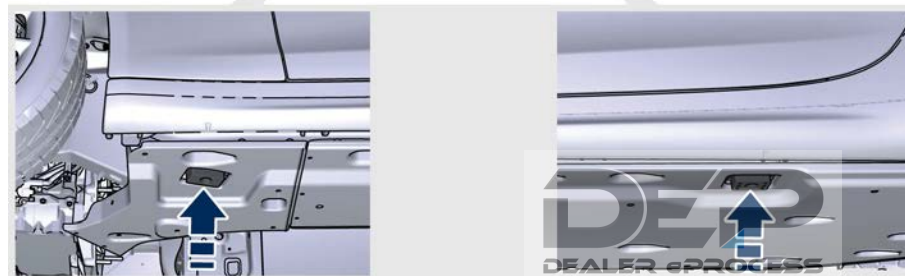
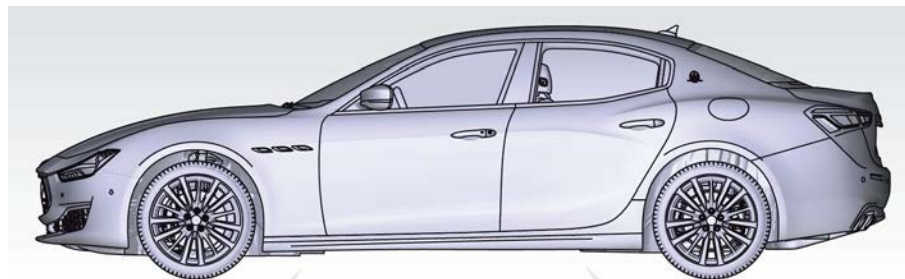
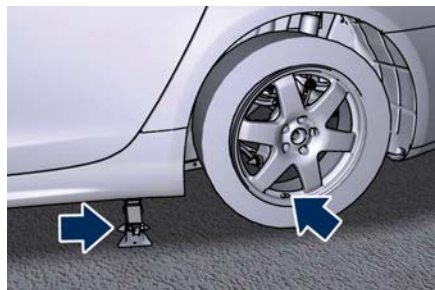

- Turn the lever of the jack to lower the vehicle and remove the jack.
- Fully tighten the bolts, alternately tightening diametrically opposite.



### WARNING!

- **FOR ALUMINIUM SPARE WHEEL**  
Observe the tightening torque for the bolts securing the spare wheel ( $72 \pm 7$  lbf-ft/  $98 \pm 10$  Nm).
- **FOR STEEL SPARE WHEEL**  
Observe the tightening torque for the bolts securing the spare wheel ( $63 \pm 7$  lbf-ft/  $86 \pm 10$  Nm).
- To avoid the risk of forcing the vehicle off the jack, do not tighten the wheel bolts fully until the vehicle has been lowered. Failure to follow this warning may result in personal injury.

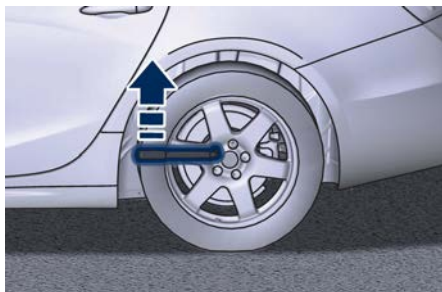

## **WARNING!**

- The spare wheel is narrower than standard wheels and must only be used to travel the distance required to reach a service station, where the punctured tire can be repaired or replaced.
- Do not exceed a maximum speed of 50 mph (80 km/h) when using the compact spare wheel; when this limit is exceeded, the stability, road holding and braking of the vehicle will be compromised. Avoid accelerating to full speed, heavy braking and fast cornering.
- The compact spare wheel must be inflated to the recommended tire pressure (see "Tire Inflation Pressure" in section "Features and Specifications").

- For safety reasons, it is absolutely forbidden to drive with more than one compact spare wheel fitted on the vehicle.
- Snow chains cannot be fitted on the compact spare wheel.
- The spare wheel can travel a maximum of 1,800 mi (3,000 km).

## To Refit the Standard Wheel with Repaired or Replaced Tire

- Following the procedure and the caution described above, raise the vehicle and remove the compact spare wheel reusing the supplied wrench with adapter, suitably extended.
- Fit the standard wheel with repaired or replaced tire.
- Tighten the original bolts on the wheel.
- Lower the vehicle and remove the jack.
- Fully tighten the bolts, alternately tightening diametrically opposite.

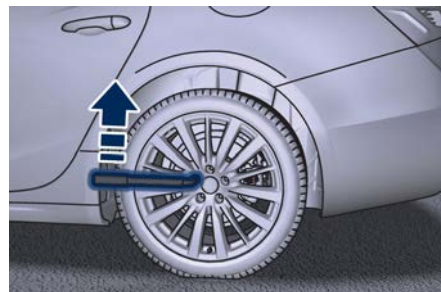

## **WARNING!**

Observe the tightening torque for the bolts securing the wheels ( $72 \pm 7$  lbf-ft /  $98 \pm 10$  Nm). Check the correct tightening torque as soon possible contacting an Authorized Maserati Dealer.

- Reassemble the center cover (if equipped) on the wheel rim.
- Once finished:
- completely deflate the compact spare wheel by pressing on the valve with the overhang of the valve cap;
  - place the compact spare wheel and tool container in the trunk;
  - fix everything in place with the locking knob;





- wrap the power cable and the inflation hose inside the compressor case;

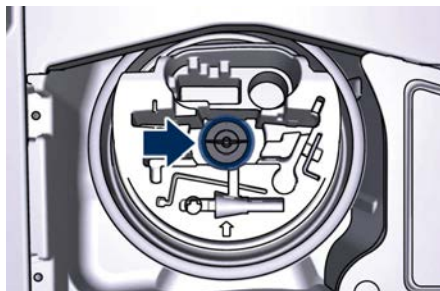

- place the compressor, the jack, the wrench and the adapter in the container inside the compact spare wheel;

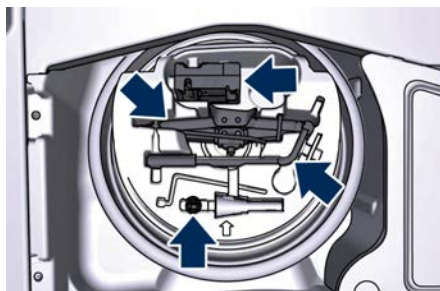

- reposition the other tools;
- lower the ground coverage at the bottom of the trunk.

## Emergency Release of the Parking Brake

In the event the electric parking brake locks due to a system failure (see "Parking Brake" in section "Driving"), it is not possible to move the vehicle, since the actuator that operates on the brake pad inside each rear caliper will lock the rear wheels.

After verifying that the battery is sufficiently charged (otherwise use an external power source connected to the vehicle electric system to operate the EPB control lever and try to unlock the parking brake), for moving the vehicle it is necessary to force the actuator to release the rear brake discs. Contact the **Authorized Maserati Dealer** to carry out this operation.



### WARNING!

**If the parking brake has been activated in manual or automatic mode and it is not possible to release it by operating on the lever of the central console, do not move the vehicle since rear brake calipers might be damaged. For more information on**

**DEP**  
DEALER ePROCESS

vehicle towing see "Towing a Disabled Vehicle" chapter in this section.



## Transmission Manual Release of P (Park) Position

The manual disengagement of the shift from P (Park) has the purpose to allow towing the vehicle if not normally possible using the shift lever (such as inability to start the engine). This procedure is exclusively intended for emergency situations, only!



### WARNING!

**Always secure your vehicle by fully applying the parking brake, before activating the manual park release. Activating the manual park release could allow your vehicle to roll away if it is not secured by the parking brake. Activating the manual park release on an unsecured vehicle could lead to serious injury or death for those in or around the vehicle.**

The cover that allows the emergency manual park release is located on the left part of the driver's foot well.

- Lift the mat on the driver side to access the cover.
- Slip the cover from its seat.

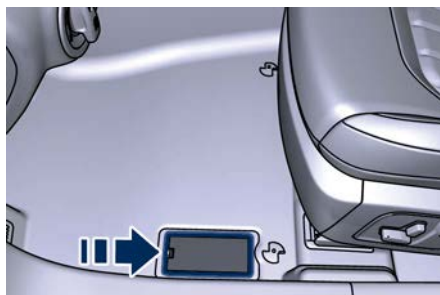

- Take strap out of its seat.
- With the tip of a screwdriver press the clip shown in the picture box and lift the strap up to release the transmission from the P (Park) position. The new position will allow vehicle moving and towing.
- Release the parking brake only when the vehicle is securely connected to a tow vehicle.

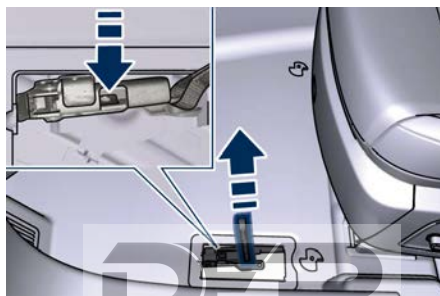

DEALER ePROCESS

## Auxiliary Jump-Start Procedure

If your vehicle has a discharged battery it can be jump-started using a set of jumper cables and a battery of another vehicle or by using a portable battery booster. It is necessary to have proper jumper cables in order to connect the booster battery to the remote posts of the discharged battery. Booster cables have positive and negative terminal clamps and are identified by the sheath color (red = positive, black = negative).

### NOTE:

*An Authorized Maserati Dealer can provide you with information about the "Maserati Jumper Cables Kit", available in the "Genuine Accessories" range.*

Jump-starting can be dangerous if done improperly so please follow the procedures in this section carefully.

### NOTE:

*When using a portable battery booster pack, follow the battery manufacturer's operating instructions and precautions.*

**CAUTION!**

- To jump start a vehicle do not use a portable battery, a booster pack or any other booster source with a system voltage greater than 14 Volts or damage to the battery, starter motor, alternator or electrical system of the vehicle with the discharged battery may occur.
- Do not use a battery charger for emergency starting under any circumstances. You could damage the electronic systems, particularly the control units managing the ignition and fuel supply functions.
- If the battery is completely discharged when the windows are fully raised, open the door with the utmost care; do not close the door again until it is possible to lower the window.

**WARNING!**

Always secure your vehicle by fully applying the parking brake, before activating the manual park release. Activating the manual park release could allow your vehicle to roll away

if it is not secured by the parking brake. Activating the manual park release on an unsecured vehicle could lead to serious injury or death for those in or around the vehicle.

**NOTE:**

*If you need to disconnect the battery from the vehicle electrical system, see "Maintenance — Free Battery" in section "Maintenance and Care".*

**WARNING!**

**California Proposition 65**  
**Operating, servicing and maintaining a passenger vehicle or off-road vehicle can expose you to chemicals including such as, engine exhaust, carbon monoxide, phthalates and lead, that which are known to the State of California to cause cancer and birth defects or other reproductive harm. To minimize exposure, avoid breathing engine exhaust, do not idle the engine except as necessary, service your vehicle in a well-ventilated area and wear gloves or wash your hands frequently when servicing your vehicle. For more information go to:**

**DEP**  
 DEALER ePROCESS

[www.P65Warnings.ca.gov/passenger-vehicle](http://www.P65Warnings.ca.gov/passenger-vehicle)

**Battery Remote Posts Position**

For easier operation, remote battery posts for jumpstarting are located in the engine compartment while the battery is stored in the trunk. Open the engine hood (see "Hood Operation" in section "Before Starting") the positive remote post (+) and the negative remote post (-) are easily recognizable by the icons labeled on the integrated power module.

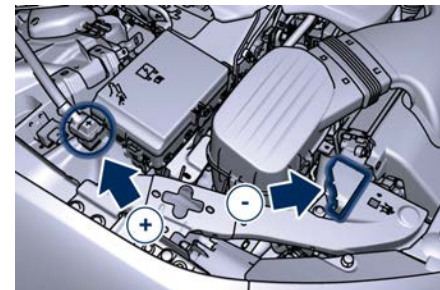



## Jump-Start Procedure



### WARNING!

- Stay clear of the radiator cooling fan whenever the engine hood is raised. It can start anytime the ignition switch is on. You could be injured by the moving fan blades.
- Remove any metal jewelry such as watch bands or bracelets that might make an inadvertent electrical contact. You could be seriously injured.
- Do not allow the vehicles involved in the jumpstarting operation to touch each other as this could establish a ground connection and cause personal injury.
- Turn off the heater, radio, and all unnecessary electrical accessories.
- Set the parking brake, shift the automatic transmission into P (Park) and turn the ignition to **OFF**.
- If using another vehicle to jumpstart the battery, park the vehicle within the jumper cables reach and set the parking brake and make sure the ignition is off.

- Connect one terminal clamp of the positive jumper cable to the positive (+) remote post of the vehicle with the discharged battery after lifting the protection cap of the cable indicated on the external side of the integrated power module.

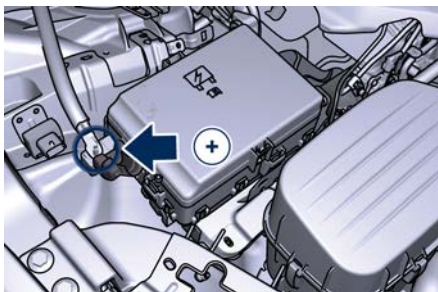

- Connect the other terminal clamp of the positive (+) jumper cable to the positive (+) post of the booster battery.
- Connect one terminal clamp of the negative (-) jumper cable to the negative (-) post of the booster battery.
- Connect the other terminal clamp of the negative (-) jumper cable to the remote negative (-) post of the vehicle with the discharged battery as rendered.

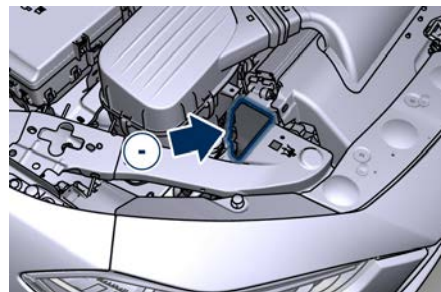

- Start the engine in the vehicle that has the booster battery, let the engine idle a few minutes, and then start the engine in the vehicle with the discharged battery. If using a portable battery booster, wait a few seconds after connecting the cables, before starting the booster vehicle. Once the engine is started, remove the jumper cables in the reverse sequence.
- Disconnect the terminal clamp of the negative (-) jumper cable from the remote negative (-) post of the vehicle with the discharged battery.
- Disconnect the other terminal clamp of the negative jumper cable from the negative (-) post of the booster battery.
- Disconnect the terminal clamp of the positive (+) jumper cable from the positive (+) post of the booster battery.





- Disconnect the terminal clamp of the positive jumper cable from the remote positive (+) post of the discharged vehicle.

#### NOTE:

If frequent jump-starting is required to start your vehicle you should have the battery and charging system inspected at an **Authorized Maserati Dealer** center.



#### WARNING!

**California Proposition 65**  
Operating, servicing and maintaining a passenger vehicle or off-road vehicle can expose you to chemicals including such as, engine exhaust, carbon monoxide, phthalates and lead, that which are known to the State of California to cause cancer and birth defects or other reproductive harm. To minimize exposure, avoid breathing exhaust, do not idle the engine except as necessary, service your vehicle in a well-ventilated area and wear gloves or wash your hands frequently when servicing your vehicle. For more information go to:  
[www.P65Warnings.ca.gov/passenger-vehicle](http://www.P65Warnings.ca.gov/passenger-vehicle)

## Towing a Disabled Vehicle

Proper towing or lifting equipment is required to prevent damage to your vehicle.



#### CAUTION!

Any improper maneuver and use of unsuitable equipment for recovering vehicle in an emergency from off road location could seriously damage the vehicle. Contact an **Authorized Maserati Dealer**.

## Manual Release of Transmission with Low Battery

In order to push or tow the vehicle if unable to shift the transmission out of P (Park) (such as a discharged battery), a manual park release is available. In this case it is necessary to manually release the shift lever and release the parking brake if inserted (see “Emergency Release of the Parking Brake” in this section). Follow the steps as indicated in “Transmission Manual Release of P (Park) Position” in this section to manually disengage the transmission.



## Vehicle Towing Conditions

Maserati only allows vehicle towing either on a flatbed or with all four wheels off the ground.

### Towing an RWD Vehicle

If flatbed equipment is not available, and the transmission is still operable, a RWD vehicle may be flat towed (with all four wheels on the ground) under the following conditions.

- The shift lever must be in N (Neutral).
- The distance to be traveled must not exceed 30 mi (50 km).
- The towing speed must not exceed 30 mph (50 km/h).

If the transmission is not operable, or the RWD vehicle must be towed faster than 30 mph (50 km/h) or farther than 30 mi (50 km) (for example on a highway), tow with the rear driving wheels off the ground and on a platform of a rescue vehicle, or with the rear wheels raised using a wheel lift.



#### CAUTION!

If you have to tow the RWD vehicle with 2 wheels raised, ensure that the

*(Continued)*



**(Continued)**  
 ignition switch is in the OFF position. If this is not observed, when the ESC is active, the ECU will store a malfunction and the relative warning light  will illuminate on the instrument cluster display. This requires the intervention of an **Authorized Maserati Dealer** to reset the system.

## Towing an AWD Vehicle



**WARNING!**

Single axle towing or use of a tow dolly is not allowed since it will severely damage components of an AWD vehicle.



**WARNING!**

Use of a tow dolly on front wheels is strictly forbidden since front wheels may still receive a residual amount of torque and disengage the vehicle from the tow dolly and affect safety of both rescuers and other road users.

## Use the Tow Hook of the Tool Kit



**CAUTION!**

The tow hook should only be used for towing the car on flat roads. Do not use the tow hook to remove the car that is stuck on off road stretches.

The tow hook is also used to tow the vehicle on the platform of a tow truck. The tow hook is contained in the tool kit (see "Tool Kit" in this section) and must be screwed in its seat accessible behind the front grille, right-hand side, after removing the protective cap.

**NOTE:**

Maximum work angle of towing cable: 15°.

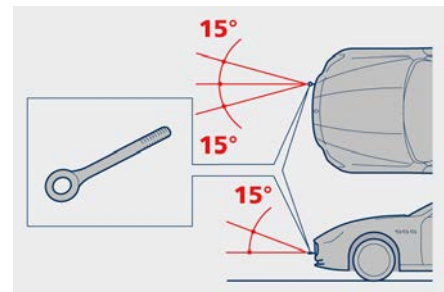

- Carefully clean the threaded seat before screwing the hook.
- Screw the tow hook into its seat for at least 11 turns.





## **7 – Maintenance and Care**

Scheduled Maintenance Service . . . . .	318
Scheduled Service Plan . . . . .	319
Maintenance Procedures . . . . .	324
Maintenance-Free Battery . . . . .	332
Fuse Replacement . . . . .	337
Bulb Replacement . . . . .	344
A/C System Maintenance . . . . .	348
Wheels Maintenance . . . . .	349
Bodywork Maintenance and Care . . . . .	350
Interior Maintenance and Care . . . . .	353
Vehicle Stored for Long Periods . . . . .	355
Restarting the Vehicle . . . . .	355
Battery Statement . . . . .	356





## Scheduled Maintenance Service

Correct maintenance is clearly the best way to guarantee vehicle performance and safety features, ensure respect for the environment and low operating costs.

### NOTE:

*Also remember that the observance of the maintenance procedures is essential for keeping your vehicle operating properly. Not adhering to the "Scheduled Service Plan" can impact your vehicle's warranty.*

## Interval Running Coupons

Maserati has therefore provided for a series of checks and maintenance operations involving the 1<sup>st</sup> service when the vehicle mileage reaches 12,500 mi (20,000 km) or after 1 year of the vehicle's life, and subsequently every 12,500 mi (20,000 km) or every year.

After the 6<sup>th</sup> service, maintenance must be restarted with the operations scheduled for the 1<sup>st</sup>, 2<sup>nd</sup> and 3<sup>rd</sup> service.



### CAUTION!

The Scheduled Maintenance services are prescribed by the Manufacturer. Failure to have the services carried out can affect your warranty.

The Scheduled Maintenance service is provided by an **Authorized Maserati Dealer**. In the event that, when a service is performed, further replacements or repairs are found to be necessary in addition to the scheduled operations, these can be carried out only with the specific consent of the Customer.



### CAUTION!

You are advised to notify the **Authorized Maserati Dealer** of any minor operating problem, without waiting for the next scheduled service.

### NOTE:

- Change your vehicle's oil if it has been 1 year since your last oil change.
- Change your engine oil more often if you drive your vehicle off-road for an extended period of time or short trips without reaching operating temperatures.

- Under no circumstances should oil change intervals exceed 12,500 mi (20,000 km) or at least after 1 year.



### CAUTION!

Failure to perform the required maintenance items may result in damage to the vehicle.

## Scheduled Maintenance (Service) Indicator

The service indicator system will remind you the deadline for the maintenance program. The indicator light  on the instrument cluster flashes for approx. 5 seconds displaying the message backed by a beeping sound, indicating that the next scheduled maintenance is due or has already overdue.





When the scheduled maintenance has overdue, the indicator light  and message will be displayed on the instrument cluster.



The service indicator and message will illuminate approximately from 620 mi (1000 km) or 30 days to the next scheduled maintenance.

Have your vehicle serviced as soon as possible.

**NOTE:**

*The service indicator will not monitor the time elapsed from the last scheduled maintenance.*

To check the km/mi and the days that remain at the inspiration of the next scheduled maintenance, consult the “Maintenance” submenu of “VEHICLE INFO” main menu (see paragraph “TFT Display : Warning/Indicator Lights of the Set Modes/ Functions” in chapter

“Instrument Cluster” of section “Dashboard Instruments and Controls” for more details). An **Authorized Maserati Dealer** will reset the service indicator message after completing the scheduled maintenance operations.

## Scheduled Service Plan

The Scheduled Maintenance services listed in this manual must be done at the times or mileages specified to protect your vehicle warranty and ensure the best vehicle performance and reliability.

More frequent maintenance may be needed for vehicles in operating conditions, such as dusty areas and very short trip driving.

Inspection and service should also be done anytime a malfunction is suspected.

Maserati recommends that these maintenance intervals be performed at an **Authorized Maserati Dealer**. The technicians at your dealership know your vehicle best, and have access to factory-approved information, genuine Maserati parts, and specially designed electronic and mechanical tools that can help prevent future costly repairs.





## Main Operations/Service Coupons

Main operations	Interval running coupons: every 12,500 mi (20,000 km) or 1 year					
	1°	2°	3°	4°	5°	6°
Vehicle road test		I		I		I
Check with Maserati Diagnosis	I	I	I	I	I	I
Engine oil and filter	R	R	R	R	R	R
Engine coolant level	I	I	I	I	I	I
Engine check for leaks	I	I	I	I	I	I
Cooling system connections and lines (check for leaks)		I		I		I
Air filter				R		
Belt for alternator	I	I	I	R	I	I
	Replace every time the part is removed					
Belt for water pump and air conditioning compressor	I	I	I	R	I	I
	Replace every time the part is removed					
Spark plugs			R			R
Intercooler check for leaks	I	I	I	I	I	I
Brake fluid	I	I	I	I	I	I
	Replace every 2 years					
Brake system (lines, calipers, connections) - Instrument cluster warning light efficiency - Parking brake operation	I	I	I	I	I	I
Tire wear, tire and spare tire (if equipped) pressure check	I	I	I	I	I	I
Joints, rods for front and rear suspensions, front and rear under-chassis		I		I		I





Service coupons	Interval running coupons: every 12,500 mi (20,000 km) or 1 year					
	1°	2°	3°	4°	5°	6°
<b>Main operations</b>	<b>Available Pre-Paid Maintenance Program</b>					
Correct operation and reliability of the seats and seat belts	I	I	I	I	I	I
Pollen filter		R		R		R
Windshield fluid level - Windshield washer	I	I	I	I	I	I
Headlight leveling	I	I	I	I	I	I
Controls and adjustment systems in general, hinges, doors, engine compartment lid and luggage compartment	I		I		I	
Condition of leather interiors	I		I		I	

I = Inspect and carry out any other necessary operation.  
R = Replace.

## Periodic Maintenance

**Every 600 mi (1,000 km) or before long journeys**

Check:

- engine coolant;
- brake fluid;
- windshield washer fluid level;
- tire inflation pressure and condition;
- operation of lighting system (headlights, direction indicators, hazard warning flashers, etc.);

- operation of windshield washer/wiper system and wear of windshield wiper blades.

**Every 1,900 mi (3,000 km)**

Check and top up, if required, the engine oil level.



### WARNING!

**California Proposition 65**  
Operating, servicing and maintaining a passenger vehicle or off-road vehicle can expose you to chemicals including such as engine exhaust, carbon

**monoxide, phthalates and lead, that which are known to the State of California to cause cancer and birth defects or other reproductive harm. To minimize exposure, avoid breathing exhaust, do not idle the engine except as necessary, service your vehicle in a well-ventilated area and wear gloves or wash your hands frequently when servicing your vehicle. For more information go to: [www.P65Warnings.ca.gov/passenger-vehicle](http://www.P65Warnings.ca.gov/passenger-vehicle)**



### Heavy-Duty Vehicle Use

If the car is mainly used under one of the following conditions:

- off-road;
  - short, repeated journeys (less than 4–5 mi/7–8 km) at sub-zero outside temperatures;
  - engine often idling or driving long distances at low speeds or long periods of idleness;
- you should perform the following inspections more frequently than recommended on the “Scheduled Service Plan”:
- check front disc brake pad conditions and wear;
  - check cleanliness of hood and trunk locks, cleanliness and lubrication of linkage;
  - visually inspect conditions of: engine, transmission, pipes and hoses (exhaust - fuel system - brakes) and rubber elements (boots - sleeves - bushes - etc.);
  - check battery charge;
  - visually inspect condition of the accessory drive belts;
  - check and, if necessary, change engine oil and replace oil filter;

- check and, if necessary, replace pollen filter of the A/C system;
- check and, if necessary, replace air cleaner filter.



#### CAUTION!

All maintenance operations for the vehicle must be carried out by an **Authorized Maserati Dealer**. For routine and minor maintenance operations which you can carry out yourself, make sure that you have the necessary experience and always use suitable equipment, original **Maserati** spare parts and the prescribed fluids. Shall this not be the case, do not carry any operation on your own and contact an **Authorized Maserati Dealer**.

### On Board Diagnostic System



Your vehicle is equipped with a sophisticated on board diagnostic system called OBD II. This system monitors the performance of the emissions, engine, and automatic transmission control systems. When these systems are operating properly, your vehicle will provide excellent performance and fuel economy, as

DEALER ePROCESS

well as engine emissions suited to current government regulations. If any of these systems require service, the OBD II system will turn on the Malfunction Indicator Light  on the instrument cluster display (refer to “Instrument Cluster” in section “Dashboard Instruments and Controls”). The system stores as well diagnostic codes and other information to assist your service technician by performing repairs. Although the vehicle will be driveable and will not need towing, contact an **Authorized Maserati Dealer** for service as soon as possible.



#### CAUTION!

- Prolonged driving with the MIL  on could cause further damage to the emissions control system. It could also affect fuel economy and driveability. The vehicle must be serviced before any emissions tests can be performed.
- If the MIL  is flashing while the engine is running, severe catalytic converter damage and power loss will soon occur. Immediate service at an **Authorized Maserati Dealer** is required.





## Emissions Inspection and Maintenance Programs



In some localities, it may be a legal requirement to pass an inspection of your vehicle's emissions control system. Failure to pass could prevent vehicle registration. For states that require an Inspection and Maintenance (I/M), this check verifies the "Malfunction Indicator Light  " is functioning and is not on when the engine is running, and that the OBD II system is ready for testing.

Normally, the OBD II system will be ready. The OBD II system may **not** be ready if your vehicle was recently serviced, recently had a dead battery or a battery replacement. If the OBD II system should be determined not ready for the I/M test, your vehicle may fail the test.

To check if your vehicle's OBD II system is ready, you must do the following:

1. Press the ignition device to the **RUN** position, but do not crank or start the engine.
2. As soon as you press the ignition device to turn the engine On, you will see the MIL remain illuminated for 15 seconds, this is a normal bulb check.
3. Approximately 15 seconds later, one of two things will happen:
  - The MIL  will remain illuminated and a message error will appear on your instrument cluster. This means that your vehicle's OBD II system is not ready and you should not proceed to the I/M station.
  - The MIL  will turn Off. This means that your vehicle's OBD II system is ready and you can proceed to the I/M station.

If your OBD II system is not ready, you should see an **Authorized Maserati Dealer** or repair facility. If your vehicle was recently serviced or had a battery failure or replacement, you may need to do nothing more than drive your vehicle as you normally would in order for your OBD II system to update. A recheck with the above test routine

may then indicate that the system is now ready. Regardless of whether your vehicle's OBD II system is ready or not, if the MIL  is illuminated during normal vehicle operation you should have your vehicle serviced before going to the I/M station. The I/M station can fail your vehicle because the MIL  is on with the engine running.

## Spare Parts

Use of genuine Maserati parts for normal or scheduled maintenance and repairs is highly recommended to ensure excellent performance. Damage or failures caused by non-genuine spare parts used for maintenance and repairs will not be covered by the manufacturer's warranty.

## Dealer Service

An **Authorized Maserati Dealer** has the qualified service personnel, special tools, and equipment to perform all service operations in an expert manner. Service Manuals are available which include detailed service information for your vehicle. Refer to these Service Manuals before attempting any procedure yourself.



Intentional tampering with emissions control systems may void your warranty and could result in civil penalties.



### WARNING!

You can be badly injured working on or around a motor vehicle. Take your vehicle to an Authorized Maserati Dealer.



### WARNING!

**California Proposition 65**  
Operating, servicing and maintaining a passenger vehicle or off-road vehicle can expose you to chemicals including such as, engine exhaust, carbon monoxide, phthalates and lead, that which are known to the State of California to cause cancer and birth defects or other reproductive harm. To minimize exposure, avoid breathing exhaust, do not idle the engine except as necessary, service your vehicle in a well-ventilated area and wear gloves or wash your hands frequently when servicing your vehicle. For more information go to:  
[www.P65Warnings.ca.gov/passenger-vehicle](http://www.P65Warnings.ca.gov/passenger-vehicle)

## Maintenance Procedures

The following pages contain the “required” maintenance standards determined by Maserati engineers. Besides those maintenance items specified in the “Scheduled Service Plan”, there are other components which may require service or replacement in the future.

To perform most of the services, it is necessary to open the hood (see “Hood Operation” in section “Before Starting”).

The following images show the position of the components involved in the maintenance service.



### CAUTION!

- Failure to properly maintain your vehicle or perform repairs and service when necessary could result in more costly repairs, damage to other components or negatively impact vehicle performance. Immediately have potential malfunctions examined by an **Authorized Maserati Dealer** or a qualified repair center.
- Your vehicle has been equipped with improved fluids that protect the performance and durability of your vehicle and also allow extended

maintenance intervals. Do not use chemical flushes for washing as the chemicals can damage your engine, transmission, power steering or air conditioning. Such damages are not covered by the New Vehicle Limited Warranty. If a flush is needed because of component malfunction, use only the specified fluid for the flushing procedure.





## Maintenance Service Components

- |  |   |
|--|---|
| <ol style="list-style-type: none"> <li>1 Engine oil dipstick.</li> <li>2 Engine oil filler neck.</li> <li>3 Air cleaner filters.</li> <li>4 Engine coolant expansion reservoir cap.</li> </ol> | <ol style="list-style-type: none"> <li>5 Coolant reservoir cap for transmission cooling system.</li> <li>6 Washer fluid reservoir cap.</li> <li>7 Brake fluid reservoir access cover.</li> <li>8 A/C pollen filter access cover.</li> <li>9 Integrated power module (fuses).</li> </ol> |
|--|---|

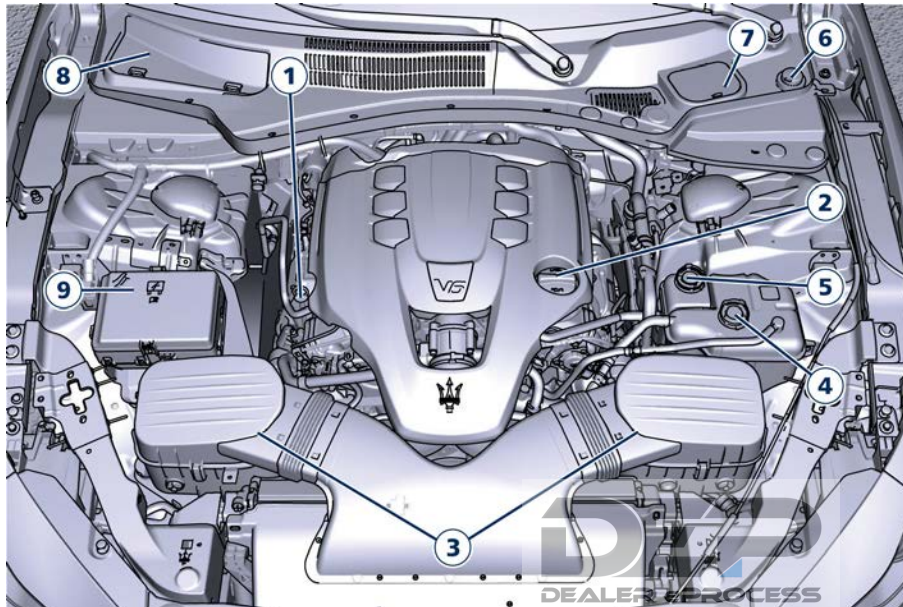

## Level Checks



### ENVIRONMENTAL!

- The engine oils and fluids used contain substances that are dangerous to the environment. For replacement you are advised to contact the Authorized Maserati Dealer, where all the necessary equipment is available to dispose of the used oil and fluids in compliance with the regulations in force and in an environment-friendly manner.
- All equipment used for fluids replacement (gloves, cloths, containers, etc) must be disposed of in compliance with the regulations in force.

### Engine Coolant Level Check

Your vehicle has been equipped with an improved engine coolant (antifreeze) that offers high protection against corrosion, freezing and allows extended maintenance intervals. To prevent reducing extended maintenance periods, it is important to use original engine coolant (antifreeze) when adding coolant throughout the life of your vehicle.



When adding engine coolant (antifreeze) use pure water only, such as distilled or deionized water when mixing the water/engine coolant (antifreeze) solution. The use of impure water will reduce the amount of corrosion protection in the engine cooling system.

- Mix a minimum solution of 50% engine coolant (antifreeze) and distilled water. Use higher concentrations (do not exceed 70%) if temperatures below  $-35^{\circ}\text{F}$  ( $-37^{\circ}\text{C}$ ) are forecast.

Please note that it is the owner's responsibility to maintain the proper level of protection against freezing according to the temperatures occurring in the circulation area of the vehicle.

The coolant bottle provides a quick visual method to determine that the coolant level is adequate. As long as the engine operating temperature is satisfactory, the coolant bottle only needs to be checked once a month. With the engine off and cold, the level of the coolant in the bottle on the left side of the engine compartment should be between the ranges indicated on the bottle and inside the filler neck.

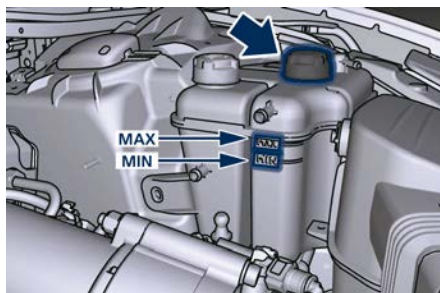

- When additional engine coolant (antifreeze) is needed to maintain the proper level, it should be added to the coolant bottle after removing the cap. Do not overfill.
- Once the desired level is reached, reassemble and firmly close cap of the bottle.
- If frequent engine coolant (antifreeze) additions are required, or if the level in the coolant recovery

bottle does not drop when the engine cools, the cooling system should be tested by an **Authorized Maserati Dealer**.

- Keep the front of the radiator and the condenser clean.



### WARNING!

- **Never add engine coolant (antifreeze) when the engine is hot. Do not loosen or remove the cap of the engine coolant bottle to cool a hot engine. Heat causes pressure to build up in the cooling system. To prevent scalding or injury, do not remove the pressure cap while the system is hot or under pressure.**
- **When adding coolant do not use a pressure cap other than the one specified for your vehicle. Personal injury or engine damage may result.**



### WARNING!

**California Proposition 65**  
Operating, servicing and maintaining a passenger vehicle or off-road vehicle can expose you to chemicals including such as, engine exhaust, carbon monoxide, phthalates and lead, that



which are known to the State of California to cause cancer and birth defects or other reproductive harm. To minimize exposure, avoid breathing exhaust, do not idle the engine except as necessary, service your vehicle in a well-ventilated area and wear gloves or wash your hands frequently when servicing your vehicle. For more information go to: [www.P65Warnings.ca.gov/passenger-vehicle](http://www.P65Warnings.ca.gov/passenger-vehicle)

### Brake Fluid Level Check

Check the fluid level immediately if the brake system warning light **BRAKE** (USA) and the related message turn on indicating a low level of brake fluid.

- Remove the brake fluid reservoir access cover.

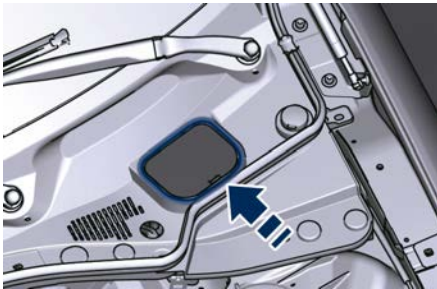

- Clean the top of the master cylinder reservoir before removing the cap.
- Add fluid to bring the level up to the “MAX” mark on the side of the master cylinder reservoir. Use only manufacturer's recommended brake fluid (see “Refillings” in section “Features and Specifications”).
- Once the correct level is reached, firmly close the cap.

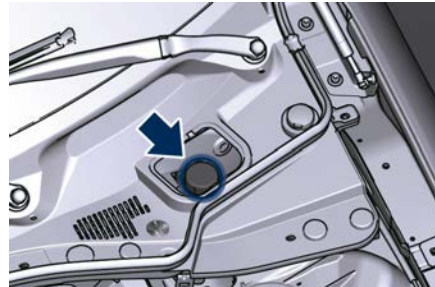

Normal brake pad wear could cause the fluid level to fall. However, low fluid level may be caused by a leak too, and requires accurate checkup of the braking system.



### CAUTION!

The symbol  on the tank cap identifies the synthetic type of brake fluid, distinguishing it from the mineral type. Using mineral fluids

damages the special rubber linings of the brake system irreparably.



### WARNING!

- To avoid contamination from foreign materials or moisture, use only new brake fluid or fluid that has been in a tightly closed container. Keep the master cylinder reservoir cap secured at all times.
- Overfilling the brake fluid reservoir can result in spilling brake fluid. Brake fluid can also damage painted and vinyl surfaces, make sure it does not spill over these surfaces.
- Do not allow petroleum based fluid to contaminate the brake fluid. Brake seal components could be damaged.

### Adding Washer Fluid

The reservoir on the left side of the engine compartment contains the fluid to wash the windshield. During scheduled services or when the message of low level of the washer fluid appears together with the related telltale  add more fluid as soon as possible.



The fluid reservoir may contain nearly 3.7 Quarts (3.5 litres) of washer fluid.

- Remove the reservoir cap in the engine compartment and lift the filler neck.

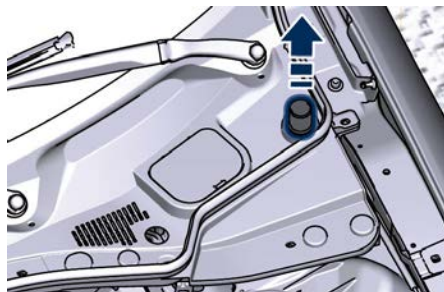

- Fill the reservoir with windshield washer solvent (refer to “Refillings” in section “Features and Specifications”) and operate the system for a few seconds to flush out the residual water.

- When refilling the washer fluid reservoir, apply some washer fluid to a cloth or towel and wipe the wiper blades clean. This will help blade performance.

To prevent freeze-up of your windshield washer system in cold weather, select a solution or mixture that meets or exceeds the temperature range of your climate. This rating information can be found on most washer fluid containers.

### NOTE:

*The Authorized Maserati Dealer can provide you with information about the Maserati recommended “Windshield Washer Fluid” with antifreeze, available in the “Genuine Accessories” catalog.*



- **Commercially available windshield washer solvents are flammable. They could ignite and burn you. Care must be exercised when filling or when working around the windshield washer system.**

- **Do not drive with the windshield washer reservoir empty; the action of the washer is essential for**

**improving visibility when driving.**



### WARNING!

**California Proposition 65**  
**Operating, servicing and maintaining a passenger vehicle or off-road vehicle can expose you to chemicals including such as, engine exhaust, carbon monoxide, phthalates and lead, that which are known to the State of California to cause cancer and birth defects or other reproductive harm. To minimize exposure, avoid breathing exhaust, do not idle the engine except as necessary, service your vehicle in a well-ventilated area and wear gloves or wash your hands frequently when servicing your vehicle. For more information go to:**  
[www.P65Warnings.ca.gov/passenger-vehicle](http://www.P65Warnings.ca.gov/passenger-vehicle)

### Engine Oil Level Check

To assure proper lubrication of your vehicle's engine, the engine oil must be maintained at the correct level. If the  warning light illuminates and the related message of low oil level displays, or during scheduled services (see “Scheduled Maintenance

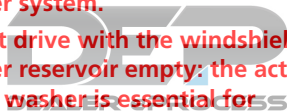



Service” in this section) it is necessary to check the engine oil level. The best time to check the engine oil level is about five minutes after a fully warmed up engine is shut off or before starting the engine after it has sat overnight. In both cases the vehicle should be parked on level ground to improve the accuracy of the oil level readings.



### CAUTION!

- Do not top up with oil with different characteristics than the engine one (refer to “Refillings” in section “Features and Specifications”).
- Overfilling or underfilling the oil pan will cause aeration or loss of oil pressure. This could damage your engine.
- Do not add any supplemental materials to the engine oil. Engine oil is an engineered product, and its performance may be impaired by supplemental additives.
- Remove the dipstick and clean it with a dry and clean cloth.

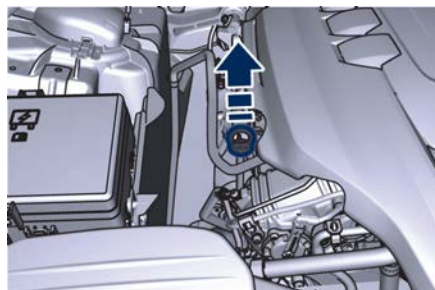

- Re-insert the dipstick completely and remove: the oil level should maintain between the “MIN” and “MAX” reference ranges (SAFE range).

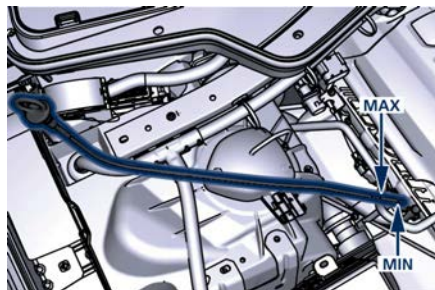

- If a refill is necessary: unscrew the filler neck cap.



- Adding 1.1 Quart (1 liter) of oil when the level is at the bottom of the SAFE range will result in the level being at the top of the SAFE range.
- Return the cap and dipstick to their position and wait for a few minutes to allow the oil to reach the oil pan.
- Check the level again.

### Engine Oil Filter Replacement

The engine oil filter should be replaced with a new filter at every oil change.

Contact the **Authorized Maserati Dealer** to perform this service.

### Automatic Transmission Oil Check

Contact the **Authorized Maserati Dealer** for the oil level check.



## Fluid Level Check for Coolant Transmission System

The coolant contained in the bottle of this system is the same as the one used for the cooling system of the engine. For the preparation of the mixture of water and antifreeze and for the control of the level, proceed as shown in the "Engine Coolant Level Check" of this chapter.

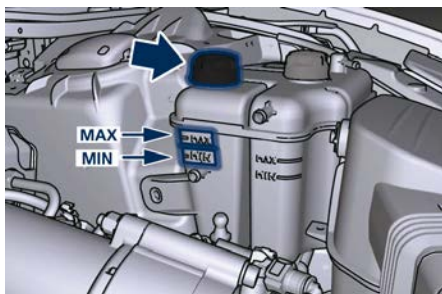
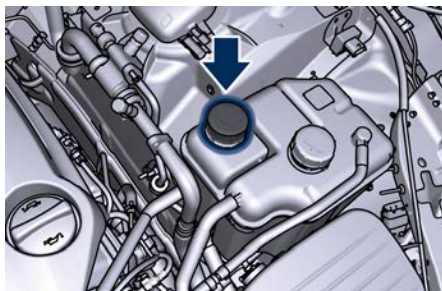

## Engine Air Filters Replacement

Contact an **Authorized Maserati Dealer** to have the air filters replaced.

## A/C Air Filter Replacement

This filter performs mechanic/ electrostatic air filtering, provided that windows and doors are closed. The filter is located under the hood on the passenger side of the vehicle, next to the windshield wipers.

To replace the filter during the scheduled maintenance services or after the vehicle has been heavily used on dusty roads, proceed as follows:

- Remove the access door in the cowl screen by pressing the retaining clips indicated.

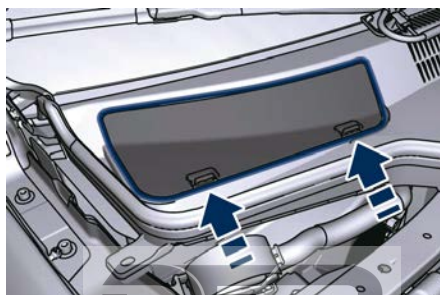

- Unsnap both ends and lift the filter retaining cover.

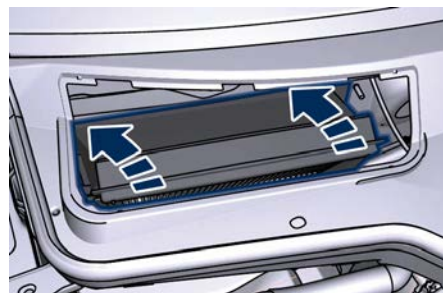

- Remove the used filter slipping it off from within the air intake.
- Install the new filter with arrows pointing in the direction of airflow, which is toward the rear of the vehicle (text and arrows on the filter will indicate this).



- Close the filter retaining cover and reinstall the access door.

**CAUTION!**

Failure to replace the filter may considerably reduce the air conditioning and heating system efficiency.

## Wiper Maintenance and Blades Replacement

### Windshield Wiper Arms Lifting

When the windshield wiper arms are in rest position it is not possible to check or replace the blades as they remain under the engine hood. To service the blades it is necessary to move the wiper arms in "Service" position (see chapter "Wipers and Washers" in section "Understanding the Vehicle"). In this way it is possible to lift the arms for cleaning or replacing the wiper blades.

**WARNING!**

It is dangerous to operate or service the wiper blades with the windshield wipers in an active position (any position different from "OFF") and with the ignition switch in the RUN position. The rain sensors may suddenly activate the wipers. Always

use the "Service" position for any intervention on the windshield wiper blades.

### Windshield Wiper Maintenance

Life expectancy of wiper blades varies depending on the geographical area's weather conditions where the car is used and frequency of use. Poor performance of blades may be present with chattering, marks on the glass, water lines or wet spots. If any of these conditions are present, clean the wiper blades or replace if necessary. Clean the rubber edges of the wiper blades and the windshield/rear window glasses periodically with a sponge or soft cloth and a mild nonabrasive cleaner. This will remove accumulations of salt or road film. Operation of the wipers on dry glass for long periods may cause deterioration of the wiper blades. Always use washer fluid when using the wipers to remove salt or dirt from a dry windshield.

Avoid using the wiper blades to remove frost or ice from the windshield. Keep the blade rubber out of contact with petroleum products such as engine oil, gasoline, etc.

DEALER ePROCESS

### Spray nozzles

If the jet does not work, first check that there is fluid in the tank (see paragraph "Level checks" in this section) then check that the nozzles are not clogged.

### Windshield Wiper Blades Replacement

- Move the wiper arms into "Service" position, (see chapter "Windshield Wipers and Washers" in section "Understanding the Vehicle") and lift them.
- Press the indicated button, slip off the blade support from the arm and replace it.

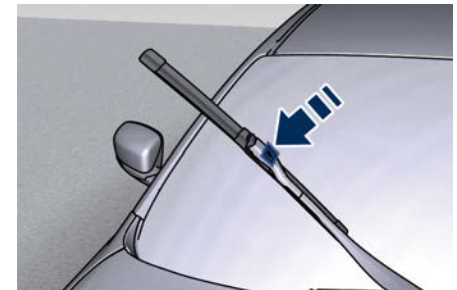

- Return the blade to its original position on the windshield.
- Turn the multifunction lever to one of the automatic settings (see chapter "Windshield Wipers and Washers" in section "Understanding



the Vehicle”) and move the ignition switch to the **RUN** position: the wiper arms will return to the resting position.

### **NOTE:**

*Due to the difficulty of this operation, we recommend that you contact an **Authorized Maserati Dealer** for replacement of the blades.*

## Maintenance-Free Battery

This vehicle is equipped with a sealed type maintenance-free battery. You will never have to add water, nor is periodic maintenance required.



### **WARNING!**

- **Battery fluid is a corrosive acid solution and can burn or damage the eyes. Do not allow battery fluid to contact your eyes, skin, or clothing. If acid splashes in eyes or on skin, flush the area immediately with large amounts of water.**
- **Battery gas is flammable and explosive. Keep flame or sparks away from the battery. Do not use a booster battery or any other booster source with an output greater than 12 Volts. Do not allow cable clamps to touch each other.**
- **Battery posts, terminals, and related accessories contain lead and lead compounds. Wash hands after handling the battery.**
- **The battery in this vehicle has a vent hose that should not be disconnected and should only be replaced with a component of the**

**same type (vented).**

### **NOTE:**

*Remote battery terminals for starting are located in the engine compartment for jump-starting to be used with an auxiliary battery or a battery from another vehicle (see “Auxiliary Jump-Start Procedure” chapter in section “In an Emergency”).*

## To Disconnect the Battery

The battery is located on the inner right side of the trunk compartment. To access the battery it is necessary to lift the ground coverage of the trunk compartment and remove the access cover turning the release latch shown.

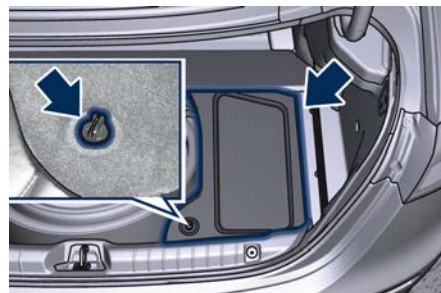



**WARNING!**

**California Proposition 65**  
**Operating, servicing and maintaining**  
**a passenger vehicle or off-road vehicle**  
**can expose you to chemicals including**  
**such as, engine exhaust, carbon**  
**monoxide, phthalates and lead, that**  
**which are known to the State of**  
**California to cause cancer and birth**  
**defects or other reproductive harm. To**  
**minimize exposure, avoid breathing**  
**exhaust, do not idle the engine except**  
**as necessary, service your vehicle in a**  
**well-ventilated area and wear gloves**  
**or wash your hands frequently when**  
**servicing your vehicle. For more**  
**information go to:**  
[www.P65Warnings.ca.gov/passenger-vehicle](http://www.P65Warnings.ca.gov/passenger-vehicle)

**CAUTION!**

- Before disconnecting the battery, open the trunk and lower the windows a few centimeters, to avoid damaging the seal when opening and closing the door. When the battery is connected, the lowering of the window is performed automatically when the door is opened and closed. The trunk lid must remain open and the windows lowered until the charged battery is reconnected.
- Never disconnect the battery from the electrical system when the engine is running.
- To temporarily disconnect the vehicle electrical system from the battery, simply remove the cable end with quick coupling from the negative post (-) of the battery.
- If the battery needs to be removed from its compartment, you must first detach the terminal clamp to the negative post (-) and then the other terminal clamp to the positive post (+), after removing the protective cover. Battery posts are marked

positive (+) and negative (-) and are identified on the battery case.

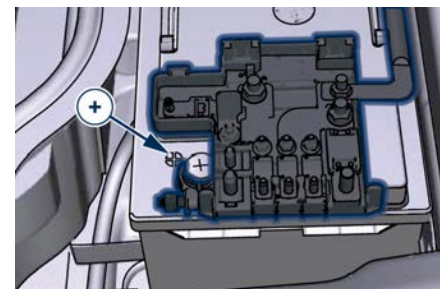
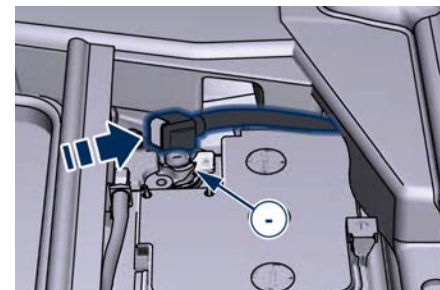

**DEP**  
**DEALER ePROCESS**



## To Reconnect the Battery

### NOTE:

When the battery cables have been disconnected and the trunk lid has been locked, it is necessary to pull the emergency release lever in order to re-open it. To access the trunk and operate the emergency release fold one of the rear seatbacks (see “Cargo Area” chapter in section “Understanding the Vehicle”).



### CAUTION!

- It is essential when replacing the cables on the battery that the positive cable is attached to the positive post (+) and the negative cable is attached to the negative post (-).
- Cable clamps should be tight on the terminal posts and free of corrosion.

After the battery has been disconnected and re-connected and before starting the engine it is necessary to proceed as follows:

- Unlock and lock the doors using the Key fob RKE Transmitter.
- Close manually the boot lid, unlock it with the key fob RKE transmitter and then lock it manually one more time.

If the vehicle is equipped with Power Boot Lid/Hand Free, manually perform the complete closure. Then move the lid automatically, using the buttons on the lid itself, performing a complete cycle of opening and closing.

- Initialize the climate control system by activating the system and pressing the “AUTO” control as described in chapter “Air Conditioning Controls” in section “Dashboard Instruments and Controls”.
- Turn on the MTC+ and set the date and time (see “MTC+ Settings” in section “Dashboard Instruments and Controls”).
- Lift, release and lift again the lever on the central console to initialize the electric parking brake. Following this operation the warning light on the instrument cluster will turn off.
- For correct activation of the approach lights on the external mirrors, press at least once the tilt button on the driver’s door panel so that the door mode recognizes the mirrors position.



### CAUTION!

- Every time the battery is reconnected, wait at least 30 seconds with the ignition switch turned on **RUN** before starting the engine, in order to allow the electronic system that manages the motor-driven throttles to run a self-learning cycle. At the same time, you can run the date and time set up procedure for the MTC+.
- Every time the battery is reconnected the warning light flash for about 10 seconds and then go off.



### WARNING!

**California Proposition 65**  
Operating, servicing and maintaining a passenger vehicle or off-road vehicle can expose you to chemicals including such as, engine exhaust, carbon monoxide, phthalates and lead, that which are known to the State of California to cause cancer and birth defects or other reproductive harm. To minimize exposure, avoid breathing engine exhaust, do not idle the engine except as necessary, service your vehicle in a



**well-ventilated area and wear gloves or wash your hands frequently when servicing your vehicle. For more information go to: [www.P65Warnings.ca.gov/passenger-vehicle](http://www.P65Warnings.ca.gov/passenger-vehicle)**

## Useful Advice to Extend Battery Life

When parking the vehicle, make sure that the doors, front, rear lids and flaps are properly closed. All interior lights should be off.

When the engine is turned off, do not keep the connected devices switched on for a long time (such as radio, hazard warning flashers, fan, etc.).



### CAUTION!

If the battery charge remains below 50% for a long period of time, it will be damaged due to sulfation; its performance and starting power will be reduced and it will be more subject to freezing.

We recommend you to have the battery charge condition checked, preferably at the beginning of the cold season, to prevent the electrolyte from freezing.

This check should be carried out more frequently if the vehicle is used mainly for short trips or if it is equipped with power-absorbing devices that remain permanently on even when the ignition switch is off. This applies above all if these devices have been retrofitted ("Aftermarket" services). If the vehicle is not used for long periods of time, please see "Vehicle Stored for Long Periods" in this section.

## Battery Recharge



### WARNING!

**The process of charging or recharging the battery produces hydrogen, a flammable gas that can explode and cause serious injuries. When charging or recharging the battery, follow the recommended precautions at all times.**

- **Before using a charger device always check that this tool is suitable for the installed battery, with constant voltage (lower than 14.0 V) and low amperage (maximum limit 15 A).**
- **Recharge the battery in a well-ventilated environment.**

- **Never charge or recharge a frozen battery.**
- **Ensure that any sparks or open flames are kept well away from the battery while it is charging.**
- **Before using a charger to charge or maintain the battery charge status, carefully follow the instructions provided to ensure the charger is connected to the battery safely and correctly.**

It is possible to recharge the battery without disconnecting the cables of the vehicle electrical system.

- To access the battery lift the ground coverage of the trunk compartment and remove the access cover as previously shown (see paragraph "To Disconnect the Battery" in this chapter.
- Remove the protection cover and connect the terminal clamp of the charger positive cable (typically in red) to the positive post (+) of the battery.
- Connect the terminal clamp of the charger negative cable (typically in black) to the nut located by the negative post (-) on the battery, indicated in the picture.

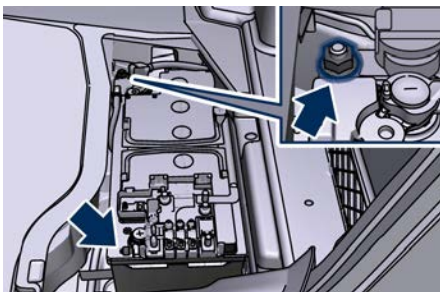

The vehicle is equipped with an IBS (Intelligent Battery Sensor) sensor able to measure charging and discharging currents and to calculate the state of charge and state of health of the battery. This sensor is located at the negative post (-) of the battery. For a successful charge/recharge operation, the charging current must flow through the IBS sensor as shown in the picture.

- Turn the charger on and follow the instructions on its user manual to completely recharge the battery.
- When the battery is recharged, turn off the battery charger before disconnecting it from the battery.
- Disconnect first the terminal clamp of the charger black cable from the battery and then the terminal clamp of the red cable.
- Reassemble the protection cover on the battery positive post and the other parts removed for this operation.

information go to:  
[www.P65Warnings.ca.gov/passenger-vehicle](http://www.P65Warnings.ca.gov/passenger-vehicle)



**WARNING!**  
**California Proposition 65**  
**Operating, servicing and maintaining a passenger vehicle or off-road vehicle can expose you to chemicals including such as, engine exhaust, carbon monoxide, phthalates and lead, that which are known to the State of California to cause cancer and birth defects or other reproductive harm. To minimize exposure, avoid breathing exhaust, do not idle the engine except as necessary, service your vehicle in a well-ventilated area and wear gloves or wash your hands frequently when servicing your vehicle. For more**

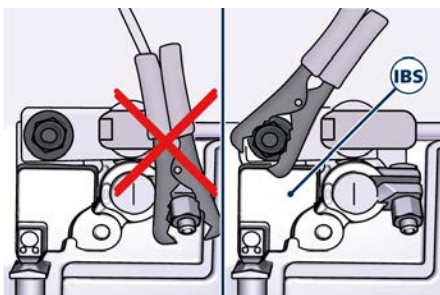



## Fuse Replacement

### Used Fuses Characteristics

When an electrical device is not functioning, check that the corresponding fuse is in proper working order (intact).

- A Fuse intact
- B Fuse blown

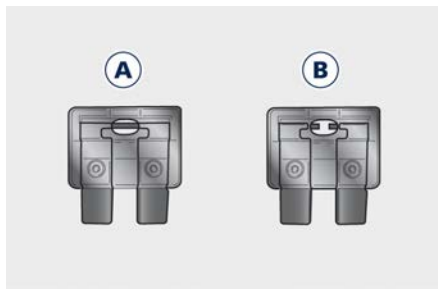

The vehicle mainly uses mini-and maxi-fuses with blade engagement. Besides these there are other types of fuses provided with holes for attaching to the cable connection terminals.

For the replacement of these fuses contact an **Authorized Maserati Dealer**.

Replace the faulty fuse with a new one featuring the same rating, by

using appropriate forceps added in the integrated power module and inside the cover of the rear power distribution center.

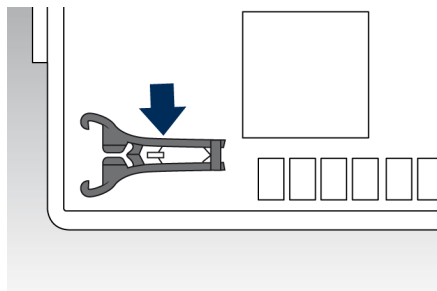

The color identifies the value of the fuses in amperes which is also reported on them.

The table shows the match between color and amperage of mini and maxi fuses.

Type	
Mini Fuse	Maxi Fuse
Beige - 5	Yellow - 20
Brown - 7,5	Green - 30
Red - 10	Orange - 40
Blue - 15	Red - 50
Yellow - 20	Blue - 60
White - 25	
Green - 30	



### CAUTION!

- Never replace a blown fuse with anything other than a new and suitable fuse (same rating).
- After replacing a fuse, if the fault recurs, contact an **Authorized Maserati Dealer**.

### Position of Fuses

The fuses are located in three parts of the vehicle, namely:

- inside the integrated power module, on the right hand side of the engine compartment;

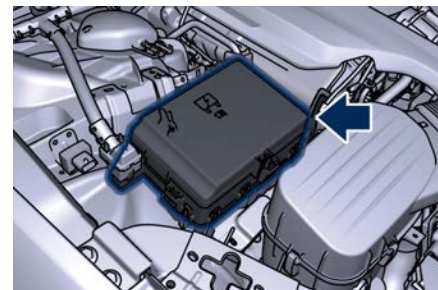

- inside the rear power distribution center, behind the battery, on the right hand side of the trunk compartment;



- on the fuse and relay box located in a covered area, behind the glove compartment on the dashboard left side.

## Integrated Power Module

- To access the module it is necessary to lift the hood (see "Hood Operation" in section "Before Starting").
- To access the fuses remove the module cover unhooking the lateral locks as shown in the picture.

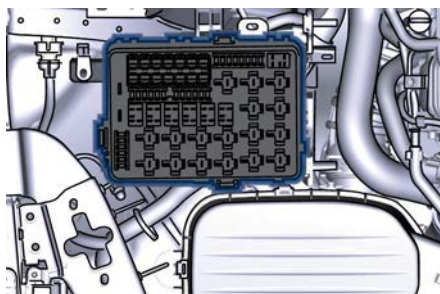
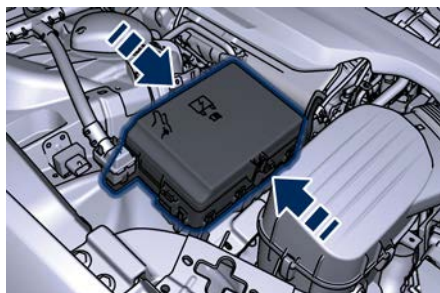

The table points out the position as featured in the figure, the type and function of the fuses included in the integrated power module.



### CAUTION!

- After replacement, refit the protective cover of the module.
- If you need to wash the engine compartment, do not direct the water for too long directly on the

module.

Ref.	Type	Function
2	–	–
3	–	–
4	Maxi – 30A	Starter motor relay input
5	Maxi – 40A	ABS-ESP pump feed
6	Maxi – 30A	AWD module (AWD version only)
7	–	–
8	Maxi – 40A	ABS-ESP valve feed
9	–	–
10	–	–
11	Mini – 20A	Horn relay input
12	Mini – 10A	AC compressor feed relay input
13	–	–
14	Mini – 7,5A	Alarm siren
15	Mini – 10A	Washer heated nozzles relay input



Ref.	Type	Function
16	Mini – 10A	Enable cooling fan relay input and enable cooling oil pump relay input
18	–	–
19	–	–

Ref.	Type	Function
20	Maxi – 30A	Wiper motor relay output
21	Maxi – 20A	LH low beam relay input (Bi-Xenon headlight)

Ref.	Type	Function
22	Maxi – 20A	RH low beam relay input (Bi-Xenon headlight)
23	–	–
24	–	–
28	Mini – 7,5A	Driver Assist System Module (DASM)
29	Mini – 10A	PCM module - Starter solenoid relay coil
30	Mini – 5A	ORC- Air bag module
31	Mini – 5A	ABS-ESP module
32	Mini – 5A	SSCU, AWD module (AWD version only), EPS and AQS
33	Mini – 20A	HDLP LED Headlights
34	Mini – 15A	Primary load to engine harness LH side
35	Mini – 15A	Primary load to engine harness RH side

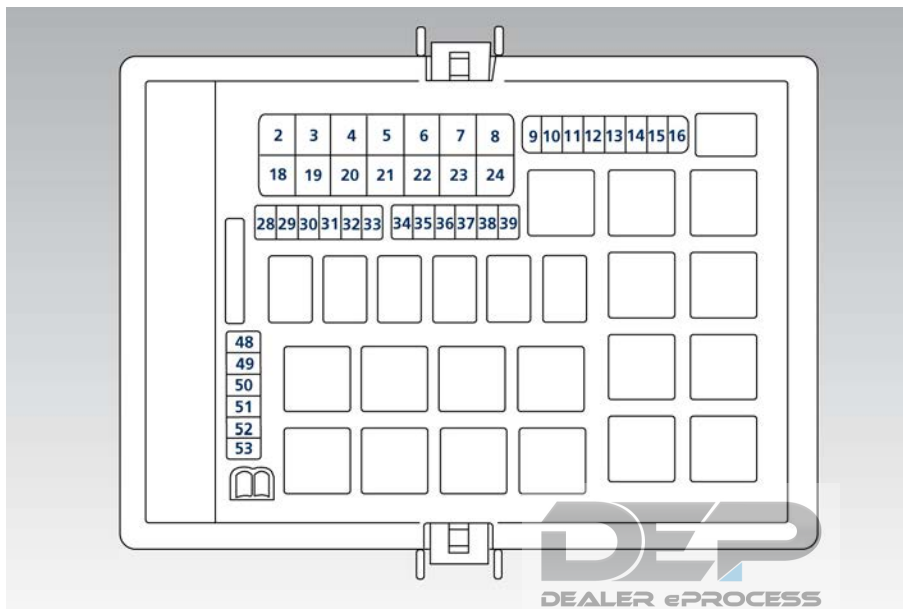



Ref.	Type	Function
36	Mini – 30A	PCM module primary load
37	Mini – 15A	Engine secondary load
38	Mini – 15A	Lambda sensor
39	Mini – 7,5A	Flow meters, tank lackage, canister, exhaust by-pass valve and relay coil
48	–	–
49	Mini – 10A	Pedal brake switch - TCM module
50	Mini – 15A	+30 PCM module
51	Mini – 30A	Fuel pump relay input
52	Mini – 5A	Starter solenoid signal for PCM and voltage stabilizer
53	Mini – 10A	AWD module (AWD version only)

## Rear Power Distribution Center

- To access the center it is necessary to lift the ground coverage of the trunk compartment and remove the access cover (refer "Maintenance Free Battery" in this section).
- To access the fuses, unhooking the cover lock shown in picture.

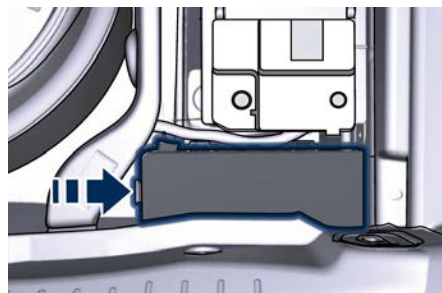

- Press the release latch and lift the lid from this side.
- Push the lid toward the right side to release the indicated latches on the unit.

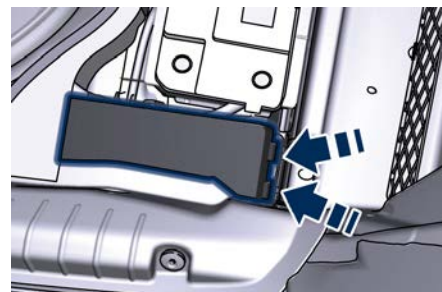

The table points out the position as featured in the figure, the type and function of the fuses on the rear area distribution control unit.

Ref.	Type	Function
2	Maxi – 40A	BCM module
3	Maxi – 40A	BCM module
4	Maxi – 30A	BCM module
5	Maxi – 30A	BCM module
6	Maxi – 20A	Sunroof module
7	Maxi – 30A	Driver door module
8	Maxi – 30A	Passenger door module
9	Maxi – 40A	Start&Stop: voltage stabilizer, dashboard





Ref.	Type	Function
10	Maxi – 40A	Start&Stop: voltage stabilizer, body

Ref.	Type	Function
11	Maxi – 40A	“High Premium” stereo amplifier unit
	Maxi – 20A	“Premium” stereo amplifier unit (1)
15	Maxi – 40A	HVAC front blower relay coil

Ref.	Type	Function
16	Maxi – 40A	Rear window defrost relay coil (HVAC module)
17	Maxi – 30A	Rear LH door module
18	Maxi – 30A	Rear RH door module
19	–	–
20	Maxi – 20A	“Premium” stereo amplifier unit (2)
21	–	–
22	–	–
23	Mini – 10A	Fuel door relay and RF Hub module
24	Mini – 10A	ITM module, ceiling light units (front and rear), rain/lights sensor
25	–	–
26	–	–
27	–	–
31	Mini – 25A	LH front seat movement
32	–	–
33	–	–

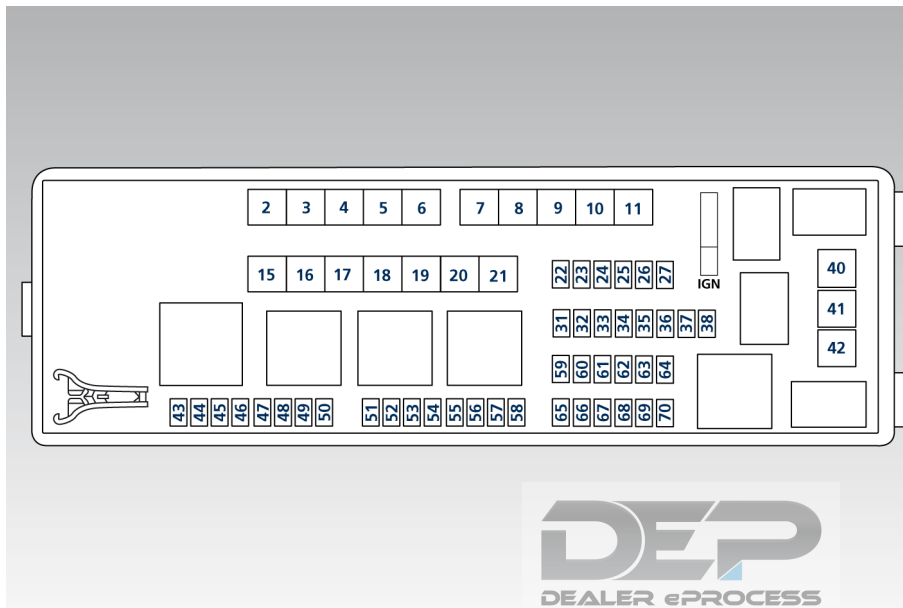



Ref.	Type	Function
34	Mini – 20A	Soft Door Close latch
35	–	–
36	Mini – 10A	Transmission lever, TPMS module, Navtrak, Hands Free access module
37	Mini – 50A	Power liftgate/trunk lid module
38	Mini – 25A	RH front seat movement
40	Maxi – 20A	Trunk power outlet
41	–	–
42	–	–
43	Mini – 20A	Seat passenger heater module
44	–	–
45	–	–
46	Mini – 5A	Rear camera
47	Mini – 5A	Navtrak
48	Mini – 5A	Surround view

Ref.	Type	Function
49	Mini – 10A	Internal temperature sensor, internal mirror and HALF
50	–	–
51	Mini – 25A	Rear seat and steering wheel heater module
52	–	–
53	–	–
54	Mini – 7,5A	Blind Spot module
55	–	–
56	Mini – 7,5A	Blower front HVAC coil relay
57	–	–
58	–	–
59	Mini – 10A	SDC module, transmission lever, ASBM, rear tunnel stack switch
60	Mini – 10A	SDC module
61	Mini – 25A	Front console power outlet and cigar lighter
62	Mini – 7,5A	HVAC module

Ref.	Type	Function
63	–	–
64	Mini – 10A	Wi-fi
65	Mini – 10A	Intelligent battery sensor
66	Mini – 10A	Wi-fi
67	Mini – 7,5A	USB charge outlet, sunroof
68	Mini – 20A	Rear sunshade module
69	Mini – 25A	Rear console power outlet and cigar lighter
70	Mini – 10A	HVAC module and Parking Aid Module (PAM)

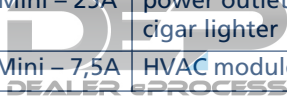



## Fuse Box under the Dashboard

This box is located in an internal area that can be accessed only by removing the glove compartment on the dashboard left side. Considering the complexity of this operation, we recommend having the fuses replaced by an **Authorized Maserati Dealer**. The table points out the position as featured in the figure, the type and function of the fuses in the box under the dashboard.

Ref.	Type	Function
8	Mini – 10A	Start & Stop switch, diagnostic outlet

Ref.	Type	Function
1	Mini – 7,5A	Cluster module, CSS, SGW, DSRC (Japan version only)
2	Mini – 15A	Cluster module, clock
3	Mini – 10A	DSRC, DTV system (Japan version only)
4	Mini – 5A	E-call
5	Mini – 5A	Security Gateway
6	Mini – 25A	Radio
7	Mini – 10A	Column software module, CSS, USB auxiliary port

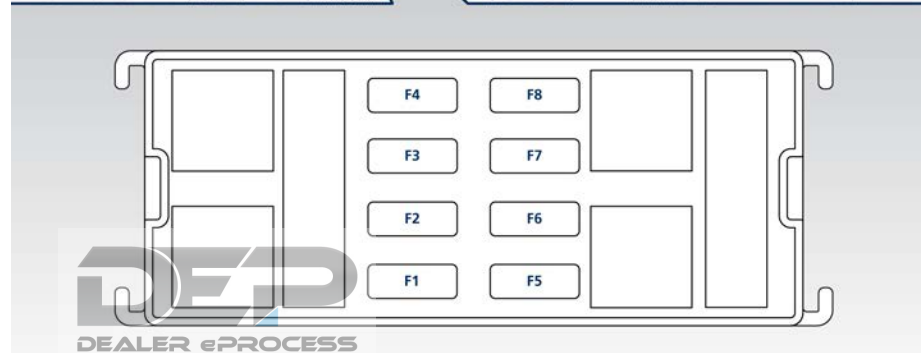
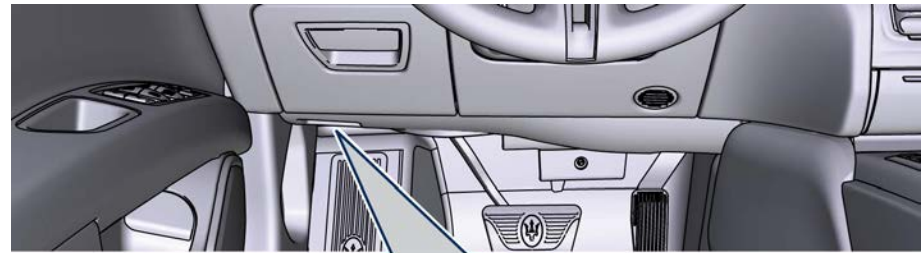



## Bulb Replacement

The signal failure of an external light (turn signal, low beam and high beam, number plate light, reverse light and brake light) is communicated to the instrument cluster that displays on the TFT screen in a graphical form and with a text message which light is faulty (see example in the figure).

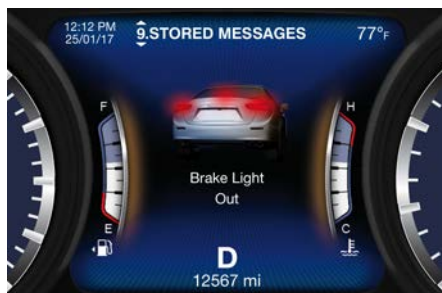

### Front Headlights

The lights are arranged as follows:

#### Bi-Xenon Version

- 1 Low-beam/high-beam light: Bi-Xenon bulb 25W.
- 2 Position and DRL light LED.
- 3 Direction indicator LED.
- 4 Side-marker LED.
- 5 Side reflex-reflector.

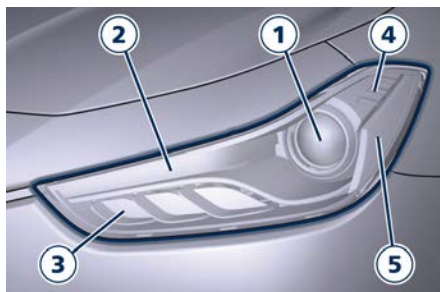

Bi-Xenon Version



#### CAUTION!

Due to the complexity of the operation, for the replacement of the headlight clusters light bulbs, we recommend that you contact an **Authorized Maserati Dealer**.



#### WARNING!

The Bi-Xenon bulb are a type of high voltage discharge tube. High voltage can remain in the circuit even with the ignition switch off. Because of this, you should not attempt to replace a Bi-Xenon bulb yourself, but take the vehicle to an **Authorized Maserati Dealer** for service.



#### Full-LED Version

- 1 Low-beam light LED.
- 2 Position and DRL light LED.
- 3 Direction indicator LED.
- 4 Side-marker LED.
- 5 Side reflex-reflector.
- 6 Bending light LED.
- 7 Matrix high-beam light LED.

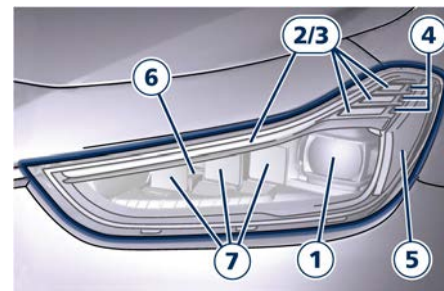

Full-LED Version



#### CAUTION!

It is not possible to replace a single LED of the headlight cluster: we recommend that you contact an **Authorized Maserati Dealer** for the replacement of the entire headlight cluster.



## Taill-Light Clusters

The lights are arranged as follows:

- 1 Position light guide LED.
- 2 Stop light LED.
- 3 Turn signal LED.
- 4 Reverse light bulb (W16W).
- 5 Rear fog light bulb (W16W).



## Light Clusters Replacement

Most of the lights in the front and rear clusters and those integrated in the exterior mirrors are LED powered and cannot be replaced individually. The only exceptions are the front fog light bulbs.

Contact an **Authorized Maserati Dealer** to locate the correct parts and replace them.

## Reverse Light

In order to replace the reverse light bulb, open the trunk lid and proceed as follows:

- Remove the cover on the fastening screws by levering from below on the indicated point.

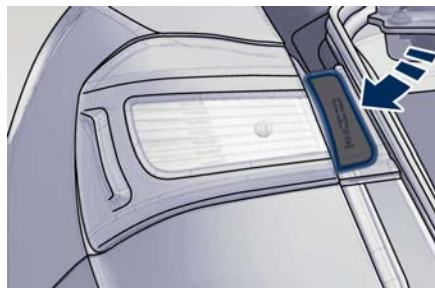

- Using the screwdriver with torx-head contained in the tool kit (see chapter "Tool Kit" in section "In an Emergency"), undo and remove the two indicated fastening screws.



- Remove the inspection cover from the trunk compartment by levering on the specific point.
- Using the 8 mm Allen wrench contained in the tool kit (see chapter "Tool Kit" in section "In an Emergency"), undo and remove the light fastening nut.

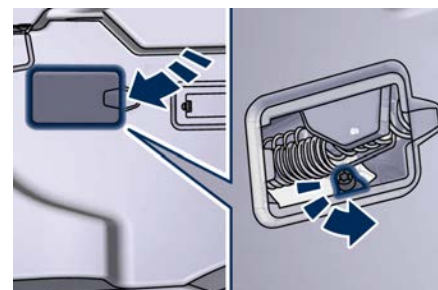

- From behind the vehicle, separate the light cluster from the body by gently pulling it out; do not tension the connecting cable.

**DEP**  
DEALER ePROCESS

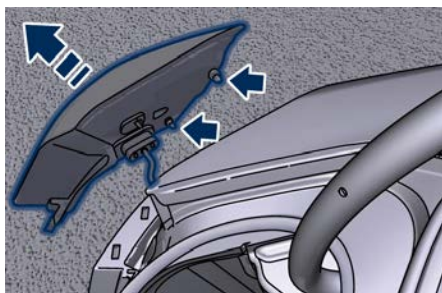

- Rotate the bulb holder anti-clockwise and extract it from the light cluster.
- Extract the bulb from the bulb holder and replace it with a corresponding one.

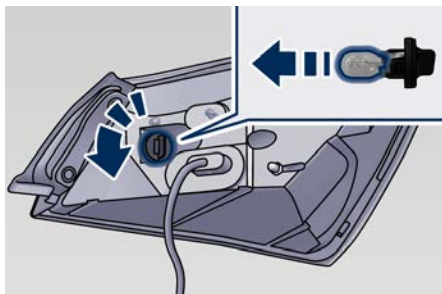

### NOTE:

- The light cluster has two centering pins, during re-assembly they must be inserted in their respective seats on the body. In this phase use particular attention to prevent that the connecting cable remain pinched between light cluster and body, as this could cause electric interruption.
- To avoid damages to the light cluster, do not fasten too much the two Torx fastening screws.

### Rear fog light

In order to replace the rear fog light bulb, open the trunk lid and proceed as follows:

- Remove the access cover by rotating the unlock device anti-clockwise as shown in the picture.

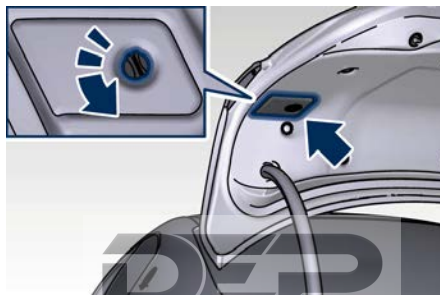

DEALER ePROCESS

- Rotate the bulb holder anti-clockwise and extract it from the light cluster.
- Extract the bulb from the bulb holder and replace it.

### NOTE:

When refitting the access cover, insert first the side tab in the trunk lid opening indicated in the picture, and then rotate the unlock device clockwise.

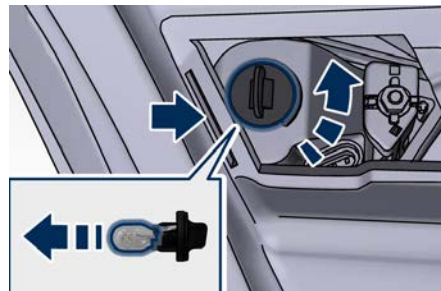

### License Plate Lights

To replace the license plate light bulb (C 5W):

- use a screwdriver positioned at the indicated point to lever out the light fixing frame;

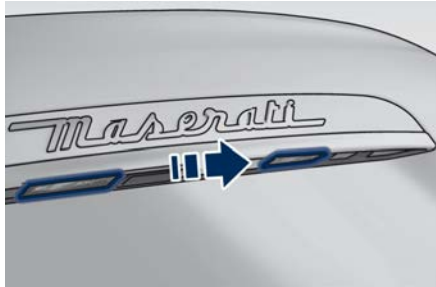

- replace the pressure-fitted bulb;
- refit the bulb holder inserting first the electrical connector side and then pressing on the other side to hook up the clip.

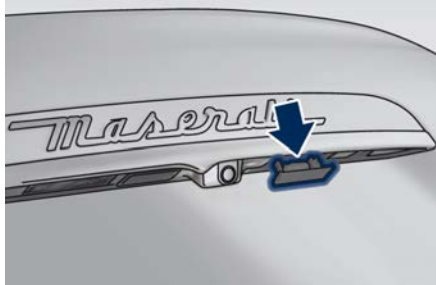

## Interior Lights

Lamps inside the glove box compartments of the dashboard and on the sun visors are LED powered and cannot be replaced by the owner.

Contact an **Authorized Maserati Dealer** to replace them.

## Trunk Compartment Light

To replace the bulbs (W5W) inside the trunk, proceed as follows after trunk lid opening.

- Remove the light fixing frame by levering it out gently at the indicated point with a screwdriver.

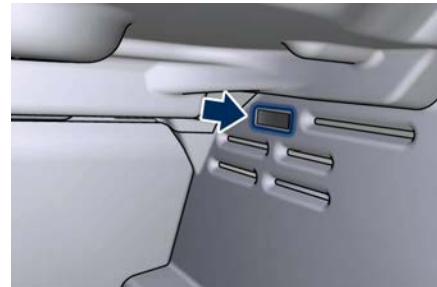

- Raise the lens cover.



**DEP**  
DEALER ePROCESS

- Replace the pressure-fitted bulb.
- Refit the lens cover, inserting first the electrical connector side and then pressing on the other side.

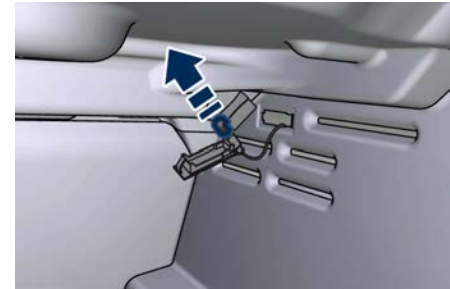



## A/C System Maintenance

For the best performance, the air conditioning system should be checked and serviced by an **Authorized Maserati Dealer** at the beginning of the warm season.

This service should include cleaning of the condenser, check of the drive belt tension and a performance test.

During the winter, the air conditioning system should be operated at least once a month for about 10 minutes.



### CAUTION!

Do not use chemical flushes in your air conditioning system as the chemicals can damage your air conditioning components. Such damage is not covered by the New Vehicle Limited Warranty.



### WARNING!

**California Proposition 65**  
Operating, servicing and maintaining a passenger vehicle or off-road vehicle can expose you to chemicals including such as, engine exhaust, carbon monoxide, phthalates and lead, that which are known to the State of

California to cause cancer and birth defects or other reproductive harm. To minimize exposure, avoid breathing exhaust, do not idle the engine except as necessary, service your vehicle in a well-ventilated area and wear gloves or wash your hands frequently when servicing your vehicle. For more information go to: [www.P65Warnings.ca.gov/passenger-vehicle](http://www.P65Warnings.ca.gov/passenger-vehicle)



### WARNING!

- Use only refrigerants and compressor lubricants approved by the manufacturer for your air conditioning system. Some unapproved refrigerants are flammable and can explode, causing injuries. Other unapproved refrigerants or lubricants can cause the system to fail, requiring costly repairs.
- The air conditioning system contains refrigerant under high pressure. To avoid risk of personal injury or damage to the system, adding refrigerant or any repair requiring lines to be disconnected should be done by an Authorized Maserati

### Dealer.

Periodically remove any leaves and insects that may build up and obstruct the inlet of external air in the air conditioning system through the grille present underneath the rear part of the hood.

To access the grille, lift the hood as described in "Hood Operation" in section "Before Starting".





## Wheels Maintenance

### Tires Maintenance



#### CAUTION!

To obtain the best performances and the longest mileage from the tires, take the following precautions during the first 310 mi (500 km):

- do not drive at the vehicle's maximum speed;
- drive at low speed on curves;
- avoid sudden steering;
- avoid sudden braking;
- avoid sudden acceleration;
- do not drive at high speeds for too long.

The tires inflation pressure must correspond to the prescribed values (see the chapter "Tire Inflation Pressure" in section "Features and Specifications") and should be checked only when the tires have cooled down. In fact, the pressure increases as the tire temperature progressively increases. Never reduce the pressure if tires are hot (see "Tires – General Information" chapter in section "Driving").

Insufficient tire inflating pressure can cause tire overheating and possible internal damage.



#### CAUTION!

After inspecting or adjusting the tire pressure, always reinstall the valve stem cap. This will prevent moisture and dirt from entering the valve stem, which could damage it.

Impacts with curbs, holes, and obstacles in the road, and prolonged trips on rough roads can cause tire damage which may not be visible to the naked eye.

Check your tires regularly for any signs of damage (e.g. scratches, cuts, cracks, bulges, etc.). If sharp objects penetrate the tires, they can cause structural damage which is only visible when the tire is removed.

In any case, any possible damage must be inspected by an experienced technician, as it may seriously reduce the tire life.

Remember that tires deteriorate with time, even if used little or not at all. Cracks in the tire tread and sides, alongside possible bulging, are a sign of deterioration.



#### WARNING!

- Check the inflating pressure of the tires when cold, at least every two weeks and before long trips.
- Have old tires inspected by an experienced technician, to make sure they can still be used safely. If the same tire has been on your vehicle for 4 or 5 years, have it inspected anyway by an experienced technician.
- Never fit tires of uncertain origin.
- "Directional" tires have an arrow on their side showing the rolling direction. To keep the best performance when replacing a tire, make sure that the rolling direction corresponds to the one shown by the arrow.
- During the tire life, the rolling direction used for the first fitting should always be observed, also in case of "nondirectional" tires.
- Check the depth of the tire tread at regular intervals. The thinner is the tread, the greater is the risk of skidding.
- Drive carefully on wet roads to decrease the risk of aquaplaning.



### Winter Tires

These tires are specially designed for driving on snow and ice and are fitted to replace the ones supplied with the vehicle.

The specific features of the winter tires lead to lower performance under normal environmental conditions or on long highway trips, compared to the standard tires.

Therefore, their use should be limited to the situations and performance for which they have been type-approved. The **Authorized Maserati Dealer** can provide all necessary information about fitting winter tires on the vehicle.

#### **NOTE:**

- *We recommend fitting winter tires on the vehicle at temperatures below 45 °F (7°C) since the driving performance of summer tires is reduced at low temperatures. Summer tires may be permanently damaged at extremely low temperatures.*
- *Comply with all state and local laws governing snow tire and tread depth requirements.*

### Wheel Rims Maintenance

All wheel trims should be cleaned regularly with a mild soap and water. To remove heavy soil and/or excessive brake dust, use a nonabrasive, non-acidic cleaner.

Do not use scouring pads, steel wool, a bristle brush, or metal polishes. Do not use oven cleaner that may affect and damage the brake calipers. Avoid automatic car washes that use acidic solutions or harsh brushes that may damage the wheel rim protective finish.

### Bodywork Maintenance and Care

---

#### Protection from Atmospheric Agents

The main causes of corrosion are:

- atmospheric pollution;
- salinity and humidity in the atmosphere (marine areas or a damp climate);
- seasonal environmental conditions;
- salt scattered on the roadbed to melt ice and snow.

The abrasive action of wind-carried atmospheric dust and sand, mud and stones should not be underestimated. On this vehicle, Maserati has adopted the best technological solutions to protect the bodywork from corrosion. The main measures are:

- paint products and systems that give the vehicle particular resistance to corrosion and abrasion;
- use of galvanized (or pre-treated) metal sheets which are highly resistant to corrosion in the most exposed parts;
- spraying of the underbody, engine compartment, insides of wheel housings, and other structures with





wax products having high protective power;

- spraying of plastic materials, with a protective function, in the most exposed points: underneath the doors, inside part of the mud guards, edges, etc.;
- use of ventilated box sections, coated with protective wax products, to avoid condensation and trapped water which could encourage the formation of internal rust.

## Useful Advice to Keep the Bodywork in Good Condition

### Paint

The paintwork does not only have an aesthetic function but also protects the underlying metal sheets. In the event of abrasions or deep scratches, we recommend to have the necessary touch-ups made immediately, to avoid any rust formation. Touch-ups do not feature particular difficulties, even on metallic finishes.

For all paint touch-ups, use only original products indicated on the plate applied on the lower left side of the hood.

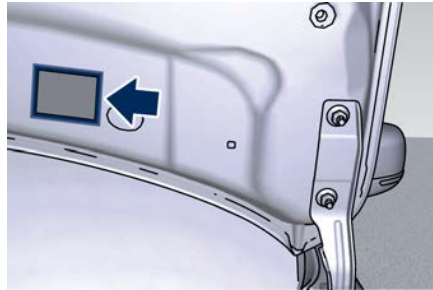

Normal paint maintenance consists in washing, the frequency of which depends on the conditions of use and of the environment. For example, if driving the vehicle in areas where there is high atmospheric pollution or the roads are spread with anti-freeze salt, it is advisable to wash the vehicle more frequently.



### ENVIRONMENTAL!

**Detergents pollute water. Therefore the vehicle should be washed in areas equipped for the collection and purification of the fluids used for washing.**



### NOTE:

*The use of alcohol-based products for cleaning the metal surfaces in the engine compartment and/or the trunk may deteriorate the protective paint. It is recommended to use water-based products.*

### Car Wash

For correct washing:

- wet the bodywork with a low pressure water jet;
- pass a sponge with a light detergent solution over the bodywork, frequently rinsing the sponge;
- rinse well with water and dry with an air jet or chamois leather.

When drying, take particular care with the parts that are less visible, such as the door and lids bays, headlight edges, in which water can be trapped more easily.

You are recommended not to take the vehicle immediately into an enclosed environment, but leave it in the open air so as to allow the water to evaporate.

Do not wash the vehicle after it has been left in the sun or when the hood is hot: the paint gloss could be affected.



External plastic parts must be cleaned with the same procedure followed for the normal washing of the bodywork. Avoid, as far as possible, parking the vehicle under trees; the resinous substances that very often drop from the trees give the paint a dull appearance and increase the possibility of originating corrosive processes. It is important that the drain holes in the lower sides of the doors, rocker panels, and trunk bottom be kept clear and open.



### CAUTION!

- Bird droppings must be washed off immediately and thoroughly, since their acidity is particularly corrosive.
- To provide better protection for the paint, polish the vehicle at intervals with a suitable product leaving a protective film on the paint.
- If the vehicle is washed using high-pressure water jets or cleaners, it is important that the nozzle of the jet be kept at a distance of at least 16 in (40 cm) from the bodywork to avoid damaging it.

### Glass Surfaces

All glass surfaces should be cleaned on a regular basis with any commercial household-type glass cleaner.

Never use an abrasive type cleaner. Use caution when cleaning the inside rear window equipped with electric defrosters. Do not use scrapers or other sharp instrument that may scratch the elements.

When cleaning the rearview mirror, spray cleaner on the towel or rag that you are using. Do not spray cleaner directly on the mirror.

Labels can be peeled off after soaking with warm water.

When cleaning is performed, keep all metal objects at a safe distance from the window.

### Cleaning Headlights

Your vehicle has plastic headlights that are lighter and less susceptible to stone breakage than glass headlights.

Plastic is not as scratch-resistant as glass and therefore different lens cleaning procedures must be followed. To minimize the possibility of scratching the lenses and reducing light output, avoid wiping with a dry cloth. To remove road dirt, wash with a mild soap solution followed by rinsing.

DEALER ePROCESS

Do not use abrasive cleaning components, solvents, steel wool or other aggressive material to clean the lenses.

### Condensation and Fogging on the Light Clusters

With cold or humid climates, after a driving rain or after cleaning the car, the surface of the front and rear light clusters could fog and/or form condensate drops on the inside. This is a natural phenomenon due to the temperature and humidity differences between the lens internal and external surface, which nevertheless does not indicate a fault and does not compromise the regular operation of the lights. The fogging/condensate disappears when switching on the lights, starting from the centre of the diffuser and gradually going to the edges.

### Moldings and Aluminum Trims

- For cleaning moldings and aluminum trims, avoid the use of acidic or alkaline cleaning agents that can destroy the protecting surface treatment.
- After washing aluminum trim with warm water, apply the cleaning agent with a clean tissue or a soft sponge on the surface. Do not use



any other equipment such as brushes, steel wool, abrasives or any other equipment for cleaning.

- After cleaning, please rinse the aluminum trim with a lot of clear water.
- While cleaning in the car, please make sure that the moldings and aluminum trims only get in contact with soft brushes or textiles.

### Engine Compartment

At the end of each winter season, carefully wash the engine compartment, remembering to avoid directing the jet of water for too long on the electric parts.

To perform this operation, you must contact an **Authorized Maserati Dealer**.

### Pre-Short Drop Function

When in a car wash, if the driver keeps the RKE Transmitter in his/her pocket, or in any place outside the vehicle within 3.3 ft (1 m) distance, the front windows will perform a pre-short drop. This is a shorter drop compared to the normal short drop performed by the “Passive Entry” function when you grab the door handle to enter the vehicle.

In order to prevent water from entering the vehicle between the upper edge of the glass window and the door outline on the bodywork, while the car is being washed, it is advisable to disable the “Passive Entry” from the MTC+ System, for further information refer to chapter “MTC+ Settings” in section “Dashboard Instruments and controls”. When deactivating the “Passive Entry”, also the “Pre-Short Drop” function will be disabled.



## Interior Maintenance and Care

Interior trim should be cleaned starting with a damp cloth. Do not use harsh cleaners.

The leather upholstery can be best preserved by regular cleaning with a damp soft cloth. Small particles of dirt can act as an abrasive and damage the leather upholstery and should be removed promptly with a damp cloth. Stubborn soils stains can be removed easily with a soft cloth and appropriate products. Avoid soaking the leather upholstery with any liquid. Please do not use polishes, oils, cleaning fluids, solvents, detergents, or ammonia-based cleaners to clean your leather upholstery. Application of a leather conditioner is not required to maintain the original condition.

Check at regular intervals that there is no water trapped under the mats (due to drips off shoes, umbrellas etc.) which may cause the metal parts to oxidize.



**CAUTION!**

Do not use alcohol, petrol or solvents

*(Continued)*



**(Continued)**  
to clean the instrument cluster's transparent dome, the MTC+ display, the analog clock and the leather upholstery. We recommended the use of “Car Care” products approved by Maserati for the maintenance and care of the interior.

### Leather Upholstery Treatment

Have the leather upholstery only treated, as provided in the Scheduled Service Plan, by an **Authorized Maserati Dealer** which has the required specific products.

### Parts in Premium Quality Wood

Remove any dirt with a damp cloth.

#### **NOTE:**

*The **Authorized Maserati Dealer** can provide you with any information about the Maserati approved “Car Care” products, available in the “Genuine Accessories” range.*



#### **WARNING!**

**California Proposition 65**  
**Operating, servicing and maintaining a passenger vehicle or off-road vehicle can expose you to chemicals including**

**such as, engine exhaust, carbon monoxide, phthalates and lead, that which are known to the State of California to cause cancer and birth defects or other reproductive harm. To minimize exposure, avoid breathing exhaust, do not idle the engine except as necessary, service your vehicle in a well-ventilated area and wear gloves or wash your hands frequently when servicing your vehicle. For more information go to: [www.P65Warnings.ca.gov/passenger-vehicle](http://www.P65Warnings.ca.gov/passenger-vehicle)**

### MTC+ Touch Screen

- Do NOT attach any object to the touch screen, doing so can result in damage to the touch screen.
- Do not touch the screen with any hard or sharp objects (pen, USB stick, jewelry, etc.) which could scratch the touch screen surface.
- Do not spray any liquid or caustic chemicals directly on the screen! Use a clean and dry micro fiber lens cleaning cloth in order to clean the touch screen. If necessary, use a lint-free cloth dampened with a cleaning solution, such as isopropyl alcohol, or an isopropyl alcohol and water solution ratio of 50:50. Be sure

to follow the solvent manufacturer's precautions and directions.



## Vehicle Stored for Long Periods

If the vehicle is going to be stored for long periods of time, follow the below precautions:

- Wash and dry the vehicle thoroughly.
- Store the vehicle on a level surface in a covered, dry and, if possible, ventilated area.
- Select P (Park) and turn off the engine.
- Disconnect the battery (refer “Maintenance-Free Battery” in this section) or connect a battery charger (refer to paragraph “Maintaining Battery Charge” of chapter “Battery Statement” in this section).
- Check the battery charge status. During parking, this check must be carried out every three weeks. Recharge the battery if the open circuit voltage is lower than 12.2 V.
- Check that the parking brake is NOT engaged.
- Do not empty the engine cooling system.
- Clean and protect the painted parts applying protective wax.

- Clean and protect polished metal parts with special products available on the market.
- Cover the vehicle with a long cloth in breathable fabric (available from an **Authorized Maserati Dealer**). Do not use thick plastic sheets, which do not allow the humidity on the vehicle surface to evaporate.
- Inflate the tires up to a pressure which must be 14.5 psi (1 bar) higher than the normally prescribed one, and check it at regular intervals.

### NOTE:

*The **Authorized Maserati Dealer** can provide you with any information about the available “Indoor and Outdoor Car Covers”, available in the “Genuine Accessories” range.*



### WARNING!

**The tire pressure must be brought back to the prescribed value before reusing the vehicle (see “Tire Inflation Pressure” in section “Features and Specifications”).**



## Restarting the Vehicle

Before restarting the vehicle after a long period of inactivity, we recommend that you carry out the following operations.

- Check the tires for pressure and for any damages, cuts or cracks. If this is the case, have them replaced.
- Do not dry-rub the external surface of the vehicle: use a damp cloth.
- Visually inspect if there are any fluid leaks (oil, brake and clutch fluid, engine coolant etc.).
- Have the engine oil and filter replaced.
- Check the fluid levels in the brake system, as well as the engine coolant level.
- Check the air filters and have them replaced if necessary.
- Reconnect the battery after checking the charge status (refer to “Maintenance-Free Battery” in this section) and perform the initializing procedure if applicable. You can consult the paragraph “Battery Reconnection” in this chapter for further information on this subject.



- With the transmission in N (Neutral), let the engine idle for several minutes.



### WARNING!

The engine idle must be performed outdoors. Exhaust gases contain carbon monoxide which is strongly toxic and potentially lethal.



### WARNING!

**California Proposition 65**  
Operating, servicing and maintaining a passenger vehicle or off-road vehicle can expose you to chemicals including such as, engine exhaust, carbon monoxide, phthalates and lead, that which are known to the State of California to cause cancer and birth defects or other reproductive harm. To minimize exposure, avoid breathing exhaust, do not idle the engine except as necessary, service your vehicle in a well-ventilated area and wear gloves or wash your hands frequently when servicing your vehicle. For more information go to: [www.P65Warnings.ca.gov/passenger-vehicle](http://www.P65Warnings.ca.gov/passenger-vehicle)

## Battery Statement

### Battery Statement Status of Charge

To avoid problems with ignition and/or the electrical system in general when you are driving, the battery charge status is constantly maintained and guaranteed by the vehicle's recharge circuit; the main component of which is the alternator. This circuit is only able to supply voltage to the battery when the vehicle is traveling.

The warning light  on the instrument cluster, will indicate any malfunctions in the recharge circuit or an insufficient battery charge status (example in figure).



The vehicle contains advanced electronic systems, such as, for example, the alarm system and various electronic control modules, which

consume power even when the ignition switch is in the **OFF** position and the vehicle is not being used. Therefore, it is fundamental that the battery is properly charged to ensure that the engine starts properly and that all the electrical/electronic systems in the vehicle work efficiently.

### Maintaining Battery Charge

If you perform short daily trips (approximately 10 miles/16 km), which correspond to an annual total of 4000 miles/6000 km, or when the vehicle is not going to be used for one week or more, Maserati recommends connecting the vehicle to a battery charger, to save you the trouble of having to recharge the battery. The battery charger will keep the battery charged properly and at the correct voltage levels required by the systems and devices in the vehicle.

Before using and/or connecting the battery charger, carefully follow the instructions provided.

If you do not use a battery charger to prevent the battery from going dead when you are not going to use the vehicle for long periods of time, you need to check and recharge the battery at least once every three weeks. Make this check if you perform





short daily trips (approximately 10 miles/16 km) which correspond to an annual total of 4000 miles/6000 km. Please note that allowing the battery to go dead repeatedly can cause premature wear on the internal cells and greatly reduce their life, leading to problems with the ignition system and other electrical/electronic systems. The **Authorized Maserati Dealer** is available to advise you on how to recharge your battery correctly and give you useful information on battery care and maintenance.

**NOTE:**

*The Authorized Maserati Dealer can provide you with any information about the Maserati approved "Battery Charger and Conditioner", available in the "Genuine Accessories" range.*



**WARNING!**

The process of charging or recharging the battery produces hydrogen, a dangerous gas that can explode and cause serious injuries. When charging or recharging the battery, follow the recommended precautions at all times:

- always charge or recharge the

**battery in a well-ventilated environment;**

- never charge or recharge a battery that has frozen;
- ensure that any sparks or open flames are nowhere near the battery while it is charging;
- before using a charger to charge or maintain the battery charge status, carefully follow the instructions provided to ensure the charger is connected to the battery safely and correctly.







## **8 – Features and Specifications**

Refillings .....	360
Fuel Consumption .....	363
Technical Data .....	364
Tire Inflation Pressure .....	370





## Refillings

### NOTE:

Maserati reserves the right to change or revise specifications without prior notification.



### CAUTION!

To guarantee vehicle's integrity and maintain performance level always use genuine parts approved and recommended by Maserati.

## Refillings and Recommended Products

Parts to be refilled	Quantity	Product specifications
Fuel tank	21 Gallons/80 litres (including 4.2 Gallons/16 litres of reserve)	Premium unleaded fuel with no less than 91 CLC or AKI (95 RON/85 MON).
Engine	7.7 Quarts/7.3 litres (max) (Difference among MIN and MAX level: 1.1 Quarts/1 litre)	Synthetic multigrade lubricants SAE 10W-60 that meet API SN/CF and ACEA A3, B3, B4 specifications. Recommended oil: PENNZOIL Platinum Maserati 10W-60 (1).
Engine (AWD version)	8.8 Quarts/8.3 litres (max) (Difference among MIN and MAX level: 1.1 Quarts/1 litre)	
Windshield washer fluid tank	3.7 Quarts/3.5 litres	Mix of water and detergent fluid, in the proportions indicated on the product package. If the temperature is below -4°F (-20°C), use pure detergent fluid. Detergent fluid: Mix of CUNA NC 956-II surfactants and alcohols. Recommended fluid: WUERTH Windshield Washer Fluid with antifreeze or AREXONS DP1.





Parts to be refilled	Quantity	Product specifications
Engine cooling circuit	9.7 Quarts/9.2 litres	Mixture of water and coolant, proportionally 50/50%. Coolant: protective, antifreeze action and ethylene glycol-based with organic inhibitors compatible with regulations:
Automatic transmission cooling circuit	2.64 Quarts/2.5 litres	<ul style="list-style-type: none"> <li>• ASTM D 3306, ASTM D 2570</li> <li>• ASTM D 4340, ASTM D 2809</li> <li>• SAE J 1034</li> <li>• CUNA NC 956/16.</li> </ul> Recommended fluid: PETRONAS Paraflu Up 50/50.
(2) Automatic transmission	8 Quarts/7.6 litres	First equipment oil: SHELL ATF L- 12108 or ZF Lifeguard 8.
(2) Differential	1.4 Quarts/1.3 litres	Synthetic Axle Lubricant SAE 75W-85 – FE Hypoid Gear Lubricant.
(2) Front differential (AWD version)	0.47 Quarts/0.45 litres	First equipment oil: SHELL TF 0951B.
(2) Transfer case (AWD version)	0.65 Quarts/0.62 litres	First equipment oil: SHELL TF 0870.
Braking system	0.93 Quarts/0.88 litres +/- 4%	Synthetic fluid: FMVSS 116 DOT 4, ISO 4925 Class 4, ENSAYOS INTA-UNE 26-109-88, SAE J1703, SAE J1704, CUNA NC 956-01. Recommended fluid: PETRONAS Tutela TOP 4/S.
 <b>CAUTION!</b> For each oil refilling and/or replacement, please contact an <b>Authorized Maserati Dealer</b> .		
Air conditioning system	24 oz +/-0.7 oz 680 g +/-20 g	Coolant: r134a.
(1) In countries where it is not available, recommended oil "PENNZOIL Platinum 10W-60". (2) No change and/or topping up expected in scheduled maintenance.		

DEALER ePROCESS



### WARNING!

#### California Proposition 65

Operating, servicing and maintaining a passenger vehicle or off-road vehicle can expose you to chemicals including such as, engine exhaust, carbon monoxide, phthalates and lead, that which are known to the State of California to cause cancer and birth defects or other reproductive harm. To minimize exposure, avoid breathing exhaust, do not idle the engine except as necessary, service your vehicle in a well-ventilated area and wear gloves or wash your hands frequently when servicing your vehicle. For more information go to: [www.P65Warnings.ca.gov/passenger-vehicle](http://www.P65Warnings.ca.gov/passenger-vehicle)

## Engine Oil Identification Symbol



This symbol means that the oil has been certified by the American Petroleum Institute (API). Maserati only recommends API Certified engine oils.



### CAUTION!

Do not use chemical flushes in your engine oil as the chemicals can damage your engine. Damage caused by use of non-approved chemicals is not covered by the new Vehicle Limited Warranty.

## Engine Oil Viscosity (SAE Grade)

SAE 10W-60 engine oil is recommended for all operating temperatures.

The engine oil filler cap also shows the recommended engine oil viscosity for your engine. For information on engine oil filler cap location, refer to chapter "Maintenance Procedures" in section "Maintenance and Care".

Lubricants that do not have both the engine oil certification mark and the correct SAE viscosity grade number should not be used.





## Fuel Consumption

### NOTE:

- The technical data, values and specifications in this Owner's Manual are provided as guidance only. The vehicle specific data can deviate from the information provided, for example, as a result of optional or special equipment ordered with the vehicle, vehicle loads, and country specific measurement methods.
- The specifications described below can change without prior notification.

The fuel consumption values shown (Miles Per Gallon - MPG) are established using EPA test guidelines.

	Ghibli S Q4 (AWD version)	Ghibli S	Ghibli
City	19.8 MPG	20.1 MPG	20.7 MPG
Highway	33.1 MPG	32.7 MPG	33.5 MPG
Combined	24.1 MPG	24.3 MPG	25 MPG



### CAUTION!

- Actual fuel economy results will vary for many reasons, including driving conditions and how you drive and maintain your vehicle.
- The type of route, traffic and weather conditions, driving style, general condition of the vehicle, equipment/accessories in the vehicle, use of the air conditioning system, vehicle load and other items or situations which may negatively affect the vehicle aerodynamics or wind resistance lead to consumption ratios differing from the indicated ones.



## Technical Data

### NOTE:

The technical data, values and specifications in this Owner's Manual are provided as guidance only. The vehicle specific data can vary from the information provided, for example, as a result of optional or special equipment ordered with the vehicle, vehicle loads, and country specific measurement methods.

## Engine Data

Data	Ghibli S Q4 (AWD version) Ghibli S	Ghibli
Cylinder number and position	6 - 60° V	6 - 60° V
Number of valves per cylinder	4	4
Bore x stroke	86.5 x 84.5 mm	86.5 x 84.5 mm
Total displacement	2,979 cm <sup>3</sup>	2,979 cm <sup>3</sup>
Compression ratio	9.7 : 1	9.7 : 1
Maximum power output (EC) - corresponding RPM	316 kW – 424 HP 5,750 RPM	257 kW – 345 HP 5,500 RPM
Peak and overboost torque (EC) - corresponding RPM	428 ft-lb (580 N-m) 1,750 – 4,500 RPM	369 ft-lb (500 N-m) 1,600 – 4,500 RPM

### Properties

Timing	The timing system uses two overhead camshafts with timing variator.
Timing system control	Timing chain.
Supply	Over-supplied with turbocompressor and related intercooler for each bank.
Injection – Ignition	High pressure 2900 PSI (200 bar) direct fuel injection system. Static ignition with digital electronic control system included and controlled by a single microprocessor ECU.





## Brakes

Self-ventilating disc brakes on the four wheels. The Electric Parking Brake (EPB) acts on the rear wheels.

	Braking System	
	Dual Cast	Base
Front disc diameter	14 in (360 mm)	13.6 in (345 mm)
Rear disc diameter	13.6 in (345 mm)	13 in (330 mm)

## Transmission

ZF automatic transmission with 8 speeds, torque converter, lock-up clutch and anti-slip function.

Sequential and traditional control type.

Automatic transfer case (AWD version).

TRANSAXLE-type transmission.

Traction system equipped with rear self-locking differential.

## Suspension

Front suspensions with double wishbone independent wheels.

Multilink system rear suspensions on independent wheels.

Optional Skyhook active suspensions with electronic controlled dampening.

## Steering

Electric Power Steering (EPS) system, axis parallel type.

Steering diameter = 12.9 yd (11.8 m).

No. of steering wheel turns = 1.37 (to the left and right).





## Wheels

### NOTE:

- Maserati recommends Maserati Genuine Tires marked with "MGT" logo specifically designed for its models.
- In order to maintain high performance and safety level, Maserati recommends to use tires equivalent to the original size.



### WARNING!

- The maximum speed reachable with the tires is indicated by the tire manufacturer. Always comply with the regulations in force in the Country you are driving in.
- Never exceed the maximum speed indicated for the tires: failure to respect the max. speed may damage these tires. Danger: risk of accident!

## Standard Wheel Dimension

Allowed tires size	Ghibli - Ghibli S - Ghibli S Q4: Basic version - GranLusso	Ghibli - Ghibli S - Ghibli S Q4: GranSport
Light alloy rims (M+S)	19" x 8,5J (front) 19" x 10J (rear)	20" x 8,5J (front) 20" x 10,5J (rear)
- Front tires	245/45 ZR 19 98Y	245/40 ZR 20 99Y XL
- Rear tires	275/40 ZR 19 101Y	285/35 ZR 20 100Y
- Front winter tires	245/45 ZR 19 102W XL M+S	245/40 R 20 99W XL M+S
- Rear winter tires	275/40 ZR 19 101W M+S	285/35 R 20 100W M+S
- Front all-season tires	245/45 R 19 98V M+S	245/40 R 20 99W XL M+S
- Rear all-season tires	275/40 R 19 101V M+S	285/35 R 20 100W M+S
Spare rim		18" x 6J
- Spare tire		175/55 18





## Optional Wheel Dimension

Allowed tires size	Ghibli - Ghibli S - Ghibli S Q4: Basic version - GranLusso	Ghibli - Ghibli S - Ghibli S Q4: GranSport
Light alloy rims	20" x 8,5J (front) 20" x 10,5J (rear)	-
- Front tires	245/40 ZR 20 99Y XL	-
- Rear tires	285/35 ZR 20 100Y	-
- Front winter tires	245/40 R 20 99W XL M+S	-
- Rear winter tires	285/35 R 20 100W M+S	-
- Front all-season tires	245/40 R 20 99W XL M+S	-
- Rear all-season tires	285/35 R 20 100W M+S	-
Light alloy rims	21" x 8,5J (front) 21" x 10,5J (rear)	21" x 8,5J (front) 21" x 10,5J (rear)
- Front tires	245/35 ZR 21 96Y XL	245/35 ZR 21 96Y XL
- Rear tires	285/30 ZR 21 100Y XL	285/30 ZR 21 100Y XL
- Front winter tires	245/35 R 21 96W XL M+S	245/35 R 21 96W XL M+S
- Rear winter tires	285/30 R 21 100W XL M+S	285/30 R 21 100W XL M+S



### Performance

**NOTE:**

*The specifications described can change without prior notification.*

	Ghibli S Q4 (AWD version)	Ghibli S	Ghibli
Maximum speed	176.5 mph (284 km/h)	177 mph (285 km/h)	166 mph (267 km/h)
Accelerations from 0 to 60 mph	4.7 seconds	4.9 seconds	5.5 seconds

### Weights

**NOTE:**

*The specifications described can change without prior notification.*

	Ghibli S Q4 (AWD version)	Ghibli S	Ghibli
Unladen vehicle weight (with tank and reservoirs filled, tools and accessories)	4,565 lb (°)	4,400 lb (°)	4,400 lb (°)
Approved Gross Vehicle Weight Rating (GVWR)	5,573 lb (2,621 lb front axle – 2,952 lb rear axle)	5,420 lb (2,468 lb front axle – 2,952 lb rear axle)	5,420 lb (2,468 lb front axle – 2,952 lb rear axle)
(°) Base configuration without options.			





## Dimensions

	Basic version - GranLusso	GranSport
Wheel base	118.03 in (2998 mm)	118.03 in (2998 mm)
Total length	195.82 in (4974 mm)	195.94 in (4977 mm)
Width without mirrors	76.57 in (1945 mm)	76.57 in (1945 mm)
Width with mirrors	82.67 in (2100 mm)	82.67 in (2100 mm)
Front track (*)	64.09 ÷ 64.29 in (1628 ÷ 1633 mm)	64.09 ÷ 64.29 in (1628 ÷ 1633 mm)
Rear track (*)	64.33 ÷ 65.31 in (1634 ÷ 1659 mm)	64.33 ÷ 65.31 in (1634 ÷ 1659 mm)
Front overhang	36.77 in (934 mm)	36.88 in (937 mm)
Rear overhang	41.02 in (1042 mm)	41.02 in (1042 mm)
Height (*)	57.44 ÷ 58.30 in (1459 ÷ 1481 mm)	57.55 ÷ 57.95 in (1462 ÷ 1472 mm)
Boot compartment volume	17.6 cu ft. (500 l)	17.6 cu ft. (500 l)
(*) Variable size according to the motorization, the tire size and the optional installed.		



### Tire Inflation Pressure

Cold tire inflation pressure value under the following loading conditions listed in the table below:

- PLC (Partial Loading Condition): considering 2 passengers + luggage.
- FLC (Full Loading Condition): considering 4 or 5 passengers + luggage.

			(*) Speed driving higher than 124 mph (200 km/h)
Load	PLC	FLC	PLC - FLC
Wheel	Front and rear	Front and rear	Front and rear
Pressure	220 kPa – 32 PSI (2.2 bar)	260 kPa – 38 PSI (2.6 bar)	260 kPa – 38 PSI (2.6 bar)
Spare tire pressure	350 kPa – 51 PSI (3.5 bar)		
(*) Not for winter and all-season tires.			

#### NOTE:

- The pressure values indicated in the table are also indicated on the driver-side door pillar information label.
- For more information about the pressure check methods, see “Tires – General Information” in section “Driving”.



#### WARNING!

- Improperly inflated tires are dangerous.
- Under-inflation increases tire flexing and can result in tire overheating and failure.
- Over-inflation reduces a tire's ability to cushion shock. Objects on the road and potholes can cause damage that results in tire failure.
- Over-inflated or under-inflated tires can affect vehicle handling and can fail suddenly, resulting in loss of vehicle control.
- Unequal tire pressures can cause steering problems.
- Unequal tire pressures from one side of the vehicle to the other can cause the vehicle to drift to the right or left.
- Always drive with each tire inflated to the recommended cold tire inflation pressure.



## 9 – Index





Abbreviations . . . . .	8	A/C Distribution . . . . .	142	Protection from Atmospheric Agents . . . . .	350
Accessories		Alarm, Vehicle Security . . . . .	27	Useful Advice to Keep the Bodywork in Good Condition . . . . .	351
Aftermarket Parts and Accessories Statement . . . . .	13	ALR (Automatic Locking Retractor) . . . . .	61	<b>Brakes</b>	
Active Blind Spot Assist - ABSA . . . . .	271	Anti-Lock Braking System (ABS) and Electronic Brake-force Distribution (EBD) . . . . .	239	Brake and Stability Control System (ESC) . . . . .	238
Adaptive Cruise Control (ACC) . . . . .	247	Assistance . . . . .	11	Brake Overheating . . . . .	242
Activation/Deactivation . . . . .	250	Assistance, if you need . . . . .	11	Brake System . . . . .	238
Display Warnings and Maintenance . . . . .	255	ATC (Automatic Temperature Control) . . . . .	202	Manual Release of Parking Brake . . . . .	311
Precautions while Driving with ACC . . . . .	256	Audio Controls . . . . .	176	Parking Brake . . . . .	233
Setting the Following Distance . . . . .	252	Audio Controls on Central Console . . . . .	176	Using the Brakes . . . . .	241
Setting the Speed . . . . .	251	Steering Wheel Audio Controls . . . . .	176		
Air bag . . . . .	64	Audio, setting . . . . .	191	Capacity/Refillings . . . . .	360
Advanced Front Air Bag Properties . . . . .	65	Audio System . . . . .	177	Cargo Area . . . . .	133
Air Bag Deployment Result . . . . .	70	Automatic Transmission Manual Release of Transmission . . . . .	315	Loading with Rear Seatbacks Folded Down . . . . .	134
Air Bag Deployment Sensors and Controls . . . . .	15	AWD		Vehicle Load Carrying Capacity . . . . .	133
Air Bag System Components . . . . .	64	All-Wheel Drive, drive mode . . . . .	223	Child Restraint Systems . . . . .	72
Front Air Bag Inflator Units . . . . .	68	BAS (Brake Assist System) . . . . .	240	Children too large for Booster Seats . . . . .	73
Passenger Air bag Labels . . . . .	20	Battery . . . . .	332	Infants and Child Restraints . . . . .	72
Supplemental Driver Side Knee Air bag . . . . .	67	Battery Recharge . . . . .	335	Installing Child Restraint Systems using the Vehicle Seat Belt equipped with ALR . . . . .	74
Supplemental Restraint System (SRS) . . . . .	64	Battery Remote Posts Position . . . . .	313	Lower Anchors and Tether for Children (LATCH) . . . . .	75
Supplemental Seat-mounted Side Air Bags (SAB) . . . . .	66	Maintaining Battery Charge . . . . .	356	Older Children and Child Restraints . . . . .	73
Supplemental Side Air Bag Inflatable Curtain (SABIC) . . . . .	67	To Disconnect the Battery . . . . .	332	Tips on getting the most out of your child restraint . . . . .	74
Transport of persons with disability . . . . .	71	To Reconnect the Battery . . . . .	334	Climate Control . . . . .	197
Air Conditioning (A/C) System . . . . .	197	Blind Spot Alert . . . . .	266		
		RCP - Rear Cross Path . . . . .	268		
		Bluetooth, Customer settings . . . . .	192		
		Bodywork Maintenance and Care . . . . .	350		
		Pre-Short Drop Function . . . . .	353		







Clock, analog . . . . .	186	Driving Conditions . . . . .	298	Fuel
Console		Before the Trip . . . . .	298	Carbon Monoxide Warning . . . . .
Central Console Components . . . . .	93	Driving at Night . . . . .	298	Emergency Fuel Filler Door
Front Dome Console		Driving in Fog . . . . .	299	Release . . . . .
Components . . . . .	94	Driving in the Mountains . . . . .	300	Emissions Inspection and
Controls Screen . . . . .	179	Driving in the Rain . . . . .	299	Maintenance Programs . . . . .
Cruise Control		Driving on Snow or Ice . . . . .	300	Fuel Consumption . . . . .
Cruise Control Adaptive (ACC) . . . . .	247	Safe Driving . . . . .	298	Fuel Filter Service . . . . .
Electronic Cruise Control (CC) . . . . .	244	DRL (Daytime Running Light) . . . . .	113	Fuel Requirements . . . . .
Cupholders . . . . .	127	EDR (Event Data Recorder) . . . . .	71	Fuel System Warnings . . . . .
Front Passengers Cupholders . . . . .	127	Electronic Cruise Control . . . . .	244	Gasoline/Oxygenate Blends . . . . .
Rear Passengers Cupholders . . . . .	128	Emergency . . . . .	5	Low Fuel Indicator . . . . .
Dashboard Compartment . . . . .	194	Hazard Warning Lights . . . . .	121	Materials Added to Fuel . . . . .
Dashboard Components . . . . .	92	In the Event of an Accident . . . . .	305	MMT in Gasoline . . . . .
Defroster . . . . .	47	Jump Starting . . . . .	312	Reformulated Gasoline . . . . .
Doors		Trunk Lid Emergency Release . . . . .	53	Fuses . . . . .
Child Protection Door Lock		Engine		Fuses Position . . . . .
System . . . . .	40	Engine Coolant Level Check . . . . .	325	Fuses Replacement . . . . .
Doors Locking . . . . .	39	Engine Oil Level Check . . . . .	328	Glove Box Feature Lock (Passenger
Doors Manual Lock . . . . .	39	Hood . . . . .	54	Side) . . . . .
Front Doors Components . . . . .	94	Normal Starting of the Engine . . . . .	208	Glove Box Lock Feature
Lock/Unlock Door Flashlight . . . . .	33	Use of the Engine . . . . .	242	Handholds and Cloth Hooks . . . . .
Power Doors Locking/Unlocking . . . . .	39	Entry/Exit, lights on . . . . .	30	Hazard Warning Flashers . . . . .
Rear Doors Components . . . . .	95	EPB (Electric Parking Brake) . . . . .	233	Head Restraints . . . . .
Soft Door Close System . . . . .	41	ESC (Electronic Stability Control) . . . . .	238	Highway Assist - HAS . . . . .
Unlock Driver Door/All Doors with		Filters		HomeLink . . . . .
Remote Key 1st Press . . . . .	33	A/C System Air Filter		Security . . . . .
DPF System		Replacement . . . . .	330	Troubleshooting Tips . . . . .
DPF Filter Replacement . . . . .	328	Engine Air Filter Replacement . . . . .	330	Using HomeLink . . . . .
"Drive Away Inhibit" strategy . . . . .	237	Forward Collision Warning (FCW) . . . . .	258	Hood
Drive Mode, controls . . . . .	224			Open and Close the Hood . . . . .
Setting the Drive Mode . . . . .	224			



Hood Operation . . . . .	.54	Replacement . . . . .	.27	Light Switch . . . . .	.110
HSA (Hill Start Assist) . . . . .	.240	Requiring and setting Additional Key Fobs . . . . .	.34	Multifunction Lever. . . . .	.115
Identification Labels. . . . .	.19	Unlock the Vehicle with Key fob .	.33	Turn Signals . . . . .	.116
Illuminated Entry/Exit. . . . .	.30	Keys. . . . .	.24	Loading the Vehicle	
Immobilizer (Sentry Key). . . . .	.26	Lane Departure Warning (LDW) . .	.261	Loading with Rear Seatbacks	
Indicator Lights		Level Checks . . . . .	.325	Down . . . . .	.134
Air Bag Warning Light. . . . .	.83	Adding Windshield . . . . .	.327	Vehicle Load Carrying Capacity .	.133
TFT Display: Menus and Settings .	.150	Brake Fluid Level Check . . . . .	.327	Main- and Submenu . . . . .	.152
TFT Display: Warning/Indicator		Engine Coolant Level Check . . .	.325	Maintenance. . . . .	.5
Lights of Set Modes/Functions. .	.163	Engine Oil Level Check. . . . .	.325	A/C System Maintenance . . . . .	.348
Warning and Indicator Lights on		Fluid Level Check for Coolant		Air Bag System Maintenance . . . .	.70
Analog Instrument . . . . .	.146	Transmission System . . . . .	.330	Bodywork Maintenance and	
Infotainment System. . . . .	.169	Transmission Oil Check. . . . .	.329	Care . . . . .	.350
Infotelematic System		Liftgate		Emissions Inspection and	
Main Menu Bar on MTC+		Liftgate and Hood Ajar		Maintenance Programs . . . . .	.323
Display . . . . .	.171	Indicators. . . . .	.166	Interior Maintenance and Care .	.353
Manual Controls and Devices . .	.170	Unlatch the Trunk Lid . . . . .	.33	Maintenance Procedures . . . . .	.324
Personalized the Main Menu Bar.	.172	Lights . . . . .	.110	Periodic Maintenance . . . . .	.321
Instrument Cluster . . . . .	.146	Automatic Headlights . . . . .	.112	Scheduled Maintenance Service .	.318
Interior Components . . . . .	.92	Automatic High Beam . . . . .	.114	Scheduled Service Plan. . . . .	.319
Interior Maintenance and Care. . .	.353	Bi-Xenon Headlight. . . . .	.113	Wheels Maintenance. . . . .	.349
Interiors Features. . . . .	.126	Bulb Replacement. . . . .	.344	Maserati Roadside Assistance	
iPad Holder . . . . .	.131	Cargo Lamps . . . . .	.121	Program . . . . .	.16
iPod Connection. . . . .	.130	Dome Lights. . . . .	.120	Mesh Pockets. . . . .	.131
Jump Start Procedure . . . . .	.314	DRL, Daytime Running Lights . .	.113	Messages on Main Display Area . .	.150
Key Fob . . . . .	.25	Fog Lights . . . . .	.115	MIL (Malfunction Indicator Light) .	.147
Key Fob Battery Replacement. . .	.34	Full-LED Headlight with Cornering		Mirrors . . . . .	.107
Preventing Inadvertent Locking of		Function . . . . .	.113	External Mirrors . . . . .	.107
key fob RKE Transmitter Inside the		Headlight Time Delay . . . . .	.112	Folding Mirrors. . . . .	.109
Vehicle . . . . .	.43	High Beam and Flashing . . . . .	.116	Integrated External Rearview Mirror	
		Interior Lights . . . . .	.118	Lights . . . . .	.122





Mirrors Positioning . . . . .	108	Phone and Voice Controls on Steering Wheel . . . . .	204	Seat Belt . . . . .	55
Rearview Mirrors . . . . .	107	Phone Mode . . . . .	205	Automatic Locking Retractor (ALR) Mode . . . . .	61
Tilt Mirrors in Reverse . . . . .	108	Phone/Bluetooth, Customer settings . . . . .	192	Enhanced Seat Belt Use Reminder System (SBR) . . . . .	62
MTC+ “Controls” Screen . . . . .	179	Power Outlets . . . . .	126	Passenger Seat Belts . . . . .	60
MTC+ Settings - Customer Programmable Features . . . . .	183	Power Outlet Inside the Central Console . . . . .	127	Seat Belt Reminder Light . . . . .	150
Auto-On Comfort & Remote Start . . . . .	190	Power Outlet Inside the Cupholder . . . . .	126	Seat Belts and Pregnant Women . . . . .	63
Clear Personal Data . . . . .	193	Power Outlet Inside the Trunk . . . . .	127	Seat Belts Pretensioners . . . . .	62
Clock & Date . . . . .	186	Rear Power Outlets . . . . .	127	Three-Point Seat Belts . . . . .	57
Display . . . . .	184	Rear Parking Camera . . . . .	78	Three-Point Seat Belts Height Adjustment . . . . .	59
Doors & Locks . . . . .	188	Refueling . . . . .	296	Three-Point Seat Belts Untwisting Procedure . . . . .	60
Engine Off Options . . . . .	190	Fuel Filler Neck Access . . . . .	296	Three-Point Seat Belts Use Instructions . . . . .	58
Lights . . . . .	188	Remote Start System . . . . .	36	Using the Seat Belt in Automatic Locking Retractor Mode (ALR) . . . . .	61
Restore Settings . . . . .	193	Restarting the Vehicle . . . . .	355	Seats . . . . .	96
Safety and Driving Assistance . . . . .	187	Restraint System . . . . .	64	Driver Memory Seat . . . . .	99
Voice Commands . . . . .	185	Child Restraint Systems . . . . .	72	Easy Entry/Exit Seats . . . . .	100
Occupant Restraint System . . . . .	55	RKE (Remote Keyless Entry) Transmitter . . . . .	24	Front Heated Seats . . . . .	97
On Board Diagnostics . . . . .	243	Roadside Assistance Program . . . . .	16	Front Power Seats . . . . .	96
ORC (Occupant Restraint Controller) . . . . .	67	Roll-Over Warning . . . . .	15	Front Ventilated Seats . . . . .	98
Park Assist . . . . .	85	Safety . . . . .		Power Lumbar Seats . . . . .	97
Enabling and Disabling Park Assist . . . . .	88	Child Restraint Systems . . . . .	72	Rear Armrest . . . . .	101
Parking . . . . .	236	Reporting Safety Defects . . . . .	12	Rear Seats . . . . .	101
Parking Brake . . . . .	233	Safety Tips . . . . .	55	Rear Side Heated Seats . . . . .	102
Passive Entry System . . . . .	41	Scheduled Maintenance Service . . . . .	318	Seat Adjustment . . . . .	96
Pedals, adjustable . . . . .	107	Scheduled Service Plan . . . . .		Service . . . . .	10
Pedestrian Emergency Braking (PEB) . . . . .	258	Scheduled Maintenance Indicator . . . . .	318	Siri Smart Personal Assistant . . . . .	205
Pets, transporting . . . . .	78			Smoking Kit . . . . .	131
				Snow Chains . . . . .	288



Spare parts service	Danger Symbols . . . . .	Tire Pressure Low Warning . . . . .
Genuine Parts . . . . .	Symbols of Prohibitions and	TPMS Deactivation . . . . .
Scheduled Maintenance . . . . .	Compulsory Measures . . . . .	Traffic Sign Assist - TSA . . . . .
Spare Parts Service . . . . .		Transmission, Automatic . . . . .
SRS (Supplemental Restraint	TCS (Traction Control System). . . . .	Automatic Transmission Lever . . . . .
System). . . . .	Technical Data . . . . .	Automatic Transmission Range . . . . .
Start&Stop System . . . . .	Telltales	Malfunction and Overheating
Occupant Safety Function . . . . .	Telltales on Speedometer . . . . .	Conditions . . . . .
Start&Stop Active Indicator . . . . .	Telltales on Tachometer . . . . .	Transmission Manual Release of P
Start&Stop Disable Indicator. . . . .	Warning/Indicator Lights of Set	(Park) Position . . . . .
Start&Stop Failure Indicator	Modes/Functions on Display . . . . .	Transmitter, Key fob RKE
Light . . . . .	TFT Display: Menus and Settings. . . . .	Preventing Inadvertent Locking of
Start&Stop Function Disabling	Tires	Key fob RKE Transmitter Inside the
Indicator . . . . .	Change a Tire . . . . .	Vehicle . . . . .
Start&Stop Menu . . . . .	Compact spare tire . . . . .	Trunk
Start&Stop System Failure . . . . .	Department of Transportation	Power Trunk Lid/Hand Free
Start the Engine	Uniform Tire Quality Grades . . . . .	(optional) . . . . .
Engine Start Failure. . . . .	General Information . . . . .	Trunk Safety . . . . .
Engine Turn Off . . . . .	Inflation Pressure . . . . .	Trunk Lid
Steering Wheel	Punctured Tire, use . . . . .	Power Trunk Lid/Hand Free
Heated Steering Wheel . . . . .	Replacement Tires. . . . .	(optional) . . . . .
Phone and Voice Controls on	Tire Pressure. . . . .	Trunk Lid Emergency Release from
Steering Wheel. . . . .	Tire Pressure Checkup . . . . .	inside the Trunk . . . . .
Sunroof	Tire Safety Information . . . . .	Trunk Lid Operation . . . . .
Pinch Protect Feature . . . . .	TPMS - Tire Pressure Monitoring	
Slide Opening Sunroof. . . . .	System. . . . .	Updating . . . . .
Sunroof Maintenance . . . . .	Winter Tires . . . . .	
Venting Sunroof. . . . .	Tool Kit . . . . .	Vehicle Identification Number (VIN) .18
Sunshades . . . . .	Towing	Vehicle Stored for Long Periods . . .355
Power Sunshades . . . . .	Towing a Disabled Vehicle . . . . .	Voice Commands . . . . .
Sun Visors . . . . .	Towing the Vehicle . . . . .	
Surround View Camera System . . . . .	Vehicle Towing Conditions . . . . .	Warning icons . . . . .
Symbols . . . . .	TPMS System . . . . .	Warnings when Driving . . . . .



Warranty . . . . .	10
Accessories . . . . .	10
Warranty Information. . . . .	12
Wheels . . . . .	349
Wheels Maintenance . . . . .	349
Windows . . . . .	45
Auto Down/Auto Up Feature . . . . .	46
Defroster . . . . .	47
Open the Windows with RKE Transmitter and Ignition Off . . . . .	47
Rear Window . . . . .	47
Reset Auto-Up/Down . . . . .	47
Window and Sunshade Lockout Button . . . . .	47
Wipers and Washers. . . . .	122
Headlight On with Windshield Wipers . . . . .	124
Rain Sensing Windshield Wipers .	123
Windshield Washers . . . . .	125
Windshield Wipers . . . . .	122
Wipers Blades Maintenance . . . . .	124



Maserati S.p.A. & Maserati North America, Inc. reserve the right to make changes and/or modifications to the content and all technical information and specifications without prior notification.

Therefore, the user is not entitled to any claims based on the contents (texts, data, illustrations, explanations and regulations) in this manual, which are based on the data known at the time of going to print.

© 2018. Maserati S.p.A. All rights reserved.

Publication n. 910042346 - 1st Edition - 03/2018

This document may not be reproduced, printed or translated, even partially, without the written consent of MASERATI S.p.A.





\*910042346\*



MASERATI SPA · VIALE CILRO MENOTTI 32 · I-41121 MODENA