



## Instructions for Use

### EPIA



Please read this manual carefully and thoroughly before using this device.  
Do not use this device for other than intended purpose.

■ EN □ ES □ CS □ DA □ DE □ ET □ EL □ CZ □ RO □ MT □ RO □ PT



This page is intentionally left blank.



# Table of Contents

<b>Chapter I. ABOUT MANUAL .....</b>	<b>2</b>
1. General Information .....	2
2. Revision History .....	2
3. Manufacturer Information .....	2
4. Applicable Standards .....	3
<b>Chapter II. PRODUCT DESCRIPTION.....</b>	<b>4</b>
1. Product Description .....	4
2. Features .....	4
3. Intended Use .....	5
4. Principle of Operation .....	6
5. Specifications .....	7
6. Operating and Storage & Transport Conditions .....	9
7. Product Description .....	10
8. Symbols (Including Safety Signs) .....	15
9. Label and Packaging .....	17
10. Product Component (List of Critical Components) .....	23
<b>Chapter III. HOW TO USE.....</b>	<b>24</b>
1. Preparation Before Use .....	24
2. Device Connection .....	25
3. Instruction to Use .....	29
4. Post-use Treatment .....	32
5. Storage and Transport Conditions .....	32
<b>Chapter IV. WARNING AND SAFETY NOTICES.....</b>	<b>33</b>
1. General Precautions .....	33
2. General Warnings .....	33
3. Interaction .....	34
4. Precaution to Use .....	34
5. Contraindications .....	34
6. Adverse Reaction .....	35
7. Warnings Related to Wireless Communication .....	35
8. Guidance and Manufacturer’s Declaration .....	36
<b>Chapter V. MAINTENANCE AND DISPOSAL.....</b>	<b>41</b>
1. Maintenance and Disposal .....	41
<b>Chapter VI. TECHNICAL CONTENTS.....</b>	<b>42</b>
1. Safety Information and Customer Service .....	42

# Chapter I. About Manual

## 1. General Information

This manual is provided to help users to understand this device's characteristics as a medical device, method, and information for the safe use. For the proper and safe use of device, users must be fully aware of all the details given in this manual.

## 2. Revision History

Rev. No.	Rev. Date (YYYY.MM.DD)	Description
0	2020.08.11	New establishment
1	2021.01.29	EC Representative Information revised. The difference of two models [EPIA-HU-B and EPIA-HU] described. Declaration of Conformity (CE RED) included.

## 3. Manufacturer Information

	<b>RIMSCIENCE CO. Ltd.</b> 601(#602-1), 53, Chungjeong-ro, Seodaemun-gu, Seoul, Republic of Korea 03736 Tel: (+82) 2-3789-1010 Fax: (+82) 2-3789-1014 Website: <a href="http://www.rimscience.com">www.rimscience.com</a> Email: <a href="mailto:sales@rimscience.com">sales@rimscience.com</a>
	<b>JaviTech e.K.</b> Sachsenhausener Straße 16, 65824 Schwalbach am Taunus, Germany Tel.: (+49) 6196-4021549 Email: <a href="mailto:info@javitech.de">info@javitech.de</a>

## 4. Applicable Standards

The device complies with the following international standards.

No.	Standard No. (Reference document No.)	Title of Standard
1	93/42/EEC as amended by 2007/47/EC	Council Directive 93/42/EEC of 14 June 1993 Concerning Medical Devices
2	EN ISO 13485:2016 (ISO 13485:2016)	Medical Device – Quality Management Systems - Requirements for Regulatory Purposes
3	EN 60601-1:2006/A1:2013 (IEC 60601-1:2005)	Medical Electrical Equipment - Part 1: General Requirements for Basic Safety and Essential Performance
4	EN 60601-1-2:2015 (IEC 60601-1-2:2014)	Medical Electrical Equipment - Part 1-2: General Requirements for Basic Safety and Essential Performance - Collateral Standard: Electromagnetic Disturbances - Requirements and Tests
5	EN 60601-1-6:2010 (IEC 60601-1-6:2010)	Medical Electrical Equipment - Part 1-6: General Requirements for Basic Safety and Essential Performance - Collateral Standard: Usability
6	EN 62366:2008 (IEC 62366:2007)	Medical Devices - Application of Usability Engineering to Medical Devices
7	EN 62304:2006 (IEC 62304:2006)	Medical Device Software - Software Life-cycle Processes
8	EN ISO 14971:2012 (ISO 14971:2007, Corrected version 2007-10-01)	Medical devices — Application of Risk Management to Medical Devices
9	EN 1041:2008	Information Supplied by the Manufacturer of Medical Devices
10	EN ISO 15223-1:2016 (ISO 15223-1:2016, Corrected version 2017-03)	Medical Devices — Symbols to be Used with Medical Device Labels, Labelling and Information to be Supplied — Part 1: General Requirements
11	EN 301 489-1 V2.2.3 (2019-11)	ElectroMagnetic Compatibility (EMC) Standard for Radio Equipment and Services - Part 1: Common Technical Requirements - Harmonised Standard for ElectroMagnetic Compatibility
12	EN 301 489-17 V3.2.4 (2020-09)	ElectroMagnetic Compatibility (EMC) Standard for Radio Equipment and Services – Part 17: Specific Conditions for Broadband Data Transmission Systems – Harmonised Standard for ElectroMagnetic Compatibility
13	EN 300 328 V2.1.1 (2016-11)	Wideband Transmission Systems; Data Transmission Equipment Operating in the 2.4 GHz ISM Band and Using Wide Band Modulation techniques; Harmonised Standard Covering the Essential Requirements of Article 3.2 of Directive 2014/53/EU
14	EN 62311:2008	Assessment of Electronic and Electrical Equipment Related to Human Exposure Restrictions for Electromagnetic Fields (0 Hz – 300 GHz)
15	MEDDEV 2.4/1 rev.9	Classification of Medical Devices
16	MEDDEV 2.7.1_rev 4	Clinical Evaluation: Guide for Manufacturers and Notified Bodies
17	MEDDEV 2.12/1 rev.8	Guidelines on a Medical Devices Vigilance System
18	MEDDEV 2.12/2 rev.2	Post Market Clinical Follow-up Studies

## Chapter II. Product Description

### 1. Product Description

EPIA is a handheld device using internal power, which can hold a 5 mL syringe and an epidural needle. EPIA assists the epidural needle to be inserted and approach the epidural space. An operator can control the movement of the syringe and the insertion of the epidural needle.

While the epidural needle is being inserted, a pressure sensor located in EPIA detects the change of pressure (Reaction Force) applied to the tip of the needle, converts the pressure data of each tissue to digital data and indicates them as a graph on a display device.

The operator can determine the target injection site by monitoring the pressure change in the graph and can control or stop the movement of the epidural needle at the target site, which is the epidural space.

When needed, the device can be detached from the syringe, and the operator can inject an anesthetic directly or can insert an epidural catheter.

### 2. Features

- Data transmitting via Bluetooth communication or USB data cable
- Real-time graph shown by display device
- Visualization of pressure and needle insertion length
- Internally powered
- 5 mL syringe compatible
- Steady and stable needle insertion
- Fine control of needle movement – Safety control button (0.2mm fine advance, stop, backward)
- Safety function – Automatic stop when the pressure detected is 50 gf lower than the maximal pressure detected.
- Applicable for various treatments accompanying epidural anesthesia and pain control

#### 2.1. Model Difference

Model	Description
EPIA-HU-B	The device can be connected to a display device via Bluetooth function.
EPIA-HU	The device can be connected to a display device using data cable connection. Data cable is included in the package as an accessory.



### 3. Intended Use

EPIA is an epidural instrument intended for use with an epidural needle for the real-time confirmation of the needle tip placement into the epidural space.

The device assists in the insertion of the needle into the epidural space by showing the needle insertion progress and the pressure data of each tissue as a graph of reaction force on a display device.

#### 3.1. Patient Population

Adults (men or women)

#### 3.2. Age

18 years of age and older

#### 3.3. Application Part

Vertebra

#### 3.4. Intended Medical Indication

- Epidural anesthesia
- Pain control (labor analgesia)

#### 3.5. Patient Contacting Part

None

#### 3.6. Potential/Possible Adverse Reaction

- Cerebrospinal fluid leakage due to dural puncture
- Spinal nerve damage
- Pain in the treatment area

#### 3.7. Contraindications

- Do not use on a patient with sepsis, bacteremia, injection site infection, severe hypovolemia, severe coagulation abnormalities, therapeutic anticoagulant therapy, increased intracranial pressure, and patient refusal.
- Do not use on a patient with neurological disorders, mental illness or dementia, aortic stenosis, left ventricular outflow tract obstruction (LVOTO), and congenital heart disease.

## 4. Principle of Operation

The product is used to assist with an epidural procedure that detects the epidural space by automatically pushing the syringe barrel to insert the epidural needle into the epidural space.

The motor rotates by using the electric power of a 3V battery, and the rotational motion is converted to a linear motion of the syringe barrel and the needle fixed to the syringe holder.

While the epidural needle is being inserted into the body, the pressure sensor in the syringe holder detects the pressure change between each tissue. The detected pressure change is converted and stored as digital data and displayed as a graph on the display device.

When the epidural needle is inserted into the body, the pressure will gradually increase in the subcutaneous (①) and ligament tissue (②), and the pressure will rapidly drop when it reaches the epidural space (③). In this way, the operators can verify whether the needle tip has successfully entered into the epidural space.

EPIA also makes use of this phenomenon and detects reaction force, which is made against the force that the needle penetrates the tissue. While the tip of needle inserts through the subcutaneous and ligament tissue, the reaction force as well as pressure at the tip of the needle increases (① and ② in the graph below). When the tip of needle reaches the epidural space, the pressure and the reaction force rapidly decrease (③). The pressure sensor of EPIA detects this change in reaction force and convert it as visual data.

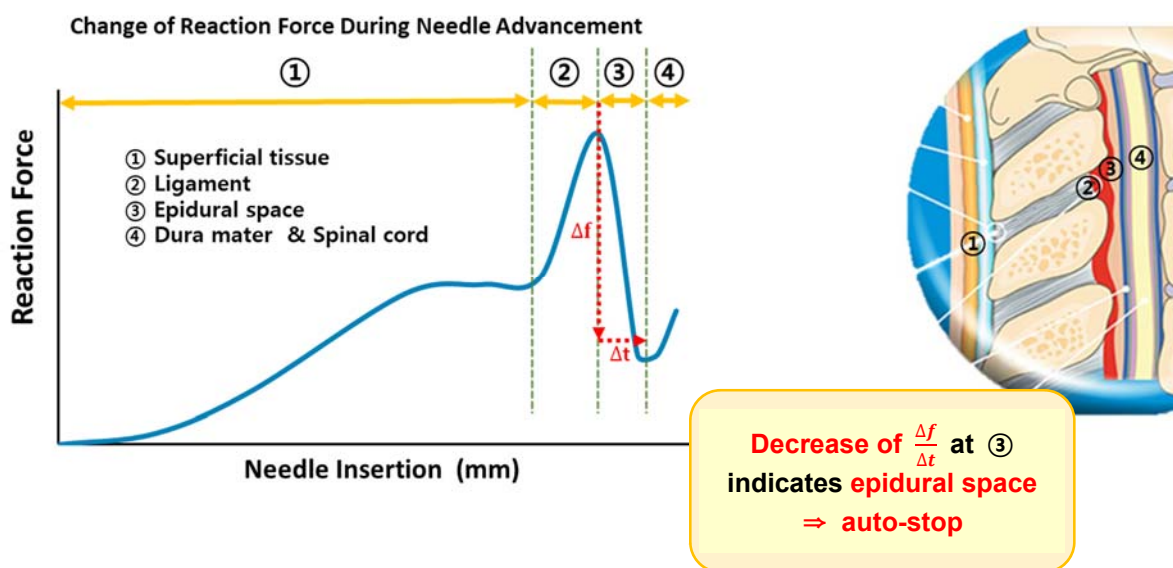



## 5. Specifications

### 5.1. General Specifications

#### 5.1.1. EPIA-HU-B

No	Category	Description
1	Product Name	Epidural Instrument
2	Model Name	EPIA-HU-B
3	Brand Name	EPIA
4	Power Input	Lithium Battery, 3Vdc
5	Dimension	Main body: 204.5 mm (L) X 41 mm (W) X 80 mm (H)
6	Weight	217 g
7	Electric Shock Protection Type and Degree	Internally powered, No Applied part
8	Software Version	Rims_EPIA version 1.0.0
9	Communication Standard	BLE (Bluetooth 4.0 or higher), RS-232
10	Accessories	N/A

#### 5.1.2. EPIA-HU

No	Category	Description
1	Product Name	Epidural Instrument
2	Model Name	EPIA-HU
3	Brand Name	EPIA
4	Power Input	Lithium Battery, 3Vdc
5	Dimension	Main body: 204.5 mm (L) X 41 mm (W) X 80 mm (H)
6	Weight	217 g
7	Electric Shock Protection Type and Degree	Internally powered, No Applied part
8	Software Version	Rims_EPIA version 1.0.0
9	Communication Standard	RS-232
10	Accessories	Data cable (USB-C)

## 5.2. Technical Specifications

### 5.2.1. EPIA-HU-B

No	Category	Description	
1	Max. Travel Distance	45 mm $\pm$ 10 %	
2	Min. Travel Distance	0.2 mm $\pm$ 20 %	
3	Moving Speed	1.8 mm/s $\pm$ 10 %	
4	Operation	Normal Operation of Forward Movement, Backward Movement, Stop, and Fine Advance	
5	Safety Function	Automatic stop when the pressure detected is 50 gf lower than the maximal pressure detected.	
6	RF Specifications	Frequency Range	2,402 MHz ~ 2,480 MHz (Bluetooth Low Energy)
		Modulation Technique	GFSK (Bluetooth Low Energy)
		Number of Channels	40 Ch (Bluetooth Low Energy)

### 5.2.2. EPIA-HU

No	Category	Description
1	Max. Travel Distance	45 mm $\pm$ 10 %
2	Min. Travel Distance	0.2 mm $\pm$ 20 %
3	Moving Speed	1.8 mm/s $\pm$ 10 %
4	Operation	Normal Operation of Forward Movement, Backward Movement, Stop, and Fine Advance
5	Safety Function	Automatic stop when the pressure detected is 50 gf lower than the maximal pressure detected.

## 6. Operating and Storage & Transport Conditions

### 6.1. Operation Conditions

- 1) Temperature: 10 - 40 °C
- 2) Relative Humidity: 30 - 75 %
- 3) Atmospheric Pressure: 800 - 1060 hPa

### 6.2. Storage & Transportation Conditions

- 1) Temperature: -20 - 60 °C
- 2) Relative Humidity: 10 - 90 %
- 3) Atmospheric Pressure: 700 - 1060 hPa

### 6.3. Sterilization Method

- 1) Sterilization Method : Sterilized with E.O. (Ethylene oxide) Gas
- 2) Sterilization Process Condition

Process	Condition
Gas Mixture	30% Ethylene Oxide + 70% CO <sub>2</sub>
Gas Concentration	700 – 800 mg/L
Temperature	40 ± 5 °C
Humidity	50 ± 25% RH
Exposure Pressure	0.7 ± 0.05 kgf/cm <sup>2</sup>
Exposure Time	240 min
Flushing	7 times or more
Temperature	10 – 40 °C
Time	48 hours
SAL	10 <sup>-6</sup>

### 6.4. Lifecycle of Device

- Shelf life: 3 years

## 7. Product Description

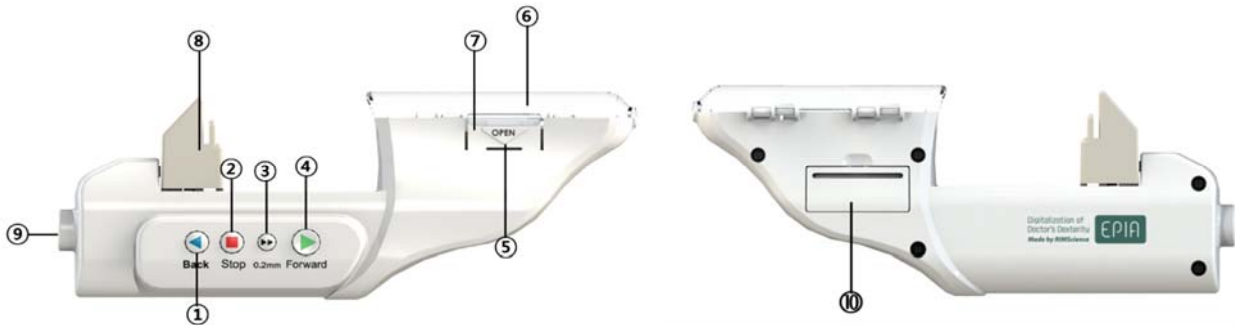

### 7.1. Appearance [EPIA-HU-B]

#### 7.1.1. Main Body



No	Component	Symbol	Description
1	Backward Button		Button to move syringe and needle backward
2	Stop Button		Button to stop the movement of syringe and needle
3	Fine Advance (0.2mm) Button		Button to advance syringe and needle for an additional 0.2 mm
4	Forward Button		Button to advance syringe and needle forward constantly
5	Cover Open		Button to open the syringe cover
6	Cover		Cover to fix the syringe and needle from falling out
7	Lock		Lock for syringe cover
8	Syringe Holder		Holder for syringe barrel flange
9	Cable Connector		Transmitting device data to a tablet PC via cable
10	Battery Cover		Cover to fix the 3V battery inserted according to the electrode

### 7.1.2. Compatibility

No	Compatible Products		Standard Requirements	
1	Syringe		5 mL	KOVAX-SYRINGE (Korea Vaccine, Co. Ltd.)
2	Epidural Needle		Puncture needle for epidural anesthesia	Tuohy type Epidural needle (TaeChang Industrial Co. Ltd.)
3	Battery		3V Lithium battery	CR123A (Panasonic)
4	Display Device	-	Tablet PC (recommended)	- OS Android 10.0 (or higher) - Storage 64 GB - Bluetooth 4.0 (or higher)
5	Software	-	Rims_EPIA	Provided by manufacturer (Rimscience Co. Ltd.)

- ※ Must use sterile syringes and sterile needles with separate and certified medical products compatible with EPIA.
- ※ Use of Tuohy type Epidural Needle is highly recommended.
- ※ A battery is enclosed in the product packaging.
- ※ Use of a display device as tablet PC is highly recommended to confirm the needle progress (insertion length) and the pressure change detected by EPIA.

## 7.2. Appearance [EPIA-HU]

### 7.2.1. Main Body



- Same as EPIA-HU-B (Please refer to “section 7.1.1 of Chapter II”).

### 7.2.2. Accessory



No	Accessory	Description
1	Data Cable	Data transmitting USB cable to connect EPIA main body and tablet PC

### 7.2.3. Compatibility

No	Compatible Products		Standard Requirements	
1	Syringe		5 mL	KOVAX-SYRINGE (Korea Vaccine, Co. Ltd.)
2	Epidural Needle		Puncture needle for epidural anesthesia	Tuohy type Epidural needle (TaeChang Industrial Co. Ltd.)
3	Battery		3V Lithium battery	CR123A (Panasonic)
4	Display Device	-	Tablet PC (recommended)	<ul style="list-style-type: none"> <li>- OS Android 10.0 (or higher)</li> <li>- Storage 64 GB</li> <li>- USB port C-type</li> </ul>
5	Software	-	Rims_EPIA	Provided by manufacturer (Rimscience Co. Ltd.)

- ※ Must use syringes and needles with separate and certified medical products compatible with EPIA.
- ※ Use of Tuohy type Epidural Needle is highly recommended.
- ※ A battery is enclosed in the product packaging.
- ※ Use of a display device as tablet PC is highly recommended to confirm the needle progress (insertion length) and the pressure change detected by EPIA.

### 7.3. Software [Rims\_EPIA (Version 1.0.0)]

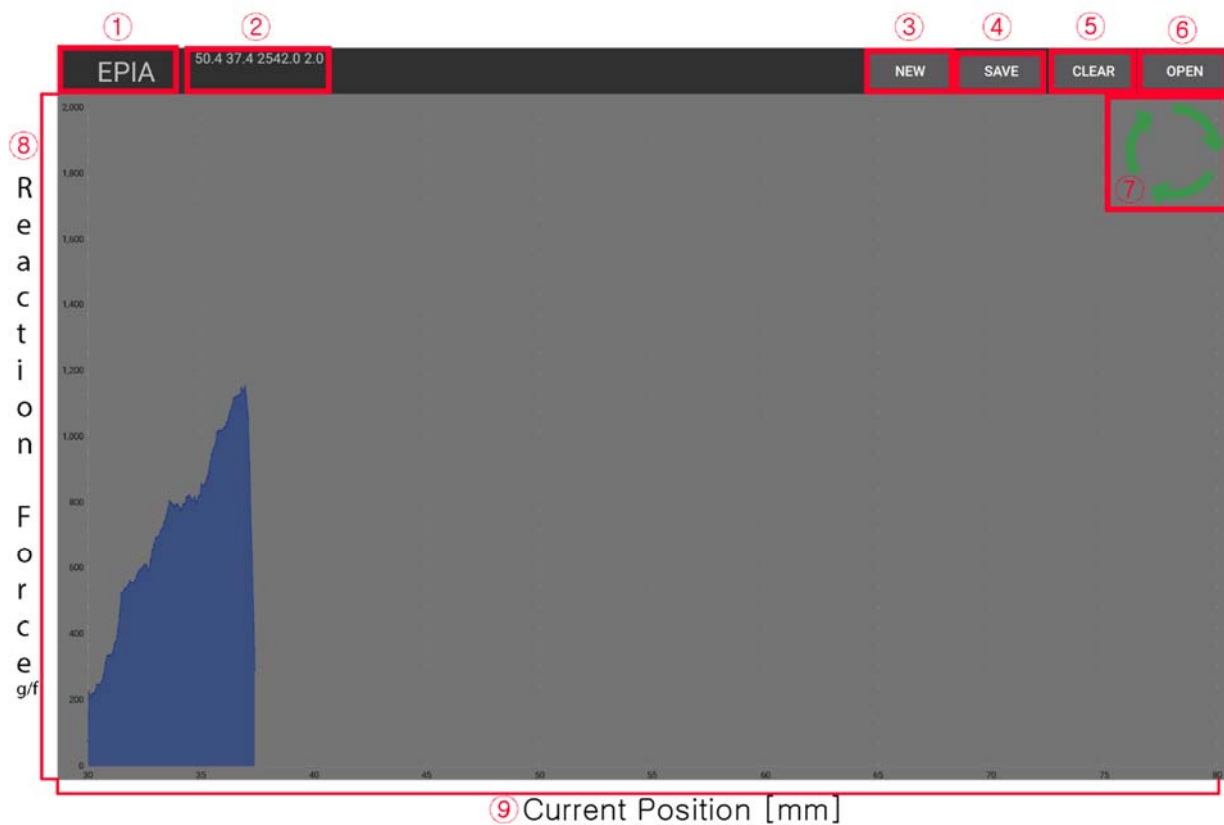

No	Name	Symbol	Description
1	EPIA Logo		Data transmission and move to Settings Page
2	Packet Information	-	Packet data transmitted from EPIA
3	NEW Button		Move to initial display (Reset graph and patient information)
4	Save Button		Save current graph and data
5	Clear Button		Save current graph and reset the graph
6	Open Button		Opens a pop-up window of saved graph file list
7	Needle Progress Direction		Show the status and the direction of the needle movement - Green arrow rotating clockwise: needle moves forward - Red arrow rotating counterclockwise: needle moves backward - No rotation: needle stops
8	Y-Axis	Reaction Force	Reaction force (gf) measured from the needle
9	X-Axis	Current Position	Current position (mm) of needle (needle insertion length)
※ Files are saved with names as below: - Data file: YYMMDDhhmmss_S_[NAME]_[AGE].txt - Graph: YYMMDDhhmmss_S_[NAME]_[AGE].png			

## 7.4. Dimensions

### 7.4.1. Main Body

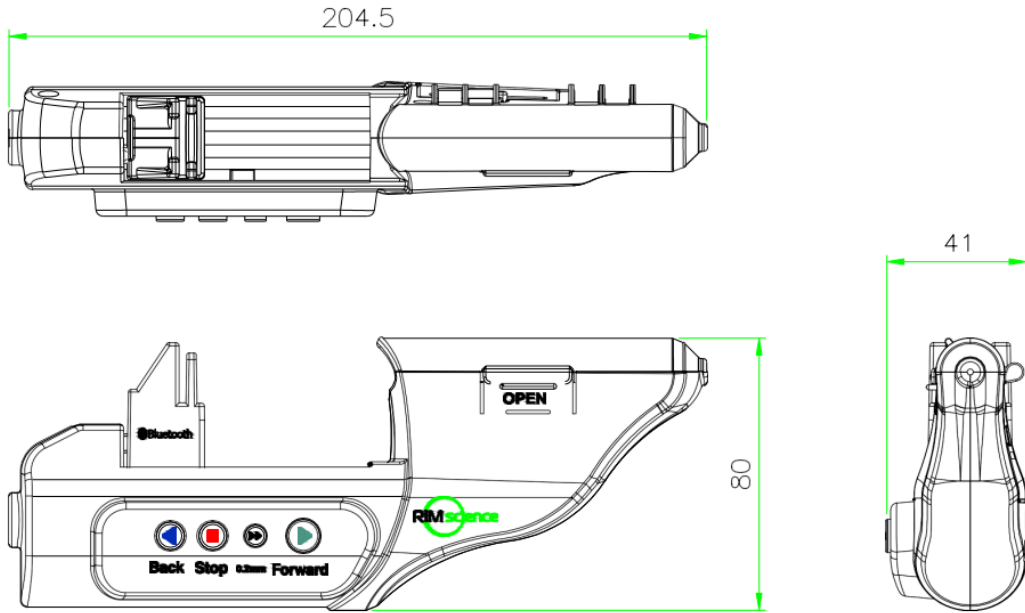

No	Name	Description	Part No.
1	Main Body	1) Dimension: 204.5 mm (L) X 41 mm (W) X 80 mm (H) 2) Weight: 217 g	EPIA-PL-B

### 7.4.2. Accessory



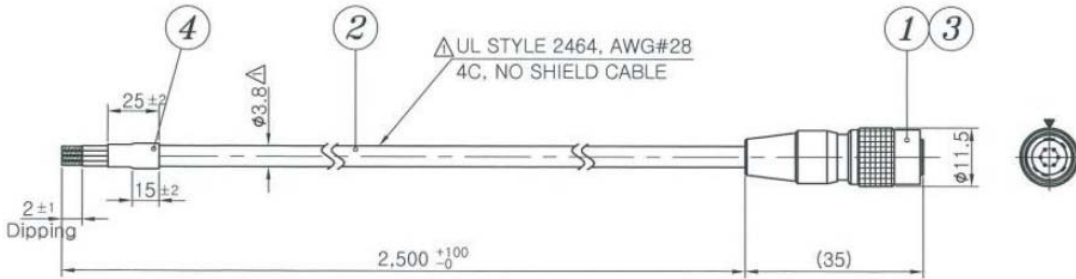















- Data Cable [EPIA-HU only]









No	Name	Description	Part No.
1	Data Cable	1) Dimension: 2,500 mm (L) 2) Weight: 100 g	EPIA-CABLE



## 8. Symbols (Including Safety Signs)

Symbol	Title	Description
	<b>Do Not Reuse</b>	Indicates a medical device that is intended for one use, or for use on a single patient during a single procedure
	<b>Do Not Use if Package is Damaged</b>	Indicates a medical device that should not be used if the package has been damaged or opened
	<b>Sterilized Using Ethylene Oxide</b>	Indicates a medical device that has been sterilized using ethylene oxide gas
	<b>Do Not Re-sterilize</b>	Indicates a medical device that is not to be re-sterilized
	<b>General Prohibition Sign</b>	To signify a prohibited action
	<b>General Warning Sign</b>	General warning sign
	<b>Caution</b>	To indicate that caution is necessary when operating the device or control close to where the symbol is placed, or to indicate that the current situation needs
	<b>Manufacturer</b>	Indicates the medical device manufacturer
	<b>Date of Manufacture</b>	Indicates the date when the medical device was manufactured
	<b>Use-by-date</b>	Indicates the date after which the medical device is not to be used
	<b>Batch Code (LOT)</b>	Indicates the manufacturer's batch code so that the batch or lot can be identified
	<b>Follow Instructions for Use</b>	Indicates the need for the user to consult and follow the instructions for use
	<b>Catalog Number</b>	Indicates the manufacturer's catalog number so that the medical device can be identified
	<b>Fragile, Handle with Care</b>	Indicates a medical device that can be broken or damaged if not handled carefully
	<b>Keep Dry</b>	Indicates a medical device that needs protection from moisture
	<b>Temperature Limit</b>	Indicates the temperature limits to which the medical device can be safely exposed
	<b>Humidity Limitation</b>	Indicates the range of humidity to which the medical device can be safely exposed
	<b>Atmospheric Pressure Limitation</b>	Indicates the range of atmospheric pressure to which the medical device can be safely exposed



Symbol	Title	Description
	<b>Battery, General</b>	On battery powered equipment
	<b>Waste Electrical and Electronic Equipment (WEEE)</b>	Do not throw this unit into a municipal trash bin when this unit has reached the end of its lifetime. To ensure utmost protection of the global environment and minimize pollution, please recycle this unit
	<b>Non-ionizing Electromagnetic Radiation</b>	Indicates the range of atmospheric pressure to which the medical device can be safely exposed
	<b>FCC Mark</b>	The electromagnetic interference from the device is under limits approved by the Federal Communications Commission (United States)
	<b>Authorized Representative in the European Community</b>	Indicates the authorized representative in the European Community
	<b>CE Marking</b>	The requirements of accreditation and market surveillance relating to the marketing of products

## 9. Label and Packaging

### 9.1. Label

- Please refer to “section 8 of Chapter II” to find more about symbols.

#### 9.1.1. Label [EPIA-HU-B]

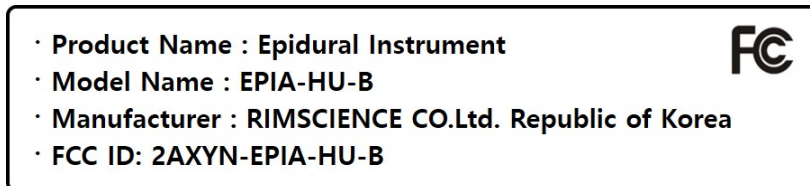

#### Product Label [EPIA-HU-B]

The label is fixed to the left exterior side of the product where it cannot be removed.

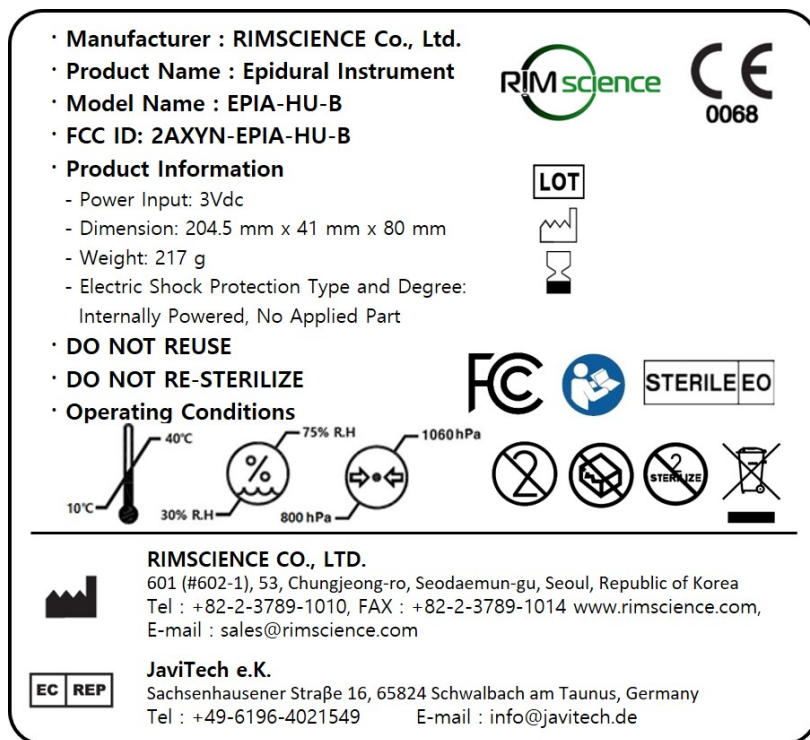

#### Product Label [EPIA-HU-B]

This product label is attached to the Tyvek paper of the inner packaging (pouch) (refer to 9.2.4 of Chapter II).

- Manufacturer : RIMSCIENCE Co., Ltd.
- Product Name : Epidural Instrument
- Model Name : EPIA-HU-B
- FCC ID: 2AXYN-EPIA-HU-B



· **Product Information**

- Power Input: 3Vdc
- Dimension: 204.5 mm x 41 mm x 80 mm
- Weight: 217 g
- Electric Shock Protection Type and Degree:  
Internally Powered, No Applied Part

LOT



· **DO NOT REUSE**

· **DO NOT RE-STERILIZE**

· **Storage & Transportation Conditions**



STERILE EO

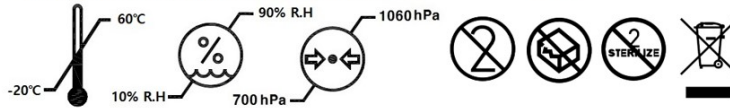

**RIMSCIENCE CO., LTD.**

601 (#602-1), 53, Chungjeong-ro, Seodaemun-gu, Seoul, Republic of Korea  
Tel : +82-2-3789-1010, FAX : +82-2-3789-1014 www.rimscience.com,  
E-mail : sales@rimscience.com



**JaviTech e.K.**

Sachsenhausener Straße 16, 65824 Schwalbach am Taunus, Germany  
Tel : +49-6196-4021549 E-mail : info@javitech.de



**Packaging Label [EPIA-HU-B]**

This packaging label is attached to the side of the inner box (refer to 9.2.5 of Chapter II).





### 9.1.2. Label [EPIA-HU]

- **Manufacturer :** RIMSCIENCE Co., Ltd.
- **Product Name :** Epidural Instrument
- **Model Name :** EPIA-HU
- **FCC ID:** 2AXYN-EPIA-HU-B





- **Product Information**
- Power Input: 3Vdc
- Dimension: 204.5 mm x 41 mm x 80 mm
- Weight: 217 g
- Electric Shock Protection Type and Degree:  
Internally Powered, No Applied Part

- **DO NOT REUSE**
- **DO NOT RE-STERILIZE**
- **Operating Conditions**

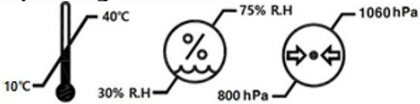

---



**RIMSCIENCE CO., LTD.**  
 601 (#602-1), 53, Chungjeong-ro, Seodaemun-gu, Seoul, Republic of Korea  
 Tel : +82-2-3789-1010, FAX : +82-2-3789-1014 www.rimscience.com,  
 E-mail : sales@rimscience.com





**JaviTech e.K.**  
 Sachsenhausener Straße 16, 65824 Schwalbach am Taunus, Germany  
 Tel : +49-6196-4021549 E-mail : info@javitech.de

**Product Label [EPIA-HU]**





This product label is attached to the Tyvek paper of the inner packaging (pouch) (refer to 9.2.4 of Chapter II).

- **Manufacturer :** RIMSCIENCE Co., Ltd.
- **Product Name :** Epidural Instrument
- **Model Name :** EPIA-HU
- **FCC ID:** 2AXYN-EPIA-HU-B





- **Product Information**
- Power Input: 3Vdc
- Dimension: 204.5 mm x 41 mm x 80 mm
- Weight: 217 g
- Electric Shock Protection Type and Degree:  
Internally Powered, No Applied Part

- **DO NOT REUSE**
- **DO NOT RE-STERILIZE**
- **Storage & Transportation Conditions**

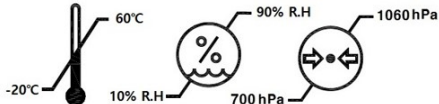

---



**RIMSCIENCE CO., LTD.**  
 601 (#602-1), 53, Chungjeong-ro, Seodaemun-gu, Seoul, Republic of Korea  
 Tel : +82-2-3789-1010, FAX : +82-2-3789-1014 www.rimscience.com,  
 E-mail : sales@rimscience.com







**JaviTech e.K.**  
 Sachsenhausener Straße 16, 65824 Schwalbach am Taunus, Germany  
 Tel : +49-6196-4021549 E-mail : info@javitech.de

**Packaging Label [EPIA-HU]**



This packaging label is attached to the side of the inner box (refer to 9.2.5 of Chapter II).

### 9.1.3. Accessory Label [EPIA-HU]

- **Manufacturer:** RIMSCIENCE Co., Ltd.
- **Accessory Name:** Data Cable
- **Model Name:** EPIA-CABLE

---

**RIMSCIENCE CO., LTD.**  
601 (#602-1), 53, Chungjeong-ro, Seodaemun-gu, Seoul, Republic of Korea  
Tel : +82-2-3789-1010, FAX : +82-2-3789-1014 [www.rimscience.com](http://www.rimscience.com),  
E-mail : [sales@rimscience.com](mailto:sales@rimscience.com)

**JaviTech e.K.**  
Sachsenhausener Straße 16, 65824 Schwalbach am Taunus, Germany  
Tel : +49-6196-4021549 E-mail : [info@javitech.de](mailto:info@javitech.de)

**Data Cable Label [EPIA-HU]**

## 9.2. Packaging

### 9.2.1. Packaging Unit

- 1 Set / Box

Model	Contents
EPIA-HU-B	EPIA Main Body (1 ea) + 3V Battery (1 ea) + User Manual (1 ea)
EPIA-HU	EPIA Main Body (1 ea) + 3V Battery (1 ea) + User Manual (1 ea) + Data Cable (1 ea)

### 9.2.2. Packaging Material and Dimension

Packaging	Material	Dimensions (mm)
Inner Packaging (Blister)	PET Blister, Tyvek Paper	271 (L) X 41.5 (W) X 109 (H)
Inner Packaging (Pouch)	PE Film, Tyvek Paper	390 (L) X 180 (W)
Inner Box (Gift Box)	Paper (Manilla Paper)	300 (L) X 135 (W) X 55 (H)
Outer Box (Carton Box)	Carton box (Paper)	325 (L) X 305 (W) X 325 (H)

### 9.2.3. Inner Packaging (Blister)

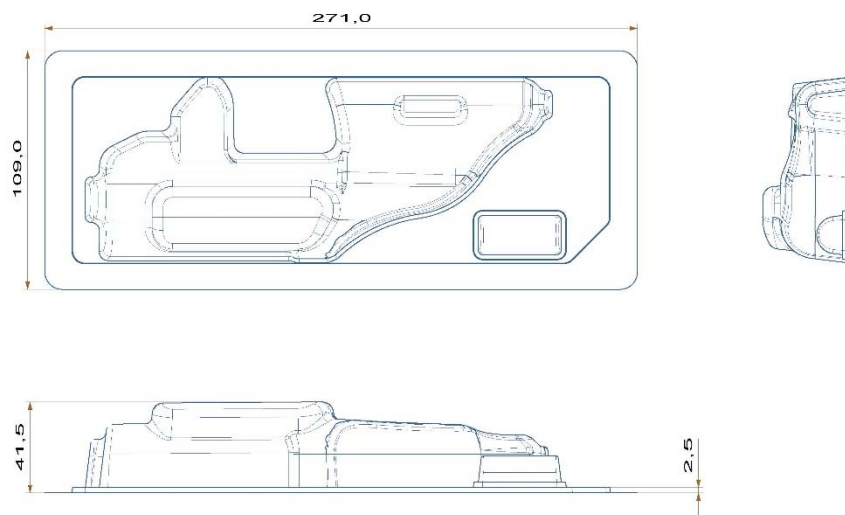

### 9.2.4. Inner Packaging (Pouch)

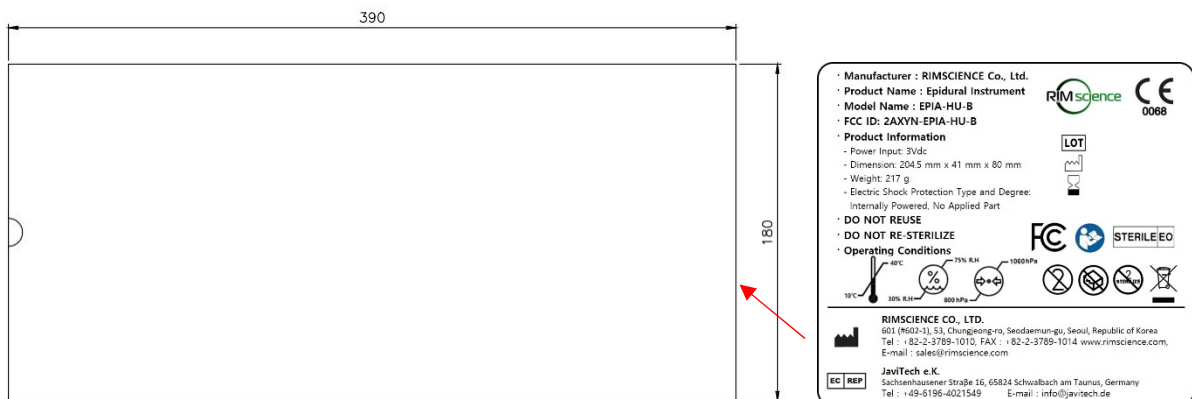

※ The product label is attached to the Tyvek paper of the packaging.

### 9.2.5. Inner Box (Gift Box)

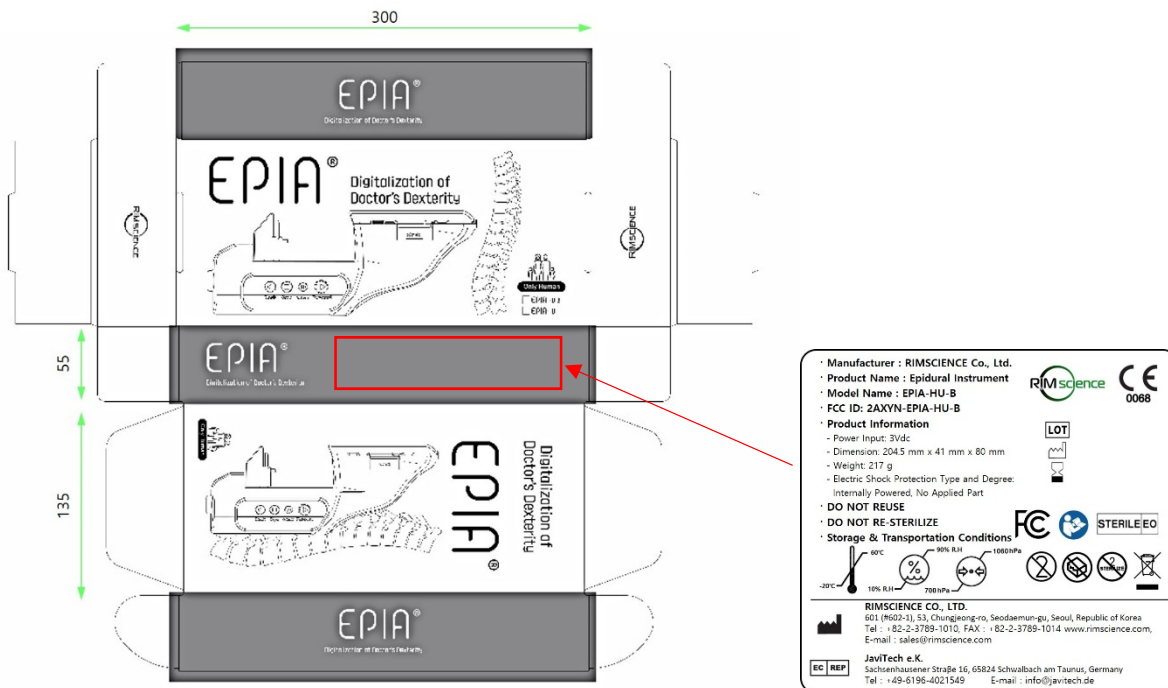

✘ The packaging label is attached to the side of the inner box (where indicated as a red box and arrow shown in the drawing above).

### 9.2.6. Outer Box (Carton Box)

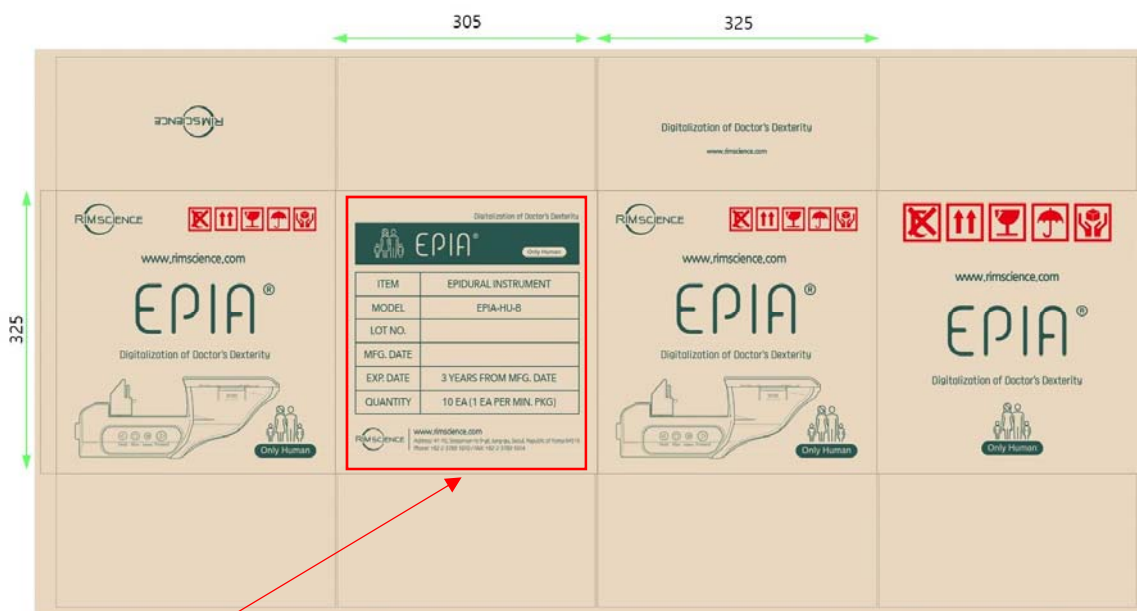

✘ The product information (Model name, Lot No., Expiry date, Manufacturer information etc.) is printed or stamped to the side of the outer box (where indicated as a red box and arrow shown in the drawing above).



## 10. Product Components (List of Critical Components)

### 10.1. List of Critical Components

No	Component	Part reference	Manufacturer	Technical Data	Standard	Conformity Reference
1	Lithium Metal Battery	CR123A	Panasonic	3, 0 V, 1550 mAh	IEC 60086-4	CB(NL-64193)
2	Enclosure	AF365(&)	LG CHEM LTD	Min Thk : 1.7 mm V-1, 60 °C	UL 94	UL(E67171)
3	PCB	FR4-74	ZHEJIANG WAZAM NEW MATERIALS CO., LTD.	Min Thk : 0.38 mm V-0, 130 °C	UL 94	UL(E136069)
4	DC Motor	MJ-180PA-42	DONGGUAN MAJOR PRECISION MANUFACTURING CO., LTD.	3 V	IEC 60601-1	Tested in equipment

### 10.2. List of Critical Components of Control Board (PCB) [EPIA-HU-B]

No	Name	Part No.
1	P-MOSFET	DMG2301L
2	Voltage Sensor IC	APX803L-28SA-7
3	MCU	ATmega328PB-MUR
4	16Mhz Oscillator	ABLS7M2-16.000MHZ-D2Y-T
5	Boost IC	MT3608
6	Bluetooth Module	BOT-nle521
7	Motor Driver	LB1930MC
8	RS232 Converter IC	SP3222eey

### 10.3. List of Critical Components of Control Board (PCB) [EPIA-HU]

No	Name	Part No.
1	P-MOSFET	DMG2301L
2	Voltage Sensor IC	APX803L-28SA-7
3	MCU	ATmega328PB-MUR
4	16Mhz Oscillator	ABLS7M2-16.000MHZ-D2Y-T
5	Boost IC	MT3608
6	Motor Driver	LB1930MC
7	RS232 Converter IC	SP3222eey

### 10.4. Lifetime of Critical Components

- Shelf life: 3 years

## Chapter III. How to Use

### 1. Preparation Before Use

#### 1.1. Training



- Before use, refer to the video or training materials provided by the manufacturer.
- The device must be used by well-trained, professional medical personnel for medical use only.
- The device requires sufficient training before use.

#### 1.2. Preparation of the Device

- Prepare EPIA, 3V battery, USB cable (if needed), a display device, a 5 ml syringe, an epidural needle, and anesthetic (or saline) to be injected.
- Check whether the sterile packaging of EPIA is damaged and whether the product is deformed or damaged.
- Check if the environment is suitable for product use. Avoid a humid or wet place.
- Read manual and be sure to be fully aware of the device features and cautions before use.



Syringes and needles must use separate certified medical products. (Please refer to “section 7.2.3 of Chapter II”)

Standard requirements (not included)

- Syringe 5 mL (KOVAX-SYRINGE (Korea Vaccine)),
- Epidural needle (Tuohy type puncture needle for epidural anesthesia (TaeChang Industrial))

#### 1.3. Power Check

- ① Open the battery cover ① on the left side of the EPIA.
- ② Insert the 3V battery (included) into ②, according to the electrode mark.  
Left (anterior side of EPIA): (+) pole, Right (posterior side of EPIA): (-) pole
- ③ Close the battery cover again as ①.



When the battery is inserted properly, the device will be turned on, and the syringe holder will automatically move to the start (setting) position.



## 2. Device Connection

### 2.1. Bluetooth Connection [EPIA-HU-B]

- ① Turn on the display device.
- ② Run the EPIA program.
- ③ Enter the patient information (Patient Name, Age, Gender) on the patient information input screen. After you fill out, click the OK button to continue.

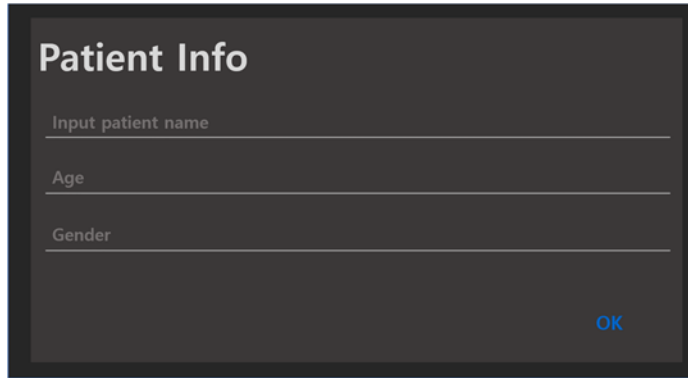

- ④ Click the “CONNECT” button  on the upper right of screen to connect the EPIA with the display device.



If EPIA is not connected properly with the display device, reconnect the device by click the “CONNECT” button again.

- ⑤ Click the “READ” button to complete the graph screen preparation.

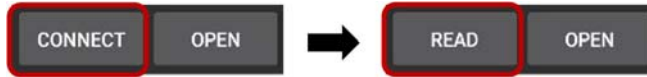

If Bluetooth Communication is not working well, the device can be connected to a display device using data cable (USB cable) provided by manufacturer (optional). For the cable connection method, please refer to “section 2.2 USB Cable Connection [EPIA-HU] of Chapter III”.

## 2.2. USB Cable Connection [EPIA-HU]

- ① Insert the USB Cable into the cable connector located at the back of the EPIA device.



- ② Connect the USB cable and a display device through USB-C port.
- ③ After connection, the following message appears.

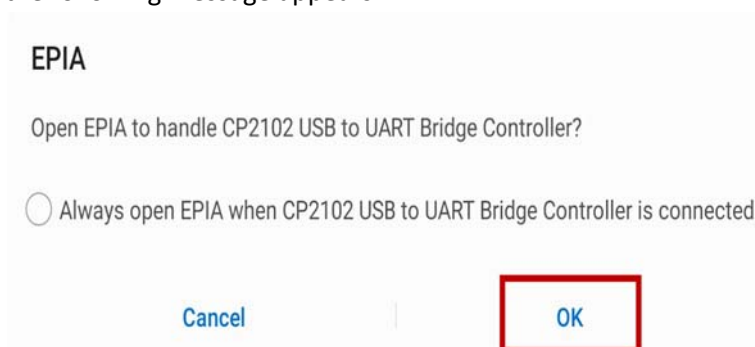

- ④ Click the OK button to start the program.



If you click the CANCEL button, EPIA will not be connected.  
Reconnect EPIA with USB cable, and press the OK button to start the program.

- ⑤ Enter the patient information (Patient Name, Age, Gender) and click the OK button to start the program.

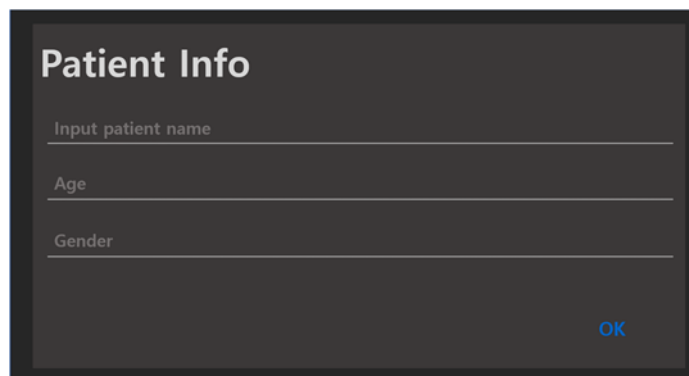
A screenshot of a "Patient Info" form. The form has a dark background and white text. It contains three input fields: "Input patient name", "Age", and "Gender". Each field has a horizontal line for text entry. At the bottom right of the form, there is a blue "OK" button.

### 2.3. Main Screen

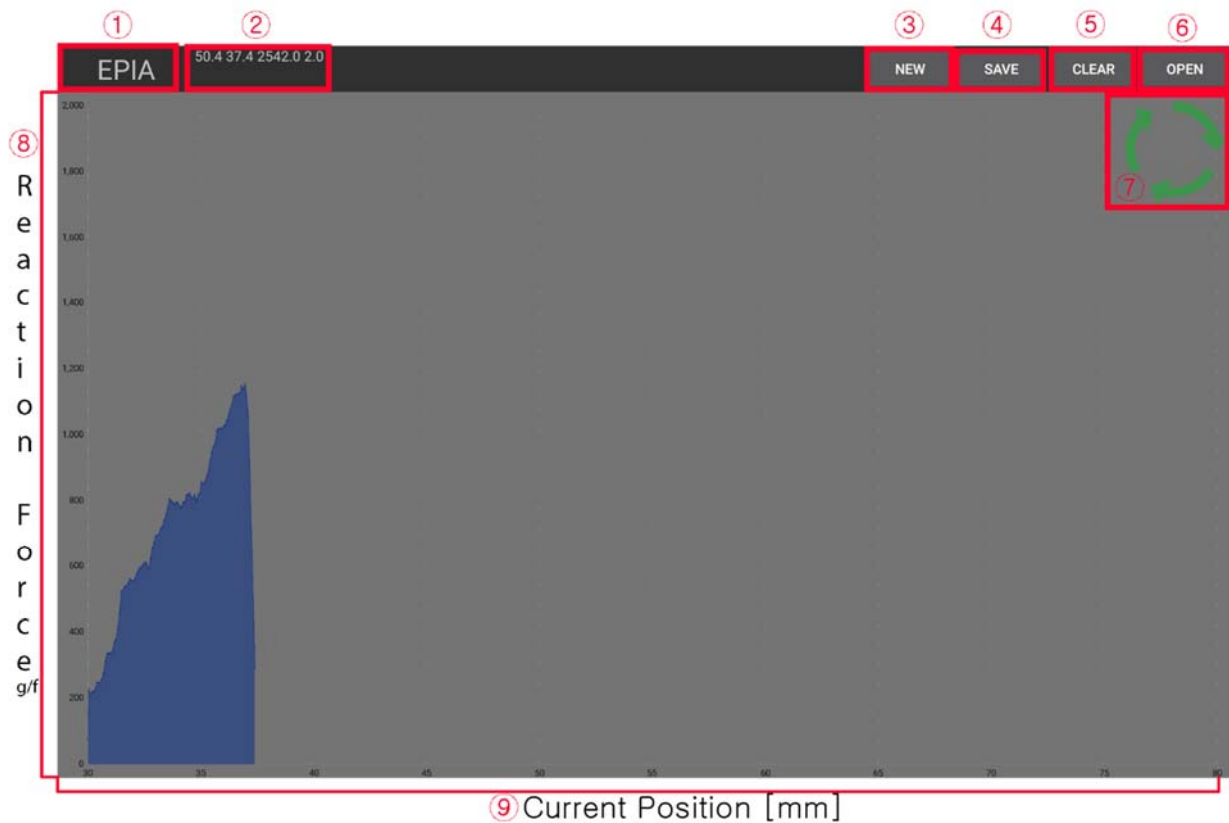

No	Name	Symbol	Description
1	EPIA Logo		Data transmission and move to Settings Page
2	Packet Information	-	Packet data transmitted from EPIA
3	NEW Button		Move to initial display (Reset graph and patient information)
4	Save Button		Save current graph and data
5	Clear Button		Save current graph and reset the graph
6	Open Button		Opens a pop-up window of saved graph file list
7	Needle Progress Direction		Show the status and the direction of the needle movement - Green arrow rotating clockwise: needle moves forward - Red arrow rotating counterclockwise: needle moves backward - No rotation: needle stops
8	Y-Axis	Reaction Force	Reaction force (gf) measured from the needle
9	X-Axis	Current Position	Current position (mm) of needle (needle insertion length)
※ Files are saved with names as below: - Data file: YYMMDDhhmmss_S_[NAME]_[AGE].txt - Graph: YYMMDDhhmmss_S_[NAME]_[AGE].png			

## 2.4. File Import

- ① Click the OPEN  button on the top right of the main screen to open the file list. The example file list is shown below.

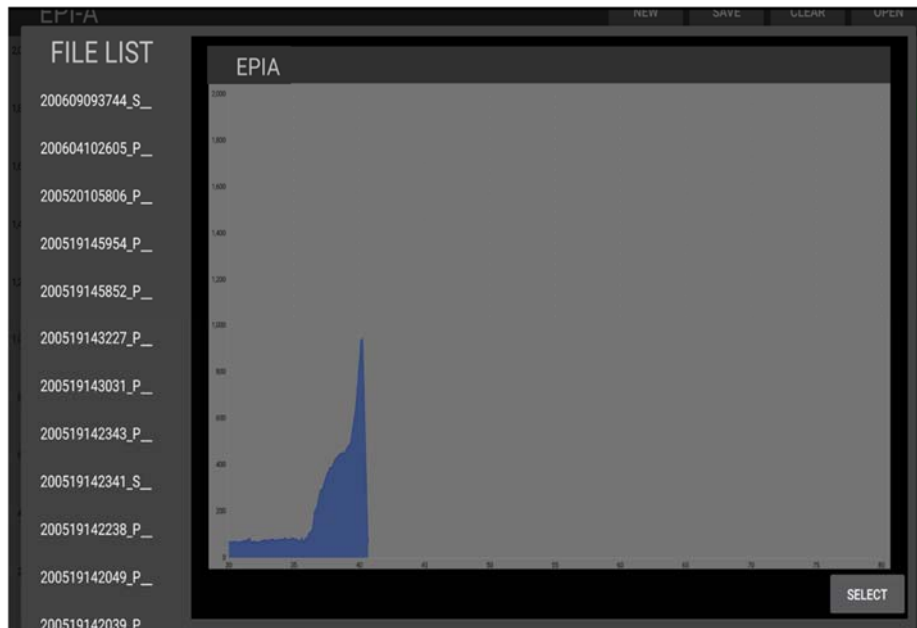

- ② Select a file from the file list and click the SELECT  button to import the data.
- ③ When the selected file is imported, the data will appear on the screen.

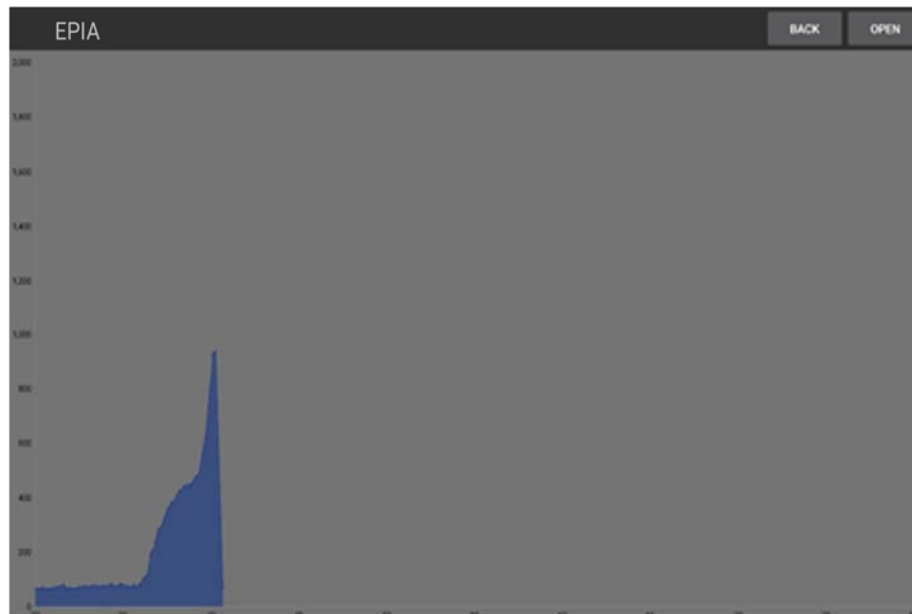

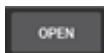
- ④ To return to the patient information page, click the BACK  button.
- ⑤ To return to the file list again, click the OPEN  button.

### 3. Instruction to Use

- ① Prepare the sterilized EPIA device, an epidural needle, and a 5 ml syringe.  
If needed, fill the syringe with saline or an anesthetic to be injected into the epidural space.
- ② Remove a stylet from the epidural needle.
- ③ Combine the syringe and the epidural needle.
- ④ Open the syringe cover of EPIA by pressing the OPEN  button.
- ⑤ Insert the flange of the syringe barrel into the syringe holder of EPIA and place the needle in the groove in the front of the device.



When using a Tuohy type needle, insert the needle and syringe in the correct direction considering the bevel (slope) of the needle tip and the curved direction. Typically, the bevel faces to anterior (cranial, toward head) so that the injected anesthetic can easily spread into anterior epidural space.



④



⑤



⑥

- ⑥ Close the EPIA cover until it clicks and secure the syringe to avoid shaking.
- ⑦ After connecting EPIA to a display device (Please refer to “section 2. Device Connection of Chapter III”), run the program on the display device.
- ⑧ Before the start, check that the graph is located at the start (setting) position.  
(The X and Y axes of the graph in the program should be located at 0.)  
Also check that the syringe holder of EPIA is located at the start (setting) position.



For the proper insertion, it is recommended to protrude a part of needle (about 20 mm) by pressing the Forward button and then Stop button.  
Use the protruding part of the needle, to insert it into the injection site in advance.

- ⑨ Insert the protruding part of the needle into the patient's injection site, and hold the EPIA firmly against the operation site.



**Hold the EPIA firmly and fix it onto the patient's injection area with one hand (left hand recommended).**

**Operate the buttons of EPIA with the other hand (right hand recommended).**

- ⑩ By pressing the Forward button,  the syringe and the needle will automatically advance, and the needle will be inserted into the patient's body.



**During the operation, make sure that the device is pressed firmly against the injection area to avoid being pushed back.**



**During the operation, the plunger is not affected, thereby the anesthetic is not injected while the needle is being inserted.**

- ⑪ The pressure data are transmitted in real-time to the display device. Through the pressure graph, the operator can monitor the intra-insertion movement of the needle, needle insertion length, and the pressure change applied to the needle.



- ⑫ When the tip of the needle enters the epidural space, the pressure decreases rapidly. While monitoring the changes in the pressure graph, the operator can stop the progress of the needle by pressing the STOP button .



**By detecting a rapid drop in pressure, the device will automatically stop at the epidural space. The operator can confirm that the pressure is constantly kept low by pressing the 0.2 mm button, thereby confirming that the automatic stop point coincides with the epidural space.**

- ⑬ After the stop, if additional progress is required, press the 0.2mm button  to advance the needle finely.

If a withdrawal is required, press the Back button  to move the needle backward.



- ⑭ When the needle is located at the epidural space, open the syringe cover, and remove the EPIA device from the syringe.



**Remove the EPIA carefully so that the tip of the needle located in the epidural space does not deviate from its proper position.**



The operator can confirm whether the needle has reached the epidural space successfully by using the Loss of Resistance (LOR) Method, manually pressing the plunger to check the pressure within the syringe.

- ✘ LOR (Loss of Resistance) method: The method to check the pressure within the syringe by manually pressing the plunger of the syringe. At the epidural space, where the relative pressure is lower, the pressure within the syringe decreases thereby the plunger goes into the syringe.

- ⑮ Push the plunger of the syringe to inject the required amount of anesthetic.  
Alternatively, after removing the syringe from the needle, an epidural catheter can be inserted into the epidural space through the epidural needle that is inserted into the treatment area, then subsequent procedures can be taken.



## 4. Post-use Treatment











- EPIA device is single use only; do not reuse the used device.
- Do not attempt to re-sterilize the device.
- Dispose of the used device as medical waste according to hospital or government regulations regarding medical devices.
- Syringes and needles are disposable; do not reuse them and dispose them as medical waste after the use.
- In the event of malfunction, stop the use immediately and contact a specialist.
- Do not disassemble, repair, or modify the product by anyone other than the manufacturer.
- After use, for EPIA-HU-B model, wipe the data cable clean with a disinfectant or disinfect it appropriately according to hospital regulations.

## 5. Storage and Transport Conditions





- Storage and transport temperature: -20 – 60 °C
- Avoid wet or humid places and store in a well-ventilated place.
- Avoid exposure to extreme temperature changes, humidity, dust, or corrosive vapors.
- Do not store near or in chemical storage areas or gas generation areas.
- Keep out of direct sunlight. Long exposure to sunlight can damage some parts.

## Chapter IV. Warning and Safety Notices





### 1. General Precautions

	Be sure to read and be aware of the instructions and cautions before use.
	Check whether the package is damaged before use.
	Check for any apparent deformation, discoloration, cracking, or foreign substances before use.
	Check the cleanliness and disinfection of the product before use.
	Check whether the device and other medical supplies are operating normally before use.
	In the rare event of mechanical malfunctions, be aware of and press the Stop button immediately. Stop using immediately and contact a specialist.
	If the static electricity or sudden high voltage occurs, the device may stop or return to the initial state. In this case, press the Back button to return the needle position to the initial state and start operation again.
	If an abnormality is detected during the device operation, press the Stop button, or pull the product backward to remove it from the patient's body.
	After use, dispose of the device as medical waste. Improper disposal methods may damage third parties or cause environmental pollution.
	Do not use the product beyond the Use-by-date specified on the label.
	High temperature or liquid contact with the product is prohibited.









### 2. General Warnings

	Use only by trained professional medical personnel.
	Do not use for other than its intended use.
	Only use for pharmaceutical treatment.
	Discard after use and avoid reuse.
	Do not disassemble, repair, or modify the product in any way.



### 3. Interactions

	Check suitability and compatibility with other medical supplies before use.
	Use sterile syringes and needles with this product.
	Use the battery provided or CR123-A 3V Lithium battery (Panasonic).
	<b>[EPIA-HU-B]</b> Use the device within 10m <sup>2</sup> area and check whether there is any interference from other communication equipment.
	<b>[EPIA-HU]</b> Use the supplied Data cable ONLY. The use of other cables may not be compatible with EPIA.

### 4. Precautions to Use

	This product is a medical device, and the user cannot use it by modifying the product at will.
	It is an assistant device to assist doctor's operation.
	If an abnormality is detected during product operation, press the Stop button, or pull the product backward to remove it from the patient's body.
	In the event of anesthesia side effects, it is recommended to be carried out by a specialist, a facility or a transport system that can handle the situation.
	If static electricity or sudden high voltage occurs, the device may stop or return to the initial state. In this case, press the Back button to return the needle position to the initial state and start operation again.
	Do not touch the device with wet hands.
	Do not place the device in a humid or wet environment.
	Do not place the cable in humid or wet environments.

### 5. Contraindications

	Do not use on a patient with sepsis, bacteremia, injection site infection, severe hypovolemia, severe coagulation abnormalities, therapeutic anticoagulant therapy, increased intracranial pressure, and patient refusal.
	Do not use on a patient with neurological disorders, mental illness or dementia, aortic stenosis, left ventricular outflow tract obstruction (LVOTO), or congenital heart disease.



## 6. Adverse Reactions

- Cerebrospinal fluid (CSF) leakage due to dural puncture
- Spinal nerve damage
- Pain in the treatment area

## 7. Warnings Related to Wireless Communication

### 7.1. FCC Compliance Statement

This device complies with part 15 of the FCC rules. Operation is subject to the following two conditions:

- (1) This device may not cause harmful interference, and
- (2) This device must accept any interference received, including interference that may cause undesired operation.

### 7.2. FCC Interference Statement

This equipment has been tested and found to comply with the limits for a Class A digital device, pursuant to part 15 of the FCC Rules. These limits are designed to provide reasonable protection against harmful interference when the equipment is operated in a commercial environment. This equipment generates, uses, and can radiate radio frequency energy and, if not installed and used in accordance with the instruction manual, may cause harmful interference to radio communications. Operation of this equipment in a residential area is likely to cause harmful interference in which case the user will be required to correct the interference at his own expense.

### 7.3. FCC Radiation Exposure Statement

This equipment complies with RF exposure requirements set forth for an uncontrolled environment.

### 7.4. FCC Caution FCC Interference Statement

Any changes or modifications not expressly approved by the party responsible for compliance could void the user's authority to operate this equipment. This transmitter must not be co-located or operating in conjunction with any other antenna or transmitter.

## 8. Guidance and Manufacturer’s Declaration [EPIA-HU-B]

### 8.1. GUIDANCE AND MANUFACTURER’S DECLARATION – Mobile RF COMMUNICATIONS

The device is intended for use in the electromagnetic environment specified below.  
The customer or the end user of the device should assure that it is used in such an environment.

#### ETSI EN 300 328 V2.1.1 (2016-11)

Wideband transmission systems;  
Data transmission equipment operating in the 2.4 GHz ISM band and using wide band modulation techniques;  
Harmonised Standard covering the essential requirements of article 3.2 of Directive 2014/53/EU

Reference Clause No.	Parameter	Test Result
4.3.2.2	RF output Power	Pass
4.3.2.3	Power Spectral Density	Pass
4.3.2.4	Duty Cycle, Tx-sequence, Tx-gap	N/A <sup>Note1</sup>
4.3.2.5	Medium Utilization (MU) Factor	N/A <sup>Note1</sup>
4.3.2.6	Adaptivity	N/A <sup>Note1</sup>
4.3.2.7	Occupied Channel Bandwidth	Pass
4.3.2.8	Transmitter Unwanted Emissions in the Out-of-band Domain	Pass
4.3.2.9	Transmitter Unwanted Emissions in the Spurious Domain	Pass
4.3.2.10	Receiver Spurious Emissions	Pass
4.3.2.11	Receiver Blocking	Pass
4.3.2.12	Geo-location Capability	N/A <sup>Note2</sup>
N/A= Not Applicable Notes: <ol style="list-style-type: none"> <li>1. These requirements do not apply for equipment with a maximum declared RF output power of less than 10 dBm e.i.r.p. or for equipment when operating in a mode where the RF output power is less than 10 dBm e.i.r.p.</li> <li>2. This device does not support Geo-location capability.</li> </ol>		

#### EN 62311:2008

Assessment of Electronic and Electrical Equipment related to Human Exposure Restrictions for Electromagnetic Fields (0 Hz – 300 GHz)

## 8.2. GUIDANCE AND MANUFACTURER'S DECLARATION – ELECTROMAGNETIC COMPATIBILITY

The device is intended for use in the electromagnetic environment specified below.

The customer or the end user of the device should assure that it is used in such an environment.

### ETSI EN 301 489-1 V2.2.3 (2019-11)

ElectroMagnetic Compatibility (EMC) standard for radio equipment and services;

Part 1: Common technical requirements; Harmonised Standard for ElectroMagnetic Compatibility

### ETSI EN 301 489-17 V3.2.4 (2020-09)

ElectroMagnetic Compatibility (EMC) Standard for Radio Equipment and Services;

Part 17: Specific Conditions for Broadband Data Transmission Systems;

Harmonised Standard for ElectroMagnetic Compatibility

Basic Standard	Description	Test Result
ETSI EN 301 489-1 clause 8.2	Radiated Emission-enclosure of Ancillary Equipment	Pass
ETSI EN 301 489-1 clause 8.3	Conducted Emission-DC Power Input/output Port	NA
ETSI EN 301 489-1 clause 8.4	Conducted Emission-AC Mains Input/output Port	NA
ETSI EN 301 489-1 clause 8.5	Harmonic Current Emissions-AC Mains Input Port	NA
ETSI EN 301 489-1 clause 8.6	Voltage Fluctuations and Flicker-AC Mains Input Port	NA
ETSI EN 301 489-1 clause 8.7	Conducted Emission-Wired Network Port	NA
ETSI EN 301 489-1 clause 9.2	Radio Frequency Electromagnetic Field (80 MHz to 6,000 MHz) – Enclosure Port	Pass
ETSI EN 301 489-1 clause 9.3	Electrostatic Discharge – Enclosure	Pass
ETSI EN 301 489-1 clause 9.4	Fast Transients Common Mode-signal, Wired Network and Control Ports, DC and AC Power Ports	NA
ETSI EN 301 489-1 clause 9.5	Radio Frequency Common Mode 0.15 MHz to 80 MHz-signal, Wired Network and Control Ports, DC and AC Power Ports	NA
ETSI EN 301 489-1 clause 9.6	Transients and Surges-DC Power Input Ports	NA
ETSI EN 301 489-1 clause 9.7	Voltage Dips and Interruptions-AC Mains Power Input Ports	NA
ETSI EN 301 489-1 clause 9.8	Surges, Line to Line and Line to Ground-AC Mains Power Input Ports, Wired Network Ports	NA
NA=Not Applicable		

### 8.3. GUIDANCE AND MANUFACTURER'S DECLARATION – ELECTROMAGNETIC SAFETY

The device is intended for use in the electromagnetic environment specified below.

The customer or the end user of the device should assure that it is used in such an environment.

#### IEC 60601-1-2:2014

Medical electrical equipment -

Part 1-2: General requirements for basic safety and essential performance –

Collateral Standard: Electromagnetic disturbances – Requirements and tests

CISPR 11			
Clause	Requirement – Test case	Basic standard	Verdict
7.1	Terminal Disturbance Voltages	CISPR 11:2009 +A1:2010	N/A
7.1	Radiation Disturbance	CISPR 11:2009 +A1:2010	P
CISPR 14-1			
Clause	Requirement – Test case	Basic standard	Verdict
7.1	Terminal Disturbance Voltages	CISPR 14-1:2005	N/A
7.1	Disturbance Power	CISPR 14-1:2005	N/A
7.1	Radiated Disturbances	CISPR 14-1:2005	N/A
ISO 7137			
Clause	Requirement – Test case	Basic standard	Verdict
7.1	RF EMISSIONS	<input type="checkbox"/> RTCA DO-160C:1989 / EUROCAE ED-14C:1989 <input type="checkbox"/> RTCA DO-160G:2010 / EUROCAE ED-14G:2011	N/A
7.1	Conducted RF EMISSIONS	<input type="checkbox"/> RTCA DO-160C:1989 / EUROCAE ED-14C:1989 <input type="checkbox"/> RTCA DO-160G:2010 / EUROCAE ED-14G:2011	N/A
IEC 61000-3-2			
Clause	Requirement – Test Case	Basic Standard	Verdict
7.2.1	AC-Mains Harmonics	IEC 61000-3-2:2005 +A1:2008 +A2:2009	N/A
IEC 61000-3-3			
Clause	Requirement – Test Case	Basic Standard	Verdict
7.2.2	AC-Mains Voltage fluctuations and flicker	IEC 61000-3-3:2013	N/A
IEC 60601-1-2			
Clause	Requirement – Test Case	Basic Standard	Verdict
8.9	ELECTROSTATIC DISCHARGE	IEC 61000-4-2:2008	P
8.9	Radiated RF EM Fields	IEC 61000-4-3:2006 +A1:2007 +A2:2010	P



8.9	Electrical Fast transients / Bursts	IEC 61000-4-4:2012	N/A
8.9	Surges	IEC 61000-4-5:2005	N/A
8.9	Conducted Disturbances Induced by RF Fields	IEC 61000-4-6:2013	N/A
8.9	RATED Power Frequency Magnetic Fields	IEC 61000-4-8:2009	P
8.9	Voltage Dips	IEC 61000-4-11:2004	N/A
8.9	Voltage Interruptions	IEC 61000-4-11:2004	N/A
8.9	Electrical Transient Conduction along Supply Lines	ISO 7637-2: 2011	N/A
8.10	IMMUNITY to Proximity Fields from RF Wireless Communications Equipment	IEC 60601-1-2:2014 Table 10	P
Supplementary Information: N/A=Not Applicable P=Pass			

## EU Declaration of Conformity

We, manufacturer, hereby declare that the product

Model: EPIA-HU-B

Type: Epidural Instrument

is in compliance with all the essential requirements of RED Directive(2014/53/EU) where applicable:

Radio: EN 300 328 V2.1.1 (2016-11), EN 62311:2008

EMC: EN 301 489-1 V2.2.3 (2019-11), EN 301 489-17 V3.2.4 (2020-09)

Safety: IEC 60601-1-2:2014

All essential radio test suites have been carried out.

Test Laboratory : KCTL Inc.

65, Sinwon-ro, Yeongtong-gu, Suwon-si, Gyeonggi-do, Korea

16677 Tel. +82-70-5008-1021 / Fax. +82-505-299-8311

www.kctl.co.kr

Representative in the EU : JaviTeck e.K.

Sachsenhausener Straße 16, 65824 Schwalbach am Taunus, Germany

Tel. +49-6196-4021549

E-mail. info@javitech.de

This declaration has been issued under the sole responsibility of the manufacturer and his authorized representative, and is marked in accordance with the CE marking directive 93/68/EEC.

Manufacturer : RIMSCIENCE CO. Ltd.

601(#602-1), 53, Chungjeong-ro, Seodaemun-gu, Seoul, Republic of Korea 03736

Tel. +82-2-3789-1010 / Fax. +82-2-3789-1014

www.rimscience.com / sales@rimscience.com

Jan. 19, 2021



Sang Jin Yoon

CEO, RIMSCIENCE CO. Ltd.

## Chapter V. Maintenance and Disposal

### 1. Maintenance and Disposal



The Epidural Instrument (EPIA) is supplied sterile and intended for **SINGLE USE ONLY**. Do not clean, re-sterilize or reuse the epidural instrument.

This may result in product malfunction, failure, or patient injury and may expose the patient to the risk of transmitted infectious diseases. After use, discard with standard medical waste disposal practices.

#### 1.1. Maintenance of Cable [EPIA-HU]

##### 1.1.1. Cleaning

After use, wipe the data cable with lint-free cloth soaked with 70 % Isopropyl Alcohol or Ethyl Alcohol. Or disinfect the cable appropriately according to hospital guidelines.

##### 1.1.2. Sterilization

Sterilize the data transmitting cable appropriately according to hospital practices.

The cable can be sterilized using Ethylene Oxide gas or plasma.

Do not sterilize with steam or dry heat as autoclave.

#### 1.2. Disposal of the Device

The Epidural Instrument (EPIA) is supplied sterile and intended for **SINGLE USE ONLY**.

**Do not clean, re-sterilize, or reuse** the epidural instrument.

After use, discard with the standard medical waste disposal practices.

#### 1.3. Disposal of the Electronic Device



This symbol indicates that the waste of electrical and electronic equipment must not be disposed of as unsorted municipal waste and must be collected separately. Please contact an authorized representative of the manufacturer for information concerning the decommissioning of your equipment.



## Chapter VI. Technical Contents

### 1. Safety Information and Customer Service

Please call **RIMSCIENCE Co. Ltd.** Customer Service at **(+82) 2-3789-1010** or send an e-mail to **sales@rimscience.com.**

If you have any device returns or questions about the device, visit our website **www.rimscience.com** for details. Some limitations apply. Any refurbishments made outside of our facility will automatically void the warranty.

