

BYTE

AUGUST 1989

A MCGRAW-HILL PUBLICATION

REVIEWS

Magellan vs. ViewLink

Pixelworks' Ultra Clipper for PS/2s

NEC's UltraLite

3 OS/2 Modula-2s

PRODUCT FOCUS



80386-Based Portables

Small Wonders

*MinisPort and Agilis Laptops
Plus: 11 80386-Based Portables*



ZENITH MINISPORT



AGILIS SYSTEM

NEURAL NETWORKS *In Depth*
Brain-like systems solve real-world problems

How Disk Optimizers Work

Expert Advice:
A New Unix column

What's Beyond RISC?

Digital Signal Processors
Move to Micros

5 Short Takes



\$3.50 U.S.A./\$4.50 IN CANADA
0360-5280

DOT MATRIX PRINTERS.

Printer System 800: \$699.95
Our highest resolution text and graphics, 24-pin dot matrix printer. Draft quality at 200 cps. Letter quality at 66 cps. Parallel and serial interfaces. Wide carriage.

Printer System 300: \$199.95
9-pin dot matrix. Draft quality at 144 cps. Near-letter quality at 36 cps. Four standard fonts. Parallel interface. Narrow carriage.

NEW MONITOR

Dell Super VGA Color Monitor. Supports all VGA modes plus new 800 x 600 standard. Call for details.

LASER PRINTERS.



SO HOW COME YOU NEVER CALL?

THE DELL SYSTEM 325 25 MHz 386

STANDARD FEATURES:



"The new top-of-the-line Dell System 325 is a flagship worth putting out in front of the fleet."
February 14, 1989

- Intel 80386 microprocessor running at 25 MHz.
- Choice of 1 MB, 2 MB or 4 MB of RAM* expandable to 16 MB using a dedicated high speed 32-bit memory slot.
- Advanced Intel 82385 Cache Memory Controller with 32 KB of high speed static RAM cache.
- Page mode interleaved memory architecture.
- VGA systems include a high performance 16-bit video adapter.
- Socket for 25 MHz Intel 80387 or 25 MHz WEITEK 3167 math coprocessor.
- 5.25" 1.2 MB or 3.5" 1.44 MB diskette drive.
- Dual diskette and hard disk drive controller.
- Enhanced 101-key keyboard.
- 1 parallel and 2 serial ports.
- 200-watt power supply.
- 8 industry standard expansion slots.

OPTIONS:

- 40 MB or 150 MB tape backup.
- 25 MHz Intel 80387 math coprocessor.
- 25 MHz WEITEK 3167 math coprocessor.
- 1 MB or 4 MB RAM upgrade kit.
- 2 MB or 8 MB memory expansion board kit.
- Graphics Performance Accelerator GPX-1024.
- Graphics Performance Display GPD-16C, GPD-19C.

**Lease for as low as \$199/Month.

◇ Extended Service Plan pricing starts at \$370.

System 325	With Monitor & Adapter			
	VGA Mono		VGA Color Plus	
Hard Disk Drive	1MB RAM	2MB RAM	1MB RAM	2MB RAM
40 MB-29 ms IDE	\$5,499	\$5,698	\$5,799	\$5,998
100 MB-25 ms IDE	\$5,999	\$6,198	\$6,299	\$6,498
150 MB-18 ms ESDI	\$6,499	\$6,698	\$6,799	\$6,998
322 MB-18 ms ESDI	\$7,299	\$7,498	\$7,599	\$7,798

Disclaimer: All systems are photographed with optional extras, which some computer retailers won't even recognize.



- Laser System 150, 15 pages per minute: \$5,995.
- Laser System 80, 8 pages per minute: \$3,295.
- Laser System 60, 6 pages per minute: \$2,195.

All Dell laser printers come with 1.5 MB RAM, full-page 300 DPI graphics, and have 31 standard fonts (7 resident and 24 downloadable from diskette). Dell laser printers also provide Hewlett-Packard LaserJet Plus, Epson/FX, IBM Proprinter and Diablo 630[®] emulations.

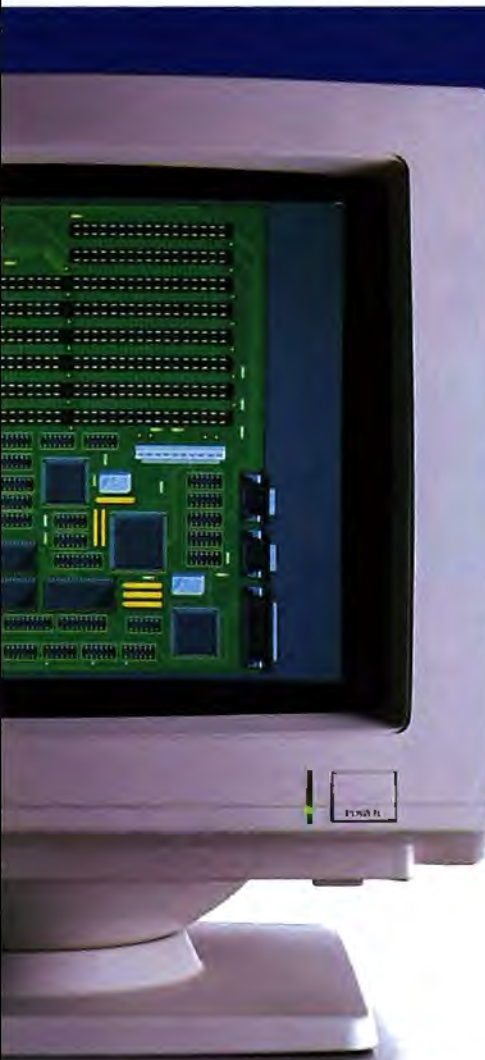

THE DELL SYSTEM 310
20 MHz: 386.

The best combination of performance and value available.

STANDARD FEATURES:

- Intel 80386 microprocessor running at 20 MHz.
- Choice of 1 MB, 2 MB or 4 MB of RAM* expandable to 16 MB using a dedicated high speed 32-bit memory slot.
- Advanced Intel 82385 Cache Memory Controller with 32 KB of high speed static RAM cache.
- Page mode interleaved memory architecture.
- VGA systems include a high performance 16-bit video adapter.
- Socket for 20 MHz Intel 80387 or 20 MHz WEITEK 3167 math coprocessor.
- 5.25" 1.2 MB or 5.25" 1.44 MB diskette drive.
- Dual diskette and hard disk drive controller.
- Enhanced 101-key keyboard.
- 1 parallel and 2 serial ports.
- 200-watt power supply.
- 8 industry standard expansion slots.

OPTIONS:

- 40 MB or 150 MB tape backup.
- 20 MHz Intel 80387 math coprocessor.
- 20 MHz WEITEK 3167 math coprocessor.
- 1 MB or 4 MB RAM upgrade kit.
- 2 MB or 8 MB memory expansion board kit.
- Graphics Performance Accelerator GPX-1024.
- Graphics Performance Doplas GPD-16C, GPD-19C.

**Lease for as low as \$135/Month. Extended Service Plan pricing starts at \$251.

System 310	With Monitor & Adapter			
	Hard Disk Drives	TTL Mon.	VGA Color Plus	
40 MB, 29ms IDE	\$3,699	\$3,898	\$4,199	\$4,398
100 MB, 25ms IDE	\$4,199	\$4,398	\$4,699	\$4,898
150 MB, 18 ms ESDI	\$4,699	\$4,898	\$5,199	\$5,398
322 MB, 18 ms ESDI	\$5,499	\$5,698	\$5,999	\$6,198



THE NEW DELL SYSTEM 316
16 MHz: 386SX.*

Expandable, affordable access to 386 architecture.

STANDARD FEATURES:

- Intel 80386SX microprocessor running at 16 MHz.
- Choice of 1 MB, 2 MB or 4 MB of RAM* expandable to 16 MB (8 MB on system board).
- Page mode interleaved memory architecture.
- VGA systems include a high performance 16-bit video adapter.
- LIM4 supports memory over 1 MB.
- Socket for 16 MHz Intel 80387SX math coprocessor.
- 5.25" 1.2 MB or 5.25" 1.44 MB diskette drive.
- Integrated high performance hard disk interface and diskette controller on system board. (ESDI based systems include a hard disk controller.)
- Enhanced 101-key keyboard.
- 1 parallel and 2 serial ports.
- 200-watt power supply.
- 8 industry standard expansion slots.

OPTIONS:

- 40 MB or 150 MB tape backup.
- 16 MHz Intel 80387SX math coprocessor.
- 1 MB or 4 MB RAM upgrade kit.
- Graphics Performance Accelerator GPX-1024.
- Graphics Performance Doplas GPD-16C, GPD-19C.

**Lease for as low as \$112/Month. Extended Service Plan pricing starts at \$234.

System 316	With Monitor & Adapter			
	Hard Disk Drives	TTL Mon.	VGA Color Plus	
40 MB, 29ms IDE	\$2,999	\$3,198	\$3,499	\$3,698
100 MB, 25ms IDE	\$3,599	\$3,798	\$4,099	\$4,298
150 MB, 18 ms ESDI	\$4,099	\$4,298	\$4,599	\$4,798
322 MB, 18 ms ESDI	\$4,899	\$5,098	\$5,399	\$5,598



THE DELL SYSTEM 200
12.5 MHz: 286.

This full-featured 286 computer runs at 12.5 MHz, and is completely Microsoft MS-DOS and MS OS/2 compatible.

STANDARD FEATURES:

- 80286 microprocessor running at 12.5 MHz.
- 640 KB of RAM expandable to 16 MB (48 MB on system board).
- Socket for Intel 80287 math coprocessor.
- 5.25" 1.2 MB or 5.25" 1.44 MB diskette drive.
- Dual diskette and hard disk drive controller.
- Enhanced 101-key keyboard.
- 1 parallel and 2 serial ports.
- 200-watt power supply.
- 6 industry standard expansion slots.

OPTIONS:

- 40 MB or 150 MB tape backup.
- Intel 80287 math coprocessor.
- 512 KB RAM upgrade kit.
- 2 MB RAM upgrade kit.

**Lease for as low as \$64/Month. Extended Service Plan pricing starts at \$166.

System 200	With Monitor & Adapter			
	Hard Disk Drives	TTL Mon.	VGA Color Plus	
40 MB, 29ms IDE	\$1,699	\$1,898	\$2,099	\$2,298
100 MB, 25ms IDE	\$2,199	\$2,398	\$2,599	\$2,798
150 MB, 18 ms ESDI	\$2,699	\$2,898	\$3,099	\$3,298
322 MB, 18 ms ESDI	\$3,499	\$3,698	\$3,899	\$4,098

*Performance Enhancements (Systems 325, 310 and 316) Within the first megabyte of memory, 384 KB of memory is reserved for use by the system to enhance performance. 4 MB configurations available on all systems. Call for pricing.



APPLICATION SOFTWARE.

We offer a complete line of software. Everything from complex CAD/CAM applications to fun flight simulator programs. All at extremely competitive prices.

OPERATING SYSTEM SOFTWARE.

- Dell Enhanced Microsoft[®] MS-DOS[®] 3.3: \$99.95.
 - Dell Enhanced Microsoft MS-DOS 4.01: \$119.95.
 - (Both MS-DOS versions with disk cache and other utilities)
 - Dell Enhanced MS[®] OS/2 Standard Edition 1.0: \$324.95.
 - Dell UNIX[®] System V/386, Release 3.2:
- Now Available. Call for details.

All prices and specifications are subject to change without notice. Dell cannot be responsible for errors in typography or photographs. **Pricing based on a 36-month open-end lease. *Leasing arranged by Leasing Group, Inc. In Canada, corporations and prices will vary. Microsoft, MS-DOS and UNIX are registered trademarks owned by Microsoft Corp. IBM is a trademark of Intel Corporation. UNIX is a registered trademark of AT&T. Dell UNIX System V is based on INTERACTIVE Systems Corporation's 386's. [®] Signifies trademarks of entities other than Dell Computer Corporation. ^Δ Service in remote locations may incur additional travel charges. [©] Provided by Xenix Corporation. © 1989 DELL COMPUTER CORPORATION.

Technically speaking, the System 325 is the most advanced 386™ computer we've ever built. And, according to PC Magazine, it's one of the most advanced 386 computers they've ever tested.

In benchmark after benchmark, the Dell System 325 25 MHz ran circles around a field

A PERSONAL COMPUTER THAT'S REALLY PERSONAL.

Of the more than 150,000 personal computers we've sold to date, each one's been individually configured to fit the needs of its owner.

The System 325 takes that idea

to its logical extreme.

For example, it runs either MS-DOS®, OS/2, or our own Dell UNIX® System V. Which is compatible with AT&T's System V Interface Definition. And the world of XENIX® applications.

If speed is of the essence, we can include an optional Intel®

**THE DELL 386 SYSTEM 325
HAS A 25 MHz CLOCK RATE,
CACHE MEMORY CONTROLLER,
IDE OR ESDI HARD DISK DRIVE,
PAGE MODE INTERLEAVED MEMORY,
AND 100% COMPATIBILITY WITH
MS-DOS, OS/2 AND UNIX SYSTEM V.**

of 386-based systems. A field that included the Compaq® 386/25.

A show of prowess that earned the System 325 PC Magazine's Editor's Choice award.

It was a goal we set for ourselves from the very beginning. And an objective anyone with a penchant for power and performance can appreciate.

80387 or WEITEK 3167 math coprocessor. And since nothing about this system is lightweight, the standard mass storage is a 100 MB IDE disk drive. Or we can configure it with a 40, 150 or 322 MB unit.

As you might expect, the output is just as intense. You can choose between VGA mono with paperwhite screen, or VGA Color



Plus, for high resolution colors displayed on a larger screen.

Even though the 325 gives you all this performance, it still leaves you six open slots for whatever else you might want to add.

And once you've told us what you want, we'll make sure what you want works—by burning-in the entire system unit.

COMPUTER RETAILERS ARE NO KNOWS.

In all probability, the average computer retailer won't have any understanding what makes the System 325 go.

He will, however, be quite aware of the fact that he could add a 35% markup if he could sell it in his store.

Which he can't.

Because we sell direct.

Meaning you now have the unique opportunity to talk directly with a computer expert. And ask things like, "What's the difference between IDE and ESDI?" Or, "How much SIMM RAM should I add?"

In other words, the kinds of questions you should be able to ask a retailer, but usually can't.

So as you might suspect, dealing direct not only saves you the 35% markup, but 100% of the aggravation.

DELL
COMPUTER
CORPORATION

Marty Branda
Account Representative
9501 ALBERTHEIM RD. #1011 AUSTIN, TEXAS 78758-2900
Tel: 800/777-4222 Fax: 512/328-7979



WE COME WHEN WE'RE CALLED.

One of the things that very clearly sets a Dell system apart

from other computers is not just how they're sold, but how they're supported.

Overkill was one description used in a PC Week article.

Perhaps.

But then, we think you'll agree, when something goes wrong, you want as much help as

we'll refund your money.

No questions asked.

MAYBE YOU SHOULDN'T BUY ONE AFTER ALL.

No matter how many reasons we give you to buy a Dell system, sometimes it makes more sense to lease one instead.

BEST OF ALL, YOU WON'T HAVE TO EXPLAIN TO A COMPUTER RETAILER WHAT ALL THAT MEANS.

possible, right?

Which is why every Dell system comes with a toll-free technical support line and self-diagnostic software. We're able to solve 90% of all problems right over the phone. The other 10% receive next-day, deskside service. Thanks to our new alliance with Xerox Corporation.

And you get all this help for a full year—whenever you need it—at no extra charge.^Δ

As you've probably guessed, one of the things that drives us most is customer satisfaction.

So we'd like to give you the ultimate guarantee: Try a System 325 in your office for a month. Run your toughest applications. Put it through its paces, at your pace. If you're not completely satisfied, send it back anytime within 30 days. And

Whether you need a single computer, or an office full, a leasing plan is like 100% financing.

And just as we can custom configure your computers, we can see to it you get a custom designed lease plan to fit your exact business needs. † A fact that has not gone unnoticed. Especially by the Fortune 500. Over half of whom now own or lease Dell systems.

And just as we welcome their business, we welcome your business, too. Just call us, toll-free. And don't be afraid to ask us the tough questions.

That's the part we like best.

DELL
COMPUTER
CORPORATION

TO ORDER, CALL

800-426-5150

IN CANADA, CALL 800-387-5752
IN GERMANY, CALL 06103/701100
IN THE U.K., CALL 0800 414535

Now we're making waves with IBM®

The ALR MicroFlex 7000

*The first 25MHz
Micro Channel®
compatible*



Frankie Avalon

6.0 MIPS

Performance is based on the ratings of CPU/Memory in Million instructions per second. (MIPS) Source Power Meter™ version 1.5 The Data Base Group, Inc. Upland, CA.



At ALR, we thrive on opportunities to beat our competitors. Our 25MHz 80386® based MicroFlex 7000 is no exception.

Unmatched performance

Our proprietary "pre-fetch" FlexCache™ design delivers the most efficient form of microcomputer processing. By combining a true 64-bit cache bus with 64-KB cache memory, performance increases 30% when compared to other 32-bit computers. And 64KB of high-speed cache memory enables you to experience the fastest

throughput for sophisticated applications. For those seeking large storage capacities, the MicroFlex 7000 gives the option of 120 or 300MB of disk storage using high-speed ESDI controllers with 1:1 interleave.

The most built-in features

The MicroFlex 7000 includes our super VGA controller with 800 X 600 graphics resolution and the sleek tower chassis offers the most internal expansion capabilities of any Micro Channel system available. Our one-

year warranty with unlimited technical support and on-site servicing available from Intel® can't be beat.

So make some waves of your own at the office with ALR's MicroFlex 7000 or any of our 33MHz systems. For more information and the name and number of your local authorized ALR reseller, please call:

1-800-444-4ALR

Advanced Logic Research, Inc.
9401 Jeronimo, Irvine, CA 92718
(714) 581-6770 FAX:(714) 581-9240

For our Canadian office: 1-800-443-4CAN
For our UK office: 44-1-399-4897
For our Singapore-Asia/Pacific office:
(65) 258-1286 FAX: (65) 258-1285

FlexCache is a trademark of Advanced Logic Research, Inc. 80386 is a registered trademark of Intel Corp. IBM and Micro Channel are registered trademarks of International Business Machines Corp. Shown with optional monitor. Prices and configurations subject to change without notice. Certified FCC class A, for business use only. Copyright 1989 Advanced Logic Research.

We're making some big waves in California

Introducing ALR's FlexCache™ 33/386Z

33MHz 80386™
performance for
as little as \$3995!



Frankie Avalon

7.5 MIPS

Performance is based on the ratings of CPU/Memory in Million instructions per second, (MIPS) Source Power Meter™ version 1.5 The Data Base Group, Inc. Upland, CA.

ALR
California
Home of the World's First 386 PC
Advanced Logic Research, Inc.

Wipe out!

Hang on because ALR's latest addition to the FlexCache 386™ Z-family is cruising at an amazing 33MHz. That's a 20% increase in processing speed when compared to the award winning FlexCache 25386.

Fast Cache

With 32KB of cache memory, award-winning FlexCache architecture and our enhanced 16-bit super VGA controller you better be ready to move.

At prices starting as little as \$3995*, the FlexCache 33/386Z delivers the most performance for all power hungry desktop applications like CAD/CAM, desktop publishing or financial modeling at a very modest price. Of course the FlexCache 33/386Z is OS/2® compatible for tomorrow's latest generation of applications. The FlexCache 33/386Z as with all of the Z-Family comes packaged with PC-Kwik®, the award-winning disk caching utility.

With ALR's FlexCache 33/386Z you'll receive unbeatable support backed by an unprecedented three year factory warranty on the main system board, a one-year system warranty, unlimited technical support and optional on-site servicing from Intel.

For more information on the FlexCache 33/386Z call:
1-800-444-4ALR.



FlexCache is a trademark of Advanced Logic Research, Inc. 386 is a registered trademark of Intel Corp. OS/2 is a registered trademark of IBM Corp. PC Kwik is a registered trademark of Muffsoft Corp. Shown with optional monitors. Certified FCC Class A, for business use only. Prices and configurations subject to change without notice. Copyright 1989 Advanced Logic Research, Inc.

PRODUCTS IN PERSPECTIVE

49 What's New

81 Short Takes

Portfolio, the new portable from Atari
Altima One, a good luggable
Finesse, Logitech's low-cost desktop publishing
MacroMind Director, video production on the Mac
MultiPlus, desktop management from SunFlex

FIRST IMPRESSIONS

- 90 **Cover Story**
The Ever-Shrinking, Ever-Expanding Laptops
by Nick Baran and Michael E. Nadeau
Agilis and Zenith introduce innovative new laptop computers.

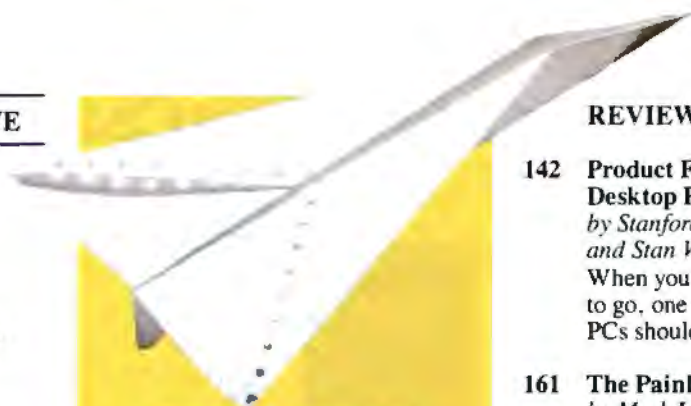

COVER STORY
The Ever-Shrinking, Ever-Expanding Laptops
by Nick Baran and Michael E. Nadeau
page 90

Agilis and Zenith announce tiny computers that broaden the market for laptops.

REVIEWS

- 142 **Product Focus: Desktop Power to Go**
by Stanford Diehl and Stan Wszola
When you need computing power to go, one of these 11 portable PCs should suit your needs.
- 161 **The Painlessly Portable PC**
by Mark L. Van Name and Bill Catchings
NEC's petite UltraLite computer is actually fun to take with you on the road.
- 167 **Ultra Graphics**
by Bradley Dyck Kliever
Pixelworks' Ultra Clipper brings enhanced graphics to MCA computers.
- 171 **Modula-2 and OS/2 Join Forces**
by Andrew Schulman
Three Modula-2 compilers take advantage of OS/2's features.
- 177 **A New World for DOS**
by Stan Miastkowski
Explore uncharted waters in DOS with intelligent DOS shells from Lotus and Traveling Software.

EXPERT ADVICE

- 99 **Computing at Chaos Manor: The Great Power Spike**
by Jerry Pournelle
A freak accident leaves Jerry extolling the humble surge suppressor.
- 113 **NEW The Unix /bin: A Calm Approach to Unix**
by David Fiedler
The average Unix user never has to worry about many of the system nuances.
- 119 **Down to Business: Neither Snow, Nor Chicago...**
by Wayne Rash Jr.
Comdex brought some good news for business users.



- 125 **Macinations: The Way of Things Considered**
by Don Crabb
There are many ways to accomplish something, but only a few of them are right.
- 129 **OS/2 Notebook: Glimmers of Acceptance**
by Mark Minasi
Microrim and Logitech announced exciting new OS/2 products at Comdex.
- 135 **NetWorks: Growing Pains**
by James Y. Bryce
Your LAN operating system can spell the difference between control and chaos.

IN DEPTH

- 214 Introduction: Neural Networks**
- 217 Time to Get Fired Up**
by Klaus K. Obermeier and Janet J. Barron
IBM PCs, Macs, and personal workstations can run neural-network simulations that learn and train themselves.
- 227 What's Hidden in the Hidden Layers?**
by David S. Touretzky and Dean A. Pomerleau
The contents can be easy to find with a geometrical problem, but the hidden layers have yet to give up all their secrets.
- 235 Building Blocks for Speech**
by Alex Waibel and John Hampshire
Modular neural networks may be the answer to the problem of machine-based speech recognition.
- 244 Neural Networks: Theory and Practice**
A guide to neural-network ideas and products.

FEATURES

- 246 Dealing with a Digital World**
by David A. Mindell
Powerful digital-signal-processing chips are finding their way into personal computers and workstations.
- 259 VLIW: Heir to RISC?**
by Peter Wayner
In the race to maximize CPU performance, a new architecture called VLIW may be the next step after RISC chips.



187
Editorial:
System 7.0 and the Macintosh IIcx
by Don Crabb

191
Short Takes
Spectrum/24, Showcase F/X,
MaxPage 1.2

196
FIRST IMPRESSIONS
System 7.0: The Next-Generation
Mac Operating System
by Tom Thompson

199
List Manager Techniques
by Jan Eugenides

205
HyperTalk Program Design
by Richard D. Lasky



Dealing with a Digital World/246

HANDS ON

- 265 Under the Hood: Hard Disk Maintenance Software**
by L. Brett Glass
How low-level hard disk optimizers work and what they can do for you.
- 279 Some Assembly Required: If Memory Serves...**
by Rick Grehan
A library of memory management routines that will help you avoid a fragmented heap.

DEPARTMENTS

- 8 Editorial: Hold onto Your Hat (and Your Wallet)**
- 17 Microbytes**
- 35 Letters, Ask BYTE, and Fixes**
- 47 Chaos Manor Mail**
- 331 Coming Up in BYTE**
- 340 Print Queue**
- 344 Stop Bit**
- READER SERVICE**
- 330 Editorial Index by Company**
- 332 Alphabetical Index to Advertisers**
- 334 Index to Advertisers by Product Category**
- Inquiry Reply Cards: after 344

PROGRAM LISTINGS

From BIX: See 338
From BYTEnet:
call (617) 861-9764
On disk or in print:
See card after 232

BYTE (ISSN 0360-5280) is published monthly with an additional issue in October by McGraw-Hill, Inc. **Postmaster:** Send address changes, USPS Form 3579, and fulfillment questions to BYTE Subscriptions, P.O. Box 551, Hightstown, NJ 08520. Second-class postage paid at Pennington, NJ 03458, and additional mailing offices. Postage paid at Winnipeg, Manitoba. Registration number 9321. Printed in the United States of America.

Not responsible for lost manuscripts or photos. Opinions expressed by the authors are not necessarily those of BYTE.
Copyright © 1989 by McGraw-Hill, Inc. All rights reserved. Trademark registered in the United States Patent and Trademark Office.



Subscription questions or problems should be addressed to BYTE Subscriber Service, P.O. Box 551, Hightstown, NJ 08520.

Microsoft profession something other lang



al languages give you uages don't. Leverage.



In an industry that evolves practically overnight, it's tough to stay ahead of the crowd.

You need tools that not only give you an edge day-to-day, but open up endless possibilities.

Tools that can only come from Microsoft.

Combine Microsoft® C and Macro Assembler and you've got enough power to create programs for MS-DOS®, Windows and OS/2 systems.

What's more, you can do it all in record time because our renowned CodeView® Debugger, Linker, Microsoft Editor, and MAKE utility work ingeniously and seamlessly together.

In other words, you've got the leverage of the most inventive and comprehensive tools around.

When you develop under OS/2 systems, you've got options no one else can touch. Like multi-tasking. And blasting through the 640K barrier.

In addition, Microsoft C and Macro Assembler can accommodate more third party add-ons than any other PC professional languages.

Maybe that's why the most popular applications on the market today were developed through the unique power of our C and Assembler: Lotus® 1-2-3®, WordPerfect® 5.0, Microsoft Excel. And Aldus® PageMaker®.

So drop by your nearest Microsoft dealer soon. And start turning out the most airtight, fine-tuned code ever to touch a disk.

After all, you've got the leverage.

Microsoft
Making it all make sense.





HOLD ONTO YOUR HAT (AND YOUR WALLET)

Apricot announces the first "real" 80486-based machine. Meanwhile, there's nothing but lawsuits on the 68040 front.

I recently received a transatlantic phone call from an excited Paul Lavin, a colleague who writes for a number of British computer publications. He'd just caught wind of a surprising development: Apricot was about to announce an 80486-based computer.

When Intel introduced the 80486 last April, it predicted that 80486-based machines would appear late this year, with volume shipments next year. I never suspected that the British company Apricot would be first with an 80486 machine, or would have one so soon.

But it was: Its 80486-based 25-MHz Micro Channel architecture machine was announced in June in London. The first production units will be available a few weeks after you read this.

Apricot even beat IBM's 80486 announcement by several weeks, although IBM had shown a nearly finished prototype in April. (For more details on the IBM machine, see the June editorial.)

Apricot's machine, called the VX FT, is a 15-million-instructions-per-second beast that comes with up to 5 gigabytes of SCSI hard disk drive storage, up to 16 megabytes of RAM on the motherboard, a digital audio tape-recording backup subsystem, built-in disk shadowing (for fault tolerance), support for up to 128 serial ports, and a 465-watt power supply with its own built-in lead/acid backup batteries (that's right, a built-in uninterruptible power supply). This is all cooled by three or four 4-inch-diameter fans, depending on how the machine is config-

ured. We're talking heavy duty.

The box, which is mounted on skids, is about the size of a fat two-drawer filing cabinet. Weighing over 150 pounds, it comes with a pair of built-in retractable handles so that two people can horse it around. Whew.

The VX FT is built around an MCA motherboard with eight slots (four 16-bit and four 32-bit). The motherboard uses standard Chips & Technologies chips and a Phoenix BIOS. This helps ensure compatibility; the machine was shown running MS-DOS 4.01, OS/2 Extended Edition, Novell NetWare, 3+Open LAN Manager, SCO Unix System V release 3.2, and other software.

While the chips and the BIOS are conventional, the Apricot designers went their own way in the addition of a separate cache on the motherboard (this is unusual because the 80486 has an on-board cache of its own). Apricot believes that this 128K-byte "Hypercache" will give the VX FT a performance edge over those machines that simply use the 80486's on-board cache.

So far, it's an unproven belief: As I write this, the Apricot engineers are eradicating some last-minute problems that cropped up in the first Hypercache prototypes. As soon as the glitches get sorted out, we'll bring you full benchmark results and Paul Lavin's hands-on report.

Of course, all this horsepower and storage isn't exactly cheap: Prices start at the very high end of the microcomputer price spectrum (about \$18,000) and go up from there, topping out in the exospheric \$40,000 range. Clearly, this won't be a high-volume system.

Meanwhile, at the Low End...

Cheetah (see the June Editorial) is still on track with a low-cost 80486-based motherboard—one that actually could cost less than a similarly clocked 80386-based system with a separate 80387 math chip and cache.

We may see the 80486 market split in two radically different directions: killer systems with killer prices for departmental computing needs, and relatively inexpensive fast systems for personal desktop use.

The prices of 80486-based systems could also be kept somewhat in check due to competition from the Motorola or RISC camps, if those chip makers can mount an aggressive attack. Unfortunately, there are problems.

For example, we still haven't heard of a single demonstration of a 68040-based system, even though the 68040 was announced before the 80486. One possible explanation is—surprise!—legal hassles: Hitachi has accused Motorola of violating Hitachi patents with its 68030 microprocessor, currently Motorola's top-of-the-line shipping CPU. The 68040 includes an enhanced 68030 as its core; it's reasonable to surmise that legal complications involving the 68030 might spill over to affect the 68040.

Sadly, legal wrangling isn't at all unusual these days. But not since NEC sued Intel over rights to make clones of the 8088 and 8086 CPUs has a suit attacked an American microprocessor maker's premier product—in this case, the Motorola 68030, which is used in Apple's Macintosh IIx and IIcx and in workstations from Sun and Hewlett-Packard.

Perhaps this lawsuit is one of the reasons why development of 68040-based systems appears to be lagging far behind that of 80486-based systems. (I can only guess; Motorola is mum on the subject.)

I hope that the legal snags will get resolved and that Motorola and others can provide healthy competition for high-end 80486s; and that companies like Cheetah can cultivate low-cost 80486s.

The Apricot VX FT is nice—very nice. But prices like that take the "personal" out of personal computing.

—Fred Langa
Editor in Chief
(BIX name "flanga")

Integrated Software for Schematics & PCB Artwork



Introducing HiWIRE®-Plus

Wintek's smARTWORK® pioneered low-cost printed-circuit-board CAD. Then HiWIRE set the standard for productivity and ease-of-use in schematic capture. Now Wintek introduces HiWIRE-Plus, integrating HiWIRE's schematic features with a powerful printed-circuit-design facility.

Creating Schematics

With HiWIRE-Plus, simply connect library symbols with wires and buses. Creating and changing symbols is fast and painless. Produce your drawing using a dot-matrix printer, laser printer, or pen plotter.

Circuit-Board Design

HiWIRE-Plus gives you all the design freedom you want: you choose the grid size, trace widths, and pad shapes. The board size and number of layers are virtually unlimited. HiWIRE-Plus is perfect for surface-mount, micro-strip, and ECL applications.

Current Versions

HiWIRE-Plus V 1.1r6
smARTWORK V 1.4r5

HiWIRE-Plus Advantages

- One tool for schematics and printed-circuit artwork
- Easy-to-learn menu-driven operation; complete documentation and tutorial
- Schematic libraries with TTL, CMOS, ECL, ladder, micro-processor, and discrete components
- Netlist and bill-of-materials utilities included
- Circuit boards up to 60x60 inches and 256 layers
- Variable grid size, trace width, and pad size (.001" resolution)
- PCB library with DIPs, SIPs, SMDs, PGAs, TOs, and edge and D connectors
- Schematic-to-layout cross-checking
- Design-rule checker
- 800 number for free support



HiWIRE®, smARTWORK®, Wintek®, and the Wintek logo are registered trademarks of Wintek Corporation.

System Requirements

- IBM PC, XT, AT, or PS/2 with 512K RAM, printer port, color monitor, and CGA, EGA, or VGA graphics card
- Microsoft Mouse
- IBM ProPrinter or Epson dot-matrix printer, and/or
- Houston Instrument or Hewlett-Packard pen plotter

Higher Performance Better Value

Still only \$895, HiWIRE-Plus delivers quality schematics and PCB artwork. You don't need to guess if HiWIRE-Plus is right for you—we guarantee it! Try it for 30 days at absolutely no risk. Call toll free today and put HiWIRE-Plus to work for you.

Wintek Corporation

1801 South Street
Lafayette, Indiana 47904-2993
(800) 742-6809 or
(317) 742-8428
FAX: (317) 448-4823
Telex: 70-9079

Europe: RIVA Ltd., England,
Phone: 0420 22666, FAX: 0420 23700
Australia: Entertainment Audio Pty, Ltd.,
Phone: (08) 363-0454

OUT-STANDING

The Company

Gateway 2000 has consistently led the pack of competitors in this highly competitive field. We have the most aggressive pricing in the industry, the most aggressive support policies, and lead the pack in quality. So shop around, then call Gateway 2000 to discover just how far ahead of the competition we really are.

The Products

Your Gateway 2000 computer system will arrive thoroughly tested and ready to run. All of our top quality systems come standard with our own *Crystal-scan 860* monitor and a 16 bit VGA card that is expandable to 512K. We have a variety of options available to suit anyone's needs. So call Gateway 2000, and we'll custom configure a system just for you.

12 Mhz 286 VGA

80286-12 Processor
2 MEGS RAM
1.2 Meg 5 1/4" Drive
1.44 Meg 3.5" Drive
40 Meg 28ms Drive
16 Bit VGA Board
14" VGA COLOR Monitor
1 Parallel/2 Serial Ports
101 Key Keyboard
MS DOS 3.3 or 4.01

\$2295.00

16 Mhz 286 VGA

80286-16 Processor
2 MEGS RAM
1.2 Meg 5 1/4" Drive
1.44 Meg 3.5" Drive
40 Meg 28ms Drive
16 Bit VGA Board
14" VGA COLOR Monitor
1 Parallel/2 Serial Ports
101 Key Keyboard
MS DOS 3.3 or 4.01

\$2395.00

20 Mhz 286 VGA

80286-20 Processor
2 MEGS RAM
1.2 Meg 5 1/4" Drive
1.44 Meg 3.5" Drive
40 Meg 28ms Drive
16 Bit VGA Board
14" VGA COLOR Monitor
1 Parallel/2 Serial Ports
101 Key Keyboard
MS DOS 3.3 or 4.01

\$2495.00



Due to the Volatility in the DRAM Market all prices subject to change.

IN THEIR FIELD

The Service

Gateway 2000 backs its computer systems with a full one year warranty and 30 day money back guarantee. If a problem does arise, you will promptly receive a solution over the phone or via *Federal Express* at our expense. In addition to this, we offer *lifetime toll-free support*, even after the warranty expires. So call Gateway 2000 for the best overall value on the market today.



20 Mhz 386 VGA

- 1 Meg RAM
- 1.2 Meg 5 1/4" Drive
- 1.44 Meg 3.5" Drive
- 80 Meg 28ms Drive
- 16 Bit VGA Board
- 14" VGA COLOR Monitor
- 1 Parallel/2 Serial Ports
- 101 Key Keyboard
- MS DOS 3.3 or 4.01

\$2995.00

(Upgrade to 4 Megs \$500)

25 Mhz 386 VGA

- 4 Megs RAM
- 1.2 Meg 5 1/4" Drive
- 1.44 Meg 3.5" Drive
- 150 Meg 16.5 ms ESDI Drive
- 16 Bit VGA Board
- 14" VGA COLOR Monitor
- 1 Parallel/2 Serial Ports
- 101 Key Keyboard
- MS DOS 3.3 or 4.01

\$4495.00

(64K Cache Add \$500)

33 Mhz 386 VGA

- 64K Cache RAM
- 4 Megs RAM
- 1.2 Meg 5 1/4" Drive
- 1.44 Meg 3.5" Drive
- 150 Meg 16.5 ms ESDI Drive
- 16 Bit VGA Board
- 14" VGA COLOR Monitor
- 1 Parallel/2 Serial Ports
- 101 Key Keyboard
- MS DOS 3.3 or 4.01

\$5995.00

Gateway 2000

P.O. Box 2000

Sgt. Bluff, IA 51054

800-779-2000

712-943-2000



Be Objective.

Turbo Pascal,* the world-standard Pascal compiler, adds Object-Oriented Programming with our new version 5.5. We combined the simplicity of Apple's Object Pascal language with the power and efficiency of C++ to create Turbo Pascal 5.5, the object-oriented programming language for the rest of us.

It's easy to extend yourself

If you're already programming with Turbo Pascal, it's easy to extend yourself from structured programming to object-oriented programming. And, Turbo Pascal 5.5 is the *only* compiler that is 100% source-code compatible with your existing Turbo Pascal 4.0 and 5.0 programs.

A fast object lesson

Object-oriented application programs more closely model the way you think. Objects contain both data and code.

As in a spreadsheet cell, the value and the formula are together. Objects can *inherit* properties from other objects. For example, a Porsche Carrera inherits most

attributes from the base model 911, but it also sports a whale tail.

Turbo Pascal 5.5's object-oriented extensions give you code that's easier to change, extend, and support.

Turbo Pascal 5.5 Professional with Turbo Debugger® and Turbo Assembler®

The award-winning Turbo Debugger now includes an object inspector and hierarchy browser. And Turbo Debugger can debug any size program.

Upgrade objectively

Pascal owners: Upgrading from Turbo Pascal 5.0 to 5.5 is only \$34.95 plus \$5 shipping and handling (\$75 plus shipping and handling for owners of Turbo Pascal 4.0 or earlier). And upgrading from Turbo Pascal 5.0 and

earlier to Turbo Pascal 5.5 Professional is only \$99.95 plus \$10 shipping and handling. To order, CALL (800) 331-0877.

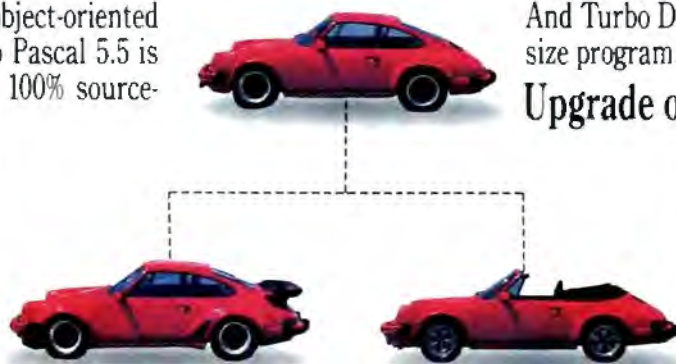

Inheritance provides powerful modeling capabilities by allowing objects to inherit attributes from other objects.

Turbo Pascal 5.5 Features

- Inheritance
- Static & dynamic objects
- Constructors & Destructors
- Object constants
- Compiles @ > 34,000 lines/minute
- New integrated environment tutorial
- Hypertext Help with copy and paste
- Enhanced smart linker & overlay manager
- Support for 8087/80287/80387
- Integrated source-level debugging



B O R L A N D

Code MA25

Mail upgrade orders to: Borland, P.O. Box 660001, Scotts Valley, CA 95066-0001. For orders outside the U.S., call (408) 438-5300. Turbo Pascal, Turbo Debugger, and Turbo Assembler are registered trademarks of Borland International. Copyright © 1989, Borland International, Inc. All rights reserved. 31-1314

Circle 46 on Reader Service Card (DEALERS: 47)

Microsoft® is a U.S. registered trademark of Microsoft Corp. ©1989 Hewlett-Packard Company HP12345

HOW TO MAKE P
How to make points.
HOW TO MAKE PO
How to Make Poi
How to Make Po
HOW TO MAKE P
How to make points
How to make points.
How to make poi
How to Make Points.
HOW TO MAKE
HOW TO MAKE POIN

How to Make HOW TO MAKE

How to make points.

How to Make Points
HOW TO MAKE POIN *How to Make Points*
HOW TO MAKE PO **HOW TO MAKE PO**
How to make points. How to make points
How to make points How to make points
HOW TO MAKE POIN. How to Make P
How to Make Points **HOW TO MAKI**
How to make p **How to Make Point**
How to make How to make poin
HOW TO MAKE PO
HOW TO MAKE POINTS.
How to make point
HOW TO MAKE POINTS
How to make point
HOW TO MAKE POIN
How to make points.
HOW TO MAKE POINTS
How to make pi
HOW TO MAKE POINT
HOW TO MAKE POINTS.
HOW TO MAKE POINTS
How to make points.
How to make point

How to
How to make
How to make p
How to Make Point'
How to make p
 How to make poin
 How to make points
HOW TO MAKE POINTS
 HOW TO MAK
How to make points.
 How to make points.
How to make point
 HOW TO MAKE POI
How to make points.
HOW TO MAKE PC
How to make points.
 HOW TO MAKE P'
 How to make points
 HOW TO MAKE POIN
 HOW TO MAKE POINT
 HOW TO MAKE POINTS
How to make points.
 How to make points.

HOW TO MAKE POIN
How to make point
 HOW TO MAKE POI
 How to make po
 How to Mak
How to Mc
HOW TO
How to

Now you can impress them like never before with your HP LaserJet printer. Because HP and Compugraphic have developed a new selection of disk-based scalable typefaces. And with our Type Director software, each face can be scaled from 4 to 200 points in 1/2 pt. increments. Of course, our new faces work with your favorite software. Including WordPerfect, Microsoft® Word and Windows, Ventura Publisher and Aldus PageMaker. Best of all, we're adding more faces all the time. So now your documents are limited by only one thing. Imagination. Call 1-800-752-0900, Ext. 711Q for your nearest authorized Hewlett-Packard dealer.



There is a better way.





Creative License.

If you've ever tried to combine windows, menus, forms, and text entry to create an effective user interface, you know how challenging it can be.

Perhaps you've turned to a third-party library for help. Only to run into restrictions, limitations, and dead ends. So you had to compromise your design. Or modify the library source code. Or start over.

Which is precisely why we designed Vermont Views™, the new generation of Windows for Data®, the best-selling C library for user interfaces.

Vermont Views offers unbridled, unrestricted creative license.

The Human Interface Of Your Dreams

Vermont Views offers an unparalleled set of interface building blocks that you can combine in unlimited ways:

- Menus can be created in any style you choose, made scrollable vertically and horizontally, and nested to any level. Features include n-th character selection, checkmarks, and unavailable items.

- Data entry forms can be bigger than their display windows, have scrollable regions for the entry of variable lines of items, lists of choices for data entry, context sensitive help, and special decimal, date, time, and toggle fields.

- A mini word processor can be attached to a field window in a form or

used as a pop-up note taker.

You're In Charge

Because you can write and attach functions to the beginning and end of menus, forms, fields, and to keys, you're always in control.

Use these control functions to call up subsidiary forms and menus, change field values and the active field, exit or abort a form, do almost any task you can imagine.

All interactive capabilities of Vermont Views use a unique system of accessible keytables, so you can easily change or disable key assignments – even add to the functions provided for menus, forms, text entry, and windows.

One For All

Vermont Views is available for DOS, OS/2, UNIX, XENIX, and VMS. Maintain the same user interface on all of these operating systems with the same source code.

Vermont Views provides international portability as well, with full support for IBM international characters, flexible date and time formats, and changeable decimal and thousands separators.

Novice Or Expert

Despite its depth and flexibility, Vermont Views is easy to learn and use. Each major facility is covered in a single, self-

contained section of the manual, so you only need to learn capabilities as you use them.

To help you become an expert in no time, we include a free copy of the Norton Guides™ Engine and our own comprehensive Pop-Up Reference™. You'll have immediate, on-line access to function names, reference pages, structures and tables.

No-Time-Limit Guarantee

We've only touched on a fraction of what makes Vermont Views special. The only way to know it is to use it.

Try Vermont Views on your hardest problems.

For as long as you want. At no risk.

If not fully satisfied, return for a full refund. Anytime.

To Order Today Call 1-800-848-1248

Call to order Vermont Views today. And we'll send your "creative license" right away.

Prices: DOS \$395; with Source \$790, UNIX, XENIX, VMS, OS/2 please call.



Vermont
Creative
Software

Pinnacle Meadows, Richford, VT 05476

MICROBYTES

Staff-written highlights of developments in technology and the microcomputer industry,
compiled from *Microbytes Daily* and *BYTEweek* reports

AT&T "Microscopic Parallel Processor" Hits 24 GHz

Scientists at AT&T's Bell Laboratories (Murray Hill, NJ) have built a new quantum-effect transistor that promises some intriguing future generations of computers. Texas Instruments was the first to announce development of a quantum transistor (see "TI's Prototype Transistor Takes a Quantum Leap," March *Microbytes*). Designers working with such a device will someday be able to implement far more functions on a chip than is possible with today's ICs.

In normal transistors, the output current increases steadily as the input current rises. But according to Frederico Capasso, one of the three co-developers of the new multistate resonant tunneling transistor, the output current peaks, falls off, and then peaks again in the AT&T device. This multistate characteristic allows it to do the work of many conventional transistors. Capasso calls it a "microscopic parallel processor." In addition to its almost unimaginably small size, the transistor operates at up to 24 gigahertz, about twice the speed of the fastest conventional silicon transistors, while it requires much less power than current ICs.

Although the device is only in an experimental prototype stage right now, AT&T scientists say they have already used a single quantum transistor to implement functions such as parity bit-checking (which normally requires about 24 transistors). They

say they've also used a single device to multiply a frequency from 300 MHz to 1.5 GHz.

Like Texas Instruments' device, AT&T's transistor uses a quantum phenomenon called *resonant tunneling*, which occurs in quantum wells—electron filters formed by stacking microscopically thin layers of semiconductor atop one another. Only electrons with certain energies can pass through the wells.

AT&T's device uses two well layers, made of gallium-indium-arsenide and measuring just 25 atoms thick; each layer is surrounded by two aluminum-indium-arsenide barrier layers of the same thickness. AT&T scientists say they created the multistate capabilities of the device by increasing the number of wells. The actual wells are made using an AT&T-developed technique called molecular beam epitaxy. Because it allows scientists to build devices one atom thick at a time, MBE lets designers concentrate the entire circuit function vertically into a single device. Capasso says this is the first demonstration of a three-dimensional integrated transistor device.

But don't expect to buy a laptop supercomputer yet. Commercial applications of the multistate resonant-tunneling transistor are probably five to 10 years away. The primary problem is that new techniques will have to be developed to allow mass production of quantum transistors.

VROOMM: Borland Says Memory Technology Will Make Future Programs Better, Not Bigger

Borland International (Scotts Valley, CA) says its new proprietary programming technology will enable it to develop applications that have more features and greater data capacity but still fit within the 640K-byte limitation of MS-DOS. Borland is calling the technology VROOMM, which stands for Virtual Real-Time Object-Oriented Memory Manager, a fancy marketing phrase for a programming concept called *dynamic segment*

swapping. The software company says that it will use VROOMM in all its applications and development tools; the new Reflex 2.0 is the first application to implement VROOMM.

In contrast to the concept of segment overlays, in which parts of the program's executable code are compiled into separate, fixed-size overlays and swapped in and out of memory, dynamic segment swapping

continued

NANOBYTES

The Trend Indicator isn't flashing yet, but we've seen more **hardware price cuts** in the past several weeks than during any time in recent memory. One of the most noticeable price drops was on the Sun386i, which Sun lowered by 10 percent to 15 percent; the system with 4 megabytes of RAM, a 15-inch monochrome monitor, and a 91-megabyte hard disk drive now costs \$8990. Dell reduced its System 200 line of 80286 machines by as much as \$400. NEC pared prices of its PowerMate SX by 11 percent to 14 percent and PowerMate 1 Plus prices by 11 percent to 20 percent. American Mitac tweaked prices of its Paragon XTs, ATs, and 80386 machines by as much as \$200. TeleVideo pruned prices of its 386/16 family by as much as 22 percent. QMS reduced the jump-back prices of its ColorScript 100 Model 30 and Model 20 printers, \$21,995 and \$16,995, respectively, to \$19,995 and \$15,995. Laser Connection trimmed the QMS-PS 810 PostScript printer from \$5495 to \$4995. Boca Research cut \$200 off its BocaRAM Micro Channel 4-megabyte memory boards and \$300 off its 4-megabyte 16-bit AT-compatible boards. AST knocked \$200 off the price of the 512K-byte RAMpagePlus/286 board. And Microtek cut scanner prices by as much as \$1300.

Software prices haven't shown any sign of tumbling, but when IBM and Interleaf cut the price of IBM Interleaf Publisher, they cut it in a major way. The new version 1.0.1 of the desktop publishing program, which runs on 80386-based systems, sells for \$995; it used to cost \$2495. The program also devours less memory now, cutting down its RAM consumption from 6 megabytes to 2 megabytes. The memory diet is made possible by the addition of a run-time version

continued

NANOBYTES

of Phar Lap's DOS Extender, which uses paged virtual memory and permits use of 32-bit-wide commands.

Tandy (Fort Worth, TX) has given its **DeskMate** environment a slight face-lift. DeskMate, which comes free with Tandy computers and in a run-time version with some application programs, now has a more three-dimensional look, with features such as buttons that look pushed down when selected. In addition to a DOS shell and simple word processor, spreadsheet, and communications packages, DeskMate has a paint-style graphics program and a digital sound-manipulation program (which works with the sound circuitry of the Tandy 1000). For \$149, you can add a WorkGroup program that provides printer sharing, file sharing, and E-mail functions.

Tennessee volunteers for ISDN:

The South Central Bell phone company is planning to make Tennessee the first state in the nation with an all-digital telecommunications infrastructure, paving the way for ISDN services to homes and businesses. The three-year, \$900 million program is designed to replace electro-mechanical and analog central office computers with digital central office equipment and to double Tennessee's fiber-optic network from 12,000 to 25,000 miles. By 1990, all Tennessee customers will be served with digital central office computers, according to a South Central Bell official. This doesn't mean all customers will have immediate access to an ISDN, he said. "Digital links provide the basis for ISDN access. Upgrading to ISDN will mostly involve adding software."

Microsoft (Redmond, WA) has introduced a new version of FORTRAN that could be good news for programmers who do their work on expensive VAX and IBM mainframes but want to move to PCs. Microsoft's **FORTAN 5.0** supports most of the syntax of

continued

lets you swap smaller segments of code at run time and in varying amounts, depending on what you're doing with the program. Many DOS programs employ fixed overlay files, typically from 30K bytes to more than 100K bytes in size, that must be loaded into memory in their entirety whenever you use them. Large overlay segments limit the amount of free memory left over for data, such as text files, spreadsheets, and database tables.

VROOMM gets around the size restrictions imposed by fixed overlays by using 2K- to 4K-byte chunks of code (segments), which make up the complete application. In the dynamic-segment-swapping model, the program can decide on the fly (dynamically) which segments of code it needs in memory at any given time. If you are currently running the Window Manager, for example, the program brings in the segments of code required to operate the Window Manager. VROOMM also allows the application to juggle the amount of

code in memory with the amount of data being stored in memory.

Consider a user working on a large database table requiring a lot of memory; VROOMM can swap more segments out to disk or to expanded memory, if available. VROOMM stores the most frequently used code segments in an object cache. The cache can reside either on disk or in expanded memory. VROOMM assigns a priority to each code segment (called *persistence prioritization*), depending on the way you use the program (e.g., whether you're working with reports, graphics, or data-entry forms).

Will Borland make VROOMM available to other software developers? According to Rob Dickerson, vice president of product development, the company has not resolved this question. At a recent meeting of the Boston Computer Society, Borland president Philippe Kahn said that the company "will provide the right tools" to other developers "when we can support them."

Lisp's Future Linked to Other Languages

Since its inception at MIT about 25 years ago, Lisp has become the lingua franca of AI; because of its symbolic and procedural capabilities, many programmers choose it for developing rule-based or expert systems. However, AI applications and Lisp have not enjoyed the success anticipated by AI proponents. Lisp has a very large syntax (about 200 primitives), and, according to some programmers, it is difficult to learn. Because it processes symbols and lists, Lisp requires a lot more computing horsepower than conventional languages like C or Pascal, which deal with predefined, fixed-length data structures. As a result, Lisp has been hampered by slow performance and slow acceptance. In recent years, several Lisp companies have gone bankrupt, and the largest AI company, Symbolics, has suffered two straight years of losses.

But some Lisp developers are optimistic about Lisp's future. With the industry's continuing advances in processing power, the performance of Lisp is becoming acceptable to more users. And developers are finally recognizing that the key to Lisp's success is integrating it into main-

stream computing—in other words, allowing Lisp to be linked to existing applications written in other high-level languages (e.g., C and Pascal).

The main trend in AI today is the integration of Lisp-based "intelligent add-ons" to existing database systems, says Pekka Pirinen, director of research and development for Intelitech, a Lisp vendor based in Helsinki, Finland. An "intelligent add-on" might be a rule-based query system that acts as an interface to a large body of existing data.

The key to the intelligent add-on concept is Lisp's ability to link directly to other high-level languages. If you simply add a direct function call to the Lisp application, the application can then link to and execute an existing C or Pascal program. Intelitech has just announced a new Lisp product, called Entity Common Lisp, for 80386-based computers. Requiring 4 megabytes of RAM and Microsoft Windows, ECL will feature links to C and Pascal compilers from Microsoft and Borland. According to Pirinen, ECL is the first Lisp product in the DOS environment that can be linked to other high-level languages. ECL is

continued

Now QuickPascal makes this software go even faster.



Even the quickest minds tend to brake suddenly when confronting new languages.

Enter new Microsoft® QuickPascal Compiler.

The first Pascal that is not only powerful but easy, intuitive and 100% headache-free.

For example, our new hypertext QuickPascal Advisor offers on-the-job training: by cutting and pasting sample code you can learn to program in Pascal from scratch. And if you do hit a snag, the Quick Advisor can straighten everything out right on the spot.

To accelerate your thought processes even more, all of our processes are seamlessly integrated; no other Pascal offers you easier

access to your editor, debugger and compiler.

What's more, QuickPascal is the first PC Pascal to offer Object Oriented Programming, or OOP. With objects, you can easily assemble whole programs from modular building blocks of code and data. And once you know Pascal, OOP is a snap. Which means, you get maximum productivity with minimum effort.

Naturally, our Pascal is also fully source compatible with Turbo Pascal®.

So stop by your Microsoft dealer soon.

You'll find our software is on the same wavelength as yours.



Microsoft
Making it all make sense.

Better is

The new 16" MultiSync® 4D and 20" 5D both offer compatibility with a wide range of graphics boards and computer systems.

NEC's award-winning multiple frequency technology, now available in larger, digitally controlled, high-resolution color monitors.



Both are optimized for the IBM PS/2, PC/AT/XT (and 100% compatibles) and the Macintosh II. Both offer a microprocessor-based digital control system for preset and custom graphics modes, automatic screen

MultiSync is a registered trademark of NEC Home Electronics (USA) Inc.

C&C

Computers and Communications

bigger.

configuration and optimal image. And both give you great resolution—

the 4D, from VGA up to 1024 x 768; the 5D, from VGA to 1280 x 1024.

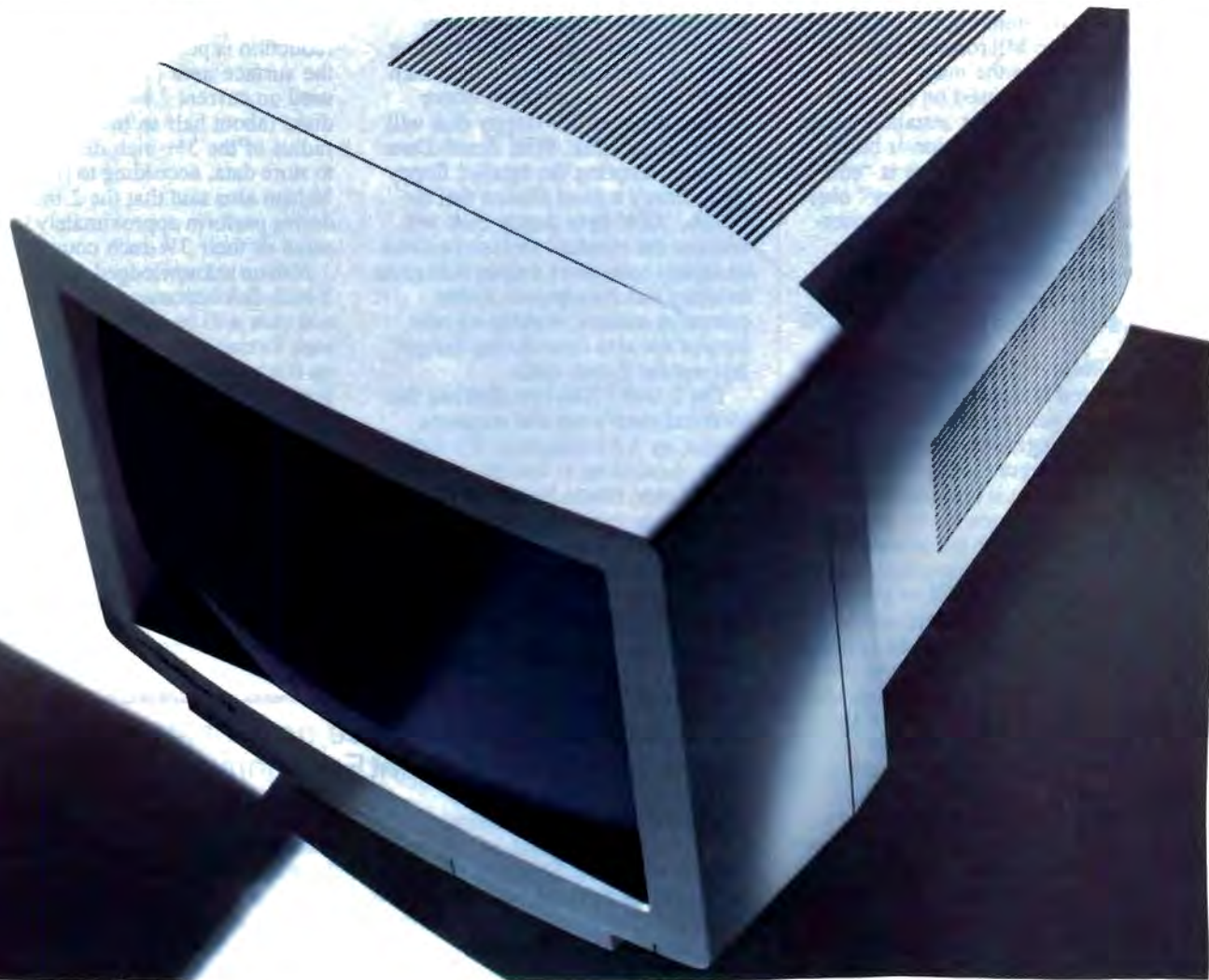

The main difference: one is for large ideas. The other, for extra-

IBM PC/ATXT and PS/2 are registered trademarks of the International Business Machines Corporation.

large. For literature, call 1-800-826-2255. For details, call NEC Home

MAC Plus is a registered trademark of Apple Computer, Inc.

Electronics (USA) Inc. 1-800-FONE-NEC.

©1989 NEC Home Electronics (USA) Inc.

NEC

NANOBYTES

IBM's Systems Application Architecture-compliant VS FORTRAN and important VAX FORTRAN extensions, such as NAMELIST, OPEN append, DO WHILE, and INCLUDE. FORTRAN 5.0 also supports the 16-megabyte addressing capability of OS/2 and library routines without recompiling the entire application. Microsoft claims that FORTRAN is the main programming language used on over half of the VAX machines installed today. Microsoft's new version is based on FORTRAN 77. There is "still some amount of controversy" over the implementation of the upcoming FORTRAN 8X standard, a company official said. FORTRAN 5.0 is available now at \$450. Upgrades range from \$100 to \$250.

Smalltalk + Schools = Object-Oriented Students: Hoping to raise the next generation of software engineers on object-oriented programming, **Digitalk** (Los Angeles) is offering educational site licenses for its Smalltalk system. For \$500, schools and universities that are registered users of the Smalltalk/V 286 or Smalltalk/V Mac development environments can install unlimited copies of the software on-site. To become a registered user requires buying Smalltalk (\$199.95), but the site license includes a 30 percent discount on all Smalltalk products, so the software ends up costing \$139.95. "Those relying on traditional procedural languages are struggling to adapt these older languages to complex environments like the Macintosh," said Barbara Noparstak, Digitalk's director of marketing. "Educating a new class of programmer with tools that simplify this complexity will reap industry benefits in the years to come."

Microtech International (Branford, CT) has a new trade-in deal for Macintosh owners looking for a new hard disk drive. You can apply your hard disk drive, whether it works or not, and from any manufacturer, toward purchase of a Microtech Nova internal or external

continued

priced at \$995; a run-time kit is \$495. The full integrated system was scheduled to be available this month, although a version without the language hooks was supposed to ship

by July. (In the U.S., ExperTelligence, Inc. (Goleta, CA), is selling the Intellitech package.) Intellitech says that it is also preparing a version of ECL for OS/2.

Zenith's 2-inch Floppy Signals Shrinking Standard

Zenith's introduction this month of its MinisPort points the way toward the next step in the shrinking of the personal computer: the 2-inch floppy disk. In an industry where smaller is better, the floppy disk will continue to shrink. With Zenith Data Systems adopting the smaller floppy disk, there's a good chance that the 2-inch, 720K-byte floppy disk will become the standard storage medium on laptop computers sooner than most industry watchers expect. Other computer makers working on new laptops are also considering designs that use the 2-inch disks.

The 2-inch 720K-byte disk has the identical read/write and magnetic format as 1.44-megabyte 3½-inch disks. According to Zenith's marketing director, Glenn Nelson, the basic engineering concept involves taking half the surface area of the magnetic film of a 1.44-megabyte 3½-inch disk and putting it on the 2-inch disk, resulting in half the data capacity, or 720K bytes. Although a 2-inch disk

has only about one-third the surface area of a 3½-inch disk, the 2-to-1 reduction is possible because not all the surface area of a 3½-inch disk is used on current 1.44-megabyte floppy disks (about half an inch of the outer radius of the 3½-inch disk is not used to store data, according to Nelson). Nelson also said that the 2-inch disk drives perform approximately the same as their 3½-inch counterparts.

Nelson acknowledged that until the 2-inch disk becomes a standard, little software will be available in the 2-inch format and users will have to rely on file transfer utilities to send applications and data to the 2-inch drive system from another computer, using the serial ports of the host and target systems.

Nelson declined to comment on which manufacturers are supplying Zenith with the 2-inch drives. However, 2-inch floppy disks are already in limited use in the video and camera market and are manufactured by Sony and other companies.

ParcPlace to Put New Face on Smalltalk-80; Plans C++ Development Environment

ParcPlace Systems (Mountain View, CA), the spin-off of Xerox's Palo Alto Research Center, thinks object-oriented programming is the answer for big computer installations bogged down in massive software projects. But first, the company has to remedy a major limitation of its Smalltalk-80 object-oriented programming language. Acceptance of Smalltalk-80 has been hampered by the fact that it runs in its own, incompatible windowing environment. Whether it's running on a Mac, an 80386-based microcomputer, or a Sun workstation, Smalltalk-80 is not compatible with the host windowing system (e.g., Macintosh, Microsoft Windows, or X Window).

To overcome this problem, ParcPlace is working on a new interface called the Stencil Paint

Imaging Model, which will include translators that "map" SPIM to the host imaging model (e.g., PostScript or QuickDraw). The company is also adding extensions to Smalltalk-80 that will allow it to make function calls to the host windowing system. ParcPlace Systems hopes to have the SPIM upgrade ready by November and plans to offer a run-time version of Smalltalk-80, which will allow developers to install Smalltalk-80 applications without the entire development environment.

ParcPlace is also diversifying into the C++ object-oriented programming language, which lets programmers add object-oriented extensions to C programs. In conjunction with Glockenspiel, Ltd., the company is readying a complete C++ development environ-

continued

Best Performer!



FoxBASE+ / Mac



The Fastest, Most Powerful, dBASE Compatible
Relational Database Management System
For The Apple Macintosh™

New!
Version
2.00

Fox Software
Nothing Runs Like a Fox.

New!
Multi-User

FoxBASE+ / Mac



The Fastest, Most Powerful, dBASE Compatible
Relational Database Management System
For The Apple Macintosh™

New!
Version
2.00

Fox Software
Nothing Runs Like a Fox.



FoxBASE+ / Mac: The Most Celebrated Mac DBMS Now Includes a Powerful Report Writer!

New
Version 2.00!

New FoxBASE+ / Mac Version 2.00 is here—and stealing the show! In its first year, FoxBASE+ / Mac won more awards—both in the U.S. and Europe—than any other DBMS ever created for the Macintosh! And Version 2.00 is faster and more powerful than ever—packed with innovative new features and language enhancements!

New FoxReport!

FoxReport lets you create virtually any columnar or free-form report—without *any* programming! FoxReport includes:

- **Page Layout:** Designate many layout settings for your report: number of columns, left margin setting, column width, space between columns, measurement size for each page, and more!
- **Report Layout Window:** Define the different areas within your report, using FoxReport's new "band" system. Start with the default bands: Page Header, Body, and Page

Footer, then bring in other bands like Title, Summary, Column Headers and Footers, etc.

- **Object Menu:** Control the Type Font, Sizes and Styles of text objects. Fill and Pen options let you change the color and shading of almost every object!
- **Page Preview:** "What-You-See-Is-What-You-Get" design ensures that the report on your screen is *exactly* as it will appear in print!
- **Label Generator:** Create labels of almost any size and configuration. You can even include pictures *anywhere* on the label space!

New Features!

- **Enhanced XCMD/XFCN Support:** Load up to 16 external XCMD's and XFCN's, then access them directly from within FoxBASE+ / Mac 2.00 programs!
- **Language Enhancements:** Other features include: support for custom hierarchical menus, new commands to help handle resources, new system functions to improve filename and screen management, and much more!

Perfect Connectivity!

FoxBASE+ / Mac 2.00's Multi-User version allows complete data and application sharing between networked Macs and PCs! (when used with FoxBASE+ / LAN). It also runs on the most popular network systems: AppleShare, Novell and 3Com! . . . *And It's Faster Than Ever!*

Order or Upgrade Now!

FoxBASE+ / Mac Version 2.00 is the *new* Leader of the Mac! And at only \$495 (\$695 for Multi-User), it's a phenomenal bargain! If you're already a FoxBASE+ / Mac registered user, you can upgrade to Version 2.00 for just \$75!

To order your copy (or ask for a **FREE** demo disk), call (419) 874-0162. Or visit your local quality software dealer.

After all, when it comes to the Macintosh, *Nothing Runs Like a Fox!*

FoxBASE, FoxBASE+ / Mac, and FoxReport are trademarks of Fox Software. Macintosh is a trademark of Apple Computer, Inc.

Fox Software

Fox Software, Inc. (419) 874-0162, Ext. 320
134 W. South Boundary Fax: (419) 874-8678
Perrysburg, OH 43551 Telex: 6503040827 Fox



Smalltalk/V[®]

Designed to blow the doors off the hybrid languages of the programming world.

Smalltalk/V does prototyping the same way Shelby prototyped the Cobra... using a blend of technical expertise and seat-of-the-



“Anyone can build a prototype by the seat of your pants.”

— CARROLL SHELBY
Creator of the legendary
Shelby Cobra

pants savvy that's startlingly sophisticated. First you doodle, design, dream. Then you explore the possibilities and begin to assemble the

prototype. You test. You tinker. You change. And you keep on changing and test-driving and refining until the prototype is just the way it was

achieve this feat without once having to go through the old “crash and burn” kind of programming so common with languages born in the age of mainframes.

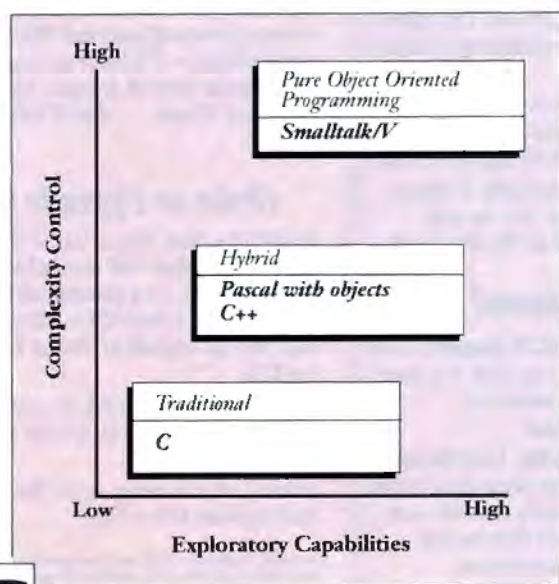

meant to be. With no compromises... of any kind. But the most remarkable thing is this prototype is not just a prototype. It runs, it races, it performs like the real application. Because it is the real application. And you

COMPLEXITY CONTROL FOR THE 1990s AND BEYOND.

The concept behind an object-oriented programming system is relatively simple. You build more complex objects out of simpler ones. Much as you can build complicated designs with a Lego set. With Smalltalk/V a programmer can write a piece of code and then





C accents in the winner's circle. Cobra. His philosophy was simple and salty. "It doesn't matter whether you're building an outhouse or a car. You don't compromise." Suddenly a Texas drawl was replacing Italian

THE "AM I READY FOR SMALLTALK/V" CHECKLIST

- Does a lot of your work involve prototyping/exploratory programming?
- Are many of your problems difficult to define?
- Are external factors constantly changing?
- Do you like to make changes from insights gathered along the way?
- Do you feel torn between efficiency and conceptual clarity?
- Are you developing for Multi-Finder or Presentation Manager?
- Are you tired of needless crashing?
- Are team projects getting harder to manage and complete on time?
- Has your creativity been intimidated by the rigorous demands of the process?

"Traditional computer languages and interfaces with their structure and detail, have appealed to those of us who are left-brained (more logical and analytical). On the other hand, object-oriented languages and interfaces, with their emphasis on perception and the whole picture, invite those of us

who are right-brained (more artistic and intuitive) to join the computer revolution as well."

—Byte

"Object-oriented programming is the key to the next great transition in personal computing."

—NY Times

book. But you create a legend



With Smalltalk/V your mouse becomes a hot programming tool for either your Mac or your PC. You'll find that Smalltalk/V is souped up with lots of other high performance features, too. The Class Hierarchy Browser, Inspector, Debugger, Class Browser, Method Browser and Walkback window are all standard equipment.

Smalltalk/V you can write a fugue without having to build the piano."

OOPS! LOOK WHAT THE WORLD IS COMING TO.

"The software of the future, OOP promises not only to boost pro-

grammer productivity but also put reuse it again and again. The "inheritance" factor lets you create, enhance and refine your applications without constantly having to re-invent the wheel. Or, as one programmer put it, "With

powerful computing capabilities in the hands of non-techies."

—Business Week

Smalltalk/V

AT THESE PRICES IT'S CERTAINLY NOT MONEY THAT'S HOLDING YOU BACK.	
Smalltalk/V (DOS 512K RAM)	\$99.95
Smalltalk/V 286 (286 or 386 1.5 MB RAM)	199.95
Smalltalk/V Mac (Plus, SE, II 1.5 MB RAM)	199.95

Smalltalk/V. A product of Digitalk Inc., 9841 Airport Blvd., Los Angeles, CA 90045. For information or to find a dealer near you call:

1-800-922-8255
1-213-645-1082
CompuServe 71361,1636

MultiFinder is a trademark of Apple Computer. Smalltalk/V is a registered trademark of Digitalk Inc. Prices subject to change without notice.



NANOBYTES

hard disk drive. Microtech will give you as much as \$200 for the old drive. Nova disk drives run in size from 20 megabytes up to 320 megabytes. The company has several bigger drives in the works.

Sharp Electronics (Mahwah, NJ) has new software cards for the **Wizard** hand-held computer. The 32K-byte and 64K-byte cards double and triple the Wizard's memory capacity in its memo, schedule, and telephone modes.

If you work at home, you may sometimes lose a fax or modem transmission because someone accidentally picks up the extension phone to make a call. **Interruption Blocker**, from **DesignTech International** (Springfield, VA), is a telephone line guard that locks in your transmission and prevents others from breaking onto the line. You plug your phone into the mouse-size box, which connects to your telephone wall jack. **Interruption Blocker** costs \$15.

Hitachi and **Motorola** are becoming the semiconductor industry's version of the forever-feuding Hatfield and McCoy clans. In the most recent shot fired, Hitachi accused Motorola of violating Hitachi patents with its **68030** microprocessor, currently Motorola's top-of-the-line CPU. It all started back when the two companies, after a long spell of technology exchanges and cross-licensing agreements, hit a snag involving Hitachi's new H-series of microprocessors. Motorola sued the Japanese company, claiming that the H-series infringes on Motorola patents. Hitachi countersued, claiming Motorola violated Hitachi patents with one of its microcontroller chips. Motorola fired back, claiming Hitachi violated a Motorola patent in that same case.

Expenditures for computer software in the U.S. will hit \$61 billion by 1993, says the market research firm **Input** (Mountain View, CA). In its latest report, Input says that's an increase of \$36 billion over what was expended on software products

continued

ment that's written in Smalltalk-80 and shares two of that language's major features, incremental compiling and linking. The C++ product will initially be available only on Sun workstations.

ParcPlace Systems is working on database "hooks" for Smalltalk-80. The integrated database capability will let you store Smalltalk-80 objects in a standard relational database. The first target database is Oracle, but ParcPlace plans to offer "back-end drivers" for other databases such as

DB/2 and Sybase. The ability to access reusable objects as fields in a database has great potential in many applications.

"We're moving from the lunatic fringe to the Fortune 1000 market," said Doug Pollack, ParcPlace's vice president of marketing. Big financial institutions and corporate MIS departments are looking for ways out of the "software crisis" and are considering more revolutionary techniques and approaches, as represented by Smalltalk-80, he said.

Toshiba's Low-Cost Systems Could Boost SPARC

If Toshiba actually delivers relatively low-cost computers based on the SPARC processor, as the company suggested when it announced that it would adopt the SPARC chip, it could be the best thing to happen yet to Sun Microsystems' RISC architecture. Toshiba's Computer Division has signed a deal with Sun to manufacture computers based on the SPARC (for scalable processor architecture) standard. Toshiba will build a "new class of high-performance, low-cost computers" based on SPARC processors, the company said. Toshiba will also license Sun's SunOS version of Unix and the Open Look graphical user interface.

SPARC processors are available from several chip manufacturers, including Bipolar Integrated Technology, LSI Logic, Cypress Semiconductor, Fujitsu, and Texas Instruments.

Toshiba said that it will announce its first SPARC machines in early 1990. Sun spokesperson Marty Coleman said Toshiba does not intend to compete directly with Sun's own workstation offerings but intends to "complement" them. While Sun has

been fairly successful with the SPARC chip, SPARC-based machines still account for less than half of Sun's business, and Sun hopes to make SPARC a standard by recruiting other vendors to license the technology.

Toshiba is not the first major computer manufacturer to license the SPARC technology. AT&T, TI, Unisys, and Xerox, among others, have publicly announced commitments to SPARC. However, Toshiba has greater experience in delivering machines to the mass market than do the other SPARC licensees, and it also has a stronger presence in the personal computer marketplace with its line of laptop computers.

The only manufacturer other than Sun that is delivering SPARC-based machines is Solbourne Computer (Longmont, CO). As Coleman put it, "Solbourne proved that SPARC is cloneable. Toshiba will prove that it can be produced in volume." The rather quiet Solbourne reported recently that it has signed distribution agreements, worth \$19 million, with computer sellers in Australia, Greece, Taiwan, and Israel.

Silicon Graphics Cuts Price of 3-D Workstation

Workstations with sophisticated graphics capabilities continue to bump down in price as high-end personal computers seem to be bumping up. In the latest indication of the workstation's improving price/performance curve, Silicon Graphics (Mountain View, CA) last month cut the price of its Personal Iris system by as much as 35 percent. The Personal Iris is a Unix-based graphics computer

built around MIPS Computer Systems' 32-bit R2000 RISC processor. The top-of-the-line model is capable of real-time three-dimensional imaging. Silicon Graphics rates the entry-level system's performance at 10 million instructions per second; a new model, based on the MIPS R3000 chip, performs at 16 MIPS, Silicon Graphics says. (For details about the

continued

Cure Hayes fever.



2400etc/e

V.42 compatible

Get fast relief from high prices with ATI's high-performance, error-free modem for a fraction of the price.



Allergic to high modem prices? Here's news that will clear your head, not your budget.

ATI® Technologies' 2400etc/e® external modem* meets the competition feature for feature...and then some! Remarkably, it costs just a fraction of the price.

Relief is fast. With MNP® level 5 data compression, the 2400etc/e's throughput speeds exceed 4800bps, thereby lowering transmission costs.

The 2400etc/e supports both V.42 and MNP error-control protocols for 100% error-free transfer. And it's fully

compatible with standard and extended Hayes® 'AT' command sets. Plus, ATI's easy-set front panel controls provide convenient access to frequently used commands.

Don't suffer from high prices. The ATI 2400etc/e external modem cures Hayes fever for only **\$299.**** And that's nothing to sneeze at.

You'll be relieved to know that the 2400etc/e's capabilities are also available in a high-performance internal modem, at an equally non-allergic price. Only **\$239.****

For more information, contact your supplier or

ATI Technologies Inc.
3761 Victoria Park Avenue
Scarborough, Ontario
Canada M1W 3S2
Tel: (416) 756-0718
Fax: (416) 756-0720



TECHNOLOGIES INC.

Technology you can Trust.

*Complies to CCITT v.22, v.22bis, Bell 103 and Bell 212A standards. ® ATI and 2400etc/e are registered trademarks of ATI Technologies Inc. Hayes is a registered trademark of Hayes Microcomputer Products, Inc. MNP is a registered trademark of Microcom, Inc. **Manufacturer's suggested retail price.



After years of fi we built

Introducing the best built, best backed 286- and 386-based systems.

Since 1983, CSR has been a leading microcomputer maintenance provider. We repair all major brands - IBM[†], Compaq[†] and the best-known peripherals - for the largest dealer networks and third-party service companies nationwide. So when we decided to build our own 286- and 386-based systems we knew how to make them even better.

With CSR, you can put your confidence in a company that has it all - the service, support, performance and IBM compatibility you expect - but at prices that will surprise you.

The industry's best 2-YEAR warranty.

For the first full year we provide complete on-site service on all parts and labor. During the second year we'll repair or replace any parts that fail. This revolutionary warranty demonstrates the high degree of confidence we have in the quality and reliability of our computers.

Plus, when you call our toll-free Technical Support Hotline you'll be connected to a highly-skilled Customer Engineer (CE). Your CE will either fix the problem over the phone or dispatch a Service Engineer to your site - within 24 hours of your call - for prompt, professional problem resolution.

And what's best about this CSR-exclusive is that everything is included in the price of your computer!

High performance, not a high price.

CSR delivers high performance in every machine we make. Our 286/20 uses an Intel[†] based 80286 chip that runs at a blazing 20 MHz and outperforms most 386-based machines.

And unlike some of our competitors, we don't imbed the VGA or disk controllers on the mother board - that can just lock you out of future innovations. Instead, we provide a high-speed VGA controller which supports all VGA modes. And a totally IBM-compatible disk controller which features the latest in track-buffer technology to boost drive performance by an amazing 30% to 50%.

Compatible with reality.

You've invested a lot in software. That's reality. So we designed our machines to be 100% compatible with all your MS-DOS[®] and OS/2[®] software.

And we know you have software on both 3 1/2" and 5 1/4" media. That's why *all* CSR computers have both size drives - even the low profile, small footprint 286/20 SL. It's a convenience we've added without adding to the price.

Plus you'll find our high resolution high contrast VGA monitors and "clickable" keyboard to be consistent with your definition of how a computer should look and feel.

Compatible with your budget.

You may have computing needs that are incompatible with what *other* computer companies would like you to spend. Tell us the details of your needs. Then tell us your budget. And we'll build you a system that's compatible with both.

So if you want a better built, better backed computer system, compare warranties. Compare specifications. Then pick up the phone and call us at 800-366-1277. We'll deliver what you need at prices that will surprise you.

Full leasing options available. Rates begin as low as \$60/mo. We accept MasterCard, VISA and certified checks.

[†]The brands or product names mentioned are trademarks or registered trademarks of their respective holders. MS-DOS and OS/2 are registered trademarks of Microsoft Corporation.
Made in the USA

CSR 386/20



CSR 386/25c



Doing their best, ours better.

CSR 286/14 CSR 286/14 SL

- 80286 Intel based microprocessor running at 14 MHz.
- 1 MB RAM expandable to 16 MB (8 MB on the system board).*
- Page mode interleave memory architecture.
- High speed VGA controller.
- Dual Diskette/Hard Disk Controller.
- 5.25" 1.2 MB or 3.5" 1.44 MB diskette drive.
- Enhanced 101 tactile "click" keyboard with copy holder and dust cover.
- Socket for Intel 80287 or Weitek math coprocessor.
- 1 parallel, 1 serial port and a Microsoft compatible bus mouse port.
- 8 industry standard expansion slots. **
- Power reset switch.
- Security keylock.
- AMI bios.
- Real time clock with battery backup.
- MS-DOS and MS-OS/2 compatible.

Popular Options

1 MB to 16 MB of high speed memory.
80287 math coprocessor.
Slim line case with one 5.25" and two 3.5" drive bays accessible.

NOTE: *Up to 8 MB in SL case. ** 5 expansion slots in SL case.

CSR 286/14 Hard Disk Drives	Monitors / Adapters Monochrome VGA Mono VGA Color		
20 MB 40 MS ST-506	\$1,699	\$2,099	\$2,399
40 MB 40 MS ST-506	\$1,899	\$2,299	\$2,599
60 MB 22 MS ST-506	\$1,999	\$2,399	\$2,699
80 MB 18 MS ESDI	\$2,599	\$2,899	\$3,299
150 MB 18 MS ESDI	\$3,099	\$3,299	\$3,699

CSR 286/20 SL CSR 286/20

- 80286 Intel based microprocessor running at 20 MHz.
- 1 MB RAM expandable to 16 MB (8 MB on the system board).*
- Page mode interleave memory architecture.
- High speed VGA controller.
- Track buffered high speed dual diskette/hard disk controller.
- 5.25" 1.2 MB or 3.5" 1.44 MB diskette drive.
- Enhanced 101 tactile "click" keyboard with copy holder and dust cover.
- Socket for Intel 80287 or Weitek math coprocessor.
- 1 parallel, 1 serial port and a Microsoft compatible bus mouse port.
- 8 industry standard expansion slots. **
- 3 speed selectable 8 MHz, 16 MHz or 20 MHz speed.
- Power reset switch.
- Security keylock.
- AMI bios.
- Real time clock with battery backup.
- MS-DOS and MS-OS/2 compatible.

Popular Options

2 MB to 16 MB of high speed memory.
20 MHz math coprocessor.
Slim line case with one 5.25" and two 3.5" drive bays accessible.

NOTE: *Up to 8 MB in SL case. ** 5 expansion slots in SL case.

CSR 286/20 Hard Disk Drives	Monitors / Adapters VGA Mono VGA Color	
5.25" 1.44 MB Diskette Drive	\$1,999	\$2,299
40 MB 22 MS ST-506	\$2,599	\$2,799
60 MB 22 MS	\$2,799	\$2,999
80 MB 18 MS ESDI	\$3,499	\$3,799

CSR 386/20

- Intel 80386 Microprocessor running at 20 MHz.
- 1 MB RAM expandable to 16 MB on the system board.
- Page mode interleave memory architecture.
- Socket for 20 MHz Intel or Weitek math coprocessor.
- 5.25" 1.2 MB or 3.5" 1.44 MB diskette drive.
- Track buffered high speed diskette/hard disk controller.
- Enhanced 101 tactile "click" keyboard with copy holder and dust cover.
- High speed 16 bit VGA controller.
- 1 parallel, 1 serial port and a Microsoft compatible bus mouse port.
- 200 watt power supply.
- 8 industry standard expansion slots.
- Power reset switch.
- Security keylock.
- AMI bios.
- Real time clock with battery backup.
- MS-DOS and MS-OS/2 compatible.

Popular Options

2 MB to 16 MB expansion memory options.
25 MHz Intel coprocessor chip.
Internal or external tape backup.

CSR 386/20 Hard Disk Drives	Monitors / Adapters VGA Mono VGA Color			
	1MB RAM	4MB RAM	16MB RAM	16MB RAM
40 MB 22 MS ST-506	\$3,099	\$4,099	\$3,399	\$4,399
60 MB 22 MS	\$3,199	\$4,199	\$3,499	\$4,499
80 MB 18 MS ESDI	\$3,699	\$4,699	\$4,099	\$5,099
150 MB 18 MS ESDI	\$4,199	\$5,199	\$4,499	\$5,499
322 MB 18 MS ESDI	\$4,799	\$5,799	\$5,099	\$6,099

CSR 386/25c

- Intel 80386 Microprocessor running at 25 MHz.
- 1 MB RAM expandable to 16 MB on the system board.
- Advanced Astek Cache memory controller with 32K of high speed static RAM Cache.
- Page mode interleave memory architecture.
- Socket for 25 MHz Intel or Weitek math coprocessor.
- 5.25" 1.2 MB or 3.5" 1.44 MB diskette drive.
- Track buffered high speed diskette/hard disk controller.
- Enhanced 101 tactile "click" keyboard with copy holder and dust cover.
- High speed 16 bit VGA controller.
- 1 parallel, 1 serial port and a Microsoft compatible bus mouse port.
- 200 watt power supply.
- 8 industry standard expansion slots.
- Power reset switch.
- Security keylock.
- Award bios.
- Real time clock with battery backup.
- MS-DOS and MS-OS/2 compatible.

Popular Options

2 MB to 16 MB expansion memory options.
25 MHz Intel coprocessor chip.
Internal or external tape backup.

CSR 386/25c Hard Disk Drives	Monitors / Adapters VGA Mono VGA Color			
	1MB RAM	4MB RAM	16MB RAM	16MB RAM
80 MB 18 MS ESDI	\$4,799	\$5,799	\$5,199	\$6,199
150 MB 18 MS ESDI	\$5,299	\$6,299	\$5,699	\$6,699
322 MB 18 MS ESDI	\$5,699	\$6,699	\$6,099	\$7,099

To order, please call **800-366-1277**



Computer Systems Research
We build ours better.

NANOBYTES

in 1988. The study projects that about \$25 billion of that total \$61 billion will be spent on microcomputer software. The rest will be split between mainframe and mini-computer products.

In other positive news, another research firm claims that more than half the **small businesses** in the U.S. now use **personal computers**. According to **CAP International** (Norwell, MA), its latest national survey of firms with less than 100 employees found that 52 percent have personal computers. When the company took the survey a year ago, the number was 46 percent. A CAP analyst said that 300,000 small businesses bought their first personal computer last year, and of the 7 million microcomputers that CAP says were sold in the U.S. in 1988, 2 million were bought by small businesses and home offices. About 14 percent of the companies said they intend to buy a personal computer in the year ahead.

Rupp Corp. (New York City) has a new software hard disk drive lock that's designed to protect data against unauthorized access. Instead of encrypting each file, the **FastLock** utility (\$69.95) encrypts only the file allocation table (FAT) of your hard disk. The table, which DOS uses to find individual files, makes the entire disk unusable when it's encrypted. A single password decrypts the FAT. If someone makes three unsuccessful attempts at giving the password, the computer locks up.

For your eyes only: **SkiSoft Publishing** (Lexington, MA) has developed software that lets you enlarge the text on a computer screen by as much as 300 percent, something laptop users in particular might find helpful. The memory-resident **Eye Relief** (\$295) can display text on the screen ranging from the normal 80 columns by 25 rows to up to 33 columns by 7 rows. It also lets you change the space between lines and the space between letters. SkiSoft says that as you increase the size, the letters are tuned, so they have smooth edges instead of jagged ones.

Personal Iris, see "Silicon Graphics Brings Down Cost of 3-D Graphics," November 1988 Microbytes.)

The company cut the price of an entry-level diskless Personal Iris from about \$18,000 to \$12,500. The top system, with features for real-time three-dimensional operations, a 380-megabyte hard disk drive, and a 14-inch color monitor, has dropped in price from \$35,000 to \$25,500. The R3000-based models cost \$4000 more. Starting at \$12,500, the Personal Iris falls in the same price zone as souped-up 80386-based systems and color Macintoshes that have fewer graphics capabilities.

Silicon Graphics has also added something to the Personal Iris package. Each system now comes with Wavefront Technologies' (Santa

Barbara, CA) Personal Visualizer, a three-dimensional rendering and animation software package. The Personal Visualizer represents Wavefront's first entry into "lower-end" three-dimensional rendering and animation packages. The Visualizer is a menu-driven system for generating photo-realistic images from three-dimensional data.

There's a good chance that Silicon Graphics' three-dimensional imaging technology and Wavefront's graphics software will show up in the next version of IBM's RT PC, which sources say will be coming soon. IBM has licensed Silicon Graphics' Geometry Engine and Graphics Library technology, which many industry observers agree IBM will use first in the next model of the RT.

Reusable Objects Coming for PM Developers

Although developers aren't exactly screaming for tools to build OS/2 Presentation Manager programs, Eikon Systems (Foster City, CA) wants to be ready if developers start making the jump to the IBM/Microsoft graphical operating system. For now, though, Eikon is selling sets of reusable graphical objects for the Microsoft Windows development environment; the company plans to offer PM versions soon, said Eikon president Kevin Welch.

Eikon's Standard Control Pak focuses on Windows objects that can be used in dialog boxes or as a child of another window. It includes three classes of control icons: the palette for display and control of colors, push-button arrows, and picture frames for displaying bit maps and metafiles.

For each class, the Standard Control Pak includes a dynamic link library and a sample application. Just one of these objects costs \$125; source code costs \$475. The Tools Control Pak (\$175, or \$525 with source code) contains three additional control classes: a slider bar for selecting a value within a range; several kinds of

rulers for defining position and spatial orientation; and a toolbox that displays an array of small icons, each representing an operation.

The Resource Scrapbook "handles anything that moves in a file in Windows," Welch said. It allows you to create and manage files that pass through Windows' shared memory block, the clipboard, and supports "all commonly used" clipboard formats, including color bit maps, PostScript text, TIFF, SYLK, DIF, and CSV, he said. It also lets developers trap Windows resources, such as cursors, icons, and dialog boxes.

In the PM version of the Control Paks, the Resource Scrapbook will contain a facility to convert Windows bit maps, icons, cursors, and dialog boxes into PM equivalents.

Due from Eikon this fall is a Windows program generator, currently called Modern Art, that's designed to allow nonprogrammers to assemble icons and connect them with arrows, creating code on the fly that can be tested interactively. "It's much more sophisticated than NeXT's Interface Builder," Welch claimed.

NEWS STAFF SEEKS NEWS. DIAL (603) 924-9281.

The BYTE news staff is always interested in hearing about new developments that might affect microcomputers, the way they work, or the way people work with them. If you know of a project that could shape the state of the art, please give us a call at (603) 924-9281 or write to us at One Phoenix Mill Lane, Peterborough, NH 03458. An electronic version of Microbytes, offering a wider variety of computer-related news on a daily basis, is available on BIX.

NOW YOUR SOFTWARE CAN TEST ITSELF.



Your customers expect software that works. All the time. The key to software quality is exhaustive testing. It's also an engineer's worst nightmare. But it doesn't have to be. Because now you can automate your software testing.

Introducing the Atron Evaluator. The first and only non-intrusive automated PC-based software testing tool.

The Atron Evaluator automatically runs your software regression testing programs. All of them. All day. All night. Giving you thoroughly tested, higher quality software.

The Atron Evaluator is hardware-based. And since it's non-intrusive, software behavior is tested without the risk of alteration. Once your tests have run, you can refer to automatically generated test reports to double-check test results.

The Atron Evaluator saves time. And time makes you money. Development cycles are shortened, so your software gets to market sooner. And while your test programs are running, you can be more productive. Start a new project. Or go home.

For more information about the Atron Evaluator, call us at **1-800-283-5933**. And put an end to your worst nightmares. Automatically.



A Division of CADRE Technologies

Saratoga Office Center
12950 Saratoga Avenue
Saratoga, California 95070

In Europe, contact:
Elverex Limited, Enterprise House
Plassey Technology Park, Limerick, Ireland
Phone: 353-61-338177

QA Training Limited, Cecily Hill Castle
Cirencester, Gloucestershire, GL7 2EF, England
Phone: (0285) 655888



Epson is a registered trademark of Seiko Epson Corporation. IBM is a registered trademark of International Business Machines Corporation. Intel is a registered trademark of Intel Corporation. Equity is a trademark of Epson America, Inc., 2780 Lomita Blvd., Torrance, CA 90505. (800) 922-8911.

EQUITY COMPUTERS

POWER

How Much Do You Need?



*The Equity 386/20 is
Epson's most powerful
computer. But is it
the right Equity
computer for you?*

It depends. Do you have a massive database to manipulate? Or lengthy reports to write? Do you want bolder, gutsier graphics? Or more sharply displayed spreadsheets?

The point is, more power may not be the only answer. What you really need is a personal computer with your ideal combination of features.

Enter the efficient, affordable Epson® Equity™ line. Each machine provides a different degree of speed, power, memory and flexibility. And though the features vary from one Equity computer to the next, they all share one important thing in common. Epson's renowned reputation for quality, reliability and value.

So which Epson Equity computer is most appropriate for the work you do?

EPSON

**WHEN YOU'VE GOT AN EPSON,
YOU'VE GOT A LOT OF COMPANY.™**

continued on following page

EQUITY COMPUTERS



Equity I+	Equity Ie	Equity II+	Equity III+	Equity 386/20
8088 CPU	8086 CPU	80286 CPU	80286 CPU	80386 CPU
4.77/10MHz	8/10MHz	8/12MHz	6/8/12MHz	8/20MHz
5 OPEN SLOTS	4 OPEN SLOTS	5 OPEN SLOTS	8 OPEN SLOTS	8 OPEN SLOTS
640KB RAM	640KB RAM	640KB RAM	640KB RAM	1MB RAM

continued from previous page

For straightforward word processing, spreadsheets and business graphics, the 8088-powered Equity I+ is an uncommonly good value. It's Epson's most popular computer with first-time buyers, schools and small businesses.

Need more speed and color? Consider the intriguing Equity Ie. It's 25% faster than an IBM® Model 30 and features four available expansion slots—one more than IBM. Built-in MCGA video provides impressive color and clarity. In short, the Equity Ie is ideally suited for office work or for work you bring home from the office.

At 12MHz, our agile Equity II+ is the personal computer cornerstone many businesses are building on. The Intel® 80286 processor moves work along at a rapid clip, handling everything from database management to desktop publishing with equal grace and efficiency.

The Equity III+ delivers the same quick-paced 80286 performance plus nine expansion slots and room for five

mass storage devices. It's the Equity 80286-based computer with the greatest growth potential.

For CAD/CAM users, database devotees and other serious power users, there's the forceful yet affordable Epson Equity 386/20. This top-of-the-line 20MHz machine handles intense number crunching applications with great speed and sophistication.

To see which Epson Equity computer fits your power requirements, visit your Epson Authorized Dealer. Or for a detailed brochure on any Epson Equity computer, phone (800) 922-8911.

What you'll discover, quite quickly, is what you've been needing all along. An Epson.

EPSON

**WHEN YOU'VE GOT AN EPSON,
YOU'VE GOT A LOT OF COMPANY.™**

IEEE-Z

LETTERS

and Ask BYTE

Graphic Details

I was very interested in your Product Focus entitled "Graphic Details" by Stanford Diehl and Steve Apiki (January). For four years, our company, Rock Technologies, has been developing and marketing graphics software that is specifically tailored to the construction industry to graphically display material quantity take-offs. Our software includes a utility to install drivers for all the digitizers mentioned in your review.

I thought the article was informative and well done, but I was disappointed that you chose not to include an evaluation of Science Accessories products. Other than a brief paragraph in the text box "Digitizers with a Twist," the company was not mentioned. The authors could have mentioned that Science Accessories' and Rock Technologies' combined technologies have produced what I would consider the only truly portable large-area digitizer. Roctek's RD-48 sonic digitizer will digitize 48 by 36 inches and will fit into a case small enough to be considered carry-on luggage at any airline counter in the world.

Gerry S. Ball
Chairman, Rock Technologies Corp.
Chandler, AZ

80286 vs. 80386

I operate my business with four computers—two Tandy 2000S 80186 machines (almost the same as 80286s) and two 80286 machines. I write most of my own software using LMI FORTH+, but I bought the 80286 machines to give me access to the great pool of elegant mathematical software out there if I ever needed it. One of my machines is more or less designated to handle housekeeping, file indexing, budgeting, and so on, leaving me three machines for projects. If any operation gets so long as to be tedious to wait for, I just use another machine until it's ready.

Now, I like to read about these 80386 machines, but I don't see how I could justify one, at least not until I need more than 14 megabytes of core memory. I have multitasking without the benefit of

an esoteric operating system devoted mostly to overhead. I also have 100 percent hardware backup. 80286 hardware is so cheap now that hardware solutions can be cheaper than software solutions. Mind you, as a programmer and a hardware nut, I'd love to have a true 32-bit machine to boss around, but the requirements are going to have to be stronger and the machines a lot better before I will jump. I'm not trying to say that there are not many valid applications today where an 80386 is appropriate and necessary, but they're not on my desk yet.

Roger Cain
Ottawa, Ontario, Canada

Windowing in Pascal

I purchased my first copy of BYTE in 1982, and I've been a regular reader ever since.

A recent article that I enjoyed was "Turbo Pascal Windowing System" (February), in which Charles J. Butler detailed a windowing system he developed for Turbo Pascal. This caught my interest because I would like to use programming tools in my applications. By "programming tools" I mean libraries or routines that add functions such as windowing, pull-down menus, and B-tree file indexing to languages like Pascal, BASIC, and C.

I have developed several simple routines that I use in my programs. These routines allow me to control the user interface and to use indexed files. Though these routines serve my purposes, I'd like to replace them with programming

continued

WE WANT TO HEAR FROM YOU. Please double-space your letter on one side of the page and include your name and address. We can print listings and tables along with a letter if they are short and legible. Address correspondence to Letters Editor, BYTE, One Phoenix Mill Lane, Peterborough, NH 03458.

Because of space limitations, we reserve the right to edit letters. Generally, it takes four months from the time we receive a letter until we publish it.

IOtech offers the widest selection of *easy-to-use* IEEE 488 (GPIB) interfaces for the Macintosh.

- NuBus IEEE board for the Macintosh II
- SCSI / IEEE controller for the Macintosh Plus, SE & II
- Serial / IEEE controller for long-distance applications
- Serial / IEEE plotter converter for HP-IB plotter interfacing
- Desk accessory software for IEEE control from any application
- Language drivers for IEEE control from Basic, C, Fortran, Pascal, Hypercard and more
- Menu-driven software for scientific analysis and graphics
- 30 day money-back guarantee
- 2 year warranty
- Call or send for your FREE Technical Guide



IOtech...the choice is easy

IOtech

(216) 439-4091 Telex 6502820864 Fax (216) 439-4093

25971 Cannon Road • Cleveland, Ohio 44146

London (0734) 86-12-87 • Paris (1) 34810178 • Zurich (01) 821 944
Milan 02-4120360 • Linköping 013 11 01 40 • Goringheim 01830-35333
Sidney (2) 452 3831 • Seoul 784-9942 • Munich and other European,
North African and Middle East countries not listed (089) 710020.

tools that would allow me to provide more functions in my programs and to streamline my code. I'd like to see BYTE do reviews and comparisons of programming tools for personal computer languages.

Randall L. Babcock
Sidney, NE

On Bridges

Regarding Peter J. Kulik's letter (May) responding to my article "When One LAN Is Not Enough" (January), I would like to make several points. Specifically, Kulik made the following incorrect or misleading statements:

- *Bridges do not assume anything about any upper-layer protocols.* As I mentioned in my article, proper operation of the bridge assumes that two communicating hosts share the same set of upper-layer protocols. Otherwise, cooperative data exchange will not occur.

- *My article discusses physical-layer bridges rather than Media Access Control (MAC)-layer bridges.* In fact, the opposite is true. A physical-layer "bridge" is in fact a repeater, and the term *bridge* is

not generally used in that case.

- *Bridges can be found between dissimilar networks.* By this, Kulik means (this is clear from a subsequent portion of his letter) that a bridge can link two networks that use different layer 1-3 protocols (e.g., an 802.5 LAN and an X.25 network) and convey data from a host on one network to a host on another. This is in fact a router. The generally accepted definition of a bridge, and the one that has been standardized by the 802.1 committee, is "a device that links networks that have a common MAC service interface."

William Stallings
Prides Crossing, MA

Controller Comments

With reference to Basse O. Bondtote's letter (Ask BYTE, March), I wish to offer the following comments:

1. If you are using a run-length-limited (RLL) controller set in the translation mode, try to set the jumpers in your Western Digital hard disk drive controller card to the nontranslation mode. You can obtain the appropriate instructions

from the *Disk Controller User's Guide*. Contact Western Digital Corp (2445 McCabe Way, Irvine, CA 92714, (714) 863-0102) for a copy of the guide.

It is interesting to note that both Gibson Research's SpinRite and Prime Solutions' Disk Technician Advanced will not work with RLL controllers set in the translation mode.

2. Try varying your interleave factor up to 1-to-10. You may see an improvement after 1-to-6, especially if you are presently using an accelerator card. An accelerator card slows down memory transfers to and from the expansion bus. Try this out (using an appropriate benchmark) both with and without your accelerator connected but with your original IBM PC XT or clone motherboard in the Turbo mode.

3. You may want to consider changing your hard disk drive controller to one that can really squeeze the maximum data transfer rates from your hard disk drive.

I wish BYTE could run a comparison of the various commonly available disk controllers for the IBM PC and XT. I'm

continued

Travel With A Fast Crowd.



Wherever your business takes you, take along the WorldPort 2400™ Portable Modem. Leaving the office doesn't have to mean leaving behind the world of high-speed, 2400 bps communications. Worldwide, in virtually every situation, including hotel rooms and phone booths, your ability to communicate clearly and efficiently remains intact.

Representing the cutting edge of modem technology, the WorldPort line of portable modems combine a broad range of features that bring you the best value in modems today. Features

that go far beyond costly internal units, such as Bell and CCITT standards, direct connect and acoustic interface (300 and 1200 bps), battery power, shirt pocket size, and a tiny price.

In fact, the WorldPort modems are the ultimate for both portable and desktop applications. And the WorldPort 2400 comes with Carbon Copy PLUS™ communications software, for even greater value.

If you want a modem that works where you do, put the WorldPort Series to work for you. In

the office. On the road. Or at home. For more information about our full line of WorldPort modems, or the name of your nearest dealer, call us at 800-541-0345. (In New York, 516-261-0423.)



Touchbase Systems, Inc.
160 Laurel Avenue
Northport, NY 11768
(516) 261-0423
TELEX: 6502848020
FAX: (516) 754-3491

WorldPort 2400 is a trademark of Touchbase Systems, Inc. Carbon Copy PLUS is a trademark of Meridian Technology, Inc.

**How To Bring
Minicomputer Power
To Your PC**

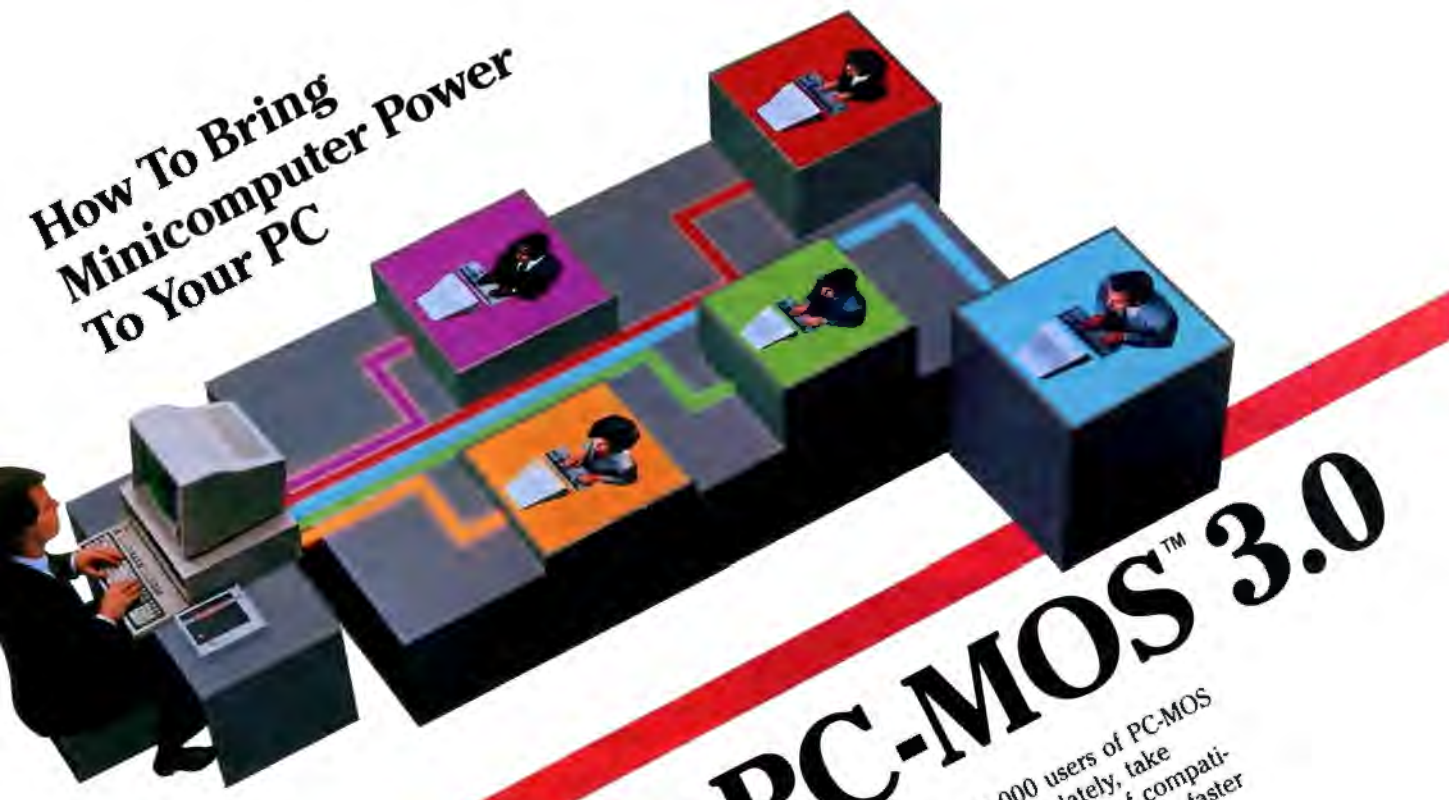

Introducing PC-MOS™ 3.0

A multiuser system no longer means only a mainframe or minicomputer. Today's 386- and 286-based PCs are more powerful than the minicomputers of just a few years ago. And they often provide more desktop power than one person can use effectively. That's why you need PC-MOS 3.0. It harnesses the power of your 386- or 286-based PC and turns it into a powerful multiuser, multitasking computer. PC-MOS is the multiuser operating system that lets you run popular DOS applications such as Windows™, Lotus 1-2-3™, dBase IV™ or WordPerfect™—without modification.

PC-MOS is the perfect solution for a small business or a department of a large company that needs users to easily and affordably share programs, databases or peripherals. It takes full advantage of the hardware's power—and saves you money in the process! For example, instead of replicating PCs, each user can have an inexpensive terminal or monitor that acts like a PC.

DOS Compatibility Means Minimal Training And Support
 Since PC-MOS is DOS compatible—unlike UNIX™ or OS/2™—there's no need for users to learn a "new" operating system or be retrained on the application programs they already know. And unlike most LANs, PC-MOS is easy to install and even easier to maintain. No hassle, no expensive wiring and no network management headaches.

There are now more than 100,000 users of PC-MOS worldwide, but if you haven't seen it lately, take another look. We've broadened our base of compatible applications and added multi-level security, faster disk performance and larger task sizes. Version 3.0 also interfaces with Novell LANs, 3270 mainframe communications products and The Software Link's LANLink™ local area network.

Call us today for more information about PC-MOS 3.0 and the location of your nearest multiuser dealer. We'll show you how to easily and affordably turn your PC into a powerful multiuser system.

Terminals and Workstations Supported
 Wyse 150™; Link MC5™; Kimtron KT-70™; IBM 3151™; AT&T 605 Business Communications Terminal™; Sun River Cygnal/386™; Video Network Adapter™ and others.



THE SOFTWARE LINK
 3577 Parkway Lane Norcross, GA 30092
 1-800-451-LINK (404) 448-5465
 Fax: (404) 263-6474 Telex: 4996147 SWLINK

PC-MOS and LANLink are trademarks of The Software Link, Inc.
 All other products referenced are trademarks of their respective companies.

**Your connection to
advanced technology**

Circle 230 on Reader Service Card (DEALERS: 231)

sure this would be of interest to readers. How about it? We know the future may belong to the 80286s, 80386SXes, and the 80386, but don't forget the 8088 and 8086 crowd.

Liew Kern Tote
Petaling Jaya, Malaysia

Why Smalltalk? Why Pascal?

I am writing with reference to "Smalltalk Can Be Cheap" by Don Crabb (April).

I realize that the article only compared Smalltalk to Pascal (presumably to point out the reduction in programming code necessary to achieve the stated objective), but I would like to make one additional comparison for the same purpose.

Why not BASIC? The listing below is written in standard BASIC. It is more than 30 characters shorter than the Smalltalk program, without relying on predefined routines. And at a quick glance, it is far more comprehensible.

```
10 DIM A%(255)
20 INPUT " ", L$
30 L%=LEN(L$)
40 FOR I%=1 TO L%
50 C%=ASC(MID$(L$,I%,1))
60 A%(C%)=A%(C%)+1
70 NEXT I%
80 FOR I%=65 TO 90
90 PRINT CHR$(I%),A%(I%)+A%(I%+32)
100 NEXT I%
110 ERASE A%
120 END
```

Norm Leo
Chatsworth, CA

Index Information

Sometimes I have to search long and hard for previous articles in BYTE. For example, in the March issue, the In Depth section resource list cites Actor software. I remembered a previous article on Actor, but it took me some time to find it (in the September 1987 issue). It would have been convenient to find this reference in the March issue. The indexes at the end of each issue are very useful for this kind of search.

I believe that BYTE publishes annual indexes. How can I get them?

P. Y. Narvor
Nantes, France

BYTE indexes for 1983-1984, 1985, 1986, 1987, and 1988 are available for \$3 each by writing to: BYTE, One Phoenix Mill Lane, Peterborough, NH 03458. —Ed.

Random Access Thinking

For many years, the thought that the human mind is a fantastic computer has impressed me greatly. Every so often, I think it advisable to pay it humble respect. Consider the human mind's following capabilities:

- *Random access.* How many computers can instantly recall names and events scores of years in the past and reconstruct relationships involving the seemingly unrelated?
- *Evaluation procedure.* How many times have you collected a bundle of facts and data, each having different worths, and quickly processed them mentally to arrive at a meaningful answer? Do a decision table sometime when you have a decision to make that proves difficult to resolve.
- *Robotics.* Have you ever given any thought to what would be involved to program a robot to tie a shoelace or twist a pretzel? Just imagine the number of

continued

GRASP is clearly the hands-down winner in terms of sheer power, flexibility, and speed.
—PC Magazine

Program in the 4th Dimension...
ANIMATE!

Get unlimited action and interaction with the most powerful PC animation system available, by calling Grasp routines from your programs in C, Pascal, Basic, and other languages.

Or develop your graphics applications directly in Grasp! Take advantage of:

- 74 animation & effects commands
- 25 predefined fades
- single-command animation
- all major graphics modes
- screen capture and graphics printing utilities

Includes Pictor, a full-featured paint program, completely integrated with Grasp for fast development and editing of programs and graphics.

GRASP 3.1
\$149

Convince yourself!
Send us \$2.00 for Episode I
"The Adventures of Ferguson Floppy"

Paul Mace
SOFTWARE

400 Williamson Way
Ashland, OR 97520
800-523-0258

MODEL	DESCRIPTION	RESOLUTION			RS-178, NTSC	RS-330
		Spatial	Gray Levels	Number		
DT2862-60Hz ^a	Arithmetic Frame Grabber	512 x 512	256	8 ¹	✓	✓
DT2862-50Hz ^a	Arithmetic Frame Grabber	512 x 512	256	8 ¹	✓	✓
DT2862-60Hz ^a w/ DT2858 ^a	Frame Grabber & Frame Processor	512 x 512	256	8 ¹	✓	✓
DT2862-50Hz ^a w/ DT2858 ^a	Frame Grabber & Frame Processor	512 x 512	256	8 ¹	✓	✓
DT2861-60Hz ^a	Arithmetic Frame Grabber	512x512	256	8 ¹	✓	✓
DT2861-60Hz ^a w/ DT2858 ^a	Frame Grabber & Frame Processor	512x512	256	8 ¹	✓	✓
DT2861-50Hz ^a w/ DT2858 ^a	Frame Grabber & Frame Processor	512x512	256	8 ¹	✓	✓
DT2851-60Hz ^a	High Resolution Frame Grabber	512 x 512	256	8 ¹	✓	✓

ARRAY PROCESSING: IBM PC/XT/AT

MODEL	DESCRIPTION	COMPUTER	IEEE 33-BIT FLOATING-POINT ARITHMETIC	PEAK PERFORMANCE
DT720	Floating-Point Array Processor	PC AT	✓	8.5MFLOPS
DT710	Floating-Point Array Processor	PC/XT/AT	✓	6.5MFLOPS

MODEL	DESCRIPTION	COMPUTER	IEEE 33-BIT FLOATING-POINT ARITHMETIC	PEAK PERFORMANCE
DT2853-50Hz ^a	Low Cost Frame Grabber	PC AT	✓	6.5MFLOPS
DT2853-SQ-60Hz ^a	Low Cost Square Pixel Frame Grabber	PC AT	✓	6.5MFLOPS
DT2853-SQ-50Hz ^a	Low Cost Square Pixel Frame Grabber	PC AT	✓	6.5MFLOPS
DT2803-60Hz	Low Cost Frame Grabber	PC AT	✓	6.5MFLOPS
DT2803-50Hz	Low Cost Frame Grabber	PC AT	✓	6.5MFLOPS



—Fred Molinari, President

Pages 8-15, New Products Handbook

If you've got an unrelenting hunger for power, we can satisfy it...in more ways than one.

The DT2861 Arithmetic Frame Grabber and DT7020 Floating-Point Array Processor.

The strategy for high-end image processing applications at the PC level is simple. You plug in our two "big guns"... the DT2861 Arithmetic Frame Grabber and the DT7020 Floating-Point Array Processor.

First, the DT2861 captures and displays images, and performs arithmetic operations on them, all at a real-time rate of 30 frames per second.

Second, the DT7020 gives you maximized performance because it bypasses the slow PC AT[®] bus and connects directly to the DT2861 frame grabber (via the DT-Connect™ Interface.)

Both boards contain multiple buffers, and are supported by a range of available software. Big guns for power hungry applications.

Call (508) 481-3700
In Canada, call (800) 268-0427

FREE 1989 Image Processing Handbook.



DATA TRANSLATION[®]

World Headquarters: Data Translation Inc., 100 Locke Drive, Marlboro MA 01752-1192 USA, (508) 481-3700 Tlx 951646
United Kingdom Headquarters: Data Translation Ltd., The Mulberry Business Park, Wokingham, Berkshire RG11 2QJ, U.K. (0734) 793838 Tlx 94011914
West Germany Headquarters: Data Translation GmbH, Stuttgarter Strasse 66, 7120 Bietigheim-Bissingen, West Germany 01742-54025
International Sales Offices: Australia (2) 662-4255; Belgium (2) 466-8199; Canada (416) 625-1907; China (1) 868-721 x4017, (408) 727-8222; Denmark (2) 274511; Finland (0) 372144; France (3) 69077802; Greece (1) 951-4944, (31) 527-039 (1) 361-4300; Hong Kong (5) 448963; India (22) 23 1040; Israel (3) 5401524; Italy (2) 824701; Japan (3) 502-5550, (3) 348-8301, (3) 355-1111; Korea (2) 756-9954; Netherlands (70) 99-6360; New Zealand (64) 9-545313; Norway (2) 53 12 50; Portugal (1) 545313; Singapore (65) 7797621; South Africa (12) 8037680/93; Spain (1) 455-8112; Sweden (8) 761-7820; Switzerland (0) 723-1410; Taiwan (2) 7020405

DT-Connect is a trademark and Data Translation is a registered trademark of Data Translation, Inc. All other trademarks and registered trademarks are the property of their respective holders.

elements that need to be coordinated to accomplish these simple tasks.

• *Sensors.* Have you ever been frustrated in an attempt to get an accurate measure of hot steel in a mill where scale and steam are a constant variable, and then found that a mill operator accurately called the correct temperature merely by visual judgment?

• *Management.* Have you ever considered what goes into a management decision in putting a team together, whether it's for sports or business? Imagine the mind's ability to weigh such factors as compatibility, health, and attitude.

Finally, we must realize that those ever-faster, ever-impressive machines that we build are, in the end, a product of the human mind.

Selwyn V. Stickler, Jr.
Vero Beach, FL

Learning Through Experience

This letter is in regard to a letter I sent previously that referred to an article on the Turbo EMS program in the Short Takes section of the March BYTE.

In that letter, I stated that the primary reason that I purchased Turbo EMS was so that I could run Fontasy. I should have taken a little more time to investigate before I wrote that letter. As it turns out, Fontasy will not run entirely correctly.

It seems that when running Turbo EMS using the hard disk drive mode rather than RAM, Fontasy has problems. The conflict prevents Fontasy from printing correctly. Apparently, Fontasy can print only the graphics that are in the RAM window at any particular moment. When the next window is called from the hard disk drive, the program locks up. Also, problems arise when you attempt to use those fonts that ordinarily would require the expanded memory. Here again, we are dealing with hard disk drive access. Regular fonts seem to work correctly.

The folks at Fontasy say that it is a timing problem. Accessing the hard disk drive simply takes too long. Fontasy cannot wait around that long. I can tell that Fontasy is, in fact, using the expanded memory. The way it paints the screen is a dead giveaway. In most respects, it works as it should, other than the above mentioned items. Things run very slowly, however. I have no complaint with this because I knew things would be slow from the start.

Obviously, if I cannot print anything, there is no reason to use Turbo EMS with Fontasy. On the positive side, however, I have gained the ability to use the ex-

panded memory in other ways. These uses justify Turbo EMS in my situation.

I can now use WordPerfect and all my memory-resident programs without other unacceptable problems cropping up—with one exception. On my Leading Edge Model D, I can run MemoryMate resident along with Hot Line and PC Tools Deluxe. Each program stays out of the other's way. Not so when I try to run MemoryMate with these same programs on my NEC PowerMate 286 portable. MemoryMate gets stepped on in some way. The program can only paint line graphics on-screen. It cannot paint its proper display. Other than hardware differences, I have no exact idea why the identical configuration runs on one computer and not on the other.

Fortunately, I have very little need for MemoryMate on the NEC. I have created a batch file that clears the other programs out of the way when I need to use MemoryMate. It works quite well. I do use MemoryMate a lot on the Model D, however, with no problem. So things have worked out OK.

At this time, I have not found a solution for the problem with Fontasy. The folks at Lantana Technology said that they would look into the trouble, but I haven't heard anything from them yet. Here, too, I have created a batch file that clears the way for Fontasy. It's a shame that I have a need for these files. Otherwise, everything works OK.

Charles T. Foley
Hixson, TN

Controller Correction

I would like to thank BYTE for publishing Jeff Holtzman's interesting article, "Advanced Floppy Disk Drive Controllers" (March). One slight correction is that Manzana MicroSystems' Mux Card lists for \$89.95 (or \$99.95 with the 3rd Internal Cable). Although, as Holtzman pointed out, the Mux Card does "perform flawlessly" in both IBM PC XT and AT systems, an end user might make better use of a Manzana High Density Controller Card (HDC) in an XT system. The Manzana HDC replaces the original XT controller and supports up to four 360K-byte or 1.2-megabyte 5¼-inch floppy disk drives (or four 720K-byte or 1.44-megabyte 3½-inch drives) internally or externally. Although it lists for only \$94.95, the HDC includes a device driver to support both capacities of 3½-inch disk drives. And with its built-in BIOS, it saves you a BIOS upgrade.

David Gluck
President, Manzana MicroSystems
Goleta, CA

A Certain Class of Problems

While responding to a plea from two NASA scientists who were working on a magnetic shock problem, I discovered a class of problems that defy conventional numerical methods. These are problems described by differential equations that require solutions by computer calculations. The conventional methods include all those that use approximations to the Taylor series, such as the Runge-Kutta methods and the predictor-corrector methods.

The conventional methods fail because they have poor approximations to the Taylor series. A true Taylor-series method can handle this class of problems. My article "The ATOMCC Toolbox" (April 1986 BYTE) and the latest ATOMFT version 2.50 are true Taylor-series methods.

Here are some sample problems. They are described by mathematicians as ones that do not satisfy the Lipschitz condition where the solution becomes zero. The meaning of this statement is, "The solution is unknown at zero." However, this is not what troubles the conventional methods.

In this collection, some problems can be solved correctly with computed solutions correctly traversing through the zero point. Some problems can be solved correctly with computed solutions correctly stopping before the zero point. Other problems cannot be solved by the conventional methods.

The clue about whether the solution of a problem should stop or continue beyond the zero point is provided by information about the singularities in the solutions. This information can also predict whether the conventional methods will succeed or fail.

In the list of problems, x is the independent variable, y' is the derivative of y with respect to x , and y'' is the second derivative of y with respect to x .

- $y'' = -0.5 - y' - (\cos(x) + y')/y$,
start $x = 0$, end $x = 1.5$,
with $y(0) = 1$ and $y'(0) = -0.95$.
- $y'' = y' - y^{**}(1/3)$, start $x = 0$,
end $x = 3.5$, with $y(0) = 1$
and $y'(0) = 1$.
- $y'' = -0.5 - y' - (\cos(x) + y')/y$,
start $x = 0$, end $x = -0.43$,
with $y(0) = 1$ and $y'(0) = 1$.
- $y' = (x - 1)/y$, start $x = 0$,
end $x = 2$, with $y(0) = 1$.
- $y' = (2x^{**3} - 2x)/y$, start $x = 0$,
end $x = 2$, with $y(0) = 1$.
- $y' = -\sin(x)*\cos(x)/y$, start $x = 0$,
end $x = 2$, with $y(0) = 1$.

continued

What we lost in pounds we gained in power.



When the readers of PC World magazine once again voted our lightweight T3100 "Top Laptop," we were flattered.

And when PC Week gave it their Corporate Satisfaction Award, we were equally honored. Everyone seemed to agree it was perfect.

Except us. Because we believe there's always room for improvement, we made a few not-so-minor adjustments to what's always been our most popular machine.

First, we reduced its weight by nearly two pounds and renamed it the T3100e. (The "e," by the way, stands for enhanced.)

Then we increased its speed from 8 to 12 MHz and gave it a new 20MB hard disk with an access rate that's three times faster.

Finally, we improved its versatility with an IBM-compatible expansion slot that lets you access LANs, mainframes and more.

All of which leads to one very powerful conclusion.

Our loss is definitely your gain.

For more information call 1-800-457-7777. Toshiba PCs are backed by the Exceptional Care Program (enrollment required). IBM is a registered trademark of International Business Machines Corp.



T3100e: 12MHz 286 with 80287 coprocessor socket, internal half-length IBM slot, 20MB hard disk with 27msec access, 1MB RAM expandable to 5MB, gas plasma display, 1.44MB 3 1/2" diskette drive.

In Touch with Tomorrow
TOSHIBA

Toshiba America Information Systems, Inc., Computer Systems Division

Call us for a free AnthroCart catalog: **800-325-3841**



**Anthro®
Technology Furniture®**
3221 N.W. Yeon St.
Portland, Oregon 97210
(503) 241-7113

Anthro, AnthroCart and Technology Furniture are registered trademarks of Anthro

Custom Key Imprinting

Create a keyboard
so easy to use, costly training time turns
into instant productivity!



Custom Keys and Snap-On IBM KeyCaps: Available in a wide variety of colors and imprinted in your choice of colors and fonts. Keytop and Keyfront Labels: Supporting emulation, word processing or custom made to your specs. Won't wear out or come off keys until intentionally removed. FlexShield Keyboard Protectors: Extend keyboard life. Protect from dirt, liquid and damaging environments without restricting keyboard operation. Call for your **FREE CATALOG of Custom Keyboard Enhancements.**

CATALOG HOTLINE: 800 628-2828, Ext. 650

Hooleon
CORPORATION

For orders or custom info, call:
602 634-7515
FAX: 602 634-4620

P.O. Box 201, Dept. BYTE, Cornville, AZ 86325

Problems 3 and 4 can be solved correctly by the conventional methods. Problem 5 can be solved only with the highest precision. Problems 1, 2, and 6 cannot be solved by the conventional methods. It may interest you that in problem 1, the numerator $(\cos(x) + y')$ is zero at the same point where $y = 0$.

The most disturbing fact is not that the conventional methods fail to solve some of these problems, but that they do so without any warning. A robust numerical algorithm must be able to identify those problems that it cannot solve and to inform its user. The conventional methods are not robust for this class of problems. For example, their solution for problem 6 at $x=2$ has the wrong sign! I am very interested to hear what happens when you apply your favorite method to these problems.

By the way, even ATOMCC has difficulty with problem 1. The newest ATOMFT version 2.50 handles it with ease.

Y. F. Chang
Claremont, CA

The Amiga and Multitasking

I found Phillip Robinson's overview of PS/2, Macintosh, and Amiga graphics ("Variations on a Screen," April Graphics Supplement) interesting but, in the case of the Amiga, misleading in two ways.

First, Robinson writes, "Because [the trio of custom ICs] can handle video information while the main CPU is working on other tasks, the Amiga has a degree of 'multitasking'—the ability to handle more than one job at a time." The custom ICs do indeed relieve the CPU of a large part of the graphics burden. But they are not what makes the Amiga a multitasking machine.

The Amiga is multitasking from its software foundation up. The system software allows multiple tasks to share the resources of the Amiga, both hardware and software, simultaneously. There are sophisticated means for intertask communication. Each task gets a share of CPU time in a manner that is transparent to it. The programmer need not make allowances for multitasking other than not hogging system resources. And each program thinks it is the only one running on the Amiga. Some programmers are impolite enough to write programs that take over the Amiga, effectively disabling multitasking, but that is restricted mainly to games.

Second, the photo of the Amiga's screen that was used to illustrate Amiga graphics was a poor example of what

continued



These unretouched print samples show the superior print quality of QMS-PS 810 over printers using first-generation print engines.



Now \$4995!
Suggested Retail Price.

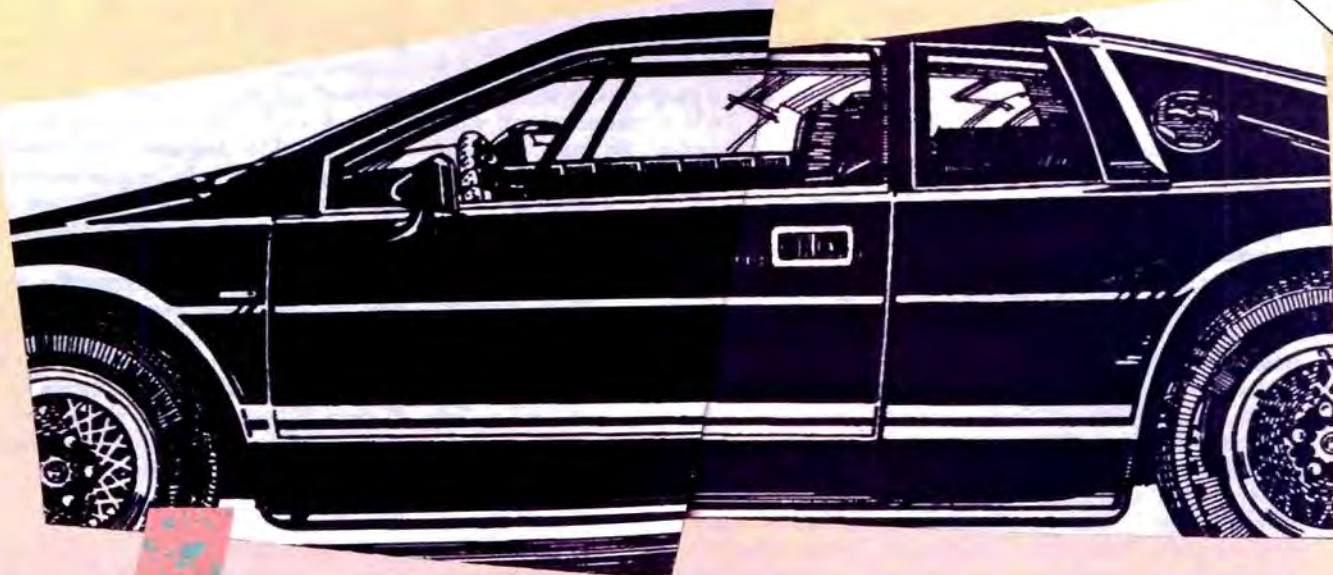

Introducing the PostScript laser printer that blacks out at high speeds.

The new QMS-PS[®] 810 can compose and print the most complex pages in record times, with richer, more saturated blacks than ever before. All with the desktop publishing power of Adobe PostScript[®], and the superior print know-how of QMS, an industry leader.

Under the hood QMS ASAP[™] (Advanced System Architecture for PostScript) is proprietary technology that helps eliminate the hardware bottlenecks that hinder other PostScript printers. As a result, QMS-PS 810 boasts processing speeds remarkably faster than other PostScript printers in its class. And faster output means greater productivity. In addition, the QMS-PS 810 laser

printer's new Canon[®] SX[®] print engine covers solid areas and prints fine detail better than previous-generation engines.

Fast start, strong finish You can adorn your documents with one or all of the 35 Adobe typefaces. Thanks to PostScript, there's an infinite number of font variations available. You can also make type as large or as small as you want. And put it anywhere on the page. In fact, with PostScript you enjoy total control over the design of your page. It gives you the complete desktop publishing power to do things that would otherwise be virtually impossible. So you get high-quality output exactly how you want it.

Along with PostScript, the HP LaserJet[™], Diablo[®] 630 and HP-GL[™] printer emulations are added for your non-PostScript software.

The QMS-PS 810 laser printer is easy to use, maintain, and comes with a one-year warranty. It's available from Laser Connection dealers. Laser Connection is a sales and marketing subsidiary of QMS. For the dealer nearest you call **1-800-523-2696**.

**The new
8-page/minute
QMS-PS 810
laser
printer**



LASER CONNECTION[™]

A QMS[®] company

The following are trademarks of their respective companies: QMS, QMS-PS, ASAP, Laser Connection of QMS, Inc. PostScript of Adobe Systems, Inc. Canon, Canon SX of Canon, U.S.A. LaserJet +, HP-GL of Hewlett-Packard, Diablo of Xerox Corp.

© 1987 Laser Connection

makes it so popular in the graphics world. Your photo looked like a CGA screen, not at all indicative of typical Amiga graphics. You could have used a hold and modify (HAM) image (e.g., girl with lollipop). Even the "low" resolution King Tut, with 32 colors, would have been better than an apparently four-color Flight Simulator screen.

Ron Charlton
Knoxville, TN

A Better Mousetrap?

I just finished reading the section on Unix in the May issue. I was thinking: What if one of the major computer companies, like IBM or AT&T, were to come up with a system that had some type of switch or button that switched between a Unix and a DOS board? Wouldn't a computer like this become a bestseller?

With such a machine, when Unix takes over for DOS as the standard system—as has been theorized—DOS could go out slowly, as many have predicted it will do. Or, even better, these two systems could work side by side.

Aaron Turpen
Alpine, UT



ASK BYTE

Losing Memory

I own a Dell 310 (an AT compatible). I'd like to write a program that will tell me how much RAM is currently being used by memory-resident programs. Can you suggest a book and/or technique that will help me?

Michael Beaupre
Minneapolis, MN

You don't need a program to do that. CHKDSK will work. Simply execute CHKDSK right after bootup, and it will tell you how much memory is available after DOS is loaded. Then load a TSR program whose memory use you wish to determine, and execute CHKDSK again. The available memory will have been reduced by whatever amount the TSR program has used.

It could be that your goal is to produce programs that are intelligent enough to determine the amount of available memory remaining after you've loaded all your TSR programs. You can determine

that by using DOS INT 21H, function 48H (allocate memory). Simply call this function, requesting 0FFFFH paragraphs' worth of memory. The call will fail (DOS doesn't have that much memory available), but in so doing, the interrupt will tell you the largest available memory block. Assuming you haven't removed any TSR programs since bootup (thus creating a "hole" in your memory map), the largest available memory block will be equal to the amount of remaining free memory.

You'll find information regarding this interrupt (and much more) in The New Peter Norton (although I liked the old one just fine) Programmer's Guide to the IBM PC & PS/2 by Peter Norton and Richard Wilton (Microsoft Press, 16011 Northeast 36th Way, Box 97017, Redmond, WA 98073).—R. G.

Unix Questions

Mark Minasi's article ("OS/2 for Cheap," April) was excellent. But how about an article on a Unix starter system for cheap? I've never used Unix before, so I'd probably want to start out with the

continued



Finally. OS/2 debugging help has arrived.

Introducing MultiScope™, an OS/2, multi-language, CodeView™-compatible debugger, like nothing you've seen before.

For a start, it provides 13 views of your program: Source—Data—Graphic Data—Assembly—Thread—Breakpoint—Watch—Register—Module—Call—Memory—Log—and Output.

Other unique features include: run-time and post-mortem debugging options; OS/2 text mode and Presentation Manager user interfaces; and even a graphical representation of your data structures! All for \$299.

Call toll free 800-231-7717.

In CA 800-552-8885. Fax 415-792-8901.

MULTISCOPE™
DEB U G G E R

From LOGITECH Software

Circle 148 on Reader Service Card (DEALERS: 149)

"For my office, the right 286 desktop PC has got to be big on power... but small on space."



ZENITH INNOVATES AGAIN™

The world's number one family of PC compatibles* now brings you everything you expect in a 286 desktop...except the size.

Big power in a small package. That's the idea behind the Z-286 LP. Another Zenith Data Systems innovation to fit your workload *and* your work space.

On the *inside*, the Z-286 LP is unmistakably a 286-based system — with enough "zero wait state" speed and power to handle heavy-duty word processing, large spreadsheets and huge databases. It's also compatible with literally thousands of industry standard peripherals.

For more advanced performance, the Z-286 LP easily lets you move up to MS OS/2® applications. It's truly a desktop PC that's built for today... and tomorrow.

The Z-286 LP also features 1MB of RAM—expandable to 6MB *without* using an expansion slot. Plus, it comes standard with MS-DOS®. And all hard drive models include Microsoft® Windows.

It's on the *outside*, however, that the Z-286 LP offers you the biggest advantage: a dramatically smaller footprint than conventional desktops for more productive use of your desk space.

So free up your workload *and* your work space with Zenith's Z-286 LP. For your nearest Zenith Data Systems authorized dealer, call:

1-800-553-0350



Less Is More With Zenith's Z-286 LP & Award-Winning Flat Technology Monitor.

ZENITH | data systems

THE QUALITY GOES IN BEFORE THE NAME GOES ON*

*Source: Dataquest Graphics simulate Microsoft® Windows, a product and trademark of Microsoft Corporation. MS-DOS and MS OS/2 are registered trademarks of Microsoft Corporation.

CHAOS MANOR MAIL

*Jerry Pournelle answers questions about his column
and related computer topics*

The Future of Computing

Dear Jerry,

Having read the January 1989 edition of BYTE, I was surprised to see that you didn't have an entry in the feature article "What Lies Ahead." More than five years ago, you wrote an article for BYTE that was entitled "The Next Five Years in Microcomputers." And you probably thought we wouldn't remember.

Rereading that article provides an interesting lesson in how times change. Valdocs (remember the Epson QX-10?), the Osborne with bundled software, the Apple Lisa, the argument over 8086 versus 68000 microprocessors—those were the hot topics way back in 1983.

On the whole, you did a good job of prognosticating (though you should refrain from taking large sums to the racetrack). Do you care to pick up the crystal ball again?

Michael Anthony Kellar
Clifton Heights, PA

I sure do remember my five-year prediction. I think my projection of the growth of this industry was much higher than anyone else's—and mine was far too low. Back then, I was writing a column for the late and lamented Popular Computing called "The Computer Revolution," and I meant every word of that.

The Osborne did indeed change the nature of the industry; it had done so by the time I wrote that. Prior to the Osborne, you had to go to a store and get a pile of boxes, which you tried to integrate into a system that would work. (You could also get a TRS-80, if you were interested in being part of Tandy's Quality Assurance Department.) Adam's machine had too small a screen, but by golly it did work, and it was portable.

I'll have to give some thought to another predictions column. Perhaps for September again, just to be symmetrical.

—Jerry

Paying for Technical Support

Dear Jerry,

Imagine this. You go and buy a new car. After you've had it for a few days,

one of the windows won't roll down. It used to roll down just fine, but now it won't go down at all. You look through all the manuals that came with the car, but you can't find anything about why the window won't go down. So you take the car into the dealer and ask the salesperson why your window won't go down. The salesperson tells you that you accidentally hit a button on your front door panel that locks that window. He tells you that it's clearly stated in the footnote on page 259 of the manual. Then he hands you a bill for \$12 for the 12 minutes you talked to him.

How many of us would just accept that bill? After all, we just paid a lot of money for the car, and who could find that footnote on page 259? After we paid all that money, we shouldn't have to pay just to have someone tell us how to use some of the more esoteric features. Yet how many times do we pay the same type of bills to software manufacturers? We spend hundreds of dollars on their software and then have some problem that we can't find in the manual, for which they charge us \$1 per minute to talk to them!

I understand that companies get a lot of calls and that they have to hire people to answer phones, which costs a lot of money. But that's part of doing business, isn't it? How many manufacturers of anything but software do you know who charge you \$1 a minute to talk to you if you have a problem with their product? I can't think of any offhand.

Most of the calls that companies receive are for problems that the users could have solved by looking in their manuals. However, most of the calls I have placed for technical support have been due to either actual bugs in programs or to awful documentation that

continued

Jerry Pournelle holds a doctorate in psychology and is a science fiction writer who also earns a comfortable living writing about computers present and future. He can be reached c/o BYTE, One Phoenix Mill Lane, Peterborough, NH 03458, or on BIX as "jerry."

situation:

**Puzzled over
which Pascal
compiler is best
for you?**

solution:

BLAISE COMPUTING INC.

Our tools support both
QuickPascal and Turbo Pascal.

POWER TOOLS PLUS/5.0 \$149

Full featured function library

- ◆ Features context sensitive help screens
- ◆ window oriented pick lists ◆ multiple-line edit fields with fully configurable edit keys
- ◆ moving bar pull-down menus and windows
- ◆ in-memory sort routines ◆ EMS support
- ◆ TSRS and ISRS ◆ and much more!

ASYNCH PLUS \$129

Asynchronous communication manager

- ◆ Features speeds to 19.2K baud
- ◆ XON/XOFF protocol ◆ support for up to 4 comm ports ◆ hardware handshaking
- ◆ XModem file transfer ◆ I/O buffers up to 64K
- ◆ and much more!

POWER SCREEN \$129

Screen I/O manager

- ◆ Features screen painter ◆ virtual screens
- ◆ data validation ◆ context sensitive help
- ◆ unlimited screens ◆ definable keys
- ◆ and much more!

Fast, flexible and affordable!

Blaise Computing offers programming tools that are fast, flexible and affordable. Call now to order or to ask for a free brochure on our full line of products for C and Pascal.

FREE with these products!

Source code, complete sample programs, a comprehensive reference manual with extensive examples, the Norton Guides Instant Access Program, and a comprehensive online database.

Supports QuickPascal and Turbo Pascal!

All of these products support Turbo Pascal 4.0, 5.0, and 5.5 and Quickpascal 1.0.

Put Blaise tools to the test!

If at any time during the first 30 days you are not completely satisfied with their speed and flexibility, we'll refund your money.

Call (800) 333-8087 today!

FAX: (415) 540-1938

BLAISE COMPUTING INC.

2000 North Street, Suite 110, Berkeley, CA 94702 (415) 540-1938

Turbo Pascal is a registered trademark of Borland International
QuickPascal is a registered trademark of Microsoft Corporation

GraphicTM

"gives you all the C language routines you need to write an impressive scientific graphing program of your own. Highly recommended."*
PC Magazine

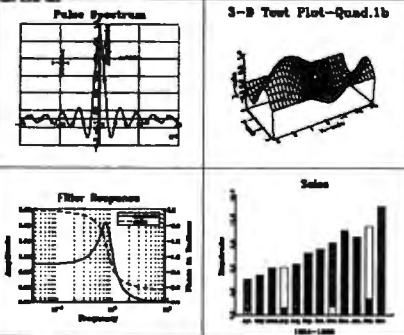

IBM[®] PC version
(with source code) \$395
Circle 226 on Reader Service Card
Macintosh[®] version
(no source code) \$295
Circle 227 on Reader Service Card
For personal use only.

VTEKTM 4.3

**DEC[®] VT100/102/52
& Tektronix[®]
4010/4014/4105
Terminal Emulator**

"its ease of use, high resolution graphics, emulation, and price make it a more attractive purchase than the other products."*

MINI-MICRO Systems
Only \$150

Circle 228 on Reader Service Card

* Full reprints on request

Scientific Endeavors
508 North Kentucky Street
Kingston, TN 37763
(615) 376-4146

leaves out important information. Why should I have to pay to talk to the company about something that's really its fault anyway?

I wonder if these companies purposely write bad documentation, thus forcing users to incur extra expense. I wouldn't be at all surprised. Do they purposely put bugs in their programs?

Perhaps \$1 per minute would not be unbelievably excessive if a user received decent help. But, in my experience, the usual answer to a question like, "Why does your program do this, when it's supposed to do that?" is, "Gee, I don't know" or "I've never heard that one." Rarely, that I can recall, has technical support been any help.

I think this problem of technical support ought to be the next big issue in computing. Now that we've mostly gotten rid of copy protection, let's try to get rid of these excessive and unfair support charges. After all, if a reasonably knowledgeable person has to spend more money on technical support than he or she spent on the program in the first place, then something is wrong with the program or documentation, not the user.

Kevin Clark
Front Royal, VA

I used to spend a lot of time berating software publishers for their lousy documentation; indeed, sometimes I still do. I am about to conclude that there are few companies willing to pay documentation writers anything like what they're worth. They pay the programmer, but the writer is left to the last minute. They also don't have anyone copyediting the documentation.

On the other hand, some programs, such as Traveling Software's LapLink, don't need documents.

As to technical support, some outfits do an excellent job of that. Two companies and their programs—Arts Computer Products' Word Perfect and Aldus's PageMaker—come to mind. The other day I called Aldus to get its press relations people. None were around, but the technical-support people were there, and did I want to talk to them? Of course, other outfits hire cretins to answer the phone, who then turn technical-support problems over to chimpanzees.

Finally, my friends in the technical-support business tell me that about half the calls are about problems unrelated to their product at all. The customer has 480K bytes of his or her system taken up with memory-resident programs or is trying to run an EGA program on a CGA system, or hasn't even plugged the machine in.—Jerry

Unix Developments

Dear Jerry,

I understand why you tell your readers that you're not a Unix expert. Unix is a big and powerful operating system, understood in its entirety by few. As a person who was an early IBM PC user but a recent Unix convert, I can appreciate the challenge of commenting on Unix in general and on Unix on the 80386 in particular. Please accept the following comments in that light:

- The Santa Cruz Operation's brand of Unix is Xenix, not Unix, but it will probably be called Unix in the future.
- The Unix/Xenix spreadsheets and word processor tend to be quite plain when compared to their DOS counterparts. But those are classic workstation applications that are best processed on essentially freestanding systems. Frankly, even with all the overlapping windows and color of DOS-based DBMSes, they tend to be rather pale in comparison to Unix-/Xenix-based DBMSes. Unix is, after all, designed basically for a multi-user environment.
- VP/ix from The Santa Cruz Operation and Interactive Systems also allows DOS to be run as a task under Unix. My company will be doing that in a production environment soon, if you're interested in the results. We have found VP/ix reasonably easy to install (not the same thing as simply typing INSTALL and pressing Return to accept the defaults, though).
- Unix does multitasking. Even on my relatively slow AT&T 3B1, it's possible to create multiple graphical windows and observe them working. For a more primitive demonstration, place multiple Unix processes in the background, and they'll process concurrently. The message you received informing you that the network version was required sounds like a special case.

Philip G. Duffy
President
Electronic Cottage Associates
West Chester, PA

I'm always interested in new developments. Thanks.

My quarrel with Unix is that while DOS applications do sort of run, they don't actually run very well in general, while the Unix-specific stuff is very vanilla compared to what is available under DOS.

But, then, the supercomputer people have to put up with writing their programs as 100,000 lines of FORTRAN using editors more primitive than we had under CP/M!—Jerry ■

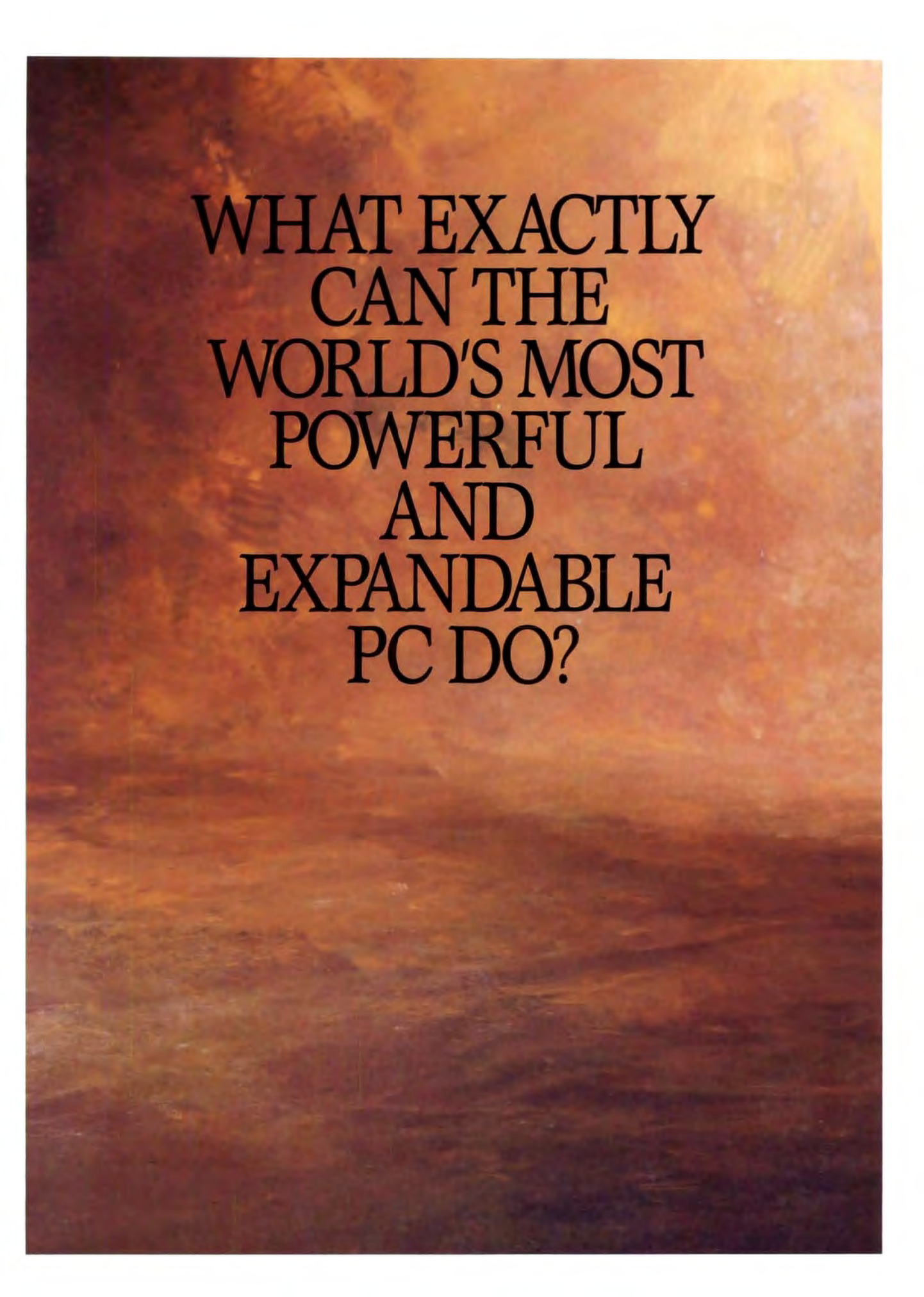

**WHAT EXACTLY
CAN THE
WORLD'S MOST
POWERFUL
AND
EXPANDABLE
PC DO?**

ANYTHING
IT WANTS.



effect the 40-column by 8-row screen has on conventional software, and how usable the keyboard is with software that's not specifically designed for the Portfolio. I'd like to see how it performs under the BYTE benchmarks.

Disk access should be very fast with the memory cards, while number crunching may be miserably slow.

I enjoyed using the Portfolio. It's wonderfully lightweight and splendidly convenient. When I used it, I thought

for the first time that I was using a truly portable computer—a truly personal computer. But for all its appeal, it's not finished yet. Right now, at \$399, the Portfolio isn't a toy, but it's an expensive executive notepad and

pocket calculator. Once it's complete, with the smart cables and memory expansion available, it could be the first PC clone that will fit in your pocket without emptying your wallet. □

—Frank Hayes

A Good Luggable



If you're the kind of person who lugs your machine from home to office and back, you'll probably like the **Altima One**.

The Altima One 80286 system has plenty of features and weighs in at a total 15 pounds. It includes a built-in 2400-bps modem; a 20-megabyte hard disk drive (soon to be 40 megabytes); a tolerable, detachable 101-key keyboard; a decent supertwist, backlit LCD; a CGA screen; a mouse (and a place to store it); and a good bit more.

Things I like about this machine include the fact that it

has an automatic setup program, runs through a visible set of diagnostics on boot-up, acts more like a desktop than a portable, and lets you choose between black text on a white background or the reverse. I also appreciate that just about everything the company says will work does.

DOS 4.0 and SideKick Plus come with the Altima One, along with a mouse. I looked at a preshipping version, and the mouse wasn't included. The system also comes with 1 megabyte of RAM (expandable via the addition of single in-line memory modules to 5

THE FACTS

Altima One
\$2699

Standard configuration:
It comes with 1 megabyte of RAM; a 20-megabyte hard disk drive; a 1.4-megabyte 3½-inch floppy disk drive; a supertwist, backlit LCD screen; an internal modem; and a 101-key keyboard.

Software:
DOS 4.0 and SideKick Plus.

Altima Systems, Inc.
1390 Willow Pass Rd.,
Suite 1050
Concord, CA 94520
(415) 356-5600
Inquiry 1035.

megabytes), 640K bytes of regular memory, serial and parallel ports, and an expansion slot for half-size 8-bit cards. It also has some built-in security functionality with a password request upon boot-up and runs with an average wait state of 0.7.

I ran the BYTE benchmarks on the system, and it ran as well as I guessed. Its CPU index is 2.02, a bit faster than the Zenith SupersPort 286, which comes in at 1.55. And the disk index is 1.34, compared to the SupersPort's 1.06.

Some things I didn't appreciate are the tinny-sounding and-feeling keyboard, the fact that the handle gets in the way while you're working, and the larger-than-life on-screen characters in color mode.

Some kibitzers commented on the forbidding, robotic look of the machine itself, and they wondered out loud what this machine has that others similar to it don't. My answer is that it's a full-featured and affordable machine that, without its external battery pack, you can tote around and not get a hernia.

A few caveats. If your software doesn't work in monochrome mode, try it in color mode. If you have a hard time getting used to the configuration of a non-IBM keyboard, you can attach an IBM PC-compatible keyboard.

Other than a few minor nitpicks, the machine seems to do what it was designed to do—amazing in itself. □

—Janet Barron

Logitech Brings Finesse to Low-Cost Desktop Publishing

Low-cost desktop publishing packages haven't exactly threatened the more expensive and capable programs like PageMaker and Ventura Publisher, and they probably never will. But Logitech's **Finesse**

brings respectability and panache to the neighborhood of low-end page-make-up software.

If you're just getting started at using a PC to lay out documents and pump text into

them, **Finesse** is an excellent package. It runs on a pretty basic system, with its most exotic requirements being 640K bytes of RAM, a hard disk drive, and a CGA board. I worked with a beta copy of the

program on a Compaq 286 with a VGA display. It looked sharp and ran flawlessly.

Finesse is a GEM application, so you work in the nice Digital Research environment

continued

SHORT TAKES

BYTE editors' hands-on views of new products

Portfolio

Altima One

Finesse

MacroMind Director

MultiPlus



A Good Thing in a Small Package?

The trouble with computers is that they're too expensive, too big, too heavy, and too inconvenient. Atari thinks it has an answer to all those problems in a portable computer that's handy, light, small, and inexpensive. The big question, of course, is whether Atari can deliver the full power of an IBM PC clone in a computer that will fit in your pocket.

The good news is that the size problem is licked. The Atari **Portfolio** is a hand-held clone that folds to about the size of a VCR tape—8 by 4 by 1 1/4 inches. It fits easily into my inside suit-coat pocket, although I wouldn't necessarily want to carry it there all day—the Portfolio weighs about a pound with its batteries (three AA cells).

So far, so good. But does it make the grade as a PC clone?

The Portfolio uses Intel's CMOS version of its venerable 8088—the CPU that was in the original IBM PC. At 4.92 MHz, it's slightly faster than a standard PC or XT but far slower than most clones. It also has less RAM and a slower CPU than most clones

offer today (the Portfolio does have a provision for up to 640K bytes of RAM).

The keyboard is the first and most obvious place where the Portfolio's downsizing presents a problem. It's usable for two-finger typists—quite usable, in fact. The keys are plastic, not the rubberized "chiclet" keys that some calculators use. But you won't have much luck touch-typing on this scaled-down keyboard, at least not without lots of practice. I found it adequate for taking notes, but I wouldn't want to use it for more than a few hundred words of typing.

The screen, like the keyboard, is designed on a small scale. However, it's easily readable. The Portfolio emu-

lates a monochrome display adapter, and although the display contains 240 by 64 pixels, the system can't really make use of graphics (at least not without special driver software). As with the keyboard, I found the screen to be quite reasonable for small, quick jobs—such as note taking and quick calculations—but I'd hate to take on a major task with it.

There will eventually be two ways of transferring software and files into the Portfolio. One way is through the serial port, using LapLink-style software. But right now, the Portfolio doesn't have a serial port. Atari says that a "smart cable" that attaches to the Portfolio's expansion port

and comes out as a standard serial port will be available shortly for under \$50.

The other way of transferring files from a desktop PC is by copying them onto a Portfolio memory card—a solid-state, removable RAM disk that's about the size of a credit card. It's the Portfolio's answer to disk drives. The memory cards slide into the left side of the machine and offer up to 128K bytes of RAM or 4 megabytes of ROM.

I saw a beta version of a new application designed for the Portfolio, but I *didn't* see any regular PC programs running on the machine. And I didn't see the soon-to-be-released memory-card drive that will fit into a standard PC slot, for transferring files back and forth between a desktop PC and the Portfolio.

The final element of the system is a memory-expansion pack that will let you boost the Portfolio's RAM from 128K bytes to a full 640K bytes. Like the smart cables, it will plug into the Portfolio's expansion port and will be essential for using the Portfolio with standard PC software. Also like the smart cables, the memory expansion wasn't yet available when I looked at the Portfolio.

I liked the Portfolio—I really did. But the questions I still have about software compatibility are serious.

The entire operating system is in ROM, and that may affect the operation of some programs. I'd like to know whether standard programs like Lotus 1-2-3, WordPerfect, dBASE III Plus, and SideKick will work in the Portfolio. Atari claims that the built-in spreadsheet uses Lotus-compatible files. I'd like to see that for myself.

I'd also like to see what

continued

THE FACTS

Portfolio
\$399

Standard configuration:
It runs at 4.92 MHz and has 128K bytes of RAM, a 40-column by 8-row display, and a 63-key miniature keyboard.

Atari
1196 Borregas Ave.
P.O. Box 3427
Sunnyvale, CA 94088
(408) 745-2000.
Inquiry 1034.

Plotters for people who want more, but can't afford expensive.

The truth is, some companies can buy any plotter they want. But most companies have to be concerned about budgets, as well as quality and performance. That's why Zericon's line of large format plotters are becoming so popular. They're made with exceptional craftsmanship utilizing advanced manufacturing techniques right here in the USA. Now you don't need a big budget to afford a great plotter.



most demanding application. And where scale is important, our X & Y calibration feature offers precision for critical applications like PCB artwork. "Installation is a Breeze" because we include a custom configured cable tailored to your software and hardware combination.

Call us today.

\$1695. - \$2995.

Starting at \$1695 for our ValueLine™ D size, to \$2995 for our Designer series A-E model, we make a large format plotter that's just right for your application.

Zericon plotters are compatible with all popular CAD software packages. They accept media sizes from 8½ x 11" to 36 x 48." With .002" repeatability, quality is assured for even the

We'll send you a free sample plot, provide full information about our entire line of large format plotters and outline our customer service program, which includes complete product satisfaction or your money back within 10 days of purchase. We'd like to win you over as a Zericon customer. And we've got the plotters to do it. Call us today. Zericon, Inc.,

40491 Encyclopedia Circle, Fremont, CA 94538.

In CA (415) 490-8380.
FAX (415) 490-3906.

(800) 727-8380



ZERICON

More plotter. Not more money.

A/C/T/ — ARCNET LAN PROFESSIONAL

OFFICE: 10543 Progress Way, Cypress, CA 90630 U.S.A.
Tel: 714-761-4477 Fax: 714-761-4783

Connectivity — No magic Word, just ACT!

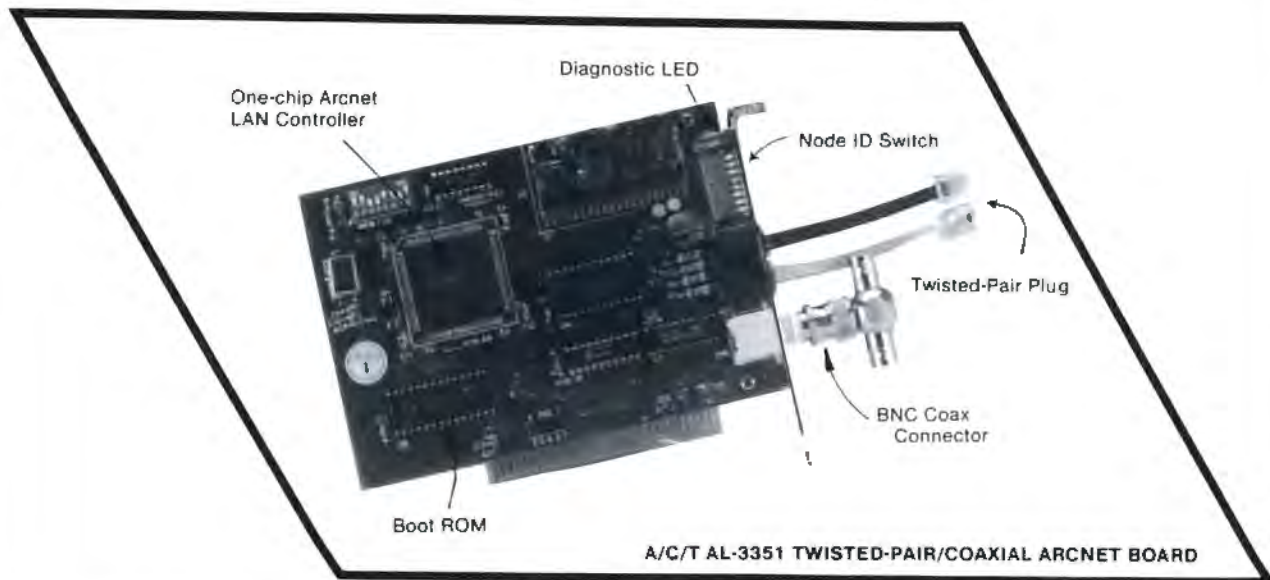

A/C/T/ AL-3351 TWISTED-PAIR/COAXIAL ARCNET BOARD

At A/C/T/, we provide:

- Complete Arcnet product line, such as 8-port twisted-pair or coaxial Active Hub, 8/16 bit Arcnet board, 4-port active plus Arcnet in one board, cable, terminator, connector, etc.
- Affordable 10 megabits Ethernet.
- Two-year full warranty and 30-day money back
- Free unlimited technical support
- Manufacturer direct pricing (call for catalogue & quotation)

*** OEM, Distributor & Dealer inquiries invited

MONTHLY SPECIAL!!

EGA 14" MONITOR 640x350 \$ 310
EGA VIDEO CARD 640x350 \$ 125

<p>386 20 MHz (1MB) \$1425 (LandMark 24.6 MHz) 386 20 MHz (1MB) \$1595 (LandMark 29.6 MHz) 386 25 MHz (4MB) \$2625 (LandMark 41.7 MHz) 80386 Motherboard \$ 450/720/1250</p> <p>286 10 MHz (512K) \$ 645 (LandMark 13 MHz) 286 12 MHz (512K) \$ 715 (LandMark 16 MHz) 286 16 MHz (1M) \$ 875 (LandMark 26 MHz) 80286 Motherboard \$ 195/255/395</p> <p>(All systems come with listed parts)</p> <p>Hard/Floppy Controller \$ 85 Monographics/Printer \$ 49 1.2 MB Floppy Drive \$ 75 AT Type Case/Power Supply \$ 100 AT Type Keyboard \$ 39 Mono Amber Monitor \$ 75</p> <p>CGP \$ 49 CLOCK \$ 20 PRINTER \$ 15 EMS RAM \$ 95 RS-232 \$ 22 RS-2324 \$ 65</p> <p>10 MHz 286 Bare Bone \$ 330 12 MHz 286 Bare Bone \$ 385</p> <p>QUADRAM JT Fax I Internal 48 \$ 245 JT Fax Pro96 9600/Fax, 2400/Modem \$ 496</p> <p>SOFTWARE MOST POPULAR PROGRAMS IN STOCK. OTHER PROGRAMS UPON REQUEST. provided by PC by Root.</p>	<p>PARADISE EGA (640x480) Auto \$ 175 VGA Plus (800x600) \$ 235 VGA Plus 16 (800x600) \$ 315 VGA Pro. (800x600) \$ 385</p> <p>VIDEO 7 VEGA Deluxe (640x480) \$ 175 VEGA VGA (800x600) \$ 255 FastWrite VGA (800x600) \$ 395 V-RAM VGA (1024x768) \$ 495</p> <p>NEC MONITORS Multisync 2A \$ 525 Multisync 30 \$ 645</p> <p>NANAQ MONITORS Flexscan 8060 H \$ 485 Flexscan 8060 S \$ 555 Flexscan 9070 S \$ 965</p> <p>LOGITECH Serial/PS-2 \$ 78 Bus/PS-2 \$ 78 SCAN MAN \$ 180</p> <p>MAXTOR HARD DISCS XT-1085 71MB MFM \$ 595 XT-1140 120MB MFM \$ 1440 XT-2190 160MB MFM \$ 1530 XT-4170E 158MB ESDI \$ 1440 XT-4380E 339MB ESDI \$ 2100 XT-4170S 158MB SCSI \$ 1440 XT-4380S 388MB SCSI \$ 2100 XT-8760S 676MB SCSI \$ 3870</p>	<p>PANASONIC PRINTERS KX-P1180 \$ 185 KX-P1191 \$ 255 KX-P1124 \$ 335 KX-P1195 \$ 465 KX-P1524 \$ 499 KX-P4450 Laser \$ 1395</p> <p>STAR PRINTERS NX-1000 \$ 185 NX-1000 RAINBOW \$ 255 NX-2400 \$ 315</p> <p>WESTERN DIGITAL WD1006V-MM1 MFM 1:1 \$ 105 WD1006V-MM2 MFM 1:1 \$ 115 WD1006V-SR1 RLL 1:1 \$ 135 WD1006V-SR2 RLL 1:1 \$ 145</p> <p>MICROPOLIS HARD DISCS 1335 71MB MFM 28ms \$ 565 1355 147MB ESDI 18ms \$ 1195</p> <p>MITSUBISHI HARD DISCS MR535 42MB/MFM 28ms \$ 395</p> <p>MICROSCIENCE HARD DISCS HH-1090 80MB MFM 28ms \$ 695 HH-1060 40MB MFM 28ms \$ 435</p> <p>MINISCRIBE HARD DISCS MIN-8450K 42MB RLL \$ 295 MIN-8051ATK 42MB w/1:1 \$ 465 MIN-8450XTK 42MB w/WX1 \$ 355</p> <p>SEAGATE HARD DISCS ST-225 20MB MFM 65ms \$ 195 ST-238 30MB RLL 65ms \$ 225 ST-251 40MB MFM 40ms \$ 335 ST-251 40MB MFM 28ms \$ 385</p>
---	--	---

FOR ITEMS OF INTEREST NOT SHOWN, PLEASE CALL

MIRACLE COMPUTERS

780 MONTAGUE EXPWY
SUITE 202
SAN JOSE, CA 95131
TEL. (408) 435-8177
FAX (408) 435-8179

Store Hours
MON-SAT 10-8 PM

FOR ORDERS, CALL COLLECT

Trademarks appearing herein belong to their respective owners.
Prices are subject to change without notice.
Not responsible for typographical errors.



Inexpensive Multitasking Platform for PCs

PC-MIX, a multitasking environment for applications running under MS-DOS, lets you run up to three programs concurrently and switch from one task to the other with two keystrokes. The program works on systems as basic as the IBM PC, but it works best with systems that support operation beyond 640K bytes of RAM with EEMS memory, such as the IBM PC AT.

Unlike DESQview, which divides concurrent applications into windows on the screen, PC-MIX uses a full-screen display with concurrent applications operating in the background. Other features include configurable memory partitions, selectable task priorities, and true preemptive scheduling. If an application writes directly to screen memory, PC-MIX lets it take over the screen and uses a batch file to control the other applications.

PC-MIX requires an IBM PC with 256K bytes of RAM and DOS 2.0 or higher.

Price: \$49.95.

Contact: Proware, 10719 Plano Rd., Suite 100, Dallas, TX 75238, (214) 349-3790.
Inquiry 894.

Program Helps Companies Stay Clean

For businesses that want to implement a drug-free workplace policy, such as those with government contracts, Clean Slate provides database and reporting tools and can generate impartial, randomly selected lists of employees for drug testing. The program automatically generates audit trails for employ-

ees or a contracting agency that provides evidence of nondiscriminatory and good faith compliance with current regulations.

The program also includes a set of policy guidelines that you can use to determine what actions your company should take when an employee tests positive for one of five classes of drugs. You can also use the program with a processor to customize notices and certifications. Clean Slate is based on dBASE IV and includes a run-time version of the program.

Clean Slate runs on the IBM PC with 640K bytes of RAM, a hard disk drive, and DOS 2.1 or higher. An update service is available for \$195 per year.

Price: \$695.

Contact: Clean Slate Software, Inc., 11260 Roger Bacon Dr., Reston, VA 22090, (800) 726-3440 or (703) 471-6071.

Inquiry 903.

Software Lets 3 + Mail Users Send Faxes Remotely

With GammaMail, 3Com 3 + Mail users can use a modem-equipped laptop computer to connect to their network and remotely send a fax message to any other fax machine. The program runs on the GammaFax CP, GammaLink's PC-to-fax board designed for networks.

With the GammaFax CP, you can connect eight boards to a fax server, all sending and receiving at 9600 bps. The board also ships with version 4.21 of its communications software, which GammaLink says is designed specifically for heavy network use.

GammaMail runs on the

IBM PC with 640K bytes of RAM, a hard disk drive, the GammaFax CP board, and a network interface card.

Price: GammaMail, \$995; GammaFax CP board, \$1095.

Contact: GammaLink, 2452 Embarcadero Way, Palo Alto, CA 94303, (415) 856-7421.

Inquiry 904.

Microsoft Releases Presentation Manager Toolkit

To give OS/2 application developers references and tools as they need them, Microsoft has released the OS/2 Presentation Manager (PM) Toolkit, which developers can buy as one package or in individual components.

The toolkit includes a set of graphics tools for PM, called Softset, four OS/2 PM books, hypertext-based QuickHelp documentation, 3 megabytes of sample code, and 2 hours of on-line support, all for \$500.

Softset includes dialog box, icon, and font editors, a resource compiler, and the book *Microsoft OS/2 Programming Tools*. Softset is available for \$150.

The three volumes of the *MS OS/2 Programmer's Reference Library* are available separately, priced from \$19.95 to \$29.95. *Programming the OS/2 Presentation Manager* is also available for \$29.95.

The OS/2 PM Toolkit includes sample code, QuickHelp on-line documentation, and the Helpmake utility, which lets you add additional on-line documentation into the QuickHelp system. It is available to Softset owners for \$150.

Contact: Microsoft Corp., 16011 Northeast 36th Way, Box 97017, Redmond, WA 98073, (800) 426-9400 or (206) 882-8080.

Inquiry 900.

New Glue Supports Color, Gray-Scale, and Hidden Notes

The newest version of SuperGlue, the print-to-disk utility for the Macintosh, now supports color and gray-scale. Solutions International calls the newest version SuperGlue II with GlueNotes. This means that the program has the ability to attach hidden notes and comments to any file that you can print. It does this by capturing an application's printer output and redirecting it to a disk file. The program's ImageSaver II file does the redirecting, while SuperView lets you examine the file.

The program lets you create electronic printouts from most Macintosh applications, such as Excel or PageMaker, so that anyone on a network or via telecommunications can view a newsletter or spreadsheet as it would appear on the printer, without requiring the application that created the file. You can also save electronic printouts as a folder of PICT documents, for a slidemaker or service bureau.

Other new features of the program include character lock, which holds a character's position in kerned documents, and font lock, which identifies fonts by name, not ID number.

SuperGlue II with GlueNotes works on the Mac Plus or higher with 1 megabyte of memory.

Price: \$119.95.

Contact: Solutions International, 30 Commerce St., Williston, VT 05495, (802) 658-5506.

Inquiry 899.

X-BANDIT

Break the 640K DOS barrier and utilize the Advanced Features of the LIM 4.0 standard while using only one motherboard slot!

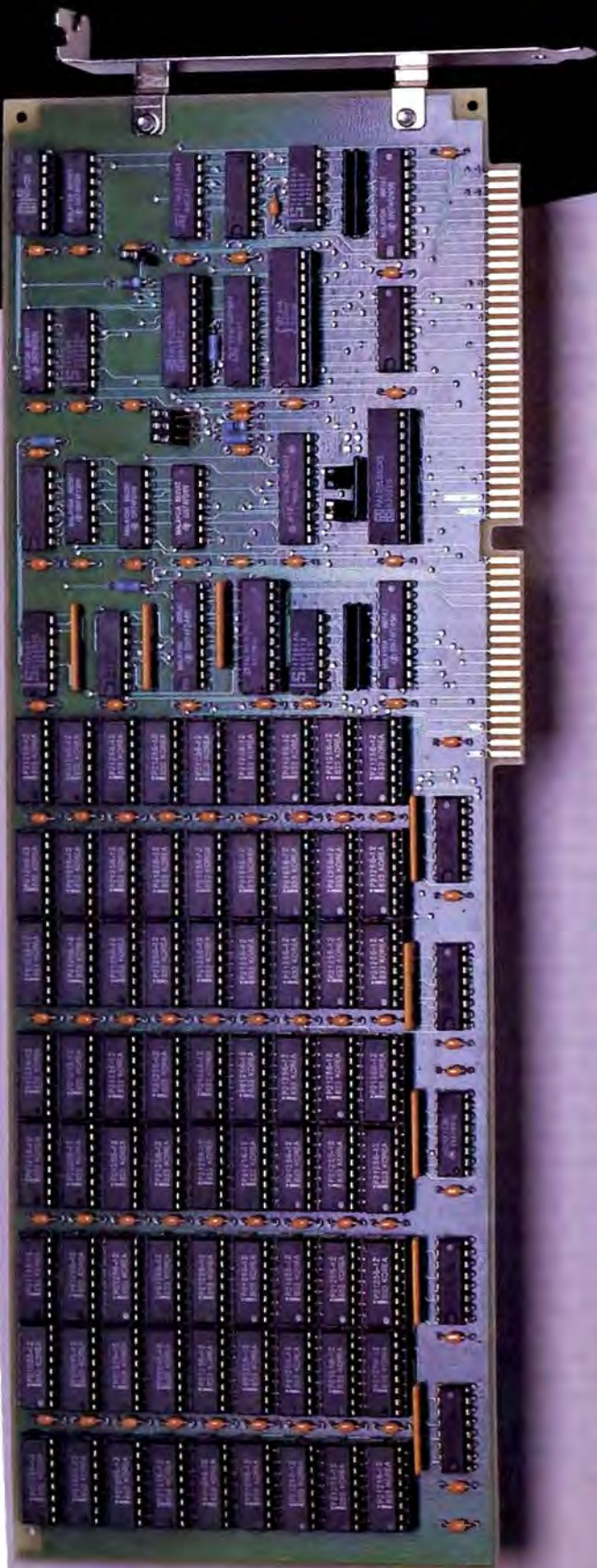

DESIGN PHILOSOPHY

- The Teletek X-Bandit was specifically designed to utilize the advanced features of the Lotus/Intel/Microsoft EMS 4.0 Specification. Further, the X-Bandit's Segmented Memory Mapping capability allows the user to extend DOS size beyond the 640K barrier. It is available in both 8 and 16 bit versions for use in the IBM XT, AT, and compatibles.

MEMORY

- Segmented Memory Mapping allows the user to fill out unused memory segments between 640K and 1024K. By "claiming" unused portions of memory in 16K increments, the user effectively increases TPA size. LAN or custom software modules, for example, can be loaded into these high memory areas thus relieving the lower 640K of TPA for other application programs.
- Split Memory Addressing allows the user to fill out conventional memory to 640K.
- Extended Memory Addressing is available for the PC/AT version.
- 2 MB capacity in a single slot. Up to 8 MB per system.
- Parity checking.

SOFTWARE

- Easy menu-driven auto configuration software.
- Device driver includes print spooler and RAM drive.
- Supports multitasking with the appropriate shell-resident software package.

SPEED

- 6/8/10 MHz speed with 0 wait states. 12 MHz speed with 1 wait state.

WARRANTY

- One year parts and labor.

TELETEK

4600 Pell Drive
Sacramento, CA 95838
(916) 920-4600
Fax (916) 927-7684

Circle 528 on Reader Service Card (DEALERS: 529)



Do You Have Questions On Data Communications?

At Datasolvers, Inc. we don't expect you to have all the answers. In today's ever-changing high tech marketplace you simply cannot know everything about every thing.

Datasolvers, Inc. along with *Multi-Tech Systems, Inc.* can, however, provide you right answers to your data communications questions.

Whether it be a simple low-speed,

point-to-point link, or a major multiplexed network, *Multi-Tech Systems, Inc.* has it all. MultiTech products, along with Datasolvers, Inc. designing expertise, equals solid, simple, cost effective solutions for your application.

Answers are free at Datasolvers, Inc. We'll even pay for the phone call. Call us now at 1-800-922-2329.

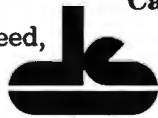

datasolvers, inc.

906 N. Main * Suite 3 * Wichita, KS * 67203

Computers For The Blind

Talking computers give blind and visually impaired people access to electronic information. The question is how and how much?

The answers can be found in "The Second Beginner's Guide to Personal Computers for the Blind and Visually Impaired" published by the National Braille Press. This comprehensive book contains a Buyer's Guide to talking microcomputers and large print display processors. More importantly it includes reviews, written by blind users, of software that works with speech.

This invaluable resource book offers details on training programs in computer applications for the blind, and other useful information on how to buy and use special equipment.

Send orders to:

National Braille Press Inc.
88 St. Stephen Street
Boston, MA 02115
(617) 266-6160

\$12.95 for braille or cassette, \$14.95 for print. (\$3 extra for UPS shipping)

NBP is a nonprofit braille printing and publishing house.

VGA



VGA it's here! From the people

who brings you the world's first color EGA portable computer, now proudly present the latest addition, PL286V and PL386V plasma VGA lunch-box portable.

The PL-386V based on the 386 architecture running at a speedy 25 Mhz with two build-in high density 3.5" and 5.25" floppy for data and program compatibility. It's standard 42MB hard drive retrieve and store your data at an astonishing speed of 28ms.

With its state-of-the-art gas plasma display you will be seeing a full 640 x 480 bit-mapped 16 shaded crispy clear VGA resolution; a build-in external VGA/Multisync monitor port for displaying simultaneously externally all in a 19.5 lbs.!

To find out more about PL386V and other Bi-Link portable computer, please call (213) 699-6684 ext. 212 (general orders and corporate account).

For OEM information, please call (213) 699-6684 ext. 322



MN286 and EGA-286 **

- 80286-12 0 wait state
- Standard 1MB/Maximum 4MB RAM
- Expanded Memory Specification (EMS)
- One 1.2MB 5.25" floppy
- One 1.44MB 3.5" floppy
- 44MB hard drive 28ms
- 4 AT-Expansion slots free
- One parallel, two serial
- Internal Modem 1200/2400 baud
- Dual frequency high resolution
- 9" amber monitor (MN286)
- 9" color EGA monitor (EGA-286)
- External monitor port

** Call for 386-20 machine specification



EGA-286



MN286

Icon Utility for Windows Now Supports EMS 4.0

PubTech File Organizer, the utility that replaces Microsoft Windows Executive with a display of files, directories, disk drives, and printers as true icons on your desktop, now supports EMS 4.0. Version 2.1 lets you place application icons on the desktop without loading the application into memory and includes a tree-structure option for viewing directories.

With File Organizer 2.1, you can print, delete, move, or copy files by pointing and clicking with a mouse. A Hot Desktop feature lets you save the size and location of open windows for future sessions. Other features include file undelete and text search.

Publishing Technologies also announced that an OS/2 version of the program will ship early next year. File Organizer for OS/2 will provide two-way transparency between DOS and OS/2 applications. Under the OS/2 version, a DOS machine will look like an OS/2 machine, making it easier to switch between the two operating systems.

Another program, MultiTack, builds libraries of graphics and text that you can reuse in Windows-compatible applications. It enhances the cut-and-paste functions of Windows by letting you copy from a Clipboard-compatible application or import compatible file formats and then insert them into your documents or retain them on disk. You can also use MultiTack to copy hit-mapped screen shots into the Clipboard. Publishing Technologies reports that the program will ship in the fourth quarter of this year.

File Organizer 2.1 requires Windows 2.0, an IBM

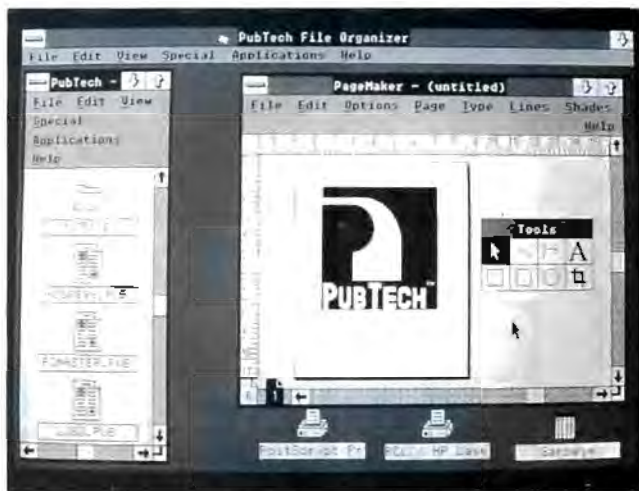

File Organizer 2.1 brings icons to Windows.

AT or higher, 512K bytes of RAM, and DOS 3.0. A mouse is strongly recommended.

Price: File Organizer 2.1, \$199.95; MultiTack, \$149.95; File Organizer for OS/2, \$395.

Contact: Publishing Technologies, Inc., 7719 Wood Hollow Dr., Suite 260, Austin, TX 78731, (800) 782-8324 or (512) 346-2835.

Inquiry 890.

New Agenda Features Starter Package

When Lotus Development shipped the first beta versions of Agenda, beta testers said that the program was difficult to learn, which prompted the company to revise the interface. Agenda 1.01, the program's newest version, features an Activities Planner, a prebuilt starter application that Lotus hopes will help reduce the time it takes to understand the personal information manager. Lotus also improved the program's file handling and added a new database recovery utility.

The starter application contains common activities

with built-in views and examples on how to use the application. The program's file handling was improved and the database recovery utility added to increase the integrity of Agenda files. File settings can maintain a working copy of a database that doesn't make changes to your actual database files, ensuring that the files won't be damaged in case of a power outage during a session.

The recovery utility, called DB2STF, creates a structured text file from a database. After you run the utility, you create a new database and import the structured file into that database. If you accidentally delete a file with an .AGB extension, DB2STF can recover items and categories, but not assignments. The utility doesn't recover .AGA files.

Agenda 1.01 runs on the IBM PC with DOS 2.0 or higher, a hard disk drive, and 640K bytes of RAM. Under OS/2, it works on the IBM PC AT with 1.5 megabytes of RAM. The file recovery utility works on both DOS versions of Agenda and Agenda 1.0 for OS/2, but it can run only under DOS.

Price: \$395.

Contact: Lotus Development Corp., 55 Cambridge Pkwy., Cambridge, MA 02142, (617) 577-8500.

Inquiry 893.

Software-Only OCR Package for Hand Scanners

The CAT Reader OCR Software package for hand-held scanners is a trainable optical-character-recognition program that can handle monospaced, proportional, dot-matrix, and typeset fonts. You can operate the program in direct or interactive mode, and the program can handle skew (up to 10 degrees), which occurs in hand scanners with inconsistent movement.

When you're scanning text that is 8 inches wide with a 4-inch-wide scanner, the program's automatic text-merging feature lets you pull the two columns of scanned text back into a single page. Mixed fonts or point sizes can be trained into one font file, and each file can be up to 200K bytes in size.

With CAT Reader OCR Software 1.52, you can use the Insert key as a simple editor, the company reports. If a character that you're scanning has garbage in it (e.g., an ink blot or a smudge), the Insert key lets you insert that character without forcing the program to learn it. You can scan left to right when scanning spreadsheets, and on-line help is available.

In 200-dpi mode, the program handles text from 9 to 20 points; at 300 dpi, it can handle text as small as 6 points. The program works on the IBM PC with 640K bytes of RAM and DOS 3.1 or higher.

Price: \$295.

Contact: Computer Aided Technology, Inc., 7411 Hines Place, Suite 212, Dallas, TX 75235, (214) 631-6688.

Inquiry 898.

DON'T TAKE OUR WORD FOR IT, SEE FOR YOURSELF!



CREATE PROFESSIONAL BASIC APPLICATIONS

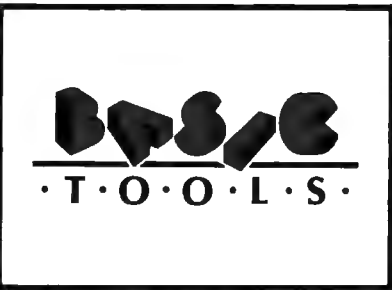

If you are a BASIC programmer and need to improve the power and ease of use of your applications, BASIC TOOLS provides all you need in a single package. Enhance your applications with WINDOWS: display multiple windows and manage their titles, footers, contents, color, size, and on-screen position; also scroll and move them around. The INPUT EDITING routines included in BASIC TOOLS help you build powerful and easy to use data entry screens. The B+TREE file manager lets you use up to ten indexed files in a single program; each record can be accessed through as many as eight different keys. POP-UP ON-LINE HELP is implemented through a terminate-and-stay-resident (TSR) utility. Sample programs with source code are included and your applications are ROYALTY FREE.

SYSTEM REQUIREMENTS: IBM® PC®, PS/2® or compatible; DOS 2.0 or higher; Microsoft® BASIC 6.0, Microsoft Quick BASIC 4.0, BASICA®, or GW® BASIC.

INTRODUCTORY PRICE
\$49.95

SIMPLIFY FINANCIAL ANALYSIS

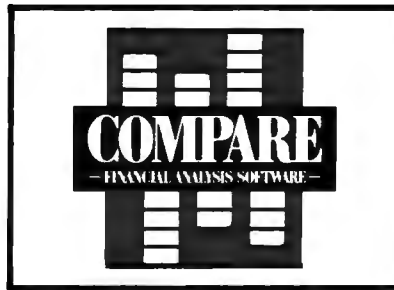

If you need to monitor the financial performance of your company or your client's company, COMPARE allows you to measure actual vs. budgeted results on a monthly and quarterly basis. Using only a few pieces of data taken from the financial statements, COMPARE helps you analyze a company's financial position, highlighting problems and opportunities. COMPARE provides, among others, balance sheet analysis, cash flow information, financial ratios, and sources and uses of cash; it automatically generates 23 management reports and 8 graphs. Additionally, the spreadsheet is open for you to enhance it if you wish.

SYSTEM REQUIREMENTS: LOTUS® 1-2-3® release 2.01 or higher, IBM® PC® or compatible.

INTRODUCTORY PRICE
\$59.95

COMMUNICATE IN SPANISH

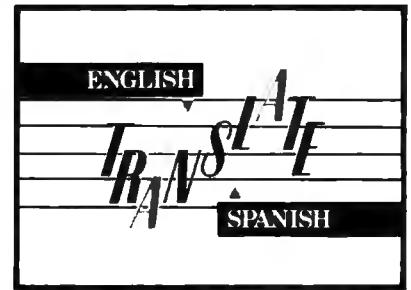

If your need is basic business communications, education, or fun, TRANSLATE will allow you to interact with the Spanish speaking world. Give TRANSLATE a straightforward English text (ASCII format) and you will get a clean Spanish translation. TRANSLATE has an English/Spanish dictionary with more than 85,000 terms; if your needs call for special terminology, you may customize TRANSLATE with the easy to use dictionary update and maintenance editor. TRANSLATE comes with a user friendly interface which includes a split screen text editor, on-line help, and unknown terminology identification. You may choose interactive or deferred translation mode.

SYSTEM REQUIREMENTS: IBM® XT® /AT®, PS/2 or compatible (8 Mhz. or higher recommended), DOS 3.0 or higher, hard disk, and 512K RAM.

\$299.00
REGULAR PRICE
\$495.00

■ **FREE TECHNICAL ASSISTANCE** ■ **30-DAY MONEY-BACK GUARANTEE ON DIRECT ORDERS** (less shipping charges)

FINALSOFT CORPORATION
40 N.W. 79th. Ave., Suite 215 Miami,
Florida 33166

Circle 514 on Reader Service Card (DEALERS: 515)

ORDER TOLL FREE
1-800-232-8228

in Florida (305)477-2703, 9-5 EDT
VISA AND MASTERCARD ACCEPTED
Add \$5.00 shipping and handling charges per
product ordered.

Copyright 1989 FINALSOFT CORPORATION. All rights reserved.
Soft is a registered trademark of Finalsoft Corporation.
PC, XT, AT, PS/2 and BASICA are registered trademarks of
International Business Machines Corporation.
Soft and GW are registered trademarks of Microsoft Corporation.
US and 1-2-3 are registered trademarks of Lotus Development Corp.



AutoKey 400 programmable macro keys !

Simplify DOS, D-base, Lotus 1-2-3.
Boost your CAD performance.
Automate word processing.

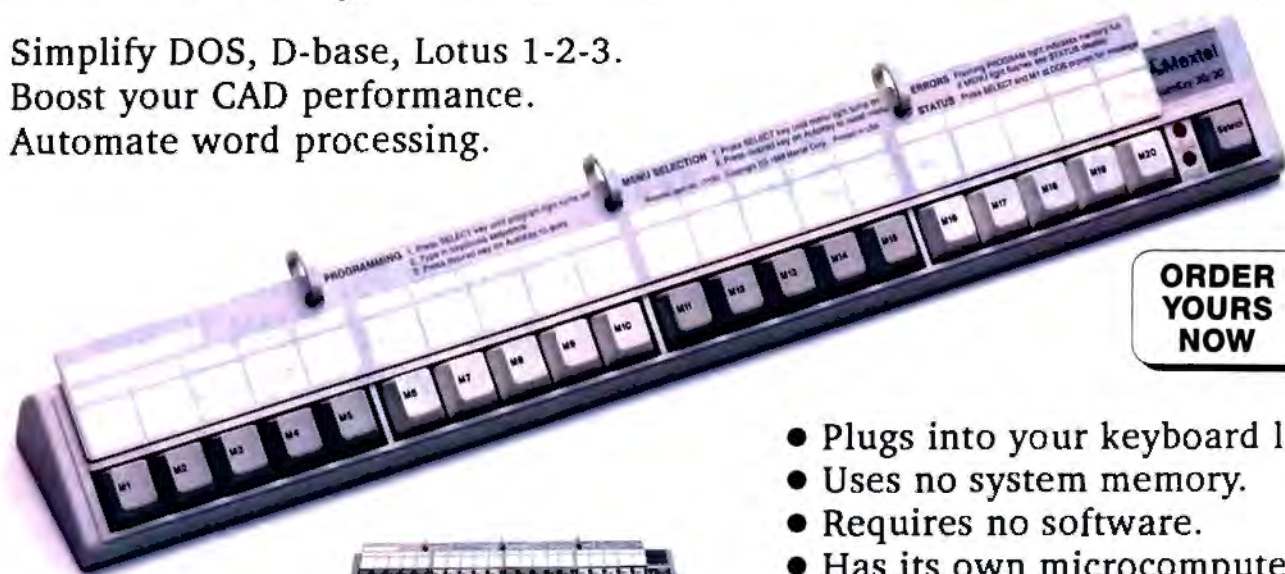

**ORDER
YOURS
NOW**

- Plugs into your keyboard line.
- Uses no system memory.
- Requires no software.
- Has its own microcomputer.
- Eliminates complicated memory resident macro programs such as SuperKey and ProKey.

Mextel Corp. 159 Beeline Road
Bensenville, Illinois 60106

AutoKey is trademark of Mextel Corp. All other product names are trademarks of their respective manufacturers. ©1989 MEXTEL CORP.

Call 1-800-888-4146
(inside IL call 312-595-4146)

AutoKey 40	\$139.00	
AutoKey 20/20	\$289.00	Visa/MC/AmEx.



The feature-packed, competitively priced, B300 286 Laptop; BFAX 4-in-1 Fax, Scanner, Copier and Printer plus Fax Manager Software; B125 Mouse & Dr Halo III; DOS 3.3, NOW SHIPPING. . from MicroDIRECT

Bondwell Office Automation Products

MicroDIRECT is an Authorized Nationwide Bondwell Office Automation Products Distributor. We deliver exceptional product and technical support you can depend on every day, thru our 15 Regional Sales Offices, and 160 Service Centers Nationwide. Call MicroDIRECT today 1-800-872-4286 for the dealers near you.

DOUBLE THE SPEED OF YOUR PS/2!

Hummingbird 50/60

RUN YOUR PS/2 MODEL 50/60
33% FASTER THAN 16 MHz
MODELS 70/80

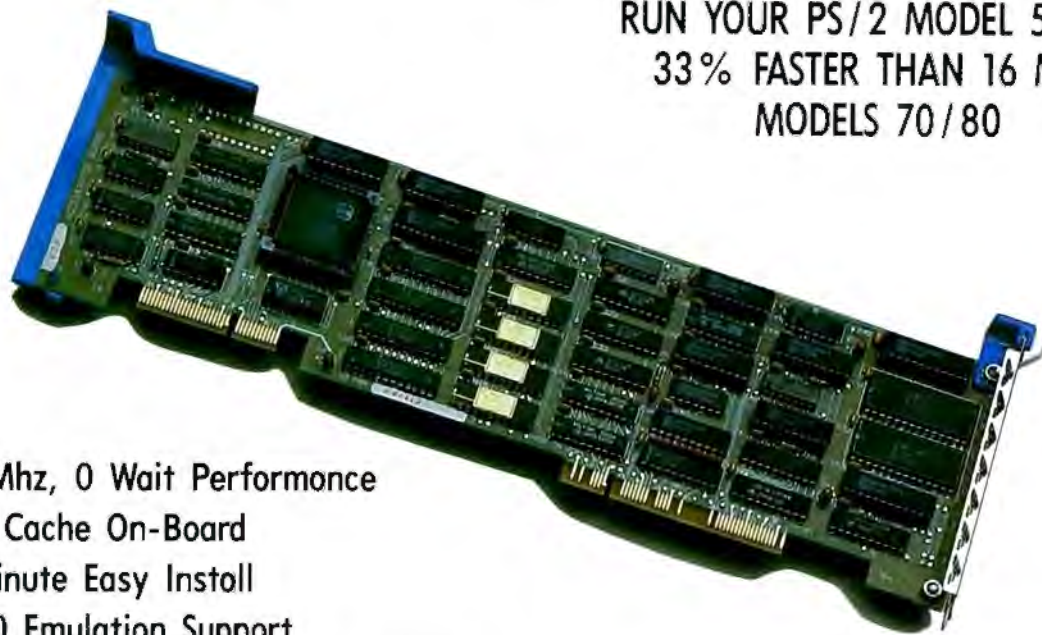

- ★ 20 Mhz, 0 Wait Performance
- ★ 32k Cache On-Board
- ★ 5 Minute Easy Install
- ★ 3270 Emulation Support
- ★ PS/2 Microchannel ID Part #6A6A

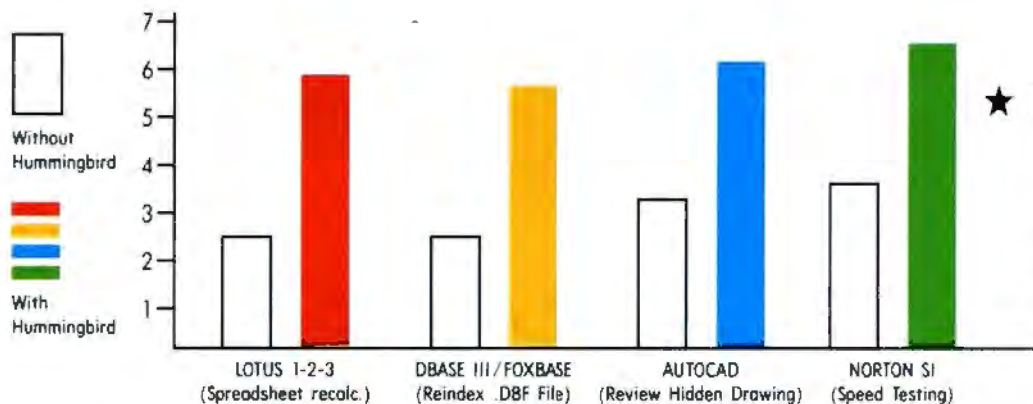

★ Immediate Delivery

★ 30-Day
Money Back
Guarantee!

Application Performance on PS/2 Models 50/60 with Hummingbird.

MANUFACTURE

JST PRODUCTS

46231 Landing Parkway
Fremont, CA 94538
Phone: 415-438-9571
FAX: 415-770-0513

CORPORATE SALES

POLYWELL, INC.

61 "C" Airport Blvd.
So. San Francisco, CA 94080
1-800-999-1278
FAX: 415-583-1974
TLX: 990235

VANCOUVER

DPE COMPUTERS

1112 West Pender Street
Suite 102
Vancouver, B.C.
Canada V6E 2S1
Tel: (604) 683-7587
FAX: (604) 683-9210

© All products are trademark of their respective company

INTEREX HP Users Group Conference

INTEREX, the international Hewlett-Packard Users Group, is holding its North American Users Conference on September 11-14 at San Francisco's Civic Auditorium and Brooks Hall Complex.

Over 300 technical sessions, hardware and software exhibitions, special-interest group meetings, and vendor product demonstrations are planned.

Price: INTEREX members: conference, before August 18, \$550; after August 18, \$650. Nonmembers: \$650 and \$750, respectively.

Contact: INTEREX San Francisco Conference, 680

Almanor Ave., P.O. Box 3439, Sunnyvale, CA 94088, (408) 738-4848.
Inquiry 918.

Information and the Global Market

A conference on the role of information systems in the global economy will be held on October 1-4 in San Francisco. Called "Information Systems Perspectives: Affecting the Global Market," the conference is sponsored by GUIDE International, an international association of IBM computer users.

Price: Before August 1, \$1295; after August 1, \$1495.
Contact: GUIDE International Corp., 111 East Wacker

Dr., Suite 600, Chicago, IL 60601, (312) 644-6610.
Inquiry 922.

Design Engineering Conference

The tenth annual Design Engineering Show and Conference/West will be held earlier this year. Normally held in December, the conference will be September 26-28 at the Los Angeles Convention Center.

The conference will include sessions on failure analysis, quality engineering, electronic packaging design, and materials for aerospace.

Price: One session, \$115; four sessions, \$335; show only, \$25.
Contact: Show Manager,

Design West, 999 Summer St., Stamford, CT 06905, (203) 352-8372.
Inquiry 921.

Information Management Conference

Publishing in the 1990s, and the science of information management will be the focus of TechDoc '89. The conference will take place at the San Jose Fairmont Hotel on August 23-25.

Price: Conference fee, \$745; tutorials, \$320.
Contact: Graphic Communications Association, 1730 North Lynn St., Suite 604, Arlington, VA 22209, (703) 841-8160.
Inquiry 925.

MODEMTM 2400

2400 BAUD MODEM PLUS PHONE

NEW & UNIQUE

Specifications:

- Compatibility: CCITT V.22 bis, V.21, V.22 and BELL 212A/103
- Speed conversion: 2400/1200/300 bps
- Data throughput: 2400 bps
- Software compatibility
- Front panel indicator
- One year warranty



DEALER/OEM/DISTRIBUTOR INQUIRIES WELCOME

E-TECH RESEARCH, INC.

2700 Augustine Dr. #275

Santa Clara, CA 95054

(408) 982-0270

Fax: 982-0272



The Power of Expansion

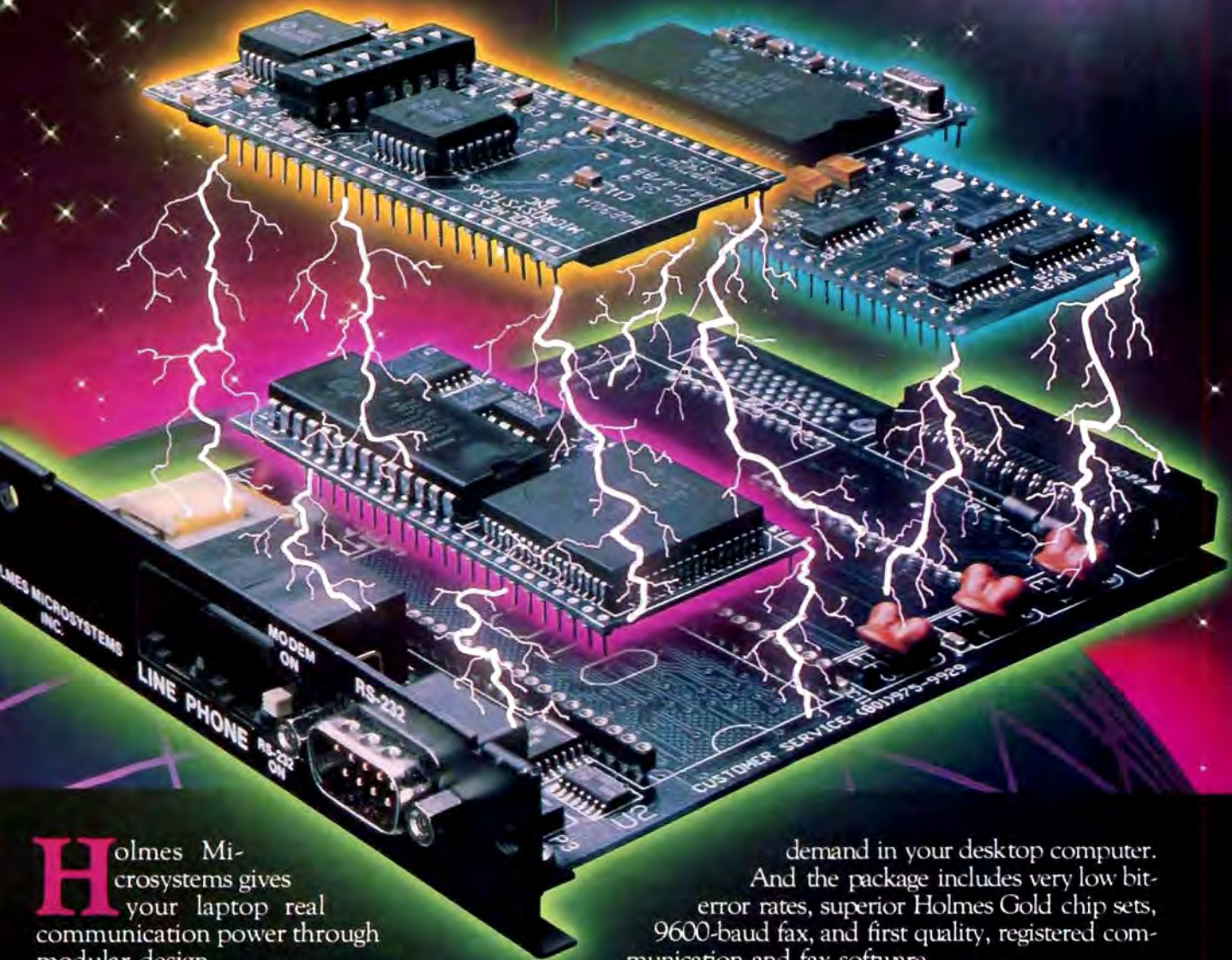

Holmes Microsystems gives your laptop real communication power through modular design.

The Holmes Correspondent™ and FAX'EM™ laptop enhancement cards are more than just modems or fax cards. Right now, if you need a 1200 or 2400-baud modem, fax capability — or both — you can have it, all on the same card. And when your needs change, Holmes changes with you.

With a Holmes enhancement card, your laptop computer has the same expansion capabilities you

demand in your desktop computer. And the package includes very low bit-error rates, superior Holmes Gold chip sets, 9600-baud fax, and first quality, registered communication and fax software.

Holmes is setting the standard for laptop communications now. Why not move into the future with confidence knowing you have the best today, and the power of expansion for tomorrow?

Holmes products are available at computer dealers nationwide.

Or for more information, contact Holmes directly.

HOLMES
MICROSYSTEMS, INC.

WHAT'S NEW

PACIFIC

Oceans and Computers

You can catch up on the latest developments of computer applications in studying our largest resource at Oceans '89 at the Washington State Convention and Trade Center on September 18-21 in Seattle. Although it is not limited to computing and oceanography only, computers will be heavily involved.

Among the scheduled topics are data acquisition systems and databases, controlling autonomous underwater vehicles, knowledge-based underwater systems, advanced marine robotics, remote sensing, DSP applications, and PC networking for ocean-going research vessels.

Price: IEEE members: before September 5, \$190; after September 5, \$220. Non-members: \$240 and \$270, respectively.

Contact: Nancy Penrose, Applied Physics Lab, University of Washington, 1013 Northeast 40th St., Seattle, WA 98105, (206) 543-3445.

Inquiry 920.

AI Group in Santa Clara

The Silicon Valley Computer Society now has a special-interest group devoted to AI. The SIG is open to SVCS members and non-members. Meetings are generally held at the Techmart, off the Great America Parkway in Santa Clara.

Contact: SVCS, 1330 South Bascom Ave., Suite D, San Jose, CA 95128, (408) 286-1271.

Inquiry 923.

Computer Interface Design Seminar

A seminar on how to design computer interfaces will be held at the University of California in Santa Cruz on August 23-25. The seminar will cover designing for performance, reduced error rates, and user satisfaction.

Price: \$895.

Contact: Institute in Computer Science, University of California Extension, Carriage House, Santa Cruz, CA 95064, (408) 429-4535.

Inquiry 924.

Software Quality Conference

The Seventh Annual Pacific Northwest Software Quality Conference will be held September 12-14 in Portland, Oregon. The conference begins September 10 with half-day tutorials.

Capers Jones, noted CASE expert, will deliver the keynote address, and over 400 software professionals are expected. The conference will be held at the Red Lion/Lloyd Center.

Price: \$100.

Contact: Lawrence and Craig, Inc., P.O. Box 40244, Portland, OR 97240, (503) 222-2606.

Inquiry 919.

continued

Dare to Compare our Modem's Quality and Pricing.

2400e Modem	1200i Modem 2400i Modem	9600 Fax/Modem
2400e MNP level 5 Modem	2400i MNP level 5 Modem	VGA / 16
features: (2400e MNP & 2400e) • Supports Microcom Network Protocol which Uses File Compression and Error Checking Techniques to Boost Through-Put as High as 4800 bps. • L.E.D. Display for Call Progress Monitoring • On Board Speaker for Call Progress Monitoring • NOVRAM Stores Telephone Number and User Defined Configuration • CCITT V.22 bis, V.22 Bell 212A, 103 • Hayes® Compatible • 2 year Warranty 2400e..... \$149.95 2400e MNP..... CALL	features: (1200i & 2400i) • CCITT V.22 bis, V.22, Bell 212A, 103 Compatible • Runs on IBM PC, XT, AT, or Compatible • Runs on all Hayes Compatible Softwares • Full or Half Duplex; Dialup Line • Synchronous/Asynchronous Operations • Auto Answer/Auto Dial • NOVRAM Stores Telephone Number and User Defined Configurations SPECIAL PRICES FOR AUGUST 1200i..... \$ 39.95 2400i..... 109.95 2400i MNP..... CALL	features: (Fax Modem) • Internal 9600 Facsimile Modem and 2400/1200 bps. • CCITT V.22 bis, V.22 V.21, Bell 103, Bell 212A and CCITT T.30 Group 3 Compatible • Auto Dialing • Software Support for the CCITT T.30 Encoding and Decoding of: <input type="checkbox"/> ASCII Text Files <input type="checkbox"/> ASCII Files in Epson Printer Format <input type="checkbox"/> Graphic Files • User friendly Software features: (VGA / 16) • Support IBM 8514 Display Resolution of (1024x768, 16 colors) • 16 bit, 8 bit Interfaces • Support Both TTL and ANALOG Monitors • Register-Level Compatibility with the IBM VGA • Downward Register-Level Compatibility with All Existing Graphic Standards (EGA, CGA, MDA, and HERCULES) • Drivers for Running Extended Graphics Mode: Autodesk AutoCAD, Digital Research GEM, Microsoft Windows, and Ventura Publisher.
Osmos Inc. 4151 Business Ctr. Dr. Fremont, CA 94538 Phone: 415-623-1000 FAX: 415-623-1004 \$299.95		

All Our Products Are Made in USA
We Offer Latest Technology at the Best Prices

Volume Discounts Available

© OEM and Private Labeling Available

CALL FOR INFORMATION



Desktop 9-Track Tape Subsystem

Now, 9-track tape lets your micro exchange data with minis and mainframes.



Simply exchange data files on a reel of 9-track tape.



#1 Selling 9-Track Systems on the Desktop

**QUALSTAR**

9-TRACK is the first choice for file interchange among data processing professionals. Now, Qualstar's low cost 1/2-inch 9-track *Ministreamer* tape systems bring full ANSI data interchange to IBM PCs or Macintosh, giving your micro the freedom to exchange data files with nearly any mainframe or minicomputer in the world.

Available in both 7" and 10-1/2" versions, compact Qualstar tape drives can sit on your desktop, using less space than an ordinary sheet of paper. Systems include DOS or XENIX compatible software, coupler card and cables. High reliability 1600 or 6250 BPI capability may be used for disk backup as well as data interchange. Discover the big advantage 9-track tape has over other micro/mainframe links.

Call us today!

FOR DETAILS AND TO ORDER:

FAX (818) 882-4081

PHONE (818) 882-5822

9621 Irontdale Ave., Chatsworth, CA 91311

© 1989 Qualstar Corp.

All product and company names and trademarks are the exclusive property of their respective owners.

Introducing the Smallest 80386 based PC Compatible Single Board Computer Only 4" x 6"

**Quark/PC® II**

- EGA® Video/Color LCD Controller
- SCSI Hard Disk Control
- Up to 4 Mbytes Memory and more

To order or enquire call us today,
Megatel Computer Corporation
 (416) 745-7214 FAX (416) 745-8792
 174 Turbine Drive, Weston, Ontario M9L 2S2

Distributors

Germany - Tech Team (06074) 98031 FAX (06074) 90248
 Italy & Southern Europe - NCS (Italy) (0331) 256-524 FAX (0331) 256-018
 UK - Bersilton (0455) 71011 FAX (0455) 71012
 Australia - Asp Microcomputers (03) 800-0628 FAX (03) 500-9461
 Denmark - Ingeniørfirmaet (02) 440388 FAX (02) 440715
 Finland - Digipoint (3580) 757 1711 FAX (3580) 757 0841
 Norway - AD Elektronik (09) 87710 FAX (09) 875990
 Sweden - (040) 97 10 90 FAX (040) 13 90 38

Quark is a registered U.S. trademark of F. & K. MFG. Co. Ltd. EGA is a registered trademark of IBM Corp.

megatel

WHAT'S NEW

CAD AND GRAPHICS



CAD Overlay lets you import scanned images to VersaCAD. The yellow lines are the scanned raster image, and the other colors are VersaCAD entities drawn over the scanned image.

Versatile VersaCAD Tool

If you've ever had to convert a digitized drawing into a VersaCAD format, you know it is a lengthy process. CAD Overlay saves time and trouble by capturing a scanned image of a paper drawing and importing it quickly into VersaCAD.

You begin by scanning an existing paper drawing. CAD Overlay displays the scanned image in the background of the screen, creating a hybrid image. You can turn off that background image, or move, zoom, or pan it. You can trace over the image with the VersaCAD drawing on the same screen.

Price: \$1000.

Contact: Image Systems Technology, Inc., 120 De-Freest Dr., Rensselaer Technology Park, Troy, NY 12180, (518) 283-8783.

Inquiry 1122.

Scorpion's Raster-to-Vector Conversion

SRV is a batch raster-to-vector conversion program that takes computer files of drawings you've

scanned and converts them to vector images, which can be manipulated with a CAD system. SRV's maker claims that over 90 percent of existing drawings are prime candidates for the conversion process.

The SRV system converts images in the background using Scorpion's Motorola 68030-based coprocessor board. During the vectorization process, the software enhances the image by deleting isolated pixels, filtering out extraneous points on the line work, closing gaps in line segments. It also normalizes line width across a line string and recognizes text, Scorpion reports.

The program retains the raster image on a separate layer so you can view the vector output and the raster data together.

SRV runs on an 80286- or 80386-based PC with Scorpion's coprocessor board.

Price: Software only, \$6000; board and software, \$12,000.

Contact: Scorpion Technologies, Inc., 101 Metro Dr., Seventh Floor, San Jose, CA 95110, (408) 452-0700.

Inquiry 1124.



ScanMan™. Turning imaginations loose everywhere.

Pop any image up to 4" x 11" straight into any IBM personal or Apple Mac™!

Select one, two, three or four hundred D.P.I. Resize, rotate, flip and edit it. With the IBM version, use PaintShow Plus™ (included free) for coloring and shading, then port into any popular publishing program.

With the Mac ScanMan use the Clipboard™ to transfer the image to virtually any application — the Mac ScanMan works just like any Desk Accessory!

ScanMan for the PC — \$309
Multi-Channel version — \$369
Macintosh version — \$499

For your nearest dealer, call:
800-231-7717

In California:
800-552-8885

In Europe:
+ + 41-21-869-96-56
Circle 152 on Reader Service Card
(DEALERS: 153)



We do Windows

Finally, full-featured communications software for Microsoft's Windows

ape (A Programmable Emulator)

- Powerful! Easy-to-use scripting
- Multiple scripts can run concurrently
- Multi-national character set support
- A wide variety of terminal emulations
- Can act as an information switch using DDE
- XModem, XModem1K, YModem, and Kermit protocols
- Built-in line monitor and data capture facility



HI-Q

INTERNATIONAL

1142 Pelican Bay Drive, Daytona Beach, Florida 32019

1-904-756-8988

Site licensing & dealer inquiries welcome
In Europe call TeleSIGMA AB 46-8-735-8560

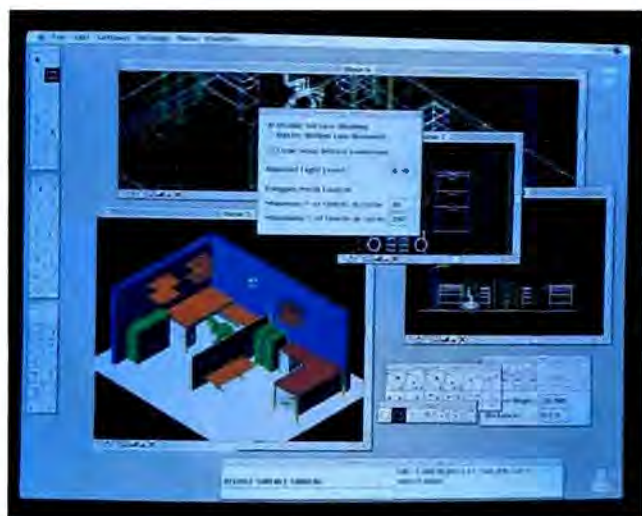

Image of an office floor plan created with MicroStation Mac.

MicroStation Mac

Intergraph's CAD software is now available in a Macintosh version. The two- and three-dimensional design software is compatible with other MicroStation programs, so you can share files without translation, according to Intergraph.

The Mac version features resizable windows, dynamic tool palettes, dialog boxes, and selection sets. You also have a choice between the Mac or the IBM PC interface.

MicroStation Mac supports up to eight separate views of a design for viewing different perspectives and scales. All views are active at the same time and can be placed on up to six monitors.

Input is by mouse, tool palettes, pull-down menus, tablet command menus, or key-ins in the command window. The program imports and exports text and PICT-format data types.

MicroStation Mac runs on the Mac SE/30, II, or Ix with at least 2 megabytes of RAM and a 40-megabyte hard disk drive. You also need System 6.0.2 and Finder 6.1.

Price: \$3300.
Contact: Intergraph Corp., One Madison Industrial Park,

Huntsville, AL 35807, (800) 345-4856; in Alabama, (800) 345-0218.
Inquiry 1121.

\$89 Graphics Software Toolkit

The 3-D Computerscape toolkit helps you create vivid displays and artistic images, according to the program's developers.

The package includes demonstration files and programs with examples of applications in robotics, animation, and solids modeling. You can create solid objects, edit them, and display them. Display options include perspective, animation, three-dimensional rotations, and multiple views.

You can incorporate the program's functions and procedures into Turbo Pascal programs or use the 3-D Drawing Board, a three-dimensional drafting system.

To run 3-D Computerscape, you need an IBM PC with 512K bytes of RAM and an EGA card.

Price: \$89.
Contact: Abbot, Foster, & Hauserman Co., 44 Montgomery St., Fifth Floor, San Francisco, CA 94104, (800) 562-0025 or (415) 955-2711.
Inquiry 1125.

continued

PROTECT INTELLIGENCE WITH INTELLIGENCE



SOFTWARE PROTECTION KEYS BY PROTECH

PROTECH KEYS:

- ☐ are totally transparent to the end user
- ☐ allow unlimited back up copies
- ☐ free up disk drives
- ☐ do not interfere with peripheral operations
- ☐ are easy to install
- ☐ protect software developers' revenues
- ☐ assembler based routines (not drivers)
- ☐ encrypted routines
- ☐ physically unique hardware KEYS
- ☐ sophisticated software installation advice
- ☐ provide the highest level of protection available

THE KEY

The KEY provides effective software protection while insuring customer satisfaction. The KEY is a random response device which is designed for identically reproduced software packages.

THE MEMORY KEY

The MEMORY KEY is a programmable software protection device. Each byte of memory can be addressed in groups or individually. Possible applications for the MEMORY KEY include:

- ☐ modular package control
- ☐ serialization
- ☐ customization
- ☐ access control to PCs
- ☐ demo control
- ☐ software leasing
- ☐ updating modules in the field
- ☐ any "counter" operation

For a demonstration package or additional information, please write or call:

1-800-843-0413

PROTECH MARKETING, INC.
4905 Pine Cone Drive • Building 10
Durham, North Carolina 27707
(919) 490-4970 FAX (919) 490-4974

WE HAVE THE KEY TO SOFTWARE COPY PROTECTION



386SX

The New ZEOS 386SX Hard Drive System. Below '286 Prices! Only \$1895.00

The future is now!

PC Magazine says "386SX-based machines are the right choice..." the new ZEOS 386SX is why. The future is yours now with the new ZEOS 386SX. It's even priced below comparable 286 systems!

- 80386SX-16 CPU, 8/16MHz Dual Speed Keyboard Selectable. Reset/Turbo buttons.
- 512K DRAM, expandable to 8MB on board (16MB System Total).
- Shadow RAM and EMS capability.
- Fast 32MB Seagate 138R Hard Drive, 1.2MB FDD
- Ultra high speed Hard/Floppy controller. 1:1 interleave, 800 KB/second transfer rate.
- Genuine Hercules® brand graphics controller. High-Res Amber Display with Tilt/Swivel.
- ZEOS Enhanced Tactile/Click keyboard.
- High Speed Serial and Parallel ports.
- 6-16, 2-8 bit expansion slots. 80387SX Math coprocessor support.
- ZEOS space saver case. Including Security Lock and LED indicators.



386DT

Complete ZEOS 20MHz '386 System. 80MB SCSI Drive! Only \$2995.00

16 MHz systems from \$2295!

The new '386 desktop standard. Featuring our 64K CACHE (twice that of most competitors) providing Zero-Wait State performance vastly superior to page/interleave memory schemes. Incredible value.

- High speed Zero-Wait 64K SRAM CACHE.
- Genuine 32-bit Intel 80386-20MHz CPU.
- 1MB of Zero-Wait DRAM Expandable to 16MB System Total.
- Fast 80MB, 28ms SCSI Seagate Hard Drive, 1.2MB Floppy Drive.
- High speed HDD/FDD SCSI Host Adapter with Software.
- Genuine Hercules® brand graphics controller. High-Res Amber Display with Tilt/Swivel.
- 101 Key ZEOS Tactile/Click keyboard.
- High speed Serial and Parallel Ports.
- 1-32, 6-16 and 1-8 bit slots.
- 80387 math coprocessor support.
- ZEOS 5-bay case. Including Security Lock and LED indicators.



386/V

Complete 25MHz '386 Vertical System. 80MB SCSI Drive! Only \$3995.00

Complete 33MHz systems only \$4995!

ZEOS 25MHz and 33MHz 80386 systems are the fastest, most advanced available anywhere. Review after review, these ZEOS systems are selected as the best price/performance buys. A power-user's dream.

- High Speed Zero-Wait 64K CACHE.
 - Genuine 32-bit Intel 386-25 or 33MHz CPU.
 - 1MB Zero-Wait 32-bit DRAM expandable to 8MB on board plus 16MB 32-bit expansion (24MB total).
 - Fast 80MB, 28 ms SCSI Seagate Hard Drive, 1.2MB Floppy Drive.
 - High speed HDD/FDD SCSI Host Adapter with software.
 - Genuine Hercules® brand graphics controller. High-Res Amber Display with Tilt/Swivel.
 - 101 Key ZEOS Tactile/Click keyboard.
 - High Speed Serial and Parallel Ports.
 - 1-32, 6-16 and 1-8 bit slots.
 - 80387 and Weitek 3167 support.
 - Heavy Duty 6-bay Vertical Case.
- Desktop configurations deduct \$150.00!

Options Galore: As PC Magazine said, "more options than even the most configuration hungry hound could possibly need." Including 14" VGA, add only \$595. And incredible selection of hard drives: SCSI, RLL, ESDI or MFM and virtually any other add-on you could want! Corporate leasing plans are available, too. Call Toll Free for details 800-423-5891.



**Order Now Toll Free
800-423-5891**

FAX Orders Dial: 612-633-1325
In Minnesota Call: 612-633-4591
MasterCard, VISA and COD
Open days, evenings and weekends
Se habla Español.

Circle 285 on Reader Service Card



286 SS

Complete 12MHz '286
with 32MB Hard Drive!

Only \$1395.00

It's the fastest '286-12 you can buy. Workhorse of the industry. Rugged from the ground up. This true Zero-Wait state system features a fast Seagate auto-park hard drive. Nothing can touch it!

- 80286-12 CPU, 6/12MHz Dual Speed Keyboard/hardware selectable. Reset and Turbo buttons right up front.
- Zero-Wait State DRAM, 512K expandable to 4MB on the motherboard (16MB System Total), EMS capability!
- Fast 32MB Seagate 138R Hard Drive with auto-park, 1.2MB Floppy Drive.
- Ultra high speed Hard/Floppy controller. 1:1 interleave, 800 KB/sec transfer rate.
- Genuine Hercules® brand graphics controller. High-Res Amber Display with Tilt/Swivel.
- ZEOS Enhanced 101 Key Keyboard, with Pleasant Tactile/Click Feel.
- Serial and Parallel Printer Ports.
- Clock/Calendar with Battery Backup.
- 6-16 and 2-8 bit expansion slots.
- 80287 support.
- Heavy Duty Case complete with Security Lock and LED indicators.

20MHz '286 HARD DRIVE SYSTEM

286/20—At 20MHz, the fastest '286. Complete with our 32MB, 33ms Hard Drive and 1MB RAM. This is what Dazzling Speed is all about. Only \$2095.00

ZEOS[®]

"For Overall Excellence.."

PC Magazine, May 30, 1989

"Out of 104 machines from 58 companies...for overall excellence in both the 16- and 20MHz categories, we selected ZEOS International's 386-16 and 386-20" PC Magazine, May 30, 1989

In the May 30th issue PC Magazine reviewed 104 machines from 58 manufacturers. Virtually every '386 in production was tested. The systems were grouped into three speed categories, 16, 20 and 25MHz. In two of the three categories *only one* company was selected for "overall excellence." That company is ZEOS.

The selection of ZEOS over IBM, Compaq and all others is a direct reflection of our goals and objectives. Simply, to deliver to you the very best *value* in computing today. To further quote *PC Magazine:*

"Price is always a consideration. So are benchmark results. But both factors can be deceiving, which is why we consider other aspects that will make the difference months and years down the road. Things like quality of construction, reliability, expandability and ease of service."

These are the qualities PC Magazine used when selecting ZEOS over 57 others. These are the qualities we build into each and every ZEOS system. And that's our commitment to you. To quality. To performance. To reliability and support. To *Value*. Comparing ZEOS to virtually every other manufacturer in the world *PC Magazine* called it "overall excellence."

In *all areas* ZEOS systems are top performers. Take our guarantee for instance. We offer every customer a 30 day Full Refund Satisfaction Guarantee. And that's backed up by our Full One Year Limited Warranty and our Express Parts Replacement policy.

And then there's Technical Support. At ZEOS, Technical Support is not only free, it's *Toll Free*. Seven days a week, 365 days a year.

Quality. Performance. Reliability and Support. *Overall Excellence*. That's why ZEOS is PC Magazine's #1 choice. And that's why ZEOS is *your best choice* as well. So pick out your dream machine today and order it now with confidence. Your choice of ZEOS excellence is *Guaranteed*. Order now by calling 800-423-5891.



All prices and specifications are subject to change without notice. Please call for current pricing and warranty details. ZEOS is a publicly traded company, MPLS. St. Paul Local OTC. © 1989 ZEOS International, Ltd., 530 5th Avenue, N.W., St. Paul, MN 55112. IBM is a registered trademark of IBM Corporation, Compaq is a registered trademark of Compaq Computer Corporation.

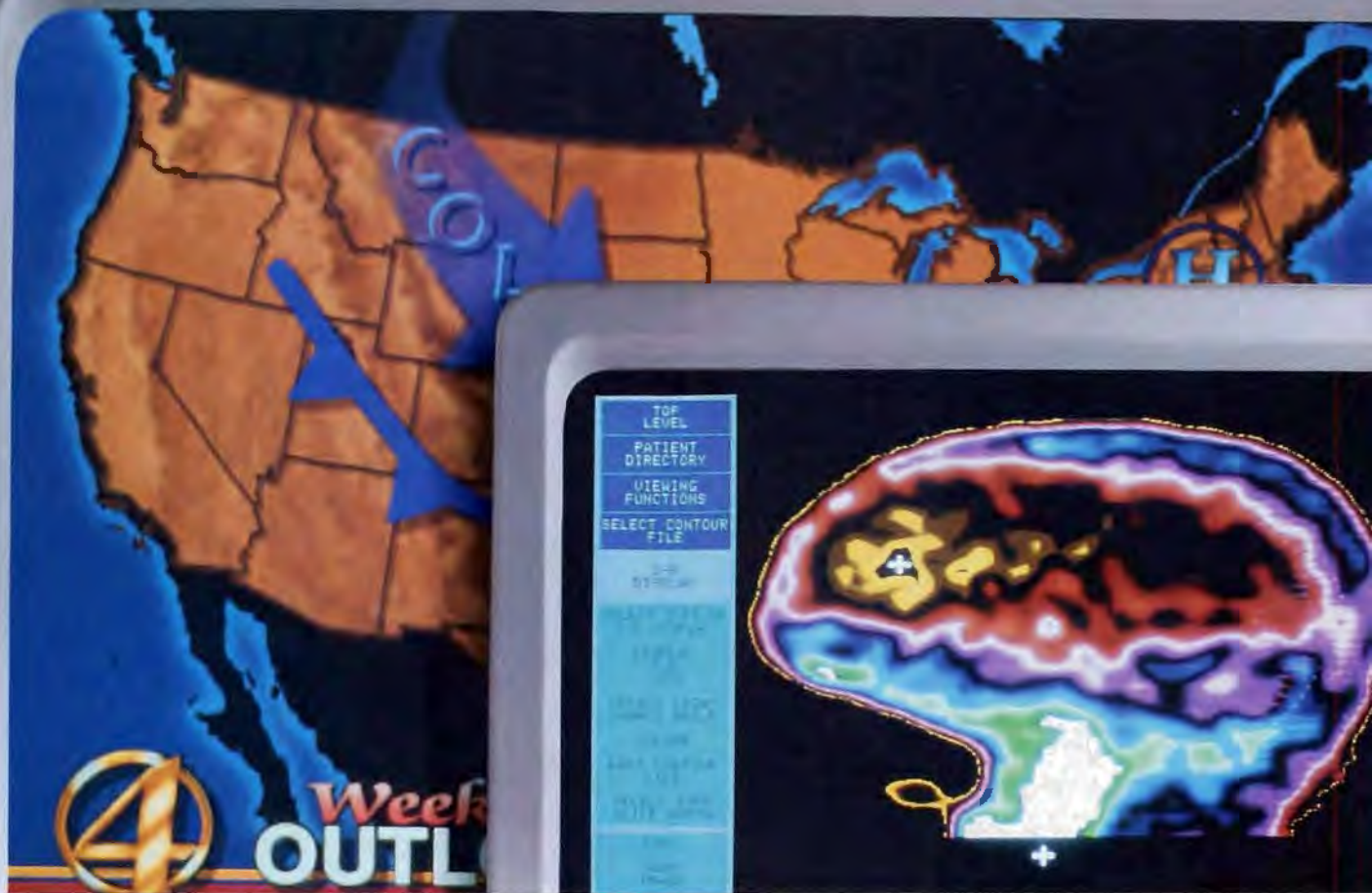

How Telebit modems can give you a graphic description in no time.

When you need error-free graphics in seconds, you need a Telebit® high-speed, dial-up modem. Because only our modems can meet the critical demands of graphics.

Like transferring medical images for diagnoses — where a lost pixel can be life-threatening, and where nearly perfect isn't nearly good enough. Which is why a major East Coast hospital chose Telebit. Now they're sending 1 million bytes of critical data from a graphics-plot screen in seconds, error-free.

That's also why a national weather service picked Telebit to collect real-time weather information at U.S. radar sites. Only Telebit modems made the connection every time.

Imagine what Telebit modems will do for you.
On all applications, from CAD/CAE/CAM

Circle 246 on Reader Service Card

and electronic publishing to point of purchase, remote diagnostics, and more.

All with our family of high-speed modems. From 9600 bps to 19,200 bps, including V.32.

To get the graphic details and a free application brochure, call 1-800-TELEBIT or 415/969-3800.

Or write Telebit, 1345 Shorebird Way, Mountain View, CA 94043.

Because no one gets the message through like Telebit.

© 1989, Telebit is a registered trademark of Telebit Corporation. Other product names are trademarks of their respective holders. Medical image courtesy of Ramtek. Map courtesy of ColorGraphics Systems, Inc. — a Dynatech Co.



TELEBIT®
When connectivity counts.

AUGUST 1989 • BYTE 75

Want to save Time, Money,
& Headaches?



GET SUPERSOFT'S
SERVICE DIAGNOSTICS

All the software, alignment diskettes, parallel/serial wrap-around plugs, ROM POSTs and extensive, professional documentation to provide the most comprehensive testing available for IBM PCs, XTs, ATs and all compatibles under DOS or Stand Alone. No other diagnostics offers such in-depth testing on as many different types of equipment by isolating problems to the board and chip level.

NEW: SuperSoft's ROM POST performs the most advanced Power-on-Self-Test available for system boards that are compatible with the IBM ROM BIOS. It works even in circumstances when the Service Diagnostics diskette cannot be loaded.

NEW: 386 diagnostics for hybrids and PS/2s!

For over nine years, major manufacturers have been relying on SuperSoft's diagnostics software to help them and their customers repair microcomputers. End users have been relying on SuperSoft's Diagnostics II for the most thorough hardware error isolation available. Now versions of Service Diagnostics are available to save everyone (including every serious repair technician) time, money, and headaches in fixing their computers, even non-IBM equipment.

All CPUs & Numeric Co-processors	All Color Graphics & Monochrome
System Expansion & Extended Memory	Monitors
Floppy, Fixed & Non-standard Disk Drives	Parallel & Serial Ports
Standard & Non-standard Printers	Mono, CGA, Hercules & EGA
System Board, DMA, Timers, Interrupt	Adapters
Real-time Clock & CMOS config. RAM	All Keyboards & the 8042 Controller

Join the ranks of XEROX, NCR, CDC, SONY, PRIME, ... who have bundled SuperSoft's diagnostics with their microcomputers at no risk because of our 30 day money back guarantee.

Service Diagnostics for PC, PC/XT, and compatibles only	\$169
Alignment Diskette for PC, PC/XT and compatibles (48 tpi drives)	\$ 50
Wrap-around Plug for PC, PC/XT and compatibles (parallel and serial)	\$ 30
Service Diagnostics for AT and compatibles only	\$169
Alignment Diskette for AT and compatibles (96 tpi drives)	\$ 50
Wrap-around Plug for AT (serial)	\$ 15
ROM POST for PC, PC/XT and compatibles only	\$245
ROM POST for AT and compatibles only	\$245
Service Diagnostics: The KIT (includes all of the above—save \$502)	\$495
Service Diagnostics for 386 or V2, V30, or Harris, etc. (please specify)	\$195
Diagnostics II is the solution to the service problems of users of all CP/M-80, CP/M-86 and MS-DOS computers	\$125
ROM POST for PS/2 and compatibles only	\$245
Alignment Diskette for PS/2 and compatibles (3.5 inch)	\$ 50

To order, call 800-678-3600 or 408-745-0234
FAX 408-745-0231, or write SuperSoft.

your microcomputer repair solution

SuperSoft

FIRST IN SOFTWARE TECHNOLOGY P.O. Box 611328, San Jose, CA 95161-1328 (408) 745-0234 Telex 270385

SUPERSOFT is a registered trademark of SuperSoft, Inc., CDC of Control Data Corp., IBM PC, AT & XT of International Business Machines Corp., MS-DOS of Microsoft Corp., NEC of NEC Information Systems, Inc., PRIME of PRIME, INC., Sony of Sony Corp.

lar and graphical form.

You can access graphical diagrams in the program and use them to illustrate the dynamic and kinematic profiles over the full 360 degrees of cam motion, according to MicroAnalysis.

CamDes is error-trapped and includes flagging options that point out possible deficiencies in the cam design. You can store and retrieve your designs for later use.

Ten standard kinematic motions are supported, and the program handles plate, barrel, and linear cams.

To run CamDes, you need an IBM PC with 384K bytes of RAM, DOS 2.0 or higher, and a CGA or EGA card.

Price: \$89.

Contact: MicroAnalysis Software, 26148 Tallwood Dr., North Olmsted, OH 44070, (216) 779-9523.

Inquiry 1111.

Low-Cost High-Resolution Scientific Graphics

Plotting technical or scientific graphs from data entered into text windows is what Edtech does best. The program reads and writes from or to data in its own database files, WKS files, or ASCII text files.

Edtech's graphics screen editor lets you size and position graphs, labels, and diagrams at arbitrary positions on the page.

The program supports Epson LQ or Toshiba P321 printers and provides hard copy at 180 by 180 dpi. A page is 1440 dots horizontally by 1800 dots vertically.

Greek and mathematical symbols are also available.

The program runs on the

IBM PC with 640K bytes of RAM. You also need a 24-pin printer and a CGA, EGA, or Hercules graphics adapter. A math coprocessor is recommended.

Price: \$65.

Contact: Digital Analytics, P.O. Box 31430, Houston, TX 77231, (713) 721-2069.

Inquiry 1110.

A Partner in the Lab

LabSolutions automates multicomponent solution and buffer preparation calculations.

For chemical reagents, you specify the concentrations desired, and the program calculates the amounts of components needed. For buffers, you specify the pH, and the program calculates the amounts of each buffer form or the amounts of common acids or bases needed.

The program accepts all standard units of weight, volume, and concentration. Molecular weights are calculated from atomic formulas or chemical names.

Routines are also included for mixing and diluting solutions.

A database of chemicals, buffers, and acids is included, which you can modify with your own entries. You can also store your solution recipes on disk or print hard copies.

LabSolutions runs on the IBM PC or PS/2s with 256K bytes of RAM.

Price: \$99.

Contact: The Center for Science Support, Inc., 54 Brattle St., Arlington, MA 02174, (617) 646-1466.

Inquiry 1112.

continued

LIMITED OFFER

Pay us the street price for Quattro and we'll give you the keyboard to drive it with.



\$149.95 buys you *both* the hot-selling spreadsheet and the TurboCalc-111 Keyboard/Calculator.

For just \$149.95—less than Quattro's street price, and a lot less than its \$247.50 suggested retail price, you can now get *both* Borland's best-seller and the keyboard you need to drive it at top speed. Namely, the TurboCalc-111 Keyboard/Calculator from Datadesk. **Boost your overall performance.** With its built-in, presentation-quality graphics, intelligent recalls, unlimited macros, easy installation and compatibility with leading spreadsheet and database software, Quattro is made to order for your business. And TurboCalc-111 is made to order for Quattro. Or for any other software you like to drive. Because, as you can see, it's loaded with features designed to turbo-



"More than 1-2-3" at less than half the cost." That's what PC Magazine says about Quattro, the hot-selling spreadsheet from Borland. Imagine what they'll say about this extraordinary deal!

charge your spreadsheet and typing performance. Like our famous tactile, positive-response keys that give you a much better feel for the road. So you can type faster with fewer mistakes than ever before. And the new, enhanced IBM™101-key layout with some logical improvements—including separate numeric and cursor keys that let you cruise through spreadsheet data entry without ever having to shift Num Lock. **Get better mileage from your desktop.** In case you haven't noticed already, the keypad doubles as a full-function business calculator complete with its own pop-up LCD display. Which saves space on your desktop and lets you perform any calculation with a single keystroke—no matter what software you're driving. What's more, the keypad packs a solar panel, so you can start up the calculator even when your computer is idle. **We wouldn't steer you wrong.** Frankly, getting into a Datadesk key-

board would be an inspired idea at this price even if you didn't get Quattro in the bargain. After all, as *InfoWorld* says, "if you haven't looked at Datadesk's keyboards, you ought to." According to the Washington Post, "for ingenuity of design and sheer dollar value, Datadesk can't be beat." And when it comes to your peace of mind, nothing beats our two-year warranty. What's more, if Quattro and TurboCalc-111 don't blow the doors off the vehicles you're currently driving, just

send them back within 30 days and we'll cheerfully refund your \$149.95. No questions asked. How, you ask, can you take advantage of this remarkable offer? Just fill out the coupon and send it in. Better yet, call us toll-free. And tell us to step on it.



RISK-FREE

\$149.95 Bundle includes Datadesk's TurboCalc-111 Keyboard/Calculator for IBM™ and compatibles and Borland's Quattro spreadsheet. Add \$10 shipping and handling per unit (Continental U.S. only). CA residents please add \$9.75 sales tax per unit.

of Units: _____ Amount Enclosed: _____

Computer Type*: _____ Disk Size: 3 1/2" 5 1/4"

*If PS/2, include additional \$5 for cable adapter.

Payment: VISA MC AMEX CHECK BY

Card No: _____ Exp. Date: _____

Name _____

Company Name _____

Daytime Telephone _____ Address _____

City _____ State _____ Zip _____

Mail to: Datadesk, 7651 Haskell Ave., Van Nuys, CA 91406. FAX: (818) 780-7307

Or Call: (800) 826-5398. In CA, Call: (800) 592-9602

30 DAY MONEY-BACK GUARANTEE

Now you can use YOUR favorite graphics package with Microstat-II.

Just some of the packages covered include *3-D Perspective Jr.*, *Harvard Graphics*, *Microsoft's Chart*, *Grapher*, and others.

Microstat-II also includes new procedures for:

- Canonical Correlation
- Factor Analysis
- MANOVA
- Discriminant Analysis
- Principal Components Analysis
- Cluster Analysis
- Covariance Analysis

While Release 1.0 was good:

"... one of the fastest IBM PC statistical packages we have tested... using Microstat-II is a breeze."

Infoworld

"Installation of Microstat-II is simple... The user interface is clean... a pleasant package to use..."

PC Magazine

Microstat-II Release 2.0 is even better!

For a limited time, you can purchase Microstat-II Release 2.0 for \$395.00. Microstat-II requires an IBM PC, XT, AT, PS2 or compatible with 512K memory or more with either a hard disk or two floppy drives. For more information, contact your local computer dealer or call:

Ecosoft, Inc.

6413 N. College Ave.
Indianapolis, IN 46220
Orders: 1-800-952-0472
Info: 1-317-255-6476
FAX: 1-317-251-4604

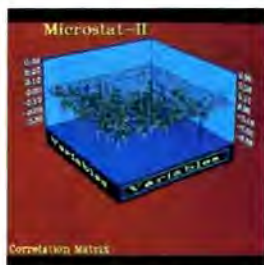

3-D Perspective Jr.

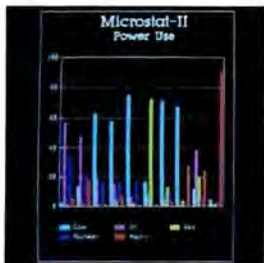

Harvard Graphics

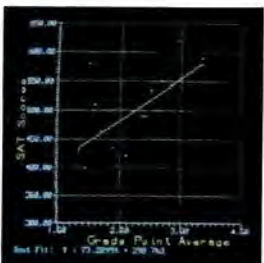

Grapher

ECOSOFT

Moving Numbers on a Mac

Mathematicians' software needs vary from simple equation processing to sophisticated plotting and modeling. Two recently released programs for the Macintosh take very different approaches to the task of number manipulation.

Formulator lets you merge text with your numbers. It is an equation processor that offers a WYSIWYG display and has a built-in text editor. Mathematical typesetting features let you italicize variables, change type size, insert space between operations, and alter the position of delimiters.

You can insert, delete, and copy anything from a symbol to a whole formula—within a document, or from one document to another, according to ICOM Simulations.

The program includes the Magnifying Glass icon, which doubles the size of a document for easy editing of small characters; the Greek icon, which opens a palette containing the Greek character set; and Left, Center, and Right Justify icons, which let you choose how to justify lines of text, formulas, elements in a formula, and columns in matrices. The program also contains a full library of symbols.

Formulator outputs in TEX. The program runs on the Mac Plus, SE, and II.

Price: \$149.95.

Contact: ICOM Simulations, Inc., 648 South Wheeling Rd., Wheeling, IL 60090, (312) 520-4440. **Inquiry 1108.**

An all-new version of the equation-solving program TK Solver Plus combines equation solving with knowledge management.

You can use the program as a basic equation solver and scientific calculator to solve sets of simultaneous linear or nonlinear equations. You enter equations as you see them.

TK Solver Plus is a rule-based declarative language that lets you solve problems using an object-oriented method. Interactive tables supply a spreadsheet-like format for input and output of user-defined functions.

You can produce high-resolution line, bar, and pie charts as well as tables of data using TK Solver Plus. You can also plot multiple curves in the same graph and any number of graphs in the same model. A whole model or any part can be saved or added to other models using a cut-and-paste approach. You can transfer data between TK Solver Plus and other programs via files in WKS, WK1, DIF, or ASCII format.

Universal Technical Systems, designer of TK Solver Plus, reports that all versions of TK Solver are compatible, so you can port data from Mac to DOS environments.

TK Solver Plus runs on any Mac from the 512KE up.

Price: \$395.

Contact: Universal Technical Systems, Inc., 1220 Rock St., Rockford, IL 61101, (800) 435-7887 or (815) 963-2220. **Inquiry 1109.**

Cam Design

CamDes assists you in designing and analyzing cams and cam-driven mechanisms.

To use the program, you describe the motion requirements of the cam, followed by selecting from known kinematic profiles. Information is output to screen, printer, or disk and is calculated in tabu-

continued

3-D Perspective Jr., Harvard Graphics, Grapher, Microsoft's Chart and IBM are all registered or unregistered trademarks of the following companies respectively: 3-D Graphics, Inc., Software Publishing Corp., Golden Software Inc., Microsoft Inc., IBM Inc.

GO AHEAD, MAKE YOUR DAY

Point-and-Pick Your Applications

Choose the application you need quickly and easily directly from the menu—or even another application!

Run Several Tasks at Once

Switch instantly between active tasks in different applications at the touch of a keystroke!

Move Data Between Applications

Share data easily between applications like SCO™ Lyrix,™ SCO Professional,™ and SCO Integra™ with the electronic Clipboard!

Print While You Work

Move on to your next job while your last one is printing out—on a local or shared workgroup printer!

Link Up Your Business with Electronic Mail

Exchange messages and files—even spreadsheets and graphics—across the office or around the world!

Talk Across The Office

Instantly converse with other system users, screen-to-screen, with the handy Intercom!

Locate Business Contacts Instantly

Store, update, find, and sort addresses and phone numbers quickly and easily with the time-saving Directory!

Schedule Meetings and Resources

Check others' Calendars online for available times—then schedule and notify them automatically!

Calculate Within Any Application

Put the four-function, "running-tape" capabilities of an online Calculator right at your fingertips!

Add Only the Applications You Need

Build your own customized solution by adding individual applications as you need them!



WITH THE SCO PORTFOLIO WORKGROUP SOLUTION

Get the competitive edge with the SCO Portfolio™ integrated workgroup solution!

Teamed with the world's most popular UNIX® System—SCO System V—the SCO Portfolio solution turns the 386™ personal computer into a workgroup powerhouse.

What's more, users only need to know how to use their familiar applications in order to put the amazing power of the UNIX System to work immediately.

With SCO Portfolio and the SCO Portfolio family of business applications, everyone in a workgroup can perform virtually any business task—from writing reports and creating financial analyses, to scheduling meetings and exchanging messages—far more productively than ever. And all using a single, standard—and cost-effective—386-based PC!

Get started today with SCO Portfolio Suite, and get all the advantages of a fully-integrated office system without compromising the functionality of full-featured business applications—all in one economical package.

SCO Portfolio Suite integrates the powerful SCO Lyrix word processing system, the SCO Professional 1-2-3® workalike, and the SCO Integra industry-standard-SQL database, with SCO Portfolio's convenient desktop tools, customizable menu system, and electronic clipboard—and lets you add any other software of your choice under its easy-to-use menu, as well.

Contact your SCO authorized supplier or call (800) 626-UNIX (626-8649) for more information about SCO Portfolio and SCO Portfolio Suite and find out how easy it is to make your day—today!



(800) 626-UNIX (626-8649)
(408) 425-7222
FAX: (408) 458-4227
E-MAIL: ...!uunet!sco!info info@SCO.COM

Integrate Text and Graphics in Windows

Precision Software's Superbase 2 Windows is a DBMS that lets you tag TIFF, PCX, and IMG images to a record. It includes an editor, mail merge, label printing, and communications capabilities with its data management features.

Superbase 2 Windows features a VCR-like control panel on the bottom of the screen that allows you to quickly browse forward or backward and pause among up to 999 index sequences. You can also use it to select a subset of records from within a field and access files by index category.

Other features include validation, multiple response, time, calculated and virtual fields, date parsing, and cross-file lookup capability. You can import and export data from Excel, Lotus 1-2-3 versions 2.1 and 2.2, dBASE II and III, and ASCII.

Superbase 2 Windows includes a run-time version of Windows 2.03.

Price: \$295.

Contact: Precision Software, 8404 Sterling St., Suite A, Irving, TX 75063, (214) 929-4888.

Inquiry 1113.



Influence does the dialing for you.



Superbase 2 Windows is a database manager with a VCR-like control panel that allows quick browsing.

Hold the Phone

The telephone works as a valuable tool for some, but for others it's just plain annoying. Vartek's Influence is a phone dialer and database that may alleviate at least some telephone tedium.

Influence stores over 10,000 names with addresses, phone numbers, and descriptions. You can access that information by category, keyword, or name. And the program acts as a dialer and a follow-up file.

When you receive a call, you enter the first two letters of the caller's name, and the program shows you all the contacts with that last name. You can flip through the information while you're on the phone, and you can add to it with follow-up information. The program runs on the IBM PC with 385K bytes of RAM and a hard disk drive.

Price: \$98.

Contact: Vartek, 3 Regent St., Suite 304, Livingston, NJ 07039, (201) 740-1750.

Inquiry 1116.

On the Road Again

Keeping track of business expenses you incur while on the road can be inconvenient at best, but WorkSmart Technologies has a solution. ExpenseSmart lets you fill out your expense reports while you're on the fly.

Designed for laptops, the program keeps your keystrokes to a minimum, according to WorkSmart. You can customize the program with whatever expense categories you need, reimbursement levels, and method of payment.

This menu-driven program works with DOS-based systems that have at least 512K bytes of RAM, and it comes in both 5¼- and 3½-inch formats.

Price: \$79.95.

Contact: WorkSmart Technologies, 5700 Hillcrest Dr., Suite PL, Lisle, IL 60532, (312) 963-2935.

Inquiry 1117.

New Excel to Break 1-megabyte Barrier, Support BIFF

The new version of Excel overcomes the 1-megabyte limit of earlier versions with its ability to address a full 8 megabytes of Macintosh RAM, Microsoft reports.

Excel 2.2 uses the Binary Interchange File Format, also used by Windows. With BIFF, you can transfer and use spreadsheets, macros, and charts between platforms without having to convert them.

The program supports the sparse-matrix method of memory management, which allocates memory to cells only where you've entered data, increasing the efficiency of memory use, Microsoft reports. You can now use up to 256 fonts in a single spreadsheet and adjust row heights to accommodate larger font sizes or highlight particular entries.

Other improvements of the program include the ability to use cell notes to specify assumptions on a cell-by-cell basis, and the use of precedents and dependents for checking proper derivation of cell values. You can also search and replace a particular entry.

Microsoft has added 200 macro functions and a macro library for common operations such as consolidation and cross-tabulation.

Excel 2.2 runs on the Mac Plus or higher with System 6.0.2 or higher. HyperCard 1.2 is required for a training module with lessons on the basics, worksheets, charting, and databases.

Price: \$395.

Contact: Microsoft Corp., 16011 Northeast 36th Way, P.O. Box 97017, Redmond, WA 98073, (206) 882-8080.

Inquiry 1114.

continued

Quarterdeck

DESQview 2.2 and DESQview 386. The multitasking, windowing environments that work with your favorite software.

DESQview™ is the operating environment that brings OS/2™ power to DOS. And it lets you, with your trusty 8088, 8086, 80286, or 80386 PC, leap into the next generation in PC productivity. For not much money. And without throwing away your favorite software.

Introducing DESQview 2.2

And now, DESQview 2.2 adds capabilities, performance, and compatibility enhancements you've been asking for:

Like being able to fine tune DESQview performance "on the fly." Run Lotus Express and Metro. And the Intel Connection Co Processor. Even use the DOS 4.0 shell with DESQview. Have DESQview automatically install Quattro, Sprint, Aldus PageMaker, Microsoft Excel, Word Perfect, Dataease and as many as 80 other programs. And using the DESQview API, be able to dynamically link them.

More bang; less bytes

While other programs get bigger, we've worked to make DESQview smaller. And we've succeeded in a big way on PCs and PS/2s with extended, EMS 3.2 (AboveBoard), EEMS and EMS 4.0 memory—as well as on 386 PCs and



DESQview lets you run your favorite programs in windows side-by-side.

PS/2s. For example, DESQview overhead on EMS 4.0 and 386 PCs can be as low as 10K on EGA/VGA PCs. And DESQview actually *increases* memory 30K on CGA PCs; 20K on monochrome and Hercules PCs. That's good news for users of big desktop publishing, CAD and database programs.

Introducing DESQview 386

For users of 80386 PCs and PS/2s (or PCs with 80386 add-in boards, such as the Intel Inboard 386), there's DESQview 386 (a combination of DESQview 2.2 and the new QEMM-386

Quarterdeck Expanded Memory Manager, version 4.2).

DESQview 386 gives you extraordinary power. Run text, CGA, EGA, VGA, and Hercules programs in windows and in the

background. Run 32-bit 386 programs, like Paradox 386, and IBM Interleaf simultaneously with your favorite DOS programs. All with the speed and performance you expect out of your 386. And with protection against 'misbehaved' programs.

Promise and performance

And, of course, both DESQviews have all the features that made prior versions the popular choice in operating environments. The ability to multitask in 640K and beyond. View programs in windows or full screen. Transfer data. Access DOS via menus. Dial your phone. And create keystroke macros within and between programs.

Our story gets better and better

If there's any doubt about our commitment to your PC and PS/2 productivity, just look at our accomplishments over the years. We think you will understand why GE, Ford, Aetna, Monsanto, and so many other major corporations use DESQview.

And why PC Magazine twice gave DESQview its Editor's Choice Award for "The Best Alternative to OS/2," why readers of InfoWorld voted DESQview "Product of the Year" three times. Why, by popular vote at Comdex Fall for two years in a row, DESQview was chosen "Best PC Environment" in PC Tech Journal's Systems Builder Contest, and just won their "Professional Solutions" Award.

DESQview lets you have it all now.



Quarterdeck Delivers.

QEMM. Break the 640K barrier for \$59.95

Your 80386 PC, IBM Personal System/2 Model 80, PC or AT with 80386 add-in board, as well as your IBM Personal System/2 Models 50 or 60 can all break through the DOS 640K barrier. Now you can have maximum use of your memory—whether you have one megabyte or 32—with the Quarterdeck Expanded Memory Manager. All without having to purchase special expanded memory boards.

QEMM uses hidden features within your existing memory to make it compatible with the Lotus-Intel-Microsoft Expanded Memory Specification (EMS) version 4.0.



Now you can run colossal spreadsheets, databases, and CAD models designed for expanded memory, using Lotus 1-2-3, Symphony, Framework, Paradox, AutoCAD, Excel and more.

And if you'd like to use these programs all together—multitasking beyond 640K—QEMM works with our popular DESQview multitasking environment.

If you are one of the 12 million or so 8088, 8086 or 80286 PC users who feel left out, don't despair. We have options that let you keep your computer and favorite programs and give you today what the newest PCs and operating systems are promising for the future.

Visit your dealer for more information on barrier-breaking Quarterdeck products.

DESQview API Toolkit. New C and Pascal Libraries, Debugger, Panel Designer. And more.

**DESQview API
Conference '89**
Coming in August
Write for details

API Reference Manual

The key to the power of the DESQview API, our Reference Manual contains all you need to know to write Assembly Language programs that take full advantage of DESQview's capabilities. And there's an 'include' file with symbols and macros to aid you in development.

API C Library

Here are C language interfaces for the entire set of API functions. It supports the Lattice* C, Metaware* C, Microsoft* C, and Turbo C compilers for all memory models. Included with the C Library package is the API Reference Manual and source code for the library.

API Pascal Library **NEW!**

The Pascal library provides interfaces for the entire set of API functions. It supports Turbo Pascal V4.0 and V5.0 compilers. Included are the API Reference Manual, source code for the library, and example programs.

API Debugger

The DESQview API Debugger is an interactive tool enabling the API programmer to trace and single step through API calls from several concurrently running DESQview-specific programs. Trace information is reported sym-

bolically along with the program counter, registers, and stack at the time of the call. Trace conditions can be specified so that only calls of interest are reported.

API Panel Designer

This interactive tool helps you design windows, menus, help screens, error messages, and forms. It includes an editor that lets you construct an image of your panel using simple commands to enter, edit, copy, and move text, as well as draw lines and boxes. You can then define the characteristics of the window that will contain the panel, such as its position, size, and title. Finally, you can specify the locations and types of fields in the panel.

The Panel Designer automatically generates all the DESQview API data streams necessary to display and take input from your panel. These data streams may be grouped into panel libraries and stored on disk or as part of your program.

More Tools are Coming

Quarterdeck is committed to adding tools as needed by our users. To that end we have been working with Ashton Tate and Buzzwords International on dBASE III and dBASEIV translators. And in the works, we have BASIC and DOS Extender libraries.

Quarterdeck

Quarterdeck Office Systems, 150 Pico Blvd., Santa Monica, CA 90405 (213) 392-9851
FAX: (213) 399-3802

For additional information, please use the following Reader Service numbers: DESQview: #207 QEMM: #208 API Tools: #209 API Conference: #210



QNX vs. OS/2 UNIX

QNX®: Bend it, shape it, any way you want it.

ARCHITECTURE If the micro world were not so varied, QNX would not be so successful. After all, it is the operating system which enhances or limits the potential capabilities of applications. QNX owes its success (over 75,000 systems sold since 1982) to the tremendous power and flexibility provided by its modular architecture.

Based on message-passing, QNX is radically more innovative than UNIX or OS/2. Written by a small team of dedicated designers, it provides a fully integrated multi-user, multi-tasking, networked operating system in a lean 148K. By comparison, both OS/2 and UNIX, written by many hands, are huge and cumbersome. Both are examples of a monolithic operating system design fashionable over 20 years ago.

MULTI-USER OS/2 is multi-tasking but NOT multi-user. For OS/2, this inherent deficiency is a serious handicap for ter-

minal and remote access. QNX is both multi-tasking AND multi-user, allowing up to 32 terminals and modems to connect to any computer.

INTEGRATED NETWORKING Neither UNIX nor OS/2 can provide integrated networking. With truly distributed processing and resource sharing, QNX makes all resources (processors, disks, printers and modems anywhere on the network) available to any user. Systems may be single computers, or, by simply adding micros without changes to user software, they can grow to large transparent multi-processor environments. QNX is the mainframe you build micro by micro.

PC's, AT's and PS/2's OS/2 and UNIX severely restrict hardware that can be used: you must replace all your PC's with AT's. In contrast, QNX runs superbly on PC's and literally soars on AT's and PS/2's. You can

run your unmodified QNX applications on any mix of machines, either standalone or in a QNX local area network, in real mode on PC's or in protected mode on AT's. Only QNX lets you run multi-user/multi-tasking with networking on all classes of machines.

REAL TIME QNX real-time performance leaves both OS/2 and UNIX wallowing at the gate. In fact, QNX is in use at thousands of real-time sites, right now.

DOS SUPPORT QNX allows you to run one PC-DOS application at each computer on a QNX network. With OS/2, 128K of the DOS memory is consumed to enable this facility. Within QNX protected mode, a full 640K can be used for PC-DOS.

ANY WAY YOU WANT IT QNX has the power and flexibility you need. Call for details and a demo disk.

THE ONLY MULTI-USER, MULTI-TASKING, NETWORKING, REAL-TIME OPERATING SYSTEM FOR THE IBM PC, AT, PS/2, THE HP VECTRA, AND COMPATIBLES.

Multi-User	10 (32) serial terminals per PC (AT).	C Compiler	Standard Kernighan and Ritchie.
Multi-Tasking	64 (150) tasks per PC (AT).	Flexibility	Single PC, networked PC's, single PC with terminals, networked PC's with terminals. No central servers. Full sharing of disks, devices and CPU's.
Networking	2.5 Megabit token passing. 255 PC's and/or AT's per network. 10,000 tasks per network. Thousands of users per network.	PC-DOS	PC-DOS runs as a QNX task.
Real Time	4,250 task switches/sec (AT).	Cost	From US \$450. Runtime pricing available.
Message Passing	Fast intertask communication between tasks on any machine.		



For further information or a free demonstration diskette, please telephone (613) 591-0931.

Quantum Software Systems Ltd. • Kanata South Business Park • 175 Terrence Matthews Crescent • Kanata, Ontario, Canada • K2M 1W8

Circle 205 on Reader Service Card

QNX is a registered trademark of Quantum Software Systems Ltd.
The UNIX Operating System is a registered trademark of AT & T. IBM PC, AT, XT and PS/2, PC-DOS and OS/2 are trademarks of International Business Machines. HP and Vectra are registered trademarks of Hewlett-Packard Company.

A Programming Tool for OS/2

If you're struggling with the intricacies of programming for OS/2, Hamilton Laboratories has a product that brings a familiar programming environment to IBM's latest PC operating system. As its name implies, Hamilton C Shell recreates the standard C shell language as described in the Berkeley 4.3 Unix Programmer's Manual. The company claims that all 42,000 lines of code in the product were written specifically for OS/2.

Hamilton Labs says its shell is a superior alternative to the standard OS/2 command processor, letting you program for the OS/2 environment more quickly and easily by manipulating files, processes, threads, and object connections.

The Hamilton C Shell includes fully nestable programming constructs for iteration and condition testing, variable arrays, and a wide range of expression operators and built-in functions. There are also advanced features for I/O redirection, piping, background execution, and parallel threading.

Rounding out the program's features are alias and shell procedures for defining your own language extensions, as well as command substitutions and advanced wild-carding.

The Hamilton C Shell runs on any OS/2-equipped system with at least 2 megabytes of RAM.

Price: \$350.

Contact: Hamilton Laboratories, 13 Old Farm Rd., Wayland, MA 01778, (508) 358-5715.

Inquiry 1105.

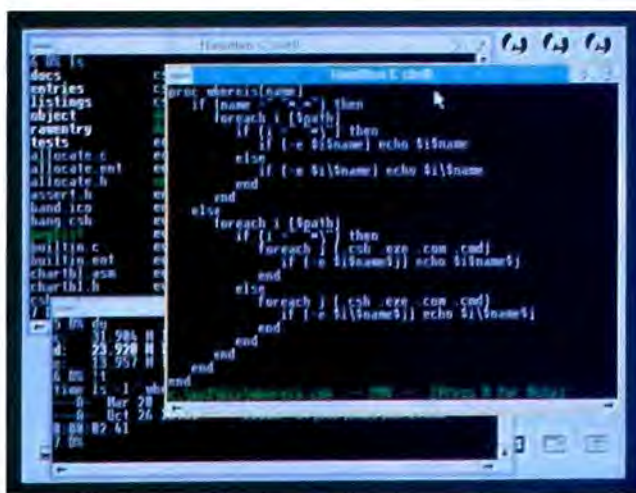

An example of a procedure within Hamilton C Shell with directory windows in the background.

Modula-2 for the Amiga

M2Sprint 1.1, a Modula-2 development system for the Commodore Amiga, includes a compiler that can handle 45,000 lines per minute, the company reports. The compiler runs from the editor, the command line, Workbench, or ARExx, and the editor supports multiple windows, letting you compile in one window while you edit in the others.

The program also includes a single-pass Modula-2 compiler and program linker, program profiler, symbolic debugger, an Amiga ROM interface library, Modula-2 library, an Amiga interface library, a C-style I/O library, and IFF and AmigaDOS Replacement Project libraries.

Features of the compiler include internal files configurable for efficient RAM management, REAL and LONG-REAL support via the Amiga's library code (allows you to use hardware floating-point processors), and termi-

nation procedures for each module. You can also use it to generate in-line calls to the Amiga's operating system, eliminating the need for "stub" routine libraries, and to generate debug information for symbolic debuggers.

M2Sprint's editor has an automatic case-correction feature, which converts Modula-2 keywords to their correct case (e.g., procedure becomes PROCEDURE), and word completion, which automatically completes long names that you specify from a dictionary when you type enough characters (e.g., imple becomes IMPLEMENTATION). You can also develop and test programs without leaving the editor. The debugger shows the code at the point of error, as well as variable contents.

M2Sprint works on all Amigas with at least 512K bytes of RAM, KickStart 1.2, and Workbench 1.3 or higher.

Price: \$385.

Contact: M2S, Inc., P.O. Box 550279, Dallas, TX 75335, (214) 340-5256.

Inquiry 1102.

continued

An OS/2 Pascal Compiler with DOS Compatibility

If you're a developer who wants to use Pascal to develop OS/2 applications but still wants to keep DOS users unalienated, Prospero's Pascal for OS/2 will allow you to keep your feet firmly planted in both worlds. Pascal for OS/2 is a one-pass compiler that's optimized for OS/2-specific applications. But it also includes a DOS linker and library that produces DOS programs (as long as your code doesn't use OS/2-specific features).

The package includes a threading function for OS/2, letting you run Pascal procedures in parallel with the

main program. You can also call OS/2 functions from Pascal by simply declaring them external. In addition, Prospero has added a new predeclared data type called ASCIIZ that allows the declaration of null-terminated dynamic-length strings in OS/2. You can also produce code to take advantage of the extra instructions available on the 80286 processor.

Total code is limited only by the size of your hard disk. And although you can generate a maximum of 64K bytes in a single compilation, any number can be linked into a program. There is a limit of

64K bytes on the outer-level static and common data, and the heap can expand to 4 megabytes.

Pascal for OS/2 includes a workbench/editor that lets you choose compilation and linking operations from a menu. Also included is the Probe source-level debugger with data breakpoint and multithreading capabilities. The whole package runs on any OS/2-equipped system.

Price: \$390.

Contact: Prospero Software, Inc., 100 Commercial St., Portland, ME 04101, (207) 874-0382.

Inquiry 1101.

New SQL Machine for LANs

The SQL Mach 1 is a dedicated database system that uses a Structured Query Language-based engine and achieves 15 to 60 times the performance of its PC-based brethren, its manufacturer claims.

One of the major keys to advanced performance is its client-server approach to database operation. The client sends a request for information; the Mach 1 performs the database operation by accessing its own disk drives and returns only the answer (unlike solutions that return the entire database of information, tying up the network).

Other key advantages include a proprietary API (application program interface), so it doesn't get bogged-down on PC operating system code, and a patent-pending relational coprocessor. It's based on an 80286 backplane and is comparable in price to fully configured 80386-based PC systems.

The caching controller, described as a discrete design with high-speed memory management, effectively speeds up some operations that once took 400 to 500 μ s and performs them in 10 μ s, the company claims.

The Mach 1 includes 4 megabytes of RAM, a 17-ms, 320-megabyte hard disk drive, 150 megabytes of tape backup, and a 1200-bps modem for remote support.

There are actually four I/O slots for four direct-channel cards to directly support up to 16 users at distances up to 200 feet. Or you can use one of the I/O slots for an Ethernet card to network the entire office with database capabilities slightly less sophisticated than if the users were connected directly to the I/O. There are also six SCSI ports.



Client-server approach speeds SQL database.

Price: \$23,950.

Contact: Advanced Data Servers, P.O. Box 4937, Boise, ID 83711, (208) 322-7800.

Inquiry 1144.

PowerBridge Across Topologies

The low-cost PowerBridge software lets you bridge from any NetBIOS-compatible LAN that uses Server Message Block protocols to any other, the manufacturer claims.

One server module runs on the dedicated or nondedicated bridge server, generally at least a 286-based system with 640K bytes of RAM. Another module is used by any bridge participant, a similarly configured machine.

You can share disks, printers, and gateway services with any network that's connected, Performance Technology says. Connections can pass through up to four bridge servers to join a total of five networks, whether they be Token Ring, Ethernet (server-based or distributed), or ARCnet.

Phone the Office for E-Mail

VoxMail is a hardware and software system that links you and your Touch-Tone telephone to the E-mail system back at the office.

Receiving messages is the easy part. You log on with a Touch-Tone access code. VoxMail then converts your text-based E-mail messages into speech. To reply, you press keys that generate pre-assigned generic responses like "No. Wait until we talk." The reply is then automatically mailed with a copy of the original message.

There are limitations. It supports only nine reply messages, and it works only with Message Handling Ser-

vice-compatible E-mail systems, a de facto Novell standard, VoxLink says. You also need a dedicated XT and two free slots for the phone interface board and the text-to-speech board. The phone interface board handles text to ASCII via phonetic algorithms.

Each complete system supports five MHS applications, nine reply messages, an adjustable security code, attachment files, and administrative log reports.

Price: \$3995.
Contact: VoxLink Corp., 432 Coventry Dr., Nashville, TN 37211, (615) 331-0275.

Inquiry 1148.

Price: \$495.

Contact: Performance Technology, 800 Lincoln Center, San Antonio, TX 78230, (512) 349-2000.

Inquiry 1149.

Novell Introduces NetWare 386

NetWare 386 version 3.0 is Novell's first network operating system that's optimized for use on the 32-bit 80386 architecture.

Unlike NetWare 286, which could support only 100 users, NetWare 386 can support up to 250 users on one server. In addition, Novell says NetWare 386 features a simplified and less time-consuming installation procedure, enhanced printer resources and file security features, and a technique called dynamic resource configuration, which automatically manages memory allocation for caches and buffers, a task formerly managed manually.

With this introduction, NetWare runs on virtually all major operating systems and hardware architectures, including MS-DOS and OS/2, Macintosh, and Unix systems such as Sun and NeXT.

Novell says NetWare 386 will support the major client/server file protocols, including AppleTalk Filing Protocol (AFP), the Unix-based Network File System (NFS) from Sun Microsystems, and IBM's Server Message Block (SMB) and OS/2 file protocols, as well as Novell's own NetWare Core Protocols, which support MS-DOS and a variety of other file types.

Price: \$7995.

Contact: Novell, Inc., 122 East 1700 South St., Provo, UT 84606, (800) 453-1267.

Inquiry 1147.

continued

• • • Eiffel

Now on
UNIX and XENIX,
Soon on the MAC

The Object-Oriented Language for Today and Tomorrow

So you're looking for reliability, reusability, and maintainability – so you know you need an object-oriented language – and you want the very best. A language which will stand the test of time – ask around, you'll hear Eiffel over and over again. And for very good reason.

Eiffel is the industrial application of modern software engineering techniques. It offers the full realm of an advanced object-oriented language and environment: single and multiple inheritance, dynamic binding, static typing, genericity and more within a simple, easy-to-learn language.

Eiffel is the only environment which includes reliable software construction techniques: assertions, invariants, rigorous exception handling. Well defined interfaces for your existing software. Robust libraries of reusable components including X-based graphics. A powerful CASE environment ensuring automatic recompilation, computer-aided documentation, graphical browsing of system structures. Portability on all UNIX systems among others. Cross-development via the generation of self-contained C packages. Easy interface with packages and

software written in other languages. And incredible support.

Don't worry, you won't be alone. The list of major companies using Eiffel is impressive: Boeing, Philips GTE, British Telecom, Thomson, HP, Sun Microsystems, Cognos, Lawrence Livermore, Tektronix, Sandia, Telecom Australia, BNR, EDF, and on and on.

Eiffel can solve your problems both today and tomorrow. Need more information? Just give us a call. So what are you waiting for?

THE BOOK

Object-Oriented Software Construction, Bertrand Meyer, called a "tour de force" by *IEEE Software*. Order from Prentice-Hall (ISBN 013-629049-3), or directly from Interactive.

THE SEMINAR

Object-Oriented Design and Programming: created and presented by the designers of Eiffel. For information and registration, call us.

SEE EIFFEL

at all the major shows. Call for location and dates.

Interactive Software Engineering Inc.

270 Storke Road, Suite 7, Goleta, CA 93117 USA
Telephone: (805) 685-1006 FAX: (805) 685-6869



European Distributors: S.O.L., 4, rue René Barthélémy, 92120 Montrouge France Tel. (33) 1 46 57 13 36, FAX (33) 1 46 57 01 03;
ETNOTEAM, Via Staro 4, 20134 Milano, Italy Tel. (39) 2 2141521, FAX (39) 2 2142231



Clean Elegant Powerful...

Everything OS/2 can do for you...

OS/2™ includes a built-in graphical interface so it's easy to use.

OS/2 lets you run your DOS programs plus hundreds of programs DOS can't.

OS/2 lets you run programs larger than 640K, so you can use more powerful applications.

OS/2 lets you take full advantage of Micro Channel.™



OS/2 provides an optional Communications Manager which allows easy networking.

OS/2 lets you keep two or more programs running at the same time, so you can do more.

OS/2 lets you take advantage of 386™ power.

OS/2 provides an optional Database Manager to make managing information easy.

This offer lets you do for less.

Right now, when you choose OS/2, you can get from \$100 to \$1,600 back on the kind of heavy duty memory that only OS/2 can handle. With this offer, the more memory you buy (up to 8Mb), the bigger your rebate.

Plus you can get thousands of dollars in rebates on over 100 different OS/2 programs. You can also get hundreds of dollars back on modems, accessory cards and hardware—all the things that help you do more work in less time with OS/2.

So if you're ready to move up to all the real advantages of OS/2, ask your IBM Authorized Dealer about these rebates today. To find the dealer nearest you call 1 800 IBM-2468, ext 128.



Pocket-size Adapter Links Laptops to NetWare Stations

The Pocket Ethernet Adapter is an Ethernet add-in card shrunk down to fit into a package the size of today's pocket modems.

Two versions are available, accommodating thick and thin coaxial cabling. Support for unshielded twisted-pair cabling should be available sometime this fall. Only Novell NetWare drivers for versions 2.0 and 2.1 are compatible today. But Xircom promises that future releases will include the latest Novell drivers and drivers for the other popular network operating systems. Drivers for 3Com's 3+ and 3+Open are scheduled to ship before the year's end.

For computers that don't have a bidirectional parallel port, the software uses the status lines of the port for input.

Price: \$695.

Contact: Xircom, 22231 Mulholland Hwy., Suite 114, Woodland Hills, CA 91364, (818) 884-8755, **Inquiry 1146.**



Pocket Ethernet Adapter runs Novell NetWare drivers.

Low-Cost Parallel Port Network

If you want inexpensive file transfer for your small office but all your serial ports are packed full of peripherals, you might try installing the 3X-Link16 network through your parallel ports.

But don't worry about tying up the parallel ports. You can plug your printer into the parallel port on the back of each 3X-Link16 transceiver.

Features include background file transfer and E-mail, the company says. All

you need is a pair of 3X-Link16 transceivers and some twisted-pair cabling, which is included in the basic package. You upgrade the network with additional adapters.

The network, which connects up to 16 PCs, has a maximum distance of only 400 feet. Data rate is 500,000 bps.

Security features include multilevel passwords. **Price:** Basic package, \$239; additional adapters, \$139; printing software, \$149. **Contact:** 3X USA, One Executive Dr., Fort Lee, NJ 07024, (201) 592-6874. **Inquiry 1145.**

Networking at 200 Megabits Per Second

The Baytec 2000 is a SCSI-based computer network its developer claims can flash data from port to port at rates up to 200 megabits per second.

This advantage is due to its SCSI connections, Baytec says, which transfer data in 64K-byte packets. At the cabling level, Baytec uses AMD's 125 taxi chip set, which supports coaxial, twisted-pair, and optical-fiber cabling.

The idea behind the Baytec 2000 network is simple. Instead of a complex array of network hardware and software, each computer or workstation on a Baytec network is outfitted with a SCSI port, complete with device driver. The nodes are daisy-chained, seven at a time, and plugged into a cable interface; up to eight interfaces can connect to each server, for a total of 56 users per server; and multiple servers can be linked together.

Installation is a matter of installing the appropriate SCSI interface, attaching a node controller, and adding the driver to the computer's operating system (an MS-DOS .SYS file, a Mac resource in the System file, or a workstation's Unix driver).

Within each base server is a 65816—the same processor that's in the Apple IIGS, and the 16-bit successor to the venerable 6502 that has powered Apple IIs for more than a decade.

Price: Base server unit, \$17,000; each node interface, \$500.

Contact: Baytec Inc., 32425 Schoolcraft Rd., Livonia, MI 48150; (313) 427-1250.

Inquiry 1151.

continued

Network Your MapInfo

MapInfo 4.0 is a networking upgrade to the popular single-user MS-DOS mapping software. The latest version, which requires an AT and DOS 2.0 or higher, lets you distribute mapping work through Novell NetWare. (Upgrades are planned for other network operating systems.)

You can either buy maps from Mapping Information Services or make your own to work with the software.

Included in the base price of version 4.0, for example, is a database of the five-digit

ZIP codes and a map of the U.S. that can be viewed as a whole or in regions. You enter the ZIP code you need to identify and MapInfo points to the region on your view of the U.S. map.

In a networked configuration, everybody with a node version of MapInfo 4.0 can simultaneously access the same maps and the same databases. Anybody on the network can access maps or data from local drives and the main file server. File locking and edit transaction files protect the data; only

one user at a time can make edits on a particular portion of the map.

But you can create several separate mapping layers and divide mapping work among several people.

Price: Server version, \$750; node version, \$595, or \$1195 for three nodes; optional maps from \$75 to \$2000.

Contact: Mapping Information Systems Corp., 200 Broadway, Troy, NY 12180, (800) 327-8627; in New York, (518) 274-8673.

Inquiry 1150.

Announcing a big leap in mouse technology.



Finally a mouse with an extraordinary body and a mind to match.

The Logitech Mouse is tuned to accelerate your cursor across any screen with the mere flick of a wrist. And slow it down on arrival for pixel-paint control.

It's guaranteed to work with all IBM personal computer applications.



And it comes with a great selection of MouseWare™ including Pop-Up DOS™—the ultimate DOS handler; the Mouse-2-3™ shell; 35 menus for popular keyboard-based applications; and unlimited Product Support.

*For your nearest dealer, call Logitech at:
800-231-7717*

*In California:
800-552-8885*

*In Europe:
+ + 41-21-869-96-56*

*Circle 150 on Reader Service Card
(DEALERS: 151)*



OCLI Shades PC Glare

For luxury eye protection from your personal computer, you might want the Glare/Guard from the Optical Coating Laboratory. OCLI recently expanded its line of add-on filters. The new models are designed specifically for the ubiquitous NEC MultiSync II, Sony's and Sun Microsystems' CAD/CAM monitors, and the Macintosh Plus, SE, IIcx, and II.

Using thin-film coating technology, OCLI applies layers of germanium, zinc sulfide, and a fluoride compound to tempered glass using a patented vacuum deposition coating process. Ion-deposition processes make the coating abrasion-resistant.

With such a filter, OCLI claims glare reduction of up to 99 percent, enhanced contrast, reduced static and dust, reduced perception of screen flicker, and low-frequency radiation level reduction of 98 percent.

Filters for all the new machines except the small Macintosh monitors come in two models: The Profile is designed to reduce glare by 95 percent and the ProfilePlus is designed to reduce 99 percent. For the Mac Plus, SE, and IIcx monitors, which have reversed type that requires more light emission, OCLI designed the Professional Plus Size M filters with glare reduced by only about 50 percent.

Price: For CAD/CAM monitors, Profile, \$199, and ProfilePlus, \$249; for the NEC and Mac II, Profile, \$69.95, and ProfilePlus, \$109.95; for the Mac, ProfessionalPlus, \$89.

Contact: Optical Coating Laboratory, Inc., 2789 Northpoint Pkwy., Santa Rosa, CA 95407, (707) 545-6440.
Inquiry 1142.



Patented thin-film coating reduces glare.

Expand Automated Data Acquisition to 1 MHz

The 64-channel Enhanced Graphics Acquisition and Analysis (EGAA) system functions as both a high-resolution digital storage oscilloscope and an electronic chart recorder.

The hardware uses four IS-16 A/D add-in boards, each with 16-channel 1-MHz A/D conversion, creating a 64-channel system. The software can operate the EGAA system as four separate digitizers at a 1-MHz sampling rate or as one

64-channel system at 62 kHz. The system contains a variety of trigger logic functions such as slope and level. External triggers, like those on a digital storage oscilloscope, complement the pretrigger that's available to capture transients.

The chart recorder mode allows simultaneous real-time monitoring and storing of data to a hard disk.

Price: \$3090; analysis options range from \$485 to \$1395.

Contact: R.C. Electronics, Inc., 5386-D Hollister Ave., Santa Barbara, CA 93111, (805) 964-6708.

Inquiry 1140.

To Draw As an Artist Draws

Variable line width and airbrush density are just two of the features available with the Wacom pressure-sensitive and cordless digitizing system.

With the pen-like stylus, you press lightly and a slender line appears. Press more heavily and the line thickens as it would if you were drawing with a pencil or brush. Colors can be programmed so you can draw to fit your mood (i.e., red for the firmest pressure and blue for a light touch).

You can also use a cordless cursor, but you won't get the

variable-line effects of the stylus. For both hand-held devices, reading speeds are selectable, up to 205 points per second. Tablet accuracy is rated at 0.2 mm, whether you buy the 6- by 12-inch tablet or the 18- by 25-inch tablet.

The system works through electromagnetic resonance technology, says Wacom. The digitizer tablet contains a fine grid of thin wires that alternately transmit and then receive their own signals, telling it where the pointing device has moved by reading from a coil-and-capacitor

Small Supplies Switch to Sine

The UniPower 4.5 and UniPower 6.0 are on-line systems that give you continuous power protection as well as power conditioning. Unison Technologies claims its true sine-wave output provides superior equipment protection over the square-wave output found in many supplies.

As the names imply, the PS 4.5 provides 450 VA of backup power, and the 6.0 gives you 600 VA. Both are relatively small, measuring 14 by 3 by 18 inches, and are designed to fit between your system and your keyboard. They weigh 30 and 32 pounds, respectively.

Both units provide patented emergency keyboard lights and a remote-on feature that lets you turn on your system over the telephone.

Price: UniPower 4.5, \$699; 6.0, \$799.

Contact: Unison Technologies, Inc., 23456 Madero, Mission Viejo, CA 92691, (714) 855-8700.

Inquiry 1143.

continued

resonant circuit.

The stylus can produce variable line widths, for example, because of a movable ferrite core. Pressure on the stylus's point changes the inductance of the resonance coil and affects the electrical frequency.

Price: Stylus, \$125; 6- by 9-inch tablet, including cursor, \$395; 12- by 12-inch tablet, including cursor, \$995.

Contact: Wacom, Inc., West 115 Century Rd., Paramus, NJ 07652, (201) 265-4226.

Inquiry 1141.

It's **Microsoft**® Month in



Microsoft, the industry trend setter at providing language tools for the software developer has done it again, with three new products to lead the way into the 90's. And Programmer's Paradise, the world's leading source of development software is ready to ship them to you. Call us today to order these and other outstanding Microsoft software products.



Microsoft OS/2 Presentation Manager Toolkit

The Microsoft OS/2 Presentation Manager Toolkit provides a complete set of visually-oriented software tools and documentation to help you develop the next generation of graphical applications for the OS/2 Presentation Manager. Presentation Manager provides a consistent, graphical user interface that makes applications easy to learn and use. The Toolkit includes the software to create and customize drop-down menus, dialog boxes, icons, and fonts that make this intuitive environment possible. Also included is a complete set of reference documentation; QuickHelp, the on-line, context sensitive reference; HelpMake to add to the QuickHelp database; over 3 MB of sample code; and 2 free hours of on-line support.

Microsoft QuickPASCAL

A powerful new implementation of Pascal that provides superior productivity and performance to current Pascal programmers, and also opens the door to object-oriented programming.

The QuickPASCAL compiler and linker are the fastest available for Pascal on a PC, assuring superior performance.



And QuickPASCAL integrates a compiler, editor and debugger into one highly productive, intuitive environment.

Object-oriented programming is expected to be the major programming development of the 1990s. Microsoft's implementation of object-oriented constructs in QuickPASCAL will provide you with an easy, smooth transition into object-oriented techniques.

Microsoft QuickC Compiler with QuickAssembler

Microsoft QuickC Compiler with QuickAssembler is the first product to fully integrate C and assembly language into one seamless environment, giving you maximum power and ease of use. Write and edit source code in C; accelerate speed-critical routines or gain low-level access to your hardware with assembly language; compile, assemble, run, and debug—all within the same integrated software development system. Comprehensive reference guides and innovative on-line learning tools make the two languages and the unique integrated environment easy to master. Two popular languages, one smooth environment—the power of C and the speed of assembler, together at last! Amazing!



THE MICROSOFT PRODUCT LINE

	LIST	OURS		LIST	OURS
MS BASIC/6.0	295	199	MS Pageview	50	40
MS C	450	299	MS Pascal	300	199
MS COBOL	900	599	MS PowerPoint (MAC)	395	279
MS Excel	495	279	MS QuickBASIC	99	69
MS Excel (MAC)	395	279	MS QuickBASIC (MAC)	99	69
MS FORTRAN	450	299	MS QuickC	99	69
MS Learning DOS	50	40	MS QuickC with QuickAssembler	199	135
MS Mach 20	495	329	MS QuickPASCAL	99	69
MS Macro Assembler	150	99	MS Sort	195	130
MS Mouse Bus or Serial			MS Windows/286	99	69
w/ Paintbrush & Mouse Menus	150	99	MS Windows/386	195	130
w/ EasyCAD	175	119	MS Windows Software Development Kit	500	319
w/ Paintbrush & Windows	200	139	MS Word	450	279
MS OS/2 Presentation Manager Softset	150	105	MS Word (MAC)	395	279
MS OS/2 Presentation Manager Toolkit	500	329	MS Works	149	99

If You Want To Talk Fast DBMS Call 1-800-db RAIMA And Start Screaming

You'll be screaming, all right. db_VISTA III from Raima Corporation combines the flexibility of a relational DBMS and the lightning speed of the network database model.

C db_VISTA III is written for C Programmers.

Source code available. The interactive database utilities and outstanding documentation make db_VISTA III easy to learn. All applications are portable to VMS, UNIX, OS/2, MS-DOS, even Macintosh. No royalties.

db_VISTA III is *Fast*. Using benchmarks originated at PC Tech Journal Laboratories, db_VISTA III measured 3 to 12 times faster than the average relational database! Call us and we'll send you the results.

Relational and Network Model Technology for Programming Flexibility.

Retrieve a record fast using the relational keyed access method

db_VISTA III Database Development System		
Features	Yes	No
db_VISTA 3.1 High Performance DBMS:		
Single and Multi-User available	✓	
Relational B-tree Indexing	✓	
Network Database Model	✓	
Multiple database access	✓	
Referential integrity	✓	
Automatic recovery	✓	
Record & File locking	✓	
RAM resident		✓
db_QUERY 2.1 SQL-based Query:		
Relational Query & Report Writer	✓	
db_REVISE 1.0 Database Restructure Program:		
Total database redesign/restructuring	✓	
Operating Systems*: VMS, ULTRIX, UNIX	✓	
BSD 4.2, SunOS, XENIX, MS-DOS	✓	
Macintosh and MS Windows, OS/2 compatible	✓	
C Compilers*: Most compilers supported	✓	
C++ compatible	✓	
LANs*: 3COM, Novell, Banyan, AppleShare	✓	
WKS Library:		
Read & Write WKS, WK1 & DBF files	✓	
SOURCE CODE AVAILABLE:	✓	
ROYALTIES: (Absolutely not!)		✓✓

*Other environments are supported; call for complete list.

and all related records can be immediately available using the network model. You decide how to combine these for best application performance.

 SQL Support with SQL-based db_QUERY, db_VISTA III's relational query and report writer.

db_VISTA Puts You in Some Fast Company.

Thousands of C programmers in over 50 countries worldwide use db_VISTA III, including APPLE, ARCO, AT&T, EDS, Federal Express, Hewlett-Packard, IBM, NASA...

Don't wait. Call Raima for more information about how you can build applications that are *screaming-fast!*

Call 1-800-db RAIMA
(That's 1-800-822-7262)

db_VISTA III™
Database Development System

 RAIMA CORPORATION BY89

10000 3245 146th Place S.E. Bellevue, WA 98007 USA (206)747-5570 Telex: 6903018237 MCI UW FAX: (206)747-1991 Texas: (214)231-3131 International Distributors:
 Denmark: (2)887249 Germany: 07127/5244 Switzerland: (01) 0410 France: (1)46092828 Benelux: 31(02159)46 814 Sweden: (013)124780 Italy: 045/584711 Norway: 47 244 88 55
 Singapore: 468 3988 Australia: (02) 939 5122 Japan: (03)473 7432 Taiwan: (02)511 3277 Mexico: (83) 57 35 94 Central America: (506) 28 07 64
 Brazil: (0192) 52 9770 © 1989

Accelerate Any Microcomputer to 33 MFLOPs

The Spirit-30 is a floating-point accelerator board for performance approaching 33 million floating-point operations per second. With the Texas Instruments TMS320C30 digital signal processor at its heart, it works with XT, AT, Macintosh, PS/2, VMEbus, Multibus II, and Q-bus based computers.

Each Spirit-30 includes 128K bytes of dual-access 25-ns static RAM that is accessible by both the host and the Spirit-30. A daughterboard gives you an additional 512K bytes of RAM, with as much as 16 megabytes of external memory available through the Spirit-30's parallel port and bus interface.

For data acquisition, memory expansion, frame grabber and graphics boards, the Spirit-30 has six expansion connectors. Multiple Spirit-30s can be configured through the serial or parallel ports.

Support software includes windows-based evaluation, debugging, simulation, and real-time digital signal processing (EDSP). A library (DSPL) is included to initiate program download, start DSP execution, halt DSP execution, and perform single-block read/write to and from the board and DSP memory.

In all, the DSPL gives you 35 DSP and utility modules in C. They incorporate functions like spectrum analysis, FFTs, and discrete cosine transforms.

Price: \$2495; EDSP software, \$495; DSPL, \$295; source code, \$985.

Contact: Sonitech International, Inc., 83 Fullerbrook Rd., Wellesley, MA 02181, (617) 235-6824.
Inquiry 1138.



Number crunch with the Spirit-30.

Replace Algorithms with Thinking Processors

Two companies recently claimed firsts in neural networking by offering commercial silicon implementations of popular neural networking theories.

Syntonic Systems introduced an XT-compatible evaluation kit with the Dendros-1 chip, an analog device that works with one of several popular neural net architectures.

Partially self-organizing, the chip stores "remembered" patterns in capacitors. Dendros-1 also performs a key calculation—input and weight vector multiplication—in parallel, achieving the equivalent of 4.3 MFLOPS performance, Syntonic says.

The way the nodes are wired determines the type of architecture in a neural net. The architecture in turn determines the learning algorithms. So if you're going to hard-wire a chip to speed up execution of a particular algorithm, you're stuck with it.

Dendros-1 implements a

variant of the "adaptive resonance theory" (ART-1), a two-layer network architecture. It has three input layer nodes and five output layer nodes. It will accept up to 22 bi-level input signals, and these can be presented via a PC, although output from Dendros-1 is limited to an LED display.

Dendros-1 is packaged in a 68-pin plastic leaded chip carrier. An evaluation board includes eight chips.

Price: \$695.

Contact: Syntonic Systems, Inc., 20790 Northwest Quail Hollow Dr., Portland, OR 97229, (503) 293-8167.

Inquiry 1135.

Micro Devices Implements Hopfield Neuron

The Fuzzy Set Comparator is a CMOS neural chip that's included in Micro Devices' neural networking kit, an XT-compatible add-in board. It implements the popular Hopfield theory of neural networking in silicon.

With the Fuzzy Set Comparator, the kit is designed for adaptive ranking and for ranking "fuzzy" data (data with inaccuracies, noise, or other discrepancies) in groups by certain predetermined characteristics.

Once the data is ranked, a neural network hardware post-processor ranks the comparisons, thus providing a superior rank-calculation speed over software implementations of neural networks. Micro Devices claims. A built-in video interface also allows the Fuzzy Set Comparator chip to "see" and "identify" people.

Price: \$250.

Contact: Micro Devices, 5643 Beggs Rd., Orlando, FL 32810, (407) 299-0211.

Inquiry 1136.

Make Graphics a Whiz with the FastWrite VGA

The FastWrite VGA from Headland Technology is designed to be faster than the original FastWrite. It's fast, the company claims, because it uses an enhanced version of the V7VGA chip.

Headland claims the chip is 100 percent register-level compatible with the VGA standard, is BIOS-level compatible with the EGA standard, and is also backward compatible with CGA, MDA, and HGC standards.

Each V7VGA chip also features memory caching, 8- or 16-bit memory and BIOS interfaces, and support of four resolutions beyond the 17 standard VGA modes. Interlaced resolution reaches

up to 1024 by 768 pixels, with up to 16 displayed colors.

Each three-quarter-length FastWrite VGA is configured with 256K bytes of on-board memory that's upgradable to 512K bytes. It comes packaged with software drivers for graphics-intensive applications: Windows/286, Windows/386, Presentation Manager, AutoCAD, AutoShade, Ventura Publisher, GEM/3, Lotus 1-2-3, and Symphony.

Price: \$499.

Contact: Headland Technology, Inc., 46335 Landing Pkwy., Fremont, CA 94538, (415) 656-7800.

Inquiry 1137.

continued

After centuries of practice, mankind perfects engineering calculations: MathCAD.

Announcing MathCAD 2.5: The Dawn of a New Age.

What the historians will call it, only time will tell.

Perhaps the Century of Speed, or the Era of Ease. But whatever the name, this is the age of MathCAD 2.5, the only math package that looks and works the way you think.

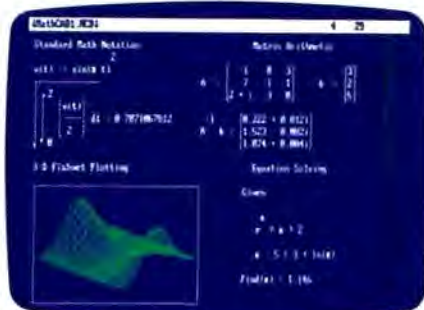

MathCAD 2.5 includes 3-D plotting, HPGL sketch import, and PostScript output.

MathCAD is far and away the best-selling math package in the world. Because it lets you perform engineering and scientific calculations in a way that's faster, more natural and less error-prone than the way you're doing them now—whether you're using a scratchpad, calculator, spreadsheet or program that you wrote yourself.

And now we've made the best even better. MathCAD 2.5 is a dramatically improved version that includes three-dimensional plotting, enhanced numerical analysis, and the ability to import HPGL files from most popular CAD programs, including AutoCAD.* And now you can print on PostScript* compatible printers.

And like before, MathCAD's live document interface™ lets you enter

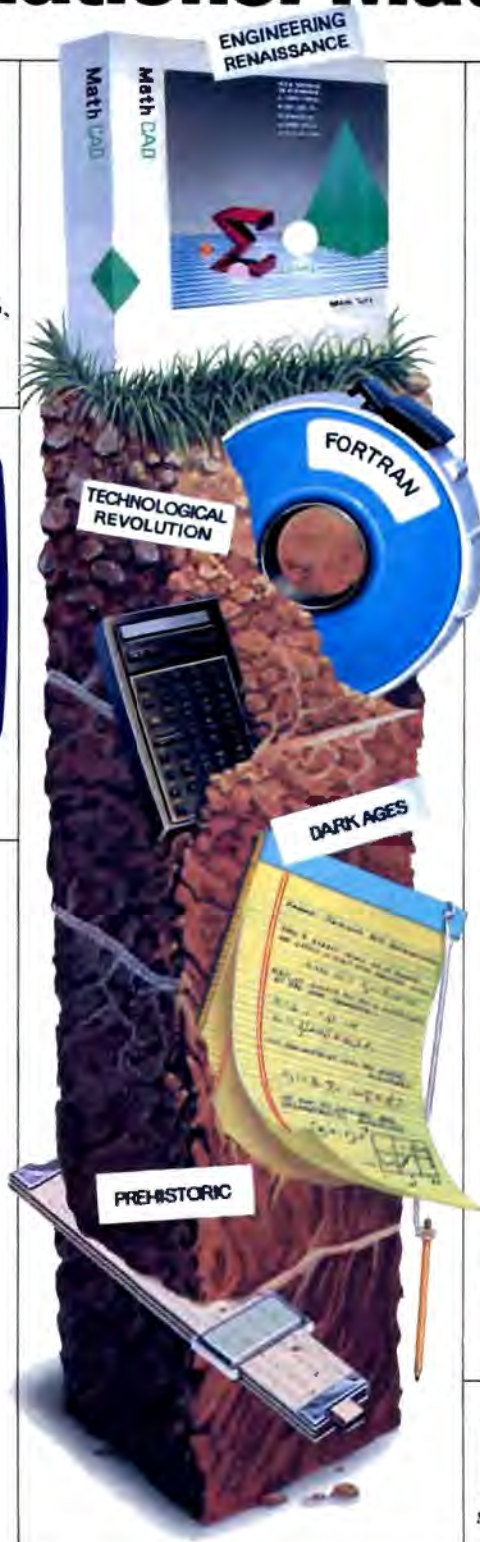

equations anywhere on the screen, add text to support your work, and graph the results. Then print your analysis in presentation-quality documents.

It has over 120 commonly used functions built right in, for handling equations and formulas, as well as exponentials, differentials, cubic splines, FFTs and matrices.

No matter what kind of math you do, MathCAD 2.5 has a solution for you. In fact, it's used by over 50,000 engineers and scientists, including electrical, industrial, and mechanical engineers, physicists, biologists, and economists.

But don't take our word for it; just ask the experts. PC Magazine recently described MathCAD as "everything you have ever dreamed of in a mathematical toolbox."

And for Macintosh* users, we present MathCAD 2.0, rewritten to take full advantage of the Macintosh interface. Entering operators and Greek letters into equations is pure simplicity!

Look for MathCAD 2.5 at your local software dealer, or give us a call. For more information, a free demo disk, or upgrade information,* dial 1-800-MATHCAD (in MA, 617-577-1017).

*If you purchased MathCAD 2.0 between 5/1/89 and 6/16/89, you can get a FREE upgrade to version 2.5 (otherwise, the upgrade cost is \$99.00 until June 30, 1989; afterwards, the cost will be \$149.00).



March 14, 1989 issue.
Best of '88
Best of '87

MathCAD®

MathSoft, Inc. One Kendall Square, Cambridge, MA 02139

Available for IBM® compatibles and Macintosh computers. TM and © signify manufacturer's trademark or manufacturer's registered trademark respectively. PE

Jasmine's DAT Stores Gigabytes

The Jasmine DirectDigital Tape drive can store up to 1.27 gigabytes of data on a single 4-mm chromium dioxide tape that's less than the size of an audio cassette tape.

The sustained data transfer rate is 174K bytes per second through a standard SCSI port, and the drive is capable of locating a single byte of information anywhere on the tape in not more than 40 seconds, Jasmine claims.

The Jasmine DirectDigital Tape drive is a hybrid of many sources: It uses a half-height JVC drive mechanism, packaged by GigaTrend into a full-height drive with I/O; Racet provided the drive enclosure and the software.

The formatting standard is Data/DAT, also favored by Apple and NCR, rather than the DDS format pushed by Sony and Hewlett-Packard, Jasmine says. This permits the drive to find data quickly and to rewrite changes incrementally, instead of rewriting the whole file if a change is made to it. The drive has a recording density of 61,000 bits per inch (using a helical scan technique, like a VCR) with almost 1900 tracks per inch. **Price:** \$6995.

Contact: Jasmine Technologies, Inc., 1740 Army St., San Francisco, CA 94124, (415) 282-1111.

Inquiry 1130.



DirectDigital drive features DAT cassettes.

HP Offers a Mac-Specific Ink-Jet Printer

The new Hewlett-Packard DeskWriter printer is a modified DeskJet, a 300-dpi ink jet for the Mac market. Gone are the serial and parallel interfaces and the cartridge ports—replaced by an ImageWriter-style connector and QuickDraw compatibility.

DeskWriter comes with four built-in font families (Times, Helvetica, Courier, and Symbol); also available are five other font families.

Font scaling is through proprietary "Intellifont font-scaling technology," HP says. These are outline fonts, scalable to 250 points.

Price: \$1195; optional fonts, \$95 each or five for \$395.

Contact: Hewlett-Packard

Company Inquiries, 19310 Pruneridge Ave., Cupertino, CA 95014, (800) 752-0900. **Inquiry 1132.**

Mac Drive Features Removable Cartridges

The Microtech R45 hard disk drive features 25-ms average access time and removable cartridges that can store as much as 42.7 megabytes of formatted information.

The interface is SCSI, and Microtech says it's compatible with the Macintosh Plus, II, SE, and IIfx. It measures 3 by 10 by 11 inches. Included in the base price is the drive, cabling, and one SyQuest SQ400 cartridge.

Price: \$1099; additional cartridges, \$90.

Contact: Microtech International, Inc., 29 Business Park Dr., Branford, CT 06405, (800) 325-1895 or (203) 488-7744.

Inquiry 1131.

Computer CD-ROM Doubles as Audio Player

Chinon America thinks you should be able to use the same device for personal computer data storage and for audio entertainment. The CDS-430 drive lets your computer use Sony and Philips CD-ROM disks, with 530 megabytes of available storage space, as a data storage/replay medium and as a drive for your audio entertainment.

It's packaged in a 13- by 11- by 3-inch box and connects to your computer system through the SCSI port. Microsoft CD-ROM Extensions software enables reading of any disk written in the High Sierra format.

The system will automatically recognize whether the compact disk is ROM or audio and use the appropriate command format for either, Chinon says. It can also read a mixed audio/CD-ROM disk. **Price:** \$695; Extensions software, \$150.

Contact: Chinon America, Inc., 660 Maple Ave., Torrance, CA 90503, (213) 533-0274.

Inquiry 1134.

continued

Store 2.8 Megabytes on 3½-inch Floppy Disks

The Megamate 2.8 is a 3½-inch floppy disk drive that can store 2.8 megabytes on your average 3½-inch floppy disks. It works because of the proprietary floppy disk controller, the CompatiCard IV.

The CompatiCard IV con-

troller allows Micro Solutions to double recording frequency. That means it writes twice as fast, writing to 36 sectors per track. Standard 1.44-megabyte drives write to 18 sectors, and 720K-byte drives use nine sectors.

The drive itself, manufac-

tured by TEAC, is backward compatible with the standard floppy disk drives, including the PS/2 drives.

The CompatiCard IV controller is a half-length card that's XT and AT compatible. Each card supports up to four 3½-inch or 5¼-inch

floppy disk drives. One cable is included.

Price: \$395; or \$149 for CompatiCard IV.

Contact: Micro Solutions, Inc., 132 West Lincoln Hwy., DeKalb, IL 60115, (815) 756-3411.

Inquiry 1133.

WHAT'S NEW

HARDWARE • SYSTEMS

Entourage Ships MCA Clones

Whether you prefer IBM's Micro Channel Architecture, the AT architecture, or the proposed EISA bus architecture, MCA-compatible machines are becoming more widespread.

The 316XMC and the 320MC, MCA clones from start-up Entourage Computer Corp., feature better performance and lower cost than IBM's PS/2 models 50Z, 55, and 70, the company says.

System 316XMC is a zero-wait-state 16-MHz 80386SX with 1 megabyte of RAM that's upgradable to 8 megabytes using 80-ns single in-line memory modules on the motherboard. Built-in floppy and hard disk drive controllers support a standard 19-ms 40-megabyte SCSI hard disk drive and your choice of a 3½-inch or 5¼-inch floppy disk drive. There are three 16-bit expansion slots.

System 320MC is a zero-wait-state 20-MHz 80386 with 1 megabyte of RAM that is upgradable to 16 megabytes. It also comes (optionally) with the 40-megabyte hard disk drive and your choice of a floppy disk drive. Expansion is through two 32-bit MCA slots and a 16-bit MCA slot.

Both systems feature 102-key PS/2-style keyboards as standard equipment, but monitors are optional. Other options include math coprocessors, MS-DOS version 3.3 or 4.01, and OS/2 version 1.1.

Price: 316XMC, \$1895; with hard disk drive, \$2395; 320MC, \$2895; with hard disk drive, \$3395.



PS/2 clones feature MCA performance.

Contact: Entourage Computer Corp., 10919 Technology Place, Suite B, San Diego, CA 92127, (619) 673-8633.

Inquiry 1126.

Mitac Clones IBM's Model 55; Includes MCA

If you want an alternative to IBM's Model 55 SX, the recently introduced 80386SX-based Micro Channel Architecture microcomputer, you might try Mitac's MPS2386. It has the same 80386SX CPU, an MCA bus licensed from IBM, and many of the same features.

One advantage of Mitac's system is that its base price—about the same as IBM's—includes an internal 1.2-megabyte 5¼-inch floppy disk drive. With IBM's Model 55, 5¼-inch drives can be supported only externally.

Mitac peripherals match IBM's also. The MPS2386 uses the same 640- by 480-

pixel Tatung monitor, and it ships with 1 megabyte of RAM (expandable to 8 megabytes of 32-bit RAM on the motherboard).

Mitac's on-board VGA adapter comes from Paradise and is "auto-switchable" to EGA and CGA modes. There's also a dedicated mouse port on the back of the box.

Price: including keyboard and MS-DOS, \$2995. Tatung Monitor, \$549.

Contact: American Mitac Corp., 410 East Plumeria Dr., San Jose, CA, 95134, (800) 648-2287.

Inquiry 1127.

Unix Sidesteps with NEC

NEC's Astra XL/100, and XL/200 are 68030-based Unix machines that contribute to the unclear distinction between microcomputers and workstations.

In stripped-down configurations, both systems offer 25-MHz zero-wait-state perfor-

mance, 2 megabytes of standard RAM, 8K bytes of cache memory, and a 1.2-megabyte 5¼-inch floppy disk drive.

The bare-bones Astra XL/100, which is bundled with Unix System V, can support up to eight users. It includes an MC68881 floating-point coprocessor and memory expandable to 10 megabytes. It has eight free 32-bit Multibus slots.

One version of a preconfigured XL/100 includes an extra 2 megabytes of RAM, a dumb terminal with cabling, an 18-ns, 130-megabyte ESDI hard disk drive, a 150-megabyte tape drive with the operating system on tape, and an eight-port controller.

The XL/200 ups the ante a few notches by supporting up to 32 users with an optional software license. In its bare-bones configuration, it includes an MC68882 floating-point coprocessor and RAM expandable to a whopping 34 megabytes. It can be upgraded with an optional Advanced Terminal Subsystem add-in card to an XL/300 system to support up to 64 users.

A preconfigured XL/200 with a minimum of extras includes 6 megabytes of RAM, a dumb terminal with cabling, an eight-port terminal controller, an 18-ns, 130-megabyte ESDI drive, a 150-megabyte tape drive with the operating system on tape, and a license for up to 16 users.

Price: XL/100, \$8995; XL/200, \$13,995; configured XL/100, \$15,995; configured XL/200, \$23,995.

Contact: NEC Information Systems, Inc., 1414 Massachusetts Ave., Boxborough, MA 01719, (508) 264-8000.

Inquiry 1128.

continued

SEND US YOUR NEW PRODUCT RELEASE

We'd like to consider your product for publication. Send us full information, including its price, ship date, and an address and telephone number where readers can get further information. Send to New Products Editor, BYTE, One Phoenix Mill Lane, Peterborough, NH 03458. Information contained in these items is based on manufacturers' written statements and/or telephone interviews with BYTE reporters. BYTE has not formally reviewed each product mentioned. These items, along with additional new product announcements, are posted regularly on BIX in the *microbytes.sw* and *microbytes.hw* conferences.



IN 386 PERSONAL COMPUTING, YOU'RE LOOKING AT THE MOST WANTED LIST.

In 1986, Compaq introduced the world to personal computers based on the 386 microprocessor.

Since then, we've made it possible for every level of user to work with this powerful technology. In fact, more people work with COMPAQ 386-based PC's than any other 386's worldwide.

Today, Compaq offers the broadest line of these high-performance personal computers. Each delivers significant technological advancements developed by Compaq engineers. Each delivers optimum performance for the needs of different users. And each is built to the highest standards for compatibility and reliability.

For power-hungry users who want 386 performance to go, the COMPAQ PORTABLE 386 Personal Computer does things normally reserved for a desktop 386 PC. Without compromise.

For people considering 286 desktops, the COMPAQ DESKPRO 386s Personal Computer is an affordable way to move up to 386 performance. And if you have a 286 that you've outgrown, the COMPAQ DESKPRO 386/20e Personal Computer

is an easy step up to the power and capabilities of a 20-MHz 386 machine.

For the increasing needs of today's 386 users, the COMPAQ DESKPRO 386/25 Personal Computer offers advanced performance. And for those who desire the most power and expandability available in a desktop PC, the COMPAQ DESKPRO 386/33 stands alone.

For a free brochure on COMPAQ 386-based personal computers and the location of your nearest Authorized COMPAQ Computer Dealer, call 1-800-231-0900, Operator 93. In Canada, 1-800-263-5868, Operator 93.

COMPAQ, COMPAQ DESKPRO 386s, COMPAQ PORTABLE 386, It simply works better, Registered U.S. Patent and Trademark Office. Intel, Intel 386 and Intel 387 are trademarks of Intel Corporation. Microsoft, MS, XENIX and MS-DOS are trademarks of Microsoft Corporation. MS Windows/386 and MS OS/2 are products of Microsoft Corporation. UNIX is a registered trademark of AT&T. Registered U.S. Patent and Trademark Office. Product names mentioned herein may be trademarks and/or registered trademarks of other companies. COMPAQ DESKPRO 386/25 graphics © 1988 Accent Software, Inc. © 1989 Compaq Computer Corporation. All rights reserved. Printed in the U.S.A.

COMPAQ

It simply works better.®

Now it's possible to do just about anything you can think of, faster than you can think.

Introducing the COMPAQ DESKPRO 386/33 Personal Computer. Never before has so much performance, expand-

ability and storage been put into one desktop PC. And never before has one PC been capable of so much.

Inside its new system unit, you'll find that our engineers have redesigned just about every component to deliver a minicomputer level of power with unmatched PC flexibility.



A total of eight expansion slots let you customize the system to your needs by expanding memory and choosing from thousands of industry-standard expansion boards.

So you can use it as a stand-alone PC, putting its power to work on the most demanding CAD/CAE, financial analysis, database management and other personal productivity applications.

Or you can spread the power around, using the COMPAQ DESKPRO 386/33 as the driving force for a network or multiuser system. At the heart of the system is the Intel 386™ microprocessor. Running at a blazing 33 MHz, it works in concert with a series of technological advancements. Like a 33-MHz cache memory controller with 64K of high-speed static RAM. Interleaved memory architecture. And the exclusive COMPAQ Flexible Advanced Systems Architecture.

This high-performance combination delivers a 35% performance improvement in

CPU-intensive applications over 25-MHz 386 cache-based PC's.

Or said another way, nothing will slow you down. No matter what you want to do.

You can expand the 2 MB of standard RAM up to 16 MB using the high-speed 32-bit slot. That leaves up to six industry-standard slots free to customize the system to the demands of

the application you're using.

If your job is particularly demanding, you can use up to five high-performance internal storage devices to hold up to 1.3 gigabytes of data. And if that's not enough, bring

total system storage to 2.6 gigabytes with the optional COMPAQ Fixed Disk Expansion Unit.



Built-in interfaces make it easy to connect pointing devices, printers, plotters or other peripherals without using an expansion slot.

There's more. You can run MS-DOS®, MS® OS/2, Microsoft® Windows/386 and the XENIX® and UNIX® operating systems. Access memory over 640K under DOS with the COMPAQ Expanded Memory Manager that supports Lotus/Intel®/Microsoft (LIM) 4.0. And speed through calculations with 33-MHz Intel 387™ and Weitek 3167 coprocessor options.

All the new advancements engineered into the COMPAQ DESKPRO 386/33 deliver an unmatched level of power, expandability and storage.

To do anything you want.



High-speed VGA graphics are built in. And for greater graphics capabilities, add the optional COMPAQ Advanced Graphics 1024 Board.

COMPAQ

It simply works better.®



Embedded systems designers have already used CrossCode C in over 413 different applications.

How to choose a 68000 C compiler for your ROMable code development

These twelve important CrossCode C features could make the difference between success and failure

It's hard to know ahead of time what features you'll be needing in a 68000 C compiler. But if you're using CrossCode C you won't need to think ahead, because CrossCode C is already equipped with these twelve important features for your ROMable code development:

- 1. A 100% ROMable Compiler:** CrossCode C splits its output into five memory sections for easy placement into ROM or RAM at link time.
- 2. Integrated C and Assembler:** You can write your code in any combination of C and assembly language.
- 3. Readable Assembly Language Output:** The compiler generates assembly language code with your C language source code embedded as comments, so you can see each statement's compiled output.
- 4. Optimized Code:** CrossCode C uses minimum required precision when evaluating expressions. It also "folds" constants at compilation time, converts multiplications to shifts when possible, and eliminates superfluous branches.
- 5. Custom Optimization:** You can optimize compiler output for your application because you control the sizes of C types, including pointers, floats, and all integral types.

- 6. Register Optimization:** Ten registers are reserved for your register variables, and there's an option to automatically declare all stack variables as *register*, so you can instantly optimize programs that were written without registers in mind.

- 7. C Library Source:** An extensive C library containing over 47 C functions is provided in source form.

- 8. No Limitations:** No matter how large your program is, CrossCode C will compile it. There are no limits on the number of symbols in your program, the size of your input file, or the size of a C function.

- 9. 68030 Support:** If you're using the 68030, CrossCode C will use its extra instructions and addressing modes.

- 10. Floating Point Support:** If you're using the 68881, the compiler performs floating point operations through the coprocessor, and floating point register variables are stored in 68881 registers.

- 11. Position Independence:** Both position independent code and data can be generated if needed.

- 12. ANSI Standards:** CrossCode C tracks the ANSIC standard, so your code

will always be standard, too.

There's More

CrossCode C comes with an assembler, a linker, and a tool to help you prepare your object code for transmission to PROM programmers and emulators. And there's another special tool that gives you symbolic debugging support by helping you to prepare symbol tables for virtually all types of emulators.

CrossCode C is available under MS-DOS for just \$1595, and it runs on all IBM PCs and compatibles (640K memory and hard disk are required). Also available under UNIX, XENIX, and VMS.

CALL TODAY for more information:

1-800-448-7733
(ask for extension 2001)

Outside the United States, please dial

PHONE: 1-312-971-8170
FAX: 1-312-971-8513

SOFTWARE DEVELOPMENT SYSTEMS, INC.
DEPARTMENT 21
4248 BELLE AIRE LANE
DOWNERS GROVE, ILLINOIS 60515 USA

CrossCode™ is a trademark of SOFTWARE DEVELOPMENT SYSTEMS, INC. MS-DOS® is a registered trademark of Microsoft. UNIX® is a registered trademark of AT&T. XENIX® is a registered trademark of Microsoft.

THE FACTS

Finesse
\$199**Requirements:**

IBM PC, XT, AT, PS/2, or compatible with at least 640K bytes of RAM, a floppy disk drive and a hard disk drive, DOS 2.1 or higher (3.1 required for Fontware), and a CGA, EGA, VGA, Hercules, or other graphics adapter; a mouse is recommended.

Logitech International
SA
6505 Kaiser Dr.
Fremont, CA 94555
(415) 795-8500
Inquiry 1037.

of icons, menus, and windows. The program uses the technique of text frames; before you can pour the text into the publication, you have to first set down frames—boxes that you draw on the page with the "text frame" tool. This is an easy operation, but it does require physically, rather than

just conceptually, blocking out your page design before you start laying down text. You can't put a thing down on the page unless you put it in a frame. This takes some personal adjustment if you've been working with a more flexible package like Page-Maker.

Importing text is just a matter of clicking on the frame and then on the file you want to paste down on the page. Finesse will work with ASCII, Word, WordStar, WordPerfect, 1st Word+, and GEM Write formats. The same fill-a-frame procedure works with graphics; after you've drawn the frame, the program will pull in bit-map, TIFF, PCX (as in PC Paintbrush), and Metafile images.

Getting text to go from one frame to another involves using a *chaining* tool. After you've told the program which columns are linked, which you do by clicking inside the appropriate frames, it will run the text into the appropriate columns. Finesse doesn't have the powerful auto-flow capabilities of more expensive

packages, but its chaining procedure is relatively painless if you're working on a short publication. Anything over eight pages could mean racking up a significant number of mouse-clicks.

The copy I worked with included two fonts (called Dutch and Swiss) and came with several more Bitstream fonts on separate disks. I had trouble with the font installation program, though, and was unable to work with styles other than those embedded in the program. The final version, which the company expects to have ready by now, will come with several more typefaces, a collection of clipart, and a few prefab document styles, a Logitech spokesperson said.

Finesse has the basic tools you need to put together a brochure, newsletter, or other short document.

Screen redrawing seemed pretty slow, though, so laying out a long publication could be tedious. However, Logitech has added some shortcuts that are very handy and speed up some text-manipulation operations. For example, you can

raise or lower the size of selected text with a simple key combination: Alt-4 kicks the text up to the next point size, and Alt-3 brings it down again. These and other shortcuts are a nice touch.

I wish the developer would add the capability of working on a page when you're looking at it in "full-page" mode, though. As it is now, you can work on a document only when you've got it in "actual size" view, which unfortunately means you can see only that part of the page that fits on the screen. Setting a headline that runs across the page means you have to scroll back and forth or toggle between actual and full-size modes.

Despite a few limitations, Finesse is a fine program for producing short documents. If you've never used a publishing package and you don't want to climb a steep learning curve, this is the software for you. Finesse is easy to use, works well, and will run on most low-end PCs. It's not Page-Maker, but it's not trying to be. □

—D. Barker

Let the Mac Entertain You

Will affordable multimedia production capabilities be the most important breakthrough in computing during the 1990s? After working with MacroMind's new product, **MacroMind Director**, I'm beginning to think that this might be the case. MacroMind Director does indeed make video production, complete with animation and sound, accessible to anybody who has a Macintosh.

MacroMind Director is a greatly improved and enhanced version of VideoWorks, which has been the company's primary product since its inception in 1984. According to the product literature, over 100 new features are found in MacroMind Director.

Some important features

include automatic animation, a new color paint program, new music and sound capabilities (including MIDI control), and a greatly improved user interface with on-line help. A HyperCard driver, which lets

MacroMind Director sequences be included in HyperCard stacks, should be available soon.

Although you can get started in a few hours, Macro-

continued



THE FACTS

MacroMind Director
\$695**Requirements:**

Mac with 1 megabyte of RAM; a hard disk drive is recommended.

Options:

MacroMind Director, Interactive (\$300, available later this year; includes advanced HyperTalk-like procedural language and production utilities).

MacroMind, Inc.
410 Townsend St.,
Suite 408
San Francisco, CA 94107
(415) 442-0200
Inquiry 1036.

Until now there was only one way to integrate C and Assembler.



While C and Assembler give you power to burn, switching back and forth between them can leave your brain feeling a little fried.

All that stopping. And starting. And constantly retracing your steps.

Well, relax. Now there's Microsoft® QuickAssembler. Available with our clever QuickC® Compiler in one location: the first integrated environment for C and Assembler.

For the first time, you can save time with an integrated editor, compiler, assembler and debugger that let you create C programs, mixed C and Assembler programs, or Assembler programs that stand alone.

To make sure you feel at home in your new environment, we've designed Microsoft Quick Advisor, a hypertext electronic manual that coaches, coaxes and guides you on screen.

Quick Advisor gives you access to information on all ROM BIOS and MS-DOS® calls. And it even lets you cut and paste sample programs, so you can make both C and Assembler subroutines part of your routine in no time.

For more details on the incredible integrated power of QuickAssembler and QuickC Compiler, call (800) 426-9400. If you own QuickC Compiler version 2.0 already, we'll tell you how to add on QuickAssembler quick.

And take a load off your mind.



Microsoft
Making it all make sense.

Protects while you type!



- Remains In Place while you use your computer.
- Avoids Costly Repairs. Protects delicate electronics from dust, spills, smoke, ashes, staples.
- Soft, Flexible, retains normal keyboard feel.
- Washable, Durable High-Tech Polymer lasts years.
- Hundreds of Models. SafeSkin is available for most PCs, laptops, workstations and clone keyboards.
- Office • Home • Factory • Classroom • Laboratory

List Price \$29.95. Please call or write for free color brochure. Dealer inquiries encouraged.

SafeSkin™

KEYBOARD PROTECTOR

Merritt Computer Products, Inc. 5565 Red Bird Center Drive
Suite 150, Dallas, Texas 75234/(214) 339-0753 • FAX (214) 339-1313
In Canada call 1-800-663-1061

GURU THE ONLY COMPLETE UNIX™ DRIVER TUTORIAL

Whether you write UNIX Drivers
or just want a better understanding of them,
Driver Guru is for you!

De-mystifies UNIX Drivers forever!

Provides expert assistance in driver modification
Hypertext Environment

For the experienced UNIX
programmer:

- Detailed source code written in "C"
- Complete explanation of kernel interaction
- Hypertext access to specific information

For the programmer new
to UNIX:

- Years of experience at your fingertips
- Broad explanation of UNIX driver theory
- Segmented for quick and complete education

Driver Guru • \$ 149.95 U.S.

CALL TODAY

USA 1-800-433-9711 FAX 206-627-5934

UK 05436-71699 FAX 05436-75093

Empirical Research

P.O. Box 583 • Tacoma, WA 98401 • (206) 627-8511
A Public Corporation (OTC)

Requires Dos 2.0 or higher UNIX is a registered trademark of AT&T

SHORT TAKES

Mind Director is not a trivial program. You'll need to expend some time and effort to learn and master its capabilities.

The program consists of two parts: the Overview and the Studio. The Overview is basically a slide sorter with a control panel similar to that of a VCR. In the Overview section, you create individual frames or visual images that you can later combine into a "movie" using the Studio section of the program. Supported file formats include Scrapbook, PICT, PICS, MacPaint, Glue, and sound files from sound-sampling programs like MacRecorder. You can overlay images, animated sequences, and sounds in a single frame.

In the Studio section, you create the animated sequence of frames with the appropriate timing. The main workpiece in the Studio is the Score, which is similar to a spreadsheet in appearance. The rows represent separate frame sequences or channels, of which there can be up to 24. Each channel can contain any of the multimedia components (e.g., sound, graphics, or text), which you select from a Cast consisting of the library of images you created or imported using the Overview section.

The columns represent time. Therefore, multiple channels can appear simultaneously in the score. You can time the starting points and endpoints of each channel individually, so you can develop complex video sequences. Video sequences can also be controlled with the mouse button, if you're giving a talk simultaneously and want to click the mouse button to advance the frame sequence.

While MacroMind Director runs on all Macs with 1 megabyte of memory, it runs best on a Mac II, particularly since you then have 256 colors to work with. You can have separate color palettes for each frame, allowing much flexibility with the choice of

colors. You can get gray-scale imaging on a Mac SE, however. And performance is roughly the same on a Mac Plus or SE and on a Mac II. This is because the Mac Plus and SE don't have to worry about processing all the 8-bit color information.

Whether you use a Mac Plus/SE or a Mac II, getting into serious video production and presentation is not a minor investment. Aside from the computer and the software, you'll need a large screen to display the video. If you want to use scanned images, you'll need a scanner. If you want to output video to a VCR, you'll need a genlocking card that can convert the digital RGB output to the analog National Television System Committee format required by TVs and VCRs.

For a company or an educational institution, the expense for all this equipment makes sense. And there's no question that it costs thousands of dollars less than the traditional equipment required for video production.

However, for the hobbyist or casual user, full video-production capabilities require a pretty deep pocketbook. And although using MacroMind Director on the 9-inch screen of your Mac SE may prove to be entertaining, you can't really do presentations for other people on such a small screen.

On the other hand, MacroMind Director is a serious production tool for professionals who need its presentation capabilities. After a few hours of working through the tutorials, you can put together animated presentations, combining bulleted text charts, graphs, music or voice sounds, graphics images, and, if you have the equipment, scanned images or video sequences from a VCR. Overall, I think MacroMind Director is well designed and can be of great benefit and utility in all forms of visual communication. □

—Nick Baran
continued

More Powerful Than Ever ... Up To 5 KVA



MINUTEMAN[®]
UNINTERRUPTIBLE POWER SUPPLIES

STANDBY UPS MODELS

- 250 To 1600 Watt Output
- Synchronized Sinewave with 1 msec Switching Time
- Full One Year Warranty

ON-LINE UPS MODELS

- 1000 To 5000 VA Sinewave Output
- True On-Line — Total Isolation
- Static Bypass Switch Standard

SHUTDOWN SOFTWARE

- Auto Shutdown of Local Area Networks for Unattended Operation
- Compatible with SCO XENIX 2.2.3 and above
- Novell ELS 2.12 and above
Advanced Netware 2.11 & above
SFT Netware 2.11 and above



STANDBY UPS MODELS

Power Output	120 Volt Models	208-240 Volt Models
250 WATT	\$ 379.00	\$ 429.00
300 WATT	\$ 549.00	N/A
500 WATT	\$ 699.00	\$ 799.00
600 WATT	\$ 899.00	\$1049.00
900 WATT	\$1249.00	N/A
1200 WATT	\$1499.00	\$1749.00
1600 WATT	\$1999.00	\$2299.00

TRUE ON-LINE UPS MODELS

Power Output	120 Volt Models	208-240 Volt Models
1000 WATT	\$2249.00	Available
3000 WATT	\$5495.00	Available
5000 WATT	\$8950.00	Available



FOR L.A.N.
NOVELL LABS
TESTED AND
APPROVED
NetWare Compatible

PARA SYSTEMS, INC.

1455 LeMay Drive
Carrollton, TX 75007

Telephone:
(214) 446-7363

1-800-238-7272

FAX: (214) 446-9011

TELEX: 140275 OMEGA

NEW FOR TURBO C PROGRAMMERS

Three Serious Tools at a ridiculously low price.

Your time is valuable! Now you can reduce your programming time like you never imagined, using The Working Toolbox Software program by Be Aware Inc. Our program comes with an extensive, easy-to-use manual that is loaded with examples. Also included is a 30-day money back guarantee. Here are some of the features of these three great timesaving tools.

THE WORKING TOOLBOX

THE WORKING ISAM

- Stores data in B+ Trees
- Maximum of 256 indexes.
- RAM buffers for high speed.
- 6 types of indexes available
- Multi-field indexing
- All indexes stored in one file
- Automatic Recovery
- FREE SOURCE CODE

THE WORKING SCREEN PAINTER

- Friendly interactive environment
- Data entry and display.
- Box & line drawing supported
- Multi color screens at a glance!
- SUPER FAST SCREENS
- Writes C source code ready to be compiled under any memory model.

THE HANDY LIBRARY

- Great functions for easier programming and professional results.
- Intelligent data entry and display.
- Overlapping windows
- Pop Up, Pull down and bar menus with one function call!
- All memory models supported.
- Date conversion functions.

So don't waste any more time, order now! Only \$79.99 plus shipping and handling. Call (our toll-free number) or fax your order.

Be Aware Inc.

1443 Banks Road, Margate, FL 33063

No Royalties! ORDER NOW ONLY \$79.99

1 800-423-1611 or 305-970-0372

or FAX 305-735-3459

Turbo C is a registered trademark of Borland International.

SHORT TAKES

MultiPlus Takes on SideKick



THE FACTS

MultiPlus
\$99

Requirements:

IBM PC or compatible
with 512K bytes of RAM,
DOS 2.1 or higher, and
a hard disk drive.

SunFlex Software
1447 Peachtree St.,
Suite 503

Atlanta, GA 30309
(404) 874-9699

Inquiry 1038.

Want the best neural network?

Choose **BrainMaker**. Here's why:

Fast: 10 times faster than any other neural network.

Powerful: "BrainMaker does what hardware-based systems costing \$30,000 do." John Dvorak, PC Magazine
"High-performance software" Steve Gibson, INFOWORLD

Easy: "An ideal tool for learning this technology." Barry Simon, PC Magazine. You'll get our 255 page *Introduction to Neural Networks* that shows you what you need to know. The 332 page users guide shows you 8 working networks.

Fun: "BrainMaker is the strangest and most fascinating software I've ever seen." John Dvorak, PC Magazine.

Expandable: Our complete line of network products includes the *amazing* Hypersonic Training Program, an accelerator board, toolkit, and run-time licensing.

Guaranteed: for 30 days. "I recommend BrainMaker without reservation." Steve Gibson, INFOWORLD.

Order your BrainMaker *now* by phone, or write us for our **free** neural net catalog!

California Scientific Software

160 E. Montecito #E, Sierra Madre, CA 91024

\$195 (818) 355-1094

IBM PC, XT, AT, PS/2 or compatibles

256k, color or mono, supports mouse, hard disk

In the years since SideKick first appeared, many competitors have come and gone. So I have to admire companies that have the spunk to tilt at Borland's madly spinning windmill. A new contender is SunFlex Software, with a product called **MultiPlus**.

MultiPlus is yet another in the seemingly interminable line of desktop management packages. It has the usual assortment of SideKick-like features, including a word processor, a calendar and appointment scheduler, an address database and telephone dialer, and more. But I found MultiPlus an oddly eccentric package, filled with both nice touches and some maddening oversights.

All of its myriad files took up nearly a megabyte of disk space, so I couldn't use it with my floppy-disk-only laptop computer. It is possible to save disk space by eliminating one or more of MultiPlus's individual modules, and the core

RAM-resident module takes up just 10K bytes of RAM.

The word processor is full-featured, not just a notepad like SideKick's. And the five special-purpose calculators in MultiPlus are way ahead of Borland's. But the calendar/appointment maker has what I consider an unforgivable problem: There's no alarm option to remind you of an appointment. Then there's the address database and phone dialer. It does the job, but there's no telecommunication option.

SunFlex is pushing MultiPlus's built-in vaccine feature to set it apart from SideKick. But I think vaccine programs are a fad, good only for the truly paranoid and those who rely on public domain software. All in all, I give MultiPlus a B for effort, but there are too many rough edges. Although SideKick Plus sells for twice as much as MultiPlus, I'll stay with Borland. ■

—Stan Miastkowski

SEND AWAY FOR YOUR VERY OWN COMPUTER STORE.

When you buy a computer, about 35% of your money goes to the store.

But we'd much rather see your money go to somebody who deserves it a lot more.

You.

So we give you a completely different kind of computer store.

The Dell Computer Store.

Instead of a crowded, high-overhead showroom, you get our brand new 44-page catalog. Which gives you a full line of 386™ and 286 systems, printers, peripherals, software, and accessories.

And since you buy direct from the manufacturer, you save about 35%.

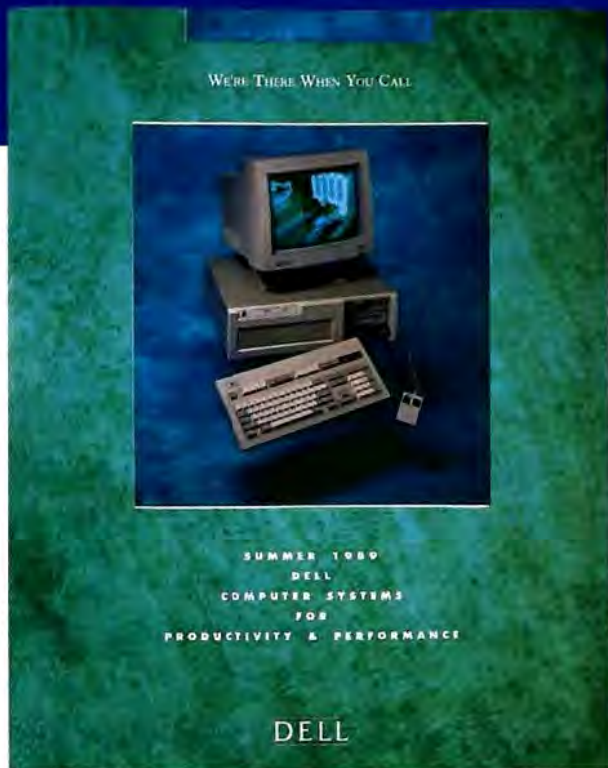

But there's a lot more to it than saving money. We offer you the most complete service and support in the industry. Including a 30-day money-back guarantee. A toll-free technical support hotline. Self-diagnostic software. And next-day desktide service from

Xerox Corporation. If you read our ad in the front of this magazine, it will tell you a lot more about the systems we offer. And the service we put behind them. So if you'd like a much more intelligent way to buy a personal computer, have a look at our ad. Or call us at 800-426-5150. Or send us the card on this page.

And we'll send the best computer store you've ever seen.

One you don't have to set foot in.



TO ORDER, CALL US.
800-426-5150.
FOR DELL IN CANADA, CALL 800-387-5752.



The Ever-Shrinking,

Agilis and Zenith announce tiny computers that

It seems that the smaller laptop PCs get, the more desirable they become. A fully functional XT compatible that travels as well as a hardcover novel is a powerful business tool. Furthermore, smaller form factors provide the opportunity for computers to enter interesting and unique new markets.

This month, we look at the **Zenith MinisPort** (page 94) and **Agilis System** (page 91) computers. The Zenith is a laptop in the truest sense of the word and very portable—a businessman's dream. Although the Agilis could serve as a laptop, it incorporates the latest technology to produce an expandable hand-held system intended for use in remote locations. These machines represent both evolutionary and revolutionary trends in laptop technology.

Ever-Expanding Laptops

broaden the market for laptops

Agilis Hand-Held Workstations: Computing Power in the Field

Nick Baran

In recent First Impressions, I've focused on computers that break new ground in price versus performance. I now have the opportunity to look at a machine that breaks new ground in size versus performance—the Agilis System hand-held workstation. In its top-of-the-line configuration, the Agilis System is a complete 80386 machine about the size of a notebook, about 3 inches thick and weighing 8 pounds. A lower-performance 80C88 version can weigh as little as 4 pounds.

The Agilis System is not just another laptop. It is designed for use outside the office and in harsh environments requiring mobility but also networking and remote communications capabilities. You can operate it with one hand using a touch-screen interface. And you can use it on a wireless Ethernet network with a range of up to 1 kilometer.

In the last 10 years, the personal computer has dramatically changed and improved the way we work in the office. But a major part of the work force has been left out of the computer revolution—namely, those who work away from the office or “in the field.” These workers include maintenance and service person-

Nick Baran is a BYTE senior technical editor based in San Francisco. He can be reached on BIX as “nickbaran.”



A notebook-size 80386 system showing the console slice, keypad slice, battery packs, and PrairieTek hard disk drive.

nel, sales representatives, workers on the factory floor or at test sites, public safety workers, building and utilities inspectors, military personnel, and many others.

Computers in the field could eliminate the paperwork associated with schedules, maps, diagnostic procedures and manuals, inventory, and telemetry, to name a few. And, if the computers in the field are connected to a network, they can communicate with other computers, such as file servers at the home office.

Although laptop computers offer some of the features needed for field work, they have major limitations: They are too large to operate comfortably while standing up; they have limited battery power and are dependent on wall-outlet power

sources; and they have limited networking capability and are not designed for harsh environments.

Any Way You Slice It

Created by former GRiD, 3Com, and NeXT engineers, the Agilis System is designed specifically for use in the field. Based on the Intel processor line, the Agilis System takes advantage of the latest advances in miniaturization and high-density electronic packaging. It is built on the concept of modular slices, each slice providing a component of the system, such as the CPU component or “processor slice,” a communications

slice, a data-storage slice, and a battery-power slice.

Made from ruggedized plastic, each slice is about one-third the size of a sheet of paper (8 $\frac{1}{8}$ by 3 $\frac{3}{4}$ by 1 inch). Each slice can connect front-to-back or top-to-bottom to another slice by means of the AgileConnect interface, which consists of an 802.3 Ethernet network interface operating at 10 megabits per second and a power distribution interface. The Ethernet and power paths are integrated into a single 34-pin connector built into every slice.

Power can come from nickel-cadmium battery packs, converters for standard 110-volt or 220-V alternating current, and 12-V automotive or 28-V military

continued



Photo 1: The components of the 80C88 processor slice. Note that the entire 80C88 system fits into a slice about the size of one-third of a piece of paper. The logic board shows a 512K-byte memory card inserted in the memory card slot. The 80C88 system boards feature surface-mounted components and are mounted back-to-back. The primary chip set is manufactured by Western Digital.



Photo 2: The 80C88 with the touchscreen console slice and a battery pack. This configuration constitutes a complete touch-operated personal computer. Note the programmable function keys around the perimeter of the flat-panel display.



Photo 3: The internals of the 80386 Agilis System. The underside of the board has a bay for a 20-megabyte 2 1/2-inch PrairieTek hard disk drive. The primary chip set is manufactured by Headland Technology. Note the serial and parallel ports at the lower edge.

direct current. The Agilis System software includes utilities for monitoring power consumption and battery life.

One of the important breakthroughs of the Agilis System is its efficient power distribution throughout the system. The Ethernet/power bus passes through each slice and includes a transceiver with a circuit that detects packets on the network and powers up the circuit automatically. When the circuit is idle, the transceiver is turned off. This design greatly minimizes the power requirements for network communications. The system software also includes utilities that automatically shut down the hard disk drive and the backlit display after a specified period of inactivity.

The AgileConnect interface includes a miniaturized, but fully functional, AT and XT bus interface. The 8-bit XT bus interface is contained in a 68-pin U-block connector. The 80386 processor slice includes an additional 34-pin connector, which extends the bus interface to the 16-bit AT standard. Slices connected end-to-end simply latch together, directly mating the male/female AgileConnect connectors. Slices placed top-to-bottom use a U-block connector to make the interface connection.

The Agilis System is designed for use outdoors or in dusty or damp indoor environments. It is reasonably waterproof and dustproof and can handle rough use. The limiting factors on its durability are the glass of the flat-panel display and the PrairieTek hard disk drive, if installed.

The heart of the Agilis System is the processor slice, which comes in 9.54-MHz 80C88 and 20-MHz 80386 versions. The 80C88 processor slice consists of two 6-by 2-inch logic boards mounted back-to-back in a single slice. The 80C88 system comes standard with 640K bytes of RAM and a card slot for a removable 512K-byte memory (RAM/ROM) card. Note in photo 1 that the RAM/ROM card is inserted into the slot on the logic board. It is the main storage and boot device for the 80C88 system. However, you can also plug a standard floppy disk drive slice into the 80C88 processor slice.

The 80C88 processor board uses a Western Digital chip set that supports both 4.77- and 9.54-MHz clock speeds and standard XT-compatible direct memory access and interrupt control, keyboard input control, and memory management for up to 640K bytes. The board includes an RS-232C connector and an external keyboard connector, as well as the standard XT-bus and Ethernet/power connectors. The complete

80C88 slice requires only about 4 watts of power.

The 80C88 also includes 128K bytes of flash, electrically alterable ROM, which you can use to load MS-DOS or custom applications into ROM. In this way, you can use the 80C88 slice as an embedded processor or for custom touchscreen applications. In fact, Agilis expects that a very common configuration of the 80C88 processor will simply include a battery slice and the touchscreen console slice (see photo 2). This configuration weighs about 4 pounds.

The console slice is one of the most interesting features of the Agilis System. It's actually the size of two single slices and features a backlit, 6-inch diagonal flat-panel display (built by Kyocera) that supports EGA gray-scale and bit-mapped graphics with 640- by 480-pixel resolution. The console slice has an infrared sensor for use with attached or detached keypads. And most important, the console slice has a built-in processor that supports touchscreen operation, including mouse and keyboard emulation.

The touchscreen lets you press on the screen and activate a command. You can also use your finger to move the mouse cursor. You can program the function keys on the perimeter of the touchscreen to execute macros, or you can simply use them as DOS function keys. The keys along the bottom row of the display console control cursor movement and the Enter function.

While the touchscreen interface works, it needs applications specifically designed to take advantage of it. With the programmable console keys, numerous possibilities exist for field-specific applications that maximize the use of the touchscreen. A reflective display slice without touchscreen capability is also available.

The top-of-the-line system is based on the 20-MHz 80386 processor (see photo 3). The 80386 system includes a bay for a 20-megabyte 2½-inch PrairieTek hard disk drive. The 80386 processor slice is actually the size of four single slices. With the PrairieTek hard disk drive, the 80386 system requires only about 9 W of power. The 80386 slice includes two serial ports, a parallel port, and the Ethernet/power and AT-bus interfaces. The 80386 board uses a G-2 chip set that features 360-pin surface-mount technology. The 80386 system is available with 1, 4, or 8 megabytes of memory.

Other Options

The beauty of the Agilis System is that the slice technology lets you configure it

in numerous ways, depending on your requirements. In fact, Agilis intends to license its AgileConnect interface to third-party manufacturers who want to build optional slices for the Agilis System. At this writing, Agilis has completed battery slices, a wireless packet-radio communications slice, and a floppy disk drive slice. Agilis is also developing a general-purpose expansion slice that will support standard XT and AT half-length expansion cards, such as internal modems or external video adapters.

Of particular interest is the wireless packet-radio communications slice. It offers 230,000-bps network communications within a range of 1 kilometer outdoors and about 100 meters indoors. The

The Agilis System doesn't compete directly with standard PC and laptop prices.

packet radio operates in the spread spectrum frequency range of 902 to 928 MHz and supports up to 16 channels. The communications slice requires about 15 W when it is transmitting packets but is automatically powered down to 2 W when idle. The communications slice is the size of two single slices. I did not see the communications slice demonstrated.

System Software

The Agilis System comes with either MS-DOS 3.3 or Interactive Unix V.3.2. DOS comes either on a floppy disk or on the 512K-byte RAM card for the 80C88 system. Unix is available on a floppy disk. Both operating systems come with additional system configuration utilities and system programs.

The additional software includes a System setup panel, which you can configure at system start-up to enable or disable certain components in the system, such as the serial ports or extended memory (in the 80386 version). A Power Management panel lets you specify whether you want video or audio low-battery warnings, and whether you want the system, hard disk drives, or Ethernet controller shut off when they are idle. You can also specify the threshold voltage at which the low-battery warning

should come on.

The system software includes the Agilis Action Point utilities. The utilities contain configuration files for specifying mouse or keyboard emulation and for programming the console keys. Another utility installs DOS or other applications in the 128K bytes of flash ROM in the 80C88 slice. An extension to the DOS FORMAT command is included for formatting the 512K-byte RAM cards used in the 80C88 slice.

Configurations and Prices

Because of the durability and density of the electronic packaging, Agilis components are not inexpensive. The Agilis System does not compete directly with standard PC and laptop prices and is not intended to compete in the traditional desktop or laptop market.

A typical high-end system would consist of an 80386 processor, 4 megabytes of memory, a 20-megabyte hard disk drive, the console slice, a keypad slice, two battery slices, and a power converter. Such a system would cost just over \$12,000. An intermediate system might simply be an 80386-based 3+ mail server (with 3Com's 3+ network E-mail software installed on the hard disk drive), which would consist of an 80386 slice with a hard disk drive and a power supply. This setup with 1 megabyte of RAM would cost about \$6600.

At the other end of the spectrum, an 80C88 system with the touchscreen console slice, the 512K-byte RAM card, a battery slice, and a power converter would cost about \$5000.

Hands On

I had an opportunity to try out an early prototype version of the 80C88 slice with the touchscreen console. The system was running Microsoft Windows, a paint application, and a CAD drawing display application called FastView, all installed on the 512K-byte RAM card. This system was small and light enough that I could stand and cradle the system on my left arm and operate it with my right hand. Using the console's function keys, I could make changes to the Setup Panel and to the Power Management configuration. I ran the FastView application and loaded a CAD drawing on the screen. Using the console keys, I could Pan and Zoom on areas of the drawing.

To make a long story short, the system works. However, the system I tested needed some improvements in the display backlighting and the touchscreen sensitivity. It was hard to see the mouse

continued

cursor as I dragged it across the screen, and I had to keep adjusting my viewing angle so that I could view the screen. Agilis engineers assured me that commercial versions of the touchscreen would have the necessary improvements.

I also tried assembling and disassembling various slices. I was impressed with the quality and solid engineering of the components. Each slice has guide rails, which make assembly of slices literally a snap. Once assembled, the slices are locked together with spring-

loaded tabs on each side.

The real promise of the Agilis System hinges on the development of innovative software that can take advantage of the system's touchscreen and networking capabilities. While clearly not designed for the everyday user, the machine could have enormous utility in all kinds of field operations. According to Agilis's marketing director, Bert Keely, the machine has generated the greatest interest from automotive and airplane manufacturers, who intend to use the hand-held work sta-

tion for diagnostics and data retrieval for mechanics and test engineers.

I am impressed with the innovative engineering of the Agilis System. While I did not get a chance to work with a final production version of either the 80C88 or 80386 system, the preliminary components appear to be well designed and manufactured. I also saw preliminary versions of the documentation, which is thorough and well written. The Agilis System points the way to new advances in portable computing. □

The Littlest Zenith

Michael E. Nadeau

Looking at many of the so-called "laptop" computers makes you wonder how they got the name. Though portable, few of them are practical for computing on the go, even if they do fit comfortably on your lap. Having a computer that you can easily pick up and move to another location is one thing; using it during transit is another.

My ideal laptop would fit into a briefcase with room to spare and weigh under 5 pounds. Its screen would be easily readable in poor lighting; its nonvolatile memory would be large enough to store program and data files. The battery life would be at least 4 hours. A 2400-bps modem would be a must, as would be ports for an external monitor, a floppy disk drive, and a printer. The keyboard would be responsive and intelligently designed. The laptop would also have a painless means of porting programs and data files to and from my desktop PC. And it would have all this for under \$1000.

No such critter exists, but the Zenith's new MinisPort comes closer than any other laptop, with the exception of the NEC UltraLite (see the review "The Painlessly Portable PC" by Mark L. Van

Michael E. Nadeau is the associate managing editor of the reviews section of BYTE. He can be reached on BIX as "miken."



The Zenith MinisPort. The configuration shows the 2-inch 720K-byte floppy disks.

Name and Bill Catchings on page 161). At around \$2400 (Zenith had not set final prices at press time), the MinisPort beats the \$3000 4½-pound UltraLite on price, but at 12½ by 9½ by 1½ inches and 6 pounds, the MinisPort narrowly loses to it in the size and weight categories. Minor faults aside, the MinisPort should be a desirable entry in the little-laptop arena.

BYTE's preproduction evaluation unit came with the standard 1 megabyte of surface-mount RAM, up to 368K bytes of which can be configured as a nonvolatile RAM disk, EMS memory, or a combination of both. You can configure a 1-

megabyte upgrade option (\$799) as either additional RAM disk space or EMS memory. DOS 3.3 resides in 360K bytes of ROM, along with Rupp Corp.'s FastLynx file transfer program.

The MinisPort's 80C88 CMOS CPU is switchable between 4.77 MHz and 8 MHz via the keyboard or software. It has a Centronics-type parallel port and an RS-232C serial port with a DB-9 connector. The external video port supports both CGA-type RGB-intensity TTL-level and composite monochrome output. The fourth port is for an external floppy disk drive. A tiny slot is also available for a Saltine-size 1200-bps modem card (\$299), which was unavailable at this writing. The MinisPort's screen is a backlit, supertwist, 640- by 200-

pixel LCD.

A unique feature of the MinisPort is its double-sided, double-density, 720K-byte 2-inch floppy disk drive, the first of its kind to be used in a laptop or any other kind of personal computer. The floppy disk drive and disks look like scaled-down 3½-inch versions. An external 3½-inch floppy disk drive is a \$299 option.

Look and Feel

Somewhat larger than a kid's Etch-A-Sketch, the MinisPort is easily totable. Two of them would fit snugly into my briefcase.

Flipping up the screen reveals a typical laptop keyboard arrangement. The function keys are on the top row, and a numerical keypad is embedded within the alphanumeric keys on the right and accessed via the Fn key. Zenith committed no "mortal sins" in designing the keyboard; the only idiosyncrasy is the placement of the left single quotation mark (') and backslash (\) keys in the column farthest to the right. Since you don't use these keys frequently, their position is a minor inconvenience.

The keyboard feel is firm and responsive. I quickly became comfortable typing on the MinisPort. Functions called by the Fn and Alt keys are color-coded—a nice touch. Although the MinisPort is smaller than nearly all other MS-DOS laptops, the keyboard didn't feel cramped.

The LCD display, while not state-of-the-art, is adequate for most situations. Working in a dimly lit room, I had a little trouble picking out the underline cursor in a screenful of text. You can adjust the contrast and brightness via slide controls at the bottom of the screen, and you can position the screen from 90- to 180-degree angles. The 8½- by 3¼-inch viewing area exhibits some horizontal distortion of graphics images typically associated with such displays.

The 12-V battery is lighter than most and slides in and out easily from the left side of the case. It's rated for 3 hours, although I got only 1 hour and 45 minutes on a full charge (which takes 10 hours). Extra battery packs are \$79 each. The MinisPort warns of imminent shutdown with a flashing red LED indicator and intermittent beeps. According to the documentation, I got shorter battery life because I had the screen backlighting on and several ports enabled. A Zenith spokesperson said that up to 5 hours on a charge is possible, although not guaranteed, if you don't use the LCD backlighting.

All ports are easily accessible at the rear, and the modem line is on the left side next to the battery. A handle swings out at the front. The MinisPort has all the usual LED indicators, plus ones for the silicon disk drive (SDD) and padlock.

Many businesses and users fret over losing their laptops to theft. The MinisPort has a unique "security bracket" to prevent theft. This steel bar slides out from the right rear of the case and has a hole for a padlock. Attempts to break off the bar destroy the computer, since it is attached directly to the motherboard. A determined thief could saw through this bar, but it wouldn't be easy.

MFM-180

Zenith provides a multifunction monitor program, MFM-180, which lets you set operating parameters, examine and manipulate areas of memory and register contents, test system components, set video commands, and change the boot drive.

Pressing Ctrl-Alt-Insert gets you to the MFM-180 -> prompt. From there, you can access the monitor's utilities. Most users will need only the Setup program, which establishes operating parameters. The Setup menu lets you set the time and date, CPU speed, video display, backlight time-out, and boot drive. You also can enable or disable the ports and RAM disk backup, and you can allocate RAM to either the RAM disk or EMS memory.

Somewhat
larger than a kid's
Etch-A-Sketch, the
MinisPort is totable.

The Setup program also lets you establish password protection against unauthorized use of your MinisPort. You can also change fonts; your choices are Norwegian, Turkish, Greek, Hebrew, and the default, U.S./English. This feature was not implemented on the BYTE machine.

Data Come, Data Go, Data Stay

Manipulating data and program files on a laptop can be a problem. Zenith provides several ways of running application software and transferring software to and from a desktop PC.

You have three ways to get software and data into the MinisPort: You can beam it over via the serial port using FastLynx; send it over a null-modem cable using a communications program; or use the petite, new 2-inch floppy disks in conjunction with an external 3½- or 5¼-inch floppy disk drive attached to the MinisPort or an external 2-inch floppy disk drive (\$349) attached to your desktop PC. Zenith will offer an extra-cost starter kit that includes a slipcover, the cable for FastLynx, and 10 2-inch floppy disks. The kit's price was not set at press time.

Most users will want an external drive on either the MinisPort or their desktop PC. No commercial software is available in the 2-inch format, and a Zenith spokesperson said that the company sees these floppy disks only as a means of transferring programs and data files. Panasonic and Sony, however, produce the 2-inch media. It is similar to media used in digital cameras. Zenith had no pricing information on the disks.

While nonstandard media has its problems—potential availability problems, higher cost, lack of commercial software—conventional formats would simply not work in laptops as small as the MinisPort. The drive hardware would add too much weight and bulk. Zenith obviously hopes that the 2-inch media will become standard for laptops of the MinisPort class.

Once you have your files in the MinisPort, you can use them from either the floppy disk or the SDD (drive D) in RAM. True to its billing, drive D does behave like a very fast hard disk drive, although a small one. I could not run all the BYTE disk I/O benchmarks because some require a megabyte of disk space to run. The DOS seek tests, however, showed a time of 3.90 seconds for a sector read and 18.22 seconds for a 32-sector read. The IBM PC AT times were 14.95 and 65.18 seconds, respectively.

A pair of lithium batteries provides up to three days of backup power to the RAM memory, so you won't lose data in drive D when the main battery goes dead or when you change it. You can turn off the battery backup option from the Setup menu.

The downside is that the 368K bytes available as an SDD in the 1-megabyte model is just not enough to run most meaningful applications. PFS Professional Write barely fits if you leave the spelling checker behind, and you can forget XyWrite. The extra megabyte available for the SDD in the 2-megabyte model is a necessity.

Performance per Pound

With its 80C88 CPU, you wouldn't expect blistering performance from the MinisPort, and the BYTE CPU index of 0.38 bears this out. This rating makes the little Zenith either a fast XT or a slow AT, depending on how you look at it.

The applications that anyone is likely to use on a computer like the MinisPort don't require a quick CPU. Word processing, communications, and light information management will be the major applications for the small laptops. I saw

continued

THE EVER-SHRINKING,
EVER-EXPANDING LAPTOPSMade
in
USAComplete /AT System
On A Single Card
(Standard IBM /AT Card Size)

Build your own system by selecting from DTI's card family with features that include:

- On-board RAM up to 8M
- 12, 16, 20, MHz CPU Speed
- CPU-8088, 286, 386SX, 386
- Graphics-VGA, EGA, CGA, MDA
- SCSI, ST506, IDE
- Floppy Interface
- Keyboard Interface
- 2 Serial Ports
- 1 Parallel Port
- Ethernet Interface
- Award or Phoenix Bios

3088, 286, 386SX, 386 are trademarks of Intel Corp.
XT, /AT, IBM are trademarks of IBM Corp.
Award is a trademark of Award Inc.
Phoenix is a trademark of Phoenix Inc.

Also Available:

- Card Cages
- Backplanes
- Chassis
- Rackmounts
- much more



112 E. State St. • Ridgeland, MS 39158

(601) 856-4121

1-800-443-2667

Designed and Manufactured by DTI in the USA

no noticeable difference in these areas between the MinisPort and my 10-MHz 80286 AT clone. Besides, the speedy SDD tends to compensate for performance penalties that the CPU imposes.

MinisPort vs. UltraLite

The laptop most comparable to the MinisPort is NEC's UltraLite. Aside from the differences mentioned earlier, the two most significant areas that set these machines apart are performance and storage media.

NEC put its own 9.83-MHz V30 CPU in the UltraLite, and, consequently, its BYTE CPU index is higher at 0.93. Both machines simulate a hard disk drive in RAM, so disk-access times are similar, although the UltraLite's minimum SDD size is 1 megabyte. The MinisPort seems to have an edge in battery life, and its battery is user-replaceable, whereas the UltraLite's isn't.

Zenith went with something familiar when it chose the 2-inch floppy disk drive as the removable storage media. NEC chose battery-backed 256K-byte RAM and ROM cards. Both approaches seem to work well, although NEC's is more expensive: The cards cost \$299 each. Both vendors must assure potential buyers of reliable supplies of each medium, since they are new.

The Mini Future

I like the MinisPort. I travel frequently and would welcome its company. Corporate America seems hungry for smaller, fully functional DOS laptops. The MinisPort fills that need, at least for those who can afford its price.

It could be better. A 2400-bps modem would be nice (Zenith says one is in the works), as would a better screen, more RAM for the SDD, a longer-lived battery, and a price tag to match its size. It should also lose a little weight. These improvements will come as laptop technology advances. In the meantime, the MinisPort makes a good travel companion. ■

COMPANY INFORMATION

Agilis Corp.
1101 San Antonio Rd.
Mountain View, CA 94043
(415) 962-9400
Inquiry 885.

Zenith Data Systems
1000 Milwaukee Ave.
Glenview, IL 60025
(800) 842-9000
Inquiry 886.

FREE INFO KITS FOR DEVELOPERS!

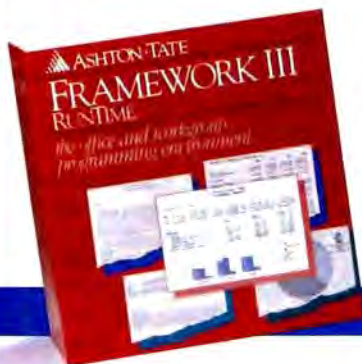

NEW! Build better applications faster and more economically with **Framework III™ RunTime**—the first integrated PC software development engine with built-in multiple functions and a royalty-free licensing agreement.

SPECIAL ADVANCE NOTICE! Get more programming power, flexibility and control over integrated microcomputer applications development with the **Framework III Developer's ToolKit**.

CALL TOLL-FREE 1-800-437-4392, EXT. 1801

GET YOURS NOW!

YES, ASHTON-TATE! I want to find out how I can save time, save money and enhance my software applications! Send me the FREE software information I've checked!

NAME (PLEASE PRINT) _____

TITLE _____

COMPANY NAME _____

CITY _____

STATE _____

ZIP _____

BUSINESS PHONE _____

Mail to Ashton-Tate, 14 Inverness Drive East, Building E, Suite 104, Englewood, CO 80112. Or for faster service, call us toll-free at 1-800-437-4392, ext. 1801.

ASHTON-TATE®

The Ashton-Tate logo and Ashton-Tate are registered trademarks of Ashton-Tate Corporation. Framework III is a trademark of Ashton-Tate Corporation. © 1989 Ashton-Tate Corporation. All rights reserved. Specifications and prices subject to change without notice.

New Report:
Framework III RunTime
Info Kit. Available Now!

Fast-breaking news:
Framework III Developer's
ToolKit Information.
Available Soon!

Tell us what you do:

- Developer VAR
 Corporate/MIS Manager
 Other

It goes with the territory.

If your territory is field engineering, the GRiD portable computer can make your work more productive.

GRiD laptops make it easy for you to analyze data on-site for fast error identification, correction and reporting. You can retrieve information from remote databases while in the field, and share information via electronic mail.

GRiD laptops are lightweight, battery-powered and ruggedly built. The GRiDCase 1535 EXP has two, full-sized expansion slots, to let you plug in the board you need for communications and storage expansion. And the 1535's 386 processor gives you fast processing for complex calculations.

We help you find the right software too, whether it's an existing DOS or UNIX program, or customized package. We also offer after-sale consulting and responsive technical support. We'll give you a complete, systems solution that you just won't find from a hardware-only vendor or local retailer.

Why? Because at GRiD, we think that goes with the territory.

Give us a call at **800-222-GRiD**.

GRiD

First in Field Systems

Circle 294 on Reader Service Card

GRiD Systems Corporation

47211 Lakeview Blvd., Fremont, CA 94537

(415) 656-4700



Things aren't always what they seem.

Like our DesignView/1600 system

A system that Publish magazine called "a real knockout with the finest text display you'll find on any monitor — Mac or PC."

With all the features it has, it certainly looks like a pretty costly workstation quality display system.

Features like an impressive 1,600 x 1280 resolution. That's 109 x 121 pixels per inch!

■ **200-MHz performance.** To give you a steady and easy-to-read display, the DesignView/1600 has the highest data rate in its class - 200 MHz. And the high, 67 Hz screen refresh rate gives you a picture that's flicker-free and easy on your eyes.

■ **Two pages at a time.** With two full-sized pages on a 19-inch landscape display, the DesignView/1600 makes scrolling a thing of the past. That means it's faster and easier to create newsletters or magazines, ad or manuals, financial reports, books, and virtually anything else because the DesignView/1600 lets you see exactly what you'll print.

■ **Sharper fonts and images with grayscale.** The DesignView/1600 optional levels of gray enhance details that might go unnoticed on other displays. And delivers the sharpest image available on the market. We even bundle four proprietary gray-level DesignFonts (Times Roman, Helvetica, Symbol, and Courier) in a variety of sizes so you can see - and read - everything accurately before you print.

■ **The highest resolution for a PC.** The 1600 x 1280 pixel resolution of the DesignView/1600 display lets you read fine print (as small as 5-point type) while seeing two whole pages. **This is the same resolution as the Sun-4 workstation monitor.** The extraordinary display quality, combined with a clean, stable, flicker-free picture means your images are razor sharp, your alignments are perfect, and your drawings are pin-point precise. We even provide high resolution screen fonts so what you see is exactly what you get.

■ **Work with your existing software.** The DesignView/1600 display system offers extensive software driver support for most major applications, including Microsoft Windows 386 and 286, Aldus PageMaker, Microsoft Excel, Adobe Illustrator, CorelDraw, Designer, GEM, Ventura Publisher, AutoCAD, AutoShade, WordPerfect, WordStar, Publisher's Paintbrush, Lotus 1-2-3, Sun Microsystems' NeWS, Xenix, and many more. Plus, our flawless on-board Hercules emulation ensures that existing applications will run without modifications.

The DesignView/1600 offers many more features, yet it isn't as costly as it sounds. **This excellent display costs hundred of dollars less than our nearest competitor!**



We guarantee your complete satisfaction by offering...

■ **Fast service.** All orders are shipped within 24 hours. Specify optional Priority Service and your order is shipped the same day by overnight express.

■ **The best warranty on the market.** Our display products carry a three year warranty on all parts and labor.

■ **60 days money back guarantee.** If you are not completely satisfied with any of our display systems, for any reason whatsoever, just return it within 60 days and we will refund your money in full. **Plus** we'll pick up all freight charges.

The DesignView/1600 is part of our extensive family of display products for IBM compatible and Macintosh computers. We carry a complete line of high resolution color, monochrome and gray-scale systems.

In fact, the monitor you've got in mind is probably in our warehouse right now!

To get a better picture, call our toll free number for a copy of our free information package.

1-800-343-5532

Dealers Inquiries Welcome.

Elite Microsystems, Inc.

4201 Remo Crescent - Bensalem, PA 19020 - USA

Tel. (215) 639-1636 Fax: (215) 639-3421

Circle 92 on Reader Service Card



THE GREAT POWER SPIKE

When the lights go out at Chaos Manor, it's a serious matter

Jim Ransom, my deputy chairman of the Advisory Council on National Space Policy, had just finished some updates to the SSX (Space Ship Experimental) briefing to go to the Defense Council, and we'd shut down the Mac IIx. We'd been using Microsoft's PowerPoint presentation software to make some changes to the briefing. Although there are other powerful programs, such as More II, I don't find all Macintosh software quite so easy to learn as it's generally advertised; when you've learned the quirks of a program that's good enough, it's sometimes best to stick with what you have. We started our spaceship briefings with PowerPoint, and we've never had enough time to learn anything else.

Anyway, we used the Mac IIx software shutdown procedure. When you do that on my Mac, a voice shouts, "Bring out yer dead!" after which the screen goes dark. We'd been using the Apple Scanner, which is attached to the Mac IIx, and the CD-ROM reader, but we'd taken no particular steps to shut those down. We'd also been using the Laser-Writer IINTX, and we didn't turn it off.

I'd just poured a pair of brandies to celebrate the work we'd done when the lights went out.

Actually, it was worse than that. Not only did the lights go out, but they instantly came back on for a brief moment, and this time there were sparks and bright flashes all over the room. A light bulb exploded. There were more flashes outside. Then quiet, and darkness.

The only light was from the screen of the Northgate 386. It had been connected to a Clary PC-1.25k Onguard PC unin-

terruptible power supply; and while other stuff fried, the UPS-protected Northgate didn't even glitch.

We got down the wall flashlights—I keep flashlights in my desk, but the main emergency light sources are Black & Decker Spotlights connected to wall recharger units, two upstairs and two down—and went around turning off all the computers just in case the power came back on. By that time the high-pitched "No Power, Boss!" warning signal from the UPS was getting to me, so I shut down the Northgate—it had never noticed that anyone had a problem—and turned off the Clary UPS. We still had telephones, and I thought of plugging Big Cheetah and the modem into the UPS and getting on-line to BIX, but I didn't do it. We waited a few minutes, but it became obvious that the lights weren't coming back on, so we finished our brandy, Jim went home, and Roberta and I went to bed.

I woke about 4:00 a.m. to discover that some of the lights in the house were on, but some weren't and wouldn't go on. A main 30-amp fuse was blown, and when I replaced it the replacement blew instantly. I thought about what could do that and half-concluded that a power spike had shorted out the refrigerator. After all, Roberta had just that day replaced its vegetable crisper at a cost of \$135 and a lot of her time; why not? But there was nothing to be done at 4:00 a.m.

Come morning we horsed the refrigerator out of its alcove, discovering about 2 inches of greasy dirt underneath—it's very difficult to pull the fridge out, and evidently we hadn't done it for several years—and unplugged it. Then we went through the house looking for anything else that might be plugged in—and lo!, in Roberta's office, there was an Isobar Power Isolator and Surge Protector. Her Kaypro 386 and Mannesmann Tally laser printer had been plugged into it. When I disconnected the Isobar from the wall, something inside it rattled.

We replaced the main fuses. No problem. Then we cautiously plugged in the refrigerator. It started up fine. I took the Isobar upstairs and used a multimeter to discover there was a dead short from the hot side of the plug to ground. No wonder it blew fuses.

After that, it was a matter of testing.

The first casualties were in the back room. My son Richard had been playing Earl Weaver Baseball on the Tandon 286 when the lights went out. Alas, the Tandon was plugged directly into the wall, no surge suppressor, and it was dead. So were the family room VCR and TV, both of which had been on when things happened.

Next were light bulbs. Fluorescents were all right, but every incandescent light bulb that had been on was dead.

"Some power failure," I said. Roberta called the Department of Water and Power to see what had happened. The chap who answered said it had been amusing to listen to the stories at first, but now it sounded like one big whine: everyone had lost equipment. Some chap had managed to drive his car into a power pole, which fell, taking out a transformer. He offered to give us the telephone number of the poor fellow's insurance company.

In discussions with Joanne Dow ("jdow," the Amiga wizardess on BIX) and her friend Alan ("arog" on BIX), we decided that a 16K-volt AC line had dropped across one side of the 220-volt lines that supply the houses in my neighborhood. The result was one heck of a power surge.

So. Now we knew what happened. Next thing was to assess the damage.

First, Roberta's machine, printer, and USRobotics external modem, which had been plugged into the now dead-shortened Isobar, worked fine. When we took the Isobar apart, we discovered that every choke coil was discolored and several of the metal-oxide varistors (MOVs) had

continued

literally melted. My son Alex looked at it and clucked his tongue. "It died that others might live," he said. I've still got the Isobar; one of these days we'll bury it with military honors.

It deserves it. I bought that gadget back in 1977 at the behest of Dan MacLean, who insisted that all electronic equipment ought to have surge protection. Clearly he was right; alas, after he died I became slothful and neglected some of the gear. I sure wish I hadn't.

My upstairs suite in Chaos Manor has its own electrical supply box with circuit breakers rather than fuses. I found that three breakers had tripped. When I reset them, I noticed that my incandescent lights were gone, but the fluorescents were all right, and so was the pump for the tropical fish tank.

When I turned on the Clary UPS, there was no whine; it had power. The Northgate 386 connected to it was fine, too.

Big Cheetah, my main machine, had been plugged into a Compuguard surge suppressor that I bought from Priority One. That unit also supplied power to my USRobotics modem, a Maximum Storage APX-3200 WORM (write once, read many times) drive, an Amdek Laser-drive CD-ROM reader, and an Electrohome 19-inch high-resolution monitor. I had turned off the switch on the Compuguard while the lights were out; now I held my breath and turned it back on.

Big Cheetah came up fine. So did all his auxiliary equipment. No damage.

Next was the Macintosh, which was plugged into a Woods surge suppressor. The Mac had been shut down when the spike hit, and it came up with no problem. All its peripherals, such as the scanner, worked properly, too. Alas, not so the Priam SCSI 330-megabyte MacDisk, which was also plugged into the Woods suppressor and had been left on after the Mac was shut down. Inspection revealed that the Priam's 2-amp automobile-style cartridge fuse had blown so violently that there was metal plated all over the inside of the glass cylinder. Replacement of the fuse did no good. The Woods suppressor might as well not have been there.

In a panic I called Alex. After all, he's in the business of recovering data from zapped hard disks. He came right over. "Power supply, probably," he said, and proceeded to cannibalize the power supply from a spare external WORM drive box. In minutes he had the Priam up and running. It looks a bit odd in the old WORM box, but it works fine. Priam is getting us a new power supply, and I can still report that we've yet to lose a single byte of data from a Priam hard disk.

Then there was the Apple LaserWriter IINTX: dead as a doornail. I sure hope it's just the power supply. There's no fuse visible. Apple is sending me a replacement. Meanwhile, in the two days since we lost it, I've found just how much I do with it: not novels and articles, but letterheads, everything with graphics, and a lot of other stuff. I'll sure be glad to get it running again.

Anyway, to cut the story short: the power surge killed every unit of electronic equipment that was turned on and not plugged into a surge suppressor. It also burned out nine incandescent light bulbs and literally exploded two others; and it killed three surge suppressors, one of which, the Isobar, failed in a dead short, while two others (brand name unknown) simply died—they didn't blow fuses, but they no longer let power through at all. One of those protected the VCR and TV

continued

WHY DESIGN YOUR PRODUCT AROUND A COMPUTER?

Design the computer in.

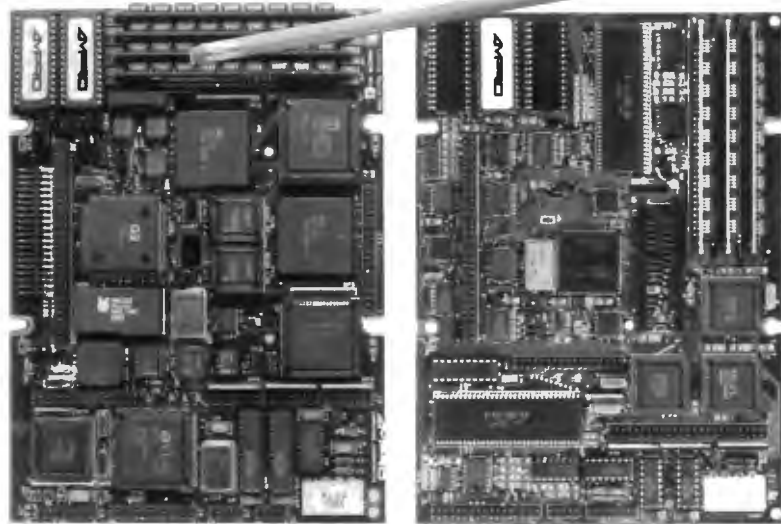

Little Board™/286

Little Board/PC

Built-in vs. built-around. External systems mean boxes, boards, backplanes, cables, and reliability problems. Ampro's Little Boards give you a complete system on a single board you can build right into your product.

Small size. Big power. Eliminate the bulk and constraints of multi-board, backplane-based systems. Embed a Little Board that requires just 2/3rds the power and volume of a 5¼" floppy drive. But with the full power of a PC or AT®.

Fully compatible. Little Board/286 and Little Board/PC are functionally identical to multi-board PCs and ATs. They run PC-DOS™ 2.0 to 3.X. They run DOS languages, compilers and applications. You'll be standing on a proven foundation of hardware and software.

Ampro's Single Board Systems. It's all there. Up to a Megabyte of RAM. RS-232C and Parallel ports. AT/PC-compatible controllers and bus expansion. EGA/CGA/MDA and Hercules™.

compatible video options. Even optional solid-state disk. Plus SCSI support for hard disk, tape, optical drives, bubble drives... you name it. And, low power consumption (+5VDC, less than 8W) and a wide operating temperature range (0 to 60°C). Perfect for standalone operation and harsh environments. Anywhere that reliability is a critical consideration. Available worldwide. For information and the name of your nearest U.S. or international Ampro representative, call us at the number below. Or write for Little Board Product information.

Now includes DR DOS™

408-734-2800

Fax: 408-734-2939 TLX: 4940302

AMPRO
COMPUTERS, INCORPORATED
1130 Mountain View/Alviso Road
Sunnyvale, CA 94089

Reps: Australia—61 3 720-3298; Austria—43 222/45 45 01; Canada—(604) 438-0028; Denmark—45 3 86 20 20; Finland—358 0 585-322; France—331 4502-1800; Germany, West—49 89 611-6151; Israel—972 3 49-16-95; Italy—39 6 811-9406; Japan—81 3 257-2830; Netherlands—010-411 85 20; Spain—34 3 204-2098; Sweden—46 8 55-00-65; Switzerland—41 1 740-41-05; United Kingdom—44 2 964-35511; USA—contact AMPRO

Trademarks IBM AT—IBM Corp. Hercules—Hercules Computer Technology, Inc. Little Board—Ampro Computers, Inc. DR-DOS—Digital Research, Inc.

that I keep up here in my part of Chaos Manor. Recall that the unprotected family TV and VCR were killed, so that was cheap enough protection.

Meanwhile, there was quite a lot of equipment plugged into Compuguard surge suppressors I had bought on sale from Priority One. Not one unit of any kind protected by a Compuguard was harmed in any way.

Joanne Dow and her friend Alan, who's a county building inspector and

knows about building electrical systems, tell me I had better replace all the surge suppressors that lived through The Great Power Spike. The MOVs in those units may have been damaged in the process of protecting the equipment, and there's no simple way to test them. Of course, I can buy MOVs from Radio Shack for a buck or so each, and if I were so inclined I could pry apart all those Compuguard units and solder in new MOVs; but the fact is that I'm not going to do that. I do

wish I had a simple way to test the surge suppressors—after all, I'm about to replace 10 of them at about \$30 each, and it would be nice to know whether the expense is *really* needful—but in fact it's fairly cheap insurance.

Alan also tells me I had better replace all three of the circuit breakers that tripped. They undoubtedly arced over, and their ability to protect my circuits is now very much in question.

The morals of this story are simple: if you don't have surge suppressors on all your electronic equipment, including stereos, VCRs, and TVs, as well as your computers, then you're gambling. Look, here in southern California we almost never get real lightning storms. The Los Angeles Department of Water and Power, and Southern California Edison (which supplies power to the parts of the county outside the city), are very reliable, seldom have power failures, and nearly never have power spikes. My electric power is probably as clean and reliable as you'd find anywhere in the world.

So what? No one is safe from weird accidents like automobiles crashing into power poles. I now have to replace some \$300 worth of surge suppressors, pay another \$350 for repairs to equipment that wasn't protected, and we're without our TV and VCR for a week. The alternative is worse; it could have cost a *lot* more.

If your work is at all valuable, get a UPS. Not just any old UPS, but one rated powerful enough to keep your equipment going. Be sure to look into the power surge protection capabilities.

I don't know if power surges will damage a UPS. The Clary people are sending me a new unit to swap for the one I have; they want to see what it looks like inside after taking a hit like that. I'll let you know next month. Meanwhile, I've tested this one about 10 times by simply yanking the plug while the Northgate 386 was doing a big copy operation from floppy disk to hard disk. About half those tests were done after the Big Power Surge. Nothing at all happened during any test; the Northgate went right on about its business, totally unaware that someone was messing with its power. I've also tested the WORM drive on the UPS with the same result.

I have become a believer. From now on, all electronic equipment in Chaos Manor will have surge protection, and any computer doing a vital job will have a UPS. I do wonder why surge protection isn't routinely built into power supplies. The parts cost only a couple of dollars.

I sure don't have any trouble rating the

continued

ARE YOU STILL DRAWING FLOWCHARTS BY HAND?

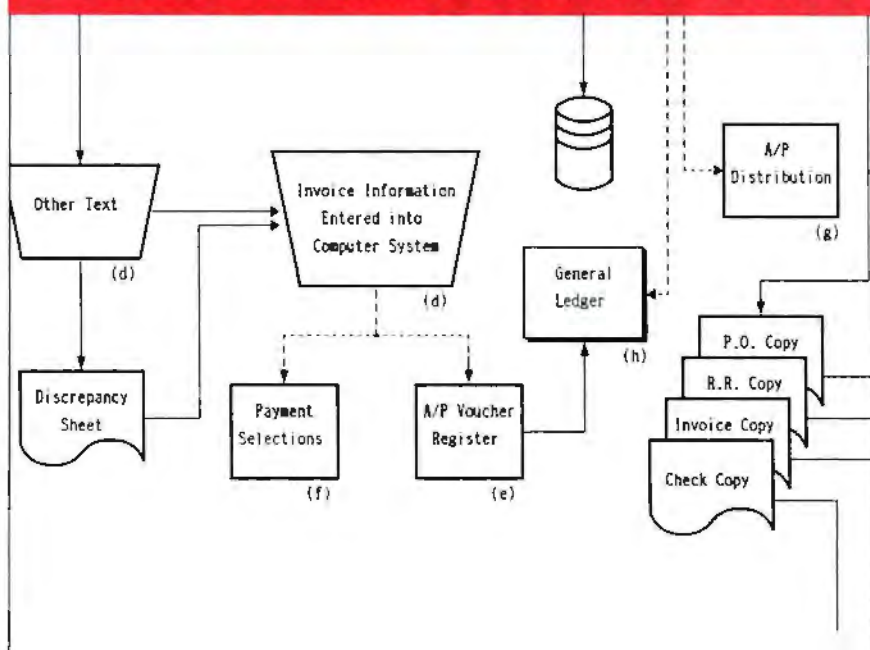

FLOW CHARTING II+

Flow Charting II+ will *amaze* you with its speed, power and simplicity.

- Update and print charts as fast as the situation changes
- See your revisions right away—no long wait for charts to be hand drawn
- Select 26 standard shapes; 10 text fonts
- Tutorial manual makes learning easy
- Runs on IBM or compatibles
- Produces excellent organizational charts!
- Only \$229!

PATTON & PATTON

Software Corporation

Excellence in charting the flow of ideas

For more information, see your local retailer or call
 1-800-525-0082, ext. 47 (outside Calif.) 408-629-5376 (Calif./Int'l.)
 81 Great Oaks Blvd., San Jose, CA 95119

THE NEW STANDARD FOR HIGH PERFORMANCE STATISTICAL SOFTWARE

CSS

COMPLETE STATISTICAL SYSTEM

WITH DATA BASE MANAGEMENT

AND GRAPHICS

A powerful, comprehensive, elegant, and super-fast statistical package for IBM (PC, AT, PS/2) and compatible computers. ■ The CSS optimized user interface with fast hierarchical menus incorporates elements of artificial intelligence; even complex analyses require only a few keystrokes (batch processing is also supported). ■ CSS features comprehensive, state of the art implementations of: *Basic statistics, Multi-way frequency tables, Nonparametric statistics, Exploratory data analysis with analytic graphs, Multiple regression methods, Time series analysis with modeling and forecasting (incl. full ARIMA), General ANOVA/ANCOVA/MANOVA, Contrast analysis, Discriminant function analysis, Factor analysis, Principal components, Multidimensional scaling, Item analysis/Reliability, Log-linear analysis, Cluster analysis, Non-linear estimation, Logit/Probit analysis, Canonical analysis, Survival and Failure Time analysis (Censored data), Quality Control analysis, and much more.* ■ All statistical procedures are integrated with fast data base management and instant, presentation quality graphics (over 100 types); full support for all mono and color graphics boards (incl. VGA) and over 100 plotters and printers (incl. the HP and Postscript standards). ■ All CSS screen output is displayed via customized Scrollsheets™ (i.e., dynamic, user controlled, multi-layered tables with cells expandable into pop-up windows); all numbers in a Scrollsheet™ can be instantly converted into a variety of presentation quality graphs; contents of different Scrollsheets™ can be instantly aggregated, combined, compared, plotted, printed, or saved. ■ The flexibility of the CSS input/output is practically unlimited: CSS offers an intelligent interface (read/write) to all common file formats (Lotus, Symphony, dBase, dBase III+, dBase IV, SYLK, ...) and special utilities to easily access data from incompatible programs; graphics can be saved in files compatible with desktop publishing programs (Aldus, Ventura). ■ CSS data files can be as large as your operating system (DOS) allows; OS/2 version coming soon. ■ CSS precision exceeds the standards of all common precision benchmarks. ■ *Technical note: The CSS user interface and all I/O were written in Assembler and bypass DOS; graphics and data management were written in Assembler and C; the computational algorithms were written in Assembler and optimized Fortran.* ■ \$495 (plus \$5 sh/h); 14-day money back guarantee.

Circle 236 on Reader Service Card



StatSoft

2325 East 13th Street ■ Tulsa, OK 74104 ■ (918) 583-4149

Fax: (918) 583-4376

Overseas Offices: StatSoft of Europe (Hamburg, FRG), ph: 040/4200347, StatSoft UK (London, UK), ph: 0438/310056 or 316561, StatSoft Pacific (Melbourne, Australia), ph: 613-663-6580

Available From: CORPORATE SOFTWARE and other Authorized Representatives Worldwide: Holland: Lemax BV 02968-94210; France: Conceptel (t) 45669700; Sweden: AkademiData 018-696201;

Korea: Geul Bang (02) 272-1973; So. Africa: ISISS 663-4500.

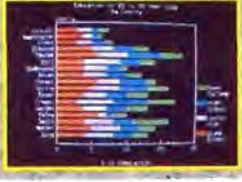
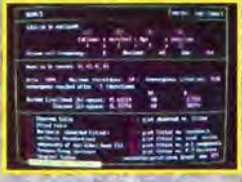
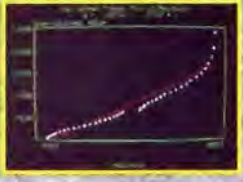
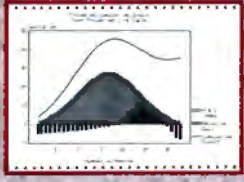
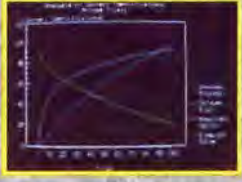
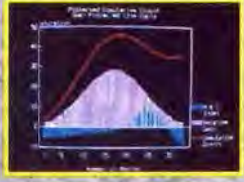
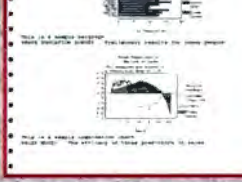
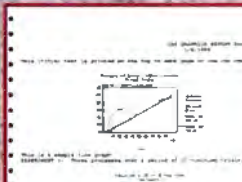
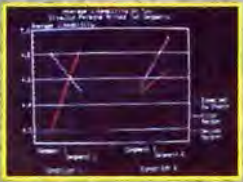
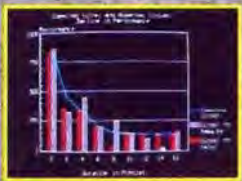
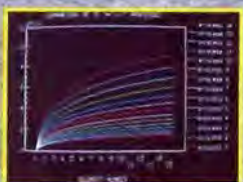
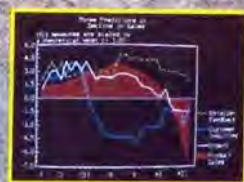



A Clear View To Monitor Quality

CHAOS MANOR

Clary UPS: highly recommended. Ditto the Priority One surge suppressors.

Lucy Retires

Back in 1981 when the IBM PC first came out, I thought I ought to buy one. It took me a while, because I really hated the original PC keyboard, and I couldn't make up my mind between monochrome and color; but eventually we went to our local Computerland and bought one. Alex named it Lucy Van Pelt because it was such a fussbudget. We've since upgraded the machine with a genuine Hercules graphics card, an AST extended memory board with on-board clock, a DataDesk keyboard, a larger power supply, new ROMs, an AST hard disk card, and a bunch of other stuff. After 1985 she became the test-bed for add-on boards, gadgets, and gilhickies, and in 1986 she was relegated to the back room, where she's been used by my editorial assistant Frank Gasperik to keep the correspondence database.

The original IBM PC design was conservative, not state-of-the-art, but maybe that's just as well. I have to say that Lucy Van Pelt, though a fussbudget, has served

me well. She never developed a glitch we couldn't fix, and in over six years there have been darned few days of downtime. Still, she is old and slow. For weeks I've threatened to replace her, and this week I got around to doing it. There remained the problem of extracting some 15 megabytes of files from Lucy's hard disk.

The way we used to do that was to drop in a CompuPro ARCnet PC Board and fire up ARCnet. Alas, the Golem, our CompuPro ARCnet file server, is still up at Bill Godbout's emporium in Hayward, where he's getting an 80386 board and other goodies. Since there weren't all that many files to transfer, we could have used LapLink, but there was one problem: the generic AT that will replace Lucy doesn't have a serial port on the motherboard, and I couldn't find a spare board that has one. Scratch that solution.

Artisoft's LANtastic was the next thing to try. I installed a LANtastic board in Lucy and connected that to Frank's new AT. Everything seemed fine, except that I couldn't log onto the network. I called Artisoft and got their technical support troops on-line. Still no go. Apparently, no one at Artisoft head-

quarters ever met anyone as old as Lucy.

Eventually we solved the problem by setting Lucy up next to the Zenith 386. The Zenith has the Maximum Storage APX-4200 (400 megabytes per side) WORM drive. We needed to make a backup of Lucy's data files—I'm ashamed to say how long it's been since we did the last one—and a WORM cartridge is ideal for that, since data stored on that is safe for half of eternity. I used LapLink to transfer all of Lucy Van Pelt's files to the Zenith's WORM.

This is mildly trickier than you think. The Maximum Storage WORM drive looks to DOS just like any other drive, but when you start using file transfer software, there seems to be some confusion about subdirectories. For example, I created a subdirectory called LUCY on the WORM, logged onto that, and told LapLink to copy everything, including subdirectories.

It did that; but instead of copying those files into the WORM subdirectory LUCY, it went back up to the WORM's ROOT directory each time it created a subdirectory. So, when I was done, instead of having all the PC's files as

Only one supplier of color monitors offers the widest selection of features and operating flexibilities in the market today.

That company is Mitsubishi Electronics.

Mitsubishi® delivers the reliability and performance that can meet your color information display requirements today as well as tomorrow. Larger screen sizes, truer colors, and optimum resolutions make your work easier—and far more productive.

Whether your requirements call for fixed-frequency graphics standards, like EGA and VGA, or multiple-frequency performance, Mitsubishi has the color monitor

with the resolution and size to fit your specific needs. This includes the Diamond Scan Series of 14", 16" and 20" auto-tracking monitors, some with microprocessor-enhanced programmable display settings. All at very competitive prices.

To get a clear view of monitor quality and value, look to Mitsubishi.

For product information or nearest authorized Mitsubishi Electronics sales representatives, please call 1-800-556-1234, ext. 54M. In California, call 1-800-441-2345, ext. 54M. Mitsubishi Electronics America, Inc., Computer Peripherals Division, 991 Knox Street, Torrance, CA 90502, (213) 217-5732.



XC1429C
VGA Compatible
640 x 480 pixels

XC1410C/XC1430C
EGA Compatible
640 x 350 pixels

Mitsubishi Model	Screen Size (inches)	Horizontal Scan Frequency (kHz)	Mask Pitch (mm)	Compatibility/Resolution						
				NTSC	CGA	VGA		Apple Mac II	1024 x 768 (48 kHz)	1280 x 1024 (64 kHz)
						Std.	Ext.			
Diamond Scan 14 (AUM1381A)	14/13V	15.7 ~ 36 auto-tracking	0.31	*	*	*	*	*	*	*
Diamond Scan 16L* (HL6605TK)	16/15V	30 ~ 64 auto-tracking	0.31			*	*	*	*	*
Diamond Scan 20A (HA3905ADK)	20/19V	15.7 ~ 36 auto-tracking	0.31		*	*	*	*	*	*
Diamond Scan 20L* (HL6905TK)	20/19V	30 ~ 64 auto-tracking	0.31			*	*	*	*	*
XC1429C	14/13V	31.5	0.28			*				
XC1410C	14/13V	22 or 15.75	0.40		*	*				
XC1430C	14/13V	22 or 15.75	0.31		*	*				

*Microprocessor-enhanced programmable display settings



© 1988 Mitsubishi Electronics America, Inc.
Mitsubishi is a registered trademark of Mitsubishi Electric Corp., Tokyo.

Screen images produced with permission from the following companies (trademarked software package name follows company name): Autodesk, Inc. (AutoShade); CompuVision Corporation (Personal Designer); Computer Friends, Inc. (Modern Artist); SuperMac Software (PresPaint); Three-D Graphics, Inc. (Perspective); Microsoft Corporation (Excel version 2.0).

And Value.

CHAOS MANOR

branches of the subdirectory LUCY. I ended up with that subdirectory completely empty and new subdirectories created at the root level of the WORM drive. If this seems confusing, don't worry about it; I mention it for the benefit of readers who have a WORM and use LapLink to transfer large blocks of files. It works all right, and all the subdirectories are created and copied, but the structure isn't quite what you think it will be.

Once that was done, I got LANtastic going on both the Zenith and the new generic AT that replaces Lucy, and discovered another quirk.

LANtastic recognizes WORM drives, but not from a remote. That is, when I accessed the Zenith from the AT and attempted to read the Zenith's WORM drive, instead of a real directory I got something very strange, a series of "Temporary" files, all empty. By then it was too late to call Artisoft.

However, when I went to the Zenith and logged onto the WORM drive, I had no trouble accessing both the WORM and the remote AT; so it was simple and fast to copy all of Lucy's old files from the Zenith WORM to the new generic AT

machine. I've just finished doing that.

LANtastic has a way for you to tell the network software that the drive you're trying to access is a CD-ROM; it may be that I should have told it to treat the WORM as if it were a CD-ROM. In any event, I got the job done. It was no more inconvenient to control the AT from the Zenith than it would have been the other way around, and that worked fine. I could send from the WORM drive to a remote unit. Even with that problem, LANtastic remains one of the best and easiest-to-use networks I know of.

Lucy's not quite old enough to join old Zeke at the Smithsonian, and indeed she's got a few years of useful life left in her, so I'll donate her to a good cause. Farewell, thou good and faithful servant....

The Curator

We have another new machine here, the Mac IIx, which is a cut-down version of the Mac IIx; it has a small footprint at the cost of having three fewer slots. I haven't time to do it justice now, but I like it a lot.

The Mac is a machine that generates strong emotions; at least it sure does in

me. I alternately get mad at it and then decide I can't live without it. One thing is certain, though: you can sure get software for a Mac that other systems haven't even thought of. Case in point: The Curator. This program is so neat it's hard to believe.

The Macintosh lets you collect pictures, and I've accumulated a lot of them. (It doesn't hurt that I have a Priam 330-megabyte MacDisk; pictures take up a lot of disk space.) One picture source was Clickart from T/Maker, the publishers of WriteNow (a word processor that in my judgment is preferable to MacWrite). Clickart will give you just about everything you could want: religious symbols, from crucifixes to Nativity scenes; business images; famous people; presidents; outlines of the states; you name it, they probably have it. I also have pictures and diagrams I've scanned in; maps I've drawn to illustrate my books; charts and graphics files we've made as part of the SSX briefings; and just a whole bunch of stuff like that.

These illustrations are scattered all over my Priam disk. Of course that's

continued

CHAOS MANOR

they don't quote him.

There are organizational holes. Much of the material is in superficial form. There's a lot more on music and architecture than literature. Dante Alighieri gets one terse line in addition to his name and dates: "*Divine Comedy*, 1321, one of the first works in Italian (Tuscan dialect.)" You'd think he deserved more. Machiavelli is represented by a single possessive that reminds you that he was the author of *The Prince* but says very little else.

Although the program doesn't tell anything about Benvenuto Cellini—he gets the single word "autobiography"—it does have a bunch of gratuitous comments. We're told that Lord Acton, an English historian, had Savonarola, an Italian Renaissance religious reformer, in mind in his dictum "Power tends to corrupt. Absolute power corrupts absolutely," and that Oliver Cromwell should have studied the case of Savonarola. Now I'm a closet Royalist myself, but perhaps there ought to be a hint that there are differences of opinion about Cromwell. The historian Macaulay could say "Cromwell was no more; and those who had fled before him were forced to content themselves with the miserable satisfaction of digging up, hanging, quartering, and burning the remains of the greatest prince that has ever ruled England." Culture says, "After the Restoration of the monarchy he was disinterred and hung up on a gallows in 1661." I think I prefer Macaulay. Alas, Macaulay himself gets only one line.

In other words, Culture is sketchy.

It doesn't work as well as you'd like, either. The search feature is impossible. You can look for key words, but when it finds the first instance, the program stops looking. There's probably a way to make it go on to the next instance, but if there is, the instructions don't tell you, or worse, they tell you to do something that doesn't work. All of which is a pity, because Culture is a magnificent attempt at a project worth doing. It would take a CD-ROM to do it right. Perhaps someone will make one.

Until then, Culture will turn your Mac into an educational workstation, but you'll have to bring your own motivation.

Wordfind

The shareware of the month (a new feature I just instituted) is Wordfind, a program to help you solve word puzzles, crosswords, acrostics, cryptograms, and other word games. It's available from Castle Oaks Computer Services and runs on just about any MS-DOS machine. It's

continued

"TURN MY PC INTO A PROTOCOL ANALYZER FOR UNDER \$400?"



If you're involved in data communications, the PC Comscope can give you data line monitor capabilities at a fraction of the cost using your PC. Making use of pull down menu's and built in help screens provides true operator simplicity. The combination of these features and price make this an extraordinary buy. You can view the bidirectional data and control signals of any RS-232 link. The PC Comscope capabilities include ASYNC, SYNC, HDLC, TIME STAMPING, SOPHISTICATED TRAPPING, STORE DATA ON DISK, ASCII, EBCDIC, IPARS. Teletype does it again!

PC Comscope for under \$400

TALK TO **TELETYPE** 270 E Pulaski Rd. Greentown, NY 11740
(516) 423-3232 / 385-8080 or 1-800-835-3298
FAX (516) 385-8184

People are talking about us.

When professional FORTRAN programmers develop or port large programs they use Lahey's F77L-EM/32 and F77L-EM/16, *PC Magazine's 1988 Technical Excellence Award Winners*. F77L-EM/32 is a fast 32-bit protected-mode compiler that accesses up to 4 gigabytes of memory on 80386s. F77L-EM/16 gives 80286 users the power to create 15 megabyte programs. These protected-mode FORTRANS include the features that have made them, and our F77L and Lahey Personal FORTRAN, market leaders: full ANSI 77 Standard, VAX and IBM VS extensions, fast compilation, comprehensive diagnostics, and a powerful debugger.

Now shipping F77L-EM/32 version 2.0



When people talk about FORTRAN
the name mentioned most often is

Lahey
Computer Systems, Inc.

Contact us to discuss our products and your needs. (800) 548-4778
Lahey Computer Systems, Inc. P.O. Box 6091, Incline Village, NV 89450
Tel: (702) 831-2500 FAX: (702) 831-8123 Tlx: 9102401256

ITEMS DISCUSSED

**Clary PC-1.25k
Onguard PC UPS**..... \$2395
Clary Corp.
320 West Clary Ave.
San Gabriel, CA 91776
(818) 287-6111
Inquiry 1085.

Clickart
for PC.....\$69.95-\$129.95
for Mac\$49.95-\$129.95
T/Maker Co.
1390 Villa St.
Mountain View, CA 94041
(415) 962-0195
Inquiry 1086.

Compuguard surge supressor..... \$59
Priority One Electronics
21622 Plummer St.
Chatsworth, CA 91311
(818) 709-6789
Inquiry 1087.

Culture 1.0.....\$175
Cultural Resources, Inc.
7 Little Falls Way
Scotch Plains, NJ 07076
(201) 232-4333
Inquiry 1088.

The Curator\$139.95
Solutions International
30 Commerce St.
Williston, VT 05495
(802) 658-5506
Inquiry 1089.

Hard disk data recovery
Workman & Associates
1925 East Mountain St.
Pasadena, CA 91104
(818) 791-7979
Inquiry 1090.

LANtastic
Starter kit\$399
Network adapter.....\$199
LANtastic-NOS ports for three to
120 users \$295 per network
Artisoft, Inc.
Artisoft Plaza
575 East River Rd.
Tucson, AZ 85704
(602) 293-6363
Inquiry 1091.

"Master's Collection"
Sub Battle \$19.95
EPYX
600 Galveston Dr.
P.O. Box 8020
Redwood City, CA 94063
(415) 368-3799
Inquiry 1092.

**Northern Fleet
Long Lance
In Harm's Way**
(prices not available)
Simulations Canada
Box 452
Bridgewater, Nova Scotia,
Canada B4V 2X6
Inquiry 1093.

**Priam SCSI 330-megabyte
MacDisk for the Mac II** \$3995
Priam Corp.
20 West Montague Expy.
San Jose, CA 95134
(408) 434-9300
Inquiry 1094.

Remote Keyboard\$395
FORTE Communications
680 West Maude Ave.
Sunnyvale, CA 94086
(408) 733-5100
Inquiry 1095.

Strike Fleet \$39.95
688 Attack Sub \$49.95
Electronic Arts
P.O. Box 7578
San Mateo, CA 94403
(415) 572-2787
Inquiry 1096.

Wordfind..... \$15
Castle Oaks Computer Services
P.O. Box 36082
Indianapolis, IN 46236
(317) 823-6366
Inquiry 1097.

pretty neat if you're into solving word puzzles.

Remote Keyboard

This is one of those gadgets that not everyone needs, but if you do need it, you'll want it a lot. Despite the name, it's not a keyboard; it's a gilhickie about the size of a TV remote control with 40 buttons. It comes with an infrared receiver that plugs into your computer's serial port, plus the software that makes the computer listen.

Once it's installed, you can do just about anything with Remote Keyboard that you could do with your regular keyboard; but you won't do it quickly, because doing hunt-and-peck typing on a four- by 10-button array with keys laid out in alphabetical order is darned near impossible. Of course, that's not what Remote Keyboard is for; what you do is use it to control your computer during a presentation in the same way that you'd

use a remote control to advance slides during a briefing. You can use PageUp and PageDown, Print Screen, and the rest of it. You can also set up various macros to be executed by Control or Alt keys. (You can't use both keys at once; unlike your regular keyboard, to get Control-C you'd press Control, release it, and then press C; ditto for Alt keys.)

The obvious use for this is in connection with a projection system; however, it would also work in a situation where you have several people crowded around a computer screen while the briefer stands in another part of the room. It can also be used to control a robot, and I understand one medical center is doing that.

Remote Keyboard works with just about any PC-compatible, including my Zenith Portable. I won't use it often, but I'm glad to have it here, and I'll probably use it at the next meeting of the Advisory Council on Space Policy. It would be neat to have one for the Macintosh as well.

Join the Navy!

I did my military service in the Army, and I worked for the Air Force for a good part of my aerospace career, but my number-three son Phillip is a midshipman in the U.S. Navy. That probably explains my interest in naval war games. We get a lot of them.

Two of the most recent are submarine warfare simulations: EPYX's "Master's Collection" Sub Battle, which simulates World War II submarine warfare; and Electronic Arts' 688 Attack Sub, which is modern nuclear submarine warfare. The versions I have are the new Mac II EPYX Sub Simulator, which does a wonderful job of bringing Macintosh color graphics to an older (but fun) game, and the PC VGA version of 688.

Of the two, the EPYX simulator is a lot easier to "win," but the Electronic Arts 688 Attack Sub is more realistic. Both are easy to learn and have a realistic

continued

Rupp Corporation Presents Power Products Showcase No. 19

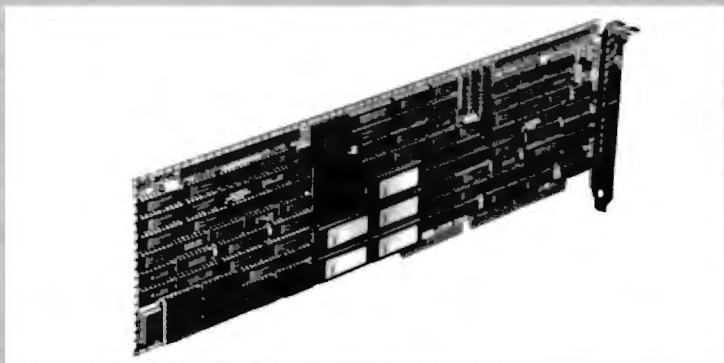

PM3011 CACHING CONTROLLER

Up to 16MB of hardware implemented cache for ESDI, RLL or ST506 drives.

Product Profile: The PM3011 caching controller is the single most effective performance improvement tool available for disk-intensive applications. The PM3011 accesses data in as little as 0.5ms; that's 50 to 150 times faster than a random disk access.

Advanced Caching Algorithms: Such advanced caching features as disk read ahead and elevator sorting during cache write-back increase disk performance to levels unattainable by non-caching controllers. The controller's on-board 68000 microprocessor enables it to access the disk

drive at the same time as the computer reads or writes to the controller cache.

Compatibility: Since PM3011 caching controllers operate transparently to the operating system, special software drivers or ROM BIOS changes are not required.

Up to 16MB of Cache: The PM3011 Cache RAM is expandable from the on-board 512KB to 16MB with the optional Cache Expansion board. The cache is totally independent from system memory and does not require device drivers.

PM3011/70 Caching Controller With 512KB cache. **\$1150**

Circle 304 on Reader Service Card

DPT Introduces Hardware Disk Mirroring

Distributed Processing Technology, the leader in the field of Caching Disk Controllers, has announced a long-awaited addition to its product line—Hardware Disk Mirroring.

Hardware Disk Mirroring provides true fault tolerant disk storage for PC/AT systems regardless of the application and operating system environment. It is available for all DPT PM3011 Caching Disk Controllers supporting ST506, RLL, and ESDI drives.

Disk mirroring is important in environments where disk data integrity is vital, such as network file servers, multiuser systems, and CAD workstations. Since the DPT caching disk controllers operate without special software drivers, the mirroring feature is transparent.

The Hardware Disk Mirroring can be added to PM3011 controllers as a field upgrade by installing a DM3011 Key Card directly onto the controller.

DM3011 **\$795**
Circle 303 on Reader Service Card



XIRCOM

The Xircom Pocket Ethernet Adapter allows you to conveniently connect any IBM compatible personal computer to an Ethernet or IEEE 802.3 local area network. This adapter connects externally to any parallel printer port, eliminating the hassles of installing an internal Ethernet adapter.

It's the only adapter that can easily be used with laptop computers and is also an ideal choice for workstations where board slots or power are at a premium.

The Pocket Ethernet Adapter is also an economical choice for a group of in-

frequent network users because it can be quickly and easily moved from computer to computer. It contains no configuration switches, completely avoiding the problems of address and interrupt conflicts common with other Ethernet adapters. Drivers for Novell Netware version 2.0 and 2.1 are included.

Features:
Uses LPT port.
For all IBM compatibles.
Netware 2.x compatible.
IEEE 802.3 standard.

PRICE

*Circle 305
on Reader
Service Card*

\$695

*For pricing on RLL, ST506 controllers and other options please call

Call 212-517-7775

Fax 212-249-8243

Dealer Inquiries Welcome

Charge Cards Accepted: Amex, Visa, MC

Hours (EST) 9:00 to 5:00



Exceptional Computer Products

Rupp Corporation
835 Madison Avenue
New York City, NY 10021

feel. As you'd suspect, there's a lot more action in the World War II simulation. Either one makes for a good way to waste an evening.

Strike Fleet, also from Electronic Arts, is a simulation of a modern surface battle group without submarines or carriers; you can command a single ship such as the USS *Stark* or a whole escort group in the Persian Gulf, a British ASW force off the Falkland Islands, or a large U.S. strike force off Iceland. I played this every day for more than a week, and the only reason I quit was that I got behind in my work. There are 10 scenarios, and the last few get really tough.

All three of these games are what you'd call "modern" computer games: lots of graphics and a great deal of player control over each unit. For example, in Strike Fleet you have to control each ship in your force; you're not only the fleet commodore, but the skipper of each ship, and for that matter, the weapons officer for each ship. While these are not really arcade-style games—you can pause them, and things don't move all that fast—there is a certain arcade flavor to them, although do understand that good strategy and tactics are more important than manual dexterity.

There's another kind of naval war game. Simulations Canada has a series of games ranging from the early days of World War II to Northern Fleet, an operations game set in the North Atlantic in 1990.

There are no fancy graphics to these games. Unlike Strike Fleet, which has a manual that could serve as a general introduction to modern weapons capabilities, Simulations Canada provides almost none of that; you're expected to know something about the systems you command. There aren't any control rooms or individual weapons commands, either. In Simulations Canada games you do what an admiral would normally do: issue orders to battle groups and get reports on what is known about your forces and those of the enemy.

The result is surprisingly realistic. I say surprisingly because the conventional wisdom in simulations is that you need fancy graphics and detailed unit reports; but in fact that's not realism at all. Generals and admirals aren't often required to smell the gunpowder. As John Keegan shows in *The Mask of Command*, most of that changed irrevocably in the period of the U.S. Civil War.

Anyway, the Simulations Canada games are different, because all you'll see is screen after screen of menus and lists and tables; but they're actually more

realistic, and to those with the proper temperament, no less enjoyable than games with "better" interfaces.

VGA

Video standards change. When IBM first came out with color, the screen resolution wasn't good enough for sustained text work. Then came EGA, which was good enough, but which was defectively designed. Now we're getting VGA, which is really pretty nifty.

There aren't too many programs that take advantage of VGA, so it's not always easy to tell just how good it is; indeed, I really discovered the difference when I ran Electronic Arts' 688 Attack Sub on the Northgate 386 (which has VGA and a Princeton monitor) and then transferred the game to Big Cheetah and the 19-inch Electrohome, which was running EGA.

The result was horrible. I'd previously thought EGA to be good enough; after seeing what you can do with VGA, I thought different.

However, when I put Video Seven's newest 16-bit VRAM VGA in Big Cheetah, the output was a mess. I knew that it wasn't the monitor's fault because I was testing the system with the Zenith Flat Technology Monitor, and that worked fine with the VRAM in the Zenith.

It turns out that the Cheetah's motherboard is a bit too fast for most video boards; but Cheetah will send you new programmable-array-logic chips that will fix the problem.

Meanwhile, I tested Big Cheetah with the Video Seven VEGA VGA, which is an 8-bit video board. Although not as fast as the 16-bit VRAM, the VEGA is certainly faster than EGA, and of course the resolution is better. The result is absolutely gorgeous on the Electrohome monitor. Getting it running on the Electrohome requires a special cable: the monitor only has 9-pin input, and VGA boards universally have 15-pin output. I've tried about 10 different commercial cables, including a set made up by Candy Cable of San Diego, and none work; the only one that will work came direct from Electrohome. Once you have the right cable, though, an Electrohome with VGA is something to see.

There is one problem: VGA uses more memory than EGA. Since that memory is up in the area between 640K bytes and 1 megabyte, it wouldn't matter, except that we're using Quarterdeck's QEMM to load stuff like buffers, the mouse driver, and the WORM driver up into that area. We can still do that, but we don't have quite so much of that high memory available with VGA, which means that we

have to reduce the size of our DESQview windows. So it goes.

Winding Down

My desk is still covered with stuff, but I'm out of time and space. The book of the month is *What Do You Care What Other People Think* (Norton, 1988), which, with Dick Feynman's previous *Surely You're Joking, Mr. Feynman*, make up the extraordinary autobiography of an extraordinary man. If you like those, get his *QED*, which is a readable explanation of what quantum electrodynamics is all about, and his *Character of Physical Law*, a short and highly readable work on the philosophy of science. I've just re-read all those, and I'm a bit sad because there are so many things I never got a chance to discuss with him; but I'm sure glad to have known him.

The computer book of the month is Jeff Duntzman's *Complete Turbo Pascal* (third edition; Scott, Foresman, 1989). This is one of the best introductions to Pascal ever done; it's organized differently from other language books. If you've never read another book on programming, try this; you may like it, and you'll at least learn something of what programming is all about. Of course Duntzman doesn't cover the absolutely latest version of Turbo Pascal; but that's all right. There's plenty to be learned before you try dealing with *objects*.

The programs of the month are Turbo Pascal 5.5 and Microsoft Quick Pascal. Both have objects, the new programming fad that may well deserve all the attention it's getting. If I had to choose one and only one, I'd go with Turbo Pascal, since it's built up from a mature and stable compiler developed in-house, while Quick Pascal was bought from outsiders and is in its first model year; but I'll know a lot more about that next month.

Meanwhile, I'm off to Globe, Arizona, and thence to Fort Apache, where with luck no one will find me; if I don't get *Wrath of God* done, they're going to repossess my house. ■

Jerry Pournelle holds a doctorate in psychology and is a science fiction writer who also earns a comfortable living writing about computers present and future. Jerry welcomes readers' comments and opinions. Send a self-addressed, stamped envelope to Jerry Pournelle, c/o BYTE, One Phoenix Mill Lane, Peterborough, NH 03458. Please put your address on the letter as well as on the envelope. Due to the high volume of letters, Jerry cannot guarantee a personal reply. You can also contact him on BIX as "jerryip."

NEW! TOPSPEED TOOLKITS



"Everything about this product exudes quality... it is one of the most complete and powerful development systems available today."

Scott Robert Ladd
Computer Language

"...TopSpeed* is surely one of the finest new products introduced to date in the PC arena...DDJ doesn't give unqualified raves very often, but there's no question about it in this case: JPI's TopSpeed Modula-2 is first-rate."

Kent Porter
Dr. Dobbs Journal

"JPI Modula-2 looks like another classic in the making. It generates code as good as or better than leading C compilers and the programming environment is a genuine pleasure to use."

Dick Pountain
BYTE Magazine

In England and Europe contact:

Jensen & Partners UK Ltd., 63 Clerkenwell Road, London EC1M 5NP. Phone: (01)253-4333 FAX: (01)251-0141. Each Toolkit £49.95* DOS Compiler £59.95, TechKit £34.95* VID £34.95, DOS 3-Pack £119.95* OS/2 Compiler £124.95* *Prices effective through Oct. 1, 1989.

Handling charges: In UK please phone for VAT & P&P. In Europe, add £6 for each compiler and 3-pack, £3 for each toolkit.

TopSpeed* Modula-2 is a high-speed optimizing compiler (3,000-5,000 lines/min. on a PC AT 8MHz), integrated menu-driven environment with multi-window/multi-file editor, automatic *make*, fast smart linker. All Modula-2 sources to libraries included. Available for DOS or OS/2.

Communications Toolkit is designed to help you write applications that use IBM PC serial port hardware. Features include an interrupt driven low-level driver; VT100 and ANSI terminal emulation; XModem, YModem, and Kermit support; compiled script language; and full source for all modules. The same version supports both DOS and OS/2.

B-tree Toolkit provides you with the tools you need to write powerful database applications. Store multiple tables and indexes in one or more physical files (no record count limit; each physical file up to 4 gigabytes). Automatic network support allows opening of sharable or private physical files and full control of file locking. Indexes can be linked to tables so that index updates are automatic. The same version supports both DOS and OS/2.

VID (Visual Interactive Debugger): A source-level, multi-window symbolic debugger. (DOS only)

TechKit* Includes assembler, assembler source for start-up code, TSR module, error handlers, communications driver, dynamic overlays, and PROM locator. (DOS only)

System Requirements: IBM PC or compatible, 384K available RAM, two floppy drives (hard disk recommended).



TopSpeed's seamlessly integrated environment.



VID (Visual Interactive Debugger): power without complexity.

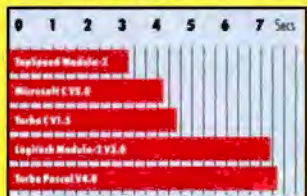

Sieve benchmark measured by the British Standards Institution (BSI)—25 iterations on an 8MHz AT.

Each Toolkit \$79.95*
DOS Compiler \$99.95
TechKit \$59.95*
VID \$59.95

DOS 3-Pack \$199.95*
(Compiler, TechKit & VID)

OS/2 Compiler \$195.00*
*Prices effective through 10/1/89

To Order:

In the US, call:
1-800-543-5202

In Canada, call:
1-800-543-8452

Or mail us your order with a check, money order, or VISA/MC information. 30-day unconditional money-back guarantee.

Shipping & handling charges:

In North America: add \$5 for each product ordered. CA residents please add applicable sales tax. Overseas: Add \$20 for EACH compiler and \$8 for each other product. 3-pack s & h is \$36.00.



Jensen & Partners
International

1101 San Antonio Rd.
Suite 301
Mountain View, CA 94043
Phone: (415)967-3200

TopSpeed and TechKit are trademarks of Jensen & Partners International. Other brand and product names are trademarks or registered trademarks of their respective holders.

Maxon MVGA-16 adapter works with flying colors

providing VGA® compatibility equal to IBM's own VGA adapter

That's right . . . Maxon's MVGA-16 adapter is 100% IBM® compatible. So, if you're using one of the standard IBM modes (up to 640x480 with 16 colors), you don't need a special driver at all.

When extended resolution* is required, Maxon still comes through with flying colors. The MVGA-16 includes drivers for AutoCAD® - ADI® versions 2.1 and 3.1, Lotus® 1-2-3® - release 2.x, Framework II® - releases 1.0 and 1.1, GEM® Desktop™ - version 2.x, Ventura Publisher® - releases 1.1 and 2.0, MS® Windows®/286 - versions 2.03 and 2.1, WordPerfect® - releases 4.0 and above, and WordStar® - release 3.xx.

And that's not the whole story . . . additional drivers are being added constantly.

Circle 157 on Reader Service Card (DEALERS: 158)

*High-res drivers offer different resolutions for different software packages

with features that make it unequalled by any other VGA adapter

- Operates up to 400% faster than IBM VGA adapter
- Extended modes (require 512K of RAM): 1024x768 - 16 colors; 640x480 - 256 colors
- Full BIOS and REGISTER compatibility with MDA®, CGA®, MCGA®, EGA®, VGA® and Hercules®
- Works with either XT™ or AT™: 16 bit design - auto-detects and adapts to 8 bit slots
- High-res drivers for popular software

For more information about Maxon's 16 bit VGA adapter, phone (415) 377-0269, FAX (415) 377-0236 or write to Maxon Systems, Inc., One Waters Park Drive, Ste. 117, San Mateo, CA 9440

maxon®
SYSTEMS INCORPORATED

A Wholly Owned Subsidiary of Maxon Electronics Co. Ltd. of Korea

The following are trademarks or registered trademarks of the companies listed: IBM, XT, AT, VGA, MDA, CGA, MCGA and EGA - International Business Machines Corp.; Hercules, Hercules Corp.; Computer Technology, Inc. - MCGA; In - AutoCAD and ADI - Autodesk, Inc.; Lotus and 1-2-3 - Lotus Development Corp.; Framework II - Ashton-Tate Corp.; GEM and Desktop - Digital Research, Inc.; Ventura Publisher - Ventura Software, Inc.; MS and Windows - Microsoft Corp.; WordPerfect - WordPerfect Corp.; and WordStar - MicroPro Int'l. Corp.

© 1989 - Maxon Systems, Incorporated

A CALM APPROACH TO UNIX

The average Unix user never has to worry about, let alone learn, many of the system services and nuances

Editor's note: David Fiedler has written about Unix for *BYTE* many times. Now that Unix has established itself in the vocabulary (if not the office) of the majority of the computing community, we've established David as our Unix columnist. This is the first installment.

David is the editor and publisher of the Unix newsletter *Unique*, which he started on his kitchen table in 1981. He was also cofounder of the magazines *The C Journal* (now *The C User's Journal*) and *Unix Review*.

With Bruce Hunter, he coauthored the best-selling book *Unix System Administration*, the first book to cover this important subject. Its success led to the recent launch of *Root*, their journal of Unix and Xenix system administration. David has been a consultant to AT&T, ITT, CBS, and Sandoz Pharmaceuticals, among others, and has been in charge of software development efforts at many large companies.

My prized first issue of *BYTE* (September 1975) contains such articles as "Which Microprocessor for You?" (your choice of the 8008, 8080, or IMP-16) and "Recycling Used ICs" (how to use a blowtorch to remove chips from printed circuit boards). That same issue also had an advertisement from Processor Technology for a 3P+SI/O board for Altair compatibles that would "fully interface two TV Typewriters with keyboards and a modem or teletype at the same time!" This board even let the pe-

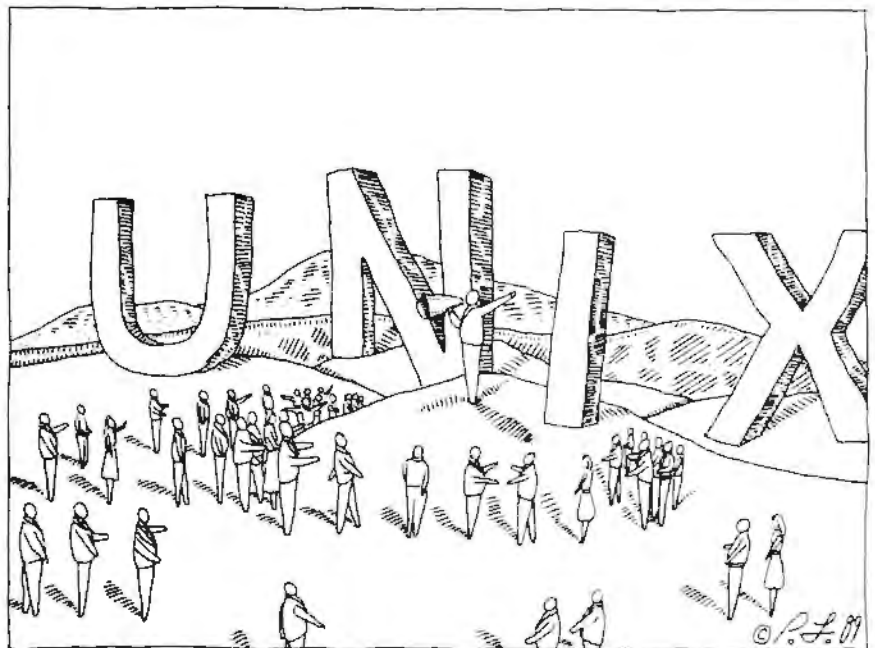

ripherals talk at 9600 bps over the serial port. All this was quite advanced for the time. The only problem was that the software of the day couldn't possibly have supported simultaneous use of all those terminals.

I'll leap forward to the present, where—except for a few proprietary multiuser PC-DOS-like systems and special background print spoolers and communications programs—most personal computers are limited to doing a single thing for a single user at a time. In other words, today's microcomputers can also have a number of serial ports, but still can't use more than one at a time!

But with all the hardware advances in personal computers since they were first designed, today's microcomputer users have more power at their command than the users of many minicomputers of 20 years ago. The machines are now being severely underutilized. So it makes economic sense to look at ways of increasing personal productivity on computers,

whether by sharing physical machines or by enabling one computer to do a lot more. That's what the idea of multitasking and multiuser operating systems is all about.

Enter Unix

At the time that *BYTE*'s first issue was published, the Unix operating system was already six years old—about the same age MS-DOS is now. Unix has undergone many changes—not all for the better, perhaps—in its 20 years.

Just for the record, I'll list a few important features of Unix:

- It is written in C and is portable to other architectures.
- It is multiuser and multitasking.
- It has a hierarchical file system with mountable disk volumes.
- It has file redirection and pipes.
- It is ready for communications: local- and wide-area networking.

continued

Debug Your Program BEFORE You Write It!

"Deep bugs", the kind that show up after you ship the product, are usually the result of logic flaws. Such bugs include redundancies, contradictions, unique conditions without specified actions, etc.

Logic Gem, a proven programmer's tool, helps you avoid these bugs in three ways:

- ◆ Catches logical errors before you code the program. Saves hours of debugging time.
- ◆ Automatically produces written documentation of your logic, which insures good communications between designer and coder. (And helps remind you of the logic from one work session to the next.)
- ◆ Automatically generates flawless code for the "guts" of your program... in C, BASIC, Pascal, FORTRAN, and dBASE.

Logic Gem works with whatever compiler you are using. The only change: with **Logic Gem** you catch and correct the logic bugs before you write the program.

Jerry Pournelle says (*Chaos Manor*, BYTE, March 1989), "It has already saved me several hours, and I haven't had it a week. Highly recommended."

Avoid hours and days of needless debugging time. Call 1-800-722-7853 now for details about **Logic Gem**. Or put **Logic Gem** to work for you immediately: Order a copy (it costs only \$195) and use it for 90 days at our risk. You can return it for any reason within 90 days for a complete refund.



Sterling Castle, Inc.
702 Washington St. #174
Marina del Rey, CA 90292
1-800-722-7853
1-800-323-6406 (in CA)
1-213-306-3020
1-213-821-8122 FAX

THE UNIX /bin

- It has many useful standard and optional utilities.
- It can handle a wide variety of devices in an identical manner.
- It has many software development tools built in.
- It has an E-mail system.
- It has a true print spooler system.

Most people who say things like, "I don't think Unix is any better than xxx" are ignoring the importance of the first two features. It is uncommon that an operating system is portable across machines with different architectures and from different manufacturers. And to compare a system with the size and complexity of Unix to a system that can run only one thing at a time is pointless.

The problem most users have when faced with the task of "learning Unix" (or learning Xenix; for all practical purposes, they are now equivalent) is that it's *big*. Unfortunately, some companies have promoted Unix to microcomputer users by telling them that Unix is a kind of large DOS. Then the users encounter a meter-wide set of manuals and command names that sound like extinct animal species. They run screaming for the nearest exit. Unix gets some more bad press.

Perhaps the best approach to Unix is a calm one. Unix is a *real* operating system, not just a glorified program loader. Most people get along fine in DOS, even

though DOS has many commands with unusual syntax (I assure you, pressing the F3 key to repeat a command is nonintuitive). The average Unix user never has to worry about (let alone learn) many of the system services and nuances. Unix was developed in the days when a teletype was the standard input device, and anyone who has ever used an ASR-33 knows you don't want to type any more characters than necessary. So command names tend to be short (vowels are the first to go). In the interest of harmony and mutual understanding, therefore, table 1 presents a cross-reference of common DOS and Unix commands. This table is all you need to get started in Unix. Not really so bad, is it?

You'll notice that many Unix command names are the same as in DOS. Perhaps that should be written the other way: Quite a few Unix features (such as hierarchical directories, redirection, and pipes) were used as "role models" when DOS was being designed. It's just that DOS got the slash backward.

Let's Get Graphical

Macintosh users aren't being ignored here, but they have a much different user interface than either DOS or Unix, and I'm not particularly good at drawing pictures. The Macintosh *has* made a great contribution to computing: graphical

continued

Table 1: Common DOS commands, their Unix equivalents, and an English explanation. (Note that my definition of dd is facetious.)

DOS	Unix	English
backup	tar	Tape ARchiver
cd	cd	Change Directory
chkdsk	fsck	File System Check
cls	clear	Clear screen
compare	cmp	CoMPare two files
copy	cp	CoPy a file
date	date	Set or show the date and time
del	rm	ReMove file
dir	ls	LiSt directory contents
dir /w	ls -C	LiSt directory in Columns
diskcopy	dd	DarNeD if I know what it stands for
erase	rm	ReMove file
find	grep	Global Regular Expression Print
format	format	Format disk
join	mount	Mount disk or partition on file
system label	labelit	Label file-system volume
mkdir	mkdir	MaKe DiRectory
mode	stty	Set TeleType characteristics
more	more	Show file a page at a time
print	lp	Line Printer
rename	mv	MoVe file to new name
rmdir	rmdir	ReMove DiRectory
set	set	Show environment variables
sort	sort	Sort
type	cat	conCATenate (can be used for either)



MKS Toolkit™

UNIX™ Tools on DOS or OS/2

Programming today means you must work within more than one environment. A diverse range of hardware is now a fact of life. With the MKS Toolkit, you can enjoy the best of DOS or OS/2 and UNIX environments. The MKS Toolkit offers both experts and novices the purest form of UNIX utilities that the DOS or OS/2 environment allows.

Reduce Keyboard Shock

With our proprietary code, the MKS Toolkit offers you more than 140 UNIX System V.3-compatible tools for DOS or OS/2. With the MKS Toolkit, your computer or clone becomes a comfortable environment for shells, string matching, editing, file manipulation, and more. Productivity increases because all the familiar commands are at your fingertips.

Site Licenses

The MKS Toolkit reflects its users' needs. Organizations such as AT&T, H-P, ITT, and NCR - all heavily committed to the UNIX system - use the MKS Toolkit to create a standard operating environment. Universities, including UCLA, use the MKS Toolkit to enrich personal research computing environments and double the bandwidth of their PC teaching labs. The National Institute of Standards and Technology fulfills diverse needs by using the MKS Toolkit as standard operating environment for experts and as a POSIX-conforming training tool for neophytes.

Interconnectivity

The MKS Toolkit provides two types of valuable interconnectivity. First, it interacts well on most standard PC and PS/2 networks. Combined with Novell Netware™, the most popular LAN for

PCs, the MKS Toolkit creates a UNIX time sharing system in DOS or OS/2 organizations. UNIX shops can now hook up all their PCs using PC-NFS™ and the MKS Toolkit, enabling you to use a PC as a UNIX workstation and off-load your mini or mainframe machine. The second level of interconnectivity is created by the MKS Toolkit's ability to recognize common UNIX file formats on DOS or OS/2 and to make DOS or OS/2 file formats available on UNIX systems.

POSIX-Conforming Tools

MKS is an active participant on the POSIX 1003 standards committee. This involvement reflects MKS' commitment to tracking the shells and utilities standard to the fullest extent possible under DOS or OS/2. Apart from multitasking and constraints on file names under DOS or OS/2, the MKS Toolkit follows the POSIX standard. MKS achieves this by building the underlying POSIX system on DOS or OS/2 before moving utilities.

Cost-effective Learning Tool

If your organization is committed to moving into the UNIX environment, then the MKS Toolkit is the perfect learning path. DOS or OS/2 users retain the familiar world of their PC keyboard and programs and move effortlessly to a UNIX environment on their desktop. Exposure to new commands and functionality now becomes an integral part of the novice's working day. UNIX solutions are easily available and the DOS or OS/2 world is but a keystroke away.

MKS Programming Platform

The MKS Toolkit is the vital core of the programming platform created by MKS software. In addition to the MKS

Toolkit, it is now possible to have:

- MKS RCS™ (Revision Control System)
- MKS Make™ (automated program builder)
- MKS LEX&YACC™ (compiler construction tools)
- MKS SQPS™ (enhanced Documentor's Workbench™)

Additive Software!

The MKS Toolkit offers you power and diversity. Here is a complete list of commands you receive in the package:

alias	ed	let	sort
awk	env	line	split
banner	eval	login	strings
basename	ex	ls	strip
bdiff	exec	mkdir	sum
break	exit	more	switch
c	expand	mv	sync
cat	export	nl	tail
case	expr	nm	tee
cat	false	od	test
cd	fc	pack	
chdir	fg	passwd	time
chmod	file	paste	times
cmp	find	pcat	touch
:	fmt	pg	tr
comm	fold	pr	trap
compress	for	print	true
continue	function	praf	ty
cp	getopt	ps	type
cpio	glob	pwd	typeset
crypt	grep	r	ulimit
ctags	fgrep	read	unalias
cut	grep	readonly	uname
date	gres	return	uncompress
dd	hash	rev	unexpand
deraff	head	rm	uniq
dev	help	rmdir	unpack
df	history	rsh	unset
diff	if	sed	unstrip
diff3	init	set	until
difft	integer	sh	vi
dirname	jobs	shift	wc
.	jain	size	whence
[.dot]	kill	sleep	which
du	lc	spell	while
echo			who

No wonder our users call it additive software!

System Requirements:

The MKS Toolkit works on IBM PC, XT, AT, PS/2 and compatible machines under DOS 2.1 and higher or under OS/2. A hard disk is recommended for improved performance and convenience.

Order Information

Price: \$199 for MKS Toolkit, \$495 for OS/2.
30-day money-back guarantee

1-800-265-2797 (continental U.S. only)

1-519-884-2251 (outside continental U.S.)

1-519-884-8861 (FAX)

Ask for Department BY



35 King Street North
Waterloo, Ontario N2J 2W9 Canada

Mixing REAL TIME With REAL UNIX[®] Is Not Magic...

It Is Technology.

VenturCom's real time UNIX product family has the only real time kernel for standard hardware platforms which is AT&T's UNIX System V. Not a simple UNIX clone. Not just UNIX on top of a real time executive.

Real UNIX provides designers with SVID and POSIX standards, RFS and NFS, X-windows, Streams, complete development tools, multiple DOS under UNIX tasks. And early access to future technologies.

Real time adds performance and functionality to UNIX with preemptive and biased scheduling, contiguous file system, average interrupt latency of 50 μ s, bounded context switches, memory locking, asynchronous I/O, and much more.

Ask us about VENIX[™] for 80286/80386 PCs and Single Board Computers; RTX[™] for other UNIX versions, such as Interactive System's 386/ix[™], and small, diskless, and ROMable UNIX kernels. Find out why Foxboro, Toshiba, GE, and many others are using VenturCom's real time UNIX products.

 **VenturCom**
Real Time/Real Unix

215 First Street
Cambridge, MA 02142
(617) 661-1230

Nippon VenturCom, Inc.
Tokyo 102 Japan 03-234-9381

UNIX is a registered trademark of AT&T
386/ix is a trademark of Interactive Systems Corp.
VENIX, RTX are trademarks of VenturCom, Inc.

THE UNIX /bin

user interfaces (sometimes abbreviated GUI and pronounced the same as the word that implies ice cream dripping on your shirt—see "A Guide to GUIs" by Frank Hayes and Nick Baran, July BYTE). AT&T has announced that Open Look will be the standard interface for Unix in its next release (Unix System V release 4, or simply SVR4). It is clear that graphical interfaces are here to stay.

To anyone who has seen Open Look (and most other graphical interfaces) in action, it is also clear that a great deal of computing power will be necessary to support this kind of interface. It's a real dragon-and-egg problem: Are graphics becoming popular because we finally have processors powerful enough to support them? Or are the processors being developed because they're needed for today's graphics overhead?

Personally, I find multiple windows on one screen distracting. Yes, you have the ability to cut and paste between them, and the simultaneous display of text and graphics. But for working on several things at once, I prefer the approach popularized in The Santa Cruz Operation's (SCO) Xenix: A function-key combination switches you to a different "virtual screen," replacing the original completely. This helps me to switch context mentally. It also gives me much higher performance on my hardware. No CPU time is wasted on something I don't need.

What About Networking?

As many users think of it, networking refers to a spider's web of cables attaching personal computers to each other and to "server machines." The servers are essentially multiuser computers whose main purpose is to send files to the personal computers. As generally implemented, personal computer networks of today are limited to the basics: file transfer and E-mail.

Unix systems have had the basics built in for many years, by way of the UUCP (for Unix-to-Unix copy) subsystem. Today, UUCP is known as the Basic Networking Utilities, and it's still included in every Unix or Xenix system sold. Using UUCP as a base, you can set up complex processes such as automatic file servers, E-mail "answering machines," and transparent remote printing. None of this needs hardware that's any more high-tech than an auto-dialing modem. And, of course, there is the store-and-forward worldwide UUCP-Net E-mail network, with perhaps 1.5 million mailboxes, and the distributed Usenet BBS, NetNews. (See "The Unix Connection" by Ben Smith, May BYTE.)

Networking in the larger sense implies much more. The Network File System (NFS) and Remote File Sharing (RFS) capabilities, generally implemented via Ethernet, allow multiple machines to combine their file systems as if they were all on one large computer. Users can move around in the file system, reading and writing to files, unaware and unconcerned that they are actually accessing files on machines across the hall, across the street, or even across the country. This has led to the growth of LANs with many connected diskless workstations that use a central file server to hold material on disk. . . . Did you say that sounds like personal computer LANs? It does—but with Unix workstations, the sharing of files is transparent, so there's less need to copy whole files back and forth. The net result (pun not intended, but not ed) is less traffic on the network and less special software that must be added (and learned!) to use the network.

A Breather

Here's a preview of the future of this column. For the first few articles, I'll be concentrating on Unix on microcomputers: Why would you want to bother with Unix on personal computers? I'll discuss the choices and trade-offs you'll be confronted with, once you've made the big step. Will you ever be able to go back to DOS? Will you ever have to? (Or want to?) And general Unix topics: How you can get some of the public domain Unix software that you're always hearing about; why Unix might be useful even if you're not a programmer; and some drawbacks to Unix (nothing's perfect, after all). And of course, I'll discuss how you can learn some of the more involved Unix commands, utilities, and languages so that you can "increase your personal productivity," too.

Meanwhile, I'll be waiting to receive some mail from you. Tell me what you want to read about in future articles. In general, the idea is to cover both hardware and software as it relates to Unix and give you enough detail to keep you challenged, but not get so esoteric that your eyes cross and you turn the page. Everything else is wide open. ■

David Fiedler is editor and publisher of the Unix newsletters Unique and Root and coauthor of the book Unix System Administration. He can be reached on BIX as "fiedler."

Your questions and comments are welcome. Write to: Editor, BYTE, One Phoenix Mill Lane, Peterborough, NH 03458.

MicroWay Means Numerics!

MicroWay is your best source for the software and hardware you need to get true 32 bit performance from your 386. These include 32-bit tools, such as NDP Fortran, C, and Pascal, and the 32-bit applications that were developed with them (see last paragraph). These products run in protected mode under Unix, Xenix, or Phar Lap extended MS-DOS.

Starting with release 1.4VM, NDP Fortran, C and Pascal not only access 4 gigabytes of memory, but run with Phar Lap's new VMM extension which provides 386 protected mode virtual memory. Now you can run a program with a 30 MB array on a 2 MB system simply by having 30 MB of space on your hard disk.

MicroWay also offers transputer based parallel processing boards and languages that run in an XT, AT, or 386. Each of the T800 RISC processors on these boards packs the power

Dr. Robert Atwell, leading defense scientist, calculates that NDP Fortran-386 is saving him \$12,000 per month in rentals of VAX hardware and software while doubling his productivity!

Fred Ziegler of AspenTech in Cambridge, Mass. reports, "I ported 900,000 lines of Fortran source in two weeks without a single problem!" AspenTech's Chemical Modeling System is in use on mainframes worldwide and is probably the largest application to ever run on an Intel processor.

Dr. Jerry Ginsberg of Georgia Tech reports, "My problems run a factor of six faster using NDP Fortran-386 on an mW1167 equipped 386/20 than they do on my MicroVAX II."

of a 20 MHz 386/1167. Our best selling board, the Quadputer2™, has four T800s and boasts 40 MIPS/6 megaflops of processor throughput.

MicroWay manufactures Weitek 1167 and 3167 coprocessor cards that run with the 80386. Both cards include an 80387 socket. The 1167 is 2 to 4 times faster than the 80387. The 3167 runs 30% faster than the 1167 in double precision. The key to achieving this speed increase is our NDP Fortran or C and the new 32-bit applications that offer Weitek support. Either processor provides a dramatic increase in throughput for graphics intensive applications. These include VersaCad and Hoops 3D graphics, ANVIL 5000 CAD/CAM, SRAC and Swanson Analysis finite element packages, Mathematica and a host of other packages that were recently ported to the 386 using our NDP Fortran and NDP C. Please call (508) 746-7341 for more information.

32-Bit Compilers and Tools

NDP Fortran-386™, NDP C-386™, and NDP Pascal-386™ compilers generate globally optimized, mainframe quality code. Each runs in 386 protected mode under Unix, Xenix or Phar Lap extended MS-DOS. The memory model employed uses 2 segments, each of which can be up to 4 gigabytes. They generate code for the 80287, 80387, mW3167 or mW1167 and include high speed EGA graphics extensions written in C that perform BASIC-like screen operations. NDP Fortran-386™ is a full implementation of FORTRAN-77 with Berkeley 4.2 and Fortran-66 extensions. NDP C-386™ is a full implementation of AT&T's PCC with MS and ANSI extensions. NDP Pascal-386™ is a full implementation of ANSI/IEEE Pascal, with extensions from C and Berkeley 4.2 Pascal. NDP Fortran/C/Pascal-386/DOS each \$595 NDP Fortran/C/Pascal-386/VM..... \$695 NDP Fortran/C/Pascal-386/UNIX..... \$795

Phar Lap 386/VMM extensions are supported by the VM releases of NDP Fortran, C, and Pascal, making it possible to compile and run programs as large as the free space on your hard disk.

Phar Lap Virtual Memory Manager... \$295
Phar Lap Development Tools... \$495

NDP Windows™ — NDP Windows includes 80 functions that let you create, store, and recall menus and windows. It works with NDP C-386 and drives all the popular graphics adapters..... Library: \$125, C Source: \$250

NDP Plot™ — Calcomp compatible plot package that is callable from NDP Fortran. It includes drivers for popular plotters and printers. Works with CGA, MDA, EGA and VGA... \$325

NDP/FFT™ — Includes 40 fast running, hand coded algorithms for single and double dimensioned FFTs which take advantage of the 32-bit addressing of the 386 or your hard disk. Callable from NDP Fortran with mW1167 and 80387 support..... \$250
387FFT for 16-bit compilers..... \$250

NDP to HALO '88 Graphics Interface — Enables you to call graphics routines in HALO '88 from NDP Fortran, C or Pascal..... \$100

Parallel Processing

Videoputer™ — The highest performance graphics card on the market. Uses a T800 and TI 34010 in conjunction with a 130 MHz Brook-Tree DAC. Includes one MB of system RAM, one meg of video RAM and a library of graphics primitives. Runs standalone or in conjunction with a transputer network and drives 32 and 64 KHz analog monitors..... \$4995

Monoputer™ — The world's most popular PC transputer development product now extends the memory available for developing transputer applications from 2 to 16 MB. The board features a DMA bus interface for fast I/O.

Monoputer with T414 (0 MB)..... \$995
Monoputer with T800 (0 MB)..... \$1495

Quadputer™ — This board for the AT or 386 can be purchased with 2, 3 or 4 transputers and 1 or 4 MB of memory per transputer. Two or more Quadputers can be linked together to build networks of up to 100 or more transputers providing mainframe power..... from \$3495

Linkputer™ — Uses four Inmos C004 programmable cross bar switches. It allows the user to dynamically change the topology of the processors in a network. Using this board, it is possible to get 100% linkage among eight Quadputers and design larger, custom topologies..... CALL

Transputer Compilers and Applications

These Parallel languages are designed for use with Monoputer2 and Quadputer2.

Logical Systems Parallel C..... \$595
3L Parallel C or 3L Parallel Fortran... \$895
COSMOS/M - Finite element analysis... CALL
ParaSoft: Parallel Environment... \$500
Performance Monitor... \$500
C Source Level Debugger \$500
T800/NAG™ (See NDP/NAG)..... \$2750

387BASIC™ — Our 16-bit MS compatible compiler introduces numeric register variables to produce the fastest running 80x87 code on the market..... \$249

NUMERICS HOTLINE
(508) 746-7341

386 Your AT

386/387 Turbo™AT — This board plugs into your 80286 socket, allowing your IBM AT to run 32-bit protected-mode code written for the 80386. Includes an 80387 socket. The most cost-effective AT upgrade!

386/387 Turbo AT/16MHz..... \$495
386/387 Turbo AT/25 MHz..... \$695

Weitek-Based Coprocessor Boards

mW1167™ and mW3167™ coprocessor boards are built at MicroWay using Weitek components. Each includes an 80387 socket.

mW1167-16..... \$895
mW1167-20..... \$1095
mW1167 Microchannel-16/20... CALL
3167-20..... \$995
3167-25..... \$1295
3167-33..... \$1695
mW3167/80387 Board..... \$150

Intel Coprocessors and RAM

80387-33..... \$550
80287-8..... \$195
80387-16..... \$360
80387-20..... \$400
80C287A (CMOS)..... \$280
287 Turbo-12 (for AT compatibles)..... \$350
RAMpak™ one meg 32-bit memory module for Compaq 386 20/25..... \$425
RAMpak™ - four meg..... \$1500
256K 80ns DRAM..... \$8.00
256K 100ns DRAM..... \$6.50
256K SIMMs 100ns..... \$90
1 meg SIMMs 100ns..... \$275
(All of our Intel coprocessors include 87Test.)

Multi-User Accelerators

MicroWay's AT8™ and AT16™ intelligent serial controllers run 8 to 16 terminals under Unix or Xenix without bogging down your AT, 80386 or PS/2 PC. AT8: \$895 AT16: \$1295

12 MHz PC Accelerators

FastCACHE-286 12 MHz..... \$299
SuperCACHE-286 12 MHz..... \$399
FastCACHE-286 9 MHz..... \$199

MicroWay

World Leader in PC Numerics

Corporate Headquarters: P.O. Box 79, Kingston, MA 02364 USA (508) 746-7341
32 High St., Kingston-Upon-Thames, U.K., 01-541-5466
USA FAX 508-746-4678 Germany 069-75-2023

FINALLY. A debugging tool tough enough to handle the DOS Nasties.

New Version 2.0



Nasty over-write? No sweat!

Soft-ICE memory range break points help you track down memory over-write problems whether you are doing the over-writing or another program is over-writing you.

Hung program? No problem!

When the system hangs, you now have hope. With Soft-ICE you can break out of hung programs no matter how bad the system has been trashed. And with Soft-ICE's back trace ranges you can re-play the instructions that led up to the crash.

Program too large? Not with Soft-ICE!

Soft-ICE runs entirely in extended memory. This means you can debug even the largest DOS programs. And since your program runs at the same address whether Soft-ICE is loaded or not you can find those subtle bugs that change when the starting address of your code changes.

System debugging? Soft-ICE is a natural!

Soft-ICE is ideal for full source level debugging of TSRs, interrupt service routines, self booting programs, DOS loadable device drivers, real-time kernels, non-DOS OS's and ROMs. Soft-ICE can even debug within DOS & BIOS

How Soft-ICE Works

Soft-ICE uses the power of the 80386 to surround your program in a virtual machine. This gives you complete control of the DOS environment, while Soft-ICE runs safely in protected mode. Soft-ICE uses the 80386 to provide real-time break points on memory locations, memory ranges, execution, I/O ports, hardware & software interrupts. With Soft-ICE you get all the speed and power of a hardware-assisted debugger at a software price.

Don't want to switch debuggers?

You don't have to!

Soft-ICE can run stand-alone or it can add its powerful break points to the debugger you already use. Use your favorite debugger until you require Soft-ICE. Simply pop up the Soft-ICE window to set powerful real-time break points. When a break point is reached, your debugger will be activated automatically.

MagicCV with Soft-ICE

Using Soft-ICE with CodeView gives you the features necessary for professional level systems debugging. MagicCV and Soft-ICE can work in concert with CodeView to provide the most powerful debugging platform you will find anywhere.

"These may be the only two products I've seen in the last two or three years that exceeded my wildest expectations for power, compatibility and ease-of-use."

— Paul Mace
Paul Mace Software

Soft-ICE	\$386
MagicCV	\$199
MagicCV for Windows	\$199
Buy Soft-ICE & MagicCV(W)	—Save \$86.
Buy MagicCV and MagicCVW	—Save \$100.
Buy All 3	—Save \$186.

30 day money-back guarantee
Visa, MasterCard and
AmEx accepted



New Soft-ICE 2.0 features

- Back Trace Ranges
- Symbolic & Source level debugging
- EMS 4.0 support with special EMS debugging commands
- Windowed user interface



CALL TODAY (603) 888-2386
or FAX (603) 888-2465

RUN CODEVIEW IN 8K MagicCV



CodeView is a great integrated debugger but it uses over 200K of conventional memory. MagicCV uses advanced features of the 80386 to load CodeView and symbols in extended memory. This allows MagicCV to run CodeView in less than 8K of conventional memory on your 80386 PC.

NEW—Version 2.0 includes EMS 4.0 driver
Attention Windows Developers!
Version available for CVW

P.O. BOX 7607 ■ NASHUA, NH ■ 03060-7607



NEITHER SNOW, NOR CHICAGO...

Spring Comdex was no picnic, but there was good news for users

Neither the snow nor the relocation to Chicago could hide the good news that Spring Comdex had for business this year. While Comdex may have suffered a bit from those factors, it was a significant show for business users of personal computers. This was the show where business found that the computers of the future would get both better and cheaper; where the flirtation between computers and the fax process became lust; and where the "Year of the LAN" became the great expectation of connectivity.

The move to things better, faster, and cheaper was shown no more clearly than in the introduction of the Intel 80486. This is the processor that will lead business users to the world of a mainframe on a desk. That mainframe on a desk will communicate with ever-more-powerful laptops and peripherals through LANs without traditional cards and even LANs without wires.

It was impossible to tell what was happening in the Macintosh world. Apple wasn't there, and Macdex crashed and burned. Apple's absence was the PC world's gain, however, and the 80486 gained center stage.

80486 Fever

The 80486 is important because it allows a high-performance computer to be built with fewer components. This chip incorporates into its design many functions that were formerly done by support chips. Thus, you will no longer need separate components for the math coprocessor or for caching. The processor will have these functions built in.

The reduction in components will



allow the 80486 to be designed to run much faster than did earlier processors. In addition, a computer using the 80486 can be built at a lower cost than can a comparable one with an 80386. Cheetah's Gene Sumrall was one of the first to point this out to me. He was also one of the first to show a motherboard that would support the 80486. Cheetah had designed its new board so that it would take a daughterboard for the CPU. This means that the company can offer the same basic board for an entire product line, changing only the daughterboard that supports the processor.

A few manufacturers, including IBM and Zenith, promised to have machines based on the 80486 by the year's end. Zenith's Andy Czernek said that his company's computer would use the Extended Industry Standard Architecture bus. If so, Zenith would be one of the first companies to introduce an EISA machine. According to Czernek, it will be available at the end of the year.

The fact that the 80486 will bring business users machines that are faster and cheaper is good news. It's likely, of course, that the first prices to drop will be those of the 80386 and systems that are based on it. That's even better news.

More Speed

Zenith was one of the first manufacturers to announce that it had begun shipping a 33-MHz 80386-based computer, the Z-386/33. There were others as well, including Compaq and Everex. We had been expecting 33-MHz machines for about six months—ever since Fall Comdex—but they became available only when Intel began shipping the chips in late March. A few companies had previously built systems that ran at this speed, but those machines used components designed for 25 MHz and simply run beyond their design speed.

The advent of commercially available 33-MHz machines means a great deal to

continued

Other Laptop Connectivity Products Don't Measure Up...

Introducing LANLink Laptop

The rules have changed for laptop file transfer utilities. That's because our new LANLink Laptop™ gives you much more than just simple file transfer between laptops and desktop PCs. Now you can run desktop programs from your laptop, share remote printers or disks and even transfer files while you're wordprocessing.

The Whole Nine Yards

Of course, if you just want to transfer files you can do that too—at speeds up to 500K bps, the fastest on the market. But since LANLink Laptop offers so many other benefits, and sells for about the same price as the other programs, why would you settle for less?

For more information on LANLink Laptop, or the distributor nearest you, call us today. We'll show you how you can extend the capabilities of your laptop to new heights.

LANLink Laptop™



THE SOFTWARE LINK

3577 Parkway Lane
Norcross, GA 30092
800-451-LINK (404) 448-5465
Fax: (404) 263-6474
Telex: 4996147 SWLINK

Your Connection To Advanced Technology

LANLink Laptop is a trademark of The Software Link, Inc.

Gain LAN capabilities

Transfer files at up to 500K bps

Utilize multiuser and multitasking OS support

Benefit from low overhead (only 40K)

Share printers, disks and other peripherals

Use DOS commands, no need to learn anything new

Transfer files



companies that use their machines for CAD or desktop publishing. There, the improvement in speed will more than offset the higher cost through gains in productivity.

A Few Pertinent Fax

A year ago, Comdex attendees realized that computers and fax were becoming a team. Fax cards were everywhere. The trend continues, but the bare fact is that fax is finally becoming integrated well enough to be useful. In addition, it is moving out of the desktop PC and into areas where it makes more sense to have a fax interface.

In my June column, I looked at some of the earlier fax cards, as well as a stand-alone fax machine made by Murata, a long-established manufacturer of stand-alone fax systems. At Comdex, Murata introduced its F-50 network fax server. This is a complete fax machine, including scanner and printer, that plugs into a network via a workstation. You can send faxes through the network, and you can scan them as you normally would. The F-50 contains its own processor and memory, so the conversion from a file to a fax image occurs inside the F-50 itself. This reduces the load on the network and the file-server or workstation disks.

The F-50 is not the first network fax server, but it seems to be the best thought out. There are times, after all, when you need to send something that is already on paper, and creating an image so that you can send it using a fax card can be cumbersome in the extreme. Likewise, there are times when you simply want to leave the fax machine turned on while everything else is shut off for the weekend. The F-50 will let you accomplish this.

At the other end of the spectrum is a new card from Holmes Microsystems that contains a combination 9600-bps fax and a 2400-bps modem. The FAX'EM card is about 2 inches square and contains only a few surface-mount chips, yet it's fully functional. It fits inside the expansion slot on Toshiba and Zenith laptop computers and costs about the same as competing full-size fax cards. Holmes also introduced a combination fax printer and scanner called PFIDO that attaches to a laptop computer. The entire machine is about 9 inches long and 1 inch square.

LAN Sakes

Clearly, the Year of the LAN has happened. A year ago, LANs were still something mysterious. By Fall Comdex, they were an accepted part of the computing environment. This year, they're

continued

Faster computers sooner... from FORTRON.



NetSet™ 286
12, 16, 20 MHz

NetSet™ 325, 333 DeskTop or Power

Desktop 286 or 386
12, 16, 20 MHz

As fast as products are designed, that's about how fast you can get them from Fortron. In early 1987 we were one of the first to ship an Intel 386™ based personal computer.

Now we're ready to dazzle you with speed again: the **NetSet™ 325** and **NetSet™ 333** personal computers, based on Intel 386™ 25 MHz and 33 MHz microprocessors. Designed for optimum performance of **CAD/CAM, UNIX, XENIX, and network server** applications.

Like all our other personal computers, these come with **one full year of service, free, at your site (USA)**. We're that sure of the reliability. And because we manufacture the computers ourselves, right here in California, you know exactly who to call with any technical questions; and if they do need service, we can fix them fast. **Speed, service, and savings. That's Fortron.**

BASIC SYSTEM PRICES START AT:

NetSet 286-12	386-16	386-20 Plus	NetSet 386-325	NetSet 386-333
\$995	\$1950	\$2400	\$3290	\$5450
512K	2MB	1MB	1MB	4MB

To Order Call Toll Free
1-800-821-9771

In CA 415-373-1008

Leasing Program Available
International Distributors Wanted

*386™ is a trademark of Intel Corp.
NetSet is a trademark of Fortron/Source Corp.

FORTRON

Fortron/Source Corp.
6818-G Patterson Pass Road
Livermore, CA 94550
Tel: 415-373-1008
FAX: 415-373-1168 TELEX: 559291

- Please have a sales representative call me.
- Please send me more information.
1. I am most interested in
A. 286-based systems
B. 386-based systems
2. I am a
A. End User
B. VAR
C. Corporate Purchaser
D. DP/MIS.

Name _____

Title _____

Company _____

Address _____

City _____

State _____

Zip _____

Phone No. _____

8/89

ITEMS DISCUSSED

F-50\$3595	Q-PC\$3755
factory upgrade.....\$895	Q-MCAX\$4495
Murata Business Systems, Inc.	Datapath, Ltd.
5560 Tennyson Pkwy.	Datapath House
Plano, TX 75024	High St.
(214) 403-3300	Melbourne, Derby
Inquiry 1025.	DE7 1GJ, UK
	44-332-862-227
FAX'EM	Inquiry 1029.
1200-bps.....\$599	TrackerMouse\$169
2400-bps.....\$699	Penny and Giles Computer
PFIDO\$1500	Products, Ltd.
Holmes Microsystems, Inc.	35 Reynolds St.
2620 South 900 West	Attleboro, MA 02703
Salt Lake City, UT 84119	(508) 226-3008
(801) 975-9929	Inquiry 1030.
Inquiry 1026.	
	Z-386/33
LAWN\$495	Model 150.....\$11,499
O'Neill Communications, Inc.	Model 320.....\$13,499
100 Thanet Cir., Suite 202	Zenith Data Systems
Princeton, NJ 08540	1000 Milwaukee Ave.
(609) 924-1095	Glenview, IL 60025
Inquiry 1027.	(800) 553-0331
	(312) 699-4800
Pocket Ethernet Adapter\$695	Inquiry 1031.
Xircom	
22231 Mulholland Hwy.,	
Suite 114	
Woodland Hills, CA 91364	
(818) 884-8755	
Inquiry 1028.	

part of the scenery. In fact, they're everywhere. Still, there is some wonder remaining in the land of the LANs.

One of the problems with the office LAN has been that you needed a computer with an expansion slot to use the LAN properly; portables need not apply. While you could always use a LAN with a modem or a serial interface, this is difficult and usually too slow to work well with most personal computer software.

Xircom has solved that problem with its Pocket Ethernet Adapter. This device, about the size of a pack of cigarettes, plugs into the parallel port on any IBM PC-compatible computer. The adapter is available to support either thick- or thin-wire Ethernet. Included with the adapter are drivers for Novell NetWare.

The Pocket Ethernet Adapter is designed for use with laptops, but it will work well with computers that otherwise have limitations in the number of slots available. This means that you can buy one of those Zenith EaZy PCs being sold on the cable TV shopping channels and use it for a Novell workstation.

At \$695, the Pocket Ethernet Adapter is a bit more expensive than some other

Ethernet cards, but not by much. It's certainly worth the price if it can give you access to your office LAN where you didn't have it before.

Of course, at times the problem isn't the network interface card, but rather the cables that accompany a LAN. O'Neill Communications has found a way to eliminate that part of a LAN by using radio instead of cables. O'Neill calls the result a LAWN (local-area wireless network). The system uses spread-spectrum packet switching, and it is a little slower than traditional LANs. On the other hand, it works better without cables than do traditional LANs.

LAWN has a great deal in common with the printer servers that I discussed in my December column. It attaches to the computer's serial port and is used most effectively for printer sharing, although it will support E-mail and file sharing. As I'm writing this, LAWN is undergoing FCC certification, but it should be available by late summer.

English Inroads

Comdex always brings exhibitors from all over the world, and this year was no

exception. Several companies from the U.K. were part of a government-sponsored group. One company, Penny and Giles Computer Products, has produced a trackball that really will take the place of a mouse. Normally, a trackball requires two hands to operate (at least it does for me), which offsets the advantage of using little desk space.

You operate TrackerMouse with one hand. Pressable areas on the sides of the device take the place of mouse buttons. The trackball protrudes through the top and bottom of the device, so that you can operate it without having it planted on the desktop.

TrackerMouse includes a solar calculator on its top. I suppose that this is based on an assumption that anyone who has a desk sufficiently messy to preclude the use of a mouse is also likely to lose a calculator. Probably a safe assumption.

[Editor's note: For more information on TrackerMouse, see *Computing at Chaos Manor in the July BYTE.*]

Also from the U.K. is the Datapath video board, an extremely high-resolution board designed for CAD and for desktop publishing. The Datapath video board supports resolutions of up to 1600 by 1280 pixels on the IBM PC (Model Q-PC) and the PS/2 (Model Q-MCAX), and it's extremely fast. I watched one board running at 1280- by 1024-pixel resolution redraw Autodesk's sample drawing of St. Paul's Cathedral in 1½ seconds. I don't think I've ever seen it done faster.

Modern Maturity

Spring Comdex this year was quiet. This was partly because Chicago's huge McCormick Place convention center swallowed the crowds more easily than do convention centers in Atlanta or Las Vegas. I suspect that the timing also had something to do with it. Not everybody likes Comdex in the snow.

Finally, the hype level seemed to be down a little. Perhaps that means that we are more sure of ourselves—a more mature industry. ■

Wayne Rash Jr. is a contributing editor for BYTE and a member of the professional staff of American Management Systems, Inc. (Arlington, VA). He consults with the federal government on micro-computers and communications. You can contact him on BIX as "waynerash," or in the to.wayne conference.

Your questions and comments are welcome. Write to: Editor, BYTE, One Phoenix Mill Lane, Peterborough, NH 03458.

Ask The Doctor

Your Most Important Questions

About PC Data Security.



Escalating instances of PC data theft and misuse affecting both government and industry have shown the need for an effective yet easy-to-use data security product. U.S. Public law 100-235 now mandates that government agencies protect sensitive data files.

In response, Dr. Alan K. Jennings, Ph.D., inventor and co-founder of Rainbow Technologies, has designed the DataSentry™, an external hardware key that provides data file security without the problems associated with internal hardware and software-based protection.

In this first of a series of informational bulletins, Dr. Jennings answers some of the more frequently asked questions on PC data security and the DataSentry system from Rainbow Technologies.



Data Sentry

- Completely user-installable
- Pocket-sized external device
- Menu-driven, user-friendly interface
- Single- or multi-user security system
- Audit trail, log-on identifiers and automatic encryption/decryption of entire directories
- Secures data transmitted by modems
- Prevents recovery of data by utility programs

Dealer Inquiries Welcome.

Q. What is the DataSentry system?

A. The DataSentry protection system consists of a combination of a hardware encryption device – Personal Access Key – and associated software that runs on an IBM or compatible PC having a parallel printer port and a floppy disk drive. The DataSentry provides three types of security: mandatory use of the access key to open a file, encryption and password protection.

Q. What is inside the Personal Access Key?

A. Inside each pocket-sized Personal Access Key is a proprietary custom-designed integrated circuit, often referred to as an Application Specific Integrated Circuit (ASIC). This ASIC was designed by engineers at Rainbow Technologies specifically for the DataSentry system. The full capabilities of the ASIC are known only to Rainbow. In operation, the proprietary ASIC implements a special function called an algorithm, chosen from many thousands of possible algorithms when the key is being manufactured at the Rainbow factory.

Q. What is the disadvantage of password-only software protection?

A. The main disadvantage of password-only protection is that users find it difficult to remember a password unless it is something quite familiar to them – like their spouse's name, their dog or the street they live on. It was recently estimated that about 75% of ARPANET passwords could be discovered by trying these three choices. Choosing a less familiar name requires that it be written down. This, of course, is a security risk. As a result, password-only protection is fairly easy to defeat.

Q. What is the advantage of external hardware keys over internal security boards?

A. Some protection systems depend on circuit boards being installed inside the PC. In addition to objection to the expense of installation and training, many users are reluctant to open their PCs. IBM PS/2s and laptop PCs do not accept the standard add-in boards. As a result, nearly all PC users have a strong preference to the addition of low-cost external hardware to achieve the desired protection.

Q. Is the DES (Data Encryption Standard) government-specified algorithm available with the DataSentry system?

A. Yes. The DES algorithm as defined by U.S. government standard FIPS 46 is implemented in the DataSentry system.

Q. Can the DataSentry system be used on local area networks?

A. Yes. It can be used on LANS as long as the automatically protected files are stored on a local computer. It does not matter if the application is stored on the local PC, on a shared file server or on any other PC.

Q. Can a DataSentry system be used to secure mainframe data files?

A. Yes. The mainframe could send files to the PC for encrypting or decrypting.

Q. What are some of the new special features of the DataSentry system?

A. Audit trail, log-on identifiers, and automatic encryption/decryption of entire directories.

To consult Dr. Jennings and the DataSentry sales staff about your personal data security questions, call Rainbow Technologies today.



RAINBOW TECHNOLOGIES

18011-A Mitchell South, Irvine, CA 92714 • (714) 261-0228 • TELEX: 386078 • FAX: (714) 261-0260
Rainbow Technologies, Ltd., Shirley Lodge, 470 London Rd., Slough, Berkshire, SL3 8QY, U.K., Tel: 0753-41512, Fax: 0753-43610

© 1989 Rainbow Technologies. All product names are trademarks of their respective manufacturers.



THE WAY OF THINGS CONSIDERED

There are many ways to accomplish something, but only a few of them are right

Can computers spawn ideologies? Can computer companies tread successfully on ground formerly held by philosophers and politicians? Can a corporate culture possibly exhibit a strong ethical and moral component?

If you believe Guy Kawasaki, the answer is a resounding yes. Kawasaki, the president of software publisher Acius, has written a book about an important aspect of Apple's corporate culture: *The Macintosh Way* (Scott, Foresman, 1989, \$19.95). Although I was quite skeptical about any company (especially a high-tech one) spawning a way of doing business that has a strong ethical and moral component, after reading this book, I've come around full circle.

Although the book will likely be bought because it offers a frank discussion of Kawasaki's years at Apple and his own exposure to the Macintosh way of doing business, that's not the best reason to buy it. *The Macintosh Way* offers an important glimpse at how a corporate culture is created and spread, how it can be corrupted, and how you can take advantage of it long after the original product on which it was based is history. Reading it will give you a very personal and insightful account of how to do business in today's Mac software market.

The book makes a strong case for two simple precepts: doing the right things, and doing them the right way. I'm amazed at how many people in the computer business fail to look beyond the end of their respective bottom lines. As long as sales curves rise and profits are made, they're satisfied. That's really too bad.



Among all the growing industries in this country, the computer companies should be setting the trends for corporate morality and ethical conduct, with their emphasis on empowering individuals with new and more powerful computing tools. Sadly, this isn't the case. Moral shortsightedness and ethical ignorance seem to run rampant in some computer companies, and corporate attorneys are left to find legal solutions for resulting problems. It's time that more companies paid attention to the lessons that *The Macintosh Way* teaches, rather than hiding behind a "well, that doesn't really apply to us" attitude.

Besides its important lessons on doing the right things in the right way, *The Macintosh Way* also gives an insider's view of how Apple developed the way it has developed and how one entrepreneur decided to leave the relative safety of its corporate culture to run with a software idea he thought important.

In fact, after rereading the book last

night, I think that its lessons go way beyond Apple and the Mac.

Application Development Standards

In the past few months, I've commented on what I think Apple needs to do to extend the life span of the Finder and the Mac operating system well into the next decade. Although I'm sure that Apple is not waiting with bated breath to hear my further thoughts on the subject, one segment of the Mac interface deserves Apple's special attention. The applications that Apple creates (e.g., HyperCard) and the extensions it makes to the Finder, the MultiFinder, and the Mac operating system serve as the de facto and de jure standards that vendors follow when building their own applications. This situation bears a close examination.

Conventional wisdom dictates that every Mac application should follow the standards set by those first two Mac applications: MacWrite and MacPaint.

continued

That means that the first two menu-bar items are invariably File and Edit. That also means that the Quit command resides in the File menu, and it can be activated by a Command-Q key combination. Furthermore, Cut, Copy, Paste, Clear, and Select All reside in the Edit menu. But is this enough to ensure a good Mac application interface?

I don't think so. Of course, Apple has published its application guidelines in the multivolume *Inside Macintosh* series, published by Addison-Wesley. Other Apple employees have extended the definition of what constitutes a good Mac application interface in a variety of books published since 1984. Those efforts are all fine, and I don't have a problem with them. But I do have a problem with how these ideas are going to be extended on the one hand and controlled on the other, as the Finder and the Mac operating system move toward the 1990s.

As I'm writing this, Apple has announced its next-generation System software, version 7.0. At May's Worldwide Developer's Conference in San Jose, I heard about the features that Apple intends to include in System 7.0. Among the changes is a redesigned Finder that incorporates significant new interface hooks and a greater level of functional integration. It will also include support for E-mail, larger directories, networks, international scripts, and foreign file systems, while also being more extensible. This prototype Finder supposedly organizes files along the lines of AppleShare's Desktop Manager, which does a much better job than the current Finder at handling multiple large volumes.

The new Finder is also supposed to include many file management features borrowed from Unix, including file aliasing, so that you can open a file with a variety of applications directly from the Desktop, rather than opening the file within an application. This should make file organization much simpler.

The point, though, is not how accurate this description is of future Apple system software. John Sculley has repeatedly announced that Apple intends to create a new operating system that depends on a brand-new system kernel that could be outfitted with different shells depending on the operating environment desired. The important point is what the changes to the Finder and its file management methods do to the standardization of Mac application interfaces.

Will new Finders make that standardization harder or easier? How will Apple help developers maintain application interface consistency? If past experience is

ITEMS DISCUSSED

Nisus 1.0.....\$395
Paragon Concepts, Inc.
990 Highland Dr., Suite 312
Solana Beach, CA 92075
(800) 922-2993
(619) 481-1477
Inquiry 1032.

Word 3.02.....\$395
Microsoft Corp.
16011 Northeast 36th Way
P.O. Box 97017
Redmond, WA 98073
(800) 323-3577
(206) 882-8080
Inquiry 1033.

a guide, the future promises more confusion than clarity. As the Mac moves into its second five years, Apple needs to be a trendsetter for application developers, pointing the way toward sensible interface standards that vary according to the application, but retaining cross-application conventions where possible. As *The Macintosh Way* puts it, Apple needs to do the right thing in the right way.

Corruption

A look at some current Mac programs gives you some clue as to how application interface standards can get corrupted. I'm writing this column using the Nisus word processor. Nisus follows the interface ideas first established by MacWrite pretty closely. One look at the Nisus menu bar confirms this: It has File, Edit, Search, Tools, Font, Size, and Style selections. The Quit command resides within the File menu and can be activated via either the menu bar or the Command-Q key combination. Cut, Copy, Paste, Clear, and Select All reside (as they should) in the Edit menu. The Font menu contains all the available fonts, while the Size and Style menus modify the characteristics of the current typeface.

The upshot of all this is that you know how to use Nisus without opening the user's manual. That's the way it should be, and it's the reason I love the Mac. I can spend my time computing with the Mac, rather than learning an application. But what's going to happen with these kinds of interface standards when Apple extends the Finder and makes it more extensible?

Even with the present Finder and its allied set of interface conventions, applications can quickly diverge from accepted standards. Microsoft Word 3.02 is a case in point, with its Short and Full

menu settings. These settings change what is available under each menu-bar listing, rather than just dimming those items that are unavailable.

You'd be surprised at how many people call me up and ask how they can install all their system fonts for use in Word. They tell me that they have 20 fonts installed in their System file that they can use in MacWrite or WriteNow, but only five of them show up in Word's Font menu. The problem, of course, is that they've selected Short menus as their default setting. This eliminates all but the five most commonly used fonts from the Font menu and causes a great deal of confusion, especially among new users.

What Apple Should Do

I'm lousy at predicting the future, but I know that Apple can do a lot toward ensuring a future that makes consistent user interfaces easy for application developers to incorporate. First, Apple should show developers exactly how to use the new Finder features in its Tech Notes series. Second, Apple should modify MPW and MacApp (perhaps with an MPW version 4.0) to include the interface extensions that Apple would like to see in other Mac applications.

Third, Apple should publish a new series of books (perhaps through its publishing arrangement with Addison-Wesley) devoted to incorporating what Apple thinks is a standard user interface for applications. Naturally, those interface standards will vary according to the kind of application. For example, things that would be interface oddities in a CAD program (e.g., a separate menu entry for text searching) make perfectly good sense in a word processing program.

As Apple moves toward a more integrated Finder that controls the Mac without the assistance of desk accessories and small applications like the Font/DA Mover, Mac software developers will have to pay special attention to establishing new application interface standards and sticking with them, even when "hot" new ideas argue for violation of those standards. In the past, these hot ideas have produced dubious software achievements like the Short and Full menus of Word, the many interface anomalies of Lotus's failed Jazz program, and the quirkiness of chart manipulation in Microsoft's Excel. ■

Don Crabb is the director of laboratories and a senior lecturer for the computer science department at the University of Chicago. He can be reached on BIX as "decrabb."

Enter The New Age of Electronic CAD



The wait is over for a powerful, easy to use electronic design workstation.

With the new Douglas CAD/CAM Professional System, you can now experience computer-aided design without going over budget and without sitting through months of tedious training. Running on the Apple Macintosh Plus, SE and II, the Professional System from Douglas Electronics excels in price/performance, short learning curves and ease of use.

As the newest addition to the Douglas CAD/CAM line of printed circuit board design and manufacturing systems, the Professional System is a fully integrated engineering tool that will take you from the schematic drawing to the final routed board. The software features full color, unlimited multi-

layers and .001" control which makes surface mount technology (SMT) and other difficult tasks a snap. Professional Layout includes a parts placement facility. Schematic includes fully interactive digital simulation and net list generation. A flexible, multi-pass router completes the design cycle with a 16 layer routing capability.

The new age of electronic CAD has come with the high resolution and speed of a Macintosh engineering workstation. You'll be designing your first circuit board just minutes after the Professional System software has been loaded into your computer. In addition, the Macintosh's graphics capa-

bilities allow for powerful features such as the ability to transfer Professional System drawings into final engineering documentation.

Computer-aided design wasn't meant to be time consuming and complicated. If your present CAD system has got the best of you, it may be time you enter the new age of electronic CAD with the powerful, easy to use Douglas CAD/CAM Professional System.

Take your first step by ordering a full-feature Demo. All three programs are included for just \$25.

Call or write for more information and to place your order.

Circle 457 on Reader Service Card

Douglas
Electronics

718 Marina Blvd.
San Leandro, CA 94577
(415) 483-8770

Aw...What the Heck!

EXTREMELY POWERFUL

DesignCAD 3-D version 2.0 is as powerful as most CAD systems costing \$5000 - \$10,000! Features like: Complex Extrusions-linear, scalar, and circular, Blending of Surfaces, Shading, Cross Sectioning, Complex Sweeps and Translations, and Boolean operations make DesignCAD 3-D one of the most powerful 3-D CAD systems available... at any price! Engineers, Architects and Consultants constantly tell us that they use CAD systems costing thousands of dollars which are not as powerful as DesignCAD 3-D.



VERY EASY TO USE

Just because DesignCAD 3-D is powerful doesn't mean it is difficult to use. Single keystroke commands and side-bar menus which give short directions on how to proceed make DesignCAD 3-D a snap to use! While not required, DesignCAD 3-D supports all popular digitizers and mice.

Many of the older, more cumbersome CAD systems require weeks of training before a user can be productive. DesignCAD 3-D users find they can be producing useful drawings in a matter of minutes! In a recent CAD contest only one contestant was able to match our drawing time. The package sold for \$3000.00. The other CAD packages took up to twice as long to perform the same drawing and cost up to \$5000.00!

Still don't believe us? The goblet pictured below required only 16 keystrokes and 3 commands to create! The top, front, side, and isometric views were created simultaneously... in less than one minute!

VERY LOW PRICED

The first question asked by many people is, "Why is DesignCAD 3-D priced so low?" The answer? After developing DesignCAD 3-D version 2.0, we were unable to decide how the product should be priced. We consulted experts. We used the finest spreadsheets on the market. We took employee polls. Finally, in the great American Tradition, we said, "Aw... What the Heck! Let's see the other guys beat this price!" DesignCAD 3-D version 2.0 sells for \$399.



DesignCAD 3-D only \$399!

WHY BUY THIS ONE?

There is a very important reason to buy DesignCAD 3-D. **PERFORMANCE.** No other CAD system can match our price/performance ratio. Many people make the serious mistake of thinking that it is necessary to spend thousands of dollars to obtain "a good 3-D CAD system." This is not true! We talk to people everyday that are sadly disappointed with their "expensive" CAD systems. Don't be one of them! Call us and we will send you a complete set of literature and a free slide show demo disk. Once you compare DesignCAD 3-D version 2.0 with other CAD systems we know you will choose DesignCAD 3-D.

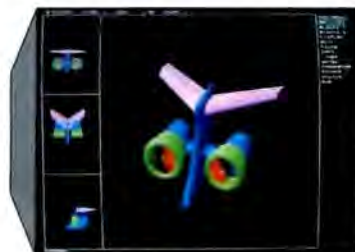

DON'T TAKE OUR WORD FOR IT

Here is what other people have to say about DesignCAD 3-D:

"After you've worked with DesignCAD, the single keystroke commands are simple to remember and it becomes easy to "flick one key" to execute a command. An extremely ergonomically designed program."

HENRY LEVET, Level 5 Daigle Architects - New Orleans, LA
Designed a 65,000 sq ft nursing home using DesignCAD

"Recently I worked with a firm that builds decks. They purchased your product on my recommendation. I sat down with them and in two hours they were very proficient in DesignCAD. Now they are more effective, and we can communicate... it's wonderful to be able to do a block repeat 42 times and there are 42 2x4's to make the deck!"

J. TURNER, Architect TAO Ltd - The Woodlands, Texas

"Allows scientists and engineers to expend minimum time learning and using CAD software so that their time can be expended on the project at hand. It also allows scientists and engineers to quickly present to management all views of a subject. (3-D)."

DR. STEVENS, NASA Space Scientist/Engineer



HOW DO I GET ONE?

DesignCAD 3-D version 2.0 is available from most retail computer stores, or you may order directly from us. DesignCAD 3-D is available in a number of foreign languages from distributors throughout the world. All you need to run DesignCAD 3-D is an IBM PC Compatible and 640K RAM. DesignCAD 3-D supports most graphics cards, printers, plotters and digitizers. Free information and a demo diskette are available by contacting us at:

American
Small Business Computers, Inc.

327 South Mill Street
Pryor, OK 74361
918/825-4844
FAX: 01-918-825-8359
TELEX: 9102400302



SPRING COMDEX: Glimmers of Acceptance

OS/2 may take the world by storm after all

Spring Comdex took place in Chicago this year. That transformed it, as Wayne Rash put it, into Winter Comdex, because it actually snowed on Sunday. Some people blamed the snow on the return of a Daley to the mayoralty. Others wanted to blame Comdex's organizers, the Interface Group. But I've spent a lot of time in Chicago. I knew it was just April and came prepared.

Microrim and Logitech announced exciting new OS/2 products. Also, many more OS/2 applications are actually shipping. Some are still late, like Microsoft Word (at least at this writing; it should be out by the time you read this). WordPerfect filled the gap with a full-featured version 5.0 for OS/2. Despite growing OS/2 acceptance, several important applications appeared under DOS extenders rather than OS/2. And industry officials beat the drum for OS/2, of course.

The First PM Screen Generator

Microrim was one of the first companies with an OS/2 product, R:base Series 5000. Now it's offering a completely new database product called Atlas, intended to manage complicated database relationships and integrate databases from places as disparate as a Macintosh or a mainframe DB2/SQL database. Microrim says that Atlas will be available for the Presentation Manager (PM), the Mac, Sun workstations, and AIX-based systems. The company also indicates that Atlas will understand graphics images in its database.

The feature that interested me, however, was the screen generator. Like the



applications generator in R:base, Atlas will have a simple way to generate user input screens. No big deal, right? Right, until you realize that this can generate a complete PM screen—including buttons, radio buttons, dialog boxes, and all the rest of the PM notions!

Microrim says it won't have the PM version ready until the end of the year, and I'd be surprised if it can finish something that big by then. However, some of the screen generator does work, and I was able to put together a PM screen in a few minutes. (When a screen is transported to the Mac, it even translates items like buttons and slider bars to items from the Mac metaphor.) I've been complaining that we need something that lets normal mortals design PM-type applications. Atlas could be it, provided it ships early enough.

Multiscope

Developers the world over know CodeView. Microsoft offered it several years

ago, and it's still the software-based debugger of choice for many folks. Now it has some competitors, all claiming to be "CodeView killers." (Why do we use such violent language in this business?) Some are marginally better, but Logitech may have a product that can do the job. It's called Multiscope.

Multiscope does everything that CodeView does, and much more. It has a real-time debugger that works the way CodeView works: You run the program to be debugged under the real-time Multiscope, and you can set breakpoints (places where the application should yield control back to the debugger so that you can examine variables and registers) and "watch" windows where a variable's value is continuously monitored in a window. Multiscope also has some fairly sophisticated abilities to use conditional breakpoints (stop whenever variable IS-READY changes), something I find I use all the time when debugging.

continued

SOLUTIONS

Bigger—

Vfeature Deluxe™ lets your DOS system use hard disks it thought it couldn't, all in one bootable piece—no artificial partitions! Span two drives into C: and boot from it, use MFM, RLL, ESDI, or SCSI. Interleave selection, physical format, security options included. DOS 3.1-3.3 \$120

DUB-14™ PCB takes a different approach to drive expansion, stretches your AT's Drive Table to support the drive you choose—MFM, ESDI, RLL, up to 2048 cylinders! Comes with setup and low-level format routines, works with UNIX, XENIX, Pick, Novell, DOS. \$95

Faster—

Vcache™ speeds disk operations, stores data in RAM so it's there for you next time you need it—no waiting! Optional delayed sector write, lookahead buffer. Works with any type of memory, caches up to 15 Mb, bundles accelerators for your diskettes, screens, and keyboard. DOS 2 - 4. \$59.95

Vopt™ defragments disks for quicker access. Run it every day and keep your drive as fast as new! In a few seconds at boot time, Vopt arranges all your files neatly in contiguous clusters so you won't waste any time reading them back. Bundles timing and diagnostic utilities. DOS 2 - 4 \$59.95

Safer—

Vlock™ protects your system and its data from vandals and accidents. System access passwords control booting, activity menus decide who does what to which files, even locks out Ctl-Break during boot! \$135

Easier—

Vtools™ is a slick set of disk management tools for DOS and OS/2. Display directories in whatever order you like, browse files and change or delete them, compare and update multiple versions, find and manipulate categories of files, and more! \$49.95

SEE YOUR DEALER OR CALL TOLL-FREE

1 (800) 284-3269



GOLDEN BOW SYSTEMS

2870 5TH AVENUE
SAN DIEGO, CA 92103
(619) 298-9349

FAX (619) 298-9950 TELEX 201520 GBS UR
MC/VISA US shpg/hdlg \$3 CA orders add 7%

Vfeature, DUB-14, Vcache, Vopt, Vlock, and Vtools are trademarks of Golden Bow Systems.

All that is only mildly more powerful than CodeView. The neat stuff starts with the postmortem debugger (see, another violent metaphor). If a program dies unexpectedly under many debuggers, you just get dumped into the debugger's main menu. Instead of that, Multiscope's postmortem debugger lets you see everything that led to the untimely demise of your program: One window shows why it stopped, you see the assembly language or source code in another window, and the sequence of called routines is in another.

Multiscope can also isolate and debug individual threads. Although I haven't said much about them so far, threads are the basis of OS/2's multitasking capability. An OS/2 program can be made up of a number of threads; OS/2 gives each thread, in turn, a slice of the processor's time. Multiscope's ability to focus on a particular thread of execution is an important feature.

C programmers will love Multiscope's graphical representation of pointers. The tough part of data manipulation in C is getting used to the notion that you're not dealing with data structures, but often indirect references to data structures called pointers. In some cases, C programmers find themselves with pointers that lead to other pointers, which in turn lead to other pointers, which finally lead

Multiscope
can also isolate
and debug individual
threads.

to a data structure. This takes some getting used to.

The folks who advocate graphical user interfaces (GUIs) often cite the old saw that "a picture is worth a thousand words." In this case, it's worth probably ten thousand words. Multiscope actually draws a picture of a program's pointers. Logitech demonstrates this with some source code that is absolutely impenetrable—pointers to pointers to... However, the graphic representation clears it up immediately.

This is, of course, only a brief overview of the things that Multiscope can do. It's arranged so that all these windows are PM windows, so you can arrange them as you like or collapse any of them to icons. Oh, and I almost forgot, you can use Multiscope as a PM debugger. PM is tough to write code for. The essence of PM is the user interface, so it kind of ruins the effect while developing if half the screen contains debugging information.

Facing a similar problem in the Mac world, Apple originally counseled developers to buy two Macs for development—one to run the program, the other to display the debugging information. It sounds goofy, but it's the fastest way to develop GUI-type code.

Windows has a feature wherein you can shoot debugging information out the serial port to a dumb terminal or a PC behaving like a dumb terminal, a great help to Windows developers. Now you can't do that for PM, unfortunately, but Logitech does the next best thing: Just run a null modem cable between two PM machines, and the second becomes the debugger. The first is, of course, the debuggee. (I couldn't resist.) That's my biggest gripe with Multiscope. Why not just send out simple line-oriented asynchronous messages? That way, the otherwise-useless PCs that are lying around an OS/2 developer's shop could earn their keep as recipients of debugging information. Please, Logitech—it's a nice product now, but you could make it a killer.

continued

ITEMS DISCUSSED

Designer 2.0\$695
Micrografix, Inc.
1303 East Arapaho
Richardson, TX 75081
(214) 234-1769
Inquiry 1021.

GML/PC\$995
Command Technology Corp.
1900 Mountain Blvd.
Oakland, CA 94611
(415) 339-3530
Inquiry 1022.

Multiscope\$395
Logitech International SA
6505 Kaiser Dr.
Fremont, CA 94555
(415) 795-8500
Inquiry 1023.

WordPerfect 5.0\$495
WordPerfect Corp.
1555 North Technology Way
Orem, UT 84057
(801) 225-5000
Inquiry 1024.

You know
exactly what
your company
wants in a
color printer.

OS/2 and ~~or~~ DOS? MultiBoot is the answer.

BYTE May 1989

MultiBoot Brings OS/2 Back to Earth

Bolt Systems has come to the rescue with a program called **MultiBoot**, which does away with the dual-boot problem for good.

MultiBoot is simple, inexpensive, and foolproof, and it works flawlessly. It's a good example of a utility that fills a much-needed niche.

—Stan Miastkowski

OS/2 NOTEBOOK

Once you've spent thousands of dollars on OS/2 and an OS/2-ready work station, what's another \$49.95 to have easy access to DOS? Highly recommended.

—Mark Minasi

Not all DOS programs work in the OS/2 compatibility box. **MultiBoot** lets you install both systems in your computer. **MultiBoot** works with DOS versions 3.0-4.01 up. And OS/2 versions 1.0 and 1.1.

TO ORDER:

Send \$49.95* + \$3.00 shipping and handling (check or money order) to:

MultiBoot, Bolt Systems, Inc.
4340 East-West Highway
Bethesda, Maryland 20814
or call 1-301-656-7133

FAX: 1-301-907-8736 to order by Visa/Mastercard. Specify 3.5" or 5.25" diskettes.

*Maryland residents add 5% sales tax.
Ask about our volume discounts

A Product of **BOLT** Systems Inc.

Other OS/2 Applications

Mark Mackaman of Microsoft told the audience at the "OS/2 Update" session that there are currently 850 announced OS/2 applications, 370 of which are shipping now ("now," recall, is mid-April). The audience chuckled when he then announced that "three of these are even PM applications."

WordPerfect Corp. showed its character-based implementation of WordPerfect 5.0 under OS/2. It seems to have all the features of the DOS version, including the ability to seemingly talk to all graphics formats possible.

Micrografx again showed beta copies of Designer 2.0 under PM. Designer is the application that you show your Mac-using friends when they start talking about all the neat things that they can do with their machines and MacPaint that you can't do with the PC.

I'm not really the person to comment on the power of Designer, because I use it to draw fairly simple pictures. But I'm happy with it, and even happier with version 2.0 under DOS. (I'll report on the OS/2 version as soon as I can get a copy of it.) Probably the neatest thing is an auto-outline feature that reads in a scanned TIFF file and converts it to a line drawing.

Desktop Publishing

I have said in earlier columns that the first big class of OS/2 applications to come along would be databases, and that certainly has come true: Just about any database vendor that you care to name has an OS/2 implementation (save Ashton-Tate, and it won't be far behind). But I never guessed that the second class would be, of all things, desktop publishing systems. It's a reasonable fit in hindsight: Desktop publishing needs a graphics platform and gobs of memory, so it and the PM are a natural match.

I have mentioned in passing a desktop publishing system that I've been using since December, one that I'm happy with. However, I've been a might remiss in naming names.

Command Technology Corp. has for years marketed a PC implementation of a mainframe document-preparation language called Script or GML (General Markup Language). It originally interested me because it *does not* come with an editor and can use about any editor that can write ASCII text files. This means that I can generate documents that are useful in both the mainframe environments of my clients and the PC environment of my company.

It's fast and very powerful. It contains

a sophisticated macro language, so you can make it do almost anything that you need it to do. It reads Designer or PC Paintbrush files and can be coerced to use a host of others. The package, called GML/PC, is a character-mode application, because it is not WYSIWYG except for a VGA preview feature that I find to be a bit slow and tend not to use. It is shipped with a DOS version, an OS/2 version, and a 32-bit DOS-extender version for 80386 machines.

CTC was the first, but it's not alone. Lennane Advanced Products showed a fairly stable desktop publishing system called DeScribe that it will ship in the third quarter of this year, which is Comdex for at the end of September. It is an integrated package, but it will write out GML text if asked, so I intend to use it as a preview-and-edit package in combination with GML/PC. The editor is a WYSIWYG-type editor with the Choice Words spelling checker built into it.

Xerox was showing Ventura Publisher 2.0 for PM, and everyone selling a version of PM was using a beta Aldus PageMaker as a demonstration application. Xerox says it will ship Ventura Publisher at the end of the year, but it may be out by the end of September. As soon as I can get hold of these packages, I'll compare them in this column.

These packages (except for GML/PC) will be in dire straits, however, if some printer drivers don't show up pretty soon. There was a lot of talk about a PostScript driver coming soon and some talk of a LaserJet-compatible Printer Command Language driver by Christmas, although the PCL driver would not support graphics in its early versions. Strangely enough, the Hewlett-Packard people that I talked to believed that it wasn't HP's responsibility to develop the drivers, saying that it was up to Microsoft and IBM. That's an unfortunate attitude, particularly if it means that we're going to be waiting until the middle of 1990 for graphics drivers for our LaserJets. Perhaps Microsoft and IBM will get the drivers out, or perhaps a third party will (hint, hint) see the enormous amount of money to be made writing a good PM driver for PCL. ■

Mark Minasi is a managing partner at Moulton, Minasi & Company, a Columbia, Maryland, firm specializing in technical seminars. He can be reached on BIX as "mjminasi."

Your questions and comments are welcome. Write to: Editor, BYTE, One Phoenix Mill Lane, Peterborough, NH 03458.

Monet, not money.



The HP
PaintJet.
\$1395*

HEWLETT
PACKARD PaintJet

Who says fine art is out of reach? The HP PaintJet color printer produces brilliant color for a price any business can afford.

So now there's no limit to what you can create



with your business communications. Surprise your audience with thousands of colors. Beamed up on an overhead. Or tucked neatly into a report. Persuading people up to 85% more effectively than black and white.

The PaintJet works with all your favorite graphics, presentation, spreadsheet and word processing software. Just hook it up to your IBM-compatible or Macintosh computer and start painting.

For only \$1395 (add \$125 for the Macintosh interface).

Call **1-800-752-0900 Ext. 711K** for your nearest authorized HP dealer and a free sample output. The HP PaintJet. It's what artists are starving for.

There is a better way.

 **HEWLETT
PACKARD**

Circle 114 on Reader Service Card



Our Printer Sharing Unit Does Networking!

An Integrated Solution

Take our **Master Switch™**, a sophisticated sharing device, combine it with **MasterNet™** networking software for PCs, and you've got an integrated solution for printer and plotter sharing, file transfer, electronic mail, and a lot more. Of course you can also share modems, minis, and mainframes or access the network remotely. Installation and operation is very simple.

Versatile

Or you can use the Master Switch to link any computer or peripheral with a serial or parallel interface. The switch accepts over 20 commands for controlling the flow of data. It may be operated automatically, by command, or with interactive menus. Its buffer is expandable to one megabyte and holds up to 64 simultaneous jobs. The

MasterLink™ utility diskette for PCs comes with every unit and unleashes the power of the switch with its memory-resident access to the commands and menus.

Other Products

We have a full line of connectivity solutions. If you just want printer sharing, we've got

it. We also have automatic switches, code-activated switches, buffers, converters, cables, protocol converters, multiplexers, line drivers, and other products.

Commitment to Excellence

At Rose Electronics, we're not satisfied until you're satisfied. That's why we have thousands of customers around the world including large, medium, and small businesses, factories, stores, educational institutions, and Federal, state, and local governments. We back our products with full technical support, a one-year warranty, and a thirty-day money-back guarantee.



**ROSE
ELECTRONICS**

**Call now for literature or
more information.
(800) 333-9343**

Give a Rose to your computer



GROWING PAINS

The LAN operating system you choose can spell the difference between control and chaos as your network expands

Network operating systems are made up of many elements that must work together. But when you're planning for future network growth, the architecture of two components—the LAN's administrative controls and network object identity—are crucial.

The design of network operating systems rests on a few fundamentally different theoretical premises that affect their ease of use and adaptability to outside connection. While many other characteristics affect network growth, administrative controls and network object identity are so fundamental that they're easy to overlook when you're facing the plethora of detail streaming from vendors' advertising or engineering departments.

Maintaining Control

Control refers to the largest possible unit of a network that you can configure with respect to network resources. The larger the unit that you can configure, the larger the network can grow without becoming unmanageable. There are three levels of control: workstation, server, and network.

At a minimum, a network must provide for control on a workstation-by-workstation basis. If all the control possible under the network operating system is vested solely in the workstations, then you can place the information regarding user names, rights, files, pathways, and

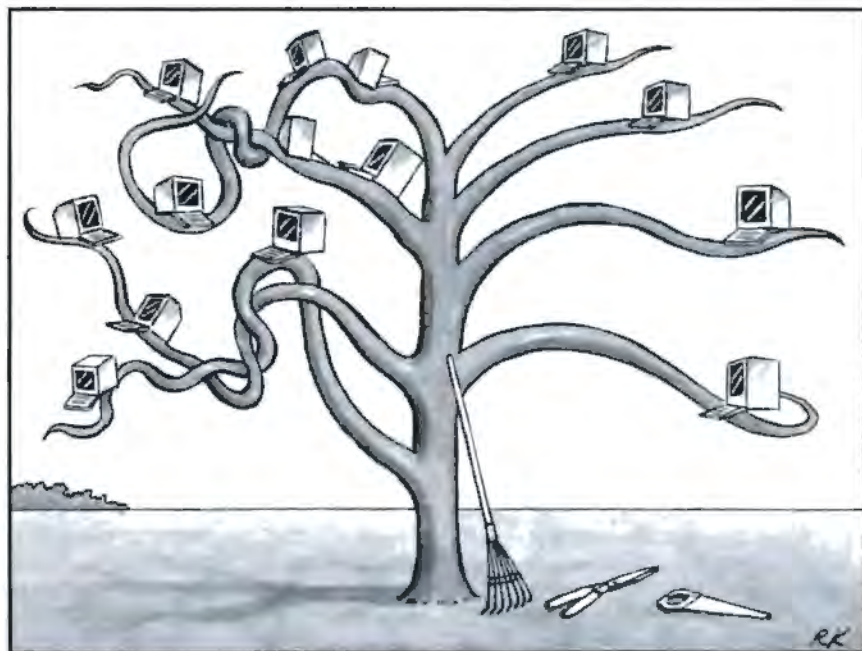

security only within each workstation, and the ability to change this configuration is generally open to all or most users of the system as they log on at any given workstation. The system administrator must make system configuration changes by going to all workstations that are to have shared resources and changing the necessary pathways, ports, and so forth. The original version of the IBM PC LAN Program is an example of a network operating system that uses workstation-level control.

A network configuration is server-controlled when servers on the network store information regarding user names, rights, files, pathways, and security, and the ability to change this configuration is restricted to those administrators and users who are defined as having this right of control. In this model, a change in network configuration often requires a visit to every server in the network or, at the least, remote log-on as the supervisor of each server to make the changes at each

server. Novell's NetWare 286 is a good example of a network operating system that uses server-based control.

In the third category of control, overall network administration, the network software recognizes the network as a whole, and a single user can administer the network from a single point. The network administrator has control over the entire network configuration, regardless of the number of servers and workstations or their location. 3Com's 3+Open, Banyan's VINES, and Torus's Tapestry II all support network-level control.

Another name for network control is domain management. Usually, one computer on the network, designated as the domain manager, stores the overall configuration, identity of objects (using the naming conventions that are discussed later), and information on resources outside the boundaries of the domain to provide transparent communication to other domains. You can construct a domain

continued

based on physical boundaries, or you can establish it using logical groups of users, independent of the network's physical layout. The domain concept is most common in large, multiserver LANs.

Pathways vs. Names

Identity speaks to the means by which the network identifies objects. An object is any entity that the network needs to identify. Workstations, printers, and servers are objects, but so are somewhat more abstract items, such as users and administrators, directories, files, and the configuration of the network itself. LAN operating systems maintain the identity of objects via a pathway or a name.

A network configuration maintains identity of objects within it by pathway if access to a given object from any other object requires a statement of the paths, routes, trees, or other structures that the network operating system must traverse to find the object sought. This is the traditional means of describing objects in computing systems based on terminal and host structures. A typical network using pathway identity might describe an item of information as Server1\SYS:Root\Apps\Spsht\Lotus\123. Novell's NetWare 286 uses pathway identity techniques.

Pathway identity schemes are acceptable in smaller environments when the network configuration doesn't change very often. However, in large, multiserver LANs, or even in small LANs where user moves and changes are frequent, this technique becomes inefficient.

Ancient peoples believed that knowledge of a name gave one power. In a similar fashion, naming conventions in computer networks give users power. A network maintains the identity of objects within it by name if access to a given object from any other object requires only that the user state the name of the object

Relative naming lets you create similar names but distinguishes between them by relating each one to something else.

sought. This technique provides the most power in distributed computer networks. Several methods may be used to name the objects that the network must manipulate.

Absolute naming provides a unique name for each object across the entire network and all networks to which it is attached. Just as, in the case of social security, no two people have the same number, so here, no two objects have the same name. And unlike pathway identities, the name remains the same wherever

er the person goes.

Relative naming lets you create similar names but distinguishes between them by relating each one to something else. For example, there are many people named John Smith, but relating the name to a street address and a city provides a relative description that removes the ambiguity.

The absolute convention encourages centralization and is the form often found in traditional data-processing environments. The relative convention encourages decentralization but requires a system that will look up the names in their relative context.

Hierarchical naming adds a layer of structure to naming. It lets you embed both absolute and relative naming functions. You can add more levels of hierarchical naming if needed. The telephone system is a good example of hierarchical naming. Each locale has telephone exchanges and numbers. At the regional level, there are area codes. Finally, international calling adds country codes. This illustration demonstrates the utility of hierarchical naming for combining networks.

For a naming system of any size to work, there must be some device or set of devices that contain the names and provide appropriate mappings with objects. At the Xerox Palo Alto Research Center (PARC), which conducted pioneering research that established the basis of distributed processing, such a device is called a *clearinghouse*.

Names consist of three parts: local *continued*



AUREX

The Best Diskette to Pass Data on to Future Generations.

Aurex Computer diskettes have the highest clipping level in the market, which represents unique advantages for you that no other brand can offer:

- Absolute compatibility when information was recorded on different drives.
- The use of diskettes with higher clipping level translates in less computer retries to find the desired information, which represents a substantial saving in valuable time (that means profits to you).

Also available in bulk

P. O. BOX 337 V.P. Orange County CA 92667 USA

TWO POWERFUL

TWO ATs on ONE card!

The QL 2286 board features TWO 80286 AT business workstations on ONE AT add-in card. Plug one or more QL2286s into your Compaq or IBM AT's bus and create an instant closely-coupled network!

TWICE THE POWER FOR HALF THE PRICE!

QL 2286 features TWO 80286 processors with full EGA/CGA colour support and up to TWO MB RAM per user, for about the price of ONE standalone AT. Word processors, spreadsheets and thousands of Novell multiuser applications operate with lightning speed.

JUST PLUG IT IN!

Plug the QL 2286 into your fileserver's bus, connect a low profile, noiseless peripheral box to the board, attach your monitor, printer and mouse, load NetWare or ELS (or Network-OS), and your installation is complete! No need for hubs, controllers, transceivers or complicated wiring schemes.

ULTIMATE NETWORK SPEED!

Network transfer is at AT bus speeds — that's as fast as you can go — which makes QL 2286 ideal for processing disk intensive database applications. Data travels much faster on the bus than on controller based topologies that require inefficient protocols, serial data paths and expensive controllers.

NETWORKING AT ITS BEST!

QL 2286 boasts an unsurpassed state of the art design that allows you to maximize performance and minimize cost.



QL 2286 supports TWO independent users

Each user has:

- 80286 AT processor
- 80287 math coprocessor (optional)
- 1 MB RAM (with expansion to 2 MB)
- EGA/CGA video card
- Keyboard, Monitor, and Mouse or printer support
- COM 1 Port
- COM 2 Port supported
- Parallel Port supported
- Multisync colour monitor support



Put QL 2286 in your LAN plan and be TWO POWERFUL TOO!

Network-OS is a trademark of CBIS, Inc.
Compaq 386 is a trademark of Compaq, Inc.
IBM AT is the trademark of International Business Machines.
Novell NetWare is the trademark of Novell, Inc.

Call 1-800-648-2130 to order.

 CUBIX
CORPORATION

Cubix Corporate Offices • 2800 Lockheed Way, Carson City, Nevada 89706 • Tel (702) 883-7611 • Fax (702) 882-2407
Europe • Unit 4 Colonial Business Park, Watford, Hertfordshire, WD2 4PR, England • Tel (44) 923 51150 • Fax (44) 923 37021

Circle 73 on Reader Service Card (DEALERS: 74)

AUGUST 1989 • BYTE 137

name, domain, and organization. With just this three-part name, users can identify and locate any object in any network. The syntax generally looks like this: localname@domain@organization.

You could identify a user in such a network as JohnSmith@Marketing@Greater Tuna, Inc. He could have alias names such as John and JS. The administrator might refer to a physical resource as Laserprinter@Marketing@Greater Tuna, Inc. And information might be designated as Budget1988@Marketing@Greater Tuna, Inc.

The mechanical process involves establishing a clearinghouse, usually called a name server. This is simply a server running a database that relates the name with the pathway to find the object. Thus, any reconfiguration, which involves moving objects around, need only change the one reference in the name service at the name server.

Contrast this with an identification technique based only on the pathway. In such a system, a reconfiguration would have to seek out every reference to the now-changed pathway and alter it—good luck in a network with hundreds of work-

stations, users, and servers. Banyan's VINES and 3Com's 3+ both use three-part naming techniques. Torus bases its product on icons associated with objects through a library service; this is analogous to the name/clearinghouse concept.

Strengths, Weaknesses, and Changes

A network operating system based only on workstation control simply can't provide the management and consistency of configuration that are needed to provide a stable network environment for more than a handful of workstations. Although the original IBM PC LAN Program has this limitation, version 1.3 of PC LAN Program and the newly emerging LAN Server, IBM's OS/2 LAN Manager-based network operating system, use what IBM calls Domain Management to achieve network control. The new system also has a name identity technique.

A network operating system based on server control provides an excellent single-server network, but the need to administer several servers becomes an overwhelming headache. Novell is aware

of this limitation in NetWare, as well as similar difficulties that arise from NetWare's lack of a name service. This problem arose historically because NetWare's designers conceived of PC LANs as single-server systems much like minicomputers; they never anticipated the advent of larger multiserver networks that need easy, flexible control and identity methods.

NetWare is an elaborate product based on proprietary coding down to the machine code level; total redesign will take time. Eventual upgrades to NetWare should provide network-level control and name identity.

Network control gives the best possible environment for growth. A networked system may start with only one server and grow to tens or possibly hundreds, assuming that there is a consistent method of control. The added protection and power of machines based on the Intel 80386, Motorola 68030, Sun SPARC, and others will provide complex combined workstation/server systems that challenge even the best designs. Combine this with a name service, and administration is eased substantially. Both Banyan and 3Com historically benefited from their designers' early involvement in the initial research for such networks at Xerox PARC.

There is, however, one serious problem that still lies within name service-based systems (and within systems that are dependent on a single physical device for overall management): What happens if the name service (or the domain management device) fails? 3Com implements the name service in a single server; loss of that server leads to loss of the entire network. Most large 3Com installations maintain a "hot spare" for the name server. Banyan distributes the name service over several servers, but the service isn't redundant; loss of any server loses a portion of the name service. The final solution for large systems is a totally redundant name service and domain management service. Providing these capabilities will be the next major push in the LAN operating-system market. ■

James Y. Bryce is an independent network consultant and author living in Austin, Texas. He is the author of the forthcoming Networking Personal Computers: The Total Context (New York: Van Nostrand Reinhold). You can reach him on BIX c/o "editors."

Your questions and comments are welcome. Write to: Editor, BYTE, One Phoenix Mill Lane, Peterborough, NH 03458.

Definitions on disk

Choice Words gives you instant access to 80,000 dictionary definitions plus more than 470,000 synonyms from Merriam-Webster—the English language authority.

The dictionary contains definitions, usage notes and hyphenation points. The thesaurus contains synonyms, meanings for each synonym group and properly inflects all responses.

Choice Words works with over 35 word processors on IBM-PC compatibles running MS-DOS and is available on either 5¼" or 3½" disks. Your system must contain a hard disk and at least 100K of free memory.

Whether you're writing, reading, or simply want to explore the English language in a new and exciting way, Choice Words is for you.



CHOICE WORDS™

\$99



See your dealer, or order directly by calling 1-800-323-0023, (305) 566-3511 in FL) Dealers: Order Choice Words from Micro-D

PROXIMITY

Intelligence You Can Use™
3511 N.E. 22nd Avenue
Fort Lauderdale, FL 33308

SOME COMPANIES MAKE ALL THE RIGHT CONNECTIONS.



THEY CONNECT WITH 16-BIT ARCNET® CARDS.

Face it. Some companies are better connected than others. Success often depends on who can deliver. Successful businesses are turning to Thomas-Conrad for reliable ARCNET networking products.

- **GET 12 HOURS OF WORK IN AN 8 HOUR DAY.** Our 16-bit interface gives you up to a 50% increase in network throughput.
- **COAX, TWISTED-PAIR, FIBER OPTICS** – Whatever you want to work with, we work with.
- **DELIVERABLE HARDWARE** – While others are talking, Thomas-Conrad is shipping.

To find out how you can connect with ARCNET products that have the networking world talking, call Thomas-Conrad today.

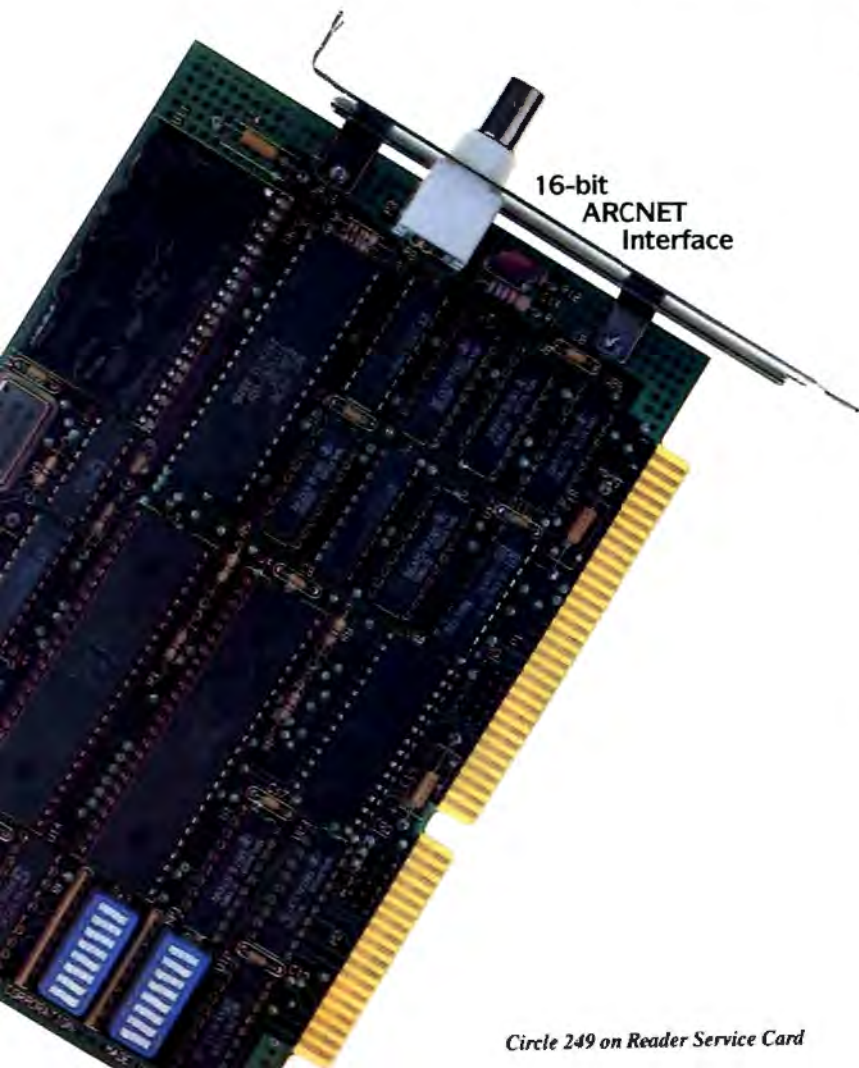

THOMAS • CONRAD
CORPORATION

800-332-8683

1908-R Kramer Lane
Austin, Texas 78758, (512) 836-1935

Circle 249 on Reader Service Card

Arcnet is a registered trademark of Datapoint Corporation.

Benefit from breakthrough and experience

Complete* 12, 16, 20, 25 and 33 MHZ Systems with

SIVA Systems from VNS America Corp. delivers the uncompromising power you want, plus the hardware/software products you need. Promptly. Courteously.

Enjoy the IBM®-compatibility, speed and future upgradeability you would expect from up-to-date premium quality computers. And, enjoy the price savings and fast service so many have come to appreciate from VNS America Corp.

About VNS America Corp.

VNS America Corp. and its associate companies pool their expertise and buying power to bring you premium, name brand products at breakthrough prices.

We're bold, colorful and innovative. We have to be to gain your attention in this ultra-competitive industry. But, our products and service are first rate because we need your confidence to succeed.

IBM set the standard... we're just making it affordable to thousands of companies and individuals that want the best quality at the best prices.

TRY US
Call 1-800-444-SIVA

VNS America Corp.

Suite 270, 910 Boston Post Road
Marlboro, Massachusetts 01752 U.S.A.
In Massachusetts 508-481-3726
FAX: 508-481-2218

The Powerful SIVA 386 System

Standard 386 Features:

- 32-bit Intel 80386-16 CPU.
- 1MB of 32-bit RAM on board. System expandable to 16MB.
- 16/20 MHZ Keyboard selectable.
- ST-251-1 Seagate 40MB Formatted 28 ms high speed, with ultra high speed Controller 1:1 interleave.
- 1.2MB High Capacity Floppy Drive.
- Super deluxe heavy duty tower case with 5 half-height drive openings.
- High-resolution 12" Non-Glare Amber Display. Tilt and Swivel base, Hercules-compatible Adapter.
- EGA Controller Standard.
- 101 Key Enhanced Keyboard, Pleasant "Tactile-Click" Feel.
- 80287/387 Math-Coprocessors optional.
- Fully compatible with virtually all XT/AT and 386 software.

\$1995.

Upgrades for your 386 System:

- VGA Color Upgrade — add only \$495.
- EGA Upgrade — add only \$295.
- 20 MHZ CPU Upgrade — add only \$195.
- Call for all other options and upgrades.



pricing from VNS America™ unmatched performance!

Premium Name Brand Peripherals and Software!



The Economical SIVA 286

A Complete 12 MHZ High-Speed SIVA 286 System
with 40MB (28MS-ST251-1) Hard Disk

Complete System Features:

- 80286 CPU, 8/12 MHZ Dual Speed, Keyboard Selectable
- High-Speed RAM, 512K Expandable to 4MB on the Motherboard (16MB System Total)
- Phoenix BIOS
- 40MB Hard Drive, 1.2MB Floppy Drive
- Ultra High-Speed Floppy, Hard Disk Controller 1:1 Interleave, 800KB/Sec Transfer Rate
- High Resolution 12" Amber Display with Tilt and Swivel Base, Compatible Graphics Controller
- Full 101-Key Enhanced Keyboard, Pleasant Tactile-Click Feel
- Two Serial and One Parallel Printer Ports and One Mouse Port (IBM PS/2 Compatible)
 - 3-16 Bit and 1-8 Bit Free Expansion Slots
 - Clock Calendar with Off-Board Battery Backup
 - 80287 Support, up to 10 MHZ
 - Meets FCC Requirements

\$1295.

Standard System without Hard Disk \$995

Lowest Cost Upgrades

- Additional 512K Memory... \$195.
- Additional 1.5MB Memory... \$395.
- EGA Upgrade... \$295.

Five Additional Reasons to Call VNS America Now...

- Produced by High Technology Manufacturing Processes
- Supports 3.5" and 5.25" Floppy Disks
- Phoenix BIOS
- Same Day Shipment
- 100%-Compatible with Your Budget

*Complete: includes 12 MHz high-speed SIVA 286 System with 40 MB hard disk drive, monitor and keyboard.

**VNS America is a trademark of VNS America Corp.

VNS America Corp.

Circle 267 on Reader Service Card

Call 8:30 to 9:00 EST Mon.-Fri.
8:30 to 5:00 EST Sat.

Order Now Toll-Free
1-800-444-SIVA

*Complete unit includes CPU, monitor, keyboard and 40 MB hard disk drive.



Desktop Power to Go

The BYTE Lab sizes up 11 of the best 80386 portables

Stanford Diehl
and Stan Wszola

In the past, when you grabbed your portable computer and hit the road, you left a lot behind in your desktop computer. Portability was inversely proportional to computing power. That's not the case anymore. Modern portables offer fast CPUs, plenty of RAM, big hard disk drives, and enough options for almost any computing situation.

The new line of portable powerhouses blurs yet another distinction in the evolving computer world. You no longer need to choose between portable convenience and desktop power; today's portables deliver both. Even the distinction between portables and workstations is fading. Designers keep packing more features and firepower into an ever-shrinking shell.

Portable computer vendors have devised many variations on a common theme. This month, we'll look at 11 of the most powerful computers currently available: the Compaq Portable 386 Model 40, the Dolch-P.A.C. 386-25, the GRiDCase 1530 and 1535 EXP, the IBM PS/2 Model P70 386, the Micro Express Regal II, the NEC PowerMate Portable SX and ProSpeed 386, the Toshiba T5100 and T5200, and the Zenith TurbosPort 386. Each machine offers a unique combination of computing power and portable convenience (see table 1).

No More Trade-Offs

Since the very first portable computer appeared, buyers have always had to

weigh the importance of small size and weight versus computing power. If you wanted a powerful computer, you had to accept bulk. Lightweight portables usually lacked power.

But an amazing evolution has occurred in portable computers. By means of smaller components, better batteries, and VLSI surface-mount technology, today's portables squeeze more computer into smaller packages. For example, one of the first portable computers, the Osborne 1, weighed 23½ pounds. It was a CP/M system with 64K bytes of RAM, a CRT display, and dual floppy disk drives. Today's portables pack 1 or more megabytes of RAM, up to 170 megabytes of hard disk drive storage, high-resolution displays, and your choice of DOS, OS/2, or Unix into even smaller and lighter packages.

Even though these new computers are lighter, ranging from 12½ pounds for the GRiDCase 1535 EXP with its magnesium case to the Micro Express Regal II at a hefty 22½ pounds, most people don't carry a "naked" computer. Add the weight of a carrying case, an AC power supply, a spare battery, a modem, blank floppy disks, and assorted hardware and software manuals, and you have enough weight to make a business trip an endurance contest. The Traveling Weight column in table 1, which is the sum of the weights of the computer, the case, and essential accessories, is our idea of a more realistic weight.

Most portable machines fall into two design groups: the large lunch box (e.g., the Compaq and IBM) or the clamshell (e.g., the Toshibas and the Zenith). With its detachable keyboard, the lunch box style works best on a desktop, while the clamshell models can sit on your lap. In terms of functionality, both designs can get the job done.

Power for the Road

For those portables that use batteries, the power source of choice is the nickel-cad-

mium cell. It provides a relatively steady voltage per charge, and it recharges easily. One disadvantage, however, is that it can develop a "charge memory." Repeated recharging when a battery is only partially discharged can render a nickel-cadmium battery pack incapable of being fully charged. Most portable manufacturers recommend that you discharge the batteries as much as possible before recharging.

Most portables can run on internal batteries for 2 to 3 hours, depending on the size of the battery pack. The Zenith TurbosPort 386 extends battery life through a built-in monitor program. This ROM-based program lets you enter the number of seconds that the hard disk drive runs after the last disk access and the amount of time that the LCD backlight remains on if there is no keyboard activity. The monitor program will power down these sections of the computer to conserve battery power.

Picture This

Displays for high-end portables fall into two groups: LCD or gas-plasma/electroluminescent (ELDs). The photo on page 144 shows a sample of both.

LCD screens are popular because of their light weight and low power requirements. An LCD is a reflective screen; the individual pixels in the screen work like a set of light shutters. They control whether light is absorbed (producing a dark spot on the display) or whether light is reflected (producing a light spot). Unfortunately, the LCD scheme lacks sharp contrast between the dark spots (text and graphics) and the lighter background. This caused serious problems with early LCD screens. You needed good ambient illumination for comfortable viewing. Portable designers have overcome that problem by using fluorescent backlighting for their LCD screens. The backlighting increases the apparent contrast between the text and the background

continued



Table 1: 80386 portable features and conventional benchmark results. For the Livermore Loops and Dhrystone tests only, higher numbers mean faster performance. LINPACK and Livermore Loops benchmarks are in seconds; Dhrystone benchmarks are in Dhrystones per second. Prices are for base models not including options. The weight for each portable includes the battery or AC power adapter. The Traveling Weight includes the optional case, battery and/or AC adapter, power cord, modem cord, external monitor cable, and four floppy disks. For a full description of all the benchmarks, see "Introducing the New BYTE Benchmarks," June 1988 BYTE.

Model	Price	CPU speed (MHz)	Conventional benchmarks			Display/mode	Memory (Mb) Std./Max.	Floppy disk drive ¹
			LINPACK	Livermore	Dhrystone			
Compaq Portable 386 Model 40	\$7999	20	182.80	0.0688	5117	Gas-plasma/CGA	1/2	5¼-inch
Dolch-P.A.C. 386-25	\$9495	25	155.55	0.0797	6410	ELD/CGA	4/8	5¼-inch
GRiDCase 1530	\$4695	12.5	445.66	0.0217	2955	Backlit LCD/CGA, gas-plasma/CGA opt.	1/8	3½-inch
GRiDCase 1535 EXP	\$6995	12.5	448.08	0.0219	2956	Backlit LCD/CGA, gas-plasma/CGA opt.	1/8	3½-inch
IBM PS/2 Model P70 386	\$7695	20	196.58	0.0577	4975	Gas-plasma/VGA	4/8	3½-inch
Micro Express Regal II	\$2999	20	177.57	0.0662	6410	Gas-plasma/EGA	1/2	5¼-inch
NEC PowerMate Portable SX	\$6595	16	508.50	0.0240	1813	Gas-plasma/VGA	2/10	3½-inch
NEC ProSpeed 386	\$7699	16	242.60	0.0526	4009	Backlit LCD/VGA	2/10	3½-inch
Toshiba T5100	\$7199	16	238.27	0.0525	4081	Gas-plasma/EGA	2/4	3½-inch
Toshiba T5200	\$9499	20	149.10	0.0790	6459	Gas-plasma/VGA	2/8	3½-inch
Zenith TurbosPort 386	\$7999	12	313.00	0.0363	3448	Backlit LCD/CGA	2/3	3½-inch

¹5¼-inch floppy disk drive = 1.2-megabyte; 3½-inch floppy disk drive = 1.44-megabyte
²NC = Nickel-cadmium
 N/A = Not available

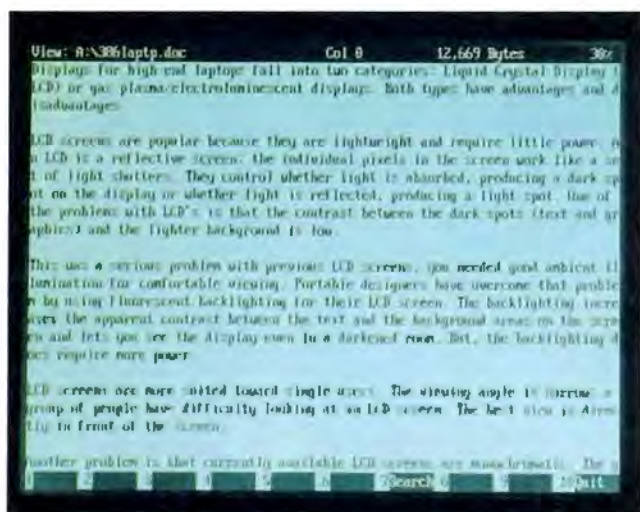

Portable computer screen displays. A sample of the two principal technologies: the Toshiba T5200 gas-plasma display (left) and the Zenith TurbosPort backlit LCD (right).

areas on the screen and lets you see the display even in a darkened room. But the backlighting requires more power.

LCD screens are more suited to single users. Since the viewing angle is narrow, a group of people have difficulty looking at an LCD display. The best view is from

directly in front of the screen.

Another problem is that currently available LCD screens are monochromatic. The gray scale available on an LCD is very limited. When you run software that depends on a color display, the display circuitry must resort to color

mapping to present different colors as contrasting graphics patterns. Color LCD screens have arrived (e.g., on the Sharp PC-8000), but they are not yet widely available.

LCD screens are also slower than gas-plasma or CRT displays. The individual

Hard disk drive (Mb)	Battery	Size (inches)	Weight (pounds)	Traveling weight (pounds)	Notes
40 or 100	None	16×9.8×7.8	21.9	25.6	
40, 80, or 100	None	16.25×10.25×8.5	20.6	25.2	
20, 40, or 100	NC ²	11.5×15×2.3	12.7	17.1	Magnesium case
40	NC ²	11.5×15.1×2.5	12.5	16.8	Magnesium case
60 or 120	None	18.3×12×5	21.7	25.9	PS/2-compatible
40	None	16.25×10.25×8.5	22.8	27.5	Four months on-site service
42	None	15.5×11.3×7.75	21.9	25.8	
40 or 100	NC ²	15.35×3.94×15.5	22.5 (w/batt.)	27.7	Bundled with VM/386
40 or 100	None	12.2×14.2×3.5	14.6	N/A	Bundled with Windows/386
40 or 100	None	14.6×15.6×3.9	18.7	N/A	82385 cache controller; 32K-byte static RAM cache
40	NC ²	13.25×4.75×14.75	18.7	24.1	Intelligent Power Manager

pixels in LCDs are electrochemical devices that require an appreciable fraction of a second to turn on or off. They are not ideal for use with animated graphics software or games.

Gas-plasma displays and ELDs are attractive for portable computers. These screens offer high contrast, a wide viewing angle, and good speed. You pay more for these features, and both types of displays require more power compared to LCDs.

Gas-plasma displays are composed of a pair of glass plates. The inside of one of the plates is coated with a horizontal set of transparent electrodes, while the other plate has vertical electrodes, thus forming a grid. Neon gas floats between the plates. When a high voltage is applied to the electrodes, the neon gas located at the intersection of any electrodes in the grid is ionized and becomes a glowing plasma. These glowing points of neon plasma produce the illuminated pixels on the screen.

ELDs are similar to gas-plasma displays, but instead of a gas they use a dielectric thin-film sandwich that contains a layer of manganese-doped zinc sulfide that fluoresces in the presence of AC

voltage. ELDs use slightly less power and are more rugged than gas-plasma displays, but they cost more to manufacture.

Both gas-plasma and ELD screens share a problem with LCDs: a limited gray-scale display. They, too, must resort to color mapping to represent colors. In addition, both types of displays have a yellow or reddish-orange color that might not appeal to some users.

For those accustomed to high-resolution desktop displays, using a portable might be a disappointment. The graphics adapter circuitry in these machines ranges from double-scan CGA (640 by 400 pixels) to VGA. CGA on a monochrome screen is only adequate for most users. The Toshiba T5200, both NEC models, and the IBM PS/2 Model P70 386 employ VGA graphics circuitry for good screen displays.

External monitor ports, which are available on several of the portables that we reviewed, offer an easy upgrade for desktop use. An external CRT monitor has much better contrast than LCD, gas-plasma, and ELD screens, and, with color monitors, you can use color-based software.

Keyboard Quirks

When it comes to keyboards, a portable computer designer's imagination runs rampant. Nearly every keyboard has a unique layout. Cursor-control keys, numeric keys, and programmable function keys (F1 through F12) can all be "redistributed" on the keyboard.

Because of space limitations, many keyboards are "compressed." Accessing some keys requires holding down a function key before pressing another key. For example, the numeric keypad can be embedded in the alphabetic keys, and some control keys might have double, or even triple, functions. Certain keystroke combinations that are used in word processing programs or program editors might increase in complexity and become awkward. A Ctrl-Shift-F5 might turn into a Function-Ctrl-Shift-F5. Before you select any portable, consider the software you're likely to use and how it will function on a particular computer.

A notable exception to the rule of compression is the IBM PS/2 Model P70 386. Its keyboard adheres to IBM's standard. It has separate numeric and cursor-control keypads, and it also has a mouse port. Users of PS/2 desktop machines can switch easily to the P70.

Some portables, such as the Dolch-P.A.C., the GRiDCases, and the Micro Express Regal II, support a full-size IBM PC-compatible keyboard through an external keyboard port. Another popular option offered by some portable manufacturers is an auxiliary numeric keypad to ease intensive math data entry.

Our best advice to you is to try the keyboard before you buy a portable computer. A fast 80386 CPU is no advantage when your fingers are constantly lost on the keyboard.

Megabytes to Go

The data storage options for portables can cover almost anything you want. You can have your choice of floppy disk drives: 360K-byte or 1.2-megabyte 5¼-inch drives; 720K-byte or 1.44-megabyte 3½-inch drives; and—soon to be available—the 720K-byte 2-inch microfloppy disk drive.

When it comes to hard disk drives, the choices are even more impressive. Hard disk drives in portables range from a pedestrian 10 megabytes to a staggering 170 megabytes as an option for the Dolch-P.A.C. The sizes vary from the standard 5¼-inch size to the 3½-inch units and down to the recently announced 2½-inch hard disk drives.

Most portable hard disk drives are
continued

specifically designed for portable use; some can withstand up to 75 g's of shock. Some portables (e.g., the Toshiba and the Compaq) have special hard disk drive mounts to minimize shocks.

Traveling Options

It used to be that when you bought a portable computer, you were stuck with what you got. Some machines had sockets for more RAM, but that was it for expandability. That's not the case now. Many portables have either proprietary or PC-compatible expansion slots. Peripherals and options are widely available from portable manufacturers and third-party suppliers. Toshiba offers a variety of external floppy disk drives, plus memory and modem options that will fit in the T5100 and T5200's proprietary slots.

Third-party manufacturers, such as the Megahertz Corp., offer a variety of enhancement products for portable computers. Megahertz offers both 1200- and 2400-bps internal modems for Toshiba and Compaq portables. In addition, Megahertz sells the LapLan card for Toshiba portables, which follows the IEEE 802.3 protocol and is Novell NetWare-compatible, and the MHZ-T-3270 remote terminal emulation card, which supports all IRMA and IBM emulations.

You can now travel from office to office and literally plug into your company's mainframe computer or LAN. It's also possible, using laptops with large hard disk drives and plenty of RAM, to design your own portable LAN.

With so many portables offering big hard disk drives, the question of data backup arises. Floppy disk drives aren't convenient when dealing with hard disks that are 100 megabytes or larger. Some manufacturers, such as Compaq, offer tape backup units for their computers as an option. Procom Technology offers its PLT series of external tape backup units for most popular portables. Both Compaq's and Procom's units use the industry-standard QIC-40 format with the DC2000 tape cartridge.

When the need for expansion options goes beyond the ordinary, many portable users add optional expansion units. One of the most unique is the NEC ProSpeed 386 Docking Station. The Docking Station attaches to the rear of the ProSpeed and has space for two half-height drives and slots for three 16-bit and one 8-bit full-length PC-compatible cards. Even the diminutive GRiDCase 1535 EXP has a clip-on expansion tray that can hold one 16-bit and one 8-bit card.

What follows is a closer look at each of the 11 portables we examined.



Compaq Portable 386 Model 40

Old Reliable keeps plugging away. Compaq has slimmed down its portable and made some subtle changes, but this machine is still the same old rugged workhorse we've come to count on. When it comes time to do some tough computing work, the Compaq is ready to go. It's a solid 20-MHz performer, though it finished only fourth on the BYTE benchmarks (see the figure on page 154). It doesn't have the best individual specs, and it's not the cheapest portable, either. The gas-plasma screen lacks the sharpness of other models. Yet the final combination adds up to an optimal mix of features, performance, and quality. Other portables may seem flashier, but none are more dependable.

Perhaps the Compaq's biggest flaw is its gas-plasma display. At one time this screen seemed brilliant, but it doesn't shine so brightly when set next to today's new crop of portables. You can make it brighter with the only control knob, but most likely you'll keep that button fully tweaked, anyway. Forget about adjusting contrast; there's no knob for that. In the end, you can't avoid the washed-out look of the Compaq display.

The standard Compaq Portable configuration includes a megabyte of 32-bit RAM, one 1.2-megabyte 5¼-inch floppy disk drive, the CGA gas-plasma display, and a hard disk drive. The Model 40 packs a 40-megabyte hard disk drive, while the Model 100 delivers 100 megabytes of hard disk space. You get a full keyboard with a separate numeric keypad and an RGB port for an external CGA monitor. If you need more than CGA graphics, you'll have to buy the expansion box and install a better graphics adapter. The \$199 expansion unit plugs into the rear of the main unit and provides a pair of 16-bit expansion slots. Like the Compaq, the expansion unit is functional, easy to use, and fully IBM PC-compatible.



Dolch-P.A.C. 386-25

The P.A.C., which packs the fastest CPU in our lineup, harkens back to more traditional IBM PC AT technology. It uses the AT bus on its motherboard and a 1.2-megabyte 5¼-inch floppy disk drive. Yet it combines those features with an 80386 running at 25 MHz with zero wait states, an ELD screen, and a SCSI hard disk drive controller with a 4-megabyte-per-second data transfer rate. In addition, the P.A.C. has a proprietary 64K-byte disk cache for faster data access.

The P.A.C. has a lunch box configuration. The keyboard detaches to reveal the ELD screen. You must plug the keyboard into the side of the unit before turning it on. The screen tilts up if you push a large release button. The screen brightness control and display control are to the left of the screen. The display control lets you adjust the screen for light text on a dark background or vice versa.

The ELD screen is CGA-compatible and has a 640- by 400- (double scan) pixel resolution. Text display is a pleasing yellow on a dark-gray background, with excellent contrast.

If you remove six screws from the back, you'll see the AT bus motherboard with its six slots. The review unit came with 8 megabytes of RAM, a 40-megabyte hard disk drive, a SCSI drive controller, an I/O card for serial and parallel ports, and an ELD/CGA video card. This leaves one 8-bit slot and two 16-bit slots free, which allows for easy expandability. The port connectors are located beneath a plastic cover on the left side of the P.A.C. Dolch also offers the Back Pack, an external expansion module for three full-length 16-bit cards.

Dolch sells a version of the P.A.C. called the COBRA for hosting a variety of computer-based instruments, data acquisition boards, and industrial control modules.

continued



Turn Any Place Into An Instant Office.

Why be limited by four walls and a desk? Just turn on the mp286L desktop-laptop and you're in business. Anywhere.

The Mitsubishi® mp286L is the instant office. Plus, with every mp286L, you get Microsoft® Works, a modem and a travel bag free.

Easy to learn and use, Microsoft Works is rated by PC World as the #1 integrated software program including word processing, spreadsheet, chart maker, database, report



generator and communication modules. So it will bring out the best in the high performance mp286L.

See the Mitsubishi mp286L in action. For your nearest Mitsubishi dealer call 1-800-556-1234, ext. 25 in the U.S. and Canada (in California 1-800-441-2345, ext. 25).

Then go with the instant office.



Mitsubishi Electronics America, Inc., Information Systems Division, 991 Knox Street, Torrance, CA 90502.
Mitsubishi Electric Sales Canada, Inc., 8885 Woodbine Avenue, Markham, Ontario L3R 5G1.

© 1989 Mitsubishi Electronics America, Inc. Mitsubishi is a registered trademark of Mitsubishi Electric Corp., Tokyo. Microsoft is a registered trademark of Microsoft Corp.



1530



1535

GRiDCase 1530 and 1535 EXP

GRiD Systems has attained the status of a portable pioneer, and the company deserves its reputation. The company shipped the first battery-powered portables, and it owns the patent for the basic portable design. The GRiDCase line is a testament to this notable design savvy. The GRiD portables are rugged, battery-powered systems that fold into stylish magnesium cases.

The GRiD models are remarkably similar in that they share basic system specifications. Both units house an 80386 processor running at 12.5 MHz, a standard 1 megabyte of RAM, and two handy ROM slots just above the keyboard. The 1535 EXP features a snap-on tray that delivers one 16-bit and one 8-bit expansion slot.

The first thing you notice when you turn the GRiD on is the startlingly sharp screen display. Our 1535 EXP came with a blue backlit LCD, while the 1530 sported an orange gas-plasma screen. The LCD was impressive enough, but the GRiD gas-plasma screen is stunning. For pure readability and sharpness, it can't be beat. Both screens are CGA-compatible, as is the 9-pin video port.

The second thing you notice when booting the GRiDs is the SCO Xenix sys-

tem installed on them. You immediately start taking these slim portables seriously. GRiD has designed its portables for field engineers and traveling professionals, and the boot-up configuration confirms this focus. If you need DOS, though, it's easy enough to fire it up from the log-in prompt or to change the active partition.

It's a mystery why a company with such a discerning eye for design could not come up with a keyboard better than the GRiDCase's. The keys are awkwardly flat and spaced too closely together, and the keyboard lacks a standard layout. GRiD shrank the Enter key and moved the Backspace key out of easy pinky range. The embedded cursor-control and numeric keys will frustrate any traveling professional who works extensively with numbers; however, GRiD offers an optional numeric keypad to solve that problem. Perhaps GRiD, given its projected market, can afford to alienate the touch typist, but this is a keyboard that even the most ardent hunt-and-peck artist could dislike. If you're placing the GRiD on a desktop, you'll appreciate the external keyboard port.

The GRiDCase line lacks nothing—if you're willing to pay the price. The only problem with its impressive add-ons is that more of these options aren't included under the hefty GRiD price tag. The standard configuration doesn't even include a hard disk drive. Add \$1675 to the 1530's base price (\$4695) or \$500 to the 1535 EXP's base price (\$6995) if you need a 40-megabyte unit. Once you go with the hard disk drive, there's no room left for an internal floppy disk drive. An external "pocket floppy," though included with the hard disk drive configuration, must be carried along when you need a floppy disk drive. You can also purchase 5¼-inch drives, backup tape cartridge drives, high-density Xenix drives, internal battery packs and external battery chargers, and an Ethernet Network Expansion Cartridge. By the time you're through adding on, you'll have a fully configured 80386 system, a busted bank account, and a broken back.

That both the GRiDCase 1530 and the 1535 EXP did poorly on the benchmarks is more related to their 12.5-MHz CPU speed than any performance flaw. We would like to see a little more power under the hood, but it's hard to question design decisions when this is one of the few vendors that can free you from an AC plug. If you can leave all the extras at home, you'll carry along a unique combination of power, compactness, and black-tie style.



IBM PS/2 Model P70 386

IBM has finally produced a portable computer that has all the right features. The P70 is a Micro Channel architecture (MCA) machine with the performance of the Model 70 desktop computer. It uses an 80386 running at 20 MHz. There is a socket for an optional 80387 math coprocessor chip.

The P70 has a lunch box configuration in a briefcase size. You must slide two catches to release the keyboard, which folds down to reveal the gas-plasma display. The keyboard can be detached from the computer for easier desktop use. The bottom edge of the display can be pulled out to tilt the display up. Pushing on the inside upper-right corner of the case causes the 3½-inch floppy disk drive to fold out.

The rear of the P70 features slide-up covers for access to the AC power connector, serial port, parallel port, VGA external monitor connector, PS/2 mouse port, and external expansion connector.

If you fold back the rear door, you'll see a storage area for a mouse and have access to connectors for two MCA slots. One slot can hold a 32-bit full-length board, and the other can hold a 16-bit half-length board. The review unit came with a 60-megabyte hard disk drive with an integrated ESDI controller and 8 megabytes of RAM. An IBM 2400-bps modem and an IBM Token Ring Adapter Network board were also included.

The P70 maintains the PS/2 tradition of simple user access. Installing MCA cards is easy: Just release three screws to remove the rear cover. All parts of the portable are at hand. An internal fan keeps the unit cool.

The P70 has a VGA-compatible gas-plasma display with a 640- by 480-pixel resolution. Like many other portables, the P70 uses color mapping when it runs color-based software. But unlike other

continued

“Xerox this memo.” “FedEx this proposal.” “LapLink these files.”

When something becomes a standard, using it becomes second nature. That's true about LapLink. It's so effective that it has become the most popular laptop-to-desktop and desktop-to-desktop file transfer program ever.

And now Release III improves on the original with added power—while preserving the simple design that has made LapLink the choice of more major corporations.

LapLink III offers both serial and parallel file transfer, and you can take advantage of parallel transfer speeds of 500,000 baud or higher. It comes with a “six headed” universal cable that provides you with everything you need to use both serial and parallel modes.

And LapLink III will even install itself automatically on a remote computer.

That's in addition to ease-of-use and productivity features like our popular split screen design, flexible transfer options, and disk and printer sharing.

For the same fast, error-free file transfers between PCs and Macintoshes, get LapLink Mac. And for more information about any Traveling Software product, call us at (800)662-2652.

LapLink III. The standard in file transfer software.



Suggested Retail Price \$139.95

LAPLINK III



Traveling Software, Inc.
18702 North Creek Parkway Bothell, WA 98011
(206)485-8088

LapLink is a reg. trademark of Traveling Software, Inc., Xerox is a reg. trademark of Xerox Corporation, FedEx is a reg. trademark of Federal Express Corporation. © 1989 Traveling Software, Inc. All Rights Reserved

portables, the P70 uses a different method to produce the color mapping for the gas-plasma display.

If a program directly writes a color value to a particular location in VGA memory, the P70's VGA circuitry translates that value to another value that can be displayed as part of the color mapping. If the program reexamines that particular memory location, it will see a different value from what it had originally written. This could cause a problem in that some software that uses direct hardware control of the VGA circuitry might not operate correctly with the P70.



PowerMate

Micro Express Regal II

Since we hold the Compaq Portable in high regard, it's hard not to like the Micro Express Regal II as well. It shares the same lunch box look of the Compaq, the same pop-up gas-plasma screen, the same snap-off detachable keyboard, and the same outstanding performance. In fact, the Micro Express outperformed the Compaq, perhaps helped by a 64K-byte, 35- to 40-nanosecond static RAM cache.

No doubt, the Regal II really screams. In terms of benchmarks, it came in behind only the Toshiba T5200 and the 25-MHz Dolch-P.A.C., returning solid numbers across the board. It finished no worse than third on all the low-level modules and posted top honors on the disk benchmark. It surpasses the Compaq in the expandability department, too, with four expansion slots accessible from a sliding door on the left side of the unit. The right side houses a 5¼-inch floppy disk drive with a standard flip-down latch. We didn't like the way the Regal II packs its keyboard cable, however. Unlike the Compaq, which tucks its keyboard cable effortlessly into a slot next to the screen, the Regal II offers a compartment within the keyboard to store the cable. It doesn't make for a

smooth fit, and the cover for the cable bay can unlatch easily.

The rear of the Regal II offers a parallel printer port and a 25-pin serial port. It lacks an external video port, though you could install an adapter in a free expansion slot. Priced at \$2999, the Regal II certainly looks attractive. Of course, when you select the Regal II as an alternative to the Compaq Portable 386, you are sacrificing Compaq's proven record for quality. Though the Regal II seems rugged enough, only time will tell. For the price of the Regal II, it could be worth taking the chance.



ProSpeed

NEC PowerMate Portable SX and ProSpeed 386

Please don't refer to the PowerMate Portable SX as a stunted system. Yes, it employs a 16-MHz 80386SX processor; and, yes, our benchmarks reveal lackluster performance; but this system delivers a remarkable set of features for the price. NEC may have cut some corners on the data bus, but it didn't cut corners anywhere else: The unit has 2 megabytes of RAM, a 42-megabyte hard disk drive, a 1.44-megabyte 3½-inch floppy disk drive, a VGA gas-plasma display, three expansion slots, a 5¼-inch external

drive interface, a 93-key keyboard, and an external VGA port.

All those impressive features add up to a hefty luggable shell, so you sacrifice some portability. Once you set this system up, though, you give up very little. The expansive keyboard offers a separate numeric keypad and dedicated cursor-control keys. The light clicky feel and full-size keys make for comfortable touch-typing. A single-screw door atop the unit exposes three full 16-bit expansion slots as well as the memory and co-processor sockets. A side door affords easy access to the system DIP switches. If you don't really need blazing speed or a 32-bit data path, this machine delivers a wealth of standard features that no other vendor can match.

NEC refers to the ProSpeed 386 as a "modular workstation." If you're really looking to buy one computer for both travel and desktop use, the ProSpeed philosophy may be the answer. The battery-powered portable unit houses a 16-MHz 80386, a 40- or 100-megabyte hard disk drive, up to 10 megabytes of RAM, a fold-down LCD VGA screen, an external VGA port, and an 92-key keyboard with a separate numeric keypad. Even as a stand-alone portable, it's an impressive unit. It has the design of a true portable with battery power and lap-size dimensions; however, with the battery installed, the ProSpeed weighs in at a back-straining 22½ pounds.

When you get back to your desk, you can plug the ProSpeed into the optional Docking Station (\$1199). With the Docking Station, you get one 8-bit and three 16-bit expansion slots, bays for two standard half-height storage devices, an external keyboard port, two serial ports, and a parallel port. You can connect an external analog monitor to the RGB port on the portable unit and plug the monitor into an AC outlet at the rear of the Docking Station. A fully configured ProSpeed could indeed qualify as a low-end workstation. While the expansion slots could provide connectivity and other enhancements, the drive bays can support mass storage options, including CD-ROM drives. NEC also bundles VM/386 multitasking software with the ProSpeed.

With these two units, NEC offers some unique portable choices. In addition to being the only SX machine in our survey, the PowerMate offers a fully featured luggable system at a competitive price. The ProSpeed provides a creative solution to users who need both a powerful portable on the road and a fully configured 80386 on their desktop.



T5100



T5200

Toshiba T5100 and T5200

Both of Toshiba's portables show a definite family resemblance; they have the same clamshell design. The T5100 uses a single large, front-mounted latch to release the display from above the keyboard. The T5200 uses two small latches and has a combination lock. The T5100 has a handle mounted on its back; the T5200 has a small handle mounted on the front that folds under. Both units have a gray matte finish, but under the skin, they differ significantly.

The T5100 is smaller, lighter, and slower. It's not as tall or wide as its brother. It's 4 pounds lighter, runs at 16 MHz, and costs over \$2000 less. The model we received had a 40-megabyte hard disk drive and came with 2 megabytes of RAM, the standard configuration. The rear of the T5100 sports a serial port, a parallel port, and an EGA connector. You can also use the parallel port to connect an optional external floppy disk drive. A switch on the side of the T5100 configures the parallel port as drive A, drive B, or printer port LPT1.

A metal plate at the rear of the T5100 covers Toshiba's proprietary expansion port connector. The port provides an easy upgrade path; Toshiba offers an

continued

Some Things Never Change

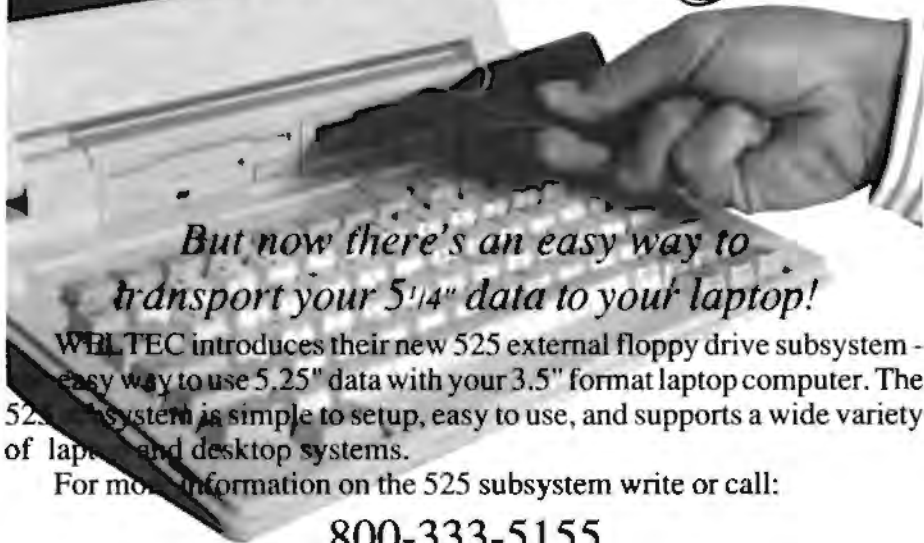

But now there's an easy way to transport your 5 1/4" data to your laptop!

WELTEC introduces their new 525 external floppy drive subsystem - easy way to use 5.25" data with your 3.5" format laptop computer. The 525 subsystem is simple to setup, easy to use, and supports a wide variety of laptop and desktop systems.

For more information on the 525 subsystem write or call:

800-333-5155



WELTEC digital, inc.

17981 Sky Park Circle, Suite M, Irvine, CA 92714
Phone: 714-250-1959 • Telex: 3728057 • FAX: 714-250-1964

DATASTAR 5. MAKING ALL OTHER LAPTOP MODEMS OBSOLETE.

**THE ONLY UPGRADEABLE
2400 bps LAPTOP MODEM
WITH MNP5 & TPO
"True Power Off"**

Introducing a revolution in Laptop Communications, Datastar 5. This unique 2400 bps Laptop Modem with MNP5 and TPO "True Power Off", extends battery life, is fully compatible and is the only upgradeable Laptop Modem available today. Never in the history of Laptop Communications has so little, done so much, for so many.

Features

- Upgradeability
- Automatic TPO "True Power Off"
- MNP5 - 100% error free transmission
- Data Compression - 4800 bps throughput
- Compatibility - "AT" and "Extended AT" command sets
- Ease of installation
- 3 year warranty
- High performance (custom low distortion phone interface)



See us at PC Expo Booth #860



210 Matheson Blvd. East, Mississauga, Ontario, Canada L4Z 1X1
(416) 890-1956 FAX (416) 890-8129



Now available for COMPAQ, HEWLETT PACKARD, BULL, NEC, TOSHIBA, and ZENTH, LAPTOP computers.

COMPANY INFORMATION

Compaq Computer Corp.
(Compaq Portable 386)
20555 FM 149
Houston, TX 77070
(713) 374-1562
Inquiry 1071.

**Dolch American
Instruments, Inc.**
(Dolch-P.A.C. 386-25)
2029 O'Toole Ave.
San Jose, CA 95131
(408) 435-1881
Inquiry 1072.

GRiD Systems Corp.
(GRiDCase 1530 and 1535)
47211 Lakeview Blvd.
Fremont, CA 94537
(800) 222-4743
Inquiry 1073.

IBM Corp.
(Model P70 386)
U.S. Marketing and Services
1133 Westchester Ave.
White Plains, NY 10604
Contact your local dealer.

Megahertz Corp.
4505 South Wasatch Blvd.
Salt Lake City, UT 84124
(801) 272-6000
Inquiry 1074.

**Micro Express
(Regal II)**
2114 South Grand Ave.
Santa Ana, CA 92705
(800) 642-7621
(714) 662-1973
Inquiry 1075.

NEC Home Electronics, Inc.
(ProSpeed 386)
1255 Michael Dr.
Wood Dale, IL 60191
(800) 632-7638
(312) 860-9500
Inquiry 1076.

**NEC Information
Systems, Inc.**
(PowerMate Portable SX)
1414 Massachusetts Ave.
Boxborough, MA 01719
(800) 343-4418
Inquiry 1077.

Procom Technology
200 McCormick
Costa Mesa, CA 92626
(714) 549-9449
Inquiry 1078.

**Toshiba America
Information Systems
Division**
(T5100 and T5200)
9740 Irvine Blvd.
Irvine, CA 92718
(714) 583-3000
Inquiry 1079.

Zenith Data Systems
(TurboPort 386)
1000 Milwaukee Ave.
Glenview, IL 60025
(312) 699-4800
(312) 842-9000
Inquiry 1080.

optional 2-megabyte memory board, modem, and external expansion chassis. The T5100's gas-plasma EGA display has 640- by 400-pixel resolution. The display is crisp, and the contrast and brightness controls lie directly underneath.

The T5200 is the top of the line for Toshiba portables. It has an outstanding line of features, but it is one of the most expensive portables. The T5200's 80386 runs at 20 MHz with a 32-bit path to system memory, an 82385 cache controller chip, and a 32K-byte static RAM cache. The review model came with a 40-megabyte hard disk drive and 4 megabytes of RAM. The cache controller chip explains why the T5200 can outrun the Dolch-P.A.C. in some of the BYTE benchmark tests. The rear of the T5200 has connectors for the parallel port/external floppy disk drive port, two serial ports, a VGA connector for an external monitor, and the Toshiba proprietary expansion connector.

One of the reasons why the T5200 is larger than its brother is that you can install two PC-compatible expansion boards, one short 8-bit board and one full-length 16-bit board, inside the rear of the unit. Installation involves removing the rear panel and two metal cover plates. Once installed, the rear of the expansion boards can be accessed through a removable plastic cover on the left side. This provides a convenient upgrade path for expansion boards, such as LAN interfaces or data acquisition cards.

The T5200 also has a gas-plasma

display; it is VGA compatible and has a 640- by 480-pixel resolution. The gas-plasma display can be removed when using the computer with an external monitor. You can simultaneously view both the gas-plasma display and an external monitor.

Both units use AC power only. They come bundled with PC-Kwik Power Pak utility software, QEMM-386 memory management software, and Microsoft Windows/386.



Zenith TurboPort 386

The TurboPort combines good performance, an innovative design, and convenient operating features. When we used the TurboPort, we got the impression that a considerable amount of engineering skill went into its design.

The TurboPort has a modified clamshell design. To open it, you move two

slide releases on the sides and tilt up the LCD screen from the keyboard. Once the screen is up, you can detach the keyboard from the rest of the computer by pressing on two latches. This makes the machine easier to use on a desktop.

The rear of the TurboPort has a serial port, a parallel port, a DB-15 external monitor connector, and RJ-11 connectors for the built-in modem. The machine that we received for review, the Model 40M, came equipped with a 40-megabyte hard disk drive and a 2400-bps internal modem. The TurboPort's 80386 runs at 12 MHz with zero wait states. The socket for an optional 80387 resides in back of the display. The TurboPort comes standard with 2 megabytes of RAM, expandable to 3 megabytes internally. The internal SETUP program allows you to configure the memory beyond 640K bytes as either extended or expanded memory.

The TurboPort's screen is a "page white" backlit fluorescent LCD with 640- by 400-pixel resolution (double-scan CGA). We judged the TurboPort's LCD screen as one of the best.

The TurboPort can run on internal nickel-cadmium batteries or an external AC adapter. The adapter is a 7¼- by 2¼- by 4¼-inch box, weighing 1¾ pounds, with a special cable and connector that plugs into the side of the TurboPort. The nickel-cadmium battery can be recharged in 2 hours if the computer is off, or it can be trickle-charged during use. You access the battery through a

continued

SINCE 1979,
servicing our PC buyers
with low pricing,
technical experience –
and reliable service.



WAREHOUSE DATA PRODUCTS

Order Status,
Technical & Other
Info: (602) 246-2222
Fax: (602) 246-7805
Call for programs
not listed.

1-800-421-3135 WITHIN THE USA AND CANADA TOLL-FREE

S O F T W A R E

SPREADSHEETS		CAD & ENGINEERING		PROJECT MANAGER		UTILITIES		DESKTOP PUBLISHING	
Lotus 1-2-3	\$305	Autosketch Enhanced	\$61	Super Project Plus	\$255	Allways	\$85	Adobe Illustrator Window	\$409
Lucid 3D	62	DesignCad 2D 3.0	219	Timeline Pro Ver. 3.0	364	Battery Watch	25	Bitstream Fonts	119 ea.
Microsoft Excel	224	Easy Cad 2.05	119	Total Harvard Manager 3.01	369	Copy II PC	23	Pagemaker Ver. 3.0	469
Plan Perfect	189	Generic Cad Level 3	159			Copywrite	55	PFS: First Publisher 2.0	73
Quattro	159	MathCad 2.0	245	WORD PROCESSING		Core Fast	72	Ventura Publisher 2.0	479
SuperCalc 5	305	COMMUNICATION PROGRAMS		Grammatik III	\$49	Desqview 2.2	79	Ventura Pro EXT	377
Twin Advanced	69	Brooklyn Bridge Universal	\$75	Microsoft Word 5.0	225	Direct Access	49	EDUCATION/GAMES	
YP Planner Plus	119	Carbon Copy Plus	106	Multimate Advantage II	285	Disk Manager	59	688 Attack Sub	\$33
DATA BASE MANAGERS		Crosstalk XVI	99	PFS Professional Write 2.1	129	Disk Technician Advanced	108	Chuck Yeager Flight Simulator	35
Clarion Personal Developer	\$95	Desklink	99	Right Writer	49	Fastback Plus 2.01	104	Gunship	35
Clarion Pro Developer	379	Lap Link 3	79	SPF/PC 2.1	169	Formtools	56	Leisure Suit Larry II	28
Clipper	419	PC Anywhere III	69	Will Maker 3.0	37	Formworx	85	Kings Quest IV	30
D Base IV	459	Pro Com. Plus	44	Word Perfect 5.0	225	Gopher	45	Mavis Beacon Teaches Typing	30
D Base IV Developers Ed	819	Relay Gold	149	Word Perfect Library 2.0	65	H-TEST	49	Microsoft Flight Simulator 3.0	35
DB-XL Diamond 1.4	145	GRAPHICS		Wordstar Pro 5.5	229	Mace Gold	81	Typing Tutor IV	30
Data Perfect	283	Corel Draw	\$349	Wordstar 2000 Plus	273	Microsoft Windows 286	63	Where in the World	30
Fox Base Plus 2.1	199	PFS First Graphics	87	Xywrite III Plus	216	Microsoft Windows 386	125	Many More Titles Available	Call
Genifer	189	Grasp	92	LANGUAGES		Norton Advanced 4.5	79	ACCOUNTING	
Paradox 3.0	449	Harvard Graphics 2.12	274	Brainmaker	\$79	Norton Commander 2.0	49	Bedford Accounting	\$139
PFS: Professional File 2.0	165	Mapmaster	219	Microsoft C 5.1	299	Org Plus Adv	55	Check Write Plus	29
Powerbase 2.3	169	Printmaster Plus	29	Microsoft Fortran	295	PC Tools Deluxe 5.0	44	Dac Easy Acct. Ver 3.0	59
Q&A 3.0	209	Printshop	34	Microsoft Macro Assembler	99	Q DOS II	49	Dac Easy Light	42
Revelation Advanced	469	Printshop Companion	29	Microsoft Quick Basic 4.5	65	QEMM 386	39	Dollars & Sense	99
R Base Compiler Ver. 1.0	580	Show Partner Fx	199	Microsoft Quick C 2.0	65	Sidekick Plus	125	Managing Your Money 5.0	119
R Base For DOS 2.1	459	INTEGRATED		Borderland		Sideways	39	Peachtree Business Acct.	149
Reflex	95	Enable OA	\$415	Turbo C 2.0	95	Software Carousel	43	Peachtree W/PDO	220
Relate & Report	99	PFS First Choice	89	Turbo C Professional	165	Spinrite	49	Quicken	30
VP Info	63	Microsoft Works	89	Turbo Pascal 5.5	99	XTree	35		
		Smart Software	439	Turbo Prolog 2.0	95	XTree Pro	64		
		Symphony 2.0	419	Turbo Prolog Toolbox	65				

H A R D W A R E

ACCESSORIES		VIDEO BOARDS		BOARDS		PRINTERS		LAPTOP COMPUTERS	
Curtis Ruby Plus	\$69	AST VGA Plus	\$349	AST Rampage 286 Plus, 512K	\$489	Epson		Toshiba T-1000	\$699
Emerson Surge Protector	69	ATI EGA Wonder 800	229	AST Sixpac Plus w/64K	129	All Models	Call	Toshiba T-1200FB	1579
Keytronics KB101	99	ATI VGA Wonder	319	ATI Wonder VGA	433	NEC		Toshiba T-1600	3359
Logical Connection 256K	469	Everex Viewpoint 256K	249	Copy II PC Deluxe Board	109	P5200	\$519	Toshiba T-3100E	2839
Mach III Joystick	30	Orchid Designer 800	232	Everex RAM 3000	69	P5300	669	All Other Models	Call
Masterpiece	85	Orchid Pro Designer w/256K	299	Everex 2MB Above Board	59	OKIDATA			
NTC 101 Keyboard	89	Paradise Autoswitch EGA 480	179	Everex I/O XT/AT	65	OKI 182 Turbo	235		
Targus Laptop Bags	Call	Paradise VGA Plus	259	Intel nboard 386 AT	894	OKI 320	349		
150 Watt Power Supply	69	Paradise VGA Pro	449	Intel Above 286, Plus w/512K	419	OKI 321	479		
HARD DRIVES		Vega Fastwrite	349	Intel Connection Co-Processor	739	OKI 391	649		
Bernoulli B120X	\$1049	Vega V-RAM	499	Orchid Tiny Extra Turbo	Call	PANASONIC			
Bernoulli Carts	In Stock	MICE/SCANNERS				1124	339		
Core Hard Drives	Call	Complete Hand Scanner 400	\$143	MONITORS		1180-I	189		
MiniScribe	Special	Data Copy 730 GS	930	Hyundai Amber w/tilt	\$79	1191-I	249		
Seagate 20 MB w/Cont	259	DFI Scanner	189	Samsung White	95	STAR MICRONICS			
Seagate 30 MB w/Cont	279	Logitech Bus NEW	79	Samtron Amber	89	NX1000	169		
Seagate 251-1 40MB 28 Mil.	409	Logitech Scanman Hi-Res	179	CGA		NX1000 Color	229		
Seagate ST 125 w/Cont	319	Microsoft Bus w/Paintbrush	99	Samtron RGB SC 452	235	HARD CARDS			
Seagate ST 138 w/Cont	369	PC Mouse II w/Paint	79	Magnavox 8762 RGB	255	Plus Hardcard 20 MB	\$529		
Seagate ST 251	369	COMPUTERS		EGA		Plus Hardcard 40 MB	669		
Seagate ST 4096	585	AST		Samtron 14" EGA	369				
CD-PROCESSOR		Bravo 5	\$889	Magnavox CM 9053	370				
INTEL		Model 140	2599	VGA					
80287	\$153	Model 140X	2299	NEC Multisync 2A	519				
80287-8	219	ARC		Seiko 1430	599				
80287-10	259	Pro Turbo 88	739	Zenith Flat ZCM 14	629				
80387-16	399	Pro Turbo 286 w/512	1209	Multisync					
80387-20	439	Pro Turbo 286, 1 MB	1319	Mitsubishi Diamondscan	499				
8087-2	139	386 Skyscraper	2729	NEC Multisync 3D	679				
8087-3	95								
UPS									
Emerson									
UPS 200	\$289								
UPS PC ET 700 WATT	499								



CALL FOR
ITEMS NOT SHOWN

1-800-421-3135 • 1-602-246-2222
2727 W. Glendale Ave., Phx, AZ 85051

USER FRIENDLY TERMS & CONDITIONS:

- We welcome international accounts. please call for special pricing
- Volume discounts for corporate and institutional orders
- We do not charge your credit card until your order is shipped
- Shipping minimum is \$5.00. Arizona orders - 6.7% sales tax
- Personal/company checks allow fourteen (14) days to clear

All shipments insured at no extra cost

- All prices are subject to change without notice
- We do not guarantee compatibility
- No charge for Visa or MasterCard

Technical Support: (602) 246-2222
FAX: (602) 246-7805

Phone Hours: Monday thru Friday 5:30 a.m. - 6:00 p.m. MST
Saturday 9:00 a.m. - 5:00 p.m. MST

BY 08

panel in the bottom of the machine. Battery life is approximately 2 to 3 hours per charge.

Portable Performance

The Compaq Portable's standing in our BYTE benchmark graph (see below) reveals the power of the portables we reviewed. Despite its usual place at or near the top of our benchmark listings, the Compaq could do no better than fourth out of the 11 portables tested. This is not so much a sign of Compaq's slide as it is a testament to the quality of this crop of luggable powerhouses. Few users would ever need more power than this—even for their desktop applications.

For the most part, the results reflect the speed of the CPU. However, the Toshiba T5200, a 20-MHz model, outscored the 25-MHz Dolch-P.A.C. The Toshiba T5200 posted a higher CPU

A 32K-byte static cache and 82385 cache controller boosted the T5200's performance above that of the competition.

score and a higher overall applications score, and it even performed more Dhrystones per second. It consistently placed at the top of our applications tests. A 32K-byte static cache and 82385 cache

controller boosted the T5200's performance above that of the competition.

The Micro Express Regal II topped our disk benchmark listing, a result corroborated by applications tests such as printing a PostScript file to disk, loading an extensive Lotus 1-2-3 spreadsheet, and storing large documents. The Dolch-P.A.C. also performed admirably on disk-intensive applications. It suffered somewhat on the low-level tests because we had to factor out the Hard Seek test. The P.A.C.'s SCSI connector hides low-level operations from the user. This makes a low-level Seek test useless. The Toshiba T5200 and the NEC ProSpeed also returned impressive disk results. The NEC PowerMate, as if not already hampered enough by the SX chip, suffers from a sluggish hard disk drive. It finished at the bottom of our low-level

continued

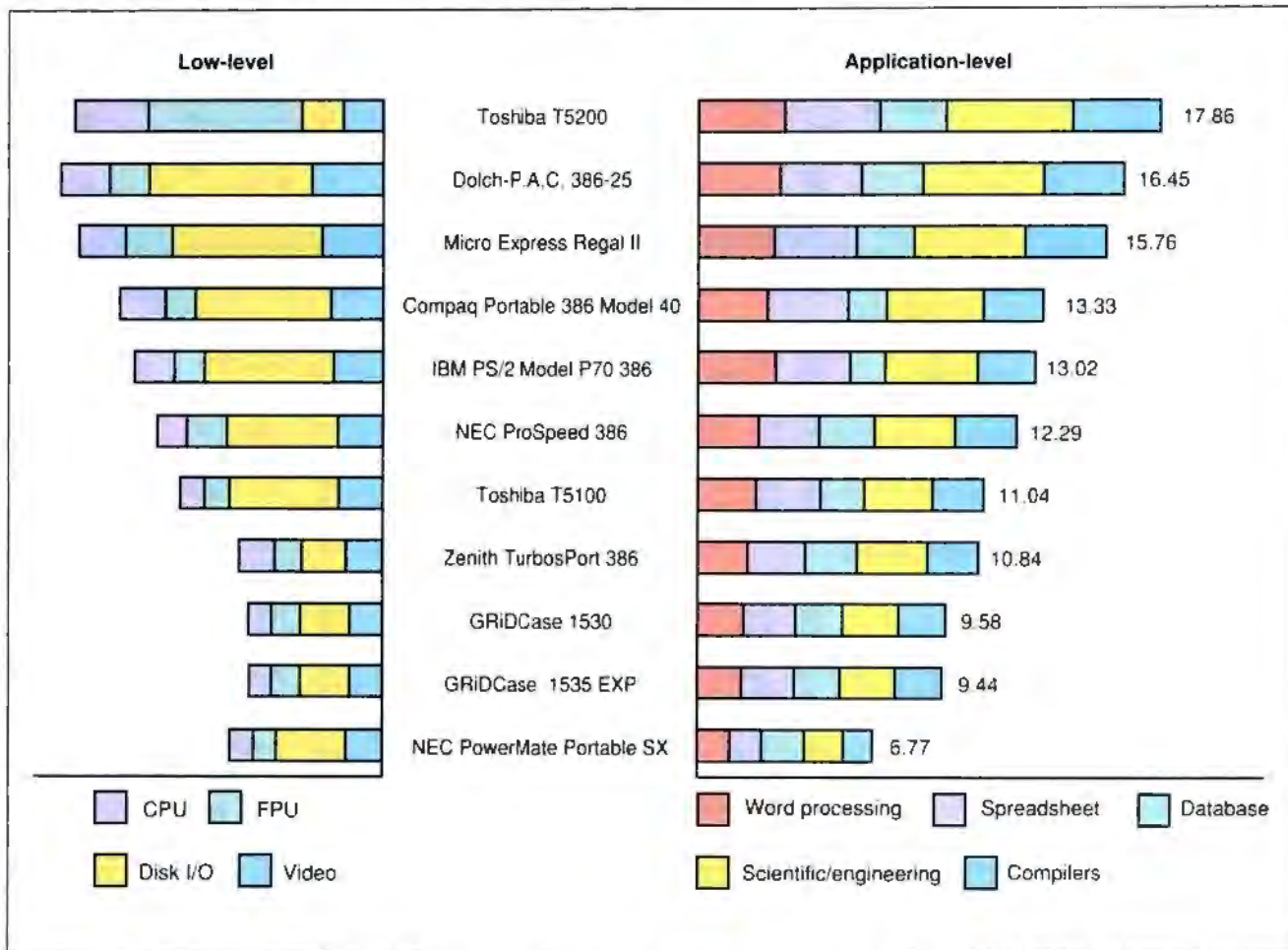

The 20-MHz Toshiba T5200 outscored the 25-MHz Dolch-P.A.C. 386-25 on the applications index and the low-level CPU index. Cumulative indexes at right show relative performance: an 8-MHz IBM PC AT = 1. All low-level benchmarks use the 80386 version (1.1) of Small-C (32-bit integers). The P.A.C. finished highest on the FPU and video tests. The Micro Express Regal II had the best disk index. We blame slow CPUs for poor performance showings by the GRiDCases and the Zenith TurbosPort 386.

The shortest distance between Laptop and Desktop.

Need to move files, directories - even complete disks of information - between IBM-compatible 3 1/2" laptop and 5 1/4" desktop disk drives? Send them First Class. With FASTLYNX.

FASTLYNX is faster than any other product of its kind. Over 500K baud parallel. More than 200K baud serial. And only FASTLYNX supports both CRC and Checksum error-checking, for 100% accuracy at maximum speed.

No other file transfer utility is as easy to use as FASTLYNX. Just connect a cable from the 2 supplied, and decide which files to transfer. FASTLYNX connects itself and automatically selects port, baud rate, and error-checking mode.

FASTLYNX provides a unique self-cloning ability. So you only need to install FASTLYNX on a single system. A bootstrap upload feature automatically transfers FASTLYNX to the target computer.

FASTLYNX is the only file transfer system with 3 separate modes of operation. SPLIT SCREEN MODE makes file transfer as simple as point-and-

shoot. Use FORM MODE to create time-saving file transfer macros. With COMMAND MODE, advanced users can issue file transfer commands from the DOS prompt.

FASTLYNX makes printer and disk sharing easy. Use the unique, ultra-fast parallel driver to share printers effortlessly. Or run remote programs with the speedy direct disk access you'd expect from a network. We've even included

management functions. And on-line and context-sensitive help makes you so comfortable with these features that you'll actually use them.

2 cables are better than 1. Unlike other file transfer products, FASTLYNX includes both parallel *and* serial cables for optimum convenience.

FASTLYNX culminates 5 years of file transfer leadership. Rupp Corporation built upon its highly acclaimed Fastwire II file transfer utility to make FASTLYNX the fastest, easiest to use, and most complete product of its kind.

Call 1-800-852-RUPP for the name of your nearest FASTLYNX dealer.



The FASTLOCK file protection system safeguards your hard disk files with simple, effective password security. Until October 31, 1989, participating dealers are offering special savings when you purchase FASTLOCK and FASTLYNX together.



835 Madison Avenue
New York, NY 10021
(212) 517-7775, Fax: (212) 249-8243



FASTLYNX and FASTLOCK are trademarks of Rupp Corporation

THINK BIG

Phar Lap Virtual Memory Manager.

It will let you write applications up to 5, 10, 15 megabytes or more for any 386 PC running MS-DOS*. *Forget about RAM limitations.* Your application can run on a machine with as little as 1 or 2 megabytes of memory.

Only Phar Lap 386IVMM* gives you demand-paged virtual memory capability so you can write mainframe-sized applications for the PC. Applications your customers can run on their 386 PCs now with no additional memory. No kidding. All you need is 386IVMM and our family of 386 development tools. Existing programs developed with our 386IDOS-Extender can be easily expanded with 386IVMM too.

Our tools let you take full advantage of the 386 protected mode architecture. Break the DOS 640K limit in the language of your choice; C, Fortran, Pascal, or Assembler.

For fast compact code, use 386IASM, our 80386 assembler that's upwardly compatible with the MASM* 8086 assembler. Existing DOS and mainframe applications written in a high level language are easily ported by recompiling. And 386LINK, our 32-bit native mode linker, puts it all together.

Debugging is made easy too. With our 386 symbolic debugger you can debug applications written in assembler or any high level language. Best of all, with Phar Lap's 386IDOS-Extender* you can run your native mode program on any 386-based PC running MS-DOS. And you have full access to DOS system services through INT 21.

NO COMPATIBILITY PROBLEMS

Phar Lap's tools are compatible with the industry's leading systems: DESKPRO 386*, IBM Model 70/80*, 386 clones and accelerator boards. Not only will your new applications be compatible with the leading systems, they'll run alongside all other DOS applications.

NO ROYALTY PAYMENTS

Once your 386 application is complete, all you pay is a low one-time fee to license 386IDOS-Extender for redistribution.

386IVMM is also developer friendly. Call to find out about our flexible runtime pricing.

You can unlock the entire DOS market now. Don't wait for OS/3.

- \$495 386IASM/LINK-Package includes 386 assembler, linker, MINIBUG debugger and the developer version of 386IDOS-Extender
- \$895 MetaWare 80386 High C* compiler
- \$595 MicroWay NDP Fortran-386* compiler
- \$195 386IDEBUG symbolic debugger
- \$295 386IVMM - developer version of the Phar Lap Virtual Memory Manager

(617) 661-1510

PHAR LAP SOFTWARE, INC.

60 Aberdeen Avenue, Cambridge, MA 02138

Fax: (617) 876-2972

"THE 80386 SOFTWARE EXPERTS"



disk benchmark and required 31 seconds to load the large spreadsheet, three times longer than it took the Regal II. Other file I/O applications were similarly slow.

The IBM PS/2 Model P70 had the lowest score of the 20-MHz CPUs tested, but that is no disgrace, given the quality of portables in this field. The P70 posted results in line with those of a desktop Model 70-121 (a 20-MHz 80386 machine), so you can now lug around the equivalent of a top-of-the-line PS/2.

Transferring the benchmark files uncovered another slight annoyance. Both the P70 and the Regal II lack a 9-pin serial port. Granted, adapters are easy enough to find, but didn't IBM introduce the 9-pin serial port? Now that the 9-pin connection has become a standard in the portable world, IBM has unveiled a portable without one. Go figure.

The NEC ProSpeed finished surprisingly strong, scoring higher than the 16-MHz Toshiba T5100. A fast hard disk drive helped the ProSpeed. The PowerMate scored credibly on our CPU benchmark, but it consistently placed at the bottom of our applications tests. The CPU works well, until you access the narrow data path. The Zenith TurboSport 386 performed adequately for a machine with a 12-MHz CPU, while the GRiDCases' 12.5-MHz CPUs kept those two models at or near the bottom of every test.

King of the Road

When it comes to choosing the best portable computer in the bunch, we're hard-pressed to make a choice. All the portables we've tested run well; you just can't go wrong with any of them.

Our particular favorite was the Toshiba T5200. It's an excellent combination of computing power and portability all wrapped up in an attractive shell. Unfortunately, it's also one of the most expensive portables in the group.

At the opposite end of the economic scale is the Micro Express Regal II. Its price is an astoundingly low \$2999, less than half the price of the Toshiba. It isn't at the top of the performance chart, but it finished third, well ahead of some pricey competition.

All 11 machines we've looked at prove that a well-equipped portable computer can match the capabilities of many desktop models. A portable can now be the computer on your desk. ■

Phar Lap and 386IDOS-Extender and 386IVMM are trademarks of Phar Lap Software, Inc. MS-DOS and MASM are registered trademarks of Microsoft Corp. DESKPRO 386 is a trademark of Compaq Corp. NDP Fortran-386 is a trademark of MicroWay, Inc. High C and Professional Pascal are trademarks of MetaWare Incorporated. IBM Model 70/80 is a trademark of IBM Corp.

Stanford Diehl and Stan Wszola are testing editors for the BYTE Lab. They can be reached on BIX as "sdiehl" and "stan," respectively.

Designed for desktop graphics, priced to be personal.

Drawing Board to Board Room

Plot your designs, present your plans, and illustrate your point with the new HI Image Maker.™ Houston Instrument's newest plotter can improve all your images at a price that makes personal productivity gains affordable.

Precision CAD or Graphic Presentations

Your HI Image Maker uses a variety of technical pens on vellum or presentation bond—and produces vibrant color graphics on transparencies, paper, or vellum. Drawings on media up to 11×17 inches can be produced quickly and beautifully at a resolution of one thousandth of an inch.

Confidence and Value

Industry experts agree, HI drafting plotters defined the price-performance standard for PC-based CAD plotters. The HI Image Maker is a product you can buy with confidence. Priced at only \$1295,* you can use this plotter throughout your company—or keep it for yourself!

For details, call 1-800-444-3425 or 512-835-0900.

**U.S. suggested retail price. Subject to change.*



HOUSTON INSTRUMENT

A DIVISION OF AMETEK

8500 Cameron Road, Austin, TX 78753

*Houston Instrument and HI Image Maker
are trademarks of AMETEK, Inc.*

Circle 121 on Reader Service Card

We keep telling people
this is not a laser printer.



The new \$995 HP DeskJet PLUS Printer.

But they keep looking at the evidence.



Mr. Arnold R. Jones
220 Bush Street, Suite 845
San Francisco, CA 94104

Dear Reader:

Imagine being able to put out merged text and graphics that look in fact, that your clients will think you're using a laser printer. You're not. You're using the \$995 HP DeskJet PLUS printer instead.



This is one of many business charts you can print out on the new HP DeskJet PLUS printer. Software for this test and graphics demonstration by Harvard Graphics.

Sincerely,

Alan Grube
Alan Grube

One reason you can't get graphs around so fast is that you're using a DeskJet PLUS printer. You can create your message in your favorite program and print it out beautifully.

We call it a personal printer. For a small price, for a big return.

Of course, you know how good it is. You've been on a business trip to your printer.

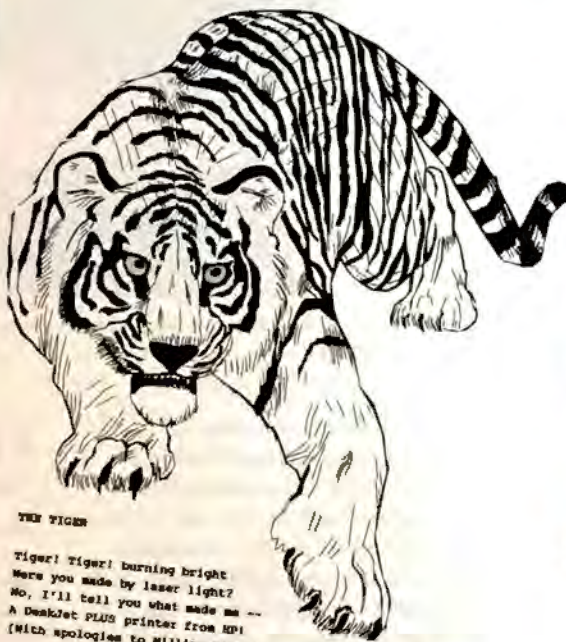

THE TIGER

Tiger! Tiger! burning bright
Were you made by laser light?
No, I'll tell you what made me --
A DeskJet PLUS printer from HP!
(With apologies to William Blake)

MegaCorp 1988 Sales History

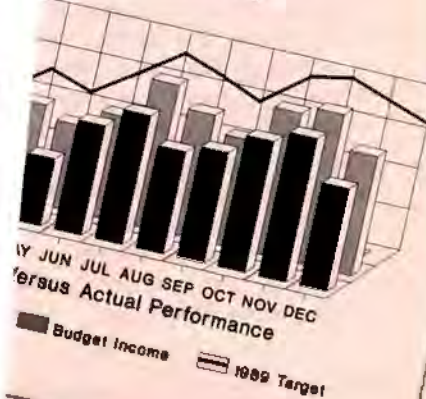

You won't believe your eyes (or ears), either. The HP DeskJet PLUS printer gives you the same crisp, black lettering. Clean, sharp graphics. And whisper-quiet operation. But it uses advanced inkjet technology to supply these laser-like qualities for the price of a 24-wire printer.

For just \$995, you get 300 dpi in a trim 15-pound package that's twice as fast as the original. What's more, it has built-in landscape and improved font selection. Including ten built-in fonts and over 100 optional fonts, with sizes up to 30 points. And its 20,000-hour MTBF

assures a long, happy life.

So call 1-800-752-0900, Ext. 276J for the name of your nearest authorized HP dealer. Then judge the HP DeskJet PLUS printer for yourself.



FLEXSCAN™ 9070S, PC Hi-Res That Looks Like a Million.

The FLEXSCAN 9070 Multiple Scan monitor is of course compatible with other multi-scans, but includes improvements that will give you the professional edge which is the mark of a good investment.

You can extend your multi-scan range from 20kHz to 50kHz in practical terms. This means that, at the 48-50 kHz range, you can make use of PC CAD/CAE capabilities at a resolution of up to 1024 dots × 768 lines. The FLEXSCAN 9070 takes advantage of non-interlace high resolution signal as high as 1024 × 768 to provide you with a flicker free display at much brightness. You can also use the 9070 with IBM PS/2 or VGA compatible boards at a high resolution mode like 800 × 600 and 1024 × 768 (non-interlace).

The FLEXSCAN 9070 provides a 16-inch screen, large enough for CAD/CAE and 3-D projections, yet small enough to fit comfortably into your home work space.



1024 dots × 768 lines Graphics (Non-interlace)
AutoCAD



Also, for your convenience, all controls and switches, including the alternate video input, are located within easy reach on the front panel. The FLEXSCAN 9070 is compatible with a wide range of IBM, Apple, and other products, allow you to use all of today's popular programs---at a resolution that looks like a million.

FLEXSCAN™ MODEL 9070S

- IBM VGA(PS/2), 8514/A, PGC, EGA compatible and CAD/CAE use.
- Apple Mac II and SuperMac Spectrum compatible
- Max. 1280 dots × 800 lines high resolution
- 1024 dots × 768 lines display on Non-Interlace signal delivers flicker-free high-res graphics
- 20kHz to 50kHz horizontal scan automatic adjustment. 50Hz to 80Hz vertical scan automatic adjustment
- 16 inch, 0,31mm dot pitch and newly developed XF(Extended Field) Gun to obtain both brightness and sharp focus.
- Front mounted controls including the input signal select switch between 2 video input.
- Selecting white or Amber displays colored application in shades of gray or amber
- Tilt-Swivel stand standard

NANA O[®]

NANA O USA CORPORATION

23510 TELLO AVE., SUITE 5 TORRANCE, CA 90505
PHONE (213) 325-5202 FAX (213) 530-1679

Specifications are subject to change without notice.

APPLE Macintosh II are registered trademarks of Apple Computers Inc. ARTIST ARTIST I Plus ARTIST II ARTIST 1016 are trademarks of Control Systems Inc. IBM IBM PC XT AT and PS/2 are registered trademarks of International Business Machines Corporation. SuperMac is a trademark of SuperMac Technology SuperEGA million SuperVGA and SuperVGA II/III are trademarks of Genoa Systems Corporation. Orchid Designer VGA Orchid Designer VGA-2 TurboEGA and TurboVGA are trademarks of Orchid Technology. Paradise VGA Professional Card Paradise VGA Plus Card and AutoSwitch EGA are trademarks of Paradise Systems Inc. Paradise Systems is a registered trademark of Paradise Systems Inc. VEGA Deluxe and VEGA VGA are trademarks of Video Seven Inc. Metheus is a registered trademark of Metheus Corporation. Imagraph is a trademark of Imagraph Corporation. AutoCAD is a registered trademark of Autodesk Inc. SEM is a registered trademark of Digital Research Inc. L3704 and 1-2-3 are registered trademarks of Lotus Development Corporation. SigmaVGA and SigmaEGA are trademarks of Sigma designs, Inc. FLEXSCAN is a trademark of NANA O CORPORATION. NANA O is a registered trademark of NANA O CORPORATION.



The Painlessly Portable PC

NEC packs power into a seductive little package, but for a price

Mark L. Van Name
and Bill Catchings

NEC's new UltraLite is just plain cute. Its sleek black finish looks modern, while in size and shape it resembles a large hardcover book—and it's not much harder to carry. The 4 $\frac{3}{4}$ -pound UltraLite fits into any briefcase, or you can use its optional carrying case. (See photo.)

You pay a pretty price, however, for this tiny MS-DOS machine: The basic UltraLite runs \$2999, while our fully loaded evaluation unit (with \$129 carrying case) would set you back \$4526. Since a comparably equipped Toshiba T1000 lists for around \$1700, we're talking about a stiff price premium.

Taking It on the Road

The first things to check on any portable computer are its screen and its keyboard. The UltraLite scores well on both fronts.

The screen is a backlit, supertwist, electroluminescent, blue-on-white display with a full 25 rows by 80 columns in a 9 $\frac{1}{2}$ -inch-diagonal viewing area. It emulates IBM's CGA, with seven gray scales instead of colors.

The screen is nearly twice as wide (8 $\frac{1}{4}$ inches) as it is tall (4 $\frac{1}{4}$ inches), so its aspect ratio is a bit distorted (e.g., circles appear as ovals). The display phosphors decay so slowly that the screen is almost impossible to read when it scrolls. And it does not fare well in bright light or glare.

The keyboard, like the screen, is adequate. Its keys are full size with an audi-



The NEC UltraLite weighs in at only 4 $\frac{3}{4}$ pounds but offers greater performance than an IBM PC XT.

ble keyclick. While the keys travel only 2 millimeters (more than 1 mm less than the keys on most conventional keyboards), you can feel them spring back.

The 78 keys are arranged well, with a row of function keys across the top and the numeric keypad overlaid onto other keys. As with most portables, you get to the numeric keypad and other special keys by using an Fn key. Unfortunately, NEC followed the IBM Enhanced keyboard and put the Caps Lock key where our fingers expect the Control key to be.

Overall, we give the screen and keyboard a high B: not great, but adequate.

Storage Options

The next priority with any portable computer is its disk storage. The UltraLite of-

fers several different disk options.

Its main working storage is a "silicon hard disk drive," a battery-backed 1 or 2 megabytes of DRAM with firmware that superbly emulates a hard disk drive. This drive acts as the UltraLite's C drive. It appears to have 58 cylinders, four heads, and 17 sectors per track. Such disk utilities as the Norton utilities have no trouble recognizing it as a hard disk drive.

It's extremely fast (average access time is 9 milliseconds), and it makes the entire machine feel quicker than you would expect. While even 2 megabytes is not a lot of disk space, it's enough for one or two applications and their data.

Of course, you have to be able to load and back up the silicon hard disk drive.

continued

UltraLite

Company

NEC Home Electronics (U.S.A.), Inc.
Computer Products Division
1255 Michael Dr.
Wood Dale, IL 60191
(312) 860-9500

Components

Processor: 9.83-MHz NEC V30

Memory: 640K bytes of 120-ns DRAM on motherboard; 128K bytes of BIOS ROM

Mass storage: 1- or 2-megabyte silicon hard disk drive; optional external 1.44-megabyte 3½-inch floppy disk drive; optional 256K-byte RAM card; optional ROM software cards

Display: Backlit, supertwist, electroluminescent, blue-on-white LCD with CGA emulation via seven gray scales; CGA support on the motherboard

Keyboard: 78 keys in IBM Enhanced layout; indicator lights on Caps Lock and Num Lock keys; uses Fn key to provide numeric keypad and page keys

I/O interfaces: One RS-232C serial port with mini-DIN-9 connector; two RJ-11 connectors for the built-in modem's telephone and line inputs; one mini-DIN-8 connector for the AC power adapter; one 68-pin NEC-proprietary connector for the external disk drive

Size

11¼ × 8½ × 1¾ inches; 4¾ pounds

Software

MS-DOS 3.3 (subset); MS-DOS Manager 2.0; LapLink 2.16a; SETUP program

Documentation

Quick-start guide; portable guide; comprehensive user's manual

Price

UltraLite with 1-megabyte silicon hard disk drive: \$2999

UltraLite with 2-megabyte silicon hard disk drive: \$3699

System as reviewed: \$4526

Inquiry 853.

NEC offers four ways to get those jobs done. The simplest is the optional external 1.44-megabyte 3½-inch disk drive, which NEC calls its FDD-BOX (\$399). The FDD-BOX is 4¼ inches wide, 6¾ inches deep, and 2 inches high, and it weighs a little under 2 pounds. It connects to a 68-pin NEC-proprietary external connector on the rear of the UltraLite and appears as the machine's A drive.

Unfortunately, the FDD-BOX draws its considerable power from the Ultra-

Lite. Therefore, you can use the drive only when the UltraLite is running off the standard-equipment AC power adapter that plugs into a mini-DIN-8 connector on the rear of the machine.

Inside the FDD-BOX is a TEAC floppy disk drive. Under that drive is an NEC 4- by 6-inch floppy disk drive controller that uses Western Digital's controller chip and about 16 support chips. The FDD-BOX also has a standard female DB-25 parallel connector on its rear, to which you could attach a printer.

We don't see how anyone would want to live with any machine without a disk drive, but it is possible. For one thing, you can transfer files to another machine. NEC includes Traveling Software's LapLink program in the UltraLite's ROM. (The ROM appears as the UltraLite's D drive.) Because you also need a copy of LapLink on the other machine, the UltraLite comes with both 3½-inch and 5¼-inch LapLink disks.

You can hook up to another machine with the null-modem cable that is included. This cable has a female DB-25 serial connector that hooks up to the second machine. The connector appears to the UltraLite as its COM1 serial port. Unfortunately, you have to use that specific cable, because the UltraLite's RS-232C connector is a nonstandard mini-DIN-9 jack. While there seems to be enough room for a standard DB-9 connector, an NEC spokesperson said that the firm chose the smaller nonstandard connector to save space.

While the disk drive and LapLink are the UltraLite's two main links to the outside world, NEC offers two others that involve a tiny expansion slot under a cover on the right side of the unit. This slot accepts RAM and ROM cards that are the width and length of credit cards but about twice as thick. NEC offers both 256K-byte battery-backed RAM cards (\$299 each) and ROM cards. Both types appear to the UltraLite as its B drive. You can pull these cards out and insert new ones while the machine is running, as you would with floppy disks. The 256K-byte RAM card uses a replaceable 3-volt lithium battery that NEC claims is good for up to 6 months.

NEC says that it will offer both 512K-byte and 1-megabyte ROM cards containing such applications as Lotus 1-2-3 and WordPerfect. NEC was unable to furnish us with any ROM cards by our deadline, however, and only time will tell how many companies will produce software on this nonstandard medium. (An NEC spokesperson said that the firm was to begin shipping ROM cards in

June and estimated that they will cost roughly the normal price of the software they contain plus \$50 for the card itself.)

The UltraLite also includes an internal 2400-bps Hayes-compatible modem hooked to its COM2 serial port. There are two standard RJ-11 connectors on the rear of the machine with which you can link the modem to a phone jack and a telephone. The UltraLite includes cables for both connections.

Compatibility and Performance

The UltraLite ran everything we threw at it, including Borland's Quattro 1.0, Reflex 1.14, SideKick 1.56a, SuperKey 1.16a, Turbo Basic 1.1, Turbo C 2.0, and Turbo Pascal 4.0; Digital's Smalltalk/V 1.2; Kermit 2.30; MicroPro's WordStar 3.3 and 4.0; Microsoft's PC Paintbrush 2.0 and Word 4.0; the Norton Utilities 3.00; Quarterdeck's DESQview 2.0; and Symantec's Q&A 1.0.

The UltraLite supports these applications with a subset of MS-DOS 3.3 that is built into its D-drive ROM. That ROM also contains Microsoft's MS-DOS Manager 2.0, a good but not outstanding DOS shell, and a SETUP program. The system boots into the MS-DOS Manager by default, but you can have it go straight to MS-DOS by changing a line in the standard AUTOEXEC.BAT file.

SETUP runs as a TSR program. With it you can choose the boot disk, set the CPU speed, and change several screen options, the most interesting of which is a color palette that lets you determine how the UltraLite maps the 16 possible CGA colors to its seven gray shades.

While the UltraLite is in many ways a portable XT compatible, it offers far better than IBM XT performance. Its extremely fast silicon hard disk drive helps a lot. Its CPU, a 9.83-MHz NEC V30 with a compatibility speed of 4.92 MHz, also performs well; the UltraLite's 640K bytes of system RAM uses eight 1-megabit 120-nanosecond DRAM chips that let the V30 run with no wait states. The combination gives the machine the feel of an AT with a very fast hard disk drive.

The BYTE disk I/O benchmarks did show an anomaly on the 32-sector DOS Seek test. The time of 90.40 seconds does not match up with the single-sector time of 3.48 seconds. A spokesperson for NEC suggested that the result could have occurred because the UltraLite emulates a hard disk drive controller using software that calculates a checksum for each sector. The algorithm for generating these checksums may have been at fault. In our side-by-side comparisons with

continued



NEC UltraLite

APPLICATION-LEVEL PERFORMANCE

NEC UltraLite **3.2***

WORD PROCESSING

XyWrite III+ 3.52	Medium/Large
Load (large)	22
Word count	08/1:00
Search/replace	:14/:49
End of document	:04/:26
Block move	:22/:22
Spelling check	:25/3:09
Microsoft Word 4.0	
Forward delete	43
Aldus PageMaker 1.0a*	

Index: 1.00

SPREADSHEET

Lotus 1-2-3 2.01

Block copy	10
Recalc	:04
Load Monte Carlo	:41
Recalc Monte Carlo	:20
Load riarge3	10
Recalc riarge3	:03
Recalc Goal-seek	12

Microsoft Excel 2.0

Fill right	13
Undo fill	6:27
Recalc	05
Load riarge3	1:04
Recalc riarge3	04

Index: 0.90

DATABASE

dBASE III+ 1.1*	N/A
Index:	N/A

SCIENTIFIC/ENGINEERING

AutoCAD 2.52

Load SoftWest	6:35
Regen SoftWest	6:15
Load StPauls	1:53
Regen StPauls	1:43
Hide/redraw	85:43

STATA 1.5

Graphics	2:38
ANOVA	1:49

MathCAD 2.0

IFS 800 pts	3:34
FFT/IFFT 1024 pts	4:15

Index: 0.35

COMPILERS

Microsoft C 5.0

XLisp compile	10:34
---------------	-------

Turbo Pascal 4.0

Pascal S compile	10
------------------	----

Index: 0.99

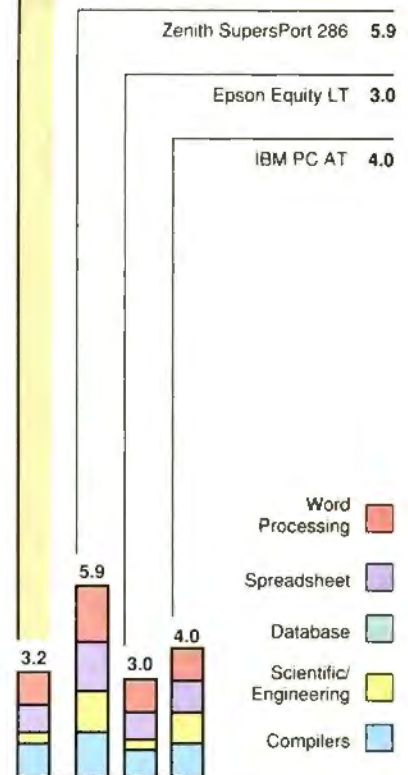

All times are in minutes:seconds. Indexes show relative performance. For all indexes, an 8 MHz IBM PC AT=1.

*Due to the limited space on the UltraLite's silicon hard disk drive, we were unable to run every application test of the BYTE benchmarks. Tests using Aldus PageMaker and dBASE III Plus were omitted. We also omitted the results of those tests for the systems used for comparison and adjusted their application indexes accordingly.

LOW-LEVEL PERFORMANCE¹

NEC UltraLite

CPU

Matrix	15:75
String Move	
Byte-wide	86:53
Word-wide:	
Odd-bnd.	86:49
Even-bnd.	43:32

Sieve	83:51
Sort	67:04

Index: 0.93

FLOATING POINT

Math	N/A
Error ²	

Sine(x)	N/A
Error	

e^x	N/A
Error	

Index: N/A

DISK I/O

Hard Seek³	
Outer track	1:36
Inner track	1:34
Half platter	1:28
Full platter	1:32
Average	1:33

DOS Seek	
1-sector	3:48
32-sector	90:40

File I/O⁴	
Seek	0:40
Read	0:93
Write	0:96

1-megabyte	
Write	11:70
Read	11:29

Index: 1.42

VIDEO

Text	
Mode 0	14:83
Mode 1	14:83
Mode 2	14:76
Mode 3	14:76
Mode 7	N/A

Graphics	
CGA:	
Mode 4	6:16
Mode 5	6:19
Mode 6	6:46

EGA:	
Mode 13	N/A
Mode 14	N/A
Mode 15	N/A
Mode 16	N/A

VGA:	
Mode 18	N/A
Mode 19	N/A
Hercules	N/A

Index: 0.80

CONVENTIONAL BENCHMARKS

LINPACK	7154:48
Livermore Loops ⁵ (MFLOPS)	0:00
Dhrystone (MS C 5.0) (Dhry/sec)	1422

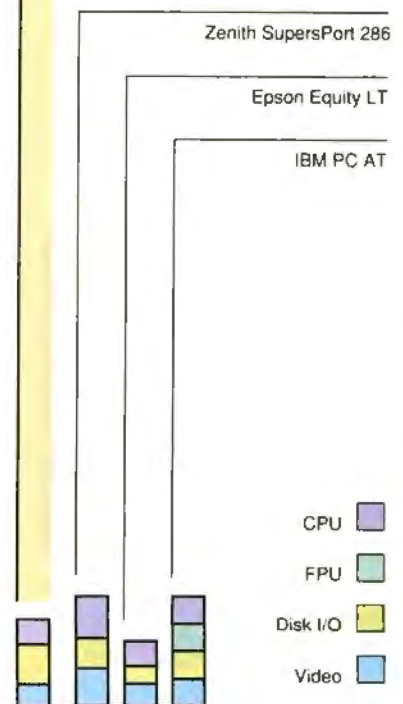

N/A=Not applicable

¹ All times are in seconds. Figures were generated using the 8088/8086 version (1.1) of Small-C.

² The errors for Floating Point indicate the difference between expected and actual values, correct to 10 digits or rounded to 2 digits.

³ Times reported by the Hard Seek and DOS Seek are for multiple seek operations (number of seeks performed currently set to 100).

⁴ Read and write times for File I/O are in seconds per 64K bytes.

⁵ For the Livermore Loops and Dhrystone tests only, higher numbers mean faster performance.

Complete Communications. ONE Software Package.



PC, MAC, UNIX, XENIX, VAX, and more. 30 popular operating systems. Connect and manage file transfers around the office or around the world.

RIGHT OUT OF THE BOX

Use regular modems, V.32, new high speed modems, X.25, LANs . . . BLAST makes them all compatible.

FOR INSTANT NETWORKS

Link two computers or 2000 . . . with

- One easy, identical interface
- One set of commands
- One powerful script language
- One reliable program

WITH ALL THE FEATURES

- Bulletproof file transfer
- Terminal Emulators - VT 100/220, etc.
- Scripting for customized routines
- PC to PC Remote Control
- Fully automated operation
- Unbeatable noise resistance

IN GOOD COMPANY

- Over 50,000 users worldwide
- Top-Notch technical support

Call 800-24-BLAST

APPLE	MAGINTOSH
IBM PC-XT, AT, PS/2	MS-DOS, SCO XENIX, UNIX V
UNIX Systems	UNIX V3.4.2, 386
DEC	VMS, RSX, RT-11, ULTRIX
BATA GENERAL	DOS, MPOS, RDOS, AOS/V5
HARRIS	VOS, UNIX, XENIX
HEWLETT-PACKARD	MPE, RTE, UNIX
IBM	VME/CMS/MVS/TSD
PRIMO	PRIMO
UNIST	BTOS, CTOS, UNIX
WARR	V5 OS, MS-DOS
. . . plus many more	

BLAST

Communications Research Group

5615 Corporate Blvd. • Baton Rouge, Louisiana 70808
(504) 923-0888

conventional hard disk drives, however, the UltraLite's silicon hard disk drive performed well and showed no signs of a bottleneck.

Interestingly, the V30 is socketed on the motherboard, so perhaps NEC plans some future CPU upgrade. However, the UltraLite has no coprocessor socket.

The UltraLite's ROM BIOS is Phoenix Technologies' version 2.52, so the machine should not have any compatibility problems there.

Our Microsoft Serial Mouse worked fine with the unit, although we needed a DB-9-to-DB-25 adapter to connect it to the machine's null-modem cable.

Nice, but for How Long?

The final key aspect of any battery-driven portable computer is its battery life—how long you can go between recharges. With the UltraLite, that's actually a two-part issue.

The main system power comes from a rechargeable nickel-cadmium "battery" that is actually a collection of seven Molicel nickel-cadmium batteries wired together. This battery is supposedly good for about 2 hours with the basic UltraLite. On our fully loaded evaluation unit, however, we got only 1 hour and 25 minutes of constant use before the first warning message. Fortunately, that message and the accompanying low-battery indicator light come about 5 minutes before you actually run out of power, so you can save your work.

The other half of the UltraLite's battery picture is a separate rechargeable nickel-cadmium battery that supports the silicon hard disk drive. It's good for five to seven days between charges.

The UltraLite's batteries are one of the machine's biggest frustrations. An hour and a half just isn't enough time. We could live with it, however, if we could just carry a few spare batteries. There are even openings on the bottom of the unit for both batteries. Unfortunately, you can't replace the batteries yourself. This is clearly an area for NEC to improve in the next UltraLite.

A Peek Inside

To get a better look inside, you can take the UltraLite apart. We did, but you definitely need to be careful. This little wonder is packed tightly.

Its motherboard sits under the ultra-thin keyboard. The board is essentially the same width and length as the case, with cutouts for a system ROM card and the silicon hard disk drive card, both of which you can reach via covers on the bottom. The board has fewer than 30

chips, including the eight memory chips. Fewer than a dozen chips do most of the work. In fact, on this board the analog devices and support parts (such as capacitors) almost outnumber the digital parts.

Documentation and Support

The UltraLite's three manuals are all useful and very well written. The quick-start manual is a model for books of its kind. Even novice users can follow its clear instructions easily, and it uses pictures frequently and effectively. The portable guide, which is also very well done, contains most of the data you need on the road.

The comprehensive user's manual is a thorough reference guide to all of the system's capabilities. It does not, however, contain a complete MS-DOS reference section; if you want that, the manuals suggest that you buy an MS-DOS book.

If you need help, you can call NEC technical support toll-free. Unfortunately, while we found the technical-support number in several NEC ads, it was not in the manuals. (An NEC spokesperson said that this problem has been corrected in subsequent printings of the manuals.) The warranty information in the comprehensive user's manual listed a number to call with problems other than repairs, and you can get from that number to technical support. The technical-support people with whom we talked were friendly and helpful. Expect to wait for them, however, as NEC's lines were usually busy when we called.

The UltraLite includes a one-year warranty, and you can buy up to three additional years of protection for \$300 per year for a unit with a 1-megabyte silicon hard disk drive, or \$370 per year for the 2-megabyte version.

Sleek and Expensive

The UltraLite clearly defines a new size standard for portable MS-DOS computers; no other machine comes close. It looks great and doesn't weigh much.

Unfortunately, it is also extremely expensive. You can buy some 80386 portables for almost the same money. In the end, you have to decide how you want to look at it: Are you getting a lot of computer for the size, or not enough computer for the money? We don't know how you would vote, but we both wish that we could afford an UltraLite. ■

Mark L. Van Name and Bill Catchings are independent consultants and freelance writers based in Raleigh, North Carolina. They can be reached on BIX as "mvanname" and "wbc3," respectively.

Our Swans make waves.



Swan XT10

The perfect budget-priced home computer. A solid, reliable, compatible performer.

\$549

Base System with Single Floppy. No Video

XT10 Drive Options	VIDEO OPTIONS Include Monitor & Video Adapter			
	Mono*	CGA	EGA	VGA
Single Floppy	\$699	\$869	\$1098	\$1198
Dual Floppies	\$779	\$949	\$1178	\$1278
*w/20MB (65ms) Hard Drive	\$979	\$1149	\$1378	\$1478
*w/32MB (40ms) Hard Drive	\$979	\$1149	\$1378	\$1478

* Includes Single 360K Floppy Drive

* Upgrade from 12" to 14" Flat Screen, add \$49



Swan 286/12

You probably never thought you could get into a reliable business system this inexpensively. But with the 286/12, you can. Now.

\$999

Base System with Single Floppy. No Video

286/12 Drive Options	VIDEO OPTIONS Include Monitor & Video Adapter			
	Mono	14" Flat Mono	EGA	VGA
w/32MB (40ms) & 1:1 Interleave	\$1399	\$1448	\$1798	\$1898
w/40MB (28ms) & 1:1 Interleave	\$1499	\$1548	\$1898	\$1998
w/80MB (28ms) & 1:1 Interleave	\$1849	\$1898	\$2248	\$2348

* Items returned must be as-new, without modification or damage. Sorry - shipping charges and upgrade fees are not refundable.

** Custom configured systems may take longer.

Circle 259 on Reader Service Card

The Swan line of computers is creating waves of excitement among computer users. One reason is price. Swan computers are true bargains, offering you the most for your investment. But price alone doesn't tell the complete value story.

Swan computers are solid, reliable performers... assembled by Tussey Computer Products, a solid, reliable company with a tradition of unsurpassed customer satisfaction.

Swan computers are highly compatible. In fact, all Swan computers offer the top-rated Phoenix ROM BIOS to assure 100% PC compatibility.

And the benefits keep coming, wave after wave...

- 30-day satisfaction guarantee
- Toll-free technical support
- Full 1-year warranty
- Fast, sure delivery
- SorbusSM on-site service option

Swan offers a full line of services tailored to the needs of educational and corporate computer users. Call our Educational & Corporate Sales Department toll-free at 1-800-468-9044. Learn how a Swan can be a business animal... or a teacher's pet.

With their compatibility, reliability, performance and value, Swans are making waves in the computer industry. Waves that may make some competitors run for safer ground.

Standard Features	XT10	286/12	386SX	386/20D
CPU	8088-1	80286	80386SX	80386
Speed (MHz)	10/4.77	12/6	16/8	20/8
BIOS	Phoenix	Phoenix	C & T	Phoenix
Norton SI Rating v 4.0	2.1	11.2	17.6	22.0
Wait State	0	0	0	0
Standard Memory	640K	512K	1MB	1MB
Shadow BIOS	—	—	—	384K
Memory Upgrades	—	1MB	1.5/2/3/5/6/8MB	2/4/8/16/16MB
Coprocessor Support	8087	80287	80387SX	80287 or 80387
Expansion Slots: 32-bit	—	—	—	1
Expansion Slots: 16-bit	—	6	6	4
Expansion Slots: 8-bit	8	2	2	3
Dual HD/FD Controller	w/HD systems	Yes	Yes	Yes
Device Bays (Expansion/Internal)	2 Exp./2 Int.	3 Exp./2 Int.	3 Exp./1 Int.	3 Exp./2 Int.
Serial Ports	1	1	1	2
Additional I/O Ports	1 Parallel and 1 Game Port			
Power Supply	150W	200W	200W	200W
Keyboard	101 Key	101 Key	101 Key	101 Key
Additional Features	Clock Calendar w/Battery Backup and Setup/Utilities Disk			
OPTIONS:	XT10	286/12	386SX	386/20D
3.5" Floppy Drive	Optional	Your choice	Your choice	Your choice

Swan/MS-DOS & GW BASIC add \$89

Order Now Toll-Free

1-800-468-9044

FAX:814-237-4450 • International:814-234-2236

To order: No surcharge on Discover, Visa, MasterCard or AMEX
 • Your credit card is not charged until your order is shipped.
Shipping: 3% or \$5 minimum for UPS Ground. Call for shipping charges on Express Air, APO, FPO, AK, HI and all foreign orders.
 • Allow 2 weeks for personal and company checks to clear.
 • Defective items replaced or repaired at our discretion. PA deliveries add 6% sales tax. Prices and terms subject to change without notice. **Open:** 8a.m.-11p.m. M-F, 10p.m.-8p.m. Sat, 12p.m.-8p.m. Sun



a division of
tcp

TUSSEY COMPUTER PRODUCTS

3075 RESEARCH DRIVE • STATE COLLEGE, PA. • 16801



Swan 386SX

This system gives you 386 compatibility, power and performance... at a 286 price.

\$1499

Base System with Single Floppy. No Video

386SX Drive Options	VIDEO OPTIONS Include Monitor & Video Adapter			
	Mono	14" Flat Mono	VGA Mono	VGA Color
w/32MB (40ms) & 1:1 Interleave	\$1899	\$1948	\$2098	\$2398
w/40MB (28ms) & 1:1 Interleave	\$1999	\$2048	\$2198	\$2498
w/80MB (28ms) & 1:1 Interleave	\$2349	\$2398	\$2548	\$2848
w/150MB (17ms) ESDI w/1:1 Interleave	\$2994	\$3043	\$3193	\$3493

Upgrade to 2MB only \$396



Swan 386/20D

"Tussey's Swan 386/20 flies."

— Computer Shopper, April 1989

Gracefully combining power and performance, this Swan has soared to the upper limits of today's technology.

\$1999

Base System with Single Floppy. No Video

386/20D Drive Options	VIDEO OPTIONS Include Monitor & Video Adapter			
	Mono	14" Flat Mono	VGA Mono	VGA Color
w/40MB (28ms) & 1:1 Interleave	\$2549	\$2598	\$2748	\$3048
w/80MB (28ms) & 1:1 Interleave	\$2849	\$2898	\$3048	\$3348
w/150MB (17ms) ESDI w/1:1 Interleave	\$3494	\$3543	\$3693	\$3993

Upgrade to 2MB only \$436

Because Resources Should Be Shared

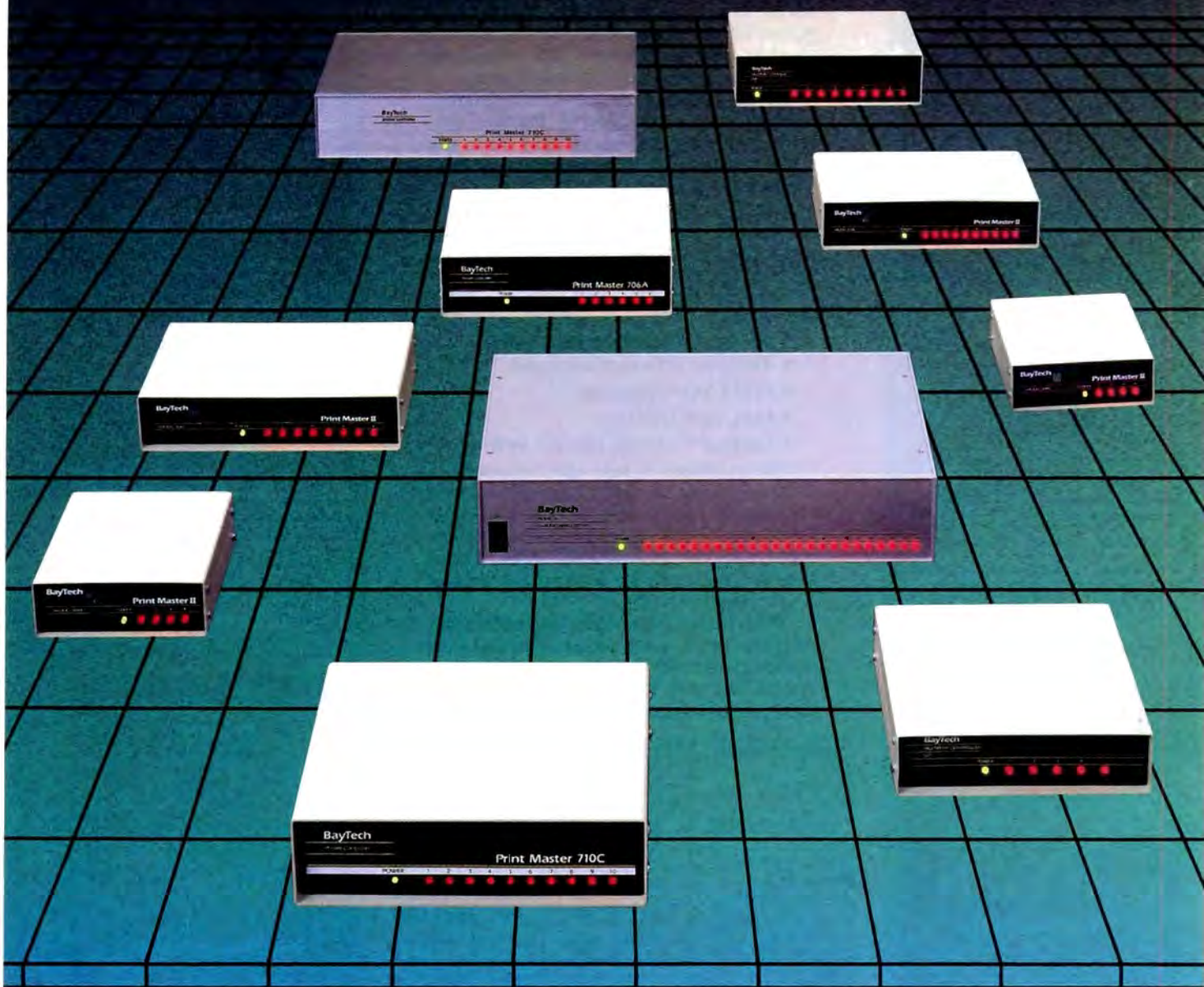

BayTech engineers resource sharing solutions.

Because we know your applications for sharing printers, plotters, modems and data are unique, BayTech has developed over 30 resource sharing products, which offer you a broad range of solutions for sharing your resources.

We realize that you shouldn't have to fit your application to the specifications of a single product. With BayTech, you select the

model that meets *your* needs.

From simply sharing one or more printers between computers, to creating a complete network of computers, printers, plotters and modems, BayTech has a product designed for you.

Call us toll-free today. Our technical support staff will show you how to make the most of your resources.



Bay Technical Associates, Inc.
Data Communications Products Division
200 N. Second Street, P.O. Box 387
Bay St. Louis, MS 39520 USA
FAX: 601-467-4551
Telex: 910-333-1618 BAYTECH
Phone: 601-467-8231 or toll-free

800-523-2702



Ultra Graphics

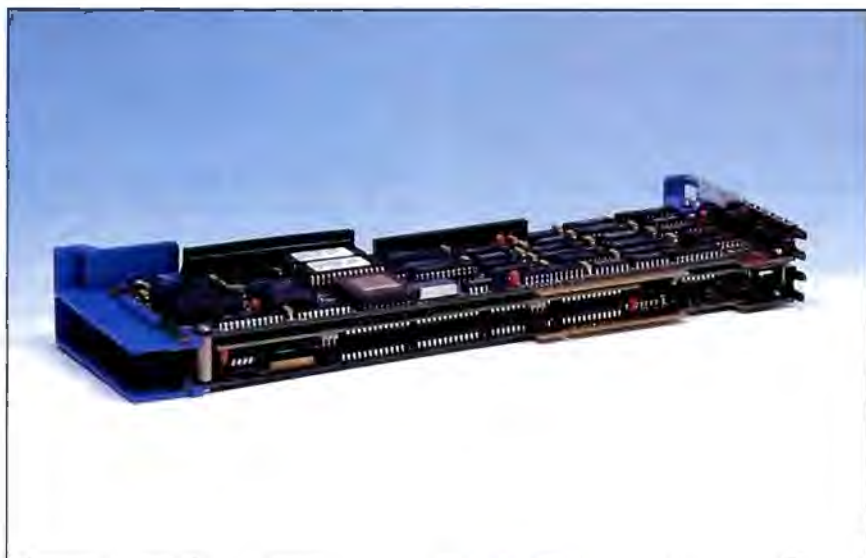

The Ultra Clipper UM1280, Pixelworks' bus-mastering coprocessor, brings enhanced graphics to MCA-compatible computers

Bradley Dyck Klierer

Pixelworks has taken a big step in the Micro Channel market by becoming one of the first companies to introduce a high-resolution (1280- by 1024-pixel) bus-mastering graphics controller for the PS/2s, the Ultra Clipper UM1280. As a bus-mastering device, the Ultra Clipper can take temporary control of the bus and directly transfer data without intervention from the CPU. This improves system throughput by leaving the CPU free for other tasks.

The Ultra Clipper requires a Micro Channel-compatible bus with two empty slots. Depending on the configuration, you need either a 30- to 64-kHz multifrequency monitor (when using a single monitor for both the VGA and Ultra Clipper high-resolution display) or separate VGA and 64-kHz monitors.

The board is available in two configurations: a 4-bit, 16-color version (\$2895), and an 8-bit, 256-color version (\$4095). Each includes a Texas Instruments 320C25 chip—a more general-purpose processor than the 34010 and better suited to the programming needs

of the Ultra Clipper. The 8-bit board contains 1.25 megabytes of display RAM—just enough to hold the graphics data for a 1280- by 1024-pixel by 8-color display (the 4-bit-plane model has half as much memory).

The Ultra Clipper is clearly targeted for CAD markets; the only drivers supplied with my board were for AutoCAD (ADI drivers for releases 9 and 10), VersaCAD, and Bentley Microstation.

Dual-Slot Configuration

Installing the Ultra Clipper is fairly easy. The board includes two switch blocks for specifying monitor types, and it requires two adjacent slots (any two Micro Channel slots will work, including mixed slots—one 16-bit and one 32-bit). The installation program, which you copy onto the IBM installation disk, performed flawlessly. You can use the Ultra Clipper in a two-monitor system (the best option), or you can install a pass-through cable between the VGA output and the Ultra Clipper to use a single monitor.

I tested the 8-bit-plane (256-color) Ultra Clipper on a 20-MHz IBM PS/2 Model 70-121 running DOS 3.3 with a Mitsubishi HL 6905 multifrequency monitor. When I configured the board as a single-monitor system, the Model 70 failed its self test, generating a video adapter error. But when I bypassed the error message, the system worked perfectly. IBM has modified the monitor detection routines in some PS/2 models, and the system wasn't detecting a valid monitor type (the VGA output connects to the pass-through adapter instead of to the monitor). Pixelworks sent a new pass-through daughterboard that changed the resistance slightly, solving the problem.

Unlike graphics coprocessors that are I/O-mapped, the Ultra Clipper can work in either I/O- or memory-mapped mode. In I/O-mapped applications, all the drawing commands pass through the I/O

continued



PS/2® MEMORY

Introducing OS/RAM4™.

- ✓ 4 megabytes of memory.
- ✓ Extended and expanded memory. LIM 4.0.
- ✓ Works with all of your programs.
- ✓ Run DOS or OS/2 effortlessly.
- ✓ Fast and simple switchless installation.
- ✓ Auto-configuration for all operating systems.
- ✓ Works in all Micro Channel™ computers.
- ✓ Expanded memory 10 times faster than Intel.
- ✓ Risk free guarantee. Two year warranty.
- ✓ IBM approved ID. \$349 0K.

Call today 1-800-234-4232 or 617-273-1818

cec Capital Equipment Corp.
Burlington, MA. 01803

PS/2 and Micro Channel are trademarks of IBM

registers, which typically run at a slower speed than memory. In memory-mapped mode, the PC stores lists of drawing commands and parameters in a memory buffer; the Ultra Clipper then uses its bus-mastering capability to process the display list directly from PC memory. The processing benefits both from the faster speed of memory and from the lack of system CPU overhead.

When using memory buffers, the board further improves performance through double buffering. The application reserves two areas in system memory to act as command buffers. While the CPU writes commands to one memory buffer, the Ultra Clipper reads commands from the other. The Pixelworks

PHLIP (Pixelworks High-Level Interactive Protocol) libraries, which are available for several C compilers, provide functions that make writing double-buffered programs simple. I ran tests in both unbuffered and buffered modes (the buffered modes used two 2K-byte buffers); the speed difference can be dramatic.

The Ultra Clipper's graphics commands create an entire programming language of sorts, supporting NOOPs (no operations), rudimentary flow control, and comments. The graphics instructions are rich: In addition to the

basic points, polylines, polygons, and text, the Ultra Clipper supports circles, ellipses, arcs, and Bézier curves. You can also specify points, polylines, polygons, and Bézier curves in three-dimensional coordinates, and there are functions for modifying the view. The Ultra Clipper also provides BitBlt functions for transferring data between the system and adapter memory or for copying data from one screen area to another.

Programming the Ultra Clipper is simple. The PHLIP documentation (available on request) includes program fragments with most of the function-call descriptions, and the descriptions are fairly complete. The documentation includes several complete program listings that are useful for learning PHLIP.

Performing Arts

I adapted the test programs from the BYTE graphics benchmarks and compiled them with Microsoft C 5.1. The programs are similar to those used for my review of the IBM 8514/A and Artist 10 MC graphics boards ("Pixels on the March," January BYTE). To test memory transfer speeds, I also adapted the BITBLT program from the review "Debunking 16-bit VGA" (June BYTE).

The test results, which appear in tables 1 and 2, were remarkable. The detail available in AutoCAD is impressive, and the proportionally spaced roman font used for the menus is attractive. For graphics-intensive work, the Ultra Clipper outperforms both the IBM 8514/A and the Artist 10 MC. And, as with any graphics coprocessor, drawing commands execute hundreds of times faster than standard graphics adapters such as EGA and VGA. AutoCAD times are about the same for VGA and Ultra Clipper, but the Ultra Clipper displays over

Table 1: BYTE benchmark results for the Ultra Clipper UM1280. Benchmark times are in minutes:seconds.

	AutoCAD
SoftWest	
Load and draw	1:51.5
Regen	0:34.8
Redraw	0:02.1
StPauls	
Load and draw	0:20.3
Regen	0:06.1

Table 2: BITBLT test results. Times are in seconds. BITBLT copies an 8- or 16-pixel by 1-line block from one screen area to another. The BITBLTP tests copy the same information from system memory to the screen. The BITBLT2 tests perform the same functions using an 8- by 8-pixel or 16- by 16-pixel block. Note the faster times for the BITBLT2 tests, which require fewer instructions to fill the screen.

	Unbuffered	Buffered
BITBLT-8	45 14	24 38
BITBLTP-8	52 89	31 47
BITBLT2-8	11 15	8 46
BITBLT2P-8	28 78	16 40
BITBLT-16	23 46	13 13
BITBLTP-16	27 68	16 97
BITBLT2-16	5 27	4 50
BITBLT2P-16	9 50	8 68

four times as many pixels, and when you remove system overhead (using REDRAW instead of REGEN), the Ultra Clipper is over twice as fast.

Ultra Clipper's primary disadvantage is its physical design. It uses several daughtercards (looking down on the card, there are three layers of boards), which requires two slots in the host computer. For users of the Model 70 or Model 50, this leaves only one slot free. The monitor connection uses a 9-pin D-shell instead of the 15-pin D-shell that IBM uses for PS/2 video connections (a 15-pin connector is too thick to fit between the sandwiched boards). And on single-monitor configurations, the pass-through cable adds an extra cord outside the system unit.

Using a pass-through cable is an understandable design decision. It simplifies the design of the Ultra Clipper, since Pixelworks doesn't need to replicate the VGA D/A converter, which could potentially create minor incompatibilities with the VGA. Also, a video extension would limit the Ultra Clipper to one position in the machine—not a desirable option when the board requires two slots.

A Niche Fit

On Micro Channel systems that have several free slots, I wouldn't hesitate to recommend the Ultra Clipper. But on smaller systems, such as the Model 70, consider your expansion needs carefully. Adding a single card would fill the system. I typically add either a tape backup or a network card, which would leave no room for additional memory (not as big a concern on the Model 70, which can take up to 8 megabytes on the system board) or other options.

The Ultra Clipper is far superior to high-resolution VGA. It's also competitively priced with other graphics coprocessor boards, with the exception of the IBM 8514/A, which costs about \$2700 less. However, the Ultra Clipper has some advantages over the 8514/A. Its 1280- by 1024-pixel noninterlaced display is much sharper. Also, the board's bus-mastering capabilities and its extensive drawing primitives give the Ultra Clipper a potential performance advantage over other coprocessor boards when it's used with CAD packages that support the board's hardware-level primitives (currently, PCAD, for which Pixelworks is developing drivers, is the only CAD package that supports advanced hardware primitives).

Advances in software always lag behind hardware, so you probably won't see commercial software supporting the



PS/2[®] MEMORY

Introducing OS/RAM8™

- ✓ 8 Mbytes of memory + 2 serial ports.
- ✓ Extended and expanded memory. LIM 4.0.
- ✓ Works with all of your programs.
- ✓ Run DOS or OS/2 effortlessly.
- ✓ Fast and simple switchless installation.
- ✓ Auto-configuration for all operating systems.
- ✓ Works in all Micro Channel™ computers.
- ✓ Expanded memory 10 times faster than Intel.
- ✓ Risk free guarantee. Two year warranty.
- ✓ IBM approved ID. Best price. Fast delivery.

Call today 1-800-234-4232 or 617-273-1818



Capital Equipment Corp.
Burlington, MA. 01803

PS/2 and Micro Channel are trademarks of IBM

Ultra Clipper UM1280

Company

Pixelworks, Inc.
7 Park Ave.
Hudson, NH 03051
(800) 247-2476
(603) 880-1322

Features

Maximum 1280- by 1024-pixel resolution, noninterlaced; 16 colors from a palette of 4.096 million (4-bit board), or 256 colors from a palette of 16.7 million (8-bit board); three-dimensional support, including real-time pan and zoom; driver software for AutoCAD, VersaCAD, and Bentley Microstation CAD programs

Size

Full-length (requires 2 slots)

board's more advanced features for some time. But if you write your own graphics routines for custom applications, the Ultra Clipper is a terrific combination of high resolution, powerful graphics primitives, and easy-to-program routines. ■

Editor's note: *The test programs used for this review are available on BIX as Clipper.ARC. They're also available in a va-*

riety of other formats. See page 5 for details.

IBM PS/2 Micro Channel or compatible computer, 64-kHz monitor and VGA-compatible monitor (for dual-monitor system), or 30- to 64-kHz multifrequency monitor for VGA pass-through (for single-monitor system)

Software Needed

DOS 3.3 or higher

Documentation

Installation manual, PHLIP programmer's guide (available on request)

Price

4-bit (16 colors) \$2895
8-bit (256 colors) \$4095

Inquiry 852.

Bradley Dyck Kliever is the author of EGA/VGA: A Programmer's Reference Guide (McGraw-Hill, 1988) and principal of DK Micro Consultants, a micro-computer consulting business in Bloomington, Indiana. You can reach him on BIX as "bkliever."

*By popular demand,
we've extended this program.*

FREE* SIVA 386 SYSTEM

*with the purchase of \$3295++
of software or \$5495++ of
hardware.*

Standard 386 Features:

- 32-bit Intel 80386-16 CPU.
- 1MB of 32-bit RAM on board. System expandable to 16MB.
- 8/16/20 MHz Keyboard selectable.
- ST-251-1 Seagate 40MB Formatted 28 ms high speed, with ultra high speed Controller 1:1 interleave.
- 1.2MB High Capacity Floppy Drive.
- Super deluxe heavy duty tower case with 6 half-height drive openings.
- High-resolution 12" Non-Glare Amber Display. Tilt and Swivel base, Hercules-compatible Adapter.
- 101 Key Enhanced Keyboard, Pleasant "Tactile/Click" Feel.
- 80287/387 Math-Coprocessors optional.
- Fully compatible with virtually all XT/AT and 386 software.

Upgrades for your FREE 386 System:

- VGA Color Upgrade — add only \$495.
- 20 MHz CPU Upgrade — add only \$195.
- Call for all other options and upgrades.

Choose Your Hardware

*A hardware purchase of \$5495 or more is required
to receive the SIVA 386 System FREE.*

- | | |
|---|--------|
| • QMS PS 810 Postscript Laser Printer | \$5495 |
| • CDC WREN IV 300MB SCSI Hard drive with Controller | \$2595 |
| • CDC WREN III 155MB SCSI Hard drive with Controller | \$1795 |
| • CDC WREN II 86MB ST506 Hard drive with HD/FD Controller | \$ 895 |
| • Eight Port RS232 Intelligent Card with Xenix Driver | \$ 995 |
| • 32-Bit 8MB Memory Expansion Board | \$2997 |
| • Intel 80387 — 16 Coprocessor | \$ 495 |

Software

- | | |
|---|--------|
| • Complete SCO Xenix System (including Operating System, Developing System and Text Processing System for 80386-based System) | \$1595 |
| • SCO Lyrix System | \$ 595 |
| • SCO Professional | \$ 895 |
| • SCO Integra | \$1295 |
| • SCO Foxbase Plus | \$ 995 |
| • SCO VP/IX (integrated DOS environment — two users) | \$ 495 |
| • Language & Development Tools | CALL |
| • Networking & Communication Packages | CALL |

*A software purchase of \$3295 or more is required to receive
your FREE SIVA 386 System. Mix and match to meet
your needs!*



Ask about our Professional Services:

- Data Processing and Network Consulting
- Application Development and Training
- System Administration
- Hardware and Software Installation & Support

1-800-444-SIVA

VNS America Corp.

Suite 270, 910 Boston Post Road
Marlboro, Massachusetts 01752 U.S.A.
In Massachusetts 508-481-3726
FAX: 508-481-2218

All prices subject to change without notice.



Modula-2 and OS/2 Join Forces

Three Modula-2 compilers take advantage of OS/2's features

Andrew Schulman

Although Microsoft endorses C as the language of choice for OS/2 development, Niklaus Wirth's Modula-2 is better suited to exploit OS/2's multitasking and dynamic linking capabilities. At the core of Modula-2 are the twin concepts of *process* and *module*; these conveniently map onto OS/2 threads and dynamic-link libraries (DLLs).

I'll look at three implementations of Modula-2 for OS/2: Logitech's Modula OS/2 1.00, TopSpeed Modula-2 OS/2 1.20 from Jensen and Partners International (JPI), and Stony Brook's Professional Modula-2 2.0. I'll focus on the OS/2-specific features of each compiler: support for the OS/2 API (Application Programming Interface), PM (Presentation Manager) applications, DLLs, virtual memory, run-time error checking, and protected-mode debugging.

The OS/2 API, Modula-2-Style

All three compilers provide API bindings in the form of Modula-2 definition modules (.DEF files). Both Stony Brook and JPI divide the API .DEF files along the lines that OS/2 itself uses: DOS (the OS/2 kernel), VIO, KBD, and MOU. Logitech uses a different scheme, breaking the API down into smaller modules, such as DynLink, FileIO, MemManager, MultiTasking, and Misc.

The OS/2 API (unlike the MS-DOS programming interface) was designed to be used from high-level languages.

Thus, you can use the OS/2 procedures, constants, and data structures exported from the three vendors' API modules just as you would any other Modula-2 exports. Of course, programs using these features will only run under OS/2.

Say you wanted to use the OS/2 `DosGetInfoSeg` routine. `DOS.DEF` exports this in JPI, `DOSCALLS.DEF` in Stony Brook, and `MISC.DEF` in Logitech. You could either `IMPORT` the specific routine from the appropriate module (e.g., `FROM MISC IMPORT DosGetInfoSeg`) or you could `IMPORT` the entire module (e.g., `IMPORT MISC`) and then call the routine using its qualified name (e.g., `MISC.DosGetInfoSeg`).

When you call `DosGetInfoSeg`, by whatever means, you pass two segment selectors—one for the global-information segment, one for the local-information segment. Although selectors are words (2-byte quantities), you can't, in C, simply pass `DosGetInfoSeg` a pair of selectors by value. OS/2 expects references, so you must either pass pointers to selectors or, alternatively, declare selectors but pass their addresses. In Modula-2, though, `VAR` parameters are automatically passed by reference. You declare a selector and pass it to OS/2. This method simplifies working with the OS/2 API.

You need to turn the selector that `DosGetInfoSeg` passes into a 4-byte far pointer that you can use to access the values stored in the information segment. In Microsoft C, a utility macro, `MAKEP`, performs the necessary conversion. None of the Modula-2 environments provide an equivalent function, and you can't just use a Modula-2 absolute variable to point to the information segment—its selector isn't available until run time. Both Stony Brook and Logitech require you (and JPI permits you) to put the selector in the segment slot of an address variable and then assign the variable to a long pointer. The address type in Modula-2 is implementation-dependent; all three compilers tailor it to work

with selectors. JPI also provides a powerful, although nonportable, extension that simplifies this process. You can use a *pointer constructor* to cast an address (given in segment:offset form) directly to a far pointer.

JPI and Logitech supply header files (Modula-2 .DEF files) for the enormous PM API; Stony Brook doesn't yet, but expects to in a forthcoming release. JPI and Stony Brook also provide stand-alone graphics modules that don't rely on PM. Because multiple threads can call these graphics modules simultaneously, you can use the Stony Brook and JPI compilers to easily produce multitasking graphics programs. To demonstrate its graphics module, Stony Brook includes a Paint program—written in 500 lines of Modula-2—that's virtually identical to the Paint program that comes with the MS-DOS version of Stony Brook's QuickMod.

All three compilers work well with the OS/2 API—because Modula-2 helps the programmer localize the parts of a program that import and use OS/2's services. You can do the same thing in C, but you have to work at it. Where C merely permits modularity, Modula-2 encourages it.

Building DLLs

Modula-2, like Ada, specializes in the construction of abstract data types (ADTs) and the definition of operations on those types. In an ADT, a Modula-2 definition module exports an opaque type and a set of operations; the internal data representation is not exported. OS/2's DLLs are a perfect vehicle for implementing Modula-2 abstract data types. Because a DLL can export code but no data, implementing a module as a DLL guarantees a functional interface between the module and its clients.

DLLs are tricky to build—in part, because they must be reentrant. OS/2's own DLLs (such as `VIOCALLS.DLL`),

continued

	Logitech Modula OS/2 1.00	Stony Brook Professional Modula-2 2.0	TopSpeed Modula-2 OS/2 1.20
Company	Logitech, Inc. 6505 Kaiser Dr Fremont, CA 94555 (800) 231-7717	Stony Brook Software, Inc. 187 East Wilbur Rd., Suite 9 Thousand Oaks, CA 91360 (800) 624-7487 (805) 496-5837	Jensen and Partners International, Inc. 1101 San Antonio Rd., Suite 301 Mountain View, CA 94043 (800) 543-5202
Hardware Needed	OS/2 capable PC compatible	OS/2-capable PC compatible	OS/2-capable PC compatible
Software Needed	OS/2 1.0 or 1.1	OS/2 1.0 or 1.1	OS/2 1.0 or 1.1
Price	\$349	\$295	\$195
	Inquiry 883.	Inquiry 884.	Inquiry 882.

for example, are used simultaneously by different processes and by different threads within the same process. Designing reentrant code takes special care. But another big obstacle to the widespread use of DLLs has been the awkward mechanism Microsoft has provided for building them. With Microsoft C 5.1, you have to use special DLL-oriented libraries to create a DLL. All three Modula-2 compilers dispense with this problem. Modula-2 compilers naturally produce DLL-ready code (i.e., code that doesn't assume that the stack and data segments are one and the same). This is crucial to OS/2 programming for two reasons. First, code in a DLL doesn't have its own stack; it uses its caller's stack. Second, although OS/2 threads (lightweight processes) share data space, each maintains its own stack.

Although all three compilers can easily make DLLs, JPI's scheme is the most convenient. JPI provides its own linker, which is well integrated with the automatic make facility. The make procedure in the JPI TopSpeed compilers is controlled by a dynamic-library description (.DLD) file that contains linker directives. To build a DLL, you simply put the `-main` directive in a program's .DLD file (because a DLL has no main entry point). The JPI integrated environment looks for a .DLD file when making an application. You can have JPI automatically put your newly built DLL in its proper place in your OS/2 LIBPATH.

Just as Modula-2 modules can have initialization routines, so can DLLs. But using this feature of DLLs is another aspect of OS/2 programming that the Microsoft tools handle awkwardly: You have to drop into assembly language to tell OS/2 to call the initialization routine. JPI solves this problem neatly. The INITDLL module, which is written in assembly language and which contains the necessary instructions, gets assembled by JPI's built-in assembler and can

be included with each DLL.

Both Logitech and JPI provide the Modula-2 run-time library in DLL form. The Logitech compiler uses the DLL version by default, and so produces extremely small executables. The JPI compiler doesn't use the DLL version until you ask it to do so—by putting an option into the DEFAULT.DLD file. The first time you compile with that option, the compiler builds the run-time DLL and puts it on your LIBPATH. Stony Brook's compiler doesn't provide a run-time DLL, but the company says that its forthcoming QuickMod product will.

Portable Multitasking

Unlike the original Modula, Modula-2 doesn't include multitasking or interprocess communication (IPC) primitives as part of the language definition. Niklaus Wirth argued that such facilities should be made available by way of an appropriate library module. In *Programming in Modula-2*, Wirth illustrates such a module, called Processes. JPI and Stony Brook each provide a version of this module. Logitech doesn't, although you can, of course, create one (and Logitech says the forthcoming version 2.0 will provide one).

An ideal Modula-2 program for OS/2 wouldn't look like an OS/2 program at all. Instead of calling native OS/2 routines like `DosCreateThread` directly, a program should handle threads and IPC by way of generic facilities defined in Processes, thereby remaining portable. That's just how the multitasking demos provided by JPI and Stony Brook work. Each program creates a set of windows under the control of multiple threads; each window executes a unique task and moves around on the screen under independent control.

Because these programs are written in terms of Processes, and because the two vendors' DOS products also implement Processes, you can compile them under

DOS, and they run identically. Of course, since Wirth's Processes module isn't yet a standard, the JPI and Stony Brook interpretations of it differ. While multitasking constructs are not portable between Modula-2 implementations, within an implementation of Modula-2, you can write a multitasking program that will port between OS/2 and DOS.

Although none of the compilers assumes an equivalence between the stack and data segments, there's the additional question of reentrancy in the standard libraries. As C programmers know, the use of static data in routines, such as `printf`, can cause problems in a multi-threaded environment. Wirth's recommended solution is to make a module a monitor and assign it a priority, ensuring mutual exclusion. Only Stony Brook implements this scheme, by means of the OS/2 routine `DosEnterCritSec`. In principle, it's not a good idea to use `DosEnterCritSec` this way; it suspends all other processes, even ones that aren't trying to enter the monitor. Semaphores would be the preferred solution. Nevertheless, Stony Brook's scheme seems to work well, since a given thread of execution stays within the library only briefly.

Big Country

OS/2 offers not only big memory (a 16-megabyte address space) but, equally important, virtual memory. In a properly configured OS/2 system, the amount of free disk space is a better indicator of available memory than the amount of RAM. Modula-2 programs built using any of these Modula-2 compilers enjoy these benefits. None of the compilers emulates Microsoft C's inefficient but convenient huge construct, however, so you can't statically allocate anything larger than 64K bytes.

All three compilers supply a Storage module that maps Modula-2's `ALLOCATE`, `NEW`, `DEALLOCATE`, and `DISPOSE` to OS/2 memory management

routines. JPI's Storage module uses an OS/2 feature called suballocation—the allocation of chunks of memory from a previously allocated pool. Suballocation is slower than normal allocation. In a test program that attempted to create an infinitely long linked list, JPI's compiler slowed to a snail's pace far sooner than did Logitech's or Stony Brook's. On the other hand, only JPI's Storage module can detect attempts to free the same piece of memory twice, and this is a very valuable feature.

In an OS/2 system properly configured with MEMMAN=SWAP,MOVE and with sufficient disk space, a call to ALLOCATE or NEW should never fail. That's fortunate, because both JPI's and Logitech's manuals say that if an allocation does fail, the calling program will unceremoniously terminate. Stony Brook takes a more reasonable approach: its system raises a run-time error that you can field with an error handler.

The three compilers implement memory models in different ways. Stony Brook provides the same assortment that most C compilers offer. JPI defaults to a large model, but you can use the \$N directive to get the compiler to use near pointers for intersegment function calls. That's awkward, though; you have to issue the directive from a comment within the code. I like Logitech's scheme the best: all code pointers are near unless the procedure is imported from another module, assigned to a procedure variable, or used as the body of a process. There's no option to change that behavior, but it's unlikely that you would want to.

Errors, Exceptions, and Debugging Modula-2's run-time error checking nicely complements OS/2 protected mode. Protected mode can catch bugs that make software development a nightmare—like writing to the wrong segment. But it can't catch all errors. For example, you could overrun the bounds of an array without stepping into a forbidden segment.

All compilers can add checks for run-time errors, such as out-of-range array indexes, stack overflow, or dereferencing the NIL pointer. Stony Brook produces the best run-time error messages; the compiler reports the module name and the line at which the error occurred. Logitech reports only the nature of the problem (e.g., "Range Error"), not its location. JPI's integrated environment cites the module and line number of a run-time error. But if you run an erroneous program as a stand-alone, it reports

only that there was a run-time error; there's no indication of which one or where. Stony Brook provides the support that you need to recover from run-time errors. Its Error module doesn't have full-blown exception handling à la Ada, but it does maintain a stack of user-installable error-handling procedures. Logitech's RTSExcept module does provide some error-handling but doesn't permit a program to field an error and keep going. JPI does a particularly good

job of checking for OS/2 errors within the standard library.

JPI's wonderful Visual Interactive Debugger is not yet available for OS/2, so I had to fall back on CodeView when debugging programs built with the JPI compiler. Stony Brook's source-level debugger is fully integrated into the compiler/editor environment, works with the mouse, and features watchpoints, breakpoints, and a backtrace facility. I tried a

continued

Finally, A Trackball for your PC

Two High Performance Mouse Alternatives



PC-TRAC™

Serial version \$119
Bus version \$159

The standard in PC Trackballs for direct mouse replacement



FastTRAP™

Serial version \$149
Bus version \$169

Trackball with Trackwheel™ for third axis pointing capability in advanced applications

Attention PC users. Introducing two products that have been quietly appearing on desks of thousands of PC users for over a year: MicroSpeed's PC TRAC™ and Fast TRAP™ trackballs.

- Uses 1/4 the desk space of a mouse
Free up your desk space to do what it was designed to do — hold your coffee cup and stacks of incoming work.

- Plug and play compatibility

MicroSpeed's advanced pointing device driver is fully compatible with application software supporting Microsoft™, Logitech™, and other popular mice. Also included is a Windows™ driver and a utility for use with non-mouse driven software.

- PC-TRAC and FastTRAP work where you put them

No more "row, row, row the mouse" when you run out of desk space before you run out of screen. Scroll across spreadsheets with finger tip



MICROSPEED
INCORPORATED

control. Page up and down documents without so much as moving your wrist. Control CAD programs to a single pixel. All in a space less than 4 1/4" wide.

- Pinpoint accuracy automatically

MicroSpeed's pointing device driver has "self adjusting" resolution from 50 to 1,000 dpi. Speeding across the screen or working with precision graphics, the MicroSpeed driver automatically adjusts to the resolution you need.

- PC-TRAC and FastTRAP require no cleaning

Our quiet, durable opto-mechanical design requires no cleaning or maintenance.

Looking for a proven mouse alternative for your PC? Give us a call. We're rolling!

1-800-232-7888

In California call (415) 490-1403

MicroSpeed, PC-TRAC, FastTRAP and Trackwheel are registered trademarks of MicroSpeed Inc. Microsoft and Windows are registered trademarks of Microsoft Corporation. Logitech is a registered trademark of Logitech Inc.

Table 1: Times for a VM2 prime-number generator, running on a virtual machine implemented in three versions of Modula-2. In all cases, background operation is far more efficient. All times are in seconds.

	Logitech	Stony Brook		JPI	
Foreground	883 ¹	939 ²	866 ³	939 ²	870 ⁴
Background	456 ¹	503 ²	436 ³	507 ²	440 ⁴

¹Default memory model, which automatically uses near pointers whenever possible.
²Large model.
³Medium model.
⁴Near pointers (\$N) enabled.

beta version of Logitech's MultiScope debugger but, unfortunately, couldn't get it to run on my 2-megabyte system. Logitech is, however, the only one of the three companies with an approach to debugging multithreaded applications, and I expect the final version of MultiScope will be impressive.

Environmental Issues

All three compilers support both a command-line interface and a full-screen windowed environment. Logitech, of course, supports a mouse, as does Stony Brook; JPI, which has the environment I otherwise find most intuitive, does not. Stony Brook and JPI use proprietary schemes for structuring a development project and naming the paths to the various components of a project; I found these schemes a bit disconcerting. I prefer to use the OS/2 PATH for this purpose, as the Logitech compiler does.

Version control is an integral part of Modula-2. Compilers must not only check that all imported procedures are used in accordance with the definition module; they must also ensure that a program uses the right version of an implementation module. You can't simply compile .DEF files into .SYM files, then .MOD files into .OBJ files, and then link. The order in which you compile the .DEF files matters. A Modula-2 compiler must compile .DEF files in the right order, or at least tell you what that order is.

Stony Brook's compiler automatically compiles .DEF files in the right order. Logitech's M2MAKE utility determines file dependencies and then creates a .CMD (OS/2 batch) file that drives the compilation. JPI dispenses with .SYM files entirely; the JPI compiler always recompiles .DEF files. Fortunately, it is fast enough so that you don't really notice—except when you're crunching through those huge PM definition modules.

The source code for the standard li-

braries contains some of the best documentation for these products. All three companies give you that source code. The printed documentation varies in quality. Logitech's documentation mostly contains printouts of .DEF files. There's little in the way of useful description or examples, and the OS/2-specific information is poorly organized. Stony Brook does slightly better. There's an example for each library module and a separate—though barely adequate—section on OS/2. JPI does the best job on documentation. There's an example of each library routine, an excellent introduction to the OS/2 specifics of the product, and a first-class Modula-2 tutorial.

VM2 Revisited

To exercise the compilers, I used Jonathan Amsterdam's VM2—a compiler, assembler, and virtual machine, all written in Modula-2. See the articles "An Assembler for VM2" (November 1985 BYTE) and "Building a Computer in Software" (October 1985 BYTE). The port to JPI's compiler was the most time-consuming of the three, despite the speed of JPI's excellent environment. That's because it's a one-pass compiler and doesn't allow forward references. You either have to move procedures around so they're declared before they're used or, alternatively, use JPI's Forward keyword.

The compilers differ in how they track the various editions of Niklaus Wirth's *Programming in Modula-2*. Both Stony Brook and Logitech accept an Export statement in a .DEF file, while JPI follows the practice set forth in the third edition and regards the .DEF file itself as an export list.

Both JPI and Stony Brook allow this assignment:

```
VAR s : ARRAY [1..5] OF CHAR;
(* ... *)
s := "Hello";
```

whereas Logitech, following the fourth edition, correctly regards this as a type incompatibility, because the assignment of a string with length five to an array of five characters does not leave room for the terminating null character. Since so many of OS/2's API routines expect ASCIIZ strings, it's important that they actually be zero-delimited.

I compiled the VM2 programs using each of the compilers and then wrote a prime number generator in the VM2 high-level language, compiled it to VM2 assembly language (with the VM2 compiler), and assembled it to create VM2 object code (using the VM2 assembler).

I ran that code on Logitech, JPI, and Stony Brook versions of Jonathan Amsterdam's virtual machine (the results are shown in table 1). Even though Stony Brook (using the medium-memory model) had the best times, the differences among the compilers are small. With each of the compilers, the VM2 primes program ran much faster in the background.

Soul Mates

OS/2 and Modula-2 are, in many ways, well matched. Each of these compilers is a genuine OS/2 product, not just a port of a DOS product. Logitech earns points for PM support, a DLL run-time library, an intelligent default memory model, and a multithreaded debugger.

Stony Brook offers a useful debugger, a stand-alone graphics module, a Processes module, a run-time error-recovery mechanism, and a solution to the problem of reentrancy in the standard libraries.

JPI, like Stony Brook, has a stand-alone graphics module and a Processes module, and like Logitech provides a DLL run-time library and PM support. The JPI product also has what I found to be the most intuitive interface and—a crucial point for OS/2 development—exceptionally good support for building DLLs.

Logitech's Modula-2 compiler for DOS is an industry standard—that is, more third-party Modula-2 libraries exist for Logitech's implementation than for JPI's or Stony Brook's. On balance, nevertheless, I believe that the Stony Brook and JPI products best exploit the multitasking and dynamic linking capabilities of OS/2. But stay tuned—each of these products is evolving rapidly. ■

Andrew Schulman is a software engineer working in Cambridge, Massachusetts. He can be reached on BIX c/o "editors."

THE EXPANDED MEMORY BUILDER

TC! POWER

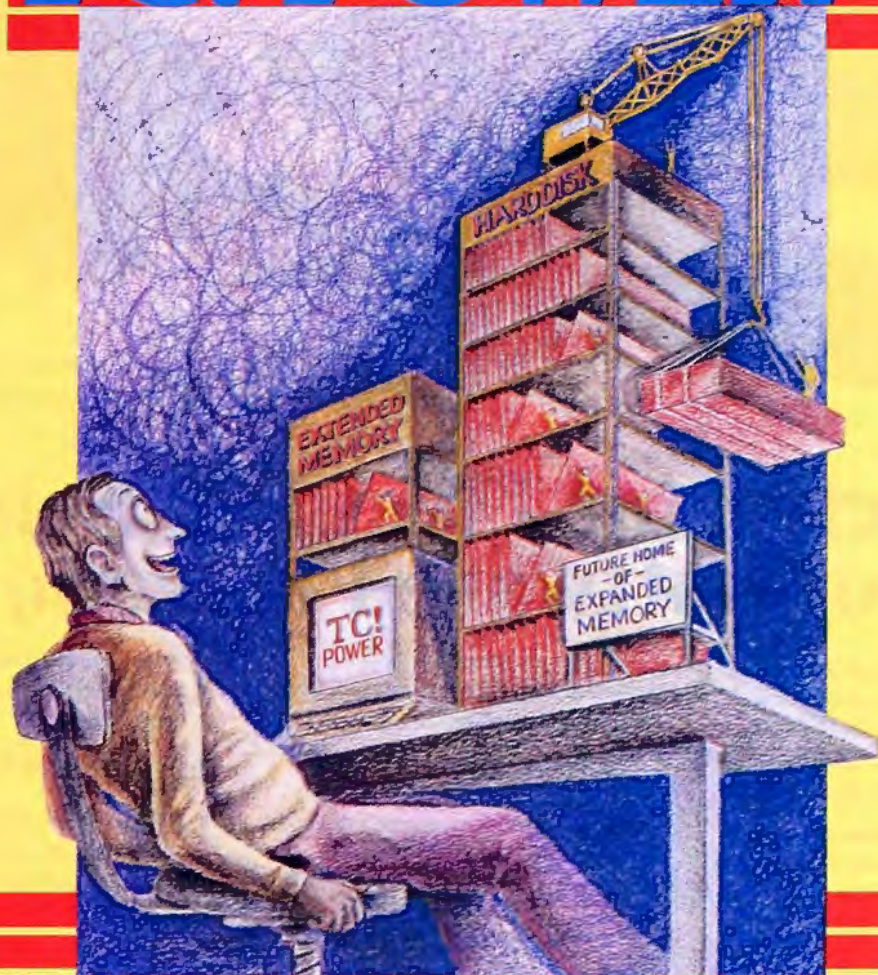

EXPANDED MEMORY SOFTWARE

Now you can build Expanded Memory that MS-DOS can use, from your unused extended memory, free hard disk space or both. Eliminating the need for expensive expanded memory boards.

TC!Power lets you gain more memory on your PC and portable computer for today's larger programs. Don't let your unused extended memory or free hard disk space in your computer go to waste. Let TC!Power convert it into Expanded Memory that MS-DOS can exploit.

This new and exciting product, TC!Power, will let you add enormous amounts of memory to your system, thereby optimizing the use of your machine's hidden resources.

TC!Power breaks the 640kb DOS barrier and eliminates the *out of memory* and *memory full* messages when running today's bigger programs that use the Lotus / Intel / Microsoft EMS specifications like Lotus 123,

Symphony, Quattro, SideKick Plus, Auto Cad and Harvard Graphics.

TC!Power accomplishes the task of building EMS memory for computers with only 640K of RAM by turning free hard disk space into expanded memory. Memory that DOS can use. TC!Power also senses unused extended memory on AT 286 and 386 computers and converts this extended memory into useable expanded memory. If needed, additional expanded memory can be built from free hard disk space and added to the already converted memory.

TC!Power is easy to use and easy to learn, designed for the non-experienced and intermediate user. Its installation and configuration program are com-

pletely automatic and menu driven with context sensitive help always available at the touch of a key.

As more and more programs grow in size, expanded memory will almost become a necessity. TC!Power has been developed to create all the expanded memory you will need at an affordable price, thereby eliminating the need to purchase an expanded memory board costing \$500.00 to \$1,000.00 dollars or more.

A TAKE CHARGE!® PRODUCT

\$79.95 Plus \$5.00 Shipping and Handling

Major Credit Cards Accepted

Tel 201-786-6878 / FAX 201-786-5868

All product names are trademarks of their manufacturers copyright 1989 Compufix. All rights reserved.

Now Available
Activator/M™
with
Programmable
Memory

Software Developers



*Natural selection provides unique
passive protection for the porcupine.*

The Activator - Natural Selection For Software Protection



*Inventor and entrepreneur
Dick Erett explains how
"The Activator" provides
sane protection for your in-
tellectual property.*

"In any industry, just as in nature, the process of natural selection raises one solution above another. Natural selection is the most elegant of engineers.

In the area of software protection The Block has been selected by the marketplace as the solution that works. Over 500,000 packages are protected by our device.

For the past 4 years our philosophy has been: *'You have the right and obligation to protect your intellectual property.'*

A New Ethic For Software Protection

In allowing end-users unlimited copies of a software package and uninhibited hard disk and LAN operation, The Block has created a new ethic for software protection.



By removing protection from the magnetic media we remove the constraints that have plagued legitimate users.

They simply attach our key to the parallel port and forget it. It is totally transparent, but the software will not run without it.

A New Technology For Software Protection

Our newest model, The Activator, builds on our current patented design, and establishes an unprecedented class of software protection.

We have migrated and enhanced the circuitry of The Block to an ASIC (Application-Specific Integrated Circuit) imbedded in The Activator.

This greatly improves speed and performance, while reducing overall size. Data protection can also be provided.

Programmable Option

The Activator allows the software developer the option to program serial numbers, versions, or other pertinent data known only to the developer, into the circuit, and access it from the program.

Once you program your part of the chip, even we have no way to access your information.

The ASIC makes emulation of the device
Circle 234 on Reader Service Card

virtually impossible. It also presents an astronomical number of access combinations.

Full 100% Disclosure

Since The Activator is protected by our patent we fully disclose how it works. Once you understand it, endless methods of protection become evident.

Just as no two snowflakes are the same, no two implementations of The Activator are identical. And like the snowflake the simplicity of The Activator is its greatest beauty.



We never cramp your programming style or ingenuity. Make it as simple or complicated as you desire.

Let us help safeguard what's rightfully yours. Please call today for additional information or a demo unit. *It's only natural to protect your software.*

1-800-333-0407 ext.105
In Connecticut 203-329-8870
Fax 203-329-7428

**Software
Security inc.**

870 High Ridge Road
Stamford, CT 06905

Unlimited Copies • Programmable • No Batteries • Small Size • Fast • Patented • Data Protection



A New World for DOS

ViewLink and Magellan explore uncharted waters in man/machine interfacing

Stan Miastkowski

Over the past few months, several new products have tried to go beyond the capabilities of standard DOS shells such as the Norton Commander and Executive Systems' XTree. Although they're difficult to place into rigid software categories, you might think of them as intelligent DOS shells. Developed using object-oriented programming technology, they give you a radically different means of interacting with your system.

In a way, Traveling Software's ViewLink 1.05 and Lotus Development's Magellan 1.0 are new categories of software. Both packages incorporate some of the features of DOS shells, indexers, outliners, and even HyperCard. But taken as a whole, their multiple levels of functionality add up to more than the sum of those parts.

At first glance, these packages appear to be similar—and, to a point, they are. Both let you organize your data by function and context, no matter where it's located on your disk. But although their on-screen displays look similar, they take very different approaches to man/machine interaction.

The ViewLink Connection

A common thread in Traveling Software products has been the concept of linking; LapLink links computers, and ViewLink links together your data and applications

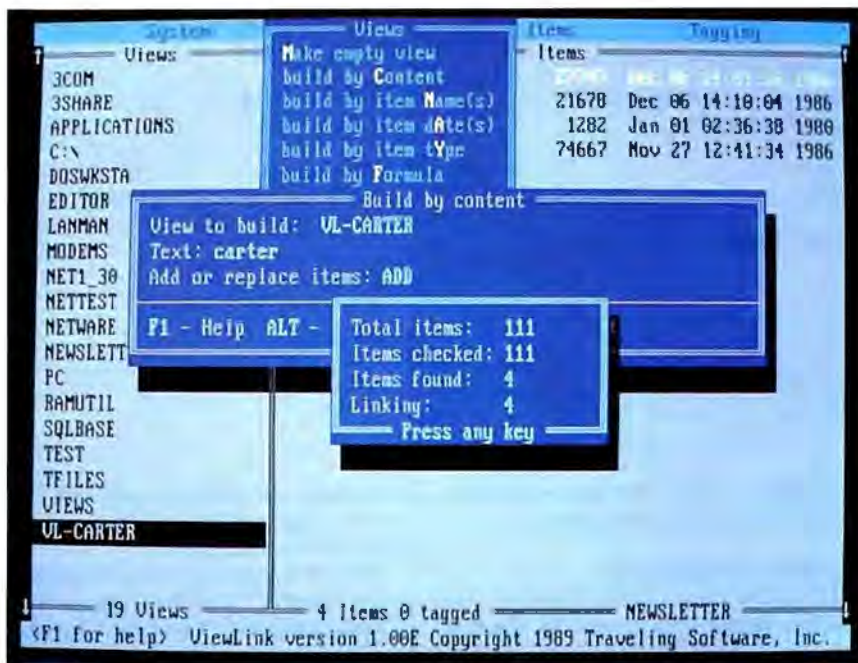

Photo 1: ViewLink lets you create "views" of files that all contain a specific search word or phrase.

using a concept called *views*—logical categories of related data. In fact, Traveling Software calls ViewLink an "associative access manager," because it lets you group related (associated) data into views based on your work preferences instead of the constraints of DOS subdirectories.

To get an idea of how views work, say you're a manager who's responsible for a specific product. You're likely to have many different files on your PC that are directly related to your responsibilities. There might be spreadsheet files with budget projections, scheduling files for project management software, and numerous letters, memos, and E-mail messages. ViewLink lets you link all these files together into one view where they're easily accessible.

You can also link individual items to any number of different views. For ex-

ample, you might have a view that contains only items that relate to the product's financial planning, or a view that includes only items that relate to a specific member of the project team. In addition, a view can be linked to other views. Beyond that, you can have different sets of views, called *domains*. This is particularly effective in LAN installations, where each individual user can have his or her own domains, as well as share common domains with the workgroup.

When you start ViewLink, you see a split screen with views on the left and files associated with the views on the right. Initially, the views are primarily subdirectory names. Because the data files that you incorporate into a view are automatically linked to their associated

continued

ViewLink 1.05

Company

Traveling Software, Inc.
18702 North Creek Blvd.
Bothell, WA 98011
(206) 483-8088

Format

One 5¼-inch floppy disk or
one 3½-inch floppy disk

Hardware Needed

IBM PC or compatible with 384K bytes
of RAM and a hard disk drive

Software Needed

DOS 2.0 or higher

Documentation

User's manual, overview guide,
applications guide

Price

\$149.95

Inquiry 885.

Magellan 1.0

Company

Lotus Development Corp
55 Cambridge Pkwy
Cambridge, MA 02142
(617) 577-8500

Format

Three 5¼-inch floppy disks or
two 3½-inch floppy disks

Hardware Needed

IBM PC or compatible with 512K bytes
of RAM, one floppy disk drive, and a hard
disk drive with approximately 720K
bytes of free disk space for the program
plus 5 percent to 10 percent of free disk
space for the index

Software Needed

DOS 2.1 or higher

Documentation

User's manual, quick start-up guide,
suggested user's guide

Price

\$195

Inquiry 886.

applications, ViewLink takes care of the actual launching of applications.

Multilevel Installation

Getting the most out of ViewLink requires a sizable time investment. Besides an initially steep learning curve, the very nature of the program means the installation is time-consuming. There are really two levels to setting up ViewLink: the automatic initial installation and the fine-tuning process that customizes it to your particular preferences.

The first-level installation is actually quite simple. ViewLink's functionality is tightly coupled to specific applications. The installation utility lists some 60 of the most popular application programs, including all major categories. You tell ViewLink which applications you'll be using, and it goes through a multiple-step process. First it finds the specified applications and their related files, and then it links them to specific macros that ViewLink requires.

After it has found the applications that you'll be using, ViewLink then searches your entire hard disk for files that obviously work with them. For example, it links .WK1 files to Lotus 1-2-3, .DOC files to Microsoft Word, and .CMD files to Procomm. If you've used nonstandard

filenaming conventions, it may link files to the wrong applications, but you can easily unlink those later.

The end result of the initial installation is a master link file that keeps track of views and links. ViewLink's link file is extremely small: My initial link file for 48.6 megabytes of applications and data took up just 130K bytes of disk space, and it grew very little as I customized my own views.

The second part of the installation is considerably more time-consuming and involves the actual creation of individually tailored views. ViewLink gives you several options for building views, including filenames, dates, and types. You can even enter complex Boolean formulas to tell ViewLink what to include and exclude in a view. And when all else fails, you can physically move through the filenames on your disks, tagging the ones you want as you go along.

But ViewLink's most powerful feature is the ability to build views by content. For example, you can enter text strings, and the program will search for them. Every time it finds a match, it includes the file in the view (see photo 1).

Once you've generated your own personal views, each of the individual items is linked to the specific application under

which it runs. For example, you can point to a spreadsheet file and press Return, and the file link automatically launches the application, bringing up the spreadsheet on the screen with the desired file already loaded. Likewise, pointing to a text file launches a word processing application. There's also a cut-and-paste feature that lets you move data between applications.

To run under ViewLink control, specific applications must be installed and closely tied to ViewLink via macros. For each application installed, there are up to four standard application macros (execute, run, print, and create) and two key macros. ViewLink automatically invokes the application macros, and you use the two key macros to save your work and quit the application.

If the applications you use most often are not in the program's install list, you'll need to write a specific application macro for it. Traveling Software provides detailed information for macro creation, but you'll need a modicum of programming skill.

Keeping the Faith

Once you've installed and set up ViewLink to your individual preferences, it requires a continuing commitment. Another powerful feature of ViewLink is its ability to automatically incorporate new items into a view without your having to specifically add them each time you create a file. With "automatic view update" on, each time you generate a data file that contains any of the search criteria you used in generating the original view, ViewLink automatically updates the view to include the new item. And the process is very fast, usually taking not more than 3 to 5 seconds.

Traveling Software says an OS/2 version of ViewLink that runs under Presentation Manager will be available by the end of the year. ViewLink 1.05, which is now shipping, lacks mouse support and the ability to use expanded memory. A Traveling Software spokesperson says these features will be included in version 1.1, which should become available at about the time you read this.

Exploring with Magellan

Instead of ViewLink's approach of associating files into categories (views) that you customize to your personal preferences, Magellan takes an inherently different approach to dealing with data. It treats your hard disk (or even multiple disks) as a whole. During Magellan's initial installation, it creates an index of all

continued

NOW YOU CAN DESIGN JUST ABOUT ANYTHING... INCLUDING YOUR OWN CADD SYSTEM!

PC
MAGAZINE
EXCELLENCE
AWARD
CADD
3.0



Anyone can produce a computer-aided drafting and design package that sells for thousands of dollars. But creating one that's fast, powerful, and affordable takes real ingenuity.

That's exactly what we've done at Generic Software.™ We sell the most widely used CADD program in the world for under \$500.



PC Magazine ranked it "Editors Choice" in a face off with 17 low-cost CADD packages. "This product is an outstanding value from every point of view and is highly recommended." "A paperback version of AutoCAD", stated PC Week.

And our CADD programs are just part of what we offer.

You can start with Generic CADD Level 1,™ then advance to other levels as your needs—and skills—expand.

And you can use our CADD add-ons, Utilities, and symbols libraries to design the CADD system that fits your needs.

You only pay for the functionality you need, and the functionality you get has depth.

Critic tested, market approved. Generic Software offers price, quality, and support. Match our customer support against anyone!

- Unconditional 60-day guarantee on most products
- Unlimited free technical support
- Free monthly newspaper
- Regular updates at modest prices. All adding up to prove that the only thing generic about us is the price.

Call us for a free CADDalog™ or for the name of your local dealer: 1-800-228-3601.

© Generic Software Inc., Level 1 and Generic CADD are trademarks of Generic Software Inc., 11911 North Creek Parkway South, Bothell, WA 98011. Macintosh is a trademark of Apple Computer Inc.

Generic
S O F T W A R E



Photo 2: Magellan's search ability is fast and uses fuzzy logic to evaluate the success of a search.

the data on your hard disk. Like View-Link, Magellan uses a proprietary technology. It creates a surprisingly compact index. Lotus says that it normally takes up 5 percent to 10 percent of the data space, and my 48.6 megabytes of applications and data resulted in an index of about 2.5 megabytes.

Magellan also does lots of the initial work for you. Although the program took about an hour to index my disk, I could start using it almost immediately once the indexing process was complete.

Magellan's forte is *viewing* (not to be confused with ViewLink's views). On the left side of the screen is an alphabetical list of all the files on your hard disk. It can be daunting—in my case, there were 2087 files. But there are many ways of narrowing the list to a more manageable length, including a clever "incremental find" feature that instantly finds filenames as you press the letter keys.

As you scroll down the list, you can see the contents of each file on the right side of the screen. Magellan has over 16 customized view utilities that present data in the format that you'd see in the associated application file. A .WK1



Many so-called storage subsystems are no more than a collection of third-party components thrown together in a box.

At Storage Dimensions, we think a total storage solution means a lot more.

A Complete Solution From Start To Finish.

At Storage Dimensions, we design our subsystems using a "total systems" approach.

We start by developing our own software, firmware and host adapters. We also engineer and test all components to ensure they work together in *your* application environment.

And we finish the job with responsive service and knowledgeable technical support.

This means you get an easy-to-use mass storage solution designed to meet *your* mass storage needs.

What Makes A Total Solutions Company?

- Completely Integrated Solutions
- High-Quality Disk Drives
- In-House Software Development
- In-House Controller Design
- All Components Tested as a System
- Responsive, Knowledgeable Technical Support
- Comprehensive Documentation
- Full One-Year Systems-Level Warranty
- Financially Strong Company

Total Storage Solutions.

1-2-3 spreadsheet file looks like the spreadsheet, a dBASE file is formatted correctly, and so on. It's all done automatically, because, in the index process, Magellan (like ViewLink) associates the data files with applications. But what's even more amazing is that Magellan lets you peek into binary files, and it instantly shows you certain packed files (.ARC) in their unpacked state.

Like ViewLink, Magellan lets you point to a file and start it up in its application. You do it with a Launch function key. But unlike with ViewLink, the process isn't completely automatic. When you press the Launch key, Magellan asks you which application you want to start and presents a list of choices. It points to the most obvious application (e.g., Lotus 1-2-3 for a .WK1 file). Although this extra keystroke may sound inconvenient, it makes a lot of sense. I use two different editors—XyWrite and Norton Editor—for different applications, and the ability to quickly choose either one is handy indeed. ViewLink, on the other hand, always assumed I wanted to use XyWrite.

Although it's not exactly a new concept, one of Magellan's handiest features

is that it displays the main function-key commands across the bottom of the screen. This is one of the reasons that Magellan is more immediately useful than ViewLink. When you press and hold the Alt key, the menu changes to 10 new function-key commands. Many of the commands are your standard DOS shell options, such as Copy, Delete, and Sort. But there are also some intriguing new ones, such as Gather and Zoom. The Gather function lets you mark text from any application shown in a view window and exports it into an ASCII file. Zoom expands the filename or the file view.

The Warm Fuzzies

If Magellan just gave you a huge list of files and the ability to quickly peek into them, it would be useful enough. But where Magellan's real power starts to show is in its ability to do fuzzy searches of all the files on your hard disk. Although Magellan can quickly find specific words or phrases anywhere on your hard disk, that's a feature shared by several indexing programs. Magellan's Explore function extends this ability by letting you use common English words or

phrases. This feature uses AI techniques that Lotus first included in its HAL natural-language interface to 1-2-3.

For example, you can tell Magellan to explore all files concerning "Telephone Installation Corporation." Magellan searches for close matches to the words "Telephone," "Installation," and "Corporation," and flags a match if it finds the words within a short distance of each other. Magellan then shows you a list of the files where it found a fuzzy match, followed by a percentage. This *explore rank* shows you the number of exact matches (ranging from 75 percent to 100 percent) and the number of fuzzy matches (ranging from 0 percent to 74 percent) (see photo 2). You can then browse through the matched files, with the words or phrases that you searched for highlighted.

Although dealing with fuzzy searching is initially a bit confusing, it doesn't take long to see what a powerful concept it is. It's most helpful when you're looking for a concept and don't remember the exact wording that you used in the original file. Most of Magellan's searches

continued



Complete Subsystems For DOS, NetWare® and Macintosh®.

With Storage Dimensions' broad line of storage solutions, you get the performance you need, and the choices you want—from 45 megabytes to 2.6 gigabytes, in internal and external configurations. With support for all popular interfaces.

Plus, our subsystems install easily in minutes, are 100%

compatible with your operating environment, and deliver exceptional reliability.

Hard Disk And Optical Subsystem Families.

Product Family	Application	Capacity Range	Interfaces Supported
SpeedStor™	PC/MS-DOS	120 MB to 2.6 GB	ESDI, SCSI, ST412, RLL
LANStor™	Novell NetWare	115 MB to 2.6 GB	ESDI, SCSI, ST412, DCB
LaserStor™	Write-Once Optical PC/MS-DOS & Mac	786 MB (DOS) 732 MB (Mac)	SCSI
MacinStor™	Apple Macintosh	45 to 650 MB	SCSI

Get Your Mass Storage Needs In Line. Call (408) 879-0300.

Don't trust your valuable data—or your business—to an incomplete storage solution. Call the company that does it right from the start.

More In Store.™



STORAGE DIMENSIONS
A MANTOR COMPANY

2145 Hamilton Avenue, San Jose, CA 95125

Across The Line.

©1989 Storage Dimensions
SpeedStor, LANStor, LaserStor and MacinStor are trademarks of Storage Dimensions

Seven ~~Bit~~ Five easy ways to boost your BASIC



PROBAS™ Basic Programming Library

So who cares that BYTE magazine calls PROBAS a "Supercharger for QuickBASIC" or that PC Tech Journal says that PROBAS is a "high-quality, high-quantity package"? Who buys a product just because Jerry Pournelle said "Anyone doing serious QuickBASIC programming would do well to get [PROBAS]"? And who cares that Wayne Hammerly calls PROBAS "The greatest thing since sliced bread"?

Who?--Only those who want to write better, faster, slicker programs and save hundreds of programming hours in the process. With all of that hoopla out of the way, we are formally announcing the momentous release of PROBAS Version 3.1, now with over 400 assembly routines to make BASIC programs faster and more powerful than you ever dreamed with features like:

- A 1,000-page two-volume manual
- Full mouse support
- Extended and EMS memory support
- Full-featured windowing
- Moveable, resizable windows
- Screen snapshots (text & graphics)
- Virtual screens in memory
- Lightning-fast file I/O
- Critical error handling
- String, array, and pointer sorts
- Search directories and archives

Create dazzling screens in text, CGA, EGA, VGA, and Hercules graphics modes with windows that can overlay one another and be moved and resized on the fly. Store megabytes of string, data, or screen snapshots in extended or EMS memory. Draw complex text or graphic screens to memory and snap them on in an eyeblink. The PROBAS file I/O routines allow you to read or write huge chunks of data at a clip, far faster than with BASIC.

PROBAS also has over 300 other essential services, including handy string, date, time, directory, and array manipulation routines; string, screen, and data compression routines; valuable equipment and input routines; and faster replacements for many BASIC commands.

Whether you are a professional or a novice, PROBAS will boost your BASIC in ways you never thought possible. PROBAS allows the professional to write faster, tighter code in much less time and allows novices to quickly and easily write professional-quality programs that would be impossible with BASIC alone. The bottom line is PROBAS adds power and saves time. After all, how much is a few hundred hours of your time really worth?

For all DOS versions of QuickBASIC and BASCOM. **Just \$149.00!**

PROREF™ On-Line Help For PROBAS

PROREF provides on-line help for the routines in the PROBAS library. This hypertext manual links directly to the QB Advisor in QuickBASIC 4.5 so that the PROBAS reference becomes an integral part of your QuickBASIC on-line manual. Includes information and examples on PROBAS routines and helpful hints on programming in BASIC. **Just \$50.00!**

PROSCREEN™ Screen Management

PROSCREEN is a full-featured screen generator/editor that will save you more design and coding time than you ever thought possible. PROSCREEN treats screens like a word processor treats text to provide complete control over characters, colors, and placement. Design input screens with up to 130 fields, 19 pre-defined and 2 user-defined masks. Save screens to screen files or .OBJ files and use the tight BASIC/Assembly code that comes with PROSCREEN to access the screens. There's no kludgy code generator here! Access hundreds of input screens with less than 25k of total code. **Just \$99.00!**

PROMATH™ Mathematics Library

PROMATH is a collection of over 150 high-level routines that provide mathematical functions and operations for programmers who often work in mathematics, science, or engineering. Complex variables, real and complex matrices, real and complex trigonometric and hyperbolic functions and their inverses, solution of linear equations, integration, differential equations, Fast Fourier transforms, graphics support, and many other useful routines are provided.

For years Fortran has been the language of choice for scientific and engineering applications, but it lacks many of the useful features of QuickBASIC. PROMATH contains most of the Fortran mathematical and numeric functions and allows you to easily translate Fortran code to BASIC or write new programs in BASIC, while retaining Fortran's numerical prowess.

The PROMATH manual is over 200 pages and provides a complete description of each routine, including any algorithm and the mathematical formula the routine uses, shown in standard notation. For QuickBASIC 4 and BASCOM 6 only. **Just \$99.00!**

PROBAS™ TOOLKIT

The TOOLKIT is a collection of high-level BASIC and assembly modules that use the routines in the PROBAS library to save you even more hours of grunt work. Why spend hundreds of hours re-inventing the wheel when you can just plug in TOOLKIT modules like:

- Super-fast B-Tree indexing
- Ring, Bar, Pop-Up, Pull-Down menus
- Scroll-bar tag windows
- Dialog boxes with radio buttons
- Two mini-editors with word wrap
- BCD math routines
- Julian date & calendar routines
- Patch .EXE files
- Protected memory storage area

The TOOLKIT now supports EGA and VGA graphics modes for menus, windows, editors, calendars, and more. Complete with BASIC source code and an all-new comprehensive manual. The TOOLKIT requires the PROBAS library and helps conserve your greatest asset of all—time! **Just \$99.00!**

PROBAS™ TELECOMM TOOLKIT

The PROBAS TELECOMM TOOLKIT is a collection of high-level communications modules that you plug into your code to provide popular file transfer protocols, terminal emulations, login scripts and baud rates up to 115,200 baud. You get:

- Xmodem/Modem7/Xmodem-1k
- Ymodem (single and batch)
- CRC-16 and Checksum
- VT52, VT100, ANSI, BBS etc.
- Auto Dialer & data base
- Documented BASIC source

Why use clumsy SHELLS to complex terminal programs when you can plug just the communications routines you need into your code? Implement just the features and commands you want. Requires PROBAS. **Just \$75.00!**

Our thirty-day, money-back guarantee assures you the highest quality and our technical support staff is always ready to help.

HAMMERLY
COMPUTER SERVICES, INC.

9309 JASMINE COURT • LAUREL, MD 20707

(800) 343-7484

INT'L. ORDERS: (301) 953-2191 FAX (301) 725-8147
BBS: (301) 953-7738

Add \$5.00 per item (\$8.00 Canada) for shipping per order. Europe: \$39.00 for 1st item plus \$5.00 for each additional item. Visa, M/C, C.O.D. (US Only) checks and approved POs accepted. Trademarks PROBAS, PROREF, PROSCREEN, PROMATH: Hammerly Computer Services, Inc. Quick BASIC, BASCOM: Microsoft Corp.

finished in 3 to 5 seconds on my system, and even complex fuzzy searches seldom took more than 10 to 15 seconds.

Staying Up-to-Date

Keeping Magellan's index up-to-date is essential to use the program's fuzzy search feature to best advantage. Although Magellan doesn't automatically update its master index, it does tell you that you need to do the update by putting an "Update" message in the upper-right corner of the screen. The reason that Magellan doesn't automatically update is that the process can be time-consuming, especially if you've created many files in a marathon work session. By pressing Alt-F5, you bring up an index box, and to update the index, you press the U key. Magellan tells you how many files need to be indexed and also estimates how long the process will take. I created 80 new files in two days of work, and it took Magellan about 5 minutes to update the index.

One nice feature that's missing from Magellan is a way for the program to automatically update its index at a certain time. It would be nice if Magellan would *know* to update its index at 3:00 a.m. every day.

Customizing with Macros

While Magellan is useful as well as easy to use right out of the box, it, like ViewLink, has layers and layers of features that increase its functionality. Taking advantage of them requires some time and study. But more important, getting the most out of Magellan requires that you learn and use the program's macro facility. It's really the only way to customize Magellan to your preferences.

Magellan's macros are straightforward. There's a standard learn mode that records your keystrokes into a macro. You can have up to 50 macros, with up to 255 characters in each. And, as with any good macro language, you can chain macros together so that they call each other when you need to do a particularly complicated job.

Magellan macros can be powerful. For instance, it's relatively easy to use a few keystrokes to write a start-up macro that brings your favorite applications or file areas to the top of Magellan's view window. This saves about two dozen keystrokes. Although macros are easy to write, getting the most out of them requires that you be familiar with Magellan's myriad features. It would have been nice if Lotus had supplied a selection of sample macros for common Magellan use. But there are none, although the

Idea Book that comes with Magellan does at least give a few suggestions for macro starting points.

Making a Choice

For those who are well-entrenched in dealing with the comfortable old C> prompt, getting used to programs like ViewLink and Magellan can be a real challenge. After years of working the way systems forced you to, having the ability to deal with files and data in a much more natural way is initially intimidating. Both of these programs are essentially textual equivalents to the Macintosh Desktop and HyperCard, but they also go beyond simple analogies. And they show that even in this age of graphical user interfaces, a text-only approach can still be effective.

Both programs use RAM-resident core modules. ViewLink's takes up 42K bytes, while Magellan's uses a sparse 5.5K bytes. So neither package works with Microsoft Windows, but both worked fine with Quarterdeck's DESQview.

Despite their similarities, the programs take divergent approaches. If you want to get up and running quickly, Magellan is your best bet. And with its fuzzy search abilities, it shines at snooping around your hard disk, quickly finding related information.

On the other hand, if you're willing to deal with ViewLink's steep learning curve, developing personalized views of your data is much closer to a truly symbiotic man/machine interface. But to get the most out of ViewLink, you'll need to learn new concepts and change your mental paradigm of computerized data.

One problem that ViewLink and Magellan share is that both are multilayered products with multitudes of features. Realistically, you should plan on spending a sizable amount of time cloistered with the documentation. It's the only way to get full power out of either program.

In a computer market that's overflowing with "me-too" products, ViewLink and Magellan are unique. Currently, there's nothing else like them on the market, although that's likely to change quickly. Too many DOS-shell products have claimed to let you use your PC "the way people think." But ViewLink and Magellan are the first to make serious advances in fulfilling that promise. ■

Stan Miastkowski is a BYTE consulting editor, managing director of K+S Concepts (a documentation and consulting firm) and editor of the "OS Report" newsletter. He can be reached on BIX as "stannm."



Unleash the BASIC Power of Hypertext!

Our latest BASIC-booster includes the first hypertext engine designed to be called from BASIC. With the **PROBAS HYPERHELP TOOLKIT** you can use the hypertext engine to put one or more manuals on-line with full hypertext search facilities. Imagine having one or more manuals on-line with all of the fantastic hypertext abilities in the QuickBASIC 4.5 compiler and then some:

- Choose single- or multi-window display
- Specify window colors and placement
- Move and resize windows with mouse or keys
- Sophisticated mouse and keyboard interface
- Up to 40 bookmarks to move between hyperlinks

In less than a dozen lines of code you can pop-up context-sensitive help at any time. Your users can then jump to related help, examples, or just browse the manual(s) in one or more windows that they can move or resize at will. The text will automatically wrap within the window to stay fully visible!

Create HyperCard Applications

Use the **HYPERHELP** engine to create full-blown hypercard applications. Create sophisticated multi-window, multi-thread hypercard stacks. Mix cards and manuals for total data integration. Moving from link-to-link or card-to-card is instantaneous and the speed will amaze you.

Adding hypertext to your applications takes less than about a dozen lines of BASIC code. Converting ASCII text to hypertext is just as easy—just put delimiters around keywords, hyperlinks, and items you want to display in boldface.

Multiple Help Subsystems

The hypertext engine is just a part of the **HYPERHELP TOOLKIT**. There is a wide selection of help subsystems with various displays, user interfaces, and memory requirements to suit almost any need. Want a small, window-oriented, keyword help system? It's in there! Need a Terminate & Stay Resident help system? It's in there! How about a lightbar indexing system that then pops-up the selected text? It's in there!

The **HYPERHELP TOOLKIT** gets its blinding speed by using the low-level routine in our **PROBAS Professional Basic Programming Library**. **HYPERHELP** requires the **PROBAS Library**. See our ad on the opposite page for information on **PROBAS**, shipping rates, and our thirty-day money-back guarantee.

Special Introductory Price—For a short time this powerful hypertext engine and collection of help subsystems is available for **just \$99.00!**

HAMMERLY
COMPUTER SERVICES, INC.

9309 JASMINE COURT • LAUREL, MD 20707

(800) 343-7484

INT'L ORDERS: (301) 953-2191 FAX: (301) 725-8147
BBS: (301) 953-7738

Add \$5.00 per item (\$8.00 Canada) for shipping per order
Europe \$39.00 for 1st item plus \$5.00 for each additional
item Visa, M/C, C.O.D. (US Only) checks and approved
POs accepted Trademarks **PROBAS**, **PRORES**, **PROSCREEN**,
PROMENU Hammerly Computer Services, Inc. Quick-
BASIC, BASCOMP, Microsoft Corp.

PARK A CAR ON YOUR DESKTOP.



Now you can have the best of both design worlds: the powerful Macintosh interface plus a workstation-quality graphics display, thanks to Truevision's HR graphics card. The HR card bridges the gap in today's computing marketplace by offering a non-interlaced, sharp 1280 x 960 pixel display at 8 bits per pixel. Its 256 colors (from

a 16.7 million color palette) give you tremendous flexibility for engineering drawings, scientific visualizations, or 3D modeling.

Truevision's HR card is QuickDraw™ compatible*, which means that you can run with virtually all Macintosh® software. And you may select the monitor of your choice from manufac-

turers like JVC, Philips and SONY®. There are two Truevision HR Cards: The HR 2M (\$3995) addresses a desktop up to 2048 x 1024 pixels and the HR 4M (\$5995) addresses a desktop up to 2048 x 2048 pixels. Take a test drive soon by visiting your Authorized Truevision reseller, or call us at **800/858-TRUE** to obtain literature.



The HR Graphics Card works with the Macintosh II, IIx and IIcx.

 **TRUEVISION®**
Truevision, Inc.
7351 Shadeland Station, Indianapolis, IN 46256

Circle 258 on Reader Service Card

INTERNATIONAL: Canada 416/499-9400 France 33-13-952-6253 Italy 39-2-242-4551 Switzerland 41-1-825-0949 U.K. 44-1-991-0121 West Germany 49-89-612-0010 Other International 617/229-6900. Suggested retail price is US domestic price, and is subject to change.

*All graphics cards with more than 1MByte of memory require 32-bit QuickDraw. QuickDraw is a trademark and Apple, Macintosh and Mac are registered trademarks of Apple Computer, Inc. SONY is a registered trademark of Sony Corporation of America. Image courtesy of Electric Image. © 1989, Truevision Inc.

August 1989

BYTE

Macintosh Special Supplement

Bonus All-Mac Supplement



Mac System 7.0
HyperTalk
Spectrum/24 • Showcase F/X
MaxPage 1.2
List Manager Techniques

How to make your VAX talk Mac.

And your Mac talk back.

And how to do it *fast*.

Introducing MacRAF.

The fastest Mac-to-VAX link in the industry. (Over 100,000 cps transfer rate.)

No staring out the window or tapping your fingers while you wait for an application to load. Or a file to save.

VAX access from your Mac is as fast as launching an application on your local hard disk. And just as easy too. So easy, in fact, you won't notice MacRAF working for you. It's absolutely transparent.

What's more, connecting to the VAX is so easy... no VAX commands, no VMS prompts... just connect your Mac to Ethernet and you're ready to go.

Finally, MacRAF brings you all the auto log-on, terminal emulation and multiple VT220 VAX session features of RAF, Datability's IBM PC-to-VAX software.

We've already DECed over 30,000 IBM PC-to-VAX users with our RAF (Remote Access Facility) software. And now your Mac can join the club.

Try MacRAF for a 30 day, no-risk, free trial.*

OR

Receive free: "How to DEC a Mac. Or PC." When you call or FAX:

1-800-DIAL-DSS

NY (212) 807-7800

FAX (212) 463-0459

Canada (613) 937-4444

Our brochure explains how MacRAF provides network integrity, seamless files sharing and storage, as well as terminal emulation.

*Offer valid in the U.S. only and expires October 31, 1989

YES. I would like to try MacRAF for 30 days. I understand that it is a no-risk, free trial of MacRAF.

YES. Please send me your brochure on "How to DEC a Mac. Or PC."

Name _____

Title/Dept _____

Company _____

Address _____

City _____ State _____ ZIP _____

Telephone () _____

DATABILITY

322 Eighth Avenue, New York, NY 10001 London • Boston • Chicago • San Francisco

DATABILITY

Copyright 1989, Datability Software Systems, Inc. MacRAF and RAF are trademarks of Datability Software Systems, Inc.

IBM and Macintosh are respective trademarks of IBM Corporation and Apple Computer, Inc.

BYTE

Macintosh Special Supplement

Short Takes 191

FIRST IMPRESSIONS: System 7.0:
The Next-Generation Mac Operating System 196

List Manager Techniques 199

HyperTalk Program Design 205

EDITORIAL

System 7.0 and the Macintosh IIcx

Apple's plans for the future of computing

During 1989, Apple gave us a glimpse of its plans for the future of personal computing. With the introduction of the Macintosh IIcx in March and the announcement of the next-generation operating system, System 7.0, at the May Developer's Conference, Apple has staked its claim to the future of innovative personal computing. While neither the Mac IIcx nor System 7.0 is a product breakthrough, both do indicate the direction that Apple will take during the 1990s. Why are the Mac IIcx and System 7.0 so important?

The Mac IIcx is not important because of what it's made of. Plenty of vendors sell machines with processors at least as fast as the IIcx's 16-MHz 68030. Plenty of vendors sell machines with an industry-standard bus architecture for expandability. And plenty of vendors sell machines with high-resolution graphics capabilities. No, the hardware is not the exciting part of the Mac IIcx. The real

excitement is how the Mac IIcx is made. It is the first Mac design to really take modular construction—or *design for manufacturing* (DFM)—to heart.

DFM is the wave of the present in personal computer manufacturing. DFM dictates that a computer's hardware be designed with ease of assembly and disassembly in mind. This results in a machine that's cheaper to make and cheaper to fix when it breaks.

In the area of software, the excitement is System 7.0. Although it won't be available until 1990, the May announcements promise that System 7.0 will include most of the modern operating-system features that we'll all need to handle information in the new decade. Things like outline fonts, interapplication communication, virtual memory, an improved Finder interface, and printing enhancements are all important, but the crucial part of System 7.0 is what it lacks.

What's missing is backward compatibility. You can run System 7.0 on any Mac, from the Mac Plus to the Mac IIcx, as long as you have 2 megabytes of RAM. Ever tried to run OS/2 on an old PC or XT? It won't work, no matter how much memory you have. There's no backward compatibility for OS/2 on IBM's older PCs because the 8088 processor lacks

the horsepower, and so OS/2 was written for a later-generation Intel processor, the 80286. A Mac Plus or Mac SE, however, even with their dated and overworked 68000 processors, will run System 7.0. They'll take advantage of all System 7.0's new features, with the exception of virtual memory. This is no easy trick, and it points to Apple's commitment to its installed base of Macs.

Apple has the unique opportunity to really broadcast its vision of computing during the 1990s by expanding both of these hardware and software concepts. It can do this by taking DFM and building an inexpensive Macintosh (under \$750 list) that runs System 7.0. This Mac, which I call the Macintosh Classic (as opposed to the "classic Macintosh," which started with the Mac 128K and exists now as the Mac Plus), would offer Apple's vision to many people. It would accomplish this because many people—not just large corporations—could afford such a machine, and it would replace the aging Apple IIs that fill our schools, small businesses, and homes. Let's hope that Apple doesn't waste this important opportunity.

—Don Crabb
Contributing Editor
(BIX name "decrabb")

It syncs to

The fact that you're considering a Macintosh II shows you're serious about computers. That you want to reach as far as a great system will let you. So you can reach your potential.

Well, now there's a way to go even further.

By giving your Mac II a MacSync™ monitor from NEC.

MacSync is designed solely for the Macintosh II Video Card. And because it is the

direct result of some meaningful conversations with Mac II users, it has all the features you've always wanted in a monitor.

For instance, you asked for easier, more convenient controls. So we moved them up front. You also wanted a 14" non-glare screen to reduce



the Macs.

fatigue. A smaller footprint and a tilt-swivel base, for more comfortable viewing. They're yours. What's more, we give you a cabinet that looks as good from the back as it does from the front. And a HyperCard stack

on-screen user reference guide called MacSync Valet.™

All at no extra cost.

And if you don't mind us saying so, that's the least you and your Macintosh II deserve.

Designed and optimized just for the Macintosh II.

MacSync from NEC. We've taken everything we've learned about

Macintosh II Video Card is a trademark of Apple Computer, Inc.

making great color monitors. And applied it to the Macs.

Macintosh and HyperCard are registered trademarks of Apple Computer, Inc.

For literature, call 1-800-826-2255. For technical details, call NEC

MacSync and MacSync Valet are trademarks of NEC Home Electronics (USA) Inc.

Home Electronics (USA) Inc. 1-800-FONE-NEC.

© 1989 NEC Home Electronics (USA) Inc.

NEC

10 Important Reasons C Programmers Use Our Macintosh DBMS

1. db_VISTA III™ for the Macintosh is written for professional C developers.

It is not just a PC product ported to the Mac. db_VISTA III integrates all modules and utilities in an easy-to-use windowed environment with full mouse support.

2. db_VISTA III is Fast.

No other DBMS for the Macintosh combines this much capability with such speed!

3. db_VISTA III provides Relational and Network Model Technology for Programming Flexibility.

This combination delivers outstanding performance over relational systems. Development costs are lower, too.

4. db_VISTA III applications are portable to MS-DOS, UNIX, OS/2, VMS and more.

Costly development for new environments is nearly eliminated since your applications can be ported easily. Lower costs; increased productivity.

5. Complete C source code is available.

6. No Royalties. Save thousands of dollars!

7. db_VISTA III provides transaction logging and automatic recovery, providing protection and security for your valuable data.

db_VISTA III™ Database Development System		
Features	Yes	No
db_VISTA 3 High Performance DBMS:		
Single and Multi-User available	✓	
Relational B-tree Indexing	✓	
Network Database Model	✓	
Multiple database access	✓	
Referential integrity	✓	
Automatic recovery	✓	
Record & File locking	✓	
RAM resident		✓
db_QUERY 2 SQL-based Query:		
Relational Query & Report Writer	✓	
db_REWISE 1 DBMS Restructure Program:		
Total database redesign/restructuring	✓	
C Compilers*: MPW & LightspeedC	✓	
Operating Systems*: Macintosh,	✓	
Also VMS, ULTRIX, UNIX SYSTEM V,	✓	
BSD 4.2, SunOS, XENIX, MS-DOS	✓	
and MS Windows. OS/2 compatible.	✓	
LANs*: AppleShare, 3COM, Novell,	✓	
Banyan and more ...	✓	
SOURCE CODE AVAILABLE:	✓	
ROYALTIES: (Absolutely not!)		✓

*Other environments are supported; call for complete list.

8. SQL-based db_QUERY let's you embed SQL into your applications or use it ad hoc with the stand-alone interface provided. db_QUERY also includes a report writer.

9. db_VISTA III is a proven performer! Thousands of C programmers in over 50 countries worldwide use db_VISTA III, including APPLE, ARCO, AT&T, EDS, Federal Express, Hewlett-Packard, IBM, NASA...

10. Complete customer support services are available, including telephone support.

Training classes, consulting and custom development services are available, too.

Don't put it off any longer! Call today and find out why more C programmers are choosing db_VISTA III for the Macintosh. We'll gladly answer your technical questions and the call is free.

Call 1-800-db_RAIMA
(That's 1-800-327-2462)

db_VISTA III

Database Development System
for the Macintosh

Special Offer
For a limited time only
Starting at **\$395**



Raima Corporation 3245 146th Avenue, Redmond, WA 98072 USA (206)747-5570 Telex: 6803018237 MCI MAIL FAX: (206)747-1991 Texas: (214)231-3131 International Distributors:
U.K.: (0992)500919 Germany: 07127/5244 Switzerland: (01)725 0410 France: (14669)2828 Benelux: (02)9946 814 Sweden: (0131)24780 Italy: 045/584711 Norway: 47 244 88 55
Denmark: (2)887249 Singapore: 468 3888 Australia: (02) 959 5122 Japan: (03)473 7432 Taiwan: (02)511 3277 Mexico: (83) 57 35 94 Central America: (506) 28 07 64
Caribbean: (809) 834 4069 Colombia: 57 1 218 9245 Argentina: 54 1 315 4200 Chile: 56 2 696 4300 Uruguay: 92 19 37 Brazil: (0192) 52 9770 © Copyright Raima Corporation 1989

BY89M

SHORT TAKES

BYTE editors' hands-on views of new products

Spectrum/24

Showcase F/X

MaxPage 1.2

True Colors, Revisited

A year ago, I evaluated SuperMac Technology's Spectrum/24, a NuBus video board that could display 24-bit color pixels. At the time, Color QuickDraw didn't provide any large-pixel support: It only worked with color pixels 8 bits in size. SuperMac cleverly used a chunky/planar mode that was defined—but unsupported—by Apple to work around this limit. Drawing operations were somewhat slow and made for some interesting screen effects as the primary colors rippled into the frame buffer, but it worked. Nor could you argue with the photographic quality of the results. Since the Spectrum/24 used an unsupported graphics mode to function, SuperMac Technology sold the board only to developers.

Apple's 32-Bit QuickDraw changes all that: Now Macs that support color have the capability of displaying, manipulating, and printing full-chunky pixel images that are 16 or 32 bits deep. It seemed appropriate to check back on the Spectrum/24 video board to see if it had changed with the times.

The Spectrum/24 most certainly has changed. Although it still sports the same name and features, the board's electronics have been completely



THE FACTS

Spectrum/24
\$3999; with NuBus board trade-in: \$2499

Requirements: Mac II with 2 megabytes of RAM, a color monitor, and a hard disk drive, and running System 6.0.3/Finder 6.1 with 32-Bit QuickDraw installed.

SuperMac Technology
485 Potrero Ave.
Sunnyvale, CA 94086
(415) 245-2202
Inquiry 471.

redesigned to fully conform to 32-Bit QuickDraw's full-chunky pixel format.

One feature that the new Spectrum/24 inherited from its predecessor is support for both SuperMac's 16- and 19-inch monitors (displaying 1024 by 768 pixels) and Apple's 12- and 13-inch monitors (displaying 640 by 480 pixels). Another inherited feature is screen depths of 1, 2, 4, 8, and 32 bits (of which 24 bits actually hold color information).

At "shallower" screen depths (4 bits or less), the unused portions of the Spectrum/24's frame buffer are used to either expand the dimensions of the Mac screen (in what SuperMac calls a "virtual desktop") or to provide a 2x-zoom magnification fea-

ture on part of the screen. A built-in hardware pan function scrolls this enlarged screen automatically as the mouse pointer reaches the edge of the display.

I used the Spectrum/24 on a Mac II equipped with 2 megabytes of RAM and a 40-megabyte hard disk drive, and on a Mac IIcx with 4 megabytes of RAM and an 80-megabyte hard disk drive. For both systems, the video board drove a SuperMac 19-inch Trinitron monitor. Installation was as simple as plugging in the board and rebooting.

The Spectrum/24 worked fine with the alpha version of 32-Bit QuickDraw that I was using, and it switched through all screen depths without a hitch. The 24-bit-deep images that I had captured with a

Howtek Scanmaster color scanner closely resembled the original photos. Screen performance at 32-bit screen depths was slower than at 8 bits, but not prohibitively so, as it was with the chunky/planar boards.

The Spectrum/24 helps provide the hardware portion of Apple's 32-bit imaging solution, and it definitely brings WYSIWYG to high-end color prepress applications. It and 32-Bit QuickDraw work synergistically to provide crisp screen updates without any of the color after-images that plagued chunky/planar hardware implementations, and they do it with very snappy throughput. I'm looking forward to seeing what other interesting applications develop now that the Spectrum/24 makes this type of display technology available.

The Spectrum/24 costs \$3999. For a limited time, you can upgrade to a Spectrum/24 for \$2499 by trading in your existing NuBus video board (it can be a SuperMac, RasterOps, or Macintosh II video board) to SuperMac. □

—Tom Thompson

Special F/X on the Mac

Did you ever see the movie *Clash of the Titans*? Despite a stellar cast, it was a clunker of a film that was redeemed only by Ray Harryhausen's special effects. I kept thinking of that movie while working with Aegis Development's Showcase F/X, a program for creating and animating text for use in desktop presentations and videos. This multifeatured Macintosh package won't make you the

continued

Harryhausen of computer-based presentations, but it will give you some easy-to-use tools for spiffing up your slide show, videotape, or product demo.

Showcase F/X (the name, which comes from the cinema's abbreviation for special effects, signifies the program's film heritage) is strictly for working with text. It has animation capabilities, but you can use them only with alphanumerics; this is not a package for drawing cartoons. For an idea of what you can do with this program, think of opening credits you've seen at the movies, in which the titles flash across the screen or come at you from the background or glow like neon.

The program gives you a blank drawing board on which you type the text you want, using either the Mac's fonts or what Aegis calls Poly fonts, unique object-based characters that you can manipulate (e.g., stretch, shrink, flip, mirror, and distort) by pulling on the handles that surround the chunk of text. Showcase F/X has several effects you can apply to the text; for example, you can add shadows, a three-dimensional look, a neon-like glow, smears, or colors (16 or 256, depending on your system).

Animating the text is relatively easy, but it does require studying the manual a bit. (This isn't the sort of software you should just dive right into.) If you've worked at all with film animation, you'll find the program to be pretty intuitive; it essentially follows a metaphor of setting up frames and then linking them.

You can do this frame by frame, or you can let the program do some of the work for you. Let's say you're putting together a 50-frame script; you don't have to specify every frame—you can establish frames 5, 10, 15, and so on, and the program will automatically handle the transitions between those frames.

After you've established your script—the content and

THE FACTS

Showcase F/X
\$395

Requirements:
Mac II with a color or gray-scale monitor, at least 2 megabytes of RAM, a hard disk drive, System 6.0.2 or higher, and Finder 6.1 or higher; for use with videotape, you'll need a genlock board.

Aegis Development
2115 West Pico Blvd.
Santa Monica, CA
90405
(213) 392-9972
Inquiry 472.

sequence of frames—you can preview it to see how it'll look when animated. When you're ready to shoot your script, so to speak, you just click on a button, and Showcase F/X then records each frame.

Showcase F/X will import images from programs that use the PICT file format, such as MacDraw and PixelPaint, but you can use these pictures only as backgrounds behind the titles. You can also scan in images for use as backgrounds.

Now what can you do with all this fancy titling? Well, you can use it in a stand-alone presentation that runs on your Mac (or is projected onto a big screen), or, if you've got the appropriate genlock device, you can transfer the text to a videotape machine; I wasn't

able to test this capability, but Aegis says Showcase F/X will work with genlocks from RasterOps, Mass Micro Systems, and Computer Friends. (You could also send output to a printer, but this seems a waste of the program's talents.)

As a bonus, Aegis throws in its SlideShow program, which you can use to enhance your animated script. SlideShow lets you alter the playback speed of your animation, change transition colors, and loop a group of animation files.

I worked with Showcase F/X on a Mac II with 4 megabytes of RAM; the company recommends at least 2 megabytes, and I'd say that's definitely the bottom line. With a 256-color board, some of the screens were downright daz-

zling. If you're into visuals, you can find yourself spending a lot of time with this package, checking out its box of tricks. I did run into a few weird spots, however. While trying to record a 50-frame animation, I repeatedly got the message that "An I/O error has occurred." I also got a message I'd never seen before: "Can't understand lock." Lock? What lock?

One warning: This program can be pretty slow. Screen drawing seemed a bit poky, and the recording process gives you ample time to go fetch a cup of coffee; in fact, it takes long enough that you can brew a new pot.

Not everybody needs a program like this. But if you've got a presentation or demo to give and would rather have the audience looking at the screen than at you, Showcase F/X can help you out by providing the tools to create brilliant displays. If you're a filmmaker looking to put effective titles on your videotape, doing it yourself using this program is considerably less expensive than hiring someone else to do it with traditional equipment. Showcase F/X is one more indication that personal computers, particularly the Macintosh, can meld beautifully with the visual arts. □

—D. Barker

The \$89 Page

If you've been thinking about doing some desktop publishing with your Mac, **MaxPage 1.2** may be a good program to get you going. The program costs only \$89 and has most of the standard desktop publishing features.

Like most desktop publishing programs, MaxPage put me immediately into an untitled page. To start, I drew a text box by holding the mouse button down, dragging down and to the right to size it, and then letting go of the button. To work with multiple columns, I called up the full-page

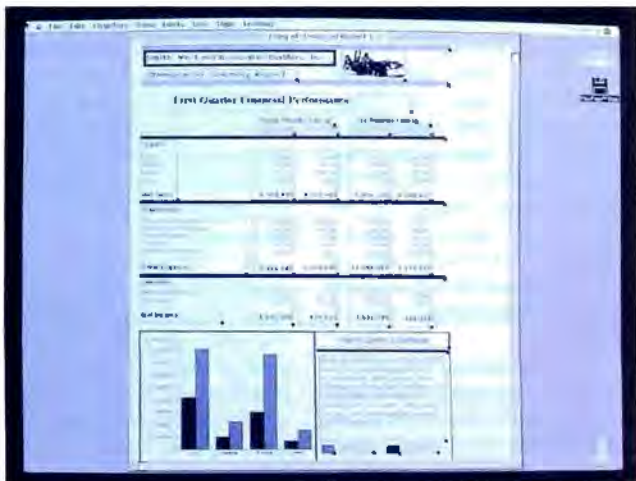

grid, which, unfortunately, is divided into inches rather than picas, with subdivisions in one-quarter-inch rules. It also has horizontal and vertical half-page and third-page dividing lines. I learned to hide the grid before printing my document.

After positioning columns, I started adding text. When I moved the cursor into a box, it changed into a text-editing I-beam. I simply pushed the mouse button down, and the text-insertion bar began blinking within the box. Once I selected a box, any menu commands affecting a box applied only to that particular box.

I entered text by typing, but I could have imported any ASCII file as well. When you import text, it uses the box's right side as its right margin and automatically wraps around until all the text has been added. If the text length goes below the bottom of the importing box, it is stacked below the visible area.

MaxPage also offers all the usual Macintosh editing features, such as select, cut, copy, and paste, as well as the typical selection of fonts on the Mac II. You can change the font inside a box at any time, the same way you do within any Mac document. One thing to remember is that if you change fonts for a particular box, the text in corresponding boxes will also appear in that font unless you change it.

If you increase the width of a box, the text automatically adjusts to fit inside the new box size. If your text goes beyond the last box on a page, you can wrap it into memory and then wrap it into a box on the next page.

You can also import draw-

ings or paintings from source files that are in PICT format or in PNTG, a MacPaint-style format. This lets you use MacDraw and MacPaint to create detailed graphics that you can import into your MaxPage documents. Each time that MaxPage redraws a graphic, it reimports it quickly.

One feature that I found useful is MaxPage's ability to automatically adjust the graphic inside the box to fit, no matter how many times you resize the box. The manual recommends that you make your original drawing fill an entire page in your graphics application before you import it into MaxPage. In that way, your drawing will completely fill the box that you import it into, giving you total control over its sizing.

MaxPage also gives you picture-adjustment facilities in the form of scroll bars immediately below and to the right of the picture. These scroll bars let you expand your pictures from the center, equally outward on all sides, to the left or right, and upward or downward. Again, if you change the size or shape of the box, MaxPage will adjust your drawing proportionally. An additional scroll bar farther to the right lets you enlarge the picture or, if you change your mind, reduce it again.

You can also add a background to your document. Backgrounds can be full-page PICT files, but you cannot use PNTG files for this purpose.

MaxPage is an easy-to-use page-layout program for the Macintosh that gives you many of the features included in more-expensive page-layout programs. ■

—Martha Hicks

THE FACTS

MaxPage 1.2
\$89

Requirements:
Mac 512KE or Mac
512K with 128K-byte
ROMs.

Applied Systems &
Technologies, Inc.
227M Hallenbeck Rd.
Cleveland, NY 13042
(315) 675-8584
Inquiry 473.



Oops!

CCMI/McGraw Hill's National Tariff Library Service Will Fill in the Blank!

At CCMI/McGraw Hill's National Tariff Library Service, we know tariffs. Not just the rates, but the tariff complexities that govern your business telecommunications services. We can help you be sure you'll get the most for your voice/data dollar.

Our service provides the most frequently requested U.S. tariff information. If your requirements are very

specialized, we'll focus on the jurisdictions, carriers, and services that matter to your company.

Call the experts at CCMI/McGraw Hill's National Tariff Library Service today at 1 800 526-5307 or 1 201 825-3311.

CCMI/McGraw-Hill
500 North Franklin Turnpike
Ramsey, New Jersey 07446



Diamond quality in SINGLE IN-LINE MEMORY MODULES for Mac Plus, SE, II, Iix

- 1,2,4, or 8 Megabytes
- Easy to Install
- Lo Profile SMD CMOS
- Lifetime Guarantee
- Manufactured in USA
- Static Protected
- Nationwide Distribution
- Same Day Delivery

Expand your Mac memory by 1 to 8 megabytes with Diamond-Pac SIMM modules, the Mac's "best friend". The many facets of Diamond-Pac include 100% testing, "fail safe" installation instructions, and a lifetime guarantee. All combined to ensure your Diamond-Pac's are forever. Government & University PO's welcomed.



AMERICAN MICRO DISTRIBUTORS, INC.

16897-D Algonquin, Huntington Beach, CA 92649
714/840-5560 • 800-243-6654 • FAX: 714-846-0570





Aside from being a tad easier to install than a satellite, the Hayes Smartmodem 2400M™ for the Macintosh® II and Smartcom II® for the Apple® Macintosh make up the most advanced communications system you can put inside a Mac.®

With this modem and software package, you can set up an extensive Macintosh work group system through a feature called HayesConnect.™

HayesConnect™ allows any Mac access to the Smartmodem 2400M across an AppleTalk® Network.

Which means all Macintosh computers on the Network will be able to communicate with or without a modem of their own. This makes for extremely efficient office communications.

THE ONLY COMMUNICATIONS SYSTEM MORE ADVANCED THAN OURS WON'T FIT INSIDE YOUR MAC.

To make them even more efficient, the system offers Smartcom II for the Macintosh. It's the only software designed to take full advantage of the power and graphics capabilities of all of the computers in the Macintosh family. For example, you can program your own on-screen buttons to create a personalized user interface. You also get features like moveable icons, custom color selection and full support of ImageWriter® and LaserWriter® for incredible graphics. You can even run the system unattended using an Autopilot feature. Of course, there is much more you can do with a few simple clicks on standard, easily identifiable icons.

By now it's probably clear that whether they're just used with the

Macintosh II or shared by Mac computers on an AppleTalk Network, the Smartmodem 2400M and Smartcom II make a communications system that can't be beaten. At least not by anything on this planet.



Hayes.

For your nearest Hayes Advanced Systems Dealer, call 800-635-1225. Hayes Microcomputer Products, Inc., P.O. Box 105203, Atlanta, GA 30348.

Apple, Macintosh, Mac, ImageWriter, LaserWriter and AppleTalk are registered trademarks of Apple Computer, Inc. © 1989 Hayes Microcomputer Products, Inc.

System 7.0: The Next-Generation Mac Operating System

Tom Thompson

*It offers many
features competitive
to OS/2 yet
remains compatible
with the existing
software base*

In early May, Apple announced certain details about its much-rumored System 7.0 operating system for the Macintosh. This served to eliminate much of the rampant speculation about its features and also revealed Apple's course for desktop computing in the 1990s.

For starters, System 7.0 will correct a number of limitations with the existing Mac operating system: It will handle large hard disk drives with thousands of files; accurately display fonts on low-resolution devices, such as impact or SCSI printers; provide support for color printing and third-party printing devices; and expand the address space out of its current 16-megabyte limit. At the same time, System 7.0 will supply many new features: virtual memory; a new Finder with a more consistent way to add fonts, desk accessories (DAs), sound resources, and Control Panel modules (cdevs); an enhanced file system that can handle MS-DOS or NFS volumes; communications support (serial and networked); database support; and ways to establish live data links between running applications. But there's still no preemptive scheduler or hardware memory protection; it's still up to MultiFinder to provide multitasking capabilities. Nevertheless, System 7.0 promises a lot of OS/2's features and will provide them across the entire Macintosh line, from the Mac Plus to the Mac IIcx.

All you need to run System 7.0 on existing machines is a minimum of 2 megabytes of RAM. An IBM PC system using OS/2 and Presentation Manager requires at least 3 megabytes of RAM and an 80286 processor.

I must stress that much of the information Apple supplied is preliminary and subject to change. Also, I had no hands-on experience with even prototype software. With that in mind, I'll focus on a few of the more interesting parts of System 7.0. I'll provide a more comprehensive report when the software becomes available.

The New Finder

The new Finder lets you customize your system or add enhancements using a consistent interface. To add DAs, fonts, and sounds to the system, you simply copy the files into the appropriate folder.

DAs and Control Panel files appear as icons on the Desktop, and you activate them by double-clicking on the icon—the same as launching a Mac application. Attached printers appear as icons, and you can print a document by dragging it onto the printer icon. The new Finder also provides a built-in file search function, a help window, and file aliasing.

A 32-bit Address Space

The current Mac operating system is limited to a 24-bit address space 16 megabytes in size, of which only 8 megabytes is available to applications. This is the case even though the Mac II family and the Mac SE/30 use 68020 and 68030 processors that can handle a 32-bit address space (4 gigabytes). This occurs because not all of the Mac operating system implements 32-bit addressing (two of the offenders here are the Memory Manager and QuickDraw)—a legacy from the 68000 processor's 24-bit address bus. System 7.0 will eliminate the vestiges of the 24-bit addressing limit in the Macin-

tosh operating system.

Interestingly, QuickDraw's addressing problems could be dealt with apart from the rest of the operating system and are fixed with the release of 32-Bit QuickDraw (see "Apple's 32-Bit QuickDraw Covers the Spectrum," July BYTE). A Mac can use 32-Bit QuickDraw's enhanced capabilities while running in a 24-bit environment under System 6.0.3.

These modifications in System 7.0 will further the migration of Mac software to a 32-bit environment. They will allow present and future Mac applications to access larger amounts of RAM, in order to deal with the large computing jobs of the 1990s.

Virtual Memory

System 7.0 will implement virtual memory; unused objects in RAM are written to a file on disk and read back into memory when needed. Although there's a performance penalty because of this "swapping" overhead and because disk accesses are slower than RAM, virtual memory lets you work with objects larger than the computer's physical memory.

System 7.0's virtual memory will use a demand-paging scheme using 4K-byte pages (one block of memory). In the 24-bit environment, you can configure virtual memory to a maximum of 14 megabytes. In the 32-bit environment, you'll be able to use the entire address space, 4 gigabytes.

Virtual memory requires the use of a memory management unit that determines when to swap objects to and from RAM. Since an MMU is an integral part of the 68030 processor, the Mac IIx, Mac IIcx, and Mac SE/30 will have virtual memory the moment System 7.0 is installed. For the Mac II, a 68851 paged memory management unit chip must be placed in the MMU socket. The Mac Plus and Mac SE, using 68000 processors, won't be able to take advantage of this feature.



Outline Fonts

The bit-mapped fonts normally used by the Mac have several limitations. You can display a font—and print it on a non-PostScript printer—with good results if you have the font resident on your system. The problem is, handling every possible point size of every typeface you might ever need requires lots of disk space. Not only that, but these low-resolution bit maps reproduce poorly on high-resolution laser printers.

Apple's solution is outline fonts. In outline fonts, a character is stored as points that describe its outline mathematically as a series of quadratic B-splines. As with PostScript fonts, this technique allows the accurate representation of characters on high-resolution output devices, such as laser or Lintronic printers. For low- or medium-resolution devices, such as impact printers or the screen, where the character must be mapped into the constraints of a grid containing a limited number of print wires or pixels, the outline fonts provide another display mechanism.

An Apple instruction set allows a font vendor to associate a program with each character that, when executed by System 7.0's low-level software, will correct the character's appearance to fit within the grid of the output device. This promises to give the Mac the ability to generate attractive text for an output device of any resolution and at any point size while using just a single outline font for a given typeface. Apple plans to publish the outline specifications and instruction set for use by third-party font vendors.

Communications Toolbox

As its name implies, the Communications Toolbox will provide all applications with high-level access to standard communications functions. Currently, an application must access serial or networking drivers directly to use communications services. The Communications Toolbox will accomplish this in much the

same way that Color Quick-Draw does: by providing a set of versatile device-independent routines, while low-level software handles the chore of translating these routines to hardware-specific calls for a particular I/O board. A set of "standard" dialog boxes will allow the user to configure communications parameters, such as the transmission rate, parity, and stop bits for the serial port.

The Communications Toolbox has been under development for some time. It will be available for use with System 6.0.3 in the third quarter of this year.

New Print Architecture

System 7.0 will provide a new printing architecture that supports color, gray-scale, and custom page sizes (e.g., mailing labels and tickets). It will accomplish this while retaining a one-to-one correspondence with the old printing calls.

As a result, the new printing architecture will be compatible with most existing applications; note, however, that existing printer *drivers* won't work with System 7.0. However, Apple will license a developer's toolkit so that third-party vendors can rapidly modify their drivers to work under the new operating system. This will also allow the Mac to support a larger variety of printers.

No Memory Protection

One of the biggest disappointments in the System 7.0 announcement is that the machine will have no preemptive scheduler or hardware-supported memory protection. This is unfortunate. I've seen MultiFinder handle an application crash elegantly with just an informative message on more than one occasion, but just as often I've had an application crash toss me into the safety net of the TMON debugger. While MultiFinder works, it is only as capable as the most poorly behaved application. Obviously, you should

run only reliable applications with Multi-Finder, but I think the onus of system integrity should lie with the operating system, not with the application designer.

To be fair, the reason Apple did not implement hardware protection at this time was to maintain compatibility with existing applications. The Mac operating system currently makes no distinction between system code and application code: everything runs in the 68000's supervisor mode. Furthermore, the system stack is used to share resource information among running applications. If memory protection "walled off" the Mac operating system and the system stack from Mac applications, much of the application software would break. Under these circumstances, it seems to me that the lack of hardware memory protection is reasonable, but I'd like to see it in the future.

Future Course

I've covered only a handful of the features that System 7.0 will provide the Mac user. Again, most of the information is preliminary. I'll report more on System 7.0 and other features as it's released and the details become firm. You can expect to see System 7.0 released early next year.

I'm encouraged by the new openness at Apple. The publication of the outline font specifications and the printer toolkit are a significant step in the right direction in the era of open system architecture. The support for the entire product line is also encouraging, but I'm skeptical that this can be accomplished for the Mac Plus. Nevertheless, if Apple makes System 7.0 live up to its promise and can deliver it on schedule, the Mac will have many of the features found in OS/2 systems, and in some areas, it will surpass them. ■

Tom Thompson is a BYTE senior technical editor at large. He can be reached on BIX as "tom_thompson."

WE CHOSE THE WORLD'S MOST POWERFUL C TO POWER THE DEVELOPMENT OF OUR DARKROOM.



Don Cone



Ed Bomke



"Power, power, and more power," says Ed Bomke, when asked why he chose THINK's LightspeedC to develop Digital Darkroom.™ "With its unparalleled power, it really deserves its reputation as *The Professional's Choice*." Don Cone, his partner, agrees, "Its power really shows in the debugger. It lets us test code, debug, revise and rerun in one smooth, fast process.

debugger. That's why professional programmers choose THINK's LightspeedC over competing C implementations.

THINK's LightspeedC is the industry leader. Its integrated multi-window text editor, compiler, linker, source level debugger, and auto-make facility make for a winning combination. It's the C that created winners like Digital Darkroom, FoxBASE + /Mac,™ Aldus PageMaker,® Adobe Illustrator,™ and Quark XPress™ 2.0. Ed Bomke says its power and performance made developing Digital Darkroom "almost instamatic."

Call (800) 228-4122 Ext. 298Y for more information, or visit a dealer near you.

The Professional's Choice.



Circle 464 on Reader Service Card

- THINK's LightspeedC 3.0**
- Full K&R implementation with Harbison and Steele extensions.
 - Macintosh-style source level debugger for incredibly fast development.
 - Code generator support for 68881 & 68020.
 - Precompiled headers for ultimate compilation speed.
 - Compiles up to 48,000 lines per minute.*
 - Links any size program in seconds.
 - Full Toolbox, OS, UNIX libraries, and SANE numeric support.
 - Generates 32-bit clean code.
 - Free telephone support.

That's power. The benefit to us is faster turnaround time. So, it's easy to test out ideas while we're thinking about them. Then turn them into working programs sooner... without any wasted effort."

Power, speed, reliability, code quality... and a superior Macintosh-style source level

See Us At MacWorld Expo, Booth #5104, World Trade Center

List Manager Techniques

Jan Eugenides

Handling lists of information? Here's how the List Manager can help.

One of the Macintosh interface's distinguishing characteristics is the way it lets you scroll through, highlight, and select individual entries in lists of information. That information can take the form of data or filenames—either as text or as icons. The tool that gives you this power and mobility is called List Manager, and it's one of the handier items ever conceived for easing the lives of both users and programmers.

Briefly, List Manager provides an easy way of displaying small lists of data in a row-and-column format. It handles most of the mouse interactions (e.g., scrolling, highlighting, hit testing, and selecting list elements). It's best for straight text lists, but it can smoothly handle graphical items such as icons and the kinds of pictures you've come to know through MacPaint's tool palette window.

The information in this article will let you take an informed look at List Manager. If your interest in the Mac is primarily as a user of applications, this detailed examination will help you gain an insight into the complexity underlying the Mac interface. Whether you're a casual programmer who'd like to customize commercial software or a professional who writes applications from scratch, you'll recognize straightforward techniques you can use to take some of the hassle out of Mac programming.

Although my code is written in MPW C 3.0, the techniques I use apply to other languages as well. Please note that although I refer to sample code in this article, it was not possible to include the code in its entirety. It is, however, available on disk and on BIX for downloading (see page 5 for details).

List Manager Basics

The first item of business when working with the List Manager is to create an empty list. A list is always associated with a particular window and is displayed in a rectangle within that window. The list can have vertical and horizontal

scroll bars if needed, and it can be made resizable. The call to create a new list, `LNew()`, is shown in listing 1. To help distinguish them from the other 400-odd Mac Toolbox calls, List Manager calls are prefaced with an "L."

Most of `LNew()`'s parameters are fairly self-explanatory. The `Rect rView` is the rectangle in which the list will be displayed in the window's local coordinates. It does not include the area for the scroll bars, if any.

The size of the list in rows and columns is given by `Rect dataBounds`. The dimensions of a list are always specified in numbers of cells; for example, if you wanted to create a list with 5 columns by 10 rows, you would set `dataBounds` to `(0,0)(5,10)`.

A `Cell` is really nothing more than a `Point` structure; that is,

```
struct Point {
short v;      /*vertical*/
short h;      /*horizontal*/
};
```

The size of a cell in the list is determined by the vertical and horizontal values of the `cSize` parameter.

The parameter `theProc` is the resource ID number of the list definition (LDEF) to use for the new list. If you pass `NULL` for this parameter, the default text-only list definition is used. Much of the power of the List Manager lies in writing your own list definitions, which I'll discuss in more detail later.

The `WindowPtr w` is the window to which the list should be attached. The Boolean `drawIt` determines whether drawing is turned on or off when the list is created (more on this later); the Boolean `grow` determines whether the list will be resizable; the Boolean `scrollH` determines whether the list has a horizontal scroll bar; and the Boolean `scrollV` determines whether the list has a vertical scroll bar.

continued



The handle returned by `LNew()` references a data structure called a List Record. It's a fairly complex structure, but since various List Manager routines are provided for accessing cell data, you'll rarely, if ever, have to deal with it directly.

The sample program that accompanies this article on BIX, `ListMgrDemo`, has two routines that create lists: `CreateList()` and `CreateIconList()`. Look in the `ListMgrDemo.c` for two examples of calling the `LNew()` function. You must

keep in mind several important points when setting up the List Manager.

First, set the size of the list by using a `userItem`. I almost invariably wind up using the List Manager in a dialog box of some kind. When I lay out the dialog with `ResEdit` (Apple's resource editor), I find it most convenient to place a `userItem` wherever a list will go. This allows me to visually select the placement of the various dialog elements. By writing my code to reference the `userItem`, I also gain the freedom to move or resize the

list later without having to change code.

Bear in mind when you use the size of the `userItem` to determine the size of a list that an area for scroll bars is *not* included in the rectangle that you pass to `LNew()`. In the `CreateList()` routine in the sample program, notice that I subtract 15 from the right side of the rectangle before passing it to `LNew()`, which leaves room for a horizontal scroll bar in the window.

Second, be careful about turning the list's drawing on or off. If you examine the `CreateList()` and `CreateIconList()` routines, you'll see that when I call `LNew()`, I specify that drawing should be turned off (the `drawIt` parameter is false). Generally speaking, it makes for a cleaner display if you create the list with drawing turned off and then turn drawing on with the `LDoDraw()` call sometime before the first update event occurs. Otherwise, the list will be drawn twice. It's also a good idea to turn drawing off when adding data to multiple cells so that the list won't be redrawn for each cell.

Third, set the selection flags. The selection flags allow you to customize the way the List Manager handles mouse-clicks and drags. Figuring out just how to set them can be a little bit confusing, however, so I'll show you the two flag settings I've found that provide the most useful behavior. The two lists in the sample application show how to set the flags, but I'll explain what they accomplish.

In `CreateList()`, the flags are set to `INoExtend + INoRect + IUseSense + INoNilHilite`, which are predefined List Manager constants. This allows the user to select multiple items by holding down the Shift key and clicking on them. The items do not have to be contiguous, as shown in the two scrollable windows in figure 1. It also prevents empty cells from being selected.

In `CreateIconList()` the flags are set to `IOnlyOne + INoNilHilite`. This setting allows the user to select one and only one item at a time.

Finally, take advantage of the Dialog Manager. When you use a `userItem` for your list, you can write a small update function to attach to it. Whenever a screen update is required, the Dialog Manager automatically calls your function. This eliminates the need for you to check and handle update events yourself and saves a bit of code.

To accomplish this feat, you must pass the address of a properly designed function to the Dialog Manager's `SetDItem()` function. `SetDItem()` is a ROM Toolbox call usually used to set a partic-

Listing 1: The parameters for the `LNew()` function, which creates a new list.

```
pascal ListHandle LNew(rView, dataBounds, cSize, theProc, w, drawIt, grow,
    scrollH, scrollV)
Rect    rView;          /*The display rectangle in local coordinates*/
Rect    dataBounds;     /*The size of the list in rows and columns*/
Cell    cSize;          /*The size of a cell in pixels (a Cell is a
    Point)*/
short   theProc;        /*The ID of the list definition (LDEF) to use*/
WindowPtr w;           /*The window the list should be displayed
    within*/
Boolean drawIt;         /*Whether drawing is turned on*/
Boolean grow;           /*Whether the list is resizable*/
Boolean scrollH;         /*Whether there is a horizontal scroll bar*/
Boolean scrollV;         /*Whether there is a vertical scroll bar*/
```

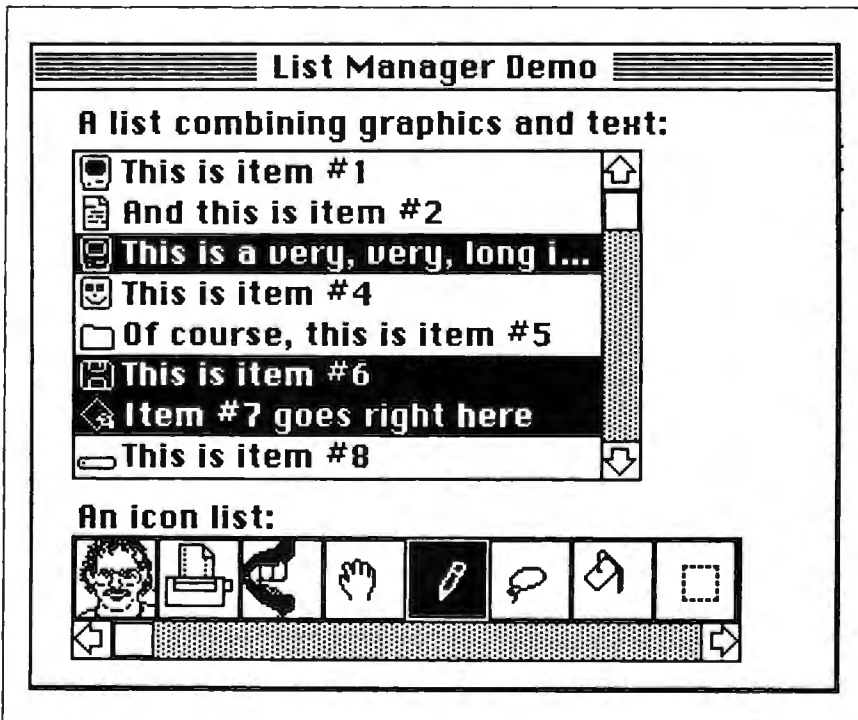

Figure 1: The sample application `ListMgrDemo` in action. The top window shows the output of `MyList.c`, which is a combination of scrollable text and graphics. Note that you can select more than one item in the list, as determined by the selection flags. The bottom window shows the output of `IconList`, which is a list of icons. This type of List Manager output makes it easy to implement a tool palette window for a painting or CAD application.

ular dialog item to a given rectangle or to change the appearance of a control. It's declared as follows:

```
SetDItem(DialogPtr dlg, short
  item, short kind, Handle h,
  Rect r);
```

In the case of a userItem, however, you can pass a pointer to an update function in the h parameter. The update function should be declared like this:

```
pascal void DrawItem(DialogPeek
  dpeek, short itemNo)
```

In the sample program, there are two update procedures, one for each list. They are named DrawList() and DrawIconList(). They are installed into the userItems right after the selection flags are set in both CreateList() and CreateIconList().

The DrawList routine is short enough to include here (see listing 2). It calls LUpdate() to redraw the list and then draws a simple one-pixel frame around the entire list.

Working with Cells

Once you have the list installed in a window or dialog box, you're ready to add data to it. It's unlikely that you'll know beforehand how many rows and columns a list will need unless the data is always a fixed size. Because of this, it is simpler to create the list with only one row or column and then use the List Manager's LAddRow() and LAddColumn() calls to dynamically size the list. LAddRow() and LAddColumn() are declared as follows:

```
pascal short LAddRow(short count,
  short rowNum, ListHandle list);
```

```
pascal short LAddColumn(short
  count, short colNum, ListHandle
  list);
```

Both work in a similar manner. The count parameter is the number of rows or columns you want to add. RowNum (or colNum) indicates where the new rows or columns should be inserted. They are inserted before the given row or column. Rows and columns that are greater than or equal to rowNum (or colNum) are increased by count. If these values are larger than the last row (or column) in a list, new rows (or columns) are added to the end. Passing a value of 32767 for these parameters always adds rows and columns to the end of the list. The short integer that is returned by LAddRow() is the number of the first added row. LAdd-

Column() returns the first added column. All added cells are empty.

In the sample program, the mixed text/graphics list is vertical, and the FillList() function uses LAddRow() to grow the list downward. I've used canned data for the demonstration application, with the data stored in an STR# (string list) resource and in several SICN (small icon) resources. This allows you to see how the list works without having to enter any data. In a real-life program, however, you would fill the list from some user-supplied data.

The icon list in the sample program is horizontal and uses LAddColumn() to grow the list sideways. This happens in the FillIconList() function. Again, I've used canned data for the demo.

There are two calls for removing cells from a list: LDelRow() and LDelColumn(). These are declared as follows:

```
pascal short LDelRow(short count,
  short rowNum, ListHandle list);
```

```
pascal short LDelColumn(short
  count, short colNum, ListHandle
  list);
```

Each of these deletes the number of rows or columns specified by the count parameter, starting with the row or column specified by the rowNum or colNum parameter. If count is 0, all the data in the list is quickly deleted. This gives you a quick way to dump all the data in a list without having to go through and dispose of each Cell one by one.

Now you have a list, and it's the right size for the data you want to display. There are two calls for putting data into cells: LAddToCell() and LSetCell().

They are declared as follows:

```
pascal void LAddToCell(Ptr data-
  Ptr, short dataLen, Cell theCell,
  ListHandle list);
```

```
pascal void LSetCell(Ptr dataPtr,
  short dataLen, Cell theCell,
  ListHandle list);
```

They both work the same way, adding the data that is pointed to by dataPtr, of length dataLen, to the cell specified by theCell. The difference is that LAddToCell() appends the data to whatever is currently in the cell, while LSetCell() replaces current data with new data.

The sample program uses only LSetCell() in the FillList() and FillIconList() functions.

To get data back out of a cell, use LGetCell(). It is declared as follows:

```
pascal void LGetCell(Ptr dataPtr,
  short *dataLen, Cell theCell,
  ListHandle list);
```

LGetCell() copies the data from the given cell into the space pointed to by dataPtr. For this call, dataLen specifies the maximum number of bytes to be copied. If the data in the cell is longer than dataLen, only dataLen bytes will be copied. After the call, dataLen contains the actual number of bytes copied.

The sample program doesn't retrieve any data, so it doesn't use LGetCell().

Handling Mouse-Clicks

Mouse-clicking is an area where the List Manager really shines. When you click on an item in the list (a mouse-down

continued

Listing 2: The DrawList() function. It's an update procedure that's called by the Dialog Manager when the Mac's screen must be redrawn.

```
pascal void DrawList(dpeek, itemNo)
DialogPeek    dpeek;
short         itemNo;
{
short         iType;
Handle        iHand;
Rect          iBox;

SetPort((GrafPtr)dpeek);
LUpdate(dpeek->window.port.visRgn, myList); /*Call list manager to update
                                                the list-it will call our
                                                LDEF*/
GetDItem((DialogPtr)dpeek, itemNo, &iType, &iHand, &iBox);
InsetRect(&iBox, -1, -1);
iBox.right += 15;
FrameRect(&iBox); /*Draw a nice outline around the list*/
}
```

event), you have to make only one call to LClick(). It manages control until the user releases the mouse button and handles all selection of cells (according to the rules set by the selection flags), scrolling, and auto-scrolling. If a cell is double-clicked, LClick() returns true. LClick() is declared as follows:

```
pascal Boolean LClick(Point pt,
    short modifiers, ListHandle
    list);
```

The pt parameter is the mouse location in local coordinates, and modifiers is the modifiers word from the event record.

The sample program calls LClick() in response to a mouse-down event in either list. Consult the DoEvent() function in the source code listing for all the details.

After LClick() has returned, one or more cells can be selected. In many situations, you don't have to do anything in

particular when a cell is selected. If you do need to perform some housekeeping, such as highlighting a control, you can find out which cells are selected by using LGetSelect(). It is declared as:

```
pascal Boolean LGetSelect(Boolean
    next, Cell *theCell, ListHandle
    list);
```

LGetSelect() acts differently depending on the value of next. If next is false, LGetSelect() returns true if the given Cell is selected. If next is true, LGetSelect returns in theCell the next selected cell in the row that is greater than or equal to theCell.

For simple lists that can have only one selected item, you can get the currently selected item by setting next to true and theCell to 0,0. For lists that allow multiple selections, use a while loop with next set to false.

Overcoming the 32K-byte Limit

One major limitation of the List Manager is that a list can contain only 32K bytes of data. If you use the default text-only list definition, all the text in the list must add up to less than 32K bytes. There is also an overhead of 2 bytes per cell that counts toward this limit.

While 32K bytes can hold a fair amount of text, it is wholly insufficient for many types of graphics. A single PICT, for example, can be more than 32K bytes in size. Then how can you use the List Manager? The secret is in how you write your custom list definition functions.

Look closely at the FillList() and FillIconList() functions in the sample program. In particular, examine the LSetCell() call, which adds data to the list. In both cases, you'll find that the only data added to the list is a handle, which is only 4 bytes long. I've written both of the custom list definition functions for this program to reference their data through handles. That way, it doesn't matter how large the actual data is—only 4 bytes are required in the list itself (plus 2 bytes overhead). With 32K bytes of possible list data, that gives you over 5300 elements, no matter how big they are.

There is one caveat when using this method: You must dispose of your data yourself. You can't just call LDelRow() or LDelColumn() with a count of zero. Only data that is actually in the list (that is, the handles) will be deleted this way. You must go through the list cell by cell and dispose of the data referenced by the handles.

America's LARGEST "Mac ONLY" Store...

POWER AND PRICE!

Call our Mac Specialists NOW for the latest powerful Macintosh components & peripherals at the NATION'S LOWEST PRICES!

\$3288



IICX

PACKAGE #4

\$6488

List \$8600. Save Over \$2100.

PACKAGE #5

\$5988

List \$8900. Save Over \$2900.

\$2988



Mac II

Mac II Packages

- Ultraflo Hard Drive
- 2mb. Main Memory
- 1960 Color Monitor
- 1.44 FDD/2 Drive
- 101 Keyboard
- Mac Printer

PACKAGE #1

\$3488

List \$6900. Save Over \$1900.

- 2mb. Ram
- 800k Drive
- Mac Printer
- 101 Keyboard
- 30mb. Drive

\$2988



SE 30

Our CPU Price With Package
Apple's List Price: \$4369

\$1988



SE

\$4988

List \$5200. Save Over \$1700.

- 30mb. Drive
- 101 Keyboard
- 800k Drive
- Mac Printer
- 2mb. Ram

\$1988

Credit Cards Leases CODs ... OK!

Mac Friends

COMPARE OUR ATTITUDE, PRICING WARRANTY & SUPPORT! WE'RE YOUR MAC STORE!

WE WORK WITH YOU TO DESIGN A MAC SYSTEM TO MEET YOUR SPECIFIC NEEDS.

Call for our **Special Prices** on Hard Drives, Monitors, Scanners, Laser Printers and More!

800 331-1322

YOUR PRICE

WE CAN BEAT ANY PRICE ... CALL US LAST!

© 1989 Compa Mart, Inc. AD # 61 Mac. Macintosh™ APPLE COMPUTER, INC.

Custom List Definition Functions

This brings me at last to writing the list definition functions that I promised at the beginning of this article. They are surprisingly simple to write and are very useful. Formally, they are declared as follows:

```
pascal void ListDefProc(short
  message, Boolean select, Rect
  *lRect, Cell cell, short dataOff-
  set, short dataLen, ListHandle
  listH);
```

They must be written as a single piece of code, with the entry point located at the beginning of the code. This code is put into an LDEF resource. With MPW, it is easy to create a make file to do this automatically. Check out the file ListMgr-Demo.make in the sample program to see how it's done.

The message parameter that controls what the list definition must do can assume four values: lInitMsg, lDrawMsg, lHiliteMsg, and lCloseMsg. Most lists won't need special initialization and can ignore both lInitMsg and lCloseMsg.

When your list definition function receives an lDrawMsg message, it means that a cell needs to be drawn. The lRect parameter is the rectangle in which the cell should be drawn. The lDataOffset parameter is the offset into the list data of the cell's data; lDataLen is the length of the cell's data.

The lHiliteMsg message means that a cell must be highlighted. In most cases, this simply means the cell is highlighted, and a simple InvertRect() call will do the job.

Two That Do the Job

In the sample program, there are two custom list definitions. The icon list definition is contained in the file IconList.c, and the mixed text/graphics list definition is in the file MyList.c. Refer to figure 1 to see how these lists appear on-screen.

The simpler of the two definitions is IconList.c. Because the data consists of nothing but a handle to an icon, and the cells contain nothing but icons, it is a simple matter to draw the icon in the given rectangle.

MyList.c contains a somewhat more complex drawing function. For this list, the handle refers to a structure that contains a string and a handle to a small icon (SICN) resource. To draw the cell, the drawing routine first checks the width of the string to see if it will fit in the cell. If it will, the routine just draws it with DrawString(). If it won't fit, the string

is shortened until it will, and an ellipsis (.) is appended to the end.

There is no Toolbox call to plot a small icon, so the list definition contains its own routine to do this. The PlotSICN() function treats the small icon as an off-screen bit map, which is all that it really is, and then uses CopyBits() to put it into the cell. The result is a small icon followed by some text, much like the display used by Standard File for file selection.

As I hope you've seen from examining my two list definitions, writing one is really no big deal. It does give you a lot of flexibility when you need to display a scrollable list of graphics or text, or both. The built-in List Manager functions make this chore an easy one. ■

Jan Eugenides is a senior software engineer for Solutions, Inc., of Williston, Vermont. He can be reached on BIX as "j.eugenides."

This space
represents the
potential memory
available in
your Mac.

But this
is all you've
got.

Until now. But now there's a way to take full advantage of the Macintosh operating system's 8 megabyte capacity—without shelling out megabucks for expensive memory chips.

Introducing VIRTUAL—the virtual memory software for the Macintosh II, IIx, IIcx and SE/30. By putting information normally stored in RAM on your hard disk—and retrieving it transparently as required—VIRTUAL allows you to run multiple “memory hogs” concurrently under Multifinder. And at just \$295 (or \$695 for the Macintosh II), VIRTUAL not only helps with memory that's too full... it also helps keep your checkbook from getting too empty.

To order, call 415/324-0727.

MEGABYTES NOT MEGABUCKS CONNECTIX

Connectix Corp. 125 Constitution Dr. Menlo Park, CA 94025



Think CRATE



...and think solutions to your external and internal disk drive needs.

Think MacCrate. . . and think of Crate Technology's great line of external disk drives ranging from 20MB to our performance driven 160MB.

Think InnerCrate. . . and think of our line of internal disk drives now ranging from 20MB to 100MB for the Macintosh SE, and 40MB to our new upgraded high performance 600MB for the Macintosh II.

...and now think of our most recent addition of 20 to 100MB internal drives for the Macintosh IIx.

MacCrate and InnerCrate are registered trademarks of Crate Technology, Inc. Macintosh II, Macintosh SE and Macintosh IIx are registered trademarks of Apple Computers, Inc.

Inner CRATE

20MB	65ms	\$477.00
30MB	28ms	\$560.00
40MB	28ms	\$585.00
50MB	28ms	\$730.00
60MB	40ms	\$655.00
80MB	27ms	\$849.00
100MB	27ms	\$949.00
160MB	17ms	\$1525.00
300MB	16ms	\$2785.00
600MB	16ms	\$3845.00

Mac CRATE

20MB	65ms	\$545.00
40MB	28ms	\$740.00
60MB	40ms	\$839.00
80MB	27ms	\$949.00
100MB	27ms	\$1049.00
160MB	17ms	\$1625.00

Call for the Crate authorized dealer nearest you!

In California Nationwide
800-323-9994 800-543-5808



6850 Vineland Avenue, Building M, North Hollywood, CA 91605

HyperTalk Program Design

Richard D. Lasky

How to improve stack efficiency and appearance

HyperCard's most attractive feature is, perhaps, the accessibility of its programming language, HyperTalk. Never before has so much programming power been put in the hands of so many. However, in programming, just as in politics, power carries with it certain responsibilities. HyperTalk is a concise yet potentially powerful programming language. Using it properly, a novice programmer can produce a stack with all the utility and grace of a stand-alone program. On the other hand, a carelessly crafted stack can be awkward and full of bugs. In this article, I'll discuss some of the programming issues you should consider when you want to design efficient, professional-looking stacks.

General Stack Design

As a stack designer, you have a responsibility to provide users with easy and logical navigation through your stack. Many stacks have dozens of cards and several different backgrounds, and the menu bar is often hidden in order to gain screen space or limit the choices available to users. These factors make navigational aids even more important. It's a good idea to provide a map of the major routes within your stack or use visual effects to give users a sense of direction for navigating within the stack. Also, be consistent: If the "iris open" effect is used when branching off from the main card, then use the "iris close" effect when returning from that diversion.

HyperCard is quite poky when running on a standard 1-megabyte Mac Plus, even from a hard disk. When a delay is likely, you should give users immediate feedback. Use automatic highlighting buttons whenever possible and get into the habit of placing the line "set the cursor to 4" at the beginning of your mouse-up message handler scripts. This will display the "watch" cursor while your script is working. It is not necessary to reset the "hand" cursor at the end of your script. HyperCard will automatically re-

vert to it the moment that your script terminates.

Efficient Code

One measure of programming proficiency is the ability to write clear, concise code. This is just as valuable in HyperTalk as in any other programming language. Because it is so easy to get a stack up and running in HyperCard, script writers may not write the most concise script possible. For example, the script in listing 1 was designed to hide all the buttons on a card so that only the text fields would print. After the card was printed, the card buttons were to be made visible again. The script in listing 1 accomplishes its task, but the same result is also obtained by the more succinct script shown in listing 2. Fifteen lines of script are replaced by nine. Another advantage of the second script is that it will still work if you need to add more buttons to the card.

While the difference in speed and performance for any one message handler may not amount to much, small inefficiencies will quickly add up as you build your stack. HyperCard, an interpreted language, is slow compared to compiled languages such as C or assembly. Writing tight, efficient message handlers enables you to make the best use of the HyperTalk language.

Choosing Stack Levels

Another dimension of efficiency in HyperTalk programming is choosing the most advantageous stack level for your code to reside in. Each message handler script is attached to a certain object in the stack, and the classes of objects in HyperCard are assigned a definite hierarchy. You can make a stack much more efficient, and easier to edit and debug, by placing as much of the code as possible at the highest level in the hierarchy consistent with function. This goal can be facilitated by creating custom messages

continued



with their own message handlers.

Here is an example: Radio buttons are often used in HyperCard to enable you to select one of a number of choices, each represented by a button. The last button to be chosen is highlighted, while the others are not. When you make a different selection, the targeted button is highlighted and the highlight of the former choice is turned off. This is easily accomplished by including the lines in listing 3 in the script of each button.

While this approach will do the job, there is a better way than having to include these same lines of code in each button's script. Simply define a handler for a custom message I'll call `updateButton` (but it could be any single word not already reserved by HyperCard),

shown in listing 4. When the `updateButton` handler is placed at a higher level in the hierarchy than the button level, it can be called by simply typing the single word `updateButton` on a line in the

You must
try to prepare scripts
to handle every
contingency.

script of the radio button (see the `mouseUp` handler in listing 4).

The only question remaining is where to put the `updateButton` message handler. You could put it in the script of the card that contains your group of radio buttons. But if you decide later to have another card full of radio button choices, you'll have to duplicate the message handler in the script of that second card, which is an inefficient technique. Including the handler in the background script will cover all the cards of the same background, but you may want to do the same thing in another background. With a custom handler such as this, the best place for it is the stack script, where it will be accessible to calls from anywhere in the stack.

Listing 1: *This HyperTalk script hides all the buttons on a card so that only the text will be printed. Note that it has a length of 15 lines.*

```
on mouseUp
  hide button "Boston II"
  hide button "Times"
  hide button "New York"
  hide button "Home"
  hide button "Next Card"
  hide button "Print Card"
  doMenu "Print Card"
  show button "Boston II"
  show button "Times"
  show button "New York"
  show button "Home"
  show button "Next Card"
  show button "Print Card"
end mouseUp
```

Listing 2: *A script of nine lines that accomplishes the same task as that in listing 1. Plus, it will still work if you add more buttons.*

```
on mouseUp
  repeat with n=1 to the number of buttons
    hide button n
  end repeat
  doMenu "Print Card"
  repeat with n=1 to the number of buttons --hidden buttons
    show button n-- still counted by HC
  end repeat
end mouseUp
```

Listing 3: *A simple button-highlight-control script.*

```
on mouseUp
  repeat with n=1 to the number of buttons
    set the hilite of button n to false
  end repeat
  set the hilite of the target to true
  <other commands here>
end mouseUp
```

Avoiding Error Messages

Another problem that may befall a HyperTalk programmer is an error message caused by an unanticipated user response. If you want to give your stack the look of a professional program, you must try to prepare your scripts to handle every contingency. This is particularly important when asking users to input data that will be used for arithmetic calculations. I wrote the script shown in listing 5 to handle such situations. This message handler was placed in the stack script. Whenever the user enters data that must be a valid number, the script calls the `checkResponse` handler as shown in the `mouseUp` handler in listing 5. The `checkResponse` handler does two things. It checks to see whether each character in the response is either a decimal point or one of the 10 digits, and it also makes sure there is not more than one decimal point in the response. Thus, any input that passes this test may be used by HyperCard for arithmetic operations.

Passing Parameters

The scripts in listing 5 also present a good illustration of parameter passing. A user's entry is put into the local variable `response`, which is then used as a parameter to the message `checkResponse`. This invokes the message handler, on `checkResponse`, which is passed the variable `response`. The `checkResponse` handler then determines if `response` is a valid number.

Note the use of the global variable `valid` in both scripts. This is necessary because parameters can be passed in only one direction, to the called handler. Any changes in the value of a parameter will not be passed back to the calling script. In this example, I needed a way to

HYPERTALK PROGRAM DESIGN

Listing 4: A button-highlight-control handler, updateButton.

```

on updateButton
  repeat with n=1 to the number of buttons
    set the hilite of button n to false
  end repeat
  set the hilite of the target to true
end updateButton

on mouseUp
  updateButton
  <other commands here>
end mouseUp

```

Listing 5: This script checks that input data is of the anticipated type.

```

on checkResponse response
  global valid
  put 0 into pointCount
  repeat with n=1 to the length of response
    if char(n) of response = "." then put 1 + pointCount
    into pointCount
    if char(n) of response is not in ".1234567890" or
    pointCount > 1 then
      answer "Please enter a number only."
      put false into valid
      exit checkResponse
    end if
  end repeat
  put true into valid
end checkResponse

on mouseUp
  global valid
  put false into valid
  repeat until valid
    ask "Number of inches to convert"
    if it is empty then exit mouseUp
    put it into response
    checkResponse response
  end repeat
  put response * 2.54 into msg
end mouseUp

```

pass a Boolean result back from my response-checking script to the script that would use the response. This was accomplished with the use of a global variable.

User Levels

HyperCard has five userLevels. Many actions possible on userLevel 5 are not allowed at userLevel 1 or 2. If your stack requires a particular userLevel, you should provide scripts that set userLevel to the desired level upon opening the stack and reset the previous userLevel when leaving the stack. Suppose you wanted to set the userLevel to script as well as hide the menu bar and the tool, pattern, and message windows. You would put the handlers in listing 6 into the stack script. The openStack handler

*continued***Listing 6:** A script to set userLevels.

```

on openStack
  global oldLevel
  get userLevel
  put it into oldLevel
  set userLevel to 5
  hide menuBar
  hide tool window
  hide pattern window
  hide msg
end openStack

on closeStack
  global oldLevel
  set userLevel to oldLevel
end closeStack

```



Simulate with Extend™

Model electronic systems, cash flow, factory production, computer networks, neural response, signal processing, earthquakes, process control, material handling...

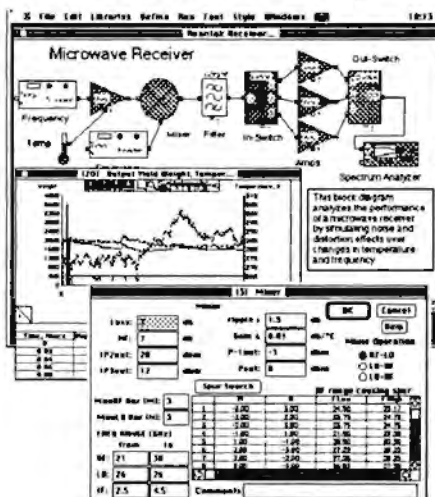

"... create some dazzling simulations without the pain normally associated with simulation programming. For my money, Extend lives up to its name."
- Don Crabb, Byte Dec. '88

Extend's unique features include:

- Continuous and Discrete Event
- Block diagram, library based
- Built-in programming language
- Custom dialog boxes and icons
- More than 150 built-in functions
- File, Serial, Driver I/O
- Engineering libraries included
- \$495 for the Mac Plus, SE, II, IIfx

See Extend at **MACWORLD**
Boston, Aug '89 - Booth 644

Imagine That, Inc.

(408) 365-0305

7109 Via Carmela, San Jose CA 95139

Imagine That! and Extend are trademarks of Imagine That, Inc.

Equations Made Easy

with

Expressionist 2.0

The Personal Mathematical Equation Editor

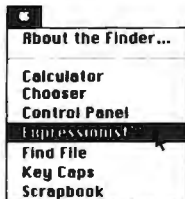

"An excellent toolkit that all technical people should have..."

- Jean Louis Gassée, Apple Computer Inc.

1.) Select the DA ...

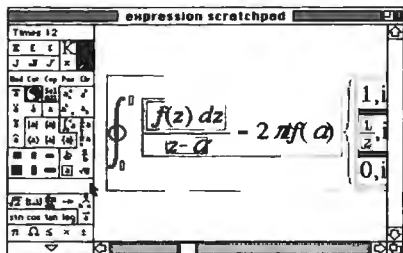

2.) Create your equation ...

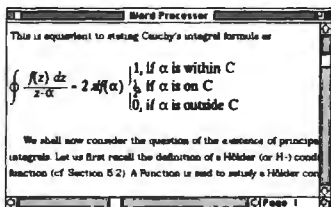

3.) Copy & paste into your word processor!

and get

Results like this:

$$\nabla^2 E - \frac{\mu\epsilon}{c^2} \frac{\partial^2 E}{\partial t^2} = 0$$

$$\nabla^2 B - \frac{\mu\epsilon}{c^2} \frac{\partial^2 B}{\partial t^2} = 0$$

$$\operatorname{erfc}\left(\frac{|z_1 - z_2|}{\sqrt{2} \sqrt{\frac{1}{N_1 - 3} + \frac{1}{N_2 - 3}}}\right)$$

$$f_o(z) = \frac{1}{2\pi i} \int_C \frac{u_o(z') dz'}{(z' - z)}$$

Send \$129.95 for the complete package, or for a brochure and FREE Demo disk write to:
allan bonadio associates
 814 Castro Street #54
 San Francisco, CA 94114
 (415) 282-5864

Listing 7: You can put dialog boxes in your stack by using this script.

```
card button "Choose Fruit"
on mouseUp
    global fruit --variable keeps track of fruit chosen
    put empty into fruit --initialize value
    put "Please select a fruit from the list." into msg
    show card field "FruitList"
    show card field "Mask"
    show button "OK"
    show button "Cancel"
end mouseUp
```

```
card button "OK"
on mouseUp
    global fruit
    put "You chose " & fruit into msg
    hide card field "FruitList"
    hide card field "Mask"
    hide button "OK"
    hide button "Cancel"
end mouseUp
```

```
card button "Cancel"
on mouseUp
    put empty into msg
    hide card field "FruitList"
    hide card field "Mask"
    hide button "OK"
    hide button "Cancel"
end mouseUp
```

```
card field "FruitList"
on mouseUp
    global fruit
    set lockText of me to FALSE
    --Unlocks field: allows selection.
    click at the clickLoc
    select the selectedLine
    --selects text in chosen line
    put the selectedText into fruit
    --stores selection in global variable
    set lockText of me to TRUE
    --Locks field: user can't mess up text.
end mouseUp
```

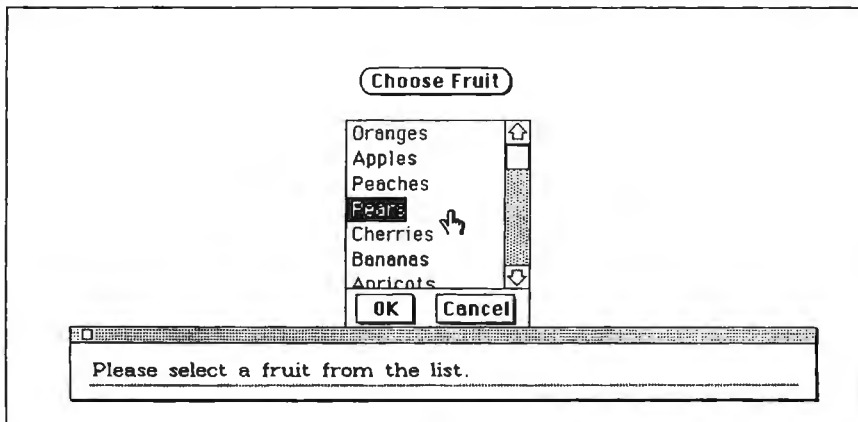

Figure 1: The dialog box described in listing 7. The user has just clicked on the word Pears. After the OK or Cancel button is clicked, the dialog box vanishes.

declares a global variable, `oldLevel`, puts `userLevel` into `oldLevel`, and then sets the current `userLevel` to 5. The `closeStack` handler resets `userLevel` to `oldLevel`.

Dialog Boxes

One of the standard features of the Macintosh interface is the scrolling-field dialog box. The user is presented with a scrolling list of items and asked to select one. Whenever the user clicks on an item, it is highlighted, and if he or she is satisfied with that choice, clicking an OK button records the selection and closes the dialog box. With a bit of clever programming in HyperTalk, you can duplicate this type of interface from within your stack, but the implementation of this feature requires HyperCard 1.2 (for the `select` command and `selectedLine` property).

Figure 1 shows a dialog box created with the HyperCard scripts shown in listing 7. In this example, a scrolling list of fruit pops up in response to clicking on the button Choose Fruit. The message handler for this button gives the command to show the objects that make up

A good approach is to restrict the font styles in text fields to fonts required by the system: Geneva, Chicago, or Monaco.

the dialog box: a scrolling field called `FruitList`, a field called `Mask` to provide room for buttons, and the OK and Cancel buttons. Depending on the order in which they are created, you may have to use the Bring Forward or Send Back commands to arrange the objects in the proper order.

The key to the dialog box is contained

in the `mouseUp` message handler in the script of the `FruitList` field. A global variable is used to store the chosen fruit. The field is unlocked, which allows it to recognize the line selected. The text is highlighted with the `select` command, and the `selectedText` is put into the global variable `fruit` for later retrieval. The field is locked again, to prevent the user from altering the text in the list. Clicking the OK or the Cancel button closes the dialog box by hiding its component objects. If OK is clicked, the fruit chosen is identified in the message box.

Smart Scroll Bars

In most Macintosh windows, the scroll bars are not active unless they are required. A HyperCard scrolling field, on the other hand, always shows an active scroll bar, even if there is plenty of room for the text it contains. I decided to remedy this situation while working on a stack with several background fields shared by a group of cards. This stack enables a user to keep a daily log of meals eaten. Food items for each meal are chosen from menus and are then listed in

continued



Nisus. The word heard around the world.

Sang Chaul Shin: Software Engineer, Seoul, Korea
Business: Elex Computer, Inc.
Word Processor: Nisus™

I like the Nisus word processor very much. Many others must like it too, because Nisus will be supplied with every new Macintosh sold in Korea.

Nisus is replacing the word processors Koreans use now because it is so powerful. Desktop publishers and business people really like it. There are many menus so you can be complicated or easy.

The macros and Easy Grep are especially good because Koreans like to have as many functions as possible. Another thing Koreans like is the graphic support. With MS Word, there was no support. Nisus puts graphics right in the text.

Nisus is - what is the word? - Amazing!

Nisus (nī 'sus): 10 clipboards, 32,000 undos, text pattern search/replace, footnotes/endnotes, open/closed file search, programmable macros.



We make good ideas work.

990 Highland Dr., Suite 312, Solana Beach, CA 92075
 (619) 481-1477 Outside CA call toll-free (800) 922-2993

Computers For The Blind

Talking computers give blind and visually impaired people access to electronic information. The question is how and how much?

The answers can be found in "The Second Beginner's Guide to Personal Computers for the Blind and Visually Impaired" published by the National Braille Press. This comprehensive book contains a Buyer's Guide to talking microcomputers and large print display processors. More importantly it includes reviews, written by blind users, of software that works with speech.

This invaluable resource book offers details on training programs in computer applications for the blind, and other useful information on how to buy and use special equipment.

Send orders to:
National Braille Press Inc.
88 St. Stephen Street
Boston, MA 02115
(617) 266-6160

\$12.95 for braille or cassette, \$14.95 for print. (\$3 extra for UPS shipping)
NBP is a nonprofit braille printing and publishing house.

Listing 8: A script that creates "smart" scroll boxes.

```
on openCard
  if the number of lines in field 1 > 6 then
    set the style of field 1 to scrolling
  else
    set the style of field 1 to rectangle
  end if
  if the number of lines in field 2 > 4 then --This part adjusts field
    set the style of field 2 to scrolling --style.
  else
    set the style of field 2 to rectangle
  end if
  if the number of lines in field 3 > 7 then
    set the style of field 3 to scrolling
  else
    set the style of field 3 to rectangle
  end if
  if the number of lines in field 4 > 3 then
    set the style of field 4 to scrolling
  else
    set the style of field 4 to rectangle
  end if
  --other commands as needed here
end openCard
```

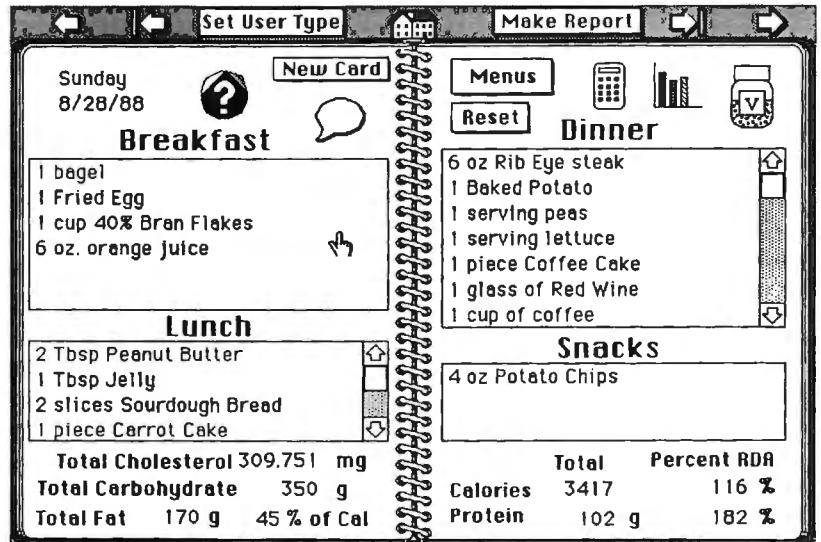

Figure 2: A card illustrating the use of automatic scrolling fields. The script in listing 8 determines which of the four meal list fields needs to be scrolling and which should be rectangular for a given card in this background.

a background field representing that meal. Each card represents a different day in the log. Because I did not know how many food items would be chosen for a given meal, I had to make use of scrolling fields when necessary. My solution is shown in listing 8, with a sample card shown in figure 2.

The script in listing 8, placed in the background script of the food log, checks each field to see whether it con-

tains more lines of text than are visible for that field. If it does, the field style is set to scrolling; otherwise, it is set to rectangle. Note that there is no problem in setting a field to a style it already has. Because these are background fields, they have to be updated each time a different card is opened. While the text of a background field is specific for a given card, the style of that field will remain the same for every card in that back-

ground unless it is changed by a script, as in listing 8.

Font Control

I would like to make one final point regarding text fields. If you intend to distribute your stack, it is important to ensure that the text font you choose will not be changed drastically when your stack is run on another Mac. I was made acutely aware of this problem when I ran one of my stacks on another machine recently. I had some fields that were originally set for the Boston II font. This text was barely recognizable on the other Mac, as my carefully measured words were converted to an ornate font that forced undesired line returns, thus cutting off part of the text at the bottom of the field. The explanation was simple: The System file on this Mac didn't have the Boston II font, and another, quite inappropriate, font (with the same font ID as Boston II has on my system) had been substituted in its place.

There are two ways to prevent this problem. One is to use Font/DA Mover to install the desired font on your stack (hold down the Option key while selecting open from Font/DA Mover). I don't favor this approach, however; stacks grow in size too rapidly as it is, without loading them up with fonts. A better approach is to restrict the font styles used in your text fields to those fonts required by the system: Geneva, Chicago, or Monaco. If you must use a fancy, exotic font in your stack, don't place the text in a field at all. Simply select the text tool and do your writing on the graphics layer. Text that you create in this way exists as a bit-mapped image that will not be affected by system fonts.

More Fun with HyperTalk

I have presented some guidelines for programming HyperCard stacks that I hope you will find useful. HyperTalk has its limitations as a programming language, but its utility for many users is limited only by their imagination and creativity. HyperCard has made programming the Mac more fun than ever.

By attending to the issues I have raised here, HyperTalk scripters will be more likely to create stacks people will value and enjoy using. I'm looking forward to seeing more of them in the future. ■

Richard D. Lasky is a biochemist, Macintosh enthusiast, and certified Apple developer. He is the author of Nutrition Stack, which calculates the nutritional content of meals. He can be reached on BIX c/o "editors."

Producibility

With MGMStation, if you can design it, you can produce it.



MGMStation™ is the only CAD program smart enough to force geometric precision and dimensioning. But that should be no surprise, since it was conceived and developed as part of a high-precision integrated CAD/CAM package.

"Its refinement shows. Despite the influx of new CAD software, including heavyweights from the MS-DOS world, MGMStation rates as one of the best values in the field."

"...excellent correct-by-design dimensioning capabilities, something we first saw on mainframe CAD—and something you don't expect at this price level."

Macintosh Buyer's Guide Comparison Test, Fall 1988

"Experienced users of both AutoCAD and MGMS will like the latter's accuracy of object placement and speed of drawing construction. MGMS's user interface makes designing easier with MGMS than with AutoCAD..."

Rusei DeMaria, Byte Magazine p. 182, January, 1988



MGMStation pioneered the icon bar interface that makes every command accessible on screen. It's so much easier to learn and use than other major CAD programs that designers can be productive in days rather than weeks.

MGMStation runs up to *eight times faster* than its competitors. And its built-in file compression conserves disk space.

No wonder so many AutoCAD users are upgrading to MGMStation. The optional IGES/DXF file conversion package makes it easy to switch. And right now, through August 31, 1989 we're offering a \$250 rebate on AutoCAD trade-ins. Contact Micro CAD/CAM for details.

MGMStation

from Micro CAD/CAM Systems, Inc.

an Aura Systems Company

5900 Sepulveda Boulevard, Van Nuys, California 91411
(818) 376-0008 Fax: (818) 901-0617 Telex: (650) 310-7078 MCI-UW

Circle 462 on Reader Service Card

MacUser
Eddy Award
for
Best New
CAD/CAM
Program
1988

FORTTRAN Power for Macintosh



Chosen #1 by ...
MACWORLD (March 1989)

Judged Most Powerful by ...
Computer Language (Nov. 1988)

Full ANSI 77, VAX-compatible extensions, high precision IEEE floating point data types, complete access to the Toolbox, direct code generation for the 68020/030 and 68881/2, and Macintosh Programmer's Workshop (MPW) make the Language Systems compiler the most powerful FORTRAN for the Macintosh.

Language Systems FORTRAN has a full complement of VAX-compatible extensions including structures, nested includes, DO WHILE, IMPLICIT NONE, and all VAX intrinsic functions and data types. Supports even the largest subroutines and functions from VAXes and mainframes.

\$345 (plus shipping).

Runs on all Macintoshes with a hard drive and at least one megabyte of memory, including the new IIX, IICX, and SE030.

LANGUAGE SYSTEMS
CORPORATION



441 Carlisle Drive, Herndon, VA 22070
(703) 478-0181 fax (703) 689-9593

BYTE's All-Macintosh Supplement

Free
Information

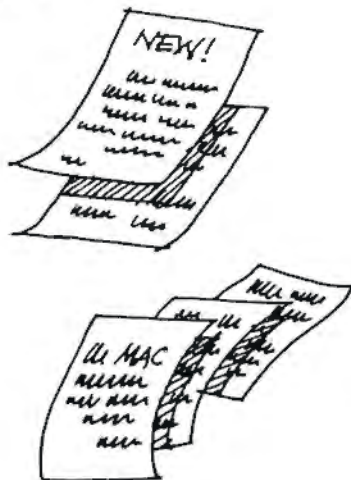

Now you can receive free information on the Macintosh products and services advertised in BYTE's All-Macintosh Supplement. Simply refer to the Reader Service Card, located in the back of BYTE, and look for the boxed numbers (451-480).

- Circle the numbers on the reply card that correspond to the numbers assigned to items of interest to you.
- Check all the appropriate answers in questions "A" through "C."
- Print your name and address, and mail.

Take this
opportunity to
receive information
direct from
Macintosh suppliers
TODAY!

INERTIA

Engineering in Common Sense



Analysis & Design

For Manufacturers and Designers of Mechanical, Structural, Electrical, Aeronautical, and Architectural systems. Productivity via graphical modeling, speed and power. Free video tape and seminars.

MCAE Inc.

Tel: 800-444-6223

Fax: 317-463-7166

Circle 460 on Reader Service Card (DEALERS: 461)

READER SERVICE

To get further information on the products advertised in BYTE, fill out the reader service card by circling the numbers on the card that correspond to the inquiry number listed with the advertiser. This index is provided as an additional service by the publisher, who assumes no liability for errors or omissions.

* Correspond directly with company.

Alphabetical Index to Mac Advertisers

Inquiry No.		Page No.
451	ALLAN BONADIO ASSOC.	208
452	ALLAN BONADIO ASSOC.	208
453	AMERICAN MICRO DISTRIB.	193
455	CONNECTIX	203
456	CRATE TECHNOLOGY	204
465	DATABILITY SOFTWARE SYS	186
457	DOUGLAS ELECTRONICS	127
458	HAYES MICROCOMPUTER PROD.	194,195
459	IMAGINE THAT!	207
466	LANGUAGE SYSTEMS	212
454	MACFRIENDS	202
460	MCAE	212
461	MCAE	212
462	MICRO CAD/CAM INC.	211
	* NEC HOME ELECT USA	188,189
463	PARAGON CONCEPTS INC.	209
	* RAIMA	190
464	SYMANTEC	198

Index to Mac Advertisers by Product Category

Inquiry No.	Page No.	Inquiry No.	Page No.
HARDWARE			
800	ADD-INS	463	PARAGON CONCEPTS, INC. 209
453	AMERICAN MICRO DISTRIB. 193	806	APPLE II/MAC — CAD
801	MASS STORAGE	457	DOUGLAS ELECTRONICS 127
456	CRATE TECHNOLOGY 204	462	MICRO CAD/CAM INC 211
802	MONITORS	807	APPLE II/MAC — LAN
	* NEC HOME ELECT. USA 188,189	465	DATABILITY SOFTWARE SYS 186
SOFTWARE			
803	APPLE II/MAC APPLICATIONS Business/Office	808	APPLE II/MAC — LANGUAGES
459	IMAGINE THAT! 207	466	LANGUAGE SYSTEMS 212
	* RAIMA 190		* RAIMA 190
804	APPLE II/MAC APPLICATIONS Scientific/Technical	464	SYMANTEC 198
451	ALLAN BONADIO ASSOC. 208	809	APPLE II/MAC — UTILITIES
452	ALLAN BONADIO ASSOC. 208	455	CONNECTIX CORP. 203
459	IMAGINE THAT! 207	810	APPLE II/MAC — COMMUNICATIONS
460	MCAE 212	465	DATABILITY SOFTWARE SYS 186
461	MCAE 212	458	HAYES MICROCOMPUTER PROD. 194,195
811 MAIL ORDER/RETAIL			
		453	AMERICAN MICRO DISTRIB. 193
		454	MACFRIENDS 202

1	Exxon
2	General Motors
3	Mobil
4	Ford Motor
5	IBM
6	Texaco
7	E.I. du Pont
8	Standard Oil (Ind.)
9	Standard Oil of Cal.
10	General Electric
11	Gulf Oil
12	Atlantic Richfield
13	Shell Oil
14	Occidental Petroleum
15	U.S. Steel
16	Phillips Petroleum
17	Sun

27
million
Americans
can't read.
And guess
who pays
the price.

Every year, functional illiteracy costs American business billions.

But your company can fight back... by joining your local community's fight against illiteracy. Call the Coalition for Literacy at toll-free **1-800-228-8813** and find out how.

You may find it's the greatest cost-saving measure your company has ever taken.

**A literate
America is a
good investment.**

  Coalition for Literacy

Neural Networks

- 217 Time to Get Fired Up**
by Klaus K. Obermeier
and Janet J. Barron
- 227 What's Hidden in the Hidden Layers?**
by David S. Touretzky
and Dean A. Pomerleau
- 235 Building Blocks for Speech**
by Alex Waibel
and John Hampshire
- 244 Neural Networks: Theory and Practice**

You could describe neural networks as humanity's attempt to create an artificial brain—shades of science fiction. In their current stage of development, however, it would be more correct to describe them as humanity's attempt to mimic the way the brain does things in order to harness its versatility and its ability to infer and intuit from incomplete or confusing information.

What happens when you learn something? Most of us would probably answer with words like remembering, understanding, storing, and retrieving. But there's more. Brain surgeons or behavioral psychologists might discuss firing neurons, making new connections, or retraining behavior patterns. But even they can't tell you *exactly* what happens when you learn—or how.

To find out, you can observe and record the tangible inputs to the learning process as well as the end result. You can show how learning varies from person to person depending on the pattern of inputs and on such intangibles as past history, emotional state, and so on. Then you can surmise from these elements some of what has occurred.

Learning about neural networks requires a new vocabulary. You don't program a neural network, you "teach" it. You measure its speed not in instructions per second but in interconnections per second.

This month's In Depth section defines and describes neural networks, their differences from traditional computing, and their implications and uses in the microcomputer arena.

In "Time to Get Fired Up," Klaus K. Obermeier and Janet J. Barron provide a look at today's neural-network technology and show how IBM PCs, Macintoshes, and personal workstations can

run neural-network simulations to solve problems that digital means can't handle efficiently. And the text box "In an Upscale World" by Kingsley G. Morse Jr. explains the dynamics of neural-network scalability, going from a sample-size network to a real-world application.

Neural networks have input and output like conventional computing, but what happens in between the two has long been a mystery. In "What's Hidden in the Hidden Layers?" David S. Touretzky and Dean A. Pomerleau show how you can determine what lies in between—what's really going on.

Speech recognition is a complex task for which even the largest computers are not particularly well suited. Neural networks, however, have the flexibility to interpret complex and confusing audio signals. In "Building Blocks for Speech," Alex Waibel and John Hampshire show how neural networks can be used to create high-performance speech-recognition systems.

Neural networks may sound like science fiction, but they aren't. As this month's resource guide, "Neural Networks: Theory and Practice," will show, they are the basis for real microcomputer products. Science fiction is known as a domain of visionaries, a field that often leads the way to the future. While an artificial brain may still reside in the world of science fiction, neural networks have bridged the gap to become science fact.

—Jane Morrill Tazelaar

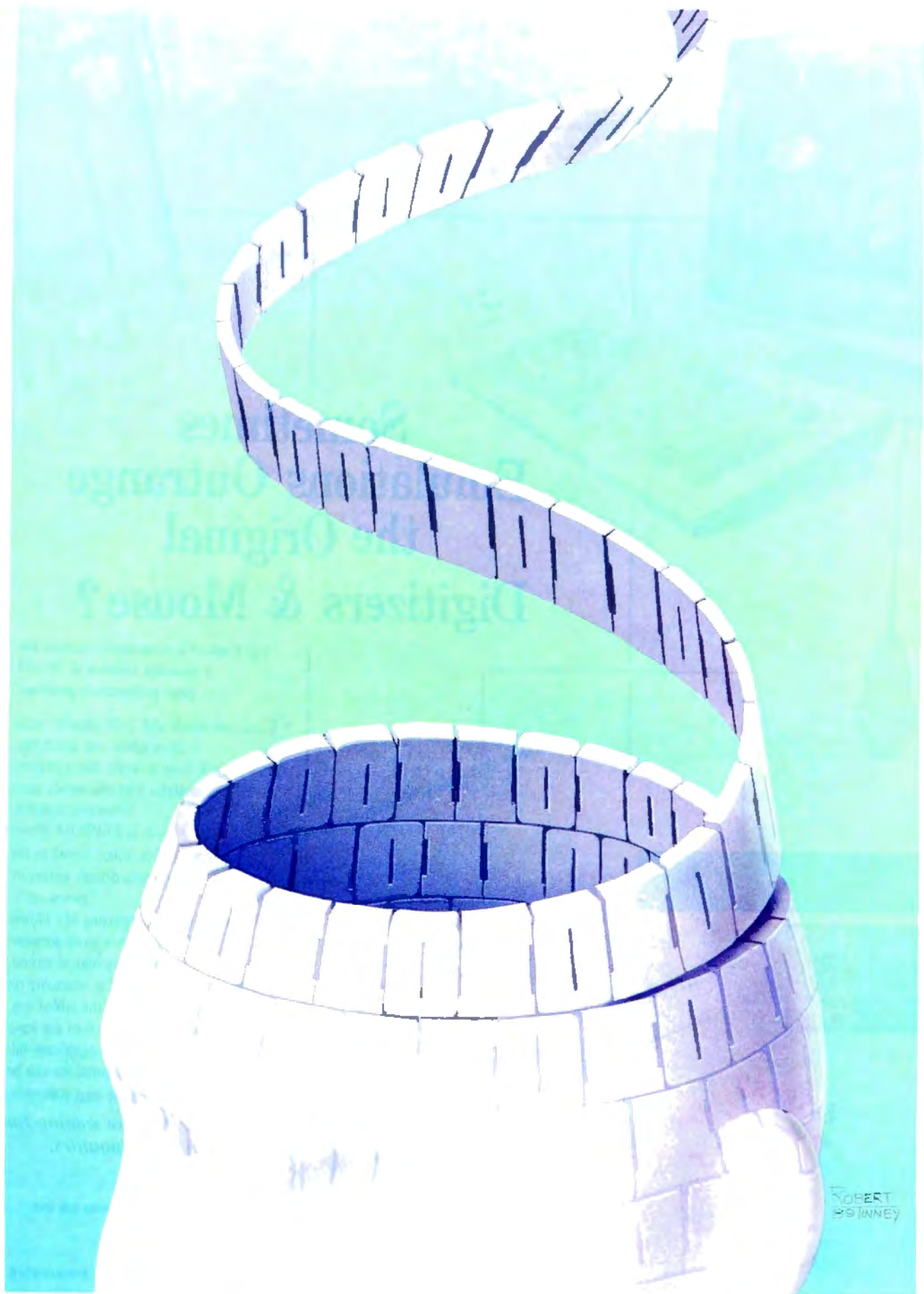

ROBERT
TINNEY

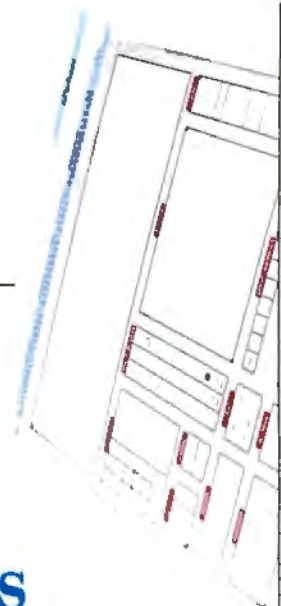

Sometimes Emulations Outrange the Original Digitizers & Mouse ?

The Podscat is remarkable example for a successful solution of the old price-performance problem:

- Emulation mode and configuration menu allow tablet top selections.
 - A built-in single chip computer emulates 9 of the worlds most renowned digitizers.
 - Built-in EEPROM allows custom configuration, stored as the digitizer's default setting at "power-on".
 - Emulating and surpassing MS Mouse & PC mouse, it is more accurate than any optical mouse.
 - Button 'click' on/off is selectable on the tabled top.
 - Ultra stable jitter = 0 of the least significant bit.
- And, of course, configurations can be loaded down from the host computer.

What do you say? We're waiting for your comments and inquiries.

Multipal International LA Inc.
 17231 E. Railroad St.
 #500 City of Industry
 CA 91748 U.S.A.
 Tel: 818-913-4188 Fax: 818-913-9149

TABLET MODE												
SETUP	SUM	GT	HT	PT	PC	CC	AL	CB	KB	MS	PC	MS
M A B	M A B	C O	T C H A	T E C	A L	A L	B A	B A	B A	B A	B A	B A

ACTIVE AREA	12 x 12
SETUP AREA	12 x 0.4
RESOLUTION	7,000LPI
SAMPLE RATE	180 PPS
ACCURACY	+ 0.01 INCH
JITTER	0 LSB
PROXIMITY	+ 0.5 INCH
DIMENSIONS	
INTERFACE	RS-232C

US\$189

Time to Get Fired Up

IBM PCs, Macs, and personal workstations can run neural-network simulations that learn and train themselves

Klaus K. Obermeier and Janet J. Barron

Every time that you use a high-speed modem, you are using a single-neuron, many-synapse, neural network. This tiny neural network uses adaptive signal processing, learns the system, and eliminates some of the problems (such as echoing) that may occur. This adaptive filtering process is just one of the neural networks developed in the 1950s by Stanford University's Bernard Widrow, pioneer in and founder of the field of neural networks.

Another of Widrow's early neural-network applications was a simple weather-forecasting system in 1963. When fed many samples of yesterday's pressure and today's weather, it came up with tomorrow's forecast. Widrow's system was correct about 83 percent of the time (compared to an accuracy rate of about 65 percent for the local meteorologist).

For some time, there has been a need for a way to solve problems that cannot be efficiently handled by digital means. A neural network is composed of many interconnected processing elements that operate in parallel. It works in a way similar to how we think the neurons in



the human brain encode information.

Instead of programming a neural network, you "teach" it to give acceptable answers. You input known information, assign weighted values to the connections within the architecture, and run the network (which adjusts those weights by using several criteria) over and over until the output is satisfactorily accurate. A weighted matrix of interconnections

allows neural networks to learn and remember. As a result of the way they work, even when you enter new information that is not stored in the network, they can still provide adequate responses.

Neural-network technology, also called *connectionism*, is moving very quickly, and working tools are rapidly coming into use. As they emerge, you'll be able to use that technology to resolve issues that don't have straightforward black-and-white, yes-or-no answers.

When they work correctly, neural networks provide some major benefits, such as the ability to take incomplete data and produce approximate results. Their parallelism, speed, and trainability make them fault-tolerant, as well as fast and efficient for handling large amounts of data.

But, because neural networks work as we believe the human brain does, they don't handle numbers well, especially if you need accurate answers and you need them fast. Accuracy, computational power, and logic are not among their strong points. And when they solve a problem, they can't tell you how they did it. At this early stage in the technology

continued

curve, the "real things" (biological neural-network clones) are not available. What we have are simulations (artificial neural networks) that run on digital machines, and they are good at pattern recognition and functional synthesis.

Today, artificial neural networks are being used for a variety of commercial applications, including speech, character, text, equipment, and human recognition tasks; financial analysis; database management; image and signal processing; medical diagnosis; dealing with fuzzy, chaotic, or incomplete information; and some kinds of manufacturing, quality, and process control.

Biologically Inspired

Artificial neural networks are biologically inspired. A biological neuron consists of axons, dendrites, and synapses. An artificial neuron, or processing element, emulates the axons and dendrites of its biological counterpart with wires and emulates the synapses by using resistors with weighted values.

Essentially, neural-network models consist of processing elements, interconnection topologies, and learning schemes. Processing elements contain combinations of excitatory (positive) or inhibitory (negative) weights that act on the inputs in a summation function, in an activation function based on the inputs to the processing element, and in an output function that is both sigmoid and stochastic.

Processing elements interact with each other depending on how they are interconnected—fully (as opposed to partially), or with or without a feedback loop. As part of setting up the neural network, a variety of criteria is used to define specific interconnections and determine its characteristic architecture. The nature of its feedback loops determines the network's trainability; the degree of its interconnection determines its parallelism.

While a digital computer's memory is measured in bytes, a neural network's "memory" is judged by interconnections. Likewise, while the speed of a digital computer is expressed in instructions per second, the neural network's speed is measured in interconnections per second.

Most cognitive processes take humans no longer than a few hundred milliseconds, while individual neurons in the human brain compute operations at a rate as slow as that of a single instruction of a digital computer. The brain performs its processing feat through massive parallelism, using 10 billion neurons and more

than 1000 times that many interconnections.

Training the Network

To simulate massive parallelism, the neural-network approach consists of setting up a network of processing elements, the electronic analogy to neurons. Each processing element has a number of inputs, a small set of possible states, and an output that is a function of the inputs. Each input to the processing element has a weight value, which usually ranges from 1 to -1.

When a processing element is activated, it evaluates all its inputs and computes their respective weight values. If the weight value is above a certain threshold, the computing unit generates an output value that is used as input by other processing elements. (Only the weight values of the inputs change during learning.)

Training a neural network is a matter of adjusting weights, either manually or automatically. A neural network is a directed graph consisting of a number of nodes, or *processing elements*. Each processing element has only one output signal, which fans out to interconnect with other processing elements. Each node processes the incoming signal based on the values of the constants stored in it. Currently, neurocomputer technology is based on the assumption that the update of signals within each node occurs discretely, rather than continuously or concurrently.

Neural-network learning takes place in one of three ways: supervised, unsupervised, or self-supervised. Supervised learning occurs when you provide trial-and-error inputs, teaching the network correct and incorrect responses. In unsupervised learning, data is simply entered, without human intervention. This process leads to internal data clustering—the desired result. Self-supervised learning occurs when the network monitors itself and corrects errors in the interpretation of data by feedback through the network.

A neural network computes by the process of spreading activation. After the initial weights are set, you enter data into the network; this process causes it to pass through state changes and ultimately reach stability. A network achieves stability when the weight values that are associated with the processing elements stop changing.

When neural networks first became popular, they consisted of only one or two layers—an input and/or an output layer. This severely limited what the net-

work could represent. Adding more layers allowed the system to form an internal representation of the problem. Networks with only one layer (made popular by Frank Rosenblatt and unpopular by Marvin Minsky and Seymour Papert) thus restricted what could be represented to what was in the input configuration.

Today's multilayer, hierarchical networks are more powerful because they can generate their own internal representations in the so-called hidden units. Hierarchical networks are used for the better-known applications, such as speech and character recognition.

A hierarchical network consists of an input and output layer and one or more hidden layers (see "What's Hidden in the Hidden Layers?" by David S. Touretzky and Dean A. Pomerleau on page 227). If the number of processing elements in the middle layer is too great, it will replicate the elements from the input layer, causing problems similar to those encountered with a single-layer network. If the number of processing elements in the middle layer is too small, the network will require many iterations to train, and recall accuracy will suffer.

All This on a Micro?

IBM PCs and compatibles, Macintoshes, and personal workstations play very important parts in the neural-network world. You can run simulations on them and, in some cases, perform neural-network development and experimentation on them as well.

Neural networks are being used and produced in the form of either *neurocomputers* (hardware that models the parallelism of neurons) or *netware* (software that emulates neurons and their interconnections on conventional serial computers). An important aspect of netware is that it can be simulated on conventional computers.

Neurocomputers have been configured on the chip level, the board level, and the complete system level. General-purpose neurocomputers are available to use as coprocessors for digital computers. In this case, you access the neural network as if it were a subroutine that you can call whenever you need it. In this form, neurocomputers are able to operate side by side with conventional computer technology.

Last summer, NEC announced that it had developed a personal neural-network computer that uses the back-propagation learning algorithm. NEC's current plans are to market and sell the Neuro-07 only in Japan. The total system, which sells for about \$11,000, consists of a personal

Glossary

activation function A function by which new output of the basic unit is derived from a combination of the net inputs and the current state of the unit (the total input).

auto-associative (memory system)

A process in which the system has stored a set of information repeatedly presented to it. Later, when you submit a similar pattern to the system, it can recall the information from a degraded or incomplete version of the original.

axon That part of a nerve cell through which impulses travel away from the cell body; the electrically active parts of a nerve cell.

back-propagation A learning algorithm for a multilayer network in which the weights are modified via the propagation of an error signal "backward" from the outputs to the inputs.

chaos The study of nonlinear dynamics (also called deterministic disorder).

connection A pathway between processing elements, either positive or negative, that links the processing elements into a network.

dendrite The branched part of a nerve cell that carries impulses toward the cell body. The electrically passive parts of a nerve cell.

directed graph Representation of the variation and direction of flow for processing elements with respect to other processing elements.

feedback loop A loop wherein continued input is fed back into the network to achieve the expected output.

fuzzy logic Incomplete or contradictory information.

hidden layer A third layer of units between the input and output layers that provides additional computational power.

learning The phase in a neural network when new data is introduced into the network, causing the weights on the processing elements to be adjusted.

network paradigm A network architecture that specifies the interconnection structure of a network.

neuron The structural and functional unit of the nervous system, consisting of the nerve cell body and all its processes, including an axon and one or more dendrites.

perceptron A large class of simple neuron-like networks with only an input layer and an output layer. Developed in 1957 by Frank Rosenblatt, this class of neural network had no hidden layer.

sigmoid Having a double curve like the letter S.

spreading activation A process of applying the activation function simultaneously to a neural network.

stochastic Involving chance, probability, or a random variable.

summation function A function that combines the various input activations into a single activation.

synapse The point of contact between adjacent neurons where nerve impulses are transmitted from one to the other.

threshold A minimum level of excitation energy.

training A process whereby a network learns to associate an input pattern with the correct answer.

weight The strength of an input connection expressed by a real number. Processing elements receive input via interconnects. Each interconnect has a weight attached to it. The sum of the weights make up a value that updates the processing element. The output value of a processing element is described by a level of excitation that causes interconnects to be either on (i.e., excitatory output) or off (i.e., inhibitory output).

computer, a neuro-engine board, neural-network learning software, and a color display.

The neuro-engine board performs parallel processing with a maximum speed of 216,000 interconnections per second. Its software is composed of a definition section to determine the network's configuration, a computing section to calculate the network's output, a software-control section, and a user interface to perform editing and monitoring functions.

In 1988, about 10,000 personal computer packages of neural network were sold in the U.S., most of these from a disk included with *Explorations in Parallel Distributed Processing* (see reference 1). In general, commercially available neural-network programs are those that lend themselves to simulation on very small scales—based either on the soft-

ware itself or on special-purpose boards.

James A. Anderson, professor of psychology and cognitive and linguistic sciences at Brown University, notes that he teaches a course in neural networks for undergraduate and graduate students. Most of them, he says, do the simple assignments on their home computers—Macintoshes and IBM PCs. But, says Anderson, these machines with their standard compilers can't cope with networks that have between 50 and 100 processing elements.

"It's not the MIPS [millions of instructions per second] a device can handle that determines whether or not you can use it for neural networks," Anderson says. He notes that simple measurements of processor speed are especially misleading because many personal computers are fast but are unable to handle large arrays or matrices. Effective mem-

ory management, large memories, and good compilers are much more important than raw CPU speed in performing neural-network computations quickly, he explains.

"Engineering workstations—VAXstations, Suns, and so forth—are ideally suited for the task, but even on fast workstations, jobs may run for hours. Many personal computers completely run out of steam when faced with a system with 150,000 connection strengths and 400 dimensional arrays, whereas workstations are designed for large jobs. Again, it's how good your compiler is," Anderson says. "Suns and VAXes—especially VAXes—have wonderful compilers. But you can do useful development work on personal computers by learning a lot, experimenting a lot, and taking the time to run your own assembly language

continued

projects.”

But not everyone shares Anderson's opinion about why small systems currently have limited neural-network capabilities. There are other reasons as well. Smaller machines have problems running certain large applications, such as complex vision systems, in real time. Digital machines simulate what are intrinsically very parallel systems, and they are limited by their own speed and processing power. Therefore, while large problems, like analyzing scenes, are difficult to run on a personal computer or workstation, less-complex tasks are very workable. Presently, there are about 300 companies involved in neural-network technology, many of them making software for personal computers or workstations.

Among the products spilling out of the neural-network pipeline are software, shells, development tools, chips, and accelerator boards. Some companies are in the process of developing special-purpose hardware and chips for use in large-scale applications. The next year should bring the introduction of many products that go beyond the simulation stage.

Applying the Knowledge

Neural-network applications tend to fall into several classes: sensor and knowledge processing, pattern recognition, and control systems. Neural networks are not very good at handling tasks that standard serial computers are noted for, such as number crunching or making highly accurate calculations. But when it comes to tasks requiring incomplete data sets, or fuzzy or contradictory information, neural networks will very likely outperform conventional computers, including parallel processors.

Massive parallelism gives neural networks a high degree of

- *fault tolerance*—built-in redundancy or the ability to withstand component failures without crashing;
- *associative recall*—the ability to retrieve information instantaneously based on content and to make an “educated” guess if there's no exact match for the requested information; and
- *graceful degradation*, the ability to recover gracefully from processor failure.

These properties make neural networks attractive for many commercial, military, and industrial applications.

One interesting example of a combination of neural-network applications is called SNOOPE (for System for Nuclear On-line Observation of Potential Explosives).

Developed by Science Applications International Corp. (SAIC) of Santa Clara, California, SNOOPE is a detection system that determines the existence of concealed plastic explosives in luggage and cargo.

Successfully tested since June 1988 on 40,000 bags and luggage items at the San Francisco and Los Angeles International Airports, SNOOPE is a neural network based on a back-propagation supervised-learning algorithm. The network runs in parallel with another technique called *thermal neutron analysis*.

SAIC was given certain criteria for the system: It had to continuously process 10 bags a minute, not damage film or magnetic recording media, be reliable, and be built from commercially available components wherever possible. The output, a decision as to whether or not a bag contains a threat, must be signaled by the time the bag exits the system.

The first SNOOPE system was due to be installed at New York's John F. Kennedy International Airport in July. After that, others are slated for installation in airports around the world. Says Samuel K. Skinner, U.S. Secretary of Transportation, “It is the best available technology to detect explosives. . . . Detection is performed by computer. No human interpretation is involved.”

Sensor processing and pattern recognition are among the many ways in which neural networks are being implemented. Applications include image processing, image compression, character recognition, and continuous speech recognition.

You can use these types of neural networks to recognize underwater targets by sonar. Bendix Aerospace compared a neural-network program with a conventional program. The results showed that the neural network not only was better but also took only hours to be configured, as compared to the months it takes to set up a conventional classifier-based program.

Programs for handwriting character classification also fall into the sensor-processing category. NestorWriter, produced by Nestor in Providence, Rhode Island, for instance, can figure out some recognition rules based on common character features, such as curvature and orientation; thus, the system can recognize characters it hasn't seen before. Applications for this technology range from processing checks to reading Japanese characters.

Among neural-network pattern-recognition and control-system applications are programs for robotics and autonomous vehicles. One of the oldest exam-

ples of control-system neural networks is adaptive routing and switching. Widrow's classic Adaline (for adaptive linear element) is a program that eliminates echoes in telephone lines. The same principles can be used to reduce data-transmission errors in modems.

Neural networks are efficient at handling many knowledge-processing tasks, such as storage and retrieval of information in large databases, and predictive modeling. In one medical expert-system application, a neural network was trained on the functional relationships between symptoms, diagnoses, and treatments. Test results showed that the network responded with 100 percent accuracy to nonequivocal cases, weighed the evidence in equivocal cases, and, if unknown cases were presented, fell back on known relationships.

The neural network was configured in only a fraction of the time it would have taken a knowledge engineer to configure and build the expert system. Besides showing new conceptual solutions, in certain applications neural networks seem to avoid the impasse of having to laboriously construct and maintain expert systems.

In the area of speech synthesis (see “Building Blocks for Speech” by Alex Waibel and John Hampshire on page 235), a program called NETalk was jointly developed by Terence Sejnowski of the Salk Institute in La Jolla, California, and Charles Rosenberg of Princeton University. NETalk provides an impressive demonstration of the potential of neural-network technology. The program learns to read English text aloud without the benefit of any preprogrammed linguistic rules. In contrast, conventional programming techniques (including AI programming) have real problems executing this function.

Current Events

The study of neural networks, the “reborn” science, has gone from great promises in the 1940s, with the age of McCulloch and Pitts, to the Widrow and Rosenblatt era in the 1950s, through attacks on the field in the 1960s from Minsky and Papert in their book, *Perceptrons* (see reference 2). From there, it moved into a strong and legitimate revival in the 1970s and 1980s with Grossberg, Kohonen, Hopfield, Rumelhart, and others. Because of computational advances, significant progress has been made ever since the so-called “perceptron” era.

Leading-edge neural-network tech-
continued



CompuStar II



IT EATS IBM'S LUNCH... AND SERVES DELL FOR DINNER!

Introducing Wells American's CompuStar II. It's one *hungry* machine. Feed it the toughest applications you can dish out and it's ready for "seconds" before IBM, Dell and all the others even get started.

IT FEEDS ON THE COMPETITION.

CompuStar II's enormous appetite for devouring the competition comes from its unique, modular design. Interchangeable, plug-in CPU "modules" are available in 80286, 80386SX and 80386 configurations.



The modules are remarkably inexpensive — as little as \$750 for a '286 module, and incredibly powerful.* The 33MHz '386 module achieves a stunning MIPS rating! Best of all, for up to one full year after purchase, you can trade in the module you originally select toward the purchase of any of the other more powerful modules.

IT DEVOURS OTHER COMPACTS.

Unlike other small footprint micros, CompuStar II won't put your computer expansion needs on a diet. Each system features an amazing six bus slots — four of them available in a fully configured VGA system. That's 25% more than IBM or Dell gives you. Better yet, you can have up to 11 slots with CompuStar II's exclusive bus expansion chassis. No other compact system available offers this much room for growth. And no other comparably sized system can accommodate that growth better than CompuStar II.



BUS EXPANSION CHASSIS

Its whopping 200 watt power supply gives you more than twice as much reserve power as IBM or Dell.



And CompuStar II has more room for disk/tape drives — *four* compartments in all; three accessible from the front panel. IBM and Dell give you just three compartments and only two are accessible from the front. CompuStar II also accommodates 5 1/4" and 3 1/2" disk drives. IBM and Dell restrict you to 3 1/2" drives only.

IT'S ALSO WELL-MANNERED.

Worried about quality and reliability? Don't! Wells American has been making PCs longer than IBM or Dell! Each CompuStar II is money back guaranteed for 31 days, factory warranted for a full year and can be field serviced from hundreds of locations worldwide.

When you think about it, buying an IBM or Dell system instead of our new CompuStar II is sort of like eating hamburger when you could have had steak — and paid less for it. CompuStar II... from Wells American. It makes "mincemeat" of everything else.

To receive a CompuStar II product information kit, call 1-803-796-7800. VAR inquiries also welcome.

 **Wells American.**

Corporate Headquarters: 3243 Sunset Boulevard • West Columbia, South Carolina 29169 • 803/796-7800 • FAX 803/796-7029

IBM is a trademark of International Business Machines Corporation. Dell refers to Dell Computer Corporation. *CompuStar II'S CPU performance is so incredible you won't believe it! Call or write for complete benchmark information. Certified FCC Class A. For business use only.

In an Upscale World

Kingsley G. Morse Jr.

When you want to enlarge a small experimental neural network into a real-world application, scalability becomes important. Even with the limited resources of a microcomputer, you can train large neural networks quickly if you're careful. The key is to make the neural network's training algorithm scalable. "Scalable," in this case, refers to the ability of a neural network developed on a microcomputer to be enlarged easily to perform larger—sometimes much larger—real-world tasks.

Although scalability is still more of an art than a science, several techniques exist to help you stay within the speed and memory limits of a microcomputer. You want the network to be able to use more neurons, synapses, or training patterns and still train reasonably fast on a microcomputer.

The graph in figure A compares three scalability standards. As you can see, an algorithm whose training time is a polynomial function of the number of training patterns will allow you to train many more patterns than an algorithm whose training time is an exponential function of the number of training patterns. If you improve a training algorithm from exponential to polynomial scalability, you will significantly increase the number of patterns you can train; achieving *linear* scalability would be extraordinary.

The following techniques will help you make a scalable neural-network training algorithm.

- Use "computational-complexity functions" to estimate how scalable an application and a neural-network training algorithm are. Benchmarking scalability early can save you from wasting time on untrainably large networks or applications.

First, you plot the training time (or memory) against the "size" of the problem; then you fit several curves to the

data. The curve that best fits the data is its computational-complexity function. If training time increases exponentially with the problem size, the training algorithm and the application aren't scalable, and you should consider other training algorithms or applications. If, however, training time is a linear or polynomial function of problem size, it should be scalable. Once you have approximated the complexity function, you can estimate how long it will take to train larger problems on your microcomputer. This is a good way to benchmark various training algorithms.

For example, you could use the following method to benchmark a training algorithm that interests you. Train the network with several small but different sets of training patterns. Keep a record of the training times and corresponding numbers of training patterns. Plot these points on a graph with training times (in minutes) on the graph's vertical axis and the number of training patterns that you used on the horizontal axis. Then try to fit the data with combinations of the standard components of computational complexity (i.e., linear, polynomial, and exponential terms). Choose the curve that fits the data points best.

A typical polynomial computational-complexity function for back-propagation's training time is:

$$178 + (0.014 \times (\text{number of training patterns}^{3.535}))$$

You can use this function to estimate how long it will take to train more patterns; this is a good measure of the training algorithm's scalability. You can also use this technique on other training algorithms and compare them to the first algorithm.

This technique is also good for avoiding applications that are unscalable no matter which training algorithm you use. If you've tried several training al-

gorithms, and all of them have strongly exponential computational-complexity functions, then you might want to consider another application.

- Avoid *second-order* training algorithms that use memory proportional to the network's size squared. For example, some methods store and update a matrix of second derivatives, where the memory required is proportional to the square of the number of synapses in the network. The training algorithm must also update each element in these arrays, so the training time to maintain second-order data can increase with the square of the number of synapses. A square relationship is an example of the polynomial curve on the graph. Although second-order methods converge rapidly for smaller problems, they become unwieldy for large networks. First-order methods only use memory proportional to the number of synapses; the linear curve in the graph illustrates this.

For example, if you want to expand a microcomputer's neural network from 100 synapses to 1000 synapses, and you're using 4-byte floating-point numbers, the amount of storage that a second-order technique needs would increase from $4 \times (100^2) = 40,000$ bytes to $4 \times (1000^2) = 4,000,000$ bytes.

This is a hundredfold increase, and most microcomputers don't have enough memory for the second-order method. A first-order method would increase memory usage from only 400 bytes to 4000 bytes, an amount well within the memory capacity of most microcomputers. Furthermore, you can enhance first-order methods with a "momentum" term and conjugate gradient techniques.

- Avoid training algorithms that are known not to scale well. For example, back-propagation becomes unstable as more layers are added. Some research indicates that a back-propagation net-

nology developments are being addressed at universities (e.g., Caltech) and high-technology companies (e.g., TRW, General Electric, and Texas Instruments) before being farmed out to start-ups (e.g., Nestor and Hecht-Nielsen). Neural-network technology cuts across many disciplines, including psy-

chology, biology, physiology, philosophy, mathematics, physics, computer science, and linguistics.

Recent advances in the fields of mathematics, neurology, and neurobiology have led to a neural-network reawakening. Consequently, the theory of neural networks is being studied in two aspects:

first, the efficiency of a neural-based electronic architecture, and second, the achievement of an understanding of the biological functions of neural networks.

There is a variety of factors holding back the widespread implementation of neural networks. The technology itself is

work's training time grows exponentially as the number of neurons increases. In comparison, when you can use multiple-regression algorithms for inherently linear applications, the training time is only a polynomial function of the number of inputs. The good news is that back-propagation appears to scale polynomially as the number of training patterns increases.

- Use the machine-specific characteristics of floating-point mathematics, as some numerical algorithms do. When adding many floating-point numbers, round-off error may preclude smaller numbers from affecting the running total. By keeping calculations within accuracy limits, you can avoid numerical runaway, promote stability, and thus attain faster training.

- Consider training the network until it produces answers that are good but not optimal. For example, if the desired response of the network's output neurons is either 0 or 1, the network will learn "correct" answers faster when you compare the outputs to 0.5 instead of exactly 0 or 1. In other words, anything less than 0.5 would correspond to a 0; anything more, to a 1.

- Consider developing a training algorithm that solves a special case of the application. For example, instead of training an insurance neural network with loan data from all age groups, it may be faster to train several smaller networks for different age groups. In some cases, a linear reformulation of the application is possible, which allows you to use much faster methods, such as multiple regression.

- Do away with unnecessary neurons and synapses, leaving a smaller network to train. If redundant neurons exist and you can remove them, then you may be able to train a smaller network. This could make a noticeable difference if the training time is polynomially or exponentially related to the number of

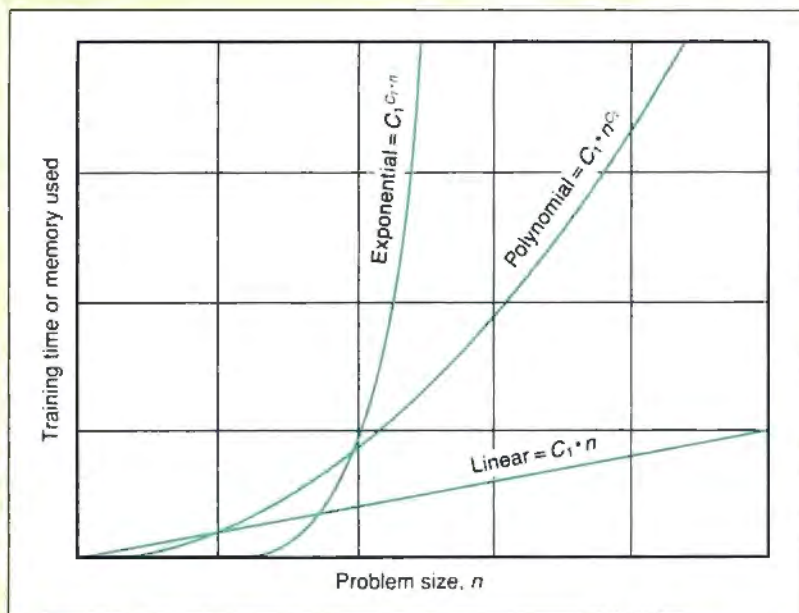

Figure A: Three standard measures of scalability; n is the problem size, which can be training patterns, neurons, or synapses, and C_1 and C_2 are constants.

neurons or synapses.

- Consider using a math coprocessor to speed up multiplication, a common bottleneck for neural-network algorithms. Intel, Weitek, and Motorola, among others, sell math coprocessors. Also, some compilers are more efficient than others for numeric processing. BYTE's March 1988 In Depth on floating-point processing outlined some hardware and software options.

- To speed up your neural network that last little bit, you may want to rewrite some parts of the code in assembly language. For example, many neural networks spend a lot of time evaluating the activity of the network. This part of the code may be a good candidate for assembly language.

- Look to neuroscience for ways to train neural networks quickly. A staggering amount of neuroscientific knowledge is available. Biological elements such as neurons and synapses have traditionally inspired neural-network research, but what roles do genetics, cortical columns, and the hypothalamus play?

- Watch for benchmark results from the Defense Advanced Research Projects Agency. DARPA has budgeted millions of dollars for neural-network research. Specifically, it intends to fund benchmarked comparisons between neural-network algorithms and classic pattern-recognition algorithms. Hopefully, this research will address benchmarking techniques that can be applied to scaling up neural-network training algorithms.

BIBLIOGRAPHY

- Morse, Kingsley G. Jr. "Neuroscience as a Possible Research Standard for Neural Networks." *Proceedings of the IEEE First International Conference on Neural Networks*, 1987.
- Vose, G. Michael, and George A. Stewart. "Floating-Point Processing." *BYTE*, March 1988.

Kingsley G. Morse Jr. founded the AI Forum of Silicon Valley and works at Hewlett-Packard in Mountain View, California. He can be reached on BIX c/o "editors."

still in its infancy. Many elements have yet to be worked out and put into place—not the least of which is how to model the human brain. We still understand very little about how the brain works, and so far, no one has been able to come up with a "brain in a box." We don't even know whether or not we really want to model

our biological neural networks. Other ways of implementing the technology may prove to be more effective.

Today, some of the major neural-network dilemmas concern training/learning, scaling, and performance. One current area of research is trying to identify the network paradigm, or pattern, best

sued for a specific application. There are dozens of known network paradigms, and the number is steadily increasing.

Currently, neural networks have meager processing power, even when compared to the brains of such simple creatures as cockroaches, flies, and leeches.

continued

Although in principle the networks are capable of handling raw data well, there may be severe practical limits in scaling neural networks (see the text box "In an Upscale World" on page 222).

We have a long way to go before we understand a neural network's learning capabilities. Currently, we know little about our own biological memories. Thus, we don't know what, if anything, distinguishes learning from recall. In addition, the current neural-network learning algorithms are neither very novel nor powerful.

The training effort for large-scale applications may be as substantial as that required to program conventional computers. Because so little is known about why a neural network behaves in a certain way, there are still risks in over-training the network and constructing inefficient hidden layers. The state of the art is still hindered by the limits of the hardware.

A neural network's performance depends on many elements. Some of today's most important issues are: How many layers and processing nodes are enough? How creative should the system be (i.e., how many times should it "guess" before it gives up)? If it finds one good answer, should it continue to search for another? What happens if neurocomputers base their conclusions on data other than what we use? Once a neural network has reached a conclusion, what should it do about contradictory evidence?

Neural-network computing has I/O constraints, just as conventional computing does. The basic problem remains: Unless the communications channel is relatively large compared to the system's average total communications load—even compared to its occasional near-peak loads—the system's behavior will significantly deteriorate.

As we approach the twenty-first century, we need a new approach to the information science describing neural-network machines. Just as there is a formal structure to our biological neural network, more efficient artificial neural networks will need a framework and an order to determine how they will learn, preprocess, and select input information. They will also need to deal with how different parts of an intelligent system will perform specific functions.

One of the areas of study being explored by David Rumelhart, professor of psychology at Stanford University, is that of developing networks that can choose their own architectures. Still in its most rudimentary stages, this science

will use a kind of a built-in feedback loop as people use neural models to solve relatively specialized problems and learn from their experiences.

Robert Hecht-Nielsen, cofounder of the Hecht-Nielsen Neurocomputer Corp. in San Diego, suggests that you check out at least six criteria when you choose a neural-network configuration:

1. optimal I/O format
2. training time
3. data preprocessing requirements
4. mathematical optimality
5. performance estimates
6. debugging/diagnostics requirements

In addition, you should also ask an important question: Can you achieve the same or better results with conventional technologies?

A Marriage of Convenience

According to optimistic predictions, by the year 2000, neural-network technology will account for half the total revenues of the robotics and computer markets. With little but pure research to build on and no concrete knowledge of how the brain really works, the last few years have brought products to market that range from simulation software to a neural network implemented in a chip, hard-coded to duplicate a neural-network architecture.

One company, Oxford Computer in Oxford, Connecticut, has developed an intelligent memory chip that can be used for neural networks. According to Steve Morton, founder and chief technical officer of the firm, because these chips are inherently parallel, you can combine them to build powerful board-level neurocomputers performing tens of billions of operations per second.

Why this rapid growth in neural-network technology and impressive list of products and technology implementations just a few years after the resurgence of interest in the field? Primarily because of the time-urgent need for an alternate way to solve problems that conventional processing techniques don't handle well. In addition, over the last few years, there have been important mathematical and computational advances.

But neurocomputing must overcome many significant barriers before it can become an accepted way to solve real-world problems. The future of practical neural networks depends on the advent of technologies that support their speed and storage requirements. The interconnects per second found in the brain of a common housefly are two orders of magni-

tude faster than the fastest neural-network tool available today.

In the short term, the development of the digital signal processing chip will support improvements in speed, while the advent of DRAM chips of up to 16 megabits will increase storage capacities. In the midterm, better gallium-arsenide chips will help to improve speed, and better wafer and analog devices will improve capacities. In the long term, optical computing and optical storage will be key factors.

Neural networks won't replace database and knowledge-based processing because they don't work well with numbers or cut-and-dried information. In the next few years, it is likely that the first practical neuron-like circuits will appear in silicon, and a neural network may be used as a coprocessor controlled by a host digital computer. One company, Micro Devices of Orlando, Florida, has already produced a chip on a board that it claims is a working neural network, not a simulation.

Most forecasters believe that neural networks will not replace conventional methods of computing—especially those that deal with high-speed numeric processing—but will complement them and add to their utility. The combination of traditional computers and the unique power of neural networks could unravel problems that otherwise would remain unresolved.

In spite of all the hype and excitement, however, the verdict is still out and will remain so for about the next 10 years. Exaggeration has been and still is the bane of the neural-network industry. Everyone deeply involved in this field continually and appropriately warns against the setbacks that can occur if hype becomes the order of the day. ■

REFERENCES

1. McClelland, James L., and David E. Rumelhart. *Explorations in Parallel Distributed Processing*. Cambridge, MA: MIT Press, 1987.
2. Minsky, M., and S. Papert. *Perceptrons*. Cambridge, MA: MIT Press, 1969 and 1988.

Klaus K. Obermeier is the natural-language-query product manager at Battelle Institute in Columbus, Ohio. He received his Ph.D. in linguistics/AI from Ohio State University and has established a neural-network technology clearing-house. He can be reached on BIX c/o "editors." Janet J. Barron is a technical editor for BYTE. She can be reached on BIX as "neural."

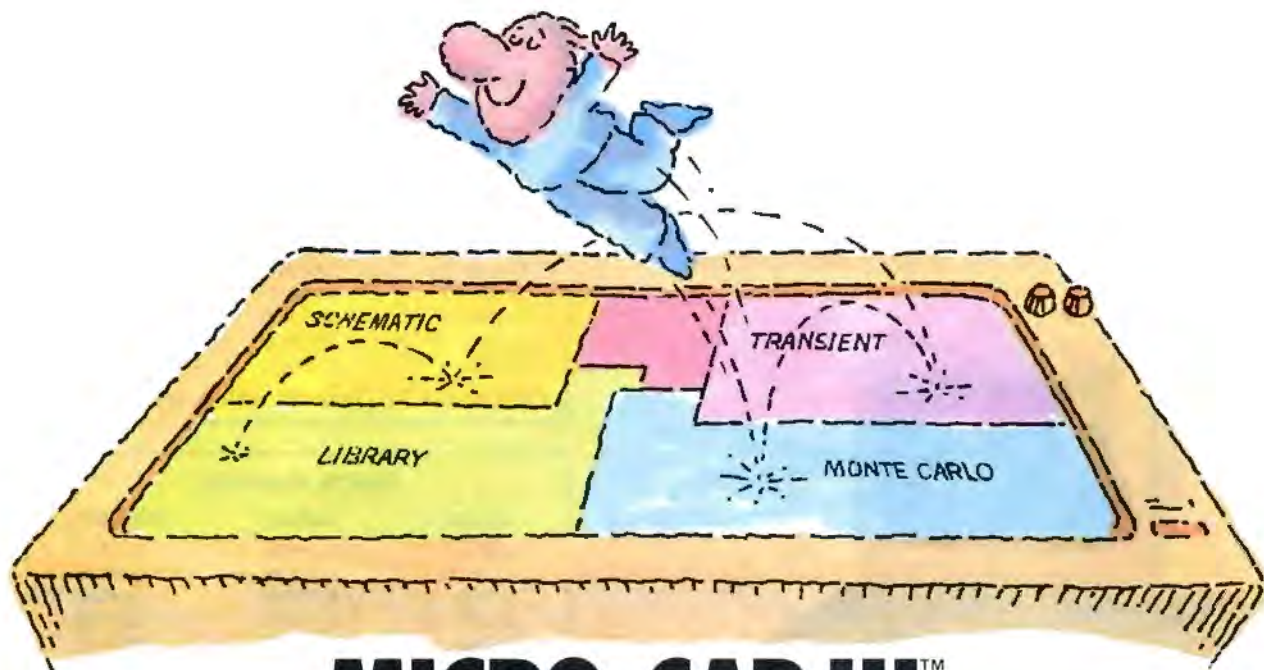

MICRO-CAP III.TM THIRD-GENERATION INTERACTIVE CIRCUIT ANALYSIS. MORE POWER. MORE SPEED. LESS WORK.

MICRO-CAP III,TM the third generation of the top selling IBM® PC-based interactive CAE tool, adds even more accuracy, speed, and simplicity to circuit design and simulation.

The program's window-based operation and schematic editor make circuit creation a breeze. And super-fast SPICE-like routines mean quick AC, DC, Fourier and transient analysis — right from schematics. You can combine simulations of digital and analog circuits via integrated switch models and macros. And, using stepped component values, rapidly generate multiple plots to fine-tune your circuits.

We've added routines for noise, impedance and conductance — even Monte Carlo routines for statistical analysis of production yield. Plus algebraic formula parsers for plotting almost any desired function.

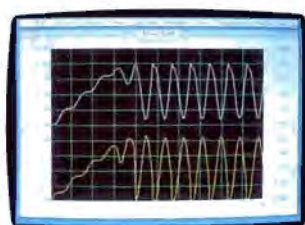

Transient analysis

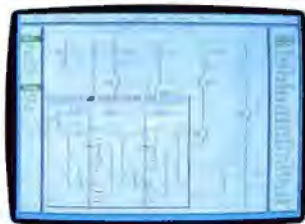

Schematic editor



Monte Carlo analysis

Modeling power leaps upward as well, to Gummel-Poon BJT and Level 3 MOS — supported, of course, by a built-in Parameter Estimation Program and extended standard parts library.

There's support for Hercules® CGA, MCGA, EGA and VGA displays. Output for laser plotters and printers. And a lot more.

The cost? Just \$1495. Evaluation versions are only \$150.

Naturally, you'll want to call or write for a free brochure and demo disk.

spectrum

1021 S. Wolfe Road,
 Sunnyvale, CA 94086
 (408) 738-4387

MICRO-CAP III is a registered trademark of Spectrum Software.
 Hercules is a registered trademark of Hercules Computer Technology.
 IBM is a registered trademark of International Business Machines, Inc.

Automation For The 90's From The Heartland

CORPORATE COMPUTERS OF IOWA provides the nation's most aggressive prices on all TOSHIBA®, EPSON®, NEC® and PANASONIC® printers, FAX machines, laptops and cellular phones.

Call one of our account executives today and experience the performance and quality you'd expect from the "Heartland."



CORPORATE COMPUTERS OF IOWA 386 PERFORMANCE AT THE NATIONS LOWEST 286 PRICING!!!

CCI AT 286/20 MHZ

80286 Processor Running At 20/10	14" Multisynch Monitor
Phoenix Bios/Digital Speed Display	EVGA Graphics Card
80287 Math Co-Processor Socket	1 - Parallel - 2 Serial - Game Port
8 Expansion Slots	101 Key AT Keyboard w/Dust Cover
1 Meg RAM (Expandable to 8 Megs)	DOS 4.01 w/GW Basic Surge Suppressor
1.2 Meg Floppy	1 Year Parts and Labor Warranty
1.44 Meg Floppy	30 Day Money Back Guarantee
80 Meg Seagate ST-4096 (2BMS)	2nd Year Warranty \$49.95
WD Controller	

**CORPORATE COMPUTERS OF IOWA PRICE
\$2,799.00**

1 Year On Site Service Contract FREE

Corporate Computers of Iowa Policies

- Toll Free Number 1-800-533-0948 for Ordering and Post Sale Support
- MasterCard, VISA - No Surcharge, American Express - Add 3%
- C.O.D. Cashiers Checks
- 30 Day, Money Back Guarantee
- Prices Subject To Change In Manufacturers Pricing.
- Allow 10 Days For Personal Checks To Clear
- Call For Corporate Purchase Orders
- Dealer Inquiries Invited

1-800-533-0948

TOSHIBA LAPTOPS

MODEL	RETAIL	CCI PRICE
T-1000	\$1249.00	\$ 760.00
T-1200F	\$2099.00	\$1299.00
T-1200FB	\$2399.00	\$1485.00
T-1200H	\$3499.00	\$2159.00
T-1200HB	\$3699.00	\$2275.00
T-1600	\$4999.00	\$3000.00
T-3100E	\$4299.00	\$2599.00
T-5100	\$7199.00	\$4300.00
T-5200	\$9499.00	\$5700.00

FREE box of 3.5 Diskettes with every Toshiba

EPSON PRINTERS

MODEL	RETAIL	CCI PRICE
LX-800	\$ 299.00	\$167.00
FX-850	\$ 549.00	\$339.00
FX-1050	\$ 799.00	\$449.00
LQ-500	\$ 529.00	\$299.00
LQ-850	\$ 859.00	\$519.00
LQ-950	\$ 949.00	\$589.00
LQ-1050	\$1199.00	\$699.00
LQ-2550	\$1499.00	\$925.00

Corporate Computers of Iowa offers a "FREE" 6 foot cable with every Epson Printer Purchased!!

PANASONIC PRINTERS AND FAX MACHINES

MODEL	RETAIL	CCI PRICE
KXP-1180	\$299.95	\$179.00
KXP-1191	\$399.95	\$230.00
KXP-1592	\$649.95	\$389.00
KXP-1595	\$729.95	\$429.00
KXP-1124	\$529.95	\$315.00
KXP-1524	\$899.95	\$539.00
UF-150 FAX	\$1795.00	\$955.00
UF-260 FAX	\$2795.00	\$1479.00

**386 25MHz
Tower
\$3999.00**

**286 12 MHz
CALL FOR PRICING**



CORPORATE COMPUTERS OF IOWA

P.O. Box 714
Sioux City, Iowa 51102
712/277-2100
Toll Free: 1-800-533-0948
Corporate Showroom
609 5th Street
Sioux City, Iowa 51101

Circle 69 on Reader Service Card (DEALERS: 70)

What's Hidden in the Hidden Layers?

*The contents can be easy to find with a geometrical problem,
but the hidden layers have yet to give up all their secrets*

David S. Touretzky and Dean A. Pomerleau

Much of the current fascination with neural networks has to do with their ability to learn. The most popular learning algorithm today is back-propagation, which can be implemented rather easily on a microcomputer (see "Back-Propagation," October 1987 BYTE).

To solve a problem with a back-propagation network, you show it sample inputs with the desired outputs, over and over, while the network learns by adjusting its weights. If it solves the problem, it will have found a set of weights that produce the correct output for every input.

But what has the network learned? Unlike an expert system, neural networks do not automatically explain their reasoning. Whatever knowledge the network acquires is encoded in its numerical weights. It's not easy to decipher the network's solution to a problem when all you have to look at is a set of floating-point numbers.

In the past, the difficulty in interpreting weight patterns contributed to the neural-network mystique. Networks were sometimes billed as magic boxes whose learning algorithms produced



solutions unintelligible to mere humans.

Today, we have a better understanding of neural-network learning procedures like back-propagation, and we can analyze, to some extent, the representations that develop. Back-propagation consists of two passes. In the forward pass, inputs proceed through the network and generate a certain output. Then, in the backward pass, the difference between the ac-

tual and desired outputs generates an error signal that is propagated back through the network to teach it to come closer to producing the desired output.

Between the input and output layers, there may be additional layers of units, called *hidden units*. When analyzing a network, we study two kinds of hidden-unit representations. First, we want to understand what the weights mean. Second, we want to look at the patterns of activation of units in the hidden layer in response to particular inputs.

Hidden units should really be called "learned-feature detectors" or "re-representation units," because the activity pattern in the hidden layer is an encoding of what the network thinks are the significant features of the input. The

two representations (weights and activity patterns) are closely related, but, for some problems, looking at one is more informative than looking at the other.

To understand the hidden-layer representations that real networks develop, look at two examples of geometric problems that have recently been solved by back-propagation. The first is a highly

continued

nonlinear binary classification problem; the second involves driving a robotic vehicle along a road through a park.

The Unit Square

In two-layer networks, input units connect directly to output units, and each connection has a number, or weight, attached to it. One widely known limitation of these networks is that they cannot compute the XOR function. Introducing a third, hidden layer of units between the input and output layers provides the necessary computational power for XOR.

You can view XOR as a special case of a more general problem: classifying points in the *unit square* (as in figures 1a and 1b). Each point in the unit square is either in class 0 or class 1. In the case of XOR, you consider only the four corners of the square: the points (0,0), (0,1), (1,0), and (1,1). The first and fourth points are in class 0 ($0 \text{ XOR } 0 = 0$, and $1 \text{ XOR } 1 = 0$); the second and third are in class 1 ($0 \text{ XOR } 1 = 1$, and $1 \text{ XOR } 0 = 1$).

A single artificial neuron computes a linear sum of its inputs and produces either a 0 or a 1 as output. This in effect draws a line that partitions this square into two regions. For all points on one side of the line, the neuron outputs a 1; for all points on the other side, the neuron outputs a 0.

The position and orientation of the line are determined by the weights on the neuron's input connections. You can't draw a single straight line through the unit square so that (0,1) and (1,0) end up in one region and (0,0) and (1,1) end up in the other. Therefore, you can't solve XOR with a two-layer network.

Introducing a layer of hidden units increases the power of the network, since each hidden unit can partition the input space in a different way. The output unit then computes a linear combination of these partitionings to solve the problem.

In the XOR example, a hidden layer containing two units is adequate (see figure 1c). The first unit partitions the space so that it is activated when either input, (0,1) or (1,0), or both, (1,1), are active, as in figure 1a. It has an *excitatory* connection (a positive weight) to the output unit. The network sets the second hidden unit's weights so that it becomes active only when both inputs, (1,1), are active, as in figure 1b. It has a stronger *inhibitory* (negative) influence on the output unit than the excitatory influence of the first hidden unit.

This network correctly solves the XOR problem. When neither input is active, (0,0), neither hidden unit is active, so the output unit remains off. When a single input unit is on, (0,1) or (1,0), the first hidden unit turns on, activating the output unit. If both input units are active, (1,1), both hidden units turn on. Since the inhibitory input from the larger negative weight of the second hidden unit is greater than the excitatory input from the first, the output unit will be turned off.

Hidden units act as feature detectors, or *filters*, for some types of inputs. By combining these features, the output unit can perform more powerful classifications than it can without the hidden units.

Solving Two Spirals

Additional hidden layers allow artificial neural networks to efficiently partition

the input space into arbitrary regions and perform complex tasks. One such task is the two-spirals problem, originally posed by Alexis Wieland of the Mitre Corp. in Cambridge, Massachusetts. In this problem, the network must distinguish between points on two intertwined spirals in the unit square (see figure 2).

The black dots are all in class 0, the white dots in class 1. Like XOR, this problem is not linearly separable. There is no way to draw a single straight line through the unit square so that all the black dots end up on one side and all the white dots on the other.

Two of our colleagues at Carnegie Mellon University, Kevin Lang and Michael Witbrock, recently taught a neural network to solve the two-spirals problem and analyzed the hidden-layer representations that developed (see reference 1). Their network, shown in figure 3, has two input units, representing the *x* and *y* coordinates of the point, and one output unit. The activation levels of the input units are not restricted to binary values, but they can take on any value between 0.0 and 1.0.

This network has two hidden layers of five units each. The units in each layer receive connections from the units in all layers below it. The connections that skip layers provide direct information pathways from lower layers in the network and allow more flexible hidden-layer representations. Unlike the XOR problem, however, it's not obvious what a good set of hidden-layer feature detectors would look like for this task.

Back-propagation develops the feature *continued*

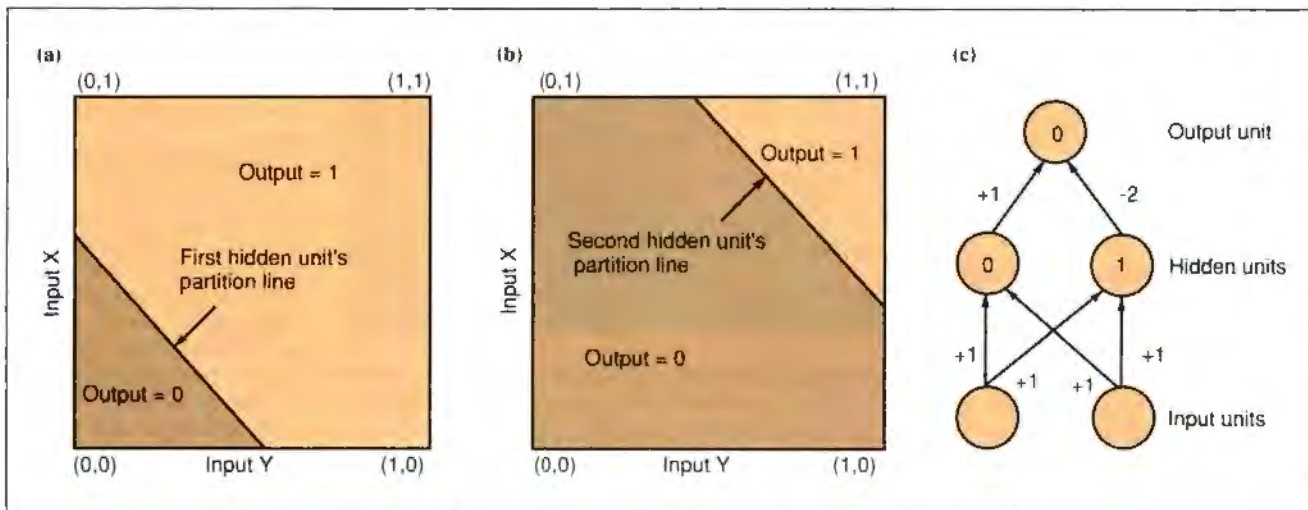

Figure 1: A network designed to solve the XOR problem. (a) and (b) The regions of input space for which the two hidden units are active. (c) The number inside each unit is its threshold. A unit turns on when its total input exceeds its threshold. The total input is equal to the sum of its input values (each input multiplied by the weight on the line).

Take Our Course In C And The First Lesson You'll Learn Is In Economics.



C's power, and portability make it the language of choice for software developers. Unfortunately, learning C can be a very costly proposition. Classroom instruction is, in a word, expensive. And many C video courses carry hefty price tags.

The top C video course at the lowest possible price

But now, there's The Complete C Video Course from Zortech. It's the ultimate C training tool for home or work. And all it costs is \$295.



You get ten videos with 36 lessons covering all levels of programming skill. A comprehensive, easy-to-follow 365 page workbook. And even a free C compiler.

Free C compiler included

Yes, that's right. The Complete C Video Course includes our famous C compiler (it runs on any MS-DOS machine) with linker, library manager, full graphics library and on-line help. It's the choice of professional programmers everywhere for fast code, fast development and fast debugging.

```
#include <stdio.h>
#define NAMLEN 15
#define NUMMARK 4
struct person
{
    char name[NAMLEN];
    int mark[NUMMARK];
};
```

Learn C in as little as two weeks

Speaking of speedy, with The Complete C Video Course you can learn C in only two weeks.

Compare that with the up to four months it can take to learn C in class.

Each lesson averages 17 minutes of clear, concise instructions. Used in conjunction with our workbook you'll find they provide everything you need to know to become proficient in programming in C.

Save your company thousands

If you think The Complete C Video Course is a great way for you to save money learning C, think about how much it could save your company. Use it instead of sending programmers to school and you'll save thousands. What's more, The Complete C Video Course is even tax deductible. C is unquestionably the most valuable programming language you can master. And now you can get everything you need to become productive in it from course to compiler to tools for an economical \$295. Mail the coupon or call our hotline to receive it ASAP.

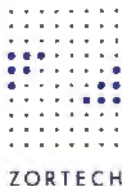

Look at all these C video pluses

- Only \$295 complete.
- Ten videos with 36 lessons.
- Comprehensive 365-page workbook.
- Free C compiler with linker, library manager, full graphics library and on-line help.
- Compiler and hardware independent.
- Designed to help you learn C in as little as two weeks.
- Tax deductible.



Zortech Inc.
366 Massachusetts Ave.
Arlington, MA, 02174
Tel: (617) 646-6703
Fax: (617) 643-7969

- ★ Yes, rush me The Complete C Video Course including free C compiler for \$295.00 (VHS only)
- ★ Please include (No.) extra workbooks at \$29.95 each.
- ★ I'd like to order (No.) extra C compilers with this course at the special price of \$49.95.

Name/Company

Address

.....

Phone

City

State Zip

Here's my check for

VISA/MC #

Exp. Date

Prices do not include shipping

The Complete C Video Course \$295

Order Hotline (800)848-8408

detectors in figure 4. Each square in the figure graphs the response of a single unit to points at various positions in the interior of the unit square. (The squares in figure 4 correspond directly to the circles in the same positions in figure 3.) The brightness of each point in a square indicates the activation level of that hidden unit when the network is shown an

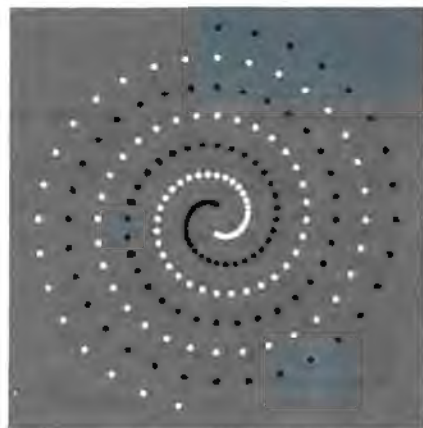

Figure 2: Training points for the two-spirals problem. Black points should produce an output of 0; white points should produce an output of 1.

input point at that position.

Units in the first hidden layer divide the input space into two regions along various angles. Units in the second layer use combinations of these first-layer features to produce curved response patterns. The output unit then uses these curved patterns to form successive turns of the spiral.

The imperfections of the solution are an interesting aspect of the way back-propagation works. Notice the bumps and gaps in the spirals that the output unit forms. The network learns to classify all the points in the training set in figure 2 correctly, but it is *underconstrained*: It is not told how to respond to the remaining points in the unit square. Given this kind of freedom, back-propagation almost never develops a perfect solution.

One of the most difficult parts of training neural networks is choosing the training set. You want back-propagation to develop a network that classifies patterns in the training set correctly and also generalizes to new patterns correctly. Providing additional training data and constraining the network architecture are two techniques that reduce excess freedom and clean up the network's representations.

A Road Tracker

Proper generalization is particularly crucial in real-world problems where you can't train a network in advance for every circumstance it might encounter in the field. One such problem we have been working on at Carnegie Mellon is autonomous vehicle navigation (see photo 1 and reference 2).

The goal of ALVINN (for autonomous land vehicle in a neural network; see reference 3) is to drive the NAVLAB vehicle along a winding road. The inputs to ALVINN are more complex than the coordinates of a single point in the unit square, but they are geometrical in nature.

ALVINN receives two types of sensor inputs from the NAVLAB (see figure 5). One is a 30- by 32-pixel image from a video camera mounted on the roof of the vehicle. (Each pixel in the video image corresponds to an input unit in the video retina.) The activation level of each unit in the video retina indicates the brightness of the corresponding pixel in the video image.

The other input is an 8- by 32-pixel image from a laser range finder. The activation levels of units in the range finder's retina represent its distance from the corresponding area in the image. The darker the color, the closer the object is. A stylized input sample is shown in figure 5. Notice that the tree to the left of the road in the video image shows up as an area of constant brightness in the range finder image. This is because the tree surface is essentially perpendicular to the horizontal range finder beam and, therefore, at a constant distance away.

The two input retinas are connected to a single layer of hidden units, which are in turn connected to the output units. (In other words, all input units are connected to all hidden units, and all hidden units are connected to all output units.) The response of the output layer is a linear representation of the direction in which the vehicle should travel to head toward the center of the road. The center-most output unit represents the "travel straight ahead" condition, while units to the left and right of center represent successively sharper left and right turns.

To drive the NAVLAB vehicle, video and range finder data from the on-board sensors are injected into the input layer. After completing a forward pass, the network reads a steering command from the output layer. The output unit with the highest output value determines the direction in which the vehicle will head.

Training the network is difficult. To develop a hidden-layer representation that generalizes correctly to new situa-

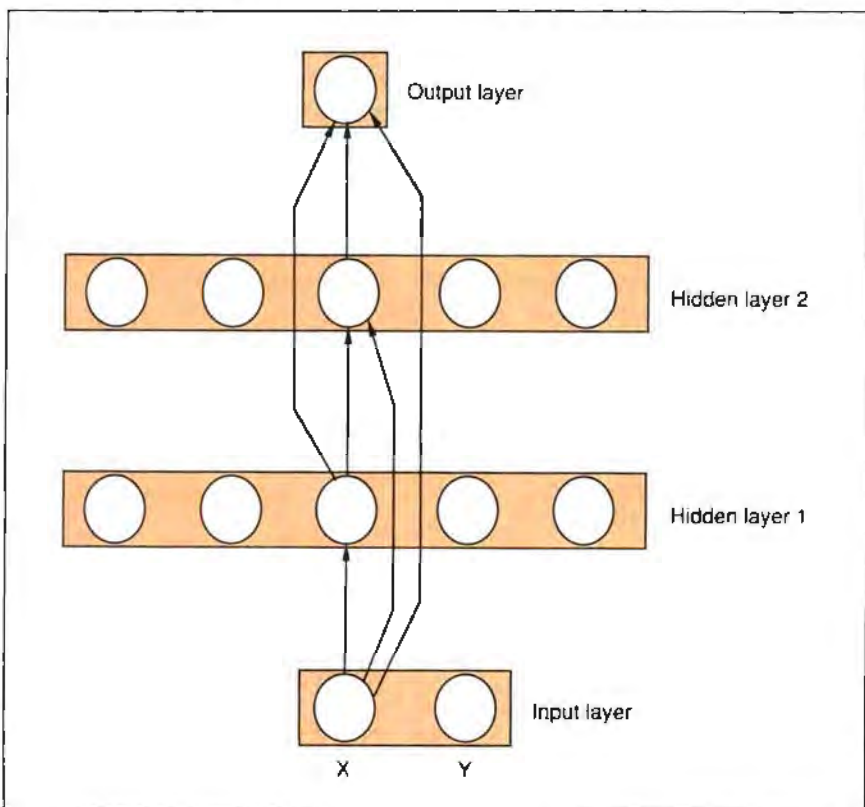

Figure 3: Lang and Witbrock's network for learning the two-spirals problem. Each unit receives input from all the units in all the layers below it.

tions, we fed the network road images taken under a wide variety of viewing angles and lighting conditions. It would be impractical to try to collect thousands of real road images for such a data set. Instead, we developed a synthetic road-image generator that can create as many training examples as we need.

To train the network, 1200 simulated road images are presented 40 times each, while the weights are adjusted using the back-propagation learning algorithm. This takes about 30 minutes on Carnegie Mellon's Warp systolic-array supercomputer. (This machine was designed at Carnegie Mellon and is built by General Electric. It has a peak rate of 100 million floating-point operations per second and can compute weight adjustments for back-propagation networks at a rate of 20 million connections per second.)

Once it is trained, ALVINN can accurately drive the NAVLAB vehicle at about 3½ miles per hour along a path through a wooded area adjoining the Carnegie Mellon campus, under a variety of weather and lighting conditions. This speed is nearly twice as fast as that achieved by non-neural-network algorithms running on the same vehicle. Part of the reason for this is that the forward pass of a back-propagation network can be computed quickly. It takes about 200

milliseconds on the Sun-3/160 workstation installed on the NAVLAB.

The hidden-layer representations ALVINN develops are interesting. When trained on roads of a fixed width, the net-

work chooses a representation in which hidden units act as detectors for complete roads at various positions and orientations. When trained on roads of variable

continued



Photo 1: The NAVLAB autonomous navigation test-bed vehicle and the road used for trial runs.

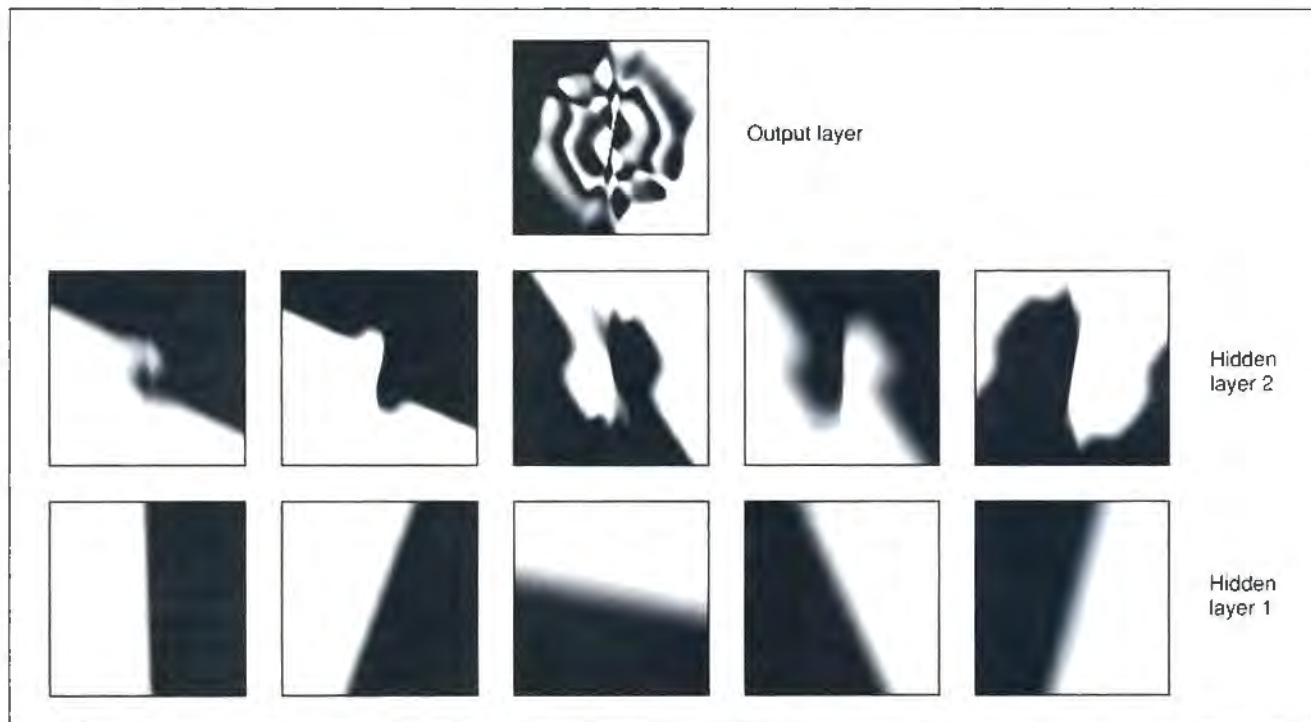

Figure 4: Response function plots for the units in the two-spirals network. Each plot shows the activation level of a single unit as the x,y input to the network ranges over the interior of the unit square. The topmost plot is for the output unit, and the plots below are for the five units in each of the two hidden layers. (Figure courtesy of Kevin Lang and Michael Witbrock)

widths, the hidden units turn into road-edge detectors, sensitive to only one of the two road edges. (Some look for left edges, and some for right edges.)

Figure 6 shows the weights to and from a single hidden unit after ALVINN was trained on roads of a fixed width. White squares represent positive values; black squares represent negative values. This hidden unit acts as a filter for two types of roads, one slightly to the left of center and one slightly to the right.

The weights from the video camera retina, along with the explanatory schematic, show the positions and orientations of the two road types that activate the hidden unit. Notice that the road specifications overlap: The large white region in the center of the weight diagram is a merger of the weights for the left edge of the rightmost road with the weights for the right edge of the leftmost road.

This hidden unit is also excited by obstacles in the periphery of the image and inhibited by obstacles in the center of the image where it expects the road to be. By fusing data from the video-camera and range finder sensors, hidden units can determine the position and orientation of the road more accurately than they could with either sensor alone.

This hidden unit makes excitatory connections to two sets of output units, dictating a slight left or right turn. Since it provides support for two turn directions, it must work with other hidden units to pin down the correct steering direction. Double-duty hidden units like this provide a compact representation. They allow a network with a small hidden layer to perform a complex task, like following a road, accurately.

Reducing the size of the hidden layer not only increases the rate at which a computer can simulate the network, it can also improve the network's performance. With too many hidden units, a network can simply memorize the correct response to each pattern in its training set instead of learning a general solution.

By limiting the size of the hidden layers, the network is forced to develop appropriate feature detectors to efficiently classify large sets of input patterns. These general-purpose feature detectors are more likely to be relevant to novel inputs, so the network performs better. In one experiment, we drove the NAVLAB vehicle using a network trained with only nine hidden units without any significant loss in driving proficiency.

Hidden units that act as filters for one to three roads are the most common result when ALVINN is trained on roads of a fixed width. The network develops a different representation when trained on images with varying road widths. Instead of developing into detectors for entire roads, the hidden units learn to look for a single road edge at a particular position and orientation.

The units support a wide range of travel directions. The correct travel direction for a road with an edge at a particular location varies substantially depending on the road's width. The hidden units cooperate with each other to determine the correct travel direction in any situation.

It's important to understand that no single hidden unit can perform the task alone; the collective activity of all the hidden units determines how the network behaves. Through this kind of cooperation, the network can use relatively coarse feature detectors and still maintain performance accuracy.

Hidden Units Demystified

It's easy to uncover what's in the hidden layers when you apply a neural network to a geometrical problem, as illustrated by the two-spirals and road-tracking examples. The visualization tools made practical by microcomputers and personal workstations have proved invaluable for this type of analysis.

Some researchers display only a hidden unit's weights when trying to analyze a network. The work of Lang and Witbrock (see reference 1) shows that, for geometric problems, it can be more helpful to display the unit's response to a systematic sampling of points in the input region, especially when the network has more than one hidden layer.

This practice is also common in classical neuroscience investigations of the visual system. You can't measure the weights between living neurons in the cortex of the brain, but you can measure their response to various inputs. Many studies of the visual system have been done by graphing the firing rate of cortical neurons while varying a stimulus pattern presented to the retina.

In the case of ALVINN, we saw from the weights that the network learns to efficiently exploit regularities in the input by making its hidden-layer units sensitive to a range of road types. We also tried plotting the units' response patterns while varying the retinal input (presenting roads at various positions and orientations); this confirmed our interpretation of what the hidden layer was doing.

Training ALVINN is time-consuming

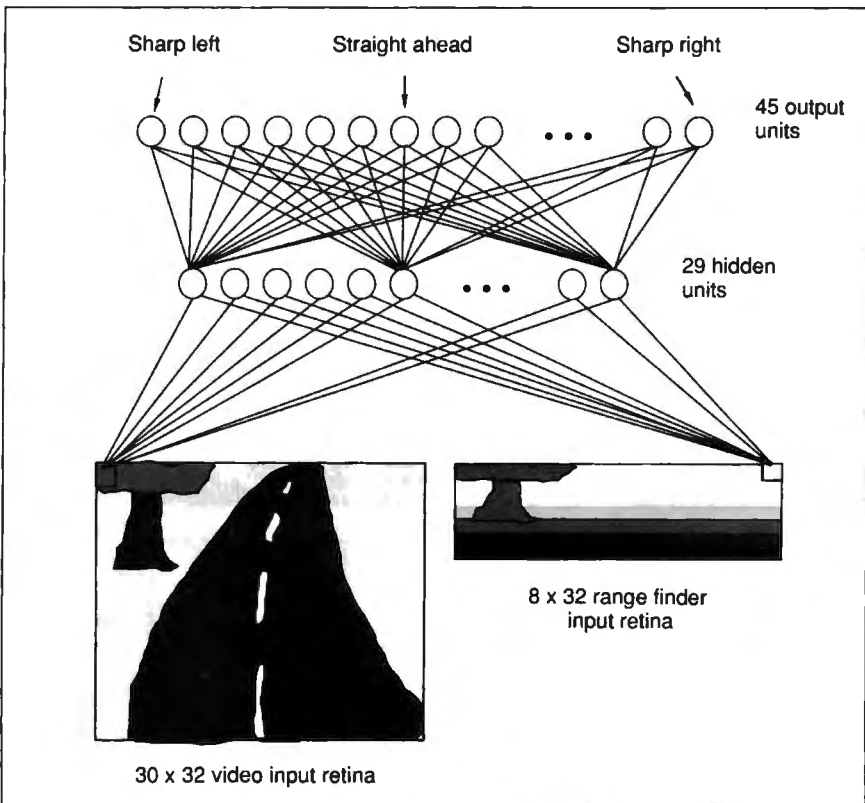

Figure 5: The architecture of ALVINN (autonomous land vehicle in a neural network).

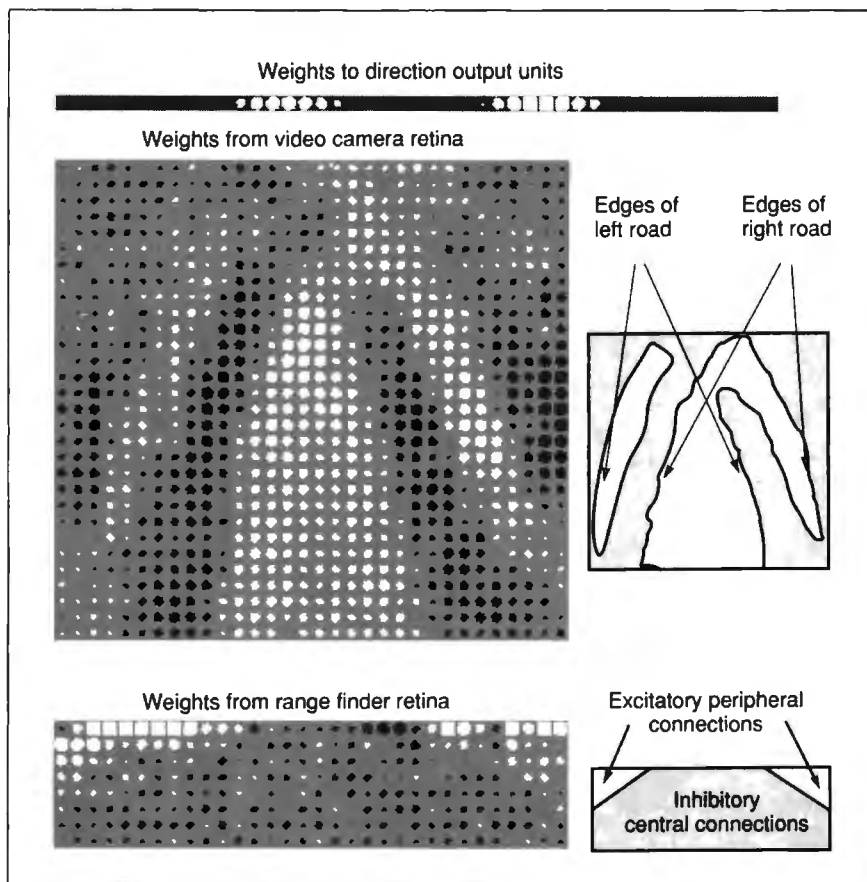

Figure 6: Pattern of weights projecting to and from a single ALVINN hidden unit after training on roads with a fixed width. This hidden unit acts as a filter for two types of road, one slightly to the left of center and one slightly to the right. The explanatory schematics on the right side of the figure highlight our interpretation of these weights.

and requires serious computing power, but you can implement the resulting network on a personal computer or workstation. We see this as a developing trend in neural computing: Training for real-world applications will be expensive, but delivery will be cheap. Analysis of networks through visualization is also easily done on personal workstations.

While we have removed some of the mystery concerning the representations that neural networks develop, the hidden layers have yet to give up all their secrets. One question still to be answered is how ALVINN accomplishes "sensor fusion," combining inputs from its video-camera and range finder retinas to arrive at the best steering direction. Experiments are under way to answer this. ■

REFERENCES

1. Lang, K. J., and M. J. Witbrock. "Learning to Tell Two Spirals Apart." In *Proceedings of the 1988 Connectionist Models Summer School*, D. S. Touretzky,

G. E. Hinton, and T. J. Sejnowski, eds. San Mateo, CA: Morgan Kaufmann Publishers, 1988.

2. Thorpe, C., M. Herbert, T. Kanade, S. Shafer, and the members of the Strategic Computing Vision Lab. "Vision and Navigation for the Carnegie Mellon NAVLAB." *Annual Review of Computer Science Vol. II*, Joseph Traub, ed. Palo Alto, CA: Annual Reviews, Inc., 1987.

3. Pomerleau, D. A. "ALVINN: An Autonomous Land Vehicle in a Neural Network." In *Advances in Neural Information Processing Systems I*, D. S. Touretzky, ed. San Mateo, CA: Morgan Kaufmann Publishers, 1989.

David S. Touretzky is a research computer scientist at Carnegie Mellon University in Pittsburgh, Pennsylvania. He has a Ph.D. in computer science from Carnegie Mellon. Dean A. Pomerleau is a doctoral student in computer science at Carnegie Mellon. They can be reached on BIX c/o "editors."

Rack & Desk PC/AT Chassis

Integrand's new Chassis/System is not another IBM mechanical and electrical clone. An entirely fresh packaging design approach has been taken using modular construction. At present, over 40 optional stock modules allow you to customize our standard chassis to nearly any requirement. Integrand offers high quality, advanced design hardware along with applications and technical support *all at prices competitive with imports*. Why settle for less?



Rack & Desk Models

Accepts PC, XT, AT Motherboards and Passive Backplanes

Doesn't Look Like IBM

Rugged, Modular Construction

Excellent Air Flow & Cooling

Optional Card Cage Fan

Designed to meet FCC

204 Watt Supply, UL Recognized

145W & 85W also available

Reasonably Priced

Now Available

Passive Backplanes



INTEGRAND
RESEARCH CORP.

Call or write for descriptive brochure and prices:
8620 Roosevelt Ave. • Visalia, CA 93291

209/651-1203

TELEX 5106012830 (INTEGRAND UD)

FAX 209/651-1353

We accept Bank Americard/VISA and MasterCard

IBM, PC, XT, AT trademarks of International Business Machines. Drives and computer boards not included.

WHETHER REPORT.

Whether you're a software developer writing new applications for the IBM or Mac, or a PC user securing proprietary data files, software and data protection has never had a brighter silver lining. For a number of very good reasons.

Beginning with the 'whether-expert' Rainbow Technologies. And ending with its Software Sentinel family of hardware keys. Starring five models that fit virtually any software program or data file you need to protect.

There's the best-selling SentinelPro for the IBM PC/XT/AT, PS/2 and compatibles, and even the Atari ST. Known worldwide for its virtually unbreakable security. And its ASIC technology. And its invisible operation. A close relation, the Sentinel-C stands at-the-ready for custom configurations and multiple software packages.

In the Apple market, security-minded Mac software developers turn to Eve. For completely transparent operation and world-class security of the protected software. Just by plugging Eve into the Mac ADB connector.

PC users wanting a low cost, user-friendly solution to the problem of securing sensitive data can call on the DataSentry. Using a proprietary Rainbow algorithm or DES, the DataSentry encrypts data files on individual PCs, protects modem transmissions and secures data on local area networks.

Rainbow's latest protection strategy is the SentinelShell—that lets users place a 'shell' around existing, off-the-shelf programs. Because access can be limited to those issued a key, libraries, universities and corporations can very simply guard their software investments.

Whatever your whether, Rainbow Technologies has the software and data protection products that make the difference. For more information, call 714-261-0228 in the U.S., or contact Rainbow Technologies Ltd. in the United Kingdom for the distributor nearest you. Whethercasters are standing by.

SentinelPro™

- Runs under DOS, OS/2 and Xenix
- Algorithm technique (Never a fixed response)
- External parallel port installation
- Minimal implementation effort
- Higher level language interfaces included
- 100 times faster than fixed-response devices (1 ms)
- ASIC design for reliability



Sentinel-C™

- Protects multiple packages with one device
- 126 bytes of non-volatile memory programmed before shipment of the software
- Rainbow supplies a unique adapter for programming the unit
- Higher level language interfaces included
- Runs under DOS, OS/2 and Xenix
- External parallel port installation



Eve™

- For the Macintosh SE and II
- Complies with Apple Desktop Bus Interface requirements
- Rainbow-assigned developer passwords to prevent tampering by other developers or sophisticated "hackers"
- 7 locks per key, usable individually or in combination, on one or up to seven applications



DataSentry™

- Completely user-installable
- Pocket-sized external device
- Menu-driven, user-friendly interface
- Single- or multi-user security system
- Audit trail, log-on identifiers and automatic encryption/decryption of entire directories
- Secures data transmitted by modems
- Prevents recovery of data by utility programs



SentinelShell™

- Runs under DOS on IBM PCs and compatibles
- Protects without requiring access to the source code
- Completely transparent to the end user
- User-friendly software
- Pocket-size key attaches quickly to any standard PC parallel port
- ASIC design for reliability



RAINBOW TECHNOLOGIES

18011-A Mitchell South, Irvine, CA 92714 • (714) 261-0228 • TELEX: 386078 • FAX: (714) 261-0260
Rainbow Technologies, Ltd., Shirley Lodge, 470 London Rd., Slough, Berkshire, SL3 8QY, U.K., Tel: 0753-41512, Fax: 0753-43610

© 1989 Rainbow Technologies. All product names are trademarks of their respective manufacturers.

Building Blocks for Speech

*Modular neural networks are a new approach
to high-performance speech recognition*

Alex Waibel and John Hampshire

Some speech-recognition abilities that we take for granted—understanding a conversation involving several different speakers over lots of extraneous noise, for instance—are still beyond the reach of even the most powerful supercomputer. This may seem strange, since the human brain can't hope to match the arithmetical performance of a pocket calculator, but it does indicate the complexity of automatic speech recognition. Modular neural networks, however, might hold the key to achieving rapid and more-reliable machine-based speech recognition.

We recognize speech by applying an enormous body of knowledge to rapidly interpret the audio signals from the world around us. This knowledge ranges from low-level acoustic features to high-level facts about the world and the speaker's intent. These features and facts are heavily interrelated. No piece of the speech-recognition puzzle can be considered by itself, nor can pieces be evaluated sequentially. Rather, each provides a constraint that, together with many other facts and constraints, forms a total picture.



Neural Nets in Speech Recognition

The limited ability of current computer models to absorb and apply a large body of facts restricts efforts to achieve automatic recognition of human speech. Effective models must determine, maintain, and program all necessary facts and rules of speech into a system. They must then integrate the massive number of interrelationships between these facts and

rules to rapidly interpret the spoken word. If speech-recognition systems could learn important speech knowledge automatically and represent this knowledge in a parallel distributed fashion for rapid evaluation, they would then be able to overcome the deficiencies of current systems. Such a system would mimic the functions of the human brain, which consists of several billion simple, inaccurate, and slow processors that perform reliable speech recognition.

The development of parallel distributed processing (PDP) or neural-network models and the development of automatic learning algorithms (see reference 1) are two very important steps in the development of reliable speech-recognition systems.

You can implement algorithms that simulate PDP learning models on anything from a microcomputer to a supercomputer (see reference 2). These algorithms are even available commercially.

Two major problems have to be addressed, however, before neural-network models become useful for speech recognition: time and scaling.

continued

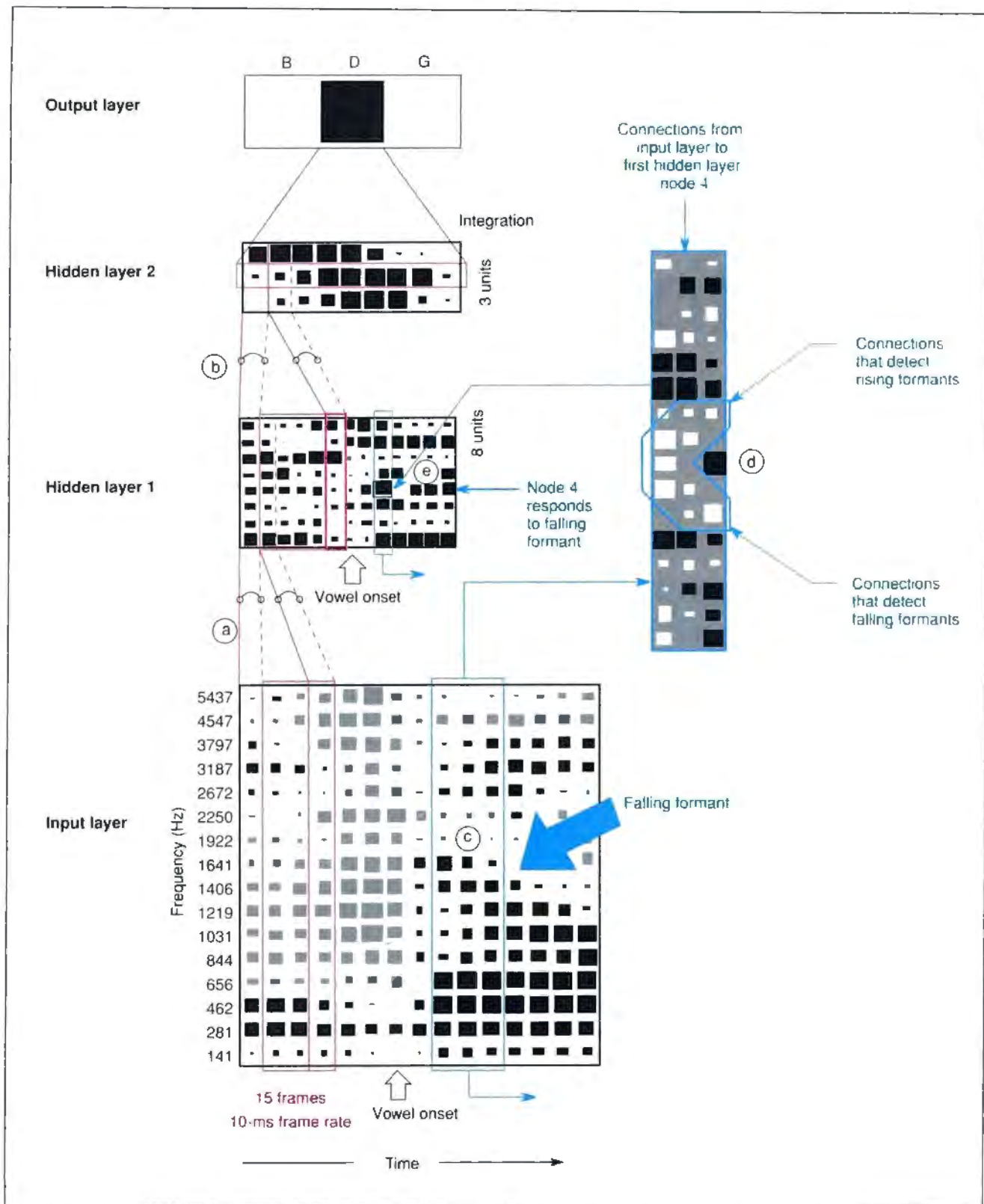

Figure 1: The left side (in red) shows the time-delay feature of the network. Three 10-millisecond input slices are combined to create activations in the first hidden layer (a). Activations in the second hidden layer (b) are created by combining five slices from the first hidden layer. The right side (in blue) shows the connections from the input layer to node 4 of the first hidden layer. When an input (c) matches the pattern of the connections (d), the node is activated strongly (e).

Speech and Time

Speech is a dynamic signal, and a speech-recognition system must be able to classify sounds without knowing when a particular sound will occur. It must also be able to capture the time-varying properties—the *signature*—of speech in feature space rather than simply taking static “snapshots” of the signal. These requirements are addressed by the Time-Delay Neural Network (TDNN) (see reference 3).

Rather than trying to decide whether a particular sound is, for example, a letter *b* (the speech signal may not contain useful information at certain points in time), the TDNN scans the input for clues that provide the evidence it needs to construct an overall recognition decision. Using this method, the TDNN has demonstrated performance superior to that of other speech-recognition models in small but difficult recognition tasks.

The TDNN shown in figure 1a is designed to discriminate the voice-stop consonants *b*, *d*, and *g* as they occur in a large database of isolated spoken words. At the output, three units represent each of the three *phoneme* categories. (Phonemes are the unique sounds of a spoken language; they form the acoustic-phonetic building blocks of speech.) The input layer of the network consists of 15 time slices of speech. Each one of these time slices is a frequency spectrum representing 10 milliseconds of the speech waveform—a 10-ms voiceprint of the speaker. Each spectrum, in turn, consists of 16 coefficients representing frequencies ranging from the lower limit of hearing (about 20 Hz) to over 5 kHz.

In many neural networks, each node in a given layer is connected to all the nodes in the next layer. This is not the case, however, for the TDNN. The reasons for this are related to the temporal complexity of human speech.

Windows to the Spoken Word

Rapid changes in human speech occur over several tens of milliseconds. Therefore, a 30-ms “window” of speech (or an overlapping series of such windows) can capture the local acoustic-phonetic events that act as identifying features of a particular phoneme. The TDNN groups three 10-ms time slices from the input layer into a 30-ms window. Each coefficient in this window connects to eight nodes in the first hidden layer of the TDNN. Each of these nodes forms a condensed feature representing important cues that the network looks for in the input. The network shifts the window one time slice at a time across the input (a

range of 150 ms of speech), creating 13 distinct firings at the eight nodes of the first hidden layer.

The grouping scheme in the first hidden layer and its connections to the second hidden layer are analogous to the input layer’s groupings and connections to the first hidden layer. The firing patterns of the eight nodes in the first hidden layer over a five-time-slice window form the

The TDNN
has learned—without
any supervision—
the importance of
rising and falling
formant transitions in
discriminating between
similar sounds.

input to each of three nodes in the second hidden layer. As this window sweeps over the activation patterns in hidden layer 1, it generates activations at the three nodes in hidden layer 2. These form preliminary votes for one of the output’s three phoneme categories.

Because their weights are fixed across time shifts, the connections between the layers allow the network to find key features of the speech waveform despite the fact that these features may be spread across time or shifted along the time axis. Figure 1a illustrates the activation of a TDNN when given the voiced consonant *d* in the syllable *do*. In this figure, negative node activations in the input layer are gray, and positive node activations throughout the network are black. The degree of node activation is proportional to the size of the rectangle depicting a given node.

In figure 1c, connections from the input-layer window to node 4 of the first hidden-layer time slice are shown to the side of the TDNN. (Unlike activations, positive connections are white and negative connections are black; the background is gray.) The activation level of node 4 in the first hidden layer at a given time slice is obtained by taking the activation of each of the 48 nodes in the input

layer window, multiplying this node activation by the strength of its connection to node 4, and adding up these 48 products. This sum forms the input to node 4, which uses a thresholding (or “squashing”) function to produce the output activation shown.

Note that the connections from the input layer to node 4 of the first hidden layer are positive for midrange frequencies in the input that rise or fall over time. The positive (white) connections that slope downward over time provide a strong input stimulus to node 4 when they detect a downward-sloping spectrum over time in the input layer. The arrow in figure 3 marks the onset of the *ü* sound in *do*. Beginning at this point, the nodes in the input layer corresponding to frequencies from 800 Hz to 1600 Hz show the downward-sloping activation pattern over time indicative of a *falling formant*. (A formant is a quality of sound representative of vowels.) This results in a strong firing of node 4 in the first hidden layer.

Falling midrange frequencies are characteristic of the utterance *do* shown in figure 1c. There is a great deal of experimental evidence showing that humans rely heavily on the perception of this acoustic event (a *formant transition*) for accurate speech recognition. The positive connections in the figure that slope upward over time detect rising formant transitions, which are also vital to understanding human speech. Clearly, the TDNN has learned—without any explicit supervision—the importance of both rising and falling formant transitions for accurate discrimination of the *b*, *d*, and *g* phonemes.

Because the TDNN scans across the input speech signal, it is relatively insensitive to the timing of vowel onset for the voice stops *b*, *d*, and *g*. A version of the same utterance shown in figure 1c shifted forward in time results in the same strong output activation indicating the detection of the *d* phoneme. The advance of vowel onset merely causes the hidden units to fire earlier, in synchrony with events in the input. The combined accumulated evidence from these firings still allows the network to recognize the utterance as a *d*, as opposed to a *b* or a *g*.

The TDNN has been experimentally evaluated on a number of small phonemic discrimination tasks and has achieved excellent recognition performance. The voiced consonants *b*, *d*, and *g*, for example, can be detected in more than 98 percent of the trials with a TDNN trained on data from a single

continued

speaker and tested on different data obtained from the same speaker.

Modular Training

The second problem for practical neural-network-based systems is scaling. Since neural networks depend on computationally intensive learning algorithms and simulations of large parallel networks, they are difficult to extend to large systems and to run on commonly accessible computing facilities such as microcomputers and personal workstations. It is extremely important, therefore, that the construction of large systems take place incrementally, without requiring repeti-

tive retraining of ever-larger structures every time the task size increases.

In examining problems of scale, it is important to note that neural networks are made up of extremely simple computing elements that can be simulated easily in real time on most personal computers and workstations. Moreover, since such a system is completely specified by its connections and its weights, it is easily portable and can run on any machine. In our own implementation, a simple generic program has to simply load a set of weights and a wiring table to run an entirely different system.

A much more serious computational

limitation of neural-network-based systems arises during training. Here, you must execute many recognition passes over many training patterns to gradually modify the network's weights and achieve a satisfactory output response. Depending on the network's size and the number of training tokens, you might have to devote significant computational resources to training.

This is acceptable in many cases, since learning can frequently be done off-line over several days and weeks while recognition must be fast and efficient. Nevertheless, cost-effective system development requires that you be able to create flexible and effective designs using commonly available resources. Luckily, you can create such designs using modular-network training techniques without incurring a performance penalty.

To recognize continuous speech from any speaker, you need neural networks that are orders of magnitude more complex than the single three-output TDNN. Training such a network from scratch to recognize all phonemes in continuous speech is a daunting task.

An alternative method would exploit the knowledge developed by smaller, independently trained networks by incorporating these smaller network modules into large superstructures. This modular approach could not only reduce training time but also lead to a more incremental and distributed design approach to the construction of large-scale, efficient connectionist systems.

Figure 2 shows one promising approach to such a modular design. Here, two networks are trained independently: one to perform *b, d, and g* discrimination, and the other to discriminate *p, t, and k*. The features learned by the hidden units in layer 1 of each network are the useful representations of speech that you want to retain for the training of a larger *b-d-g/p-t-k* supernetwork.

Combining the two networks, you get a modular network that consists of a common input layer linked to task-specific first hidden layers. The connection strengths are obtained from the individual *b-d-g* and *p-t-k* networks. These first hidden-layer modules are then linked to a common second hidden layer, and from there to the output layer.

The training for this network occurs in two phases. First, the two TDNNs are trained individually for best performance on their subtasks. Then, the higher-layer connections of the modules are trained collectively to integrate the individual modules into the combined

continued

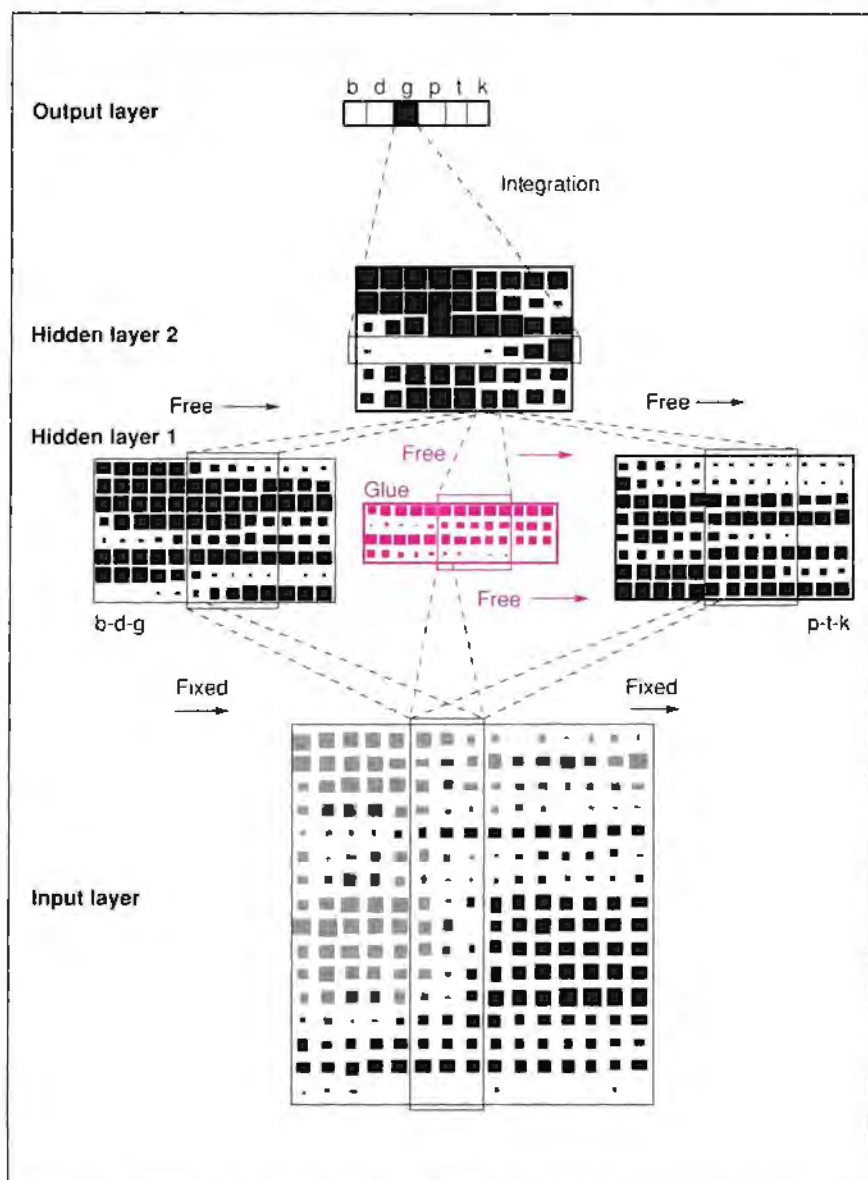

Figure 2: To form a modular network, you combine independently trained first hidden layers with a common second hidden layer. For greater accuracy, you can also provide free units (shown in red) for the combined first hidden layer.

Whose ad is this, anyway?

That's a very good question.

Because, instead of being an ad for the 20 very different companies you see here, it's actually an ad for the one industry standard that makes them very much alike.

The PostScript® language from Adobe Systems.

Choose a printer or typesetter from one of these companies and you can make the choice for PostScript. Because each of these manufacturers has licensed Adobe's page description language.

Why did they do it?

For one thing, PostScript delivers the ultimate in output quality and

capability. Whether you're printing simple text for everyday correspondence or complex graphics for electronic publishing, PostScript makes it easy.

PostScript also gives you absolute freedom to select the best hardware and more than 4,000 software programs for your needs and budget.

That's called compatibility and Adobe PostScript guarantees it.

So, even though different PostScript printers and typesetters offer different resolutions, paper handling options and output speeds, you can be sure they all work together.



Because they all speak the same language. The language of PostScript.

Now, aren't you glad you asked?



This ad is presented by Adobe Systems Incorporated, which encourages you to look for the PostScript symbol on computers, printers and other products that support PostScript software from Adobe Systems. It is your guarantee of quality and compatibility. Adobe, PostScript and the PostScript logo are registered trademarks of Adobe Systems Incorporated in the U.S.A. The logos of the original equipment manufacturers supporting PostScript are the trademarks or registered trademarks of their respective companies. © 1989 Adobe Systems Incorporated. All rights reserved.

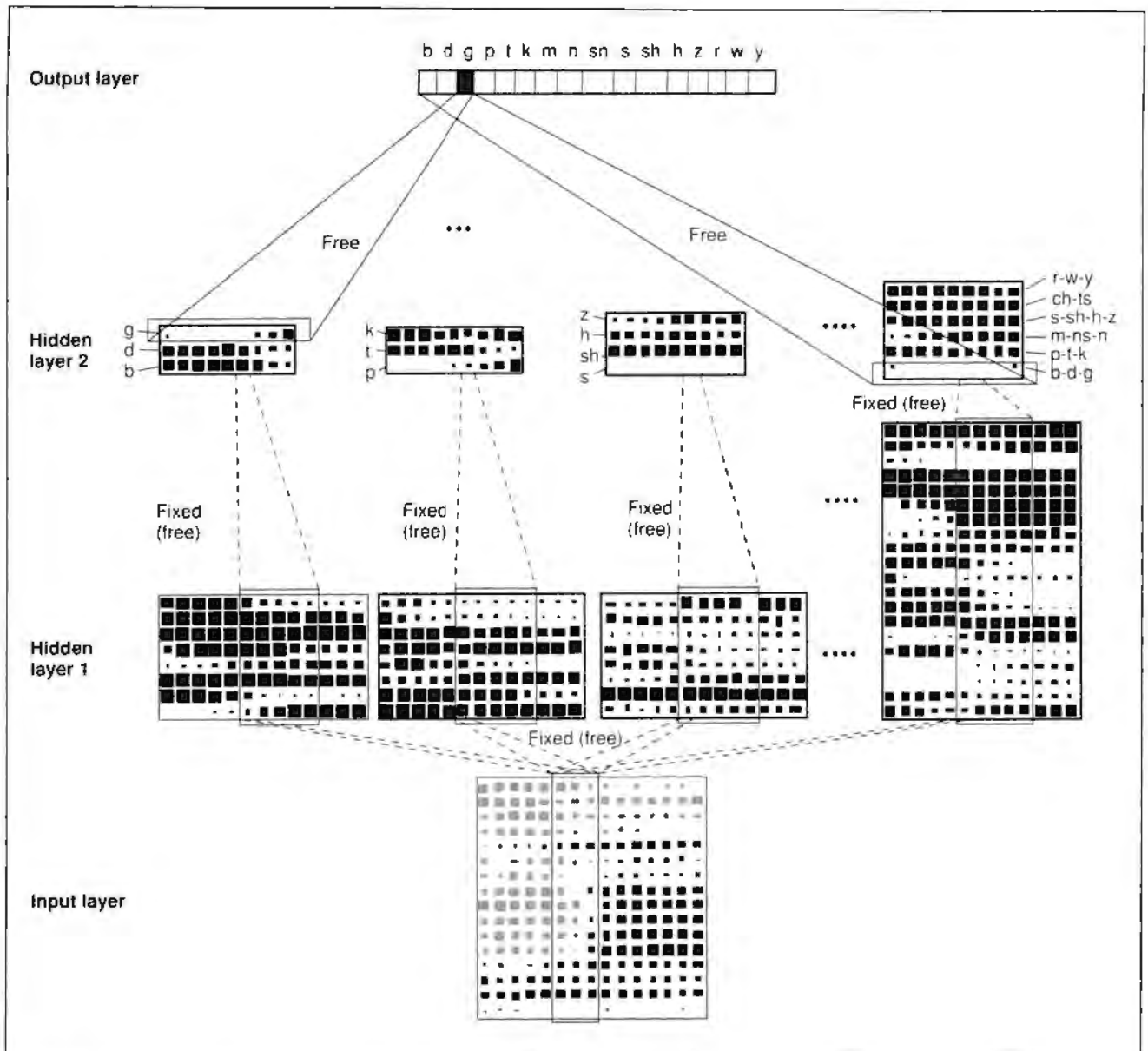

Figure 3: Modular construction of an all-consonant network.

network. This modular network achieves a single-speaker recognition rate of 98.1 percent for the *b-d-g/p-t-k* task.

To enhance performance, you can augment the modular architecture with four additional "free" units, which we call *connectionist glue* (see figure 2). These units glue together two previously disjointed networks. During the second phase of training, these glue units supplement the pretrained *b-d-g* and *p-t-k* units in hidden layer 1 by extracting any additional useful features from the input. With this network, we have achieved a single-speaker *b-d-g/p-t-k* recognition rate of 98.6 percent. Thus, this network performs as well as or better than the in-

dependently trained networks do separately. It also performs at least as well as a monolithic network that was trained for the task from scratch.

Expanding the Network

Figure 3 shows a larger modular network built to recognize all the consonants of a single speaker. Like the one in figure 2, this network has individual TDNNs trained in subcategories of the consonant set. These modules are then linked to a module that recognizes the subcategory of the input. The extra features in this module tend to assimilate the features developed in the consonant modules.

Training this network occurs in three

phases. As before, the first phase involves training each module for best performance in its subtasks. In the second phase, the connections from the second hidden layer to the output are trained collectively. In the final phase, all connections of the network are trained in unison for a few learning iterations to fine-tune the global network's recognition performance. This sort of training is significantly faster than training a huge network from scratch. Working in parallel, the modules form a distributed representation of the speech signal that can achieve a recognition rate of 96 percent for the consonants of a single speaker.

continued

An offer from CDP for PC users who have always wanted to try CD-ROM, but never had the drive.

For a limited time, we're offering a special NEC CD-ROM/Microsoft software package that lets you take this exciting new technology out for a spin—at a price that even the most prudent PC user will find affordable.

This one-of-a-kind package includes:

- Your choice of NEC CD-ROM drives—Choose from a NEC internal or stand-alone unit.
- *Microsoft Bookshelf*—A comprehensive collection of 10 renowned reference works for writers on one disk. **PLUS** you'll receive a coupon to purchase *Microsoft's Stat Pack* and *Small Business Consultant* bundled—for only \$100.

All for over \$700 off the regular retail price!

"I believe more than ever that CD-ROM products will be a major force in the expansion of the information industry..."

Bill Gates, Chairman, Microsoft

When you use CD-ROM with your PC you'll be able to access—and speed through—more information than you ever dreamed possible. What's more:

- A single 4.72" CD is capable of holding up to 1,500 floppy disks (or 250,000 text pages).

- CD-ROM is compatible with existing IBM PC/XT/AT/386 and PS2 computers.

- Information encoded on a CD is virtually indestructible.

Inexperienced users can't harm data.

- And most importantly, CD-ROM is growing! Over 25 new titles are being published every month!

A unique offer from CDP—the largest specialized supplier of CD-ROM products in the U.S.

CDP (Compact Disk Products, Inc.) distributes a complete range of CD-ROM, WORM and Erasable optical memory drives and software. For over two years, we've provided our customers with prompt service...expert advice...and the most competitive prices possible. Most importantly, we've established a commitment to bringing this exciting, new technology to PC users like you. There's no better time than right now to get in on CD-ROM. Here's what you'll get when you take advantage of our special offer:

- **NEC CD-ROM Drive**—Your unit comes complete with an interface card for PC/XT/AT/386 compatibles (specify if you require a PS2 Microchannel card), connection cable, MS-DOS Extensions and Instructions. Choose from the NEC CDR-77 stand-alone unit, or CDR-80—an easy-to-install, half-height internal drive.

- **Microsoft Bookshelf**—A comprehensive reference collection for writers on a single disk including: *The World Almanac*, *Chicago Manual of Style*, *Bartlett's Familiar Quotations*, *Roger's II: Electronic Thesaurus*, *American Heritage Dictionary*, *Business Information Sources*, *The U.S. Zip Code Directory*, *Houghton Mifflin Spell Checker and Usage Alert*, and *Forms and Letters*. **PLUS** you'll receive a coupon allowing you to purchase the two following programs bundled for only \$100!

- **Microsoft Stat Pack**—Databases on this disk include Statistical Abstracts, Area Wage Surveys, Business Statistics, agricultural and land management statistics from the federal government, plus Microsoft Excel and Lotus 1-2-3 Spreadsheet files for each statistical table.

- **Microsoft Small Business Consultant**—The most popular publications of the Small Business Administration and the accounting firm of Deloitte, Haskins & Sells on running a small business. Find tips on writing a business plan, obtaining credit, personnel issues, import-export regulations, and more.

- In addition, you can order **Microsoft Programmer's Library**. Over 15,000 pages of Microsoft's technical reference manuals, covering OS/2, Windows, MS-DOS, C, Basic, MASM, Pascal Fortran and assorted hardware products.

Place your order now and receive these free gifts. Order your NEC/Microsoft package from CDP now and receive:

- A free subscription to CD-ROM *End User* magazine.

- A free CD-ROM quartz clock—valued at \$24.95 (clock offer available for mailed or faxed orders, only) Note: Free gift offer limited to first 500 orders.

TO ORDER, CALL TOLL-FREE:
1-800-MEGABYTE (1-800-634-2298),

FAX YOUR ORDER TO
(212) 737-8289, OR RETURN THE COUPON TO:

Compact Disk Products, Inc.
223 East 85th Street
New York, New York 10028
(For inquiries, call
(212) 737-8400.)



GUARANTEE

- 1) If you are unable to install a NEC drive purchased from CDP in your computer system within 30 days of receipt, we will issue you a complete refund, including shipping.
- 2) If, by June 30, 1991, you believe the NEC drive you receive is incompatible with prevailing CD-ROM technology, we will provide you with a new, compatible drive at 50% of the listed retail price of the new drive.
- 3) All hardware is backed by a full 90-day manufacturer's warranty. If you receive a defective unit, CDP will replace it at any time during the warranty period.



Please send the package I've checked below.

Microsoft Package "A"—Complete CD-ROM drive kit (internal or external) plus *Bookshelf* (includes a coupon to purchase *Stat Pack/Small Business Consultant* bundle for \$100) for only \$895!

Microsoft Package "B"—Complete CD-ROM drive kit (internal or external) plus *Bookshelf* and *Programmer's Library* (includes a coupon to purchase *Stat Pack/Small Business Consultant* bundle for \$100) for only \$1189!

Please send the following drive configuration with my order:

Stand-alone Internal

NEC CDR-77 Stand-alone drive, select PC/XT/AT/386
 Microchannel

(NEC CDR-80 Internal drive for PC/XT/AT/386 only)

Circle 57 on Reader Service Card

Please send me a free catalog of all your products.

Corporate / personal check / money order enclosed
Charge my (circle one) American Express Optima VISA
MasterCard Diner's Club

Acct. # _____ exp. date _____

Signature _____

Name _____

Company _____

Address _____

City/State/Zip _____

Phone _____

Prices include shipping and handling. New York residents add 8.25% sales tax.

Accelerated Learning

Coincident with the development of modular design techniques, recent advances in neural-network learning strategies and hardware and software implementations have led to dramatic improvements in

What
seemed impossible
a short time ago
will soon be done on
a personal computer.

network processing speeds. Learning speeds are also accelerating. These can be increased by improving the metrics that a network uses to measure how well it classifies training data.

Speed can also be increased significantly by improving the numerical search techniques that form the basis of network learning. Research in this area has resulted in learning procedures that converge to near-optimal results much more rapidly than before (see references 4, 5, and 6). Indeed, improvements in learning algorithms have brought the training time for a typical TDNN task down from three days of run time on a supercomputer to 8 minutes of CPU time

on a high-end engineering workstation.

High-speed computing capabilities for neural-network training are becoming more accessible to personal computer and workstation users. Several manufacturers now offer plug-in floating-point accelerator boards for microcomputers that yield speeds of more than one million floating-point operations per second, while workstation manufacturers are producing desktop machines that rival super-minicomputers produced just a few years ago. Massively parallel connectionist hardware designs are also under development in various laboratories (see reference 7).

Speech recognition using modular neural networks is progressing rapidly. What seemed impossible a short time ago will soon be done on a personal computer. Advances in system-design techniques, learning software, and underlying hardware are creating the computing power required for very-large-scale neural-network tasks. All these advances bring connectionist design for speech and signal interpretation within reach of commonly available and affordable technology. ■

REFERENCES

1. Rumelhart, D., J. McClelland, and the PDP Research Group. *Parallel Distributed Processing*, vols. 1 and 2. Cambridge, MA: MIT Press, 1987.
2. McClelland, J., and D. Rumelhart. *Explorations in Parallel Distributed Processing*. Cambridge, MA: MIT Press, 1988.
3. Waibel, A., T. Hanazawa, G. Hinton, K. Shikano, and K. Lang. "Phoneme Recognition Using Time-Delay Neural Networks." *IEEE Transactions on Acoustics Speech and Signal Processing*, vol. ASSP-37, March 1989.

4. Fahlman, S. "An Empirical Study of Learning Speed in Back-Propagation Networks." *CMU Technical Report CMU-CS-88-162*, June 1988.

5. Haffner, P., A. Waibel, H. Sawai, and K. Shikano. "Fast Back-Propagation Learning Methods for Neural Networks in Speech." *ATR Interpreting Telephony Research Laboratories Technical Report*, TR-1-0058, 1988.

6. Watrous, R. "Speech Recognition Using Connectionist Networks." TR-MS-CIS-88-96, Dept. of Computer and Information Science, University of Pennsylvania, 1988.

7. Alspector, J. "Research results in VLSI implementations of neural networks." Speech presented at the 1988 Conference of the Acoustical Society of Japan.

ACKNOWLEDGMENT

We gratefully acknowledge K. Lang, G. Hinton, K. Shikano, T. Hanazawa, H. Sawai, and P. Haffner for their significant contributions, and ATR Interpreting Telephony Research Laboratories, Bell Communications Research, and the National Science Foundation for supporting this research.

Alex Waibel holds a Ph.D. in computer science from Carnegie Mellon University, where he is a research computer scientist. John Hampshire is a Ph.D. candidate at Carnegie Mellon in electrical and computer engineering. The authors can be reached on BIX c/o "editors."

Neural Networks are Solving Real Problems

Here's What NeuroShell Users are Doing:

Circuit board problem diagnosis • Psychiatric evaluations • Stock market predictions • Sales forecasts • Oil exploration • Optimizing biological experiment results • Price forecasts • Analysis of medical tests • Optimizing scheduled machine maintenance • Predicting student performance • Horse racing picks • Factory and shop problem analysis • Optimizing raw material orders • Spectral analysis • Selection of criminal investigation targets • Employee selection • Process control • and much, much more.

Since NeuroShell learns by example, handles fuzzy logic, can give tight data fits, and doesn't try to capture knowledge in rules, it is also being used as an alternative in many cases to expert systems, the ID3 algorithm, and regression analysis.

NeuroShell is ready to use for real problems on your IBM PC or compatible, and still only \$195. Math coprocessor recommended. No programming or Ph.D. required! Shipping free by mail in US, Canada, and Mexico (\$9 elsewhere). Add 5% tax in MD.



Ward Systems Group, Inc.

228 West Patrick St. / Frederick, MD 21701
TEL (301) 662-7950 FAX (301) 663-6656

NeuroShell™

Taking AI Beyond the Expert System™

NeuroShell is a trademark of Ward Systems Group, Inc. IBM PC is a registered trademark of International Business Machines

Over 1,500,000 Sold!!

Make a Great Impression

How do you make a great impression in an industry where everything is so impressive? We made it with the Graphics Solution, a multi-purpose Monochrome-Color Graphics Card. Displaying Color Graphics, Games or the latest Software Applications on either Monochrome or RGB monitors are not the only features of the Graphics Solution. It's ease of use



which has made this card so attractive to hundreds of thousands of Computer users. The ability to display spreadsheets and word-processing in the wide screen format of 132 columns is another of its many impressive features. Uncomplicated and dependable, just what

you're looking for? Check it out; even the price will impress you.

Available at all leading Computer dealers.

\$99.00

Suggested List Price

Circle 26 on Reader Service Card



TECHNOLOGIES INC.

Technology you can Trust.

ATi Technologies Inc.
3761 Victoria Park Ave.
Scarborough, Ontario, Canada
M1W 3S2
Tel. (416) 756-0711

Telex 06-906640
Fax (416) 756-0720

NEW

Graphics Solution™

Neural Networks: Theory and Practice

For most of their existence, neural networks and neural-network simulations have been solely objects of university-based research. In the last few years, however, researchers and others have founded companies dedicated to producing commercial products based on neural-network technology. To reflect both the academic and commercial aspects of the technology, this resource guide consists of two parts. The In Theory section lists books and articles you can read to learn more about neural networks. The In Practice section lists some of the available neural-network hardware and software products, listed alphabetically by company name.

IN THEORY

- Anderson, J. A., M. T. Gately, P. A. Penz, and D. R. Collins. "Radar Signal Categorization Using a Neural Network." *Neural Networks*, 1 Supp. 1, 1988.
- Anderson, J. A., and E. Rosenfeld, eds. *Neurocomputing: Foundations of Research*. Cambridge, MA: MIT Press, 1988.
- Anderson, J. A., J. W. Silverstein, S. A. Ritz, and R. S. Jones. "Distinctive Features, Categorical Perception, and Probability Learning: Some Applications of a Neural Model." *Psychological Review*, vol. 84, 1977.
- Brugge, J. F., and R. A. Reale. "Auditory Cortex." In A. Peters and E. G. Jones, *Cerebral Cortex*. Vol. 4, *Association and Auditory Cortices*. New York, NY: Plenum Press, 1985.
- Davis, P. J., and J. A. Anderson. "Non-analytic Aspects of Mathematics and Their Implication for Research and Education." *SIAM Review*, vol. 21, 1979.
- Hadamard, J. *Psychology of Invention in the Mathematical Field*. New York, NY: Dover, 1945.
- Hinton, G. E., and J. A. Anderson, eds. *Parallel Models of Associative Memory*, rev. ed. Hillsdale, NJ: Lawrence Erlbaum Associates, 1989.
- Jones, W. P., and J. Hoskins. "Back-Propagation." *BYTE*, October 1987.
- Josin, G. "Neural Network Heuristics." *BYTE*, October 1987.
- Knapp, A., and J. A. Anderson. "A Theory of Categorization Based on Distributed Memory Storage." *Journal of Experimental Psychology: Learning, Memory and Cognition*, vol. 9, 1984.
- Knudsen, E. I., S. du Lac, and S. D. Esterly. "Computational Maps in the Brain." *Annual Review of Neuroscience*, Volume 10. Palo Alto, CA: Annual Reviews, 1987.
- Kohonen, T. *Associative Memory*. Berlin: Springer-Verlag, 1977.
- Kohonen, T. *Self-Organization and Associative Memory*. Berlin: Springer-Verlag, 1987.
- Kosko, B. "Constructing an Associative Memory." *BYTE*, September 1987.
- Lang, K. J., and M. J. Witbrock. "Learning to Tell Two Spirals Apart." In *Proceedings of the 1988 Connectionist Models Summer School*, D. S. Touretzky, G. E. Hinton, and T. J. Sejnowski, eds. San Mateo, CA: Morgan Kaufmann Publishers, 1988.
- Lippmann, R. "An Introduction to Computing with Neural Nets." *IEEE ASSP Magazine*, vol. 4, April 1987.
- McClelland, J. L., and D. E. Rumelhart, eds. *Parallel Distributed Processing: Explorations in the Microstructure of Cognition*, vols. 1 and 2. Cambridge, MA: MIT Press, 1986.
- McClelland, J. L., and D. E. Rumelhart. *Explorations in Parallel Distributed Processing: A Handbook of Models, Programs and Exercises*. Cambridge, MA: MIT Press, 1988.
- McCulloch, W. S. *Embodiments of Mind*. Cambridge, MA: MIT Press, 1988.
- Mead, C. *Analog VLSI and Neural Systems*. Reading, MA: Addison-Wesley, 1988.
- Minsky, M., and S. Papert. *Perceptrons*. Cambridge, MA: MIT Press, 1969 and 1988.
- O'Shaughnessy, D. *Speech Communications*. Reading, MA: Addison-Wesley, 1986.
- Pomerleau, D. A. "ALVINN: An Autonomous Land Vehicle in a Neural Network." In *Advances in Neural Information Processing Systems I*, D. S. Touretzky, ed. San Mateo, CA: Morgan Kaufmann Publishers, 1989.
- Rabiner, L. R., and R. W. Schafer. *Digital Processing of Speech Signals*. Englewood Cliffs, NJ: Prentice-Hall, 1978.
- Thorpe, C., M. Herbert, T. Kanade, S. Shafer, and the members of the Strategic Computing Vision Lab. "Vision and Navigation for the Carnegie-Mellon NAVLAB." *Annual Review of Computer Science, Volume II*, Joseph Traub, ed. Palo Alto, CA: Annual Reviews, Inc., 1987.
- Viscuso, S. R., J. A. Anderson, and K. T. Spoehr. "Representing Simple Arithmetic in Neural Networks." In *Advanced Cognitive Science: Theory and Applications*, G. Tiberghien, ed. London: Horwoods, 1989.
- Waibel, A. "Modular Construction of Time Delay Neural Networks for Speech Recognition." *Neural Computation*, vol. 1, March 1989.
- Waibel, A., H. Sawai, and K. Shikano. "Modularity and Scaling for Phonemic Neural Networks." In *IEEE Transactions on Acoustics Speech and Signal Processing* (in press).
- Wasserman, P. *Neural Computing, Theory and Practice*. New York, NY: Van Nostrand Reinhold, 1989.

IN PRACTICE

- The Brain Simulator** \$99
Runs under MS-DOS
Tutorial software for neural circuit design
Abbot, Foster & Hauserman
44 Montgomery, Fifth Floor
San Francisco, CA 94014
(800) 562-0025
(415) 955-2711
Inquiry 1181.
- N-NET**
MS-DOS version \$895
VAX/VMS version starting at \$2995
Integrated neural-network development system; uses functional link net architecture
AI Ware, Inc.
11000 Cedar Ave., Suite 212
Cleveland, OH 44106
(216) 421-2380
Inquiry 1182.
- BrainMaker** \$99.95
Runs under MS-DOS
Neural-network simulation software; supports five types of nodes and can process up 500,000 connections per second
California Scientific Software
160 East Montecito, Suite E
Sierra Madre, CA 91204
(818) 355-1094
Inquiry 1183.
- Cognitron**
MS-DOS Windows and Mac versions \$600
INMOS transputer version \$1800
Neural-network/parallel-processing prototyping and delivery system
Cognitive Software, Inc.
703 East 30th St.
Indianapolis, IN 46205
(317) 924-9988
Inquiry 1184.
- Connections** \$87.95
Runs under MS-DOS
A traveling-salesman demo modeled after Hopfield networks

NetWurkz \$79.95
Runs under MS-DOS
Elementary introduction to neural networks
 DAIR Computer Systems
 3440 Kenneth Dr.
 Palo Alto, CA 94303
 (415) 494-7081
Inquiry 1185.

Savvy Text Retrieval System
Savvy Signal Recognition System
Savvy Vision Recognition System
 (Call for pricing)
Run under VAX/VMS, MS-DOS, and Unix
Libraries of C subroutines that use neural technology to solve real-world problems
 Excalibur Technologies
 2300 Buena Vista SE
 Albuquerque, NM 87106
 (505) 764-0081
Inquiry 1186.

ANZA from \$7000
AT-compatible neural-network coprocessors; includes software and programming interface

ANZA Plus from \$12,500
AT-compatible neural-network coprocessors

ANZA Plus/VME \$24,950
Neural-network coprocessor for Sun workstations

AXON \$1950
A neural-network description language

Neural Network Development Toolkit \$3950

For ANZA Plus and ANZA Plus/VME systems
Ports C programs into ANZA Plus and ANZA Plus/VME formats; includes AXON

ExploreNet
 MS-DOS version \$995
 Sun version \$3950

Stand-alone neural-network software

HNC, Inc.
 5501 Oberlin Dr.
 San Diego, CA 92121
 (619) 546-8877
Inquiry 1187.

MD/210 Fuzzy Set Comparator \$38

Hardware implementation of Hopfield neurons

Micro Devices
 5695B Beggs Rd.
 Orlando, FL 32810
 (407) 299-0211
Inquiry 1188.

N1000
Neural-network development tools for signal and image processing applications
 Including 80386 computer
 from \$19,000
 Support package only (for Sun-4, Sun-3, IBM PC AT, and PS/2 Model 50) from \$7955

N500 from \$495
Runs on IBM PC AT and PS/2 Model 50
Single-unit RCE network software
 Nestor, Inc.
 1 Richmond Sq.
 Providence, RI 02906
 (401) 331-9640
Inquiry 1189.

Awareness \$275
Runs under MS-DOS
Introduction to four types of neural-network paradigms

Genesis \$1095
Runs under MS-DOS
Neural-network development environment

Neural Systems
 2827 West 43rd Ave.
 Vancouver, BC Canada V6N 3H9
 (604) 263-3667
Inquiry 1190.

NeuralWorks Explorer \$299
Runs under MS-DOS
An introduction and tutorial on neural networks

NeuralWorks Professional II
 MS-DOS and Macintosh
 versions \$1495

Sun-3, Sun-4, and Sun386i
 versions \$2995

NeXT and INMOS transputer
 versions call for pricing
Neural-network development system

NeuralWorks Designer Pack \$1995
MS-DOS and Sun versions
Links Professional II networks with C programs

NeuralWare, Inc.
 103 Buckskin Court
 Sewickley, PA 15143
 (412) 741-5959
Inquiry 1191.

MacBrain \$995
Runs on Macintosh
Lets you prototype and deliver neural-network applications

HyperBrain
(Comes with MacBrain)
Toolkit allows you to build neural-network applications within HyperCard

Neurix, Inc.
 1 Kendall Sq., Suite 2200
 Cambridge, MA 02139
 (617) 577-1202

Inquiry 1192.

Owl I, II, III from \$349
Libraries of modules for IBM and compatibles that lets you define and access 10 different neural networks

Extension Pack \$149
Three additional networks

Olmsted & Watkins
 2411 East Valley Pkwy., Suite 294
 Escondido, CA 92025
 (619) 746-2765

Inquiry 1193.

Intelligent Pattern Recognition Chips \$500
Stores a 1000-by-64 matrix of weights and multiplies it with an input vector
 Oxford Computer
 39 Old Good Hill Rd.
 Oxford, CT 06483
 (203) 881-0891
Inquiry 1194.

ANSim 2.1 \$495
Runs under MS-DOS
13 neural-network models

ANSkit \$950
Runs under MS-DOS
Neural-network development system

ANSpec \$2995
Runs under MS-DOS
Neural-network specification language

Delta Floating Point Processor \$24,950
Runs on IBM PC, AT, PS/2s, and Sun386i

Neural-network accelerator boards
Sigma Neurocomputer Workstations from \$31,500

80386-based systems with Delta Processor, ANSkIt, Delta C, Delta Macro, and ANSpec

SAIC
 10260 Campus Point Dr.
 Mail Stop 71
 San Diego, CA 92121
 (619) 546-6290

Inquiry 1195.

DENDROS-1 \$35
Neural-network chip that produces the dot product of the inputs and the connection weights of 22 synapses

DENDROS-1 Evaluation Board ... \$695
Uses eight DENDROS-1 chips to create a hardware-based neural network

Syntonic Systems, Inc.
 20790 Northwest Quail Hollow Dr.
 Portland, OR 97229
 (503) 293-8167

Inquiry 1196.

TRW Mark V Neural Processor
 Write for pricing information
Runs on VAX/VMS

MC68020-based parallel-processing system includes tools for neural-network applications

TRW
 Military Electronics & Avionics Div.
 One Rancho Carmel
 San Diego, CA 92128
 (619) 592-3482

Inquiry 1197.

NeuroShell \$195
Runs under MS-DOS
Creates neural-network applications using a modified back-propagation

Ward Systems Group, Inc.
 228 West Patrick St.
 Frederick, MD 21701
 (301) 662-7950

Inquiry 1198.

Inclusion in the resource guide does not indicate that BYTE endorses or recommends either the product or the company. In addition, BYTE accepts no responsibility for any omissions, changes, or errors in the information listed.

DEALING WITH A DIGITAL WORLD

Digital signal processors move to micros, where they handle complex data like sound and images with speed and flexibility

David A. Mindell

Last fall, Apple founder Steve Jobs introduced the NeXT machine, hailed as the first of a new generation of personal computers. It has a 17-inch "megapixel" display, a 256-megabyte magneto-optical disk drive, an Ethernet port, a SCSI port, and the multitasking Mach operating system, derived from Unix. While these features typify the growing sophistication of the personal computer marketplace, one chip in the NeXT "cube" represents a truly new direction in personal computer systems: a digital signal processor (DSP).

DSPs have been around for at least 10 years, mostly in high-end military or industrial applications and research. Recent developments in technology, however, have made single-chip DSPs widely available and affordable, as well as easily integrated into larger systems. Consequently, digital signal processing is expanding into numerous new applications, particularly on personal computers, and is one of the fastest-growing areas in digital technology today.

Telecommunications is a primary arena for digital signal processing, and many of today's high-speed modems use digital-signal-processing techniques to reduce errors and increase transmission rates. Specialized "adaptive" algorithms sense the noise and bandwidth properties of the telephone line and adjust transmission and filtering parameters accordingly. DSPs also encrypt and compress data for reasons of security and efficiency. Voice-mail systems, for example, process speech signals and convert them to compressed ASCII files for transmission over standard E-mail systems.

A single DSP chip can accomplish virtually all telecommunications functions within a system, eliminating the need for expensive additional hardware. The chip in the NeXT machine, for example, can act as a modem, a fax machine, a voice digitizer, and a data compressor while also serving as a high-throughput numeric processor.

The advent of digital audio has created a niche for DSPs in all areas of music processing, including synthesis, recording, mixing, equalization, and editing. "Direct to disk" has become

very popular, where compact-disk-quality audio is recorded through a DSP in a personal computer onto a high-capacity hard disk drive. DSP systems can also clean up poor recordings, removing noise, and even replacing clicks and pops with interpolated artificial music. Some can perform time compression and expansion of speech and music signals without affecting the pitch. A 40-second message, for example, could fit into a 30-second commercial, all without "munchkinizing" or "Frankensteining." Despite its popularity, however, digital signal processing is still largely misunderstood by even the computer literati.

Digital Signals

The term *digital signal processing* refers to the digital implementation of filters and algorithms to process some kind of data or *signal*. These techniques, while more complex than their analog counterparts, provide all the advantages associated with numerical processing: speed, accuracy, increased noise immunity, greater dynamic range, flexibility and programmability, and the power to create sophisticated pseudo-intelligent systems.

Analog signals are *continuous-time* representations of a given quantity (see figure 1a). A microphone, for example, produces a varying voltage that is proportional to the sound it detects. The first problem of a digital system, then, is to convert these analog signals into numbers—that is, to digitize them. To do this, the system must *sample* at regular intervals to convert the continuous-time signal into a *discrete-time* representation (see figure 1b).

The time between these samples, the *sampling period*, is determined by Nyquist's sampling theorem, which states that samples must be taken at twice the highest frequency contained in the data. Audio signals, for example, have a 20-kHz bandwidth, that being the upper limit of human hearing. Digital audio, then, must take at least 40,000 samples per second to accurately reproduce sound (CDs actually operate at 44.1 kHz

continued



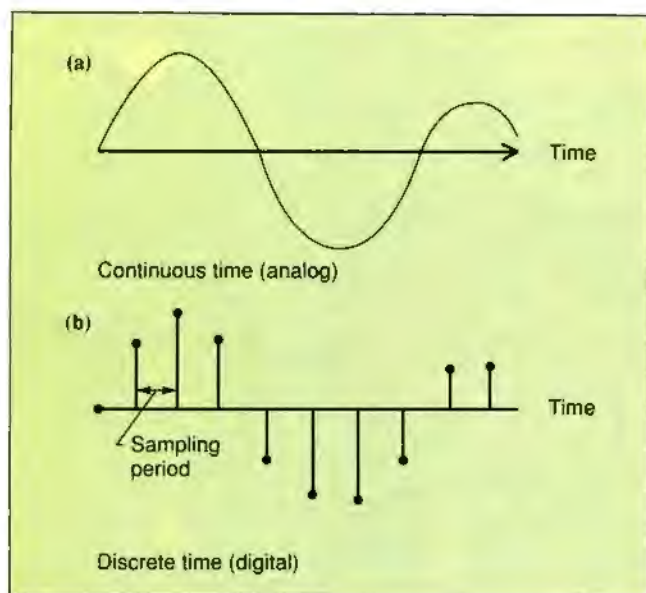

Figure 1: In digitization, (a) an analog signal is sampled and converted to (b) a sequence of digital data. The data can then be passed through a digital signal processor for processing.

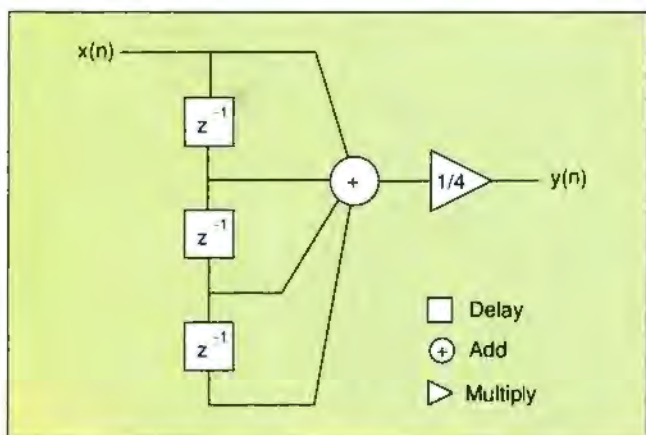

Figure 2: In this diagram, a filter (a four-sample averager) adds an input $x(n)$ to the three preceding inputs (which have been delayed for this purpose) and divides the total by 4 to give the output $y(n)$. The effect of this averaging filter is to smooth out rapid deviations in the input signal, while leaving slower deviations, or low frequencies, relatively unaffected.

to provide error correction and reduce noise).

An A/D converter converts a sampled analog voltage into a binary number. A DSP takes a string of numbers from an ADC, processes them in some way, and produces another string of numbers, which can then be passed through a D/A converter to reconstruct an analog signal. The digital data can also be passed directly to a computer for further processing or storage.

DSP Microprocessors

Until recently, most digital filters were hard-wired. A hardware multiplier was connected to an accumulator, which was connected to another multiplier, and so forth. Early microprocessors were simply not fast enough to perform the operations required for sophisticated filters. Advances in VLSI, however,

have produced specialized DSP microprocessors with enough power to implement digital filters in software.

General-purpose microprocessors are bulky things. Loaded with features for memory management, system control, and compiler design, they can be clumsy to operate in real time (RISC architectures are an attempt to avoid this problem). DSP chips are similar to other microprocessors in that they execute programs, grab instructions and data from memory, and perform calculations. They are stripped down, however, and optimized for simple, repetitive operations with very high rates of data flow.

The distinguishing feature of DSP chips is their emphasis on the multiply-accumulate (MAC) operation, which is central to digital filtering. Current DSP chips—for example, the Texas Instruments TMS320C30, the Motorola DSP56001, and the AT&T DSP16A—can perform MAC operations in a single clock cycle in 60 to 80 nanoseconds, a value approximately equivalent to 25 to 33 million floating-point operations per second. (See the text box "A Look at DSP Chips" by John E. Hart on page 250 and table 1.) Impressive even by today's standards, such processing rates extend DSP chips' range well into the high-fidelity audio domain and just to the edge of video. Other features of DSP processors include extensive parallelism and pipelining, independent memories, and "bit-reversed" addressing modes for Fourier-transform data.

Another difference between general-purpose microprocessors and DSPs is that DSPs employ the Harvard architecture. In this scheme, data and instructions are kept in separate memories to allow the processor to perform several operations in parallel. There are numerous variations on this structure; some even allow access to five or six data banks simultaneously. The Motorola DSP56001, for example, has two data memories, denoted X and Y. For image processing, then, X and Y data can be kept separate, or for a complex Fourier transform, the X and Y memories can be used for real and imaginary data. A filtering operation might use the Y memory for the data stream and the X memory to hold the filter coefficients.

Most DSPs have some data and code memories on-chip and can access more memory through external buses. The on-board memories are small (rarely more than a few K bytes), but they are usually sufficient because DSP operations, while complex, produce relatively short programs. Some processors even include lookup tables for constants such as sine coefficients as part of on-chip ROM.

Because DSP chips are optimized for data throughput, there are usually several ways of presenting data to the CPU. Digital signals can enter through external buses, direct memory access, or one of several types of serial ports. These data paths, combined with flexible control features, also allow for several DSPs to be strung together to perform parallel operations.

The problem with DSP chips has been that, because they are so streamlined and were made with data flow and not systems in mind, they can be very difficult to program. Without convenient registers and instructions, compilers do not generate efficient code. Therefore, because high-bandwidth DSP applications often run under significant real-time constraints, critical routines must be written by hand and fine-tuned in assembly language. But the special architectures and extensive parallelism of most DSP chips mean that the assembly languages are obscure and esoteric and thus difficult to code.

Industry consensus is that the proliferation of DSPs has been slowed by these and other development difficulties. The situation is changing, however, as chip companies offer design aids such as emulators, library routines, and software simulators.

continued



When you pick a printer for the office, the only thing you have to fear is being wrong.

An office printer can cost a few hundred dollars, or it can cost as much as a small car. And depending on how well it does (or doesn't do) what everybody in the office wants it to do, it can cost you a lot of sleep.



That's why when AEG Olympia talks about printers, the feature we talk about most is good technology. Which may explain why we're the number one business machine company in our native Germany, where technology is a number one passion.

So before an AEG Olympia dealer tells you about all our dot matrix and daisywheel and laser printers, he'll probably show you how beautifully they all work. We live and breathe solid engineering, sensible design and dependable mechanics for printers, just as we do for our typewriters,

facsimiles, copiers and shredders.

For the name of our nearest dealer, call 1-800-999-6872. Or write AEG Olympia, Box 22, Somerville, NJ 08876-0022. You can't go wrong with good technology. **Where technology counts, business counts on us.**

AEG
OLYMPIA

A Look at DSP Chips

John E. Hart

The AT&T DSP32, introduced in 1985, was the first self-contained single-chip floating-point digital signal processor (DSP). Computer scientists and engineers found the compact architecture, ease of hardware integration, and impressive performance ideally suited to a variety of applications. It rapidly became clear that the DSP had great potential, in both single and multiprocessor configurations, to address a wide range of computational needs.

Although floating-point DSPs are only now beginning to appear in personal computers, competition between the major microprocessor designers has resulted in skyrocketing performance-to-cost ratios. Even though sample prices can be high, full-scale production DSPs are selling for as little as \$40 per unit, or about \$4 per million floating-point operations per second (MFLOPS). In what follows, I want to look at some of the more common floating-point DSPs, selected from table 1 on page 255.

The AT&T DSP32

The major AT&T DSP chips are the fixed-point DSP16 and DSP16A and the floating-point DSP32 and DSP32C. The DSP32 contains two processing units, the control arithmetic unit and the data arithmetic unit (DAU). The CAU is an integer processor with 16-bit resolution in the 25-MHz model; in the newer DSP32C, a 50-MHz device, it has 24-bit resolution. The DSP32 runs at 12.5 MFLOPS, while the DSP32C reaches a peak speed of 25 MFLOPS.

The CAU contains 21 registers that can be loaded from and stored to memory and that can be manipulated arithmetically in add, subtract, and various Boolean operations. Each operation takes four clock cycles. The first 14 CAU registers serve as address pointers to 32-bit floating-point operands held in either the internal or the external RAM; R_{15} through R_{19} can be used as post-index registers for floating-point memory accesses.

The DAU does floating-point computations exclusively. It has four 40-bit data accumulators (32-bit mantissas with 8-bit exponents), enabling "single-extended-precision" calculations within the DAU itself. All results are truncated or rounded to 32 bits when accumulators are stored to memory.

The generic DAU instruction involves two registers and three operands. It has the form

$$z = A_n = \pm A_m \pm y \times x$$

or

$$z = A_n = \pm y \pm A_m \times x$$

The A_j are the DAU accumulator registers ($j = 0$ to 3), and the variables z , x , and y can refer to specific address pointer registers within the CAU, to accumulator registers, or to an implicit 1 or 0. A DAU instruction statement occupies 32 bits of memory. The impressive floating-point speed of the DSP32 and its compact object codes is, in part, a result of the fact that one instruction can do two floating-point operations involving five variables.

The DSP32 is a four-state machine, with each instruction taking just four clock cycles. For example, if x , y , and z all

refer to data in memory, using AT&T assembly language syntax, you could replace these variables with their address pointer registers $*R_n$, where $n = 1$ to 14. The instructions are then executed as follows:

Cycle 1: Fetch and decode the instruction.

Cycle 2: Fetch operand pointed to by the x -variable pointer $*R_x$.

Cycle 3: Fetch operand pointed to by the y -variable pointer $*R_y$.

Cycle 4: Do the floating-point operations and write the result to the z variable pointed to by $*R_z$.

There is a 32-bit memory access during each clock cycle. At the 40- to 50-MHz clock rates at which the DSP32s can run, this would require extraordinary memory performance. To make these high bandwidths possible, the memory is partitioned into two banks, Bank0 and Bank1.

The address location of the 4K bytes of internal memory is flexible. All the external memory, if included, is located in Bank0. Memory activity is interleaved between the banks to allow for two-cycle access to each bank. One bank is being addressed while the other is being accessed. Data flow on the internal 32-bit bus can proceed at a rate of one long word (or 4 bytes) per cycle, but on the external Bank0 bus, it proceeds at one long word for every two clock cycles. At 50 MHz, this interleaving yields an internal bus bandwidth of 200 megabytes per second.

A look at the four-state cycle sequence indicates that perfect implementation of this interleaving scheme requires a very careful allocation of data and instructions between the two banks. In practice, a useful programming compromise is simply to place data in one bank (usually the lower one, because this bank is expandable off-chip) and to put the instructions in Bank1.

The DSP32 connects to a host microprocessor through its 8-bit parallel interface (16-bit in the DSP32C). This interface features a cycle-stealing direct-memory-access (DMA) controller that allows the host to read or write to DSP memory without having to halt and restart the CAU or DAU processors via software. This ability to change data "on the fly" is central to uses of the DSP32 in interactive scientific teaching and research computing applications.

The serial I/O section of the DSP32 permits input and output of 8-, 16-, and 32-bit data. One use for this port is to connect DSPs together in multiprocessor systems. Another is to drive 16-bit D/A converters, providing a convenient high-speed analog data stream for monitoring computations in real time.

The Motorola 96002

The Motorola 96002's instruction set is a superset of that for the MC56000 (the fixed-point DSP), and the instruction mnemonics are similar to those for Motorola's general-purpose microprocessors. The floating-point chip will be available later this year in both a single-port (the 96001) and a two-port version (the 96002).

The 96002 chip features multiple internal and external buses, with internal memory arranged to support parallel transfers of program and operand data to and from the program controller and the data ALU, respectively.

Running at 26.6 MHz, the MC96002 can attain a peak throughput of 40 MFLOPS and 13.3 million instructions per second (MIPS), although the floating-point throughput will more typically be about 27 MFLOPS in 32-bit single precision or 43-bit single-extended precision. This high performance is a result of internal concurrency and parallelism. The program controller, address-generation unit (AGU), and data ALU operate in parallel. A typical instruction in the 96002 consists of a floating-point operation involving accumulator registers A_0 through A_7 in the ALU as sources and destinations, along with a parallel move.

While the ALU is executing a multiply-accumulate on several ALU accumulator registers, the AGU can be fetching two 32-bit numbers from each of two data memory banks and placing them in other data registers for use in a subsequent instruction. This latter data can be obtained from the internal RAM banks of x -data and y -data or from static RAM attached to the two external memory ports, A and B.

Both transfers use addresses contained in two of the eight pointer registers located in the AGU. The effective pointer addresses can be modified using index registers that are also contained in the AGU. At the same time that the floating-point operations and data transfers are occurring, the program controller prefetches and decodes the next instruction from the program memory. All this can occur in just one instruction cycle (two clock cycles).

The data ALU contains a single-cycle floating-point multiplier/accumulator that works with either 32-bit or 43-bit input data, the latter being made up of 32-bit mantissas and 11-bit exponents. The results are written to ALU registers in "infinite precision."

For example, a single-precision multiply produces a 48-bit mantissa. The result, stored in a 96-bit register, can be used in future register-to-register arithmetic operations without truncation. However, when a result is written from an ALU register to memory, it is automatically rounded down in hardware to single precision.

Double-precision calculations must be done in software, but the bus structure, in which the x -data and y -data can be concatenated, speeds up the transfer of double-precision data to and from the ALU registers. In addition, these 10 96-bit registers provide expanded capability for computing larger expressions than can be performed in the four DSP32 accumulators. To take one example, repeatedly used numeric constants can be permanently stored in some of these registers, avoiding the necessity of collecting them from memory each time they are needed.

The TI TMS320C30

The Texas Instruments TMS320C30 has several features in common with Motorola's 96002 and AT&T's DSP32. The CPU contains a floating-point multiplier and an accumulator, which operate on the eight 40-bit single-extended-precision accumulator registers, as well as on data directly transferred from memory. As in the DSP32, a multiply instruction can get its operands either from data registers (accumulators A_0 through A_7) or from memory locations pointed to by address pointers in the AGU. Like the 96002, the TMS320C30 has multiple internal and external buses.

The 320C30 uses a modified Harvard architecture. This means that there are separate data buses for instructions and data. Both program and data memories can be accessed at the same time via two address generators carried in the CPU unit. The internal zero-wait-state RAM is contained in two blocks of 1K byte by 32 bits. The on-chip memory also includes 4096 32-bit ROM locations and a 64- by 32-bit instruction cache.

The cache can be used for short but often-used subroutines, and the ROM can be used to hold code or constants that are common to a range of applications. Standard math libraries have been implemented in some ROMs (the DSP32, for one), and such ROM libraries save valuable memory space. The on-chip memory in all the DSPs occupies a substantial fraction of the chip's real estate. In the C30 chip, almost half the 700,000 transistors are related to memory.

The chip has four 24-bit address buses, a 24-bit peripheral bus, and three 32-bit data buses. The architecture facilitates rapid execution of operations involving two variables, such as dot products and correlations. The 320C30 is a two-state machine, and peak speeds, in which a multiply-accumulate is done in two clock cycles, reach 33 MFLOPS with the standard 60-nanosecond instruction cycle.

The TMS320C30 contains a large number of parallel arithmetic commands. A "normal" three-operand floating-point multiply instruction, specified by a 32-bit instruction, multiplies the contents of Source1 and Source2 and places the result in a destination register, which is one of A_0 through A_7 .

In a parallel floating-point multiply-add instruction, the CPU takes operand data from four sources (registers or memory locations). The first two sources are multiplied together, and the second two are added. The results of these two operations, carried out in parallel in the same instruction cycle, are placed into two accumulator registers (which must be among A_0 through A_3). Two of the sources must be among accumulator registers A_0 through A_7 , and the other two must be data from memory (accessed via reference to pointer registers in the AGU).

Parallel arithmetic can involve pairs of a wide range of arithmetic operations, including floating-point, integer, and bit-manipulation instructions. The indirect addressing modes include various indexing operations to facilitate rapid execution of vector algorithms.

The 320C30 has several peripheral interfaces, which should lead to easy integration of the chip into host systems. Two 8-megabit-per-second serial ports permit communication with other DSPs or external devices. There are two 32-bit parallel interfaces that can be attached to external memory, a 32-bit bus of a host CPU, or other processors in multiprocessor systems. With the on-board DMA controller, you can use the I/O ports concurrently without having to start and stop the CPU.

TI has just introduced a 29-MIPS, 16-bit DSP chip tagged the TMS320C5x. This new chip is an update of its TMS320 series of 16-bit fixed-point DSPs.

John E. Hart is a professor in the astrophysical, planetary, and atmospheric sciences department at the University of Colorado in Boulder. He can be reached on BIX c/o "editors."

Digital Filters

The basic signal-processing operation is filtering, which blocks or passes selected frequencies in the data. Filters come in several types: low-pass, which eliminates high frequencies; high-pass, which eliminates low frequencies; and band-pass and band-reject, which operate on specified frequency bands.

The simplest digital filter is an averager, also known as a *tapped delay line*. Consider an input stream $x(n)$ and an output stream $y(n)$, where n is the "index" of the digital samples.

The basic
signal-processing operation
is filtering, which blocks or passes
selected frequencies in the data.

Then a "four-sample averager" can be constructed that implements the following equation:

$$y(n) = 1/4[x(n) + x(n-1) + x(n-2) + x(n-3)]$$

Thus, the output of the filter is the average of the present sample $x(n)$ and the three samples preceding it. Figure 2 shows this equation as a digital filter structure using standard notation, with adders (a circle with a plus sign), multipliers (a triangle with a gain value), and delays (boxes marked with a z^{-1} , indicating a delay by one sample).

The function of this filter is easy to understand: Rapid deviations in the input signal, or high frequencies, tend to get smoothed out by the averaging function. Slower deviations, or low frequencies, remain relatively unaffected. Thus, the four-sample averager implements a low-pass filter.

The logical extension of this basic filter is a discrete version of an operation called *convolution*. Convolution consists of taking a set of filter coefficients and "sweeping" them across the stream of input data (see figure 3). At each point, the output is determined by the sum of products of the coefficients of the input data:

$$y(n) = \sum_{k=0}^f x(n-k)b(k)$$

where $b(0)$ to $b(f)$ are the filter coefficients and $x(n)$ is the input data. The filter structure is then rewritten as in figure 3. Note the importance of the multiply-add operation, which, as I mentioned earlier, is reflected in DSP chip design. This basic filter is known as a nonrecursive or finite impulse response (FIR) filter; given an input (an impulse), its response will decay to zero when the input is removed. [Editor's note: For more on convolution, see "Introduction to Image Processing Algorithms" by Benjamin M. Dawson, March 1987 BYTE, and "Finding the Titanic" by Marti Spalding and Ben Dawson, March 1986 BYTE.]

The next level of complexity is a recursive filter with feedback; its output $y(n)$ depends not only on inputs $x(n)$ but also on

continued

Entering the World of DSPs

John E. Hart, Scott Kittelman, and Dan Ohlsen

While floating-point digital signal processors are showing up in top-of-the-line computer systems, you can already purchase DSP add-in cards for smaller systems. These cards allow you to implement many applications in areas such as chaotic dynamics, numerical analysis, and other compute-intensive scientific and engineering subjects. Table A shows a number of DSP add-in boards that are available for a variety of small systems, including the IBM PC and compatibles and the Macintosh.

If you'd like a little more hands-on experience, you may be interested in a project we developed at the University of Colorado as part of our research into the equations, formulated by E. N. Lorenz, that formed the basis for modern chaos theory. Our simple AT&T DSP32-based coprocessor board contains address-decoding logic, a 40-pin DSP32 with internal memory only, and two D/A output circuits that are driven from the DSP32's serial output. This coprocessor board can be attached to a PC, XT, AT, or 80386 machine that has the standard PC bus.

The board can be wire-wrapped on a PC prototype card, using documentation consisting of a layout diagram (for wire-wrapping), circuits, a parts list, and a wire-wrap list. To save cost, the board has no external memory, which would have to be expensive 30-nanosecond static RAM. However, the DSP32's 4K bytes of internal RAM is adequate for a wide range of small database problems, provided that I/O is handled externally through the host PC using the direct-memory-access capability of the DSP32 (e.g., many scientific problems that you would like to do interactively will be small enough to fit into the 1024-number internal capacity of the 40-pin DSP32). You can build a 25-MHz coprocessor board for about \$250, or you can order it assembled and tested in a 30-MHz, 15-MFLOPS printed-circuit version called the FS-2, which requires an adjacent open slot for heatsink clearance (see below for details).

The software needed to operate the DSP32 must include some form of macro assembler that converts assembly language mnemonics into DSP32 machine code, and a device handler that can load programs and extract data from the DSP32 across the PC bus. A compiler that converts high-level language into DSP32 instructions is also helpful. The AT&T MS-DOS assembler-linker package costs \$500, and its C compiler \$1500.

Those who don't want to become involved in extensive low-level programming can obtain an inexpensive software package that includes a mini-BASIC compiler, a macro assembler, an interactive graphics-oriented controller, a FORTRAN interface, a small special-function library, and several demonstrations of the integration of ordinary differential equations and the generation of images using both BASIC and assembly language codes. This software can be used with either the assembled FS-2 board or your own wire-wrapped board.

John E. Hart is a professor and Scott Kittelman and Dan Ohlsen are research associates in the astrophysical, planetary, and atmospheric sciences department of the University of Colorado in Boulder. Plans for the DSP32 board are available for \$5 from FASTec, Inc., 189 Mine Lane, Boulder, CO 80302, (800) 468-4142. (You can obtain the software package mentioned above for \$95, including the manual, or the software package complete with the 15-MFLOPS FS-2 board for \$399.95.)

Table A: These companies make add-in digital-signal-processing boards for a variety of computer architectures, including ISA (the Industry Standard Architecture, on which the IBM PC AT and compatibles are built) and NuBus (Macintosh compatible). Development support (development system, assembler, C language, libraries, debugger, and simulator) is available for each board listed below. (Table courtesy of DSP Update)

Company	Board	Bus	Processor	Width	Price
Ariel Corp. 433 River Rd. Highland Park, NJ 08904 (201) 249-2900	DSP-C25	ISA	TMS320C25	16-bit integer	\$595
	PC-56	ISA	Motorola DSP56001	24-bit Integer	\$595
Atlanta Signal Processors, Inc. 770 Spring St. Atlanta, GA 30308 (404) 892-7265	Banshee	ISA	TMS320C30	32-bit floating point	\$6995
	Chimera	ISA	TMS320C25	16-bit integer	\$2195
Burr-Brown Corp P.O. Box 11400 Tucson, AZ 85734 (602) 746-1111	SPV120	VME bus	TMS320020	16-bit integer	\$2995
	SPV125	VME bus	TMS320C25	16-bit integer	\$2995
	ZPB32	ISA	WEDSP32	32-bit floating point	\$995
Communications Automation & Control, Inc. 1642 Union Blvd. Allentown, PA 18103 (215) 776-6669	DSP32-PC	ISA	AT&T DSP32	32-bit floating point	\$1045
Data Cube, Inc. 4 Dearborn Rd. Peabody, MA 01960 (508) 535-6644	Euclid	VMEbus	ADSP-2100	16-bit integer	\$5000
Digidesign, Inc. 1360 Willow Rd., Suite 101 Menlo Park, CA 94025 (415) 327-8811	Sound accelerator	NuBus	Motorola DSP56001	56-bit integer	\$1295
Impact Technologies 2082-B Walsh Ave. Santa Clara, CA 95050 (408) 988-4980	Viper 8704	VME bus	Zoran VSP161	16-bit block floating point	\$9950
Microstar Laboratories 2863 152nd Ave. NE Redmond, WA 98052 (206) 881-4286	DAP2400 series	ISA	Motorola DSP56001	56-bit integer	\$2395- \$3195
OKI Semiconductor 785 North Mary Ave. Sunnyvale, CA 94086 (408) 720-1900	PSP92	ISA	MSM6992	22-bit floating point	\$6265
Sky Computer, Inc. Foot of John St. Lowell, MA 01852 (508) 454-6200	Challenge-S	P4 bus	TMS320020	16-bit integer	\$5300
Spectral Innovations, Inc. 4633 Old Ironsides Dr., Suite 450 Santa Clara, CA 95054 (408) 727-1314	MacDSP series	NuBus	AT&T DSP32	32-bit floating point	\$2295- \$8995
Spectrum Signal Processing, Inc. 264 H St. Blaine, WA 98230 (604) 438-7266	56001	VME bus	Motorola DSP56001	24-bit integer	\$5995
	320C25	ISA	TMS320C25	16-bit integer	\$1995
Zoran Corp. 3450 Central Expy. Santa Clara, CA 95051 (408) 720-0444	VSPX series	ISA	ZR34161	16-bit integer	\$1000- \$3000

The most powerful expanded memory software available.

TURBO EMS



Turbo EMS now includes "Automatic Spillover" and special support for Windows, Excel, DESQview, and Ventura.

- Provides "Automatic Spillover" between any combination of expanded memory, extended memory and disk file space
- Simulates LIM 4.0 expanded memory with LIM 3.2 hardware
- Allows customized individual configuration files for multiple software applications
- Supports the LIM XMS 2.0 specification for extended memory
- Provides up to 32 megabytes of LIM 4.0 expanded memory
- Totally network compatible and relocatable to RAM between 640KB and 1 megabyte

Turbo EMS \$99.95 suggested retail

For the name of the dealer nearest you or for more information call Lantana.

4393 Viewridge Avenue, Suite A • San Diego, CA 92123 • 619/565-6400 • FAX 619/565-0798

A MESSAGE TO OUR SUBSCRIBERS

FROM TIME TO TIME WE MAKE the BYTE subscriber list available to other companies who wish to send our subscribers material about their products. We take great care to screen these companies, choosing only those who are reputable, and whose products, services, or information we feel would be of interest to you. Direct mail is an efficient medium for presenting the latest personal computer goods and services to our subscribers.

Many BYTE subscribers appreciate this controlled use of

our mailing list, and look forward to finding information of interest to them in the mail. Used are our subscribers' names and addresses only (no other information we may have is ever given).

While we believe the distribution of this information is of benefit to our subscribers, we firmly respect the wishes of any subscriber who does not want to receive such promotional literature. Should you wish to restrict the use of your name, simply send your request to the following address.

BYTE MAGAZINE
ATTN: SUBSCRIBER SERVICE
P.O. Box 555
HIGHTSTOWN, NJ 08520



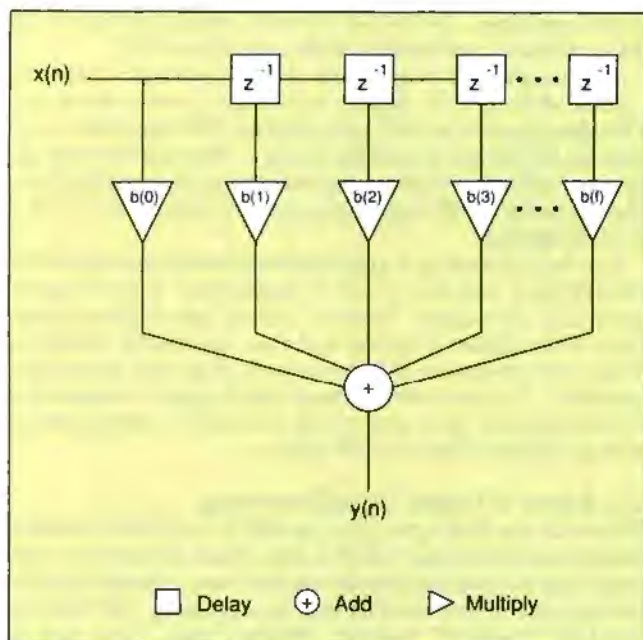

Figure 3: The digital filter structure shown here performs discrete convolution. The output $y(n)$ is the sum of an input $x(n)$ and k previous inputs, each multiplied by a coefficient ranging from $b(0)$ to $b(f)$. Convolution can be used in a number of different applications, such as edge enhancement in image processing.

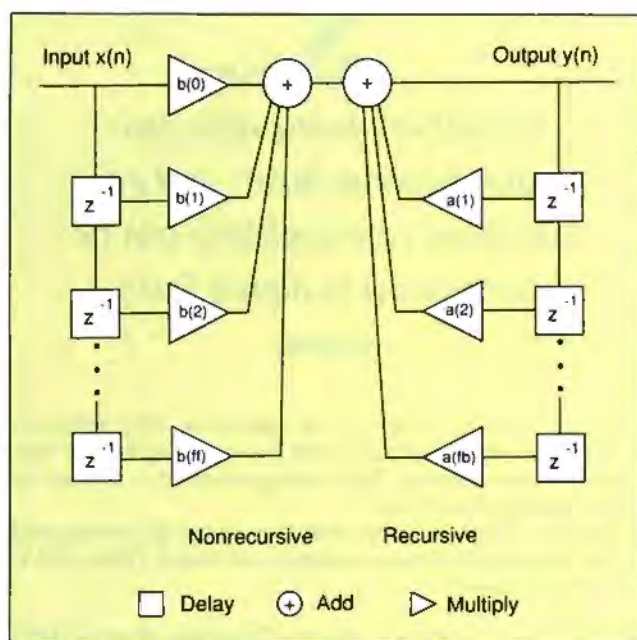

Figure 4: This diagram of a general digital filter combines a nonrecursive section on the left (like those in figures 2 and 3) and a recursive section, in which the output $y(n)$ is multiplied by a series of coefficients $a(k)$ to $a(f)$ and added to the next output. Such filters are useful because their behavior closely models that of analog systems.

Table 1: Specifications for currently available digital-signal-processor chips (N/A = not available). (Information courtesy Nelson R. Manohar Alers and AT&T Bell Laboratories)

DSP chip	Manufacturer	Year announced	Multiply operands	Multiply time	Technology design rule	Power dissipation (in watts)	Instruction cycle (in ns)	Data word length (in bits)
TMS32010	TI	1982	16 × 16 → 32	200.0 ns	2.4 μ NMOS	0.9	200	16
TMS320C25	TI	1986	16 × 16 → 32	100.0 ns	1.8 μ CMOS	0.6	100	16
TMS320C30	TI	1988	32 × 32 → E8	60.0 ns	1.0 μ CMOS	1.0	60	32
DSP56001	Motorola	1986	24 × 24 → 56	97.5 ns	1.5 μ CMOS	N/A	97	24
DSP96001	Motorola	1988	24 × 24 → 56	97.5 ns	HCMOS	N/A	75	32
DSP16	AT&T	1986	16 × 16 → 32	55.0 ns	1.0 μ CMOS	0.25	55	16
DSP16A	AT&T	1988	16 × 16 → 32	25.0 ns	0.75 μ CMOS	0.35	25	16
DSP32	AT&T	1985	32 × 32 → 40	160.0 ns	1.5 μ NMOS	2.0	160	32
DSP32C	AT&T	1988	32 × 32 → 40	80.0 ns	0.75 μ CMOS	0.8	80	32
μPD 7720SPI	NEC	1981	16 × 16 → 31	250.0 ns	3.0 μ NMOS	N/A	250	16
NEC 77230	NEC	1986	24E8 → 47E8	150.0 ns	1.75 μ CMOS	< 1.0	150	32
Intel 2920	Intel	1979	--- No multiplier ---		N/A	N/A	400	25
IBM RSP	IBM	1983	N/A	2 bits/cycle	2.0 μ NMOS	2.5	200	16/24
HSP	Hagiwara	1983	12E4 → 16E4	250.0 ns	3.0 μ CMOS	0.25	250	20
ADSP2100	Analog Devices	1986	16 × 16 → 32	125.0 ns	1.5 μ CMOS	< 0.5	125	16
DSSP-VLSI	NTT	1986	12E6	N/A	1.2 μ CMOS	0.7	50	18
MSM6992	OKI Electric	1986	16E6	100.0 ns	2.0 μ CMOS	0.4	100	22
μSP32	Mitsubishi	1986	32 × 16 → 32	150/450 ns	1.3 μ CMOS	N/A	150	32
MB8764	Fujitsu	1986	N/A	N/A	N/A	0.3	100	16
TS68930	Thomson	1986	T16 × 16 → 32	160.0 ns	N/A	N/A	160	16
NS LM32900	National Semiconductor	1986	16 × 16 → 32	100.0 ns	2.0 μ CMOS	0.5	100	16

Society's
signals are being digitized:
Letters become faxes, and even
telephone conversations can be
transmitted in digital form.

previous outputs $y(n-1)$, $y(n-2)$, and so on. This feedback, however, can cause ongoing or even diverging oscillations when input has been removed. Thus, these are known as infinite impulse response (IIR) filters.

Because filters can have both recursive and nonrecursive parts, a general difference equation for digital filters can be written as follows:

$$y(n) = \sum(k = 1 \text{ to } fb) y(n-k)a(k) + \sum(k = 0 \text{ to } ff) x(n-k)b(k)$$

where $a(k)$ is the feedback (recursive) coefficient and $b(k)$ is the feed-forward (nonrecursive) coefficient. Thus, the structure in figure 4 can be produced.

For an FIR filter, the recursive coefficients are set to zero. From this equation, you see that digital filters do nothing more than calculate a linear combination of current and previous inputs and previous outputs. The filter's frequency response depends on the function determining the coefficients for this combination.

FIR filters are easier to design than IIR filters because they are inherently stable. IIR filters must be designed to avoid unstable oscillations due to feedback. The signal delay in FIR filters is the same for all frequencies: a beneficial property called *linear phase response*. IIR filters, however, provide better response curves with fewer calculations.

Determining the best filter coefficients is a complicated task and involves selecting *poles* and *zeros* (solutions to the filter's characteristic equation, which determines its behavior) in the complex z -plane. CAD programs are now available that will produce optimized filters from specifications of frequency and phase response.

The Fourier Transform

Signals are composed of varying frequencies. A stereo system, for example, provides ways to control the frequency content of music. An increase in the treble control emphasizes the high frequencies. Increase the bass, and you'll hear the lows. Similarly, a prism breaks white light into its component frequencies, a process that reveals the spectrum's rainbow. Digital signal processing also has such a mechanism, a computational prism that analyzes signals in the frequency domain. It is called the Fourier transform.

The Fourier transform takes a signal in the time domain and converts it into the frequency domain, a process that reveals its spectrum. For digital signals where a continuous signal is represented as a set of points, the discrete Fourier transform is used. Because the DFT is computationally intensive, it has been optimized in the form of the fast Fourier transform. The FFT is a recursive routine that divides an initial signal into smaller and smaller pieces in order to perform 2-point DFTs as

trivial operations. The results of these smaller operations are then scaled and combined to produce the entire FFT.

The straight DFT requires the order of n^2 complex multiplications, while the FFT requires only $n \log^2 n$, a reduction of over a hundred (times for a 1024-point data set. FFT algorithms also have the advantage of working *in place*, meaning that they require no additional memory beyond storage of the initial data. Most of today's DSP chips can perform a 1024-point FFT in a few milliseconds.

I've been discussing a one-dimensional data model that fits chronological data like sound or temperature. Digital-signal-processing techniques, however, extend into higher dimensions. Convolution, filtering, and even the Fourier transform all have two-dimensional equivalents dealing with "spatial frequencies." For that reason, image processing is essentially a subset of digital signal processing, and today's image processors are often built around DSP chips.

The Future of Digital Signal Processing

Experts in the field agree that the DSP in the NeXT machine makes that system the first of a new breed of personal computer. Industry sources corroborate this view, reporting an imminent wave of new workstations incorporating DSP chips as standard "on-board" features. [Editor's note: *For a look at DSP boards currently available for personal computers, see the text box "Entering the World of DSPs" by John E. Hart et al. on page 252.*] Surely, as such systems proliferate and as DSP programming becomes simpler, there will be an explosion of diverse applications. Even more certain is that digital signal processing, like all truly innovative technologies, will extend beyond current visions and alter basic assumptions.

Society's signals are being digitized; Letters become faxes; records become CDs; speech is compressed and sent as mail. Even telephone conversations, paradigms of analog communications, are being transmitted through fiber-optic networks in digital form. But digital storage forces a kind of equivalence on various signals, removing them from their "real world" analog contexts.

In fact, digital signal processing is so broadly applicable only because, once inside a computer, "signals" are essentially all the same. Music, speech, codes, and even images can be converted to strings of numbers containing a given quantity of "information" to be distinguished and extracted from noise.

Recent controversies over digital audio tape are a good example of how digital techniques, with their capacity to make perfect copies, are calling into question concepts of originality and ownership in the information industry. Given the new equivalence it imposes on data, digital signal processing may require a rethinking of the very meaning of information: as a creation, as a signal, and as a commodity. ■

ACKNOWLEDGMENTS

The editors would like to thank Nelson R. Manohar Alers, member of the technical staff of AT&T Bell Laboratories, for providing information for table 1. Thanks also to DSP Update (a monthly newsletter covering DSP markets, products, technology, and competition, published by BDG Publications, P.O. Box 3044, Stanford, CA 94309) for providing the information in table A, which accompanies the text box "Entering the World of DSPs" on page 252.

David A. Mindell is a technical consultant with Exactitude Consulting based in Pittsford, New York. He also writes about how computers and digital processing are altering our conceptions of symbolic exchange. He can be reached on BIX c/o "editors."

INTRODUCING ENTITY COMMON LISP

- FULL COMMON LISP FOR THE 386, MS-DOS & MS-WINDOWS -

One of the greatest challenges of today's AI is delivering sophisticated applications at reasonable cost. AI is a technology to be integrated into a standard business environment. Lisp is a great way of developing complex software but this far Lisp-based applications have been costly to deliver.

Entity Common Lisp just changed that!

Entity Common Lisp runs on standard 386 PCs under MS-DOS and uses MS-Windows to provide a flexible graphics user interface.

Entity Common Lisp provides Common Windows as a high level interface to Windowing.*) The development environment includes an integrated emacs-style editor and an extensive set of debugging tools.

\$995 full version - \$195 interpreter-only version - available now!

THE FACTS:

- 2 MB extended Memory to run, 4 to develop.
- 1.4 MB Run Time size including all Common Lisp, Common Windows and input Editor.
- 1.5-3 times faster than the competition.
- Interface to C and other applications through MS-Windows.



Circle 128 on Reader Service Card

ExperTelligence, Inc.
5638 Hollister Avenue
Galeto CA 93117
tel: (805) 9671797
fax: (805) 964 8448
(800) 828 0113
(800) 826 6144 in CA

FOR ADDITIONAL INFORMATION PLEASE CONTACT:

Intellitech Ltd.
Hietalahdenkatu 2
00180 Helsinki
Finland
tel: +358 0 605 604
fax: +358 0 603 639

Intellitech U.K. Ltd.
5 Omega Gate,
Greenland Dock,
London SE16 1PR
tel: +44 1 237 8237
fax: +44 1 252 1625

VLIW: HEIR TO RISC?

*In the race to maximize CPU performance,
a new architecture called VLIW may succeed RISC chips*

Peter Wayner

For some people, reading and watching TV at the same time is a problem. Traditional parallel computers have a similar problem. Although they can do two things at the same time, coordinating the tasks can be a daunting and inefficient process. A new computer architecture, known as the very long instruction word (VLIW) machine, is designed to solve the problems of coordination and exploit previously untapped opportunities for parallelism.

VLIW machines are based on the simple notion that if one processor is fast, two are faster, and n are faster still. Designers have understood this concept for a long time and have produced many schemes for parallel machines with countless processor configurations. Unfortunately, getting a program to run twice as fast is not a simple matter of throwing two processors together in a box. The two processors must synchronize their operations; the communication between them is overhead.

If you can split a problem into n parts that don't need to coordinate their actions, the overhead is small and n processors will finish the work almost n times as fast as one processor. On the other hand, if the problem is particularly complicated and the n processors must continually talk to each other to keep track of each other's progress, one processor might be able to finish the task before n processors chattering endlessly could. This communication bottleneck is the most important factor to consider when you are programming parallel machines.

Some problems run naturally in parallel. Ray tracing for graphics, factoring numbers, and computing the Mandelbrot set are three examples. In these cases, it's very easy to split up the work so that one processor doesn't need to know the results obtained by the others until the end. Unfortunately, most programs are not this simple. For example, operating systems often contain thousands of branches to handle all the different cases that occur. More often than not, splitting up these programs is difficult because the n parts would have to coordinate with each other after every branch or jump. The overhead of communication would add so much time to the job that it would

be more efficient to let one processor handle it.

In cases where there isn't enough parallel work to overcome the total communication time lag, some work can still be done simultaneously. Usually there are little bits of several operations between the branches that offer opportunities for parallelism. For example, a program might command the computer first to fill register R1 with the results of dividing register R1 by R2 and then, in the next instruction, compute the sum of registers R3 and R4 and put the result in R5. These two instructions could be carried out simultaneously, but the time spent sending the information back and forth is much greater than the time saved by using two processors.

The VLIW solution is to build one big processor with n arithmetic units that connect to the same register file. The name *very long instruction word* comes from the fact that each of these n units must be told what to do, so that, consequently, the instruction word must be n times longer. Because all the processors work with one set of registers, the communication delay is virtually nonexistent. (You could say there is some delay, because this special register file that can talk with n arithmetic units is slightly slower than a regular one.)

Just a Jump to the Left . . .

Adding more arithmetic units is just part of the solution. System code may average only two or three operations between branches, and, with more arithmetic units, the program would speed up by a factor of only two or three. This result isn't bad, but a better solution must work around branches to speed things up even more. If the VLIW machine executes several arithmetic operations at once, it can certainly do a branch at the same time, too.

The obvious solution is to have the CPU calculate operations from both before the branch and after it. When it decides whether or not to jump, the CPU can keep the results from the calculations along the path it chose and throw away the results from the path it didn't take. In this case, the machine does more

continued

work than absolutely necessary, but in total, more work is saved at the end. Here is an example. Two instructions come before the branch:

```
R1 + R2 → R1
R3 + R3 → R3
```

At the branch, the computer executes

```
R5 × 2 → R5 if R4 > 0
R6 × R6 → R6 if R4 ≤ 0
```

Notice that all the operations can be done at the same time because none of them depends on the results of the other. If the CPU is not designed to deal with branches, it can execute the first two operations in one cycle. Then it can test to see if R4 is greater or less than zero. Finally, it would execute one of the operations on R5 or R6. That would take three cycles. It's easy to see how branches can prevent the computer from doing much work in parallel.

On the other hand, a VLIW machine could execute all four operations and test to see if R4 is greater or less than zero in one operation. It would write the results of the first two operations to R1 and R3 automatically. If R4 is greater than zero, it would save the R5 × 2 in R5 and throw away the calculation of R6 × R6. In the other case, when R4 is less than or equal to zero, it would do the opposite. This entire process would take only one cycle—a big saving in time over the three cycles used before.

Obviously, there are limits that keep a VLIW computer from executing a huge program in one cycle. In the example, all four operations can be performed simultaneously because none of them depends on the results of another. Interdependencies often prevent large parts of a program from being executed in one cycle. An operation after the branch might use the results in R5 that were computed by an operation before the jump.

It is hard to know how many times this situation will happen in real-world programs because every program has a different set of interdependencies. Finding the parallelism is the job of the compiler, and very sophisticated compilation techniques are necessary.

Determining which operations can be done simultaneously is

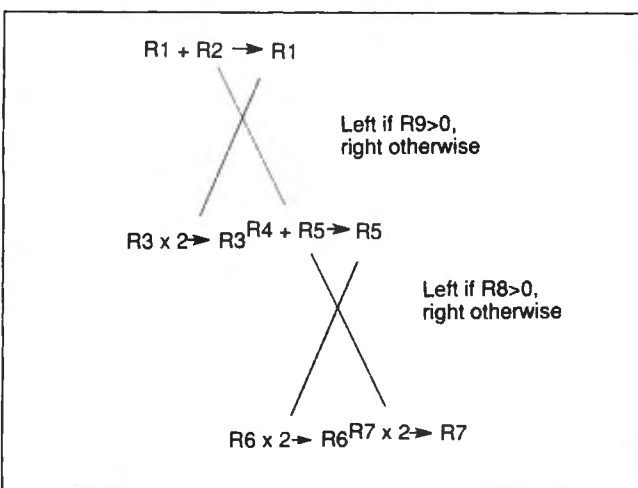

Figure 1: A fragment of code with five instructions and two branches. The trace-scheduling compiler chose the three emphasized instructions by predicting the computer's path at each of the branches.

a straightforward process, but it's extremely tedious. You could program VLIW computers in machine code, but you'd have trouble trying to keep the entire CPU working. And if the work can be automated, there's no reason not to let the computer do the work. The only problem is being able to design the algorithms to do the job as efficiently as possible.

The two major methods for creating VLIW code are known as *trace scheduling* and *percolation scheduling*. Both of them compact the code so that operations that can be done simultaneously end up getting done simultaneously, but the two methods are based on different visions of how to do it.

Trace-Scheduling Compiling

Trace scheduling was developed by Josh Fisher and several of his graduate students at Yale. It assumes that a computer spends its time executing one particular path or "trace" through the program. The computer may occasionally follow one branch off the path, but a trace-scheduling compiler hopes that the process will soon return. Once the compiler picks the trace, it compacts the code along the trace and moves all operations that can be performed simultaneously into the same instruction.

Compiling a program for a VLIW machine is a matter of guessing the right path before the program executes—often a difficult challenge. But, in some cases, as with loops, the trace is simple to find because the program will probably jump to the beginning of the loop again. Unfortunately, the compiler can't always predict many other branches. Half the time it will be right, and half the time it will be wrong.

Figure 1 shows a fragment of code arranged in a tree with the trace chosen by the compiler emphasized. When compiled, figure 1 becomes

```
Inst1: R1+R2->R1 ; if R9<=0 then Inst2 else R4+R5 ->R5;
        if R8<=0 then Inst3 else R7*2->R7
Inst2: R3*2 -> R3
Inst3: R6*2 -> R6
```

Notice that the computer will be doing three operations at once. The compiler predicted that the machine would probably find that both R8 and R9 are less than zero. The branches decide which results will be kept and which will be forgotten. If the branches decide to jump out of the trace, everything after the branch is thrown away. The three operations are all from the trace that the compiler chose. If it made a mistake and R9 turns out to be greater than zero, all the extra work was wasted.

Percolation-Scheduling Compiling

Percolation scheduling is a more general model for VLIW machines. It was invented by Alex Nicolau, a former graduate student of Josh Fisher's and now a professor at the University of California at Irvine. This method of compiling treats the set of operations executed on each cycle as a tree with branches instead of a straight line in a trace. This procedure saves the processor the trouble of predicting a particular trace. The machine must execute all the operations in the tree and save the ones from the path the process takes.

Because the various combinations of branches can lie in a tree, not just a trace, this method is more general. A percolation-scheduling compiler could pack all the operations from figure 1 into one instruction. The computer would be simultaneously executing all five instructions and picking the results it wanted after it also computed the branches.

The compiler creates the instructions by "percolating" all the instructions up as far in the program as they can go without changing the action of it. It starts with ordinary code and places

Intel's 80860: On the Road to VLIW

Early this spring, Intel introduced the 80860 and started calling it a "Cray on a chip" because, under ideal conditions, the microprocessor reportedly can reach speeds nearing those of the early Cray supercomputers. To accomplish this feat, Intel implemented one of the main design tenets of very long instruction word (VLIW) machines—the ability to start more than one instruction at the same time.

The chip has a RISC processor that handles the branching and the integer instructions. An FPU on the same chip can simultaneously do a multiply and an add. That means that, under ideal conditions, three operations can be done concurrently and that, running at 50 MHz (peak performance), one of these chips will process 150 million operations per second.

Naturally, the best rate doesn't occur in all cases. The perfect program for pushing the chip to its maximum has equal amounts of integer operations, floating-point adds, and floating-point multiplies that can be executed simultaneously. The floating-point hardware has a pipeline that must stay filled to achieve the one multiply and one add per cycle. Gaps in the floating-point operations in the program drain the pipeline, and it takes several cycles to restart.

The one major application that will be able to use the chip

structure well is graphics. If you want to draw pictures on the screen, your computer needs to be able to perform a vast number of floating-point calculations. The 80860 thrives on this kind of work because the graphics computations keep its floating-point pipeline filled. The chip hardware, in fact, is especially tuned to easily handle several routine computations frequently used in graphics software.

The 80860 does not implement all of VLIW's design ideas. It can carry out only one branch instruction in each clock cycle. This capability is not particularly necessary when only three different processors are used. In the future, more functional units will require multiway branching to make the best use of all the different units.

The 80860 is one of the first major chips to start down the path to implementing VLIW architectures. Apollo Computer has a RISC chip that issues multiple instructions per cycle. Weitek introduced a chip set that can also perform three instructions per cycle. It will be only a matter of time before more processors begin to be able to operate in this manner. The RISC philosophy will lead to faster and faster chips well into 1992, but after that, CPU architects will need to explore other paths like VLIW machines. The 80860 is one of the first steps.

each instruction in a node by itself and then considers the program as a list of nodes to be executed one after the other.

The compiler begins to percolate by comparing each node with the node that precedes it. If the instructions in both nodes can be simultaneously performed without interference, the compiler merges the two nodes. If it finds that only some of the lower node's instructions can be moved to the upper node, it will move just those. The compiler wants to move as many instructions as it can as far up the program as possible. This action is essentially the same as the compression that the trace scheduler performs, but it's done in a more general way.

The differences between the two methods become apparent when one of the nodes contains a branch. If the branches and the instructions in the two nodes can be performed simultaneously, the compiler merges the two nodes, and the shape of the operations inside the node begins to look like the tree in figure 1. Sometimes these trees can grow quite bushy, and the percentage of work kept by the machine decreases because only the work from one trace is stored to the registers. In effect, this loss of efficiency illustrates part of the law of diminishing returns. More and more processors executing bushier and bushier trees are necessary to save executing one additional operation.

Machines Now and Tomorrow

Some VLIW computers are already on the market, but they are mainly large machines aimed at the minicomputer/supercomputer market. Smaller versions are already announced for microcomputers, and larger ones will certainly follow. The Intel 80860 also exhibits many VLIW-like qualities (see the text box "Intel's 80860: On the Road to VLIW" above).

The Multiflow Computer Company of Branford, Connecticut, makes a machine aimed at the minicomputer/supercomputer market. The basic model, the Trace 7, can simultaneously perform seven operations. It has two units for floating-point arithmetic and two more for integer math. The integer units run twice as fast as the FPUs, so six operations are performed at the

same time. The compiler does trace scheduling.

Kemal Ebcioglu at the IBM Yorktown Heights research lab is currently building an experimental VLIW computer. This machine is designed to use a percolation-scheduling compiler that will create tree-like instructions. It will have 16 ALUs and eight units for loading from and storing to memory. While the ALUs evaluate these operations, the CPU can also choose one of 16 different paths on the tree and base the results that it keeps on this information.

The IBM machine will have 128 registers. Since 16 arithmetic operations with two operands and eight stores can happen with each cycle, the register file must have 48 different ports. Each ALU will be able to access any of the 128 registers. Most of the computer's other parts are coming from "off-the-shelf" silicon designs, but this register file required a special effort.

The compiler for the IBM computer was prototyped long before any of the details about the hardware were finalized. Many different programs were compiled, and the resulting data was used to guide the design. An earlier version of the hardware had only eight functional units because the compiler had only produced nodes with eight instructions in them. Then a new way to compile and percolate loops yielded some examples where as many as 16 functional units could be kept busy. The hardware design was expanded to take advantage of this.

These experiments also showed that a real application program would use about six of the functional units on average, meaning that the program would run about six times faster on a VLIW machine than on a machine with one processor. Unfortunately, it is difficult to keep all 32 functional units going at once, and so it is rarely possible to get an increase in speed directly proportional to the increase in functional units.

The experimental results showed that the CPU discarded an average of 40 percent of the operations because the program took only one of the possible paths. The percolation-scheduling compiler had scheduled many operations from all these paths in

continued

anticipation of taking just one. You can readily see the law of diminishing returns at work here.

VLIW: Extended RISC?

Many of the precepts that guide VLIW design are extensions of the RISC philosophy. In many ways, the VLIW is the next logical step. Like the RISC chip, the IBM VLIW machine requires

For the
hardware to be as simple
as possible, RISCs rely on smart
compilers to rearrange the code.

all arithmetic operations to obtain their operands from registers and return all the results in registers. Loads and stores to memory must be performed separately. This separation allows the machine to perform as much work as possible without being slowed down while the bus obtains information from memory.

In order for its hardware to be as simple as possible, RISCs rely on smart compilers to rearrange the code. Ideally, RISC chips can start one new instruction each cycle, even when the previous instruction hasn't finished executing. The compiler must arrange the instructions so there are no conflicts with other instructions waiting for available data.

If one instruction stores its results in one register, the compiler will try to follow it with an operation that need not wait for the result of the first operation. Thus, the CPU can start work on the next instruction without waiting for the results of the first. VLIW machines take this process a step further. Instead of overlapping instructions as much as interdependencies permit, the machines perform all instructions concurrently.

There are trade-offs. The VLIW machines need more hardware, which has to be more sophisticated. There must be n functional units where before there was one. The traffic between the CPU and memory now comes in large bursts of n loads and stores instead of a steady stream of single requests. The bus must be larger and faster. On the other hand, super-RISC chips need state-of-the-art fabrication to keep the cycles short enough. They must be $1/n$ th the length to compete with an n -arithmetic-unit VLIW processor.

These are a few of the reasons why some people think that a super-RISC chip could achieve close to a VLIW machine's performance at much lower cost. These trade-offs also illustrate just some of the simple issues that designers must balance when dealing with questions about the architecture. There are many more. Changes in the development of fast memory, caches, bus capacity, and silicon fabrications will all affect the balancing.

In several years, microcomputer processors will become available that can do two, three, or n things at once. The addition of functional units is the natural way to speed up microprocessors. The use of large-scale parallelism with many autonomous processors can be great for scientific applications that need simultaneous calculations performed. Word processors, window managers, and databases, however, are all difficult to move to parallel machines because there are not n little tasks that can be done simultaneously. The VLIW approach is better suited for fine-grained parallelism.

The precepts that form the canon of VLIW design are far from fixed. Only a few machines exist, and they are large and expensive. Time, experimentation, and lots of research will eventually resolve the questions regarding how many functional units will be considered optimal, how many loads and stores should be performed per instruction, how many branches are necessary, and other questions not yet thought of. In time, the evolution of microprocessors will begin to follow the lead of these large machines. ■

Peter Wayner, a graduate student at Cornell University's department of computer science, helped design part of the IBM VLIW project's compiler. He can be reached on BIX c/o "editors."

High Performance Multi-Channel Serial I/O

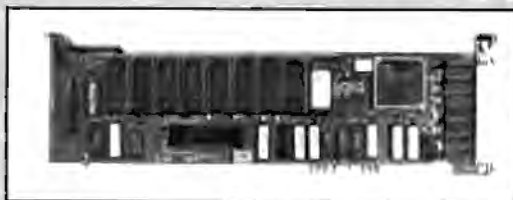

MCSS-9IM

GTEK

Development Hardware & Software
P. O. Box 2310
Bay St. Louis, MS 38521-2310

Order Toll Free 1-800-255-GTEK (4835)

Fax: 1-601-467-0935 MS & Technical Support 1-601-467-8048

MCSS-9IM

For IBM Micro-Channel compatible bus

- ▶ Serial Communication Co-processor with 9 channels per card.
- ▶ Dynamemory™ automatically finds and allocates up to 1 Megabyte of buffer memory. To add more memory just plug it in!
- ▶ Baud rates up to 57,600 baud. Upward compatible with the PCSS-8I.

PCSS-8IM

For IBM PCIXT/AT compatible bus

- ▶ Serial Communication Co-processor with 8 channels per card.
- ▶ Dynamemory™ automatically finds and allocates up to 2 Megabytes of buffer memory. To add more memory just plug it in!
- ▶ Baud rates up to 57,600 baud. Upward compatible with the PCSS-8I.

MCSS-6T

For IBM Micro-Channel compatible bus

- ▶ Serial I/O card adds 6 channels to a Micro-Channel machine.
- ▶ Compatible with the PCSS-8T, PCSS-8TX, and the PCSS-8TH.

PCIXT/AT and Micro-Channel are registered trademarks of IBM Corp.

Reach for ultimate portability

Systems Start \$790.00!



120 MBytes of power, speed and security in a revolutionary, removable hard drive.

At last, the Disk Pack gives you everything you've always wished for in a data storage system. The speed and high storage capacity of a hard drive. The ease and convenience of a floppy diskette. And the safety of a tape backup. All wrapped up in a state-of-the-art rugged unit, about the size of a paperback book. Designed to make your life a lot simpler and more secure.

True portability is here

Just picture this: With the Disk Pack you carry your whole work environment with you, wherever you go. All your files, all your data stay organized and configured just the way you created them. Between your office and remote sites. Or home. Or another department. You can even mail a Disk Pack. It's that rugged.



The Disk Pack frees you from the constraints of fixed computers. Your whole work environment fits in the palm of your hand.

Total security for your data

Simply slide out a Disk Pack module and lock away your entire business customer base and payroll figures in a drawer or safe. Same for lawyer,

banker or accountant sensitive data and Uncle Sam confidential information. All fully secured in a snap.

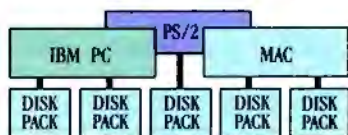

Get full data portability and security on the computer of your choice. Macintosh, PC Compatible or PS/2.

Blazing speed Rock-solid reliability Limitless expansion

Breakthrough technology makes the Disk Pack four to five times more reliable than other removable products. Access times as low as 13 ms make it one of the fastest hard drives on the market. The Disk Pack doesn't limit you to a single storage capacity either. You can interchange 20-, 40-, 80- or 120-MByte modules in your

system and between systems. Link modules up for a whopping Half-GByte + of on-line data. Store them for unlimited off-line data. And do lightning-fast data backups.

That's not all. The Disk Pack turns a shared computer into your fully personal machine within seconds. It's ideal for space grabbing applications such as color graphics, CAD, or music. One Disk Pack module does the job of 100 diskettes.

Ten times faster. And with a lot less hassle.

And thanks to the Disk Pack's unique architecture, you'll use it equally well on any Mac, Apple, PC-compatible or PS/2 computer. It's that advanced.

Outside the USA, contact IEF, Tel: (33) 1 45 57 14 14
217 Quai de Stalingrad 92134 Issy, France



The Disk Pack is ideal for data security. Lock it away and forget about accidental or intentional data loss.

For more information call

1-800-322-4744

IEF **DISK PACK**

The new standard in data storage technology

MEGADRIVE

SYSTEMS
11693 San Vicente Blvd, Suite 370
Los Angeles, CA 90049
Disk Pack is a trademark of IEF

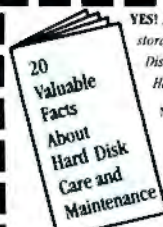

YES! I want to know more about Mega Drive Systems' new data storage technology. Please rush me more information about the Disk Pack and your free booklet "20 Valuable Facts About Hard Disk Care and Maintenance" today.

Name _____
Company _____
Address _____
City _____ State _____ Zip _____
Phone (____) _____

Mega Drive Systems, Inc.

11693 San Vicente Blvd, Suite 370
Los Angeles, CA 90049 (213) 556-1665

Number of Micros _____ Mac _____

Circle 321 on Reader Service Card

NEW FROM PERISCOPE



Real-Time Debugging for 386s and 286s

User Jeff Garbers, Crosstalk Communications' Director of Software Development, has been debugging with Periscope® Model IV and says, "The hardware really makes Periscope shine, especially when you've got timing-related problems. I can now track down changing pointers and altered buffers on my 386. I've been using it to debug Crosstalk® Mk. 4 and there's just no better way to do it."

Periscope IV gives you the ability to debug time-sensitive programs, hardware-interrupt routines, and programs with intermittent errors. You can run your program at full speed while tracking down unwanted memory overwrites. You can use the information captured in Periscope IV's real-time trace buffer to see EXACTLY what the system is doing, and to improve its performance.

Periscope manual, disk, quick-reference card, and 512K Plus board that provides write-protected RAM for Periscope Models I, III, and IV.



A New Generation of Hardware-Assisted Debugging

Compatible with virtually any 286 or 386 with an AT-style bus, Periscope IV works on machines running up to 25MHz with any number of wait states. Because it gets information directly from the CPU, instead of from the system bus, Model IV is not sensitive to bus compatibility issues.

Periscope IV collects CPU information in its hardware trace buffer while the CPU runs at full speed. Whether you tell Periscope IV to capture just selected information or to capture everything, you can use its powerful trace buffer commands to search for and display the execution history the way you need to see it. And you can use the CPU cycle count information to get the last bit of performance out of your code.

With Periscope IV you can set hardware breakpoints on memory accesses (within the first 16MB), I/O ports, and data. You can also set breakpoints on the occurrence of specific sequences of events, such as "watch for the routine FOO to begin executing, then while it is, watch for the variable BAR to be written." This capability, called sequential triggering, enables you to define complex conditions, then stop your program and examine what has happened when these conditions occur.

If you're developing a large application that needs all of the lower 640K, you can use the optional Plus board to keep Periscope totally out of normal DOS memory. The Plus board requires the use of a second slot.

The Periscope IV software is an extension of the software that comes with all models of Periscope. So, along with Periscope IV's powerful hardware, you get a full-function software debugger with source and symbol support for most popular PC compilers and linkers, Microsoft® Windows support, PLINK overlay support, dual monitor support, support for debugging device drivers and TSRs as well as regular programs, DOS independence, crash recovery, ease-of-use, and much more.

Prices on Periscope range from \$145 for software-only Model II-X to \$2,995 for a 25MHz 386 hardware-assisted Model IV. Call 800/722-7006 for pricing details, free information, to talk about your debugging needs, or to order your Periscope.

**Order Your Periscope, Toll-Free,
Today! 800-722-7006**

MAJOR CREDIT CARDS AND QUALIFIED
COMPANY PURCHASE ORDERS ACCEPTED



"No matter what your debugging needs, a single call to the Periscope Company has always sufficed..."

Ross Greenberg
"Best of 1988" (Development Tools)
PC Magazine, January 17, 1989

The
Periscope
Company, Inc.

1197 PEACHTREE ST.
PLAZA LEVEL
ATLANTA, GA 30361
404/875-8080
FAX 404/872-1973

HARD DISK MAINTENANCE SOFTWARE

Clever programs optimize your disk's interleave and fix potentially destructive errors

Are you getting optimal performance from your hard disk drive? Did you know that potentially destructive errors—intentionally ignored by DOS—may lurk uncorrected on those rapidly spinning platters? In this installment of Under the Hood, I'll look at the technology behind *low-level disk maintenance utilities*—programs that can optimize the arrangement of the sectors on each track of your disk while testing for (and often repairing) hidden glitches that can lead to loss of data.

Reserving Space for Data

The data on a hard disk is laid out on one or more platters in concentric *tracks*. If the disk has more than one platter, it usually has a read/write head for each surface; the heads are mounted on a single arm that moves them simultaneously across the tracks. A group of tracks that lie directly above and below one another is called a *cylinder*.

Every track of a hard disk is organized into sectors, each of which contains an equal portion of the data stored on that track. Obviously, the disk drive controller needs to be able to tell the sectors of a track apart to deliver the right data; the method it uses depends on whether the disk is *hard-sectored* or *soft-sectored*.

If the disk is hard-sectored, the drive hardware is responsible for remembering the physical locations of the sectors on a track. The controller receives a signal telling it which sector is passing under the head at any given moment; it doesn't

need to look for identifying marks on the disk itself. Hard sectoring can be very efficient because no space needs to be reserved on each track to mark the sectors. However, because the electronics necessary to do hard sectoring add to the cost of a disk drive, most drives (including virtually all those on personal computers) use soft sectoring.

On a soft-sectored drive, each sector is preceded by a special *sector ID header* that gives the number of that sector. (It also gives the number of the head and cylinder so the controller can make sure an error isn't causing it to access the wrong place on the disk.) Because the sectors can be laid out in different ways on the track (see the text box "Interleaving: Delivering the Data on Time" on page 266), the controller must read each header until it finds the sector it wants to access. Then, if it's going to write to the sector, the controller must shift from reading to writing during the short gap between the header and the sector. The headers for all the sectors must be written to the disk before the disk can be used. This process is called *low-level formatting*.

When you format a floppy disk on a typical computer, the computer actually performs a low-level format. Not so, however, for hard disks, where low-level formatting can take a long time and is usually done by the dealer before delivering the machine. When applied to the hard disk, the FORMAT command in PC-DOS only sets up the file allocation table, the root directory, and (optionally) the operating system. In fact, FORMAT won't work on a hard disk at all unless the drive has already had a low-level format (using IBM's Advanced Diagnostics) and has been partitioned with the FDISK utility.

The vast majority of users have never done a low-level format. This means that while the data on their hard disks may have been rewritten thousands of times, the low-level formatting information—the original headers that show the con-

troller where the sectors are—have never been rewritten. As the drive ages, this can become a source of serious problems, as I'll discuss below.

Alignment Drift

All electromechanical devices—including disk drives—age over time. Parts wear, tolerances shift, components drift out of alignment. Even on a new drive, the alignment may change a bit depending on whether or not it's had a chance to warm up. All these factors can combine to cause the same symptom: The heads on a hard disk drive no longer wind up exactly the same distance from the center of the disk when the drive steps to a particular track.

Alignment drift can lead to several interrelated problems. The data portion of each sector can drift inward or outward relative to the sector ID header (see figure 1). Since the information written to the disk during a low-level format is never rewritten during normal use, it is skewed relative to the sector itself—and may get so far away that the sector cannot be located at all. It's even possible for the contents of a recently written sector to overlap (and destroy) the contents of an adjacent sector that hasn't been written to for a long time.

Floating Defects

"Floating defects" are another source of potential problems. The quality of the disk surface is critical to the operation of a disk drive; the tiniest flaw can make an area of the disk unusable for data. So, when a hard disk drive is new, the manufacturer carefully tests it (using equipment costing hundreds of thousands of dollars) to find defects in the hard disk surface. He then writes a "defect map" on a label and attaches that label to the drive. The defect map shows the head and track where each defect is located; you can use this information to alert your low-level format software to the presence

continued

of defects. On some drives, the manufacturer also writes a defect map on a special track of the drive for the software to use. (It shouldn't alarm you, by the way, to find out that your drive has some surface defects; it's quite rare to find a drive that doesn't have any.)

If the drive's alignment didn't drift, the defect map would be an accurate indication of where the flaws are (at least all of them that existed at the time of manufacture). But since the map shows only defects that are *in* the tracks, not *between* the tracks, it's possible for defects that

were not mapped to show up as the tracks drift (see figure 2). You can solve this problem in part by doing a *surface analysis* when you perform a low-level format on your hard disk drive. But if the tracks drift between low-level formats, floating defects can still appear amid the data.

Interleaving: Delivering the Data on Time

Each circular track of a hard disk is divided into sectors—arcs of the circle that contain equal portions of the data stored on that track. You may well ask, "Why don't they make the entire track one huge sector?" The answer is that the disk drive controller must always read or write whole sectors at a time. Having only one sector per track would mean that every read or write would require as much as two revolutions of the disk: up to one revolution to get to the beginning of the track and another full revolution to read it. (The designers of the Commodore Amiga, incidentally, tried to implement this approach with floppy disks, but they added a special trick. The unique Amiga disk drive controller can start a read or write operation at any point on the track—something no other controller I know of can do. This sets the time

for every read or write to exactly one revolution of the disk. Alas, the latency is still a bit long, causing the Amiga floppy disks to exhibit lackluster performance except on large files.)

Each track of a standard IBM PC hard disk contains 17 sectors of 512 bytes each. The outermost ring in figure A shows the most obvious arrangement of the sectors: They're placed in ascending order around the track, from 1 through 17. (This is called *1-to-1 interleave*.) In practice, however, this might not be the most efficient arrangement. Often, disk drive controllers, disk I/O routines, and the host systems they run in require time between accesses to successive sectors. They may use this time to transfer data to and from memory, acquire control of the system bus, set up direct-memory-access channels, or allow other I/O to take place. If the

time required for these tasks is too long, the controller may find that the next sector it wants is already under the disk drive head—or past it—by the time everything is ready.

Interleaving solves this problem. If, instead of following one another, sectors with successive numbers have one or more other sectors between them, the next sector will be approaching the disk drive head just when the controller is ready for it. The second ring from the outside in figure A shows an example of 2-to-1 interleave, in which sectors with successive numbers always have one other sector between them. The order becomes 1, 10, 2, 11, 3, 12, 4, 13, 5, 14, 6, 15, 7, 16, 8, 17, 9.

If the system can keep up with it, 1-to-1 interleave will generally provide the best performance. But there are severe performance penalties if the interleave factor is too low. The controller will "miss" each sector—possibly by only a few hundred microseconds—and will have to wait until it comes around again. Since a typical hard disk drive spins at 3600 revolutions per minute (60 revolutions a second), the time to read all 17 sectors of a track would become 17 sectors \times 1 revolution/sector \times 1/60 second/revolution, or about a third of a second. This is a long time for only 8.5K bytes of data!

If the interleave factor is set one notch too high (say 3-to-1 instead of 2-to-1), the penalty isn't nearly as bad. The controller will wait an extra 1/17th revolution per sector; that's 17 sectors \times 1/17 revolution/sector \times 1/60 second/revolution, or 1/60th second longer, to read all the sectors.

The optimum interleave may be different even for two operating systems on the same machine. On my 8-MHz AT clone—not a particularly fast machine by today's standards—DOS works best at a 1-to-1 interleave. OS/2, however, likes a 2-to-1 interleave; the intervening sector gives the system time to handle interrupts and switch in and out of protected mode as needed.

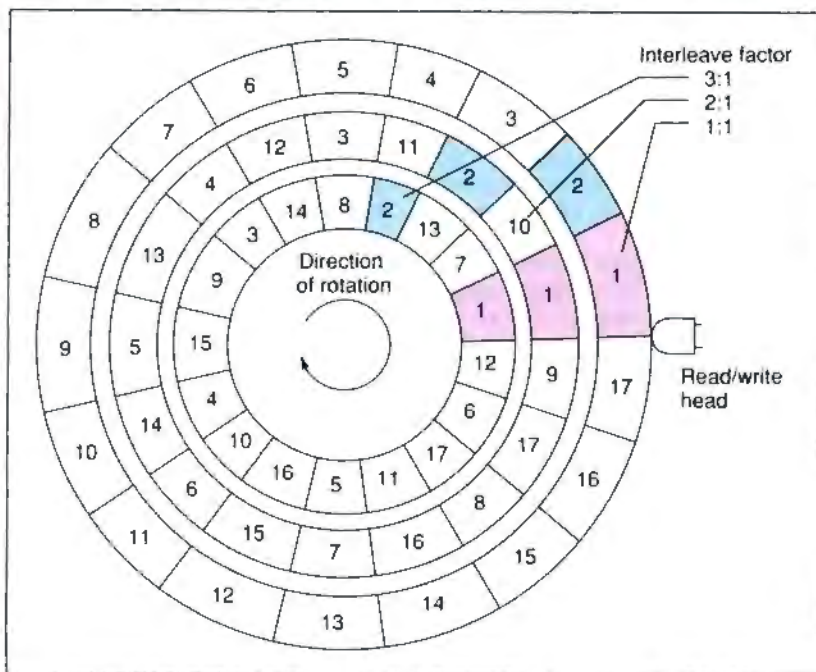

Figure A: Arrangements of sectors for different interleave factors. At 1-to-1 interleave, the sectors are numbered in sequence; at 2-to-1, sectors with consecutive numbers are separated by one other sector, and so on.

Magnetism and Friction

Other hard disk problems stem from the fact that data is recorded magnetically on the disk. Each time you turn your computer off or on, a small pulse of current travels through the read/write head, potentially weakening or erasing the magnetic domains underneath. The head may also jerk to one side at this time, spreading this small burst of magnetism across the disk. (This is a good reason to get a drive with a head that retracts automatically when the disk is turned off; many of the better models do.)

Disk drive heads, like the heads of audio tape recorders, accumulate residual magnetism that can partially erase the data over which they pass. And if the power is turned off at just the wrong moment during a write operation—or if the computer is reset at the wrong instant—it's possible to leave scrambled data on the disk. (Some computers and drives are designed to prevent this, but they're far from infallible.) All these factors can weaken or destroy the data—or, worse, the low-level formatting information—on your drive.

If the data portion of a sector is damaged, you have lost only the data—which is bad but not catastrophic. But if the low-level formatting information is damaged, you are in more serious trouble. There is no easy way to access the affected sectors, and many operating systems have no way of "learning" to avoid them. The result is persistent disk errors that can be cured only by performing a low-level format on the entire disk.

On disk drives without head retractors, the head comes to rest in the middle of the disk surface when the power is shut off. When the drive powers up again, the head "takes off" and flies on a very thin cushion of air above the platter; however, it takes a bit of time for this to happen, and some abrasion can occur as the head slides along the lightly lubricated disk surface. (If the frictional force between the head and the platter is strong enough, it can prevent the disk from starting to spin at all; this phenomenon is known as "stiction.") The mechanical damage to the disk surface caused by this abrasion can result in loss of data.

Disk Errors, ECC, and PC-DOS

What does your operating system do about potential (and actual) disk damage? The answer varies, of course, from manufacturer to manufacturer, but one of the most common operating systems—IBM PC-DOS—actually aggravates hard disk problems by ignoring them until it's too late.

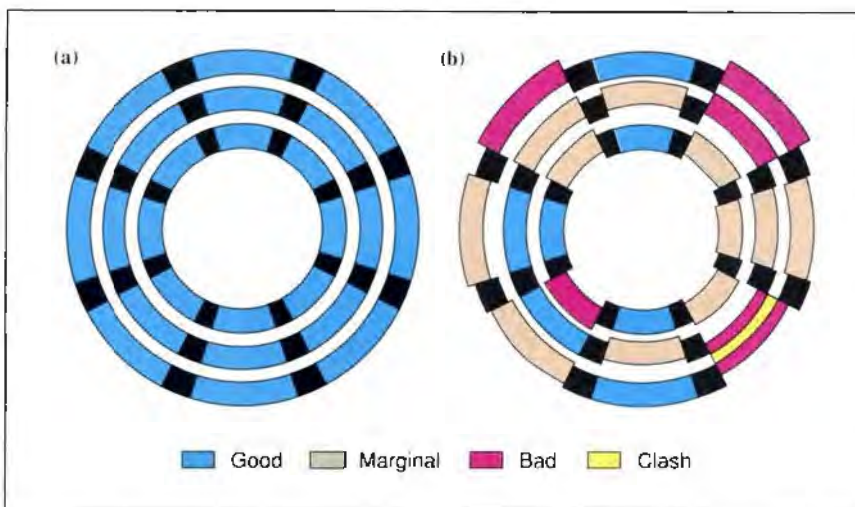

Figure 1: This diagram shows what happens when alignment drift causes the data portions of sectors to move out of line with the sector ID headers. (a) Before drift, there is good sector alignment; (b) after alignment drift, some sectors may even clash. (Figure courtesy of Prime Solutions)

As you've gathered by now, errors on hard disks are a common occurrence, and controller manufacturers have worked out ways to deal with them. Every sector of every modern hard disk includes not only data but also an ECC—an *error correction code*—that detects errors and lets the controller fix up to 11 consecutive incorrect bits. When an error occurs while reading the disk, the controller first retries the read as many as 40 times (depending on the settings and the make of the controller). Then, if it's still unable to read the data 100 percent correctly, it applies an error correction algorithm in an attempt to restore the data. This scheme affords plenty of margin for error and is responsible for the trouble-free operation of most hard disk systems.

When the controller successfully retries a read, it normally won't notify the BIOS at all. If the data is corrected using the ECC, the BIOS gets a message that says, "I was able to correct the data, but there are errors on the disk that should be fixed before the sector becomes unreadable." In the IBM PC, the BIOS relays this warning to PC-DOS.

And what does PC-DOS do with this message? Does it rewrite the data before it becomes even more illegible? Does it warn the user? Amazingly enough, it does neither of these things; it ignores the error entirely. In fact, the file `IBMBIO.COM`—a low-level driver that's loaded when PC-DOS boots—contains a short program that "captures" Interrupt 13 (the software interrupt vector that does disk I/O), intercepts BIOS calls, and fil-

ters out all the messages that report correctable errors. The result is that even programs that use the BIOS for direct disk access no longer receive this vital warning message.

DOS's "ignorance is bliss" approach to disk errors "works" only until enough errors accumulate to make the data uncorrectable. When the controller finally fails to correct the data, DOS will at last stop ignoring the problem. You'll get an error message from DOS: "Bad sector error on C:." But at this point, there are guaranteed to be errors in your file. Furthermore, DOS will refuse to read past the first error, so you cannot access any good data that follows.

Two Real-World Products

If DOS isn't willing to cooperate, what can you do about gradual disk degradation, alignment drift, and other problems? One solution is to periodically back up your entire disk and do a low-level format. While backing up is always a good idea, a complete low-level format takes a lot of time. You'll also have to repartition your disk and reinstall DOS—not exactly the kind of procedure you'll want to do very often. Finally, unless you're lucky enough to have a tape backup unit, you'll need to shuffle the backup disks twice—once during the backup and once during the restore process. The whole operation could take an entire morning to complete—especially on a large hard disk.

Fortunately, there are at least two non-destructive low-level disk maintenance

continued

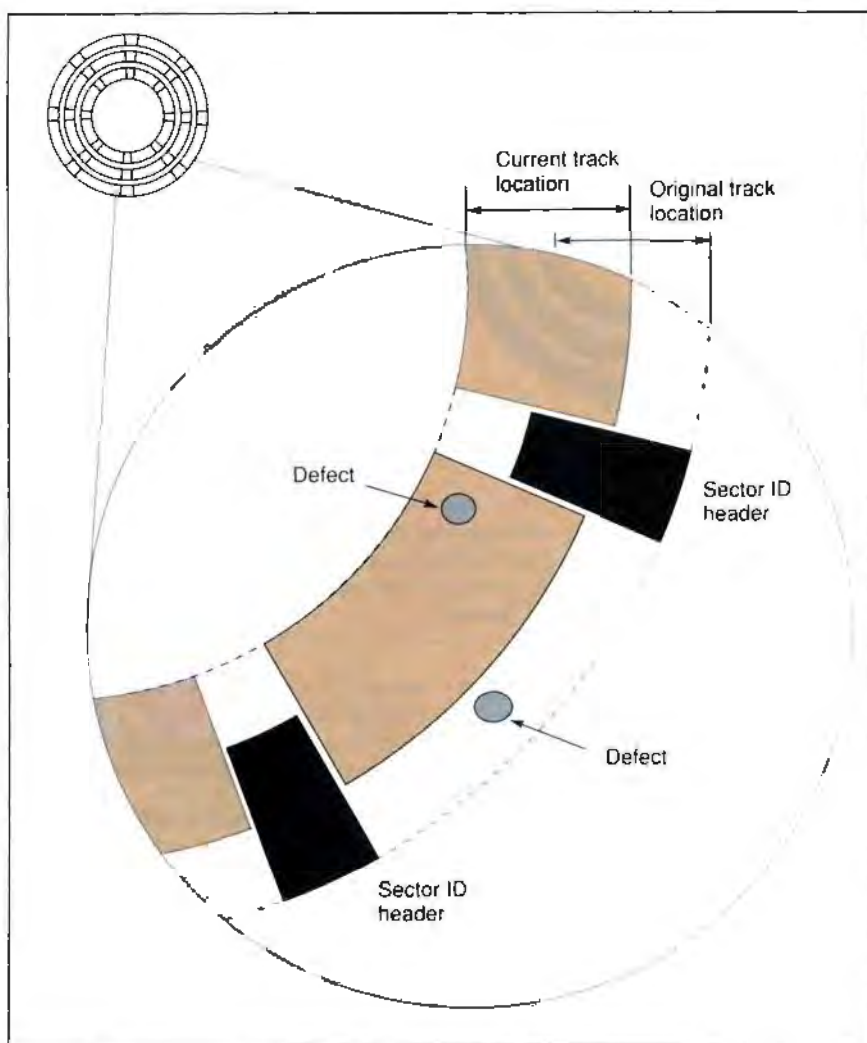

Figure 2: Alignment drift can cause "floating defects" not found in the manufacturer's defect map to appear in the data areas of a hard disk. The upper defect, originally harmless because it was between tracks, is now in the middle of the data, while the lower defect is now between tracks. The sector ID headers are now so far from the current track center that the sector may not be locatable. (Figure courtesy of Gibson Research)

programs on the market (and I'm sure there are more I haven't heard about). SpinRite, by Gibson Research, and Disk Technician/Disk Technician Advanced, by Prime Solutions, perform similar functions: They'll find physical defects that can cause data loss, correct "soft" (correctable) errors on your hard disk, refresh the information on the disk (including the low-level formatting information), and even adjust the interleave factor to an optimal value. Because the programs are "nondestructive," there's normally no need for you to restore your data from a backup (although both manufacturers do recommend that you perform a backup before you use the program).

It's important to understand the distinction between these two programs and programs that work at the DOS level, such as the Norton Disk Doctor. DOS-level utilities can repair damage due to accidental formats and erasures. But they cannot see errors that DOS ignores—or repair damage to the disk's "infrastructure" (i.e., the low-level format).

The makers of SpinRite and Disk Technician Advanced make different (and often contradictory) claims about their software. In the remainder of this article, I'll give you the information you'll need to cut through the marketing hype and understand how these utilities really work.

Circumventing DOS

To detect the true condition of the hard disk, both programs need to circumvent DOS's BIOS "patch" and find out when there's really an error on the hard disk. One technique—used by Gibson's SpinRite—is to bypass DOS's path routines and call the underlying ROM BIOS routines directly. Since DOS overwrites the Interrupt 13 vector at boot time, it seems as if there's no way to determine the original entry points of the ROM BIOS routines. But technical wizard Steve Gibson has a clever trick up his sleeve; SpinRite uses a technique that really does find those entry points.

The IBMBIO.COM file is loaded into memory when DOS boots; this is the time when the BIOS interrupt vectors are "captured" and redirected. But when you install SpinRite, you first boot the system with a floppy disk that does not have DOS on it. Instead, the boot track of the installation disk contains a custom program that reads the addresses from the interrupt vector table and saves them on the disk. Once these addresses are known for a given computer's ROMs, they won't change unless you change BIOSes—and SpinRite can use them to bypass DOS and call the ROMs directly.

Two other possible techniques are to read the controller status from the BIOS data area or get the status information from the controller itself.

Detecting Retries

Bypassing IBMBIO.COM allows a program to discover errors that were corrected via the ECC—but what about retries? The controller chips used in most PC and AT hardware adapters never report the fact that they've retried while reading a sector—not even to the BIOS. Most of the claims made for the different programs center around their ability to detect these errors that normally go unreported.

Disk Technician looks for retries using a timing approach. The disk drive controller has to wait for disk data to pass under the head again when it retries a read; Disk Technician detects this delay via the system clock and sensitive timing loops. Prime Solutions' literature states that this is the only possible way to solve the problem: "Disk Technician Advanced is the only software able to detect that the controller had to retry a sector." But engineers at controller manufacturer Western Digital say otherwise, noting that the IBM BIOS (which WD developed with IBM) has a provision for disabling retries. When this option is set, a

continued

WE HAD TO LEAVE OUT SOMETHING TO GIVE YOU ALL OF THIS

- AT Compatible 12 Mhz 80286 with 1 Meg of 0 Wait State Ram
- 8 ISA Expansion Slots (6-16 Bit, 2-8 Bit) 4 Full Length, 1 1/2 Length Slots free in standard model
- Expand up to 4 Megs on the motherboard, 16 Megs maximum Memory
- Includes EMS 4.0 driver for full 384K memory in 1 meg system (Most ATs limit this 384 K to useless shadow Ram)
- Advanced VLSI chip sets on motherboard and all I/O cards for enhanced reliability
- Runs with DOS 3.3, 4.01, OS/2, XENIX, Windows/286, Novel etc.
- Includes System User's Guide and Technical Reference Manuals

- Renaissance VGA card is 100% Hardware Register and BIOS compatible
- Packard Bell 640x480 256,000 color Analog Monitor with Tilt/Swivel Base
- VGA delivers up to 256 simultaneous colors at up to 640x480 resolution

- Choice of 64 Meg 28ms ST-277N SCSI or 40 Meg 28ms ST-251-1 1:1 MFM hard disk
- Choice of Top Quality Teac 1.2 or Teac 1.4 Meg floppy disk

- 3 5.25" and 2 3.5" drive slots, 3 free in standard system

- US Made Keytronics 101 key Keyboard has superior feel

- 2 Serial Ports, 1 Parallel Printer Port Standard
- 200 Watt Power Supply
- Real Time clock/calendar, ROM-based setup



\$1,895

PRICE:

Monochrome Graphics System, 60 Meg or 40 Meg
Diskless Network VGA Workstation

\$1,495
\$1,395

OPTIONS:

Teac 1.4 Meg 3.5" Floppy Drive

\$99

Microsoft MSDOS 3.3/4.01

\$79/\$89

OTHER OPTIONS

inquire

BitWise - Building and servicing PCs since 1985 - we understand what we sell! FREE SHIPPING to NY, New England, NJ, PA. Others, you pay UPS shipping ONLY, no surcharges. Full 1 Year Parts & Labor Warranty, 30 day money back guarantee. Personal Financing and Corporate Leasing Available. This is our price for cash in advance orders. VISA, MC, DISCOVER, COD welcomed (3% surcharge).

386-25 MHZ 0 wait state
40 or 60 Meg
VGA Monitor
4 Megs of RAM — \$3995.00
8 Megs of RAM — \$4795.00

1-800-367-5906
or 518-274-0755
FAX 518-274-0764

297 River St.
Suite 501
Troy, NY 12180-9933

BITWISE
DESIGNS, INC.

EZ-DOS

Break the stranglehold on your PC.

Digital Research & 2001 Sales have developed EZ-DOS as an enhanced replacement for your current DOS.

Now you can use the sophistication of EZ-DOS instead of accepting the limitations of another DOS.

The main features of EZ-DOS are:

- * DOS compatibility
- * Multiple 512 megabyte partitions - quit dissecting your hard disks
- * Password protection of files and directories
- * Full screen text editor
- * On-line HELP for command syntax
- * Command history
- * LIM 4.0 Extended memory driver
- * Menu based installation that works with all compatibles

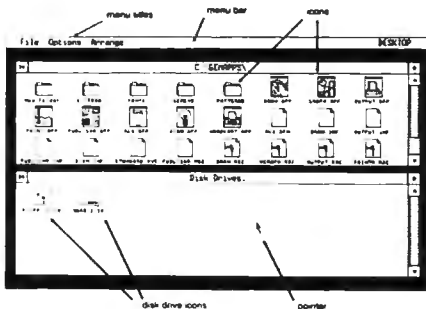

* A true graphic, windowing operating environment - GEM/3 Desktop is our user interface.

* Inexpensive - compare costs

- EZ-DOS 4.1 Deluxe..... \$79.00
- plus True BASIC..... \$99.00
- plus serial Mouse..... \$139.00
- plus T.BASIC & Mouse.. \$159.00

2001 Sales, Inc.

16580 Harbor Blvd., Ste. D
Fountain Valley, CA 92708.

Tel: (714) 531-6551

Fax: (714) 531-8546

Dealer, Distributor & OEM Inquiries welcome.
VISA and Master Card accepted.

correctly implemented BIOS and controller stop immediately and show *any* error instead of retrying. They also note that a timing approach may react to disk speed variations and unexpected interrupts.

Testing the Surface

Both SpinRite and Disk Technician can test the surface of your drive for defects

There's no way to make SpinRite or Desk Technician work with ESDI or SCSI drives right now.

not found by the original manufacturer's tests. They do this by writing "worst case" patterns—patterns that are most likely to cause errors—to the drive and seeing if they can be read back correctly.

Each program has a unique, proprietary set of patterns that changes with the encoding scheme used on the disk. Modified-frequency-modulation (MFM), run-length-limited (RLL), advanced-run-length-limited (ARLL), and enhanced-run-length-limited (ERLL) disks all require different signals to "bring out the worst" in a disk drive. The "worst" patterns tax the data separator and phase-locked loop circuitry by forcing maximum and minimum run lengths and going from high pulse rates to low ones and back again.

Adjusting the Interleave Factor

Both programs will also adjust the interleave factor on your disk drive for optimal performance. A caveat is in order, however: The optimal interleave suggested by the program may not be the best one under all circumstances.

For instance, if you're running OS/2 (both SpinRite and Disk Technician Advanced run under DOS), you may need to use a higher interleave factor; also, TSR programs may slow your system performance just enough to require a different interleave. If you're not sure, the tactic I would recommend is to take advantage of the nondestructive nature of these programs and carry out empirical performance tests to see which interleave factor actually works best.

Recovering Bad Tracks

One useful function both these programs will perform is to recover sectors that were unnecessarily marked as bad during a low-level format. Most low-level formatting programs will mark an entire track as bad if even one sector has a defect in it; this is usually overkill, because the rest of the track is likely to be good. Because these utilities can perform extensive tests on each sector of the track, they can restore the unblemished space to active use.

Parking the Head

Both packages also offer head-parking programs, which are designed to solve the problem of data loss due to friction and transients at power-on and power-off. SpinRite comes with a utility called PARK.COM that parks the heads; you run it before powering down.

Disk Technician comes with a TSR program called SPA (SafePark Advanced). This TSR program moves the disk drive heads to a "safe" area whenever the drive is inactive for a predefined period—a good idea if you aren't good at remembering to execute a program.

The Translating Controller Problem

A standard IBM PC hard disk has 17 sectors per track, with 512 bytes per sector. This configuration is ideal for a standard MFM drive, but drives that use different encoding schemes—such as RLL—have different optimal configurations. Most RLL controllers, for instance, can squeeze 26 512-byte sectors on a track; the Plus Development HardCards, which pack data very tightly indeed, have a variable number of sectors per track (more on the outside than on the inside).

DOS is capable of handling disks with more than 17 sectors per track, but some other operating systems (such as older versions of NetWare) aren't. To run with these environments, many controllers perform *sector translation*. A translating controller "tells" the system that the disk has 17 sectors per track and more cylinders than it really has but keeps the total number of sectors in the "imaginary" drive the same as the number that exist on the real drive. Then, when the system does I/O to a sector on the imaginary disk, the controller uses a simple algorithm to pick a corresponding sector on the real disk and diverts the request to that sector.

Neither SpinRite nor Disk Technician Advanced is equipped to work with a translating controller. These utilities need to know which sectors are really on

continued

Now workgroup computing is simple. Thanks to VM/386 MultiUser, several terminals or PCs can share one 386 computer. Just add VM/386 MultiUser, a graphics adapter card and/or a multi-port card to your 386, and you'll have a multi-user system that is completely DOS compatible.

In fact, each application program sharing your 386 will have its own copy of DOS. So everyone

will be able to continue using their favorite programs, without changing the way they work. As one user told us: "All you see is your application and DOS. You don't even know you're running on a multi-user system."

VM/386 MultiUser is based on VM/386,™ our multitasking program, which has won both the PC Magazine Technical Excellence award and Editor's Choice award.

We've built that same solid product quality and functionality into VM/386 MultiUser.

Want more than one user to share your 386? VM/386 MultiUser is the easiest, most cost-effective way around the DOS single-user barrier. For more information, contact: IGC, 4800 Great America Parkway, Santa Clara, CA 95054
Tel: 408-986-8373
Toll Free: 800-458-9108

Finally: Multi-user DOS

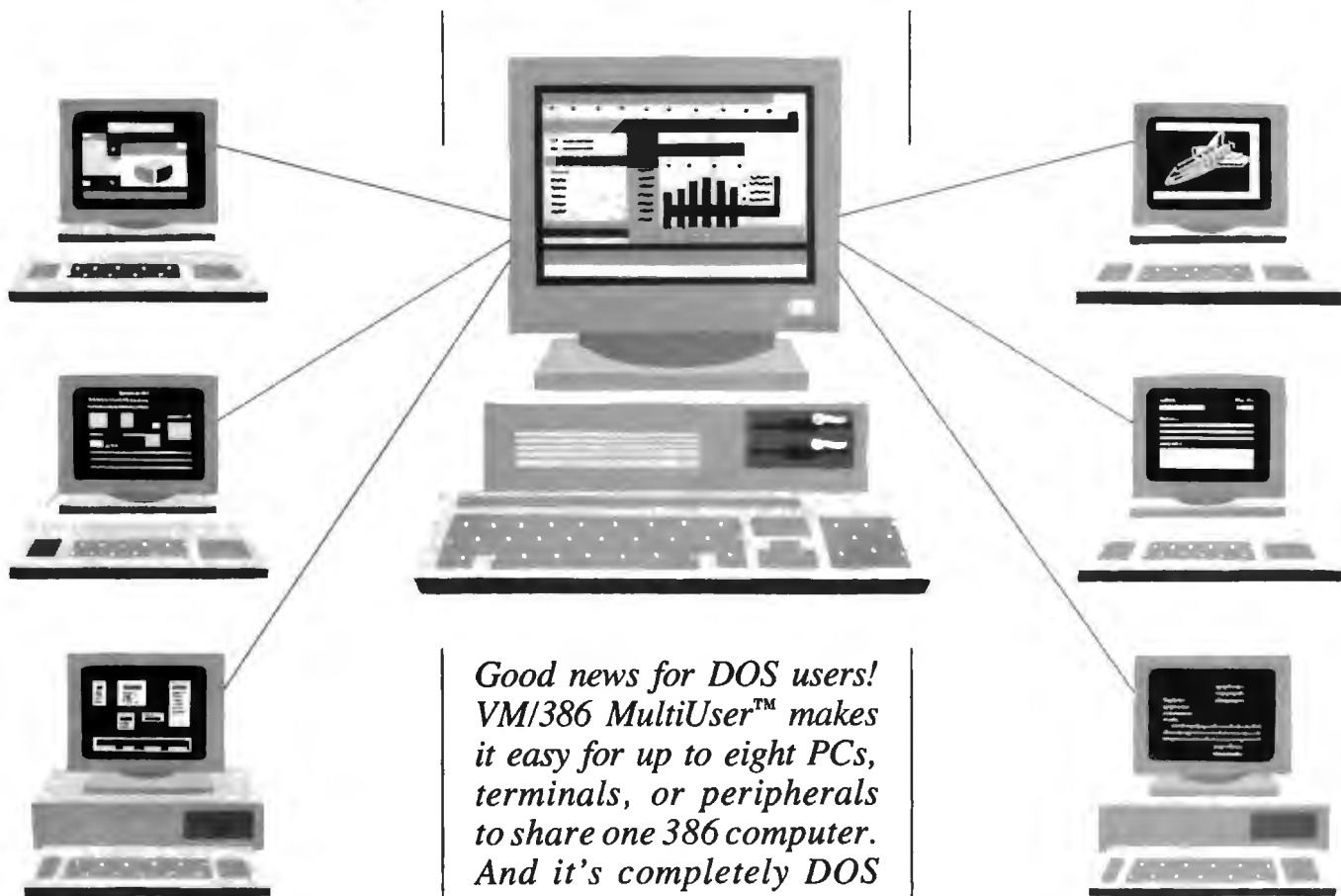

*Good news for DOS users!
VM/386 MultiUser™ makes
it easy for up to eight PCs,
terminals, or peripherals
to share one 386 computer.
And it's completely DOS
compatible.*

IGC

Let us help make your job easier



A Brand New Resolution The Handy Scanner HS-3000

Free HALO DPE™

The Handy Scanner HS-3000 from DTP offers you clarity and accuracy in a little package. Like the other Handy Scanners, the Handy Scanner HS-3000 fits the IBM PC, PCs and compatibles in terms of most of the time the desktop scanner can't do a scan and return to you.

We give you the scanner you need the most in a Handy Scanner. The new 4.1" scanning width makes other words of the original product. You can't reach the scanner between 400-200-100 DPE. For more than 1000 dpi resolution, the Handy Scanner HS-3000 has a 100 dpi resolution. The real-time screen display lets you instantly see your scan so you can quickly make scanner adjustments as necessary. With adjustable full scan and contrast, you get a clear, true picture. Two col-

ors, not one, are used to scan your originals. In fact, one such as red or yellow can now be scanned without losing detail.

The Handy Scanner HS-3000 comes complete with full featured powerful software for scanning, editing, and copying you with your graphics. Based on files any computer will almost all graphics software (including PageMaker, Ventura WordPerfect 3.0 and many others). The package includes the scanner interface card, the HALO DPE (drinking pulling off) font package (worth \$195), a utility diskette and an instruction manual.

The Handy Scanner HS-3000 is a high scanner that does a lot and more in just a few hours.

\$299.95 \$229.95

Now Available for PS 2

NOW DELUXE OCR VERSION

Trainable to read many "loose" proportional and typeset fonts such as Times Roman, Helvetica, Modern and Title. Supports popular PC word processors - WordPerfect, WordStar, MicroSoft Word, Multimate, IBM, DCA, DisplayWrite 3.0, Volkswriter 3.0, Xywrite, PC Write. Also processes scanner and FAX images of a variety of image data formats. Reads images of TIFF, PCX, CUTT, Group 3 FAX formats. Runs on PC/XT computer & compatibles. Requires MSDOS 3.0+ 640K.

Deluxe OCR and HS3000 \$459.95

Mono Spaced OCR HS3000 & OCR \$329.95

NEW for HS3000 CADSCAN SOFTWARE \$139.95



1ST QUALITY MERCHANTISE QUALITY CUSTOMER SERVICE 508-278-6555 TECHNICAL ASSISTANCE 508-278-6556 FOR YOUR PROTECTION WE CHECK FOR STOLEN CREDIT CARDS

TOLL FREE ORDER LINE
1-800-635-0300
TRUE DATA PRODUCTS
115 MAIN ST., P.O. BOX 347
UXBRIDGE, MA 01569
508-278-6555
HOURS: MON-FRI 9-6, SAT 10-4 (EST)

CORPORATE P.O. & WELCOME!
ALL PACKAGES SHIPPED UPS EXCEPT CANADA AND A.P.O. & C.O.D. & ADD \$2.75 MASTERCARD/VISA ADD 2%
ALL RETURNS MUST HAVE RMA# (CALL 508-278-6555). YOU MAY BE SUBJECT TO A RESTOCKING FEE. SHIPPING/HANDLING CHARGES NON-REFUNDABLE.
1 YEAR WARRANTY UNLESS OTHERWISE NOTED. PRICES/TERMS/CONDITIONS SUBJECT TO CHANGE WITHOUT NOTICE.

which tracks in order to perform interleaving or low-level formatting; they won't be able to do the right thing if the controller is trying to "outsmart" them.

Fortunately, on the Western Digital 1002-27x, one of the most common RLL controllers, translation can be turned off by moving a jumper. You can use the controller with these packages if you back up the disk, shift the jumper, and then repartition and reformat.

No ESDI or SCSI... Yet

Unfortunately, there is no way to make either SpinRite or Disk Technician work with ESDI or SCSI drives right now. In ST-506/MFM and RLL configurations, the controller contains the data separator and determines the encoding scheme. But in ESDI, the data separator is in the drive itself. Different drives can use different encoding schemes; most ESDI drives use 2,7 RLL, but there's nothing to stop them from using 1,7 RLL, group codes, or even zone bit recording (ZBR). The program must know which is used to determine the correct worst-case test pattern.

Another problem can also keep low-level reformatting programs from working with ESDI drives. PC-DOS and some PC BIOSes have an internal limit of 1024 cylinders per drive. Most ESDI drives above 300 megabytes have more—my Maxtor XT4380, for example, has 1222 cylinders. So, in order to let DOS use all of that big hard disk, I use a translating ESDI controller.

This controller (in my case, the DTC 6280) "fools" DOS into believing that the disk has *more* sectors per track and *fewer* cylinders than it really has. An operating system that requires 17 sectors per track won't run with this configuration, but DOS doesn't mind (nor does OS/2, because the controller is register-compatible with the standard AT controller). Even so, a low-level maintenance program won't be able to do its work properly unless it knows the true configuration.

SCSI presents a similar problem. Blocks on a SCSI device are normally referenced by their "absolute" numbers relative to the start of the disk; the attached computer is not supposed to know—or need to know—how the sectors are laid out or how the data is encoded. This makes it difficult for any optimizer or disk fixer to do more than refresh the data in each sector and perhaps look for errors.

Finally, *no* low-level reformatting utility will work correctly on Priam hard

continued

SHOOT TO THRILL!

Count Disk Computer Dart Gun Game

Relieve stress and have hours of fun with your computer!

\$19.95



INCLUDES:
 *45 Caliber Dart Gun
 *6 Soft Darts (Suction Type)
 *5.25" Game Disk With:
 Bullseye Darts
 Championship Darts
 Baseball Game
 Count Disk Target
 Executive Decision-maker
 Boss Panic Screen
 And FREE membership to the Count Disk Club

1-800-344-1996

Supports: IBM, & Compatibles, CGA, EGA, VGA and Hercules

*To order call our toll-free order line or send \$19.95 + \$3.00 (S & H) Check or Money Order to Count Disk, 2601-38 South Military Trail, Suite 164, West Palm Beach, FL 33415. Florida residents add 6% sales tax. Dealer inquiries welcome at (407) 241-6050.



Compuclassics

ACCOLADE	
Test Drive	22 00
ADOBE	
Illustrator/Windows	409 00
ALDUS	
Pagemaker	499 00
ALPHA	
Alpha/408	319 00
AMERICAN SMALL BUSINESS	
Design Cad	159 00
Design Cad 3D	209 00
APPLAUSE	
Perfect Addition	39 00
APPLICATION TECHNIQUES	
Pivaz Plus	89 00
ASHTON-TATE	
DBase IV	499 00
Framework III	455 00
DBase III Plus	455 00
Mastergraphics	295 00
Multimate Advantage II	295 00
ASK SAM	
Ask Sam	179 00
AUTODESK	
Autosketch 2.0	85 00
BANNER BLUE	
Org Plus	55 00
BLOC PUBLISHING	
Formtool	55 00
BLAISE	
Turbo C Tools	92 00
Turbo Power Tools Plus	92 00
BORLAND	
Turbo C	99 00
Turbo Pascal	99 00
Turbo C Pro	169 00
Turbo Pascal Pro	169 00
Quattro	165 00
Sidelock Plus	135 00
Turbo Assembler/Debugger	99 00
Paradox	479 00
BOURBAKI	
1 Dir Plus	49 00
BRIDGEWAY	
Fast Trax	35 00
BRODERBUND	
Print Shop	39 00
Memory Mate	45 00
BUMBLEBEE	
DB Fast/DBS	60 00
BUTTONWARE	
PC File DB	69 00
CALIFORNIA SCIENTIFIC	
Brainmaker	79 00
CENTRAL POINT	
PC Tools Deluxe	79 00
Copy II PC	25 00
CHANNELMARK	
Quick Schedule Plus	49 00
CHRONOS	
Who/What/When	119 00
CLARION	
Professional Developer	409 00
COMPUTER ASSOCIATES	
Supercalc 5	319 00
Superproject Expert	455 00
CONCENTRIC DATA	
R & R Report Writer	109 00
CORE	
Corefast	79 00
CROSSTALK	
Crosstalk Mark 4	125 00
Remote 2	95 00
DAC	
Lucid 3D	160 00
DAC Easy Bonus Pack	115 00
DAC Easy Accounting	59 00
DATAEASE	
Database 4.0	499 00
DATASTORM	
Procomm Plus	49 00
DELFINA	
Perform	172 00
DELTA TECHNOLOGY	
Direct Access	55 00
DIGITAL RESEARCH	
Gem Artline	285 00
Gem Draw Plus	179 00
DIGITALK	
Smalltalk V285	145 00
DYNAMIC MICROPROCESSOR	
PC Anywhere III	80 00
ELECTRONIC ARTS	
Maxis Beacorn Teaches Typing	35 00
Deluxe Paint II	69 00
EPYX	
California Games	25 00
FIFTH GENERATION	
Fastback Plus	109 00
FORNWORX	
Formwork w/ Fill & File	99 00
FOX	
Fontbase Plus	199 00

FUNK	
Sideways	42 00
Allways	85 00
GAZELLE	
ODDS II	39 00
GENERIC	
Generic CADD Level 3	169 00
GIBSON	
Spinrite	50 00
GOLDEN BOW	
V Cache	45 00
HAVENTREE	
Interactive Easy Flow	115 00
IBM	
DOS 4.01	125 00
Displaywrite IV	289 00
INDIVIDUAL	
101 Macros For WordPerfect	45 00
INSET	
Inset Plus	139 00
INSIGHT DEVELOPMENT	
Laser Control	85 00
Print-A-Plot	105 00
INTUIT	
Quicken	35 00
LASERGO	
Go Script	139 00
Go Script Plus	269 00
LEARNING COMPANY	
Reader Rabbit	25 00
LOTUS	
Agenda	275 00
Other Products	Call
MATHSOFT	
Mathcad	215 00
MECA	
Managing Your Money	119 00
MERIDIAN	
Carbon Copy Plus	115 00
MICROGRAFX	
Windows Graph Plus	329 00
Designer	449 00
MICROLOGIC	
Tornado	55 00
MICROLYTICS	
Gofor	42 00
MICROPROSE	
F19 Stealth Fighter	49 00
MICRORIM	
RBase For DOS	489 00
MINDSCAPE	
Balance of Power	30 00
MULTISOFT	
PC Kwik Power Pack	79 00
MICROSOFT	
Quickbasic	67 00
Quick C	67 00
Windows 286	67 00
Windows 386	135 00
Excel	249 00
Macro Assembler	99 00
C Compiler	299 00
Word	209 00
Flight Simulator	35 00
MICROTEKNOLOGY	
Softbytes 286	35 00
NANTUCKET	
Clipper	439 00
HEW ENGLAND	
Graph-In-The-Box	75 00
NOLO	
Willmaker	35 00
NORTH EDGE	
Timeslips III	169 00
NOVELL	
Advanced Net 2.15	1895 00
Other Products	Call
OWL	
Guide	169 00
PAPERBACK	
VP Planner Plus	129 00
PATTON & PATTON	
Flowcharting II Plus	139 00
PAUL MACE	
Mace Utilities	55 00
PEACHTREE	
Compte Accting W/Data Query	235 00
PERSOFT	
Ize	265 00
Smartterm 240	209 00
PERSONICS	
Ultravision	79 00
See More 1-2-3	49 00
PETER NORTON	
Norton Utilities	59 00
Norton Commander	52 00
Norton Utilities Advanced	89 00
POLARIS	
Packrat	265 00
PRECISION SOFTWARE	
Superbase 4	499 00
PRIME SOLUTIONS	
Disk Technician Advanced	119 00
PRIMETIME	
Primetime	69 00
PROXIMITY TECHNOLOGY	
Choice Words	65 00

PURTECH	
File Organizer	145 00
QUAID	
Copywrite	55 00
QUALITAS	
386 To The Max	60 00
QUARTERDECK	
Desqview	79 00
QEMM 386	37 00
REFERENCE	
Grammatik III	57 00
RIGHTSOFT	
Rightwriter	52 00
RIX	
Colorix VGA Paint	109 00
ROYKORE	
Opus One	275 00
SAMNA	
AMI	129 00
SANTA CRUZ OPERATIONS	
SCO Operating System 286	405 00
SCITOR	
Project Scheduler 4	429 00
SIERRA ON-LINE	
Leisure Suit Larry #2	32 00
Kings Quest IV	37 00
Space Quest III	39 00
SIMON & SCHUSTER	
Webster Prof Thesaurus	79 00
SOFTKLONE	
Mirror III	65 00
SOFTLOGIC	
Disk Optimizer	45 00
SOFTWARE DIRECTIONS	
Print Q	89 00
SOFTWARE MASTERS	
Flash	49 00
SOFTWARE PUBLISHING	
Harvard Graphics	289 00
PFS 1st Publisher	79 00
PFS 1st Choice	95 00
PFS 1st Graphics	85 00
Professional Write	139 00
SOLUTION SYSTEMS	
Brief	169 00
SPECTRUM HOLOBYTE	
Tetris	24 00
Falcon-A1	32 00
STSC	
Statgraphics	589 00
STORAGE DIMENSIONS	
Speedstor	39 00
SUBLOGIC	
Jet	32 00
Scenery Disks	Call
SYMANTEC	
Q & A	229 00
TimeLine	389 00
Grandview	189 00
SYMSONT	
Hotshot Graphics	149 00
SYSTEMS COMPATIBILITY	
Software Bridge	79 00
THREE D GRAPHICS	
Perspective Jr	109 00
TIMWORKS	
Publish It!	125 00
TRAVELING SOFTWARE	
Laplink III	85 00
Viewlink	89 00
TURBO POWER	
Turbo BTree Filter	79 00
Turbo Professional	79 00
UNISON WORLD	
Printmaster Plus	32 00
VERSASOFT	
DB Man V	139 00
WHITE CRANE	
Brookline Bridge	75 00
WOLFRAM RESEARCH	
Mathematica 386	599 00
WORDPERFECT	
Word Perfect	239 00
Word Perfect Library	69 00
Word Perfect Network	355 00
WORDSTAR	
Wordstar Professional 5.5	239 00

WORDTECH	
Quickcover Diamond	349 00
DRM Diamond	145 00
XEROX	
Ventura Publisher	519 00
Xerox Presents	119 00
ZOR	
NFL Challenge	59 00
ZTREE	
Xtree Pro	69 00
ZSOFT	
Publishers Paintbrush	69 00
HARDWARE	
ACER	
Computers	Call
AST RESEARCH	
5251/11 Enhanced	599 00
Six Pak Plus 64K	129 00
ATI	
VGA Wonder 256	335 00
BELKIN/DATASPEC	
Callies/Switchboxes	Call
CENTRAL POINT	
Copy II Option Deluxe	119 00
CURTIS	
Ruby Plus	65 00
ELGAR	
IPS 1100 Power Backup	979 00
EVEREX	
Internal 2400 Modem	149 00
Computers	Call
FIFTH GENERATION	
Logical Connection 512K	529 00
HAYES	
Smartmodem 2400	449 00
HEWLETT PACKARD	
Font Cartridges	Call
IBC	
AT Replacement Battery	19 50
INTEL	
Above Board Plus 512K	449 00
Coprocessors	Call
KENSINGTON	
Masterpiece Plus	109 00
KEYTRONIC	
KB101 Plus Keyboard	39 00
KYE	
Genius Mouse	54 00
LOGITECH	
Scanman PC	199 00
New Logmouse	89 00
MICROSOFT	
Bus or Serial Mouse w/Paint	109 00
MICROSPPEED	
Fast Trap Serial	95 00
MOUSE SYSTEMS	
Bus or Serial PC Mouse II	89 00
NEC HOME	
Multisync 3D	739 00
ORCHID	
Pro Designer VGA Plus	409 00
PANASONIC	
KXP 1124 Printer	369 00
PARADISE	
VGA Plus	295 00
POLAROID	
EGA Palette	7399 00
PLUS	
Handcard 40	699 00
PRACTICAL PERIPHERALS	
2400 External Modem	179 00
SEAGATE	
Hard Disks	Call
SUMMAGRAPHS	
Summascript Plus 12x12	419 00
SYGEN	
Bridge File w/adaptor	289 00
TOSHIBA	
Printers	Call
TOUCHBASE	
Worldport 2400 Modem	255 00
Worldport 2496 Fax Modem	499 00
VIDEO 7	
Vram VGA 256K	499 00

We ship to
APO & FPO
PO
Boxes

WE
WELCOME
CORPORATE
ACCOUNTS AND
INTERNATIONAL
ORDERS

**FAX YOUR
ORDER!**
**(818)
347-
9977**

► IMMEDIATE SHIPMENT ON PURCHASE
ORDERS FROM GOVERNMENT AND STATE AGENCIES,
CITIES, COUNTIES, SCHOOL AND UNIVERSITIES.

► Prices subject to change without notice and while stocks
last. ► We Ship the latest versions. ► We accept Visa, Master
card, American Express. ► 2% Surcharge on American Express.

► Please call (818) 347-9400 for an Authorization # for defective goods or
your return will not be accepted. ► Due to copyright laws we cannot take
back any software where the seal has been broken. ► \$5 minimum shipping
per item, less on bulk orders. ► \$9 Blue Label shipping. ► 3.50 C.O.D. charge.

► Heavier items are charged accordingly. ► We do not guarantee compatibility.
► Call for prices for any software item not included in this ad. ► Order desk open 7 a.m.
to 5 p.m. (PST), Saturday 10 a.m. - 2 p.m. (PST). ► P.O. Box 10598, Canoga Park, CA 91309.
Showroom: 7959 Deering Ave., Canoga Park, CA 91304 ► Customer Service 818 347 9400.
General Office 347 9500

ORDERS CALL 800 733 3888

Circle 58 on Reader Service Card

disk drives. Priam explicitly forbids the use of any such utility on its disks, which require a special type of low-level format.

Long-Term Maintenance

Although both software vendors recommend that you run their programs daily or at least weekly, SpinRite and Disk Technician Advanced take distinctly different philosophical approaches to the problem of long-term hard disk maintenance.

The SpinRite documentation reads like a good tutorial on hard disks. Hard disk errors are inevitable, it says; but with regular maintenance, even sectors that have slight defects can be kept in use. You're encouraged to be knowledgeable about what goes on inside your hard disk drive and take control.

Disk Technician Advanced has fewer technical explanations. The documentation simply assures you that its "artificial intelligence" features will take care

of all your hard disk problems. Unlike SpinRite, Disk Technician Advanced maintains a database with cumulative information on where errors have occurred. This lets the program track repeated trouble spots. Disk Technician Advanced does not appear to be as tolerant of "weak" sectors as SpinRite; it takes them out of service rather than refreshing them regularly.

Peace of Mind?

Both SpinRite and Disk Technician are worthy programs; still, no matter what assurances the literature gives, it's important to use low-level maintenance software intelligently rather than in a spirit of blind trust. Some things can and do go wrong, and you will certainly rest easier if you know how to avoid some of the most common pitfalls inherent in these utilities.

One lesson I've learned—the hard way—is never to run this type of utility on a disk drive that's not fully warmed up. Disk Technician Advanced strongly recommends that you load it from a floppy disk, and SpinRite insists on it, so it seems natural to run either utility when you start the machine in the morning. In theory, the drive's temperature compensation should let this work; in practice, it's not a good idea.

Some time ago, I noticed that a particular Seagate 4026 hard disk drive was producing a few (not many) errors. In an attempt to prevent these errors from getting worse, I started work one morning by running Disk Technician Advanced on the drive.

After an hour of nightmarish noises—the kind I dread hearing from a disk drive—I discovered that Disk Technician Advanced's "artificial intelligence" algorithms had marked more than half the drive as bad, including some areas that had never failed before. But after I had let the drive warm up, performed a low-level reformat using the AT Advanced Diagnostics, and transferred the files back to the disk, Disk Technician gave it a clean bill of health. (After that experience, I replaced the drive with a Maxtor, which has worked perfectly to this day.)

Some users have reported that Disk Technician Advanced may be a bit too sensitive—that it sometimes marks larger and larger portions of a hard disk bad as time goes by. I don't know if this is generally true or not, but I suspect that at least some such problems are due to the thermal effects I saw. The lesson: Heed the manual. If you check your disk, do it at the end of the day, when your drive is

continued

TRY THIS ON A STANDARD DESKTOP PUBLISHING SYSTEM

$$\int_{-\infty}^n \frac{X^{y \cdot Z} dt}{X - tY} = \sum_{i=1}^n \left(\frac{(x^4 - i)^3}{\sqrt{Z^3 + y^{10}}} \right) / (Z - X^5 Y)$$

For professional looking mathematical formulation, tables and scientific notation—no matter how complex—PC_TEX is unequalled. That's why many university engineering departments and scientific societies now require papers for publication be submitted in T_EX. In the world of desktop publishing systems, INFO_WORLD rated PC_TEX #1, saying: "...No non-T_EX-based program has such a comprehensive built-in grasp of typological aesthetics..."

And from PC MAGAZINE: "...You can achieve incredible precision in formatting text, especially mathematical expressions."

TYPESET & FORMULAS & MANUALS

In the same format as dIfferEnt

BIG WIDE OR NARROW LIGHT or BOLD

IT'S NICE TO KNOW PC_TEX WON'T LIMIT YOUR IMAGINATION.

WHEN YOU ADD PC_TEX, COUNT ON MORE THAN PRETTY NUMBERS.

Finished with the formula? Then try this formatting exercise on a standard desktop system. All positioning, sizing and typesetting are done with PC_TEX—no more cut'n'paste.

INFO_WORLD again: "...Enormously flexible and offers complete control over the output of your printer."

And with Bitstream's 30+ font families, any type of type you like is easy as

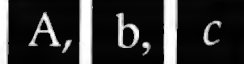

PC_TEX = the professional camera-ready, publisher-ready manuscripts you want.

PC_TEX SUBTRACTS TIME FROM AUTHOR TO PRINTED PIECE, MULTIPLIES AUTHOR CONTROL.

For a free PC_TEX demo diskette, the new PC_TEX 88 product catalog and information on a PC_TEX configuration for your system, give us a call at 415-388-8853

TRY IT WITH PERSONAL T_EX INC

12 Madrona Ave. Mill Valley CA 94941

PC_TEX is a registered TM of Personal T_EX, Inc. T_EX is an American Mathematical Society TM. Manufacturer's product names are their TMs. Inquire about PTI distributorships. Site licenses available to qualified organizations. This ad was typeset using PC_TEX and Bitstream fonts.

Tatung super VGA: 1024 x 768

NEC™ super VGA: ooooooooops!

Even the great ones slip every now and then. For instance, NEC's Multisync 2A™ is a good Super VGA monitor. But our Super VGA monitors give you more of what Super VGA is all about: **maximizing every ounce of potential a VGA card can offer... no matter what card is used.**

Both brands offer 100% VGA and 800x600 compatibility. But, with appropriate cards, our Super VGA monitors will deliver

40% higher resolution. That's just part of the picture. Along with superior image quality, Tatung Super VGA monitors are more versatile, incredibly reliable, and more affordable. Check the chart.*

Tatung Super VGA. You have to see it to believe it. And you can see it at your Tatung dealer. Or call for complete details. We'll send them along with the name of the Tatung Dealer near you.

FEATURES	NEC Multisync 2A	Our CM-1496X	Our CM-1498X
Max. Res.	800 x 600	1024 x 768**	1024 x 768**
CRT Size	14"	14"	14"
Dot Pitch	0.31	0.31	0.28
IBM 8514™ Compatible	NO	YES	YES
Sugg. Retail	\$799	\$749	\$799
Maximum Resolution w/Graphic Card (Partial List)			
ATI VGA Wonder™	800 x 600	1024 x 768**	1024 x 768**
GENOA Super VGA Hi-Res Model 5400™	800 x 600	1024 x 768**	1024 x 768**
RENAISSANCE GRX RENDITION II/256™	800 x 600	1024 x 768**	1024 x 768**
STB VGA EM-16™	800 x 600	1024 x 768**	1024 x 768**
TECMAR VGA/AD™	800 x 600	1024 x 768**	1024 x 768**

**Interlaced



TATUNG

We monitor the world.

Tatung Company of America, Inc., 2850 El Presidio St., Long Beach, CA 90810 (213) 979-7055
Tatung Science & Technology, Inc., 2060 Ringwood Ave., San Jose, CA 95131 (408) 435-0140
Outside California: (800) 421-2929 - Eastern Region: (609) 395-6770



fully warmed up. It may save you a lot of headaches.

The second point (and I can't emphasize this enough): It's super-important to make *complete* backups before running these utilities. Each has, at one time or another, discovered or created a situation where I've had to restore some or all of my disk from a backup.

Finally, since both of these programs are "working around" the limitations of the operating system software and disk drive controller hardware, they sometimes fail to do the right thing despite their best efforts. For instance, both SpinRite and Disk Technician Advanced perform a bit of "black magic" in an attempt to determine what kind of hard disk drive controller you have—and sometimes they guess incorrectly. One of my machines contains a Western Digital WDM-2 motherboard with an MFM hard disk drive controller built in. The hard disk drive—a Seagate 4051—is divided with FDISK into two partitions: C and D.

SpinRite and Disk Technician Advanced both worked on the C partition and correctly determined that it was an

ITEMS DISCUSSED

Disk Technician Advanced\$189.95
Prime Solutions, Inc.
1940 Garnet Ave.
San Diego, CA 92109
(800) 847-5000
(619) 274-5000
Inquiry 1179.

SpinRite\$59
Gibson Research Corp.
2291 La Cadena
Laguna Hills, CA 92653
(714) 830-2200
Inquiry 1180.

MFM drive with a 2-to-1 interleave. However, both malfunctioned on partition D, reporting strange interleave factors and/or encoding schemes. (I have reported the problem to both vendors, and each says that it has, or is working on, a fix.) So be sure to keep a watch on these utilities as they go to work; if you see anything unusual, it's a good idea to abort the program immediately.

In the long term, disk maintenance utilities should be part of the operating system rather than special-purpose tools. (The only operating system I'm aware of that performs any disk maintenance as a part of normal operation is Novell's SFT NetWare, which runs only on dedicated network servers.) As multitasking becomes commonplace, it will make sense to run disk maintenance utilities as background tasks; for those of us who run DOS, it would be convenient to have them as TSR programs.

In the meantime, the best policy is to buy a good hard disk drive in the first place—one that parks the heads when it powers down. Then—if your drive and controller permit—use a low-level disk maintenance utility to help keep your hard disk drive in top fighting form. ■

L. Brett Glass is a freelance programmer, author, and hardware designer residing in Palo Alto, California. He can be reached on BIX as "glass."

Your questions and comments are welcome. Write to: Editor, BYTE, One Phoenix Mill Lane, Peterborough, NH 03458.

How to make 2 plus 2 equal 1.

Get the DSDP-402 communication board, from Qua Tech. Along with two independent parallel ports, it has two optional serial port modules that can support any combination of RS-232, RS-422, or RS-485 at the same time.

The DSDP-402's parallel ports offer the convenience of connecting two printers to your PC-AT workstation or file server.

The serial ports have selectable and sharable interrupts.

And all ports are address

selectable, so they won't interfere with existing serial or parallel hardware.

All on one board, all in one slot.

For order info, call:
1-800-553-1170.



QUA TECH

QUA TECH, INC.
478 E. Exchange Street
Akron, OH 44304

SUBSCRIPTION PROBLEMS?



We want
to
help!

If

you have a problem with your BYTE subscription, write us with the details.

We'll do our best to set it right. But we must have the name, address, and zip of the subscription (new and old address, if it's a change of address). If the problem involves a payment, be sure to include copies of the credit card statement, or front and back of cancelled checks. Include a "business hours" phone number if possible.

BYTE MAGAZINE

ATTN: SUBSCRIBER SERVICE
P.O. Box 555
HIGHTSTOWN, NJ 08520

The Cool Machine Cometh

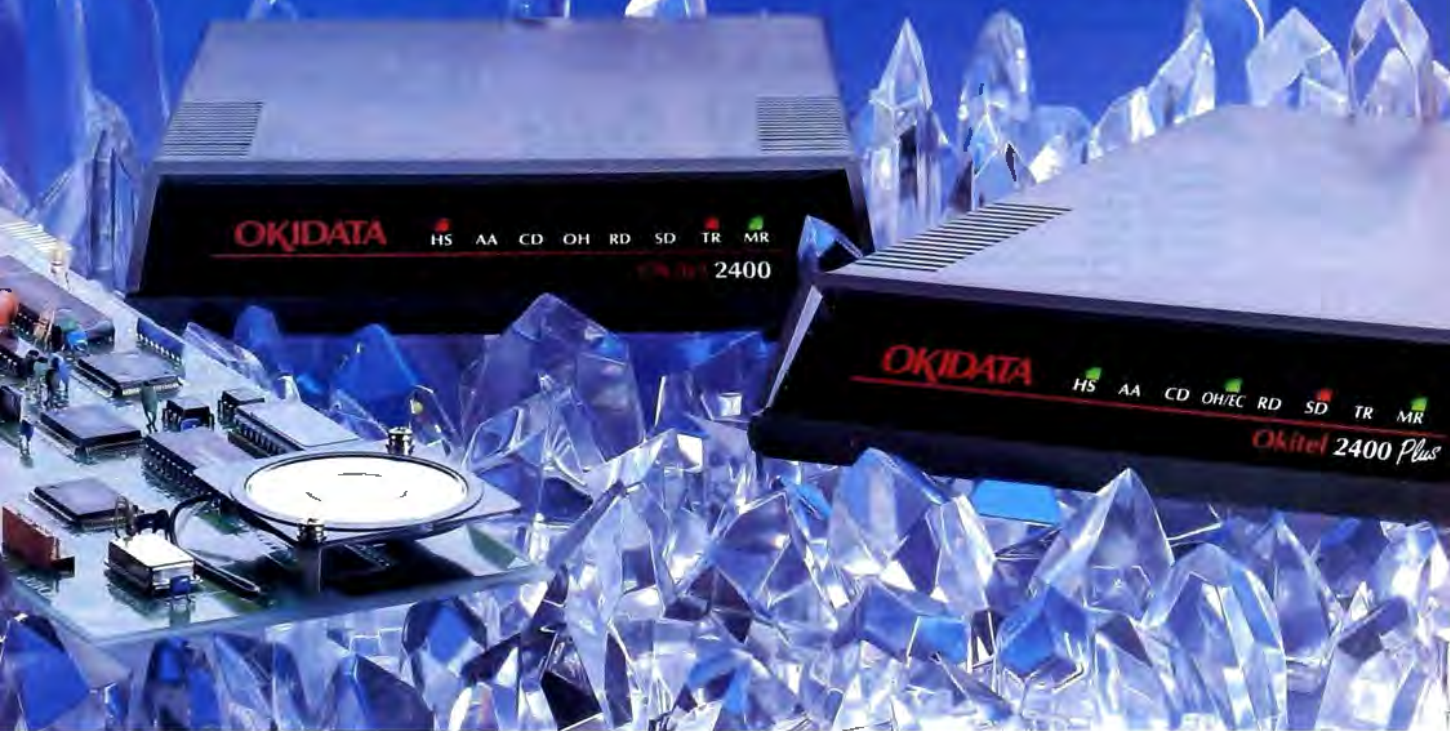

OKIDATA introduces a line of PC modems that run so cool they're guaranteed for 5 years.

Our new 1200, 2400 and 2400 Plus PC modems are built around a very simple fact: the cooler they run, the longer they last.

That's important in any modem, and it's vital in the case of an internal board. That's why we engineered a special chip that does the work of three ordinary chips. It also generates less heat—and consumes 50% less power—than the leading brand. Which is why we back our modems twice as long as they do.

But reliability on the inside comes as no surprise when the OKIDATA name is on the outside.

We have over a century of experience in telecommunications all over the world. And you'll see it in everything we make, from tank-tough printers to award-winning PC modems to a full line of high-speed modems.

To see our new "cool machines" in person, visit your OKIDATA dealer. Or call 1-800-OKIDATA for the name of the dealer nearest you.

Circle 320 on Reader Service Card

PC DIGEST

... gave five stars to our 1200 bps modem and top-rated our 2400 bps modem.

PC WORLD

... gave our 2400 their coveted "Best Buy" title.

Registered Trademarks: OKIDATA, Oki America, Inc.
Marque déposée de Oki America, Inc.
Trademarks: PC Digest, National Software Testing Laboratories, Inc.; PC World, PC World Communications, Inc.

OKIDATA[®]
an OKI AMERICA company

We put business on paper.



COMPUTER DISCOUNT WAREHOUSE™



#1

- CDW Sales
- CDW Services/Support
- CDW Product Knowledge
- CDW On Time Delivery



ZENITH data systems

Supersport 86, 2 Drive	CALL
Supersport 86, 20 Meg	CDW*
Supersport 286, 20 Meg	FOR
Supersport 286, 40 Meg	LOWEST
TurboSport 386, 40 Meg	ZENITH
TurboSport 386, 40 Meg w/modem	PRICING

WHY PAY RETAIL?

CDW™ Sells For Less

AND SERVICES YOU BETTER

S-330 4.77/10 MHz, 640K, 6 Slots, Built-in CGA, DOS 3.3, Enhanced Keyboard
 S-330, 1 Floppy \$745.50
 S-330, 20 Meg/40 Meg \$994.95/1019.52
 S-550 AT Compatible 8/12 MHz, 8 Slots, 25/PC, Built-in EGA, DOS 3.3, Enh. Keyboard
 S-550, 1.2M Floppy \$1220.45
 S-550, 20 Meg/40 Meg \$1569.80/1695.45
 S-800, 386 20 MHz, 8 Slots, 1 Meg, 1.2 & 720 Floppies \$2570.69
 S-800, 40 Meg/80 Meg \$2990.01/3280.00
 S-800, 40 Meg (28 ms) \$3050.50

SAMSUNG



Facsimile Products

SHARP FO-220	\$454.48
SHARP FO-300	1194.10
SHARP FO-330	1084.70
Complete Fax 9600	396.50
QUADRAM JTFAX 9600 Int.	\$27.85
QUADRAM JTFAX Portable	\$26.25

HARDWARE, SOFTWARE & PERIPHERALS AT DISCOUNT PRICES

COMPUTERS

AST SPECIALS

MDL 140	CALL CDW™ MDL 340C	IN STOCK
MDL 140	FOR ALL MDL 310C & READY	
MDL 170	AST MDL 350C	TO SHIP
MDL 300C	PRICING	

WORKSTATIONS

AST 105X	ALL AST
AST 386SX Model 5/Model 45	WORKSTATIONS
AST Bravo	IN STOCK
SAMSUNG PC TERMINAL 286	\$1054.85
EARTKSTATION V40 or 286, Arcnet or Ethernet	CALL

PACKARD BELL

PK8000 12 Meg	\$1218.70 PK8000 12 Meg	\$1198.60
PK8000 40 Meg	\$1614.81 PK8000 16 Meg	\$1384.70

IBM PS2

MDL 30, 20 Meg	\$1655.17 MDL 502, 60 Meg	\$2710.20
MDL 60, 40 Meg	\$3340.16 MDL 70, 60 Meg	\$3747.20
MDL 60, 70 Meg	\$6444.52 MDL 120, 121 Meg	\$5250.84
MDL 30286 1 dr	\$1412.10 MDL 80, 40 Meg	\$374.40
MDL 30286 20 Meg	\$1929.80 MDL 80, 70 Meg	\$5069.37
MDL 502E, 30 Meg	\$2876.75 MDL 80, 315 Meg	\$2624.19

COMPAQ

286, Md1 1	\$1699.95 386-20E, 40 Meg	\$4565.12
286E	NEW 386-20E, 100 Meg	\$5654.22
386, 20 MHz, 130	\$718.33 Port II, Md 2,	\$1858.10
386, 25 MHz, 80	\$683.90 Port II, Md 4,	\$897.42
386S, Md 1	\$234.49 Port II, Md 20	\$3495.85
386S, Md 20	\$278.12 Port II, Md 40	\$3999.35
386S, Md 40	\$1092.84 Port 386 Md 100	\$4526.24
386S 25 Mhz M10	\$6995.95 Port 386 Md 100	\$6869.74
386S 25 Mhz M1 300	\$8895.99	

LASER TURBO

XT 1 drive	\$699.19 XT w/40 Meg	\$1095.74
XT w/20 Meg	\$99.29 XT w/70 Meg	\$1395.36

TOSHIBA

T-1000	\$799.96 T3200	\$3497.20
T1200 2 Drive	\$1573.55 T5100	\$4025.88
T1200 20 Meg	\$2362.72 T5200 40 Meg	\$6219.60
T3300E	\$282.32 T5200 100 Meg	\$7995.17

WYSE

MDL 2108	\$895.50 MDL 2214	\$1921.30
MDL 2112	\$1271.20 MDL 3216	\$2067.37

DRIVES, TAPES & CARDS

FLOPPIES, DRIVES & TAPES

CONNER 40 Meg/110 Meg	\$572.34/895.80
GENOA 60 Meg Int tape/Ext tape	\$689.60/819.10
OMEGA 150 Meg Int tape	1070.85
OMEGA 20 & 20 External 8"	1658.92
OMEGA B120Z	992.80
IRWIN 40 MB/80 MB 5 1/4"	1819.40
IRWIN 20 M/40 M Internal Tape	399.10/539.20
MOUNTAIN 4400 Int./Ext.	385.80/557.75
MOUNTAIN 155M Filesave	1398.39
PLUS Passport 20/40	479.10/579.86
PLUS 20 & 40 System Kit	489.75
PLUS PS2 MC System Kit	565.58
PRIME 40 Meg/80 Meg	669.55/739.55
SYGEN 5 1/4 Ext. Floppy	225.25
WELTEC 5 1/4 External Floppy	207.77

MINISCRIBE

MIN-8425	\$239.40 MIN-3085	\$729.40
MIN-8438	299.95 MIN-6085	599.52
MIN-3053	469.52 MIN-9380	1859.58

SEAGATE

SEAGATE 20 Meg	\$269.58 SEAGATE ST-251-0	\$344.36
SEAGATE 30 Meg	\$287.32 SEAGATE ST-251-1	\$378.23
SEAGATE 4096 80	\$99.95	

STORAGE DIMENSION

AT-155E	\$1950.52 AT-650E	\$15850.56
AT-335E	\$2420.26	

HARD DRIVE CARDS

PLUS DEVELOPMENT 20 Meg	\$539.28
PLUS DEVELOPMENT 40 Meg	677.80
WESTERN DIGITAL 30 Meg	399.37

MOST ORDERS RECEIVED BY 5:00 P.M. C.D.T. SHIP SAME DAY

PRINTERS

EPSON

LX810	CALL	LO510	ALL EPSON MODELS
EX800	CDW*	LO850/LO960	READY
FX850	FOR BEST	LO1050	TO SHIP
FX1050	PRICE EVER	LO2650	
CDW* stocks all cut sheet feeders and ribbons			

NEC

P2200	\$344.65 P5300	\$680.53
P5200	\$19.12 P960XL	\$1039.24

IBM

Pro Printer III	\$499.95 Quickwriter III	\$295.62
Pro Printer IV XL	\$734.98 Pro Printer III XL2AE	\$31.62

brother

M-1724L	\$579.64 M-1709	\$364.47
HR20	\$48.60 HRA0	\$29.12

OKIDATA

ML 182 Turbo	IN STOCK	ML 321	\$479.28
ML 172	\$199.95	ML 390	475.96
ML 182/BIM	\$232.50	ML 391	\$39.48
LASERLINE S	\$282.69	ML 393	\$65.20
ML 320	\$39.63	ML 393 Color	\$107.60

PANASONIC

1124	\$351.78 1592	\$412.44
1595	\$433.45 3131	\$318.30
1810	\$53.95 1524	\$62.10
1911	\$244.12 CALL FOR ACCESSORIES	

CITIZEN

1200	\$190.55 180D	\$174.11
MSP4S	\$36.58 MSP5PS	\$28.58
MSP5D	\$84.10 Premier 35	\$15.17

ALPS

Allegro 24	\$342.50
------------	----------

LASER PRINTERS

BROTHER HL-8e	\$1865.90
H-P Laser Jet Model 2/110	1699.95/2833.95
H-P DeskJet	599.00
NEC LB950	3095.60
PACIFIC DATA 25 in 1 cartridge	296.86

INTEL BOARDS & COPROCESSORS

INTEL Inboard 386/PC	\$569.53
INTEL Visual Edge	448.39
INTEL Connect Co-processor	712.43
INTEL 8087-2/8087-3	\$149.90/112.20
INTEL 80287-6/4	\$54.30/236.55
INTEL 80287-10	236.55
INTEL 80387-16/80387-20	399.69/465.65
INTEL 80387-25/80387-3X	639.92/399.82
INTEL 80387-33	575.20
INTEL 80C86-A	395.50

TERMINALS

WYSE 50, Amber or Green	\$373.40
WYSE 60, Amber or Green	390.16
WYSE 85/30 Amber	375.90/294.10
WYSE 99GT	394.82

PLOTTERS, DIGITIZERS & SCANNERS

CALCOMP

1023	\$3745.38 12 x 12	\$358.12
1043	\$477.15 12 x 18	719.10
1044	\$915.06 36 x 48	3236.15

KURTA

1212IS1	\$349.06 36x48	\$2891.53
12x17	\$499.35 4 Button Cursor	75.00

SUMMASKETCH

12x12	\$379.30 12x18	\$599.50
-------	----------------	----------

HEWLETT PACKARD

HP7744A	\$968.30
HP7745A	1389.89
HP7750	2808.56
HP7570 - LOWEST PRICE	
HP7576-EXL	4546.40
HP SCANJET	SAVE

FAX MACHINES

COMPLETE Fax 9600	\$399.50 SHARP FO-220	\$854.48
QUADRAM JTFax 9600 Int.	\$278.85 SHARP FO-300	1199.10
QUADRAM JTFax Portable	\$29.25 SHARP FO-330	1085.70

NOVELL NETWORKING

SOFTWARE & STARTER KITS

Entry-level 286 Starter Kit, 4 Users	\$429.90
Entry-level 286 Starter Kit, 8 Users	899.89
NOVELL 286 Software V. 2.15	1539.65
NOVELL SFT Software V2.15	2988.60
NOVELL NETPRO	1120.50

INTERFACE CARDS

3COM ETHERLINK	\$417.29
ARCNET PC110 LANBoard PS2	\$39.40
ARCNET PC120 LANBoard	165.27
ARCNET PC220 LANBoard	199.50
ARCNET SMC 16-Bit File Server Bd	437.55
ARCNET SMC 16-Bit Workstation Bd	359.25
ETHERNET Interface Connector (NE1000)	298.90
ETHERNET Plus Board (for 286) (NP600)	635.35
G-NET Interface Card w/cable	289.52
NOVELL NE2000	394.15
THOMAS CONRAD 6042	126.22
THOMAS CONRAD 6045	299.88
WESTERN DIGITAL Ethernet Cards	249.10

ACCESSORIES

ARCNET Passive Hub	\$74.00
ARCNET Active Hub	395.10
ARCNET SMC Turbo Kit	49.95
ARCNET SMC Active Link	264.70
THOMAS CONRAD 16 Port Hub	614.25
THOMAS CONRAD 8 Port Hub	378.65
Ethernet Terminators	39.50

Novell trained and authorized sales and support. See WORKSTATIONS under Computers.

MODEMS & COMMUNICATIONS

EVEREX 1200B	\$97.90
EVEREX 2400B	184.15
EVEREX 2400 EXT/2400 PS/2	199.80/205.45
PACKARD BELL 2400 Int/2400 Ext	169.99/199.32

HAYES

HAYES 1200	\$278.60 2400B	\$378.45
1200B	269.20 2400PS2	387.15
2400	416.08 Personal Modem	CALL

I-Robotics

Router 1200	\$174.80 1200 External	\$129.10
Router 2400	279.60 2400B	199.70
1200B	108.45 9600 HST	645.20

MTH - MEGAHERTZ CORPORATION

2400 by ZENITH	\$167.10 1200 by COMPAQ SLT	\$259.80
2400 by NEC	225.80 2400 by TOSHIBA	183.74

BATTERY BACKUP & SURGE

AMERICAN

AME-1200VX	\$929.45 AME-520EX	\$449.48
AME-330XT	279.72 AME-600RT	699.19
AME-450AT	395.82	

DATASHIELD

500 Watt	\$555.05 SS700	\$787.90
800 Watt	628.56 1200 Watt	962.75
5100	59.95 6 Outlet Surge	27.85

DURANT TECHNOLOGIES

BPS-300	\$330.10 BPS-550	\$499.85
BPS-600	465.11 BPS-1200	710.65

TRIPLITE

BC-450	\$349.98 4 outlet	\$ 44.25
BC-1200	649.55 LC-1200	158.85
BC-2000	1179.80 LC-1800	196.80

MISC. & ACCESSORIES

A-B Switching Box (par or serial)	\$39.95
BASF 5 Pack of 10 DS/DD disks	39.00
INTELLIDISK Long Link	129.70
KENNINGTON Masterpiece Plus	199.99
KENNINGTON Masterpiece Plus	123.40
KEYTRONICS 5151 IBM or AT&T	149.95
KEYTRONICS 101	97.95
5TH GEN Logical Connection 256K/512K	447.72/514.36
Electronic 4-Way Switchbox	94.85
XT Power Supply 150 Watt	59.00

SOFTWARE

WORDPERFECT 5.0 514/386	\$220.90/238.90
ASHTONDATE dBase III - dBase IV	424.00/476.10
ASHTONDATE Multitask Advantage II	298.12
LOTUS 1-2-3 514/386	299.95/305.95
ANSA Paradox 3.0	439.17
BORLAND Quattro/Slide Kick	149.52/131.27
MICROSOFT EXCELLENT/WINDOWS 386	252.50/217.40
MERIDIAN Carbon Copy	119.37
SMARTC D&A	212.00
XEROX Ventura Software Version 2.0	478.00

MONO MONITORS & CARDS

CDW™ color/mono cards w/tp	\$99.00 \$8.00
HERCULES color/mono cards w/tp	148.14/117.84
AT&T Monochrome Monitor	188.40
AMDEK 410A/1280	148.99/679.78
COMPAQ Mono/VGA Mono	177.00/209.95
IBM PS2 8510	709.85
GOLDSTAR Amber	34.10
NEC Monograph	127.25
PS2 MAX I/O/ MAX 15	136.40/256.35
PACKARD BELL Green or Amber	85.95

COLOR GRAPHIC MONITORS

IBM PS2 8512/8513	\$445.40/530.20
SAMSUNG RGB Color	239.60
TAGAN 720	269.30
MAGNAVOX 8762	239.05

VGA & EGA PRODUCTS

VGA & EGA MONITORS

COMPAQ VGA monitor	\$548.69
MAGNAVOX 9436GA/9CM06Z	365.40/372.57
MITSUBISHI 1409/1410	282.44/385.56
MITSUBISHI 1381 Lymanord Scan	519.20
NEC Multisync PLUS	680.00
NEC Multisync LX 19 inch	709.40
NEC Multisync 2A/Multisync 3D	499.85/699.85
PACKARD BELL 8541 VGA	318.20
PACKARD BELL 8524 Enhanced VGA	389.95
PACKARD BELL 8526 Enhanced VGA	477.40
PGS Ultrasync 12	483.31
PGS Ultrasync 14/16	519.66/807.71
SONY Multiscan 1302/1303	619.95/629.80
ZENITH T-1450	629.80

ATI VGA Wender 256

ATI VGA VIP	289.24
GENOA 5200 5300	330.55/393.90
RENAISSANCE RVGA II RVGA I	298.06/219.06
PARADISE VGA/VGA II	262.88/296.33
VIDEO 7	299.10
VIDEO 7 Fast Write/VRAM	372.15/488.75

EGA DISPLAY CARDS

ATI VGA VIP	289.24
GENOA 5200 5300	330.55/393.90
RENAISSANCE RVGA II RVGA I	298.06/219.06
PARADISE VGA/VGA II	262.88/296.33
VIDEO 7	299.10
VIDEO	



IF MEMORY SERVES...

Here is a library of memory management routines that will help you avoid a fragmented heap.

Memory—silicon memory—is one of those precious commodities in the computer industry. Like disk-storage space, it's something you can't get enough of. Lately, it has been reasonable to complain that the amounts of memory you'd like to have would cost too much money (although compared to times not far gone, believe me, you're living in DRAM paradise).

Sometimes, though, you can't get enough of it not because you can't afford it, but because some operating system won't let you get at it. I won't name names here, but one particular operating system whose initials are D-O-S has—through inadequacies inherited from the CPU it was born on—created a trend of extension products (hardware and software) all designed to “break the 640K-byte barrier.” Even when you can easily access the memory you need, you discover another need: some governing force that will keep you from squandering your windfall. As I mentioned back in my column on overlays (see “An Overview of Overlays,” December 1988), you'd like to treat memory as a stretch of unbroken real estate extending out past the horizon. But that's not the reality—the reality is that you've got to get smart about managing your memory.

DOS Memory

The DOS memory manager keeps tabs on the memory that's free for use by the operating system or whatever programs happen to be executing at the time. DOS

also tracks the portions of memory that some routine has laid claim to. If no programs are being executed, all memory not used by the operating system, its buffers, or COMMAND.COM is free. (I'm assuming that no TSR programs are currently in residence.) When you execute a program by typing its name at the command prompt, the operating system allocates however much memory that program needs, loads the program into the allocated block, and transfers control to that program. (To be strictly accurate, DOS is not that intelligent all the time. When you execute a .COM program, for example, DOS hands *all* the free memory over to it.)

As the program executes, it may need a chunk of memory to create strings, arrays, and so on. It can request this memory from DOS via a call to INT 21H function 48H. Later, when the program has finished with that memory, it can, using INT 21H function 49H, tell the operating system: “Here, you can have this back... I don't need it anymore.” This pool from which an executing program can draw memory blocks (and to which it can return them) is often referred to as the “heap.” Thus, DOS is put to the task of tracking all the variable-size chunks of memory within the heap, where each chunk is either free or in use. The operating system's bookkeeping employs a kind of linked-list structure embedded in the memory itself, as shown in figure 1.

DOS precedes each memory block with a 16-byte *control block*. The control block contains information such as how big the memory block is and whether it is in use. DOS can use a control block's length field to calculate the location of the next-higher memory block. So when someone makes a request for memory, the operating system follows the chain of control blocks in search of a slice of memory to satisfy the request. The last control block in the chain contains a byte that tells DOS it has reached the top of the heap (sorry).

Fragmentation and Other Problems

Although DOS's memory management is entirely adequate for most needs, it is afflicted with one problem: fragmentation. This happens when you've allocated and freed a number of memory blocks in random fashion. Observe figure 2a, wherein a number of memory blocks have been used and released. Suppose that a program requests a 16K-byte block of memory. Although a total of 18K bytes is available, the free memory is scattered throughout the heap in unusably small pieces.

The solution to this situation is obvious: Simply move all the used memory blocks down to the bottom of the heap, thus allowing the unused fragments to percolate to the top, where they can be joined into a single chunk of 18K bytes. That request for 16K bytes could then be honored (see figure 2b). This process of shuffling memory blocks around to combine the unused fragments is called *compaction*.

But wait. You can't just slide things around in memory without telling anyone. Suppose a subroutine has built a pointer variable that references the beginning of block A in figure 2a. If the contents of memory have been shifted to what's shown in figure 2b, that pointer will be 4K bytes out of whack. The solution has spawned a second problem; is there a second solution?

What's Your Handle?

I'll take a lead from the memory manager of Apple's Macintosh and introduce the concept of the doubly indirect pointer—known as the “handle.” Don't let the term “doubly indirect” frighten you. A pointer is singly indirect: It holds the address that you're ultimately interested in. A handle holds *the address of the address* that you're ultimately interested in. Put another way, a handle points to a pointer (a “master pointer” in Macintosh terminology); in turn, the master pointer

continued

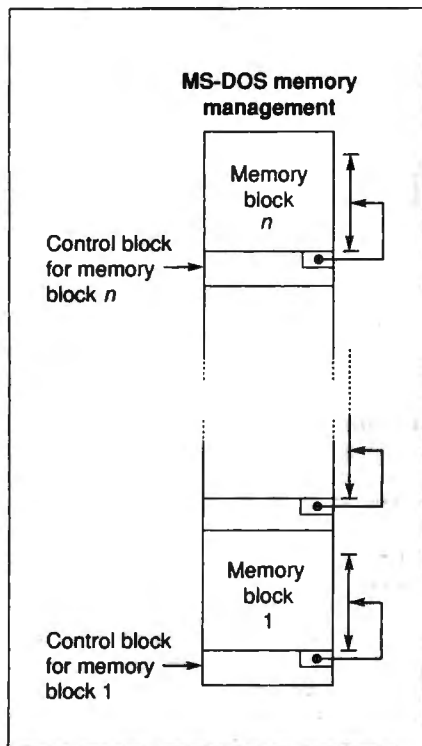

Figure 1: MS-DOS uses a singly linked list, embedded in the memory itself, to manage the heap.

points to the actual memory block. Master pointers are typically kept together in a large table that remains fixed in memory. The advantage of this scheme is that, while memory blocks are moved about during compaction, the master pointer stays in place (only its contents change). Consequently, the value of the handle never changes; you can always locate the memory block in spite of compaction.

Handles carry at least one disadvantage. If you overlook the minor additional memory overhead of the table of master pointers, access to memory through a handle requires at least an initial doubly indirect reference. I'm using the word "initial" loosely; a memory block's actual address as retrieved via a pointer is valid only as long as compaction doesn't take place. Once compaction occurs, you have to follow the trail from handle to pointer to see where a memory block has moved to. (The process is called "calculating the effective address.")

A sample scenario might go like this: Your program has requested 60K bytes from the memory management system; the request is granted, so your program retrieves the address and begins stuffing data into the 60K-byte block. A subroutine of this process requires a 4K-byte scratch area for string manipulation. The

request for 4K bytes causes compaction to take place. When the subroutine returns, the main routine will have to recalculate the effective address of the 60K-byte block before resuming work.

The repeated recalculation of the address becomes time-consuming. The situation is made worse by the fact that only the memory manager knows if compaction has taken place. So, after every allocation request to the memory manager, you've got to recalculate the effective address of all the blocks you might be using even if the recalculation is not necessary.

Well, there's a fix for this one, too. You simply define a new attribute for blocks in use: the lock attribute. If a block is locked, that tells the compaction algorithm that the contents of that block may not be moved. . . period. Thus, locking a block means you don't have to re-evaluate its address every time there's a chance that memory compaction has taken place. The downside to this is that

continued

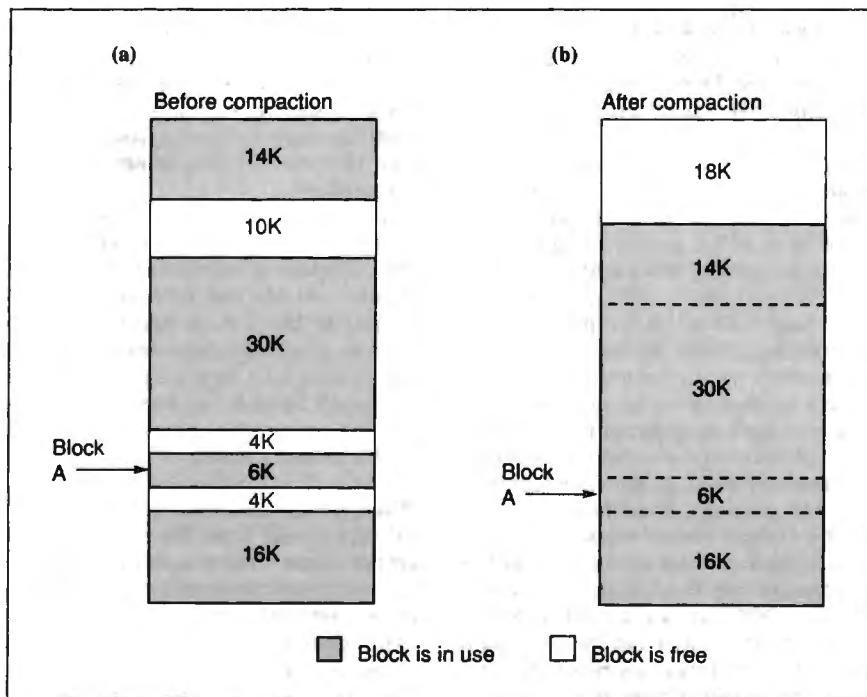

Figure 2: (a) If pieces of memory are randomly allocated and freed, the free memory is scattered throughout the heap in unusably small pieces. (b) If all the used blocks are moved to the bottom, the free memory percolates to a single large block.

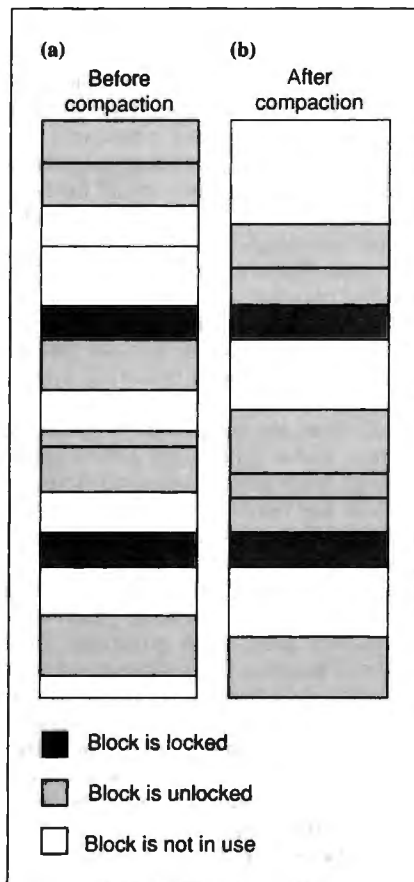

Figure 3: (a) Two locked blocks have divided the usable memory into three partitions. (b) After compaction, you are still left with three separate blocks of free memory.

How to create high-performance programs without wasting your time or money

MDX
Software



The High-Performance C Compiler



C Source Window

The screenshot shows the Power C Trace Debugger interface. It features four main windows:

- C Source Window:** Displays C code with line numbers 30-39. A watchpoint is set at line 32: `size > 0`. A message box indicates: "A watchpoint has matured. size > 0. Old value was 0. New value is 122. Space bar will clear notice & watchpoint."
- Watch Point Window:** Shows the current watchpoint: `size > 0`.
- Output Window:** Shows the program's output: "The structure number values... Joe Bob's Texas 1251 Cow Chip Trail Fort Worth TX 76442."
- Variables Window:** Lists variables and their values: `addr->name` (array "Joe Bob's Texas"), `addr->street` (array "1251 Cow Chip Trail"), `addr->city` (array "Fort Worth TX"), `addr->state` (array "TX"), `addr->zip` (array "76442"), `size` (122), `job[0]` (pointer 0x0202), `job[1]` (struct 0x04202), and `job[2]` (pointer 0x0202).

Watch Point Window

Output Window

Variables Window

Power C Trace Debugger

Step 1: The \$19.95 Power C compiler

Power C is the new ANSI compatible C compiler that runs faster than Microsoft C[®] and has more functions than Turbo C[®]. Power C combines high-performance software with superb documentation, all for less than the price of most C books alone. It's your fast route to fast programs without the fast bucks.

The quality of the Power C documentation makes it easier to learn C. The manuals that accompany our competitor's products are terse at best. They contain little or no information about C, and very few examples. In contrast, the Power C book includes a step-by-step tutorial and is chock-full of example programs. Most of our customers are saying that it's the best C book they've ever used.

The quantity of functions in the Power C library makes it easier to accomplish your programming tasks. The Power C library contains more than 420 functions, a superset of the functions in Microsoft C[®] 4.0 and Turbo C[®] 1.0. In addition, Power C includes a large number of video and graphics functions. You get super-fast functions for drawing lines, boxes, circles, ellipses, pie charts, and more.

The speed of the Power C compiler makes programming fast. Power C's integrated *Make* utility saves you time and effort by automatically managing your large programming projects. If you modify your program, Power C makes a new version by recompiling only the files that have changed. The compiled programs are equally fast. Just check out the performance chart. See how much time and money you save with Power C.

Performance / PriceChart

(execution times in seconds)

	Power C [®]	Quick C [®]	Turbo C [®]
1) fib	23.8	53.4	26.4
2) sieve	27.6	43.2	25.5
3) tdb1	3.5	9.0	9.6
4) diskio	13.5	14.4	14.3
5) report	11.0	71.7	60.7
6) drystone	36.6	41.6	31.8
Compile/Link	73.9	113.5	81.4
EXE File Size	25120	32092	27184
Compiler/Debugger	\$39.90	\$99.00*	\$149.95*
Library Source	\$10.00	\$150.00	\$150.00
Total Cost	\$49.90	\$249.00	\$299.95

*Includes limited debugger only. Benchmark programs used by Dr. Dob's Journal and Computer Language Magazine.

Step 2: The \$19.95 Power C Trace debugger

Power C Trace is the new state-of-the-art C debugger that makes Microsoft's Codeview[®] look like old technology. Power C Trace reduces the time you spend debugging your C programs by at least a factor of 10. With Power C Trace, you work smarter instead of harder. Actually, using Power C Trace is so much fun that debugging doesn't even feel like work anymore.

Power C Trace shows you 7 windows of program information: 1) C source statements, 2) screen output, 3) variables, 4) watch points, 5) memory, 6) symbols, and 7) assembly instructions. You can view a single window or as many as 4 windows at the same time (as shown on the screen above). Eight predefined window arrangements are available at the press of a key, or you can design your own.

Power C Trace is loaded with many other advanced features. Power C Trace automatically displays all of your variables (including arrays and structures), saving you from having to remember and type their names. The virtual output window lets you see the screen output from your program while simultaneously viewing any of the other windows. Interruptible input allows you to get control even while your program is reading input from the keyboard. Backwards tracing gives you the ability to trace backwards through the execution path.

With all its advanced features, the single most important feature of Power C Trace is simple operation. With Power C Trace, you won't waste any time trying to understand or remember cryptic commands. A single keystroke is all it takes. Help screens show you which key to press and pop-up menus list your options. Invest just 10 minutes of your time with Power C Trace now, and you'll save hours from now on.

Order Line: 1-800-333-0330

Technical: 1-214-783-6001

1132 Commerce Dr., Richardson, TX 75081

60 day money back guarantee

Name _____
 Street _____
 City _____
 State _____ Zip _____
 Telephone _____
 Paying by Money Order Check
 Visa MC AX Discover
 Card # _____
 Card Expiration Date _____
 Computer Name _____ Disk Size 5 7 3 ^{1/2}"
 Product(s) (Not Copy Protected)
 Power C compiler (\$19.95) \$ _____
 Power C Trace debugger (\$19.95) \$ _____
 Library Source Code (\$10.00) \$ _____
 (includes assembler & library manager)
 BCD Business Math (\$10.00) \$ _____
 Add Shipping (\$5 USA - \$20 Foreign) \$ _____
 Texas Residents add 8% Sales Tax \$ _____
 Total amount of your order \$ _____
 (Requires DOS 2.0 or later) B

it makes the compaction routine's job a little tougher. Look at figure 3a. The two locked blocks have divided the usable memory into three partitions. Unused memory cannot "bubble up" past the locked blocks; the result of an attempt at compacting the heap appears in figure 3b. Locking the blocks has fragmented the free memory.

Granted, if you wanted to make your compaction routine *really* smart, it could nose around through the three partitions, trying to find an arrangement that would

create the largest contiguous free block. But this would likely consume so much time that the benefits would no longer outweigh the expense, especially if lots of locks were in place. It's best, then, to lock a block only when it's absolutely necessary. (An aside: The Macintosh's memory manager runs into the same problems with locked blocks. *Inside Macintosh* explicitly warns against locking too many blocks and thereby creating the very fragmentation that compaction is supposed to relieve.)

Now! Handles on DOS

I've put together a modest handle-based memory management package for DOS that includes the features I've just described. Specifically, the package combats the fragmentation problem by performing compaction whenever there is a request for memory that this memory manager can't fulfill. (Of course, if the compaction routine still fails to rustle up enough memory, you're simply out of luck.) I've also added block locking for those critical times when your program doesn't want its memory disturbed.

My memory management system keeps track of memory usage via a list of four-word blocks that I refer to as *m-nodes* (with apologies to the Unix folks). These *m-nodes* are the master pointers in this scheme, and each consists of the following:

- A base pointer, which is the address of the start of a memory block on the heap. This address is in paragraphs (where a paragraph is 16 bytes); the true byte address is the base pointer shifted left by 4 bits.
- A length count, which is the number of paragraphs in the block controlled by this *m-node*.
- A pointer to the next *m-node* in the list. (The package actually maintains two lists—one links all *m-nodes* that control a memory block on the heap, another links the unused *m-nodes*.)
- A pointer to the previous *m-node* in the list. This pointer is not used on the free *m-nodes* list.

Figure 4 shows how all this works. The *m-nodes* that point to memory blocks on the heap are kept on a doubly linked list. And if you follow this list from start to finish, you'll see that *m-nodes* reference memory blocks from low to high memory (this is important for the compaction algorithm, which I'll explain in a moment). A doubly linked list allows for rapid insertion and removal; this in turn ensures that the allocation and deallocation processes are nimble. The package keeps *m-nodes* that don't currently reference a memory block in a separate, singly linked list, the "dead list."

16-Byte Dollops

The most-significant bits in an *m-node*'s next and previous pointers act as status bits. If the most-significant bit of the next pointer is set, the associated block of memory is in use. If the most-significant bit of the previous pointer is set, the associated block of memory is locked.

continued

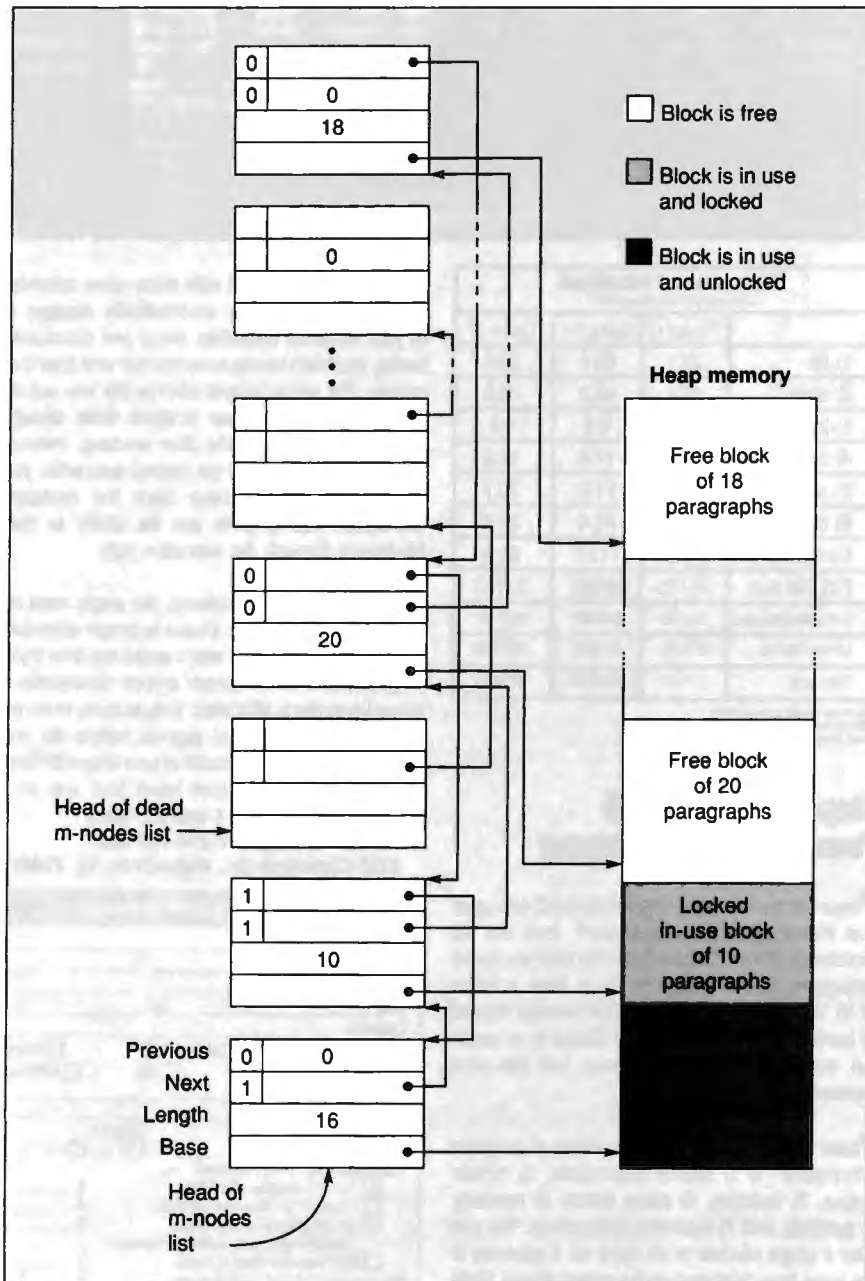

Figure 4: In my memory management system, *m-nodes* that point to memory blocks on the heap are kept on a doubly linked list.

REMOVABLE. ERASABLE. OPTICAL. REMARKABLE!

REO-650 single-drive system

\$4,995

REO-1300 dual-drive system

\$9,990

650/600 Meg optical cartridges:

\$250 each

Interface kits for Macintosh.

Sun, HP, IBM-AT, XT, PS/2

and compatibles:

\$995 each

Pinnacle Micro is the world's leader in removable, erasable, optical storage systems for personal and workstation computers.

The REO-650 is a single drive, SCSI system. The REO-1300 is a dual-drive system. Up to 1.3 gigabytes of facts and figures at your fingertips!

Each optical cartridge holds up to 650 megabytes of precious memories. Graphics. CAD files. Databases. Images.

You can write, erase and rewrite data... file by file... a million times or more.

Interface kits give you the flexibility to use Pinnacle drives with the computer of your choice: Macintosh. Sun Microsystems. Hewlett Packard. IBM-AT, XT, PS/2 and compatibles.

Software provided with each kit supports a host of working environments: UNIX, Xenix, Novell Netware 2.1, and many more.

Removable, erasable, optical. The new standard in mass storage. Available now from Pinnacle Micro.

Call today for the location of your sales representative or authorized dealer.

☎ (800) 553-7070

PINNACLE MICRO

THE ERASABLE OPTICAL STORAGE COMPANY™

AUGUST 1989 • BYTE 283

Trademarks owned: REO-650, REO-1300 and Pinnacle Micro of Pinnacle Micro, Inc. Sun of Sun Microsystems, HP of Hewlett Packard, AT, Xenix, IBM, PS/2 of International Business Machines Corporation, Novell of Novell, Macintosh of Apple Computer, Inc.

15265 Alton Parkway • Irvine, CA 92718 • In CA (714) 727-3300 • FAX (714) 727-1913

Circle 295 on Reader Service Card (DEALERS: 296)

BECAUSE YOU CAN SAVE A HUB !

Our ARCNET BUS is designed to eliminate the need for HUBS in a small (up to eight nodes) installation with segments that extend up to 1,000 feet.

Other Network Products:

8-PORT ACTIVE HUB
TWISTED PAIR ETHERNET BOARD
TWISTED PAIR ETHERNET CONCENTRATOR
16-BIT ETHERNET BOARD
DISKLESS PC
CHEAPERNET REPEATER
INTELLIGENT ETHERNET BOARD
INTELLIGENT ARCNET BOARD
MICRO CHANNEL ETHERNET BOARD

NOVELL LABS
TESTED AND APPROVED
NETWORK COMPATIBLE

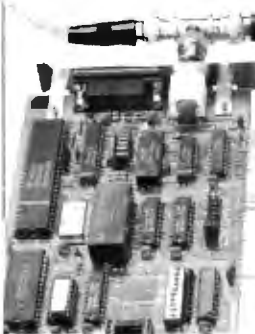

The PCN-002b
supports a linear bus topology



HEADQUARTER
5830 E. WASHINGTON BLVD.
CITY OF COMMERCE, CA 90040
TEL: (818) 968-0643
TEL: (213) 724-0643
FAX: (213) 724-5453

EAST COAST OFFICE
307 WEST CENTRAL ST.
NATICK, MA 01760
TEL: (508) 820-1102

601 WEST 112 AVE.
NEW YORK, NY 10025
TEL: (212) 865-5030

MCA is a trademark of IBM

WHY TAKE A BUS?

8-PORT ACTIVE HUB/TWISTED PAIR ETHERNET BOARD/TWISTED PAIR ETHERNET CONCENTRATOR/16-BIT ETHERNET BOARD/DISKLESS PC

HANDS ON SOME ASSEMBLY REQUIRED

As indicated in the features list, all memory referenced by m-nodes appears on 16-byte boundaries. Actually, the trend goes farther than that: You request memory in paragraph-size slices. This is an...ahem...a feature of the Intel 80x86 architecture. Since segment registers must be aligned to paragraph boundaries, the entire memory management package is much simpler if it treats mem-

ory in dollops of 16 bytes. This adds the benefit of speeding up the compaction algorithm: Because the package allocates memory in an even number of bytes, it can use MOVSW instructions (16 bits at a time) rather than MOVSB instructions (8 bits at a time) to shuffle the contents of memory blocks around.

The algorithm for the allocation of a
continued

Listing 1: The pseudocode for compaction in my memory management system. The algorithm calls for all unlocked blocks to move to the lowest memory possible, thus causing free blocks to congregate near the top.

COMPACT:

```
{ COMPACT makes use of the following externally defined routines:
{ RELEASE(m_NODE) removes an m_node from the doubly linked list of m_nodes
{ referencing memory and places it on the available list.
{ GET_MNODE() fetches a new m_node from the available list.
{ MOVE_MEMORY(SADDR,DADDR,LENGTH) moves LENGTH bytes from address SADDR to
{ DADDR. The routine handles the possibility of overlapping regions.
```

```
CURRENT_BASE := 0;
CURRENT_LENGTH := 0;
SAVED_MNODE := 0;
DIRTY := 0;
PARAS_FREED := 0;
PREVIOUS_MNODE := 0;
```

```
{ Start with first m-node in list.
{ INUSE_LIST points to the head of the doubly linked list of m_nodes that
{ actually reference memory.
CURRENT_MNODE:=INUSE_LIST;
```

REPEAT

```
IF high bit of CURRENT_MNODE's NEXT link
is set THEN
```

BEGIN

```
{ This block is in use. See if it's locked.
IF high bit of CURRENT_MNODE's PREVIOUS link
is set THEN
```

BEGIN

```
{ This block is locked. See if DIRTY is
{ set. If so, the contents of CURRENT_BASE
{ and CURRENT_LENGTH must be written into
{ an m-node.
```

```
IF DIRTY=1 THEN
```

BEGIN

```
IF SAVED_MNODE<>0 THEN RELEASE(SAVED_MNODE);
NEW_MNODE := GET_MNODE();
NEW_MNODE's BASE field := CURRENT_BASE;
NEW_MNODE's LENGTH field := CURRENT_LENGTH;
CURRENT_BASE := 0; CURRENT_LENGTH := 0;
{ NEW_MNODE must now be attached to the
{ list preceding CURRENT_MNODE.
NEW_MNODE's NEXT link := CURRENT_MNODE;
NEW_MNODE's PREVIOUS link := CURRENT_MNODE's
PREVIOUS link;
```

```
CURRENT_MNODE's PREVIOUS link := NEW_MNODE;
TEMP_MNODE := NEW_MNODE's PREVIOUS link;
```

```
IF TEMP_MNODE = 0 THEN
```

```
{ NEW_MNODE is the head of the list.
```

```
INUSE_LIST := NEW_MNODE;
```

ELSE

```
TEMP_MNODE's NEXT link := NEW_MNODE;
```

```
DIRTY := 0;
```

continued on page 337

Graphics Choices Driving You Crazy?



Indecision about graphics platforms is costing software developers money. At Media Cybernetics, we maximize our development productivity and minimize our risks by basing our application programs on HALO. We used HALO to develop popular applications like Dr. HALO and Image-Pro.

Making the HALO choice gives you DOS or OS/2 support today with a clear source code compatible path to Presentation Manager tomorrow. It also gives you a shortcut to building a user interface, the hardest part of application development.

The HALO development environment offers a comprehensive, reliable series of libraries and tools that are professionally documented and supported. Even more important, HALO is here to stay. We've been supporting software developers since 1982 and we are proud that 70,000 programmers and nearly 400 Independent Software Vendors (ISVs) are part of the HALO family.

Media Cybernetics now offers three versions of the HALO Graphics Toolkit:

HALO

- The premier graphics toolkit
- 200 graphics subroutines
- Supports over 180 input, output, and graphics devices
- Device support for scanners, high resolution imaging and VESA boards
- 18 compiler interfaces

The HALO Window Toolkit

- Event-driven environment for graphical user interface design
- Command bars, pull-down menus, scroll bars, radio buttons and icons
- Available for Microsoft C
- Intelligent memory management
- Full HALO capability

HALO for OS/2

- Source code compatible with HALO
- HALO speed, power and capability
- Multi-threaded, multi-tasking
- Dynamic Link Library
- Supports background mode graphics

HALO™

Making these decisions isn't easy, but HALO has the best track record in the industry. We believe that a strong contemporary graphics toolkit is essential to your success.

If you are concerned about the long term consequences of your graphics choices, call 1-800-992-HALO

**MEDIA
CYBERNETICS™**
Imaging and Graphics Technology

8484 Georgia Avenue
Silver Spring, Maryland 20910
301/495-3305
301/495-5964 FAX

How To BUILD A REAL-TIME DATA ACQUISITION & CONTROL APPLICATION FOR \$50 PER CHANNEL.

Attend the Free SOLUS™ Seminar
and discover a new world of control, economy and simplicity.

At the free introductory seminar in your area you'll get a first-hand look at the all new SOLUS™ Personal Control Computer.™

You'll discover a surprising array of features and capabilities. Like 36 digital/analog I/O channels. The ability to locate SOLUS in remote locations. And daisy-chain multiple SOLUS computers for large applications.

All for just \$895.*

And, you'll learn how easy it is to create real-time applications that solve your acquisition, monitoring, data logging and control needs — more easily and cost effectively than you ever thought possible.

For seminar information or reservation, call:

503-635-3023
(8:00 am to 5:00pm PDT)

Or, to receive more info on the SOLUS Personal Control Computer, call:

800-247-5712



SOLUS' menu-driven graphical software runs on a host PC, and makes it easy to create real-time data acquisition and control applications.

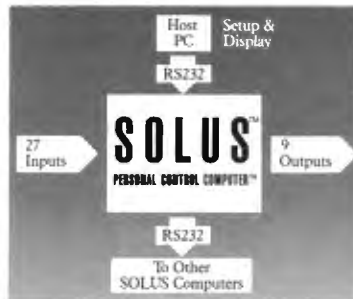

36 digital and analog I/O channels in a compact, intelligent, stand-alone unit that can be located anywhere. 8" wide, 2.25" high, 6.25" deep; 2 lbs; requires just 200 mA.

SEMINAR SCHEDULE

Sept. 6 Boston, MA
Sept. 7 Raleigh/Durham, NC
Sept. 19 Newark, NJ
Sept. 20 Washington, DC
Sept. 27 Portland, OR
Oct. 3 Los Angeles, CA
Oct. 5 Orange County, CA
Oct. 10 San Diego, CA
Oct. 12 Dallas/Ft. Worth
Oct. 17 Chicago, IL
Oct. 19 Houston, TX
Oct. 24 San Jose, CA
Oct. 26 Seattle, WA

Call 503-635-3023 for reservations and seminar information.

*Host PC software extra. Monitoring software: \$595. Control software: \$495.

TMI, inc.
4000 Kruse Way Place, 2-285
Lake Oswego, OR 97035
Phone (503) 635-3966
FAX (503) 635-3004

© 1989 TMI, inc., SOLUS™ and Personal Control Computer™ are trademarks of TMI, inc.

memory block is simple—so simple, in fact, that I won't bother with the pseudocode. I used the "first-fit" technique. This simply means that when your program requests a block of memory, the memory manager begins scanning at the m-node at the head of the chain and stops at the first m-node that references a free block large enough to fit your request. If the block has more memory than you need, the system pares off the amount you've requested and creates a new m-node to reference the leftover portion. Finally, it passes back to your program an offset to the m-node associated with your newly claimed block of memory. This offset is the handle.

COMPACT to the Rescue

Things get squirrely when the memory manager hits the top of the list and hasn't found a block large enough to meet your request. That's when it summons the compaction routine (see listing 1 for the pseudocode). The COMPACT routine skims through the list in bottom-to-top fashion, moving all unlocked blocks into the lowest memory possible, thus causing free blocks to congregate near the top. Any m-nodes that reference adjacent free blocks are merged into a single m-node referencing the lump sum. Finally, COMPACT returns the number of paragraphs in the largest free memory block that it was able to put together. The allocation routine can then quickly determine whether COMPACT was able to free a large enough piece of memory.

I've also added routines for locking and unlocking blocks, plus a routine for deallocating memory blocks. The deallocation routine is intelligent enough to do some defragmenting of its own: If it discovers that a deallocated block is adjacent to blocks that are already free, it combines the adjacent blocks into a single, larger block of free memory referenced by a single m-node. Again, these routines are rudimentary enough that I won't expend space on their pseudocode.

Hot-Rodding the System

As usual, I feel the urge to suggest additions to this package that might make it suitable for your particular application. First, a "first-fit" algorithm is by far the simplest to code (so now you know why I picked it). Its alternative is the "best-fit" algorithm, which seeks to reduce fragmentation by attempting to locate the block that most closely matches the allocation request. This seems a reasonable tack to take, since it improves your chances of finding a free block that fits

continued on page 337

PRODUCT SHOWCASE

■ BUYER'S MART
■ BYTE BITS

■ PRODUCT SPOTS
■ MICRO PRODUCT CENTER



THE BUYER'S MART

A Directory of Products and Services

THE BUYER'S MART is a monthly advertising section which enables readers to easily locate suppliers by product category. As a unique feature, each BUYER'S MART ad includes a Reader Service number to assist interested readers in requesting information from participating advertisers.

RATES: 1x—\$525 3x—\$500 6x—\$475 12x—\$425
Prepayment must accompany each insertion. VISA/MC Accepted.

AD FORMAT: Each ad will be designed and typeset by BYTE. Advertisers must

furnish typewritten copy. Ads can include headline (23 characters maximum), descriptive text (250 characters is recommended, but up to 350 characters can be accommodated), plus company name, address and telephone number. Do not send logos or camera-ready artwork.

DEADLINE: Ad copy is due approximately 2 months prior to issue date. For example: November issue closes on September 8. Send your copy and payment to THE BUYER'S MART, BYTE Magazine, 1 Phoenix Mill Lane, Peterborough, NH 03458. For more information call Brian Higgins at 603-924-3754.

ACCESSORIES

CUT RIBBON COSTS!

Re-ink your printer ribbons quickly and easily. Do all cartridge ribbons with just one inker! For crisp, black professional print since 1982. You can choose from 3 models: Manual E-Zee Inker — \$39.50
Electric E-Zee Inker — \$94.50
Ink Master (Electric) — \$189.00
1000's of satisfied users. Money-back guarantee.

BORG INDUSTRIES

525 MAIN ST., JANESVILLE, IA 50647

1-800-553-2404 Fax: 319-987-2251

Inquiry 576.

ARTIFICIAL INTELLIGENCE

NATURAL LANGUAGE C LIBRARY

Increase your market share! Use JAKE to add a natural language front end to your application. JAKE translates English queries and commands into C function calls and data structures. JAKE offers context-sensitive semantic processing; interfaces easily; < 64K mem.

JAKE \$495. INTERACTIVE DEMO \$10

ENGLISH KNOWLEDGE SYSTEMS, INC.

5525 Scotts Valley Dr. #22, Scotts Valley, CA 95066

(408) 438-6922

Inquiry 581.

BAR CODE

PRINT BAR CODES AND BIG TEXT

On EPSON, IBM, OKI dot matrix or LaserJet. Design any format on ONE easy screen. 1-120 fields/label. 13 text sizes to 1" — readable at 50 ft. AIAG, MIL-STD, 2 of 5, 128, UPC/EAN, Code 39. File Input, FAST—\$279. Logos, Product Symbols. Other menu-driven bar code programs from \$49. 30-day \$ back.

Worthington Data Solutions

417A Ingalls St., Santa Cruz, CA 95060

(800) 345-4220 In CA: (408) 458-9938

COMPANION AND EXTENDER

Place a keyboard and monitor up to 600' from your CPU with EXTENDER and COMPANION products. Keep a second Keyboard/Monitor at the CPU with COMPANION. Supports MDA, CGA, EGA, VGA, PS/2. Uses single 3/4" cable.

Prices start at \$149.00 for EXTENDER and \$219.00 for COMPANION 25 ft. unit complete.

CYBEX CORPORATION

2800-H Bob Wallace, Huntsville, AL 35805

205-534-0011 International Fax # 205-837-9212

Inquiry 577.

NanoLISP \$99.99

An MS-DOS Common LISP interpreter that supports most Common LISP operations and strictly adheres to the standard. Numerous advanced and extra features, excellent debugging facilities, sample AI programs, fully-indexed manual, free technical support.

Microcomputer Systems Consultants

P.O. Box 6646, Santa Barbara, CA 93160

(805) 967-2270

Inquiry 582.

BAR CODE READERS

For PC, XT, AT, & PS/2, all clones, and any RS-232 terminal. Acts like 2nd keyboard, bar codes read as key data. With steel wand—\$399. Works with DOS, Xenix, Novell, Alloy, -ALL software. Lasers, magstripe, & slot badge readers. One-year warranty. 30-day \$ back. Direct from USA manufacturer.

Worthington Data Solutions

417A Ingalls St., Santa Cruz, CA 95060

(800) 345-4220 In CA: (408) 458-9938

FREE CATALOG

A complete source for computer supplies at low prices. Fast Service. Call, write or circle inquiry card for a FREE CATALOG. Use your VISA, MC or C/D to order the following bulk diskettes.

5.25" DS/DD (Min 50) 26¢

5.25" DS/HD (Min 50) 62¢

3.5" DS/DD (Min 30) 99¢

GAAN COMPUTER SUPPLIES

186 B East Sunnyvale Ave., Campbell, CA 95008

(800) 523-1238, In Calif. (408) 370-6747

Inquiry 578.

muLISP™ 87 for MS-DOS

Fast, compact, efficient LISP programming environment. muLISP programs run 2 to 3 times faster & take 1/2 to 1/3 the space of other LISPs. 450 Common LISP functions, multi-window editing & debugging, flavors, graphics primitives, lessons & help, demo programs, comprehensive manual.

Soft Warehouse, Inc.

3615 Harding Ave., Suite 505, Honolulu, HI 96816

(808) 734-5801

Inquiry 582.

BAR CODE SOLUTIONS

Bar coding is so easy with our complete line of readers. Our PC-Wand readers emulate your PC keyboard or ASCII terminal, and are carried around taking inventory, entering road sales and clocking time. Our bar code label printing software packages work with DOS and most matrix of laser printers. We also sell pre-printed labels. Our hardware can work with nearly every computer in the world.

International Technologies & Systems Corp.

635-C North Berry St., Brea, CA 92621

(714) 990-1880 FAX: 714 990-2503 TLX 6502824734 MCI

Inquiry 583.

BAR CODE

PRINT BAR CODES/BIG TEXT FROM YOUR PROGRAM

Add bar codes and big graphics text to your program. Print from ANY MS-DOS language. Bar codes: UPC, EAN, 2 of 5, MSI, Code 39, Epson, OKI, IBM dot matrix text up to 1/2". LaserJet up to 2". Font cartridges not required. \$179-\$239. 30-day \$\$ back.

Worthington Data Solutions

417A Ingalls St., Santa Cruz, CA 95060

(800) 345-4220 In CA: (408) 458-9938

REFILL LASER PRINTER & COPIER CARTRIDGES

Don't throw away that used laser printer or copier cartridge. Refill it and save over 75%, it's easy. For use with Canon EP & EPS cartridges, HP LaserJet & LaserJet II, Apple Laserwriter & Laserwriter II, Canon LPB, FAX, and many others. Also kits for Canon Copiers.

COMPLETE REFILL KIT \$29.95

Includes toner, felt pad, and instructions.

VIDEO TAPE PROGRAM \$45.00

Shows disassembly, cleaning, and remanufacture.

MORACK INC.

8847 W. 87th St., Hickory Hills, IL 60457

For order or information (312) 598-0580

Inquiry 579.

BAR CODE SOFTWARE SOLUTIONS

ISD has software solutions that allow you to use bar codes for most anything. Like identifying products. Labeling packages. Or even managing assets and paperwork. You'll be able to speed and simplify data collection. Track products dock-to-stock. Streamline inventory control. And more.

Integrated Software Design, Inc.

171 Forbes Blvd., Mansfield, MA 02048

TEL: (508) 339-4928 FAX: (508) 333-2257

© 1989 Integrated Software Design, Inc.

Inquiry 584.

RIBBONS • RIBBONS • RIBBONS

Fast, Professional, Friendly Service. Over 1,100 Printer & Typewriter Ribbons Available. One Call For All Your Ribbon Needs!

—THE RIBBON SOURCE—

SATISFACTION GUARANTEED!

U.S. So. Cal. San Diego

(800) 354-7744 (800) 453-6688 (619) 259-8800

Inquiry 580.

PORTABLE READER

Battery-operated, handheld reader with 64K static RAM, 2x16 LCD display, 32-key keyboard, RealTime-Clock. Wand or laser scanner. Program prompts and data checking thru its own keyboard. Easy data transfer by RS-232 port or PC, PS/2 keyboard. Direct from USA manufacturer. 30-day \$\$ back.

Worthington Data Solutions

417A Ingalls St., Santa Cruz, CA 95060

(800) 345-4220 In CA: (408) 458-9938

WHEN EASE-OF-USE COUNTS

Reading bar codes should be as easy as a "quick flick of the wrist." But many bar code readers require you to flick and flick and Flick and FLICK until the bar code label is finally read. PERCON designed bar code readers that really are as easy as a "quick flick of the wrist."

PERCON

2190 W. 11th Ave., Eugene, OR 97402

Phone: (800) 873-7266 FAX: (503) 344-1399

THE BUYER'S MART

BAR CODE

PERCON: THE BAR CODE SPECIALISTS

If you have questions about bar code technology, it's nice to know an experienced, friendly bar code specialist is only a phone call away. Want to know where to start or where to find hard-to-find bar code accessories? Call PERCON for answers.

PERCON

2190 W. 11th Ave., Eugene, OR 97402

Phone: (800) 873-7266 FAX: (503) 344-1399

5-YR. WARRANTY AT PERCON

PERCON decoders are now covered by a five-year limited warranty. That means you won't spend one cent replacing your PERCON bar code decoder for five full years. That's reliability you can count on!

PERCON

2190 W. 11th Ave., Eugene, OR 97402

Phone: (800) 873-7266 FAX: (503) 344-1399

PC BAR CODE SPECIALISTS

Bar code readers designed for fast, reliable, cost effective data entry. Looks just like keyboard data! Choose from stainless steel wand or laser interface. Also, powerful Bar Code and Text printing software. Great warranty. Dealer inquiries welcome.

Seagull Scientific Systems

15127 N.E. 24th, Suite 333, Redmond, WA 98052

206-451-8966

DATA INPUT DEVICES

Bar Code, Magnetic Stripe Readers & SmartCard Encoder/Reader for microcomputers & terminals, including IBM PS/2 & others, DEC, Macintosh, AT&T, CT, Wyse, Wang. All readers connect on the keyboard cable & are transparent to all software. UPC & 39 print programs, magnetic encoders, & portable readers are also available.

TPS Electronics

4047 Transport, Palo Alto, CA 94303

415-856-6833 Telex 371-9097 TPS PLA

FAX: 415-856-3843

Inquiry 585.

VARIANT MICROSYSTEMS BAR CODE READERS DELIVER

WAND/LASER/MAGNETIC CARD CONNECTIVITY

• Keyboard wedges (Internal/External) for IBM PC/XT/AT, PS/2 and portables.

• RS232C wedges for WYSE, Link, Kimtron terminals

• Bar code and label printing software

• Full two-year warranty

• 30-Day Money-Back Guarantee

• Extensive VAR/Dealer Discounts

3140 De La Cruz Blvd., Suite 200/Santa Clara, CA 95051(408) 980-1880

FAX: 415-623-1372

Inquiry 586.

CAD/CAM

PHOTO PLOTTING

from your Smartwork Edit file or any RS-274 Gerber Photo Plot file. Raster type Photoplotting supplied on .007" thick Kodak Ultraline film. Plot data accepted by modem, 5 1/4", 3 1/2" MS-DOS format disks or 9-track mag tape. Gerber plot file 8"x10" plots start from \$15.00.

Call for details.

KEPRO CIRCUIT SYSTEMS

Fenton, MO

1-800-325-3878 / 1-314-343-1630 in MO.

Inquiry 587.

CASE

STATE OBJECT ORIENTED COMPILERS

The COMPEDITOR's use finite state and object oriented programming techniques to design, develop and document source programs in: Ada, Basic, C, Fortran and Pascal, IBM DOS 2. + 250K RAM.

Prices: \$200-\$300 (With Primer and Debugger)
Sampler \$75 (With All manuals & Credit)

AYECO 5025 Nassau Circle, Orlando
INCORPORATED FL 32808 (407) 295-0930

Inquiry 588.

CD-ROM

CD-ROM BUILDERS OMNIBUS

Provides the complete computer system and software prerequisites needed for a fast, productive DOS-based CD-ROM development environment. AMI 80386 25MHz, 4 MB RAM; 338MB Wren; Hitachi CDR-3500 w/audio; 800 MB WORM, AUM-1381A VGA. Other high performance, capacity, and reliability developer platforms/file servers also available. Send for catalog.

5G Corporation

4131 Spicewood Springs Road A-4, Austin TX 78759
800/333-4131 FAX 512/345-9575

Inquiry 589.

CD-ROM Drives & Titles

Largest selection for PC & Mac.
Microsoft Programmers Library & Drive \$995
Computer Library \$695 • Public Domain S/W \$99.

Drives from \$699. Hundreds of titles from \$29.

MC/VISA/AMEX, Money-back Guarantee.

Call or write for free 100-page catalog.

Get it all from "The Bureau"

Bureau of Electronic Publishing

121 Norwood Ave., Upper Montclair, NJ 07043
(201) 746-3031

Inquiry 590.

Food/Analyst CD-ROM

Analyze foods, meals, and recipes for any number of persons based on the complete USDA food nutrient database 4700+ foods, 80+ nutrients. See graphs, printed reports, summaries. Other titles and CD-ROM publishing services available.

Hopkins Technology

CD-ROM Publisher
421 Hazel Lane, Suite 104
Hopkins, MN 55343

(612) 931-9376 Compuserve 74017,614

Inquiry 591.

CD-ROM Developer's Lab

Multimedia production resource for Mac & PC developers & managers. Proven design, management, data prep, programming, premastering, and manufacturing techniques & specs from 18 leading companies. Demos of off-the-shelf tools for imaging, audio, animation (Mac). Real applications using Media-Mixer source tools. CD-ROM XA. PC or Mac \$795; Transportable \$845. Visa or MasterCard.

Software Mart, Inc.

4131 Spicewood Springs Road I-3, Austin, TX 78759
512-346-7887

Inquiry 592.

COMPUTER INSURANCE

INSURES YOUR COMPUTER

SAFEWARE provides full replacement of hardware, media and purchased software. As little as \$39 a year provides comprehensive coverage. Blanket coverage; no list of equipment needed. One call does it all. Call 8 am-10 pm ET. (Sat. 9 to 5)

TOLL FREE 1-800-848-3469

(Local 614-262-0559)

SAFEWARE, The Insurance Agency Inc.

Inquiry 593.

COMP. MAINT. CHEMICALS

Buy Direct

A full line of Computer Maintenance chemicals: Pressurized Duster, CRT Screen Cleaner, Hood & Housing, Anti-Static, Head & disc, Freon T.F. Solvent, Cleaning Diskettes, Wipes, Swabs. All at wholesale prices. Call Data-Chem at:

1-800-FON-6698

Inquiry 594.

CROSS ASSEMBLERS

CROSS ASSEMBLERS

Universal Linker, Librarian

Targets for 36 Microprocessors

Hosts: PC/MS DOS, micro VAX, VAX 8000

ENERTEC, INC.

BOX 1312, 811 W. Fifth St.

Lansdale, PA 19446

Tel: 215-362-0966 Fax: 215-362-2404

Inquiry 595.

68000 CROSS ASSEMBLER

Assembles 68000/68010 code on a PC Compatible

• Very High Speed—2MB source code assembled per minute • Macros • S-Records

Knowledge Based Systems, Inc.

2746 Longmire • College Station • Texas • 77840

Phone: (409) 696-7979 • Fax: (409) 696-7277

BBS: (409) 696-7055

Inquiry 596.

Professional Series

PseudoCode releases its PseudoSam professional Series of cross assemblers. Most popular processors. Macros, Conditional Assembly, and Include Files. Virtually unlimited size. For IBM PCs, MS-DOS 2.0 or greater. With manual for \$50.00. (MI res. 4% tax). Simulators and disassemblers also available. Shipping \$5, Canada \$10, Foreign \$15. Visa/MC.

KORE Inc.

6910 Patterson, Caledonia, MI 49316

30-Day satisfaction guaranteed or purchase price refunded.

Inquiry 597.

FANTASTIC SIMULATORS

For the 8048, 8051, 8080, 8085, & Z80 families. Full function simulation including ALL MODES of interrupts. Built-in disassembler. Better than expensive I.C.E.'s.

CROSS ASSEMBLERS

We support the 8048, 8051, 8080/8085, 8096 & Z80 families. Just \$75 each.

Lear Com Company

2440 Kipling St./Ste. 206, Lakewood, CO 80215

303-232-2226

Inquiry 598.

MACINTOSH CROSS ASSEMBLERS

"ASM"—available for most 8-bit MPUs. Fast. Full Mac interface. S or Hex output downloads to most EPROM programmers. Features macros, conditional ass'y, local and auto labels, symbol table cross-reference, module sectioning. Editor included. \$129.95 each plus S/H. MC/VISA. Technical bulletin available.

MICRO DIALECTS, INC., Dept B

PO. Box 30014, Cincinnati, OH 45230

(513) 271-9100

Inquiry 599.

THE BUYER'S MART

CROSS ASSEMBLERS

CROSS ASSEMBLERS

Macros, PC Compatible, Relocatable, Conditionals, Fast, Reliable from \$150
also: Disassemblers

EPROM Programmer Board

MICROCOMPUTER TOOLS CO.

Phone (800) 443-0779

In CA (415) 825-4200

912 Hastings Dr., Concord, CA 94518

Inquiry 600.

680X0 Cross Assemblers

Now, inexpensive quality 680X0 Cross-Assemblers that use your IBM PC or compatible. All versions support up to 32 char labels, INCLUDE files, PATH names, extensive list output, sorted symbol tables, many common directives, printed manuals. Basic versions create S-records. Linking versions include a librarian & linker, create either S-records or relocatable modules linked to create S-records or binary files. Minimum requirements are 300K, DOS 2.00, & 1-1/2" D5DD.

Basic 68000/68010—\$49.95 Basic 68020—\$69.95

Linking 68000/68010—\$89.95 Linking 68020/68081—\$129.95

Linking 68020/68081—\$149.95

Checks, VISA, MC accepted. MN residents +6% sales tax.

No POs or CODs please.

RAVEN Computer Systems

Box 12116, St. Paul, MN 55112 (612) 636-0365

Inquiry 601.

6800-Family Development Software

Our C Compilers for the 6800, 6801, 6809, & 68HC11 feature a complete implementation (excluding bit fields) of C as described by K&R and yield 30-70% less code than other compilers. Our Assemblers feature macros and conditional assembly. Linker & Terminal Emulator included.

Wintek Corporation

1801 South St., Lafayette, IN 47904

(800) 742-6809 or (317) 742-8428

Inquiry 602.

DATA CONVERSION

MEDIA CONVERSION/DATA TRANSLATION

More than just a straight dump or ASCII transfer!

Word Processing, DBMS, and Spreadsheet data on Disks or Tapes transferred directly into applications running on Mainframes, Minis, Micros, Dedicated Word Processors, Typesetters, and Electronic Publishing systems.

IBM PS/2 & Macintosh supported

#1 in the translation industry!

CompuData Translators, Inc.

3325 Wilshire Blvd., Suite 1202, Los Angeles, CA 90010

(213) 387-4477 1-800-825-8251

Inquiry 603.

DATABASE MGMT. SYSTEMS

dBASE file access from C

Code Base 4 is a library of C routines which gives complete dBASE or Clipper functionality and file compatibility. Use DOS, Unix, OS/2 or MS Windows.

\$295 with Source! FREE DEMO

Sequiter Call (403) 439-8171

Software Inc. Fax (403) 433-7460

Inquiry 604.

DATA/DISK CONVERSION

RESULTS

You Can Depend On!

- Data Conversion
- Disk Duplication
- Optical Scanning

Computer Conversions

9580 Black Mountain Rd., Suite J, San Diego, CA 92126

619-693-1697

Inquiry 605.

290 BYTE • AUGUST 1989

DATA/DISK CONVERSION

DISK CONVERSIONS

Media transfer to or from: IBM, Xerox, DEC, Wang, Lanier, CPT, Microm, NBI, CT, also WP, WS, MSWORD, DW4, MM, Samna, DEC DX, MAS 11, Xerox-Writer, ASCII.

FREE TEST CONVERSION CONVERSION SPECIALISTS

531 Main St., Ste. 835, El Segundo, CA 90245

(213) 545-6551

(213) 322-6319

Inquiry 606.

DISK & TAPE CONVERSIONS AUTOMATICALLY SAVE TIME AND MONEY

Over 1000 formats from Mini, Micro Mainframe, Word Processors, & Typesetters.

TAPE Conversions as low as \$23.00 MB

DISK Conversions as low as \$15.00 per Disk

Call or write TODAY for a cost-saving quotation.

CREATIVE DATA SERVICES

1210 W. Latimer Ave., Campbell, CA 95008

(408) 866-6080

Inquiry 607.

FROM MACs TO MAINFRAMES. . .

Our 12 conversion systems support over 1000 formats

DISK INTERCHANGE SERVICE COMPANY

2 Park Drive • Westford, MA 01886

(508) 692-0050

Inquiry 608.

THE #1 CHOICE

In disk & tape conversion

for many leading corporations, government agencies, law firms, and companies in every industry—world-wide.

Free test • Satisfaction guaranteed

Call the helpful conversion experts.

Graphics Unlimited Inc.

3000 Second St. North, Minneapolis, MN 55411

(612) 588-7571

Inquiry 609.

IBM PC ↔ HP

FILE COPY

IBM PC to HP File Copy allows IBM PCs, PS/2, compatibles to read, write files written by Hewlett-Packard Series 70, 80, 200, 300, 1000, 9000's. We offer custom work using our file copy utilities and program translators. Call for estimate, catalog, data sheet.

Oswego Software

312/554-3567

507 North Adams St.

Fax 312/554-3573

Oswego, Illinois 60543

Telex 858-757

Inquiry 610.

CONVERSION SERVICES

Convert any 9-track magnetic tape to or from over 2000 formats including 3 1/2", 5 1/4", 8" disk formats & word processors. Disk-to-disk conversions also available. Call for more info. Introducing OCR Scanning Services.

Pivar Computing Services, Inc.

165 Arlington Hgts. Rd., Dept. #B

Buffalo Grove, IL 60089 (312) 459-6010

Inquiry 611.

DEMOS/TUTORIALS

INSTANT REPLAY III

Build Demos, Tutorials, Prototypes, Presentations, Music, Timed Keyboard Macros, and Menu Systems. Includes Screen Maker, Keystroke/Time Editor, Program Memorizer and Animator, Record Great Reviews! Simply the BEST. Not copy protected. No royalties. 60-day satisfaction money-back guarantee. IBM and Compat. \$149.95 US Chk/Cr. Crd. Demo Diskette \$5.00

NOSTRADAMUS, INC.

P.O. Box 9252

Salt Lake City, Utah 84109 (801) 272-0671

Inquiry 612.

DISASSEMBLERS

80x86 .EXE/.COM to .ASM

- Accurately reconstruct, study & modify [64K+] programs with a minimum of input or editing of output.
- Assembly language output is MASM 5.x-compatible.
- Exhaustive flow-trace distinguishes code from data.
- Best formats for each. Commented BIOS calls/DOS functions. SEGMENT/PROC/other vital pseudo-ops.

PC-DISnDATA (5 1/4" disk & manual) \$165

PRO/AM SOFTWARE

220 Cardigan Road, Centerville, OH 45459

(513) 435-4480 (9 A.M.—5 P.M. EST M-F)

Inquiry 613.

SOFT-X-PLORE

See "BYTE's May '88 issue pg. 78" Disassemble 500 kb (*) program at 10,000/min. (*) in any file, ROM/RAM memory up to 80386 instruction set (*). SOFT-X-plore:

* is for MS/DOS 2.0+ systems

* uses 20 algorithms and seven passes (*)

* only \$99.95 plus S&H w/30-day guarantee.

To order call (800) 448-4656 or info (203) 953-0236

Or write: RJSWANTEK INC.

178 Brookside Rd., Newington, CT 06111

* best on the market MC/VISA accepted

Inquiry 614.

DISK COMPATIBILITY

IBM PCs USE Mac DISKS

MatchMaker lets you plug any Macintosh external floppy drive into an IBM PC. Half-size card and software lets you copy to/from, view directory, initialize, or delete files on the Mac diskette. Works with PCs, XTs, ATs, and compatibles. The easy way to move information!

\$149.00 Visa/MC/COD/Chk.

Micro Solutions Computer Products

132 W. Lincoln Hwy., DeKalb, IL 60115 815/756-3411

Inquiry 615.

DISK DRIVES

PS/2 DRIVES FOR PCs ATs

CompatiKit/PC \$279

CompatiKit/AT \$219

Built-in floppy controllers—no problem.

Supports multiple drives and formats. Lets your computer use IBM PS/2 1.4M diskettes plus more!

Call for further information or to place an order.

VISA/MC/COD/CHECK.

Micro Solutions Computer Products

132 W. Lincoln Hwy., DeKalb, IL 60115 815/756-3411

Inquiry 616.

DISK DUPLICATION

SOFTWARE PRODUCTION

- Disk duplication
- All formats
- EVERLOCK copy protection
- Label/sleeve printing
- Full packaging services
- Warehousing
- Drop shipping
- Fulfillment
- 48-hour delivery
- Consultation & guidance

Star-Byte, Inc.

2880 Bergey Rd., Hatfield, PA 19440

215-997-2470

800-243-1515

Inquiry 617.

THE BUYER'S MART

DUPLICATION SERVICES

SOFTWARE DUPLICATION

- One-Stop Shopping
- Technical Support
- Custom Packaging
- Drop Shipping
- Copy Protection
- Fast Turnaround
- Competitive Pricing

SATISFACTION GUARANTEED
800-222-0490 NJ 201-462-7628

MEGAsoft

P.O. Box 710, Freehold, NJ 07728

Inquiry 618.

EDUCATION

B.Sc. DEGREE IN PROGRAMMING

The American Institute for Computer Sciences offers an in-depth correspondence course which allows you to earn your Bachelor of Science degree in computer programming at home. Subjects covered are: MS/DOS, BASIC, PASCAL, C, Data File Processing, Data Structures & Operating System Concepts.

AMERICAN INST. FOR COMPUTER SCIENCES

1704-BY 11th Ave. So., Birmingham, AL 35205
TOLL FREE 1-800-872-AICS

Inquiry 619.

ENTERTAINMENT

BEAT THE LOTTERY

With GAIL HOWARD'S SMART LUCK COMPUTER SYSTEMS
\$23.4 Million Florida Jackpot Just Won With Computer Wheel!!
COMPUTER WHEEL™ - An absolute MUST for every serious lottery player
54" - \$29.95 + \$2 sft. (Add \$3 for 3 1/2")

COMPUTER ADVANTAGE™ - Proven to be the most successful number selection system ever devised for Lotto-5/4 - \$39.95 + \$2 sft. (Add \$1 for 3 1/2")

SMART LUCK COMPUTER SYSTEMS

Dept. B6, P.O. Box 1519, White Plains, NY 10602
1-800-876-G-A-I-L (4245)

Inquiry 620.

NEMESIS™ Go Master®

Go, a game of strategic elegance, has been a way of life in the Orient for over four thousand years. Many consider Go to be the secret of the Japanese businessman's success. "While chess is a game of war, Go is a game of market share" (President of Nikko Hotels).

"If you are interested in Go, buy this program."

Game of the Month - J Pournelle BYTE 7/87

Toyogo, Inc. The Leader in Computer Go.
78 Bedford St. #34-Y, Lexington, MA 02173, (617) 861-0488

Inquiry 621.

FLOW CHARTS

FLOW CHARTING II+ HELPS YOU!

Precise flowcharting is fast and simple with Flow Charting II+. Draw, edit and print perfect charts: bold and normal fonts, 26 shapes - 95 sizes; fast entry of arrows, bypasses & connectors; Fast Insert Line; shrink screen displays 200-column chart; 40-column edit screen for detail work, much more!

PATTON & PATTON

81 Great Oaks Blvd., San Jose, CA 95119
1-800-525-0082 Ext. 42 (Outside CA)
408-629-5376 Ext. 42 (CA/Int'l)
See our ad on page 102.

Inquiry 622.

WINDOWS FLOWCHARTER \$79

RFFlow is a drawing tool designed specifically for flowcharts. Easy to learn, easy to use. 75 shapes automatically adjust in size. Move, copy, or delete groups of objects. 7 levels of zoom. Use mouse or keyboard. On-line user's manual. Supports Windows printers, plotters, and fonts. \$5 trial disc. RFFlow requires Microsoft® Windows.

RFF ELECTRONICS

1053 Banyan Court, Loveland, CO 80538
(303) 663-5767

Inquiry 623.

FLOW CHARTS

STRUCTURED FLOW CHART

NSChart creates Nassi-Shneiderman (structured) flowcharts from a simple PDL. Key words define structures & text strings appear in the chart. Easy to create, even easier to revise! Automatic chart sizing, text centering. Translators from many languages available. For Mac and IBM PC.

SILTRONIX, INC.

P.O. Box 82544, San Diego, CA 92138
1-800-637-4888

Inquiry 624.

FORTRAN TOOLS

TAME YOUR FORTRAN CODE!

Programming tools for MS-DOS FORWARN—an invaluable aid to Fortran program development! Finds common programming errors such as mismatched parameter lists and common blocks, and uninitialized variables. Prints detailed cross-references and call-tree diagrams. \$329
FORTAN DEVELOPMENT TOOLS—includes Pretty (indents, renames, changes GOTOs to IF-THEN-ELSEs, etc.) and 6 more tools. \$129.

Qulbus Enterprises, Inc.

106 N. Draper Avenue, Champaign, IL 61821
(217) 356-8876

Inquiry 625.

GRAPHICS

35mm SLIDES—In 24 Hours

We transform your PC-Graphics files into full-color high-resolution, 35mm slides and ship within 24 hours. Harvard, Pixie, Lotus, Freelance, and others supported. Files accepted by modem. Free Federal Express on all orders of 20+ slides. Only \$8 per slide. Call for literature or circle reader service number shown below.

Accent Presentations, Inc.

950 Highland Drive, Ste. 202, P.O. Box 1303, Solana Beach, CA 92075
1-800-222-2592

Inquiry 626.

RAINDROP™

FAST, compact PrtScr Utility for end users AND developers. Hardcopy as fast as 10 secs. Average binary size - 6 kbyte. 12 video graphic standards. Scale, rotate, colorize and more. 'CALL' from user-written programs. Complete 9- & 24-pin dot-matrix, inkjet, and laserjet library \$39.95+\$3 sft.

RAINBOW TECHNOLOGIES

8106 St. David Ct., Springfield, VA 22153
(703) 440-0064

Inquiry 627.

HARD DRIVE REPAIR

HARD DRIVE REPAIR

WE WILL REPAIR YOUR HARD DRIVE AT A FRACTION OF THE COST OF REPLACING IT. FAST TURNAROUND!!! CALL FOR DETAILS.

H & W micro, inc.

528-C FOREST PARKWAY
FOREST PARK, GA 30050
(404) 366-1600

Inquiry 628.

HARDWARE

VGA COLOR MONITOR

\$249 \$249 \$249
NEW. Overstock. Made by GoldStar
14" Screen. 640 x 480. Analog/RGB
International Materials Exchange, Inc.

IME 1340 Soldiers Field Rd., Boston, MA 02135
(617) 254-1700 FAX (617) 254-0392

Inquiry 629.

HARDWARE

PC CARDS/BREADBOARDS

- AD8-1, 8 bit A/D, digital osc. software . . . \$99
- 8 bit fast A/D, 8CH, GAIN 1,10,100 . . . \$199
- 12 bit A/D, 8CH, S/H, GAIN 1,10,100 . . . \$279
- DIO24, 24 TTL I/O, 8255 PPI . . . \$89
- Driver, 21-50V, 300mA) OC outputs . . . \$99
- Printer Port or RS232 Breadboard . . . \$129

JB COMPU-TRONIX

P.O. Box 27717, Lakewood, CO 80227
(303) 987-3239

Inquiry 630.

Apple • Service Parts
• Accessories • Systems •
BUY ★ SELL ★ TRADE

PRE-OWNED Electronics, Inc.

30 Clematis Avenue, Waltham, MA 02154
800-274-5343 FAX 617-891-3556

Service Centers and Dealers welcome

Inquiry 631.

NEED AN EXTRA SLOT FOR YOUR 8-BIT PC?
Add: LAN MODEM, Accelerator Card or Fixed Disk and/or 3 1/2" Diskette

RMT's 2001-F2H2 Single Card Controller:

- Uses only one expansion unit
- Supports two 3 1/2" and/or 5 1/4" diskette drives
- Supports two fixed disk drives (up to 140 MB each)
- On-board BIOS, automatically handles any comb. of drives

RMT 2001-F2H2 THE SPACE ODYSSEY
RMT SYSTEMS, INC. (714) 863-1092

Inquiry 632.

HARDWARE

LAPTOPS • APPLE • IBM
COMPAQ SLT IBM PS2
ZENITH MACINTOSH
SHARP LASERWRITER
TOSHIBA IMAGEWRITER
NEC HP LASERJET
PLOTTERS EPSON

Call UCC 213-921-8900 For Prices
13738 E. Artesia Blvd. 150 Carritos, CA 90701
Fax 213-802-0831 International Orders Welcome

Inquiry 633.

HARDWARE/ADD-ONS

Memory Card for NEC MultiSPEED

Add up to 8Mbytes of battery backed RAM, with ramdrive software. Fits in modem port. Opt. LIM4.0EMM. Buy 512K now & trade-up to 2M or 8M later. OK AU\$289 (US\$202); 128K AU\$428 (US\$299); 512K AU\$859 (US\$601) 2M-Scan EMM \$110 (US\$77) MC68HC811F11 programmer AU\$399 (US\$279) Add AU\$25 (US\$17.50) airmail. Add AU\$17 (US\$11.80) insurance optional. Prices subject to change & exchange rate. (1AU\$ approx=70:US quoted) Visa, MC accepted.

SAMWAYS ELECTRONIC Eng.

P.O. Box 46 Robertson 2577 Australia
+61 48 851541

Inquiry 634.

The World's First Highest Density Module!

- * 18 Meg on the smallest surface
- * Organization: 2x1024Kx8 bit
- * Package: DIL 64 pin Jedec-Standard
- * Technology: CMOS, hybrid, 18xHMS1100JP-10
- * Compatibility: With two Hitachi HB56A 19-10
- * Suitable for extension of basic memory
- * Engineers take notice. This product can be manufactured on large scale.

For more information please write or call:

TermoTrol Corp.

1888 Century Park East, Suite 1900, L.A., CA 90067
Tel: 213-284-3242

Inquiry 635.

THE BUYER'S MART

HARDWARE/COPROCESSOR

DIGITAL SIGNAL PROCESSOR
DSP products for the IBM PC/XT/AT based on the TI TMS32010 and TMS320C25 up to 12 MIPS operation. Designed for applications in communications, instrumentation, speech, and numeric processing. Offered with 12 bit 110 KHz A/D and D/A and continuous-to-disk data acquisition & playback option. From \$650.

DALANCO SPRY

89 Westland Ave., Rochester, NY 14618
(716) 473-3610

Inquiry 636.

SC/FOX™ PARALLEL COPROCESSOR
PCXT/AT/386 plug-in board with Fortran software. 10 MIPS operation, up to 50 MIPS burst. 64K to 1M byte memory. Uses Harris RTX 2000™ RISC real-time CPU with 1-cycle multiply, 1-cycle 14-priority interrupts, two 256-word stacks, three 16-bit timer/counters, 16-bit I/O bus. Ideal for real-time control, signal and image processing, and multiple board operation. From \$2,295.

Optional SC/FOX Single Board Computer version for stand-alone operation. Eurocard size with software, starting at \$1,495.

SILICON COMPOSERS, INC. (415) 322-8763
210 California Ave., Suite K, Palo Alto, CA 94306

Inquiry 637.

INVENTORY MANAGEMENT

STOCK-MASTER 4.0

Commercial grade inventory management software at micro prices.

- Supports all 12 transaction types
- Trend Analysis
- Quality Control
- Multiple Locations
- Purchase Order Tracking
- Open Order Reporting
- Serial/Lot # Tracking
- Stock Status Reporting
- Activity History Analysis
- Bill of Materials
- Purchase Order Writing
- Order Entry
- Material Requirements
- On Line Inquiry

Applied Micro Business Systems, Inc.
177-F Riverside Ave., Newport Beach, CA 92563 714-759-0582

Inquiry 638.

dFELLER Inventory

Business inventory programs written in modifiable dBASE source code.

dFELLER Inventory \$150.00

Requires dBASE II or III, PC-DOS/CPM

dFELLER Plus \$200.00

with History and Purchase Orders

Requires dBASE III or dBASE III Plus (For Stockrooms)

Feller Associates

550 CR PPA, Route 3, Ishpeming, MI 49849

(906) 486-6024

Inquiry 639.

LANS

The \$25 Network

Try the 1st truly low-cost LAN

- Connect 2 or 3 PCs, XT's, AT's
- Uses serial ports and 5-wire cable
- Runs at 115K baud
- Runs in background, totally transparent
- Share any device, any file, any time
- Needs only 14K of ram.

Skeptical? We make believers!
Information Modes

P.O. Drawer F, Denton, TX 76202
817-387-3339

Inquiry 640.

LAPTOP COMPUTERS

Laptop Savings

Laptops: Toshiba • Zenith • Nec • Sharp
• Epson • Mitsubishi • Compaq
Also Laptop Accessories: Modems, Fax Modems, External Drives, Portable Printers, Memory, Key Pads, Hard Drives, Batteries, and Auto Adapters.

Computer Options Unlimited

12 Maiden Lane, Bound Brook, NJ 08805

Phone: 201-469-7678 (Fax: 201-469-7544)

Hours: 9am/10pm 7 days Worldwide sales

Inquiry 641.

292 B Y T E • AUGUST 1989

LAPTOP PERIPHERALS

LAPTOP BACKLIGHTS

Factory Installed • 90 Day Warranty

Toshiba, Amstrad, Sanyo, DG,
Kaypro, IBM, HP, etc. \$295

The Portable Peripherals People

Axonix Corporation

(801) 466-9797

Inquiry 642.

TOSHIBA PERIPHERALS	T1000	T1200	T3100	T3100e
Battery Adapter (12V)	PX25T	PX1T	P90	P90+
Vehicle Battery Adapter	X25		A80	A80+
Built-in 2400bps Modem		M24BI		
Internal 2400bps Modem	M24IC		M24EC & M24ES	
Single COMMS Port Card	S232T		S232E	
Dual COMMS Port Card			D232E	
SCSI Interface Card			SC38E	

PRODUCT R&D Corporation

1194 Pacific St., Suite 201, San Luis Obispo, CA 93401
(805) 546-9713 or 800-234-5584

Inquiry 643.

LASERJET FONTS

9000 FONTS FOR 1¢ EACH

DOWNSCALE font generator is the fastest, easiest, and cheapest source of soft fonts for your HP LaserJet. Make portrait, landscape, expanded or condensed fonts from 2 to 120 points. 3 styles \$25, 10 styles \$50, 21 styles \$90. Scaling software included. VISA/MC

TRIONUM, INC.

P.O. Box 305 Kendall Sq., Cambridge, MA 02142
1-800-TRIONUM

Inquiry 644.

MAC EDUCATION

Gradebook emulation
for
micro-computers

Da Poma GB

First dedicated gradebook
on the Macintosh
available since 1984

Da Poma, Inc.

P.O. Drawer H, Hondo Texas 78861 (512) 428-5932

Inquiry 645.

MAC PROGRAMMING TOOLS

MAC DEVELOPMENT TOOLS

Professional Programmers Extender: Standard Mac interface, lists, printing, graphics, tiling. Extender GraphPac: Quality color graphs. Line, bar, semi-log, customizable symbols.

INVENTION Software

(313) 996-8108

Inquiry 646.

MEMORY CHIPS

MEMORY CHIPS

41256-15-12-10	Call	51000 (1 Meg)	Call
4164-15	Call	51258 for Compaq 386	Call
4164-12	Call	8087-3-2	Call
41126 Piggy Back for AT	Call	80287-6-8-10	Call
41464-12 (84Kx4)	Call	80387	Call
414255 (256Kx4)	Call	NEC-420-8	Call
2784-27128-27256-27512	Call	Mouse	Call

Prices subject to change

ESSKAY 718-353-3353

Inquiry 647.

MEMORY CHIPS

MEMORY

NEW OR PULL

64-15 P \$1.25 ONE MEG, ZIP

256-15 P \$5.95 SIP AVAILABLE

256-12 - \$6.95 INTEL CPU IN STOCK

MODEM

VOICE CARD

ITC

(714) 730-1121 FAX: (714) 730-3837

PRICES SUBJECT TO CHANGE WITHOUT NOTICE

MasterCard VISA

Inquiry 648.

MONITOR INTERFACE

COMPUTER VIDEO GENERATOR

Test EGA, VGA, Multisync & Data Projectors with handheld monitor tester. From 15.7 KHz to 64.0 KHz, battery powered, 4 patterns, all plug-in with no adapter cables.

NETWORK TECHNOLOGIES INC.

800-RGB-TECH In OH: 216-543-1646

UK: 0244-880478 Paris: 01331-476-32789

Inquiry 649.

NETWORKING

NETWORK BUSINESS SYSTEMS

Keyword Eliminator \$99.
D C B Eliminator \$99.
ELS Utilities \$59.
Netcrack (lose password?) \$99.
Getdisk (get BIOS drives) \$59.
BIOS Tools (patch drive tbls) \$99.

NETWORK BUSINESS SYSTEMS

1215 Woodhollow Drive, Suite 1104, Houston, TX 77057
(713) 783-4457

Inquiry 650.

So Far Your Computers Have Been Talking to Each Other NOW Your Staff Can as Well

CHAT — ACCESS

A Complete Chatting and Messaging Solution to 300m, Novell, and Other Network Networks. CHAT-ACCESS is the ultimate in user friendly software, enabling you to send messages, receive them and engage other logged-in users in full scale conversation. Using only 1 Kbyte of your workstation RAM (for TSR program), CHAT-ACCESS provides a list of logged in users and sends one or all of them a brief message. It also enables you to "CHAT" with another workstation through interactive windows that simultaneously display both sides of the conversation. CHAT-ACCESS operates on 386 or SP-LIB. 3+ OPEN (MS-DOS workstation), Novell NetWare and all other PC LANs that support NetBIOS.

Shany Computers Ltd.

Rechter Building, 4 Smilansky st., Natanya, Israel 42304

Tel: (972) (53) 333931 Fax: (972) (53) 342418

Inquiry 651.

SHANY COMPUTERS, SOFTWARE THAT MAKES YOUR NET... WORK

CO/FILE+

An essential expansion to your MS-DOS and Network operating system so that you can run your existing single user applications with no modifications as multi-user applications running on your network. Using only 1/2 Kbytes of your workstation RAM, CO/FILE+ enables your single user applications to share common files on any MS-DOS 3.10 and higher LANs. Data is protected by automatic file or record level locking and unlocking. FEATURES/BENEFITS: • Supports all the MS-DOS 3.10 and higher Local Area Networks. • Consumes only 2Kbytes of RAM at each workstation for the TSR program. • Supports 3 levels of file sharing: • Read Only Sharing. • Write Sharing. • Create Sharing. • Supports automatic record or file level locking and unlocking for Write and Create Sharing.

Shany Computers Ltd.

Rechter Building, 4 Smilansky st., Natanya, Israel 42304

Tel: (972) (53) 333931 Fax: (972) (53) 342418

Inquiry 652.

NEURAL NETWORKS

"STATE OF THE ART

I recommend BrainMaker without reservation." Steve Gibson, INFOWORLD "An ideal tool for learning this technology" Bary Simon, PC Mag.

Let us help you solve:
• Stock Forecasting • Data & Business Analysis • Video Recognition & OCR • Signal Analysis
10 times faster than any other neural net!!!

California Scientific Software

160 E. Montecito #E, Sierra Madre, CA 91024

(818) 355-1094 \$195 IBM PC, XT, AT, PS/2

Inquiry 653.

THE BUYER'S MART

OBJECT ORIENTED TOOLS

OBJECT-ORIENTED TOOLKIT

TRIPLE your productivity with Complete C™
The only C object-oriented development utility with precompiler, foundation classes (source code included), make, integrated debugger, documentation generator, profiler, streamliner, and full technical support.

Introductory Price: \$269

Complete Computer Corporation
111 West 57th St., NY, NY 10019
212-582-2635

Inquiry 654.

PROGRAMMERS TOOLS

HYPERINTERFACE™

Menu Creator™ — A program generator for menu-driven user interface. Excellent for complex menu systems. \$99.95. **Advanced Library** — Extended capability for data entry and advanced text-display control from your programs. \$99.95. FORTRAN, Pascal, C, BASIC supported. **HYPERMATH™** — An application of Menu Creator™ and the Advanced Library. FREE

Avanpro Corp.

P.O. Box 969, Pacific Palisades, CA 90272
(213) 454-3866

Inquiry 655.

TLIB™ 4.12 Version Control

"TLIB" is a great system" — *PC Tech Journal* 3/88. Full-featured configuration mgmt for software professionals. All versions of your code instantly available. Very compact, only changes are stored. Check-in/out locks, revision merge, branching, more. Mainframe deltas for **Pansophic, ADR, IBM, Unisys**. Only \$99.95 + S&H, or 5-station LAN \$299.95 + S&H. MS-DOS VISA/MC

BURTON SYSTEMS SOFTWARE
P.O. Box 4156, Cary, NC 27519 (919) 656-0475

Inquiry 656.

Have Same 'C' Source for UNIX and DOS
D-ISAM—Unix standard indexed file management library for UNIX DOS and NETWORKS. Manages all locking. UNIX/DOS source \$595 (for both), DOS libs \$145.

"W"—Character windowing with COLORS, Line Graphics, Bells and more. You need not modify DOS code to work WELL on any UNIX terminal. UNIX/DOS source \$295 (for both), DOS libs \$95.

BYTE DESIGNS

P.O. Box F195-76, Blaine, WA 98230
1-800-663-8547 or (604) 278-5200

(DOS lib available for Microsoft or Borland 'C' compilers)

Inquiry 657.

Async Executive™ & Tutorial

Interrupt driven transmit & receive. Supports up to eight ports. Buffered I/O to 64K. 50 to 19200BPS. XON/XOFF. DTE/DCE. Modem controls. Transfer characters or blocks. Millisecond timing. Universal language interface. BIOS/DOS extension capabilities. XMODEM w/CRC 300+ page comprehensive manual. Sample programs include a spooler written in C. For IBM PC/XT/AT & all compatibles. Software Developer's Kit: \$195. NO ROYALTIES

Shipping \$5, Canada \$10, International \$15
CA residents must add sales tax. Checks/MO only.

CIRRUS SOFTWARE, INC.
P.O. Box 51924, Dept. B., Palo Alto, CA 94303
(415) 949-1470

Inquiry 658.

ProPak 2.0

The Programmer's Productivity Pack

The most useful programmer's tools and utilities, smoothly integrated into a single package. Ideal for professional programmers, software developers, and students, tool Versions for MS-DOS, DESQview and OmniView included. Powerful, flexible, and easy to use. Fully customizable! Full 30 day money back guarantee! Only \$79.95 plus S&H

Falk Data Systems
5322 Rockwood Ct., El Paso, TX 79932
(915) 584-7670

Inquiry 659.

PROGRAMMERS TOOLS

WINDOWS APPLICATION PROGRAMMING ENVIRONMENT (WAPE)

WAPE is an INTERACTIVE CODE GENERATOR for over 450 MS-Windows system calls. Set of LIBRARY FUNCTIONS for windows, menus, dialog boxes, list boxes, and clip board. Built-in Menu Editor Windows Application Development Tools can be invoked from within WAPE. Context-sensitive ONLINE HELP available.

INTERSOFT INC.

5285 S.W. Meadows Rd., Lake Oswego, OR 97035
(503) 639-3555

Inquiry 660.

FREE CATALOG!

QuickBASIC Libraries and Utilities
286, 386, PC/XT AWARD ROM BIOS
Hardware Upgrades

1-800-423-3400 or (412) 782-0384
KOMPUTERWERK, INC.
851 Parkview Blvd., Pittsburgh, PA 15215

Inquiry 661.

TURBO PLUS \$149.95

Programming tools for Turbo Pascal 5.0 Screen Painter, Code Generator, I/O Fields, Dynamic Menus, Programming Unit Libraries, Sample Programs, 260-Page Illustrated Manual. 60-Day Satisfaction Guarantee! Brochures & Demo Diskettes avail. Highly Favorable Reviews! IBM & Compatibles.

Nostradamus Inc.

P.O. Box 9252, Salt Lake City, UT 84109
(801) 272-0671

Inquiry 662.

Get INSIDE!

The best PC software performance tool is now better than ever with source line timing, caller timing and arbitrary event timing—all with microsecond accuracy and without source modification. The expanded DOS analysis mode identifies I/O bottlenecks. \$125

Call today for a free brochure and the latest list of supported compilers. 30-day guarantee. VISA/MC/COD

Paradigm Systems

P.O. Box 152, Milford, MA 01757
(800) 537-5043 In MA: (508) 478-0499

Inquiry 663.

FREE BUYER'S GUIDE

Programmer's Connection is an independent dealer representing more than 300 manufacturers with over 800 software products for IBM personal computers and compatibles. We have serviced the professional programmer since 1984 by offering sound advice and low prices. Call or write today to receive your FREE comprehensive Buyer's Guide.

Programmer's Connection US 800-336-1166
7249 Whipple Ave. NW Canada 800-225-1166
North Canton, OH 44720 International 216-494-3781

Inquiry 664.

PUBLIC DOMAIN

Prima Data (the latest programs Club)
1.50 DISK + FREE BOOKS
absolutely free

- 101 Computer Business Ideas
- The Computer Dictionary (NEW UPDATED)
- How to Get Started With Modems
- 10 Best IBM Utilities (and more BOOKS)

We Have the latest Best SHAREWARE & PUBLIC DOMAIN + Free CATALOG +

PRIMA DATA

P.O. BOX 1175, Cardiff, CA 92007 Tel: (619) 931-2520

Inquiry 664.

PUBLIC DOMAIN

\$3.00 SOFTWARE FOR IBM PC

Hundreds to choose from, word processors, databases, spreadsheets, games, lotto, communications, business, music, bible, art, education, language and useful utilities for making your computer easier to learn. Most programs have documentation on the disk.

Free 125-page catalog.

BEST BITS & BYTES

P.O. Box 8245, Dept. B, Van Nuys, CA 91409
In CA: (818) 764-9503 800-245-BYTE

Inquiry 665.

\$1 per DISK Sale

20 TOP IBM PC PD/SW DISKS
(360K) ONLY \$20 + \$3 S&H

CubeCalc, EDRAW, AutoMenu, Math Tutor, PC-DOS Help, Baker's Dozen, Languages, EZ-Form, PC-Style, PackDisk, PC-Stock, KidGames, Best Games, Home Inventory, PC-Outline, Form Letters, ImagePrint, SideWriter, PC-Prompt, Best Utilities.

BRIGHT FUTURES INCORPORATED

P.O. Box 1030, East Windsor, CT 06088
FREE CATALOG (\$1.50 per disk)

Inquiry 666.

FREE CATALOG PUBLIC DOMAIN/SHAREWARE

• 400 IBM PC & compatibles disks •
• 200 Amiga disks • 125 Atari ST disks
PC disks as low as \$1.25 each, Amiga & ST as low as \$1.60 each! Rent or buy. Free shipping! Call toll free, write or circle reader service for FREE BIG CATALOG with full descriptions. Please specify computer—48-hr. turnaround!

Computer Solutions

P.O. Box 354—Dept. B, Mason, Michigan 48854
1-800-874-9375 (M-F 10-6 EST) 1-517-628-2943

Inquiry 667.

- CLIP ART
- GRAPHICS
- LASER FONTS
- CAD
- ELECTRONICS
- GAMES
- TRAVEL
- AUDIO/VIDEO
- SECURITY
- EDUCATION

For FREE CATALOG write to:
CWI Information Services

P.O. BOX 4851, Anaheim, CA 92803
800-777-5636

Or telephone (714) 879-7917 24 HOURS!

Inquiry 668.

RENT SOFTWARE \$1/DISK

Rent Public Domain and User Supported Software for \$1 per diskfull or we'll copy. IBM (3 1/2" also), Apple, C-64, Sanyo 550 and Mac. Sampler \$3. VISA/MC. 24-hr. info/order line. (619) 941-3244 or send #10 SASE (specify computer) Money-Back Guarantee!

FutureSystems

Box 3040 (T), Vista, CA 92083
office: 10-6 PST Mon-Sat. (619) 941-9761

Inquiry 669.

FREE IBM SOFTWARE

FREE CATALOG also contains SHAREWARE, 5 1/4 and 3 1/2-inch. All categories. ENGINEERING, CAD, DESKTOP PUBLISHING, LANGUAGES, UTILITIES, BUSINESS, GRAPHICS, SPREADSHEETS, WORD PROCESSORS, CHURCH, MEDICAL, HEALTH, EDUCATION, HOME.

SECTOR SYSTEMS COMPANY, INC.

Dept. B-6, 416 Ocean Avenue, Marblehead, MA 01945
(617) 639-2625

Inquiry 670.

THE BUYER'S MART

PUBLIC DOMAIN

FREE CATALOG

\$1 IBM SOFTWARE

For your free 32-page Master Edition catalog featuring the best of IBM Shareware from just \$1 each, call or write today!

1-800-338-2118

SOFSOURCE

Box 828, East Lansing, MI 48826

Inquiry 671.

SECURITY

THE ULTIMATE COPY PROTECTION

- Completely Menu Driven
- Defeats all Hardware/Software Copiers
- No Source Code Changes
- Multiple Layering
- No Damaged Media
- Full Hard Disk Support
- Unlimited Metering
- FREE Demo Disk

*Quite
Simply
The Best
Way To
Protect
Your Valuable
Software Investment*

STOPCOPY* \$325** STOPCOPY PLUS* \$450**
BBI COMPUTER SYSTEMS® (301) 871-1094
14105 Heritage La., Silver Spring, MD 20906 FAX: (301) 460-7545

Inquiry 677.

SOFTWARE/BASIC

Save time, money, & brain cells!

QuickWindows Advanced user-interface library supports windows, menus, dialog boxes, help, mouse, and more. For text and graphics modes thru VGA. Fast and intuitive!

QuickComm communications library supports up to 16 comm ports, Hayes modems, xmodem and ymodem file transfer, and more. All interrupt driven. Easy to use!

Each library written in assembly and comes with complete manual. \$139 each. For Microsoft QuickBasic or BASCOM.

Software Interphase, Inc.

5 Bradley Street, Suite 106, Providence, RI 02908
(401) 274-5465 Call now for FREE terminal/demo program.
Fax # 401-272-1273

Inquiry 683.

TOP 10 IBM SOFTWARE - FREE

10 disk set — PC Write, PC Calc+, Trendview, DanCad, FileExpress, Moraff's Revenge, HGCIBM, Novatron, Home Base, Spacewars plus our 1600+ disk catalog

We accept Visa/MC/Amex

PAY ONLY \$5.00 shipping/handling

(limited introductory offer)

INTERNATIONAL SOFTWARE LIBRARY

511 Encinitas Blvd • Ste 104 • Encinitas CA 92024

order today toll free 800 669-2669

Inquiry 672.

BIT-LOCK® SECURITY

Piracy SURVIVAL 5 YEARS proves effectiveness of powerful multilayered security. Rapid decryption algorithms. Reliable small port-transparent security device. PARALLEL or SERIAL port. Complemented by economical KEYLOK™ and multifaceted COMPU-LOCK™ including countdown, timeout, data encryption, and multiproduct protection.

MICROCOMPUTER APPLICATIONS

3167 E. Olaro Circle, Littleton, CO 80122

(303) 922-8410/770-1863

Inquiry 678.

SOFTWARE/BUSINESS

DATA ENTRY SYSTEM

Heads-down data entry with two-pass verification for the IBM PS/2-PC/XT/AT & compatibles. Features include: Auto dup/skip, verify bypass, range checks, table lookups, a complete edit language. Fully menu driven. Price \$395

Call for our free 30-day trial period.

COMPUTER KEYS

21929 Makah Rd., Woodway, WA 98020
Tel: 206/776-8443 USA: 800/356-0203 Fax: 206/776-7210

FREE SOFTWARE CATALOG

Low as \$1.20/disk

Over 1000 quality IBM software

On 5.25" and 3.5" format

From outside U.S.A., except Canada,

please send US \$2.00 refundable with order.

For fast service, write to

SOFTSHOPPE

P.O. BOX 709, Ann Arbor, MI 48105

(313) 763-8721

Inquiry 673.

PC Security "Password"

With All the Computer Security Talk, PASSWORD is the Perfect Security Lock.

Password is a software program providing security for your PC. Password is Easy to understand and Simple to install, requires no reformatting. The boot limit option secures your hard disk. Password provides for up to 100 users with the supervisor controlling access to protected directories. Password is menu-driven with pop-up windows and help screens. The program provides an audit trail of users, and a screen blanking feature.

PASSWORD \$98.00 US Visa, MC, Amex
Nasdec International Inc.
2704-85 Garry Street, Winnipeg MB Canada R3C 4J5
PH: (204) 956-2798 FAX (204) 943-3702

Inquiry 679.

MILP88—MIXED-INTEGERS LP

A general-purpose system for solving mixed-integer linear programs with up to 800 constraints and 4000 general integer or noninteger variables. Build MILP88 into your own programs with compiled Turbo Pascal units. MILP88 reads/writes Lotus worksheets. Use 1-2-3/Symphony as a matrix generator or post processor. Other features include interactive and batch operation, spreadsheet LP display and editing, an equation processor, problem/branch list storage, file I/O, download/reload, report generator, and sensitivity analysis. \$149 with manual and 8087 support. \$299 with Turbo Pascal units.

Eastern Software Products, Inc.

P.O. Box 15328, Alexandria, VA 22309
(703) 360-7600

Inquiry 684.

YOUR SALES MESSAGE

about the special computer product or service that you provide belongs in print.

THE BUYER'S MART

can help you reach computer professionals and produce valuable inquiries for your company!

Call Brian Higgins for more information

603-924-3754

Inquiry 674.

COPY PROTECTION

The world's leading software manufacturers depend on Softguard copy protection systems. Your FREE DISKETTE introduces you to SuperLock™—invisible copy protection for IBM-PC (and compatibles) and Macintosh.

- Hard disk support
- Customized versions
- No source code changes
- LAN support
- New upgrades available

(408) 773-9680

SOFTGUARD SYSTEMS, INC.

710 Lakeway, Suite 200, Sunnyvale, CA 94086
FAX (408) 773-1405

Inquiry 680.

LOW COST/HIGH QUALITY

Established, Powerful, Complete, Business Management Software Systems. Point-of-Sale/Inventory Control "SALES-PRO". Service and Repair, Video/Rental Store Management, Church Management, Accounting and Many more starting at \$39. For IBM PC Compatibles and the Atari ST.

HI-TECH ADVISERS

P.O. Box 7524, Winter Haven, FL 33883-7524

1-800-882-4310 Florida (813) 294-1885

Inquiry 685.

16 and 32 BIT MICROS

EDUCATIONAL TRAINING SYSTEMS in a notebook with power supply — for the Motorola 68000/68020/68881, TMS32010 DSP, Intel 8086/8087, A/D-D/A Converters, cross assemblers, serial interfaces with software, complete systems, documentation, schematic, operating system, cables. Starting Prices — \$230.00

Phone URDA, Inc.

1-800-338-0517

Inquiry 675.

PC TIME CLOCK

AutoTime is an Employee Management System that allows you to turn any PC into an Electronic Time Clock. AutoTime provides Time & Attendance, Job Clocking, Payroll Interface, and Labor Distribution reporting. Network compatible. Prices start at \$495. Other Business Products: Network FAX, Absence Call-In, db-EDI.

Chase Technologies

1617 Kingman Ave., San Jose, CA 95128

(408) 998-2917

Inquiry 681.

SOFTWARE/ENGINEERING

Affordable Engineering Software

FREE APPLICATION GUIDE & CATALOG

Circuit Analysis • Root Locus • Thermal Analysis • Plotter Drivers • Engineering Graphics • Signal Processing • Active/Passive Filter Design • Transfer Function/FFT Analysis • Logic Simulation • Microstrip Design • PC/MSDOS • Macintosh • VISA/MC

BV Engineering Professional Software

2023 Chicago Ave., Suite B-13, Riverside, CA 92507

(714) 781-0252

Inquiry 686.

SECURITY

EVERLOCK COPY PROTECTION

- Thwarts ALL Bit-copy Software
- Protect any COM/EXE w/o Source changes
- Shut down Debug Tracing & Disassemblers
- Install to Floppy, Hard Disk, or LAN
- Remotely Reset Program Install-Count, Expire-Date or #Executes
- No damaged media or I/O plugs

For IBM and clones. \$195 & up. Free Info.

Az-Tech Software, Inc.

305 East Franklin, Richmond, MO 64085

(800) 227-0644

(816) 776-2700
FAX: (816) 776-8398

Inquiry 676.

dBASE BUSINESS TOOLS

- GENERAL LEDGER
- ORDER ENTRY
- JOB COSTING
- BILL OF MATLS
- PAYROLL
- PURCH ORD/INVENTORY
- ACCOUNTS RECEIVABLE
- JOB ESTIMATING
- SALES ANALYSIS
- ACCOUNTS PAYABLE

\$99 ea. + S&H

DATAMAR SYSTEMS Cred. Card-Check-COD

4576-B Santa Monica Ave.

San Diego, CA 92107

(619) 223-3344

Inquiry 682.

Analog Circuit Simulation

- Schematic Entry
- SPICE Simulator
- Model Libraries
- Monte Carlo Analysis
- Parameter Sweeps
- Plotting/Graphics Output

Intusoft has a complete PC based system including everything from schematic entry through SPICE simulation using extended memory to comprehensive interactive post processing. Starting at \$95 for ISpice, the complete system sells for just \$790.

Intusoft

The leader in low cost, full featured CAE software

P.O. Box 6607, San Pedro, CA 90734
(213) 833-0710 FAX (213) 831-3956

Inquiry 687.

THE BUYER'S MART

SOFTWARE/ENGINEERING

SIMULATION WITH GPSS/PC™

GPSS/PC™ is an IBM personal computer implementation of the popular mainframe simulation language GPSS. Graphics, animation and an extremely interactive environment allow a totally new view of your simulations. Simulate complex real-world systems with the most interactive and visual yet economical simulation software.

MINUTEMAN Software

PO Box 1717, Stow, Massachusetts, U.S.A.
(508) 897-5662 ext. 540 (800) 223-1430 ext. 540

Inquiry 688.

Circuit Analysis — SPICE

Non-linear DC & Transient; Linear AC.
• Version 3B1 with BSIM, GaAs, JFET, MOSFET, BJT, diode, etc. models, screen graphics, improved speed and convergence.
• PC Version 2G6 available at \$95.
Call, write, or check inquiry # for more info.

Northern Valley Software

28327 Rothrock Dr., Rancho Palos Verdes, CA 90274
(213) 541-3677

Inquiry 689.

FREE ENGINEERING MAGAZINE

Personal Engineering is a monthly magazine sent free of charge (USA only) to scientists/engineers who use PCs for technical applications. Topics each month include **Instrumentation • Data Acq/Control • Design Automation**. To receive a free sample issue and qualification form either circle below or send request on letterhead to:

Personal Engineering Communications
Box 300, Brookline, MA 02146

Inquiry 690.

ECA-2 Analog Circuit Simulation

ECA-2 Electronic Circuit Analysis is a high performance, interactive, analog circuit simulator. Available for a wide range of computers and operating systems.

ECA-2 Offers

- AC, DC, Transient, Fourier, Temperature
- Worst-case, Monte-Carlo
- 2 to 50 times faster than SPICE—Now with multiple plots!

ECA-2 2.40 IBM PC \$775 FREE DEMO.

Turn-key Systems Available

Tatum Labs, Inc.

3917 Research Park Dr. B-1, Ann Arbor, MI 48108
313-663-8810

Inquiry 691.

TUTSIM™ FANSIM™

- Time Domain
- Control sys. Simulation
- Linear and nonlinear
- Block Diagram Syntax
- Transient response
- \$40 (eval copy)/\$495
- Frequency Domain
- FFT, Inverse FFT
- Find Xfer Functions
- Find roots, poles
- Bode, Nyquist, tables
- \$40 (eval copy)/\$395 full

Info, examples: **TUTSIM Products**

200 California Ave., #212, Palo Alto, CA 94306
(415) 325-4800

Inquiry 692.

SOFTWARE/FORTRAN

EXPAND & EXTEND LIBS

122 FORTRAN callable routines. EXPAND allows DOS compilers access to LIM/EMS 3.2 or 4.0 expanded memory. EXTEND provides CGA, EGA, VGA, Hercules, HP, Tektronix, AutoCAD DXF graphics, access to BIOS/DOS functions plus additional utilities. EXPAND \$119, EXTEND \$149, both \$218.

DESIGN DECISIONS, INC.

PO. Box 12884, Pittsburgh, PA 15241
(412) 941-4525

Inquiry 693.

SOFTWARE/GEOLOGICAL

GEOLOGICAL CATALOG

Geological software for log plotting, gridding/contouring, hydrology, digitizing, 3-D solid modelling, synthetic seismogram, fracture analysis, image processing, scout ticket manager, over 50 programs in catalog. Macintosh too! Please call, or write, for Free Catalog!

RockWare, Inc.

4251 Kipling St., Suite 595, Wheat Ridge, CO 80033 USA
(303) 423-5645 Fax (303) 423-6171

SOFTWARE/GRAPHICS

QuickGeometry Library

Many powerful math subroutines for CAD/CAM and graphics: LINES, ARCS, CIRCLES, ELLIPSES, NON-UNIFORM RATIONAL B-SPLINES WOFFSET (NURBS), INTERSECTION (even splines), ROTATE, SCALE, TRANSLATE, MIRROR, OFFSET, BREAK, TRIM, ENDPOINTS, TANGENTS, CURVATURE, DXF I/O; lists. IBM PC comp MS-DOS 2+ • \$199.00 + no S&H; incl C source, manual, support, 30-day guarantee.

Building Block Software

P.O. Box 1373, Somerville, MA 02144
(617) 628-5217

Inquiry 694.

PROFESSIONAL GRAPHICS FOR SCIENTISTS AND ENGINEERS PC/MS-DOS • Macintosh FREE 48-page Catalog

Linear/Log Scaling • Graphs with error bars • AUTO PLOT • BATCH Mode • Multiple Yaxes • Multiple data files • Auto/Forced Scaling • Full labeling • Built-in editor • 1-2-3 Interface • Curve fitting • Statistics • CGA, EGA & Hercules Compatible. 40 pen plotters supported.

BV Engineering Professional Software

2023 Chicago Ave., Suite B13, Riverside, CA 92507
VISA/MC (714) 781-0252

Inquiry 695.

Technical Report Graphics

Edit data and graphics with EDTECH for \$65

- Database, worksheet-style data editing
- Technical XY plots from data for reports
- Graphics editing on screen, drawing, text
- 180x180 dots/inch output, 24-pin pit read
- Log axes, Greek, symbols, Lotus Implex

DIGITAL ANALYTICS

P.O. Box 31430, Houston, TX 77231
(713) 721-2069

Inquiry 696.

NEW! TurboGeometry-Plus

Over 300 2D & 3D routines. Surfacing, Solids, HiddenLine, Volumes, Areas, Transforms, Perspectives, Tangents, Clipping, Decomp. & more. IBM PC/Comp, MAC, MSDOS 2+. Turbo Pascal, Turbo C, MSC & Turbo Pascal MAC. Manual \$199.95 or \$299.95 w/source. Foreign \$225 or \$325 w/source S&H Incl. VISA, MC, Chk, PO. 30 Day guarantee.

Disk Software, Inc.

2116 E. Arapaho Rd., #487, Richardson, TX 75081
214-423-7286 FAX 214-423-4465 800-636-7760

Inquiry 697.

TECHNICAL GRAPHICS

FROM ANY LANGUAGE

- Logarithmic, Time/Date & Linear Axes.
- Easy Curve Fitting and Data Smoothing.
- Supports all Video & Device Standards.
- 10 Curves with up to 8000 points each.
- Plus much much more...

Only \$95 Call Today 800-284-3381

Edmond Software, Inc.

5900 Mosteller Dr. #1125, Oklahoma City, OK 73112

Inquiry 698.

SOFTWARE/GRAPHICS

PEN PLOTTER EMULATOR

FPlot turns your dot matrix or laser printer into an HP pen plotter. Fast hi-res output. No jagged lines. Vary line width, color. Works with Autocad, Drafrix, etc. Supports NEC P5/P6, IBM Proprinter, Epson LQ/FX, Toshiba, HP Laserjet, Okidata 29x/39x, Hercules/CGA/EGA/VGA. \$64 check/m.o.

Fplot Corporation

24-18 Steinway St., Suite 605, Astoria, NY 11103
718-545-3505

Inquiry 699.

GRAPHICS PRINTER SUPPORT

AT LAST! Use the PrtSc key to make quality scaled B&W or color reproductions of your display on any dot matrix, inkjet, or laser printer. GRAFPLUS supports all versions of PC or MS-DOS with IBM (incl. EGA, VGA), Techar, and Hercules graphics boards \$49.95.

Jewell Technologies, Inc.

4740 44th Ave. SW, Seattle, WA 98116
800-628-2828 x527 (206) 937-1081

Inquiry 700.

FORTRAN PROGRAMMER?

Now you can call 2-D and 3-D graphics routines within your FORTRAN program.

GRAF/MATIC: screen routines \$135
PLOT/MATIC: plotter driver 135
PRINT/MATIC: printer driver 135

For the IBM PC, XT, AT & compatibles. We support a variety of compilers, graphics bds., plotters and printers.

MICROCOMPATIBLES

301 Prelude Dr., Dept. B, Silver Spring, MD 20901 USA
(301) 593-0683

Inquiry 701.

STANDARD GRAPHICS

NOVA XLJIB: Optimized. Window/viewport, arcs, splines, figure fill, borders, text (scale, rotate, align), bitmaps, bitbit, keyboard, mouse, image capture. Over 150 functions. \$75.

PC_VDI: Outline fillable text. Includes Segmentation. Free Demo Disk. \$395.

Both products ANSI CGI compatible, drivers for printer, plotter, HP laser. CGA/EGA/VGA. For most "C" compilers. MS FORTRAN, QuickBASIC. Demos, manual.

NOVA INC.

PO BOX 68976, Schaumburg, IL 60168

312-882-4111

Inquiry 702.

SOFTWARE/INVESTMENT

Compare over 1300 Mutual Funds with Business Week's Mutual Fund Scoreboard and your IBM PC or compatible. Use simple menu commands to search and sort on over 25 information fields. No additional software required. Data transports easily to Lotus 1-2-3. Search, total, average, rank, display and print reports—at the touch of a key!

Only \$69.95 each for an Equity or Fixed Income Diskette

\$199.95 per subscription for either the Equity or Fixed Income version

\$319.95 for a subscription to both versions (a savings of \$60!)

Order now or receive more information by calling 1-800-553-3575

(In Illinois, call 1-312-250-9292)

Or write to: **Business Week Diskettes**

PO. Box 621, Elk Grove, IL 60009

Inquiry 703.

STOCKS OPTIONS FUTURES

Turn Your PC Into A

MARKET QUOTATION MONITOR

85-page book covers satellite and radio data reception of financial news and quotes for your PC, \$19 (includes demo diskette). Free informative catalog of

- Data receivers and kits
- Quote processing and display software
- Descrambling software utilities

303-223-2120 \$2 Shipping & Handling

DATArx

111 E. Drake Rd., Suite 7041, Fort Collins, CO 80525

Inquiry 704.

THE BUYER'S MART

SOFTWARE/LANGUAGES

FORTH with DRUMA FORTH-83
Break the 64K barrier without speedspace penalty. Well designed, attractively priced. '83 Standard.

- 1Mb+ automated memory management
- On-line documentation, ASCII/block files
- Many powerful and useful features
- Other products: windows, modules, profiler
- IBM PC/XT/AT & all compatibles

Write or call for FREE example diskettes.

DRUMA INC.

6448 Hwy. 290 East E103, Austin, TX 78723

Orders: 512-323-0403

BBoard: 512-323-2402

Inquiry 705.

FORTRAN for Macintosh

Language Systems FORTRAN is a full-featured FORTRAN 77 compiler integrated w/MPW. Full ANSI FORTRAN 77 plus VAX-type extensions. SANE numerical calculations & data types incl. COMPLEX*16, 68000, 68020 and 68881 object code. Arrays greater than 32K. Link with Pascal, C, MacApp. \$359 w/MPW via air. MC/VISA/Check. MAC+, SE, Mac II, HD req.

Language Systems Corp.

441 Carlisle Drive, Herndon, VA 22070

(703) 478-0181

See our ad on page 212

Inquiry 706.

SOFTWARE/MATHEMATICS

MATH EDITING FOR THE PC

$$x^2 = \sum_{n=0}^{\infty} [x_n^{(n)}] + \left(\frac{1}{\alpha} \int \frac{f ds}{\alpha \pm \beta x} \right)$$

- MathEdit constructs math equations to be inserted into WordPerfect and manuscript documents.
- User-friendly interface—no new word processor needs to be learned.
- MathEdit—\$149

K-TALK
COMMUNICATIONS

50 McMillan Ave., Suite 100
Columbus, Ohio 43201
(614) 294-3535

Inquiry 707.

SOFTWARE/MUSIC

IBM MUSIC FEATURE CARD!

Option card with 8 voice, multi-timbral MIDI synthesizer on board. Includes 240 pre-programmed Yamaha sounds, 96 programmable patches and a MIDI in/out thru interface. Use two cards to double capacities. An all-in-one MIDI Studio for IBM and compatibles for only \$495. Software available for recording, arranging and educational needs. Packages recommended. Dealers, catalogers, & VARS call for discount schedule.

Distributed by MIX BOOKSHELF

6400 Hollis St., #12, Emeryville, CA 94608 (415) 653-3307

1-800-233-9604

Inquiry 708.

SOFTWARE/PACKAGING

HARD TO FIND COMPUTER SUPPLIES FOR SOFTWARE DEVELOPERS & POWER USERS

Cloth binders & slipcases like IBM's. Vinyl binders, boxes, and folders in many sizes. Disk pages, envelopes, & labels. Low quantity imprinting. Bulk disks. Everything you need to bring your software to market. Disk and binder mailers. Much more! Low Prices! Fast service. Call or write for a FREE CATALOG.

Anthropomorphic Systems, Limited

376-B E. Saint Charles Rd., Lombard, IL 60148

1-800-DEAL-NOW

312-629-5160

Inquiry 708.

SAVE SAVE SAVE SAVE LET'S TALK PACKAGING

From Disk Labels to Manuals to Shipping Boxes—We are a complete packaging service. Everything you need to market your software. Call for our free catalog.

SOFCOM Printing and Packaging

10305 Reading Rd., Cincinnati, OH 45241

512-563-7136

Inquiry 710.

SOFTWARE/PRINTING

PRINTER GENIUS

Powerful memory-resident printer management • Control printer features from menus or within documents • Print spool-to-disk files or memory • Background print • File & directory browse • Edit small text • and more... • User friendly pop-up screens • 92-page manual • Pre-set for all printers • Completely flexible • PC MS-DOS • \$89 + \$4 S/H • VISA/MC

Nor Software Inc.

527 3rd Ave., Suite 150, New York, NY 10016

(212) 213-9118

Inquiry 711.

SOFTWARE/SCANNERS

Optical Character Recognition

Stop retyping: PC-OCR™ software will convert typed or printed pages into editable text files for your word processor. Works with HP ScanJet, Panasonic and most other scanners. Supplied with 18 popular fonts. User trainable; you can teach PC-OCR™ to read virtually any typestyle, incl. foreign fonts. Proportional text, matrix printer output. Xerox copies OK. \$385. Check/VISA/MC/AmExp/COD

Essex Publishing Co.

P.O. Box 391, Cedar Grove, NJ 07009

(201) 783-6940

Inquiry 712.

SOFTWARE/SCIENTIFIC

TableCurve—TableCode

Curve-Fit 211 Equations in a Single Step

TableCurve™ generates printed reports and Lotus, dBase, Quattro, Harvard Graphics, and Pagemaker/Ventura output. TableCode™ generates functions and calling code for C, Pascal, BASIC, FORTRAN, Modula-2 and dBASE languages.

Demo \$5, TableCurve \$159, TableCode \$149 MC/Visa

AISN Software

P.O. Box 32277, Phoenix, AZ 85064

602-266-1925

Inquiry 713.

DATA ACQUISITION & ANALYSIS ON PCs

- Free application assistance. Tell us about your DSP, process control, A/D or D/A needs. Our expert engineering staff will provide you with a system solution to fit your needs and budget.
- A/D & IEEE-488 boards from Metrabyte, Scientific Solutions and National Instruments.
- Analysis software including PRIME FACTOR FFT subroutine library, FOURIER PERSPECTIVE II advanced linear systems analysis.
- Measurement software from United Laboratory Technologies, Quinn-Curtis, and Golden. Scientific engineering 2 & 3D graphics.

See "What's New" page 80, BYTE July, 1988

LOW PRICES—Satisfaction GUARANTEED

ALLIGATOR TECHNOLOGIES

P.O. Box 9708, Fountain Valley, CA 92708

Tel. (714) 850-9984 FAX. (714) 850-9987 MCI: ALLIGATOR

Inquiry 714.

Chaos/Nonlinear Dynamics

- Ordinary and Delay Differential Equation Solvers • Bifurcation Diagrams • 2- and 3-D Plotting, Sequential Magnification, Poincaré Sections • Next Maximum, 1-D & Circle Maps
- Phase Portraits with Multiple Initial Conditions • Spectral Analysis

Fractional Dimensions, Lyapunov Exponents

DS-I \$250.00 DS-II \$350.00

CHAOS IN THE CLASSROOM \$49.95

DYNAMICAL SYSTEMS, INC.

P.O. Box 35241, Tucson, AZ 85740, 602-825-1331

Inquiry 715.

C SCIENTIFIC LIBRARY

Extensive library of matrix, mathematical, and statistical routines. Developed and documented for use by technical specialists and C programmers in research, education, engineering, and scientific applications. Over 550 functions, superior documentation—four manuals, including Tutorial, Function Pages, and Example Programs. Includes Real and Complex Linear Algebra, Eigenvalues, Differential Equations, Quadrature, Smoothing, Fitting and Prediction, MultiVariate Statistics, Multi-Dimensional Optimization, Linear Programming, Curve Fitting and Interpolations, etc. \$295 object only and \$395 with C source code.

EIGENWARE TECHNOLOGIES

13096 La Vista Dr., Saratoga, CA 95070 (408) 867-1184

Inquiry 716.

SOFTWARE/SCIENTIFIC

ORDINARY/PARTIAL DIFFERENTIAL EQN SOLVER

FOR THE IBM PC & COMPATIBLES

MICROCOMPATIBLES INC.

301 Prelude Dr., Silver Spring, MD 20901

(301) 593-0683

Inquiry 717.

OUR CATALOG WILL SAVE YOU TIME AND MONEY!

It describes (i) GRAPH, a \$79 scientific plotting program; (ii) MINSQ, a powerful \$179 package for curve fitting and model development; (iii) LAPLACE, a simulation program employing numerical inversion of transforms (\$249); and (iv) RSTRIP for exponential stripping (\$249). Call today for our free 16-page catalog with detailed technical application notes.

MicroMath Scientific Software

Salt Lake City, Utah 84121-3144

For orders or catalogs call: (800) 942-MATH

Inquiry 718.

POWER FFT

High performance FFT routine library for the IBM-PC Forward/Inverse FFT, Prime Factor, and General-N single and double precision 1-p. routines. Over 6000 efficient lengths up to 64K points. Complex 1024 FFT in .142s on Compaq 20MHz 386/387 or 840s on Compaq 12MHz 286/8MHz 287. Also includes integer FFT to 16K points. Complex 1024 in .060/.144s on Compaq 20MHz 386/12MHz 286. Multidimension and real transforms, all routines. Use with most C, FORTRAN, Pascal, Basic products.

SOFFTEC

Introductory offer \$85 plus \$3 shipping

P.O. Box 2363, Westford, MA 01886

Inquiry 719.

SP-4 Plotting Program

Linear, Log, Weibull, Normal, Lognormal Axes • 60,000 data • Curve fitting • 20 symbols • Transformations • CGA/EGA/HP Plotters.

Send for our 32-page catalog of engineering/scientific software.

Software Consulting Group

P.O. Box 3298, Santa Clara, CA 95055

(408) 446-1008

Inquiry 720.

SOFTWARE/SECURITY

CodeSafe™ Virus Protection System

Over 100,000 copies sold • Protects all hard disks, any size • Protects all programs on the disk • Detects corruption of Boot sectors, and DOS • Supports all PC/MC-DOS machines • DOS 2.0 to 4.0 • Mono, Hirc, CGA, EGA • Includes both 319" and 319" disks • Transparent to user • Windows containing options will appear if a program has been compiled.

TOLL-FREE TECH SUPPORT • 30-Day Money-Back Guarantee

NOT COPY-PROTECTED \$68.85

Visa, MasterCard, American Express, Discover Club cards accepted

ChrisWare, Inc.

Computer Security Software

15415 N. Eden Dr., Eden Prairie, MN 55348

24-HOUR SERVICE TOLL-FREE 1-800-325-6448

In Minnesota or International Call Collect (612) 949-1116

Inquiry 721.

HANDS OFF THE PROGRAM®

- Locks Hard Disk - Restricts Floppy Use.
- Protects Subdirectories.
- Normal Use of DOS Commands and Application Software.
- IBM PC, XT, AT and True Compatibles.
- DOS V2.0 and Higher. Hard Disk System.
- Keep Other People's HANDS OFF Your System.

\$89.95

VISA/MC

SYSTEM CONSULTING, INC.

314 Canterbury Dr., Pittsburgh, PA 15238

(412) 963-1624

Inquiry 722.

THE BUYER'S MART

SOFTWARE/SORT

OPT-TECH SORT/MERGE

Extremely fast Sort/Merge/Select utility. Run as an MS-DOS command or CALL as a subroutine. Supports most languages and file types including Btrieve and dBASE. Unlimited file sizes, multiple keys and much more! MS-DOS \$149. XENIX \$249.

(702) 588-3737

Opt-Tech Data Processing

P.O. Box 678 - Zephyr Cove, NV 89448

Inquiry 723.

SOFTWARE/UTILITIES

VERIFY DISK INTEGRITY

Quickly checks for visible file changes. File contents check finds hidden changes. Checks for disk errors. Detects deleted/missing files. Easy to use—menu or command line. Not copy protected. Fastest program of its kind. Requires minimal disk space—not memory resident. Works on multiple floppy/hard drives.

VIRO-SCAN 2.01 \$39 + \$3 S&H

OMNICRAFT, INC.
15020 N. 74th St., Ste. C, Scottsdale, AZ 85260
(800) 531-9528 (602) 991-3652

Inquiry 724.

STATISTICS

SX STATISTIX

PC Magazine Editors Choice!

- Easy to learn and use • Fast Free Support
- Money-Back Guarantee

At \$179 SX outperforms higher priced programs!
If you value your time and money,
call today for FREE SX demo disk

612-631-2852

Analytical Software Box 13204, Roseville, MN 55113

Inquiry 725.

The BASS System™

Why use up 8 meg and 640K just to run a data step on your PC? Now you can run your data step code and statistical procs with a system that takes only 1 meg and 400K (and costs only \$399)! Free information:

BASS Institute, Inc.

P.O. Box 349, Chapel Hill, NC 27514

(919) 933-7096 or BB: (919) 968-6755 (N,8,1)

Inquiry 726.

Go with SOLO

Statistics and graphics for the PC. Quick and easy to use. All the popular statistics plus the latest in graphics. For business professionals for occasional use, researchers for basic statistics, or students. Satisfaction guaranteed! \$149 complete with graphics. Call today. VISA or MC.

BM DP Statistical Software, Inc.

1440 Sepulveda Blvd., Suite 316, Los Angeles, CA 90025
(213) 479-7799

Inquiry 727.

STATATA

Stata 2.05 Now Available. More statistics, graphics and an all-new manual. Still only \$590. Quantity Discounts Available. New, lower academic price, \$20 Demo. Call toll-free for more information.

1-800-STATAPC

Computing Resource Center

10801 National Boulevard, Los Angeles, CA 90064

(213) 470-4341

Inquiry 728.

STATISTICS

THE SURVEY SYSTEM

An easy-to-use package designed specifically for **questionnaire data**. Produces banner format, cross tabs & related tables, statistics (incl. regression) & bar charts. Codes and reports answers to open-end questions. All reports are camera-ready for professional presentations. CRT interviewing option.

CREATIVE RESEARCH SYSTEMS

15 Lone Oak Cir., Dept. B, Petaluma, CA 94952

707-765-1001

Inquiry 729.

STATISTICS CATALOG!

Call for the catalog full of professional programs for general statistics, analysis of variance, regression, questionnaire analysis and quality control. Thoroughly tested and easy to use, the programs come with complete documentation. Programs available for PC or Apple II. Call toll free now for your free catalog.

HUMAN SYSTEMS DYNAMICS

9010 Reseda Blvd., Suite 222

Northridge, CA 91324

(800) 451-3030 (818) 993-8536 (CA)

Inquiry 730.

MINITAB's a PC of cake!

MINITAB's intuitive commands are easy to use and remember. Features descriptive statistics, regression, time series, chi-square, hi-res graphics, much more. PC version incl. LOTUS interface, data editor, network pricing. Call for FREE brochure.

Minitab, Inc.

3081 Enterprise Dr., State College, PA 16801

(814) 238-3280

Inquiry 731.

NCSS

Professional, easy to use, menu-driven statistical system. Used by over 5,000 researchers.

- 5.0 Statistical System—\$99
- 5.1 Graphics (2D & 3D)—\$59
- 5.3 Power Pac Supplement—\$49
- 5.4 Exp. Design/QC—\$49
- 5.5 Survival Analysis—\$59
- 5.6 Forecasting—\$69

We accept checks, P.O.s, Visa, MC. Add \$3 s/h.

NCSS-B 801-548-0445

865 East 400 North, Kaysville, UT 84037

Inquiry 732.

StatPac Gold™

StatPac Gold is the award-winning statistics and forecasting package that delivers. It's fast, flexible, easy to use and dependable. Time-tested and loaded with features. You be the judge. Get the facts! Call for your FREE brochure.

1-800-328-4907

Walonick Associates, Inc.

6500 Nicollet Ave. S., Minneapolis, MN 55423

(612) 866-9022

Inquiry 733.

TERMINAL EMULATION

DEBBI Does Dbase

Dbase/Emulation Board Binary Interface
Now all you need is DEBBI & Dbase to easily design applications that utilize your 3270 emulation board. Load DEBBI and then call her throughout your application to exchange data with your host. Data returned in memory. Requires IBM & PJ compatibility. Introductory price: \$85.00 single user/\$795.00 network

Finity Software

6802 Ridge Blvd., Suite 4-H, Brooklyn, NY 11220

(718) 748-0249

Inquiry 734.

UTILITIES

COPY AT TO PC—BRIDGE-IT 3.5

"COPY2PC" RELIABLY writes 360KB floppies on 1.2 MB drives, saving a slot for a second hard disk or tape back-up tape. Only \$79.00 + S/H
"BRIDGE-IT 3.5" is a DEVICE DRIVER supporting 3 1/2" 720KB/44MB drives for PC/XT/AT without upgrading DOS/BIOS. Only \$39.00 + S/H
BRIDGE-IT 3.5 BUNDLED WITH INTERNAL 1.44MB DRIVE AT \$129.00 + S/H

VISA/MC/COD UPS B/R

MICROBRIDGE COMPUTERS

655 Sky Way Suite 113, San Carlos, CA 94070

1-415-593-8777(CA)

1-415-593-7676 (FAX)

1-514-845-0818 (CANADA)

1-800-523-8777

Inquiry 735.

PC-REFERENCE

The best computer publications on-line index. Find articles by keyword, date interval, author, title, publication, type (article, review, etc.) or any combination. Our packing method gets more info into smaller files. Written in optimized C and assembler for speed and compactness. Byte, PC Mag, Personal Computing, PC Computing, PCTJ, more—get just the ones you want. As low as \$49.95 per year.

Nova Software

Box 37464 • Albuquerque, NM 87176

(505) 836-8400

Inquiry 736.

Recover deleted files fast!

Disk Explorer now includes automatic file recovery. You type in the deleted file's name. Disk Explorer finds and restores it. Disk Explorer also shows what's really on disk; view, change or create formats, change a file's status, change data in any sector MS-DOS \$75 U.S. Check/Credit card welcome.

QUAD SOFTWARE LIMITED

45 Charles St. E. 3rd Fl.

Toronto, Ontario, Canada M4Y 1S2

(416) 961-8243

Inquiry 737.

DATABASE UTILITIES

NORTAK Software Ltd. now offers a menu-driven ASSIST-like file utility for dBASE, Clipper, and FoxBASE. Self-contained (.EXE file), fast and simple to use.

SINGLE VERSION—\$35; 3-VERSION PACKAGE—\$60.

To order call:

SHOSHIN Systems Inc.

USA 1-800-267-0755

Canada 1-800-267-8856

Info Only 513-235-2310

VISA and MC accepted

Inquiry 737.

\$79.95!!

Order the RED Utilities now! Programs include: Disk cache speeds hard and floppy disks. Printer spooler. Batch file compiler speeds batch files. Path command for data files. Wild card exceptions. Sort directories. Over 10 more programs. IBM PC. Visa/MC. Send for free catalog.

The Wenham Software Company

5 Burley St. Wenham, MA 01984 (508) 774-7036

Inquiry 738.

WORD PROCESSING

FARSI / GREEK / ARABIC / RUSSIAN

Hebrew, all European, Scandinavian, plus either Hindi, Punjabi, Bengali, Gujarati, Tamil, Thai, Korean, Viet, or IPA. Full-featured multi-language word processor supports on-screen foreign characters and NLO printing with no hardware modifications. Includes Font Editor, \$355 dot matrix; \$150 add'l for laser; \$19 demo. S/H in U.S. incl'd. Req. PC, 640K, graphics. 30-day Guarantee. MC/VISA/AMEX

GAMMA PRODUCTIONS, INC.

710 Wilshire Blvd., Suite 609, Santa Monica, CA 90401

213/394-8622 Tlx: 5106008273 Gamma Pro SNM

Inquiry 739.

THE BUYER'S MART

WORD PROCESSING

DuangJan

Bilingual word processor for English and: Armenian, Bengali, Burmese, Euro/Latin/African, Greek, Gujarati, Hindi, Khmer, Lao, Punjabi, Russian, Sinhalese, Tamil, Telugu, Thai, Ukrainian, Viet. . . . Only \$109+\$5 s/h (foreign + \$12 s/h). Font editor included. For any IBM compatibles with dot-matrix & LaserJet printer. Demo \$9+\$1 s/h.

MegaChomp Company

3438 Cottman Ave., Philadelphia, PA 19149-1606
(215) 331-2748 FAX: (215) 331-4188

Inquiry 740.

PC-Write 3.0 — Shareware

Fast, full featured word processor for IBM PC. Now edits large files & multiple columns. Also spell check, mailmerge, networking, ASCII, and macros. Easy-to-use, optional menus. Supports 500 printers incl. lasers. Software, guide and tutorial on disk: \$19. Registration with manual, support newsletter and 2 free updates: \$99.

90-day money-back guarantee. VISA/MC.

Quicksoft 1-800-888-8088
219 First Ave. N., #224-BYTC, Seattle, WA 98109

Inquiry 741.

YOUR SALES MESSAGE

about the special computer product or service
that you provide belongs in print.

THE BUYER'S MART

can help you reach computer professionals
and produce valuable inquiries for your company!

Call Brian Higgins for more information

603-924-3754

BBS Sysops

Are you looking for ways to improve your board? Something that will set you apart from other boards in your area? Are your subscribers interested in Microcomputers? Listen to this!

Announcing the Bulletin Board EXchange - BBX

The BBX allows you to become a publisher of MicroBYTES Daily, an on-line news service from BYTE. BBX/MicroBYTES is a custom package of news and features designed specially for local BBSes, and is available only to sysops.

Every Monday through Friday you get articles about developments in microcomputing, telecommunications and selected new product announcements. Get the latest news about MS DOS machines, Macintoshes, Unix workstations, Amigas, Atari STs, peripherals and software. All the stories are reported, written, and edited by the staff of BYTE Magazine, BYTEweek and BIX, and our world-wide network of reporters and editors.

Not only do you get a great resource for your subscribers, but you also get access to BIX which will cut your cost of exchanging information and conducting BBS network business.

All this is just \$49 a quarter. Your one-year subscription to the BBX (billed quarterly) may be cancelled any time without further charge; just notify us. If you prefer, you may subscribe for three months only, at just \$69.

If you call BIX directly, you pay no hourly telecommunications charge. If you call using Tymnet, the rates are only \$2/hour on evenings and weekends and \$8/hour on weekdays. You may also purchase unlimited off-peak Tymnet for just \$15 a month

Subscribe today.

BIX

One Phoenix Mill Lane
Peterborough, NH 03458
1-800-227-2983 In NH (603) 924-7681

RS-232 NETWORKING

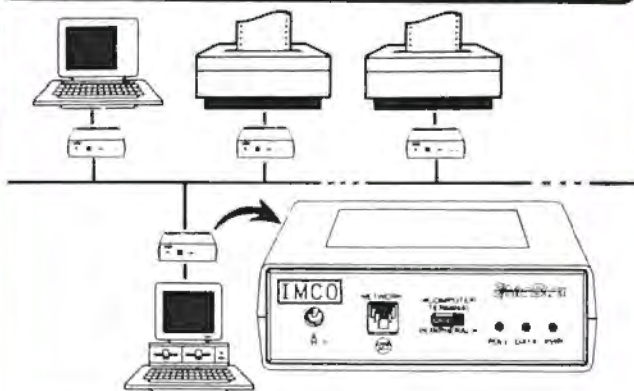

- Network up to 50 serial ports over a single pair of telephone wires in any topology transparent to all software. Built in menus and help screens.
- Access any PC, printer, modem, plotter, or minicomputer from your keyboard!
- Choose print destination from within spread sheet or word processor with POP UP communications utility. Includes background PRINT SPOOLING and X/Modem.
- Uses existing telephone wires in most offices. Easy to install, train and use.
- Add stand-alone BusDrivers, one at a time, at any point along the network, or use standard telephone splitters to add separate addressable ports to a single jack!
- **SPECS:** Distributed, packet-switched, full-duplex, asynchronous, RS-232 data network. Supports 50 devices, independent speeds up to 38,400 BPS (all devices may be simultaneously engaged in full-duplex conversation).

\$350 Per BusDriver (1 per port)

\$295 Each In Six-Packs

IMCO

(508) 485-6950

Protect Your Copies of **BYTE**

NOW AVAILABLE: Custom-designed library files or binders in elegant blue simulated leather stamped in gold leaf.

Binders—Holds 6 issues, opens flat for easy reading.
\$7.95 each, two for \$14.95, or four for \$35.95.



Files—Holds 6 issues.
\$7.95 each, two for \$14.95, or four for \$27.95.



Order Now!

Mail to: Jesse Jones Industries,
Dept. BY, 499 East Erie Ave.,
Philadelphia, PA 19134

CALL TOLL FREE (24 hours)
1-800-972-5858

Please send _____ files;
binders for BYTE magazine.

Name: _____

Enclosed is \$ _____

Address: _____

Add \$1 per file/binder for postage and handling. Outside U.S.A. add \$2.50 per file/binder (U.S. funds only please).

City: _____

Charge my: (minimum \$15)

State: _____ Zip: _____

____ American Express
____ Visa _____ MasterCard
____ Diners Club

Satisfaction guaranteed. Pennsylvania residents add 6% sales tax.
Allow 1-4 weeks delivery in the U.S.

Card # _____

Exp. Date _____

Signature _____

BYTE

9600bps MODEM



+FAX

\$299

2400 bps MODEM \$95 30 DAY FREE TRIAL

ECONOFAX™ OR MNP-5...CALL

Many low cost modems are faulty or very error prone...**Not ours!!!**
PERFORMANCE "I have recently had a lot of trouble getting 2400 BAUD MODEMS to work...this one is working perfectly." R.T. Moreno Valley CA. **SUPPORT** "I get the impression that your company, indeed, bends over backwards to provide service to its customer." M.F. Selma CA. **SUPERIOR TECHNOLOGY**...The phone connection is the main source of data errors. **DYNAMIC IMPEDANCE STABILIZATION™, DIS™** (invented by CompuCom) improves signal quality and reduces these errors by up to 95% compared to a standard modem. Model 2400 (without DIS) at \$95 outperforms the low cost alternatives. The 24DIS at \$119 outperforms the challengers, regardless of cost. IBM internal, Hayes compatible, made in USA, 6 COM ports, internal speaker, five year warranty, EasyCom software, dealers inquire. *If you aren't totally satisfied, return within thirty days for a full refund!*

CompuCom Corporation
March 89 p102 **BYTE MAGAZINE**
"Real deal...worked fine...quite a bargain!"
CALL (408) 732-4500 (800) 228-6648

BIOS SOURCE CODE

The **AT BiosKit** gives you a complete Bios with source code you can modify for your own applications! The BiosKit includes a Bios on diskette ready for programming an Eprom, and includes the utilities you need to Rom the source code. The Bios also has a Rom Monitor/Debug and Setup. At last **you have control** over the core of your system. Over 380 pages, with diskette, \$199. The **XT BiosKit** is only \$99, or get both for \$279. The **Intel Wildcard Supplement** for the XT BiosKit is \$49.

FREE We'll include a free copy of the pocket-sized **XT-AT Handbook** by **Choiesser and Foster** with each BiosKit if you mention this ad when you order. Of course, this \$9.95 value is also available by itself. Or buy five or more for only \$5.00 each.



(619) 271-9526



Annabooks
12145 Alta Carmel Ct Suite 250-262
San Diego, California 92128 **Money-back guarantee**

NEC 8088 IC'S

Replace the 8086 or 8088 in Your IBM PC and Increase its Speed by Up to 30% Price

Part No.	1-9	10+	Part No.	1-9	10+
7400	SALE	.15	7474	SALE	25
7402	SALE	.29	7475	SALE	39
7404	SALE	.15	7476	SALE	35
7405	SALE	.35	7483	SALE	59
7406	SALE	.39	7485	SALE	45
7408	SALE	.35	7486	SALE	29
7410	SALE	.15	7489	SALE	1.95
7411	SALE	.19	7490	SALE	35
7414	SALE	.25	7495	SALE	29
7416	SALE	.19	74107	SALE	13
7417	SALE	.19	74121	SALE	25
7420	SALE	.29	74123	SALE	35
7427	SALE	.19	74157	SALE	35
7430	SALE	.15	74147	SALE	1.49
7432	SALE	.39	74150	SALE	1.10
7438	SALE	.25	74151	SALE	13
7442	SALE	.29	74154	SALE	1.35
7445	SALE	.59	74161	SALE	.69
7446	SALE	.79	74173	SALE	.59
7447	SALE	.69	74174	SALE	.35
7448	SALE	1.95	74175	SALE	.35
7473	SALE	.39	74193	SALE	.79

Part No.	1-9	10+	Part No.	1-9	10+
74LS00	SALE	.15	74LS139	SALE	29
74LS02	SALE	.15	74LS151	SALE	29
74LS03	SALE	.15	74LS153	SALE	25
74LS04	SALE	.19	74LS154	SALE	1.19
74LS05	SALE	.15	74LS157	SALE	35
74LS06	SALE	.59	74LS161	SALE	29
74LS07	SALE	.59	74LS163	SALE	35
74LS08	SALE	.28	74LS164	SALE	35
74LS09	SALE	.15	74LS165	SALE	.75
74LS10	SALE	.15	74LS166	SALE	.69
74LS11	SALE	.19	74LS173	SALE	35
74LS14	SALE	.29	74LS174	SALE	29
74LS20	SALE	.15	74LS175	SALE	29
74LS21	SALE	.19	74LS191	SALE	39
74LS27	SALE	.19	74LS192	SALE	.69
74LS30	SALE	.15	74LS193	SALE	.59
74LS32	SALE	.19	74LS194	SALE	.55
74LS38	SALE	.25	74LS221	SALE	.49
74LS42	SALE	.49	74LS240	SALE	.45
74LS47	SALE	.89	74LS241	SALE	.49
74LS73	SALE	.25	74LS244	SALE	.49
74LS74	SALE	.19	74LS245	SALE	.59
74LS75	SALE	.25	74LS246	SALE	.59
74LS76	SALE	.39	74LS259	SALE	.89
74LS83	SALE	.59	74LS273	SALE	.89
74LS85	SALE	.59	74LS279	SALE	.39
74LS86	SALE	.29	74LS367	SALE	.29
74LS90	SALE	.29	74LS373	SALE	.59
74LS93	SALE	.29	74LS374	SALE	.49
74LS123	SALE	.49	74LS383	SALE	.69
74LS125	SALE	.49	74LS541	SALE	.99
74LS132	SALE	.29	74LS590	SALE	5.95
74LS138	SALE	.49	74LS888	SALE	2.39

Part No.	1-9	10+	Part No.	1-9	10+
74S00	SALE	.19	74S188	SALE	1.49
74S04	SALE	.19	74S189	SALE	1.49
74S32	SALE	.19	74S240	SALE	1.39
74S74	SALE	.19	74S244	SALE	.75
74S112	SALE	.19	74S287	SALE	.75
74S124	SALE	.25	74S298	SALE	1.49
74S138	SALE	.49	74S373	SALE	.99
74S153	SALE	.25	74S374	SALE	.99
74S163	SALE	.75	74S397	SALE	1.29
74S174	SALE	.25	74S472	SALE	2.49
74S175	SALE	.25	74S477	SALE	2.49

CMOS

Part No.	1-9	10+	Part No.	1-9	10+
CD4001	SALE	.19	CD4051	SALE	.59
CD4002	SALE	.19	CD4052	SALE	.59
CD4007	SALE	.25	CD4053	SALE	.59
CD4011	SALE	.19	CD4060	SALE	.29
CD4012	SALE	.25	CD4066	SALE	.59
CD4013	SALE	.29	CD4069	SALE	.19
CD4015	SALE	.49	CD4070	SALE	.29
CD4016	SALE	.29	CD4071	SALE	.22
CD4017	SALE	.49	CD4072	SALE	.22
CD4018	SALE	.59	CD4073	SALE	.22
CD4020	SALE	.59	CD4081	SALE	.22
CD4021	SALE	.59	CD4083	SALE	.35
CD4024	SALE	.45	CD4094	SALE	.39
CD4028	SALE	.45	CD4503	SALE	.89
CD4029	SALE	.69	CD4511	SALE	.79
CD4030	SALE	.35	CD4518	SALE	.65
CD4040	SALE	.65	CD4520	SALE	.75
CD4042	SALE	.59	CD4522	SALE	.75
CD4043	SALE	.59	CD4528	SALE	.69
CD4046	SALE	.65	CD4538	SALE	.79
CD4047	SALE	.65	CD4543	SALE	.79
CD4049	SALE	.29	CD4584	SALE	.49
CD4050	SALE	.29	CD4585	SALE	.69

EPROMS

2816A	2048x8	350ns	9V	15V	5V	Read/Write	5.25
2816A	2048x8	250ns	9V	15V	5V	Read/Write	5.49
2817A	2048x8	250ns	5V	Read/Write	10A	7.95	
2864A	8192x8	300ns	5V	Read/Write	10A	13.95	
2865A	8192x8	300ns	5V	Read/Write	10A	12.95	
2865A	8192x8	250ns	5V	Read/Write	10A	12.95	
52B13	2048x8	350ns	(21V)	5V	Read Only	1.49	

IC'S

Part No.	Price	Part No.	Price	Part No.	Price
Z80	1.19	8155-2	3.49	8286	2.29
Z80A	1.29	81C55	3.95	8741	9.96
Z80A-CTC	1.65	8156	2.95	8742	47.96
Z80A-DART	4.06	8205	8.99	8748 (25V)	7.95
Z80A-PIO	4.86	82C11	6.95	8748H (HMOS)(21V)	9.95
Z80B	2.06	8212	1.99	8749	9.95
Z80B-CTC	3.06	8224	1.96	8751H (3.5-12MHz)	36.95
Z80B-PIO	3.25	8228	1.49	8755	13.95
Z8681B1	8.06	8228-1	1.49	80286 10 (10MHz)	49.95
8000 SERIES					
8001	2.06	8250A	3.95	80287 3 (5MHz)	109.95
80031	0.96	8250B	1.75	80287 8 (5MHz)	209.95
80035	1.06	8251 (Flat BGA)	6.06	80287 10 (10MHz)	259.95
80039	4.06	8251	3.69	80386 16 PGA	279.95
8052AH-BASIC	2.95	8253	1.89	80387 16 (16MHz)	395.95
8080A	2.06	8253-5	1.95	80387 20 (20MHz)	459.95
8085A	2.49	82C53-5	3.95	80387 25 (25MHz)	569.95
8085A-2	3.59	8282	3.95	82294 (8MHz)	8.49
8087 (5MHz)	99.96	8255A-5	2.05	82298 (8MHz)	9.96
8087 1 (10MHz)	184.95	8259-5	3.49	DATA ACQUISITION	
8087 2 (5MHz)	134.95	8272	2.96	ADC0804LCN	3.25
8088 (5MHz)	4.06	8274	6.06	ADC0808CCN	6.06
8088 2 (8MHz)	6.06	8279-5	2.96	ADC0809CCN	3.69
8116	4.06	8282	2.75	AOC1205CCJ-1	18.49
8155	2.49	8284	1.75	ADC0808LCN	4.76
				AY-3 10150	4.49
				AY-5 1013A	1.95

CMOS

Part No.	Function	Price	Part No.	Price	
2016-12	2048x8	120ns	3-76	2.95	
2102	1024x1	350ns	3-76	2.95	
2112	256x4	450ns	MOS	3.49	
2114N	1024x4	450ns		.99	
2114N-2L	1024x4	200ns	Low Power	1.49	
21C14	1024x4	200ns	(CMOS)	.49	
5101	256x4	450ns	(CMOS)	2.49	
6116P-1	2048x8	100ns	(16K) CMOS	3.96	
6116P-3	2048x8	150ns	(16K) CMOS	3.49	
6116LP-1	2048x8	100ns	(16K) LP CMOS	4.30	
6116LP-3	2048x8	150ns	(16K) LP CMOS	3.96	
6264P-10	8192x8	100ns	(64K) CMOS	9.06	
6264P-15	8192x8	150ns	(64K) CMOS	9.26	
6264LP-10	8192x8	100ns	(64K) LP CMOS	10.25	
6264LP-15	8192x8	150ns	(64K) LP CMOS	10.49	
6264LP-15	8192x8	150ns	(64K) LP CMOS	48.26	
6514	1024x4	350ns	CMOS	3.75	
43256-10L	32	768x8	100ns	(256K) Low Power	26.96
43256-15L	32	768x8	150ns	(256K) Low Power	26.96
62256LP-10	32	768x8	100ns	(256K) LP CMOS	27.96
62256LP-12	32	768x8	120ns	(256K) LP CMOS	28.26
62256LP-15	32	768x8	150ns	(256K) LP CMOS	28.26

DRAM

42100A8A-10	1,048,576x9	100ns	1MEGx9 SIP	99.06	239.95
42100A9B-10	1,048,576x9	100ns	1MEGx9 SIM	99.06	239.95
42100A9A-80	1,048,576x9	80ns	1MEGx9 SIP	449.06	249.95
42100A9B-80	1,048,576x9	80ns	1MEGx9 SIM	449.06	249.95
TMS4416-12	16,384x4	120ns		6.76	5.95
TMS4416-15	16,384x4	150ns		6.36	5.49
4116-15	16,384x4	150ns	(MM5290N-2)	1.30	1.25
4128-15	131,072x1	150ns	(Poggyback)	3.49	3.49
4164-100	65,536x1	100ns		2.96	
4164-120	65,536x1	120ns		2.96	
4164-150	65,536x1	150ns		2.96	
41256-60	262,144x1	60ns		11.00	9.25
41256-80	262,144x1	80ns		10.40	7.95
41256-100	262,144x1	100ns		9.76	7.25
41256-120	262,144x1	120ns		9.06	6.95
41256-150	262,144x1	150ns		8.40	6.49
41264-12	64Kx4	120ns	Video RAM	12.95	
41464-10	65,536x4	100ns		14.40	8.95
41464-12	65,536x4	120ns		14.06	8.25
41464-15	65,536x4	150ns		14.06	7.95
51258-10	262,144x1	100ns	Static Column	14.06	8.95
41258A-10	262,144x1	100ns	SIP	14.06	9.95
41258A-10	262,144x1	100ns	256x9 SIM	14.06	74.95
511000P-10	1,048,576x1	100ns	(1 Meg)	26.06	19.95
511000P-80	1,048,576x1	80ns	(1 Meg)	36.06	22.95
514256P-10	262,144x4	100ns	(1 Meg)	34.06	24.95
514258P-10	262,144x4	100ns	Static Column	31.95	

CMOS

TMS2516	2048x8	450ns	(25V)	6.06	4.95
TMS2532	4096x8	450ns	(25V)	5.95	
TMS2532A	4096x8	450ns	(12.5V)	6.49	3.25
TMS2564	8192x8	450ns	(25V)	6.95	
TMS2716	2048x8	450ns	(5V +5V, +12V)	6.06	6.49
702A	256x8	2K	(µs)	6.06	4.25
2708	1024x8	450ns		6.06	5.95
2716	2048x8	450ns	(25V)	3.76	3.25
2716-2	2048x8	350ns	(25V)	3.96	3.49
2721	2048x8	450ns	(25V) CMOS	4.36	3.75
2726	4096x8	450ns	(25V) CMOS	4.36	3.95
2732A-20	4096x8	200ns	(21V)	4.26	3.95
2732A-25	4096x8	250ns	(21V)	4.06	3.75
2732C	4096x8	450ns	(25V) CMOS	4.26	4.25
2732C-20	4096x8	200ns	(21V)	3.96	3.95
2732C-25	4096x8	250ns	(21V) CMOS	6.40	5.95
2728-20	16,384x8	200ns	(12.5V) CMOS	6.40	5.95</

Now Available...Jameco's NEW Summer Sizzler Flyer #139 with 48 pages of Computer Peripherals, Components & More!

15th ANNIVERSARY YEAR 1974 - 1989

SPECIAL! Monochrome Text Card

Sperry Monochrome Display Adapter

- IBM PC/XT Compatible
- Use for Text only
- Great for Network Servers and Dedicated Work Stations

TEXT.....\$12.95

DFI Handy Scanner and 3 Button Mouse for IBM PC/XT/AT

FREE DPE Software with HS3000!

The HS3000 offers a full 4 inch window at 400dpi resolution. Scan photos, logos, drawings, etc. Can be used with today's most popular applications.

- HS3000 Handy Scanner.....\$199.95
 DMS200 200DPI 3-Button Ser Mouse \$39.95
 DMS200S 200DPI 3-Button Ser Mouse with Dr. Halo Software \$59.95

IBM Compatible Cases and Power Supplies

JE1030 Pictured

- JE1010 Flip-Top Standard PC/XT Case..... \$39.95
 JE1018 Slide Baby AT Case.....~~\$69.00~~ \$59.95
 JE1030 150 watt PC/XT Power Supply..... \$59.95
 JE1032 200 watt Baby AT Power Supply..... \$89.95
 JE2010 Tower Case w/250 watt Pwr Supply.... \$279.95
 JE2014 Flip-Top Baby XT Turbo Case..... \$69.95
 JE2019 Flip-Top Baby AT Case..... \$69.95

2400/1200/300 Baud Modems Datatronics

- Hayes command compatible
- Bell 103/212A compatible
- Auto-dial/auto-answer • FCC approved • 1-year warranty • Includes ProComm Communication Software

- 1200P 1200/300 Baud Pocket Size Modem..... \$89.95
 2400P 2400/1200/300 Baud Pocket Size Modem \$149.95
 1200H 1200/300 Baud Internal Modem..... \$69.95
 2400H 2400/1200/300 Baud Internal Modem..... \$129.95
 1200C 1200/300 Baud External Modem..... \$99.95
 2400C 2400/1200/300 External Modem..... \$169.95

TEST EQUIPMENT

Metex Digital Multimeters

- Metex General Specs:**
 • Handheld, high accuracy
 • AC/DC Voltage, AC/DC Current, Resistance, Diodes, Continuity, Transistor hFE • Manual ranging w/overload protection
M3650/B & M4650 only:
 • Also measures frequency and capacitance
M4650 only:
 • Data Hold Switch
 • 4.5 Digit

- M3610 3.5 Digit Multimeter..... \$49.95
 M3650 3.5 Digit w/Freq & Capacitance \$69.95
 M3650B Same as M3650 w/Bargraph..... \$79.95
 M4650 4.5 Dgt. w/Freq., Capacitance and Data Hold Switch..... \$99.95

1355 Shoreway Road
 Belmont, CA 94002
24 Hour Order Hotline (415) 592-8097
 FAX's (415) 592-2503 or (415) 595-2664
 Telex 176043 - Ans. Back Jameco Blmt
 IC Data Sheets - 50¢ each
 Send \$2.00 Postage for a FREE 1989 Catalog
 1989 Jameco Electronics 8/89
 IBM is a registered trademark of International Business Machines

Jameco 16MHz 80286 NEAT Computer Kit With 2 Megabyte RAM

- Fully IBM AT Compatible
- Free! QAPLUS Diagnostic Software Included!
- Free! PC Write Word Processing Software Included!
- 2Mb RAM Included, Expandable to 8Mb
- 8 or 16MHz Operation
- AMI BIOS ROMs Included
- Flip-Top Case w/200 Watt Power Supply
- 1.2Mb Disk Drive
- 18.0 Norton SI Rating
- 101-Key (Enhanced) Keyboard



SAVE \$168.85!

Shown with VGA Option (not included)
 JE2055 Monitor and Adapter Card...\$999.95 (See Below)

- JE3013 16MHz IBM AT Comp. Kit...\$1100.95 \$999.95
 EZDOS Digital Research MS/PC-DOS Comp Operating Sys..\$49.95
 EZDOSP Same as above with TrueBASIC.....\$69.95

IBM COMPATIBLE DISPLAY MONITORS

- AMBER 12" Amber Mono \$99.95
 HD55H 14" RGB 640x240 \$249.95
 TM5154 EGA 14" 720x350 \$299.95 \$369.95
 JE1059 EGA Monitor & Card...\$619.95 \$499.95
 TM5155 14" Multiscan 800x560 \$640.95 \$499.95
 QC1478 14" VGA 720x480 \$449.95 \$399.95
 JE2055 VGA Monitor & Card... \$649.95 \$599.95



QC1478 Pictured

JAMECO IBM PC/XT/AT COMPATIBLE CARDS

- JE1041 20/40MB Hard Disk Controller Card (PC/XT)..... \$79.95
 JE1043 360K/720K/1.2Mb/1.44Mb Floppy Disk Controller Card (PC/XT/AT)..... \$49.95
 JE1044 360K/720K/1.2Mb/1.44Mb Floppy/Hard Disk Controller Card (PC/XT)..... \$129.95
 1003VMM2 360K/720K/1.2Mb/1.44Mb Floppy/Hard Disk Controller Card (AT)..... \$149.95
 JE1050 Monochrome Graphics Card w/Parallel Printer Port (PC/XT/AT)..... \$59.95
 JE1052 Color Graphics Card w/Parallel Printer Port (PC/XT/AT)..... \$49.95
 JE1055 EGA Card w/256K Video RAM (PC/XT/AT)..... \$159.95
 GC1500 Orchid 8-Bit VGA Card w/256K Video RAM (PC/XT/AT)..... \$269.95 \$249.95
 GC1501 Orchid 8/16-Bit VGA Card w/256K Video RAM (PC/XT/AT)..... \$349.95 \$329.95
 JE1060 I/O Card w/Serial, Game, Printer Port & Real Time Clock (PC/XT)..... \$59.95
 RS232 Serial Half Card (PC/XT)..... \$29.95
 JE1062 RS232 Serial Half Card (AT)..... \$34.95
 JE1065 I/O Card w/Serial, Game and Parallel Printer Port (AT)..... \$59.95
 JE1071 Multi I/O Card w/Controller & Monochrome Graphics (PC/XT)..... \$119.95
 JE1081 2MB Expanded or Extended Memory Card (zero-K on board) (AT)..... \$99.95

SEAGATE HALF-HEIGHT HARD DISK DRIVES

- ST225 20Mb Drive only (PC/XT/AT) \$224.95
 ST225XT 20Mb w/Controller (PC/XT) ...\$269.95
 ST225AT 20Mb w/Controller (AT) \$339.95
 ST238 30Mb Drive only (PC/XT/AT) \$249.95
 ST238XT 30Mb w/Controller (PC/XT) ...\$299.95
 ST238AT 30Mb w/Controller (AT) \$389.95
 ST251 40Mb Drive only (PC/XT/AT) \$379.95
 ST251XT 40Mb w/Controller (PC/XT) ...\$419.95
 ST251AT 40Mb w/Controller (AT) \$489.95
 ST251-1 40Mb Fast 28ms (Drive only) \$469.95

Your One-Stop Center for Hard Disk Drive Needs!



Seagate 60Mb, 80Mb & 120Mb Hard Disk Drives Also Available!

- JE1001 4.778MHz (PC XT)..... \$89.95
 JE1002 4.7710MHz (PC/XT/AT).....\$109.95 \$99.95
 JE3005 Baby 8/12MHz (AT).....\$329.95 \$299.95
 JE3010 Baby 8/16MHz NEAT (AT).....\$469.95 \$399.95
 JE3020 Baby 16MHz 80386 (AT).....\$4199.95 \$999.95
 JE3025 Baby 20MHz 80386 (AT).....\$4499.95 \$1199.95
 JE3026 Full-Size 25MHz 80386 (AT) \$2299.95 \$1999.95



IBM PC/XT/AT COMPATIBLE 3.5"/5.25" DISK DRIVES

- 352KU 3 5" 720Kb (PC/XT/AT).....\$109.95
 356KU 3 5" 1.44Mb (PC/XT/AT).....\$129.95
 JE1020 5.25" 360Kb (PC/XT/AT) Black\$89.95
 JE1021 5.25" 360Kb (PC/XT/AT) Beige\$89.95
 JE1022 5.25" 1.2Mb (PC/XT/AT) Beige\$99.95



SUPER SONY SALE

720Kb 3.5" Floppy Drive

- For use with IBM PC/XT/AT and compatible computers • Double-sided, double density • 135TPI • 160 tracks • Rotation speed 300rpm • Size 4" W x 6" D x 1" H

For 3.5" slots only.

MPF11 720Kb Drive \$69.95

PROTOTYPING PRODUCTS

Jameco Solderless Breadboards

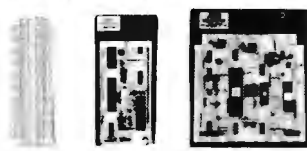

Part No.	Dim. L" x W"	Contact Points	Binding Posts	Price
JE21	3.25 x 2.125	400	0	\$4.95
JE23	6.5 x 2.125	830	0	\$7.95
JE24	6.5 x 3.125	1,360	2	\$12.95
JE25	6.5 x 4.25	1,660	3	\$19.95
JE26	6.875 x 5.75	2,390	4	\$24.95
JE27	7.25 x 7.5	3,220	4	\$34.95

COMPUTER ACCESSORIES

Jameco IBM PC/XT/AT Compatible Keyboards

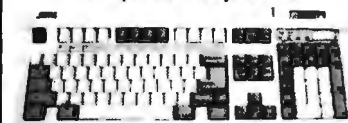

JE2016 Pictured

- JE1015 Standard AT Layout (PC/XT/AT)..... \$59.95
 JE1016 Enhanced Layout (PC/XT/AT)..... \$69.95
 JE2016 Enh w/Solar Calculator (PC XT AT).... \$79.95

Jameco Switch Boxes

- Female Connectors
- All Pins Switched



- Part No. Description Price
 JE1170 DB25-pin A/B Switch..... \$22.95
 JE1171 DB25-pin A/B/C Switch..... \$27.95
 JE1172 DB25-pin A/B/C/D Switch..... \$29.95
 JE1173 Centronics 36-pin A/B Switch..... \$24.95
 JE1174 Centronics 36-pin A/B/C Switch..... \$27.95

30Mb Hard Disk Card for IBM PC/XT



SA30.....\$379.95

Colorado Memory 40Mb Tape Back-Up for IBM PC/XT/AT

- DJ10 40Mb Tape Back-Up and Tape.....\$299.95
 TB40 40Mb Tape Cartridge..... \$24.95

ENGINEERING/DATA BOOKS

- 21035 Sams TTL Cookbook (88) \$14.95
 21398 Sams CMOS Cookbook (88) \$19.95
 22453 Sams Op-Amp Cookbook (88) \$21.95
 270645 Intel 8-bit Controller Hndbk (89) ... \$19.95
 270646 Intel 16-bit Controller Hndbk (89) ... \$19.95
 270647 Intel 32-bit Controller Hndbk (89) ... \$19.95
 400041 NSC Linear Data Book Vol 1 (88) ... \$14.95
 400042 NSC Linear Data Book Vol 2 (88) ... \$9.95
 400043 NSC Linear Data Book Vol 3 (88) ... \$9.95
 ICM89 1989 IC Master (3 Volume Set) ... \$119.95

\$20.00 Minimum Order - U.S. Funds Only
 CA Residents Add 6%, 6.5% or 7% Sales Tax
 Shipping - Add 5% plus \$1.50 Insurance
 (May vary according to weight)

Terms Prices subject to change without notice
 We are not responsible for typographical errors
 We reserve the right to substitute manufacturers
 Items subject to availability and prior sale
 Products pictured may only be representative

Complete list of terms/warranties is available upon request

24-Hour Order Hotline (415) 592-8097 • The Following Phone Lines Are Available From 7AM - 5PM P.S.T.:

• Customer Service (415) 592-8121 • Technical Assistance (415) 592-9990 • Credit Department (415) 592-9983 • All Other Inquiries (415) 592-7108

YOUR MEMORY UPGRADE SPECIALISTS

WE ACCEPT
AMERICAN
EXPRESS



Special of the Month

386 MOTHERBOARD - Uses CHIP'S TECHNOLOGY Chip Set
386-16 w/OK \$995 386-20 w/OK \$1195
Upgrade your memory with our low priced SIMM'S

ESTABLISHED 1976

MEMORY EXPANSION BOARDS

SIMM SIPP MODULES

1 MG X 9 - for IBM TYPES
1 MG X 9-120 NS...\$175
1 MG X 9-100 NS...\$185
1 MG X 9-80NS...\$219
1MG X9-70NS...\$289

256 X 9 - for IBM TYPES
256 X 9-120NS...\$59
256 X 9-100NS...\$75
256 X 9-80NS...\$89
256 X 9-80NS...\$109

APPLE SIMM MODULES

1 MG X 8 - for APPLE
1 MG X 8-100NS...\$169
1 MG X 8-100NS...\$179

256 X 8 - for APPLE
256 X 8-120NS...\$59
256 X 8-100NS...\$69

PS-2 SIMM'S

256 X 9 (FOR PS2)
256 X 9-120NS...\$79
256 X 9-100NS...\$95

MODEL 30-286

1 mg x 9-100...\$229

PS-2 MODEL 70&80 SIMM

1 MG X 9-100NS...\$249
1 MG X 9-80NS...\$299
2 MG X 9-80NS...\$679

VIDEO RAM FOR VGA CARDS

64 x 4(150NS)...\$7
64 X 4(120ns)...\$10
64 X 4(100ns)...\$13



D-RAM

1 MG X 1
1 MG X 1-120 NS...\$14
1 MG X 1-100 NS...\$15
1 MG X 1-70 NS...\$20
1 MG X 1-80NS...\$18

256 X 1
256 X 1-150 NS...\$5.00
256 X 1-120 NS...\$5.50
256 X 1-100NS...\$6.00
256 X 1-80NS...\$7.00
256 X 9-70NS...\$7.50
256 X 1-60NS...\$8.00

256 X 4
256 X 4-120 NS...\$15
256 X 4-100 NS...\$17
256 X 4-80NS...\$21

54 X 1
4164-150NS...\$1.40
4164-120NS...\$2.10
4164-100NS...\$2.40

64 X 4
4464-150 NS...\$5
4464-120 NS...\$8
4464-100NS...\$7
4464-80NS...\$9

256 X 4 STATIC COL
514258-10...\$25

256 X 1 STATIC COL
51258-10...\$7.50
51258-80...\$9.00
51258-70...\$9.50

Compaq 386 Memory
1 mg-expansion...\$399
4 mg...\$1300

Daughter 8D Mod 70-80
1 mg (6450375)...\$429
2 mg (6450370)...\$929

MATH CO-PRO

8087-3(5MHZ)...\$88
8087-2(8MHZ)...\$118
8087-1...\$168
80287-5...\$128
80287-8...\$195
80287-10...\$218
80287-12...\$299
80387-16...\$320
80387-20...\$375
80387-25...\$479
80387-33...\$649

CPU CHIPS

8088...\$5.00
80286-8LCC...\$49
80286-10LCC...\$59
80286-12LCC...\$69
80386-16...\$180
80386-20...\$280
80386-25...\$439
V-20 (8MHZ)...\$7.50
V-20 (10MHZ)...\$10.00

CACHE

80385...CALL

MAC CHIPS

68881-16 Math Co...\$169
68881-20 Math Co...\$179
68882-16...\$149
68882-20...\$169

RAM TESTER

only \$139
Tests the following memory chips:
64K X 1 256 X 1
64K X 4 256 X 4
4M X 1 1M X 4
The RTI can help anyone come through the frustrating process of identifying bad (or good) D-RAM chips.

ORCHID

RAMQUEST IIZ - Up to 2MB with-9 K for PS2 MOD 50, 50Z & 60 - EMS & OS/2 Compatible- Uses 1MG D-RAM...\$209

RAMQUEST EXTRA - Up to 8MB - for PS2 MOD 50, 60,70 & 80, EMS & OS/2 Compatible - Has 2 serial ports - Uses 256K of 1MB SIMM'S...\$319

RAMQUEST EXTRA-16/32 - up to 8MB - For PS2 MOD 50, 50Z, 60, 70 & 80- Fully Supports 16 BIT & 32 BIT- 1 serial & 1 par - EMS & OS/2 Compatible- Uses 256K of 1MB SIMM'S...\$319

RAMQUEST XT/AT -Up to 8 MB- For XT, AT, PS2 MOD25,30 - 8 BIT or 16 BIT - Uses 256K or 1MB SIMM'S...\$259

TINY TURBO 286 -High speed Half-slot Accelerator for PC/XT- 3 times faster with an 8 MHZ 286 CP - 80287 9KT...\$239

JET 386 - Hyper speed Accelerator for AT- 3 times faster with 16 MHZ 386 CPU - 80387 9KT...\$895

BOCA RESEARCH

For PS2
BOCARAM 36 - with 9K RAM...\$129
Expands to 2MG - Uses 1MG X 1 D-RAMS
BOCARAM 50/60 with 9K RAM...\$179
Expands to 4 MG with Software
Uses 1 MG X 1 D-RAMS
BOCARAM MCA 50Z with 9K RAM...\$189
Expands to 2 MG - Uses 1 MG X 1 D-RAMS
BOCA MCA Parallel Card...\$99
BOCA MCA Serial/PAR...\$169

EVEREX

MINI-MAGIC - #EV138 - 576K Memory Card...\$59
for PC & AT with OK - Uses 64K & 256K D-RAM
RAMII 4000 - #EV-136 - 4MB EMS...\$249
Extended Memory card with 0 K-Uses 1 MGD-RAMS

IBM

1497250 - For PS-2 MOD 50/60...\$439
with OK Expands to 8MB
Uses 256K SIMMS (IBM only)
6450605 - For PS-2MOD 70/80...\$1299
with 2 MG Expands to 8 MB
Uses 2MG SIMMS (IBM only)
6450203 - For AT - Has 512K RAM...\$129

IDEA ASSOCIATES

IDEA max 80 - for PS2 MOD 70/80...Call
Expands to 8MB
Uses 256K or 1MG SIMMS
IDEA Supermax/MC - for PS2 MOD 50/60...Call
Expands to 8MB/2 Extended memory/2SER/EMS
Uses 256 or 1MG SIMMS
IDEAmax/MC - for PS2 MOD 50/60 & 80...Call
Expands to 12MB Extended memory with software
Uses 1MG SIMMS

UNITEX

3MG Multifunction - for AT...\$149
Expands to 3MG - has SER/PAR PORT
Uses 1MG D-RAMS
384 Multi-function Card for PC/XT...\$89
Expands to 384K - has SER/PAR/CLK/Game port
Uses 64K or 256K D-RAMS

VIDEO ADAPTER

ATI
EGA Wonder 800...\$239
Supports EGA, MDA, CGA & Hercules
VIP VGA - 800 X 560...\$275
Supports VGA, CGA, MDA & Hercules

VIDEO 7
Fastwrite VGA...\$349
256 D-RAM, 800 X 600, 640 X 480
Supports VGA/EGA/MDA/CGA & Hercules
V-RAM VGA...\$519
256 K V-RAM, 1024 X 768, 800 X 600
VEGA Deluxe...\$239
640 X 480 Multi-sync
VEGA Pro...\$319

ORCHID
DESIGNER 800 VGA...\$229
800 X 600 - 16 Colors
PRODESIGNER VGA...\$319
Supports 1024 X 768 - 16 Colors
PRO DESIGNER VGA PLUS...\$399
Same as Prodesigner - Has downloadable fonts

UNITEX
MONOCHROME GRAPHICS CARD...\$41
with par port - MDA/CGA/Hercules
COLORGRAPHICS CARD...\$41
RGB Color with Par Port - EGA/MDA/CGA/Hercules
EGA CARD...\$149
640 X 480, 16 Colors, EGA/MDA/CGA/Hercules
VGA CARD...\$199
600 X 800, 16 Colors = VGA/EGA/MDA/CGA/

TERMS AND CONDITIONS

No Surcharge for MC/VISA Terms: MC • VISA • COD • CASH • AMEX add 4%
Purchase Orders from qualified firms. 20% restocking fee on non-defective returns
Prices Subject To Change

2852 F Walnut - Tustin, CA 92680

Phone: 714/730-5232 • FAX#: 714/838-8593

Customer Service #: 714/730-9527

TOLL FREE OUTSIDE CA: 1/800/533-0055

99% OF ALL ORDERS SHIPPED SAME DAY

Circle 263 on Reader Service Card



TIMELINE INC.

ORDER DESK ONLY

Continental U.S.A.
(800) 872-8878

Inside California
(800) 223-9977

L.A. & Technical Info.
(213) 217-8912

OEM INQUIRIES
WELCOME

16 Characters x 1 line Dot Matrix Liquid Crystal LIQUID CRYSTAL DISPLAY

- MFG: Optrex • 5v power required • C-MOS/TTL compatible signal level • Built-in RAM for display data storage • Multiple instruction set (based on 13 commands) • Built-in C-MOS LCD driver & controller • Easy "Microprocessor" interface • Low power consumption • 5x11 dot matrix formation with cursor, alphanumerics & special symbols • 98 ASCII character generator (plus 64 katakana) • 8 programmable characters • ribbon cable connector already prewired • Unit is backlit.

Physical size 3-1/8"L x 1-3/8"W x 1/4"D



3 for \$30 (Repeat of a sellout)

\$55

**360K/
720K
FLOPPIES**

\$60

1/2 Ht. 360K 5 1/4"
DS/DD
NEC Model 1053

1/2 Ht. 720K 3 1/2"
DS/QD
NEC Model 1035

PERSYST™ MONOCHROME DISPLAY AND MULTIFUNCTION CARD FOR IBM PC/AT

This card has 1 serial port and 1 parallel port. It can be expanded to 1.5MB memory. This card has extended memory only. (This is not EMS or EEMS.)

You can attach a monochrome monitor to the card as well as hook up a lightpen.

Also includes utility software: drive emulator, printer spooler, utility to control calendar/clock

Uses 64K or 265K chips Has (18)
4164-200 chips on board (128K)

\$49.00

85MB Full Height Drive

Maxtor 1085

28 ms access time
RLL compatible

\$499.00

VGA PACKAGE Special Price \$549

800x560 in 16 colors 300x200 in 256 colors 640x480 in 16 colors
Fully VGA, EGA, CGA, Hercules™ and monochrome graphics compatible
UPGRADES ANY XT OR AT to VGA GRAPHICS—

This is an IBM style analog monitor. The card is an ATI improved VIP Card. The package comes with user friendly manual and step-by-step instructions.

One year warranty on the monitor.

Two year warranty on the card.

- Max resolution (800x560)
- Bandwidth: 17 Mhz
- Software selectable to VGA, EGA, CGA, MDA, HGA
- Anti-reflective, coated non-interface, flicker free screen
- 31 dot pitch
- Call for quantity discounts



EXPERIMENTER'S DREAM!

OPTICAL MECHANISM

Includes the following:

- Carriage drive mechanism (moves a 42.5 watt halogen light source and 3 front surface mirrors.)
- Charge coupled device with all drive electronics (4 microprocessors and 1 EPROM)
- Fan
- All interconnect cables
- Bi-directional Centronics interface

\$199

NOTE...The CCD is physically mounted to a lens and the lens is prefocused.

This is a great source for all different optical and electro-mechanical parts. You can devise all sorts of interesting experiments.

60 MB TAPE CARTRIDGES

555 ft. **\$19.95 each**
10,000 ftpi **17.95 3-9**
\$15.00—10 or more

DC300 (these are not the XL version. 30 Mb only) **\$10.00 each**
DC1000 **\$5.00 each**

5 INCH COMPOSITE AMBER MONITOR

Unit is non-enclosed with chassis around it.
Excellent resolution comes with pin-out.

\$5500

Liquid Crystal Display Graphic and Alphanumeric 480 Dot (W) x 128 Dot (H)

This is a very high quality device. Microprocessor interface easily accomplished with supporting circuitry. Offers bit map graphics as well as text. Other applications not tied to microprocessors are possible.

- Driving voltages all available from microprocessor port
- CMOS TTL compatible signal level
- Built-in RAM for display data storage
- Comes with built-in CMOS LCD driver and controller
- Low power consumption
- 480 dot x 128 dot (pixel) matrix formation
- Supports full ASCII character set and extended character set
- Character size: 5x7 or 7x9
- Package price includes LCD and driver board

Dimensions:
10.6" L x 4.3" W
x 4/100" D

\$99

POWER SUPPLY BLOWOUT!

YOUR CHOICE **\$12.00** Minimum 2 per Order

Please check dimensions. These are open frame supplies.

Compower 130 Watt supply. Unit is open framed.
Output: +5V @ 5A, +12V @ 3A, -12V @ .5A, +12V @ 5A
Dimensions: 8 1/2" L x 4 3/4" W x 2 1/2" H

Power Systems—180 Watt supply.
Unit is open framed with 2 four pin power connectors built onto the unit.

Output: +5V @ 20A, +12V @ 4A, -12V @ 5A
Dimensions: 9 3/8" L x 4 3/8" W x 2 1/2" H

Minimum Order: \$20.00. Minimum shipping & handling charge \$5.00. We accept cashiers checks, MC or VISA. No personal check COD's. California residents add 6 1/2% sales tax. We are not responsible for typographical errors. All merchandise subject to prior sale phone orders welcome. Foreign Orders require special handling. Prices subject to change without notice. FAX (213) 532-8304.

TANDON 8" 1/2 HT. DRIVES

848-2 **\$180.00**

Minicassette Tape Unit Hobbyist's Delight

All metal, high precision reversible tape deck. Operates at 9 to 12 Volts DC. (This is a digital device.) Excellent motor drive and gear reduction unit. Originally used as a computer input/output device.

Includes
Complete
Schematics

\$19.00



FULCRUM TRACK BALL



- Stationary Mouse
- PC Magazine Editors First Choice for CAD Use
- New Menu Key • Does Lotus 123, Wordperfect or your own menus

\$89

ROBOTIC LENS

Great source of optical and electro-mechanical parts and systems including the basis for an infrared communications system.

Contains f1.4-12 to 72 mm (6x) zoom lens with macro capability. DC motor driven or manual zoom and focus systems with precision gear reduction units, mechanical clutches, and high quality DC motors, DC rotary actuator controlled iris diaphragm unit.

\$19.00



1490 W. ARTESIA BLVD, GARDENA, CA 90247

Order Desk Only OEM Inquiries Welcome
Inside California Continental U.S.A. L.A. Area & Technical Info
(800) 223-9977 (800) 872-8878 (213) 217-8912

15% Restocking fee for returned orders.

TIMELINE



Dealers are welcome

SPECIAL SALE

Dealers are welcome

LCD-286-10 PORTABLE \$1395.00

- 10 MHz 80286
- 640K RAM
- SI = 10.3
- LCD Screen
- Super Twist
- Back Lighting
- 86 Key Board
- External RGB Adapter
- LCD-286-12 (Option \$50)
- LCD-286-20 (Option \$150)
- 640 X 200 Dots (Option 640 X 400)
- Serial / Parallel / Game



LCD-386-20 \$2595.00

- 80386-20 MHz
- One 1.2 MB Floppy Drive
- 40 MB Hard Disk (ST - 251)
- LCD Screen (640 X 200)
- Key Board (86 Keys)
- IO Serial / Parallel / Game
- 80387 Socket
- 200 W Power Supply
- 1 MB RAM
- Built-in Backlight
- LCD Screen 600 X 400 (Option)
- External RGB monitor
- Size 15 1/2" X 9 1/2" X 8"
- EGA DISPLAY (OPTION)

PCI-286 / LT \$2595

- 80286
- 640K RAM
- 1.44 MB FD
- 40 MB HD
- Serial / Parallel
- LCD Screen
- CGA Ext. Monitor
- AT Key Board
- Carrying Bag



GAS PLASMA 286-12 \$1999.00

- 640 K RAM
- 1.2 MB FD
- 20 MB HD ST-225
- IO Card
- Key Board
- MM2 HD/FD Controller
- Gas Plasma 640 X 400
- Carrying Case (Option)
- 200W Power Supply
- 80287 Socket
- 23 lbs
- Serial / Parallel
- 16 MHz (Option \$100)
- EGA DISPLAY (OPTION)



GAS PLASMA 286-20 \$2295.00

- 80286-20
- 20 MB ST-125

GAS PLASMA 386-20 \$3095.00

- 80386-20
- SI = 23
- 1MB RAM
- 40 MB HD ST-251
- I/O Card
- 86 Key Board

CRT PORTABLE

CRT-PORTABLE-286-10 \$1295

- Compact Type
- 10 MHz 80286
- One 1.2 MB Floppy Drive (2nd Drive Option)
- 200 W Power Supply
- TTL Display 17" Amber
- AT Key Board
- Serial / Parallel / Game
- 20 MB Hard Disk
- Size 16 1/2" (D) X 17 1/2" (H) X 10 1/2" (W)
- 12 MHz (Option \$50)
- 20 MHz (Option \$150)
- 640K RAM
- EGA DISPLAY (OPTION)



CRT-386-20 \$2389 W/40 MB HD (ST-251)

MAIN BOARD

286-16 \$395 286-12 \$245

- CPU 80286 - 16
- SI = 18, Lanmark = 21
- OK (RAM module)
- 0 Watt
- 80286-12
- SI = 13.5
- 0 K
- Use DRAM

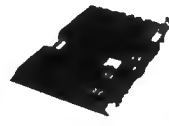

Dealer Call For Quantity Price

DESK TOP PCI-286-12

- 80286-16 (Option \$100)
- 80286
- 1.2 MB Floppy Drive
- 640K RAM
- Serial / Parallel / Game
- 101 Key Enhanced Key Board (Click)
- SI = 15.2 (8 Watt)
- 6/12 MHz Key Board Switchable
- MM2 HD & FD Controller
- 80287 SOCKET
- 200W POWER SUPPLY

- MONO SYSTEM
- W/Mono Monitor & Card
- 20 MB Hard Disk
- \$1195

- VGA COLOR SYSTEM
- W/VGA Card & Monitor
- 20 MB Hard Disk
- \$1795

- EGA COLOR SYSTEM
- W/EGA Card & Monitor
- 20 MB Hard Disk
- \$1580



PCI-386-20

- MONO SYSTEM \$2095
- VGA SYSTEM \$2595
- \$1580

PCI PACIFIC COMPUTER

702 S. Del Mar Ave., #B,
San Gabriel, California 91776
(FAX) 818-286-8662

Office Hour
Mon - Sat
9:00 AM - 6:00 PM



(800) 421-1102 (IN CA)
(800) 346-7207 (OUT CA) ORDER ONLY
(818) 571-5548 (Technical support)

*ALL SYSTEMS COME WITH ONE YEAR PARTS & LABOR WARRANTY

Price are subject to change without notice.

Dealers are welcome.
Call for quantity price.

LAPTOPS

\$385 FAX

TOSHIBA T1000 ... \$645	NecUltralite 2meg . \$2289	" CANON Fax 20 ... \$949	AVATEX 110/220V
" T1200F \$1299	Prospeed 286/20 .. \$3049	" Fax 225 \$1545	Portable \$625
" T1200FB \$1385	" 286/40 \$3399	" Fax 270 \$1795	NISSIE 303 \$498
" T1200H \$2189	" 386-/40 \$4395	" Fax 350 \$1995	MURATA 1200 \$569
" T1200HD \$2245	Mitsubishi286-219 . \$1995	" Fax 450 \$2349	" 1600 \$669
" T1600 \$3045	" 386-290 \$2299	" Fax 630 \$2699	" F30 \$1399
" T3100E \$2565	" 386-240 \$2795	" Fax 705 \$2999	RICOH RF800 \$649
" T3200/40 \$3299	SHARP 4502 \$899	" Fax 730 \$3499	" Fax 15 \$1155
" T5100 \$4325	" 4602 \$1595	PANASONIC	" Fax 25 \$1295
" T5200 40 \$5699	" 4641 \$2395	KXF 100 \$825	" Fax 35 \$1545
" T5200 100 \$6699	" 5541 \$3689	KXF 120 \$975	" Fax 65 \$1595
ZENITH Z-184-10 . \$1495	PANASONIC PRINTERS	PANAFAX UF 135 . \$799	SHARP FO 220 ... \$699
" Z-184-20 \$2129	KXP1180 \$179	" UF 145 \$895	" FO 300 \$849
" Z-286-20 \$2949	KXP1191 \$229	" UF 250 \$1349	" FO 330 \$999
" Z-286-40 \$3388	KXP1124' \$325	" UF 260 \$1549	" FO 550 \$Call
"Z-386-40 \$4799	KXP1592 \$395	SANYO SF 100 ... \$765	" UX 350 \$1155
COMPAQ286-20mb \$call	LASER KXP 4450 . \$1369	" SF 200 \$929	TOSHIBA 30100 ... \$745
" 286 40 MB \$call	KXP1595 \$425	" SF 515 \$1145	T3300 \$799
NEC MLTSPD HD . \$1949	KXP1524 509	SHARP UX 30	T3600 \$965
" MLTSPD EL \$1499	CANON Fax 8 \$619	Remfg. \$385	T3700 \$1099

PREPAY PRICES: VISA/MC/COD + 2.9% Restock 20% Handling Chg. 5.95 No Exchange/Returns.

T.P.C. 12603 Hoover St.
Garden Grove, CA 92641

714/898-8262
FAX 714/891-1202

1-800-383-3199



PS/2 model 30/286	1949
PS/2 model 50/30 meg	2695
PS/2 model 70/60 meg	3895
PS/2 model 80/40 meg	4395
PS/2 model 70/120 meg	5595
PS/2 model 80/115 meg	Call

Call for other models



386 S 40 meg	Call Call
386 20E - 40 meg	4595
286E 40 meg	Call
386 110 meg/25 MHz	7395
386 60 meg/25 MHz	5895
Portable III 40 meg/12 MHz	4095

CARD & MONITOR EXTRA
Call for other models



Mac-SE/20 Meg	2795
Mac-II/40 Meg	4249
Mac-SE-2 DR	2295
Call for 60 and 100 Meg	
Lazer NT	3595
Lazer NTX	Call

LOW PRICE LEADER

SINCE 1983

LAP-TOP

Compaq SLT 286-20	Call
SLT 286-40	Call
Toshiba T1000	Call
T1200F	Call
T1200HB	Call
T1600	Call
T3100E	Call
T3200-40 Meg	Call
T5100	Call
Zenith Supersport	
286-20 Meg	3195
286-40 Meg	Call
8088-20 Meg	Call
Epson LT	Call
NEC Lap-Top	Call
Mitsubishi 286-20	2595

Toshiba Sale!
Call for all!

Everex

Step 286 - 12 & 16 MHz & 20 MHz
1 Meg RAM
Set up utility in ROM
S/P, C/C
Enhanced keyboard
1.2 MB floppy
DOS/BASIC

Call! for your configuration

Everex

Step 386-20 MHz & 16 MHz & 25 MHz
Up to 256K cache of very high speed RAM
2 Meg RAM, expandable to 16 Meg
S/P, C/C
Enhanced keyboard
1.2 MB floppy
DOS/BASIC

Call!



AST 286 model 140X	2350
AST 286 model 80	1495
AST 386 model 300c	Call
AST 386 40 Meg	3195

CARD & MONITOR EXTRA
CALL FOR OTHER MODELS

WE STOCK

CITIZEN
OKIDATA
EVEREX
GOLD STAR

TOSHIBA
NEC
WYSE
HITACHI

PRINCETON GRAPHICS
SONY
ACER
HOUSTON INSTRUMENTS

AMDEK
HAYES
SAMSUNG
CALCOMP

PC MOUSE
MICROSOFT MICE
LOGITECH
MITSUBISHI

IRWIN & ARCHIVE
TAPE BACK
TAXAN
MAGNOVOX

BOARDS

Paradise VGA +	285
Vega VGA	299
Everex EVGA	265
Everex EGA	179
Tatung 16 bit	265

SOFTWARE SPECIALS

dBase IV	455
Wordperfect	239
Aldus Pagemaker	479
Ventura Publisher	495
Clipper	415
Quatro	145



NOVELL
Authorized Dealer

PRINTERS

EPSON	
LX-800/LQ-500	195/315
LQ-850/1050	535/735
OKIDATA	
320/321	359/490
390/391	490/649

LASER PRINTERS

HP Laser II	1695
HP Desk Jet ±	695
Panasonic 4450	1549
Brother HL-8	1949
Nec LC 890	3195
PageLaser 12	\$\$\$\$\$
Canon Laser	Call

MONITORS

Nec Multisync IIA	525
Nec Multisync 3D	649
Nec Multisync Plus	899
Nec Multisync XL-19"	2295
Samsung EGA	359
Goldstar VGA	375

FAX MACHINES

Sharp FO 220	875
Sharp UX 350	1249
Canon	Call
Brother	Call
Richo	Call
Murata	Call

Intel Coprocessors

8087-3	105
8087-2	145
80287-8	235
80287-10	275
80387-16	409
80387-20	499
80387-25	599

TOSHIBA

321-SL/341-SL	439/595
351-SX 350 CPS	895

BROTHER

1709-9 PIN	425
1724-24 PIN	595

MODEMS

Everex 1200 Int	89
Everex 2400 Int	159
Hayes 1200 B	289
More in Stock	Call

WE ACCEPT LC, CASHIER CHECKS, MONEY ORDERS, VISA, MC, AmEx
3% charge on VISA, MC & 5% on American Express

EXPORTS
Available

COMPUTERLANE

HOURS:
M-S 9-6

1-800-526-3482 (Outside CA)
(818) 884-8644 (In CA)
(818) 884-8253 (FAX)

22107 ROSCOE BLVD.
CANOGA PARK
1/2 BLOCK W. OF TOPANGA
CA 91304

CORPORATE ACCOUNTS WELCOME
CALL FOR VOLUME DISCOUNTS
CONSULTANTS CALL FOR PRICING

Prices subject to change without notice

Compaq is a Registered Trademark of Compaq
IBM is a Registered Trademark of International Business Machines

A-BUS™ MAGIC

Classroom to advanced industrial applications.

Be a Wizard in your Lab, Factory, College, Home...

It used to be difficult and costly to do process control, robotics, data acquisition, monitoring and sensing with your computer. Now the low-cost A-BUS system makes it easy to do almost any project you can imagine.

Versatility. A-BUS cards handle most interfacing, from on/off switching, to reading temperatures, to moving robot arms, to counting events, to sensing switches...

Adaptability. The A-BUS is modular, allowing expansion well beyond your needs. It works with almost any computer, or even as a remote data station with the new serial adapters.

Simplicity. You can start using the A-BUS in minutes. It's easy to connect, and software is a breeze to write in any language.

Reliability. Careful design and rugged construction make the A-BUS the first choice in specialized I/O.

An A-BUS system consists of: - An A-BUS adapter plugged into your computer - A cable to connect the adapter to 1 or 2 A-BUS function cards. - The same cable will also fit an A-BUS Motherboard for expansion to up to 25 cards in any combination.



NEW: REMOTE A-BUS! Use the new Serial (RS-232) Adapter or Processor to control any A-BUS system. Cards can be up to 500 ft away using phone type cable, or off premises using a modem. Call or send for the new A-BUS Catalog which covers all the products.

Important

All A-BUS Systems: ♦ Come assembled and tested ♦ Include detailed manuals with schematics and programming examples ♦ Can be used with almost any language (BASIC, Pascal, C, assembler, etc.) using simple "IN" and "OUT" commands (PEEK and POKE on some computers) ♦ Can grow to 25 cards (in any combination) per adapter ♦ Provide jumper selectable addressing on each card ♦ Require a single low cost unregulated 12V power supply ♦ Are usually shipped from stock. (Overnight service is available.)

About Alpha Products

Founded in 1976 for the purpose of developing low cost I/O devices for personal computers. Alpha has grown to serve over 70000 customers in over 60 countries. A-BUS users include many of the Fortune 500 (IBM, Hewlett-Packard, Tandy, Bell Labs, GM...) as well as most major universities. A-BUS products are U.S. designed, U.S. built, and serviced worldwide. Overseas distributors: England: Caldys Science Assoc. Ltd., Merseyside, 051 342 7033. Australia: Brumby Technologies Pty. Ltd., NSW, 759 1638. France: Coserm, Rungis, 46 86 64 75

Inputs, Outputs, etc.

Analog Input: 8 analog inputs. 0-5.1V in 20mV steps (8 bits). 0-100V range possible. 7500 conversions/second. **AD-142: \$142**

12 Bit A to D: Analog to digital converter. Input range -4V to +4V, expandable to 100V. On-board amplifier. Resolution 1mV. Conversion time 130ms. 1 channel. (Expand to 8 channels with the RE-156 card.) **AH-146: \$153**

Relay Card: 8 individually controlled industrial relays each with status LED's (3A at 120VAC contacts. SPST). **RE-149: \$142**

Reed Relay Card: 8 reed relays (20mA at 60VDC. SPST), individually controlled and latched, with status LEDs. **RE-156: \$109**

D/A converter: 4 Channel 8 Bit D/A converter with output amplifiers and separate adjustable references. **DA-147: \$149**

24 line TTL I/O: Connect 24 input or output signals (TTL 0/5V levels or switches). Variety of modes. (Uses 6255A) **DG-148: \$72**

Digital Input: 8 optically isolated inputs. Input can be 5 to 100V voltage levels or switch closures. **IN-141: \$65**

Digital Output Driver: 8 outputs: 250mA at 12V. Drive relays, solenoids, stepper motors, lamps, etc. **ST-143: \$78**

Clock with Alarm: Powerful clock/calendar. Battery backup. Timing to 1/100 sec. Alarm relay, LED and buzzer. **CL-144: \$98**

Touch Tone Decoder: Each tone is converted into a number which is stored on the board. **PH-145: \$87**

A-BUS Prototyping card: 4x4.5" card. Will accept up to 10 I.C.s. With power & ground bus. **PR-152: \$16**

Counter Timer: Three 16 bit counters/timers. Use separately or cascade for long (48 bit) counts. **CT-150: \$132**

Motion Control

Smart Quad Stepper Controller: The world's finest. On board microprocessor controls four motors simultaneously. Uses simple English commands like "MOVE ARM 10.2 (INCHES) LEFT". For each axis, you control coordinates (absolute or relative), ramping, speed, units, scale factors, etc. Many inputs for limit switches, etc. On the fly reporting of speed, position... Built in drivers for small motors (such as MO-103 or 105). **SC-149: \$299**
Options: ▶ 5 amp/phase power booster for 1 motor: **PD-123: \$49**
▶ Remote "teach" keypad for direct motor control: **RC-121: \$54**



A large A-BUS system with two Motherboards Adapter in the foreground plugs into PC/XT/AT type slot.

Stepper Driver Kit: For experimenting with stepper motors. Includes 2 MO-103 motors and a ST-143 dual driver. **PA-181: \$99**

Stepper Motors: (4 phase, unipolar)
MO-103: 2 1/4" dia. 1/4" shaft. 7.5"/step. 12V. 5 oz-in torque. **\$15**
MO-104: 2" dia. 1/4" shaft. 1 8"/step. 5V. 60 oz-in torque. **\$45**
MO-105: 1.7" square. 2" shaft. 3.75"/step. 12V. 6 oz-in. **\$15**

A-BUS Adapters

▶ Can address 64 ports and control up to 25 A-BUS cards.
▶ Require one cable. Motherboard required for more than 2 cards.

A-BUS Parallel Adapters for:
IBM PC/XT/AT & compatibles. Uses one short or long slot. **AR-133: \$69**
Apple II, II+, IIe Plugs into any slot inside. **AR-134: \$52**
Commodore 64, 128 Plugs into Expansion Port on back. **AR-139: \$48**
TRS-80 Model 102, 200 Uses 40 pin "System bar". **AR-136: \$76**
Model 100 (Tandy portable) Plugs into socket on bottom. **AR-135: \$75**
TRS-80 Model 3, 4, 4D Y-Cable available if 50 pin bus is used. **AR-132: \$54**
TRS-80 Model I Plugs into 40 pin expansion bus. **AR-131: \$39**
Tandy Color Computers Fits ROM slot. Multiplex or Y-Cable. **AR-138: \$49**

A-BUS Cable: Necessary to connect any parallel adapter to one A-BUS card or to first motherboard. 50 pin, 3 ft. **CA-163: \$24**
Special Cable for two A-BUS cards **CA-162: \$34**

Serial Adapter: Connect A-BUS systems to any RS-232 port. Allows up to 500 ft from computer to A-BUS. **SA-129: \$149**

Serial Node: To connect additional SA-129/A-BUS systems to a single RS232 serial port (max 16 nodes). **SN-128: \$49**

Serial Processor: same as above plus built in BASIC for off-line monitoring, logging, decision making, etc. **SP-127: \$189**
Use SA-129 or SP-127 with modems for remote data acquisition.

Motherboard: Holds up to 5 A-BUS cards in sturdy aluminum frame with card guides. A sixth connector allows (using cables CA-161: \$12) additional Motherboards to be added. **MB-120: \$108**

Power Supply: Power pack for up to 4 cards. **PS-126: \$12**

Complete Catalog Available

For Orders and info call (203) 656-1806

Weekdays from 9 to 5 EST or FAX 203 656-0756

Call our application engineers to discuss your project.

Ordering Information: We accept Visa, Mastercard, Checks, and M.O. C.O.D. is \$4 extra. Purchase orders are subject to credit approval. CT residents add 7.5% sales tax. Shipping: \$4 per order (usually UPS ground). UPS 2nd Day Air: \$4 extra. Next Day service available. Canada: \$6 per order (Airmail). Outside US and Canada: Add 10% of order total.



ALPHA Products

242-B West Avenue, Darien, CT 06820

Circle 17 on Reader Service Card

386SX Performance IS as Easy as Pi

Upgrade to 386SX Power with 2 MB Ram for only \$995.00!



Featuring:

- Fits XT, Baby or Full AT's and Towers
- 387SX and Shadow BIOS Support
- Your choice of Award™ or Phoenix™ BIOS
- SXD (4 MB dip) or SXS (8 MB SIMM) versions
- Three year parts & labor warranty
- 45 day money back guarantee
- 286 and 386 motherboards, RAM, Drives, Cases, P/Ss, Add-in Cards, and Full Systems ARE Available



For information, Call 804-978-3917
To Order, Call: 800-666-9248

Pi Computer Corporation

Your Best Value in Motherboards*

1030 Earlysville Forest Drive, Earlysville, VA 22936

Fax: 804-978-3906

Visa, MC and AM EX Accepted

* Since 1983

© 1989 Pi Computer Corp.

DON'T MOVE WITHOUT TELLING

BYTE

CLIP OUT THIS FORM AND MAIL TO:

BYTE Magazine
P.O. Box 555
Hightstown, NJ 08520

At least 8 weeks before you move please give us your NEW ADDRESS: NAME CHANGE.

Name _____ (please print)

Address _____ Apt. _____

City/State _____ Zip _____

Print CURRENT ADDRESS (or affix the mailing label from your current BYTE Magazine here)

CURRENT ADDRESS: NAME _____

Name _____

Address _____ Apt. _____

City/State _____ Zip _____

9-Track Tape For Your IBM PC/XT/AT/PS-2™

Read 1600 bpi 9-track tapes from a micro, mini or mainframe in EBCDIC or ASCII as mirror image or by individual files.

Use the 2000 PC™ for disk backup, data interchange or archival storage.

PC/XT/AT/PS-2 are trademarks of IBM
2000 PC is a trademark of Digi-Data



DIGI-DATA CORPORATION
8580 Entregue, San Diego
San Diego, CA 92121
(619) 459-0200
Telex 877 580
First In Value

Circle 83 on Reader Service Card

SAVE ON

9 TRACK TAPE SYSTEM

FOR IBM PC/XT/AT & PS-2



- Mainframe to PC Data Transfer
- High Speed Backup
- All Software, Complete System
- Service and Support... easy installation

call (818) 343-8505 or write to:

CONTECH Computer Corp.
P.O. Box 153 Torrance, CA 91365



Circle 67 on Reader Service Card

DYNAMIC RAMS

SIMM	80/100	\$CALL
1MBIT	100ns	\$14.95
514256	100ns	\$15.75
41464	150ns	\$ 5.50
41256	120ns	\$ 5.00
41256	150ns	\$ 4.50
51258	100ns	\$ 5.95
4164	150ns	\$ 2.50

* For high-speed, 20. Pic. Simm. Please Call!

PROCESSORS			PROMS		
80387-88	25MHz	\$470.00	270181	250ns	\$ 20.00
80387-30	20MHz	\$375.00	270219	200ns	\$ 12.00
80387-16	16MHz	\$320.00	27012	250ns	\$ 5.50
80287-12	12MHz	\$295.00	270256	250ns	\$ 5.25
80287-10	10MHz	\$225.00	27256	250ns	\$ 4.75
80287-8	8MHz	\$198.00	27128A	250ns	\$ 4.50
8087-1	10MHz	\$170.00	2704A	200ns	\$ 4.25
8087-2	8MHz	\$130.00	278A	200ns	\$ 3.50
V-30	8MHz	\$ 12.75	S. RAMS		
V-20	8/10MHz	\$ 8.515	A3554	120ns	\$ CALL
			436A	150ns	\$ 8.95

I.C. EXPRESS

15358 Valley Blvd. City of Industry, CA 91746 Tel: 818-369-2688
ORDER YOURS FREE (Mon-Fri 8-5 PM)
(800) 892-8889 • (800) 862-8181

CALL FOR CURRENT PRICES & VOLUME DISCOUNTS
Prices shown for cash. MasterCard/Visa add 3%. Prices are subject to change.
Minimum order \$10.00. Shipping & Handling: UPS Ground \$8.00 for \$9.00 (1 lb.)
ALL MERCHANDISE IS 100% GUARANTEED WITH PROMPT DELIVERY.

Circle 122 on Reader Service Card

EZ-ROUTE VERSION II



SCHEMATIC TO PCLAYOUT \$500 INCLUDES AUTO ROUTER

EZ-ROUTE Version II from AMS for IBM PC, PS/2 and Compatibles is an integrated CAE System which supports 256 layers, trace width from 0.001 inch to 0.255 inch, flexible grid, SMD components and outputs on Penplotters as well as Photo plotters and printers

Schematic Capture \$100, PCB Layout \$250, Auto Router \$250
FREE EVALUATION PACKAGE
30 DAYS MONEY BACK GUARANTEE
1-800-972-3733 or (305) 975-9515

ADVANCED MICROCOMPUTER SYSTEMS, INC.
1321 N.W. 65 Place - Ft. Lauderdale, FL 33309

Circle 21 on Reader Service Card

Terminal Emulation

TEK 4105/4010

- Tektronix 4105
- Tektronix 4010/4014
- VT220, VT102
- Picture files
- VGA and EGA support
- High resolution hardcopy

VT220

- VT220, VT102 emulation
- File transfer
- 132 column modes
- Color support
- Hot key

• • • **Diversified Computer Systems, Inc.**
3775 Iro Avenue, Suite 18
Boulder, CO 80301 (303) 447-9251
FAX: 303-447-1406

Processor: VT102, VT220 DEC Terminal: Tektronix/IBM

Circle 86 on Reader Service Card

LSPC SERIAL/2 HIGH SPEED DATA COMMUNICATION CONTROLLER



- Synchronous Full Duplex Serial Controller (Z82530)
- Max Data Rate of 400 Kbps Externally Clockled
- Support For Two DMA Channels
- Designed For The IBM PC/AT™ Bus

Computer Modules, Inc.
2348C WALSH AVENUE/SANTA CLARA, CA 95051
TEL: (408) 496-1881 FAX: (408) 496-1886

IBM PC/AT is a trademark of International Business Machines, Inc.

Circle 64 on Reader Service Card

RELAY INTERFACE



AR-16 RELAY INTERFACE \$89.95
PROVIDES SOFTWARE CONTROL OF 16 EXTERNAL RELAYS (EXPANDABLE TO 128)

ANALOG TO DIGITAL \$99.95
ADC-16 (16 ANALOG INPUTS *)

STATUS INPUT \$99.95
STA-B (8 ON/OFF INPUTS *)

*ADD UP TO 128 STATUS INPUTS / 16 ANALOG INPUTS / TOUCH TONE / 112 RELAY OUTPUTS
ALL HARDWARE CONNECTS TO AN RS-232 PORT FOR USE WITH IBM AND COMPATIBLES TANDY APPLE AND MOST OTHER COMPUTERS

24 HOUR ORDER LINE (800) 842-7714 (FREE INFO)
VISA • MASTERCARD • AMERICAN EXPRESS • COD

ELECTRONIC ENERGY CONTROL, INC.
380 SOUTH FIFTH STREET, SUITE 604
COLUMBUS, OHIO 43215
TECHNICAL SUPPORT (614) 464-4470

Circle 90 on Reader Service Card

PC PRODUCTIVITY

NEW EMU-TEK™

EMU-TEK™

4200 Plus

Turn your PC into a Tektronix Graphics Terminal

FTG DATA SYSTEMS
(800) 962-3900
10801 Dale St., Stanton, CA 90680

Circle 100 on Reader Service Card

8051 SBC \$99

oem qty 1
Single Board Computer

FEATURES: 8031, RAM and ROM Sockets, 8 bit I/O, RS 232 port, optional UART, and Expansion Bus. Size: 3.5" x 6.0", +5Vdc only.

OPTIONS: 8032, CMOS, 18 MHz, NV Memory, Monitor Firmware and High Level Languages.
Development Board.....\$199

8031 ICE \$199

Our emulator provides most of the features of an 8031 In-Circuit-Emulator at a significantly lower price. It assists in integration, debug and test phases of development. Commands include: disassembly, trace, breakpoints, alter register/memory, and load Intel Hex file.

8051 Simulator Program..... \$99
IBM PC/XT/AT Software simulation of 8051 μ C.

HTE HiTech Equipment Corporation
9400 Activity Road
San Diego, CA 92126
(619) 566-1892

Circle 117 on Reader Service Card

Statistical Navigator™

An expert system using AI strategies in helping to determine appropriate statistical analysis.

Version 1.1 - \$99.95
(plus shipping and handling)

VISA, MC, AMEX, PO and Personal Checks accepted

The Idea Works, Inc.
Call toll-free
1-800-537-4866
Missouri residents call
314-445-4554
FAX 314-445-4589



Circle 123 on Reader Service Card

HIGH QUALITY...LOW PRICE!

We've Built Our Reputation on This Premise for Almost a Full Decade.

Clone 286 With
LOW PRICE
\$1299 Complete System!

Clone 286 With
MEDIUM SPEED
\$1969

Clone 286 With
HIGH SPEED
\$2429 VGA Color!

12MHz, 32MB HARD DRIVE,
MONOCHROME MONITOR

12MHz, 48MB HARD DRIVE,
EGA MONITOR

16MHz, 65MB HARD DRIVE,
VGA MONITOR

With MS-DOS 3.3 or 4.01 and QWBASIC \$75 or \$99 Extra

SATISFACTION GUARANTEED! One year parts and labor, 30 day money back guarantee (except software and shipping).

MEMBER
BEST BUYING ASSOCIATION

MMC
MEMBER COMPUTER

SERVING YOU SINCE 1980



Standard Features of All Clone 286 Computers:

- 640K/1MB RAM Standard (see chart)
- 1:1 Interleave, 2 Floppy/2 Hard Disk Controller (798 Kb/s thru-put)
- 360K, 1.2M or 1.44M (3.5") Floppy Drive (your choice)
- 101 Key Enhanced Keyboard (Click-Tactile Option add \$20)
- 1 Parallel, 1 Serial, 1 Joystick Port
- 200 Watt Power Supply
- On-Board Clock/Calendar with Battery Backup
- FCC Certified
- System Reset Switch Located on Front Panel
- Setup in ROM
- 80287 Math Coprocessor Socket
- CPU Speed Switchable
- Fully Expandable
- Novell Compatible
- One Year Parts and Labor Warranty
- PC-Write - QModem - ExpressCalc - AutoMenu - HomeBase - Money Master - Findex - Clone Utilities

CLONE VALUE CHART

	HERC MONO	VGA MONO	CGA COLOR	EGA COLOR	VGA COLOR
12MHz 640K RAM 0 WAIT STATE	32MB 65ms 48MB 40ms 65MB 40ms 85MB 28ms	\$1299 1399 1499 1599	\$1579 1679 1779 1879	\$1859 1959 2059 2159	\$2139 2239 2339 2439
12MHz 1MB RAM 0 WAIT STATE	32MB 65ms 48MB 40ms 65MB 40ms 85MB 28ms	\$1449 1549 1649 1749	\$1729 1829 1929 2029	\$1909 2009 2109 2169	\$2279 2379 2479 2529
16MHz 1MB RAM 0 WAIT STATE	32MB 65ms 48MB 40ms 65MB 40ms 85MB 28ms	\$1849 1949 2049 2149	\$2129 2229 2329 2429	\$2309 2409 2509 2569	\$2679 2779 2879 2929

Add-On's & Accessories

- 199 1200/300 baud internal modem
- 259 2400/1200/300 baud internal modem
- 359 Logitech Mouse (bus or serial)
- 359 Microsoft Mouse (bus or serial)
- 12 Logitech ScanMan (400 DPI)

OPTIONAL EQUIPMENT

- Printers**
- Star NX-1000 144-cpi NLD \$179
 - Star NX-1000 Rainbow (w/color) 239
 - Star NX-2400 170/cpi c.s. LQ 24-pin 339
 - Star NX-15 120/30 cpi. NLD wide \$319
 - Star ND-15 180/45 cpi. NLD wide 389
 - Star NR-15 240/60 cpi. NLD wide 469
 - Star NB24-10 180/60 cpi. LQ 24 pin 459
 - Star NB24-15 (above: wide carriage) 579

- Star NB-15 300/100 cpi. LQ 24 wide \$749
- Panasonic KX-P1180 192/38 cpi. NLD 259
- Panasonic KX-P1191 240/48 cpi. NLD 259
- Pan KX-P1124 192/63 cpi. LQ 24 pin 359
- IBM parallel cable 10' molded ends 12



TURBO CLONE
AT Style Keyboard
\$699 Save Now!

Standard Features:

- 8088 @ 4.77--
- 10MHz Turbo-Speed Mainboard
- 640K RAM stdnd.
- 8087 Socket
- 150-Watt pwr sup.
- 360K Floppy Drive w/Disk Controller
- Hercules® Compatible Video Card
- HiRes TTL monitor (green or amber)
- 2-Parallel prt's
- 1-Serial port (2nd optional at \$29)
- Game-Joystick prt.
- Clock/Calendar
- Fully Expandable
- PC-Write - QModem - ExpressCalc - HomeBase - MoneyMaster - Findex - Clone Utilities - AutoMenu
- FCC Class B Cert.
- Keyboard Lock
- LED's for Power, Turbo and Hard Disk Access
- 1 yr prt's. lab. war.

- 559 Clone EGA video board 640 x 350 res \$149
- 559 Clone VGA video board 640 x 480 res 259
- 99 Paradise VGA Plus 16, Hi-speed 325
- 98 The Complete Fax 3600, mt. FAX brd 449
- 108 Intel Above Brd LIM 4.0 EMS mem brd 439
- 218 Math coprocessors all types speeds in stock

Save Your Data and Money, Too! Peripherals Sale!



This is the fastest floppy interface tape drive around!
60MB TAPE DRIVES

Up to 150MB Capacity
Works on PC, XT, AT's and 100% compatible. Connects to the internal floppy (B:) connector or the optional adapter card (\$77). Comes complete with instructions and data compression software that allows up to 100MB data storage on a 40MB tape and 150MB on a 60MB tape.

External model now available for only \$99 extra!
Add \$10 for shipping



UNINTERRUPTIBLE POWER SUPPLY

As Low As \$279 250 Watt Model
Add \$23 shipping in the lower 48 states.

250 Watt	120 Volt	\$ 279
300 Watt	120 Volt	399
500 Watt	120 Volt	499
600 Watt	120 Volt	639
1200 Watt	120 Volt	1099
1600 Watt	120 Volt	1444*

- Protects Against:
- Brownouts.
 - Blackouts.
 - Overvoltage.
 - Overload.
 - Spills/Surges.
 - EMI

- Features:
- Two Audible Alarms.
 - LED Displays.
 - Optional Network Port.
 - Transfer Times As Fast As 1 Millisecond (Depends on Model).

Save on Low Cost Floppys!

- Select the drive or drives you want, pick the enclosure and appropriate cable and we will assemble and test at no additional cost to you. All drives are brand new, not factory seconds, and carry a full one year parts and labor warranty. Add \$5 shipping and handling per drive.
- 360K 5.25" TEAC 55B bare \$69
 - 720K 5.25" TEAC 55F bare \$85
 - 1.2M 5.25" TEAC 35FGH bare \$79
 - 360K 3.5" TEAC 35B bare \$59
 - 720K 3.5" TEAC 35F bare \$85
 - 1.44M 3.5" TEAC 35FGH bare \$79
 - 5.25" mounting bracket for 3.5" drives \$10 (Includes rails, signal and power adapter. Specify beige or black faceplate)
 - Dual 3.5" external case/power supply. Use with one or two 3.5" drives (horizontal) \$49
 - Dual 5.25" same as above except vertical \$59
 - IBM external floppy cable for C/D. DB37 required \$39 (Add \$10 for brushed Stainless Steel cover)

Limited Time Only! Fantastic Prices Now On LOW COST HARD DRIVES For IBM and Tandy

- 5.25MB 95ms ST-506 MFM XT Kit \$149
- 21.4MB 65ms ST-225 MFM XT Kit \$249
- 32.7MB 85ms ST-238 12LL XT Kit \$279
- 42.8MB 40ms ST-251 MFM XT Kit \$379
- 28ms Optional

- \$329 49.1MB 40ms ST-157R RLL Bare 28ms Optional
- \$429 45.5MB 40ms ST-277R RLL XT Kit 28ms Optional
- \$599 80.2MB 28ms ST-4096 MFM Bare
- \$599 84.9MB 28ms ST-296H SCSI Kit
- \$699 127.7MB 28ms ST-4144R RLL Bare

We provide the best low cost, high quality, fast access hard drives for your IBM, 100% compatible or Tandy computer. Our XT and SCSI kits are complete with drive, controller, cables and installation instructions. We use only brand new genuine Seagate drives so you can be assured of long trouble-free drive life. Data transfer rates as fast as 500KB per second MFM, 800KB RLL and 1MB using SCSI. We provide software to park the heads (some drives self-park). Tandy 1000 requires DMA and ROM 1.01. Not for EX/HX. Please specify the computer brand and model when ordering ST 506, 4096 and 4144R are full size 5 1/4" and ST 157R is 3 1/2". All others are half height 5 1/4". Sizes listed are after formatting. One year parts and labor warranty. Satisfaction guaranteed or your money back, less shipping.

Save on 32MB & 49MB Hard Cards

- 32.7MB 48ms RLL \$329
 - 49.1MB 40ms RLL \$429
- These units are completely assembled with brand new drives and come ready to install. For IBM XT's, 100% compatibles and Tandy 1000/1000A, SL, SX, TL, TX. Please specify the exact make and model of your computer. One year parts and labor warranty.

SOFTWARE SPECTACULAR!

This list is only a small portion of our inventory! Call us for all of your software needs!

MS-DOS® BUSINESS SOFTWARE

- Aldus Pagemaker v. 3.0 \$499
- Borland Quattro (1-2-3 Clone) 189
- Borland Sprint word processor 138
- DAC Easy Bonus Pack 123
- Dbase IV 162
- Design CAD 216
- Design CAD 3D v. 2.1 216
- Formtool 55
- Framework III v. 1.1 399
- Gem Desktop Publisher v. 2.0 with GEM 3 Desktop 182
- Generic CAD Level 3 with Dotplot 174
- Grammatik III 54
- Harvard Graphics v. 2.1 310
- Lotus 1-2-3 v. 2.01 219
- Paashtree Complete System II 174
- Paashtree Double Bundle software for accounting 238
- PFS First Choice v. 3.0 99
- PFS Professional File v. 2.0 188
- Publish II 122
- Quicken 31
- R-BASE for DOS v. 2.1 519
- Rightwriter v. 3.1 52
- Wordperfect v. 5.0 255
- Wordperfect Library v. 2.0 70

UTILITIES/PROGRAMMING LANGUAGES

- Autosketch \$53
- Deskview 386 with GEMM 386 116
- Fastback Plus v. 2.01 115
- Laplank Plus v. 2.0 54
- Microsoft C Compiler 5.1 289
- Microsoft Macro Assembler 5.1 99
- Microsoft Quick Basic Compiler 4.5 87
- Microsoft Quick C Compiler 87
- Microsoft Windows 286 87
- Microsoft Windows 386 133
- Norton Utilities Adv. Ed. v. 4.5 88
- PC Tools Deluxe v. 5.0 48
- Procomm Plus 46
- Xtree Pro 69

GAMES

- Chessmaster 2100 \$32
- F-19 Stealth Fighter 44
- Falcon AT 34
- Kings Quest II, III or IV 31
- Micro Blaster Plus 28
- Print Shop Bundle 37

Clone smolD

CLONE COMPUTERS
2544 W. Commerce St.
Box 223957
Dallas, Texas 75222-3957
Tel: 682761
Fax: 214-634-8303
For information or technical assistance call 214-637-5400

ORDER TOLL FREE!
Mon.-Fri. 9-7; Sat. 10-3
Call from anywhere in the lower 48 states and Hawaii.

800-527-0347



Oh, No!!

They squashed the monitor!



Its the first laptop with a screen as readable as a CRT...

Revolutionary technology - less than an inch thick, yet looks like a hi-res amber monitor...

Viewable from all angles.

- FAST 80286 CPU
- UPGRADEABLE TO 80386
- FAST 40MB HARD DISK

For more information contact:

KISS Computers 1-800-438-5477

1-414-652-5477

Dealer Inquiries welcome

UNIVERSAL PROGRAMMER



- For E(E)PROM, PAL, BIPOLAR 8748/51Series PROGRAMMING & IC/Memory TESTING
- High-Speed, Parallel Interface

ONLY \$545 COMPLETE
Also Individual/Gang Units

XELTEK
473 Sapena Ct. Unit 24
Santa Clara, CA 95054

1-800-541-1975 (Toll Free Order)
Tel: (408)727-6995, Fax: (408) 727-6996
CODVISA, MC, AM EX Accepted

Circle 282 on Reader Service Card

Connectivity Solutions

Share - Switch - Speed

Leaders in connectivity devices since 1985, we manufacture a complete line of :

- Data converters
- Printer buffers
- Sharing devices
- Electronic switching
- Multiple port boards
- Data servers

Intelligent, high capacity, external/internal buffers, automatic serial/parallel data conversions. Connect multiple computers, printers, plotters, modems, etc. to a single management device.

Make your hardware investment pay off !

970 Terra Bella Ave # 3
Mountain View, CA 94043
(415) 968-8404



Circle 138 on Reader Service Card



DCI 286/12 IBM Compatible

30 Day Return! 5 Year Extended Warranty!
FREE FREIGHT!

- 80286 Processor Operating at 6/12 Mhz, 101 Keypoint
- 512K RAM expandable to 1 Mb on board, 0/1 WS
- 1.2 Mb or 1.44 Floppy Drive
- Western Digital WA2 HD/HD Controller
- Clock Calendar with 5 year battery
- 220 Watt Power Supply • 80287 FPP Support
- Either Full or Mini AT Case
- Made in USA, FCC A & B, True Phoenix BIOS

	20Mb	40Mb	40Mb	28ms	80Mb	28ms
Mono	1331"	1439"	1545"	1795"		
EGA	1760"	1867"	1974"	2224"		
VGA	1871"	1979"	2085"	2335"		

DCI - (408) 756-0094 • 37088 West Davis • Corona, TX 77204
* All prices cash or check. Qty & Corp discounts available

Circle 78 on Reader Service Card

9-TRACK TAPE SYSTEMS!



OVERLAND DATA IS THE EXPERT when it comes to connecting your PC to the mainframe and mini computer world.

- PC/XT/AT/386/PS2/compatibles
- 800, 1600, 3200, 6250 BPI
- Free tutorial on tape systems
- EBCDIC/ASCII conversion
- IBM & ANSI labeled tapes
- DOS, XENIX, UNIX, PICK
- Highest quality customer service
- Stock full range of tape drives
- Network backup and More!

Overland Data Inc.

5620 Kearny Mesa Rd. • San Diego, CA 92111
Tel: (619) 571-5555 • FAX: (619) 571-0982

Circle 183 on Reader Service Card

200/100MHz Logic Analyzer



- 24 channels, Timing and State
- Optional expansion to 72 channels
- 200 or 100 MHz max sampling rate
- 16 levels of triggering
- 16K samples/channel (6 channel mode)
- TTL, ECL or Variable threshold
- 3 external clocks with 11 quality inputs
- Data output to disk or printer
- PC/XT/AT compatible
- \$1299 - LA27100 (100MHz)
- \$1899 - LA27200 (200MHz)

Call - 201-994-6669

Link Computer Graphics, Inc.
4 Sparrow Dr., Livingston, NJ 07039 Fax: 201-994-0730

Circle 138 on Reader Service Card

PC-Based Programmer

\$475

PAL
EPLD
EPROM
EEPROM
MICROCONTROLLER

TI NS MMI AMD CYPRESS
ALTERA INTEL SAMSUNG...

- 20 AND 24 PIN PAL/EPLD
- 2716-27512 EPROMS
- EEPROMS
- MICROCONTROLLERS (with adaptor)
- DSP TI TMS-320 (with adaptor)
- Support for JEDEC Intel Hex, Binary and Motorola S Files
- Read, Write, Protect and Verify
- Full Screen Editing in Hex and Ascii
- Byte split for 16 and 32 bit systems.

Call- 201-994-6669

Link Computer Graphics, Inc.
4 Sparrow Dr., Livingston, NJ 07039 Fax: 201-994-0730

Circle 139 on Reader Service Card

Give us a call about our LEASING program!

International Orders, Government P.O. are Welcome!

DISK DRIVES		COMPUTERS		PLOTTERS		PRINTERS		MONITORS	
Archive 40Mb Tape	319	Acer 286/386 - 16,20,25 Mhz	Save	Calcomp 1023	3595	Alps Allegro 24	318	Amdek 410	139
CDC 100 Mb	925	Altos Computers	Save	Calcomp 1025E	4595	Brother HLBE Laser	2025	Amdek 432	155
CDC 200 Mb ESDI	1425	Apple Computers	Save	Calcomp 1043 DM	5695	Canon BJ 130	725	Amdek 632 VGA	399
Miniscribe 157 Mb ESDI	1095	AST Premium 286	1245	Calcomp 1044GT	8595	Canon LBP-8II Laser	1595	Amdek 732 VGA	399
Miniscribe 3053	398	AST Premium 386SX	2149	Enter SP1800	3295	Citizen 1200	145	Amdek 735 Smartscan	489
Miniscribe 3085	549	Compaq Computers	Save	Houston DMP 52	2295	Citizen 180D	162	Amdek 1280 w/card	649
Miniscribe 338 Mb ESDI	1645	Cordata Computers	Call	Houston DMP 52 MP	2745	Citizen MSP40	275	AST Turbovision	1645
Miniscribe 40 Mb	285	Everex Step 286/386	Save	Houston DMP 61	2995	Citizen MSP45	372	Cornerstone 15" Mac II & SE	712
Miniscribe 676 Mb ESDI	Save	IBM Computers	Save	Houston DMP 62	4088	Citizen MSP55	412	Cornerstone 19" Mac II & SE	1199
Panasonic Worm	1829	Mitsubishi 286/386	Save	HP 7440 A	958	NEC LC 890 Laser	3089	Cornerstone 19" Mono PC	2395
Plus HardCard 40	638	Mitsubishi 20 Mb Laptop	2298	HP 7475 A	1385	NEC P2200	319	Goldstar 13" EGA	335
Seagate 30 Mb Kit	258	Mitsubishi 40 Mb Laptop	2849	HP 7550 A	2912	NEC P5200	498	Goldstar 13" VGA	355
Seagate 40 Mb Kit	299	NCR Computers	Save	HP 7570 A	2898	NEC P5300	654	Goldstar Composite	95
Seagate ST251-1	375	NEC Desktop Computers	Save	HP 7595 A	6795	Okidata ML 320	328	Hitachi 20 Multi	2045
Seagate ST 4096	579	NEC Laptop Computers	Save	HP 7596	8795	Okidata ML 321	455	Imtek Multiscan	425
Teac 720 K, 3.5"	78	Packard Bell Systems	Save	HP Draftpro DXL	3595	Okidata ML 390	455	Mitsubishi 1381A	475
Teac 1.44 Mb 3.5"	88	Panasonic 286/386	Save	HP Draftpro EXL	4645	Okidata ML 391	635	Mitsubishi 1410 EGA	339
Toshiba 720 K, 3.5"	75	Samsung 8088 10 MHz/1 Drive	.665	IoLine 3500	2375	Okidata ML 393	978	Mitsubishi 1429 VGA	399
Toshiba 1.44 Mb, 3.5"	92	Samsung 80286 12 MHz, 1Mb	1299	IoLine 3700	2895	Panasonic 1124	Save	Mitsubishi HA 3905	1649
Core, Emerald, Genoa, Omega, Maynard		Sharp PC 4641	2395	IoLine 3700 MP	3145	Panasonic 1180	178	Mitsubishi HL 6605	1195
Maxtor, Mountain, Priam, Sysgen	Call	Sharp PC 5541	3745	IoLine 4000	3695	Panasonic 1191	232	Mitsubishi HL 6905	2195
BOARDS		Sharp PC 7241	2045	IoLine 4000 MP	4095	Panasonic 1524	539	Nanao 9070S	995
ADC/Alloy Slaves	Save	Toshiba T1000	719	Roland 885	675	Panasonic 4450 Laser	1299	NEC Multisynch +	858
Artist XJ1016	1795	Toshiba T1200F	1359	Roland 990	759	Qume Crystal Print Postscript	2999	NEC Multisynch 2A	489
AST 5251/3270	Save	Toshiba T1200FB	1545	Roland DPX 2000	2099	Qume Script Ten Laser	3145	NEC Multisynch 3D	629
ATI VGA Wonder	Save	Toshiba T1200HB	2375	Roland DPX 2200	3895	Star NX-1000	166	NEC Multisynch GS	232
Genoa 5300/5400	Save	Toshiba T1600	3198	Roland DPX 3300	3495	Star NX-2400	298	NEC Multisynch XL	1949
Intel Aboveboard+	392	Toshiba T3100E	2765	Roland DXY 1100	889	C/tech, Data Products, Data South, TI		Panasonic Panasync	589
Intel Inboard 386 PC	615	Toshiba T3200	3489	Roland DXY 1200	1295	Epson, Dicom, Seikoha, Vantyper Call		Peckard Bell TTL	78
Metheus 1128	1899	Toshiba T5100	Save	Roland DXY 1300	1695	MODEMS		PGS Max 15	245
Orchid Pro Design	295	Toshiba T5200 40/100	Save	Roland GRX - 300 D	3565	Anchor 2400E	145	PGS Ultra 16	829
Paradise Autoswitch 480	175	Wyse 2108	929	Roland GRX - 400 E	4975	ATI 2400 ETC, Int.	152	PGS UltraSynch	479
Paradise VGA +	252	Wyse 2112	1375	Bruning, Mural, Versatec, & Other s. Call		Avatec 1200 Ext.	65	Samsung 14" RGB	209
Paradise VGA + 16	292	Wyse 3216	2089	FAX MACHINES		Cardinal 2400 Ext.	129	Samsung 14" VGA	359
Paradise VGA Professional	439	Wyse 386/25 Mhz	Save	Cannon FaxPhone 8	785	Hayes 1200 Ext.	285	Seiko 14" 1024x768	545
Sota 286 i Accelerator	319	Zenith Supersports	Save	Cannon FaxPhone 15	899	Hayes 2400 Ext.	419	Sigma Laser + 19"	1695
Sota VGA 16 512K	399	Zenith 386/33Mhz	Save	Cannon FaxPhone 20	1079	Megahertz Laptops	Save	Sony 1302	625
STB VGA EM 512K	358	TERMINALS		Cannon FaxPhone 25	1849	Multitech 224 EH	Save	Sony 1303	459
Tecmar VGA/AD	429	Altos IV	355	Sharp UX-180	1195	Multitech 9600	Save	Sony 1304	Save
Video 7 Fastwrite	304	Altos V	485	Sharp UX-350	1525	Multitech v.32 9600	Save	Taxen 1000 Ultra	2445
Video 7 RAM	459	IBM 3151	385	Sharp UX-80	1265	Okidata 2400 Plus	299	Zenith 1490	589
Video 7 Vega VGA	258	Kimtron KT-70 PC	339	Toshiba 30100	969	Practical 1200I	65	DIGITIZERS	
Adaptik, Boca, Hercules, Tops, VMI,		Link MC-5	392	Toshiba 3300	1195	Prometheus 2400B/2	129	Calcomp 18x24	1695
Imagraph, Konan, Photon, Rasterops		Televideo 805	299	Toshiba 3700	1465	Prometheus 2400G	149	Calcomp 44 x 60	3895
Number Nine, Pixelworks, Quadram,		Televideo 955	379	SCANNERS		Racal-Vadic 2400YP	386	Calcomp 12 x 12	342
Sigma Des. Vericom, West. Dig.	Call	Televideo 965	395	Calera TrueScan Model E	2895	Telebit T1000 9600	575	GTCO 24 x 36	1895
SOFTWARE		Wyse 150	399	Calera TrueScan Model S	1995	Telebit T2000 19200	1079	GTCO 36 x 48	2295
Adobe Fonts	Save	Wyse 30	289	Complete PC Half-Page	162	USR Courier 2400	299	Hiachi Puma Pros	Save
Bitstream Fonts	105	Wyse 50	355	Complete PC Hand Scanner	157	USR Courier 2400E	328	Houston Hi Pad +	Save
Carbon Copy Plus	107	Wyse 60	399	Datacopy 730	1099	USR Courier Dual Standard	979	Kurta 12x12	279
DBase IV	Save	Wyse 85	369	Datacopy 730GS	819	USR HST 9600	588	Kurta IS 12 x 17	479
Desqview 386	105	Wyse 99 GT	465	Datacopy 830	1695	Ven-Tel Mac 2400E	Save	Kurta IS 3	Save
Fastback Plus	104	Adds, Ampex, Sun River, Others	Call	Dest PC Scan 1000	869	World Port Pocket	Save	Kurta IS 8.5x11	229
Grammatik III	54	MICE		Dest PC Scan 1020	1245	Zoom 2400 HC Int.	119	Numerica	Save
Harvard Graphics	272	Keytronics Pro Bus	75	Dest PC Scan 2000	665	Zoom 2400 MX Ext.	119	Scriptel	Save
Lotus 123	319	Logitech C7 Serial	62	Dest PC Scan 2020	999	Penril, Peckard Bell, UDS	Call	Seiko	Save
Microsoft PC Works	79	Logitech Clear Case w/Paint	72	Dest PC Scan 2020	999	CHIPS		Summa 12 x 12 +	338
Microsoft Word 5.0	212	Logitech Dexxa Base	58	HP Scanjet Plus	Call	Intel 80287 6.6/10 Mhz	139/204/238	Summa 12 x 18	568
PC Excel/Windows	245	Logitech Dexxa Serial	52	Logitech ScanMan	189	Intel 80387 16/20/25 Mhz	359/415/499	<i>Limited Quantity Specials</i>	
Peachtree Complete	146	Logitech New HiRes	79	Logitech ScanMan (Mac)	345			Okidata 193 Serial	475
Peachtree Dbl Bonus	219	Microsoft w/ paint	95	Panasonic RS505	999			Miniscribe 6053	505
Procomm Plus	47	Microsoft w/ windows	129	Panasonic RS506	1275			Microbuffer Mini 128 k	89
Rightwriter 3.0	52	Mouse Systems Bus w/A/sketch	109	PGS LS300 w/paint	725			Diamond Scan Swivel Base	12
Ventura Publisher	519	Mouse Systems PS/2	89	PGS La300 w/OCR	965			Multech 212 EH Modem	225
WordPerfect 5.0	Save	Mouse Systems Serial	109						

Phones are Open: Mon - Fri: 7 am - 6 pm, Sat: 9 am - 2 pm. Mail address: 4207 S. 37th Street, Dept B8, Phoenix, AZ 85040. Prices reflect cash discounts and are subject to change without notice. We do not guarantee compatibility. DOA's are replaced or repaired, any return requires a RMA#. Our Service dept. number is (602)437-4856. MasterCard, Visa, and American Express accepted.

INTERNATIONAL ORDERS PLEASE CALL: (602)437-4855
OUR FAX LINE IS READY FOR ORDERS AT: (602)437-9685



3 1/2 INCH 1.4 MB DISKS FOR ONLY ONE DOLLAR!

New Invention Makes It Possible!

Do you use the new, high capacity, 3 1/2 inch disks? If so, you have paid four, five, even six dollars per disk! Byte for byte, that is as much as SIX TIMES the 'old' 360K floppies. Now you can convert all your programs, data, and files to the new format, WITHOUT PAYING THESE PRICES!

HOW IS THIS POSSIBLE? Have you ever tried to format a regular, 'low density' 3 1/2 inch disk to 1.44 MB? Of course you have! It doesn't work! The computer gives an invalid media error. Our company was putting in a large network of IBM Clones. We have grown from a small company to a million-dollar corporation in two short years, and we didn't do it by wasting money. So, of course, we tried to use the cheap, 720K disks. Total failure.

ENTER OUR CRACKPOT ENGINEER. Our Crackpot Engineer wondered what was the difference between the disks. He tore them apart, analyzed the media. He found NO DIFFERENCE WHATSOEVER! Yet, they would not format. Why? Then he started examining the plastic housing. And he found the difference. It is NOT in the media, IT IS IN THE PLASTIC CASE!

TOTAL FAILURE! Our Crackpot Engineer (among other things, he invented the Electronic Flea Collar) sent a brand-new 720K disk to our machine shop, and asked them to modify it. They did... and the DISK IMMEDIATELY FORMATTED! But, within 10 minutes of use, it totally failed. It lost data all over the place. Back to the drawing board. The disk was dis-assembled and examined. It was found that, in performing the conversion, a microscopic piece of plastic had entered the housing, and totally ruined the disk. It was obvious that, if the conversion could be done reliably, it required extreme precision.

ENTER OUR OTHER CRACKPOT ENGINEER. Our president is a mechanical engineer. One of the best in the country. While a research scientist at Colorado School of Mines, he completely revolutionized the field of water jet drilling. He tackled the problem. Finally he came up with a solution - a precision tool which could perform the modification EVERY TIME and leave no plastic particles which would damage the disk!

MONTHS OF TESTING. We then commenced on a testing program. We modified and formatted thousands of disks, and tested them for data integrity. Out of one thousand disks, one would not format, two had one bad track. NOT ONE LOST ANY DATA! We then put a disk on a computer with a bat file which copied data to a disk, read and checked every byte, then copied the data back to the disk. The program ran 24 hours a day, for TWO SOLID WEEKS without even one error! We were finally convinced that the procedure was reliable enough for a product.

OUR OFFER. Here is our irresistible offer. Purchase our DoubleDisk Converter for the price of \$39.95. If you are not COMPLETELY SATISFIED, return the DoubleDisk. You will receive a FULL REFUND! What is more, if a disk ever does not convert properly, send us the disk, and we will send you a 1.44MB disk from a major manufacturer in exchange!

YOU CAN'T LOSE! You will save MORE THAN THE PURCHASE PRICE IN CONVERTING ONLY YOUR FIRST TEN DISKS! From that point on, it is all profit. After converting only 100 disks, and after deducting the cost of the DoubleDisk, you will have saved AT LEAST \$425.00! Quite a return for an investment of only \$39.95!

CREDIT CARDS AND CHECKS ACCEPTED! Purchasing our DoubleDisk is easy! Simply call our 800 number. We accept all major credit cards. Or, return the coupon below, and we will ship you one immediately. We Will gladly accept your personal check.

24 HOURS **ORDER TOLL FREE - 1-800-537-4226** 7 DAYS
(In Colorado call 303-872-8945)

YES! I want to try your DoubleDisk on your UNCONDITIONAL MONEY BACK GUARANTEE! I enclose only \$39.95 plus \$3.50 Shipping and Handling (California residents add \$2.40 Sales Tax) for each DoubleDisk Converter. If I am not COMPLETELY SATISFIED, I will return the DoubleDisk for a FULL REFUND! If any disk ever fails to convert, I will send it to you and you will IMMEDIATELY send me a 1.44MB Disk in exchange!

Name _____ Address _____

City _____ State _____ Zip _____ Telephone _____

Send To: Biological Engineering, Inc., DoubleDisk Offer
2674 Main Street, Ventura, CA 93003 Phone 805-644-1797

IMAGING CARDS

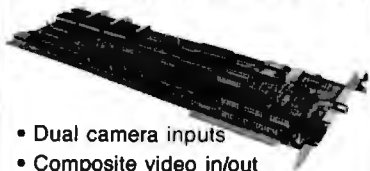

- Dual camera inputs
 - Composite video in/out
 - 256 x 240 resolution
 - Digitize/display at frame speed
 - 16 Meg. color palette out (DV-02)
 - External trigger input option
 - PC/XT/AT compatible
 - Complete with software & library
- DV-02 8-bit 256 gray levels . \$849
DV-03 6-bit 64 gray levels . . \$549
VISA/MC Demo disk available

Control Vision

PO Box 596 Pittsburg KS 66782
800/292-1160 316/231-6647

Circle 68 on Reader Service Card

DYNAMIC ELECTRONICS

SIMMS

8087-2	119.00
80287-8	185.00
80278-10	212.00
80387-20	369.00
80387-25	473.00
80387SX	299.00
80C287A	295.00
4464-12	5.25
1 MEG-100	12.85
1 MEG-80	13.75

CALL: (714)

855 - 0411

FAX: (714) 855 - 8504

23552 COMMERCE CENTER DR. # L
LAGUNA HILLS, CA. 92653

Circle 88 on Reader Service Card

IEEE 488 Solutions

- Hardware & software interfaces for PC, AT, 386, PS/2, Macintosh, SUN, HP & DEC
- IEEE converters to SCSI, RS-232, RS-422, modem, Centronics, digital I/O & analog I/O
- IEEE extenders, expanders & buffers
- IEEE drivers for DOS, UNIX, Lotus 1-2-3, Symphony & Quattro.

Call or send for your
FREE Technical Guide

Demo disks and application notes available

Please see our ad on pg 35

IOtech

(216) 439-4091

Telex 6502830864 • Fax (216) 439-4091
IOtech, Inc. • 25971 Cannon Road
Cleveland, Ohio 44146

Circle 130 on Reader Service Card

E/EPROM & MICRO PROGRAMMER

\$895

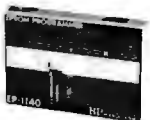

- EP-II40 includes: software, cable, user's manual, 2 free software update coupons, toll-free technical support, one-year warranty & a unconditional 30-day money back guarantee
 - Programs 24-, 28-, 32- & 40-pin E/EPROMs
 - Supports 874X & 875X series microcontrollers
 - Connects to a standard parallel port
 - 32-pin model, EP-II32, available for \$695
- The Engineer's Programmer™**

CALL TODAY 800-225-2102

BP MICROSYSTEMS

10681 Haddington, #190, Houston, TX 77043
713/461-9430 FAX 713/461-7413

Circle 31 on Reader Service Card

MIDI MUSIC

800 E. Campbell Road • Suite 199 • Richardson, TX 75081

Introducing...

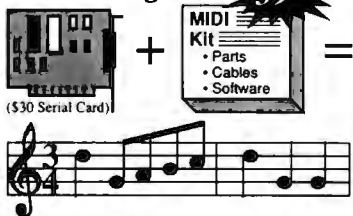

MIDI for PC Compatibles

Convert your standard serial card into a MIDI Card in less than an hour with our MIDI Kit. Kit includes easy-to-follow instructions, parts, MIDI cables, and a MIDI recording program with C source, for only \$39.95! Serial card add \$30. Assembled and tested add \$30. Professional sequencing and scoring software also available.

1-800-456-MIDI

Circle 167 on Reader Service Card

Terminal emulation the right way.

ZSTEM 240

VT240/241 emulation with VT340 ReGIS, Tektronix and sixel graphics plus all the features of ZSTEM 220.

ZSTEM 220

VT220 emulation plus file transfer, 132 columns, double-high/double-wide characters and extensive network support.

Both available with the PowerStation - VT layout keyboard.



KEA
Systems
Ltd.

2150 West Broadway, Suite 412, Vancouver, B.C.
Canada V6K 4L9 Phone: 604-732-7411
Fax: 604-732-0715 Order Desk: 800-663-8702

Trademarks: ZSTEM and PowerStation - KEA Systems Ltd.; VT240, VT241, VT340, VT220, and ReGIS - DEC; Tektronix - Tektronix Inc.

Circle 134 on Reader Service Card

3M

FREE! FLIP 'N' FILE
FORMATTED DISKS AT
UNFORMATTED PRICES!

DS-DD	Quantity Discounts Available	DS-HD
.62*	5.25" 3M Diskettes 10/box	*1.12
1.17*	3.50" 3M Diskettes 10/box	*2.84
1.89	SS/DD 8" 3M Diskettes 10/box	2.15

DC-2000	14.99	DC-800A	20.99
DC-300XLP	18.99	DC-8150(XFD)	21.99
3M Compac Tape 1/2" DEC TK50 Tape Min. 10	25.95		
3M/IBM 3480 Tape Cartridge Min. 30	5.85		
3M Mag Tape with seal 2400' Min. 10	12.70		

BASF *FREE Extra Quality Library Cases!!

DS-DD	Quantity Discounts Available	DS-HD
.52	5.25" BASF Diskettes 10/box	.80
.99	3.50" BASF Diskettes 10/box	2.55
.32	BASF 5.25" DS/DD No-Logo bulk with Tyvek sleeves, labels & W/F logo	
.29	BASF Brand 5.25" SS/DD/48TPI Diskettes in BASF plastic library box 10/box	

maxell * FREE Plastic Storage Box

5.25" DS/DD	5.25" DS/HD	3.50" DS/DD	3.50" DS/HD
.63*	1.15	1.17*	2.89*

Verbatim *FREE DataLifePlus with DISCU 11th Disk!

5.25" DS/DD	5.25" DS/HD	3.50" DS/DD	3.50" DS/HD
.63*	1.15	1.17	2.89

KAO COLOR DISKETTES

5.25" DS/DD	COLOR BULK	5.25" DS/HD	3.50" DS/DD	3.50" DS/HD
.38	.78	.89	2.50	

All 5.25" Color Diskettes with Tyvek Sleeves, Label & w/p Logos

*FREE! 11th Disk! *FREE Plastic Box

5.25" DS/DD	5.25" DS/HD	3.50" DS/DD	3.50" DS/HD
.61*	1.15	1.17*	2.89*

SONY Disk 3-1/2 DS, DD MFD-2DD 11.75

Dysan 5.25" DS/DD 6.75 BOXES OF 10's 5-1/4" DS/HD 10.50

BULK DISKETTES

5.25" DS/DD	5.25" DS/HD	3.50" DS/DD	3.50" DS/HD
.27	.55	.79	2.39

All 5.25" Bulk Diskettes in sleeves, labels & w/p tabs

3M HIGHLAND

5.25" DS/DD	3M Highland Diskettes 10/box	5.25" DS/HD
.39		.72
3.50" DS/DD	Brand Name 10/box	3.50" DS/HD
.99		2.39

RIBBONS STORAGE

Please Call for Information

TERMS: No surcharge on VISA, Mastercard or AMEX. COD only add \$3.00. PO's accepted from recognized institutions on net 30. Bank draft, T/T or L/C acceptable. Shipping: \$4/100 or fewer disks. Reduced shipping charges on large quantities. Price quoted for case (100 disks) quantities less than a case add 5% (Min. order \$25.00 Min. order on PO's \$150.00.)

Toll Free Order Line Information Line

1-800-523-9681 1-801-255-0080

TLX-9102404712 FAX-801-572-3327

DISK COTECH

DISKCO TECHNOLOGIES, INC.

213 Cottage Ave.

P.O. Box 1339 Sandy, Utah 84091

AUGUST 1989 • B Y T E 313

VOICE MASTER KEY®
VOICE RECOGNITION SYSTEM
FOR PC/COMPATIBLES & TANDY 1000 SERIES
A FULL FEATURED VOICE I/O SYSTEM

GIVE A NEW DIMENSION TO PERSONAL COMPUTING. . .The amazing Voice Master Key System adds voice recognition to just about any program or application. Voice command up to 256 keyboard macros from within CAD, desktop publishing, word processing, spread sheet, or game programs. Fully TSR and occupies less than 64K. Instant response time and high recognition accuracy. Voice recognition tool-box utilities are included. A genuine productivity enhancer!

SPEECH RECORDING SOFTWARE. . .Digitally record your own speech, sound, or music to put into your own software programs. Software provides sampling rate variations, graphics-based editing, and data compression utilities. Create software sound files you can add to macros for voice recognition verification response. A complete, superior speech and sound development tool.

SOFTWARE CONVERSION CODES. . .The Voice Master Key System operates a growing list of third party talking software titles using synthesized phonetics (text-to-speech) or digitized PCM, ADPCM, and CVSDM encoded sound files. Voice Master Key System does it all!



EVERYTHING INCLUDED. . .Voice Master Key System consists of a plug-in card, durable lightweight microphone headset, software, and manual. Card fits any available slot. External ports consist of mic inputs and volume controlled output sockets. High quality throughout, easy and fun to use.

ONLY \$149.95 COMPLETE

ONLY \$89.95 FOR TANDY 1000 SL/TL MODELS—SOFTWARE PACKAGE ONLY.

Requires Tandy Brand Electret Microphone.

ORDER HOTLINE: (503) 342-1271

Monday-Friday, 8AM to 5PM Pacific Time

Visa/MasterCard, company checks, money orders, CODs (with prior approval) accepted. Personal checks subject to 3 week shipping delay. Specify computer type and disk format (3 1/2" or 5 1/4") when ordering. Add \$5 shipping charge for delivery in USA and Canada. Foreign inquiries contact Covox for C & F quotes. **30 DAY MONEY BACK GUARANTEE IF NOT COMPLETELY SATISFIED. ONE YEAR WARRANTY ON HARDWARE.**

CALL OR WRITE FOR FREE PRODUCT CATALOG



COVOX INC. 675-D Conger St.
 Eugene, Oregon 97402 U.S.A.
 TEL: 503-342-1271 • FAX 503-342-1283

LOW COST, RELIABLE
EPROM PROGRAMMER



1 Year Warranty

Operates stand-alone or PC based. Shooter™, an intelligent EPROM programmer, uses serial port for communications. No modules to buy. Now includes 512K buffer; \$395 price includes cable, software and manual.

LOGICAL DEVICES, INC.

1201 N.W. 65th Place
 Ft. Lauderdale, FL 33309
 305-974-0967
 1-800-331-7766

Circle 140 on Reader Service Card
 (DEALERS: 141)

GANG PROGRAMMER Does 50,000 EPROMs A WEEK!



The only programmer under \$1000.00 that withstands heavy duty operation. Easy to use. Fastest possible programming speed. GANGPRO-8™ is a sure bet when reliability is what you want. All this plus a one year warranty and update for only \$995.00!

LOGICAL DEVICES, INC.

1201 N.W. 65th Place
 Ft. Lauderdale, FL 33309
 (305) 491-7404
 1-800-331-7766

Circle 144 on Reader Service Card
 (DEALERS: 145)

ICs PROMPT DELIVERY!!!
 SAME DAY SHIPPING (USUALLY)
 QUANTITY ONE PRICES SHOWN FOR JUNE 18, 1989

OUTSIDE OKLAHOMA NO SALES TAX

DYNAMIC RAM		EPROM	
SIMM (1)	256Kx36	80 ns	\$400.00
SIMM	1Mx9	80 ns	220.00
SIMM (2)	1Mx9	85 ns	195.00
SIMM	256Kx9	80 ns	95.00
1Mbit	1Mx1	100 ns	16.50
41256	256Kx8	60 ns	8.50
41256	256Kx1	80 ns	7.35
41256	256Kx1	100 ns	5.95
41256	256Kx1	120 ns	5.75
4464	64Kx4	120 ns	8.50
41264 (3)	64Kx4	120 ns	12.50
STATIC RAM			
27C1000	128Kx8	200 ns	\$28.50
27512	64Kx8	200 ns	9.95
27256	32Kx8	150 ns	7.25
27128	16Kx8	250 ns	4.50
STATIC RAM			
62256P-10	32Kx8	100 ns	\$26.50
6264P-12	8Kx8	120 ns	8.25
6116AP-12	2Kx8	120 ns	4.95

OPEN 6 1/2 DAYS, 7:30 AM TO 10 PM SHIP VIA FED-EX ON SAT.

SAT DELIVERY INCLUDED ON FED-EX ORDERS RECEIVED BY THE 3RD AIR MAIL DAY. No minimum order. Please note: prices subject to change! Shipping: residence orders add \$1.00 shipping insurance.

MasterCard/VISA or UPS CASH ON DELIVERY MICROPROCESSORS UNLIMITED INC. 24,200 S. Peoria Ave. (918) 267-4961 BEGGS, OK 74421

PAL™ /PLD SOFTWARE
 Sets The Standard



CUPL™ PLD compiler, the most powerful language for state machine logic design, now allows OrCAD™ schematic software as the front end design entry. CUPL supports all PLDs and carries the most extensive update program. Available on MS-DOS™, Apollo™, Sun™, VAX™ and most UNIX™ based platforms.

LOGICAL DEVICES, INC.

1201 N.W. 65th Place
 Ft. Lauderdale, FL 33309
 305-974-0967
 1-800-331-7766

Circle 142 on Reader Service Card
 (DEALERS: 143)

STAND-ALONE UNIVERSAL PLD PROGRAMMER
 Costs Less, Performs More



Palpro-2x™ is an intelligent programmer supporting PLDs from a wide variety of sources. Works with any PC or computer using a serial port. FREE one year device update and warranty. Price \$795.00.

LOGICAL DEVICES, INC.

1201 N.W. 65th Place
 Ft. Lauderdale, FL 33309
 (305) 491-7404
 1-800-331-7766

Circle 146 on Reader Service Card
 (DEALERS: 147)

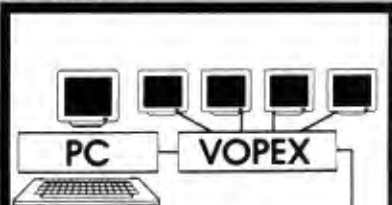

KEYBOARD & MONITOR 500 FEET AWAY - ALSO DRIVE MANY MONITORS AT ONCE — CALL FOR FREE CATALOG

NTI NETWORK TECHNOLOGIES, INC.

19145 Elizabeth St., Aurora, OH 44202
 (216) 543-1656
 (800) RGB-TECH
 UK: 0244-880478
 Paris: 01331-476-32789

Circle 178 on Reader Service Card

Low Prices, Fast Service

Satisfaction Guaranteed or your Money Back, Since 1975

Jade 10 MHz Turbo XT\$348
 640K Motherboard w/256K RAM
 140 Watt Power Supply
 101 Enhanced Keyboard

Monochrome Graphics System \$698
 640K RAM, 360K Disk Drive, Serial
 Port, Clock/Calendar, Game Port,
 Printer Port, Hi-Res Amber Monitor
 30 MB Hard Disk System ... add \$298
 CGA Color System add \$188
 EGA Color System add \$398
 VGA Color System add \$498

Jade 12 MHz Turbo 286\$698
 1 MB Motherboard w/512K RAM
 200 Watt Power Supply
 Clock/Calendar
 Enhanced 101 Keyboard

Mono Graphics System \$998
 1.2 MB Floppy Drive & Controller
 Printer Port, Hi-Res amber Monitor
 40 MB Hard Disk System ... add \$438
 12 MHz, 1 MB of RAM add \$148

Jade 20 MHz Turbo 386 \$1798
 1 MB of RAM on Motherboard
 1:1 Interleave FDD/HD Controller
 1.2 MB Disk Drive
 101 Enhanced Keyboard

40 MB Graphics System \$2348
 1.2 MB Floppy Disk Drive
 40 MB Hard Disk Drive
 Hi-Res amber Monitor

Disk Drives
 360K half height \$68
 360K full height \$118
 TEAC 55 BV \$78
 1.2 MB for AT \$88
 3 1/2" 720K \$88
 3 1/2" 1.44 MB \$98
 5 1/4" ext. 360K for PS/2 \$188
 5 1/4" ext. 1.2 MB for PS/2 \$228
 5 1/4" ext. for LapTop \$198

Hard Disk Drives
 20 MB w/controller \$248
 30 MB w/controller \$288
 40 MB w/controller \$398
 40 MB for AT \$308
 ST 125 20 MB \$248
 ST 138 30 MB \$298
 ST 251 40 MB \$328
 ST 251-1 40 MB \$348
 ST 4096 80 MB \$568

Tape Back-up
 CMS Jumbo 40 MB XT/AT \$298
 XT/AT Kit External \$128
 PS/2 Internal Kit \$58
 PS/2 External Kit \$128

Monitors

Samsung 12" amber \$98
 14" amber flat screen \$128
 RGB 640 X 240 color \$258
 EGA 640 x 350 color \$378
 VGA 640 x 480 \$348
 NEC MultiSync II Call
 NEC MultiSync II 2A \$508
 Mitsubishi Diamond Scan \$498
 Zenith 1490 flat screen \$618
 Sony 800 x 600 Multi Scan \$488

Keyboards

84 Key AT-style \$58
 101 Key enhanced \$68

Printers

EPSON LX-800 9 PIN \$178
 EPSON LX-810 Call
 EPSON FX-850 Call
 EPSON FX-1050 Call
 EPSON EX-800 Call
 EPSON DFX-5000 Call
 EPSON LQ-500 24 PIN Call
 EPSON LQ-510 Call
 EPSON LQ-850 Call
 EPSON LQ-950 Call
 EPSON LQ-1050 Call

No-Slot Clock \$29

- Uses No Slots
- 20 Year Battery
- Includes Software

Panasonic KX-P1180 \$178
 Panasonic KX-P1191 \$239
 Panasonic KX-P1124 \$318
 Panasonic KX-P1592 \$388
 Panasonic KX-P1092i \$318
 Panasonic KX-P1595 \$438
 Panasonic KX-P1524 \$538
 Panasonic KX-P4450 \$1548

Daisywheel Printer

40 CPS Parallel and serial \$199

Accessories for Hewlett Packard

25 in One Font Cartridge \$388
 4 MB card w/0 memory \$188
 1 MB memory card \$348
 2 MB memory card \$648
 4 MB memory card \$1148
 Toner cartridge \$98
 Plotter in a Cartridge \$298

Terminals

WYSE model 30 \$288
 WYSE model 50 \$368
 WYSE model 85 \$438

Joystick

Kraft 3 button Joystick \$19
 Dual Game Port \$19

Plotter \$688

Roland DXY-980

8 PEN 230mm/SEC
 .05mm Resolution
 HPGL Compatible
 Electrostatic Hold Down
 Parallel and Serial Input
 Digitizing Capacity
 List Price \$1798

Scanner

Complete Hand Scanner \$98
 Complete 4" Scanner \$198
 Logitech Scan Man \$248
 Diamond Flower 3000 \$198

Digitizers

Summa Sketch 12 x 12 \$378

Mouse

Opto-mechanical with Software \$29

LogiTech

LogiMouse Serial \$68
 LogiMouse Hi-Res Bus \$88
 LogiMouse Hi-Res Serial \$98

Mouse Systems

PC Mouse with Paint Bus \$88
 PC Mouse with Paint Serial \$88

Microsoft

Mouse w/Paintbrush \$98
 Mouse w/CAD Call
 Mouse w/Window Call

Complete PC

Complete FAX 4800 \$298
 Complete FAX 9600 \$458
 Complete Answering Machine \$248

Switch Boxes

Parallel or Serial (Specify)
 2 way AB \$28
 3 way ABC \$38
 4 way ABCD \$58
 5 way ABCDE \$68
 Crossover X \$68
 AutoSwitch 1 in 6 out \$98
 LaserSwitch 4 in 1 out \$128
 LaserSwitch 6 in 1 out \$148

Modems

1200 internal w/software \$48
 2400 internal w/software \$98
 1200 baud external \$88
 2400 baud external \$148
 2400 PS/2 internal \$198
 Intel 2400B for PS/2 \$278

Intel 80287-10 \$248
 8087 \$94
 8087-2 \$138
 8087-1 \$178
 80287-6 \$148
 80287-8 \$218
 80387-SX \$348
 80387-16 \$378
 30387-20 \$458
 80387-25 \$528
 80387-33 \$588

Above board 286 Plus 512K \$418
 Inboard 386 PC w/1 MB \$688

Cables

6' printer \$12
 10' printer \$18
 25' printer \$28
 9' serial \$18
 25' serial \$28
 50' serial \$38
 100' serial \$58
 Keyboard extender \$12
 Monitor extender \$16
 Printer extender \$16

Boards

Monographics w/Parallel \$48
 Color Graphics w/Parallel \$48
 Jade EGA card \$148
 Jade VGA+ \$198
 Jade VGA+ 16 \$258
 Dual game port \$19
 XT I/O Par/Ser/Clk/Game \$58
 AT I/O Par/Ser/Game \$58
 360/720K 1.2/1.44 MB FDC \$48
 AT FDD/HD controller \$98
 XT Hard Disk controller \$58
 AST SixPak Plus \$118
 AST XFormer \$578
 Paradise auto EGA 350 \$168
 Paradise VGA+ \$268
 Paradise VGA+ 16 \$318

Surge Protector

S. L. Waber 6 outlet \$18
 Isobar 4 outlet \$48
 Isobar 8 outlet \$68
 Isobar modem protector \$24

Tripplite Battery Back-up

450 Watt UPS \$398
 750 Watt UPS \$498
 1200 Watt UPS \$698

Tripplite Line Stabilizer

600 Watt Line Conditioner \$98
 1200 Watt Line Conditioner \$158
 1800 Watt Line Conditioner \$188

Accessories

Kensington Master Piece \$88
 AC Master Control Center \$48
 MicroSpeed PC-Trac Ball \$78
 Vertical CPU stand \$18
 Keyboard drawer \$58
 Monitor Tilt-n-Swivel \$18

4901 W. Rosecrans Ave. Box 5046
 Hawthorne, California 90251-5046



JADE COMPUTER

California
 Torrance, Costa Mesa, Woodland Hills
 Kearny Mesa, Sunnyvale

Texas
 Addison, Houston

Georgia — Arizona —
 Smyrna — Phoenix

Not all items in stock at
 our nine retail locations.



Place orders and use our technical support toll free!

Continental U.S.A. 1-800-421-5500 Inside California 1-800-262-1710

Fax machine 1-213-675-2522/All others 1-213-973-7707

We accept checks, credit card or purchase
 orders from qualified firms and institutions.
 No surcharge on credit card orders. CA., TX,
 GA. & AZ. residents add sales tax. Prices and

availability subject to change without notice.
 Shipping and handling charges via UPS
 ground 50¢/lb. UPS air \$1.00/lb. Minimum
 charge \$4.00.

SUMMER CLEARANCE — PRICES SLASHED

CAT™ 10MHZ BASE SYSTEM

- 256K (Opt. 640K) • 150 Watt Power Supply • AT Style Keyboard & Case
- 4.77 or 8 MHz Keyboard Selectable • FDC
- 8087 Socket • 360K Floppy Drive • 1 Year Warranty

\$34900



CAT 386 SYSTEM

- 12" Amber Monitor with Graphics Interface Card
- 1.2 Meg Floppy Drive (expandable to 8 Meg)
- 1 Meg of Memory
- Parallel, Serial & Clock
- 70 Meg Hard Drive

20MHz **\$159500**

CAT™ 286-10MHZ BASE SYSTEM

- 512K Exp to 1 MEG • 200 Watt Power Supply • AT Style Keyboard
- Western Digital Controller • 1.2 Meg Floppy • Legal Bios w/manuals • Systems Documentation • 1 yr war • Clock/Calc
- 10MHz DTK Motherboard

\$69900



11.3 HORTONS SL

8088 XT Compatible

640 K Upgrade	129 ⁰⁰	Clock Calendar	24 ⁰⁰
12" Amber Monitor w/Interface	139 ⁰⁰	Parallel & Serial Ports	39 ⁰⁰
DOS 4.01 w/GW BASIC	89 ⁰⁰	Additional Drives	See Below

SYSTEM OPTIONS

640 K Upgrade	49 ⁰⁰	14" EGA Monitor w/Interface	549 ⁰⁰
1 Meg Upgrade	159 ⁰⁰	Novell Network Call 12 Mhz add	100 ⁰⁰
12" Amber Monitor w/Interface	139 ⁰⁰	14" Color Monitor w/Interface	289 ⁰⁰

256K DIP UPGRADE \$45
1 MEG DIP UPGRADE \$139

WE WILL NOT BE UNDERSOLD

4 MEG COMPAQ MODULE \$999

Intel COPROCESSORS

If Your PC Uses the Intel	Running at...	Then You Need Intel	MEADS Price
8088	5MHz or less	8087	97 ⁰⁰
8089 or 8086	8MHz or less	8087-2	139 ⁰⁰
8086	10MHz or less	8087-1	199 ⁰⁰
80286	6-8MHz	80287	149 ⁰⁰
80286	8-10MHz	80287-8	229 ⁰⁰
80286	10MHz or more	80287-10	259 ⁰⁰
80386	16MHz	80387-16	379 ⁰⁰
80386	20MHz	80387-20	439 ⁰⁰
80386	25MHz	80387-25	549 ⁰⁰
386SX	16MHz	80387-SX	399 ⁰⁰

RAM UPGRADES

1 YEAR WARRANTY	64K	79 ⁰⁰	WE BUY EXCESS RAMS PLEASE CALL OR FAX LIST
4464	100 NS, 64x4	79 ⁰⁰	1 Meg. 14 ⁰⁰ 1 Meg x 1 100 NS 15 ⁰⁰ 1 Meg x 1 80 NS 16 ⁰⁰ Simms Modules 64 x 9 150 NS 29 ⁰⁰ 256 x 8 150 NS 29 ⁰⁰ 256 x 8 80 NS 79 ⁰⁰ 256 x 9 100 NS 69 ⁰⁰ 256 x 9 120 NS 59 ⁰⁰ 1 Meg x 9 120 NS 189 ⁰⁰ 1 Meg x 9 100 NS 199 ⁰⁰ 1 Meg x 9 80 NS 249 ⁰⁰ 1 Meg x 8 120 NS 149 ⁰⁰ We Carry Dips - Zips - Simms - Soj - PLCC - Sipp All Speeds - CALL
4464	120 NS, 64x4	74 ⁰⁰	
4464	150 NS, 64x4	69 ⁰⁰	
4164	150 NS, 64x1	29 ⁰⁰	
4164	120 NS, 229x1	31 ⁰⁰	
4164	100 NS, 64x1	34 ⁰⁰	
	256K		
41256	150 NS, 256x1	49 ⁰⁰	
41256	120 NS, 256x1	59 ⁰⁰	
41256	100 NS, 256x1	69 ⁰⁰	
41256	80 NS, 256x1	79 ⁰⁰	
41256	120 NS, 256x4	199 ⁰⁰	
IBM PS2 & COMPAQ 386			
256X9 100 NS	109 ⁰⁰		
1MEGX9 100 NS	259 ⁰⁰		
2MEGX9 100 NS	595 ⁰⁰		
1MEG Compaq	389 ⁰⁰		
4MEG Compaq	999 ⁰⁰		

Seagate HARD DRIVES

ST125 20Meg 40 Mil 1/2 Ht 3 1/2" Drive only	209 ⁰⁰
ST138 30Meg 40 Mil 1/2 Ht 3 1/2" Drive only	299 ⁰⁰
ST225 20Meg w/cont. & Cables	269 ⁰⁰
ST238 30Meg w/cont. & Cables	289 ⁰⁰
ST251 40Meg 1/2 HT 40 Mil w/software, Drive only	359 ⁰⁰
ST251-1 40Meg, 28 Mil Sec. Drive only	389 ⁰⁰
ST277R 60MB 40 Mil 1/2 Ht	469 ⁰⁰
ST4026 20Meg Full Ht 40 Mil	299 ⁰⁰
ST4038 30Meg 40 Mil Full Ht	399 ⁰⁰
ST4053 40MB 28 Mil Full Ht	519 ⁰⁰
ST4096 80Meg Full HT w/software	639 ⁰⁰

WESTERN DIGITAL CONTROLLERS

WX-1 8 Bit 1/2 Sized for XT	79 ⁰⁰
WA-2 16 Bit Full Sized Hard/Floppy	119 ⁰⁰
WD-27X 8 Bit RLL 1/2 Size	89 ⁰⁰
WAH 16 Bit Hard Drive Controller	129 ⁰⁰
RA2 16 Bit RLL Hard/Floppy for AT	159 ⁰⁰
MEAD Floppy Disk Controller for XT	19 ⁰⁰
MEAD 1.2 Meg & 360K Controller for XT, 720K-1.44	69 ⁰⁰
Cable Set for Hard Drive Only	5 ⁰⁰

Mitsumi FLOPPY DRIVES

360K 1/2 Ht. PC Compatible — Mitsumi	69 ⁰⁰
1.2 Meg Black Face — Mitsumi	89 ⁰⁰
720K 3 1/2" Drive w/5 1/4" mounting — Mitsumi	89 ⁰⁰
1.44 Meg 3 1/2" Drive w/5 1/4" mounting — Mitsumi	109 ⁰⁰
360K Tandon TM100-2 Full Ht (The Original IBM)	89 ⁰⁰
160K Tandon TM100-1 Full Ht	59 ⁰⁰
External Case w/Power Supply 2, 1/2 HTs or 1 Full	149 ⁰⁰

MODEMS BY EVEREX™

EV-923 EverCom 12 300/1200 bps Bitcom Software	69 ⁰⁰
EV-941 EverCom 24 2400 Baud Int. Bitcom Software	139 ⁰⁰
EV-945 External 2400 Baud	199 ⁰⁰
EV-942 2400 PS2	229 ⁰⁰
EX-955 FAX Card	349 ⁰⁰

COMPUTER PERIPHERALS — 5 YEAR WARRANTY

1200 Baud Internal w/Software	54 ⁰⁰
1200 Baud External Fully Hayes Compatible, Everex	99 ⁰⁰
2400 Baud Internal 1/2 card w/software	99 ⁰⁰
2400 Baud External Fully Hayes Compatible, Zoom	129 ⁰⁰

Imtec/SAMSUNG MONITORS

1256A 12" Amber w/Tilt & Swivel Base	89 ⁰⁰
1257 12" Amber Flat Screen 720 x 350	299 ⁰⁰
1464 14" Color 640 x 200, 16 colors	99 ⁰⁰
1453 14" EGA 640 x 350, 64 colors/31	369 ⁰⁰
1455W EGA 720x480 Multisync Compatible	449 ⁰⁰

EVEREX™ TAPE BACKUPS

40MB Mini Cartridge, 1.8MB/min, XT (DC 2000)	339 ⁰⁰
40MB Mini Cartridge, 3.6MB/min, AT (DC 2000)	339 ⁰⁰
40MB PS2 Model 50-60-70-80 (DC 2000)	419 ⁰⁰
60MB Streaming Cassette, 5MB/min w/cont (CT600)	649 ⁰⁰
60MB Streaming 600A, 5MB/min w/Full cont (DC600)	849 ⁰⁰
125MB Streaming Cartridge, 5MB/min w/Full cont.	1119 ⁰⁰
Excell 60 Model 60/80 (PS2)	999 ⁰⁰
Excell 125 Model 60/80 (PS2)	1269 ⁰⁰
DC2000 24"	External Add 195 ⁰⁰
DC600 24"	

★ SPECIALS ★

MINISCRIBE HARD DRIVE 3130E, 112Meg, 17ms, 1/2 HT, Auto parking, cables, rails, Software	List 199 ⁰⁰ Mead 949 ⁰⁰
EVEREX EV659 EGA Auto Switch 640 x 350	w/Controller add \$100 129 ⁰⁰
EVEREX Viewpoint 16 Bit VGA 256K exp. 512K	279 ⁰⁰

★ SPECIALS ★

EVEREX TAPE BACKUP	
40Meg for XT, Mini Cartridge 870A	249 ⁰⁰
COMPUTER PERIPHERALS MODEM	
2400 Baud Internal, Hayes Compat, auto answer, auto dial, 5 Year Warranty PC-XT-AT Compatible	98 ⁰⁰

★ SPECIALS ★

EVEREX MEMORY BOARDS	GOOD THRU 8-31-89
Base / Extended / Expanded 4.0 LIM Compatible	
286 AT 0-3 Meg	149 ⁰⁰ 286 AT 0-10 Meg 199 ⁰⁰
Expanded / Extended EMS 4.0 com, uses 1 Meg 120NS chips	
PS2 50/60 0-2 Meg	259 ⁰⁰ PS2 50/60 0-4 Meg 299 ⁰⁰

Liquidation Below Dealer Cost — New With Warranties

LETTER QUALITY PRINTER

DAISYWHEEL PRINTER MANUFACTURED BY C.I.TOH

Why pay \$1149 for a C.Itoh
STARWRITER™ F-10
When our 40 cps letter quality daisywheel printer from the same manufacturer is only
\$39900
ea.



100 FOR \$34900

REPEAT OF A SELLOUT

OPTIONS

• 6 ft. Serial Cable	\$ 190 ⁰⁰
• Bidirectional Tractor	149 ⁰⁰
• Cut Sheet Feeder	199 ⁰⁰
• Serial to Parallel Converter	99 ⁰⁰

STANDARD FEATURES

- 40 CPS • Accepts Paper to 15 inches • Form Length and Pitch Set from Control Panel
- Industry compatible ribbon, printheads and control commands • RS232 Serial Interface

MICROSOFT MOUSE



- In Port with Bus Interface
 - Fully IBM Compatible (of course)
 - Includes Showpartners and Paint Brush
- List \$199 Mead **\$7900** 10 for \$740

REPT MONITOR



- FREE TILT SWIVEL BASE
 - 14" Flat Screen • Paper White Phosphorus
 - TTL Monochrome & Composite Interface
- List \$199 Mead **\$9900** 10 for \$950

STATIC BUSTER

Attached to CRT face and keyboard, Static Buster works just like a sponge, dissipating static at a rated 20,000 volts in less than two seconds



List 49⁰⁰ Mead 19⁰⁰ 10 for \$160

AT STYLE / XT CASE



- 2 Bay Standard AT Style Case
 - Keypack Power and Hard Drive LED's
- List 99⁰⁰ Mead 29⁰⁰ 10 for \$240

WESTERN DIGITAL

WD1003/RAH — RLL HDC For AT 16 Bit, Full Size RLL
List 199⁰⁰ Mead 99⁰⁰

WD1005-WAH — 16 Bit ESDI Controller for AT 2 to 1 Interleave
List 269⁰⁰ Mead 99⁰⁰

PARADISE MONO EGA
Auto Switch Monochrome EGA Card, 640x350 EGA, MDA, CCA, Herc
List 319⁰⁰ Mead 129⁰⁰

CLOSEOUTS/OVERSTOCK

CS 500 Cassettes	14 ⁰⁰
Epson Universal Printer Stand	9 ⁰⁰
DC300A Used	5 ⁰⁰
SideKick Plus 1.0 by Borland	69 ⁰⁰
10Meg w/controller & cables	179 ⁰⁰
2764 Intel Eprom	2 ⁰⁰

800-654-7762

SALES: 7 a.m.-6 p.m. PST

702-294-0204

CUSTOMER SERVICE / ORDER STATUS:

8 a.m.-4 p.m. PST

FAX 702-294-1168

WE ALSO PURCHASE EXCESS INVENTORY—FAX LIST

*Best Quote applies to competitors advertised price with same terms, in this magazine



- Quantity Pricing Available — CALL
- We Accept International Orders
- Purchase Orders from Universities, Government Institutions, Fortune 1000 and Qualified Firms

NO SURCHARGE FOR MC/VISA

TERMS:

MC • VISA • COD • CASH
Purchase Orders from Qualified Firms
Personal Checks • AE add 4%

20% Restocking Fee on Non-Defective Returns within 15 days



SHIPPING: (min 6⁰⁰) UPS

1000 Nevada Hwy. • Unit 101 • Boulder City, NV 89005

Modular I/O board

Single-slot Qua Tech PXB-721 for PC-AT has 72 digital I/O lines. Connect three choices of data acquisition modules. Supports Labtech Notebook.TM

For order info, call:
1-800-553-1170



QUA TECH, INC.
478 E. Exchange Street
Akron, OH 44304

Labtech Notebook is a trademark of Laboratories Technologies Corp.

Circle 200 on Reader Service Card

Z80 HD64180 MICROPROCESSORS

C Compiler
Assembler/Linker
Remote Debug
Realtime Kernel
Emulator
PC Coprocessors
Proto Board

Integrated Software/Hardware Targeted for Z80/64180 Development on PC/XT/AT

* C Compiler-Version 2
(ask for free tech brief)

ICEPROM-In Circuit Debugger
(Cost effective alternative to ICE)

Assembler/linker (only)	\$195.00
In-circuit Emulator	\$995.00
Source/symbolic debugger	\$195.00
Standalone Proto Board (64180 μ P)	\$295.00

Z-World Engineering

1340 Covell Blvd. Suite 101
Davis, CA 95616

(916) 753-3722

fax: 753-5141



In Germany: 08131/1687

Circle 287 on Reader Service Card

2 parallel, 2 serial, 1 board

Qua Tech DSDP-402 for PC-AT has two parallel ports, and two serial ports for any combination of RS-232, 422, and 485 communication. All ports address selectable. Interrupts sharable and selectable.

For order info, call:
1-800-553-1170



QUA TECH, INC.
478 E. Exchange Street
Akron, OH 44304

Circle 201 on Reader Service Card

INTELLIGENT RS-232/422/485

On board μ P offloads tasks from Host PC/XT/AT. Ideal for complex asynchronous communications protocols.



*Baud Rates to 57,600 baud
*SBX connectors, 256K-516K RAM
*2 Serial Ports & 2 DMA channels

Z-World Engineering

1340 Covell Blvd.
Ste. 101

Davis, CA 95616

(916) 753-3722 Germany: 08131/1687



Circle 288 on Reader Service Card

New EPROM Programmer



At \$495, Wintek's Universal EPROM Programmer is a low-cost and versatile tool for programming most industry-standard EPROMs (2716-27256). Since it can operate with an IBM PC, as well as stand-alone, the Programmer is ideal for use with PC-based microcomputer development software. Credit cards are welcome.

Wintek Corporation

1801 South St., Lafayette, IN 47904
(800) 742-6809 or (317) 742-8428

Circle 279 on Reader Service Card

LOW COST INTERFACE CARDS FOR PC/XT/AT

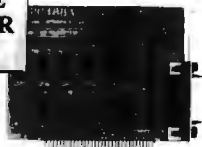

RS-485/422 Card [PC485] \$95/125

- Serial Async. Communications up to 4,000B; 2 or 4 wires; NS16450 UART;
- Can be configured as COM1-COM4; Maximum Baud Rate 56KB.
- Flexible configuration options: RTS or DTR control of transmission direction.
- Full/half duplex operation. Supports hardware handshaking (RTS,CTS).
- Dual drivers/receivers; Handles 64 devices; Compatible with most comm. swfr.
- High speed version available (supports baud rates up to 256KB) - \$165
- DB9 or phonejack. Sample communication software available - \$50/150

IEEE-488 Card [PC488A] \$145

- Includes INSTALLABLE DOS DEVICE DRIVERS and support for BASIC.
- Additional Support for ASSEMBLY, C, Pascal and FORTRAN - \$ 50.
- IRQ (1-6). DMA channel 1 or 2. Up to 4 boards per computer.
- Compatible with most IEEE-488 Software packages for IBM-PC (e.g. ASYSTANT-GPIB, Lotus Measure). Compatible with NI's GPIB-PC/IA.

IEEE-488 Card [PC488B] With Built-In Bus Analyzer \$345

- Software Support for BASICA, QuickBASIC and GWBASIC.
- Additional Libraries for C, Pascal, FORTRAN, Assembly available - \$95 (all)
- Over twenty high level IEEE-488 functions supported. Implements full range of Talker, Listener, Controller, Serial and Parallel Poll, Service Request, Pass Bus Control and Remote Programming functions.
- Powerful menu-driven BUS ANALYZER can be run in the background while 488 programs or commands are executed. Features Program Stepping, Break points, real time bus data capture (4K buffer), instant screen toggling.
- Complete Controller / Talker / Listener capability. Based on TI's TMS-9914.
- Memory-resident Printer Port Emulation Utility included. (LPT1-3).

IEEE-488 Card [PC488C] With Built-In Bus Analyzer \$445

- NEC-7210 based card (compatible with Nat. Instruments PC/IA/PC/IA)
- Supports all the features of the PC488B card. Includes the same utilities.

LOW COST DATA ACQUISITION & CONTROL CARDS FOR PC/XT/AT



12 BIT A/D/A + DIO + Counter \$295

- A/D converter: 16 single-ended channels; 12 bit resolution; Conversion time less than 30 μ sec; Built-in programmable pacer; Input range: $\pm 5V$, $\pm 1V$.
- D/A converter: 2 channels; 12 bit resolution; 0 to +5V Output Range.
- Digital I/O: 16 Input / 16 Output channels; All I/Os TTL compatible.
- Counter: 1 channel programmable interval counter/timer; Uses Intel 8253.
- Software Support: LabDAS (\$195/495), ASYST, LABTECH, UnikelScope

14 BIT A/D/A + DIO + Counter \$495

- A/D converter: 16 differential channels; 14 bit resolution; Conversion time less than 40 μ sec; Built-in programmable pacer; Input range: $\pm 5V$, $\pm 1V$.
- D/A converter: 2 channels; Resolution: 12 bits res; Settling time: μ sec; $\pm 5V$ Range.
- Digital I/O: 16 Input / 16 Output channels; All I/Os TTL compatible.
- Counter: 1 channel programmable interval counter/timer; Uses Intel 8253.
- Software: LabDAS (\$195/495), ASYST, LABTECH, UnikelScope

FAST A/D/A + DIO + Counter \$895

- A/D converter: 16 single ended or 8 differential channels; 12 bit resolution; Programmable scan rate; Built-in interrupt and DMA control circuitry. Conversion speed **60,000 samples/sec (standard)**, **100,000 samples/sec (optional)**.
- Input ranges: Bipolar $\pm 10V$, $\pm 5V$, $\pm 2.5V$, $\pm 1V$, $\pm 0.5V$; Unipolar 10.5, 2.1V.
- D/A converter: 2 channels; Resolution: 12 bits res; Settling time: μ sec; $\pm 5V$
- Digital I/O: 16 In; 16 Out; TTL compatible; All I/Os TTL compatible.
- Counter: 1 channel 16 bit programmable interval counter/timer; Uses Intel 8253. Provides pacer clock.
- Software: LabDAS (\$195/495), ASYST, LABTECH, UnikelScope

DIGITAL I/O + Counter \$160

- Input: 32 TTL compatible channels; Input load is 0.2 mA at 0.4V.
- Output: 32 TTL compatible channels; Sinks 24mA(0.5V); Sources 15mA(2.0V)
- Counter/Timer: DC to 2.6MHz; 3 channels; 16 bit counters; 6 counting modes.
- Breadboard area for prototyping.

STEPPER MOTOR CARD \$395

- Capable of independent and simultaneous control of up to 3 stepper motors.
- Speed: Programmable from 3.3 FPS to 3410 FPS; Built-in acceleration control.
- Output Mode: One clock (Pulse, Direction) or two clock (CW, CCW pulses)
- Step position Read-back; Opto-isolated output; Crystal based timing.
- Includes 8 bit digital input/output port.

MC / VISA / AMEX

Call today for datasheets!



B&C MICROSYSTEMS INC.

355 WEST OLIVE AVE., SUNNYVALE, CA 94086
TEL: (408) 738-5511 FAX: (408) 738-5521

Circle 323 on Reader Service Card



New, Gridless, 100% Autorouting Create schematics and PCBs quickly and simply with HIWIRE-Plus[®] and your IBM PC. With the new, gridless, multilayer autorouter (AR) for HIWIRE-Plus, creating printed-circuit layouts is even faster. AR and HIWIRE-Plus are each \$895 and come with 30-day money-back guarantees. Credit cards welcome.



Wintek Corporation

1801 South St., Lafayette, IN 47904
(800) 742-6809 or (317) 742-8428

Circle 278 on Reader Service Card

Quality In... Quality Out



No matter how well acquainted you are with making important personal computing decisions—decisions that may involve hundreds of thousands of dollars—the value of those decisions is only as good as the value of your information. Without quality information—it's hard to make quality decisions.

BYTEweek, McGraw-Hill's new weekly newsletter for professionals in the personal computer industry, is devoted to giving you that quality information through its timely and compact one-stop news format.

This new publication provides you with short, easy-to-read selections of the most important news and technological developments of the past week. And BYTEweek interprets this news with in-depth commentary and analysis.

Subscribe to BYTEweek for quality information. Remember, quality in...quality out.

Subscribe now and take advantage of the special one-year charter subscription rate of \$395 (\$495 outside the U.S. and Canada). This special price represents a savings of \$100 off the regular rate. Your subscription includes 50 issues plus a free three-month subscription to BIX—a \$49 value. Through BIX you can directly access the Microbytes Daily news service and communicate with other BIX users.

Don't miss this opportunity! In the U.S., call BYTEweek's toll-free number: **1-800-258-5485**, in N.H. and outside the U.S., call: 1-603-924-9281.

BYTEweek offers a *money-back guarantee* if you're not completely satisfied.

BYTEWEEK 

News and Analysis for Professionals in the Personal Computing Industry
One Phoenix Mill Lane, Peterborough, NH 03458

1.2 MB
DS/DD **59¢** IN LOTS OF 50

COLOR H.D.'s - 79¢

5.25" DD
DS/DD **25¢** IN LOTS OF 200

3.5" DS/DD... \$ 1.10

AMERICAN GROUP
800-288-8025

12132 Sherman Way
N. Hollywood CA 91604 • VISA-MC

Circle 19 on Reader Service Card

Over 120,000 sold since 1982

Never buy another ribbon !!!

\$68.50

Universal Cartridge Machine

Save thousands of dollars per year and always get a perfect printout, in black or with any of our colored inks. Universal Cartridge Machine is \$68.50. Multicolor adapters for multicolor cartridges. We support over 24,000 printer brands & have a complete range of accessories, color cartridges, OCR, heat transfer, and indelible inks. Customers vary from individuals to Fortune 500 companies. Ask for free catalog.

Computer Friends 1-800-547-3303

14250 NW Science Park Dr., Portland OR 97229
tel. (503)626-2291 • fax (503)643-5379

Circle 62 on Reader Service Card

DATA ACQUISITION

ALL needs! ANY computer!

- PC Software Included
- Serial, Modem, & Bus
- Stand Alone Ability
- Laptop & Handheld
- PC & MAC Cards
- Inexpensive
- OEM & VAR
- RTU's

MEASUREMENT TO GO

Call for **FREE DEMO DISK!**
Specialists in portable and battery backed up as well as PC compatible modular systems.

ELEXOR

Call for applications info. (201) 299-1615
P.O. Box 246; Morris Plains, NJ 07950

Circle 01 on Reader Service Card

FREE CATALOG

RS-232C INTERFACE & MONITORING EQUIPMENT CATALOG

WRITE or CALL for YOUR **FREE** COMPREHENSIVE B & B ELECTRONICS CATALOG TODAY!
Pages and pages of photographs and illustrated, descriptive text for B&B's complete line of RS-232C converters, RS-422 converters, current loop converters, adapters, break-out boxes, data switches, data splitters, short haul modems, surge protectors, and much, much more. Most products meet FCC Part 15J. Your RS-232 needs for quality, service and competitive prices will be more than met by B&B ELECTRONICS. Manufacturer to you, no middleman! Money-back guarantee! Same-day shipment! One-year warranty on products! Technical support is available.

Write For Your **FREE** Catalog Today!

B & B electronics
MANUFACTURING COMPANY
4002H Baker Road P.O. Box 1040 • Ottawa IL 61350
Phone: 815-434-0846

Order direct from manufacturer **TODAY & SAVE!**

Circle 32 on Reader Service Card

Complete Telephone Management System

TeleGenie™

Sophisticated Voice Mail and Call Processing with High Quality REAL VOICE Digital Recording for your PC, XT, AT or Compatible

CALL PROCESSING

- Unlimited Phonebook
- Database / Autodial Redial
- Search/Sort - Caller
- Computer Touch-Tone Interaction - User-Definable
- Voice Prompted Menus
- Call Forward/Call Distribution - In/Out Call
- Logging - Outbound Timed Calls • Automatic Attendant

This Unique System Also Features:

- Forward to Extensions/Beeper/Cellulars
- Individual Greetings and Passwords • Multi-User Box Capacity • Remote Touch-Tone Access
- Replay/Delete/Record/Edit

Enjoy the same benefits and features of systems costing thousands for only

\$279⁹⁵

800-637-3861
In CA 408/438-2378

Multiple Unit Discounts • Dealer Inquiries
250 Technology Circle, Scotts Valley, CA 95066

Circle 10 on Reader Service Card

MARYMAC®

13th year of Discounting Computers, FAX & Cellular Phones

Radio Shack® SCO Tandy®

We will meet or beat...
GUARANTEED LOWEST PRICES

MARYMAC INDUSTRIES INC.
22511 Katy Fwy.
Katy (Houston), TX 77450
1-713-392-0747 FAX (713) 574-4567
Toll Free 800-231-3680

Circle 155 on Reader Service Card

NEW!
Made in USA!

PC BASED UNIVERSAL DEVICE PROGRAMMER \$595-895

- Programs EEPROMs, PALs, GALs, IFLs, EPROMs, MICROS, BIPOLARS
- Software driven via drivers. D/A generated programming voltages.
- Upgradeable for virtually any future programmable devices up to 40 pins.
- Self-substant operation. No additional modules or plug-in adapters required.
- Includes user friendly MEMORY BUFFER FULL SCREEN EDITOR.
- Friendly Menu-Driven interface. Device selection by P/N and manufacturer.
- Supports 16K32 bit word. Intelligent I & II, Quick Pulse programming.
- Functional testing. Register-Preload, FUSEMAP EDITOR for logic devices.
- File formats accepted: Intel Hex, 8638, Teletext Hex, Motorola S, JEDEC.
- Customer support via voice line, dedicated BBS or fax. Full 1 year warranty.
- Base price includes Interface card, cable, Memory device library and 1 year free updates. Additional Device Libraries (Logic, Micros, Bipolar) \$95 ea.
- Libraries updates available every 6 mo and can be received via floppy or BBS.

PC BASED 8-SOCKET GANG PROGRAMMER \$595

- Handles all memory devices to 32 pins. (Upgradeable up to 8 megabit parts)
- FULL SCREEN BUFFER EDITOR plus all applicable features from above.
- Customer support via voice line, dedicated BBS or fax. Full 1 year warranty.
- Includes PC Interface card. Memory device library and 1 year free updates.

Made in USA!

UNIVERSAL RS-232 PROGRAMMER \$345-595

- Programs EEPROMs, Flash EPROMs, ZPROMs, Intel Micros, Memory Cards
- Stand-Alone Mode for EE/E-Prom and Memory Card Duplication: Verity
- All 2428/32 pin EEPROMs to 4 Mbits (upgradeable to 32 megabits)
- Micros 6741A, 2A, 4, 8, 16, 32, 64, 128, 256, 512, 1024, 2048, 4096
- Memory Cards Seiko-Epson, Fujitsu, Mitsubishi (Integrated Adapter included)
- Modular design. Firmware easily upgradeable. 4 socket Gang module available
- On-Board Programming capability. Custom interface modules available
- User friendly Menu-Driven Interface Program for IBM-PC and Macintosh
- Can be operated with any computer running an RS-232 serial port
- Optional built-in Eraser/Erase module: \$50. Top cover conductive foam pad
- OEM open board programmer configurations available (from \$285).
- Customer support via voice line, dedicated BBS or fax. Full 1 year warranty.

Made in USA!

INTELLIGENT PC ROM EMULATOR \$395

- Emulates 2716 through 27512 EPROMs (2k to 64k bytes) with a single unit.
- Connects to the standard parallel printer port. Uses standard printer cable.
- Intelligent features include: Reset Output, Address Compare, Address Snapshot, Trigger Input. Memory buffer editing capability. Selectable window sizes.
- User friendly software. Command set includes: Load, Write, Display, Run, Type, Edit, Fill, Run-Command-File, Monitor, Port, Reset, Help, Calculator.
- FAST data loading via parallel printer port (65k bytes in less than 10 seconds).
- Caseloadable up to 8 units. Includes interface cable with Trigger and Reset clips.
- CMOS version with standard 9V battery backup available (\$495). After downloading the program from the host computer, the CMOS emulator version can be disconnected and used in stand-alone mode for firmware testing.
- File formats accepted: Binary, Intel Hex, Motorola S.

MC / VISA / AMEX Call today for datasheets!

B&C MICROSYSTEMS INC.
355 WEST OLIVE AVE., SUNNYVALE, CA 94086
TEL: (408) 730-5511 FAX: (408) 730-5521

Buy with

Confidence

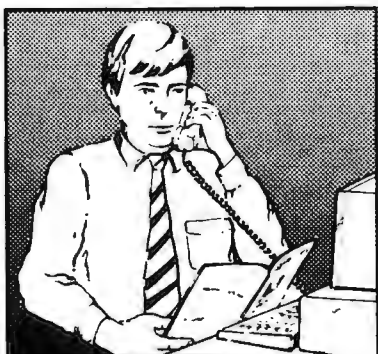

In an effort to make your telephone purchasing a more successful and pleasurable activity, The Microcomputer Marketing Council of the Direct Marketing Association, Inc. offers this advice, "A knowledgeable buyer will be a successful buyer." These are specific facts you should know about the prospective seller before placing an order:

Ask These Important Questions

- How long has the company been in business?
- Does the company offer technical assistance?
- Is there a service facility?
- Are manufacturer's warranties handled through the company?
- Does the seller have formal return and refund policies?
- Is there an additional charge for use of credit cards?
- Are credit card charges held until time of shipment?
- What are shipping costs for items ordered?

Reputable computer dealers will answer all these questions to your satisfaction. Don't settle for less when buying your computer hardware, software, peripherals and supplies.

Purchasing Guidelines

- State as completely and accurately as you can what merchandise you want including brand name, model number, catalog number.
- Establish that the item is in stock and confirm shipping date.
- Confirm that the price is as advertised.
- Obtain an order number and identification of the sales representative.
- Make a record of your order, noting exact price including shipping, date of order, promised shipping date and order number.

If you ever have a problem, remember to deal first with the seller. If you cannot resolve the problem, write to MAIL ORDER ACTION LINE, c/o DMA, 6 E. 43rd St., New York, NY 10017.

This message is brought to you by:

the MICROCOMPUTER
MARKETING COUNCIL
of the Direct Marketing
Association, Inc.
6 E. 43rd St.,
New York, NY 10017

MMC
MICROCOMPUTER
MARKETING COUNCIL
of the Direct Marketing Association, Inc.

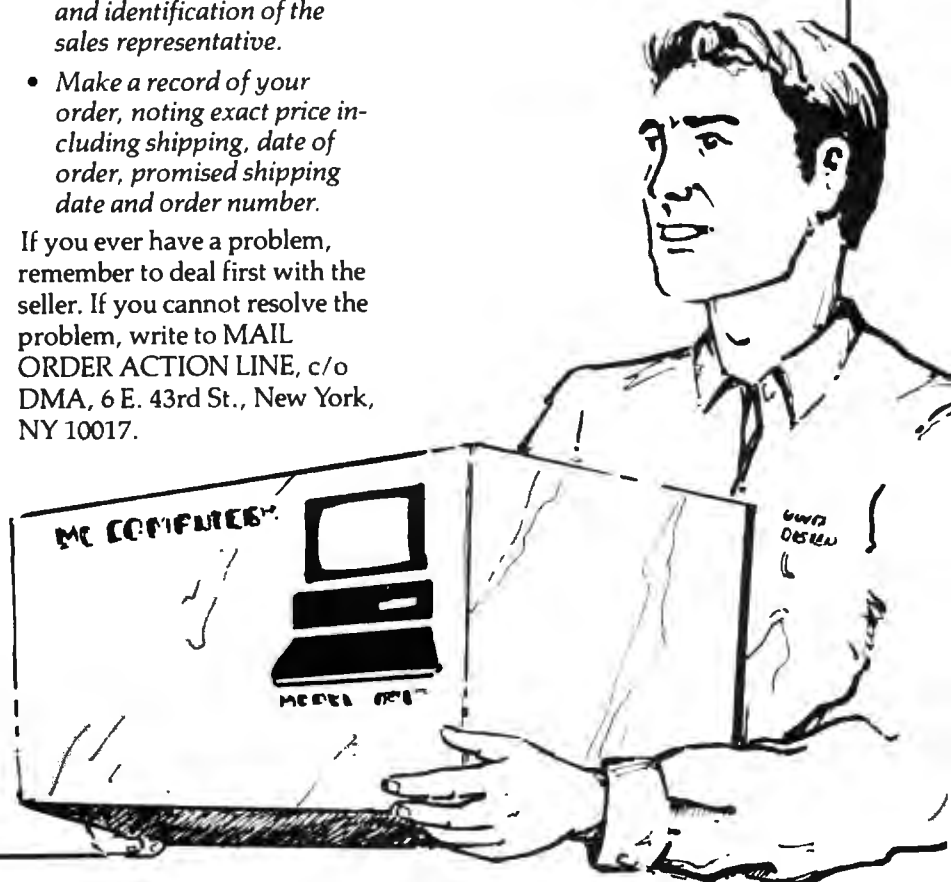

EPROM PROGRAMMER CROSS ASSEMBLERS



MODEL
SX151

RS232C OR STAND ALONE (all models). Communication protocol: XMODEM, HEX, and BIN Programs: EEPROMS, 2716 - 27512 and CMOS. Programs (w/adaptor) 25X, 27101 (and above), 68701, 68705, 68764, 6, 8741, 2, 8744, 8748/9, 8751/2, 8755, 8752, and CMOS. More available soon. Model SX151 \$214 (assembled with case). Other models are available from \$49 (kit).

Cross assemblers by PseudoCode for IBM-PCs, \$50. Z80, 1802, 6502, 68001/2/3/5/8/9/11, 68000/8/10, 8048/9, 8051/2, 8080/5, 8096, and more soon. Simulators and disassemblers also available.



KORE, Inc.

6910 Patterson S.E.
Caledonia, MI 49316
(616) 887-1444

\$5 for shipping (USA), plus \$3.00 COD.

Circle 136 on Reader Service Card

8051 68HC11

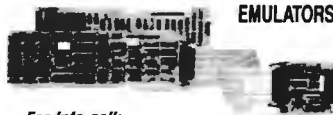

EMULATORS

For info call:

Australia	(02) 654 1873
Austria	(0222) 38 76 38
Benelux	+31 1858-16133
Denmark	(02) 85 81 11
Finland	90-452 1255
France	(01) 89 412 801
Great Britain	0962-73 3140
Israel	(03) 484832
Italy	(011) 7710010
Korea	(02) 784 7841
New Zealand	(09) 392464
Portugal	(01) 83 56 70
Scandinavia	+46 40922425
Singapore	065 743-2086
Spain	(83) 217 2340
Switzerland	(01) 740 41 05
Taiwan	(02) 7840215
West Germany	08131-1657
U.S.A. FAX	(408) 378-7869

NOHAU
CORPORATION

51 E. Campbell Ave.,
Campbell, CA 95008
(408) 868-1820

Circle 180 on Reader Service Card

9-Track Tape Subsystem for the IBM PC/XT/AT

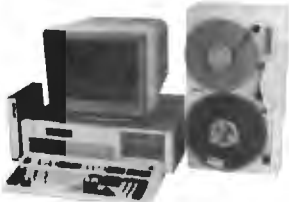

Now you can exchange data files between your IBM PC and any mainframe or mini-computer using IBM compatible 1600 or 6250 BPI 9-Track tape. System can also be used for disk backup. Transfer rate is up to 4 megabytes per minute on PCs and compatibles. Subsystems include 7" or 10 1/2" streaming tape drive, tape coupler card and DOS compatible software. For more information, call us today!

QUALSTAR

9621 Irondale Ave., Chatsworth, CA 91311
Telephone: (818) 882-5822

Circle 204 on Reader Service Card

REAL WORLD I/O For PC/XT/ATs



DG24 • 24 line digital I/O; 10 MHz 8255.	\$95
AD500 • 8 channel 12-bit (plus sign) integrating A/D; prog. gains of 1, 10 & 100; 7 digital I/O lines.	\$239
AD100 • Single channel version of AD500; 10 digital I/O lines. Same programmable gains. 700 meg input Z.	\$149
AD1000 • 8 channel 12-bit A/D. 25 uS; sample & hold: 3.5 Mhz timer/counters; 24 digital I/O lines.	\$295
ADA300 • 8 channel 8-bit 25 uS A/D; single D/A sample & hold; 24 digital I/O lines.	\$239
AD200 • 4 channel 12-bit 125 uS A/D; 3.5 Mhz timer/counters; 24 digital I/O lines.	\$239
DA600 • Fast settling dual bipolar D/A.	\$179
PD200 • Prototype board w/ address decoder; manual \$99	

All boards include BASIC, Pascal, C, and Forth drivers. 30 day return; 1 year warranty. Call for "Real World Interfacing" application notes.

Real Time Devices, Inc.

P.O. Box 906 State College, PA 16804
(814) 234-8087

Circle 216 on Reader Service Card

a complete 80386
system for only

\$1995

- 1meg ram
- 40 meg. hard drive
- TTL mono. monitor
- Parallel & Serial Ports
- Expand to 16 meg.
- 1 year warranty
- 30 day moneyback

Call for other systems and configurations at similar savings.

Scioto Computers
1-800-283-8616

Circle 229 on Reader Service Card

LOW-LOW-LOW

	Laserjet Printer Series II	\$1650
	Scanjet Scanner + interface kit	\$1355

IBM COMPAA Apple ACER
EVEREX AST & other

XT/AT Compatibles & 386 Computers
CALL for LOW PRICES

Gov't, Corporate, Schools, Dealers,
& Export INQUIRIES WELCOME.

SURAK inc.

44862 Osgood Road, FREMONT, CA 94539
PH: (415) 651-5101 FAX: (415) 651-5241
1-800-543-1001
VISA, MasterCard accepted. w/sc

Circle 242 on Reader Service Card



5 1/4 DD 6²⁵ PER BOX	5 1/4 HD 11³⁰ PER BOX
3 1/2 DS 11⁹⁵ PER BOX	3 1/2 HD 28⁹⁵ PER BOX

IBM DISKETTES

5.25 DS	6023450	— 14.60
5.25 HD	6109660	— 32.50
3.50 DS	6404107	— 23.95
3.50 HD	6404078	— 45.95
2 D-1024	1669045	— 33.95

RIBBONS

PROPRINTER	(6328829)	— 5.60
PROPRINTER XL	(1040150)	— 7.99
PROPRINTER X24	(1040475)	— 8.10
PROPRINTER XL24	(1040414)	— 11.90
PROPRINTER II	(6328829)	— 5.60
MONO PRINTER	(1040440)	— 12.95
QUIETWRITER	(1299790)	— 9.45
QUIETWRITER III	(1299933)	— 13.95
DISPLAYWRITER	(1299463)	— 8.95



3.5 DS	5 1/4 DS 6⁸⁰ PER BOX	3.5 HD
12⁷⁵ PER BOX	5 1/4 HD 10⁹⁵ PER BOX	29⁹⁵ PER BOX

the Diskette Connection™

- Delaware 1-800-451-1849
P.O. BOX 10247, WILMINGTON, DE. 19850
- Oklahoma 1-800-654-4058
P.O. BOX 1574, BETHANY, OK. 73008
- Nevada 1-800-621-6221
P.O. BOX 12396, LAS VEGAS, NV. 89112

Minimum order \$2000 No Surcharge on Visa MasterCard COD orders add \$300 Surface. Shipping UPS add \$400 per 100 for 3 1/2" or 5 1/4" add \$400 per 100 for 8" US Mail delivery add 9% Prices subject to change without Notice.

FAX (405) 495-4598

ALL NEW !!!
9 TRACK TAPE SUBSYSTEM
 for IBM PC/AT/386
 complete for only
\$2,595.00
1 YEAR WARRANTY

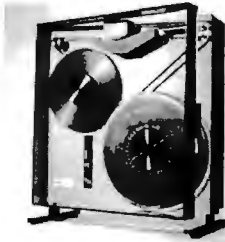

- IBM/ANSI compatible at 800*/1600/3200 bpi
- Controller, cables and software included
- Interfaces for PS/2*, Xenix* and DEC*
- SCSI*, AT or MCA* Bus I/O at 25/50/100 ips.
* optional

AKSystems Inc
 20741 Marilla St. Chatsworth CA 91311
 TEL: 818/709-8100 FAX: 818/407-5889

Circle 16 on Reader Service Card

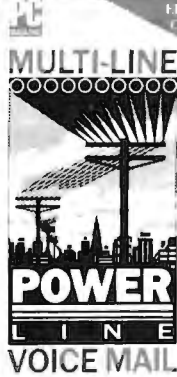

- ◆ Voice Mail System
- ◆ Call Processing
- ◆ Telemarketing
- ◆ Order Processing
- ◆ Call Distribution
- ◆ Programmers Tool Kit

Complete Systems
BIG M UTL \$295
 Starting at PLUS 6 S/H
(415) 652-9600

TALKING TECHNOLOGY, INC.
 4383 PIEDMONT AVE. OAKLAND, CA 94611

Circle 245 on Reader Service Card

SIBEC II

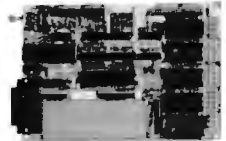

The ideal solution for embedded control applications and stand alone development.

- 8052 Basic CPU
- PROM Programmer
- iSBX* Expansion Bus
- Highest Quality
- 1 Year Warranty

\$228.00 QTY 1

Call Now! (603) 469-3232

Inquire about our 8051 product development kit for the IBM PC/XT/AT.

Binary Technology, Inc.
 Main St P O Box 67 Mendon, NH 03770
*iSBX is a trademark of Intel Corporation.

VIDEO FRAME GRABBERS



MODEL	RESOLUTION	
HRT 256-4	256 x 256 x 4	495
HRT 256-8	256 x 256 x 8	795
HRT 512-8	512 x 512 x 8	995
HRT 512-24	512 x 512 x 24	1995

- IBM PC/XT/AT COMPATIBLE
- DIGITALIZE IN REAL TIME
- COMPOSITE VIDEO IN
- 24 BIT RGB OUT except model HRT 256-4
 16 level gray scale out
- SOFTWARE LIBRARY OF IMAGE ANALYSIS ROUTINES
- FREE SOFTWARE UPGRADES TO REGISTERED OWNERS
- FULL CREDIT ON UPGRADE PURCHASE IN FIRST YEAR
 RETURN OLD BOARD AND JUST PAY DIFFERENCE

HRT HIGH RES TECHNOLOGIES
 P.O. BOX 76
 LEWISTON, N.Y. 14092
 PHONE 416-497-6493 FAX 416-497-1988

Circle 115 on Reader Service Card

TurboFlow \$69

Flowchart drawing for IBM PC/XT/AT/PS2

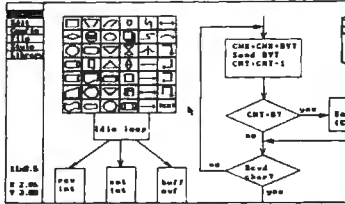

\$89 with Logitech mouse!

- Pop-up icon menus
- Variable size symbols
- Paper size to 34" x 44"
- Hercules mono, CGA, EGA
- HP-GL, DM/PL, SweetP Plotters
- Automatic PANning to scan drawing quickly
- IBM/EPSON, NEC, OKIDATA, HP LaserJet



Daytron Electronics Inc.
 610 S. sherman # 104, Richardson, Tx 75081

Add s&h (\$4 USA, \$15 foreign), Texas residents add 8% sales tax

for technical information call 214-669-2137

Order Today! 1-800-882-5822

Money-back guarantee

Circle 77 on Reader Service Card



Sure it's insured?

SAFWARE® Insurance provides full replacement of hardware, media and purchased software. As little as \$39/yr. covers:
 • Fire • Theft • Power Surges
 • Earthquake • Water Damage • Auto Accident

For information or immediate coverage call:
1-800-848-3469

In Ohio call 1-614-262-0559



SAFWARE, The Insurance Agency Inc.

Circle 222 on Reader Service Card

ON TARGET ASSOCIATES

Products and Services
 for Design and Manufacturing Engineers.

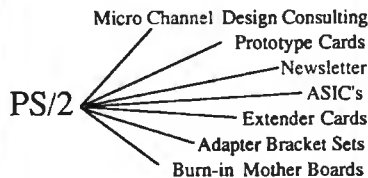

We will move your PC/XT/AT products to the Micro Channel, or create your new design.

CALL: (408) 980-7118
 for our Free catalog

ON TARGET TARGET TARGET

...the PS/2 leaders.

PS/2 and Micro Channel are trademarks of IBM Corp.

Circle 182 on Reader Service Card

Advertise your computer products through
BYTE BITS
 (2" x 3" ads)

For more information call Mark Stone at
603-924-6830

BYTE

One Phoenix Mill Lane
 Peterborough, NH 03458

Circle 48 on Reader Service Card

AMX 86

KADAK's engineers bring years of practical real-time experience to over 600 installations world wide

This real time **MULTITASKING KERNEL** simplifies real life product development

- No royalties
- IBM PC DOS® support
- C, PL/M, Pascal
- Preemptive scheduler
- Time slicing if needed
- Essential source code included
- Intertask messages
- Dynamic operations - task create/delete
- task priorities
- memory allocation
- Event Manager
- Semaphore Manager

AMX86™ v2.0 for 8086/88, 80186/88, 80286 systems

Demo package \$26 US
 Manual only \$75 US
 AMX86 system \$2195 US
 Full source Add \$895 US
 (Shipping/handling extra)
 Also available for 8088, Z80, 68000

KADAK Products Ltd.
 206 1847 W. Broadway
 Vancouver, B.C. Canada V6J 1Y5
 Tel: 604-556-70
 Fax: (604) 734-8114
 Telephone: (604) 734-2786

Circle 133 on Reader Service Card

California Digital

17700 Figueroa Street • Carson, California 90248



CD-ROM Complete Kit \$539

actor, lawyer, Indian chief... Virtually every industry and profession is disseminating information on CD-ROM. One compact disk, the same size as an audio disk, can store over 500 megabytes of data in High Sierra format.

Below is a listing of some of the CD-ROM drives currently available from California Digital. The best value is the Eclipse 430 external drive. The CDS/430 includes PC/XT interface, cables, emulator software, and MS/DOS extension. It also offers an audio input feature for multimedia presentations. The system is Manufactured in Japan by one of the Worlds largest producers of magnetic storage equipment. A super value at only \$539.

Eclipse 430 external system	\$539	NEC interface kit for above	159
chi 1503S internal system	695	Sony CD-510 internal drive only	559
chi 3500 Internal system	595	Sony 6101 external drive only	795
chi internal drive only	519	Sony 2308 interface kit	159
CDRI-77 External drive only	695	Panasonic LF5000 "write once"	1895
CDRI-80 Internal drive only	639	Panasonic interface kit for above	359

Saba Scanner \$359

The Saba Scanner inputs a printed page in less than three seconds. OCR software allows your computer to transfer printed pages into ASCII files or directly to spreadsheets and word processing programs. Archival data, legal briefs... No problem! Simply input the page into the Saba and in seconds the document is digitized into your computer and ready for editing! Also does line drawings that do not require gray tones. Limited quantities available. Original price \$1299; now only \$359.

NEC/890 Laser \$3095

PC Magazine has chosen the NEC-890 best laser printer of the year. (Jan. 12, 1988) And its obvious why the printer is Postscript, Hewlett Packard, and Apple compatible, and comes standard with three megabytes of memory. The 890 accepts data from parallel, serial and Apple-Talk devices.

Roland \$695

The DXY 980 is an eight pen, size "B" flat bed plotter. This unit is fully HP 7470/7475 compatible and accepts both parallel and serial inputs. Digital LED coordinate display, .05mm step resolution and electrostatic paper holder are only some of the outstanding features on this quality plotter.

40 Meg. Tape Back-up \$239

Crash, Power Spikes or just poor disk maintenance... don't lose data because you didn't back up. The Alloy/40 is an inexpensive way to save and restore files in the event that your data has been destroyed. A 40 megabyte half height tape back is manufactured by North America's best producer of data retrieval equipment.

You need to purchase a separate tape controller... the Alloy/40 attaches directly over your existing floppy disk controller. Supplied software allows your computer back up any time Day or Night. Come back in the morning and 40 megabytes of irreplaceable data has been stored on one Scotch DC-2000 data cassette. Pick up entire hard disk, modified files only, or by file name. Loss of data is inevitable but when you are backed up on an Alloy/40 its not a catastrophe.

SCANNERS

SABA SCANNERS		
page scanner with OCR software	1299	359
hand held scanner	799	159
OCR software for hand held		59
DEST SCANNERS		
1000 flat bed page scanner	special pricing	
2000 edge feed scanner	335	719
MICROTECHMSF300G 256 gray scales	2195	1759
DFI HandScan 300 with Halo	359	239
PRINCETON GRAPHICS LS-300	1095	789
PANASONIC		
RS505 image page scanner	1499	999
RS506 Page scanner	1999	1259
DATACOPY		
730 flat bed scanner	1800	1159
840 flat bed scanner	6800	4159
SPECIAL PRODUCTS		
XEROX Ventura PC Publisher	895	499
ALDUS PageMaker PC	795	459
COMPLETE PC FaxCard 4800	399	279
QUADRAM JT FaxCard 4800	395	259

PRINTERS

HEWLETT PACKARD		
Laser Printer II, 300x300	2595	1859
Laser Printer II/D double sided	3995	2995
QMS PS/810 2 Meg. 35 lines. Post/S.	5495	3879
APPLE Laser Writer NT	4550	3859
NEC890 Postscript, 3 meg	4975	3095
TEXAS INSTRUMENTS		
2115 Postscript 15 pgs	5995	5787
2108 Postscriptscr. par. I. & Apple	7995	4295
DATAPRODUCTS		
LZR 1260 Postscript 12 pgs	7995	5895
LZR 2600, 11 by 17, 26 pgs./min	13 500	9897
MANNESSMANN TULLY 905, HP/II	1995	1295
FUJITSU RX7100D w/ two paper bins	2550	1399

PLOTTERS

HOUSTON INSTRUMENTS		
DMP single pen, 3 ips, C&D	2995	2295
DMP 52 single pen, 16 ips, C&D	3295	2495
DMP 56C size A-E, 16 ips	5695	3095
DMP61 single pen, 32 ips, A-D	4295	3095
PC895A 4 pen, size "B" 3 ips	799	595
CALCOMP PLOTTERS		
1023 Artisan A-D, 8 pen, 30 ips	4895	3795
1043GT size A-E, 8 pen, 24 ips	7995	5495
HEWLETT PACKARD		
7475A 6 pen size "B"	1895	1495
7450A 8 pen size "B" 32 ips	3900	2995
7959A 8 pen, size A-E, 24 ips	9990	7595
HITACHI PLOTTERS		
672/XD 4 pen, size "B"	895	565
675 size "A-D" 8 pen	5600	3895
FUJITSU Imagraph, 6 pen, 11x 32	1295	895
IGLINE PLOTTERS		
LF3700 size E, 10 ips	4195	3195
LP3700HP 8 pen size "E" 10 ips	4695	3495
ROLAND PLOTTERS		
DXY980 flatbed size "B" 8 pen, 9 ips	1795	695
DPX2000 size "C" 8 pen with stand	2995	2195
DPX3000 size "D" 8 pen with stand	4995	3495
ENTER COMPUTER		
SPO300 size "B" 6 pen	995	659
SP1000 single pen size A-D	3995	2795
SP1800 8 pen, A-D, 32 ips	4695	3359
JDL 850, size "C" one meg. memory	3845	2789
VERBATEC 8524 Electrostatic	16,900	13799
5460 size "A-D"	2495	1859
5860 size "A-D"	7495	5759

MONITORS

MICROVITEC		
945CN, 20" 1freq. 31.5KHz, 1300x900	1895	659
1019, 20" autoeysc. 31 dot 1024x580	2395	1687
MITSUBISHI		
AUM 1381 13" diamond scan 800x600	889	519
HJ 6905ATK 20" multiscan	3650	2297
HITACHI		
4119 19" 1024x768, 31 dot, 48 KHz	3490	2195
4115 15" 1280x1024, 85 KHz	1990	1159
CONRAC 7250, 19" mult. 1024x1024	2995	1999
SONY MONITORS		
1303, 13" 37 dot, multiscan	625	595
1954, 19" 48 KHz	4195	2993
MEGAVOX SCHMIDT, 14" 640x480	649	459
NEC MultiSync II, 14" 800x600	949	597

DIGITIZERS

As Low As \$279

HITACHI		
HOG 1212 Puma 12x12"	595	359
HOG 1515 15x15"	969	659
Tiger 1111C, 12x12 stylus extra	727	487
HOG 3648, 36x48"	3357	3995
SUMMAGRAPHICS		
Summa 1201 plus 12x12"	599	379
TB 3648, 36x48"	4748	3729
KYE Genius Tablet w/4 but. mouse	599	279
CALCOMP		
25180, 12x18"	1275	999
91460, 36x48"	4118	3389
KURTA DIGITIZERS		
IS/ONE w/mouse & stylus	645	399
IS/THREE, 36x48"	4895	3759
HOUSTON INSTRUMENTS		
TG1011 11x11" stylus & power add.	685	519
HiPad 9012, 12x12 complete kit	495	399
HiPad 9018, 12x18 complete kit	795	599

CAD SOFTWARE

AUTODESK		
AutoCad version 10	2995	2195
AutoSketch Std. & Enhanced 2.0	99	79
VERISACAD Designer	2995	1995
GENERIC CAD Level 1	49	35
AMERICAN SM. BUS'N. Design Cad	299	179

Build Your Own Computer \$35 AT Case Only

California Digital has all the components needed to customize your own computer. Buy as much computing power as you need now, and up grade when the need arises. Here are some examples of components available.

10 MHz Mother board	589	Monochrome card, printer port	25
1024 12MHz baby AT Motherboard	229	MonoGraphics (hercules) printer port	45
all size five drive AT case	49	Color Graphics card	49
5 1/4" drive AT case	25	EGA Color Multi Resolution II	159
31/102 AT/XT German mtg. Keyboard	57	I/O card, serial & parallel	35
30 watt AT power supply	59	I/O PLUS, Ser/Par I. clock, game	59
386/KB/Byte disk drive	59	Disk I/O, disk control, clock, game	59

EGA Color Monitor \$219

Ideal for CAD/CAM and Desk Top publishing applications. The Roland CD/240 color monitor has a resolution of 720 pixels by 400/480 lines on a .31mm dot pitch 12" non-glare screen. VGA specifications in text mode. EGA in graphic mode. California Digital has made a special purchase and is able to offer the CD/240 EGA/VGA RGB color monitor for only \$219. Full featured, 132 column, multi-resolution video color adapter card available for only \$139 additional. Comparable card package would retail for \$1095.

40 Megabyte Hard Disk Kit \$397

Forty megabyte internal hard disk drive, controller and cables all for only \$397. The kit includes the a 40 millisecond Miniscribe 9650 drive and a half slot Western Digital controller.

One Two Ten

TEC501 1/2 height sgl. side	39	29	25
TEC504 1/2 ht. double sided	59	55	49
TANDON 101/4 full ht. 96 TPI.	89	89	79
TEAC FD55BR half height	89	85	79
TEAC FD55FR 96 TPI, half ht.	119	109	105
TEAC FD55GFR for IBM AT	109	105	99
PANASONIC 455 Half Height	89	85	79
PANASONIC 475 1.2 Meg./AT	99	95	89
Dual enclosure for 5 1/4" drives			69

Amstrad \$1379 \$695

Two 720K/byte 3 1/4" drives • Super twist LCD display
 640 K/byte DRAM memory • 18 color RGB/CGA output
 2400 baud internal modem • Full feature 101 keyboard

Take it to school, court, news events or anywhere that you require "computing power" on the go. Built in 2400 lbs Hayes compatible modem allows you to transfer data files with your home office or any World wide data base.

A little to large to be called a laptop but the Amstrad 640 is a true battery operated IBM compatible portable. (17.5 by 9" footprint).

Five Inch Winchester Disk Drives

Price does not include controller.

SEAGATE 225 20 Meg. 1/2 Ht. 239	229
SEAGATE 238 30 Meg. RLL	259
SEAGATE 251/151 M. 28ms.	459
SEAGATE 4096 96 M. 35ms.	559
MINISCRIBE 8425 25 M. 65ms.	239
MINISCRIBE 3650 50M 61 ms.	319
MINISCRIBE 6085 90 meg.	459
MINISCRIBE 3053 25 ms. 1/2 ht.	359
FUJITSU 2242 55 M. 35ms.	1299
FUJITSU 2243 86 M. 35ms.	1695
RODIME RO-204E 53 Meg.	895
MAXTOR XT1140 140 Meg.	1495
MAXTOR XT2190 192 Meg.	1919
TOSHIBA MK56 70 M. 30ms.	1289
CONTROL DATA WREN "V" call	

3 1/2" DISK DRIVES

SONY MP-73W, 1.44 Meg.	139	135	call
TEAC 235HF 1.44 Meg.	99	89	78
5 1/4" form factor kit			20

8" DISK DRIVES

QUME 842 double sided	189	179	175
QUME 841 single sided	99	89	79
SHUGART 851 Rbl. sided	319	309	299
REMEX RFD4000 dbl. sided	189	179	165

Winchester Controllers for IBM/PC

XEBEC 1220 with floppy controller	159
DTC 5150XC	119
OMTI 5527 RLL controller	99
ADAPTEC 2070 RLL controller	99
ADAPTEC 2372A 1/1 internal	159
WESTERN DIGITAL WD/1002WX2	89
WESTERN DIGITAL 1003WAH or WA2	139
WESTERN DIGITAL 1007/WA2	239

SCSI/SASI Winchester Controllers

XEBEC 1410A 5 1/4" foot print	239
WESTERN DIGITAL 1002-05E 5 1/4"	229
OMTI 20L	89

Winchester Accessories

Qual floppy enc. and power supply	59
Winchester enclosure and supply	139
Switching power supply	49

Every year since 1973, customers from virtually every nation in the World have chosen California Digital for their data processing requirements. If **its computer, California Digital has it...** complete minisystem or just one microchip. California Digital offers over 10,000 unique computer products. Regardless of how specialized your data processing requirements... California Digital is your one stop shopping solution.

TECHNICAL & CALIFORNIA (213) 217-0500
 TOLL FREE ORDER LINE
(800) 421-5041
 Telefax • (213) 217-1951

DEVICE PROGRAMMER \$550 \$750



1 Megabit of DRAM, User upgradable to 32 Megabit 4x20 LCD Display, 3.6 Zif socket, RS232, PARALLEL in and out 20 Key tactile keypad (not membrane), 32K internal EEPROM (easy firmware upgrades) QUICK PULSE ALGORITHM (27256 in 5 sec. 1 Megabit in 17 sec.) Completely stand alone, 10 day money back guarantee 2 year warranty, made in U.S.A. Technical support by phone, Complete manual and schematic.

NEEDHAM'S ELECTRONICS
4539 Orange Grove Ave., Sacramento, CA 95841
Call for more information
Phone (916) 924-8037 FAX (916) 972-9960
VISA/MC

Circle 177 on Reader Service Card

Super 386/25MHz \$3380

- Landmark 433.62 MIPS
- High Speed 0 wait 64 cache
- Genuine 32 bit Intel 386-25 CPU
- 1 MB RAM upgradable to 8MB or more dual SIMM 32 or expansion (16MB)
- Fast 42MB Drive 1.2 MB FDD
- Ultra High Speed HandPony controller
- High Res Amber Monitor
- 101 Backlit KB & Parallel port
- 1-32 6-16 and 1-8 bit sockets
- 80087 support USA MADE Vertical Case also available

286	Full Line of Exotic Products	
1800	8 MHz SDR 1 MB Cache	\$800
1200A	16MHz SDR 1 MB Cache	\$950
1700C	133MHz 1M 1 2M Cache	\$1795
386		
3000A	16MHz 1M 1 2M Cache	\$1980
3000C	20MHz 1M 1 2M Cache	\$2075

Schwab System 212 (2 1/2 MB 80087)

- Small format
- 512K RAM expandable to 1 MB
- 1.2 MB cassette drive
- HD/D controller
- 101 keyboard
- Mouse option

COMPLETE SYSTEM \$850

Schwab Computer Center
The Essex Store - Authorized Exotic Comp. VAR
2200 St. Charles Road, Santa Clara, CA 95050
408-241-0700 FAX 408-241-0701
M-F 9:30-11:50 11-4
Prices change without notice

Daily UPS VISA/MC

Circle 225 on Reader Service Card

A Real Breakthrough—No Bull!

20 MB HARD DRIVE \$89

Turn your 10 MB Hard Drive into a real 20 MB Hard Drive!

Our easy to use software is not a file compression program and it's not memory resident!

Use it once. It actually changes the physical characteristics of your 10 MB Hard Drive and makes it a permanent 20 MB Hard Drive. Your programs will work normally. No new hardware required.

It's true—Money Back Guarantee!
Order CONVERT® today!
We pay S & H. Mail \$89 to:

SWIRL-SOFT®

3240 Dueber Ave. S.W. Canton, OH 44706

Circle 243 on Reader Service Card

ULTIBOARD COMPUTER AIDED PCB DESIGN

The ULTiboard PCB layout package featuring:

- Full SMT support
- 32 layer support with blind and buried vias
- Curved traces
- Real-Time Design Rule Check
- Powerful placement aids
- Trace Shove and Reroute-While-Move
- Autoroute by window, component, or net
- Backannotation to OrCAD, DASH, Schema, ViewLogic

ULTIMATE TECHNOLOGIES
155A Cambridge, Massachusetts, U.S.A. • Tel: (617) 243-1270 • Fax: (617) 243-1271
Rampart, Massachusetts • Tel: (413) 238-4430 • Fax: (413) 238-4431

ASK FOR YOUR FREE DEMO DISK

Circle 262 on Reader Service Card

HEAVY DUTY PC HARD CASES

MC & VISA	AIR FREIGHT HARD CASE	HEAVY DUTY HARD CASE	LT HARD CASE
EPSON EQUITY II CPU & KB	\$226	\$149	\$129
COMPAQ PORTABLE II	\$204	\$143	\$120
IBM AT CPU & KB	\$254	\$173	\$148
IBM MONITOR #5154001	\$226	\$154	\$129

HEAVY DUTY FOAM LINED CASES WITH COMPARTMENTS FOR KEYBOARD & MOUSE

CASES ARE AVAILABLE FOR ANY COMPUTER. ALSO CUSTOM CASES

1-800-882-7112 In MI 616-374-7105
WESTERN CONTAINER & CASE
Box 125, Woodland, MI 48897

Circle 274 on Reader Service Card

IN STOCK! SIMMS

1 MEG x 9 100 NS

BEST PRICES ANYWHERE!

Major electronics mfg. 17 yrs. industry exper. will sell 1 or 1,000.

XENTEK SIMMS MART

800-748-5505 VISA

Circle 283 on Reader Service Card

OVER STOCK!! High Density Dynamic SIM/SIP Modules

Price List

DRAM SIM/SIP—Standard—Modules

Package	Organization	Unit Price
Apple	(1 Mega Bit (DIP) x 8)	175
Apple	(1 Mega Bit (DIP) x 8)	178
IBM	(1 Mega Bit (SOJ) x 8)	180
IBM	(1 Mega Bit (SOJ) x 8)	180
IBM	(1 Mega Bit (SOJ) x 9)	180
IBM	(1 Mega Bit (SOJ) x 9)	195
IBM	(1 Mega Bit (SOJ) x 18)	325
IBM	(1 Mega Bit (SOJ) x 8)	183
IBM	(1 Mega Bit (SOJ) x 8)	188
IBM	(1 Mega Bit (SOJ) x 9)	199
IBM	(1 Mega Bit (SOJ) x 9)	203
IBM	(1 Mega Bit (SOJ) x 18)	330

TermoTrol Corp.
Subject to prior sale.
Call 1-800-345-4184 or 213-284-3242
order by phone MC Visa Amex or C.O.D.

Circle 248 on Reader Service Card

FREE INFORMATION DRAM • SIMMS MATH CO-PROCESSORS

TOLL FREE 24 HRS. 7 DAYS A WEEK

1-800-338-1531

NEW! DEDICATED TOLL FREE FACSIMILE LINE 24 HRS.—7 DAYS A WEEK

1-800-242-5751

DIRECT LINE MON-FRI 9-6 C.S.T.

1-402-691-8248

Best Prices in U.S.A.

McDonald and Associates
WHOLESALE DISTRIBUTOR
THE CHOICE OF INDUSTRY PROFESSIONALS

Circle 159 on Reader Service Card

Memories for all COMPAQ Deskpro's 386/x

HANTZ & PARTNER offers all memory expansions for the COMPAQ DESKPRO 386/20/25/30 Computers that are fully compatible with and are a direct substitute for add-on memory made by COMPAQ. The modules and boards are available with 1 + 4 MB.

PRODUCTS: Memory-Modules with 1 or 4 MB for the COMPAQ Deskpro's 386/20/25/20e/s + 286e.

Memory-Boards with 1 or 4 MB for the COMPAQ Deskpro's 386/20e and 386/s

All modules and Boards are 100% compatible in size, shape and performance. We guarantee most competitive prices! Sample orders are possible with Am. Express, MasterCard, Visa and Diners without surcharge. Just call!

Dealers and distributors wanted!!!

HANTZ & PARTNER
Herdweg 8 • D-7803 Gundelfingen
Germany Tel: (49) 761-581344
Fax: (49) 761-581354

Circle 109 on Reader Service Card

ACP Selected Top 10 Mail Order

Call ACP toll-free 1-800-FONE-ACP • 1-800-366-3227



LOW COST IBM/COMP BOARDS

- ACP Advanced Cards/IBM
- ACP Mono/Color w/print port 49.
- ACP Mono w/color emulation 59.
- ACP SuperEGA/480 169.
- ACP VGA/256 199.
- ACP SuperVGA/1024 x 768 249.
- DFI Multi I/O 25.p.g.cik/XT 139.
- ACP Six-Pak compatible/XT,OK 89.
- ACP 286 Accelerator/XT 249.
- ACP Multi I/O w/floppy contr./XT 59.
- ACP Dual Floppy controller/XT 29.
- ACP Serial I/O card/XT 29.
- ACP Parallel I/O card/XT&AT 29.
- ACP Serial I/O card/AT 39.
- ACP Game adapter port/XT&AT 29.
- ACP EPROM programmer/4ports/149.
- ACP 1.44Mb Floppy controller 79.
- ACP AT Prototype card 25.
- DFI 3.0Mb Multi I/O/10MHz/AT 129.
- DFI 4.0Mb Megalithi/EEMS/4.0VAT 199.
- DFI SuperMulti I/O/W/10MHz/AT 89.
- DFI Megabit 2Mb w/serial/1Mb 3DRAM 99.
- DFI Neo20 Ethernet/Novell/adv 169.
- DFI Rambank 2/PS2 50.00 149.

Advanced PC Keyboards

- 5160 84key XT/AT switchable 59
- 5161 101key XT/AT switchable 79.
- KEYTRONICS**
- KB85151 Deluxe IBM w/99 keys 139.
- KB101 101 key/AT 110.
- MB101 101 key/XT,AT,PS2 79.
- LOGITECH**
- Serial Mouse PC/XT/AT 79.
- Serial Mouse PC/XT/AT 75.
- Serial Mouse PS/2 75.
- MICROSOFT**
- Bus Mouse w/PC Paintbrush 99.
- Serial Mouse w/PC Paintbrush 99.
- Serial PS/2 w/PC Paintbrush 99.

the Complete PC Half Page Scanner

Scans a 4" width with 300dpi resolution, includes the powerful SmartScan editing software and it's now available from ACP for under \$200.

Advanced 386 Clones save\$

- Advanced386/16 bare bones 995.
- Advanced386/16 base system 1795.
- Advanced 286 Clones save\$**
- Advanced 286/12 bare bones 399.
- Advanced 286/12 base system 849.
- Advanced 286/16 base system 1049.
- Advanced XT Clones save\$**
- Advanced XT bare bones 179.
- Advanced XT base system 588.
- call for options & details...
- AST Research**
- Premium286 Model 80 1495.
- Premium BRAVO call.
- Premium386 Model 340 3299.
- call for all AST models...

Advanced SWITCH BOXES

- ACP 2-position AB 3636 27.
- ACP 2-position AB 2525 24.
- ACP parallel/serial converter 69.
- ACP serial/parallel converter 69.
- Buffalo SX PC share (up to 7) 499.
- Logical Connection 256K 439.

MOTHERBOARDS

- XT Turbo w/BIOS/8MHz 89.
- XT Turbo w/BIOS/10MHz 99.
- AT 286 w/BIOS/12MHz/XT size 279.
- AT 286 w/BIOS/16MHz 449.
- AT 386 w/BIOS/20MHz 799.

CHIPS - SIMM MODULES

- 256K 120ns 7. 256K 100ns 8.
- 1Mb 120ns 20. 1Mb 100ns 21.
- 1Mb 80ns 23. 1Mb 70ns 25.
- 256x9 120ns 79. 256x9 90ns 99.
- 256x9 100ns 89. 64Kx1 2.
- 1Mbx9 SIMM Module 120ns 225.
- 1Mbx9 SIMM Module 100ns 245.
- 1Mbx9 SIMM Module 80ns 265.

PLUS Development

- Plus20 Hardcard, 20Mb, 49ms. 529.
- Plus40 Hardcard, 40Mb, 39ms. 669.
- Passport 20 429.

PANASONIC

- 1080/1190 189/250.
- 1092/1592 325/405.
- 1524/1124 549/349.
- Panasonic 4450 Laser 1419.

HYUNDAI

- Yundai286/Turbo16T1 call.
- Neec 286/Prospect 386 call.
- Ultraite 2000w 1199.

TRIPLETE

- Isobar4 surge supp w/4 outlets 53.
- Isobar6 surge supp w/8 outlets 69.
- Line Conditioner w/4 outlets 149.
- Backup Power Supply, 450w 299.
- Backup Power Supply, 750w 499.
- Backup Power Supply, 1200w 649.
- Backup Power Supply, 2000w 1199.

ACP has Top line of CHIPS!

- COPROCESSOR/CHIPS-INTEL**
- 8087 87. 80287 8 225.
- 8087-1 196. 80287-10 266.
- 8087-2 142. 80387-16 395.
- 8087-6 185.
- 80387-20 475.
- Wietek call 80387-SX 395.

SEAGATE

- 20Mb ST225(65ms) HH,MFM 239.
- 30Mb ST238R(65ms) RLL,HH 269.
- 40Mb ST251(40ms) MFM,HH 399.
- 40Mb ST251(40ms) RLL,HH 436.
- 60Mb ST277R(120ms) RLL,HH 469.
- 40Mb ST4053(28ms) MFM,FH 519.
- 80Mb ST4096(28ms) MFM,FH 669.
- 20Mb ST125.3 5(40ms) MFM 286.
- 30Mb ST139.3 5(40ms) MFM 369.

WESTERN DIGITAL

- Filecard PS30 PS2 model 30 399.
- Filecard30 399.
- 1006V-MM1 16bit MFM 1:1 149.
- 1003V-SR1 LLL 3:1 157.
- 1006V-MM2 F/H MFM 1:1 199.
- 1002-27X 8bit RLL/XT 98.
- WX1 Controller MFM/XT 89.
- WD286-WDM20, AT/286 MB call.

STAR

- NX 1000, 80 col, 9 pin 199.
- NX 1000, Rainbow, 80 col, 269.
- NX 2400, 80 col, 24 pin 299.

SHARP

- PC7241 Portable 286, 40Mb 1799.

ALDUS

- Pagemaker/IBM 478.
- ALPHA SOFTWARE**
- Alpha/386 II 149.

Laptops for less

Why ACP sells more...TOSHIBA

- Pricing • Service • Availability
- ACP won't be undersold for Toshiba laptops & printers.

TAPE BACKUP/VIDEO

- ALPHAMICRO**
- VCR Videotax tape backup card 269.
- VCR Videotax tape backup PS2 349.
- IOMEGA**
- Bernoulli 8120X 5 1/4" internal 993.
- Bernoulli B220X 5 1/4" ext 1599.
- Bernoulli 20x20 ext 1649.
- Tri-pak 20Mb cartridge, 5 1/4" 189.
- Tri-pak 20Mb cartridge, 8" 239.
- PC50 Adapter card 149.
- PC3B/50 Adapter card 249.
- IRWIN**
- 2020 20Mb backup(internal) 325.
- 2040 20Mb backup(internal) 425.
- 445A 40Mb backup(external) 499.
- TALLGRASS Technologies**
- 1040i 40Mb backup(internal) 338.
- 1040e 40Mb backup(external) 549.
- CITIZEN**
- 120D 149. 180D 189.
- MSP40 299. MSP55 578.
- DICONICS/KODAK**
- 150PUS/300P call/499.
- EPSON**
- DFX5000 call. LQ510 295.
- LX800 189. LQ850 525.
- FX850 349. LQ1050 735.
- FX1050 449. LQ950 595.
- EX800 399. LQ2550 925.
- Advanced Computer Products ...your full line Epson dealer
- HEWLETT PACKARD Jetset/1c**
- 25 in 1 cartridge (comp.) 345.
- Spreadsheet cartridge (comp) 165.
- Z cartridge (compatible) 119.
- Jetware 1Mb upgrade memory call.
- IBM PRINTERS**
- Proprieter II, 240cps 419.
- Proprieter X24, 240cps 24pin 599.
- Proprieter XL24, 240cps 24pin 799.
- NEC**
- PL1200, 24pin(360x360dpi) 379.
- PS200/S300 569/719.
- LC890 Silentwriter 3395.
- OKIDATA**
- ML350/391 489/659.
- ML393/393C 965/1095.

MODEMS/COMMUNICATIONS

- Advanced MODEMS**
- 1200baud w/software(int) 49.
- 1200baud w/software(ext) 87.
- 2400baud w/software(int) 96.
- 2400baud w/software(ext) 139.
- COMPLETE PC**
- CFAX 4800 PC fax board 288.
- CFAX 9600 PC fax board 449.
- Hand Scan 400
- 200,300,400dpi resolution 178.
- HalfPage Scanner 188.
- FullPage Scanner 548.
- Complete Answering Machine 247.
- HAYES**
- 1200/2400 (internal) 269/378.
- Smartmodem 2400 (external) 423.
- INTEL**
- Connection Coprocessor 699.
- optional 2400baud Modem 219.
- 2400B Modem2, 50z,60,70,8 319.
- 2400B Classic Modem2 269.
- MIGENT**
- Pocket MODEM 1200 call/79.
- PRACTICAL PERIPHERALS**
- 1200/2400 (internal) 64/149.
- 1200/2400 (external) 79/178.
- PROMETHEUS**
- 2400C (external) 188.
- 1200B/2400B (internal) 69/149.
- MONITORS/PERIPHERALS**
- AMDEK**
- 410A/1280 149/699.
- IBM MONITORS**
- 8503/8512 199/499.
- 8513/8514 549/1195.
- NEC**
- Multisync II/Multisync Plus 595/687.
- Multisync 2A/Multisync 3U 499/720.
- Multisync XL 20"(1024x768) 2099.
- Monograph sys (1024x1024) 1499.
- SAMSUNG-MTEC**
- 1256A 12" amber TTL mono 88.
- 1457A14" amber flat screen 128.
- 1457W14" white flat screen 135.
- 1464K 14" CGA/RGB Color 248.
- 1453 14" EGA Color 375.
- 1453Q 14" VGA Color 375.
- 1455 14" Multisync Color 439.
- 5671 15" Fullpig white w/card 699.
- WYSE**
- WY30/WY50 14" terminal 329/399.
- WY60/WY150 419/419.

3COM

- Etherlink card 418.

WESTERN DIGITAL

- StarLANPLUS
- kit w/sw(3 users) 877.
- (network for less than \$300/node)
- ViaNet LAN software 85.
- Starhub 329.
- Ethercard PLUS 249.
- Ethercard PLUS TP (twisted pairs) 319.
- Ethercard PLUS/ISA (microchannel) 319.
- PLOTTERS**
- HOUSTON INSTRUMENTS**
- DMPS2/52MP call.
- SCANGAD call.
- DMPS6A/61/82 call.
- CALCOMP**
- 1023 3835. 1042 7535.
- 1042 6475. 1044 9910.
- KURTA**
- 1212 IS1 349. 12x17 499.
- 36x48 2688. 4 bitn cursr 74.
- SUMMASETCH**
- 12x12 375. 12x18 629.
- INKJETTER/ACCESSORIES**
- POLAROID**
- 5 1/4" DSHD 7. 5 1/4" DSHD 13. 3 1/2" DSHD 15.
- 3 1/2" DSHDHD 39.
- 3M 5 1/4" DSHD 8.
- 5 1/4" DSHD 14. 3 1/2" DSHD 15.
- 3 1/2" DSHDHD 39.
- BULK**
- 5 1/4" DSHD box of 100 35.
- 5 1/4" DSHD box of 100 59.
- Advanced PRINTER BUFFERS
- ACP 258K parallel buffer 196.
- LOTUS**
- Graphwriter II call.
- Lotus 123 call.
- Manuscript call.
- MICROPRO**
- Wordstar Professional Rel 5 229.
- Wordstar 2000 Rel 3 199.
- MICROSOFT**
- Windows 286/386 64/124.
- Word v4.0 209.
- Excel 224.
- MORTON**
- Utilities 51.
- Commander 46.
- Advanced Utilities 75.
- SOFTWARE PUBLISHING**
- First Choice/First Publisher 91/74.
- HARVARD GRAPHICS 272.
- SYMANTEC D & A** 212.
- TRAVELING SOFTWARE**
- Laplink Plus 79.
- XEROX** Ventura 499.
- WORDPERFECT**
- WordPerfect v5.0 224.
- WordPerfect Library 65.
- ...if you don't see it, call us!

WESTERN DIGITAL

Everything you'd ever want in a motherboard...

- 12.5 MHz 80286 • Expandable to 4 Mb
- EGA on board • IBM PS/2 286 compatible

Call ACP for case power supply and your custom configurations.

Advanced Computer Products, inc.

1310 E. Edinger, Santa Ana, CA 92705 • FAX 714-558-1603 • Customer Service 714-558-1356 • Sales 714-558-8813

We accept MC/VISA/AMEX. No surcharge for credit card orders. Your card not charged until we ship. 100% guarantee, defective software replaced immediately, defective hardware repaired or replaced at our discretion. Items subject to availability. Prices subject to change without notice. Shipping \$3.00 per order 1st 10 lbs. UPS Ground. Federal Express next day available.

POWER SUPPLIES



135 WATT POWER SUPPLY
 • UL APPROVED
 • +5V @ 15A, +12V @ 4.2A,
 • -5V @ 5A, -12V @ 5A
PS-135 \$59.95
PS-150 150W SUPPLY \$69.95



200 WATT POWER SUPPLY
 • UL APPROVED
 • +5V @ 20A, +12V @ 7A,
 • -5V @ 5A, -12V @ 5A
PS-200 \$89.95



APPLE TYPE SUPPLY
 • WITH APPLE CONNECTOR
 • +5V @ 6A, +12V @ 3A,
 • -5V @ 1A, -12V @ 1A
PS-A \$59.95



36 WATT POWER SUPPLY
 • +5V @ 2.5A, +12V @ 1.5A
 • 3 PIN INPUT, 6 PIN OUTPUT
 • SELECTABLE 110V-220V
PS-3045 \$12.95



SOLDER STATIONS

SOLDER/DESOLDER STATION

• OIL-FREE VACUUM PUMP
 • TEMP ADJUSTS (212° F-900° F)
 & VACUUM (0-80 CM/HG)
 • WITH GUN-REST, COOLING TRAY,
 WIRE BRUSH & TIP CLEANER ROD
XY99SD \$399.95
XY99D DESOLDER ONLY \$349.99



DELUXE SOLDER STATION

• ROTARY SWITCH TEMP CONTROL (200° F-878° F RANGE)
 • LED TEMPERATURE READOUTS
 • INCLUDES COOLING TRAY
XY9-60L \$79.95



SOLDER STATION

• UL APPROVED
 • HEAT SETTING ADJUSTS
 • TIP TEMPERATURE READOUT
 • REPLACEMENT TIPS @ \$2.95
168-3C \$59.95

WIREWRAP PROTOTYPE CARDS

FR-4 EPOXY GLASS LAMINATE WITH GOLD PLATED
 EDGE CARD FINGERS AND SILK SCREENED LEGENDS



FOR XT
JDR-PR1 WITH +5V AND GROUND PLANE **\$27.95**
JDR-PR2 ABOVE WITH I/O DECODING LAYOUT **\$29.95**
JDR-PR2PK PARTS KIT FOR JDR-PR2 ABOVE **\$8.95**
FOR AT
JDR-PR10 16 BIT WITH I/O DECODING LAYOUT **\$34.95**
JDR-PR10PK PARTS KIT FOR JDR-PR10 ABOVE **\$12.95**
FOR PS/2
JDR-PR32 32 BIT PROTOTYPE CARD **\$69.95**
JDR-PR16 16 BIT WITH I/O DECODING LAYOUT **\$49.95**
JDR-PR16PK PARTS KIT FOR JDR-PR16 ABOVE **\$15.95**
JDR-PR16V 16 BIT FOR VIDEO APPLICATIONS **\$39.95**

DATA SWITCH BOXES

TYPE	# OF POS	PARALL	SERIAL	PRICE
PUSHBTIN	2-WAY	AB-P	AB-S	39.95
ROTARY	2-WAY	RSP-2	RSS-2	24.95
ROTARY	3-WAY	RSP-3	RSS-3	27.95
ROTARY	4-WAY	RSP-4	RSS-4	29.95

EXTENDER CARDS

FOR PROTOTYPE DEBUGGING,
 TESTING AND TROUBLESHOOTING

EXT-8088 XT COMPATIBLE **\$29.95**
EXT-80286 AT COMPATIBLE **\$39.95**
EXT-16 MICROCHANNEL 16-BIT **\$69.95**
EXT-32 MICROCHANNEL 32-BIT **\$99.95**



MOLDED COMPUTER CABLES

GOLD-PLATED CONTACTS; 100% SHIELDED

CBL-PRINTER PC PRINTER CABLE **9.95**
CBL-PRINTER-25 AS ABOVE-25 FT **15.95**
CBL-PRINTER-RA RT ANGL PRINTER **15.95**
CBL-DB25-MM DB25 MALE-MALE **9.95**
CBL-DB25-MF DB25 MALE-FEMALE **9.95**
CBL-Q-SERIAL 9 PIN-25 PIN SERIAL **6.95**
CBL-KBD-EXT KEYBOARD EXTEN **7.95**
CBL-CNT-MM 36 PIN CENTRON-MM **14.95**
CBL-HD-20 20 PIN HARD DISK **2.95**
CBL-HD-34D 34 PIN DUAL HARD DISK **4.95**
CBL-FDC-EXT 37 PIN EXT FLOPPY **9.95**
CBL-MNT-9 9 PIN MONITOR EXTEN. **6.95**
CBL-MODEM DB25-DB25 FEMALE **6.95**

RS-232

BREAKOUT BOX

FOR TROUBLESHOOTING
 SERIAL COMMUNICATIONS

• OPEN/CLOSE INDIVIDUAL
 CIRCUITS • 20 JUMPERS
 CROSS-CONNECT ANY TWO
 CIRCUITS • 10 CIRCUIT
 ACTIVITY LEDS
GENDER-BO \$34.95



NEW LOW PRICES! SOLDERLESS BREADBOARDS

PDS-100 1360 TIE PTS **\$12.95**
PDS-200 1660 TIE PTS **\$19.95**
PDS-300 2390 TIE PTS **\$24.95**
PDS-400 3220 TIE PTS **\$34.95**



PC BREADBOARD

• 62 CLEARLY LABELLED BUS LINES
 • ACCEPTS UP TO 24 14-PIN ICs
 • 1940 TIE POINTS
 • EXT FEMALE DB25 D-SUB CONNECT
PDS-604 \$49.95

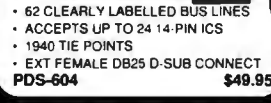

GENDER CHANGERS

GENDER-FF FEMALE-FEMALE **\$7.95**
GENDER-MM MALE-MALE **\$7.95**
GENDER-MF MALE-FEMALE **\$7.95**
GENDER-NM NULL MODEM **\$8.95**
GENDER-JB JUMPER BOX **\$8.95**
GENDER-MT MINITESTER **\$14.95**
GENDER-VGA DB9-DB15 **\$19.95**
GENDER-Q-25 DB9-DB25 **\$4.95**



SURGE SUPPRESSOR

PROTECTS YOUR EQUIPMENT!

• SIX 3-PRONG AC OUTLETS
 • 15 AMP CIRCUIT BREAKER
 • 6' HEAVY DUTY CORD
 • 15 AMP MAX LOAD, 1875 WATTS
 • UL APPROVED
POWER-SURGE \$12.95
POWER-STRIP W/O SURGE \$9.95

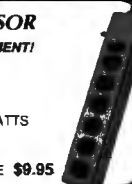

LITHIUM BATTERY

• 6V FOR 286 AND 386 PCS
 • MOTHERBOARD CONNECTOR
 • ADHESIVE VELCRO MOUNTING
 STRIP
LITHIUM 6.8V \$11.95



COIN TYPE BATTERY
 LONG-LASTING 3V LITHIUM
LITHIUM-3V \$1.95
3V-MHW \$1.49



APPLE-COMPATIBLE PRODUCTS

FLOPPY DRIVE FOR APPLE II SERIES
AP-150 (W/CABLE, CONNECTOR) **\$99.95**
REPLACEMENT KEYBOARD FOR APPLE II & II+
KEYBOARD-AP \$59.95
EPROM PROGRAMMER, NOT REC. FOR CMOS.
RP-S25 (NO POWER SUPPLY REQ) **\$89.95**
16K RAM CARD BOOSTS 48K APPLE TO 64K
RAM-CARD (2 YEAR WARRANTY) **\$39.95**

"SNAPABLE" HEADERS

SNAP APART TO MAKE ANY SIZE
 HEADER, WITH .1" CENTERS

1 x 40 STRAIGHT LEAD **.99**
1 x 40 RIGHT ANGLE LEAD **\$1.49**
2 x 40 STRAIGHT LEAD **\$2.49**
2 x 40 RIGHT ANGLE LEAD **\$2.99**



JDR INSTRUMENTS--2 YEAR WARRANTY!

35 MHZ DUAL TRACE OSCILLOSCOPE
 • WIDE BAND WIDTH • VARIABLE HOLDOFF
MODEL-3500 (SHOWN) **\$499.95**

20 MHZ DUAL TRACE OSCILLOSCOPE
 • TV SYNC FILTER • COMPONENTS TESTER
MODEL 2000 **\$389.95**

3.5 DIGIT PROBE TYPE DMM
 • AUTORANGING • AC/DC 2V - 500V, RESIS 2K-2M
DPM-1000 (SHOWN) **\$54.95**

3.5 DIGIT POCKET SIZE DMM
 • BASIC DC ACCURACY ±0.5% • 14 RANGES
DMM-100 **\$29.95**

3.5 DIGIT FULL FUNCTION DMM
 • BASIC DC ACCURACY ±0.25% • 22 RANGES
DMM-200 **\$49.95**

THE ULTIMATE 3.5 DIGIT DMM
 • BASIC DC ACCURACY ±0.25% • 34 RANGES
 • TEMP, TRANSISTOR & RESISTANCE FEATURES
DMM-300 (SHOWN) **\$79.95**

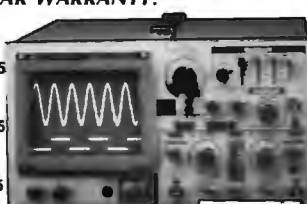

RELIABLE,
 HIGH QUALITY
 TEST EQUIPMENT,
 REASONABLY
 PRICED

IDC CONNECTORS/RIBBON CABLE

DESCRIPTION	ORDER BY	CONTACTS					
		10	20	26	34	40	50
SOLDER HEADER	IDHxxS	.82	1.29	1.68	2.20	2.58	3.24
RIGHT ANGLE SOLDER HEADER	IDHxxSR	.85	1.35	1.76	2.31	2.72	3.39
WIREWRAP HEADER	IDHxxW	1.86	2.98	3.84	4.50	5.28	6.63
RIGHT ANGLE WIREWRAP HEADER	IDHxxWR	2.05	3.28	4.22	4.45	5.08	7.30
RIBBON HEADER SOCKET	ID5xx	.55	.55	.75	.75	1.19	1.19
RIBBON HEADER	IDMxx	—	5.50	6.25	7.00	7.50	8.50
RIBBON EDGE CARD	IDExx	.95	.55	.75	.89	1.29	1.69
RIBBON CABLE 10 FT.	RCxx	1.90	3.00	3.90	5.10	6.00	7.50

FOR ORDERING INSTRUCTIONS, SEE D-SUBMINIATURE CONNECTORS BELOW

D-SUBMINIATURE CONNECTORS

DESCRIPTION	ORDER BY	CONTACTS						
		9	15	19	25	37	50	
SOLDER CUP	MALE	DBxxP	.45	.59	.69	.69	1.35	1.85
	FEMALE	DBxxS	.49	.69	.75	.75	1.39	2.29
RIGHT ANGLE PC SOLDER	MALE	DBxxPR	.49	.69	—	.79	2.27	—
	FEMALE	DBxxSR	.55	.75	—	.85	2.49	—
WIREWRAP	MALE	DBxxPWV	1.69	2.56	—	3.89	5.60	—
	FEMALE	DBxxSWV	2.76	4.27	—	6.84	9.95	—
IDC RIBBON CABLE	MALE	IDBxxP	1.39	1.99	—	2.25	4.25	—
	FEMALE	IDBxxS	1.45	2.05	—	2.35	4.49	—
HOODS	METAL	MHOODxx	1.05	1.15	1.25	1.25	—	—
	PLASTIC	HOODxx	.39	.39	—	.39	.69	.75

ORDERING INSTRUCTIONS: INSERT THE NUMBER OF CONTACTS IN THE POSITION MARKED "xx" OF THE "ORDER BY" PART NUMBER LISTED. EXAMPLE: A 15 PIN RIGHT ANGLE MALE PC SOLDER WOULD BE DB15PR

MOUNTING HARDWARE .59

IC SOCKETS/DIP CONNECTORS

DESCRIPTION	ORDER BY	CONTACTS								
		8	14	16	18	20	22	24	28	40
SOLDERTAIL SOCKETS	xxST	.11	.11	.12	.15	.18	.15	.20	.22	.30
WIREWRAP SOCKETS	xxWW	.59	.69	.69	.99	1.09	1.39	1.49	1.69	1.99
ZIF SOCKETS	ZIFxx	—	5.95	5.95	—	6.95	—	7.95	7.95	9.95
TOOLED SOCKETS	AUGATxx	.55	.59	.69	.79	.85	.85	.99	1.09	1.29
TOOLED WW SOCKETS	AUGATxxWW	1.30	1.80	2.10	2.40	2.50	2.90	3.15	3.70	5.40
COMPONENT CARRIERS	ICxx	.49	.59	.69	.99	.99	.99	.99	1.09	1.49
DIP PLUGS (IDC)	IDPxx	.95	.49	.59	1.29	1.49	—	.85	1.49	1.59

FOR ORDERING INSTRUCTIONS SEE D-SUBMINIATURE CONNECTORS ABOVE

JDR MICRODEVICES, 2233 BRANHAM LANE, SAN JOSE, CA 95124

LOCAL (408) 866-6200 FAX (408) 559-0250 TELEX 171-110

RETAIL STORE: 1256 SOUTH BASCOM AVE., SAN JOSE, CA

(408) 947-8881 HOURS: M-F 9-7 SAT. 9-5 SUN. 12-4

Terms: Minimum order \$10. For shipping and handling include \$3.50 for ground and \$4.50 for air. Orders over 1 lb and foreign orders may require additional shipping charges—please contact the sales department for the amount. CA residents must include applicable sales tax. Prices subject to change without notice. We are not responsible for typographical errors. We reserve the right to limit quantities and to substitute manufacturer. All merchandise subject to prior sales. A full copy of our terms is available upon request. Items pictured may only be representative.

ORDER TOLL FREE 800-538-5000



JDR Microdevices

MMC
MICROCOMPUTER
MARKETING COUNCIL
of the Direct Marketing Association, Inc.

• 30 DAY MONEY BACK GUARANTEE • 1 YEAR WARRANTY ON ALL PRODUCTS • TOLL-FREE TECHNICAL SUPPORT

2400 BAUD MODEM \$89.95

- Hayes COMPATIBILITY
- 1/2 CARD • AUTO DIAL/ANSWER
- SELF-TEST ON POWER UP
- FULL AND HALF DUPLEX
- TOUCHTONE OR PULSE DIALING
- 2ND PHONE JACK • CALL PROGRESS MONITORING
- ADJUSTABLE VOLUME



PRO-241

PROMETHEUS MODEMS

INTERNAL MODEMS (MIRROR II SOFTWARE INCLUDED)

PRO-241 2400 BAUD 1/2 CARD \$99.95

PRO-121 1200 BAUD 1/2 CARD \$69.95

EXTERNAL MODEMS (REQ. SERIAL PORT, CABLE, SOFTWARE)

PRO-24E 2400 BAUD \$149.95

PRO-12E 1200 BAUD \$99.95

APPLE/MACINTOSH COMPATIBLE MODEMS

EXTERNAL MODEMS, AS ABOVE WITH CABLE & SOFTWARE

PRO-24EM MAC 2400 BAUD \$199.95

PRO-24A APPLE II 2400 BAUD \$179.95

PRO-12A APPLE II 1200 BAUD \$139.95

24-HR. ON-LINE ORDERING

(408) 559-0253

JDR's Bulletin Board offers technical support, conferencing and more!

"I got the equipment when I needed it, and I am very satisfied with it. Your service is a rarity in a mail-order company." --Joe Bettinger, Palmyra NY

DFI SERIAL MOUSE \$39.95

- 3-BUTTON OPTO-MECHANICAL
- 200 DPI
- USES SERIAL PORT COM 1/2
- INCL. SOFTWARE DRIVERS
- 5-1/2" CABLE

DMS-200E

MOUSE AND HALO-DPE SOFTWARE

DMS-200 \$59.95



NEW LOGITECH 3 BUTTON MOUSE

NEW SERIES 9 MICE FEATURE 320 DPI RESOLUTION. SERIAL MICE ARE ALSO PS/2 COMPATIBLE

LOGC9 SERIAL MOUSE \$98.95

LOGC9-P SERIAL MOUSE W/PAINTSHOW \$109.95

LOGC9-PBL SERIAL MOUSE W/PUBLISHER \$149.95

LOGC9-PC SERIAL MOUSE W/PAINT/CAD \$154.95

LOGB9 BUS MOUSE \$89.95

LOGB9-P BUS MOUSE W/PAINTSHOW \$104.95

LOGB9-PBL BUS MOUSE W/PUBLISHER \$139.95

LOGB9-PC BUS MOUSE W/PAINT/CAD \$149.95

NEW LOW PRICES! VGA \$499

COMPATIBLE PACKAGE

- 720 X 540 MAX RESOLUTION
- 640 X 480 IN 16 COLORS
- 528 X 480 IN 256 COLORS
- IBM STYLE MONITOR
- VGA, EGA, CGA AND MGA COMPATIBLE



VGA-PKG (INCLUDES VGA CARD AND MONITOR)

VGA MONITOR \$359.00

• 14" ANALOG MONITOR • 720 X 480 • GLARE RESISTANT SCREEN • TILT/SWIVEL BASE

VGA-MONITOR

PAPER WHITE VGA \$119.95

14" GRAY SCALE MONITOR • 800 X 480 RESOLUTION

MONO-VGA

RELISYS MULTISYNCH \$429.00

- FULL FEATURED MULTISYNCH MONITOR WITH UNLIMITED COLORS • 800 X 560 RESOLUTION, 14" NON-GLARE DISPLAY
- AUTO SWITCHING • TTL/ANALOG VIDEO INPUT

JDR-MULTI

EGA MONITOR \$339.00

- 640 X 200/350 RESOLUTION • 16 COLOR DISPLAY
- 14" BLACK MATRIX SCREEN • 9-PIN CABLE

EGA-MONITOR

RGB MONITOR \$239.95

- COLOR/GREEN/AMBER SWITCH • 14" NON-GLARE SCREEN
- 640 X 200 MONOCHROME RESOLUTION, 320 X 200 COLOR
- TILT AND SWIVEL BASE

JDR-RGB

FLAT SCREEN MONITOR \$139.00

- LOW DISTORTION, 14" GLARE-RESISTANT AMBER SCREEN
- 720 X 350 MAXIMUM RESOLUTION • IBM COMPATIBLE TTL INPUT • SWIVEL BASE

GM-1488

MONO-SAMSUNG WITH 12" SCREEN \$129.95

JDR-MONO 12" TTL MONOCHROME -GREEN \$69.95

JDR-AMBER 12" TTL MONOCHROME -AMBER \$69.95

TILT & SWIVEL MONITOR STANDS

MS-100 DURABLE PLASTIC \$12.95

MS-200 WITH 5 OUTLETS & SURGE SUPPRESSOR \$39.95

HIGH QUALITY KEYBOARDS



101 KEY ENHANCED, WITH SEPARATE CURSOR PAD:

BTC-5339 AUTOSENSE FOR XT/AT, AUTOREPEAT \$69.95

K103-A AUDIBLE "CLICK" STYLE \$84.95

MAX-5339 MAXI-SWITCH W/TACTILE FEEDBACK \$84.95

84 KEY STYLES:

BTC-5060 AUTOSENSE FOR XT/AT \$59.95

MAX-5060 MAXI-SWITCH W/TACTILE FEEDBACK \$64.95

MODULAR PROGRAMMING SYSTEM

OUR INTEGRATED MODULAR PROGRAMMING SYSTEM EASILY EXPANDS! ALL THE MODULES USE A COMMON HOST ADAPTOR CARD, SO YOU CAN USE JUST ONE SLOT TO PROGRAM EPROMS, PROMS, PALS & MORE!

HOST ADAPTOR CARD \$29.95

- UNIVERSAL INTERFACE FOR ALL THE PROGRAMMING MODULES!
- SELECTABLE ADDRESSES
- PREVENTS CONFLICTS
- HIGH QUALITY MOLDED CABLE



UNIVERSAL MODULE \$499.99

- PROGRAMS EPROMS, EEPROMS, PALS, BI-POLAR PROMS, 8748 & 8751 SERIES DEVICES, 16V8 20V8 GALs (GENERIC ARRAY LOGIC) FROM LATTICE, NS, SGS • TESTS TTL, CMOS, DYNAMIC & STATIC RAMS • LOAD DISK, SAVE DISK, EDIT, BLANK CHECK, PROGRAM, AUTO, READ MASTER, VERIFY & COMPARE
- TEXTBOOK SOCKET FOR .3" TO .6" W. IC'S 18-40 PINS!

MOD-MUP

EPROM MODULE \$119.95

- PROGRAMS 24-32 PIN EPROMS, CMOS EPROMS & EEPROMS FROM 1K8 TO 1024K • HEX TO OBU CONVERTER • AUTO. BLANK CHECK/PROGRAM/VERIFY • VPP 5, 12.5, 12.75, 13, 21 & 25 VOLTS
- NORMAL, INTELLENT, INTERACTIVE, & QUICK PULSE PROGRAMMING ALGORITHMS

MOD-MEP

MOD-MEP-4 4-EPROM PROGRAMMER \$169.95

MOD-MEP-8 8-EPROM PROGRAMMER \$259.95

MOD-MEP-16 16-EPROM PROGRAMMER \$499.95

DIGITAL IC MODULE \$129.95

- TESTS TTL, CMOS, DYNAMIC & STATIC RAM
- AUTO SEARCH FOR UNKNOWN PART NUMBERS
- USER-PROGRAMMABLE TEST PROCEDURES

MOD-MIC

PAL MODULE \$249.95

- PROGRAMS MMI, NS, TI 20 & TI 24 PIN DEVICES
- BLANK CHECK, PROGRAM, AUTO, READMASTER, VERIFY & SECURITY FUSE BLOW

MOD-MPL

ENTRY-LEVEL PAL PROGRAMMING KIT BY CUPL

MOD-MPL-SOFT \$99.95

HARD DISKS

20 MB \$199

30 MB \$219

40 MB \$319

28 MS \$389

60 MB \$389

80 MB \$569

KITS

20 MB \$249

30 MB \$279

Seagate

NEW LOW PRICES!

NEW LOW PRICES!

SIZE	MODEL	AVG. SPEED FACTOR	FORM ONLY	DRIVE KIT	XT KIT	AT F.H. KIT
20MB	ST-225	65 MS	5-1/4"	\$199	\$249	\$309
20MB	ST-125	40 MS	3-1/2"	\$259	\$299	\$373
30MB RLL	ST-238	65 MS	5-1/4"	\$219	\$279	\$379
30MB RLL	ST-138	40 MS	3-1/2"	\$289	\$339	\$429
40MB	ST-251	40 MS	5-1/4"	\$319	\$369	\$429
40MB	ST-251-1	28 MS	5-1/4"	\$369	\$439	\$499
60MB RLL	ST-277	40 MS	5-1/4"	\$389	\$449	\$549
80MB	ST-4000	28 MS	5-1/4"	\$569	—	\$679

80MB SCSI \$499

SCSI DRIVES ARE FASTER

ST-206N BY SEAGATE

MCT-SCSI HOST ADAPTOR CARD \$49.95

ST-02 SCSI ADAPTOR W/FLOPPY \$79.95

1.44 MB 3-1/2" DRIVE

\$99.95



• ULTRA HIGH DENSITY

• READ/WRITE 720K DISKS, TOO

FDD-1.44X BLACK FACEPLATE

FDD-1.44A BEIGE FACEPLATE

FDD-1.44 SOFT SOFTWARE DRIVER \$19.95

1/2 HEIGHT FLOPPY DISK DRIVES:

FD-55B 5-1/4" TEAC DS/DD 360K \$99.95

FD-55G 5-1/4" TEAC DS/HD 1.2M \$129.95

FDD-360 5-1/4" DS/DD 360K \$69.95

FDD-1.2 5-1/4" DS/HD 1.2M \$95.95

FDD-3.5X 3-1/2" 720K (BLACK) \$97.95

FDD-3.5A 3-1/2" 720K (BEIGE) \$97.95

ARCHIVE TAPE BACK-UPS

AR5240X 40 MB TAPE DRIVE FOR XT'S & AT'S \$369.95

AR5540A FAST 40 MB TAPE DRIVE AT'S ONLY \$369.95

AR2020 EXTERNAL CHASSIS & INTERFACE \$159.95

AR20A ADDITIONAL INTERFACE CARDS \$89.95

AR340 40 MB TAPE CARTRIDGE \$24.95

UPRIGHT CASE \$299.95

SPACE SAVING DESIGN HOLDS ALL SIZES OF MOTHERBOARDS AND INCLUDES:

- 250W POWER SUPPLY • MOUNTS FOR 3 FLOPPY & 4 HARD DRIVES
- TURBO & RESET SWITCH • LED SPEED DISPLAY • POWER & DISK LEDS
- ALL HARDWARE, FACEPLATES & SPEAKER

CASE-100

CASE-FLIP FOR 8088 BOARDS \$39.95

CASE-SLIDE FOR 8088 BOARDS \$39.95

CASE-70 FOR 286 BOARDS \$89.95

CASE-50 FOR 8088/286 BOARDS \$59.95

CASE-JR MINI-286 W/150W PS \$149.95



EPROM PROGRAMMER \$129.95

- PROGRAMS 27XX AND 27VXX EPROMS UP TO 27512
- SUPPORTS VARIOUS PROGRAMMING FORMATS & VOLTAGES • SPLIT OR COMBINE CONTENTS OF SEVERAL EPROMS OF DIFFERENT SIZES
- READ, WRITE, COPY, ERASE, CHECK & VERIFY
- HEX/INTEL HEX SOFTWARE

MOD-EPROM

2400 BAUD MODEM

\$89⁹⁵

- HAYES COMPATIBILITY
- AUTO DIAL/ANSWER
- SELF-TEST ON POWER UP
- FULL AND HALF DUPLEX
- TOUCHSTONE OR PULSE DIALING
- 2ND PHONE JACK



MCT-241

PROMETHEUS MODEMS

- PRO-241** 2400 BAUD INTERNAL 1/2 CARD **\$99.95**
- PRO-121** 1200 BAUD INTERNAL 1/2 CARD **\$69.95**
- PRO-24E** 2400 BAUD EXTERNAL MODEM **\$149.95**
- PRO-12E** 1200 BAUD EXTERNAL MODEM **\$99.95**

DFI HANDY SCANNER—400 DPI

\$199⁹⁵

- QUICKLY SCANS UP TO 4 1" WIDE IMAGES • 100, 200, 300, 400 DPI BOTH DIRECTIONS • B&W & 3 HALF-TONE MODES • 32 LEVELS OF GRAY SCALE • HERCULES, CGA, EGA AND VGA COMPATIBLE
- INCLUDES HALO DPE AND IMAGE EDITOR SOFTWARE



UPRIGHT CASE

\$299⁹⁵

- SPACE SAVING DESIGN HOLDS ALL SIZES OF MOTHERBOARDS AND INCLUDES:
- 250W POWER SUPPLY • MOUNTS FOR 3 FLOPPY & 4 HARD DRIVES
- TURBO • RESET SWITCH • LED SPEED DISPLAY • POWER & DISK LED'S
- ALL HARDWARE, FACEPLATES & SPEAKER



- CASE-FLIP** FOR 8088 BOARDS **\$39.95**
- CASE-SLIDE** FOR 8088 BOARDS **\$39.95**
- CASE-70** FOR 286 BOARDS **\$89.95**
- CASE-50** FOR 8088/286 BOARDS **\$59.95**
- CASE-JR** MINI-286 W/150W PS **\$149.95**

DFI SERIAL MOUSE

\$39⁹⁵

- 3-BUTTON OPTO-MECHANICAL
- 200 D.P.I. • 5-1/2" CABLE
- USES SERIAL PORT COM 1/2
- INCL. SOFTWARE DRIVERS



NEW LOGITECH 3-BUTTON MICE

- NEW SERIES 9 MICE FEATURE 320 DPI RESOLUTION. SERIAL MICE ARE ALSO PS/2 COMPATIBLE
- LOGC9** SERIAL MOUSE **\$98.95**
- LOGC9-P** SERIAL MOUSE WITH PAINTSHOW **\$109.95**
- LOGC9-PBL** SERIAL MOUSE WITH PUBLISHER **\$149.95**
- LOGC9-PC** SERIAL MOUSE WITH PAINT/CAD **\$154.95**
- LOGB9** BUS MOUSE **\$89.95**
- LOGB9-P** BUS MOUSE WITH PAINTSHOW **\$104.95**
- LOGB9-PBL** BUS MOUSE WITH PUBLISHER **\$139.95**
- LOGB9-PC** BUS MOUSE WITH PAINT/CAD **\$149.95**

MODULAR PROGRAMMING SYSTEM

INTEGRATED MODULAR SYSTEM EASILY EXPANDS! ALL MODULES USE A COMMON HOST ADAPTOR CARD—USE JUST ONE SLOT TO PROGRAM EPROMS, PROMS, PALS & MORE

HOST ADAPTOR CARD \$29.95

- UNIVERSAL INTERFACE FOR ALL THE PROGRAMMING MODULES!
- SELECTABLE ADDRESSES PREVENTS CONFLICTS
- MOLDED CABLE



UNIVERSAL MODULE \$499.99

- PROGRAMS EPROMS, EEPROMS, PALS, BI-POLAR PROMS, 8748 & 8751 SERIES DEVICES, 16V8 AND 20V8 GALS (GENERIC ARRAY LOGIC) FROM LATTICE, NS, SGS • TESTS TTL, CMOS, DYNAMIC & STATIC RAMS • LOAD DISK, SAVE DISK, EDIT, BLANK CHECK, PROGRAM, AUTO, READ MASTER, VERIFY AND COMPARE
- TEXT TOOL SOCKET FOR 3" TO 6"W IC'S (8-40 PINS)



EPROM MODULE \$119.95

- PROGRAMS 24-32 PIN EPROMS, CMOS EPROMS & EEPROMS FROM 16K TO 1024K • HEX TO OBJ CONVERTER • AUTO, BLANK CHECK/PROGRAM/VERIFY • VPP 5, 12.5, 12.75, 13, 21 & 25 VOLTS
- NORMAL, INTELLIGENT, INTERACTIVE & QUICK PULSE PROGRAMMING ALGORITHMS

MOD-MEP

- MOD-MEP-4** 4-EPROM PROGRAMMER **\$169.95**
- MOD-MEP-8** 8-EPROM PROGRAMMER **\$259.95**
- MOD-MEP-16** 16-EPROM PROGRAMMER **\$499.95**

DIGITAL IC MODULE \$129.95

- TESTS TTL, CMOS, DYNAMIC & STATIC RAM
- AUTO SEARCH FOR UNKNOWN PART NUMBERS
- USER-PROGRAMMABLE TEST PROCEDURES

MOD-MIC

PAL MODULE \$249.95

- PROGRAMS MMC, NS, TI 20 & TI 24 PIN DEVICES
- BLANK CHECK, PROGRAM, AUTO, READMASTER, VERIFY & SECURITY FUSE BLOW

MOD-MPL

- CUPL SOFTWARE—ENTRY-LEVEL PAL DEV. KIT
- MOD-MPL-SOFT**

VGA

COMPATIBLE PACKAGE \$499



- 720 X 540 MAX RESOLUTION, 640 X 480 IN 16 COLORS, 528 X 480 RESOLUTION IN 256 COLORS • IBM STYLE MONITOR
- VGA, EGA, CGA, AND MGA COMPATIBLE
- VGA-PKG** (INCLUDES VGA CARD AND MONITOR)

VGA MONITOR \$359

- 14" ANALOG VGA • GLARE RESISTANT SCREEN • 720 X 480
- TILT/SWIVEL BASE • FRONT MOUNTED POWER SWITCH

VGA-MONITOR

RELISYS MULTISYNCH \$429

- FULL FEATURED MULTISYNCH MONITOR WITH UNLIMITED COLORS • 800 X 560 RESOLUTION, 14" NON-GLARE DISPLAY
- AUTO SWITCHING • TTL/ANALOG VIDEO INPUT

JDR-MULTI

EGA MONITOR \$339

- 640 X 200/350 RESOLUTION • 14" BLACK MATRIX SCREEN
- 16 COLOR DISPLAY • 9-PIN CABLE

EGA-MONITOR

EGA SPECIAL! CARD & MONITOR—JUST \$479

- JDR-RGB** 14" RGB MONITOR TILT/SWIVEL BASE **\$239.95**
- JDR-MONO** 12" TTL MONOCHROME—GREEN **\$69.95**
- JDR-AMBER** 12" TTL MONOCHROME—AMBER **\$69.95**

KEYBOARDS

- 101 KEY ENHANCED, WITH SEPARATE CURSOR PAD:**
- BTC-5339** AUTOSENSE FOR XT/AT, AUTOREPEAT **\$69.95**
- K103-A** AUDIBLE "CLICK" STYLE **\$84.95**
- MAX-5339** MAXI-SWITCH W/TACTILE FEEDBACK **\$84.95**

84 KEY STYLES:

- BTC-5060** AUTOSENSE FOR XT/AT **\$59.95**
- MAX-5060** MAXI-SWITCH W/TACTILE FEEDBACK **\$64.95**

MODULAR CIRCUIT TECHNOLOGY



DRIVE CONTROLLERS:

- MCT-FDC** FLOPPY DISK CONTROLLER **\$29.95**
- MCT-FDC-1.2** 1.2 MB FLOPPY CONTROLLER **\$49.95**
- MCT-HDC** HARD DISK CONTROLLER **\$79.95**
- MCT-RLL** RLL CONTROLLER **\$89.95**
- MCT-FH** FLOPPY/HARD CONTROLLER **\$139.95**
- MCT-AFH** 286/386 FLOPPY/HARD **\$149.95**
- MCT-AFH-RLL** 286/386 RLL CONTROLLER **\$199.95**

DISPLAY ADAPTOR CARDS:

- MCT-MGP** MONOCHROME GRAPHICS **\$59.95**
- MCT-CG** COLOR GRAPHICS ADAPTOR **\$49.95**
- MCT-EGA** ENHANCED GRAPHICS ADAPTOR **\$149.95**
- MCT-VGA-8** REGISTER COMPATIBLE VGA **\$199.95**
- MCT-VGA-16** 16-BIT VGA, 1024X768 RES. **\$329.95**
- MCT-MGMIO** MONOGRAPHICS MULTI I/O **\$119.75**
- MCT-MGAIO** 286/386 MONOGRAPHICS I/O **\$98.95**

MULTIFUNCTION CARDS:

- MCT-MIO** MULTI I/O FLOPPY CONTROLLER **\$79.95**
- MCT-IO** MULTI I/O CARD **\$59.95**
- MCT-AMF** 286/386 MULTIFUNCTION **\$139.95**
- MCT-AIO** 286/386 MULTI I/O CARD **\$59.95**

MEMORY CARDS:

- MCT-RAM** 576K RAM CARD **\$59.95**
- MCT-EMS** EXPANDED MEMORY CARD **\$129.95**
- MCT-MEMS** 286/386 EMS CARD **\$139.95**

HARD DISKS

- 20 MB \$199**
- 30 MB \$219**
- 40 MB \$319**
- 28 MS \$389**
- 60 MB \$389**
- 80 MB \$569**

KITS

- 20 MB \$249**
- 30 MB \$279**

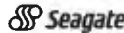

SIZE	MODEL	AVG. SPEED	FORM FACTOR ONLY	DRIVE KIT	XT KIT	AT F/M KIT
20MB	ST-225	65 MS	5-1/4"	\$199	\$249	\$309
20MB	ST-125	40 MS	3-1/2"	\$259	\$299	\$373
30MB RLL	ST-230	65 MS	5-1/4"	\$219	\$279	\$379
30MB RLL	ST-130	40 MS	3-1/2"	\$289	\$339	\$429
40MB	ST-251	40 MS	5-1/4"	\$319	\$369	\$429
40MB	ST-251-1	28 MS	5-1/4"	\$389	\$439	\$499
60MB RLL	ST-277	40 MS	5-1/4"	\$389	\$449	\$549
80MB	ST-4096	28 MS	5-1/4"	\$569	—	\$679

80MB SCSI \$499

- SCSI DRIVES ARE FASTER
- ST-286N** BY SEAGATE
- MCT-SCSI** HOST ADAPTOR CARD **\$49.95**
- ST-02** SCSI ADAPTOR W/FLOPPY **\$79.95**

1.44 MB 3-1/2" DRIVE

\$99⁹⁵



- ULTRA HIGH DENSITY
- READ/WRITE 720K DISKS, TOO!
- FDD-1.44X** BLACK FACEPLATE
- FDD-1.44A** BEIGE FACEPLATE
- FDD-1.44** SOFT SOFTWARE DRIVER **\$19.95**

1/2 HEIGHT FLOPPY DISK DRIVES:

- FD-55B** 5-1/4" TEAC DS/DD 360K **\$99.95**
- FD-55G** 5-1/4" TEAC DS/HD 1.2M **\$129.95**
- FDD-360** 5-1/4" DS/DD 360K **\$69.95**
- FDD-1.2** 5-1/4" DS/HD 1.2M **\$95.95**
- FDD-3.5X** 3-1/2" 720K (BLACK) **\$97.95**
- FDD-3.5A** 3-1/2" 720K (BEIGE) **\$97.95**

MOTHERBOARDS

25 MHZ 386 \$1049

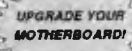

- 10/25 MHZ
- 16 MB RAM CAPACITY • 8MB ON-BOARD(OK), 8 MB RAM CARD
- USES 256K OR 1MB DRAMS
- 8 SLOTS 1X32-BIT RAM 2X 8-BIT & 5X 16-BIT
- SHADOW RAM FOR BIOS VIDEO • AMI BIOS
- INTERLEAVED MEMORY
- ADJUSTABLE BUS SPEEDS
- MCT-M386MB25**
- MCT-386MB20** 10/20 MHZ 386 **\$849.00**
- MCT-M386-M** 8MB RAM CARD (OK) **\$149.95**

12 MHZ MINI-286

- AT COMPATIBLE • KEYBOARD SELECTABLE 8/12MHZ
- EXPANDABLE TO 4MB ON-BOARD WITH 1MB DRAMS (OK)
- SIX 8-BIT & TWO 8-BIT SLOTS • AMI BIOS • LED SUPPORT
- MCT-M286-12**
- MCT-M286** 6/10 MHZ MINI-286 **\$269.95**
- MCT-M286-16** 8/16 MHZ 286 **\$489.95**
- MCT-M286-20** 10/20 MHZ 286 **\$589.00**
- MCT-XMB** STANDARD 4.77 MHZ 8088 **\$87.95**
- MCT-TURBO** 4.77/8 MHZ 8088 **\$95.95**
- MCT-TURBO-10** 4.77/10 MHZ SINGLE CHIP 8088 **\$99.00**

EPROM PROGRAMMER \$129⁹⁵

- PROGRAMS 27XX AND 27XXC EPROMS UP TO 27512
- SUPPORTS VARIOUS PROGRAMMING FORMATS & VOLTAGES • SPLIT OR COMBINE CONTENTS OF SEVERAL EPROMS OF DIFFERENT SIZES
- READ, WRITE, COPY, ERASE, CHECK & VERIFY • SOFTWARE FOR HEX AND INTEL-HEX FORMATS
- MOD-EPROM**



JDR MICRODEVICES, 2233 BRANHAM LANE, SAN JOSE 95124
 LOCAL (408) 866-6200 FAX (408) 559-0250 TELEX 171-110
 RETAIL STORE: 1256 S. BASCOM AVE., SAN JOSE, CA
 (408) 947-8881 HOURS: M-F 9-7 SAT. 9-5 SUN. 12-4

Terms: Minimum order \$10.00. For shipping & handling include \$3.50 for ground and \$4.50 air. Orders over 1 lb and foreign orders may require additional shipping charges—please contact the sales department for the amount. CA residents must include applicable sales tax. Prices subject to change without notice. We are not responsible for typographical errors. We reserve the right to limit quantities and to substitute manufacturer. All merchandise subject to prior sales. A full copy of our terms is available upon request. Items pictured may only be representative.

ORDER TOLL FREE 800-538-5000

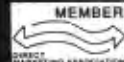

EDITORIAL INDEX BY COMPANY

Index of companies covered in articles, columns, or news stories in this issue
Each reference is to the first page of the article or section in which the company name appears

INQUIRY #	COMPANY	PAGE	INQUIRY #	COMPANY	PAGE	INQUIRY #	COMPANY	PAGE
1125	ABBOT, FOSTER &			INSTRUMENTS	142	1133	MICRO SOLUTIONS	49
1181	HAUSERMAN	49, 244		EIKON SYSTEMS	17	1111	MICROANALYSIS SOFTWARE	49
1144	ADVANCED DATA SERVERS	49	1096	ELECTRONIC ARTS	99	1021	MICROGRAFX	129
1129	ADVANCED DIGITAL	49	1126	ENTOURAGE COMPUTER	49	1033	MICROSOFT	17, 49, 125
472	AEGIS DEVELOPMENT	191	1092	EPYX	99	1114	MICROSTAR LABORATORIES	246
	AGILIS	90	1186	EXCALIBUR TECHNOLOGIES	244	1131	MICROTECH	
1182	AI WARE	244	1106	EXPERTELLIGENCE	17, 49		INTERNATIONAL	17, 49
1152	ALPHATRONIX	49	1123	FAR BIT RESEARCH	49		MICROTEK	17
1035	ALTIMA SYSTEMS	81	1095	FORTE COMMUNICATIONS	99		MIPS COMPUTER SYSTEMS	17
1127	AMERICAN MITAC	17, 49	1118	FRONTLINE SYSTEMS	49		MIT	17
	APOLLO COMPUTER	259		FUJITSU	17		MITRE	227
	APPLE COMPUTER	196, 279	1180	GIBSON RESEARCH	265		MOTOROLA	17, 135, 246
1139	APPLIED DATA SYSTEMS	49		GLOCKENSPIEL	17	1102	M2S	49
473	APPLIED SYSTEMS & TECHNOLOGIES	191	1073	GRID SYSTEMS	142		MULTIFLOW COMPUTER	259
	ARIEL	246		HAMILTON LABORATORIES	49	1025	MURATA BUSINESS SYSTEMS	119
1091	ARTISOFT	99	1105	HEADLAND TECHNOLOGY	49		NEC HOME ELECTRONICS (U.S.A.)	17, 142, 161
	AST RESEARCH	17	1137	HECHT-NIELSEN NEUROCOMPUTER	217	1077	NEC INFORMATION SYSTEMS	49, 142
	AT&T	246	1132	HEWLETT-PACKARD	49	1128	NESTOR	244
	AT&T BELL LABORATORIES	17		HITACHI	17	1189	NEURAL SYSTEMS	244
1034	ATARI	81	1187	HNC	244	1190	NEURALWARE	244
	ATLANTA SIGNAL PROCESSORS	246	1026	HOLMES MICROSYSTEMS	119	1191	NEURALWARE	244
	BANYAN	135		IBM	17, 259	1192	NEURIX	244
1151	BAYTEK	49		ICOM SIMULATIONS	49		NEXT	246
	BIPOLAR INTEGRATED TECHNOLOGY	17	1108	IMAGE SYSTEMS	49	1147	NOVELL	49, 135
	BOCA RESEARCH	17	1122	IMAGE SYSTEMS TECHNOLOGY	49		OKI SEMICONDUCTOR	246
	BORLAND INTERNATIONAL	17		IMPACT TECHNOLOGIES	246	1193	OLMSTED & WATKINS	244
	BURR-BROWN	246		INPUT	17	1027	O'NEILL COMMUNICATIONS	119
1183	CALIFORNIA SCIENTIFIC SOFTWARE	244		INTEL	135	1142	OPTICAL COATING	49
	CAP INTERNATIONAL	17		INTELLITECH	17	1194	OXFORD COMPUTER	217, 244
	CARNEGIE MELLON UNIVERSITY	227	1121	INTERGRAPH	49	1032	PARAGON CONCEPTS	125
1097	CASTLE OAKS COMPUTER SERVICES	99		INTERLEAF	17		PARCPLACE SYSTEMS	17
1134	CHINON AMERICA	49	1130	JASMINE TECHNOLOGIES	49	1030	PENNY AND GILES COMPUTER PRODUCTS	119
1085	CLARY	99	882	JENSEN AND PARTNERS INTERNATIONAL	171	1149	PERFORMANCE TECHNOLOGY	49
1120	COLLEAGUE BUSINESS SOFTWARE	49		JOHN WILEY & SONS	340		PHAR LAP	17
1022	COMMAND TECHNOLOGY	129	1104	KAETRON SOFTWARE	49	852	PIXELWORKS	167
	COMMUNICATIONS AUTOMATION & CONTROL	246	1074	LAPTOP ENHANCEMENT PRODUCTS	142	1113	PRECISION SOFTWARE	49
1071	COMPAQ COMPUTER	142		LASER CONNECTION	17	1094	PRIAM	99
1088	CULTURAL RESOURCES	99	883	LOGITECH INTERNATIONAL SA	81, 129, 171	1179	PRIME SOLUTIONS	265
	CYPRESS SEMICONDUCTOR	17	1023	LOTUS DEVELOPMENT	177	1087	PRIORITY ONE ELECTRONICS	99
1185	DAIR COMPUTER SYSTEMS	244	1037	LSI LOGIC	17	1078	PROCOM TECHNOLOGY	142
	DATA CUBE	246	886			1101	PROSPERO SOFTWARE	49
1029	DATAPATH	119					QMS	17
	DELL COMPUTER	17	1036	MACROMIND	81	1140	R.C. ELECTRONICS	49
1107	DESIGN DECISIONS	49	1150	MAPPING INFORMATION SYSTEMS	49	1115	REALITY TECHNOLOGIES	49
	DESIGNTECH INTERNATIONAL	17	1136	MICRO DEVICES	49, 217, 244		RUPP	17
	DIGIDESIGN	246	1188			1195	SAIC	244
1110	DIGITAL ANALYTICS	49	1075	MICRO EXPRESS	142		SCIENCE APPLICATIONS INTERNATIONAL	217
	DIGITALK	17				1124	SCORPION TECHNOLOGIES	49
1072	DOLCH AMERICAN						SHARP ELECTRONICS	17

COMING UP IN BYTE

PRODUCTS IN PERSPECTIVE:

First Impressions for September should include our evaluation of Lotus 1-2-3 version 3, IBM's OfficeVision/2, and Apricot's newest entry, the first 80486-based computer.

The **Product Focus** will be on multiuser/multitasking operating systems. Touted as low-cost alternatives to LANs, operating systems like Digital Research's Concurrent DOS, IGC's VM/386, and The Software Link's PC-MOS/386 connect multiple computers or terminals via the serial port. How effective are they? Find out in September.

Reviews we hope to publish in September include a look at two ends of the IBM PC clone spectrum. ALR's MicroFlex 7000 looks to be a hot-performing Micro Channel architecture machine—one of a handful. We also evaluate a workhorse 80286 unit: the AST Bravo.

Sysgen has a new removable hard disk drive—not an enclosed unit, but an actual hard disk platter you can pull out to transfer data from machine to machine. Brightbill-Roberts enters the MS-DOS hypertext fray with HyperPAD. And Arriba from Good Software is an information manager that looks promising.

In our Reviewer's Notebook, we will be looking at a number of products, including the The Complete PC's Complete Page Scanner and International Software's PixC.

IN DEPTH:

The focus in September will be on **databases**—the different types of structures they can follow and the various languages designed to interface with them.

We will discuss distributed databases and database servers, the ever-popular relational database, and look to the future with possible object-oriented databases. We will also look at the trends in microcomputer database direction. All this and SQL, too.

FEATURES:

Is IBM's Micro Channel the wave of the future, or a dead end? Will the Extended Industry Standard Architecture, supported by a group of IBM's competitors, attract users by letting them continue to use their PC AT cards? What about the NuBus? And what is Futurebus?

Our lead feature story in September will be a look at the **current battle over bus architectures**, by an author who is eminently qualified to tackle the subject. George P. White, president of Corollary (a spin-off of Texas Instruments), headed the committee that developed NuBus, and he has followed the architecture scene for years. Find out where buses are headed in the days to come.

Our Hands On columns will have L. Brett Glass discussing laptop technology in **Under the Hood** and Tom Thompson getting inside the Macintosh color lookup table in **Some Assembly Required**.

Our **Expert Advice** columnists include Jerry Pournelle in Computing at Chaos Manor, David Fiedler in Unix /bin, Wayne Rash Jr. in Down to Business, Don Crabb in Macinations, Mark Minasi in OS/2 Notebook, and Brock Meeks in NetWorks.

INQUIRY #	COMPANY	PAGE
	SILICON GRAPHICS	17
1093	SIMULATIONS CANADA	99
	SKISOFT PUBLISHING	17
	SKY COMPUTER	246
1119	SOFTWARE PARTNERS	49
	SOLBOURNE COMPUTER	17
1089	SOLUTIONS INTERNATIONAL	99
1138	SONITECH INTERNATIONAL	49
	SOUTH CENTRAL BELL	17
	SPECTRAL INNOVATIONS	246
	SPECTRUM SIGNAL PROCESSING	246
	STANFORD UNIVERSITY	217
884	STONY BROOK SOFTWARE	171
	SUN MICROSYSTEMS	17, 135
1038	SUNFLEX SOFTWARE	81
471	SUPERMAC TECHNOLOGY	191
1103	SYMMETRY SOFTWARE	49
1135	SYNTONIC SYSTEMS	49, 244
1196		
1086	T/MAKER	99
	TANDY	17
	TELEVIDEO	17
	TEXAS INSTRUMENTS	17, 246
1112	THE CENTER FOR SCIENTIFIC SUPPORT	49
	3COM	135
1145	3X USA	49
	TORUS	135
1079	TOSHIBA AMERICA	17, 142
885	TRAVELING SOFTWARE	177
1197	TRW	244
1143	UNISON TECHNOLOGIES	49
	UNISYS	17
1109	UNIVERSAL TECHNICAL SYSTEMS	49
1116	VARTECK	49
1148	VOXLINK	49
1141	WACOM	49
1198	WARD SYSTEMS GROUP	244
	WAVEFRONT TECHNOLOGIES	17
	WEITEK	259
1024	WORDPERFECT	129
1090	WORKMAN & ASSOCIATES	99
1117	WORKSMART TECHNOLOGIES	49
	XEROX	17
	XEROX PALO ALTO RESEARCH CENTER	135
1028	XIRCOM	49, 119
1146		
1031	ZENITH DATA SYSTEMS	17, 119, 142
1080	ZORAN	246

READER SERVICE

To get further information on the products advertised in BYTE, fill out the reader service card by circling the numbers on the card that correspond to the inquiry number listed with the advertiser. This index is provided as an additional service by the publisher, who assumes no liability for errors or omissions.

* Correspond directly with company.

Alphabetical Index to Advertisers

Inquiry No.	Page No.	Inquiry No.	Page No.	Inquiry No.	Page No.	Inquiry No.	Page No.	
8	2001 SALES	270	82	DIGITALK	24,25	308	RUPP CORP.	109
9	2001 SALES	270	83	DIGI-DATA CORP.	307	222	SAFEWARE	322
30	A.C.P.	325	84	DISCOTECH	313	224	SANTA CRUZ OPERATION	69
10	ACS COMMUNICATIONS	319	85	DISKETTE CONNECTION	321	225	SCHWAB COMPUTER CTR.	324
*	ADOBE	239	86	DIVERSIFIED COMPUTER SYS.	308	226	SCIENTIFIC ENDEAVORS	48
13	ADVANCED LOGIC RESEARCH	2,3	87	DIVERSIFIED TECHNOLOGY	96	227	SCIENTIFIC ENDEAVORS	48
14	ADVANCED LOGIC RESEARCH	2,3	457	DOUGLAS ELECTRONICS	127	228	SCIENTIFIC ENDEAVORS	48
15	ADVANTAGE SOFTWARE	101	88	DYNAMIC ELECTRONICS	313	229	SCIOTO COMPUTERS	321
*	AEG OLYMPIA	249	89	ECOSOFT	70	*	SOFTWARE DEV. SYS.	83
16	AK SYSTEMS	322	90	ELECTRONIC ENRGY CTRL	308	230	SOFTWARE LINK	37
451	ALLAN BONADIO ASSOC.	208	91	ELEXOR, INC.	319	231	SOFTWARE LINK	37
452	ALLAN BONADIO ASSOC.	208	92	ELITE MICROSYSTEMS	98	232	SOFTWARE LINK	120
17	ALPHA PRODUCTS	306	93	EMPIRICAL RES. SYS.	86	233	SOFTWARE LINK	120
19	AMERICAN GROUP	319	*	EPSON	32-34	234	SOFTWARE SECURITY	176
453	AMERICAN MICRO DISTRIB.	193	94	EXECUTIVE PHOTO & SPLY	124	251	SOLUS	286
20	AMERICAN SMALL BUS. COMP.	128	95	FASTLNX/RUPP CORP.	155	235	SPECTRUM	225
*	AMPRO	100	96	FORTRON CORP. (N.AMERICA)	121	236	STATSOFT	103
21	AMS	308	97	FORTRON CORP. (N.AMERICA)	121	237	STERLING CASTLE	114
22	ANNABOOKS	299	309	FORTRON CORP. (INT'L)	121	238	STERLING CASTLE	114
*	ANTHRO	42	310	FORTRON CORP. (INT'L)	121	239	STORAGE DIMENSIONS (N.AMERICA)	180,181
23	ASHTON-TATE	96	98	FOX SOFTWARE	23	240	STORAGE DIMENSIONS (N.AMERICA)	180,181
24	ASHTON-TATE	96	100	FTG DATA SYSTEMS	308	311	STORAGE DIMENSIONS (INTERNATIONAL)	180,181
25	ATI TECHNOLOGIES	27	101	GATEWAY 2000	10,11	312	STORAGE DIMENSIONS (INTERNATIONAL)	180,181
26	ATI TECHNOLOGIES	243	102	GENERIC SOFTWARE	179	241	SUPERSOFT	74
27	ATRON	31	103	GENERIC SOFTWARE	179	242	SURAH	321
28	AUREX MAGNETIC	138	104	GOLDEN BOW	130	243	SWRL SOFT	324
29	AUREX MAGNETIC	136	294	GRID SYSTEMS	97	464	SYMANTEC	198
31	B P MICROSYSTEMS	313	105	GTEK	262	244	S'NW	46
32	B & B ELECTRONICS	319	108	GTEK	262	245	TALKING TECHNOLOGY	322
322	B & C MICRO	317	107	HAMMERLY COMP. SERV.	182	249	TATUNG	275
323	B & C MICRO	317	108	HAMMERLY COMP. SERV.	183	316	TELEBIT	75
34	B & C MICRO	319	109	HANTZ & PARTNER	324	247	TELETYPE TECHNOLOGY	107
35	BAY TECH	166	458	HAYES MICROCOMP. PROD.	194,195	248	TERMOTROL	324
36	BAY TECH	166	110	HEWLETT-PACKARD PERIPH.	14,15	249	THOMAS CONRAD	139
37	BE AWARE, INC.	88	112	HEWLETT-PACKARD PERIPH.	158,159	250	TIMELINE	303
38	BE AWARE, INC.	88	113	HEWLETT-PACKARD PERIPH.	131	252	TOSHIBA	41
*	BINARY TECHNOLOGY	322	114	HEWLETT-PACKARD PERIPH.	133	253	TOSHIBA	41
40	BIOLOGICAL ENGINEERING	312	115	HIGH RES. TECH.	322	255	TOUCHBASE SYSTEMS	36
41	BIT WISE	269	117	HITECH EQUIPMENT CORP.	308	256	TRAVELING SOFTWARE	149
42	BIT WISE	269	118	HI-Q INTERNATIONAL, INC.	78	257	TRUE DATA	272
450	BIX	338,339	119	HI-Q INTERNATIONAL, INC.	78	258	TRUEVISION	184
43	BLAISÉ COMPUTING	47	290	HOOLEON	42	259	TUSSEY COMPUTER PROD.	185
44	BOLT SYSTEMS	132	291	HOOLEON	42	281	T.P.C.	304
45	BOLT SYSTEMS	132	121	HOUSTON INSTRUMENT	157	262	ULTIMATE TECHNOLOGY	324
46	BORLAND	13	122	I C EXPRESS	308	263	UNITEK	302
47	BORLAND	13	*	IBM CORPORATION	59	264	VENTURCOM	116
*	BUYER'S MART	288-298	123	IDEA WORKS	308	265	VENTURCOM	116
48	BYTE BITS	322	302	IGC	271	*	VERMONT CREATIVE S/W	16
*	BYTE SUB MESSAGE	254	459	IMAGINE THAT!	207	267	VNS	140,141
*	BYTE SUB SERVICE	276	124	IMCO MANUFACTURING	299	268	VNS	170
*	BYTEWEEK/NEWSLETTER	316	127	INTEGRAND	233	269	WARD SYSTEMS GROUP	242
*	CALIFORNIA DIGITAL	323	128	INTELLITECH	258	270	WARD SYSTEMS GROUP	242
314	CALIFORNIA SCIENTIFIC S/W	88	362	INTERACTIVE SW ENGINEERING	60,61	271	WAREHOUSE DATA	153
52	CAPITAL EQUIPMENT	168	129	IO TECH	35	297	WELLS AMERICAN (N.AMERICA)	221
53	CAPITAL EQUIPMENT	169	130	IO TECH	313	298	WELLS AMERICAN (INT'L)	221
*	CCMI/MCGRAW HILL	193	131	JADE COMPUTER	315	272	WELTEK	151
54	CLONE COMPUTERS	309	132	JAMECO	300,301	273	WELTEK	151
55	COMMUNICATION RESEARCH	164	*	JENSEN & PARTNERS	111	274	WESTERN CONTAINER & CASE	324
56	COMMUNICATION RESEARCH	164	6	J.D.R. MICRODEVICES	326-329	277	WINTEK CORPORATION	9
57	COMPACT DISK PROD.	241	7	J.D.R. MICRODEVICES	326-329	278	WINTEK CORPORATION	317
*	COMPAQ COMP. CORP.	48A-D	133	KADAK PRODUCTS	322	282	XELTEK	310
58	COMPUCLASSICS	273	134	KEA SYSTEMS	313	283	XENTEK	324
59	COMPUCOM	299	315	KISS COMPUTER	310	284	ZENITH DATA SYSTEMS	45
60	COMPUSAVE	311	135	KNOWLEDGE GARDEN	341	285	ZEOS INTERNATIONAL	76,77
61	COMPUTER DSCNT. WREHSE	278	136	KORE, INC.	321	286	ZORTECH	229
62	COMPUTER FRIENDS	319	137	LAHEY COMPUTER SYS.	107	287	Z-WORLD	317
63	COMPUTER MAIL ORDER	72,73	466	LANGUAGE SYSTEMS	212	288	Z-WORLD	317
64	COMPUTER MODULES	308	317	LANTANA TECHNOLOGY	254	211	RADIO SHACK	CIV
65	COMPUTER SYSTEMS RES.	28,29	318	LANTANA TECHNOLOGY	254	*	RAIMA	53
66	COMPUTERLANE	305	199	LASER CONNECTION	43	*	RAIMA	53
455	CONNECTIX	203	138	LINK COMPUTER GRAPHICS	310	212	RAINBOW TECHNOLOGIES	234
67	CONTECH	306	139	LINK COMPUTER GRAPHICS	310	213	RAINBOW TECHNOLOGIES	234
68	CONTROL VISION	313	140	LOGICAL DEVICES	314	214	RAINBOW TECHNOLOGIES	123
69	CORPORATE COMPUTERS OF IOWA	226	141	LOGICAL DEVICES	314	215	RAINBOW TECHNOLOGIES	123
70	CORPORATE COMPUTERS OF IOWA	226	142	LOGICAL DEVICES	314	216	REAL TIME DEVICES	321
71	COUNT DISK	272	143	LOGICAL DEVICES	314	217	ROSE ELECTRONICS	134
72	COVOX	314	144	LOGICAL DEVICES	314	218	ROSE ELECTRONICS	134
456	CRATE TECHNOLOGY	204	145	LOGICAL DEVICES	314	303	RUPP CORP.	109
73	CUBIX CORPORATION	137	146	LOGICAL DEVICES	314	304	RUPP CORP.	109
74	CUBIX CORPORATION	137	147	LOGICAL DEVICES	314	305	RUPP CORP.	109
316	DATA DESK	71	148	LOGITECH	44	306	RUPP CORP.	109
75	DATA TRANSLATION	39	149	LOGITECH	44	307	RUPP CORP.	109
465	DATABILITY SOFTWARE SYS.	188	150	LOGITECH	57	212	RAINBOW TECHNOLOGIES	234
77	DAYTRON ELECTRONICS	322	151	LOGITECH	79	213	RAINBOW TECHNOLOGIES	234
78	DCI COMPUTERS	310	152	LOGITECH	79	214	RAINBOW TECHNOLOGIES	123
79	DELL COMPUTER	CII, I	153	LOGITECH	79	215	RAINBOW TECHNOLOGIES	123
*	DELL COMPUTER	88A-B	154	M2 LAB / MICTRO	284	216	REAL TIME DEVICES	321
80	DELL COMPUTER	89	454	MACFRIENDS	202	217	ROSE ELECTRONICS	134
81	DEPARTMENTAL TECH.	175	155	MARYMAC INDUSTRIES	319	218	ROSE ELECTRONICS	134
						219	ROSE ELECTRONICS	134
						220	ROSE ELECTRONICS	134
						221	ROSE ELECTRONICS	134
						222	ROSE ELECTRONICS	134
						223	ROSE ELECTRONICS	134
						224	ROSE ELECTRONICS	134
						225	ROSE ELECTRONICS	134
						226	ROSE ELECTRONICS	134
						227	ROSE ELECTRONICS	134
						228	ROSE ELECTRONICS	134
						229	ROSE ELECTRONICS	134
						230	ROSE ELECTRONICS	134
						231	ROSE ELECTRONICS	134
						232	ROSE ELECTRONICS	134
						233	ROSE ELECTRONICS	134
						234	ROSE ELECTRONICS	134
						235	ROSE ELECTRONICS	134
						236	ROSE ELECTRONICS	134
						237	ROSE ELECTRONICS	134
						238	ROSE ELECTRONICS	134
						239	ROSE ELECTRONICS	134
						240	ROSE ELECTRONICS	134
						241	ROSE ELECTRONICS	134
						242	ROSE ELECTRONICS	134
						243	ROSE ELECTRONICS	134
						244	ROSE ELECTRONICS	134
						245	ROSE ELECTRONICS	134
						246	ROSE ELECTRONICS	134
						247	ROSE ELECTRONICS	134
						248	ROSE ELECTRONICS	134
						249	ROSE ELECTRONICS	134
						250	ROSE ELECTRONICS	134
						251	ROSE ELECTRONICS	134
						252	ROSE ELECTRONICS	134
						253	ROSE ELECTRONICS	134
						254	ROSE ELECTRONICS	134
						255	ROSE ELECTRONICS	134
						256	ROSE ELECTRONICS	134
						257	ROSE ELECTRONICS	134
						258	ROSE ELECTRONICS	134
						259	ROSE ELECTRONICS	134
						260	ROSE ELECTRONICS	134
						261	ROSE ELECTRONICS	134
						262	ROSE ELECTRONICS	134
						263	ROSE ELECTRONICS	134
						264	ROSE ELECTRONICS	134
						265	ROSE ELECTRONICS	134
						266	ROSE ELECTRONICS	134
						267	ROSE ELECTRONICS	134
						268	ROSE ELECTRONICS	134
						269	ROSE ELECTRONICS	134
						270	ROSE ELECTRONICS	134
						271	ROSE ELECTRONICS	134
						272	ROSE ELECTRONICS	134
						273	ROSE ELECTRONICS	134
						274	ROSE ELECTRONICS	134
						275	ROSE ELECTRONICS	134
						276	ROSE ELECTRONICS	134
						277	ROSE ELECTRONICS	134
						278	ROSE ELECTRONICS	134
						279	ROSE ELECTRONICS	

READER SERVICE

To get further information on the products advertised in BYTE, fill out the reader service card by circling the numbers on the card that correspond to the inquiry number listed with the advertiser. This index is provided as an additional service by the publisher, who assumes no liability for errors or omissions.

* Correspond directly with company.

Index to Advertisers by Product Category

Inquiry No.	Page No.	Inquiry No.	Page No.	Inquiry No.	Page No.	Inquiry No.	Page No.			
HARDWARE										
813 ADD INS										
17	ALPHA PRODUCTS	308	453	AMERICAN MICRO DISTRIB.	193	26	ATI TECHNOLOGIES	243		
322	B & C MICRO	317	323	B & C MICRO	317	403	BLUE CHIP	IS-46		
52	CAPITAL EQUIPMENT	168	53	CAPITAL EQUIPMENT	169	64	COMPUTER MODULES	308		
68	CONTROL VISION	313	72	COVOX	314	75	DATA TRANSLATION	39		
87	DIVERSIFIED TECHNOLOGY	96	88	DYNAMIC ELECTRONICS	313	90	ELECTRONIC ENERGY CTRL.	308		
100	FTG DATA SYSTEMS	308	413	GAMMA PRODUCTIONS	IS-6	414	GAMMA PRODUCTIONS	IS-6		
105	GTEK	262	106	GTEK	262	109	HANTZ & PARTNER	324		
115	HIGH RES. TECH	322	524	HOLMES MICROSYSTEMS, INC.	PC-3	525	HOLMES MICROSYSTEMS, INC.	PC-3		
500	HOLMES MICROSYSTEMS	NE-14	501	HOLMES MICROSYSTEMS	NE-14	420	INES GMBH	IS-32		
422	INTERQUADRAM	IS-5	423	INTERQUADRAM	IS-7	424	INTERQUADRAM	IS-9		
129	IO TECH	35	517	JST PRODUCTS	PC-5	518	JST PRODUCTS	PC-5		
138	LINK COMPUTER GRAPHICS	310	139	LINK COMPUTER GRAPHICS	310	157	MAXON	112		
156	MAXON	112	167	MIDI MUSIC	313	180	NOHAU	321		
188	PERISCOPE	264	189	PERISCOPE	264	192	PI COMPUTER CORP.	307		
193	PI COMPUTER CORP.	307	430	PRICE TREND LIMITED	IS-29	200	QUA TECH	317		
201	QUA TECH	317	202	QUA TECH	276	216	REAL TIME DEVICES	321		
247	TELEBYTE TECHNOLOGY	107	496	TELETEK	NE-3	497	TELETEK	NE-3		
528	TELETEK	PC-11	529	TELETEK	PC-11	258	TRUEVISION	184		
286	Z-WORLD	317	814 DRIVES							
321	MEGA DRIVE	263	272	WELTEK	151	273	WELTEK	151		
615 HARDWARE PROGRAMMERS										
31	B P MICROSYSTEMS	313	34	B & C MICRO	319	136	KORE, INC.	321		
140	LOGICAL DEVICES	314	141	LOGICAL DEVICES	314	142	LOGICAL DEVICES	314		
143	LOGICAL DEVICES	314	144	LOGICAL DEVICES	314	145	LOGICAL DEVICES	314		
146	LOGICAL DEVICES	314	147	LOGICAL DEVICES	314	177	NEEDHAM ELECTRONICS	324		
279	WINTEK CORPORATION	317	282	XELTEK	310	568	ZERICON	SO-3		
816 INSTRUMENTATION										
91 ELEXOR, INC.										
817 KEYBOARDS/MICE										
318	DATA DESK	71	416	GTCO CORPORATION	IS-17	417	GTCO CORPORATION	IS-17		
290	HOOLEON	42	291	HOOLEON	42	150	LOGITECH	57		
151	LOGITECH	57	544	MEXTEL	MW-2	545	MEXTEL	MW-2		
520	MEXTEL	PC-6	521	MEXTEL	PC-6	313	MICROSPEED	173		
11	MULTIPAL INT'L LA	216	12	MULTIPAL INT'L LA	216	818 MASS STORAGE				
18	AK SYSTEMS	322	28	AUREX MAGNETIC	138	29	AUREX MAGNETIC	138		
40	BIOLOGICAL ENGINEERING	312	67	CONTECH	308	456	CRATE TECHNOLOGY	204		
63	DIGI-DATA CORP.	307	321	MEGA DRIVE	263	183	OVERLAND DATA	310		
295	PINNACLE MICRO	283	296	PINNACLE MICRO	283	203	QUALSTAR	80		
204	QUALSTAR	321	239	STORAGE DIMENSIONS	180,181	240	STORAGE DIMENSIONS	180,181		
311	STORAGE DIMENSIONS	180,181	312	STORAGE DIMENSIONS	180,181	567	UNDERWARE ELECTRONICS	SO-5		
819 MISCELLANEOUS										
127	INTEGRAND	233	163	MERRITT COMPUTERS	86	303	RUPP CORP.	109		
304	RUPP CORP.	109	305	RUPP CORP.	109	306	RUPP CORP.	109		
307	RUPP CORP.	109	308	RUPP CORP.	109	820 MODEMS/MULTIPLEXORS				
25	ATI TECHNOLOGIES	27	404	CLEO SOFTWARE	IS-14	59	COMPUCOM	299		
513	E-TECH RESEARCH, INC.	PC-4	502	E-TECH RESEARCH, INC.	NE-12	320	OKIDATA	277		
527	OSMOS, INC.	PC-2	269	QUAY COMPUTER	151	246	TELEBIT	75		
255	TOUCHBASE SYSTEMS	36	371 MONITORS			92	ELITE MICROSYSTEMS	98		
170	MITSUBISHI	104,105	171	MITSUBISHI	104,105	174	NANAO	160		
175	NANAO	180	* NEC HOME ELECT. USA	20,21	* NEC HOME ELECT. USA	188,189	319	TATUNG	275	
821 NETWORK HARDWARE										
481	A/C/T	NE-15	482	A/C/T	NE-15	504	A/C/T	PC-13		
505	A/C/T	PC-13	35	BAY TECH	168	38	BAY TECH	166		
73	CUBIX CORPORATION	137	74	CUBIX CORPORATION	137	407	DATEX	IS-25		
124	IMCO MANUFACTURING	299	130	IO TECH	313	154	M2 LAB / MICTRO	284		
* MAXCIMA		310	178	NETWORK TECHNOLOGIES	314	428	NICHOLS-MORELOS	IS-40		
217	ROSE ELECTRONICS	134	218	ROSE ELECTRONICS	134	431	SCANDEC TRIBUTOR	IS-39		
249	THOMAS CONRAD	139	822 POWER SUPPLIES			185	PARASYSTEMS	87		
823 PRINTERS/PLOTTERS										
* AEG OLYMPIA		249	110	HEWLETT-PACKARD PERIPH.	14,15	112	HEWLETT-PACKARD PERIPH.	158,159		
113	HEWLETT-PACKARD PERIPH.	131	114	HEWLETT-PACKARD PERIPH.	133	121	HOUSTON INSTRUMENT	157		
532	ZERICON	PC-15	553	ZERICON	MW-10	824 PRINTER RIBBONS				
62	COMPUTER FRIENDS	319	825 SCANNERS/DIGITIZERS							
409	FLAGSTAFF ENGINEERING	IS-2	410	FLAGSTAFF ENGINEERING	IS-2	411	FLAGSTAFF ENGINEERING	IS-2		
412	FLAGSTAFF ENGINEERING	IS-2	152	LOGITECH	79	153	LOGITECH	79		
* SQUARE FIELD TECH.		SO-7	257	TRUE DATA	272	826 SOFTWARE SECURITY				
196	PROTECH MARKETING	78	212	RAINBOW TECHNOLOGIES	234	213	RAINBOW TECHNOLOGIES	234		
214	RAINBOW TECHNOLOGIES	123	215	RAINBOW TECHNOLOGIES	123	234	SOFTWARE SECURITY	176		
827 SYSTEMS										
13	ADVANCED LOGIC RESEARCH	2,3	14	ADVANCED LOGIC RESEARCH	2,3	* AMPRO		100		
401	AQUARIUS SYSTEMS	IS-27	* BINARY TECHNOLOGY		322	41	BIT WISE	269		
42	BIT WISE	269	42	BIT WISE	269	508	BI-LINK	PC-9		
509	BI-LINK	PC-9	510	CDS ADV. COMP. PROD.	PC-1	* COMPAQ COMPUTER CORP.		48A-D		
85	COMPUTER SYSTEMS RES.	28,29	406	COPAM ELECTRONICS CORP.	IS-35	89	CORPORATE COMPUTERS OF IOWA	228		
70	CORPORATE COMPUTERS OF IOWA	226	78	DCI COMPUTERS	310	79	DELL COMPUTER	CI1,1		
80	DELL COMPUTER	89	* DELL COMPUTER		88A-B	* EPSON		32-34		
98	FORTRON CORP.(N.AMERICA)	121	97	FORTRON CORP.(N.AMERICA)	121	309	FORTRON CORP.(INT'L)	121		
310	FORTRON CORP.(INT'L)	121	488	FOUNTAIN TECHNOLOGIES	NE-7	101	GATEWAY 2000	10,11		
561	GENERAL BUSINESS MACH.	SO-11	562	GENERAL BUSINESS MACH.	SO-11	294	GRID SYSTEMS	97		
489	HALSKAR SYSTEMS	NE-11	490	HALSKAR SYSTEMS	NE-11	117	HITECH EQUIPMENT CORP.	308		
421	INTERLAND INFORMATION	IS-22	542	ISD COMPANY	MW-1	543	ISD COMPANY	MW-1		
315	KISS COMPUTER	310	162	MEGATEL COMPUTER	80	526	MIRACLE COMPUTERS	PC-13		
168	MITSUBISHI	147	169	MITSUBISHI	147	569	OWL COMPUTER	SO-9		
570	OWL COMPUTER	SO-9	574	OWL COMPUTER	NE-4	575	OWL COMPUTER	NE-4		
184	PACIFIC COMPUTER	304	192	PI COMPUTER CORP.	307	193	PI COMPUTER CORP.	307		
430	PRICE TREND LIMITED	IS-29	211	RADIO SHACK	CIV	225	SCHWAB COMPUTER CENTER	324		
229	SCIOTO COMPUTERS	321	252	TOSHIBA	41	253	TOSHIBA	41		
435	TRIANGLE DIGITAL	IS-46	259	TUSSEY COMPUTER PROD.	165	267	VNS	140,141		
266	VNS	170	498	WEDGE TECHNOLOGY, INC.	NE-6	499	WEDGE TECHNOLOGY, INC.	NE-6		
297	WELLS AMERICA (N.AMERICA)	221	298	WELLS AMERICA (INT'L)	221	284	ZENITH DATA SYSTEMS	45		
285	ZEOS INTERNATIONAL	76,77	SOFTWARE							
828 APPLE2/MAC APPLICATIONS Business/Office										
98	FOX SOFTWARE	23	459	IMAGINE THAT!	207	* RAIMA		190		
829 APPLE2/MAC APPLICATIONS Scientific/Technical										
452	ALLAN BONADIO ASSOC	208	451	ALLAN BONADIO ASSOC	208	459	IMAGINE THAT!	207		
460	MCAE	212	461	MCAE	212	830 APPLE2/MAC APPLICATIONS Word Processing				
463	PARAGON CONCEPTS INC.	209								

FREE INFORMATION

Want More Information About the Products and Advertisers Featured in this Issue?

- 1** Circle numbers on reply card which correspond to numbers assigned to items of interest to you.
- 2** Check all the appropriate answers to questions "A" through "C".
- 3** Print your name and address and mail.

BUSINESS REPLY MAIL

FIRST CLASS MAIL PERMIT NO. 176 PITTSFIELD, MA

POSTAGE WILL BE PAID BY ADDRESSEE



READER SERVICE
PO Box 5110
Pittsfield, MA 01203-9926
USA

NO POSTAGE
NECESSARY
IF MAILED
IN THE
UNITED STATES



Fill out this coupon carefully. PLEASE PRINT.

Name _____
 Title _____ (_____) Phone _____
 Company _____
 Address _____
 City _____ State _____ Zip _____

- A. What is your level of management responsibility?**
 1 Senior-level Management
 2 Other Management
 3 Non-Management
- B. What is your primary job function/principal area of responsibility? (Check one.)**
 4 Administration
 5 Accounting/Finance
 6 MIS/DP/Information Center
 7 Product Design and Development
 8 Research and Development
 9 Manufacturing
 10 Sales/Marketing
 11 Purchasing
 12 Personnel
 13 Education/Training
 14 Other: _____
- C. Please indicate your organization's primary business activity: (Check one.)**
 15 Manufacturer (Hardware, Software)
- 16 Computer Retail Stores
 17 Consultants
 18 Service Bureau/Planning
 19 Distributor/Wholesaler
 20 Systems House/Integrator/VAR
 21 Other: _____
- Non-Computer-Related Businesses:**
 22 Manufacturing
 23 Finance, Insurance, Real Estate
 24 Retail/Wholesale
 25 Education
 26 Government
 27 Military
 28 Professions (Law, Medicine, Engineering, Architecture)
 29 Consulting
 30 Other Business Services
 31 Transportation, Communications, Utilities
 32 Other: _____

1	2	3	4	5	6	7	8	9	10	11	12	13	14	15	16	17	18	19	20	21	22	23	24	25	26	27	28	29	30
31	32	33	34	35	36	37	38	39	40	41	42	43	44	45	46	47	48	49	50	51	52	53	54	55	56	57	58	59	60
61	62	63	64	65	66	67	68	69	70	71	72	73	74	75	76	77	78	79	80	81	82	83	84	85	86	87	88	89	90
91	92	93	94	95	96	97	98	99	100	101	102	103	104	105	106	107	108	109	110	111	112	113	114	115	116	117	118	119	120
121	122	123	124	125	126	127	128	129	130	131	132	133	134	135	136	137	138	139	140	141	142	143	144	145	146	147	148	149	150
151	152	153	154	155	156	157	158	159	160	161	162	163	164	165	166	167	168	169	170	171	172	173	174	175	176	177	178	179	180
181	182	183	184	185	186	187	188	189	190	191	192	193	194	195	196	197	198	199	200	201	202	203	204	205	206	207	208	209	210
211	212	213	214	215	216	217	218	219	220	221	222	223	224	225	226	227	228	229	230	231	232	233	234	235	236	237	238	239	240
241	242	243	244	245	246	247	248	249	250	251	252	253	254	255	256	257	258	259	260	261	262	263	264	265	266	267	268	269	270
271	272	273	274	275	276	277	278	279	280	281	282	283	284	285	286	287	288	289	290	291	292	293	294	295	296	297	298	299	300
301	302	303	304	305	306	307	308	309	310	311	312	313	314	315	316	317	318	319	320	321	322	323	324	325	326	327	328	329	330
331	332	333	334	335	336	337	338	339	340	341	342	343	344	345	346	347	348	349	350	351	352	353	354	355	356	357	358	359	360
361	362	363	364	365	366	367	368	369	370	371	372	373	374	375	376	377	378	379	380	381	382	383	384	385	386	387	388	389	390
391	392	393	394	395	396	397	398	399	400	401	402	403	404	405	406	407	408	409	410	411	412	413	414	415	416	417	418	419	420
421	422	423	424	425	426	427	428	429	430	431	432	433	434	435	436	437	438	439	440	441	442	443	444	445	446	447	448	449	450
451	452	453	454	455	456	457	458	459	460	461	462	463	464	465	466	467	468	469	470	471	472	473	474	475	476	477	478	479	480
481	482	483	484	485	486	487	488	489	490	491	492	493	494	495	496	497	498	499	500	501	502	503	504	505	506	507	508	509	510
511	512	513	514	515	516	517	518	519	520	521	522	523	524	525	526	527	528	529	530	531	532	533	534	535	536	537	538	539	540
541	542	543	544	545	546	547	548	549	550	551	552	553	554	555	556	557	558	559	560	561	562	563	564	565	566	567	568	569	570
571	572	573	574	575	576	577	578	579	580	581	582	583	584	585	586	587	588	589	590	591	592	593	594	595	596	597	598	599	600
601	602	603	604	605	606	607	608	609	610	611	612	613	614	615	616	617	618	619	620	621	622	623	624	625	626	627	628	629	630
631	632	633	634	635	636	637	638	639	640	641	642	643	644	645	646	647	648	649	650	651	652	653	654	655	656	657	658	659	660
661	662	663	664	665	666	667	668	669	670	671	672	673	674	675	676	677	678	679	680	681	682	683	684	685	686	687	688	689	690
691	692	693	694	695	696	697	698	699	700	701	702	703	704	705	706	707	708	709	710	711	712	713	714	715	716	717	718	719	720
721	722	723	724	725	726	727	728	729	730	731	732	733	734	735	736	737	738	739	740	741	742	743	744	745	746	747	748	749	750
751	752	753	754	755	756	757	758	759	760	761	762	763	764	765	766	767	768	769	770	771	772	773	774	775	776	777	778	779	780
781	782	783	784	785	786	787	788	789	790	791	792	793	794	795	796	797	798	799	800	801	802	803	804	805	806	807	808	809	810
811	812	813	814	815	816	817	818	819	820	821	822	823	824	825	826	827	828	829	830	831	832	833	834	835	836	837	838	839	840
841	842	843	844	845	846	847	848	849	850	851	852	853	854	855	856	857	858	859	860	861	862	863	864	865	866	867	868	869	870
871	872	873	874	875	876	877	878	879	880	881	882	883	884	885	886	887	888	889	890	891	892	893	894	895	896	897	898	899	900
901	902	903	904	905	906	907	908	909	910	911	912	913	914	915	916	917	918	919	920	921	922	923	924	925	926	927	928	929	930
931	932	933	934	935	936	937	938	939	940	941	942	943	944	945	946	947	948	949	950	951	952	953	954	955	956	957	958	959	960
961	962	963	964	965	966	967	968	969	970	971	972	973	974	975	976	977	978	979	980	981	982	983	984	985	986	987	988	989	990
991	992	993	994	995	996	997	998	999	1000	1001	1002	1003	1004	1005	1006	1007	1008	1009	1010	1011	1012	1013	1014	1015	1016	1017	1018	1019	1020
1021	1022	1023	1024	1025	1026	1027	1028	1029	1030	1031	1032	1033	1034	1035	1036	1037	1038	1039	1040	1041	1042	1043	1044	1045	1046	1047	1048	1049	1050
1051	1052	1053	1054	1055	1056	1057	1058	1059	1060	1061	1062	1063	1064	1065	1066	1067	1068	1069	1070	1071	1072	1073	1074	1075	1076	1077	1078	1079	1080
1081	1082	1083	1084	1085	1086	1087	1088	1089	1090	1091	1092	1093	1094	1095	1096	1097	1098	1099	1100	1101	1102	1103	1104	1105	1106	1107	1108	1109	1110
1111	1112	1113	1114	1115	1116	1117	1118	1119	1120	1121	1122	1123	1124	1125	1126	1127	1128	1129	1130	1131	1132	1133	1134	1135	1136	1137	1138	1139	1140
1141	1142	1143	1144	1145	1146	1147	1148	1149	1150	1151	1152	1153	1154	1155	1156	1157	1158	1159	1160	1161	1162	1163	1164	1165	1166	1167	1168	1169	1170
1171	1172	1173	1174	1175	1176	1177	1178	1179	1180	1181	1182	1183	1184	1185	1186	1187	1188	1189	1190	1191	1192	1193	1194	1195	1196	1197	1198	1199	1200

AUGUST
IRSD002

FREE INFORMATION

Want More Information About the Products and Advertisers Featured in this Issue?

1 Circle numbers on reply card which correspond to numbers assigned to items of interest to you.

2 Check all the appropriate answers to questions "A" through "C".

3 Print your name and address and mail.

Fill out this coupon carefully. PLEASE PRINT.

Name _____
 Title _____ (_____) Phone _____
 Company _____
 Address _____
 City _____ State _____ Zip _____

A. What is your level of management responsibility?
 Senior-level Management
 Other Management
 Non-Management

B. What is your primary job function/principal area of responsibility? (Check one.)
 Administration
 Accounting/Finance
 MIS/DP/Information Center
 Product Design and Development
 Research and Development
 Manufacturing
 Sales/Marketing
 Purchasing
 Personnel
 Education/Training
 Other _____

C. Please indicate your organization's primary business activity: (Check one.)
 Computer-Related Businesses:
 Manufacturer (Hardware, Software)

- 16 Computer Retail Stores
- 17 Consultants
- 18 Service Bureau/Planning
- 19 Distributor/Wholesaler
- 20 Systems House/Integrator/VAR
- 21 Other _____
- Non-Computer-Related Businesses:**
- 22 Manufacturing
- 23 Finance, Insurance, Real Estate
- 24 Retail/Wholesale
- 25 Education
- 26 Government
- 27 Military
- 28 Professions (Law, Medicine, Engineering, Architecture)
- 29 Consulting
- 30 Other Business Services
- 31 Transportation, Communications, Utilities
- 32 Other _____

AUGUST
IRSD002

1	2	3	4	5	6	7	8	9	10	11	12	13	14	15	16	17	18	19	20	21	22	23	24	25	26	27	28	29	30
31	32	33	34	35	36	37	38	39	40	41	42	43	44	45	46	47	48	49	50	51	52	53	54	55	56	57	58	59	60
61	62	63	64	65	66	67	68	69	70	71	72	73	74	75	76	77	78	79	80	81	82	83	84	85	86	87	88	89	90
91	92	93	94	95	96	97	98	99	100	101	102	103	104	105	106	107	108	109	110	111	112	113	114	115	116	117	118	119	120
121	122	123	124	125	126	127	128	129	130	131	132	133	134	135	136	137	138	139	140	141	142	143	144	145	146	147	148	149	150
151	152	153	154	155	156	157	158	159	160	161	162	163	164	165	166	167	168	169	170	171	172	173	174	175	176	177	178	179	180
181	182	183	184	185	186	187	188	189	190	191	192	193	194	195	196	197	198	199	200	201	202	203	204	205	206	207	208	209	210
211	212	213	214	215	216	217	218	219	220	221	222	223	224	225	226	227	228	229	230	231	232	233	234	235	236	237	238	239	240
241	242	243	244	245	246	247	248	249	250	251	252	253	254	255	256	257	258	259	260	261	262	263	264	265	266	267	268	269	270
271	272	273	274	275	276	277	278	279	280	281	282	283	284	285	286	287	288	289	290	291	292	293	294	295	296	297	298	299	300
301	302	303	304	305	306	307	308	309	310	311	312	313	314	315	316	317	318	319	320	321	322	323	324	325	326	327	328	329	330
331	332	333	334	335	336	337	338	339	340	341	342	343	344	345	346	347	348	349	350	351	352	353	354	355	356	357	358	359	360
361	362	363	364	365	366	367	368	369	370	371	372	373	374	375	376	377	378	379	380	381	382	383	384	385	386	387	388	389	390
391	392	393	394	395	396	397	398	399	400	401	402	403	404	405	406	407	408	409	410	411	412	413	414	415	416	417	418	419	420
421	422	423	424	425	426	427	428	429	430	431	432	433	434	435	436	437	438	439	440	441	442	443	444	445	446	447	448	449	450
451	452	453	454	455	456	457	458	459	460	461	462	463	464	465	466	467	468	469	470	471	472	473	474	475	476	477	478	479	480
481	482	483	484	485	486	487	488	489	490	491	492	493	494	495	496	497	498	499	500	501	502	503	504	505	506	507	508	509	510
511	512	513	514	515	516	517	518	519	520	521	522	523	524	525	526	527	528	529	530	531	532	533	534	535	536	537	538	539	540
541	542	543	544	545	546	547	548	549	550	551	552	553	554	555	556	557	558	559	560	561	562	563	564	565	566	567	568	569	570
571	572	573	574	575	576	577	578	579	580	581	582	583	584	585	586	587	588	589	590	591	592	593	594	595	596	597	598	599	600
601	602	603	604	605	606	607	608	609	610	611	612	613	614	615	616	617	618	619	620	621	622	623	624	625	626	627	628	629	630
631	632	633	634	635	636	637	638	639	640	641	642	643	644	645	646	647	648	649	650	651	652	653	654	655	656	657	658	659	660
661	662	663	664	665	666	667	668	669	670	671	672	673	674	675	676	677	678	679	680	681	682	683	684	685	686	687	688	689	690
691	692	693	694	695	696	697	698	699	700	701	702	703	704	705	706	707	708	709	710	711	712	713	714	715	716	717	718	719	720
721	722	723	724	725	726	727	728	729	730	731	732	733	734	735	736	737	738	739	740	741	742	743	744	745	746	747	748	749	750
751	752	753	754	755	756	757	758	759	760	761	762	763	764	765	766	767	768	769	770	771	772	773	774	775	776	777	778	779	780
781	782	783	784	785	786	787	788	789	790	791	792	793	794	795	796	797	798	799	800	801	802	803	804	805	806	807	808	809	810
811	812	813	814	815	816	817	818	819	820	821	822	823	824	825	826	827	828	829	830	831	832	833	834	835	836	837	838	839	840
841	842	843	844	845	846	847	848	849	850	851	852	853	854	855	856	857	858	859	860	861	862	863	864	865	866	867	868	869	870
871	872	873	874	875	876	877	878	879	880	881	882	883	884	885	886	887	888	889	890	891	892	893	894	895	896	897	898	899	900
901	902	903	904	905	906	907	908	909	910	911	912	913	914	915	916	917	918	919	920	921	922	923	924	925	926	927	928	929	930
931	932	933	934	935	936	937	938	939	940	941	942	943	944	945	946	947	948	949	950	951	952	953	954	955	956	957	958	959	960
961	962	963	964	965	966	967	968	969	970	971	972	973	974	975	976	977	978	979	980	981	982	983	984	985	986	987	988	989	990
991	992	993	994	995	996	997	998	999	1000	1001	1002	1003	1004	1005	1006	1007	1008	1009	1010	1011	1012	1013	1014	1015	1016	1017	1018	1019	1020
1021	1022	1023	1024	1025	1026	1027	1028	1029	1030	1031	1032	1033	1034	1035	1036	1037	1038	1039	1040	1041	1042	1043	1044	1045	1046	1047	1048	1049	1050
1051	1052	1053	1054	1055	1056	1057	1058	1059	1060	1061	1062	1063	1064	1065	1066	1067	1068	1069	1070	1071	1072	1073	1074	1075	1076	1077	1078	1079	1080
1081	1082	1083	1084	1085	1086	1087	1088	1089	1090	1091	1092	1093	1094	1095	1096	1097	1098	1099	1100	1101	1102	1103	1104	1105	1106	1107	1108	1109	1110
1111	1112	1113	1114	1115	1116	1117	1118	1119	1120	1121	1122	1123	1124	1125	1126	1127	1128	1129	1130	1131	1132	1133	1134	1135	1136	1137	1138	1139	1140
1141	1142	1143	1144	1145	1146	1147	1148	1149	1150	1151	1152	1153	1154	1155	1156	1157	1158	1159	1160	1161	1162	1163	1164	1165	1166	1167	1168	1169	1170
1171	1172	1173	1174	1175	1176	1177	1178	1179	1180	1181	1182	1183	1184	1185	1186	1187	1188	1189	1190	1191	1192	1193	1194	1195	1196	1197	1198	1199	1200

Please send me one year of BYTE Magazine for \$24.95 and bill me. Offer valid in U.S. and possessions only.



NO POSTAGE
NECESSARY
IF MAILED
IN THE
UNITED STATES

BUSINESS REPLY MAIL
FIRST CLASS MAIL PERMIT NO. 176 PITTSFIELD, MA

POSTAGE WILL BE PAID BY ADDRESSEE



READER SERVICE
PO Box 5110
Pittsfield, MA 01203-9926
USA



REQUEST FREE INFORMATION BY FAX

Attention BYTE Readers!! Now you can fax your requests for free product and advertiser information featured in this issue.

Just fax this page to 1-413-637-4343. You'll save time because your request for information will be processed as soon as your fax is received.

- 1** Circle the numbers below which correspond to the numbers assigned to advertisers and products that interest you.
- 2** Check off the answers to questions "A" through "C".
- 3** Print your name, address, and fax number clearly on the form.
- 4** Remove this page or copy this page clearly and fax it to the number above.

Fill out this coupon carefully. PLEASE PRINT.

Name _____

Title _____

Company _____

Address _____

City _____

State/Province _____ Zip _____

Country _____

Phone Number _____ Fax Number _____

A. What is your level of management responsibility?

1 Senior-level Management

2 Other Management

3 Non-Management

B. What is your primary job function/principal area of responsibility? (Check one.)

4 Administration

5 Accounting/Finance

6 MIS/DP/Information Center

7 Product Design and Development

8 Research and Development

9 Manufacturing

10 Sales/Marketing

11 Purchasing

12 Personnel

13 Education/Training

14 Other: _____

C. Please indicate your organization's primary business activity: (Check one.)

Computer-Related Businesses:

15 Manufacturer (Hardware, Software)

16 Computer Retail Stores

17 Consultants

18 Service Bureau/Planning

19 Distributor/Wholesaler

20 Systems House/Integrator/VAR

21 Other: _____

Non-Computer-Related Businesses:

22 Manufacturing

23 Finance, Insurance, Real Estate

24 Retail/Wholesale

25 Education

26 Government

27 Military

28 Professions (Law, Medicine, Engineering, Architecture)

29 Consulting

30 Other Business Services

31 Transportation, Communications, Utilities

32 Other: _____

Please send me one year of BYTE Magazine for \$24.95 and bill me. Offer valid in U.S. and possessions only.

AUGUST 1989 IBJF008

1	2	3	4	5	6	7	8	9	10	11	12	13	14	15	16	17	18	19	20
21	22	23	24	25	26	27	28	29	30	31	32	33	34	35	36	37	38	39	40
41	42	43	44	45	46	47	48	49	50	51	52	53	54	55	56	57	58	59	60
61	62	63	64	65	66	67	68	69	70	71	72	73	74	75	76	77	78	79	80
81	82	83	84	85	86	87	88	89	90	91	92	93	94	95	96	97	98	99	100
101	102	103	104	105	106	107	108	109	110	111	112	113	114	115	116	117	118	119	120
121	122	123	124	125	126	127	128	129	130	131	132	133	134	135	136	137	138	139	140
141	142	143	144	145	146	147	148	149	150	151	152	153	154	155	156	157	158	159	160
161	162	163	164	165	166	167	168	169	170	171	172	173	174	175	176	177	178	179	180
181	182	183	184	185	186	187	188	189	190	191	192	193	194	195	196	197	198	199	200
201	202	203	204	205	206	207	208	209	210	211	212	213	214	215	216	217	218	219	220
221	222	223	224	225	226	227	228	229	230	231	232	233	234	235	236	237	238	239	240
241	242	243	244	245	246	247	248	249	250	251	252	253	254	255	256	257	258	259	260
261	262	263	264	265	266	267	268	269	270	271	272	273	274	275	276	277	278	279	280
281	282	283	284	285	286	287	288	289	290	291	292	293	294	295	296	297	298	299	300
301	302	303	304	305	306	307	308	309	310	311	312	313	314	315	316	317	318	319	320
321	322	323	324	325	326	327	328	329	330	331	332	333	334	335	336	337	338	339	340
341	342	343	344	345	346	347	348	349	350	351	352	353	354	355	356	357	358	359	360
361	362	363	364	365	366	367	368	369	370	371	372	373	374	375	376	377	378	379	380
381	382	383	384	385	386	387	388	389	390	391	392	393	394	395	396	397	398	399	400
401	402	403	404	405	406	407	408	409	410	411	412	413	414	415	416	417	418	419	420
421	422	423	424	425	426	427	428	429	430	431	432	433	434	435	436	437	438	439	440
441	442	443	444	445	446	447	448	449	450	451	452	453	454	455	456	457	458	459	460
461	462	463	464	465	466	467	468	469	470	471	472	473	474	475	476	477	478	479	480
481	482	483	484	485	486	487	488	489	490	491	492	493	494	495	496	497	498	499	500
501	502	503	504	505	506	507	508	509	510	511	512	513	514	515	516	517	518	519	520
521	522	523	524	525	526	527	528	529	530	531	532	533	534	535	536	537	538	539	540
541	542	543	544	545	546	547	548	549	550	551	552	553	554	555	556	557	558	559	560
561	562	563	564	565	566	567	568	569	570	571	572	573	574	575	576	577	578	579	580
581	582	583	584	585	586	587	588	589	590	591	592	593	594	595	596	597	598	599	600
601	602	603	604	605	606	607	608	609	610	611	612	613	614	615	616	617	618	619	620
621	622	623	624	625	626	627	628	629	630	631	632	633	634	635	636	637	638	639	640
641	642	643	644	645	646	647	648	649	650	651	652	653	654	655	656	657	658	659	660
661	662	663	664	665	666	667	668	669	670	671	672	673	674	675	676	677	678	679	680
681	682	683	684	685	686	687	688	689	690	691	692	693	694	695	696	697	698	699	700
701	702	703	704	705	706	707	708	709	710	711	712	713	714	715	716	717	718	719	720
721	722	723	724	725	726	727	728	729	730	731	732	733	734	735	736	737	738	739	740
741	742	743	744	745	746	747	748	749	750	751	752	753	754	755	756	757	758	759	760
761	762	763	764	765	766	767	768	769	770	771	772	773	774	775	776	777	778	779	780
781	782	783	784	785	786	787	788	789	790	791	792	793	794	795	796	797	798	799	800
801	802	803	804	805	806	807	808	809	810	811	812	813	814	815	816	817	818	819	820
821	822	823	824	825	826	827	828	829	830	831	832	833	834	835	836	837	838	839	840
841	842	843	844	845	846	847	848	849	850	851	852	853	854	855	856	857	858	859	860
861	862	863	864	865	866	867	868	869	870	871	872	873	874	875	876	877	878	879	880
881	882	883	884	885	886	887	888	889	890	891	892	893	894	895	896	897	898	899	900
901	902	903	904	905	906	907	908	909	910	911	912	913	914	915	916	917	918	919	920
921	922	923	924	925	926	927	928	929	930	931	932	933	934	935	936	937	938	939	940
941	942	943	944	945	946	947	948	949	950	951	952	953	954	955	956	957	958	959	960
961	962	963	964	965	966	967	968	969	970	971	972	973	974	975	976	977	978	979	980
981	982	983	984	985	986	987	988	989	990	991	992	993	994	995	996	997	998	999	1000
1001	1002	1003	1004	1005	1006	1007	1008	1009	1010	1011	1012	1013	1014	1015	1016	1017	1018	1019	1020
1021	1022	1023	1024	1025	1026	1027	1028	1029	1030	1031	1032	1033	1034	1035	1036	1037	1038	1039	1040
1041	1042	1043	1044	1045	1046	1047	1048	1049	1050	1051	1052	1053	1054	1055	1056	1057	1058	1059	1060
1061	1062	1063	1064	1065	1066	1067	1068	1069	1070	1071	1072	1073	1074	1075	1076	1077	1078	1079	1080
1081	1082	1083	1084	1085	1086	1087	1088	1089	1090	1091	1092	1093	1094	1095	1096	1097	1098	1099	1100
1101	1102	1103	1104	1105	1106	1107	1108	1109	1110	1111	1112	1113	1114	1115	1116	1117	1118	1119	1120
1121	1122	1123	1124	1125	1126	1127	1128	1129	1130	1131	1132	1133	1134	1135	1136	1137	1138	1139	1140
1141	1142	1143	1144	1145	1146	1147	1148	1149	1150	1151	1152	1153	1154	1155	1156	1157	1158	1159	1160
1161	1162	1163	1164	1165	1166	1167	1168	1169	1170	1171	1172	1173	1174	1175	1176	1177	1178	1179	1180
1181	1182	1183	1184	1185	1186	1187	1188	1189	1190	1191	1192	1193	1194	1195	1196	1197	1198	1199	1200

continued from page 286

the requested amount perfectly. It has been pointed out, however (Knuth, *The Art of Computer Programming*), that a best-fit algorithm may actually make the job of compaction more difficult by promoting the proliferation of too-small-to-be-useful-to-anyone fragments.

Another improvement is possible through the fact that the m-nodes are kept on a doubly linked list. It works like this: Suppose a request is made for a 16K-byte block of memory and the allocation routine finds that it cannot fulfill the request. The allocation routine calls COMPACT, and when COMPACT returns, it tells the allocation routine that the largest single free block it was able to create is 20K bytes. Now the allocation routine knows the request can be satisfied; but instead of starting at the bottom of the list of m-nodes (looking for a first-fit), the routine starts at the top of the list and works down. The idea is that since compaction has moved free blocks toward higher memory, you should begin looking at that end.

Such a Deal!

The memory management package I've described here is available in source code form. I've added interface routines for Turbo C, but I've no doubt the package can be modified to coexist with other languages. You should find the memory manager useful in putting together applications for text processing, AI, or areas where complex data structures are continually created, merged, and destroyed.

For those of you interested in immediate gratification, I'll put it this way: If you're up against the wall because your program has memory-allocation problems and you suspect that fragmentation is the culprit, this package might take care of it. In any case, you'll be making your own little assault on the latest string of virtual memory management software appearing on the market. ■

Editor's note: *The full text of the 8086 assembly language source code is available in a variety of formats. See page 5 for details.*

Rick Grehan is the director of the BYTE Lab. He has a B.S. in physics and applied mathematics and an M.S. in computer science/mathematics from Memphis State University. He can be reached on BIX as "rick_g."

Your questions and comments are welcome. Write to: Editor, BYTE, One Phoenix Mill Lane, Peterborough, NH 03458.

```

END
ELSE
BEGIN
{ This block is not locked.
{ Do we need to move it?
IF (CURRENT_BASE <> 0) OR (CURRENT_LENGTH <> 0) THEN
BEGIN
SOURCE := CURRENT_MNODE'S BASE field;
DESTINATION := CURRENT_BASE;
LENGTH := CURRENT_MNODE'S LENGTH field;
MOVE_MEMORY(SOURCE, DESTINATION, LENGTH);
CURRENT_MNODE'S base field := CURRENT_BASE;
CURRENT_BASE := CURRENT_BASE + LENGTH;
DIRTY := 1;
END
END
END
ELSE
BEGIN
{ This m-node references a free block.
{ If there is anything in CURRENT_BASE or
{ CURRENT_LENGTH, release the m-node saved
{ in SAVED_MNODE and CURRENT_MNODE becomes
{ the new SAVED_MNODE.
IF (CURRENT_BASE <> 0) OR (CURRENT_LENGTH <> 0) THEN
BEGIN
RELEASE(SAVED_MNODE);
CURRENT_MNODE'S BASE field := CURRENT_BASE;
CURRENT_LENGTH := CURRENT_LENGTH + CURRENT_MNODE'S length field;
CURRENT_MNODE'S LENGTH field := CURRENT_LENGTH;
IF CURRENT_LENGTH > PARAS_FREED THEN
PARAS_FREED := CURRENT_LENGTH;
END
ELSE
{ If there's nothing in CURRENT_BASE or
{ CURRENT_LENGTH, then this is the first free
{ memory block of this partition.
BEGIN
CURRENT_LENGTH := CURRENT_MNODE'S LENGTH field;
IF CURRENT_LENGTH > PARAS_FREED THEN
PARAS_FREED := CURRENT_LENGTH;
CURRENT_BASE := CURRENT_MNODE'S BASE field;
END
SAVED_MNODE := CURRENT_MNODE;
DIRTY := 0;
END

PREVIOUS_MNODE := CURRENT_MNODE;
CURRENT_MNODE := CURRENT_MNODE'S NEXT field;

{ This is the end of the REPEAT loop.
UNTIL (CURRENT_MNODE = 0);

{ Pick up any straggling free memory.
IF DIRTY=1 THEN
BEGIN
RELEASE(SAVED_MNODE);
CURRENT_MNODE := GET_MNODE();
CURRENT_MNODE'S BASE field := CURRENT_BASE;
CURRENT_MNODE'S LENGTH field := CURRENT_LENGTH;
CURRENT_MNODE'S NEXT field := 0;
CURRENT_MNODE'S PREVIOUS field := PREVIOUS_MNODE;
PREVIOUS_MNODE'S NEXT field := CURRENT_MNODE;
END

{ Return the size in paragraphs of the largest
{ block freed.
RETURN(PARAS_FREED);

```

BIX CALENDAR

AUGUST

Display this month's
BIX activities

A U G

T

TUESDAY, 8/1, 9 PM EST. "Favorite Computing Tricks"

What clever things do you do that others would find useful? How do you set up your startup and boot? How do you run programs? And how about backup tricks? If you're interested in what others do—or if you have a trick or two to share—drop in the `ibm.pc` conference. (join `ibm.pc/cbix`)

THURSDAY, 8/3, 8:30–9:30 PM EST. "What's so special about Ada?"

Randy Brukardt and Dan Stock of R.R. Software continue their discussion of the Ada language. Which of its features make Ada so useful for projects with many programmers? Is Ada too big? Will the next Ada standard be even bigger? (join `janus.ada/cbix`)

THURSDAY, 8/10, 6 PM EST. "Live, from MacWorld Expo in Boston . . ."

Join Macintosh Exchange Editor Larry Loeb and his special guests as they discuss the news coming out of the MacWorld Expo. (join `mac.hack/cbix`)

All-Month Conferences

You-heard-it-here-first Department—The Microbytes staff will be filing news reports from SIGGRAPH, the premiere computer graphics conference, in Boston, Jul. 31–Aug. 4. Next, it's off to MacWorld Expo in Boston, Aug. 10–12. Later this month, look for reports from UniForum, also in Boston. (join `microbytes`; join `microbytes.sw`; join `microbytes.hw`)

neural.nets conference—Looking for neural-network simulators? See the topic "source," which has the source code to various neural-network simulators in C, Common Lisp, and Smalltalk. (join `neural.nets`)

mac.hack conference—"Getting ready for MacWorld Expo." Last-minute jitters, the latest rumors, and early product introductions all heighten the tension as BIXen get ready for the MacWorld Expo in Boston on Aug. 10–12. After the show, we'll talk about what was introduced and offer our first thoughts on the new products. (join `mac.hack`)

marketing conference—"How to start a newsletter." You, too, can publish your own high-tech newsletter. But first, learn about the pitfalls of starting your own newsletter, how to promote it, what to charge, and much more—from people who have published their own. (join `marketing/promotion`)

television conference—Do consumers really need HDTV (high-definition TV)? Will viewers even notice the difference

in quality? Tune in and find out. And stay tuned for discussions on the use of HDTV in workstation environments to integrate video and computer information . . . the use of HDTV via satellite as a replacement for or a supplement to feature film distribution . . . the current use of Japan's NHK system in producing commercials, features, and music videos. (join `television/hdvtv`)

ti conference—BIX's ti conference members are trying to port MINIX 1.3, a mini Unix operating system, and the Amoeba distributed operating system to the TI Pro. BIXen can learn how a multitasking/multiuser operating system works and, later, how a network-distributed operating system works. And while they're at it, they can learn the real differences between the IBM PC and the TI Pro when it comes to hardware and software. There's no need to have a network to run Amoeba either; it can run and be tested on one processor machine as well as on a network. (join `ti/minix`)

travsoft—In keeping with BYTE's laptop computer product focus, the BIX `travsoft` conference has information on Traveling Software's LapLink data-transfer software and Battery Watch. Traveling Software personnel will be available throughout August to answer questions about data transfer or the quirks of NiCad batteries. (join `travsoft`)

Finally. An on-line service that doesn't nickel and dime you.

It's BIX's flat-fee service.

BIX is short for BYTE Information Exchange. The on-line information service that's yours for an unheard-of flat fee of just \$39 for three months* — an amount you could easily blow in just two to four hours with an hourly rate, on-line service. (Not to mention the fact that you'd be nickel-and-dimed for its monthly minimums.)

And here's another distinction: BIX is strictly for microcomputer pros; it contains no "fluff." As a subscriber, here's what you've got coming to you:

- All the information and ideas exchanged in more than 150 microcomputer-related conferences — a give-and-take in which you can participate.

- Microbytes Daily* — up-to-the-minute industry news and new product information.
- Plus support from hardware vendors and software publishers, access to extensive software libraries, and the use of our electronic mail service — which allows *binary attachments*.

Subscribe to BIX right now — using your computer and modem.

Set your telecommunications program for full duplex, 8 bits, no parity, 1 stop bit, or 7 bits, even parity, 1 stop bit. Now dial BIX at 617-861-9767, hit the return key, and respond as follows:

Prompt:	You Enter
login (enter "bix"):	bix
Name?	bix.flatfee

You can charge your BIX subscription to major credit cards, or have it billed to your company. You may also purchase

unlimited off-peak access via Tymnet for just \$15 per month, or \$2 per off-peak hour.

For additional information, including your local Tymnet access number, call 800-227-2983 (in New Hampshire 603-924-7681).

**Based on a \$156 annual fee, billed quarterly — a subscription which you may cancel at any time without future quarterly charges. If you prefer, you may subscribe for a 3-month trial at just \$59.*

BIX

One Phoenix Mill Lane
Peterborough, NH 03458
800-227-2983 • In NH 603-924-7681



PRINT QUEUE

Hugh Kenner

Somewhere Out There

PLANETS BEYOND:
Discovering the Outer Solar System

by Mark Littmann

What gets done with new technology once we have it may be anything but what its designers thought they were after. In the 1930s we were led to expect that television, when it came, would be an adjunct to the telephone. Why, you'll be talking to Jim face to face! What TV wrought instead was not eye contact with Jim (about which we can no longer care less), but the disappearance of the old *Life*, the old *Saturday Evening Post*...

And what we do with computers, perhaps more than anything else, is process words. Never mind that the machine's very name still registers what drove its development—someone's need for a lot of heavy numerical computing. ENIAC was finally pulled together when the U.S. military needed numerical information about shell trajectories—and needed it fast.

Back when guns were aimed by eye, though, heavy computation, which meant reducing seemingly endless equations, was most likely to be a burden borne by astronomers. The demand for their numbers persisted, decade by decade. Where will Jupiter be next December 11 at midnight GMT? (Some navigator may need to know.) Reams of paper, hours of candlelight, were once devoted to such chores. And repeatedly, ships got wrecked by the slip of a pencil or the fumble of a typesetter.

Around the year 1820, the error level in published tables was what prompted Charles Babbage to groan out his famous wish for tables calculated "by steam." Babbage even envisaged a "calculating engine" going on to set its output in type. He was eerily prescient. Today it's, yes, by steam that we calculate and print tables, if we happen to live near an electricity plant with steam power somewhere in its delivery chain. Counting peak-time backup systems, you'll hardly find a voltage factory in the U.S. that doesn't fit that description.

Seeking Planets

Planets Beyond is a book about computational astronomy stumbling into its great age. It covers the period from just before the computer to just after, during which the numbers were getting so refined it early grew evident that the solar system wasn't behaving the way Newton said. You've possibly heard a good deal of the story before, likely never in such fascinating detail.

It starts with a chance observation. Only about 76,000 nights ago (Tuesday, March 13, 1781), German-born William Herschel, amateur astronomer, gazing toward Zeta Tauri from Bath, England, spotted a celestial disk. "The quality of his eyes and his instrument told him that this was not one of the 'fixed stars.'" A comet, likely? No, by midsummer three separate mathematicians had fitted it to a planetary orbit. The pencil-and-paper work that Lexell and Saron and Laplace undertook is mind-boggling. So is the agreement of their results. And they

were working with circular approximations; in another two years, an elliptical orbit had been derived. Yes, Herschel had happened to glimpse an unsuspected seventh planet, on which the name "Uranus" eventually settled. Twice as far out as Saturn, its existence doubled the known size of the solar system.

The quality of Herschel's eyes we may ascribe to good genes. As for the quality of his instrument, well, Herschel was a musician (oboe and organ), organist in Bath at the Octagon Chapel, and the giver of up to 46 music lessons a week. The link of music with numbers dates back to Pythagoras. So to understand harmony, Herschel studied mathematics. "Math got him interested in optics. Optics got him interested in astronomy." Scanning the sky? That led to a need for optics.

Refractive aberrations being hard to control in those days, he devised, amid potentially lethal explosions that

continued

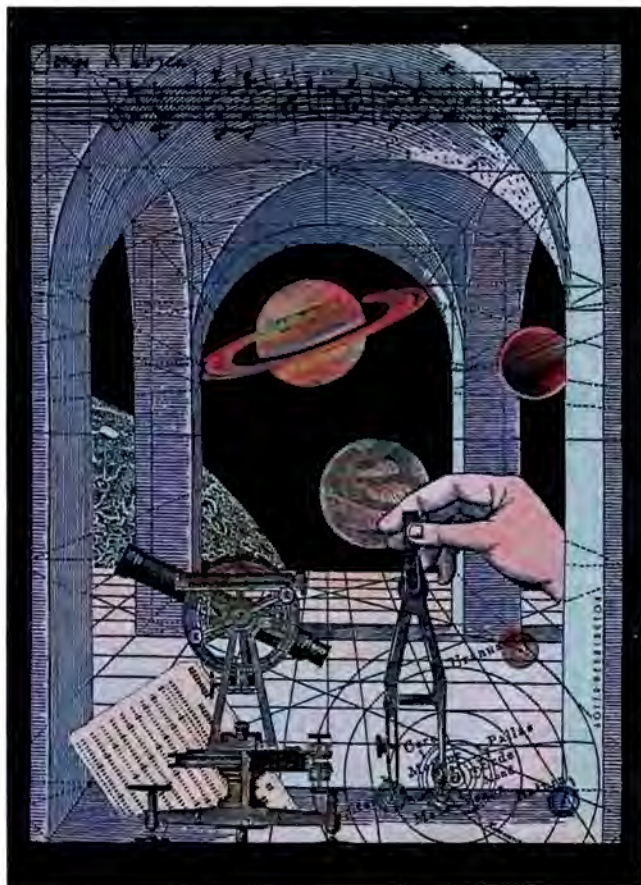

Knowledge Processing

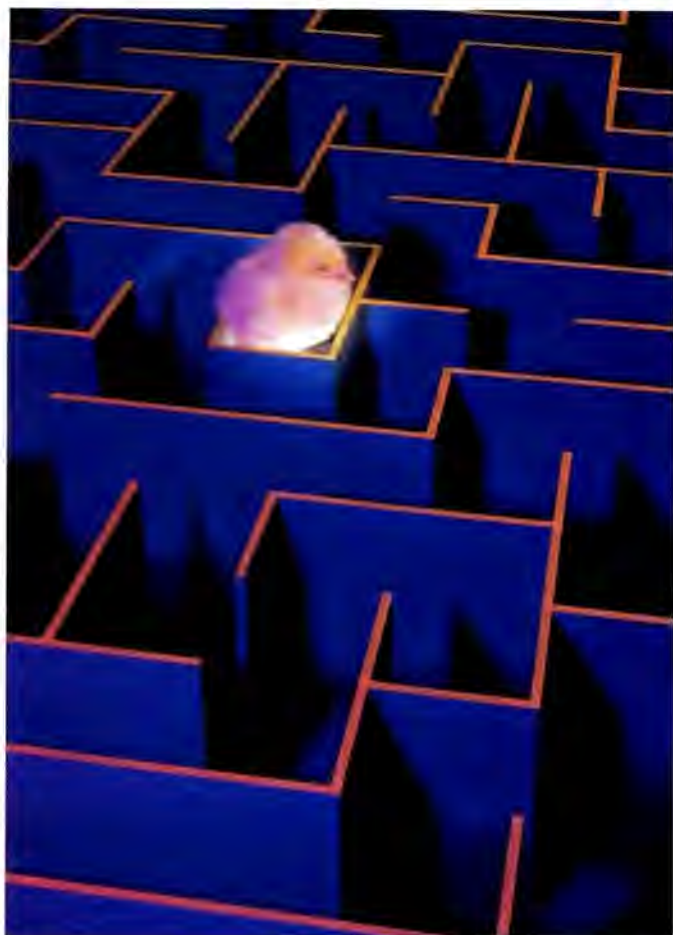

Don't leave your users lost in a maze of information!

A knowledge processor communicates knowledge - the natural extension of everything we do on a computer.

It's the intelligent integration of everyday resources like data, text, logic, graphics, and video that turns information into knowledge.

KnowledgePro is the first knowledge processor. It combines a high-level, object-oriented programming language with hypertext and expert systems technology.

KnowledgePro gives you a total development environment with the tools you need to create intelligent multi-media applications.

PC Magazine, Holland... *"KnowledgePro is the first of a new generation of software, the knowledge processor...it has the power of, for example, Pascal or PROLOG, but the programmer isn't troubled with the technical details."*

PC Week, USA... *"It's rare, but every so often a PC application comes along that breaks new ground and creates a fundamentally different way to use computers. According to its corporate users...KnowledgePro does just that."*

Infoworld... *"We don't live in a computational world. If we're going to move knowledge around we need tools...The same person who will learn macros in Lotus can learn this."*

KnowledgePro costs \$495 with no runtime fees. It runs on IBM PC, XT, AT and PS/2 compatible machines with 640k of memory and a hard disk. A working demo with a 100 page manual is available for \$33 including shipping (\$38 foreign) with credit towards purchase of the full system.

Find out what knowledge processing is all about. Call 518-766-3000 (FAX 518-766-3003) or write to Knowledge Garden Inc., 473A Malden Bridge Rd., Nassau, NY 12123, USA. Amex, Visa or M/C accepted.

KnowledgePro® The intelligent way out

Circle 135 on Reader Service Card

Another
intelligent
tool from



greatly distressed his sister, a "speculum metal" (71 percent copper, 29 percent tin) to back reflecting mirrors. And the homemade 6½-inch reflector that he spotted Uranus with was superior to anything at the Royal Observatory in Greenwich. He deserves to be all amateur scientists' patron saint.

But by 1824 Uranus was plainly refusing to operate on schedule: now fast, now slow. The most tenacious of several explanations was that Newton's universal gravitation was not quite universal, but commenced to fade out beyond Saturn. One man who espoused that idea was the relentlessly ambitious George Biddell Airy, by 1835 England's Astronomer Royal.

And here (though not in this book) we cross the path of

Herschel
had happened to
glimpse an unsuspected
seventh planet,
on which the name
"Uranus" eventually
settled.



Charles Babbage, lifelong distruster of Astronomers Royal. His first computer—the difference engine—Babbage had designed and built amid splutterings of contempt for Airy's predecessor, whose feckless computations were wrecking ships. He'd have been still less impressed, if he ever learned its details, by the "computer" Airy designed: a roomful of young boys, adding and subtracting throughout 12-hour shifts with a 1-hour mid-day break. (Replaced by brass wheels, those boys could be out flying kites; meanwhile, one might *trust* the brass.)

Airy's misplaced faith in fading gravitation had unhappy consequences for John Couch Adams. Adams, a virtually self-taught genius, resolved in 1841 to get to the bottom of the Uranus problem. By 1845, aged 26, he'd located, within 2 degrees—using pencils and unthinkable heaps of paper—the place to look for an unknown perturbing planet. There follows a long, dreary story of Airy declining to give Adams the time of day, with the result that a French mathematician, Urbain-Jean-Joseph Le Verrier, got formal credit for locating Neptune.

Adams, an amateur, had held back from publishing lest he'd made a mistake. Babbage wrote him (1847) to point out that if only the calculations could have been automated, he might have put worry behind him. Adams agreed with enthusiasm: "It would be difficult to overestimate the value of such a machine." (Babbage also wrote to Le Verrier, who wasn't excited. He'd got it right with just his quill pen, hadn't he?)

And as far back as 1842, Airy had advised the Prime Minister that calculating machinery such as Babbage proposed was useless in principle. He was proud of what he (not to mention that roomful of boys) did by hand. Airy would die ("still organizing his papers") in 1892, aged 90, bureaucrat in excelsis. Adams, an attractive, modest man, chanced to die the same year, aged 72. He'd declined, 11 years earlier, the offer of suc-

cession to Airy as Astronomer Royal.

Next, Planet X, which Percival Lowell sought. Lowell was one of *the* Boston Lowells, the ones who spoke only to Cabots while the Cabots were speaking only to God. His sister Amy smoked cigars and was something of a poet. Lowell, with the family wealth, established (in 1894) an observatory in Flagstaff, Arizona, meant to document his great enthusiasm, "canals" on Mars. Since that was not a creditable aim, Lowell hoped to gain prestige by finding the new planet one could guess at from still-unexplained irregularities in the motions of Uranus. (Neptune, which might have helped, hadn't been accessible long enough for its misbehaviors to be measurable.)

A Harvard math graduate (honors), Lowell (1855–1916) calculated tirelessly (still in the pencil-and-paper era), hiring and firing up to five simultaneous assistants. On the Airy model, he was running an interrupt-driven parallel computer with irregular wait states and human CPUs. Again and again, locations for Planet X got relayed to Arizona, where observers would point and squint.

The numbers kept improving, and by 1915 they even spotted Planet X, but failed to recognize it. Percy Lowell died the next year. So we credit the discovery of Pluto, in 1930, to Clyde Tombaugh, a 24-year-old whom the Lowell Observatory had hired just a year previously. ("Young man, I am afraid you are wasting your time," one visiting astronomer had told Tombaugh. "If there were any more planets to be found, they would have been found long before this.") Pluto was within 6 degrees of where Lowell had last said it would be: not bad, what with noisy data. The name was first proposed by an English school-girl, Venetia Burney, who was learning about mythology. Wasn't that the right name for a dim and gloomy planet? Moreover, they thought at Flagstaff that its symbol, PL., could say Percival Lowell.

Next? Yes, there may still be a trans-Plutonian planet. William H. Pickering (1858–1938) had predicted perhaps six, but none of them turned up. By 1943, Clyde Tombaugh was certain that any such body had to be dimmer than the seventeenth magnitude. His searches had discovered nothing brighter. Yet by 1976, Thomas Van Flandern (U.S. Naval Observatory) was being bothered by problems with the orbits of Uranus and Neptune. We're well within the computer age by now, and errors are most likely observational. Van Flandern's colleague Robert Harrington tells us to imagine taking a sight from Washington, DC, and identifying a drunk lurching out of a Baltimore bar by his stagger. Such is the minute scale of the wobbles. Atmospheric flickers? Maybe. That search goes on. And, with thanks to ENIAC's progeny, its difficulties no longer pertain to computation.

Meanwhile, on some of Littmann's liveliest pages, we're given details of the marvelous computer-enabled *Voyager* tours of inspection, Jupiter-Saturn-Uranus, with Neptune scheduled for late August. The photos (some in color) are entrancing.

"Very well written," says Tombaugh. "By far the best on the subject I have seen," says Harrington. Opinions from Herschel and Adams, alas, we can't have. But Littmann's is, yes, by anyone's verdict, a superb book. ■

John Wiley & Sons, New York: 1988, 286 pages, \$22.95

Hugh Kenner is a professor of English at Johns Hopkins University. His reviews have appeared in publications like the New York Times and Harper's. His recent books include A Sinking Island and Mazes. He can be contacted on BIX as "hkenner."

Your questions and comments are welcome. Write to: Editor, BYTE, One Phoenix Mill Lane, Peterborough, NH 03458.

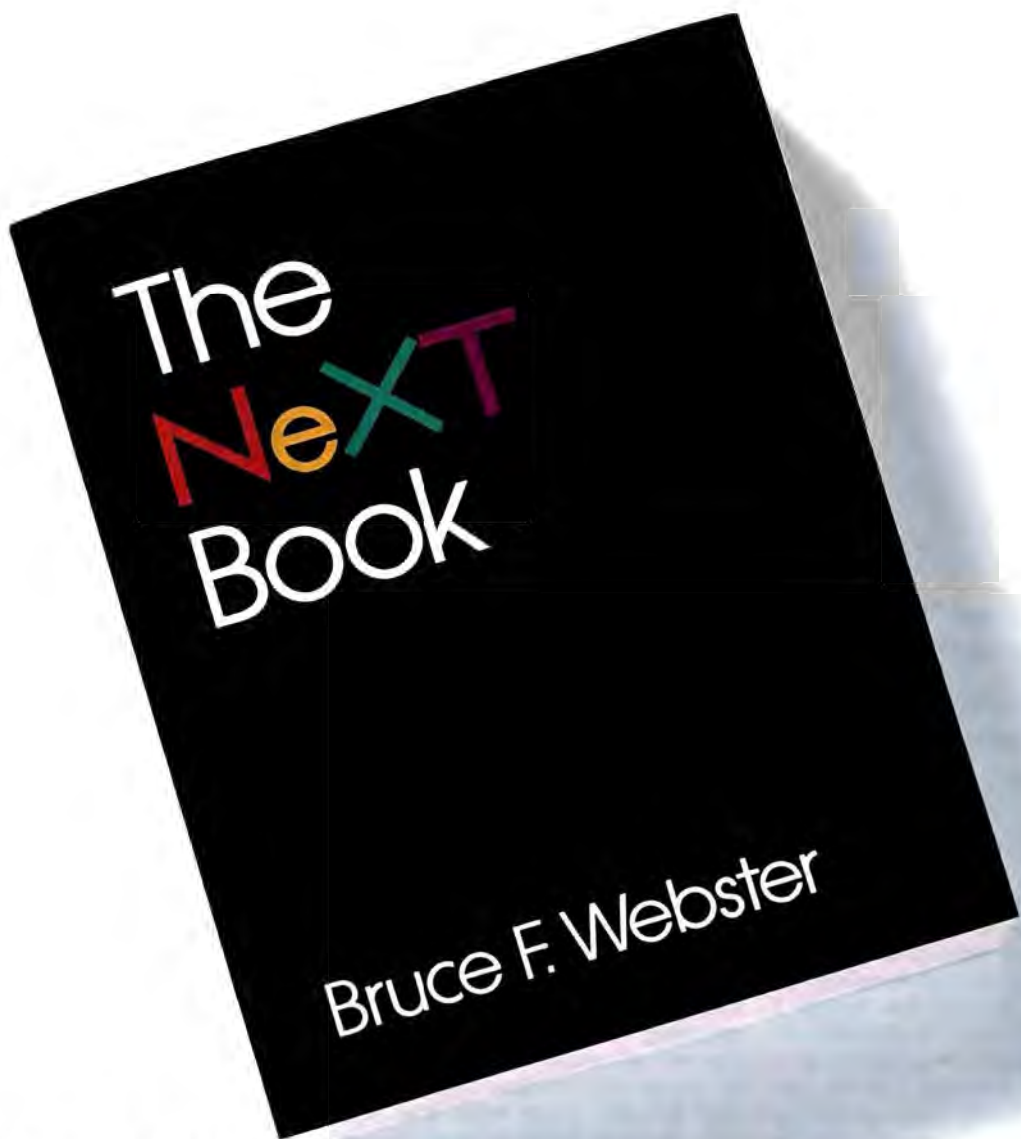

The First Word On The NeXT™ Technology.

From the time NeXT, Inc. began work on a new personal computer, its extraordinary features have been kept a well-guarded secret. Now, for the first time, the details on the revolutionary technology of the NeXT™ Computer System are revealed in *The NeXT Book* by Bruce Webster, one of the computer industry's foremost journalists.

As the only author who was allowed

access to NeXT, Inc. during the development of this remarkable system, Bruce Webster is uniquely able to discuss its innovative and truly impressive features: the read/write/erasable 256 Megabyte Optical Disk, the 68030 and 56001 microprocessor, the CD-quality stereo sound capability, the MegaPixel Display, and the sophisticated object-oriented programming environment. In addi-

tion, Webster demonstrates how to perform various functions and create applications.

If you want to understand one of the most significant breakthroughs in computing today, *The NeXT Book* is the next book you should read.

Available wherever computer books are sold; suggested retail price is \$22.95.

McGraw-Hill Bookstore 1221 Avenue of the Americas, New York, New York 10020

Number of copies _____ Check or credit card: Visa _____ Amer. Exp. _____ MasterCard _____

Acct. No. _____ Expires _____

Name _____

Address _____ City _____ State _____ Zip _____

Add sales tax plus \$2.50 postage and handling.



MB3

McGraw-Hill Bookstore **ADDISON-WESLEY**

The Professionals' Information Center

To order, call (212) 512-4100 or use coupon above.

Circle 160 on Reader Service Card

THE LONELINESS OF THE LOW-BUDGET USER

Are computer companies forgetting the people who put them where they are today?

As I watch the endless onslaught of high-priced, "high-end" computer systems and software applications with insatiable appetites for memory and disk storage, I can't help but wonder if the personal computer industry has forgotten the people who made it a success—namely, single users. You know who I'm talking about—people like you and me, who do word processing, maybe a little book-keeping or budget forecasting with a spreadsheet program, have a couple of databases, and even dabble in a little programming now and then. We may be engineers and architects who do some of our calculations or preliminary drawings on a desktop computer like an IBM XT or AT or a Mac Plus or SE. We might still be dragging our Compaq portable from the office at night to finish up a report.

We were the ones who spent a few thousand bucks early in the game to get a machine and jump on the microcomputer bandwagon so that we could get out from under the MIS department's backlog and free ourselves from system administrators, database administrators, and corporate rules and regulations for computing. To us, it looks like we're being left out in the cold by the very vendors that made this all possible—companies like IBM, Apple, Compaq, Microsoft, Lotus, and Ashton-Tate.

When they started out in the personal computer business, these companies produced affordable hardware and software. The software worked, and it required no more than 512K bytes of RAM, often

less. These microcomputer enterprises were started by pioneers, from Phil Estridge at IBM to Bill Gates at Microsoft, to the Woz and Jobs at Apple—pioneers who bucked the system and showed that you could do useful work without expensive minicomputers and mainframes and software applications that cost thousands of dollars and come with a monthly maintenance contract.

But the focus of these companies has changed. Today, it seems that we're giving control back to the MIS department and network administrators. We're worrying about mainframe connectivity and file servers. We're looking at network operating systems, like NetWare 386, that cost upwards of \$8000. Steve Jobs is off producing a machine that costs well over \$10,000 at the retail level when fully equipped. Microsoft has built a virtual army of programmers around OS/2, which requires at least 3 megabytes of memory and nothing less than an 80286 machine. Ashton-Tate and Lotus are mired in trying to shoehorn every feature under the sun into programs that were designed for single users running single tasks. Apple keeps its prices high and keeps offering ever-more-expensive and powerful machines, but very few new products that the average user can afford. Compaq has reached new heights with an 80386 machine that costs \$18,000. The low-end Compaq has become the 286 SLT, which costs a mere \$6000.

Somehow, these companies have forgotten that the whole idea is to make computer hardware and software more affordable and more accessible to greater numbers of people. They seem to have forgotten that most students don't have \$7000 or \$8000 lying around for a workstation to put in their dorm rooms. They forget that a lot of users don't have and can't afford 3 megabytes of memory.

And then there's the question of ease of use. We used to talk about "user friendliness." But the level of complexity seems to be going in the opposite direc-

tion. Most new software products (and new versions of old products) have so many features, the user doesn't know where to begin. All the on-line help in the world won't help you if there are several hundred feature options to learn. I'm afraid to upgrade to WordPerfect 5.0 because I don't want to have go through setting up my printer again and learning all those new options that I probably will never use. WordPerfect 4.2 does just fine, thank you.

I'm not saying there's no place for high-end systems and connectivity. Of course, this is a major concern for many organizations, and what can be done with personal computers these days is indeed impressive—in every type of work from engineering to accounting. But let's not forget the little guy. Let's see some new, even easier-to-use products for the single user. Let's see some new machines—with new capabilities—priced around \$2000. Let's see some innovative software engineering that employs data compression and object-oriented techniques to allow big applications to run on little machines.

There is hope. Borland recently announced a technology—the Virtual Real-Time Object-Oriented Memory Manager—that does just that. Apple has hinted at a new low-cost machine that will run the new Mac operating system in ROM. Let's hope the other computer heavyweights come up with some new low-cost innovations as well. It's in their own best interest. Somehow, I get the feeling the big companies are gambling their futures on these high-priced solutions. They had better remember what got them here before it's too late. ■

Nick Baran is a BYTE senior technical editor based in San Francisco. He can be reached on BIX as "nickbaran."

Your questions and comments are welcome. Write to: Editor, BYTE, One Phoenix Mill Lane, Peterborough, NH 03458.

DOS + QuickBASIC or C + Instrumentation Code Generation = ?

There's only one solution...

LabWindows

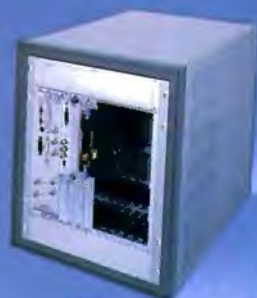

VXI

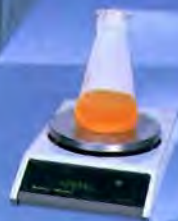

RS-232



GPIB



Plug-in Boards



Are you using a DOS-based personal computer for controlling instrumentation? Do you want the best available software tools for acquiring and analyzing data using standard DOS programming languages? If your answer to these questions is yes, LabWindows® is just the solution you're looking for. The unique LabWindows function panel interface lets you interactively control your instrumentation hardware and collect data, as well as automatically generate Microsoft® C or QuickBASIC program code for your application.

With LabWindows you can control GPIB, RS-232, or VXI instruments, or plug-in data acquisition cards for PS/2 and PC-AT computers. For standalone instrument users, the LabWindows instrument library has over 50 ready-to-use instrument drivers so you can program your instrument using intuitive instrument-specific function panels, without knowing the instrument inside-out.

Because acquiring data is only one element of your application, LabWindows has a complete set of QuickBASIC and C compatible libraries for data analysis, presentation, and storage. Manipulate arrays, create a histogram, or use the optional Advanced Analysis Library to perform operations such as Fast Fourier Transforms, digital filtering, and curve

fitting. Give your programs a big performance boost using the specially optimized LabWindows analysis routines for computers with an 80387 numeric coprocessor. For your data presentation and storage needs, use the LabWindows Graphics Library to create multiplot graphs, bar charts, or scatter plots, and use the Data Formatting Library for data logging and file operations.

If you're looking for the right tools to take maximum advantage of your DOS computer using QuickBASIC or C for data acquisition and analysis, there is only one solution...LabWindows. Call National Instruments at (800) IEEE-488 to speak with a sales or applications engineer about how LabWindows can help you.

Ask for a FREE Catalog

 **NATIONAL INSTRUMENTS®**
The Software is the Instrument™
12109 Technology Blvd.
Austin, Texas 78727-6204
(512) 794-0100

NATIONAL INSTRUMENTS OF JAPAN (03) 788-1922 •
NATIONAL INSTRUMENTS OF FRANCE (1) 486 53370 •
NATIONAL INSTRUMENTS UNITED KINGDOM (06) 355-23545 •
ARGENTINA (1) 46-5776 • AUSTRALIA (2) 736-2888 • BELGIUM (2) 466-8199 • CANADA
(416) 890-2010, (613) 596-9300, (514) 747-7878, (403) 295-0822, (604) 988-2195 • CHILE (2) 225
3689 • DENMARK (2) 251-122 • FINLAND (0) 372 144 • GREECE (1) 361-1283 • HONG
KONG (2) 0426-2707 • IRELAND (846) 661414, (3) 427-2282 • ISRAEL (3) 324 298 • ITALY
(2) 984-91071-2-3 • KOREA (2) 776-5340 • MEXICO (5) 660-4323 • THE NETHERLANDS (7)
099-6360 • NEW ZEALAND (9) 444-2645 • NORWAY (2) 53-1250 • PORTUGAL (1) 545-313 •
SINGAPORE (65) 336-4713 • SOUTH AFRICA (011) 787-0473 • SPAIN (1) 455-8112 •
SWEDEN (8) 792-1100 • SWITZERLAND (6) 552-8949 • TAIWAN/THE REPUBLIC OF
CHINA (02) 703-6280 • THAILAND (2) 234-9330 • WEST GERMANY (89) 80-7081

The New Tandy® 4000 SX

386™ performance
at a price you'd
expect from a
286 system.



A price/performance breakthrough for 386-based systems, the new Tandy 4000 SX combines more integrated features than ever in a machine at this price.

The Intel® 80386SX microprocessor combines the ability to run high-performance 80386 based software, as well as current 80286 and 8088 based software. You get the best of both worlds—32-bit performance with 16-bit hardware compatibility.

This means the Tandy 4000 SX insures your computer investment for the future. As a low-cost alternative to an expensive 386 system, you won't be left behind when you want to move on to more advanced 386 based applications, like MS® OS/2.

Built-in VGA graphics give you beautifully detailed, high-resolution displays. Add a color analog monitor and create astonishing graphics in up to 256 colors (from a

palette of 256,000) for near-photographic clarity.

The 4000 SX's SmartDrive™ Integrated Drive Electronics (IDE) technology allows you to add high-performance hard disk drives without the need or expense of installing a separate disk controller.

Innovative technology. Quality engineering. Competitive pricing. Come see the new Tandy 4000 SX today. From the best-selling family of PC compatibles made in America.

Tandy Computers: Because there is no better value.™

SmartDrive/TM Tandy Corp. Intel and 386/TM licensed from Intel Corp.
MS/ licensed from Microsoft Corp.

Radio Shack®
COMPUTER CENTERS
A DIVISION OF TANDY CORPORATION

Circle 211 on Reader Service Card