



# Clavinova®

## CVP-701

Owner's Manual  
Mode d'emploi  
Manual de instrucciones

### Thank you for purchasing this Yamaha Clavinova!

We recommend that you read this manual carefully so that you can fully take advantage of the advanced and convenient functions of the instrument. We also recommend that you keep this manual in a safe and handy place for future reference.

**Before using the instrument, be sure to read "PRECAUTIONS" on pages 5-6.**

For information on assembling the instrument, refer to the instructions on page 113.

### Nous vous remercions d'avoir choisi le Clavinova de Yamaha !

Nous vous conseillons de lire attentivement ce mode d'emploi afin de tirer pleinement profit des fonctions avancées et pratiques de votre instrument.

Nous vous recommandons également de garder ce manuel à portée de main pour toute référence ultérieure.

**Avant d'utiliser l'instrument, lisez attentivement la section « PRÉCAUTIONS D'USAGE » aux pages 5 et 6.**

Pour plus d'informations sur l'assemblage du pupitre de clavier, reportez-vous aux instructions figurant à la page 113.

### Gracias por adquirir el Yamaha Clavinova

La lectura detenida de este manual le permitirá disfrutar de las útiles y avanzadas funciones del instrumento.

Recomendamos guardar el manual en un lugar seguro y accesible, para futuras consultas.

**Antes de utilizar el instrumento, lea las "PRECAUCIONES", en las páginas 5-6.**

Para obtener más información sobre el montaje del soporte del teclado, consulte las instrucciones en la página 113.

English   
Français   
Español



EN FR ES

# SPECIAL MESSAGE SECTION

**PRODUCT SAFETY MARKINGS:** Yamaha electronic products may have either labels similar to the graphics shown below or molded/stamped facsimiles of these graphics on the enclosure. The explanation of these graphics appears on this page. Please observe all cautions indicated on this page and those indicated in the safety instruction section.

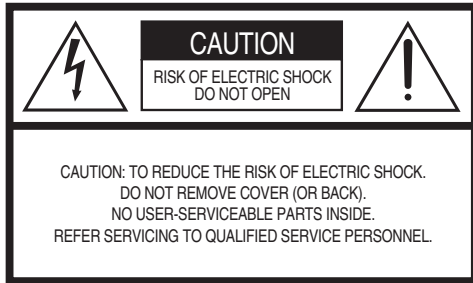

See bottom of Keyboard enclosure for graphic symbol markings.



The exclamation point within the equilateral triangle is intended to alert the user to the presence of important operating and maintenance (servicing) instructions in the literature accompanying the product.



The lightning flash with arrowhead symbol, within the equilateral triangle, is intended to alert the user to the presence of uninsulated “dangerous voltage” within the product’s enclosure that may be of sufficient magnitude to constitute a risk of electrical shock.

**IMPORTANT NOTICE:** All Yamaha electronic products are tested and approved by an independent safety testing laboratory in order that you may be sure that when it is properly installed and used in its normal and customary manner, all foreseeable risks have been eliminated. DO NOT modify this unit or commission others to do so unless specifically authorized by Yamaha. Product performance and/or safety standards may be diminished. Claims filed under the expressed warranty may be denied if the unit is/has been modified. Implied warranties may also be affected.

**SPECIFICATIONS SUBJECT TO CHANGE:** The information contained in this manual is believed to be correct at the time of printing. However, Yamaha reserves the right to change or modify any of the specifications without notice or obligation to update existing units.

**ENVIRONMENTAL ISSUES:** Yamaha strives to produce products that are both user safe and environmentally friendly. We sincerely believe that our products and the production methods used to produce them, meet these goals. In keeping with both the letter and the spirit of the law, we want you to be aware of the following:

**Battery Notice:** This product MAY contain a small non-rechargeable battery which (if applicable) is soldered in place. The average life span of this type of battery is approximately five years. When replacement becomes necessary, contact a qualified service representative to perform the replacement.

**Warning:** Do not attempt to recharge, disassemble, or incinerate this type of battery. Keep all batteries away from children. Dispose of used batteries promptly and as regulated by applicable laws. Note: In some areas, the servicer is required by law to return the defective parts. However, you do have the option of having the servicer dispose of these parts for you.

**Disposal Notice:** Should this product become damaged beyond repair, or for some reason its useful life is considered to be at an end, please observe all local, state, and federal regulations that relate to the disposal of products that contain lead, batteries, plastics, etc.

**NOTICE:** Service charges incurred due to lack of knowledge relating to how a function or effect works (when the unit is operating as designed) are not covered by the manufacturer’s warranty, and are therefore the owners responsibility. Please study this manual carefully and consult your dealer before requesting service.

**NAME PLATE LOCATION:** The graphic below indicates the location of the name plate. The model number, serial number, power requirements, etc., are located on this plate. You should record the model number, serial number, and the date of purchase in the spaces provided below and retain this manual as a permanent record of your purchase.

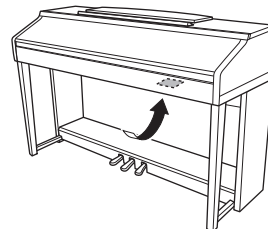

**Model** \_\_\_\_\_

**Serial No.** \_\_\_\_\_

**Purchase Date** \_\_\_\_\_

# FCC INFORMATION (U.S.A.)

## 1. IMPORTANT NOTICE: DO NOT MODIFY THIS UNIT!

This product, when installed as indicated in the instructions contained in this manual, meets FCC requirements. Modifications not expressly approved by Yamaha may void your authority, granted by the FCC, to use the product.

## 2. IMPORTANT:

When connecting this product to accessories and/or another product use only high quality shielded cables. Cable/s supplied with this product MUST be used. Follow all installation instructions. Failure to follow instructions could void your FCC authorization to use this product in the USA.

## 3. NOTE:

This product has been tested and found to comply with the requirements listed in FCC Regulations, Part 15 for Class "B" digital devices. Compliance with these requirements provides a reasonable level of assurance that your use of this product in a residential environment will not result in harmful interference with other electronic devices. This equipment generates/uses radio frequencies and, if not installed and used according to the instructions found in the users manual, may cause interference harmful to the operation of other electronic devices. Compliance with FCC regulations

does not guarantee that interference will not occur in all installations. If this product is found to be the source of interference, which can be determined by turning the unit "OFF" and "ON", please try to eliminate the problem by using one of the following measures:

Relocate either this product or the device that is being affected by the interference.

Utilize power outlets that are on different branch (circuit breaker or fuse) circuits or install AC line filter/s.

In the case of radio or TV interference, relocate/reorient the antenna. If the antenna lead-in is 300 ohm ribbon lead, change the lead-in to co-axial type cable.

If these corrective measures do not produce satisfactory results, please contact the local retailer authorized to distribute this type of product. If you can not locate the appropriate retailer, please contact Yamaha Corporation of America, Electronic Service Division, 6600 Orangethorpe Ave, Buena Park, CA90620

The above statements apply ONLY to those products distributed by Yamaha Corporation of America or its subsidiaries.

\* This applies only to products distributed by YAMAHA CORPORATION OF AMERICA.

(class B)

## COMPLIANCE INFORMATION STATEMENT (DECLARATION OF CONFORMITY PROCEDURE)

Responsible Party : Yamaha Corporation of America  
Address : 6600 Orangethorpe Ave., Buena Park, Calif. 90620  
Telephone : 714-522-9011  
Type of Equipment : Digital Piano  
Model Name : CVP-701

This device complies with Part 15 of the FCC Rules.

Operation is subject to the following two conditions:

- 1) this device may not cause harmful interference, and
- 2) this device must accept any interference received including interference that may cause undesired operation.

See user manual instructions if interference to radio reception is suspected.

\* This applies only to products distributed by YAMAHA CORPORATION OF AMERICA.

(FCC DoC)

## IMPORTANT NOTICE FOR THE UNITED KINGDOM Connecting the Plug and Cord

IMPORTANT. The wires in this mains lead are coloured in accordance with the following code:

BLUE : NEUTRAL

BROWN : LIVE

As the colours of the wires in the mains lead of this apparatus may not correspond with the coloured markings identifying the terminals in your plug proceed as follows:

The wire which is coloured BLUE must be connected to the terminal which is marked with the letter N or coloured BLACK.

The wire which is coloured BROWN must be connected to the terminal which is marked with the letter L or coloured RED.

Making sure that neither core is connected to the earth terminal of the three pin plug.

\* This applies only to products distributed by YAMAHA CORPORATION OF AMERICA.

(FCC DoC)

(2 wires)

## OBSERVERA!

Apparaten kopplas inte ur växelströmskällan (nätet) så länge som den är ansluten till vägguttaget, även om själva apparaten har stängts av.

**ADVARSEL:** Netsspændingen til dette apparat er IKKE afbrudt, så længe netledningen sidder i en stikkontakt, som er tændt — også selvom der er slukket på apparatets afbryder.

**VAROITUS:** Laitteen toisiopiiriin kytketty käyttökytin ei irroita koko laitetta verkosta.

(standby)

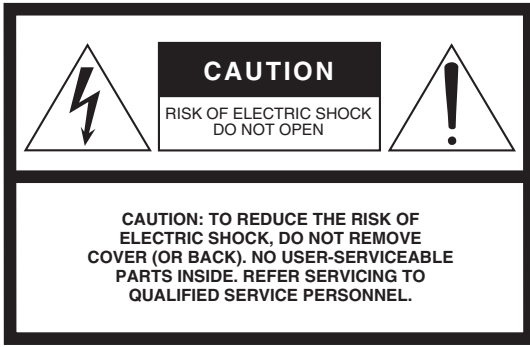

The above warning is located on the bottom of the unit.

## Explanation of Graphical Symbols



The lightning flash with arrowhead symbol within an equilateral triangle is intended to alert the user to the presence of uninsulated “dangerous voltage” within the product’s enclosure that may be of sufficient magnitude to constitute a risk of electric shock to persons.



The exclamation point within an equilateral triangle is intended to alert the user to the presence of important operating and maintenance (servicing) instructions in the literature accompanying the product.

## IMPORTANT SAFETY INSTRUCTIONS

- 1 Read these instructions.
- 2 Keep these instructions.
- 3 Heed all warnings.
- 4 Follow all instructions.
- 5 Do not use this apparatus near water.
- 6 Clean only with dry cloth.
- 7 Do not block any ventilation openings. Install in accordance with the manufacturer’s instructions.
- 8 Do not install near any heat sources such as radiators, heat registers, stoves, or other apparatus (including amplifiers) that produce heat.
- 9 Do not defeat the safety purpose of the polarized or grounding-type plug. A polarized plug has two blades with one wider than the other. A grounding type plug has two blades and a third grounding prong. The wide blade or the third prong are provided for your safety. If the provided plug does not fit into your outlet, consult an electrician for replacement of the obsolete outlet.
- 10 Protect the power cord from being walked on or pinched particularly at plugs, convenience receptacles, and the point where they exit from the apparatus.
- 11 Only use attachments/accessories specified by the manufacturer.
- 12 Use only with the cart, stand, tripod, bracket, or table specified by the manufacturer, or sold with the apparatus. When a cart is used, use caution when moving the cart/apparatus combination to avoid injury from tip-over. 
- 13 Unplug this apparatus during lightning storms or when unused for long periods of time.
- 14 Refer all servicing to qualified service personnel. Servicing is required when the apparatus has been damaged in any way, such as power-supply cord or plug is damaged, liquid has been spilled or objects have fallen into the apparatus, the apparatus has been exposed to rain or moisture, does not operate normally, or has been dropped.

### WARNING

TO REDUCE THE RISK OF FIRE OR ELECTRIC SHOCK, DO NOT EXPOSE THIS APPARATUS TO RAIN OR MOISTURE.

(UL60065\_03)

The model number, serial number, power requirements, etc., may be found on or near the name plate, which is at the bottom of the unit. You should note this serial number in the space provided below and retain this manual as a permanent record of your purchase to aid identification in the event of theft.

**Model No.**

---

**Serial No.**

---

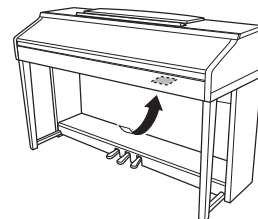

The name plate is located on the bottom of the unit.

(bottom\_en\_01)

# PRECAUTIONS

## PLEASE READ CAREFULLY BEFORE PROCEEDING

Please keep this manual in a safe and handy place for future reference.



### WARNING

Always follow the basic precautions listed below to avoid the possibility of serious injury or even death from electrical shock, short-circuiting, damages, fire or other hazards. These precautions include, but are not limited to, the following:

#### Power supply/Power cord

- Do not place the power cord near heat sources such as heaters or radiators. Also, do not excessively bend or otherwise damage the cord, or place heavy objects on it.
- Only use the voltage specified as correct for the instrument. The required voltage is printed on the name plate of the instrument.
- Use only the supplied power cord/plug.
- Check the electric plug periodically and remove any dirt or dust which may have accumulated on it.

#### Do not open

- This instrument contains no user-serviceable parts. Do not open the instrument or attempt to disassemble or modify the internal components in any way. If it should appear to be malfunctioning, discontinue use immediately and have it inspected by qualified Yamaha service personnel.

#### Water warning

- Do not expose the instrument to rain, use it near water or in damp or wet conditions, or place on it any containers (such as vases, bottles or glasses) containing liquids which might spill into any openings. If any liquid such as water seeps into the instrument, turn off the power immediately and unplug the power cord from the AC outlet. Then have the instrument inspected by qualified Yamaha service personnel.
- Never insert or remove an electric plug with wet hands.

#### Fire warning

- Do not put burning items, such as candles, on the unit. A burning item may fall over and cause a fire.

#### If you notice any abnormality

- When one of the following problems occur, immediately turn off the power switch and disconnect the electric plug from the outlet. Then have the device inspected by Yamaha service personnel.
  - The power cord or plug becomes frayed or damaged.
  - It emits unusual smells or smoke.
  - Some object has been dropped into the instrument.
  - There is a sudden loss of sound during use of the instrument.

## **CAUTION**

**Always follow the basic precautions listed below to avoid the possibility of physical injury to you or others, or damage to the instrument or other property. These precautions include, but are not limited to, the following:**

### **Power supply/Power cord**

- Do not connect the instrument to an electrical outlet using a multiple-connector. Doing so can result in lower sound quality, or possibly cause overheating in the outlet.
- When removing the electric plug from the instrument or an outlet, always hold the plug itself and not the cord. Pulling by the cord can damage it.
- Remove the electric plug from the outlet when the instrument is not to be used for extended periods of time, or during electrical storms.

### **Assembly**

- Read carefully the attached documentation explaining the assembly process. Failure to assemble the instrument in the proper sequence might result in damage to the instrument or even injury.

### **Location**

- Do not place the instrument in an unstable position where it might accidentally fall over.
- When transporting or moving the instrument, always use two or more people. Attempting to lift the instrument by yourself may damage your back, result in other injury, or cause damage to the instrument itself.
- Before moving the instrument, remove all connected cables, to prevent damage to the cables or injury to anyone who might trip over them.
- When setting up the product, make sure that the AC outlet you are using is easily accessible. If some trouble or malfunction occurs, immediately turn off the power switch and disconnect the plug from the outlet. Even when the power switch is turned off, electricity is still flowing to the product at the minimum level. When you are not using the product for a long time, make sure to unplug the power cord from the wall AC outlet.

### **Connections**

- Before connecting the instrument to other electronic components, turn off the power for all components. Before turning the power on or off for all components, set all volume levels to minimum.
- Be sure to set the volumes of all components at their minimum levels and gradually raise the volume controls while playing the instrument to set the desired listening level.

### **Handling caution**

- Do not insert a finger or hand in any gaps on the key cover or instrument. Also take care that the key cover does not pinch your finger.
- Never insert or drop paper, metallic, or other objects into the gaps on the key cover, panel or keyboard. This could cause physical injury to you or others, damage to the instrument or other property, or operational failure.
- Do not rest your weight on, or place heavy objects on the instrument, and do not use excessive force on the buttons, switches or connectors.
- Do not use the instrument/device or headphones for a long period of time at a high or uncomfortable volume level, since this can cause permanent hearing loss. If you experience any hearing loss or ringing in the ears, consult a physician.

### **Using the bench (If included)**

- Do not place the bench in an unstable position where it might accidentally fall over.
- Do not play carelessly with or stand on the bench. Using it as a tool or stepladder or for any other purpose might result in accident or injury.
- Only one person should sit on the bench at a time, in order to prevent the possibility of accident or injury.
- For benches that can be adjusted, do not adjust the bench height while sitting on the bench, since this can cause excessive force to be imposed on the adjustment mechanism, possibly resulting in damage to the mechanism or even injury.
- If the bench screws become loose due to extensive long-term use, tighten them periodically using the specified tool in order to prevent the possibility of accident or injury.
- Keep special watch over any small children so that they don't fall off the rear of the bench. Since the bench does not have a backrest, unsupervised use may result in accident or injury.

Yamaha cannot be held responsible for damage caused by improper use or modifications to the instrument, or data that is lost or destroyed.

Always turn the power off when the instrument is not in use.

Even when the [  ] (Standby/On) switch is in standby status (power lamp is off), electricity is still flowing to the instrument at the minimum level.

When you are not using the instrument for a long time, make sure you unplug the power cord from the wall AC outlet.

# NOTICE

To avoid the possibility of malfunction/ damage to the product, damage to data, or damage to other property, follow the notices below.

## ■ Handling

- Do not use the instrument in the vicinity of a TV, radio, stereo equipment, mobile phone, or other electric devices. Otherwise, the instrument, TV, or radio may generate noise. When you use the instrument along with an application on your iPhone, iPad or iPod touch, we recommend that you set “Airplane Mode” to “ON” on that device in order to avoid noise caused by communication.
- Do not expose the instrument to excessive dust or vibrations, or extreme cold or heat (such as in direct sunlight, near a heater, or in a car during the day) to prevent the possibility of panel disfiguration, damage to the internal components or unstable operation. (Verified operating temperature range: 5° – 40°C, or 41° – 104°F.)
- Do not place vinyl, plastic or rubber objects on the instrument, since this might discolor the panel or keyboard.
- In the case of a model with a polished finish, bumping the surface of the instrument with metal, porcelain, or other hard objects can cause the finish to crack or peel. Use caution.

## ■ Maintenance

- When cleaning the instrument, use a soft and dry/slightly damp cloth. Do not use paint thinners, solvents, alcohol, cleaning fluids, or chemical-impregnated wiping cloths.
- In the case of a model with a polished finish, gently remove dust and dirt with a soft cloth. Do not wipe too hard since small particles of dirt can scratch the instrument’s finish.
- During extreme changes in temperature or humidity, condensation may occur and water may collect on the surface of the instrument. If water is left, the wooden parts may absorb the water and be damaged. Make sure to wipe any water off immediately with a soft cloth.

## ■ Saving data

- Recorded Song and edited Song /Style/Voice/MIDI setup data, etc. are lost when you turn off the power to the instrument. This also occurs when the power is turned off by the Auto Power Off function (page 18). Save the data to the instrument, or to USB flash drive (page 81).
- You can back up the data and settings of this instrument to the USB flash drive as a backup file (page 38). You can restore the backup file to the instrument. To protect against data loss due to some failure, an operation mistake, etc., save your important data onto the USB flash drive.
- For information about the handling of USB flash drive, refer to page 106.
- To protect against data loss through USB flash drive damage, we recommend that you save your important data onto spare USB flash drive or an external device such as a computer as backup data.

# Information

## ■ About copyrights

- Copying of the commercially available musical data including but not limited to MIDI data and/or audio data is strictly prohibited except for your personal use.
- This product incorporates and bundles contents in which Yamaha owns copyrights or with respect to which Yamaha has license to use others’ copyrights. Due to copyright laws and other relevant laws, you are NOT allowed to distribute media in which these contents are saved or recorded and remain virtually the same or very similar to those in the product.

\* The contents described above include a computer program, Accompaniment Style data, MIDI data, WAVE data, voice recording data, a score, score data, etc.

\* You are allowed to distribute medium in which your performance or music production using these contents is recorded, and the permission of Yamaha Corporation is not required in such cases.

## ■ About functions/data bundled with the instrument

- Some of the preset songs have been edited for length or arrangement, and may not be exactly the same as the original.
- This device is capable of using various types/formats of music data by optimizing them to the proper format music data for use with the device in advance. As a result, this device may not play them back precisely as their producers or composers originally intended.
- The bitmap fonts used in this instrument have been provided by and are the property of Ricoh Co., Ltd.

## ■ About this manual

- The illustrations and LCD screens as shown in this manual are for instructional purposes only, and may appear somewhat different from those on your instrument.
- iPhone, iPad and iPod touch are trademarks of Apple Inc., registered in the U.S. and other countries.
- The company names and product names in this manual are the trademarks or registered trademarks of their respective companies.

## ■ Tuning

Unlike an acoustic piano, this instrument does not need to be tuned by an expert (although the pitch can be user-adjusted to match other instruments). This is because the pitch of digital instruments is always maintained perfectly. However, if you feel there is something abnormal concerning the keyboard touch, contact your Yamaha dealer.

### Compatible Format

---



“GM (General MIDI)” is one of the most common Voice allocation formats. “GM System Level 2” is a standard specification that enhances the original “GM” and improves Song data compatibility. It provides for increased polyphony, greater Voice selection, expanded Voice parameters, and integrated effect processing.



XG is a major enhancement of the GM System Level 1 format, and was developed by Yamaha specifically to provide more Voices and variations, as well as greater expressive control over Voices and effects, and to ensure compatibility of data well into the future.



GS was developed by the Roland Corporation. In the same way as Yamaha XG, GS is a major enhancement of the GM specifically to provide more Voices and Drum kits and their variations, as well as greater expressive control over Voices and effects.



The Yamaha XF format enhances the SMF (Standard MIDI File) standard with greater functionality and opened expandability for the future. This instrument is capable of displaying lyrics when an XF file containing lyric data is played.



“SFF (Style File Format)” is an original Style file format by Yamaha which uses a unique conversion system to provide high-quality automatic accompaniment based on a wide range of chord types. “SFF GE (Guitar Edition)” is an enhanced format of SFF, which features improved note transposition for guitar tracks.



# About the Manuals

This instrument has the following documents and instructional materials.

## Included Documents

---



### Owner's Manual (this book)

Provides overall explanations of the Clavinova basic functions.



### Data List

Contains various important preset content lists such as Voices, Styles and Effects.

## Online Materials (downloadable from the web)

---



### Reference Manual (only in English, French, German and Spanish)

Explains advanced features of the instrument, not explained in the Owner's Manual. For example, you can learn how to create original Styles or Songs, or find detailed explanations of specific parameters.



### iPhone/iPad Connection Manual

Explains how to connect this instrument to the iPhone/iPad.



### Computer-related Operations

Includes instructions on connecting this instrument to a computer, and operations related to transferring song data.



### MIDI Reference

Contains both the MIDI Data Format and the MIDI Implementation Chart, which allow you to confirm MIDI messages transmitted/recognized by this instrument.

To obtain these manuals, access the Yamaha Downloads website, select your country, enter "CVP-701" in the Model Name box, then click [Search].

### Yamaha Downloads

<http://download.yamaha.com/>

## Included Accessories

### ■ Owner's Manual (this book)

### ■ Warranty\*

### ■ Online Member Product Registration

The "PRODUCT ID" on the sheet will be needed when you fill out the User Registration form.

### ■ Data List

### ■ 50 Greats for the Piano (music book)

Song files (MIDI files) corresponding to the Music Book are available for free downloading over the Internet. To download the Song files, complete the Yamaha Online Member registration and Product registration at the following website.

<https://member.yamaha.com/myproduct/regist/>

### ■ Holder Set (page 113)

### ■ Power Cord

### ■ Bench\*

\* May not be included depending on your particular area. Check with your Yamaha dealer.

# Contents

<b>PRECAUTIONS</b> .....	5
<b>NOTICE</b> .....	7
<b>Information</b> .....	7
<b>About the Manuals</b> .....	9
<b>Included Accessories</b> .....	9
<b>Welcome to Clavinova</b> .....	12
<hr/>	
<b>Panel Controls</b> .....	14
<hr/>	
<b>Starting Up</b> .....	16
Opening/Closing the Key Cover .....	16
Using the Music Rest .....	16
Power Supply .....	17
Turning On/Off the Power .....	18
Adjusting the Master Volume .....	19
Using Headphones .....	20
Changing the Display Language .....	21
Adjusting the Brightness of the Display .....	21
Showing the Owner Name in the Opening Display .....	22
Using the Pedals .....	23
Playing the Demos .....	24
Display-based Controls .....	25
Messages Shown in the Display .....	28
Instant Selection of the Displays — Direct Access .....	28
Main Display Configuration .....	29
File Selection Display Configuration .....	30
File/Folder Management .....	32
Entering Characters .....	36
Data Backup .....	38
Restoring the Factory-programmed Settings	39

<b>1 Piano Room – Enjoying Piano Performance –</b> .....	<b>40</b>
Playing a Piano Performance in Piano Room .. .....	40
Playing the Piano in Session with Other Instruments .....	41
Changing/Resetting the Piano Room Settings . .....	42
Recording your Performance in the Piano Room .....	43
<b>2 Voices – Playing the keyboard –</b> .....	<b>44</b>
Playing Preset Voices .....	44
Calling Up the Piano Default Settings (Piano Reset) .....	48
Piano Lock Function .....	48
Playing the Realistic Resonance-enhanced VRM Voices .....	49
Playing Super Articulation Voices .....	50
Transposing the Pitch in Semitones .....	50
Applying Voice Effects .....	51
Creating Original Organ Flutes Voices .....	53
Setting the Touch Response of the Keyboard ... .....	55
Using the Metronome .....	56
<b>3 Styles – Playing Rhythm and Accompaniment –</b> .....	<b>58</b>
Playing with a Style .....	58
Chords .....	60
Changing the Chord Fingering Type .....	60
Operating Style Playback .....	62
Adjusting the Tempo .....	64
Calling Up Appropriate Panel Settings for the Selected Style (One Touch Setting) .....	64
Calling up Optimum Styles for Your Performance (Style Recommender) .....	65
Turning Style Parts On/Off and Changing Voices .....	67

Adjusting the Volume Balance Between Style and Keyboard .....	68
Changing the Split Points .....	69
<b>4 Song Playback – Playing and Practice Songs –</b>	<b>71</b>
Playback of Songs .....	71
Displaying Music Notation (Score) .....	74
Displaying Lyrics (Text) .....	75
Turning Song Channels On/Off .....	75
One-handed Practice with the Guide Lamps	76
Repeat Playback .....	77
Playing Multiple Songs Repeatedly .....	78
<b>5 Song Recording via MIDI – Recording Your Performance via MIDI –</b>	<b>79</b>
Recording Your Performance (Quick Recording) .....	79
Saving Files .....	81
Complete a Piano Piece by Recording the Right- and Left-hand Parts Separately (Multi Channel Recording) .....	82
<b>6 USB Audio Player/Recorder – Playback and Recording Audio Files –</b>	<b>84</b>
Playing Back Audio Files .....	84
Recording Your Performance as Audio .....	88
<b>7 Microphone – Connecting a Microphone and Singing Along with Your Performance –</b>	<b>90</b>
Connecting a Microphone .....	90
<b>8 Music Finder – Calling Up Ideal Setups (Voice, Style, etc.) for Each Song –</b>	<b>92</b>
Selecting Desired Panel Settings from the Records .....	92
Searching for the Panel Settings .....	95

<b>9 Registration Memory – Saving and Recalling Custom Panel Setups –</b>	<b>97</b>
Registering Your Panel Setups .....	97
Saving the Registration Memory as a Bank File .....	98
Recalling a Registered Panel Setup .....	99
<b>10 Mixing Console – Editing the Volume and Tonal Balance –</b>	<b>100</b>
Basic Procedure .....	100
<b>11 Connections – Using Your Instrument with Other Devices –</b>	<b>103</b>
Connecting Audio Devices .....	103
Connecting a Microphone or Guitar .....	104
Connecting a Footswitch/Foot Controller .	105
Connecting a USB Device .....	106
Connecting to a Computer .....	108
Connecting to an iPhone/iPad .....	108
Connecting External MIDI Devices .....	110
<b>12 Utility/System – Making Global Settings –</b>	<b>111</b>
Basic Procedure .....	112
<b>Assembly</b> .....	<b>113</b>
<b>Troubleshooting</b> .....	<b>116</b>
<b>Panel Button Chart</b> .....	<b>119</b>
<b>Specifications</b> .....	<b>122</b>
<b>Index</b> .....	<b>125</b>

# Welcome to Clavinova

## True Acoustic Piano Feel

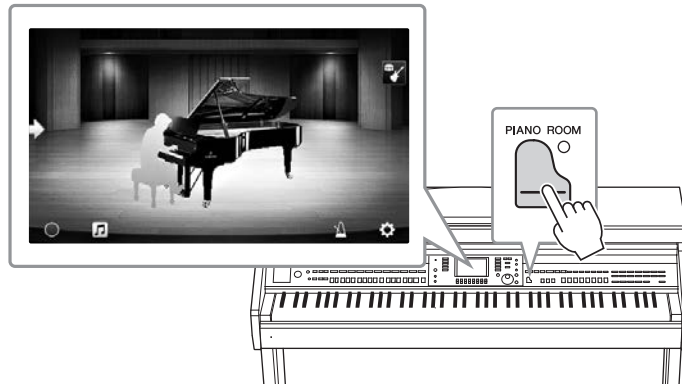

This instrument features gorgeous piano Voices, created with samples of the Yamaha CFX flagship concert grand piano and the famous Bösendorfer\* concert grand piano, as well as a special keyboard to fully reproduce the natural touch response and expressive nuances of an actual concert grand piano, including rapid repetitive capability. Moreover, the instrument features a VRM function which accurately recreates the acoustic resonance of a grand piano, which changes subtly by the timing and strength of the player's touch and pedal operation. This enables expression of even the most delicate performance nuances and responds minutely to your pedal use and key playing.

The new Piano Room features provide even greater piano performance enjoyment. Piano Room lets you select the desired piano type as well as different room ambiences — enabling a complete, realistic piano experience, as if you were playing an actual piano. What's more, you can play along with other virtual “session” players, and enjoy a convincing band-like performance experience with other musical instruments.

\* Bösendorfer is a subsidiary company of Yamaha.

▶▶▶ **page 40**

## Play in Various Music Genres

Naturally, the CVP provides many realistic piano Voices for your playing enjoyment. But it also features a wide variety of authentic instruments, both acoustic and electronic, including organ, guitar, sax, and others used in many music genres — letting you convincingly perform in any desired music style. Moreover, the special Super Articulation Voices realistically recreate many of the performance techniques and characteristic sounds generated when an artist plays an instrument. The result is superbly detailed expression — such as the realistic sound of finger slides on guitar, and the expressive breath noises of saxophone and other wind instruments.

▶▶▶ **page 44**

## Full Backing Band Accompaniment

Even if you're playing alone, the CVP can put an entire backing band behind you! Simply playing chords automatically triggers and controls the auto accompaniment backing (Style function). Select an accompaniment Style — such as pop, jazz, Latin, and various other music genres in the world — and let the Clavinova be your complete



backing band! You can change arrangements on the fly, instantly selecting different rhythm variations and breaks in real time, including Intro, Ending, and Fill-in, during your performance.

▶▶▶ page 58

## Enjoyable Song Lesson Features — with Score Display and Guide Lamps

The Lesson features are a fun way to learn and master Songs, with notation shown on the display. Moreover, each key of the keyboard has a Guide lamp, which lights to indicate the notes to be played, letting you practice melodies and phrases smoothly — even if you are a beginner or have trouble reading notation.

▶▶▶ page 76

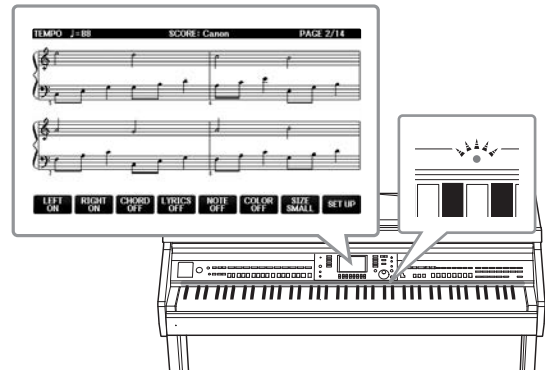

## Sing Along with Song Playback or Your Own Performance

Since a microphone can be connected to the Clavinova and Song lyrics can be shown on the display, you can enjoy singing along with your keyboard performance or along with Song playback. You can also cancel the vocal part on audio recordings, letting you sing along with (or instead of!) your favorite artists and groups, and enjoy performing even more.

▶▶▶ Pages 75, 90



# Panel Controls

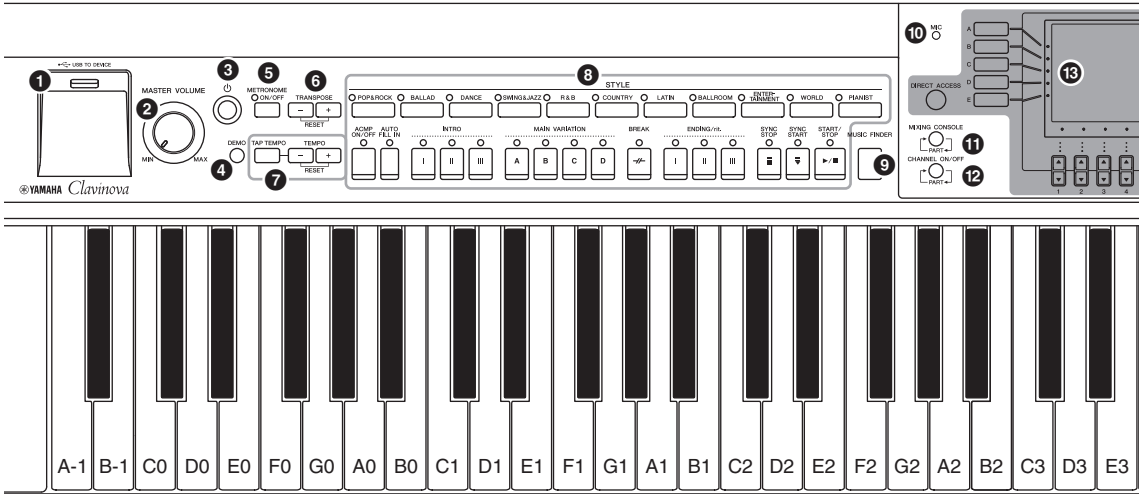

## Panel Setup (Panel Settings)

By using the controls on the panel, you can make various settings such as selecting a Voice or Style, tuning the pitch, and so on. These settings of the instrument are together referred to as “panel setup” or “panel settings” in this manual.

- 1 [USB TO DEVICE] terminal** ..... page 106  
For connecting a USB flash drive.
- 2 [MASTER VOLUME] control** ..... page 19  
Adjusts the overall volume.
- 3 [ ] (Standby/On) switch** ..... page 18  
Turns the instrument’s power on or sets it to standby.
- 4 [DEMO] button** ..... page 24  
Plays the Demos.
- 5 [METRONOME ON/OFF] button** ..... page 56  
Turns the metronome on or off.
- 6 TRANSPOSE buttons** ..... page 50  
These transpose the pitch in semitone steps.
- 7 [TAP TEMPO]/TEMPO buttons** ..... page 64  
These control the tempo for Style, MIDI Song and Metronome playback.
- 8 STYLE buttons** ..... page 58  
These select a Style and control Style playback.
- 9 [MUSIC FINDER] button** ..... page 92  
Calling up ideal panel settings for your performance.
- 10 [MIC] lamp** ..... page 90  
For checking the input level of the microphone.
- 11 [MIXING CONSOLE] button** ..... page 100  
Calls up various settings for the keyboard, Style and Song parts.
- 12 [CHANNEL ON/OFF] button** ..... pages 67, 75  
Calls up settings for turning Style/Song channels on or off.
- 13 LCD and related controls** ..... page 25
- 14 [USB] button** ..... pages 31, 84  
Calls up the display for selecting a file on the USB flash drive.
- 15 [FUNCTION] button**  
Lets you make advanced settings and create your original Styles and Songs. For details, see the Reference Manual on the website (page 9).
- 16 PART ON/OFF buttons** ..... page 47  
Turns the keyboard parts on or off.
- 17 [AUDIO] button** ..... page 84  
Plays back audio Songs and records your performance in audio format.
- 18 SONG CONTROL buttons** ..... page 71  
These select a Song and control Song playback.
- 19 [PIANO ROOM] button** ..... page 40  
For instantly calling up the optimum piano-related settings for playing the instrument simply as a piano, or for playing in a session-like atmosphere with a complete band sound.
- 20 REGISTRATION MEMORY buttons** ..... page 97  
These register and recall panel setups.
- 21 VOICE buttons** ..... page 44  
These select a Voice.
- 22 ONE TOUCH SETTING buttons** ..... page 64  
These call up the appropriate panel settings for the Style.
- 23 [VOICE EFFECT] button** ..... page 51  
These apply various effects to the keyboard performance.

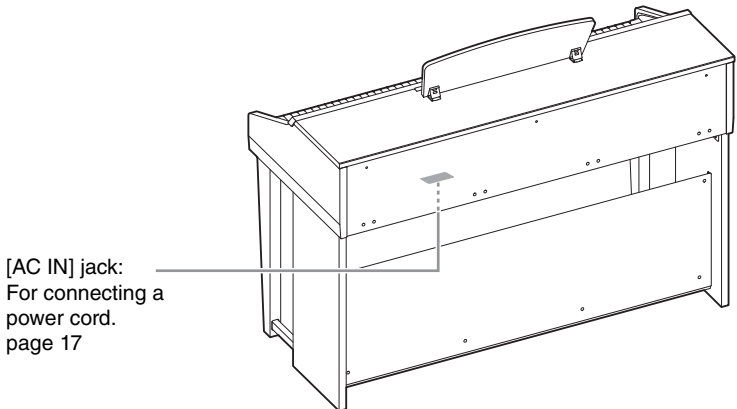
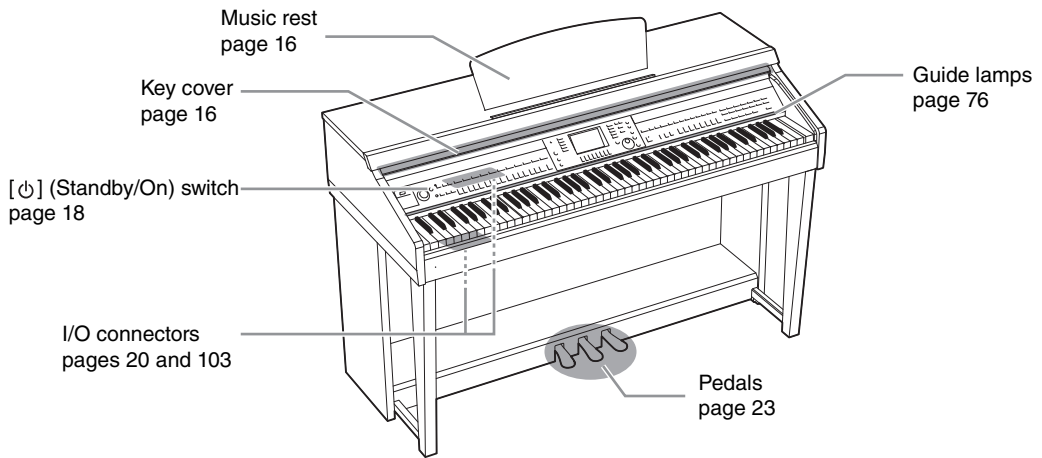
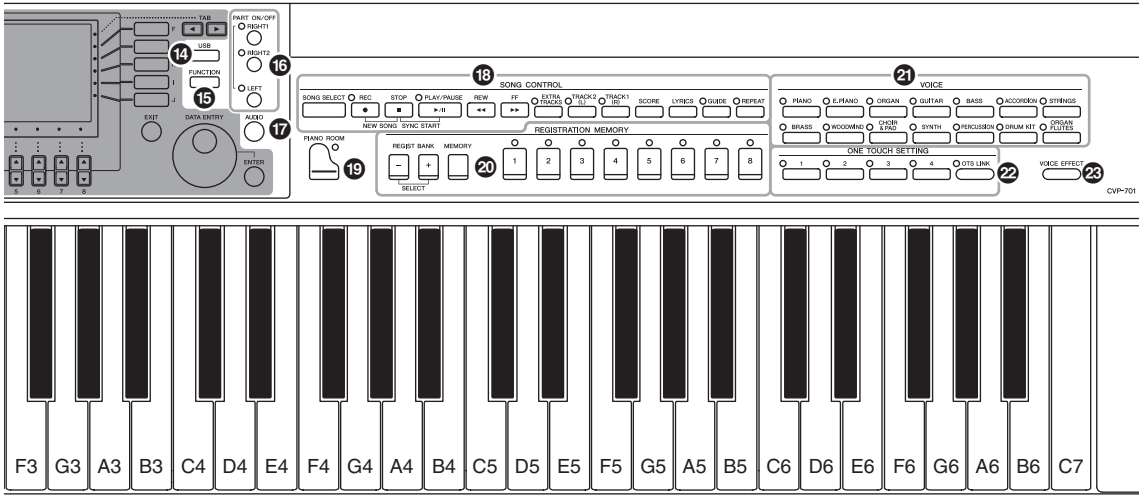

## Opening/Closing the Key Cover

When opening the key cover, lift the cover slightly, then push and slide it open.

When closing the key cover, slide the cover toward you and gently lower the cover over the keys.

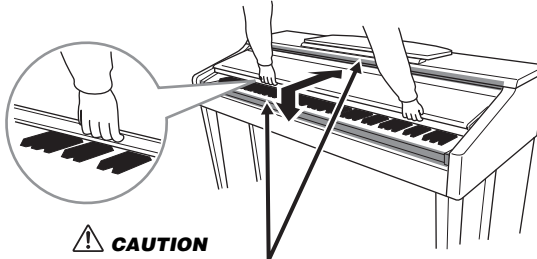

**CAUTION**  
Be careful to avoid catching your fingers when opening/closing the cover.

**CAUTION**

- Hold the cover with both hands when opening or closing it. Do not release it until it is fully opened or closed. Be careful to avoid catching fingers (yours or others, especially children's) between the cover and the unit.
- Do not place objects such as a piece of metal or paper on top of the key cover. Small objects placed on the key cover may fall inside the unit when the cover is opened and may be nearly impossible to remove. This could cause electric shock, short circuit, fire or other serious damage to the instrument.

## Using the Music Rest

To raise the music rest:

- 1 Pull the music rest up and toward yourself as far as it will go.
- 2 Flip down the two metal supports at the left and right on the rear of the music rest.
- 3 Lower the music rest so that the metal supports latch into place.

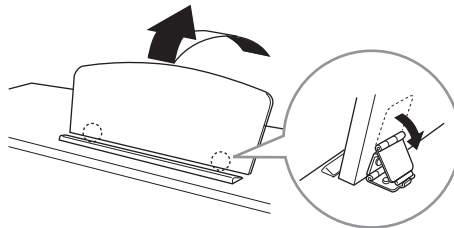

**CAUTION**

Do not try to use the music rest in a half-raised position. Also, when raising or lowering the music rest, do not release your hands from the music rest until it is all the way up or down.



## To lower the music rest:

- 1 Pull the music rest toward yourself as far as it will go.
- 2 Raise the two metal supports (at the rear of the music rest).
- 3 Gently lower the music rest backward until it is all the way down.

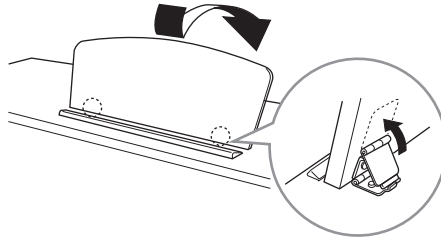

## Power Supply

Connect the plugs of the power cord in the order shown in the illustration. In some areas a plug adaptor may be provided to match the pin configuration of the AC wall outlets in your area.

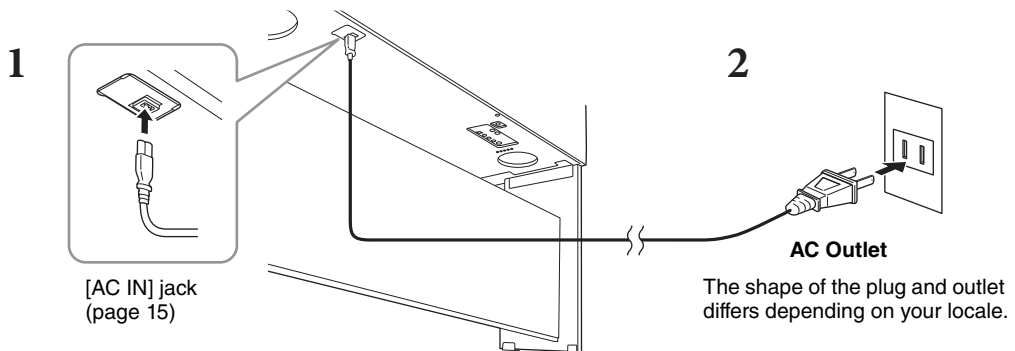

### **WARNING**

Use only the supplied power cord.



### **CAUTION**

When setting up the product, make sure that the AC outlet you are using is easily accessible. If some trouble or malfunction occurs, immediately turn off the power switch and disconnect the plug from the outlet.

### **NOTE**

When disconnecting the power cord, first turn off the power, then follow this procedure in reverse order.

# Turning On/Off the Power

- 1 Turn down the [MASTER VOLUME] dial to “MIN.”

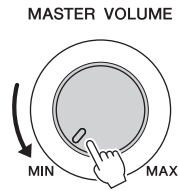

- 2 Press the [⏻] (Standby/On) switch to turn the power on.

The display and the power indicator located below the left end of the keyboard lights up. Adjust the volume as desired while playing the keyboard.

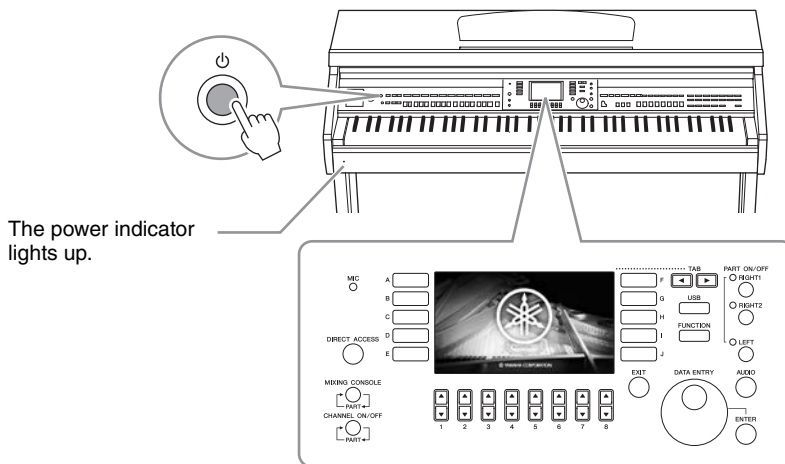

The power indicator lights up.

- 3 Press and hold the [⏻] (Standby/On) switch for about a second to turn the power off.

### **CAUTION**

Even when the [⏻] (Standby/On) switch is in standby status, electricity is still flowing to the instrument at the minimum level. Remove the electric plug from the outlet when the instrument is not to be used for extended periods of time, or during electrical storms.

### **NOTICE**

While recording or editing, or while a message is displayed, the power cannot be turned off even if you press the [⏻] (Standby/On) switch. If you want to turn off the power, press the [⏻] (Standby/On) switch after recording, editing, or after the message has disappeared. If you need to force-quit the instrument, hold down the [⏻] (Standby/On) switch for longer than three seconds. Note that the force-quit operation might cause data loss and damage to the instrument.

## Auto Power Off function

To prevent unnecessary power consumption, this instrument features an Auto Power Off function that automatically turns the power off if the instrument is not operated for a specified period of time. The amount of time that elapses before the power is automatically turned off is approximately 30 minutes by default; however, you can change the setting.

### **NOTICE**

Any data which is not saved via the Save operation will be lost if the power automatically turns off. Make sure to save your data before this happens.

## ■ Disabling Auto Power Off (simple method)

Turn the power on while holding down the lowest key on the keyboard. A message appears briefly, then the instrument starts up with the Auto Power Off is disabled.

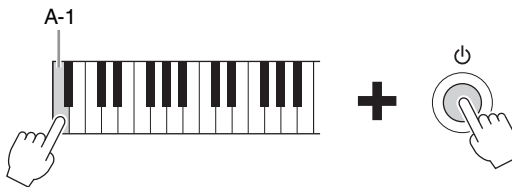

For details on how to set the desired Auto Power Off time, refer to the Reference Manual on the website (page 9), Chapter 12.

## Adjusting the Master Volume

To adjust the volume of the entire keyboard sound, use the [MASTER VOLUME] dial while playing the keyboard.

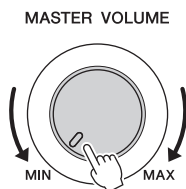

### **CAUTION**

Do not use the instrument for a long period of time at a high or uncomfortable volume level, since this can cause permanent hearing loss.

## Intelligent Acoustic Control (IAC)

IAC is a function which automatically adjusts and controls the sound quality according to the overall volume of the instrument. Even when the volume is low, it permits both low sounds and high sounds to be clearly heard. IAC Control affects only the sound output of the instrument speakers. You can turn the IAC function on or off, and set the depth, although the default setting for this function is on. For details, refer to the Reference Manual on the website (page 9), Chapter 12.

## Using Headphones

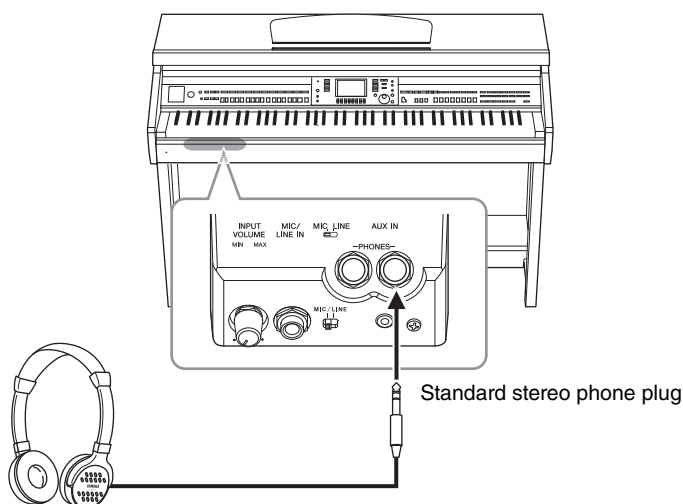

Since this instrument is equipped with two [PHONES] jacks, you can connect two sets of standard stereo headphones. If you are using only one set of headphones, insert a plug into either of these jacks.

### **⚠ CAUTION**

Do not use the headphones for a long period of time at a high or uncomfortable volume level, since this can cause permanent hearing loss.

## Reproducing natural sound distance (Stereophonic Optimizer)

The Stereophonic Optimizer feature recreates for headphones the spacious sensation you hear when you play an acoustic piano. In general, the sound from headphones is much too close to your ears for natural sound. When this function is turned on, you can sense a natural sound distance as if the sound is coming from the piano, even though you hear it on headphones. This function is effective only on the VRM Voices (page 49) and does not affect the sound output of the instrument speakers. You can turn this function off, although the default setting for this function is on. For details, refer to the Reference Manual on the website (page 9), Chapter 12.

## Using the Headphone Hanger

A headphone hanger is included in the instrument package so that you can hang the headphones on the instrument. Install the headphone hanger by following the instructions at the end of this manual.

### **NOTICE**

Do not hang anything other than the headphones on the hanger. Otherwise, the instrument or the hanger may be damaged.

Throughout this manual, arrows are used in the instructions, indicating in shorthand the process of calling up certain displays and functions.

## Changing the Display Language

This determines the language used in the display for messages, file names, and character input.

### 1 Call up the operation display.

- ① [FUNCTION] → ② TAB [◀][▶] MENU2 → ③ [G] (SYSTEM) → ④ TAB [◀][▶] OWNER

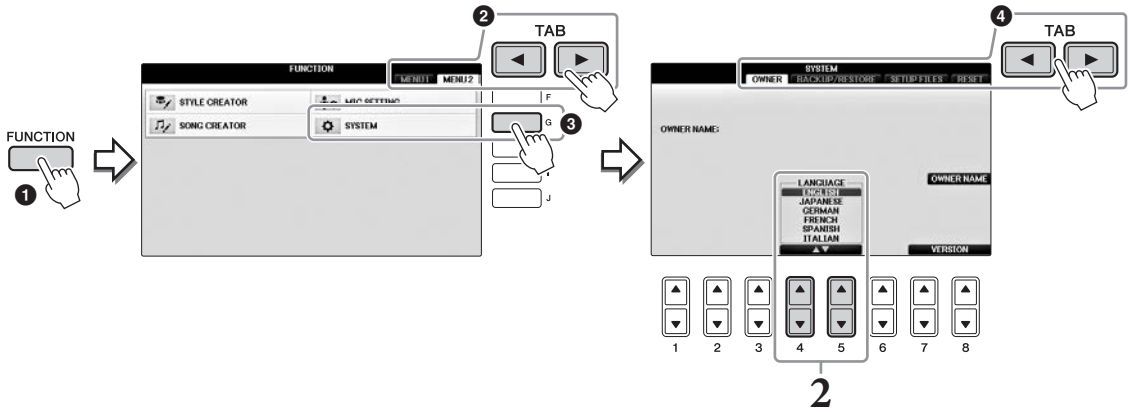

### 2 Use the [4▲▼]/[5▲▼] buttons to select the desired language.

The language is now set.

## Adjusting the Brightness of the Display

### 1 Call up the operation display.

- ① [FUNCTION] → ② TAB [◀][▶] MENU1 → ③ [J] (UTILITY) → ④ TAB [◀][▶] CONFIG1

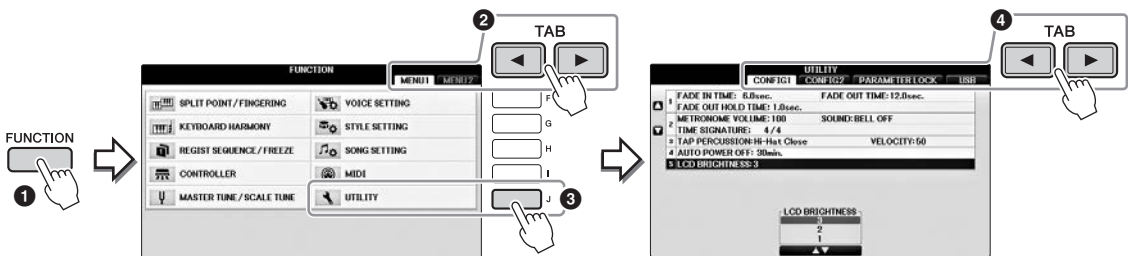

### 2 Use the [A]/[B] buttons to select “LCD BRIGHTNESS.”

### 3 Adjust the brightness of the display by using the [4▲▼]/[5▲▼] buttons.

The display is darkest at a setting of “1” and brightest at “3.”

# Showing the Owner Name in the Opening Display

You can have your name appear in the opening display (the display that appears when the power is turned on).

## 1 Call up the operation display.

① [FUNCTION] → ② TAB [◀][▶] MENU2 → ③ [G] (SYSTEM) → ④ TAB [◀][▶]  
OWNER

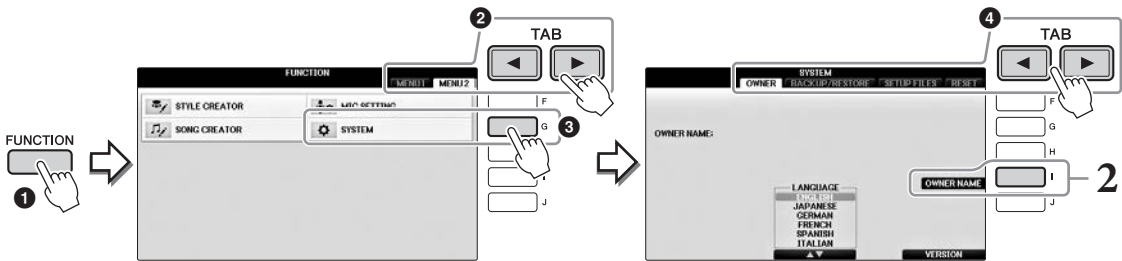

## 2 Press the [I] (OWNER NAME) button to call up the Owner Name display.

Refer to page 36 for character-entry details.

### Display the version number

To check the version number of this instrument, press the [7▲▼]/[8▲▼] (VERSION) buttons in the display in step 1 above. Press the [EXIT] button or the [8▲▼] button to return to the original display.

## Using the Pedals

The instrument features three pedals.

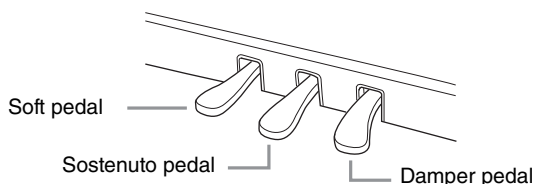

### ■ Damper pedal (Right)

Pressing this pedal lets you sustain notes even after releasing the keys. When you select a Piano Voice compatible with VRM (page 49), pressing this pedal activates the VRM to accurately recreate the unique resonance of an acoustic grand piano's soundboard and strings. This pedal can be used to control the half-pedal function.

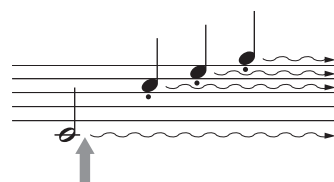

When you press the right pedal here, the notes you play before you release the pedal have a longer sustain.

### Half-pedal function:

This function allows the sustain length to vary depending on how far the pedal is pressed. The farther you press the pedal, the more the sound sustains. For example, if you press the damper pedal and the notes you play sound a bit murky and loud with too much sustain, you can partially release the pedal to lessen the sustain (murkiness). The point at which pressure on the pedal affects the damper muting (half pedal point) can be set in the following way: [DIRECT ACCESS] button → press the damper pedal → [A]/[B] RIGHT → [4▲▼] HALF PEDAL POINT

#### NOTE

Certain Voices, such as [STRINGS] or [BRASS], sustain continuously when the damper/sostenuto pedal is pressed. Also, certain Voices such as drum kits may not be affected by use of the damper/sostenuto pedal.

### ■ Sostenuto pedal (Center)

When the Piano Voice is selected, if you play a note or chord on the keyboard and press this pedal while holding the note(s), the notes will sustain as long as the pedal is held. All subsequent notes will not sustain. When a Voice other than piano is selected, a specific function appropriate for the Voice is automatically assigned to the center pedal.

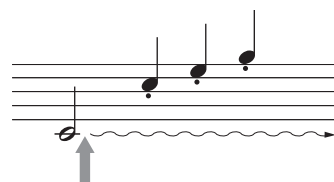

When you press the center pedal here while holding the note(s), the notes will sustain as long as you hold the pedal.

### ■ Soft pedal (Left)

When the Piano Voice is selected, pressing this pedal reduces the volume and slightly changes the timbre of the notes you play. When a Voice other than piano is selected, a specific function appropriate for the Voice is automatically assigned to the left pedal. You can adjust the depth of the left pedal effect. Voice Selection display → [8▼] MENU1 → [5▼] VOICE SET → TAB [◀][▶] CONTROLLER → [A]/[B] LEFT PEDAL. For details, refer to the Reference Manual on the website (page 9), Chapter 11.

### Making settings for the pedals

You can assign one of the various functions to the three pedals or a foot controller/footswitch (sold separately) doing things like controlling the Super Articulation Voices or starting and stopping the Song (page 105).

# Playing the Demos

The Demos provide helpful, easy-to-understand introductions to the features and functions as well as sound demonstrations.

- 1 Press the [DEMO] button to call up the Demo display.

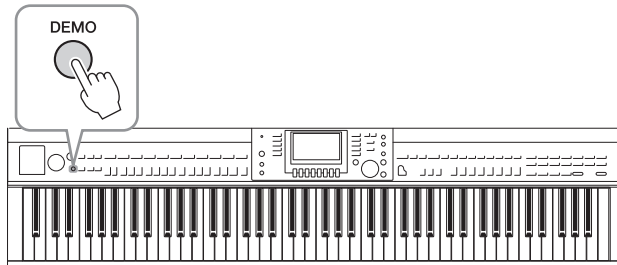

- 2 Press one of the [A] – [D] buttons to show a specific Demo.

Pressing one of the [F] – [I] buttons plays back the overview Demo continuously, calling up the various displays in sequence.



The sub menus are shown on the display. Press one of the [A] – [J] buttons corresponding to the sub menu.

**NOTE**

To return to the next higher level menu, press the [EXIT] button.

- 3 Press the [EXIT] button repeatedly if necessary to exit from the Demos.



# Display-based Controls

The LCD provides comprehensive at-a-glance information on all current settings. The displayed menu can be selected or changed by the controls around the LCD.

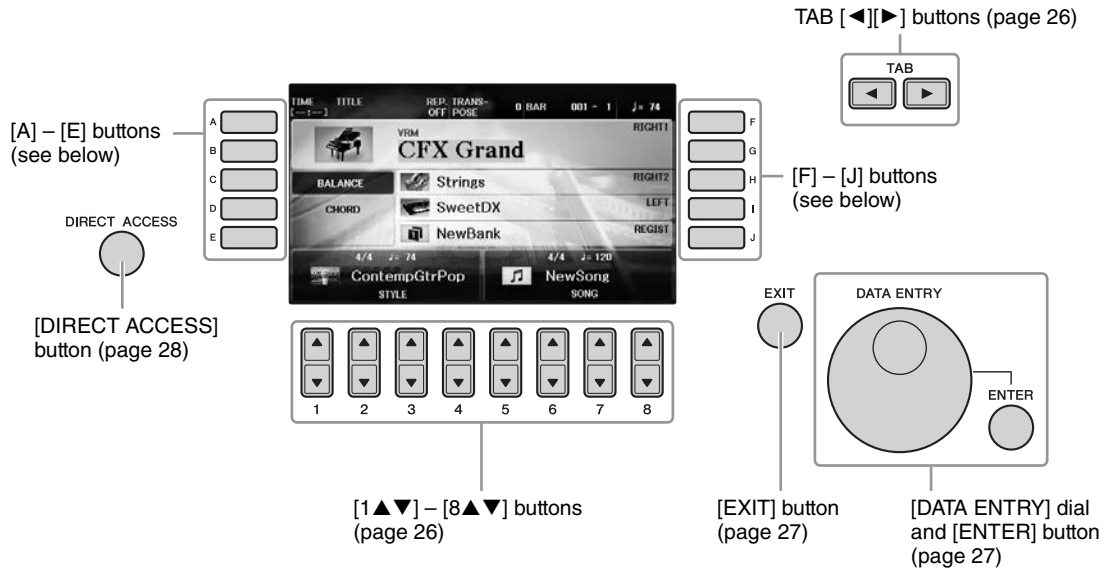

## [A] – [J] buttons

The [A] – [J] buttons are used to select the corresponding menu items shown next to them.

### ■ Example 1

In the File Selection display (page 30), the [A] – [J] buttons can be used to select the corresponding respective files.



### ■ Example 2

The [A] and [B] buttons are used to move the cursor up or down.

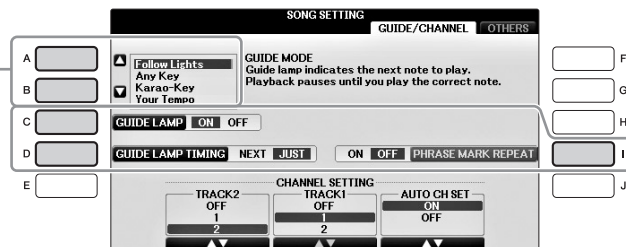

The [C], [D] and [I] buttons are used to select the corresponding parameter.

## TAB [◀][▶] buttons

These buttons are used mainly to change the pages of displays that have “tabs” at the top.



## [1▲▼] – [8▲▼] buttons

The [1▲▼] – [8▲▼] buttons are used to make selections or adjust settings (up or down correspondingly) for functions shown directly above them.

If a menu appears in this section of the display, use the [1▲] – [8▲] (upper) buttons to select the desired items.

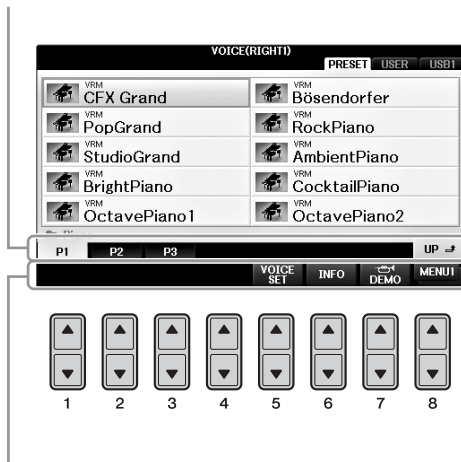

If a menu appears in this section of the display, use the [1▼] – [8▼] (lower) buttons to select the desired items.

If a menu list appears, use the [1▲▼] – [8▲▼] buttons to select the desired item.

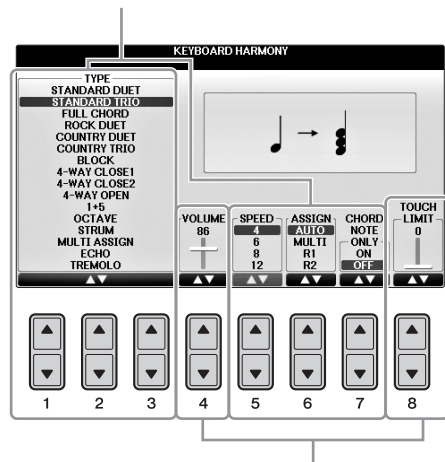

If a parameter appears in slider (or knob) form, use the [1▲▼] – [8▲▼] buttons to adjust the value.

## ■ Changing the page

If multiple pages exist in the display, the page numbers (P1, P2 ...) are shown at the bottom of the display. Pressing the corresponding [1▲] – [7▲] button changes the display page.

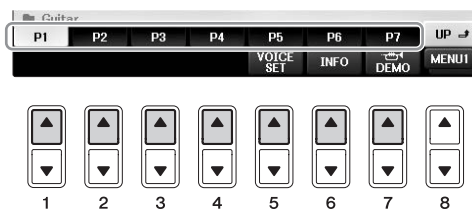

## [DATA ENTRY] dial and [ENTER] button

Depending on the selected LCD display, the [DATA ENTRY] dial can be used in the following two ways.

### ■ Selecting files (Voice, Style, Song, and so on)

When one of the File Selection displays (page 30) is shown, you can use the [DATA ENTRY] dial to move the cursor, then press the [ENTER] button to actually select a file.

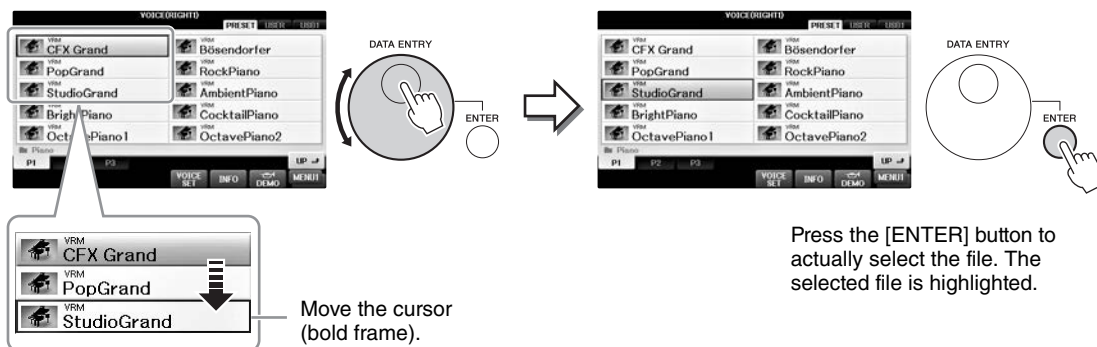

### ■ Adjusting the parameter values

You can conveniently use the [DATA ENTRY] dial in tandem with the [1▲▼] - [8▲▼] buttons to adjust parameters indicated in the display.

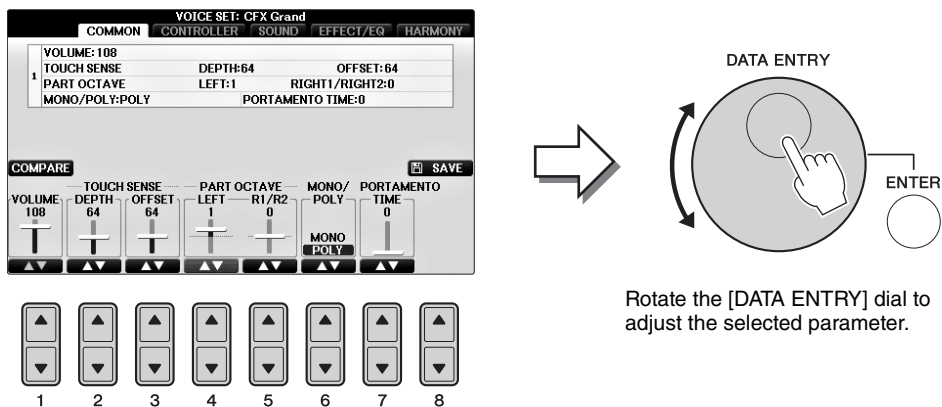

Select the desired parameter with the appropriate [1▲▼] - [8▲▼] button.

This convenient technique also works well with pop-up parameters such as Tempo and Transpose. Simply press the appropriate button (ex., TEMPO [+]), then rotate the [DATA ENTRY] dial and press [ENTER] to close the window.

## [EXIT] button

Pressing the [EXIT] button returns you to the previously indicated display. Pressing the [EXIT] button repeatedly returns to the default Main display (page 29).



## Messages Shown in the Display

A message (information or confirmation dialog) sometimes appears on the screen to facilitate operation. When the message appears, simply press the appropriate button.



## Instant Selection of the Displays — Direct Access

With the convenient Direct Access function, you can instantly call up the desired display — with just a single additional button press.

### 1 Press the [DIRECT ACCESS] button.

A message appears in the display prompting you to press the appropriate button.

### 2 Press the button or pedal corresponding to the desired setting display to instantly call up that display.

For example, pressing the [GUIDE] button calls up the display in which the Guide mode can be set.

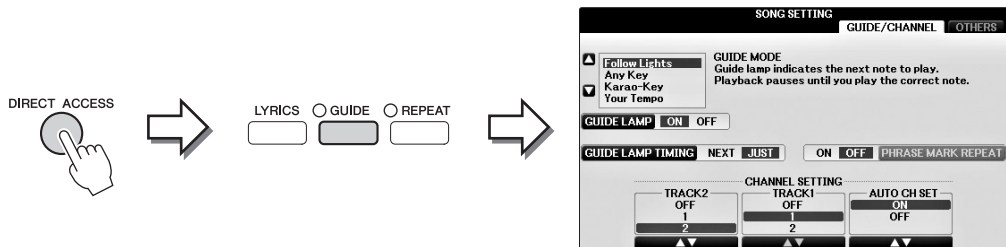

Refer to the separate Data List for a list of the displays that can be called up with the Direct Access function.

# Main Display Configuration

The display that appears when the power is turned on is the Main display. The Main display shows the current basic settings such as the currently selected Voice and Style, allowing you to see them at a single glance. The Main display is the one you'll usually see when you play the keyboard.

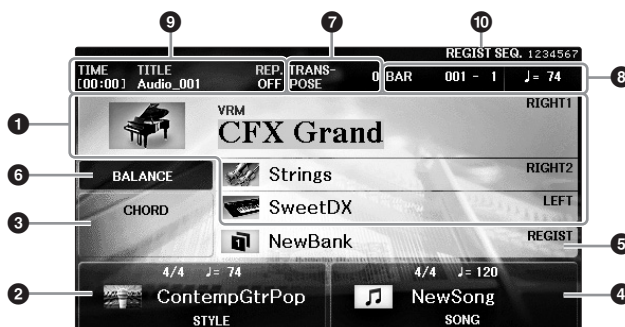

## 1 Voice name

Displays the Voice names currently selected for RIGHT 1, RIGHT 2 and LEFT parts (page 44). Pressing one of the [A] – [B] and [F] – [I] buttons calls up the Voice Selection display for each part.

### NOTE

An "H" indication appears when the Left Hold function (page 51) is set to ON.

## 2 Style name and related information

Displays the currently selected Style name, time signature and tempo. Pressing one of the [1▲▼] – [4▲▼] buttons calls up the Style Selection display (page 58).

## 3 Current chord name

When the [ACMP ON/OFF] button is set to on and the Style is being played back, the chord specified in the chord section of the keyboard will be displayed. When the Song containing the chord data is played, the current chord name will be displayed.

## 4 Song name and related information

Displays the currently selected Song name, time signature and tempo. Pressing one of the [5▲▼] – [8▲▼] buttons calls up the Song Selection display (page 71).

## 5 Registration Memory Bank name

Displays the currently selected Registration Memory Bank name. Pressing the [J] button calls up the Registration Memory Bank Selection display (page 98).

### NOTE

An "F" indication appears when the Freeze function is set to ON. It lets you maintain the settings of certain parameter groups and leave them unchanged, even when selecting other Registration Memory buttons. For details, refer to the Reference Manual on the website (page 9), Chapter 9.

## 6 Volume Balance

Pressing the [C] button displays the volume balance among the parts. There are two display pages, and you can toggle between them by pressing the [C] button (page 68).

## 7 Transpose

Displays the amount of transposition in semitone units (page 68).

## 8 TEMPO/BAR/BEAT

Displays the current position (tempo/bar/beat) in Style playback or Song playback.

## 9 Audio information

Displays information for the selected audio file (file name, time, etc.) When the recording of USB Audio Player/Recorder is in standby, a “REC WAIT” indication appears. While recording, “REC” appears.

## 10 Registration Sequence

Indicates the sequence order of the Registration Memory (if set to on; page 99) numbers, which can be called up via the TAB [◀][▶] buttons or the pedal. The selected Registration Memory number is enclosed in a frame. For instructions on programming the sequence, refer to the Reference Manual on the website (page 9), Chapter 9.

## File Selection Display Configuration

The File Selection display is for selecting Voice, Styles, and other data (files). The File Selection display appears when you press one of the VOICE or STYLE category selection buttons, SONG CONTROL [SONG SELECT] button, etc.

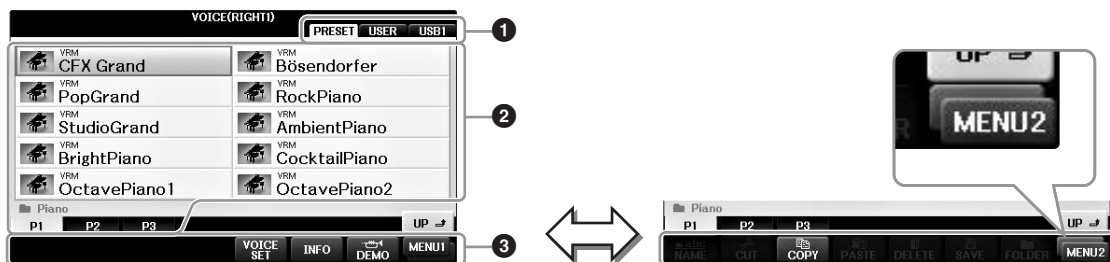

### 1 Location (drive) of data

- **PRESET** ..... Location where pre-programmed (preset) data is stored.
- **USER**..... Location where recorded or edited data is saved.
- **USB**..... Location where data on USB flash drive is saved. This appears only when USB flash drive is connected to the [USB TO DEVICE] terminal (page 106).

### 2 Selectable data (files)

The files that can be selected on this display are shown. If more than 10 files exist, the page numbers (P1, P2 ...) are shown below the files. Pressing the corresponding button changes the display page. When all page numbers cannot fit on the display, the “Next” button appears, and for previous pages, the “Prev.” button appears.

### 3 MENU1/MENU2

At the bottom of the File Selection display, you can toggle the indication between MENU1 and MENU2 by pressing the [8▼] button.

- **MENU1** ..... Selecting MENU1 shows the function names related to the current file (Voice, Style, Song, etc.). When MENU1 is selected with the Voice selection display, for example, pressing the [7▼] button will play back the Voice demo.
- **MENU2**..... Selecting MENU2 shows the function names of file/folder management, such as save, copy, move and delete. You can also rename the files and organize them in folders, by creating a new folder (pages 32 – 37.)

## Closing the current folder and calling up the next highest level folder

In the PRESET display, several data (files) are contained together in a folder. You can also organize your original data in the USER/USB display by creating several new folders (page 32). To close the current folder and call up the next highest level folder, press the [8▲] (UP) button.

### Example of the PRESET Voice Selection display

The PRESET Voice files are categorized and contained in appropriate folders.



Press the [8▲] (UP) button.

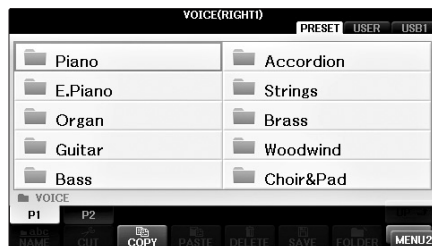

The next highest level — in this case, folder — is shown. Each folder shown in this display contains appropriately categorized Voices.

This display shows the Voice files in a folder.

## USB display

By pressing the [USB] button, you can also access Voices, Styles, and other data files which are saved in the USB flash drive.

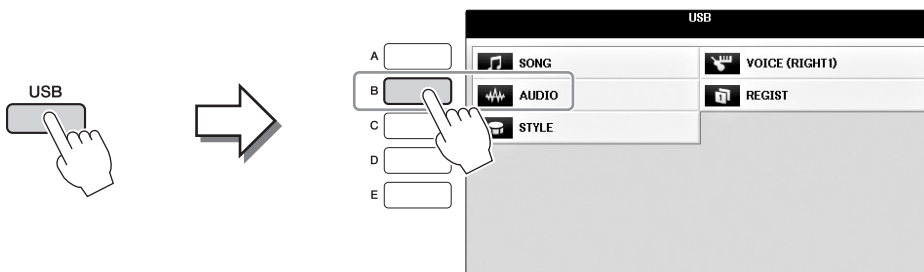

# File/Folder Management

If you've saved a lot of files to a USB flash drive or USER drive, it may be difficult to find the desired file quickly. To make it easier to find the files you want, you can organize your files in folders, rename the files, delete unnecessary files, etc. These operations are done in the File Selection display.

## Creating a New Folder

This operation lets you create new folders. Folders can be created, named and organized as desired, making it easier to find and select your original data.

### NOTE

New folders cannot be created in the PRESET tab or the "PianoRoom" folder.

### NOTE

The maximum number of files/folders which can be stored in a folder is 500.

- 1 In the file selection display, select the appropriate tab (USER or USB) to which you want to save the data by using the TAB [◀][▶] buttons.**

If you want to create a new folder within the existing folder, also select the folder here.

### NOTE

In the USER tab display, folder directories can contain up to four levels. The maximum total number of files/ folders which can be stored differs depending on the file size and the length of the file/folder names.

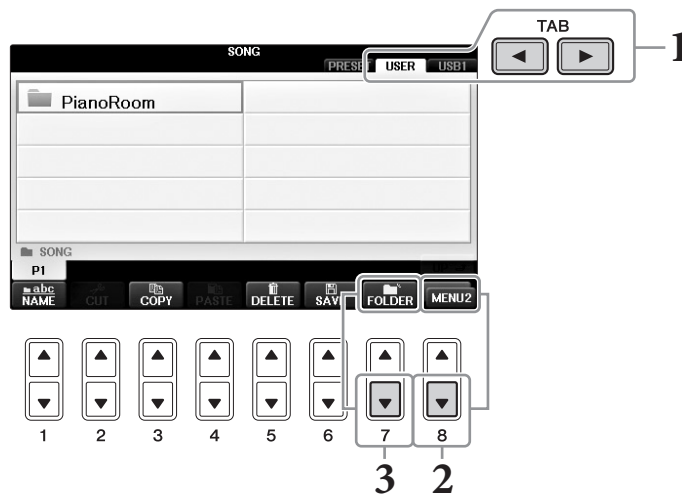

- 2 Call up MENU2 at the right bottom of the display by pressing the [8▼] button as necessary.**
- 3 Press the [7▼] (FOLDER) button to call up the naming display for a new folder.**

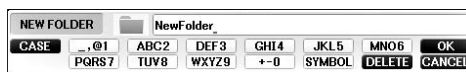

- 4 Input the name of the new folder (see page 36).**

### NOTE

The following characters cannot be entered for a file/folder name.  
¥ / : \* ? " < > |



# Renaming a File/Folder

This operation lets you rename files/folders.

## NOTE

- Files in the PRESET tab cannot be renamed.
- The "PianoRoom" folder cannot be renamed.

- 1 Call up the display containing the file/folder you want to rename.**
- 2 Call up MENU2 at the right bottom of the display by pressing the [8▼] button as necessary.**
- 3 Press the [1▼] (NAME) button.**

The pop-up window for the Rename operation appears at the bottom of the display.

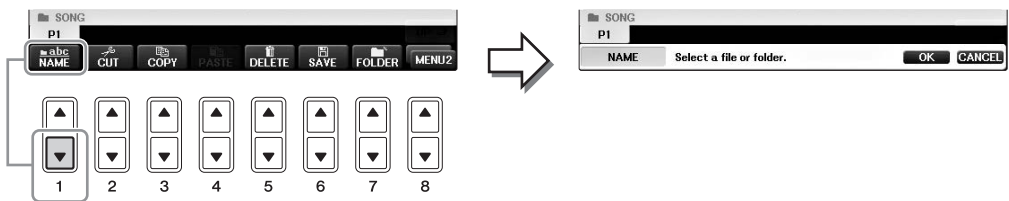

- 4 Press one of the [A] – [J] buttons corresponding to the desired file/folder.**
- 5 Press the [7▼] (OK) button to confirm the file/folder selection.**

## NOTE

To cancel the Rename operation, press the [8▼] (CANCEL) button.

- 6 Input the name (characters) of the selected file or folder (page 36).**  
The renamed file/ folder appears on the display at the appropriate position among the files in alphabetical order.

## Copying or Moving Files

This operation lets you copy or cut a file and paste it to another location (folder). You can also copy a folder (but not move it) by using the same procedure.

Please note that some files have copy/move restrictions. See “Restrictions for protected Songs” on page 73.

### NOTE

Files in the PRESET tab and the “PianoRoom” folder cannot be moved.

#### 1 Call up the display containing the file/folder you want to copy.

##### NOTE

Copying of commercially available musical data including but not limited to MIDI data and/or audio data is strictly prohibited except for your personal use.

#### 2 Call up MENU2 at the right bottom of the display by pressing the [8▼] button as necessary.

#### 3 Press the [3▼] (COPY) button to copy or [2▼] (CUT) to move.

The pop-up window for the Copy/Cut operation appears at the bottom of the display.

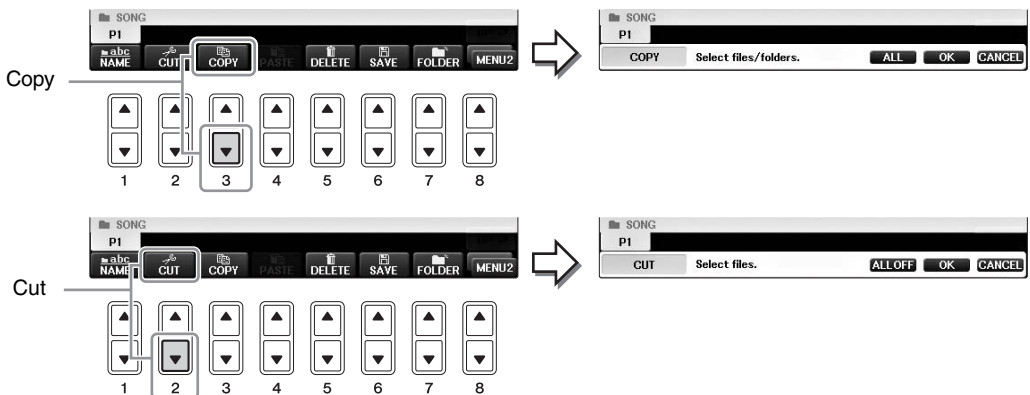

#### 4 Press one of the [A] – [J] buttons corresponding to the desired file/folder.

To cancel the selection, press the same [A] – [J] button again.

Press the [6▼] (ALL) button to select all files/folders indicated on the current display including the other pages. To cancel the selection, press the [6▼] (ALL OFF) button again.

#### 5 Press the [7▼] (OK) button to confirm the file/folder selection.

##### NOTE

To cancel the Copy operation, press the [8▼] (CANCEL) button.

#### 6 Select the destination tab (USER or USB) to paste the file/folder, by using the TAB [◀][▶] buttons.

If necessary, select the destination folder by using the [A] – [J] buttons.

#### 7 Press the [4▼] (PASTE) button to paste the file/folder selected in step 4.

The pasted file/folder appears on the display at the appropriate position among the files in alphabetical order.

# Deleting Files/Folders

This operation lets you delete a file/folder.

**NOTE**

- Files in the PRESET tab cannot be deleted.
- The "PianoRoom" folder cannot be deleted.

- 1 Call up the display containing the file/folder you want to delete.**
- 2 Call up MENU2 at the right bottom of the display by pressing the [8▼] button as necessary.**
- 3 Press the [5▼] (DELETE) button.**

The pop-up window for the Delete operation appears at the bottom of the display.

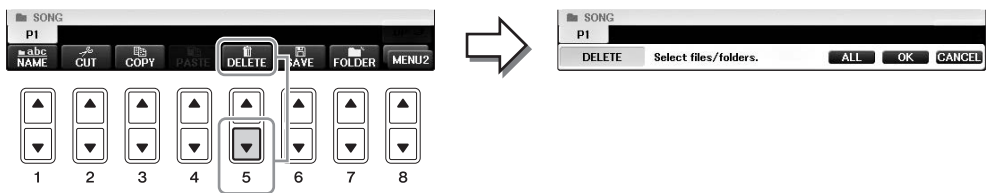

- 4 Press one of the [A] – [J] buttons corresponding to the desired file/ folder.**  
To cancel the selection, press the same [A] – [J] button again.  
Press the [6▼] (ALL) button to select all files/folders indicated on the current display including the other pages. To cancel the selection, press the [6▼] (ALL OFF) button again.
- 5 Press the [7▼] (OK) button to confirm the file/folder selection.**

**NOTE**

To cancel the Delete operation, press the [8▼] (CANCEL) button.

- 6 Follow the on-display instructions, and select the item according to the desired operation.**
  - YES .....Delete the file/folder
  - YES ALL .....Delete all selected files/folders
  - NO .....Leave the file/folder as is without deleting
  - CANCEL.....Cancel the Delete operation

**NOTE**

Depending on the particular operation, not all of these menu items may appear, and their location in the display may also differ, along with the button assignment.

# Entering Characters

The instructions that follow show you how to enter characters for naming your files/folders, inputting keywords, etc. Entering characters is done in the display shown below.

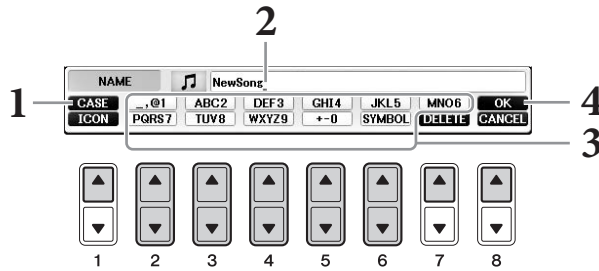

## 1 Change the type of character by pressing the [1▲] button.

■ If you select a language other than Japanese as the Language (page 21), the following different types of characters are available:

- **CASE** .....Capital letters, numbers, marks
- **case** .....Lowercase letters, numbers, marks

■ If you select Japanese as the Language (page 21), the following different types of characters and sizes can be entered:

- **かな漢 (kana-kan)** ...Hiragana and Kanji, marks (full size)
- **カナ (kana)** .....Katakana (normal size), marks (full size)
- **か** (kana) .....Katakana (half size), marks (half size)
- **A B C** .....Alphabet (capital and small letters, full size), numbers (full size), marks (full size)
- **ABC** .....Alphabet (capital and small letters, half size), numbers (half size), marks (half size)

### NOTE

Depending on the display for character entry you are working in, some types of characters cannot be entered.

## 2 Use the [DATA ENTRY] dial to move the cursor to the desired position.

## 3 Use the [2▲▼] – [6▲▼] and [7▲] buttons, corresponding to the character you wish to enter.

To actually enter the selected character, move the cursor or press another letter-input button. Alternately, you can wait for a short time and the character will be entered automatically. For details on entering characters, refer to “Other character-entry operations” below.

### NOTE

File names can contain up to 41 characters and folder names can contain up to 50 characters.

## 4 Press the [8▲] (OK) button to actually enter the new name and return to the previous display.

### NOTE

To cancel the character-entering operation, press the [8▼] (CANCEL) button.

## Other character-entry operations

---

### ■ Deleting characters

Move the cursor to the character you wish to delete by using the [DATA ENTRY] dial, and press the [7▼] (DELETE) button. To delete all characters on the line at once, press and hold the [7▼] (DELETE) button.

### ■ Entering special character marks (Japanese “<濁点>” and “<半濁点>”)

Select a character to which a character mark is to be added and press the [6▼] button before actual entry of the character.

#### NOTE

In the case of characters which are not accompanied by special character marks (with the exception of kanakan and half-size katakana), you can call up the mark list by pressing the [6▼] button after selecting a character (before actual entry of a character).

### ■ Entering marks or space

- 1 Press the [6▼] (SYMBOL) button to call up the mark list.
- 2 Use the [DATA ENTRY] dial to move the cursor to the desired mark or space, then press the [8▲] (OK) button.

### ■ Converting into Kanji (Japanese language)

When the entered “hiragana” characters are shown in reverse display (highlighted), press the [1▲]/[ENTER] button one or several times to convert the characters into the appropriate kanji. You can change the reversed area by using the [DATA ENTRY] dial. To actually enter the change, press the [1▼]/[8▲] (OK) button.

To change the converted kanji back to “hiragana,” press the [7▼] (DELETE) button.

To clear the reversed area at once, press the [8▼] (CANCEL) button.

### ■ Selecting custom icons for files (shown at left of file name)

- 1 Press the [1▼] (ICON) button to call up the ICON SELECT display.
- 2 Select the icon by using the [A] – [J] buttons, [3▲▼] – [5▲▼] buttons or [DATA ENTRY] dial. The ICON display includes several pages. Press the TAB [◀][▶] buttons to select different pages.
- 3 Press the [8▲] (OK) button to apply the selected icon.

#### NOTE

To cancel the operation, press the [8▼] (CANCEL) button.



## Restoring the Factory-programmed Settings

Restores the System Setup parameters to the original factory settings. Refer to the separate Data List booklet for details on the System Setup parameters, marked with “O” in the “System Setup” row in the Parameter Chart list.

Turning the power on while holding the right-most key on the keyboard displays a message indicating that initialization is in progress. The message disappears when initialization is complete.

Recorded Songs in the USER location (page 30) will not be deleted by this operation.

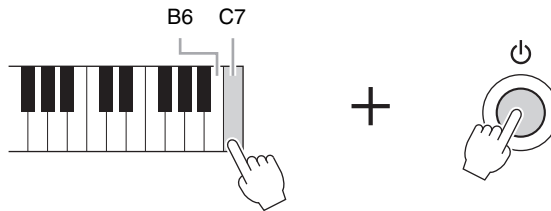

### NOTE

If you want to initialize only the Registration Memory setting (page 97), turn the power on while holding the B6 key.

You can also restore a specified group of settings to the factory default values, or delete all files/folders in the USER drive. Call up the operation display: [FUNCTION] → TAB [◀][▶] MENU2 → [G] (SYSTEM) → TAB [◀][▶] RESET

For details, refer to the Reference Manual on the website (page 9), Chapter 12.

# Piano Room

– Enjoying Piano Performance –

The Piano Room function is for those who want to simply, conveniently, and fully enjoy playing the instrument as a piano. No matter what settings you’ve made from the panel, you can instantly call up the optimum settings for piano performance with a single button press. You can also change the piano settings as you like, or you can enjoy playing the piano as if you are in a small ensemble.

## Playing a Piano Performance in Piano Room

### 1 Press the [PIANO ROOM] button to call up the Piano Room display.

This operation calls up the optimum panel settings for piano performance and disables all other unrelated functions. However, the master volume control, the [PIANO ROOM] button, and all of the display controls (excepting the [DIRECT ACCESS] button) can be used.

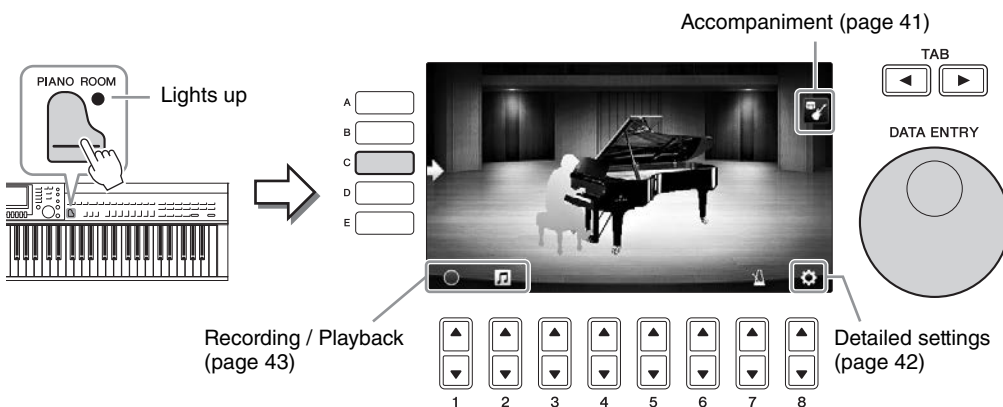

### 2 Play the keyboard.

Change the piano settings such as Piano Type, Environment (Reverb Type), etc. according to the type of music you want to play.

<b>Piano Type</b>	Press the [C] button to call up the piano list, then select the desired one using [F] – [J] buttons. To move through the pages of the list, use the [8▲▼] buttons.
<b>Environment (Reverb Type)</b>	Use the TAB [◀][▶] buttons to select the desired environment, which automatically calls up the appropriate Reverb type.
<b>Lid Position</b>	Rotate the [DATA ENTRY] dial to determine how much the Lid is opened. This can be set only when “Grand Piano” is selected.
<b>Metronome</b>	Press the [7▲▼] button to call up the setting pop-up display. You can turn it on or off using the [6▲▼] buttons, or change its tempo using the [7▲▼] buttons. You can also change the tempo by tapping the [8▲▼] button twice at the desired tempo.

To close a list or a setting display, press the [EXIT] button.

### 3 Press the [PIANO ROOM] button or [EXIT] button to exit the Piano Room display.

1

Piano Room – Enjoying Piano Performance –



# Playing the Piano in Session with Other Instruments

- 1 Press the  [PIANO ROOM] button to call up the Piano Room display.
- 2 Press the [F] button to call up the Session players in the display.  
Session players can be shown or hidden by pressing the [F] button.

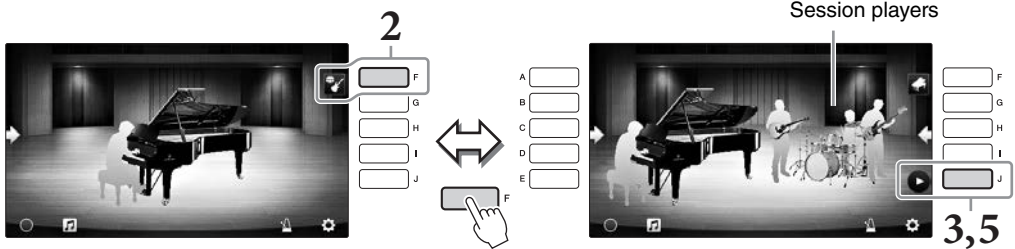

- 3 Press the [J] button to start.  
The intro starts playing back.
- 4 Play the keyboard following a few measures of the intro.  
The Session players provide accompaniment for your performance. Jazz or Pop is recommended.
- 5 Press the [J] button to stop the accompaniment.  
Accompaniment stops after an ending part is played.

**NOTE**

Accompaniment features are also available outside the Piano Room. For details, refer to page 58.

## Changing the Type and Settings of Accompaniment

Press the [H] button on the right display of step 2 above to call up the setting display for selecting the type of accompaniment, or changing the settings. You can select the type of accompaniment, change the tempo and volume, and turn each part of the accompaniment on or off. Switch the contents of the setting display by pressing the [8▲▼] button.

Changing the type of accompaniment, tempo and volume.

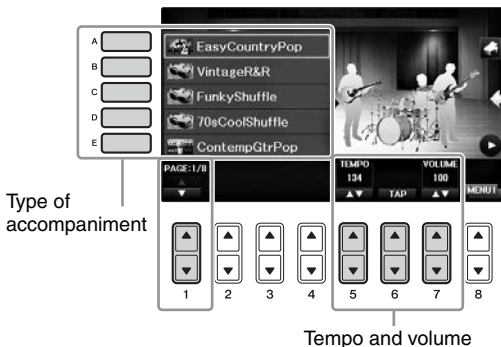

Turning each part of accompaniment on or off.

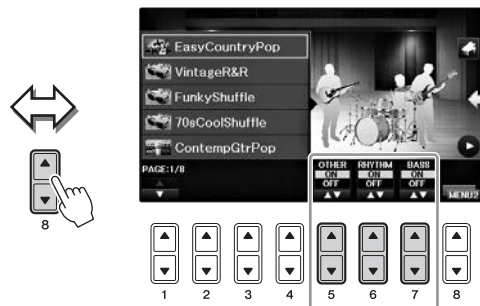

# Changing/Resetting the Piano Room Settings

You can change the settings of Piano room, such as touch sensitivity, as you like. You can also restore all Piano Room settings to the default.

- 1 Press the  [Piano Room] button to call up the Piano room display. To change the accompaniment settings, press the [F] button to display the session players.
- 2 Use the [8▲▼] buttons to call up the setting display, and then change the settings.

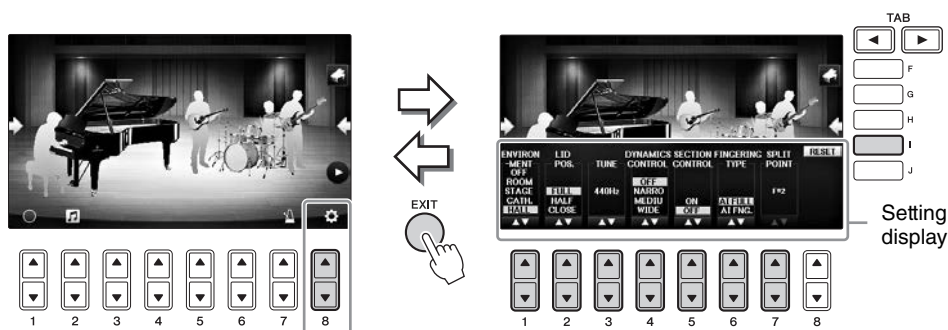

 : Shaded items are available only when session players are displayed.

[1▲▼]	ENVIRONMENT*	For selecting the environment (Reverb Type). Same as on page 40
[2▲▼]	LID POSITION*	Determines how much the Lid is opened. Same as on page 40
[3▲▼]	TUNE	Determines the pitch of this instrument in 1Hz steps.
[4▲▼]	DYNAMICS CONTROL	This determines how the Style playback volume changes depending on the playing strength. <ul style="list-style-type: none"> <li>• WIDE .....The volume changes over a wide range.</li> <li>• MEDIUM.....The volume changes over a medium range.</li> <li>• NARROW.....The volume changes over a narrow range.</li> <li>• OFF.....The volume is kept the same regardless of playing strength.</li> </ul>
[5▲▼]	SECTION CONTROL*	Turning this on calls up buttons for changing variations (Sections) of accompaniment (A · B · C · D) in the bottom of the display. By using these sections effectively with the [3▲▼] – [6▲▼] buttons, you can easily make your performance sound more dynamic and professional.
[6▲▼]	FINGERING TYPE*	Determines the Fingering type (page 60): AI Full Keyboard or AI Fingered.
[7▲▼]	SPLIT POINT*	Determines the Split Point (Style) (page 69) when AI Fingered is selected for FINGERING TYPE above.
[1]	RESET	Restores all settings of Piano Room to the default.

The settings marked with \* will be maintained even if you exit from this display or turn off the power. Pressing the [PIANO ROOM] button next time will call up the Piano settings which were made the previous time.

# Recording your Performance in the Piano Room

You can record your performance in the Piano Room to the instrument or a USB flash drive.

**NOTE**

When you record to the instrument, the method of recording is MIDI. When you record to a USB flash drive, the method of recording is Audio. Refer to page 79 for details on the difference between MIDI and Audio recordings.

- 1 If you want to record to a USB flash drive, be sure to read “Connecting a USB Device” on page 106, then connect the USB flash drive to the [USB TO DEVICE] terminal before recording.

- 2 Press the  [Piano Room] button to call up the Piano Room display.

- 3 Press the [2▲▼] (  ) button.

The setting display appears, allowing you to select the location to which you want to save the file.

- 4 Select the save location using the [3▲▼] / [4▲▼] buttons.

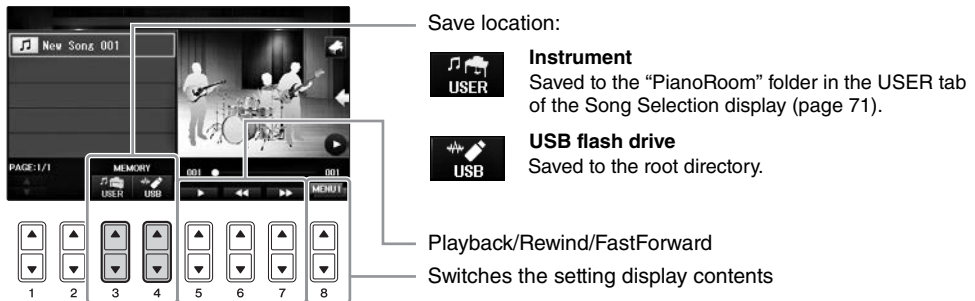

- 5 Press the [EXIT] button to close the setting display.

- 6 Press the [1▲▼] (  ) button to start the recording, then play your performance.

- 7 Press the [1▲▼] (  ) button again to stop the recording.

- 8 After a message appears prompting you to save, press the [G] (YES) button to save the file.

**NOTICE**

The recorded data will be lost if you turn the power off without executing the save operation.

**NOTE**

Data that was recorded in the Piano Room can be played outside of the Piano Room. Refer to pages 71 and 84 for details.

- 9 To hear the recorded performance, press the [2▲▼] (  ) button to call up the setting display, and then press the [5▲▼] (  ) button.

To stop playback, press the [5▲▼] button again.

■ **Playing back recorded files, changing file names, deleting files**

- 1 Select the location where the desired file is saved according to the instructions in steps 1 – 4 above.
- 2 Select the desired file using the [A] – [E] and [1▲▼] buttons.
- 3 Press the [8▲▼] button repeatedly to call up the “MENU1” indication for playing back the file, or “MENU2” for changing the name or deleting the file, then press one of the [5▲▼] – [7▲▼] buttons corresponding to the desired functions. (For details about entering characters, refer to page 36.)

# Voices

– Playing the keyboard –

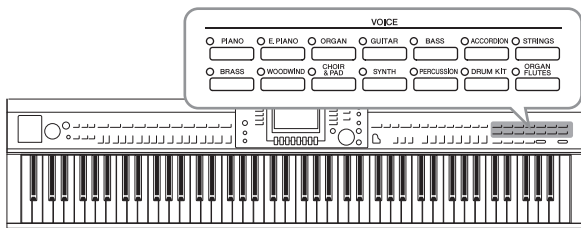

The instrument features a wide variety of exceptionally realistic instrumental Voices, including piano, guitar, strings, brass, wind instruments and more.

2

## Playing Preset Voices

### Selecting a Voice (RIGHT1) and Playing the Keyboard

You can play a single Voice over the entire keyboard range. This is used for normal performance—for example, with the piano Voice.

- 1 If a part other than RIGHT1 is highlighted (RIGHT2, LEFT), press one of the [A]/[B]/[F]/[G] (RIGHT1) buttons on the Main display.

Make sure that the PART ON/OFF [RIGHT1] button is also turned on. If it is turned off, the right-hand part will not sound.

**NOTE**

For more information on the Voice parts, see page 47.

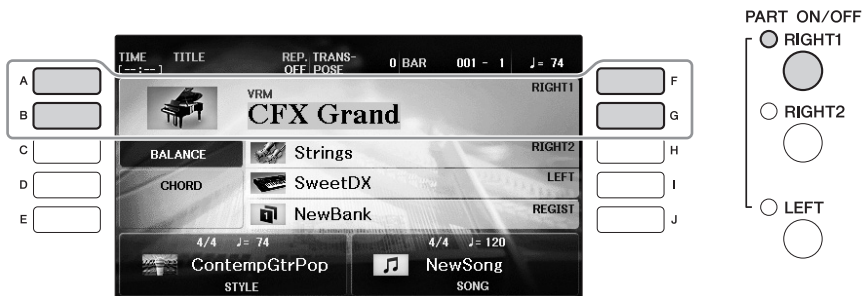

- 2 Press one of the VOICE buttons to select a Voice category and call up the Voice Selection display.

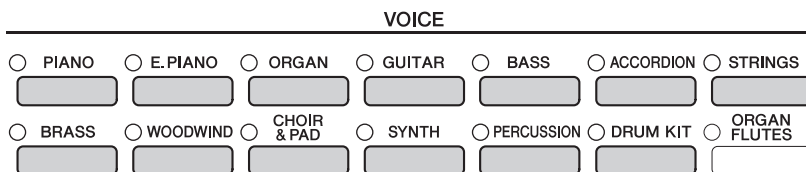

The preset Voices are categorized and contained in appropriate folders. Voice category selection buttons on the panel correspond to the categories of the preset Voices. For example, press the [STRINGS] button to display various strings Voices.

**NOTE**

For more information on the VOICE buttons, refer to page 47.

### ■ To Select XG Voices

Refer to the Reference Manual on the website (page 9).

## 3 Press one of the [A] – [J] buttons to select the desired Voice.

To call up the other display pages (P1, P2, etc.), press one of the [1▲] – [7▲] buttons or press the same VOICE button again.

### NOTE

The Voice type and its defining characteristics are indicated above the Preset Voice name. For details on the characteristics, see page 47 and the Reference Manual (page 9).



### To listen to the demo phrases for each Voice

While the file selection display is showing, press the [8▼] button as necessary to select “MENU1.” Then, press the [7▼] (DEMO) button to start the Demo for the selected Voice. To stop the demo, press the [7▼] button again.

## 4 Play the keyboard.

### Playing Two Voices Simultaneously (RIGHT1 and 2 parts)

1 Make sure that the PART ON/OFF [RIGHT1] button is turned on.

2 Press the PART ON/OFF [RIGHT2] button to turn it on.

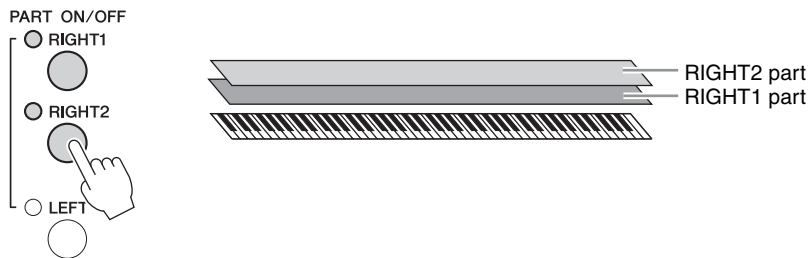

3 Press one of the VOICE category selection buttons to call up the Voice Selection display for the Right 2 part.

**4 Press one of the [A] – [J] buttons to select the desired Voice.**

**5 Play the keyboard.**

The Voice selected for RIGHT1 (page 44) and the Voice selected here are sounded simultaneously in a layer.

### Quickly selecting Voices for the Right 1 and 2 parts

You can quickly select the Right 1 and 2 part Voices, just from the Voice category selection buttons. Press and hold one Voice button, then press another. The Voice of the first pressed button is automatically set for the Right 1 part, while the Voice of the second pressed button is set for the Right 2 part.

#### NOTE

You can save the settings to Registration Memory. See page 97.

## Playing Different Voices with the Left and Right Hands (RIGHT1, 2 and LEFT parts)

- 1 Make sure that the PART ON/OFF [RIGHT1] and/or [RIGHT2] buttons are turned on.**
- 2 Press the PART ON/OFF [LEFT] button to turn it on.**

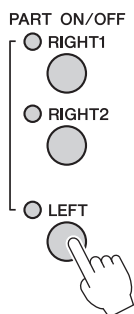

- 3 Press one of the VOICE category selection buttons to call up the Voice Selection display for the Left part.**
- 4 Press one of the [A] – [J] buttons to select the desired Voice.**
- 5 Play the keyboard.**

The notes you play with your left hand sound one Voice (LEFT Voice selected above), while the notes you play with your right sound different Voices (RIGHT1 and 2 Voices).

#### NOTE

You can save the settings to Registration Memory. See page 97.

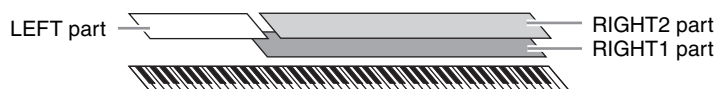

## Keyboard parts

Voices can be assigned independently to each of the three keyboard parts: Right 1, Right 2 and Left. You can combine these parts by using the PART ON/OFF buttons to create a rich, ensemble sound.

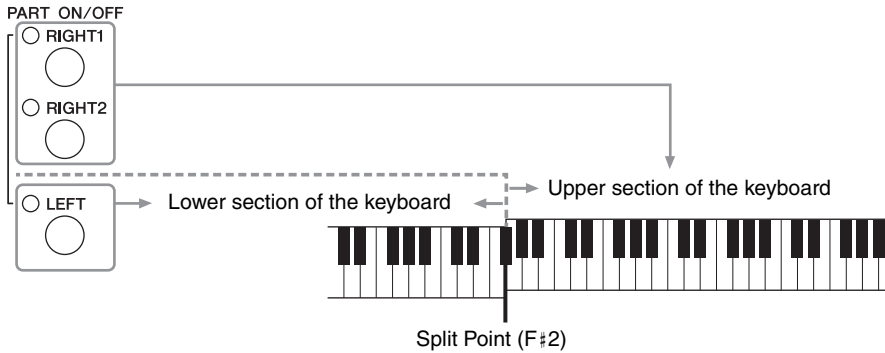

When the LEFT part is off, the RIGHT1 and 2 Voices can be played over the entire keyboard. When the LEFT part is on, keys lower than F#2 (the Split Point) are set for playing the LEFT part and those higher than the Split Point are set for playing the RIGHT1 and 2 parts. The lamp of the Split Point (at which the keyboard is divided into the right and left sections) lights. The Split Point can be changed (page 69).

If you want to select or edit a Voice, confirm the current keyboard part on the Main display.

## Voice Types

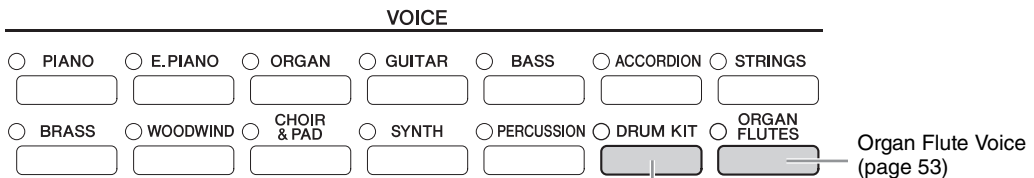

### Drum Kit Voices

When one of the Voices is selected from this button, you can play various drums and percussion instruments or SFX (sound effects) sounds on the Keyboard. Details are given in the Drum List of the separate Data List. When the icon “Drum Kit” appears at the bottom of the Voice Selection display as MENU1, you can display the Key assignment by pressing the [4▼] button. For details, refer to the Reference Manual on the website (page 9).

## Voice Characteristics

The Voice type and its defining characteristics are indicated above the Voice name — VRM, S.Art!, Live!, Cool!, Sweet!, etc. For detailed explanations, refer to the Reference Manual on the website (page 9).

In this section, only VRM and Super Articulation Voices (S.Art!) are explained.



### VRM Voices (page 49)

These recreate the characteristic string resonance of a real acoustic piano.

### Super Articulation Voices (S.Art!) (page 50)

The Super Articulation Voices enable you to create subtle, very realistic musical expressions, simply by how you play.

For example, with a Guitar Voice, if you play a C and then a D in a very legato way, the D note would sound as a “hammer on,” without the string being plucked again.

Depending on how you play, other effects such as finger noises (for Guitar Voices) will be produced.

## Calling Up the Piano Default Settings (Piano Reset)

When you turn the power on, the Voice is set to “CFX Grand,” allowing you to play the instrument as a piano across the entire keyboard. No matter what settings you’ve made from the panel, you can instantly call up these default settings.

### NOTE

This function cannot be used while the Piano Room display (page 40) or the Piano Lock display (page below) is shown.

- 1 Press and hold down the [PIANO ROOM] button for two seconds or longer.**  
A message appears on the display.
- 2 Press the [G] (RESET) button to call up the default piano settings.**

## Piano Lock Function

The convenient Piano Lock function lets you “lock” the piano so that you don’t inadvertently change the settings by pressing another button on the panel. Once locked, the instrument stays in the piano mode, even if other buttons are pressed—preventing you from accidentally playing another sound during your piano performance.

- 1 Press and hold down the [PIANO ROOM] button for two seconds or longer.**  
A message appears on the display.
- 2 Press the [H] (LOCK) button to call up the Piano Lock display.**

To disable Piano Lock, press and hold the [PIANO ROOM] button for two seconds or longer again. If you turn off the power with Piano Lock engaged, turning on the power next time will call up the same Piano settings.



# Playing the Realistic Resonance-enhanced VRM Voices

On an actual acoustic piano, if you press the damper pedal and play a key, not only does the string of the pressed key vibrate, it also causes other strings and the soundboard to vibrate, with each influencing the rest, creating a rich and brilliant resonance that sustains and spreads. The VRM (Virtual Resonance Modeling) technology featured in the instrument reproduces the complicated interaction of both string and soundboard resonance faithfully using a virtual musical instrument (physical modeling), and makes the sound more like a real acoustic piano. Since instantaneous resonance is made at the moment according to the state of the keyboard or pedal, you can vary the sound expressively by changing the timing of your pressing the keys, and the timing and depth of your pressing the pedal. When you select a Piano Voice compatible with VRM (referred to as VRM Voices), the VRM function is automatically engaged, letting you immediately enjoy the VRM effect.

## 1 Select the VRM Voice.

Press the VOICE category [PIANO] button to call up the Voice Selection display, then select a Voice having a “VRM” icon above its name.

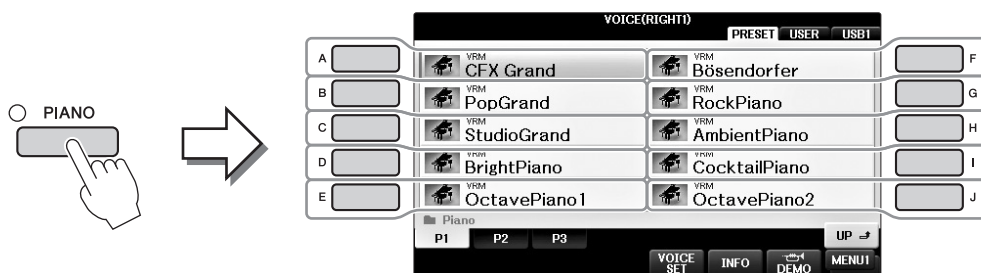

## 2 Play the keyboard.

As the default setting, the VRM function is set to on; however, you can turn it on or off, and adjust the depth in the following display as desired.

- 1 [FUNCTION] → 2 TAB [◀][▶] → MENU1 → 3 [F] (VOICE SETTING) →
- 4 TAB [◀][▶] PIANO → 5 [A]/[B] VRM

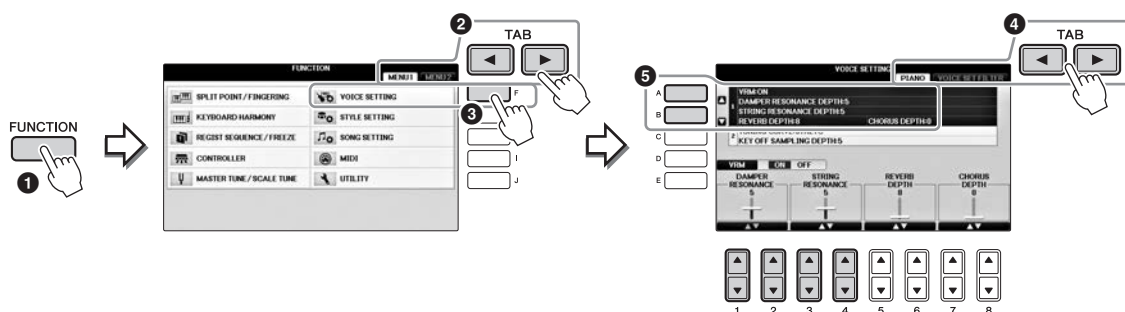

Use [D] button for turning the VRM function on or off, or use the [1▲▼][2▲▼] buttons for adjusting the depth of damper resonance and the [3▲▼][4▲▼] buttons for that of string resonance.

### NOTE

This setting is applied commonly to all parts for which VRM Voices are selected.

## Playing Super Articulation Voices

- 1 Select a Voice having the indication “S.Art!” in the Voice Selection display.
- 2 Call up MENU1 at the right bottom of the display by pressing the [8▼] button as necessary.
- 3 Press the [6▼] (INFO) button to call up helpful information on how to play the selected S. Art! Voice.

Play in the way described on the information display.

When you select a Super Articulation Voice for the RIGHT1 Voice, the function of center and left pedals are switched to control articulation effects. Thus, the pedals will not function conventionally as the Sostenuto and Soft pedals even if you press them. However, if you want to avoid this situation in which the pedal function is automatically changed depending on the selected Voice, turn the “SWITCH WITH R1 VOICE” setting to off from the display called up as follows.

[DIRECT ACCESS] → pressing the right pedal → [H] SWITCH WITH R1 VOICE

### NOTE

Super Articulation Voices are only compatible with other models which have those types of Voices installed. Any Song or Style data you've created on the instrument using this Voice will not sound properly when played back on other instruments.

### NOTE

Super Articulation Voices sound differently depending on the keyboard range, velocity, touch, etc. Hence, if you apply a HARMONY/ECHO effect, change the transpose setting or change the Voice Set parameters, unexpected or undesired sounds may result.

## Transposing the Pitch in Semitones

The TRANSPOSE [-]/[+] buttons transpose the overall pitch of the instrument (the keyboard sound, Style playback, Song playback, and so on) in semitone steps. Press the [+] and [-] buttons simultaneously to instantly reset the transpose value to 0.

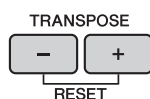

You can independently transpose the pitch of the entire instrument (MASTER), keyboard sound (KBD), or Song playback (SONG) as desired in the MIXING CONSOLE display. [MIXER] → TAB [◀][▶] TUNE → [1▲▼] - [3▲▼] TRANSPOSE

### NOTE

The Transpose functions do not affect the Drum Kit or SFX Kit Voices.

### Tuning

By default, the Tuning of the entire instrument is set to 440.0 Hz, and the Scale Tuning is set to equal temperament. You can change these settings from [FUNCTION] → TAB [◀][▶] MENU1 → [E] MASTER TUNE/SCALE TUNE → TAB [◀][▶] MASTER TUNE or SCALE TUNE. You can also adjust the Tuning parameter for each keyboard part (RIGHT1, RIGHT2 and LEFT) on the TUNE page of the Mixing Console display (page 100).

For details, refer to the Reference Manual on the website (page 9), Chapter 10.

#### Hz (Hertz):

This unit of measurement refers to the frequency of a sound and represents the number of times a sound wave vibrates in a second.

# Applying Voice Effects

The instrument features a sophisticated multi-processor effect system which can add extraordinary depth and expression to your sound.

- 1 From the Main display, select the desired part for which you want to add effects.



- 2 Press the [VOICE EFFECT] button to call up the VOICE EFFECT display.

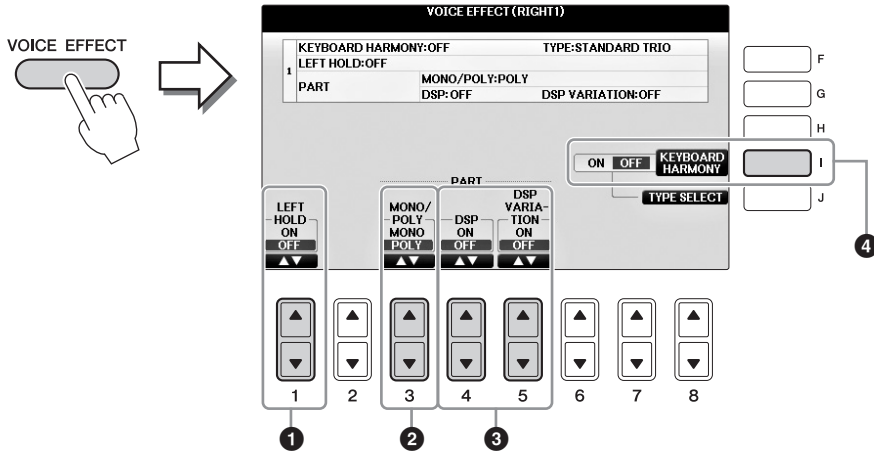

- 3 Use the [1▲▼], [3▲▼] - [5▲▼] and [I] buttons to apply effects to the Voices.

1	[1▲▼]	LEFT HOLD	This function causes the LEFT part Voice to be held even when the keys are released. Non-decaying Voices such as strings are held continuously, while decay-type Voices such as piano decay more slowly (as if the damper pedal has been pressed). When the Left Hold is ON, an "H" indication appears in the Main display.
2	[3▲▼]	MONO/ POLY	This determines whether the part's Voice is played monophonically (only one note at a time) or polyphonically. Using the MONO mode lets you play single, lead sounds (such as brass instruments) more realistically. It also lets you expressively control the Portamento effect (depending on the selected Voice) by playing legato. <b>What is Portamento?</b> Portamento is a function that creates a smooth transition in pitch from the first note played on the keyboard to the next.

3	[4▲▼]	DSP	<p>With the digital effects built into the instrument, you can add ambience and depth to your music in a variety of ways. Various effect types, such as chorus and delay are included.</p> <ul style="list-style-type: none"> <li>• The DSP switch is used to turn the DSP (Digital Signal Processor) effect on or off for the currently selected keyboard part.</li> <li>• The DSP Variation switch is used to determine whether variations of the DSP effect are effective or not. You could use this while you play, for example, to change the rotating speed (slow/fast) of the rotary speaker effect.</li> </ul> <p><b>NOTE</b> The effect type can be changed. On the Voice Selection display, select [8▼] MENU1 → [5▼](VOICE SET) → TAB [◀ ▶] EFFECT/EQ → [A]/[B] DSP</p>
	[5▲▼]	DSP VARIATION	
4	[I]	KEYBOARD HARMONY	<p>When this is set to ON and the Style is being played back (page 58), Harmony or Echo is applied to the right-hand Voices, depending on the chords played with your left hand. However, there are certain Harmony/Echo types for which harmony will be applied regardless of the chords played with your left hand. For details, refer to the Reference Manual on the website (page 9).</p>

# Creating Original Organ Flutes Voices

The instrument uses advanced digital technology to recreate the legendary sound of vintage organs. Just as on a traditional organ, you can create your own sound by increasing and decreasing the levels of the flute footages.

## 1 Press the [ORGAN FLUTES] button.

The FOOTAGE Page of the Organ Flutes Voice is called up.

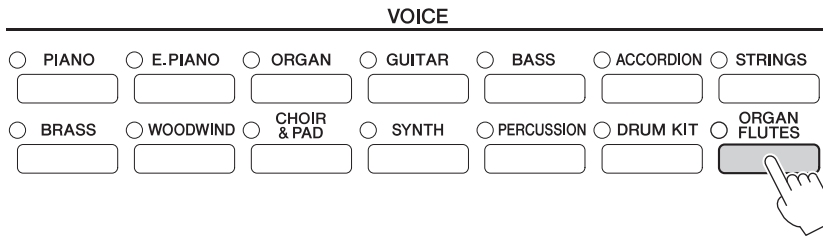

## 2 Use the [1▲▼] - [8▲▼] buttons to adjust the footage settings.

The [1▲▼] buttons control two footages: 16' and 5 1/3'. Pressing the [D] button switches between these two footages.

### What is "Footage"?

Footage is a number (16', 8', etc.) displayed at the bottom of each footage lever. The number indicates the length of pipes used on an actual pipe organ, which determines the pitch of the sound. The number 8' indicates a pipe length of 8 feet, while 4' indicates 4 feet, which creates a pitch one octave higher than 8'. Similarly, the number 16' indicates 16 feet, whose pitch is one octave lower than 8'.

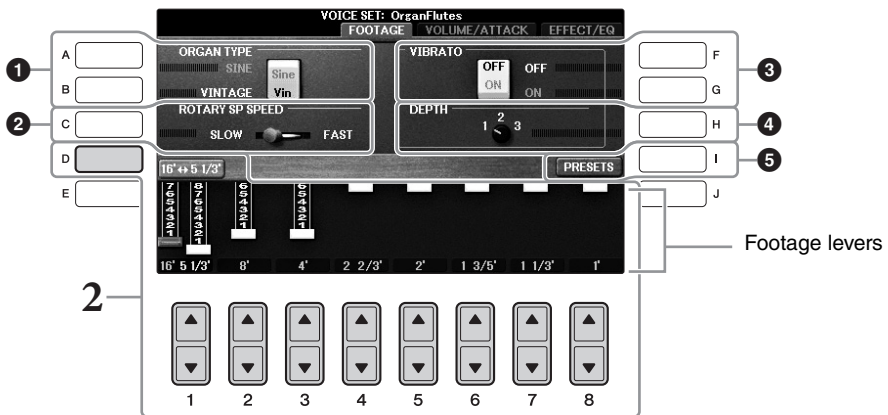

If you want, you can select the Organ type, change the Rotary Speaker speed and adjust the Vibrato setting, by using the [A] - [C] and [F] - [H] buttons.

1	[A]/[B]	<b>ORGAN TYPE</b>	Specifies the type of organ tone generation to be simulated: Sine or Vintage.
2	[C]	<b>ROTARY SP SPEED</b>	Alternately switches between the slow and fast rotary speaker speeds when an effect which contains "Rotary" or "Rot" in its name is selected for the Organ Flutes (DSP TYPE parameter in the EFFECT/EQ Page), and the DSP is turned on (page 52).

3	[F]	VIBRATO OFF	Alternately turns the vibrato effect for the Organ Flutes Voice ON or OFF.
	[G]	VIBRATO ON	
4	[H]	VIBRATO DEPTH	Sets the Vibrato depth to one of three levels: 1 (low), 2 (mid), or 3 (high).
5	[I]	PRESETS	Opens the File Selection display of the Organ Flute Voices for selecting a preset Organ Flutes Voice.

**NOTE**

About the VOLUME/ATTACK Page and EFFECT/EQ Page, see the Reference Manual on the website (page 9).

- 3 Press the [I] (PRESETS) button to call up the Organ Flutes Voice Selection display.
- 4 Use the TAB [◀][▶] buttons to select the location to which your Organ Flutes Voice will be saved.
- 5 Save your Organ Flutes Voice by following the procedure on page 81.

**NOTICE**

The setting will be lost if you select another Voice or turn the power to the instrument off without executing the Save operation.

# Setting the Touch Response of the Keyboard

You can adjust the touch sensitivity of the instrument (how the sound responds to the way you play the keys). This setting does not change the weight of the keyboard. The touch sensitivity type is commonly applied to all Voices.

## 1 Call up the operation display.

① [FUNCTION] → ② TAB [◀][▶] MENU1 → ③ [D] (CONTROLLER) → ④ TAB [◀][▶] KEYBOARD/PANEL → ⑤ [A] (TOUCH RESPONSE)

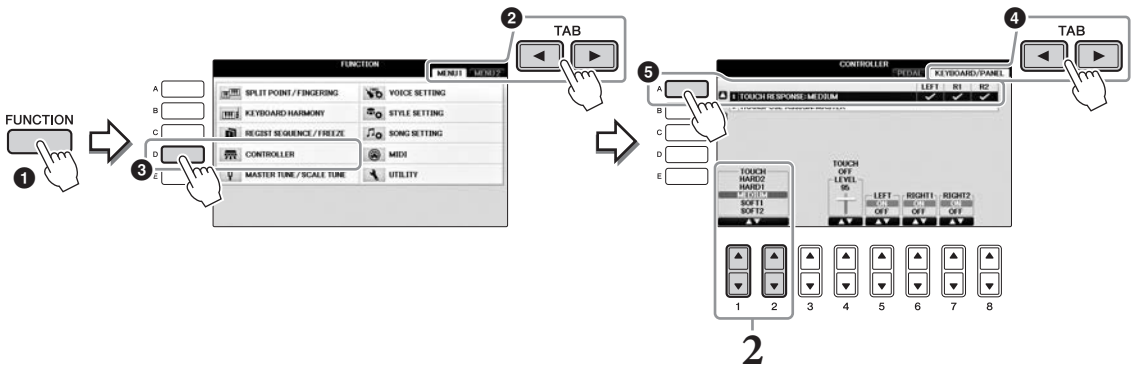

## 2 Use the [1▲▼]/[2▲▼] buttons to specify the touch sensitivity.

- **HARD 2** .....Requires strong playing to produce high volume. Best for players with a heavy touch.
- **HARD 1** .....Requires moderately strong playing for high volume.
- **MEDIUM**.....Standard touch response.
- **SOFT 1** .....Produces high volume with moderate playing strength.
- **SOFT 2** .....Produces relatively high volume even with light playing strength. Best for players with a light touch.

### NOTE

When you do not want to apply touch sensitivity, set Touch to OFF for the corresponding parts by using the [5▼] – [7▼] buttons. When Touch is set to OFF, you can specify the fixed volume level by using the [4▲▼] buttons.

### NOTE

The touch sensitivity settings may have no effect with certain Voices.

## Using the Metronome

The metronome provides a click sound, giving you an accurate tempo guide when you practice, or letting you hear and check how a specific tempo sounds. Press the [METRONOME ON/OFF] button to start/stop the metronome.

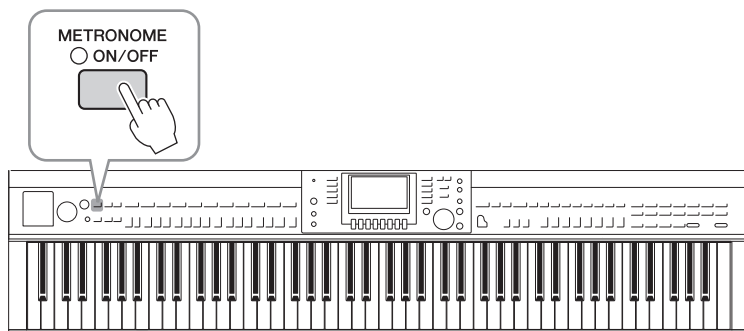

## Adjusting the Metronome Tempo

- 1 Press one of the TEMPO [-]/[+] buttons to call up the pop-up tempo setting display.

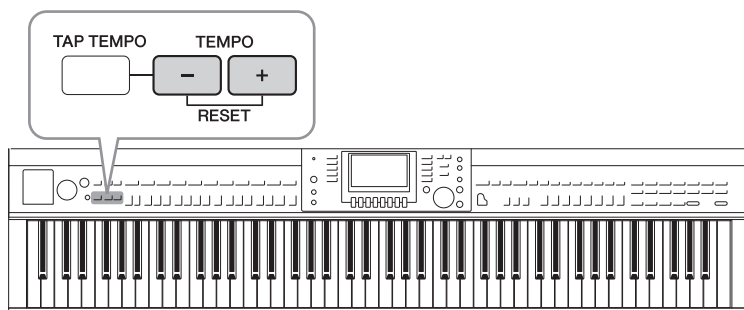

- 2 Use the TEMPO [-]/[+] buttons to set the tempo.

Pressing and holding either button lets you continuously increase or decrease the value. You can also use the [DATA ENTRY] dial to adjust the value. To reset the tempo, press the TEMPO [-]/[+] buttons simultaneously.

### NOTE

The number in the display indicates how many quarter-note beats there are in one minute.

- 3 Press the [EXIT] button to close the Tempo display.

### NOTE

You can also change the time signature and volume of the metronome sound: [FUNCTION] → TAB [◀][▶] MENU1 → [J] UTILITY → TAB [◀][▶] CONFIG 1 → [B] 2 METRONOME

For details, refer to the Reference Manual on the website (page 9).



## Advanced Features

Refer to the Reference Manual on the website, *Chapter 2*.



<b>Selecting GM/XG or other Voices from the Panel:</b>	Voice Selection display → [8▲](UP) → [2▲] (P2)
<b>Adjusting the depth of Reverb and Chorus for VRM Voices:</b>	[FUNCTION] → TAB [◀][▶] MENU1 → [F] VOICE SETTING → TAB [◀][▶] PIANO → [A] 1 VRM/DAMPER RESONANCE DEPTH/STRING RESONANCE DEPTH/REVERB DEPTH/CHORUS DEPTH
<b>Adjusting the Tuning Curve and volume of the key-off sound for Piano Voices:</b>	[FUNCTION] → TAB [◀][▶] MENU1 → [F] VOICE SETTING → TAB [◀][▶] PIANO → [B] 2 TUNING CURVE/KEY OFF SAMPLE
<b>Confirm the assignments of Drum Kit Voices:</b>	Select a Drum Kit Voice in the Voice Selection display → [8▼] MENU1 → [4▼] (DRUM KIT)
<b>Selecting the Harmony/Echo type:</b>	[VOICE EFFECT] → [J] TYPE SELECT or [FUNCTION] → TAB [◀][▶] MENU1 → [B] KEYBOARD HARMONY
<b>Pitch-related settings</b>	
• Fine-tuning the pitch of the entire instrument:	[FUNCTION] → TAB [◀][▶] MENU1 → [E] MASTER TUNE/SCALE TUNE → TAB [◀][▶] MASTER TUNE
• Scale Tuning:	[FUNCTION] → TAB [◀][▶] MENU1 → [E] MASTER TUNE/SCALE TUNE → TAB [◀][▶] SCALE TUNE
• Changing the part assignment of the TRANSPOSE buttons:	[FUNCTION] → TAB [◀][▶] MENU1 → [D] CONTROLLER → TAB [◀][▶] KEYBOARD/PANEL → [B] 2 TRANSPOSE ASSIGN
<b>Editing Voices (Voice Set):</b>	Voice Selection display → [8▼] MENU1 → [5▼] (VOICE SET)
<b>Disabling automatic selection of Voice Sets (effects, etc.):</b>	[FUNCTION] → TAB [◀][▶] MENU1 → [F] VOICE SETTING → TAB [◀][▶] VOICE SET FILTER
<b>Editing Organ Flutes parameters:</b>	[ORGAN FLUTES] → TAB [◀][▶] VOLUME/ATTACK or EFFECT/EQ

# Styles

– Playing Rhythm and Accompaniment –

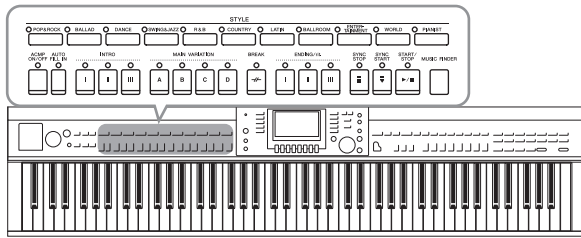

The instrument features a variety of accompaniment and rhythmic backing patterns (called “Styles”) in a variety of different musical genres including pop, jazz, and many others. Each Style features Auto Accompaniment, letting you produce automatic accompaniment playback simply by playing “chords” with your left hand. This lets you automatically recreate the sound of a full band or orchestra — even if you’re playing by yourself.

3

Styles – Playing Rhythm and Accompaniment –

## Playing with a Style

- 1 Press one of the **STYLE** category selection buttons to call up the Style Selection display.



- 2 Press one of the [A] – [J] buttons to select the desired Style.

Pressing one of the [1▲] – [4▲] buttons or pressing the same STYLE button again calls up other display pages (when available).



### Playing Only the Rhythm Parts of a Style

A Style contains eight parts (page 67). You can start only the Rhythm parts by pressing the STYLE [START/STOP] button. To stop playback, press the same button again.

#### NOTE

The rhythm does not sound for some Styles. However, when you use one of these Styles, you will hear all other parts (except rhythm) played back in step 5.

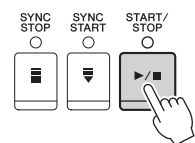

- 3 Confirm that the [ACMP ON/OFF] button is on (the lamp is lit).

If set to off (the lamp is not lit), press the button to turn it on.

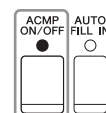

#### 4 Press the [SYNC START] button to enable synchronized start.

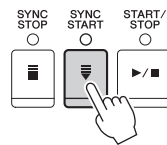

#### 5 As soon as you play a chord (page 60) with your left hand, all parts of the selected Style start.

Try playing chords with your left hand and play a melody with your right along with the rhythm.

When the [ACMP ON/OFF] button is on, the specific left-hand section of the keyboard can be used as the Chord section, and chords played in this section are automatically detected and used as a basis for fully automatic accompaniment with the selected Style.

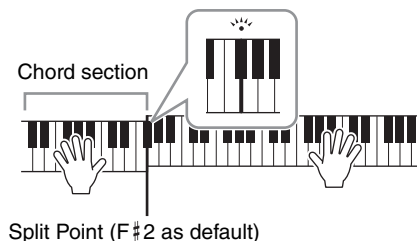

#### NOTE

The Split Point can be changed as desired (page 69).

#### NOTE

You can change the Chord Section to the right hand section (page 69).

#### 6 Press the [START/STOP] button to stop Style playback.

You can also stop playback by pressing one of the ENDING [I] – [III] buttons at the “Ending” location on the notation (page 62).

#### NOTE

You can transpose the Style (accompaniment). See page 50.

### Style Characteristics

The Style type and its defining characteristics are indicated on the Preset Style icon.

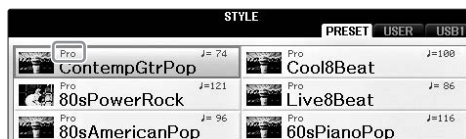

#### • Pro

These Styles provide professional and exciting arrangements combined with perfect playability. The resulting accompaniment exactly follows the chords of the player. As a result, your chord changes and harmonies/voicings are instantly transformed into lifelike musical accompaniment.

#### • Session

These Styles provide even greater realism and authentic backing by mixing in original chord types and changes, as well as special riffs with chord changes, with the Main sections. These have been programmed to add “spice” and a professional touch to your performances of certain songs and in certain genres. Keep in mind, however, that the Styles may not necessarily be appropriate — or even harmonically correct — for all songs and for all chord playing. In some cases for example, playing a simple major triad for a country song may result in a “jazzy” seventh chord, or playing an on-bass chord may result in inappropriate or unexpected accompaniment.



































#### • Pianist

These special Styles provide piano-only accompaniment. Just by playing the proper chords with your left hand, you can automatically add complicated, professional-sounding arpeggios and bass/chord patterns.

# Chords

For users who are unfamiliar with chords, this handy chart features common chords for your quick reference. Since there are many useful chords and many different ways to use them musically, refer to commercially available chord books for further details.

★ Indicates the root note.

Major	Minor	Seventh	Minor Seventh	Major Seventh
<b>C</b> 	<b>Cm</b> 	<b>C7</b> 	<b>Cm7</b> 	<b>CM7</b> 
<b>D</b> 	<b>Dm</b> 	<b>D7</b> 	<b>Dm7</b> 	<b>DM7</b> 
<b>E</b> 	<b>Em</b> 	<b>E7</b> 	<b>Em7</b> 	<b>EM7</b> 
<b>F</b> 	<b>Fm</b> 	<b>F7</b> 	<b>Fm7</b> 	<b>FM7</b> 
<b>G</b> 	<b>Gm</b> 	<b>G7</b> 	<b>Gm7</b> 	<b>GM7</b> 
<b>A</b> 	<b>Am</b> 	<b>A7</b> 	<b>Am7</b> 	<b>AM7</b> 
<b>B</b> 	<b>Bm</b> 	<b>B7</b> 	<b>Bm7</b> 	<b>BM7</b> 

## Changing the Chord Fingering Type



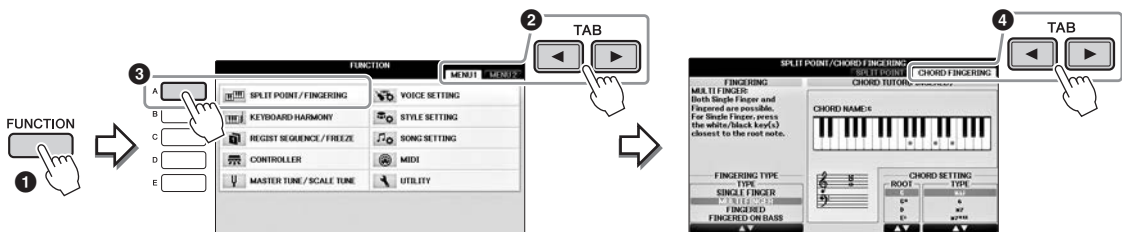

By changing the Chord Fingering type, you can automatically produce appropriate accompaniment even if you don't press all of the notes which comprise a chord.

### 1 Call up the operation display.

- ① [FUNCTION] → ② TAB [◀][▶] MENU1 → ③ [A] SPLIT POINT/CHORD FINGERING → ④ TAB [◀][▶] CHORD FINGERING



### 2 Press the [1▲▼] - [3▲▼] buttons to select the desired Fingering Type.

<b>Single Finger</b>	<p>Lets you easily play chords in the accompaniment range of the keyboard using only one, two or three fingers. This type is available only for Style playback.</p> <p><b>C</b>  <b>Major chord</b> Press the root key only.</p> <p><b>Cm</b>  <b>Minor chord</b> Simultaneously press the root key and a black key to its left.</p> <p><b>C7</b>  <b>Seventh chord</b> Simultaneously press the root key and a white key to its left.</p> <p><b>Cm7</b>  <b>Minor seventh chord</b> Simultaneously press the root key and both a white and black key to its left.</p>
<b>Multi Finger</b>	<p>Automatically detects Single Finger or Fingered chord fingerings, so you can use either type of fingering without having to switch fingering types.</p>
<b>Fingered</b>	<p>Lets you finger your own chords on the chord section of the keyboard, while the instrument supplies appropriately orchestrated rhythm, bass, and chord accompaniment in the selected Style. The Fingered type recognizes the various chord types which are listed on the separate Data List booklet and can be looked up using the Chord Tutor function shown in the same display.</p>
<b>Fingered On Bass</b>	<p>Accepts the same fingerings as Fingered, but the lowest note played in the Chord section of the keyboard is used as the bass note, allowing you to play “on bass” chords. (In the Fingered mode, the root of the chord is always used as the bass note.)</p>
<b>Full Keyboard</b>	<p>Detects chords in the entire key range. Chords are detected in a way similar to Fingered, even if you split the notes between your left and right hands — for example, playing a bass note with your left hand and a chord with your right, or by playing a chord with your left hand and a melody note with your right.</p>
<b>AI Fingered</b>	<p>Basically the same as Fingered, with the exception that less than three notes can be played to indicate the chords (based on the previously played chord, etc.). Only in the Piano Room, your performance in the Chord section produces the sound of the selected Voice as well as that of the accompaniment.</p>
<b>AI Full Keyboard</b>	<p>When this advanced fingering type is engaged, the instrument will automatically create appropriate accompaniment while you play just about anything, anywhere on the keyboard using both hands. You don't have to worry about specifying the Style chords. Although the AI Full Keyboard type is designed to work with many songs, some arrangements may not be suitable for use with this feature. This type is similar to Full Keyboard, with the exception that less than three notes can be played to indicate the chords (based on the previously played chord, etc.). 9th, 11th and 13th chords cannot be played. This type is available only for Style playback.</p>

When the Chord Detection Area (page 69) is set to “Upper,” Fingering type is set to “Fingered\*” automatically, and the Chord section is set to the right of the left split point.

### Chord Tutor

If you know the name of a chord but don't know how to play it, the Chord Tutor function conveniently shows you which notes to play.

On the CHORD FINGERING display above, specify the Chord Root and Chord Type by using the [6▲▼] – [8▲▼] buttons. The notes you need to play are shown in the display.

# Operating Style Playback

## To Start/Stop Playing

### ■ [START/STOP] button

Rhythm Parts of the Style starts playing back as soon as the [START/STOP] button is pressed. To stop playback, press the button again.

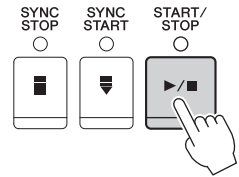

### ■ [SYNC START] button

This puts the Style playback in standby. The Style starts playing back when you press any note on the keyboard (when [ACMP ON/OFF] is off) or you play a chord with your left hand (when [ACMP ON/OFF] is on). During the Style playback, pressing this button stops playing and puts the playback in standby.

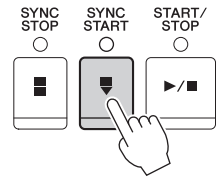

### ■ [SYNC STOP] button

You can start and stop the Style anytime you want by simply playing or releasing the keys in the chord section of the keyboard. Make sure that the [ACMP ON/OFF] button is on, press the [SYNC STOP] button, then play the keyboard.

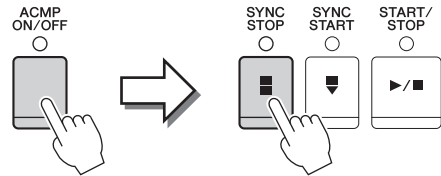

#### NOTE

When the Fingering type (page 61) is set to "Full Keyboard" or "AI Full Keyboard," Sync Stop cannot be turned on.

### ■ INTRO [I] – [III] buttons

The instrument features three different Intro sections to add an introduction before starting the Style playback. After pressing one of the INTRO [I] – [III] buttons, start playback of the Style. When the Intro finishes playing, the Style playback automatically shifts to the Main section.

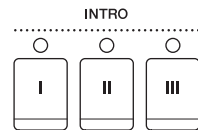

### ■ ENDING/rit. [I] – [III] buttons

The instrument features three different Ending sections to add an ending before stopping Style playback. When you press one of the ENDING [I] – [III] buttons while Style is playing back, the Style will automatically stop after the ending is played. You can have the ending gradually slow down (ritardando) by pressing the same ENDING button once again, while the ending is playing.

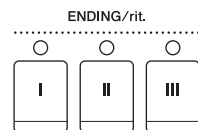

#### NOTE

If you press the ENDING/rit. [I] button when the Style is playing, a fill-in automatically plays before the ENDING/rit [I].

## About the lamp status of the section buttons (INTRO/MAIN VARIATION/BREAK/ENDING)

- **Red:** The section is currently selected.
- **Red (flashing):** The section will be played next, following the currently selected section.  
\* The Main [A] – [D] buttons also flash red during fill-in playback.
- **Green:** The section contains data but not currently selected.
- **Off:** The section contains no data and cannot be played.

## Changing Variations (Sections) During Style Playback

Each Style features four different Main sections, four Fill-in sections and a Break section. By using these sections effectively, you can easily make your performance sound more dynamic and professional. The section can be freely changed while the Style is playing back.

### ■ MAIN VARIATION [A] – [D] buttons

Press one of the MAIN VARIATION [A] – [D] buttons to select the desired Main section (the button lights in red). Each is an accompaniment pattern of a few measures and it plays indefinitely. Pressing the selected MAIN VARIATION button again plays an appropriate fill-in pattern to spice up the rhythm and break the repetition. After the fill-in finishes playing, it leads smoothly into the Main section.

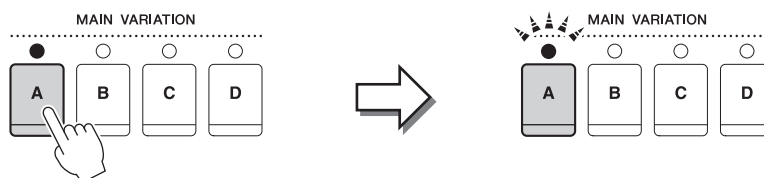

Selected Main section's lamp is lit in red

Selected Fill In section's lamp flashes in red

### AUTO FILL function

When the [AUTO FILL IN] button is turned on, pressing any of the Main [A] – [D] buttons as you play automatically plays a fill-in section before switching to the next Main section.



### ■ [BREAK] button

This lets you add dynamic breaks in the rhythm of the accompaniment. Press the [BREAK] button during Style playback. When the one-measure Break pattern finishes playing, the Style playback automatically shifts to the Main section.



## Adjusting the Tempo

### ■ TEMPO [-]/[+] buttons

By pressing the TEMPO [-] or [+] button, you can decrease/increase the tempo over a range of 5 – 500. While the TEMPO pop-up is shown on the display, you can also use the [DATA ENTRY] dial to adjust the value.

Pressing the TEMPO [-]/[+] buttons simultaneously resets the tempo to the default value.



### ■ [TAP TEMPO] button

During Style playback, you can change the tempo by tapping the [TAP TEMPO] button twice at the desired tempo.

When the Style is stopped, tapping the [TAP TEMPO] button (four times for a 4/4 time signature) starts Style playback at the tempo you tapped.

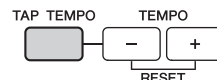

## Calling Up Appropriate Panel Settings for the Selected Style (One Touch Setting)

One Touch Setting is a powerful and convenient feature that automatically calls up the most appropriate panel settings (Voices or effects, etc.) for the currently selected Style, with the touch of a single button. If you've already decided upon a Style but don't know which Voice to use, you can have One Touch Setting automatically select the appropriate Voice for you.

### 1 Select a Style (steps 1 – 2 on page 58).

### 2 Press one of the ONE TOUCH SETTING [1] – [4] buttons.

Not only does this instantly call up all the settings (Voices, effects, etc.) that match the current Style, it also automatically turns on ACMP and SYNC START, so that you can immediately start playing the Style.

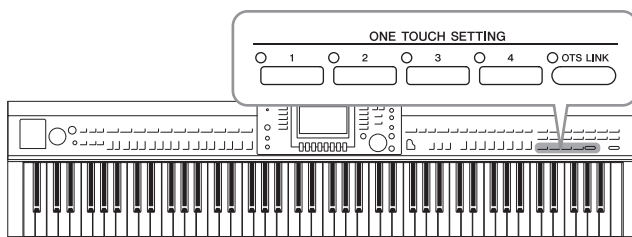

### 3 As soon as you play a chord with your left hand, the selected Style starts.

Each Style has four One Touch Setting setups. Press other ONE TOUCH SETTING [1] – [4] button to try out other setups.

#### NOTE

You can also create your own One Touch Setting setups. For details, refer to the Reference Manual on the website (page 9).



## Automatically changing One Touch Settings with the Main sections

The convenient OTS (One Touch Setting) Link function lets you automatically have One Touch Settings change when you select a different Main section (A – D). The Main sections A, B, C and D correspond to One Touch Settings 1, 2, 3 and 4 respectively. To use the OTS Link function, turn the [OTS LINK] button on.

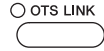

### NOTE

You can change the timing in which the One Touch Settings change with the MAIN VARIATION [A] – [D] change. Refer to the Reference Manual on the website (page 9).

## Calling up Optimum Styles for Your Performance (Style Recommender)

This convenient function “recommends” optimum Styles for the song you want to perform, based on your performance.

- 1 In the Style selection display (page 58), press the [8▼] button as necessary to select “MENU1” at the right bottom of the display.**
- 2 Press the [7▼] (RECOMMEND) button to call up the STYLE RECOMMENDER display.**

The keyboard is divided by the key B0 into two sections, as shown below. The Drum instruments (Kick, Snare and Hi-Hat) are assigned to the left of the B0 key while the Piano sound is assigned to the right.

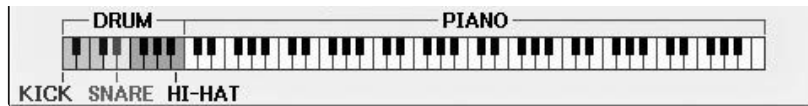

- 3 Use the Style Recommender function to find the Style.**
  - 3-1 Press the [J] (START) button sets the instrument to standby, waiting for your playing, and simultaneously turns on the metronome.**

Pressing the [J] button toggles between START and CANCEL.
  - 3-2 Use the TEMPO [-]/[+] buttons or [TAP TEMPO] button to adjust the tempo, and press the [E] (METRONOME) button to select the beat.**
  - 3-3 Play your performance on the Piano section for one or two measures along with the metronome. For better results, try playing with both hands. Or, play the rhythm you have in mind on the Drum section for one or two measures.**

Your performance is analyzed for a few seconds, and then playback of the most recommended Style starts. In addition, the candidates of the other recommended Styles are listed in the display.

### NOTE

If the song you want to play starts from the middle of a measure, or has a short silence prior to the first note, you may get better results by pausing for a measure and start playing from the next measure.

**Example 1:** Play the following piece on the Piano section.



The Styles that suit your performance with similar tempo are listed.

**Example 2:** Play the following rhythm on the Drum section.



The Styles that contain the similar drum patterns are listed.

- 4 Select the desired Style from the list by using the [1▲▼] – [6▲▼] buttons.**  
Try playing keyboard along with the Style if it matches the song you want to play.  
If the Style called up doesn't match to song you want to play, press the [J] (RETRY) button to return to step 3-3, then repeat steps 3-3 to 4.
- 5 When you've found a Style you're satisfied with, press the [7▲▼]/[8▲▼] (OK) buttons to exit from the Style Recommender display.**
- 6 Play the keyboard along with the Style you just found.**

# Turning Style Parts On/Off and Changing Voices

A Style contains eight parts: RHY1 (Rhythm 1) – PHR2 (Phrase 2) below. The performance data of each part is played back in the corresponding channel. You can add variations and change the feeling of a Style by selectively turning channels on/off as the Style plays.

## Style channels

- **RHY1/2 (Rhythm 1/2)**  
These are the basic parts of the Style, containing the drum and percussion rhythm patterns.
- **BASS**  
The bass part uses various appropriate instrument sounds to match the Style.
- **CHD1/2 (Chord 1/2)**  
These are rhythmic chord backing parts, commonly used with piano or guitar Voices.
- **PAD**  
This part is used for sustained instruments such as strings, organ, choir, etc.
- **PHR1/2 (Phrase1/2)**  
These parts are used for punchy brass stabs, arpeggiated chords, and other extras that make the accompaniment more interesting.

- 1 Press the [CHANNEL ON/OFF] button once or twice to call up the CHANNEL ON/OFF (STYLE) display.**

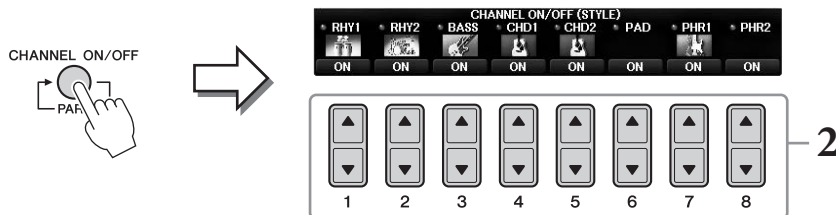

- 2 Use the [1▼] – [8▼] buttons to turn the channels on or off.**

To listen to only one channel by itself, hold down the appropriate button for the channel to set the channel to SOLO. To cancel SOLO, simply press the appropriate channel button again.

## Changing the Voice for each channel

If necessary, press the [1▲] – [8▲] buttons to change the Voice for the corresponding channel. This calls up the Voice Selection display, from which you can select the Voice to be used for the channel. See page 44.

### NOTE

You can save the settings made here to Registration Memory. See page 97.

- 3 Press the [EXIT] button to close the CHANNEL ON/OFF display.**

# Adjusting the Volume Balance Between Style and Keyboard

If you feel the sound that you play on the keyboard doesn't seem to be loud enough (or is too loud) in comparison to the Style or Song playback (page 71) volume, you can adjust the volume of each independently.

You can also independently adjust the audio volume, the sound input from the microphone or [AUX IN] jack, and the audio sound received from a smart device connected by wireless LAN (page 108).

## 1 Press the [C] (BALANCE) button once or twice on the Main display to call up the BALANCE (1/2) display.

There are two pages, 1/2 and 2/2. In the BALANCE 1/2 page, Song, Style, Microphone and the keyboard parts (RIGHT1, RIGHT2 or LEFT) can be adjusted, while the audio sound volume is controlled in page 2/2.

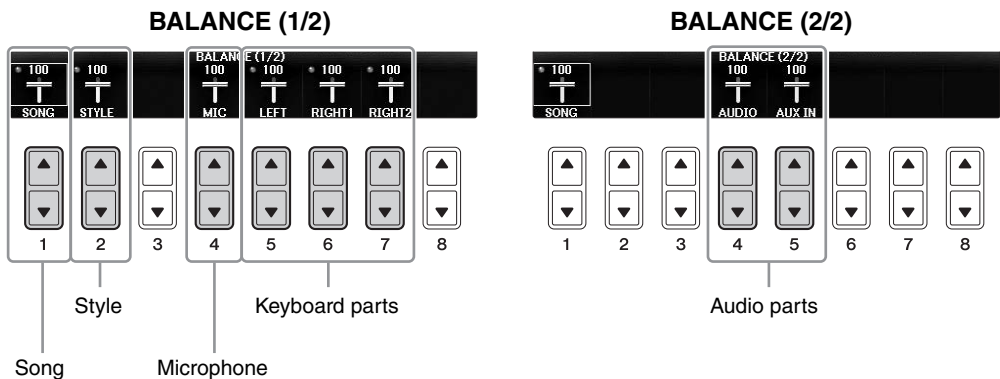

### NOTE

When the USB Wireless LAN adaptor UD-WL01 is connected to the instrument, "WLAN" appears in the BALANCE 2/2 page, and the volume of the audio input via an iPhone/iPad application tool (page 108) can also be adjusted.

## 2 Use the [1▲▼] – [8▲▼] buttons to adjust the volume of the desired parts.

Adjust the Style volume by using the [2▲▼] buttons, and adjust the keyboard volume (Right1, Right2 or Left) by using the [5▲▼] – [7▲▼] buttons.

### NOTE

In the Mixing Console display, you can adjust the volume for each of the Song and Style parts. See page 100.

## 3 Press the [EXIT] button to close the BALANCE display.

# Changing the Split Points

These are the settings (two Split Points) that separate the different sections of the keyboard: the Chord section, the LEFT part section and the RIGHT1 and 2 section. The two Split Point settings (below) are specified as note names.

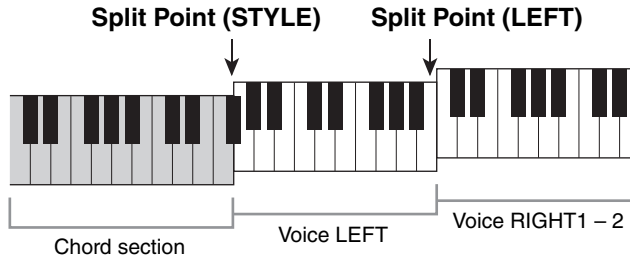

## 1 Call up the operation display.

[FUNCTION] → TAB [◀][▶] MENU1 → [A] SPLIT POINT/CHORD FINGERING → TAB [◀][▶] SPLIT POINT

## 2 Set the Split Point.

Select the desired Split Point by pressing the corresponding [F]-[H] buttons, then rotate the dial to set the value. Selecting “STYLE+LEFT” sets the Split Point (STYLE) and Split Point (LEFT) to the same note while “STYLE” and “LEFT” lets you set each Split Point independently.

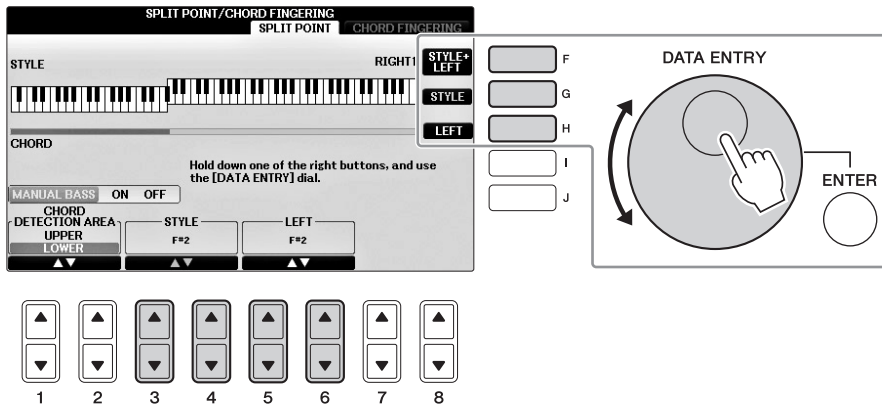

### NOTE

- Split Point (LEFT) cannot be set lower than Split Point (STYLE).
- If you set the CHORD DETECTION AREA value to “UPPER” via the [1▲▼]/[2▲▼] button on the Split Point display, the Chord section will be at the right side of the Split Point (L). With this setting, pressing the [E] button turns the MANUAL BASS function on, letting you play the bass line with your left hand while using your right hand to control Style playback. For details, refer to the Reference Manual on the website (page 9.)

## Style file compatibility

This instrument uses the SFF GE file format (page 8) and can play back existing SFF files; however, they will be saved in the SFF GE format when the file is saved (or loaded) in this instrument. Please keep in mind that the saved file can only be played back on instruments that are compatible with the SFF GE format.

## Advanced Features

Refer to the Reference Manual on the website, *Chapter 3*.



<b>Style playback related settings:</b>	[FUNCTION] → TAB [◀][▶] MENU1 → [G] STYLE SETTING
<b>Specifying chords with your right hand while playing bass with your left:</b>	[FUNCTION] → TAB [◀][▶] MENU1 → [A] SPLIT POINT/ CHORD FINGERING → TAB [◀][▶] SPLIT POINT
<b>Searching for suitable Songs for the current Style (Repertoire):</b>	Style Selection display → [A] - [J] → [8▼] MENU1 → [4▼] (REPertoire)
<b>Memorizing an original One Touch Setting:</b>	[MEMORY] + ONE TOUCH SETTING [1] - [4]
<b>Confirming the One Touch Setting contents:</b>	Style Selection display → [A] - [J] → [8▼] MENU1 → [6▼] (OTS INFO.)
<b>Creating/editing Styles (Style Creator):</b>	[FUNCTION] → TAB [◀][▶] MENU2 → [A] STYLE CREATOR
• Realtime Recording:	→ TAB [◀][▶] BASIC
• Step Recording: (Inputting events one by one)	→ TAB [◀][▶] EDIT → [G] STEP REC
• Style Assembly:	→ TAB [◀][▶] ASSEMBLY
• Editing the rhythmic feel:	→ TAB [◀][▶] GROOVE
• Editing data for each channel:	→ TAB [◀][▶] CHANNEL
• Making Style File Format settings:	→ TAB [◀][▶] PARAMETER

# Song Playback

– Playing and Practice Songs –

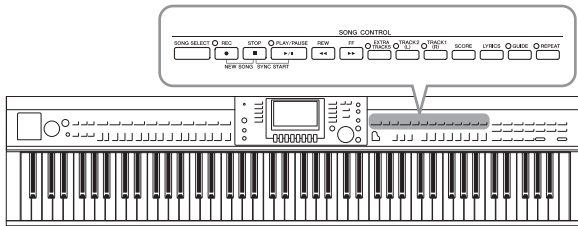

For the Clavinova, “Song” refers to MIDI songs, which include preset songs, commercially available MIDI files, and so on. Not only can you play back a Song and listen to it, but you can also play the keyboard along with Song playback.

## Playback of Songs

You can play back the following types of Songs.

- Preset Songs (in the PRESET Page of the Song Selection display)
- Your own recorded Songs (see page 79 for instructions on recording)
- Commercially available Song data: SMF (Standard MIDI File)

### 1 Press the [SONG SELECT] button to call up the Song Selection display.

#### NOTE

- For information on compatible Song data formats, refer to page 8.
- Song files (MIDI files) corresponding to the included Music Book “50 Greats for the Piano” are available for free downloading from the website (page 9).

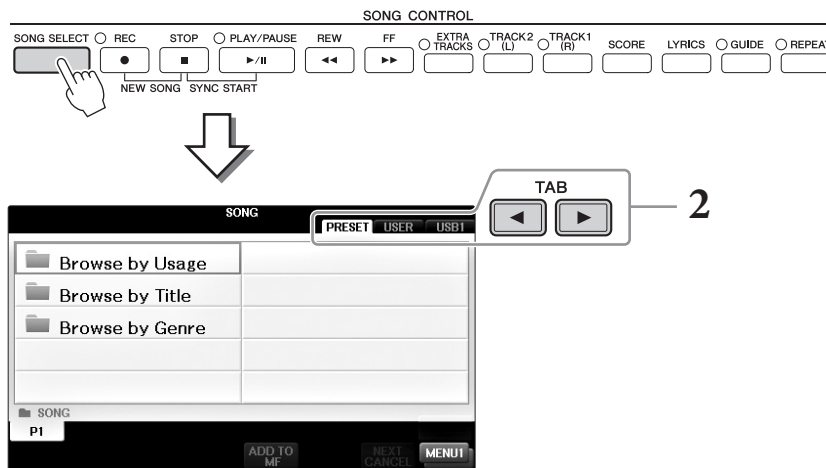

### 2 Press the TAB [◀][▶] buttons to select the location of the desired Song.

If you want to play back a Song in the USB flash drive, connect the USB flash drive containing the desired MIDI Song data beforehand, then select “USB” tab.

#### NOTE

- The preset Songs in the “Follow Lights” folder contain the Guide settings. If you want to play back a Song in this folder, press the [GUIDE] button to turn off the guide function.
- Songs recorded to the instrument in Piano Room are listed in the “Piano Room” folder (in the “USER” tab).
- Before using a USB flash drive, be sure to read “Connecting a USB Device” on page 106.
- Up to two USB flash drives can be connected using a USB hub. The indications USB1, USB2 will be displayed depending on the number of the connected USB flash drives.

- 3** If you’ve selected the “PRESET” tab in step 2, first select a browsing method by using the [A] – [C] buttons, then select a Song category by using the [A] – [J] buttons.

The preset Songs are categorized and contained in appropriate folders.

- 4** Select the desired Song by using the [A] – [J] buttons.

You can also select a Song by using the [DATA ENTRY] dial, then press the [ENTER] button to execute.

**NOTE**

You can instantly jump back to the Main display by “double-clicking” on one of the [A] – [J] buttons.

- 5** Press the SONG CONTROL [PLAY/PAUSE] button to start playback.

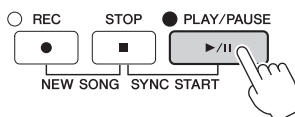

### Queuing the next Song for playback

While a Song is playing back, you can queue up the next Song for playback. This is convenient for smoothly segueing into the next Song while performing live. Select the Song you want play next in the Song Selection display, while a Song is playing back. The “NEXT” indication appears at the upper right of the corresponding Song name. To cancel this setting, press the [7▼] (NEXT CANCEL) button.

- 6** Press the SONG CONTROL [STOP] button to stop playback.

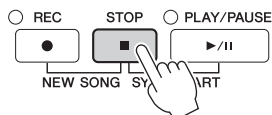

## Operations During Playback

### ■ Synchro Start

You can start Song playback as soon as you start playing the keyboard. While playback is stopped, hold down the SONG CONTROL [STOP] button and press the [PLAY/PAUSE] button. To cancel the Synchro Start function, press the SONG CONTROL [STOP] button once again.

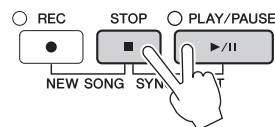

### ■ Pause

Press the [PLAY/PAUSE] button. Pressing it again resumes Song playback from the current position.

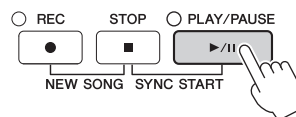



## ■ Rewind/Fast Forward

Press the [REW] or [FF] button once to move back/forward one measure. Hold the [REW] or [FF] button to scroll backward/forward continuously. Pressing the [REW] or [FF] button calls up a pop-up window showing the current measure number (or Phrase Mark number) in the display. While the Song Position pop-up is shown on the display, you can also use the [DATA ENTRY] dial to adjust the value.



### NOTE

Phrase Mark is a pre-programmed marker in certain Song data, which indicates a specific location in the Song.

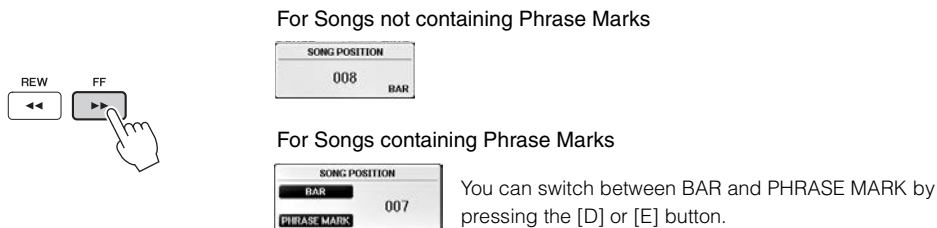

## ■ Adjusting the Tempo

Same procedure as with Style tempo. See page 64.

## ■ Adjusting the Volume Balance Between Song and Keyboard

Same procedure as with “Adjusting the Volume Balance Between Style and Keyboard” (page 68).

## ■ Transpose the Song playback

See page 50.

### Restrictions for protected Songs

Commercially available Song data may be copy protected to prevent illegal copying or accidental erasure. They are marked by the indications at the upper left side of the file names. The indications and relevant restrictions are detailed below.

- **Prot. 1:**

Indicates Preset Songs saved to the User tab display and Disklavier Piano Soft Songs. These cannot be copied/moved/saved to USB flash drives.

- **Prot. 2 Orig:**

Indicates Yamaha-protection-formatted Songs. These cannot be copied. These can be moved/saved only to the User drive and USB flash drives with ID.

- **Prot. 2 Edit:**

Indicates edited “Prot. 2 Orig” Songs. Make sure to save these to the same folder containing the corresponding “Prot. 2 Orig” Song. These cannot be copied. These can be moved/saved only to the User drive and USB flash drives with ID.

#### Note for “Prot. 2 Orig” and “Prot. 2 Edit” Song file operation

Make sure to save the “Prot. 2 Edit” Song to the same folder containing its original “Prot. 2 Orig” Song. Otherwise the “Prot. 2 Edit” Song cannot be played back. Also, if you move a “Prot. 2 Edit” Song, be sure to move its original “Prot. 2 Orig” Song to the same location (folder) at the same time. For information about compatible USB flash drive for saving protected Songs, visit the Yamaha website.

# Displaying Music Notation (Score)

You can view the music notation (score) of the selected Song. We suggest that you read through the music notation before starting to practice. You can also convert your recorded Songs to notation with this operation.

## NOTE

The instrument can display the music notation of commercially-available music data or your recorded Songs.

### 1 Select a Song (steps 1 – 4 on page 71).

### 2 Press the [SCORE] button to call up the Score display.

You can look through the entire notation by using the TAB [◀][▶] buttons when the Song playback is stopped. As soon as playback starts, the “ball” bounces along through the score, indicating the current position.

## NOTE

The displayed notation is generated by the instrument based on the Song data. As a result, it may not be exactly the same as commercially available sheet music of the same song — especially when displaying notation of complicated passages or many short notes.

4

Song Playback – Playing and Practice Songs –

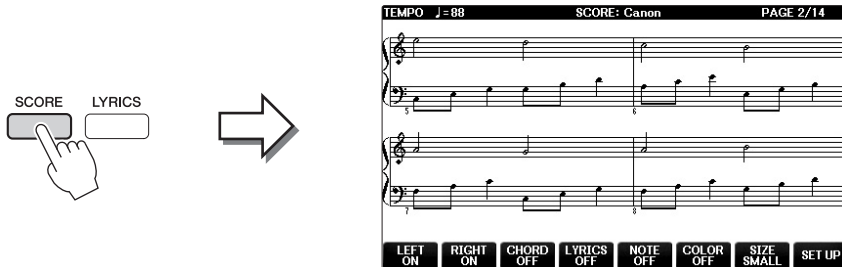

## To change the size of the notation

You can change the display resolution (or zoom level) of the notation by pressing the [7▲▼] button on the Score display.

You can also change the displayed notation style (such as showing the note name) by using the [1▲▼] – [8▲▼] buttons. For details, refer to the Reference manual on the website (page 9).

## To display the Lyrics

When the selected Song contains lyric data, you can display the lyrics within the music notation. To do this, press the [4▲▼] button to turn LYRICS on.

## Displaying Lyrics (Text)

When the selected Song contains lyric data, you can view it on the instrument's display during playback.

- 1 Select a Song (steps 1 – 4 on page 71).
- 2 Press the [LYRICS] button to call up the Lyrics display.

When the Song data contains lyrics data, the lyrics are shown on the display. You can look through the entire lyrics by using the TAB [◀][▶] buttons when the Song playback is stopped. As Song playback starts, the color of the lyrics changes, indicating the current position.

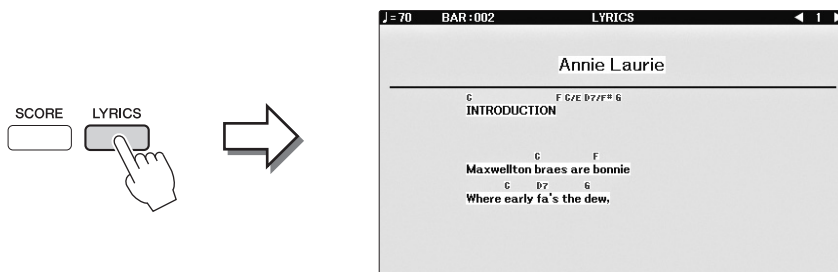

## Turning Song Channels On/Off

A Song consists of 16 separate channels. You can independently turn each channel of the selected Song playback on or off.

- 1 Press the [CHANNEL ON/OFF] button once or twice to call up the CHANNEL ON/OFF (SONG) display.

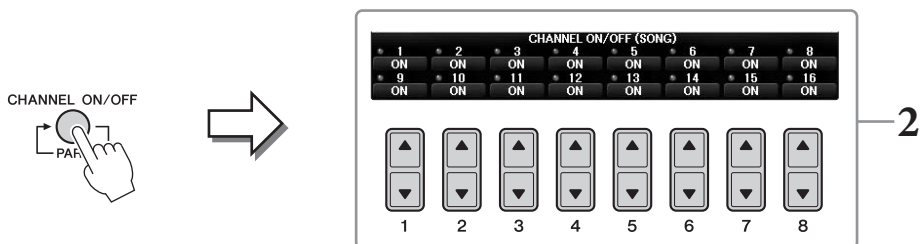

- 2 Use the [1▲▼] – [8▲▼] button to turn each channel on or off.

If you want to play back only one particular channel (solo playback), press and hold down one of the [1▲▼] – [8▲▼] buttons corresponding to the desired channel. Only the selected channel is turned to on and others are off. To cancel solo playback, press the same button again.

# One-handed Practice with the Guide Lamps

The key guide lamps indicate the notes you should play, when you should play them, and how long you should hold them down. You can also practice at your own pace — since the accompaniment waits for you to play the notes correctly. Here, mute the right-hand part and try practicing the part using the guide lamps.

**NOTE**

The guide lamps light in red for the white keys and green for the black keys.

**1** Select a Song and call up the Score display (page 74).

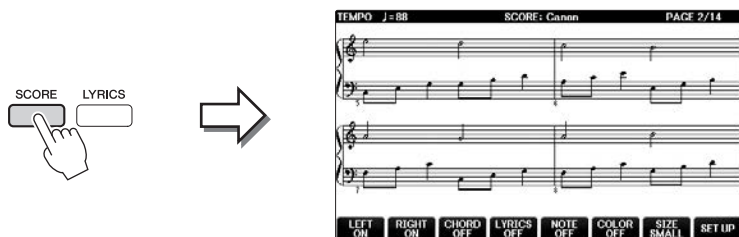

**2** Turn the [GUIDE] button on.



**3** Press the [TRACK1 (R)] button to mute the right-hand part.

The indicator of the [TRACK1 (R)] button turns off. You can now play that part by yourself.

**NOTE**

Usually, CH 1 is assigned to [TRACK1 (R)] button, CH 2 is assigned to [TRACK2 (L)] button, and CH 3 – 16 are assigned to the [EXTRA TRACKS] button.

■ **For left-handed practice:**

Press the [TRACK2 (L)] button to mute the left-hand part, and press the [ACMP ON/OFF] button to turn off the Auto Accompaniment.

■ **For both-handed practice:**

Press the [TRACK1 (R)] and [TRACK2 (L)] buttons to mute the parts of both hands.

**4** Press the SONG CONTROL [PLAY/PAUSE] button to start playback.

Practice the right-hand part at your own pace along with the guide lamps. The playback of the Left and Extra parts will wait for you to play the notes correctly.

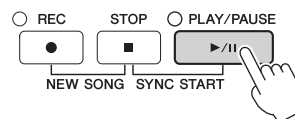

**5** After your practice, turn the [GUIDE] button off.

**Other guide functions**

There are additional functions in the Guide features, for practicing the timing of playing the keys (Any Key), for Karaoke (Karao-key), or for playing at your own tempo (Your Tempo) besides Follow Lights mentioned above. [FUNCTION] → TAB [◀][▶] MENU1 → [H] SONG SETTING → TAB [◀][▶] GUIDE/CHANNEL → [A]/[B]GUIDE MODE

For more information, refer to the Reference Manual on the website (page 9).

## Repeat Playback

The Song Repeat functions can be used to repeatedly play back a Song or a specific range of measures in a Song. This is useful for repeated practicing of difficult-to-play phrases.

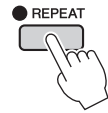

To repeat a Song, turn the [REPEAT] button on and playback the desired Song. Turning the [REPEAT] button off cancels Repeat playback.

### NOTE

You can play multiple Songs repeatedly. (page 78)

## Specifying a Range of Measures and Playing them Back Repeatedly (A-B Repeat)

- 1 Select a Song (steps 1 – 4 on page 71).
- 2 Press the SONG CONTROL [PLAY/PAUSE] button to start playback.
- 3 Specify the repeat range.

Press the [REPEAT] button at the starting point (A) of the range to be repeated. (The lamp flashes, indicating point A has been specified.) Press the [REPEAT] button again at the ending point (B). (The lamp lights continuously.) After an automatic lead-in (to help guide you into the phrase), the range from Point A to Point B is played back repeatedly.

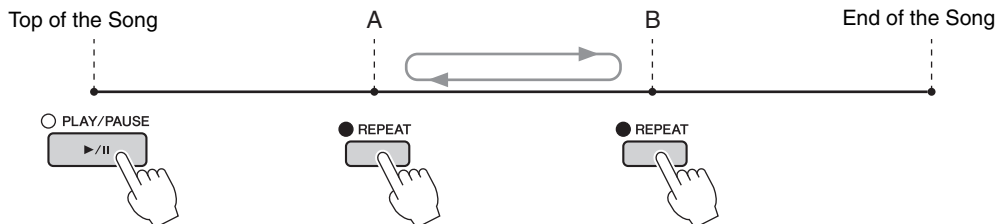

### NOTE

When you want to repeat from the top of the song to middle of the song:

- 1 Press the [REPEAT] button, then start Song playback.
- 2 Press the [REPEAT] button again at the ending point (B).

### NOTE

Specifying only Point A results in repeat playback between Point A and the end of the Song.

- 4 To stop playback, press the SONG CONTROL [STOP] button.  
The Song position will return to Point A.

- 5 Press the [REPEAT] button to turn off Repeat playback.

### Specifying the repeat range while Songs are stopped

- 1 Press the [FF] button to advance to the Point A location.
- 2 Press the [REPEAT] button to specify Point A.
- 3 Press the [FF] button to advance to the Point B location.
- 4 Press the [REPEAT] button again to specify Point B.

## Playing Multiple Songs Repeatedly

### 1 Select a Song in a folder containing multiple Songs (steps 1 – 4 on page 71).

For example, select a Song from a folder of the preset Songs.

#### NOTE

The preset Songs in the "Follow Lights" folder contain the Guide settings. These Songs are inappropriate for use with ALL or RANDOM repeat.

### 2 Call up the operation display.

① [FUNCTION] → ② TAB [◀][▶] MENU1 → ③ [H] SONG SETTING → ④ TAB [◀][▶] OTHERS

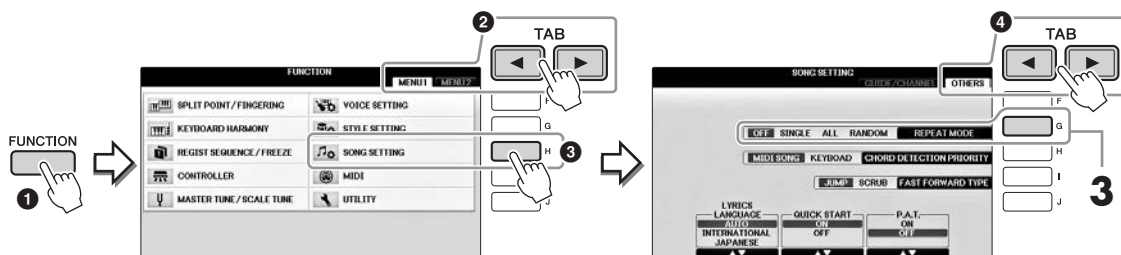

### 3 Set the repeat mode to ALL by pressing the [G] button, then start playback of the Song.

This operation continues playback through all the Songs in the folder containing the currently selected Song repeatedly. If you want to restore to the original setting, set the mode to OFF.

## Advanced Features

Refer to the Reference Manual on the website, *Chapter 4*.



#### Editing Music Notation settings:

[SCORE] → [1▲▼] – [8▲▼] buttons

#### Using the Auto Accompaniment features with Song playback:

[ACMP ON/OFF] ON → STYLE [SYNC START] → SONG CONTROL [STOP] + [PLAY/PAUSE] → STYLE [START/STOP]

#### Song playback related parameters:

[FUNCTION] → TAB [◀][▶] MENU1 → [H] SONG SETTING

- Keyboard and vocal practice using the Guide function:

→ TAB [◀][▶] GUIDE/CHANNEL → [A]/[B] GUIDE MODE

- Playing backing parts with Performance Assistant Technology:

→ TAB [◀][▶] OTHERS → [6▲▼]/[7▲▼] P.A.T.

# Song Recording via MIDI

– Recording Your Performance via MIDI –

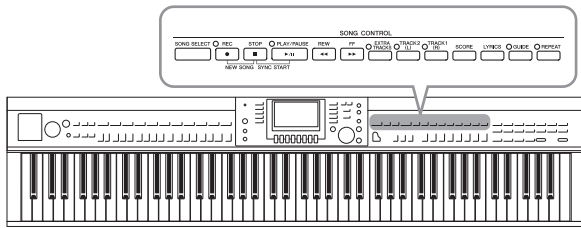

This instrument allows you to record your performance with the following two methods.

- **MIDI recording (described in this chapter)**

With this method, recorded performances are saved as SMF (format 0) MIDI files. If you want to re-record specific sections or edit parameters such as those of Voice, use this method. Also, if you want to record your performance to each channel one by one, execute Multi Channel Recording (page 82).

- **Audio recording (see page 84)**

With this method, recorded performances are saved to a USB flash drive as an Audio file. Recording is done without designating the recorded part. Since it is saved in stereo WAV format of normal CD quality resolution (44.1kHz/16bit), it can be transmitted to and played on portable music players by using a computer.

5

Song Recording via MIDI – Recording Your Performance via MIDI –

## Recording Your Performance (Quick Recording)

This simple method lets you start recording immediately without specifying a part you want to record to. For Quick Recording, each part will be recorded to the following channels. Keyboard parts: Ch. 1 – 3 Style parts: Ch. 9 – 16

- 1 Before recording, make desired settings for the instrument, such as Voice/Style selection. As necessary, connect the USB flash drive to the [USB TO DEVICE] terminal.**
- 2 Press the SONG CONTROL [REC] button and the [STOP] button simultaneously.**  
A blank Song for recording is automatically set.

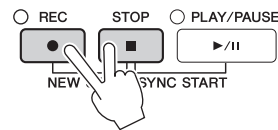

- 3 Press the SONG CONTROL [REC] button.**

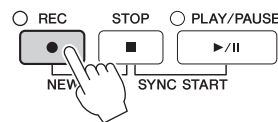

- 4 Start recording.**

Recording begins automatically as soon as you play a note on the keyboard or start Style playback.

## 5 Press the SONG CONTROL [STOP] button to stop recording.

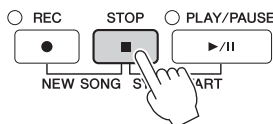

A message prompting you to save the recorded performance appears. To close the message, press the [EXIT] button.

## 6 Press the SONG CONTROL [PLAY/PAUSE] button to play back the recorded performance.

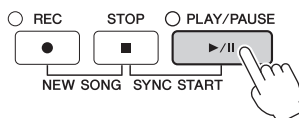

## 7 Save the recorded performance as a file. Press the [SONG SELECT] button to call up the Song Selection display, in which you can save the recorded performance as a file. For details, see next section (page 81).

### NOTICE

The recorded Song will be lost if you change to another Song or you turn the power off without executing the Save operation.

#### ■ To delete the recorded Songs:

Refer to “Deleting Files/Folders” on page 35.

#### ■ To correct any wrong notes:

After saving, you can re-record a specific section or edit the notes for each channel independently via the Song Creator function. For details, refer to the Reference Manual on the website (page 9), Chapter 5.

You can also record a performance with Style playback. For example, record Style playback with the Quick Recording method, then record melodies to channel 1 with the Multi Channel Recording method while listening to the already recorded Style playback.



## Saving Files

This operation lets you save your original data (such as Songs you've recorded and Voices you've edited) to a file. The explanations here apply when you save your recorded performance as a Song file.

- 1 In the relevant File Selection display, press the TAB [◀][▶] buttons to select “USER” or “USB” as save destination.

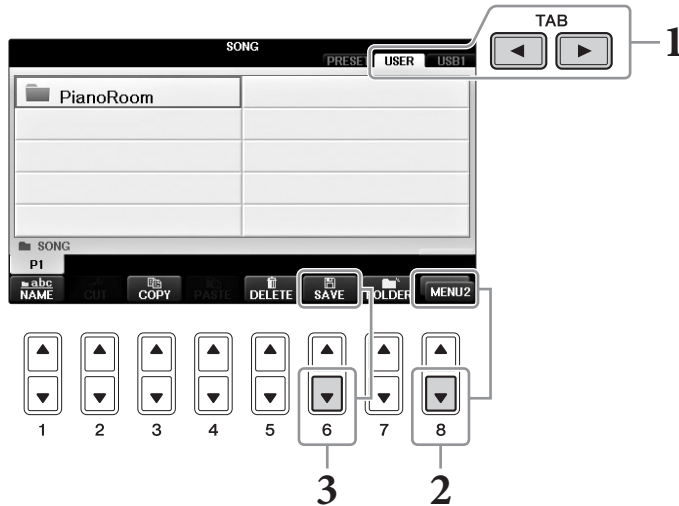

- 2 Call up MENU2 at the right bottom of the display by pressing the [8▼] button as necessary.

There are some displays for which MENU2 does not appear. In such cases, skip this step.

- 3 Press the [6▼] (SAVE) button to call up the file naming display.

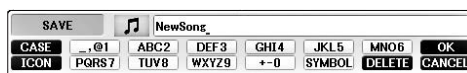

- 4 Enter the file name (page 36).

Even if you skip this step, you can rename the file at any time after saving (page 33).

### NOTE

If you want to cancel the Save operation, press the [8▼] (CANCEL) button.

- 5 Press the [8▲] (OK) button to save the file.

The saved file will be automatically located at the appropriate position among the files in alphabetical order.

# Complete a Piano Piece by Recording the Right- and Left-hand Parts Separately (Multi Channel Recording)

The Multi Channel Recording method let you record data to each channel independently, one by one, up to 16. Here, you will learn how to create a complete, two-handed piano piece by recording the right-hand part to channel 1, and then recording the left-hand part to channel 2 while listening to the already recorded data.

**1** Make sure that only the PART ON/OFF [RIGHT1] button is turned on, then select the desired piano Voice (steps 1-3 on page 44).

**2** Press the SONG CONTROL [REC] button and the [STOP] button simultaneously.

A blank Song for recording is automatically created.

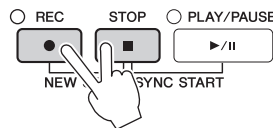

**3** Record the right-hand part to channel 1.

**3-1** While holding down the SONG CONTROL [REC] button, press the [1▲] button to set channel 1 to “REC.”

**3-2** Select “RIGHT1” (which will be recorded to channel 1) by using the [C]/[D] buttons. The “RIGHT1” indication refers to your performance using the RIGHT1 Voice (page 44).

**NOTE**

To cancel the recording, press the SONG CONTROL [STOP] button.

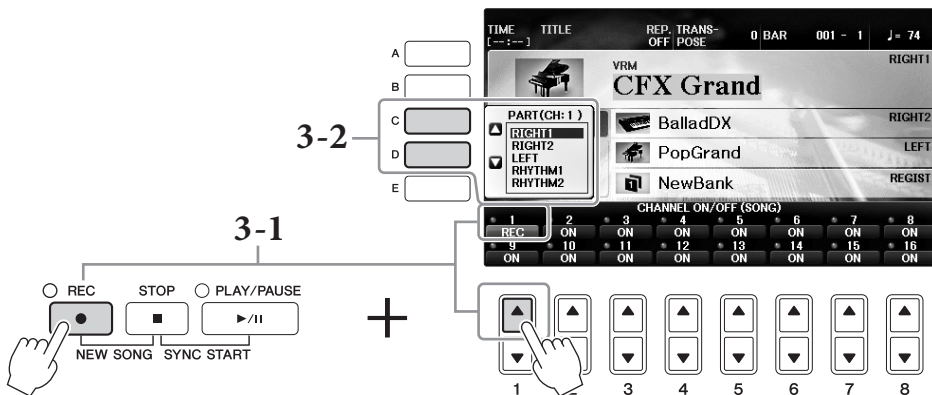

**3-3** Play the keyboard with your right-hand. Recording begins automatically as soon as you play a note on the keyboard. Play the Voice you specified in step 3-2.

**4** Press the SONG CONTROL [STOP] button to stop recording.

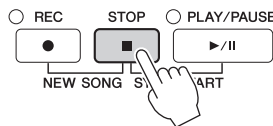

**5** Press the SONG CONTROL [PLAY/PAUSE] button to play back the recorded performance.

If you are not satisfied with the results, repeat steps 3 – 5 as desired.

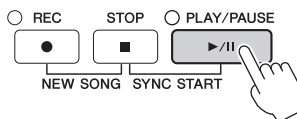

## 6 Record the left-hand performance to channel 2.

**6-1** While holding down the SONG CONTROL [REC] button, press the [2▲] button to set channel 2 to “REC.”

**NOTICE**

If you record to a channel which has already recorded data, the existing data will be erased and overwritten with the new data.

**6-2** Select “RIGHT1” (which will be recorded to channel 2) by using the [C]/[D] buttons.

**6-3** Play the keyboard with your left-hand. Recording begins automatically as soon as you play a note on the keyboard. You can also start recording by pressing the SONG CONTROL [PLAY/PAUSE] button. Play the Voice you specified in step 6-2.

You can play the keyboard while listening to the already recorded data.

## 7 Press the SONG CONTROL [STOP] button to stop recording.

## 8 Press the SONG CONTROL [PLAY/PAUSE] button to play back the recorded performance.

If you are not satisfied with the results, repeat steps 6 – 8 as desired.

## 9 Save the recorded performance as a file. Press the [SONG SELECT] button to call up the Song Selection display. The recorded performance will be saved as a file in the Song Selection display. For details, see page 81.

**NOTICE**

The recorded Song will be lost if you change to another Song or you turn the power off without executing the Save operation.

For step 2 above, if you want to re-record an existing Song, select the desired Song (steps 1 – 4 on page 71).

## Advanced Features

Refer to the Reference Manual on the website, *Chapter 5*.



### Recording Style playback first, then melodies

#### Creating/Editing Songs (Song Creator):

[FUNCTION] → TAB [◀][▶] MENU2 → [B]  
SONG CREATOR

- Recording melodies (Step Recording): → TAB [◀][▶] 1-16
- Recording chords (Step Recording): → TAB [◀][▶] CHORD
- Re-recording a specific section — Punch In/Out: → TAB [◀][▶] REC MODE
- Changing the setup parameters recorded to the Song: → TAB [◀][▶] SETUP
- Editing channel events: → TAB [◀][▶] CHANNEL
- Editing chord events, notes, System Exclusive events and Lyrics: → TAB [◀][▶] CHORD, 1-16, SYS/EX. or LYRICS

# USB Audio Player/Recorder

– Playback and Recording Audio Files –

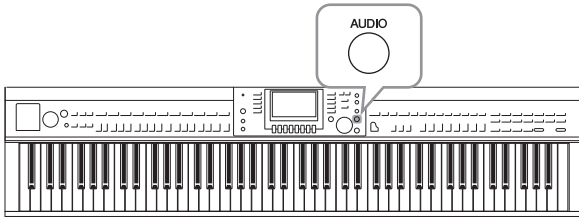

The convenient USB Audio Player/Recorder allows you to play back audio files (.WAV) saved to a USB flash drive — directly from the instrument. Moreover, since you can record your performances and recordings as audio data (.WAV) to a USB flash drive, it is possible to play back the files on computer, share them with your friends, and record your own CDs to enjoy as well.

If you want to record various parts separately or edit the Song data after recording on this instrument, execute MIDI Recording (page 79).

## Playing Back Audio Files

Try playing back audio files from a USB flash drive connected to this instrument.

### NOTE

The instrument cannot play back DRM protected files.

### File format that can be played back

.wav	44.1 kHz sample rate, 16 bit resolution, stereo
------	---

- 1 Connect the USB flash drive containing the audio files to play back to the [USB TO DEVICE] terminal.

### NOTE

Before using a USB flash drive, be sure to read “Connecting a USB Device” on page 106.

### NOTE

The AUDIO display for selecting an audio file (shown in Step 4) can be called up also by pressing the [USB] button then the [B] (AUDIO) button.

- 2 Press the [AUDIO] button to call up the USB AUDIO PLAYER display.



- 3 Press the [H] (FILES) button to display the audio files saved to the connected USB flash drive.

4 Press one of the [A] – [J] buttons corresponding to the file you want to listen to.

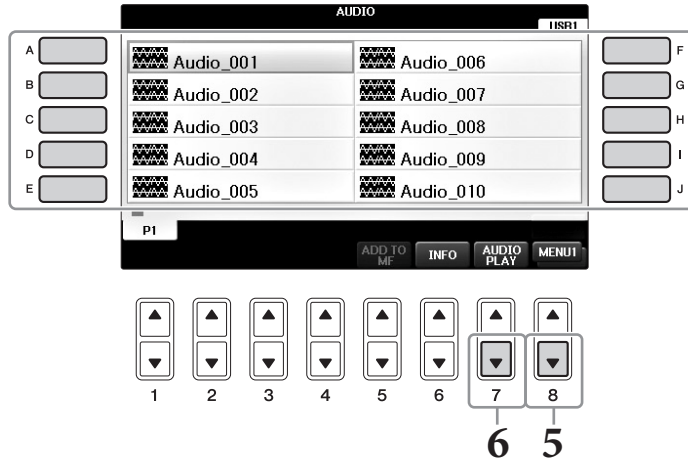

5 Call up MENU1 at the right bottom of the display by pressing the [8▼] button as necessary.

**NOTE**

To confirm the information of the currently selected audio file, press the [6▼] button to call up the Information display. To exit from the Information display, press the [F] (OK) button.

6 Press the [7▼] (AUDIO PLAY) button to start playback.

This operation returns to the USB AUDIO PLAYER display.

7 Press the [2▲▼] (STOP) button to stop playback.

**NOTICE**

Never attempt to disconnect the USB flash drive or turn the power off during playback. Doing so may corrupt the USB flash drive data.

## Playback-related Operations

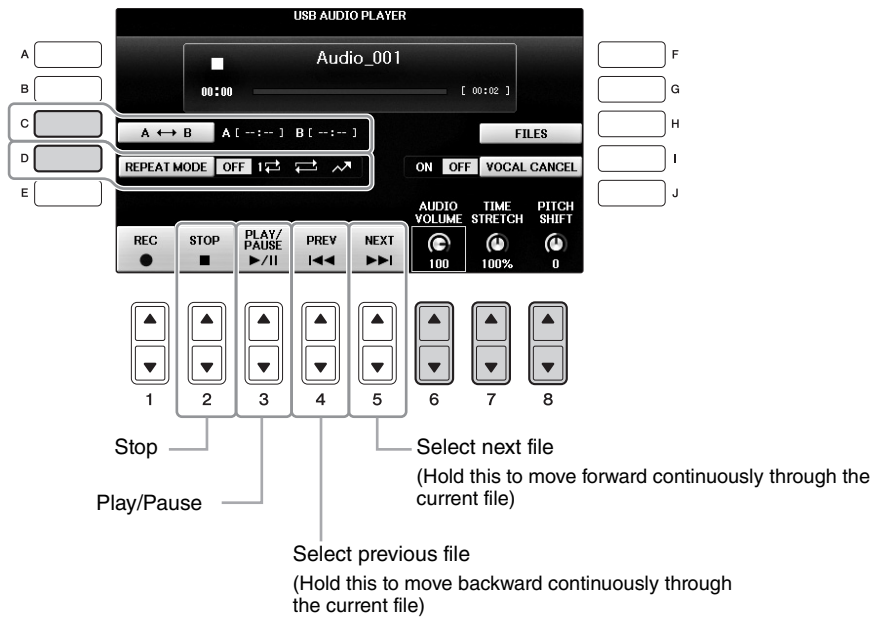

### ■ Adjusting the volume of audio playback [6▲▼] (AUDIO VOLUME) buttons

These let you adjust the playback volume of an Audio file.

### ■ Adjusting the Playback Speed [7▲▼] (TIME STRETCH) buttons

These let you adjust the playback speed of an Audio file by stretching or compressing it. The value can be adjusted from 75% to 125% and the default value is 100%. Higher values result in a faster tempo. If you select another audio file, this setting will be restored to the default value.

#### NOTE

Changing the playback speed of an Audio file may change its tonal characteristics.

### ■ Adjusting the Pitch in semitones [8▲▼] (PITCH SHIFT) buttons

These let you shift the pitch of an Audio file in semitone steps (from -12 to 12). If you select another audio file, this setting will be restored to the default value.

### ■ Playing back a specified range of an audio file [C] (A-B) button

During playback, press the [C] (A-B) button at the starting point (A), and then press the [C] (A-B) button again at the ending point (B) to start repeat playback between the A and B points. To cancel this setting, press the [C] (A-B) button again.

### ■ Playing Multiple Files Repeatedly [D] (REPEAT MODE) button

This lets you set the repeat mode of the Audio file.

- OFF ..... Plays through the selected file, then stops.
- 1 ↺ ..... Plays through the selected file repeatedly.
- ↺ ..... Continues playback through all the files in the folder containing the current file repeatedly.
- ↻ ..... Randomly and repeatedly plays back all files in the folder containing the current file.

## Canceling the Vocal Part and Playing the Part with Backing (Vocal Cancel)

This lets you cancel or attenuate the center position of the stereo sound. This lets you sing “karaoke” style with just instrumental backing, since the vocal sound is usually at the center of the stereo image in most recordings. This function cannot be applied to the sound input from the microphone or [AUX IN] jack or the audio sound received from a smart device connected by wireless LAN.

First select an Audio file, then press the [I] button to turn Vocal Cancel on. Press the [3▲▼] button to start playback, allowing you to confirm that the vocal part is muted. If you select another audio file, this setting will be switched to off.



### NOTE

Though the Vocal Cancel function is highly effective on most audio recordings, the vocal sound on some songs may not be completely cancelled.

# Recording Your Performance as Audio

Try recording your performance as audio data to a USB flash drive.

## NOTE

To record your performance with the USB Audio Player/Recorder, make sure to use a compatible USB flash drive. Before using a USB flash drive, be sure to read "Connecting a USB Device" on page 106.

## NOTE

In addition to the Audio Recording functions explained here, MIDI Recording (page 79) is also available on this instrument.

### • File format that can be recorded

.wav.....44.1 kHz sample rate, 16 bit resolution, stereo

### • Target sounds for recording

All the sounds produced via your keyboard performance, the sound input from the [MIC/LINE IN] and [AUX IN] jacks. Songs protected by copyright, such as preset Songs, and the metronome sound cannot be recorded.

### • Maximum amount of recording time

80 minutes per recording, though this may be less depending on the capacity of the particular USB flash drive.

- 1 Connect the USB flash drive to the [USB TO DEVICE] terminal.
- 2 Set the desired Voice, etc. which you want to use for your performance. (For information setting the Voice, see page 44; for setting the Style, see page 58; for using the AUX IN jack, see page 104.)
- 3 Press the [AUDIO] button to call up the USB AUDIO PLAYER display.



- 4 Press the [1▲▼] (REC) button to engage the Record Standby status.

## NOTE

The USB flash drive of "USB1" is selected as the recording destination when multiple USB flash drives are connected. You can confirm the contents of "USB1" in the file selection display called up by pressing the [H] (FILE SELECT) button on the USB AUDIO PLAYER display.

"WAIT" is shown during Record Standby.

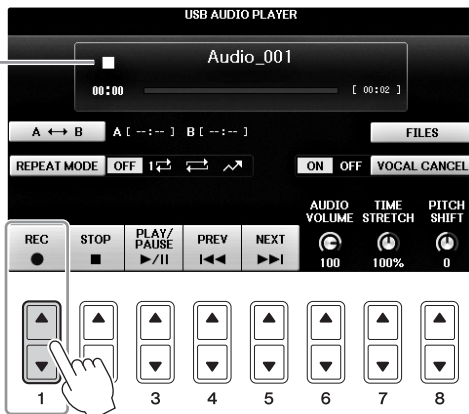



## 5 Start recording by pressing the [3▲▼] (PLAY/PAUSE) button, then start your performance.

When recording begins, the elapsed recording time is shown on the right side of the Recording display.

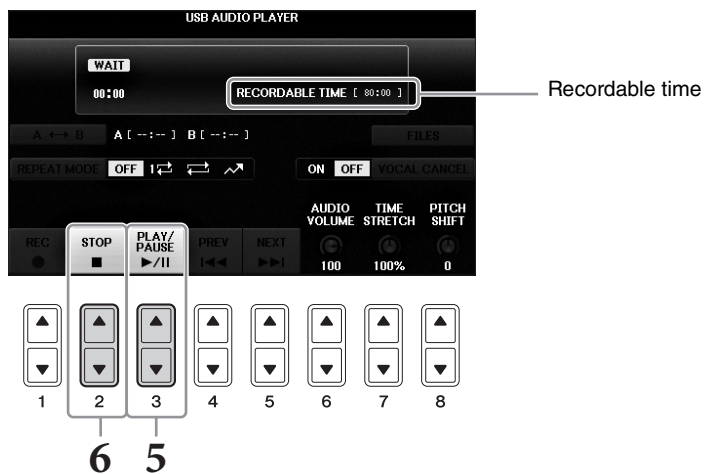

### NOTICE

Never attempt to disconnect the USB flash drive or turn the power off during playback. Doing so may corrupt the USB flash drive data or the recording data.

## 6 Stop recording by pressing the [2▲▼] (STOP) button.

The file name is automatically named, and a message indicating the file name is displayed.

# Microphone

– Connecting a Microphone and Singing Along with Your Performance –

By connecting a microphone to the [MIC/LINE IN] jack (standard 1/4" phone jack), you can enjoy singing along with your keyboard performance or with Song playback. The instrument outputs your vocals through the built-in speakers.

## Connecting a Microphone

- 1 Before turning on the power of the instrument, set the [INPUT VOLUME] knob to the minimum position.**

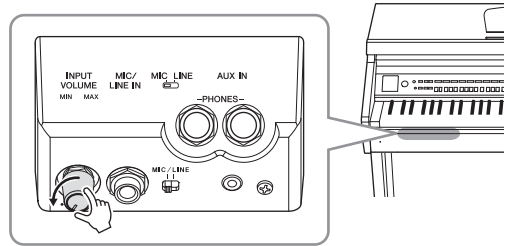

- 2 Connect the microphone to the [MIC/LINE IN] jack.**

- 3 Set the [MIC/LINE] switch to "MIC."**

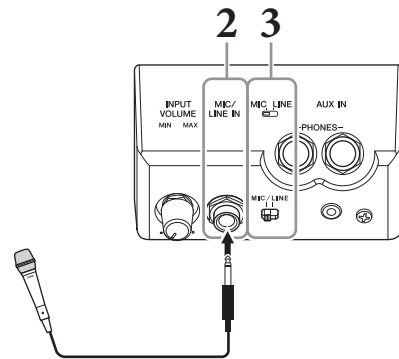

- 4 Turn on the power of the instrument.**

- 5 (If necessary, turn on the microphone.) Adjust the [INPUT VOLUME] knob while singing into the microphone.**

Adjust the control while checking the [MIC] lamp. Make sure to adjust the control so the lamp lights in green. Make sure that the lamp does not light in red, since this indicates that the input level is too high.

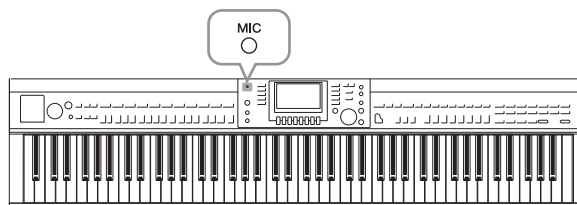

- 6 On the Balance display, adjust the volume balance between the microphone sound and the instrument sound (page 68).**

## Useful Functions for Karaoke Singing

### ■ When using the preset Songs:

- Lyrics on the display ..... page 75
- Transpose, Pitch Shift .... page 50

### ■ When using the Audio Songs:

- Vocal Cancel ..... page 87
- Pitch Shift ..... page 86

## Disconnecting the microphone

- 1 Set the [INPUT VOLUME] knob to the minimum position.
- 2 Disconnect the microphone from the [MIC/LINE IN] jack.

### NOTE

Before turning the power off, make sure to set the [INPUT VOLUME] knob to the minimum position.

## Using the Talk Function

This function lets you instantly change the microphone settings for talking or making announcements between song performances.

### 1 Connect the microphone to the instrument (page 90).

### 2 Call up the MIC SETTING display:

- ① [FUNCTION] → ② TAB [◀][▶] MENU2 → ③ [F] (MIC SETTING)

In the MIC SETTING display, you can adjust the microphone settings for singing (VOCAL page) and talking (TALK page) independently. For details, refer to the Reference Manual on the website (page 9).

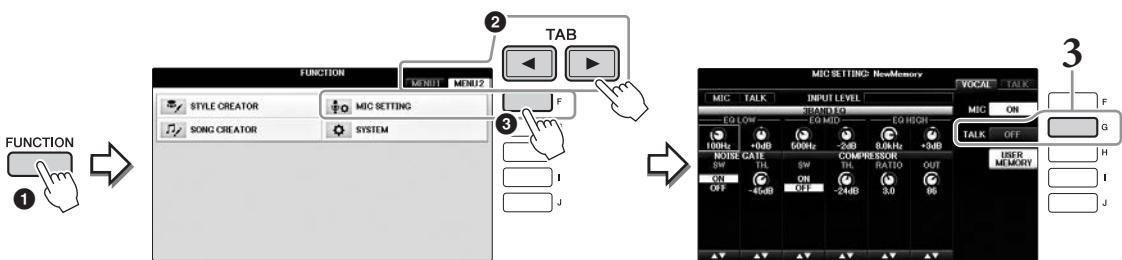

### 3 To call up the Talk setting, press the [G] (TALK) button located at the right on the display to turn TALK on. To recall the song performances setting, press the same button again to turn TALK off.

## Advanced Features

Refer to the Reference Manual on the website, *Chapter 7*.



**Making and Saving the Microphone Settings:** [FUNCTION] → TAB [◀][▶] MENU2 → [F] (MIC SETTING)

# Music Finder

– Calling Up Ideal Setups (Voice, Style, etc.) for Each Song –

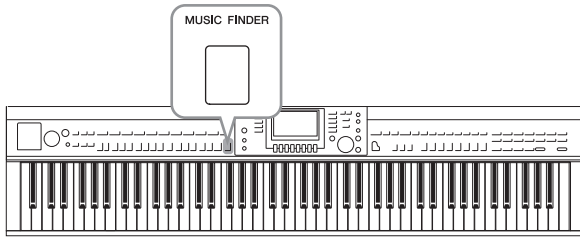

If you want to play in a certain genre of music but don't know which Style and Voice settings would be appropriate, the convenient Music Finder function can help you out. Simply select the desired music genre (or song title) from among the Music Finder panel settings, and the instrument automatically makes all appropriate panel settings to let you play in that music style.

## Selecting Desired Panel Settings from the Records

Try out the convenient Music Finder function using the built-in sample records.

### 1 Press the [MUSIC FINDER] button to call up the MUSIC FINDER display.

After a message appears, press the appropriate button. In the ALL display, all the records are shown.

Shows the music title and Style/beat/tempo appropriate for each Record.

MUSIC FINDER			
		SEARCH 1	SEARCH 2
MUSIC	STYLE	BEAT	TEMPO
Abide With Me	BossaFast	4/4	72
Aida Triumph March	BossaSlow	4/4	112
Air On The G String	BossaFast	4/4	68
Air On The G String	BrazilianBossa	4/4	69
Air On The G String	SmoothBallad16	4/4	68
Aloha Oe	Organ Quickstep	4/4	102
Amapola	Brit Pop Swings	4/4	138
Amapola	Country Hits	4/4	112
Amboss Polka	Guajira	4/4	116
American Patrol	Electronica	4/4	186
An Der Schonen Blauen Don-	ChildrensMarch	3/4	176
An Der Schonen Blauen Don-	Gospel Sisters	3/4	174
Any Old Iron	Orchestral Bolero	4/4	120
Any Old Iron	Rock Cha Cha	4/4	116

### 2 Use the [2▲▼]/[3▲▼] buttons to select the desired Record.

You can select the Record also by using the [DATA ENTRY] dial then pressing the [ENTER] button.

#### Sorting the Records

Press [F] (SORT BY) button to change the sorting criteria: MUSIC, STYLE, BEAT or TEMPO. Press the [G] (SORT ORDER) button to change the order of the records (ascending or descending). When sorting records by MUSIC, you can use the [1▲▼] button to skip up or down through the songs alphabetically. When sorting records by STYLE, you can use the [4▲▼]/[5▲▼] button to skip up or down through the Styles alphabetically. Simultaneously press the [▲] and [▼] buttons to move the cursor to the first record.

### 3 Play the Style by playing chords with your left hand and the melody with your right (page 59).

You can download the Records (panel settings) from the Yamaha website, and then load them to this instrument (page 93).

#### NOTE

Don't turn off the [OTS LINK] button. When turned off, you cannot call up the appropriate panel settings even when you select the record.

#### NOTE

If you want to avoid changing the Tempo during Style playback when selecting another Record, set the Style Tempo function to LOCK or HOLD by pressing the [I] (STYLE TEMPO) button in the Music Finder display. Setting to LOCK can also avoid inadvertent changing of the Tempo while Style playback is stopped and another record is selected.

## Downloading Records (Panel Settings) from the Website

As a factory default, some sample records (panel settings) are provided in the Music Finder. However, in order to use the Music Finder function more conveniently and effectively, we recommend that you download the Records (panel settings) from the following website, then load them to this instrument.

### 1 On the computer, download the Music Finder panel settings file from the website to the USB flash drive.

<http://download.yamaha.com/>

#### NOTE

Before using a USB flash drive, be sure to read "Connecting a USB Device" on page 106.

### 2 Connect the USB flash drive which contains the panel settings file to the [USB TO DEVICE] terminal of the instrument.

### 3 Press the [MUSIC FINDER] button to call up the MUSIC FINDER display.



### 4 Press the [7▲▼] (FILES) button to call up the File Selection display.

- Use the TAB [◀][▶] buttons to call up the USB display containing the panel settings file downloaded from the website.

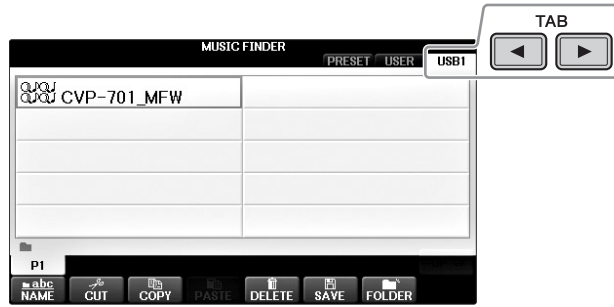

- Select the desired file by pressing the appropriate [A] – [J] button.
- Press [H] (APPEND) if you want to add Records of the selected Music Finder file, or press [G](REPLACE) if you want to replace all Records with the new ones.

Press the [G] (YES) button at the confirmation prompt.

**NOTE**

Even after replacing the Music Finder records, you can restore them to their original factory settings by selecting the "MusicFinderPreset" file in PRESET display of the step.

- Press the [G] (YES) button in the message display (indicating completion of the Replace operation) to call up the MUSIC FINDER display.

By checking the number of records in the MUSIC FINDER display, you can confirm the record has been replaced.

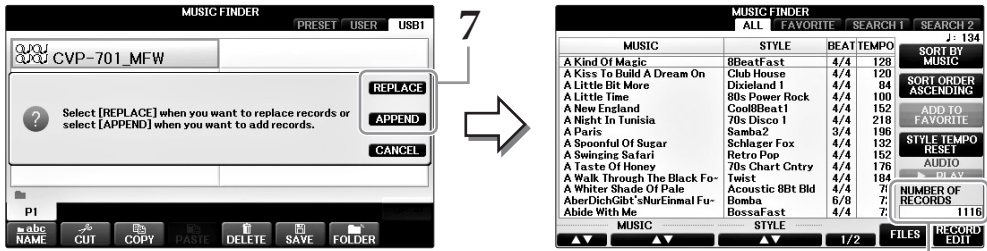

The number of records

# Searching for the Panel Settings

You can search for the Records by specifying a song name or keyword, using the Search function of the Music Finder.

- From the ALL page of the MUSIC FINDER display, press the [6▲] (SEARCH 1) button to call up the Search 1 display. (The [6▼] button corresponds to SEARCH 2.)

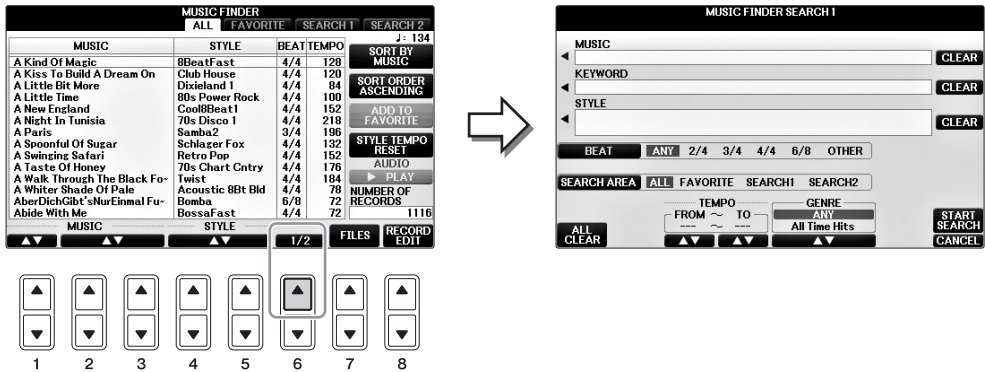

- Enter the search criteria.

[A]	MUSIC	Searches by song name. Pressing the [A] button calls up the pop-up window to enter the song name. To clear the entered Music, press the [F] (CLEAR) button.
[B]	KEYWORD	Searches by keyword. Pressing the [B] button calls up the pop-up window to enter the keyword. To clear the entered Keyword, press the [G] (CLEAR) button. <b>NOTE</b> You can search several different Keywords simultaneously by inserting a separator (comma) between each.
[C]	STYLE	Searches by Style. Pressing the [C] button calls up the Style Selection display. After selecting the desired Style, press the [EXIT] button to return back to the Search display. To clear the entered Style, press the [H] (CLEAR) button.
[D]	BEAT	Specifies the time signature for the search. All beat settings are included in the search if you select ANY. <b>NOTE</b> If you select a beat of 2/4 or 6/8, a Style suitable for performing a song in 2/4 and 6/8 beat can be searched, but the actual Style is created by using a 4/4 beat.
[E]	SEARCH AREA	Selects a specific location (the tab of the upper part of the MUSIC FINDER display) for searching. <b>NOTE</b> If you registered a Song or Audio file (page 96), you can search for them. When searching Song/Audio files, it is necessary to set the search criteria as follows. <b>STYLE:</b> Blank <b>BEAT:</b> ANY <b>TEMPO:</b> "----" – "----"
[1▲▼]	ALL CLEAR	Clears all entered search criteria.

[3▲▼]	TEMPO FROM	Sets a tempo range to which the search will be limited.
[4▲▼]	TEMPO TO	
[5▲▼]/ [6▲▼]	GENRE	Selects the desired music genre.

To cancel searching, press the [8▼] (CANCEL) button.

### 3 Press the [8▲] (START SEARCH) button to start the search.

The Search 1 display appears, showing the results of the search.

**NOTE**

If you wish to search with other criteria, press the [6▼] (SEARCH 2) button in the Music Finder display. The search result is displayed in the SEARCH 2 display.

### 4 Use the [2▲▼]/[3▲▼] buttons to select the desired Record.

### 5 Play the Style by playing chords with your left hand and the melody with your right.

## Advanced Features

Refer to the Reference Manual on the website, *Chapter 8*.



### Registering a Song, Audio or Style File (SONG/AUDIO/STYLE):

File Selection display → [A] – [J] → [8▼] MENU1 → [5▼] (ADD TO MF) → [8▲] (OK)

[USB] → [A]SONG/[B]AUDIO/[C]STYLE → [A] – [J] → [8▼] MENU1 → [5▼] (ADD TO MF) → [8▲] (OK)

### Recalling the registered data from Music Finder:

[MUSIC FINDER] → [2▲▼]/[3▲▼]

- To play back the recalled Song data

[MUSIC FINDER] → [2▲▼]/[3▲▼] → SONG CONTROL [START/PAUSE]

- To play back the recalled audio data

[MUSIC FINDER] → [2▲▼]/[3▲▼] → [AUDIO] → [3▲▼] (PLAY/PAUSE)

[MUSIC FINDER] → [2▲▼]/[3▲▼] → [J](AUDIO)

### Creating a set of favorite Records:

[MUSIC FINDER] → TAB [◀][▶] ALL → [H] (ADD TO FAVORITE)

### Editing Records:

[MUSIC FINDER] → [8▲▼] (RECORD EDIT)

### Saving the Record as a single file:

[MUSIC FINDER] → [7▲▼] (FILES)



# Registration Memory

– Saving and Recalling Custom Panel Setups –

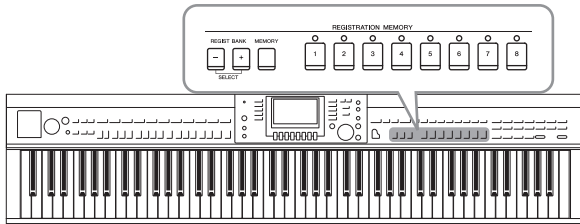

The Registration Memory function allows you to save (or “register”) virtually all panel settings to a Registration Memory button, and then instantly recall your custom panel settings by simply pressing a single button. The registered settings for eight Registration Memory buttons should be saved as a single Bank (file).

## Registering Your Panel Setups

### 1 Set up the panel controls (such as Voice, Style, effects, and so on) as desired.

Refer to the separate Data List for a list of parameters that can be registered with the Registration Memory function.

### 2 Press the [MEMORY] button in the REGISTRATION MEMORY section.

The display for selecting the items to be registered appears.

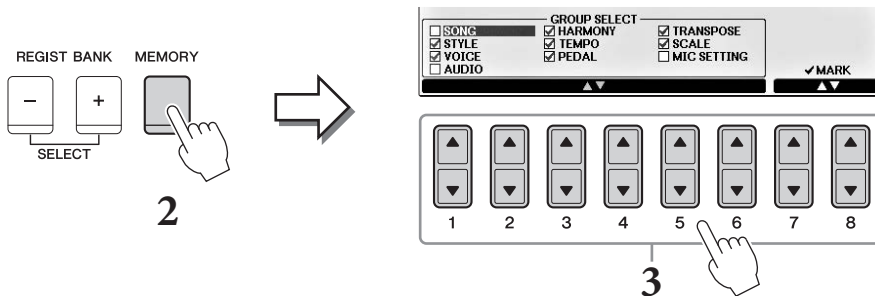

### 3 Select the items you want to register.

Select the desired item by using the [1▲▼] – [6▲▼] buttons, then enter or remove the checkmark by using the [7▲]/[8▲] (MARK ON) / [7▼]/[8▼] (MARK OFF) buttons. To cancel the operation, press the [I] (CANCEL) button.

### 4 Press one of the REGISTRATION MEMORY [1] – [8] buttons to which you wish to memorize the panel setup.

The memorized button becomes red, which indicates the number button contains data and its number is selected.

#### NOTICE

If you select the button whose lamp is lit in red or green here, the panel setup previously memorized to the button will be erased and replaced by the new settings.

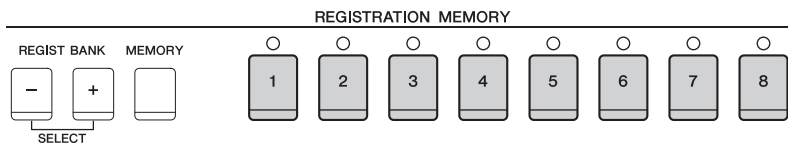

### About the lamp status

- **Red:** Data registered and currently selected
- **Green:** Data registered but not currently selected
- **Off:** No data registered

## 5 Register various panel setups to other buttons by repeating steps 1 – 4.

The registered panel setups can be recalled by simply pressing the desired number button.

### NOTE

The panel setups registered in the numbered buttons are preserved even when you turn off the power. If you want to delete all the eight current panel setups, turn the power on while holding the B6 key (right-most B key on the keyboard).

## Saving the Registration Memory as a Bank File

You can save all eight registered panel setups as a single Registration Memory Bank file.

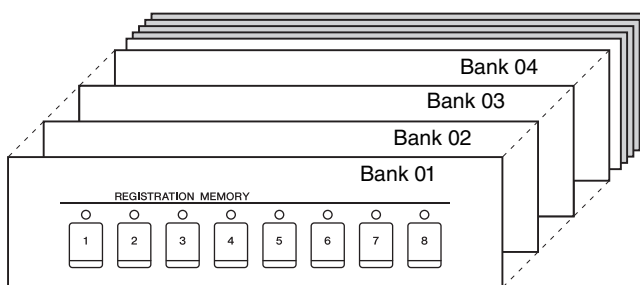

## 1 Press the REGIST BANK [+] and [-] buttons simultaneously to call up the Registration Bank Selection Display.

### NOTE

In general, Registration Memory data (Bank files) is compatible among the models CVP-709/705/701. However, the data may not be perfectly compatible, depending on the specifications of each model.

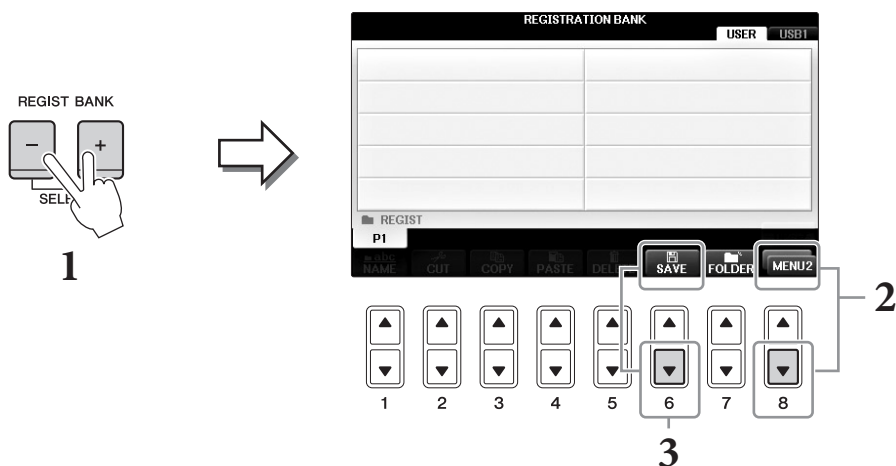

## 2 Call up MENU2 at the right bottom of the display by pressing the [8▼] button as necessary.

### 3 Press the [6▼] (SAVE) button to save the Bank file.

For instructions on saving, refer to the operation steps (starting from Step 4) on page 81.

## Recalling a Registered Panel Setup

The saved Registration Memory Bank files can be recalled by using the REGIST BANK [-]/[+] buttons or the following procedure.

#### NOTE

You can instantly call up the information display of the currently selected Registration Memory Bank by pressing the [DIRECT ACCESS] button and one of the REGISTRATION MEMORY [1] – [8] buttons in sequence.

#### NOTE

When recalling the setups including Song/Style/Audio file selection from a USB flash drive, make sure that the appropriate USB flash drive including the registered Song/Style is connected to the [USB TO DEVICE] terminal.

### 1 Press the REGIST BANK [+] and [-] buttons simultaneously to call up the REGISTRATION BANK Selection Display.

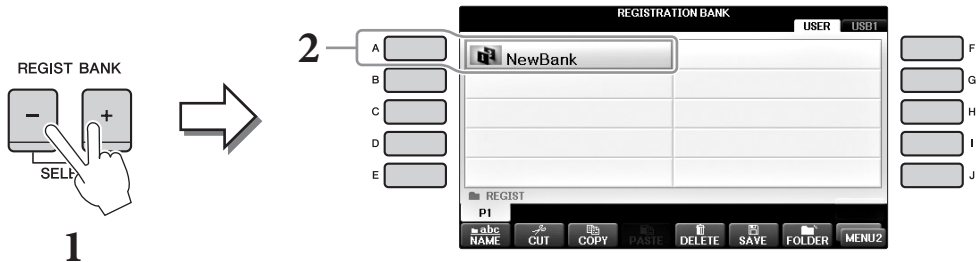

### 2 Press one of the [A] – [J] buttons to select a Bank.

You can also use the [DATA ENTRY] dial and the [ENTER] button to select a Bank.

### 3 Press one of the green-lit numbered buttons ([1] – [8]) in the Registration Memory section.

## Advanced Features

Refer to the Reference Manual on the website, *Chapter 9*.



**Deleting or renaming the Registration:** Bank Selection display → [A] – [J] → [8▼] MENU1 → [7▼] (EDIT)

**Confirming the Registration Memory information:** Bank Selection display → [A] – [J] → [8▼] MENU1 → [6▼] (INFO)

**Disabling recall of specific items:** [FUNCTION] → TAB [◀][▶] MENU1 → [C] REGIST SEQUENCE/FREEZE → TAB [◀][▶] FREEZE

**Calling up Registration Memory numbers in order:** [FUNCTION] → TAB [◀][▶] MENU1 → [C] REGIST SEQUENCE/FREEZE → TAB [◀][▶] REGISTRATION SEQUENCE

# Mixing Console

– Editing the Volume and Tonal Balance –

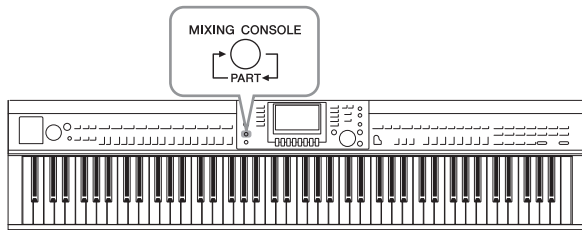

The Mixing Console gives you intuitive control over various sonic aspects of the keyboard parts and Song/Style channels, including volume balance and the timbre of the sounds. It lets you adjust the levels and stereo position (pan) of each Voice to set the optimum balance and stereo image, and lets you set how the effects are applied.

## Basic Procedure

- 1 Press the [MIXING CONSOLE] button to call up the MIXING CONSOLE display.

The volume and other settings for each Part are shown via the slider or knob icons.

### NOTE

Although the Mixing Console function provides several displays (see next page), the VOL/VOICE display is called up when you first press the [MIXING CONSOLE] button after turning on the power.

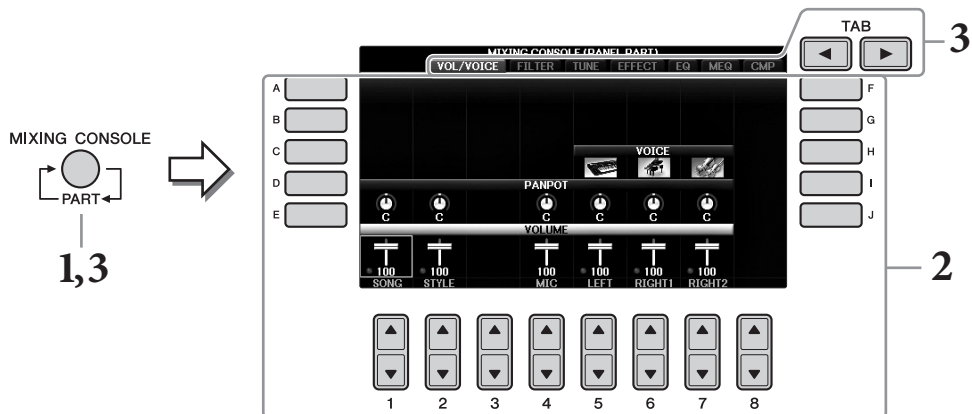

- 2 Use the [A] – [J] buttons to select a parameter, then use the [1▲▼] – [8▲▼] buttons to set the value for each part.

The slider or knob shaped parameters can be edited via the [1▲▼] – [8▲▼] buttons. For instructions on editing the other parameters, refer to the Reference Manual on the website.

To reset the value, press the same number [▲]/[▼] buttons simultaneously.

### NOTE

When editing one part, you can instantly set the same value for all other parts, by simultaneously holding down one of the [A] – [J] buttons and using the [1▲▼] – [8▲▼] buttons (or the DATA ENTRY dial).

- 3 Use the [MIXING CONSOLE] button to select the target parts, and use the TAB [◀][▶] buttons to call up the desired display, then set the values on each part/display to create the desired sound.

The operation to set the value is the same as in step 2.

■ **To select the target parts:**

Press the [MIXING CONSOLE] button repeatedly to call up the display for the following parts in sequence.

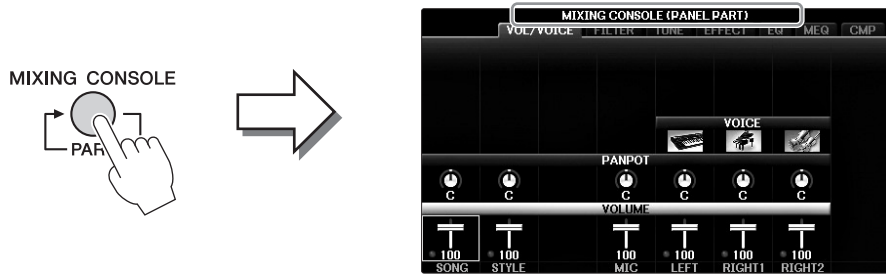

• **PANEL PART**

Use this display when you want to adjust the balance between the entire Song part, entire Style part, Mic part, Right 1 part, Right 2 part and Left part.

• **STYLE PART**

Use this display when you want to adjust the balance between all parts of the Style.

• **SONG CH 1 – 8 or SONG CH 9 – 16**

Use this display when you want to adjust the balance between all parts of the Song. Pressing the [A] (PART) button will alternate the display between SONG CH 1 – 8 and SONG CH 9 – 16.

**NOTE**

The Style/Song part components are the same as those that appear in the display when you press the panel [CHANNEL ON/OFF] button once or twice.

■ **To call up the desired display**

Press the TAB [◀][▶] buttons to select the desired display from the following items. For details about each display Page, refer to the Reference Manual on the website.



• **VOL/VOICE**

Changes the Voice for each part and adjusts panning and volume for each part.

• **FILTER**

Adjusts the Harmonic Content (resonance) and sound brightness.

• **TUNE**

Pitch-related settings (tuning, transpose, etc.).

• **EFFECT**

Selects the effect type and adjusts the effect depth for each part (page 102).

- **EQ**  
Boosts or attenuates the high and low frequencies bands for each part to correct the tone or timbre of the sound.
- **MEQ**  
Selects the Master EQ type that is applied to the overall sound, and lets you edit the parameters for tone control.
- **CMP**  
This is the Master Compressor setting which determines the dynamics of the overall sound.

## 4 Save your MIXING CONSOLE settings.

### ■ To save the PANEL PART display settings:

Register them to Registration Memory (page 97).

### ■ To save the STYLE PART display settings:

Save them as Style data.

- 1 Call up the operation display.  
[FUNCTION] → TAB [◀][▶] MENU2 → [A] STYLE CREATOR
- 2 Press the [EXIT] button to close the RECORD display.
- 3 Press the [I] (SAVE) button to call up the Style Selection display for saving your data, then save it (page 81).

### ■ To save the SONG CH 1 – 8 / 9 – 16 display settings:

First register the edited settings as part of the Song data (SETUP), then save the Song.

- 1 Call up the operation display.  
[FUNCTION] → TAB [◀][▶] MENU2 → [B] SONG CREATOR
- 2 Use the TAB [◀][▶] buttons to select the SETUP Page.
- 3 Press the [7▼▲]/[8▼▲] buttons.
- 4 Press the [I] (SAVE) button to call up the Song Selection display for saving your data, then save it (page 81).

## Advanced Features

Refer to the Reference Manual on the website, *Chapter 10*.



<b>Adjusting Panning/Volume:</b>	[MIXING CONSOLE] → TAB [◀][▶] VOL/VOICE
<b>Changing the Voice:</b>	[MIXING CONSOLE] → TAB [◀][▶] VOL/ VOICE → [C]/[H] → [1▲▼] – [8▲▼] → VOICE buttons → [A] – [J]
<b>Editing FILTER parameters:</b>	[MIXING CONSOLE] → TAB [◀][▶] FILTER
<b>Editing TUNE parameters:</b>	[MIXING CONSOLE] → TAB [◀][▶] TUNE
<b>Changing an Effect type:</b>	[MIXING CONSOLE] → TAB [◀][▶] EFFECT
<b>Editing EQ parameters:</b>	[MIXING CONSOLE] → TAB [◀][▶] EQ
<b>Selecting the Master EQ type:</b>	[MIXING CONSOLE] → TAB [◀][▶] MEQ
<b>Editing Master Compressor settings:</b>	[MIXING CONSOLE] → TAB [◀][▶] CMP

# Connections

– Using Your Instrument with Other Devices –

## ⚠ CAUTION

Before connecting the instrument to other electronic components, turn off the power of all the components. Also, before turning any components on or off, make sure to set all volume levels to minimum (0). Otherwise, electrical shock or damage to the components may occur.

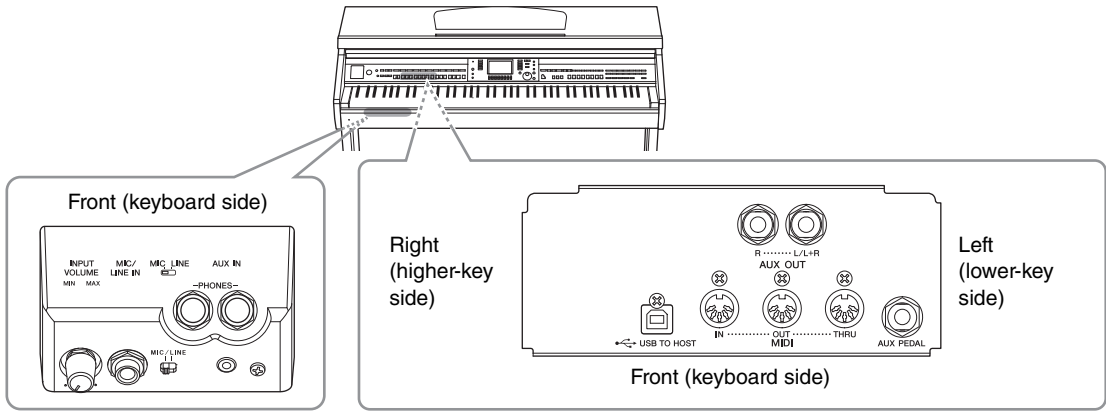

## Connecting Audio Devices

### Using External Audio Devices for Playback

You can connect a stereo system to amplify the instrument's sound by using the AUX OUT [R]/[L/L+R] jacks.

#### NOTICE

To avoid possible damage to the devices, first turn on the power to the instrument, then to the external device. When turning off the power, first turn off the power to the external device, then to the instrument. Since this instrument's power may automatically be turned off due to the Auto Power Off function (page 18), turn off the power to the external device, or disable Auto Power Off when you do not intend to operate the instrument. If the instrument's power is automatically turned off via the Auto Power Off function, first turn off the external device, then turn on the power to the instrument then the external device again.

#### NOTICE

Do not route the output from the AUX OUT [R]/[L/L+R] jacks to the [AUX IN] jack. If you make this connection, the signal input at the [AUX IN] jack is output from the AUX OUT [R]/[L/L+R] jacks. These connections could result in a feedback loop that will make normal performance impossible, and may even damage both pieces of equipment.

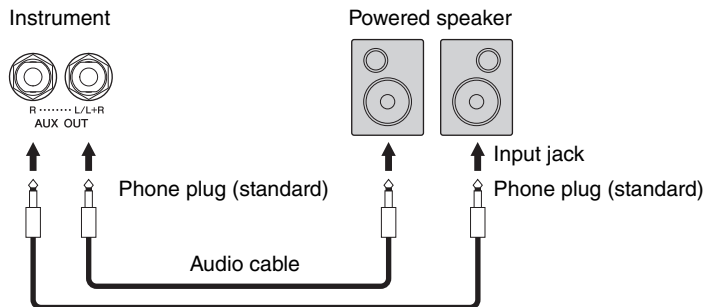

#### NOTE

Use adaptor plugs when connecting to input jacks on devices having a different shape from the plug on the cable, such as when connecting a pin plug to a phone jack.

#### NOTE

Use audio cables and adaptor plugs having no (zero) resistance.

#### NOTE

Use only the [L/L+R] jack for connection with a monaural device.

## Playing External Audio Devices with the Built-in Speakers

You can connect the output jacks of an external device such as portable audio player to the instrument's AUX IN jack, letting you hear the sound of that device through the built-in speakers of the instrument.

### NOTICE

To avoid damaging the device, first turn on the power to the external device, then to the instrument. When turning off the power, first turn off the power to the instrument, then to the external device.

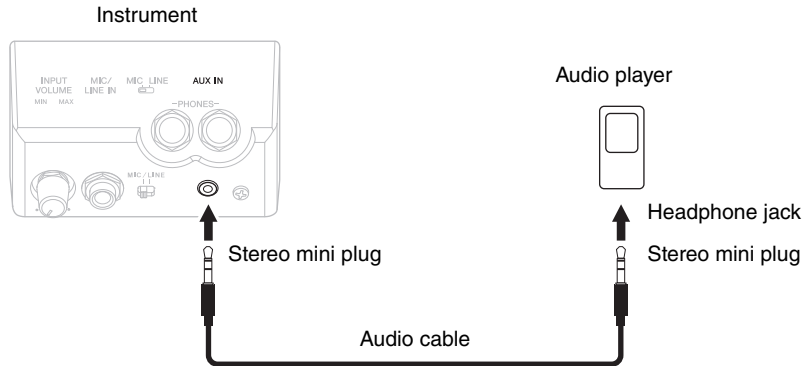

### NOTE

Use audio cables and adaptor plugs having no (zero) resistance.

### NOTE

The instrument's [MASTER VOLUME] setting affects the input signal from the [AUX IN] jack.

## Connecting a Microphone or Guitar

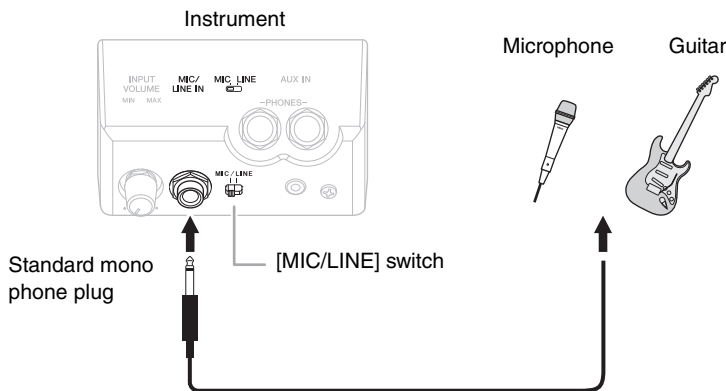

The [MIC/LINE IN] jack (standard mono phone plug) lets you connect a microphone, guitar, or other various equipment to the instrument. For instructions on connecting a microphone, refer to page 90. Note that you need to select "MIC" or "LINE IN" depending on the connected equipment. When the output level of the connected equipment (such as a microphone, guitar, bass) is low, set the [MIC/LINE] switch to "MIC." When the output level of the connected equipment (such as a synthesizer, keyboard, CD player) is high, set the [MIC/LINE] switch to "LINE."



## Connecting a Footswitch/Foot Controller

The FC4A, FC4 or FC5 footswitches and the FC7 foot controller (sold separately) can be connected to the [AUX PEDAL] jack. A footswitch can be used for switching functions on and off, while a foot controller controls continuous parameters such as volume.

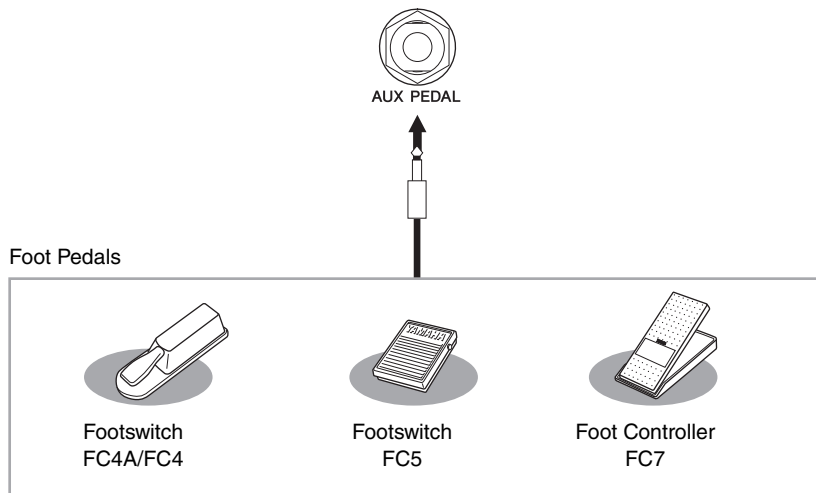

### ■ Example 1: Controlling the volume of the performance data played on the keyboard by a foot controller.

Connect an FC7 foot controller to the [AUX PEDAL] jack. With the initial factory settings, no special setup is necessary.

### ■ Example 2: Controlling Song Start/Stop by a footswitch

Connect a footswitch (FC4A/FC4 or FC5) to the [AUX PEDAL] jack.

To assign the function to the connected pedal, select "SONG PLAY/PAUSE" by using the [1▲▼] buttons in the operation display:

[FUNCTION] → TAB [◀][▶] MENU1 → [D] CONTROLLER → TAB [◀][▶] PEDAL → [A]/[B] AUX

#### NOTE

Make sure to connect or disconnect the pedal only when the power is off.

#### NOTE

Do not turn on the power to the unit while pressing the footswitch or foot controller. Otherwise, the switch or pedal type (on/off) will be reversed.

## Advanced Features

Refer to the Reference Manual on the website, *Chapter 11*.



**Assigning specific functions to each foot pedal:**

[FUNCTION] → TAB [◀][▶] MENU1 → [D] CONTROLLER →  
TAB [◀][▶] PEDAL

## Connecting a USB Device

You can connect a USB flash drive or a USB wireless LAN adaptor to the [USB TO DEVICE] terminal. You can save data you've created on the instrument to the USB flash drive (pages 38, 81), or you can connect the instrument to a smart device such as iPad via wireless LAN (page 108).

### Precautions when using the [USB TO DEVICE] terminal

This instrument features a built-in [USB TO DEVICE] terminal. When connecting a USB device to the terminal, be sure to handle the USB device with care. Follow the important precautions below.

#### NOTE

For more information about the handling of USB devices, refer to the owner's manual of the USB device.

#### ■ Compatible USB devices

- USB flash drive (sold separately)
- USB hub (sold separately)
- USB wireless LAN adaptor UD-WL01 (sold separately)

Other USB devices such as a computer keyboard or mouse cannot be used.

Although USB devices 1.1 to 3.0 can be used on this instrument, the amount of time for saving to or loading from the USB device may differ depending on the type of data or the status of the instrument.

The instrument does not necessarily support all commercially available USB devices. Yamaha cannot guarantee operation of USB devices that you purchase. Before purchasing a USB device for use with this instrument, please visit the following web page:  
<http://download.yamaha.com/>

#### NOTE

The rating of the [USB TO DEVICE] terminal is a maximum of 5V/500mA. Do not connect USB devices having a rating above this, since this can cause damage to the instrument itself.

#### ■ Connecting a USB device

- When connecting a USB device to the [USB TO DEVICE] terminal, make sure that the connector on the device is appropriate and that it is connected in the proper direction.

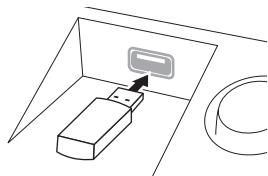

#### NOTICE

- When connecting a USB device to the [USB TO DEVICE] terminal on the top panel, remove it before closing the key cover. If the key cover is closed with the USB device connected, the USB device may be damaged.
- Avoid connecting or disconnecting the USB device while executing playback/recording and file management operations (such as Save, Copy and Delete), or when accessing the USB device. Failure to observe this may result in "freezing" of the operation of the instrument or corruption of the USB device and the data.

- When connecting then disconnecting the USB device (and vice versa), make sure to wait a few seconds between the two operations.

#### NOTE

- If you intend to connect two devices at the same time to a terminal, you should use a bus-powered USB hub. Only one USB hub can be used. If an error message appears while using the USB hub, disconnect the hub from the instrument, then turn on the power of the instrument and re-connect the USB hub.
- When connecting a USB cable, make sure that the length is less than 3 meters.

### Using USB flash drive

By connecting the instrument to a USB flash drive, you can save data you've created to the connected device, as well as read data from the connected device.

#### ■ Maximum number of USB flash drives allowed

Up to two USB flash drives can be connected to the [USB TO DEVICE] terminal. (If necessary, use a USB hub. The number of USB flash drives that can be used simultaneously with musical instruments even when a USB hub is used is a maximum of two.) This instrument can recognize up to four partitioned drives in one USB flash drive.

#### ■ Formatting USB flash drive

You should format the USB flash drive only with this instrument (page 107). A USB flash drive formatted on another device may not operate properly.

#### NOTICE

The format operation overwrites any previously existing data. Make sure that the media you are formatting does not contain important data. Proceed with caution, especially when connecting multiple USB flash drives.

#### ■ To protect your data (write-protect)

To prevent important data from being inadvertently erased, apply the write-protect provided with each storage device or media. If you are saving data to the USB flash drive, make sure to disable write-protect.

#### ■ Turning off the instrument

When turning off the instrument, make sure that the instrument is NOT accessing the USB flash drive by playback/recording or file management (such as during Save, Copy and Delete operations). Failure to do so may corrupt the device and the data.

# Formatting a USB flash drive

When a USB flash drive is connected, a message may appear prompting you to format. If so, execute the format operation.

## NOTICE

The format operation deletes any previously existing data. Make sure that the USB flash drive you are formatting does not contain important data. Proceed with caution, especially when connecting multiple USB flash drives.

- 1 Insert a USB flash drive for formatting into the [USB TO DEVICE].
- 2 Call up the operation display.  
① [FUNCTION] → ② TAB [◀][▶] MENU1 → ③ [J] UTILITY → ④ TAB [◀][▶] USB

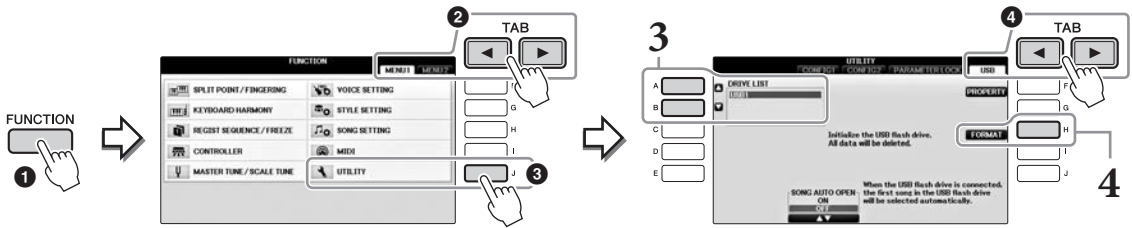

- 3 Press the [A]/[B] buttons to select the USB flash drive to be formatted from the device list.  
The indications USB 1 and USB 2 will be displayed depending on the number of the connected devices.
- 4 Press the [H] (FORMAT) button to execute the Format operation.

## Confirming the remaining memory

You can check the remaining memory of the connected USB flash drive by pressing the [F] (PROPERTY) button in step 4 above.

## Connecting to a Computer

By connecting a computer to the [USB TO HOST] terminal, you can transfer data between the instrument and the computer via MIDI.

For details on using a computer with this instrument, refer to “Computer-related Operations” on the website.

### NOTICE

Use an AB type USB cable of less than 3 meters. USB 3.0 cables cannot be used.

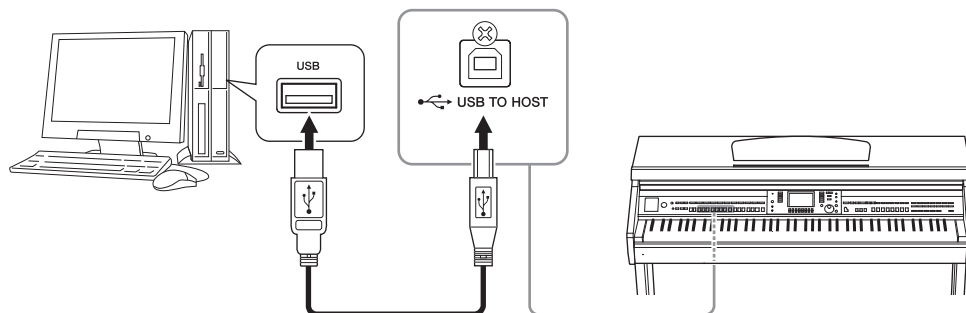

### NOTE

- The instrument will begin transmission a short time after the USB connection is made.
- When using a USB cable to connect the instrument to your computer, make the connection directly without passing through a USB hub.
- For information on setting up your sequence software, refer to the owner's manual of the relevant software.
- You cannot connect a computer to this instrument with a USB wireless LAN adaptor.

## Connecting to an iPhone/iPad

You can connect a smart device such as an iPhone or iPad to the [USB TO DEVICE] terminal of the instrument via the USB wireless LAN adaptor UD-WL01 (sold separately). The USB wireless LAN adaptor may not be available depending on your locale. In this case, connect the smart device to the [USB TO HOST] terminal via the Yamaha i-UX1 (sold separately) or to the MIDI terminals via the Yamaha i-MX1 (sold separately). By using an application tool on your smart device, you can take advantage of convenient functions and get more enjoyment out of this instrument.

- For details on connections, refer to the “iPhone/iPad Connection Manual” on the website (page 9). For information about the compatible smart devices and application tools, access the following page:  
<http://www.yamaha.com/kbdapps/>
- For inquiries about the USB wireless LAN adaptor (sold separately), contact your nearest Yamaha representative or the distributor listed at the end of this manual.  
Or you can access the following website and contact Yamaha support at your location.  
<http://www.yamaha.com/contact/>

### NOTE

- When you use the instrument along with an application on your iPhone/iPad, we recommend that you first set “Airplane Mode” to “ON” then set “Wi-Fi” to “ON” on your iPhone/iPad in order to avoid noise caused by communication.
- Certain applications may not be supported in your area. Please check with your Yamaha dealer.

## Advanced Features

Refer to the Reference Manual on the website, *Chapter 11*.



### Wireless LAN settings:

[FUNCTION] → TAB [◀][▶] MENU2 → [H] WIRELESS LAN

### NOTE

A “WIRELESS LAN” menu item will be shown only if a USB wireless LAN adaptor (sold separately) is connected to the instrument.

## Attaching an iPad to the Music Rest

Set the holder set (included accessories) on the bottom of the music rest, then set your iPad on the holders.

### NOTICE

To prevent the iPad from falling, note the following points:

- Never submit the instrument or iPad to strong shocks. Doing so may cause the iPad to fall from the music rest even though the iPad is set firmly.
- Make sure that the music rest is set firmly.
- Before moving the instrument, make sure to remove the iPad from the music rest.
- Never slide the iPad along the music rest or submit it to strong shock, such as pushing or hitting it when on the music rest.
- Never put anything else on the music rest together with the iPad, such as a Song booklet or another iPad. Doing so may make the music rest unstable.
- Never place the iPad in an unstable position.

- 1** First, pull the music rest up from the lowest position and toward you, so that there is a gap at the bottom of the music rest, then fit the holders in as shown.

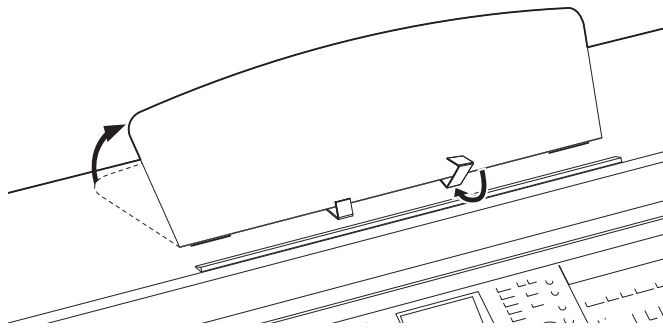

- 2** Flip down the two metal supports at the left and right on the rear of the music rest, then lower the music rest so that it rests on the metal supports (page 16).
- 3** Adjust the position of the holders to the width of the iPad, and set the iPad on the holders.

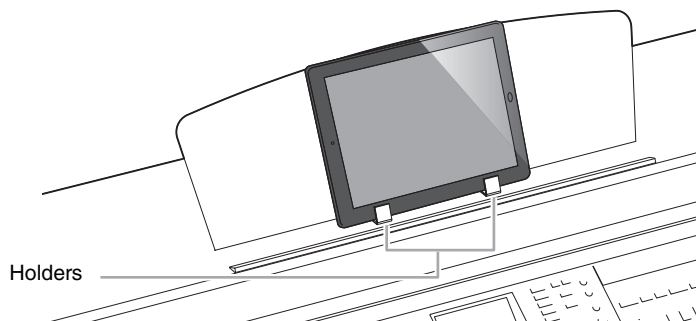

## Connecting External MIDI Devices

For details about MIDI, refer to “MIDI Basics” downloadable from the Yamaha website (page 9).

Use the [MIDI] terminals and standard MIDI cables to connect external MIDI devices (keyboard, sequencer, etc.).

- **MIDI IN**..... Receives MIDI messages from another MIDI device.
- **MIDI OUT** ..... Transmits MIDI messages generated by the instrument to another MIDI device.
- **MIDI THRU** ..... Simply relays the MIDI messages received at MIDI IN.

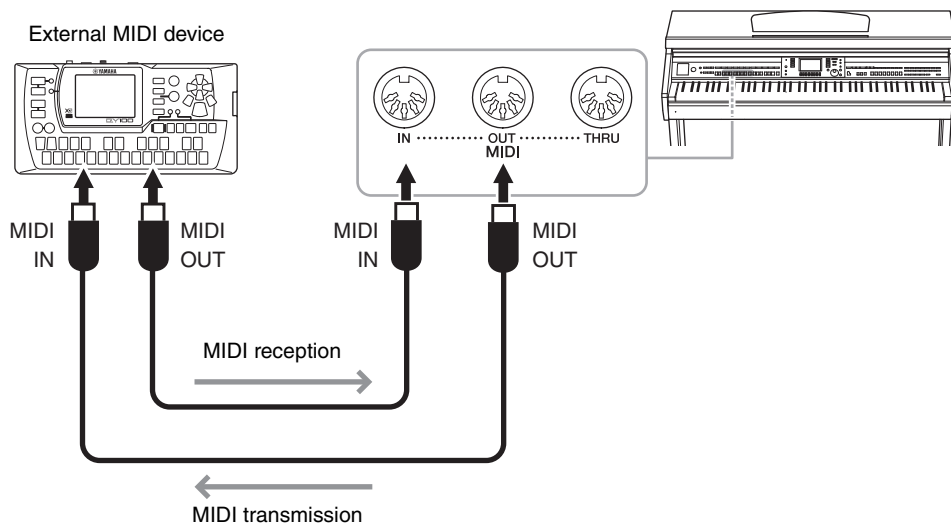

For detailed information about the instrument's MIDI settings, refer to the Reference Manual on the website.

### Advanced Features

Refer to the Reference Manual on the website, *Chapter 11*.



**MIDI settings:**

[FUNCTION] → TAB [◀][▶] MENU1 → [I] MIDI → [8▼] EDIT

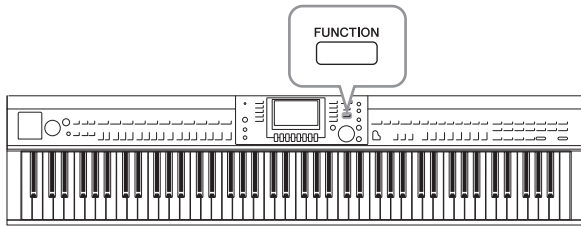

The Utility and System sections in the Function menu provide a variety of convenient tools and settings for the instrument. These include general settings that affect the entire instrument, as well as detailed settings for specific functions. Also included are data reset functions and storage media control, such as media formatting.

## UTILITY display

---

There are four pages.

### ■ CONFIG1

For general settings such as:

- Fade in/out time
- Metronome sound
- Tap Tempo sound
- Auto power off (page 18)
- LCD brightness (page 21)

### ■ CONFIG2

For general settings, such as determining:

- Whether or not the speakers will sound
- Whether the Stereophonic Optimizer (page 20) is on or off
- Whether the Noise Gate for the input signal from the [AUX IN] jack is on or off
- Whether IAC (page 19) is on or off and the depth of the effect
- Whether or not the default tempo of each Style is displayed in the Style Selection display
- Whether or not the Voice bank and number are shown in the Voice Selection display
- Whether the updated date and updated time\* are shown or hidden on the File Selection display (only in the USER/USB tabs)
- How the Voice Selection display is opened when one of the VOICE buttons is pressed
- The time which elapses before the pop-up windows close

\* Taken from a network and displayed when connecting the instrument to a network via the wireless LAN adaptor.

### ■ PARAMETER LOCK

For selecting specific parameters to be locked, so that you can maintain settings even when the panel setups are changed by Registration Memory, One Touch Setting, etc.

### ■ USB

Settings related to a connected USB flash drive, such as formatting (page 107) and confirmation of memory size.

## SYSTEM display

---

There are four pages.

### ■ OWNER

Settings of Owner name (page 22) and Message language (page 21).

## ■ BACKUP/RESTORE

For backing up or restoring the settings and data saved in the USER drive of the instrument (page 38) to or from a USB flash drive.

## ■ SETUP FILES

For saving and recalling the specified settings of the instrument.

## ■ RESET

For resetting all or specified settings of the instrument to the factory default, or deleting all the files you saved in the USER drive while leaving the settings of the instrument.

# Basic Procedure

## 1 Call up the operation display:

UTILITY display: ① [FUNCTION] → ② TAB [◀][▶] MENU1 → ③ [J] (UTILITY)

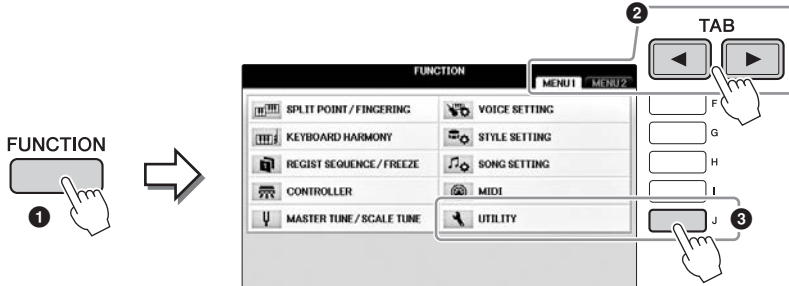

SYSTEM display: ① [FUNCTION] → ② TAB [◀][▶] MENU2 → ③ [G] (SYSTEM)

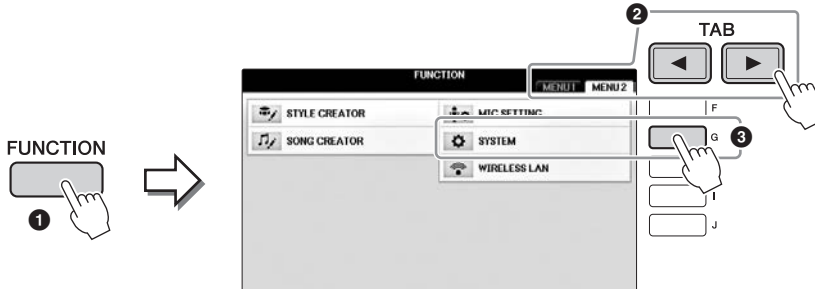

2 Use the TAB [◀][▶] buttons to call up desired page.

3 If two or more parameters are shown at the left of the display, use the [A]/[B] buttons to select the desired parameter.

4 Change the settings by using the [1▲▼] – [8▲▼] buttons or carry out the operation by using the [A] – [J] buttons.

For details of the Utility and System settings, refer to the Reference Manual on the website (page 9).



# Assembly

## Preparation Before Assembling

### ⚠ CAUTION

- Assemble the unit on a hard and flat floor with ample space.
- Be careful not to confuse or misplace the parts, and be sure to install all parts in the correct orientation. Please assemble the unit in accordance with the sequence described here.
- Assembly should be carried out by at least two persons.
- Be sure to use only the included screws of the specified sizes. Do not use any other screws. Use of incorrect screws can cause damage or malfunction of the product.
- Be sure to tighten all screws upon completing assembly of each unit.
- To disassemble the unit, reverse the assembly sequence given below.

Have a Phillips-head (+) screwdriver of the appropriate size ready.

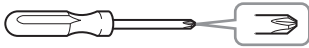

Remove foamed styrol pads from the package, position them on the floor, then place A on top of them. Position the pads so that they will not hide the connectors on the bottom of A.

Remove all parts from the package and make sure you have all of the items.

### Main Unit

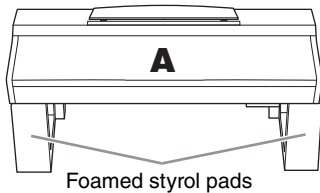

### Back panel



### Pedal Box

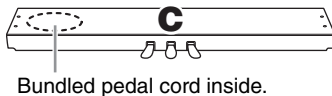

### Side panel

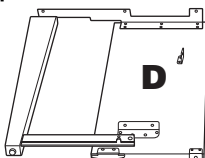

### Side panel

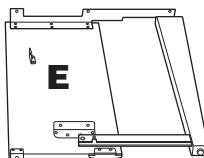

### Assembly parts

- F** 6 x 20 mm x 4
- G** 4 x 12 mm x 2
- H** 4 x 20 mm x 4
- J** 6 x 16 mm x 6

### Headphone hanger

- K** 4 x 10 mm x 2
- Headphone hanger
- Cord holders x 2
- Power cord

### Holder set

For details on how to set the holders, refer to page 109.



## Assembly

### 1 Attach C to D and E.

- 1 Untie and straighten out the bundled pedal cord. Do not discard the vinyl tie. You will need it later in step 5.
- 2 Secure D and E to C using four screws F.

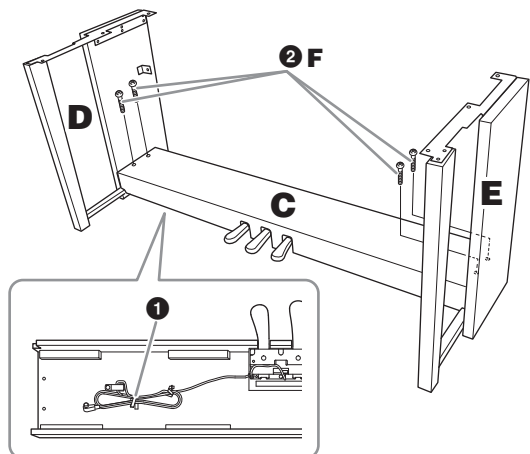

## 2 Attach B.

- 1 Align the holes on the upper side of B with the bracket holes on D and E, then attach the upper corners of B to D and E by finger-tightening two screws G.
- 2 Secure the bottom end of B using four screws H.
- 3 Securely tighten the screws G on the top of B that were attached in Step 2- 1.

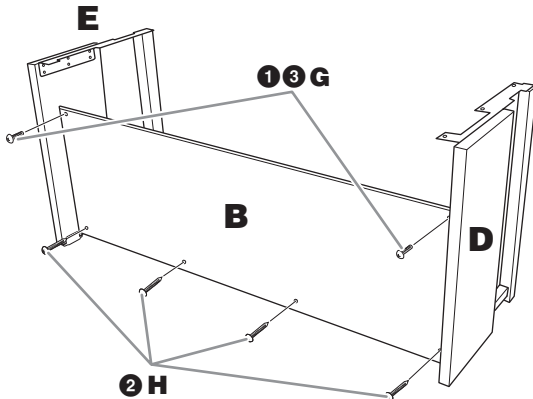

## 3 Mount A.

### ⚠ CAUTION

- Be extra careful not to drop or let your fingers be pinched by the main unit.
- Do not hold the main unit in any position other than the position specified above.

Be sure to place your hands at least 15 cm from either end of the main unit when positioning it.

Align the screw holes.

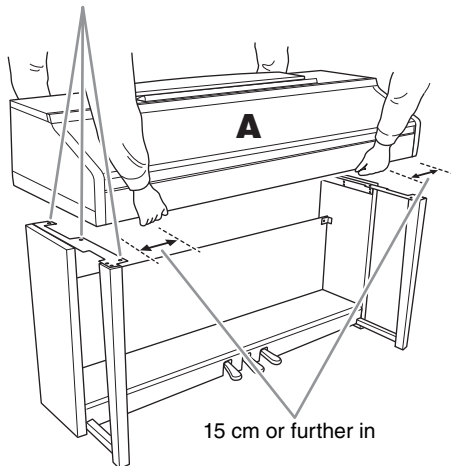

## 4 Secure A.

- 1 Adjust the position of A so that the left and right ends of A will project beyond D and E equally as shown in the illustration.
- 2 Attach A using six screws J.

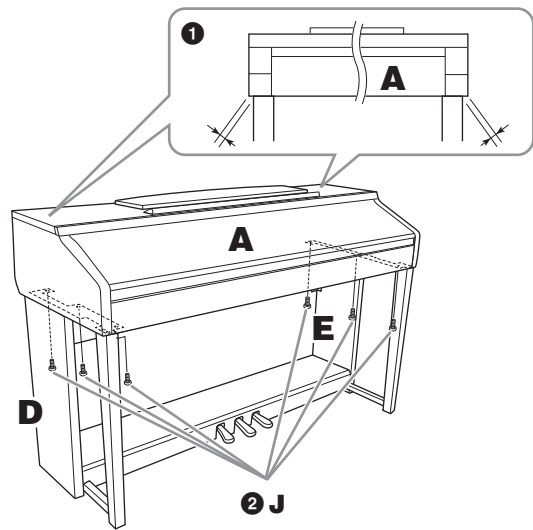

## 5 Connect the pedal cord and power cord.

- 1 Insert the pedal cord plug into the pedal connector.
- 2 Attach the cord holders to the rear panel as shown, then clip the cord into the holders.
- 3 Use a vinyl tie to take up any slack in the pedal cord.
- 4 Plug the power cord into the power connector.

Insert the pedal cord securely until the metal part of the cord plug disappears from view. Otherwise, the pedal may not function properly.

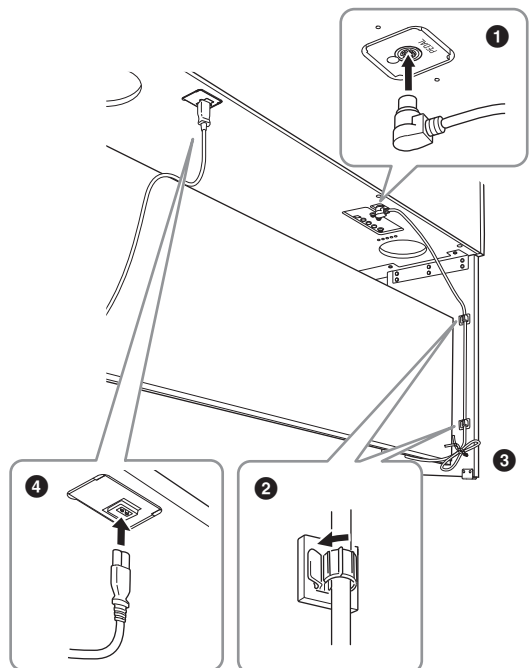
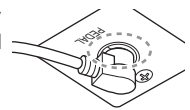

**6 Rotate the adjuster until it comes in firm contact with the floor surface.**

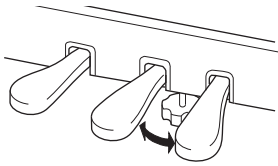

**7 Attach the headphone hanger.**

Attach the headphone hanger using two screws K as shown in the illustration.

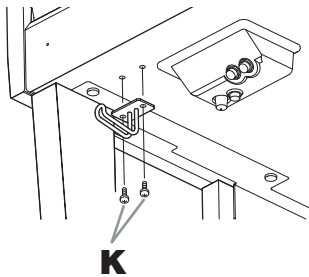

**After completing the assembly, please check the following.**

- **Are there any parts left over?**  
→ Review the assembly procedure and correct any errors.
- **Is the instrument clear of doors and other movable fixtures?**  
→ Move the instrument to an appropriate location.
- **Does the instrument make a rattling noise when you shake it?**  
→ Tighten all screws.
- **Does the pedal box rattle or give way when you step on the pedals?**  
→ Turn the adjuster so that it is set firmly against the floor.
- **Are the pedal and power cords inserted securely into the sockets?**  
→ Check the connection.

**CAUTION**

If the unit creaks or is otherwise unsteady when you play on the keyboard, refer to the assembly diagrams and retighten all screws.

When moving the instrument after assembly, always hold the bottom of the main unit.

**CAUTION**

When moving the instrument, always hold the bottom of the main unit. Do not hold the key cover or top portion. Improper handling can result in damage to the instrument or personal injury.

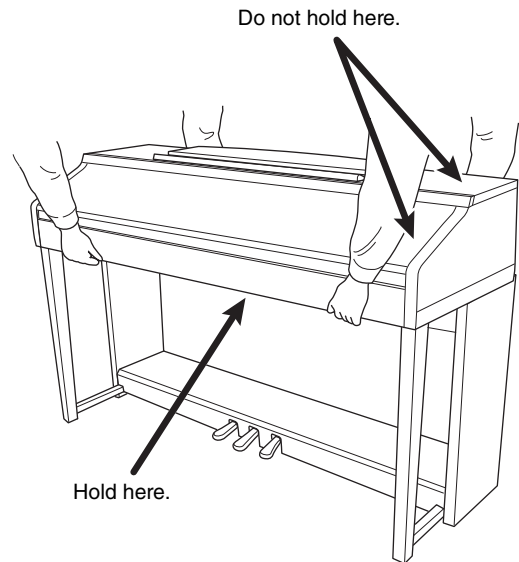

# Troubleshooting

Overall	
<b>A click or pop is heard when the power is turned on or off.</b>	Electrical current is being applied to the instrument. This is normal.
<b>The power is automatically turned off.</b>	This is normal and due to the Auto Power Off function. If necessary, turn the function off (page 18).
<b>Noise is heard from the instrument's speakers.</b>	Noise may be heard if a mobile phone is used near the instrument or if the phone is ringing. Turn off the mobile phone, or use it further away from the instrument.
<b>Noise is heard from the instrument's speakers or headphones when using the instrument with an application on an iPhone/iPad.</b>	When you use the instrument along with the application on your iPhone/iPad, we recommend that you set "Airplane Mode" to "ON" on your iPhone/iPad in order to avoid noise caused by communication.
<b>In the LCD, there are some specific points that are always lit or unlit.</b>	These are the result of defective pixels and occasionally occur in TFT-LCDs; they do not indicate a problem in operation.
<b>Mechanical noise is heard during performance.</b>	The keyboard mechanism of this instrument simulates the keyboard mechanism of an actual piano. Mechanical noise is also heard on a piano.
<b>There is a slight difference in sound quality among different notes played on the keyboard.</b>	This is normal and is a result of the instrument's sampling system.
<b>Some Voices have a looping sound.</b>	
<b>Some noise or vibrato is noticeable at higher pitches, depending upon the Voice.</b>	
<b>The overall volume is too low or no sound is heard.</b>	The master volume may be set too low. Set it to an appropriate level with the [MASTER VOLUME] dial.
	All keyboard parts are set to off. Use the PART ON/OFF [RIGHT 1]/[RIGHT 2]/[LEFT] button to turn it on.
	The volume of the individual parts may be set too low. Raise the volume in the BALANCE display (page 68).
	Make sure the desired channel is set to ON (pages 67, 75).
	Headphones are connected, disabling the speaker output. Unplug the headphones.
	Make sure that the Speaker parameter is set to ON in the Utility display (page 100). For details, refer to the Reference Manual on the website (page 9), chapter 12.
<b>The sound is distorted or noisy.</b>	The volume may be turned up too high. Make sure all relevant volume settings are appropriate.
	This may be caused by certain effects or filter resonance settings. Check the effect or filter settings and change them accordingly, referring to the Reference Manual on the website (page 9), chapters 2 and 9.
<b>Not all simultaneously played notes sound.</b>	You are probably exceeding the maximum polyphony (page 122) of the instrument. When the maximum polyphony is exceeded, the earliest played notes will stop sounding, letting the latest played notes sound.
<b>The keyboard volume is lower than the Song/Style playback volume.</b>	The volume of the keyboard parts may be set too low. Raise the volume in the BALANCE display (page 68).
<b>The Main display does not appear even when turning the power on.</b>	This may occur if a USB flash drive has been connected to the instrument. Connecting a USB flash drive may result a long interval between turning the power on and appearance of the Main display. To avoid this, turn the power on after disconnecting the USB flash drive.
<b>Some characters of the file/folder name are garbled.</b>	The language settings have been changed. Set the appropriate language for the file/folder name (page 21).

Overall	
<b>An existing file is not shown on the display.</b>	The file extension (.MID, etc.) may have been changed or deleted. Manually rename the file, adding the appropriate extension, on a computer.
	Data files with names of more than 50 characters cannot be handled by the instrument. Rename the file, reducing the number of characters to 50 or less.

Voice	
<b>The Voice selected from the Voice Selection display does not sound.</b>	Check whether or not the selected part is turned on (page 47). If necessary, press the appropriate PART ON/OFF button to turn the part on.
<b>A strange “flanging” or “doubling” sound occurs or the sound is slightly different each time the keys are played.</b>	The RIGHT 1 and RIGHT 2 parts are set to “ON,” and both parts are set to play the same Voice. Turn off the RIGHT 2 part or change the Voice of one of the parts.
<b>Some Voices will jump an octave in pitch when played in the upper or lower registers.</b>	This is normal. Some voices have a pitch limit which, when reached, causes this type of pitch shift.

Style	
<b>The Style does not start even when the [START/STOP] button is pressed.</b>	The Rhythm channel of the selected Style may not contain any data. Turn the [ACMP ON/OFF] button on and play within the left-hand section on the keyboard to sound the accompaniment part of the Style.
<b>Only the rhythm channel plays.</b>	Make sure the Auto Accompaniment function is turned on; press the [ACMP ON/OFF] button.
	You may be playing keys in the right hand range of the keyboard. Make sure to play keys in the chord range of the keyboard (pages 59, 69).
<b>Styles in a USB storage device cannot be selected.</b>	If the size of the Style data is large (about 120 KB or greater), the Style cannot be selected because the data is too large to be handled by the instrument.

Song	
<b>Songs cannot be selected.</b>	This may be because the language settings have been changed. Set the appropriate language for the Song file name (page 21).
	If the size of the Song data is large (about 300 KB or greater), the Song cannot be selected because the data is too large to be handled by the instrument.
<b>Song playback does not start.</b>	The Song has been stopped at the end of the Song data. Return to the beginning of the Song by pressing the SONG CONTROL [STOP] button.
	In the case of a Song to which write-protect has been applied (“Prot. 2 Edit” is shown at the upper left of the Song name), the original file may not be in the same folder. It cannot be played back unless the original file (showing “Prot.2 Orig” at the upper left of the Song name) is in the same folder.
	In the case of a Song to which write-protect has been applied (“Prot. 2 Edit” is shown at the upper left of the Song name), the original file name may have been changed. Rename the file with the original file name (so that “Prot.2 Orig” is shown at the upper left of the Song name).
	In the case of a Song to which write-protect has been applied (“Prot. 2 Edit” is shown at the upper left of the Song name), the file icon may have been changed. Songs to which write-protect has been applied cannot be played back when the file icon of the original has been changed.
<b>Song playback stops before the Song is finished.</b>	The Guide function is turned on. (In this case, playback is “waiting” for the correct key to be played.) Press the [GUIDE] button to turn off the guide function.
<b>The measure number is different from that of the score in the Song Position display, shown by pressing the [REW]/[FF] buttons.</b>	This happens when playing back music data for which a specific, fixed tempo is set.

Song	
<b>When playing back a Song, some channels do not play.</b>	Playback of these channels may be set to "OFF." Turn playback ON for those channels that are set to "OFF" (page 75).
<b>The Guide lamps do not light during Song playback, even after pressing the [GUIDE] button.</b>	Any notes outside of the 88-key range cannot be indicated by the Guide lamps.
<b>The Guide lamps light an octave or two lower/higher than the actual pitch.</b>	The Guide lamps sometimes light an octave or two lower/higher than the actual pitch depending on the selected Voice.
<b>The tempo, beat, measure and music notation are not displayed correctly.</b>	Some Song data for the instrument has been recorded with special "free tempo" settings. For such Song data, the tempo, beat, measure and music notation will not be displayed correctly.

USB Audio Player/Recorder	
<b>When recording an audio file, an error message appears and the recording is aborted.</b>	Make sure to use a compatible USB flash drive (page 106).
	Make sure that the USB flash drive has enough memory (page 107).
	If you are using a USB flash drive to which data has already been recorded, check first that no important data remains on the device, then format it (page 107) and try recording again.
<b>Audio files cannot be selected.</b>	The file format may not be compatible with the instrument. The only compatible format is WAV. Also, DRM protected files cannot be played back.
<b>Recorded file is played back at a different volume compared to when it was recorded.</b>	The audio playback volume has been changed. Setting the volume value to 100 plays back the file at the same volume as when it was recorded (page 86).

Microphone	
<b>The microphone input signal cannot be recorded.</b>	The microphone input signal cannot be recorded by MIDI recording. Record by Audio recording (page 88).

Mixing Console	
<b>The sound seems strange or different than expected when changing a rhythm Voice (drum kit, etc.) of the Style or Song from the Mixer.</b>	When changing the rhythm/percussion Voices (drum kits, etc.) of the Style and Song from the VOICE parameter, the detailed settings related to the drum voice are reset, and in some cases you may be unable to restore the original sound. In such cases, you can restore the original sound by selecting the same Style or Song again.

Pedal/AUX Pedal	
<b>The damper, sostenuto and soft functions do not work for the relevant pedals.</b>	The pedal cord plug is not connected. Securely insert the pedal cord plug into the proper jack (page 114).
	Make sure that each pedal is properly assigned to SUSTAIN, SOSTENUTO, and SOFT (page 23).
<b>The on/off setting of the footswitch connected to the AUX PEDAL jack is reversed.</b>	Turn the instrument's power off, then turn it on again without pressing the footswitch.
<b>The damper pedal has little effect.</b>	The damper pedal was pressed when the power was turned on. This is not a malfunction; release the pedal and press it again to reset the function.

AUX IN jack	
<b>Sound input to the AUX IN jack is interrupted.</b>	The output volume of the external device connected to this instrument is too low. Increase the output volume of the external device. The volume level reproduced via this instrument's speakers can be adjusted by using the [MASTER VOLUME] control.

# Panel Button Chart

**No.**..... Corresponds to the number in the “Panel Controls” on page 14.

**Button/Control** ..... Indicates the button/controller that you should use at first for entering the corresponding function.

**Display**..... Indicates the display title (and tab title) called up by operating the button/controller.

**Reference Manual**..... “YES” indicates that the detailed information is described in the Reference Manual on the website (page 9).

No.	Button/Control	Display	Page	Reference Manual	
1	[USB TO DEVICE] terminal	NO	106	NO	
2	MASTER VOLUME control	NO	19	NO	
3	[⏻] (Standby/On) switch	Opening display	18	NO	
4	[DEMO]	DEMO display	24	NO	
5	[METRONOME ON/OFF]	NO	56	NO	
6	TRANSPOSE [-]/[+]	TRANSPOSE (pop-up)	50	NO	
7	[TAP TEMPO]	NO	64	NO	
	TEMPO [-]/[+]	TEMPO (pop-up)	64	NO	
8	STYLE	[POP & ROCK] – [PIANIST]	Style Selection display	58	NO
		[ACMP ON/OFF]	NO	58	NO
		[AUTO FILL IN]	NO	63	NO
		INTRO [I] – [III]	NO	62	NO
		MAIN VARIATION [A] – [D]	NO	63	NO
		[BREAK]	NO	63	NO
		ENDING/rit. [I] – [III]	NO	62	NO
		[SYNC STOP]	NO	62	NO
		[SYNC START]	NO	62	NO
		[START/STOP]	NO	62	NO
9	[MUSIC FINDER]	MUSIC FINDER display	ALL	92	NO
			FAVORITE	96	YES
			SEARCH 1	95	NO
			SEARCH 2	96	NO
10	[MIC] lamp	NO	90	YES	
11	[MIXING CONSOLE]	MIXING CONSOLE display	VOL/VOICE	101	YES
			FILTER	101	YES
			TUNE	101	YES
			EFFECT	101	YES
			MEQ	102	YES

No.	Button/Control	Display		Page	Reference Manual	
11	[MIXING CONSOLE]	EQ		102	YES	
		CMP		102	YES	
12	[CHANNEL ON/OFF]	CHANNEL ON/OFF (pop-up)	SONG	75	NO	
			STYLE	67	NO	
13	TAB [◀][▶]	NO		26	NO	
	[A] - [J]	NO		25	NO	
	[DIRECT ACCESS]	(message)		28	NO	
	[EXIT]	NO		27	NO	
	[1▲▼] - [8▲▼] buttons	NO		26	NO	
	[DATA ENTRY] dial	NO		27	NO	
	[ENTER]	NO		27	NO	
14	[USB]	USB display		30	NO	
15	[FUNCTION]	MENU1	SPLIT POINT/ CHORD FINGERING	SPLIT POINT	69	YES
				CHORD FINGERING	60, 70	NO
			KEYBOARD HARMONY		57	YES
			REGIST SEQUENCE/ FREEZE	REGISTRATION SEQUENCE	99	YES
				FREEZE	99	YES
			CONTROLLER	PEDAL	105	YES
				KEYBOARD/ PANEL	55, 57	YES
			MASTER TUNE/ SCALE TUNE	MASTER TUNE	57	YES
				SCALE TUNE	57	YES
			VOICE SETTING	PIANO	57	YES
				VOICE SET FILTER	57	YES
			STYLE SETTING		70	YES
			SONG SETTING	GUIDE/ CHANNEL	78	YES
				OTHERS	78	YES
			MIDI	MIDI template selection display	110	YES
			UTILITY	CONFIG 1	111	YES
				CONFIG 2	111	YES
				PARAMETER LOCK	111	YES
				USB	111	YES
	MENU2	STYLE CREATOR	70, 102	YES		
		SONG CREATOR	83, 102	YES		



No.	Button/Control	Display	Page	Reference Manual		
15	[FUNCTION]	MENU2	MIC SETTING	91	YES	
			SYSTEM	OWNER	21, 22, 111	NO
				BACKUP/RESTORE	38, 112	NO
				SETUP FILES	112	YES
				RESET	112	YES
		WIRELESS LAN	108	YES		
16	PART ON/OFF [RIGHT1]/[RIGHT2]/[LEFT]	NO	47	NO		
17	[AUDIO]	USB AUDIO PLAYER display	84	NO		
18	SONG CONTROL	[SONG SELECT]	Song Selection display	71	NO	
		[REC]	CHANNEL ON/OFF (pop-up)	79	NO	
		[STOP]	NO	72	NO	
		[PLAY/PAUSE]	NO	72	NO	
		[REW]/[FF]	SONG POSITION (pop-up)	73	NO	
		[EXTRA TRACKS]	NO	76	NO	
		[TRACK 2 (L)]	NO	76	NO	
		[TRACK 1 (R)]	NO	76	NO	
		[SCORE]	SCORE display	74	YES	
		[LYRICS]	LYRICS display	75	NO	
		[GUIDE]	NO	76	YES	
[REPEAT]	NO	76	NO			
19	[PIANO ROOM]	PIANO ROOM display	40	NO		
20	REGISTRATION MEMORY	REGIST BANK [-]/[+]	REGISTRATION BANK (pop-up)	98	NO	
		[MEMORY]	REGISTRATION MEMORY CONTENTS display	97	NO	
		[1] – [8]	NO	97	NO	
21	VOICE CONTROL	[PIANO] – [DRUM KIT]	Voice Selection display	44	NO	
		[ORGAN FLUTES]	Organ	FOOTAGE	53	NO
			Flutes	VOLUME/ATTACK	54	YES
	VOICE SET display	EFFECT/EQ	54	YES		
22	ONE TOUCH SETTING	[1] – [4]	NO	64	YES	
		[OTS LINK]	NO	65	NO	
23	[VOICE EFFECT]	VOICE EFFECT display	51	YES		

# Specifications

<b>Product name</b>		Digital Piano	
<b>Size/Weight</b>	Width [For models with polished finish]		1352 mm (53-1/4") [1355 mm (53-3/8")]
	Height [For models with polished finish]	With Music Rest closed	918 mm (36-1/8") [921 mm (36-1/4")]
		With Music Rest	1065 mm (41-15/16") [1066 mm (42")]
	Depth [For models with polished finish]	With Music Rest	595 mm (23-7/16") [596 mm (23-7/16")]
Weight [For models with polished finish]		59.0kg (130 lbs., 1 oz) [61.5kg (135 lbs., 9 oz)]	
<b>Control Interface</b>	Keyboard	Number of Keys	88
		Type	GH3X with synthetic ivory keytops, escapement
		Touch Response	Hard2/Hard1/Medium/Soft1/Soft2
	Pedal	Number of Pedals	3
		Half Pedal	Yes
		Functions	Sustain, Sostenuto, Soft, Glide, Song Play/Pause, Style Start/Stop, Volume, etc.
	Display	Type	TFT Color LCD
		Size	4.3 inch (480 x 272 dots)
		Brightness	Yes
		Score Display Function	Yes
		Lyrics Display Function	Yes
	Panel	Language	English, Japanese, German, French, Spanish, Italian
		Language	English only
	<b>Cabinet</b>	Key Cover Style	
Music Rest		Yes	
<b>Voices</b>	Tone Generation	Piano Sound	Yamaha CFX, Bösendorfer Imperial
	Piano Effect	VRM	Yes
		Key-off Samples	Yes
		Smooth Release	Yes
	Polyphony	Number of Polyphony (Max.)	256
	Preset	Number of Voices	777 Voices + 29 Drum/SFX Kits + 480 XG Voices
		Featured Voices	10 VRM, 49 Super Articulation Voices, 23 Mega Voices, 13 Natural! Voices, 26 Sweet! Voices, 58 Cool! Voices, 70 Live! Voices, 20 Organ Flutes
	Custom	Voice Edit	Yes
Compatibility		XG, GS (for Song playback), GM, GM2	

<b>Effects</b>	Types	Reverb	58 Preset + 3 User
		Chorus	106 Preset + 3 User
		DSP	295 Preset + 3 User
		Master EQ	5 Preset +2 User
		Part EQ	27 Parts
		Master Compressor	5 Preset + 5 User
		Intelligent Acoustic Control (IAC)	Yes
		Stereophonic Optimizer	Yes
Functions	Dual (Layer)	Yes	
	Split	Yes	
<b>Styles</b>	Preset	Number of Styles	310
		Featured Styles	253 Pro Styles, 21 Session Styles, 36 Pianist Styles
	File Format	Style File Format GE (Guitar Edition)	
	Fingering	Single Finger, Fingered, Fingered On Bass, Multi Finger, AI Fingered, Full Keyboard, AI Full Keyboard	
	Style Control	INTRO x 3, MAIN VARIATION x 4, FILL x 4, BREAK, ENDING x 3	
	Custom	Style Creator	Yes
	Other Features	Music Finder (Max.)	1200 Records
One Touch Setting (OTS)		4 for each Style	
Style Recommender		Yes	
<b>Recording/ Playback (MIDI)</b>	Preset	Number of Preset Songs	65
	Recording	Number of Tracks	16
		Data Capacity	approx. 300KB/Song
	Compatible Data Format	Recording	SMF (Format 0)
Playback		SMF (Format 0 & 1), XF	
<b>Recording/ Playback (Audio)</b>	Recording Time (max.)	80 minutes/Song	
	Data Format (Recording/Playback)	WAV (44.1kHz, 16bit, stereo)	
	Time Stretch	Yes	
	Pitch Shift	Yes	
	Vocal Cancel	Yes	
<b>Functions</b>	Registration Memory	Number of Buttons	8
		Control	Registration Sequence, Freeze
	Lesson/Guide	Follow Lights, Any Key, Karao-Key, Your Tempo	
		Guide Lamp	Yes
		Performance Assistant Technology (PAT)	Yes
Demo	Yes		

<b>Functions</b>	Overall Controls	Metronome	Yes
		Tempo	5 – 500, Tap Tempo
		Transpose	-12 – 0 – +12
		Tuning	414.8 – 440.0 – 466.8 Hz
	Scale Type	9 Types	
	Miscellaneous	Piano Room	Yes
<b>Storage and Connectivity</b>	Storage	Internal Memory	approx. 2.8 MB
		External Memory	USB Flash drive
	Connectivity	Headphones	Standard stereo phone jack (x 2)
		Microphone	Mic/Line In, Input Volume
		MIDI	IN, OUT, THRU
		AUX IN	Stereo mini jack
		AUX OUT	L/L+R, R
		AUX PEDAL	Yes
		USB TO DEVICE	Yes (x 1)
USB TO HOST	Yes		
<b>Sound System</b>	Amplifiers	25W x 2	
	Speakers	16cm x 2	
	Acoustic Optimizer	Yes	
<b>Power Supply</b>	Auto Power Off	Yes	
<b>Included Accessories</b>			Owner's Manual (this book), Data List, Warranty*, "50 Greats for the Piano" music book, Online Member Product Registration, Holder Set, AC power cord, Bench*  * May not be included depending on your area. Check with your Yamaha dealer.
<b>Separately Sold Accessories (May not be available depending on your locale.)</b>			Headphones HPE-160, Footswitches FC4A/FC4/FC5, Foot controller FC7, USB wireless LAN adaptor UD-WL01, USB MIDI Interface for iPhone/iPod touch/iPad i-UX1, MIDI Interface for iPhone/iPod touch/iPad i-MX1

The contents of this manual apply to the latest specifications as of the printing date. Since Yamaha makes continuous improvements to the product, this manual may not apply to the specifications of your particular product. To obtain the latest manual, access the Yamaha website then download the manual file. Since specifications, equipment or separately sold accessories may not be the same in every locale, please check with your Yamaha dealer.

# Index

## A

A-B Repeat .....	77
Accessories .....	9
Accompaniment .....	58
ACMP ON/OFF .....	58
ADD TO MF .....	96
Assembly .....	113
Audio .....	84
Audio connection .....	104
Audio Recording .....	88
Audio Volume .....	86
Auto Accompaniment .....	58
AUTO FILL .....	63
Auto Power Off .....	18

## B

Backup .....	38
BACKUP/RESTORE .....	112
Bank .....	98
BREAK .....	63

## C

Channel (Song) .....	75
Channel (Style) .....	67
Character entry .....	36
Chord Fingering .....	60
Chord section .....	59
Chords .....	60
CMP .....	102
Compatible Format .....	8
Computer .....	108
CONFIG1 .....	111
CONFIG2 .....	111
Connections .....	103
Copy .....	34
Cut .....	34

## D

Damper pedal .....	23
Delete .....	35
Demo .....	24
Demo (Voice) .....	45

Direct Access .....	28
Display .....	21, 25
DSP .....	52

## E

Editing Voices .....	57
EFFECT .....	101
Effects .....	51
ENDING .....	62
Ending .....	62
EQ .....	102
EXIT .....	27

## F

Fast Forward .....	73
File .....	30, 32
File Selection Display .....	30
FILTER .....	101
Folder .....	32
Foot Controller .....	105
Footswitch .....	105
Format (USB flash drive) .....	107
Function .....	112

## G

Guide Lamps .....	76
-------------------	----

## H

Half-pedal .....	23
Harmony/Echo type .....	57
Headphones .....	20
Hz (Hertz) .....	50

## I

IAC .....	19
Initialize .....	39
INTRO .....	62
Intro .....	62
iPad .....	108
iPhone .....	108

## K

Key Cover .....	16
KEYBOARD HARMONY .....	52
Keyboard parts .....	47

## L

Language .....	21
LCD .....	21, 25
LEFT .....	46
Lyrics .....	74, 75

## M

Main Display .....	29
MAIN VARIATION .....	63
Master Volume .....	19
MENU1/MENU2 .....	30
MEQ .....	102
Messages .....	28
Metronome .....	56
Microphone .....	90, 104
MIDI .....	110
MIDI recording .....	79
Mixer .....	100
Mixing Console .....	100
Move .....	34
Multi Channel Recording .....	82
Music Finder .....	92
Music Notation .....	74
Music Rest .....	16

## N

Name .....	33
------------	----

## O

One Touch Setting .....	64
Organ Flutes Voices .....	53
OWNER .....	111
Owner Name .....	22

## P

PANEL PART .....	101
PARAMETER LOCK .....	111
Pause .....	72
Pedals .....	23
Piano Lock .....	48

Piano Reset .....	48
Piano Room .....	40
Pitch .....	50, 86
Playback (Song) .....	71
Playback (Style) .....	62
Power .....	17, 18
Power cord .....	17
Practice .....	76
PRESET .....	30
Preset Voices .....	44
protected Songs .....	73
Punch In/Out .....	83

## Q

Queuing .....	72
---------------	----

## R

Recording (Audio) .....	88
Recording (MIDI) .....	79
Recording (Style) .....	70
Reference Manual .....	9
Registration Memory .....	97
Repeat (Audio) .....	86
Repeat (Song) .....	77, 78
RESET .....	112
Restore .....	39
Rewind .....	73
Rhythm .....	58
RIGHT1 .....	44
RIGHT2 .....	45

## S

Save .....	38, 81
Scale Tuning .....	50
Score .....	74
Sections .....	63
SETUP FILES .....	112
Singing .....	90
Soft pedal .....	23
Song .....	71
SONG CH .....	101
Song Channels .....	75
Song Creator .....	83
SONG SELECT .....	71
Song Selection display .....	71
Sostenuto pedal .....	23
Specifications .....	122

Split Points .....	69
START/STOP .....	59, 62
Step Recording .....	83
Stereophonic Optimizer .....	20
Style .....	58
Style channels .....	67
Style Characteristics .....	59
Style Creator .....	70
Style file compatibility .....	70
STYLE PART .....	101
Style Parts .....	67
Style Recommender .....	65
Super Articulation Voices .....	50
SYNC START .....	62
SYNC STOP .....	62
Synchro Start (Song) .....	72
Synchro Start (Style) .....	62
Synchro Stop (Style) .....	62
System .....	111
System Exclusive events .....	83

## T

Tab .....	26
Tempo (Song) .....	64
Tempo (Style) .....	64
Touch Response .....	55
TRACK1 (R) .....	76
TRACK2 (L) .....	76
Transpose .....	50
Troubleshooting .....	116
TUNE .....	101
Tuning .....	50

## U

USB .....	30
USB devices .....	106
USB Flash Drive .....	106
USB wireless LAN adaptor .....	108
USER .....	30
Utility .....	111

## V

version number .....	22
VIBRATO .....	54
Vocal Cancel .....	87
Voice .....	44
Voice Types .....	47

VOL/VOICE .....	101
Volume (Audio) .....	86
Volume (master) .....	19
Volume (Voice, Style, Song, Audio) .....	68
Volume Balance .....	68
VRM .....	49

## W

WAV .....	84
Wireless LAN .....	108

## X

XG Voices .....	45
-----------------	----

## Information for Users on Collection and Disposal of Old Equipment



This symbol on the products, packaging, and/or accompanying documents means that used electrical and electronic products should not be mixed with general household waste. For proper treatment, recovery and recycling of old products, please take them to applicable collection points, in accordance with your national legislation and the Directives 2002/96/EC.

By disposing of these products correctly, you will help to save valuable resources and prevent any potential negative effects on human health and the environment which could otherwise arise from inappropriate waste handling.

For more information about collection and recycling of old products, please contact your local municipality, your waste disposal service or the point of sale where you purchased the items.

### [For business users in the European Union]

If you wish to discard electrical and electronic equipment, please contact your dealer or supplier for further information.

### [Information on Disposal in other Countries outside the European Union]

This symbol is only valid in the European Union. If you wish to discard these items, please contact your local authorities or dealer and ask for the correct method of disposal.

(weee\_eu\_en\_01)

## Information concernant la Collecte et le Traitement des déchets d'équipements électriques et électroniques.



Le symbole sur les produits, l'emballage et/ou les documents joints signifie que les produits électriques ou électroniques usagés ne doivent pas être mélangés avec les déchets domestiques habituels. Pour un traitement, une récupération et un recyclage appropriés des déchets d'équipements électriques et électroniques, veuillez les déposer aux points de collecte prévus à cet effet, conformément à la réglementation nationale et aux Directives 2002/96/EC.

En vous débarrassant correctement des déchets d'équipements électriques et électroniques, vous contribuerez à la sauvegarde de précieuses ressources et à la prévention de potentiels effets négatifs sur la santé humaine qui pourraient advenir lors d'un traitement inapproprié des déchets.

Pour plus d'informations à propos de la collecte et du recyclage des déchets d'équipements électriques et électroniques, veuillez contacter votre municipalité, votre service de traitement des déchets ou le point de vente où vous avez acheté les produits.

### [Pour les professionnels dans l'Union Européenne]

Si vous souhaitez vous débarrasser des déchets d'équipements électriques et électroniques veuillez contacter votre vendeur ou fournisseur pour plus d'informations.

### [Information sur le traitement dans d'autres pays en dehors de l'Union Européenne]

Ce symbole est seulement valable dans l'Union Européenne. Si vous souhaitez vous débarrasser de déchets d'équipements électriques et électroniques, veuillez contacter les autorités locales ou votre fournisseur et demander la méthode de traitement appropriée.

(weee\_eu\_fr\_01)

## Información para Usuarios sobre Recolección y Disposición de Equipamiento Viejo



Este símbolo en los productos, embalaje, y/o documentación que se acompañe significa que los productos electrónicos y eléctricos usados no deben ser mezclados con desechos hogareños corrientes. Para el tratamiento, recuperación y reciclado apropiado de los productos viejos, por favor llévelos a puntos de recolección aplicables, de acuerdo a su legislación nacional y las directivas 2002/96/EC.

Al disponer de estos productos correctamente, ayudará a ahorrar recursos valiosos y a prevenir cualquier potencial efecto negativo sobre la salud humana y el medio ambiente, el cual podría surgir de un inapropiado manejo de los desechos.

Para mayor información sobre recolección y reciclado de productos viejos, por favor contacte a su municipio local, su servicio de gestión de residuos o el punto de venta en el cual usted adquirió los artículos.

### [Para usuarios de negocios en la Unión Europea]

Si usted desea deshacerse de equipamiento eléctrico y electrónico, por favor contacte a su vendedor o proveedor para mayor información.

### [Información sobre la Disposición en otros países fuera de la Unión Europea]

Este símbolo sólo es válido en la Unión Europea. Si desea deshacerse de estos artículos, por favor contacte a sus autoridades locales y pregunte por el método correcto de disposición.

(weee\_eu\_es\_01)



# Important Notice: Guarantee Information for customers in European Economic Area (EEA) and Switzerland

<p><b>Important Notice: Guarantee Information for customers in EEA* and Switzerland</b></p> <p>For detailed guarantee information about this Yamaha product, and Pan-EEA* and Switzerland warranty service, please either visit the website address below (Printable file is available at our website) or contact the Yamaha representative office for your country. * EEA: European Economic Area</p>	English
<p><b>Wichtiger Hinweis: Garantie-Information für Kunden in der EWR* und der Schweiz</b></p> <p>Für nähere Garantie-Information über dieses Produkt von Yamaha, sowie über den Pan-EWR*- und Schweizer Garantieservice, besuchen Sie bitte entweder die folgend angegebene Internetadresse (eine druckfähige Version befindet sich auch auf unserer Webseite), oder wenden Sie sich an den für Ihr Land zuständigen Yamaha-Vertrieb. *EWR: Europäischer Wirtschaftsraum</p>	Deutsch
<p><b>Remarque importante: informations de garantie pour les clients de l'EEE et la Suisse</b></p> <p>Pour des informations plus détaillées sur la garantie de ce produit Yamaha et sur le service de garantie applicable dans l'ensemble de l'EEE ainsi qu'en Suisse, consultez notre site Web à l'adresse ci-dessous (le fichier imprimable est disponible sur notre site Web) ou contactez directement Yamaha dans votre pays de résidence. * EEE : Espace Economique Européen</p>	Français
<p><b>Belangrijke mededeling: Garantie-informatie voor klanten in de EER* en Zwitserland</b></p> <p>Voor gedetailleerde garantie-informatie over dit Yamaha-product en de garantieservice in heel de EER* en Zwitserland, gaat u naar de onderstaande website (u vindt een afdrukbaar bestand op onze website) of neemt u contact op met de vertegenwoordiging van Yamaha in uw land. * EER: Europese Economische Ruimte</p>	Nederlands
<p><b>Aviso importante: información sobre la garantía para los clientes del EEE* y Suiza</b></p> <p>Para una información detallada sobre este producto Yamaha y sobre el soporte de garantía en la zona EEE* y Suiza, visite la dirección web que se incluye más abajo (la versión del archivo para imprimir esta disponible en nuestro sitio web) o póngase en contacto con el representante de Yamaha en su país. * EEE: Espacio Económico Europeo</p>	Español
<p><b>Avviso importante: informazioni sulla garanzia per i clienti residenti nell'EEA* e in Svizzera</b></p> <p>Per informazioni dettagliate sulla garanzia relativa a questo prodotto Yamaha e l'assistenza in garanzia nei paesi EEA* e in Svizzera, potete consultare il sito Web all'indirizzo riportato di seguito (è disponibile il file in formato stampabile) oppure contattare l'ufficio di rappresentanza locale della Yamaha. * EEA: Area Economica Europea</p>	Italiano
<p><b>Avviso importante: informações sobre as garantias para clientes da AEE* e da Suíça</b></p> <p>Para obter uma informação pormenorizada sobre este produto da Yamaha e sobre o serviço de garantia na AEE* e na Suíça, visite o site a seguir (o arquivo para impressão está disponível no nosso site) ou entre em contato com o escritório de representação da Yamaha no seu país. * AEE: Área Económica Européia</p>	Português
<p><b>Σημαντική σημείωση: Πληροφορίες εγγύησης για τους πελάτες στον ΕΟΧ* και Ελλάδα</b></p> <p>Για λεπτομερείς πληροφορίες εγγύησης σχετικά με το παρόν προϊόν της Yamaha και την κάλυψη εγγύησης σε όλες τις χώρες του ΕΟΧ και την Ελλάδα, επισκεφτείτε την παρακάτω ιστοσελίδα (Εκτυπώσιμη μορφή είναι διαθέσιμη στην ιστοσελίδα μας) ή απευθυνθείτε στην αντιπροσωπεία της Yamaha στη χώρα σας. * ΕΟΧ: Ευρωπαϊκός Οικονομικός Χώρος</p>	Ελληνικά
<p><b>Viktigt: Garantiinformation för kunder i EES-området* och Schweiz</b></p> <p>För detaljerad information om denna Yamahaprodukt samt garantiservice i hela EES-området* och Schweiz kan du antingen besöka nedanstående webbadress (en utskriftsvänlig fil finns på webbplatsen) eller kontakta Yamahas officiella representant i ditt land. * EES: Europeiska Ekonomiska Samarbetsområdet</p>	Svenska
<p><b>Viktig merknad: Garantiinformasjon for kunder i EØS* og Sveits</b></p> <p>Detaljert garantiinformasjon om dette Yamaha-produktet og garantiservice for hele EØS-området* og Sveits kan fås enten ved å besøke nettstedene nedenfor (utskriftsversjon finnes på våre nettsider) eller kontakte kontaktpunktene i landet der du bor. *EØS: Det europeiske økonomiske samarbeidsområdet</p>	Norsk
<p><b>Vigtig oplysning: Garantioplysninger til kunder i EØO* og Schweiz</b></p> <p>De kan finde detaljerede garantioplysninger om dette Yamaha-produkt og den fælles garantiserviceordning for EØO* (og Schweiz) ved at besøge det websted, der er angivet nedenfor (der findes en fil, som kan udskrives, på vores websted), eller ved at kontakte Yamahas nationale repræsentationskontor i det land, hvor De bor. * EØO: Det Europæiske Økonomiske Område</p>	Dansk
<p><b>Tärkeä ilmoitus: Takuutiedot Euroopan talousalueen (ETA)* ja Sveitsin asiakkaille</b></p> <p>Tämän Yamaha-tuotteen sekä ETA-alueen ja Sveitsin takuuta koskevat yksityiskohtaiset tiedot saatte alla olevasta nettiosoitteesta. (Tulostettava tiedosto saatavissa sivustollamme.) Voitte myös ottaa yhteyttä paikalliseen Yamah-edustajaan. *ETA: Euroopan talousalue</p>	Suomi
<p><b>Ważne: Warunki gwarancyjne obowiązujące w EOG* i Szwajcarii</b></p> <p>Aby dowiedzieć się więcej na temat warunków gwarancyjnych tego produktu firmy Yamaha i serwisu gwarancyjnego w całym EOG* i Szwajcarii, należy odwiedzić wskazaną poniżej stronę internetową (Plik gotowy do wydruku znajduje się na naszej stronie internetowej) lub skontaktować się z przedstawicielstwem firmy Yamaha w swoim kraju. * EOG — Europejski Obszar Gospodarczy</p>	Polski
<p><b>Důležité oznámení: Záruční informace pro zákazníky v EHS* a ve Švýcarsku</b></p> <p>Podrobné záruční informace o tomto produktu Yamaha a záručním servisu v celém EHS* a ve Švýcarsku naleznete na níže uvedené webové adrese (soubor k tisku je dostupný na našich webových stránkách) nebo se můžete obrátit na zástupce firmy Yamaha ve své zemi. * EHS: Evropský hospodářský prostor</p>	Česky
<p><b>Fontos figyelemzétetés: Garancia-információk az EGT* területén és Svájcban élő vásárlók számára</b></p> <p>A jelen Yamaha termékre vonatkozó részletes garancia-információk, valamint az EGT*-re és Svájcra kiterjedő garanciális szolgáltatás tekintetében keresse fel webhelyünket az alábbi címen (a webhelyen nyomtatható fájl is található), vagy pedig lépjen kapcsolatba az országában működő Yamaha képviselői irodával. * EGT: Európai Gazdasági Térség</p>	Magyar
<p><b>Oluline märkus: Garantiteave Euroopa Majanduspiirkonna (EMP)* ja Šveitsi klientidele</b></p> <p>Täpsemat teabe saamiseks selle Yamaha toote garantii ning kogu Euroopa Majanduspiirkonna ja Šveitsi garantiiteeninduse kohta, külastage palun veebisait alljärgneval aadressil (meie saidil on saadaval printitav fail) või pöörduge Teie regiooni Yamaha esinduse poole. * EMP: Euroopa Majanduspiirkond</p>	Eesti keel
<p><b>Svarīgs paziņojums: garantijas informācija klientiem EEZ* un Šveicē</b></p> <p>Lai saņemtu detalizētu garantijas informāciju par šo Yamaha produktu, kā arī garantijas apkalpošanu EEZ* un Šveicē, lūdzam, apmeklējiet zemāk norādīto tīmekļa vietnes adresi (tīmekļa vietnē ir pieejams drukājams fails) vai sazinieties ar jūsu valsti apkalpojošo Yamaha pārstāvniecību. * EEZ: Eiropas Ekonomikas zona</p>	Latviešu
<p><b>Dėmesio: informacija dėl garantijos pirkėjams EEE* ir Šveicarijoje</b></p> <p>Jei reikia išsamios informacijos apie šį „Yamaha“ produktą ir jo techninę priežiūrą visoje EEE* ir Šveicarijoje, apsilankykite mūsų svetainėje toliau nurodytu adresu (svetainėje yra spausdintinas failas) arba kreipkitės į „Yamaha“ atstovybę savo šalyje. *EEE – Europos ekonominė erdvė</p>	Lietuvių kalba
<p><b>Dôležité upozornenie: Informácie o záruke pre zákazníkov v EHP* a Švajčiarsku</b></p> <p>Podrobné informácie o záruke týkajúce sa tohto produktu od spoločnosti Yamaha a garančnom servise v EHP* a Švajčiarsku nájdete na webovej stránke uvedenej nižšie (na našej webovej stránke je k dispozícii súbor na tlač) alebo sa obráťte na zástupcu spoločnosti Yamaha vo svojej krajine. * EHP: Európsky hospodársky priestor</p>	Slovenčina
<p><b>Pomembno obvestilo: Informacije o garanciji za kupce v EGP* in Švici</b></p> <p>Za podrobnejše informacije o tem Yamahinem izdelku ter garancijskem servisu v celotnem EGP in Švici, obiščite spletno mesto, ki je navedeno spodaj (natisljiva datoteka je na voljo na našem spletnem mestu), ali se obrnite na Yamahinega predstavnika v svoji državi. * EGP: Evropski gospodarski prostor</p>	Slovenščina
<p><b>Важно съобщение: Информация за гаранцията за клиенти в ЕИП* и Швейцария</b></p> <p>За подробна информация за гаранцията за този продукт на Yamaha и гаранционното обслужване в паневропейската зона на ЕИП* и Швейцария или посетете посочения по-долу уеб сайт (на нашия уеб сайт има файл за печат), или се свържете с представителния офис на Yamaha във вашата страна. * ЕИП: Европейско икономическо пространство</p>	Български език
<p><b>Notificare importantă: Informații despre garanție pentru clienții din SEE* și Elveția</b></p> <p>Pentru informații detaliate privind acest produs Yamaha și serviciul de garanție Pan-SEE* și Elveția, vizitați site-ul la adresa de mai jos (fișierul imprimabil este disponibil pe site-ul nostru) sau contactați biroul reprezentanței Yamaha din țara dumneavoastră. * SEE: Spațiul Economic European</p>	Limba română

<http://europe.yamaha.com/warranty/>

For details of products, please contact your nearest Yamaha representative or the authorized distributor listed below.

Pour plus de détails sur les produits, veuillez-vous adresser à Yamaha ou au distributeur le plus proche de vous figurant dans la liste suivante.

Die Einzelheiten zu Produkten sind bei Ihrer unten aufgeführten Niederlassung und bei Yamaha Vertragshändlern in den jeweiligen Bestimmungsländern erhältlich.

Para detalles sobre productos, contacte su tienda Yamaha más cercana o el distribuidor autorizado que se lista debajo.

## NORTH AMERICA

### CANADA

**Yamaha Canada Music Ltd.**  
135 Milner Avenue, Toronto, Ontario M1S 3R1,  
Canada  
Tel: +1-416-298-1311

### U.S.A.

**Yamaha Corporation of America**  
6600 Orangethorpe Avenue, Buena Park, CA 90620,  
U.S.A.  
Tel: +1-714-522-9011

## CENTRAL & SOUTH AMERICA

### MEXICO

**Yamaha de México, S.A. de C.V.**  
Av. Insurgentes Sur 1647 Piso 9, Col. San José  
Insurgentes, Delegación Benito Juárez, México,  
D.F., C.P. 03900  
Tel: +52-55-5804-0600

### BRAZIL

**Yamaha Musical do Brasil Ltda.**  
Rua Fidêncio Ramos, 302 - Cj 52 e 54 - Torre B -  
Vila Olímpia - CEP 04551-010 - São Paulo/SP,  
Brazil  
Tel: +55-11-3704-1377

### ARGENTINA

**Yamaha Music Latin America, S.A.,  
Sucursal Argentina**  
Olga Cossetini 1553, Piso 4 Norte,  
Madero Este-C1107CEK,  
Buenos Aires, Argentina  
Tel: +54-11-4119-7000

### VENEZUELA

**Yamaha Musical de Venezuela, C.A.**  
AV. Manzanares, C.C. Manzanares Plaza,  
Piso 4, Oficina 0401, Baruta, Caracas, Venezuela  
Tel: +58-212-943-1877

### PANAMA AND OTHER LATIN

### AMERICAN COUNTRIES/ CARIBBEAN COUNTRIES

**Yamaha Music Latin America, S.A.**  
Edif. Torre Banco General, F7, Urb. Marbella,  
Calle 47 y Aquilino de la Guardia, Panama,  
P.O.Box 0823-05863, Panama, Rep.de Panama  
Tel: +507-269-5311

## EUROPE

### THE UNITED KINGDOM/IRELAND

**Yamaha Music Europe GmbH (UK)**  
Sherbourne Drive, Tilbrook, Milton Keynes,  
MK7 8BL, U.K.  
Tel: +44-1908-366700

### GERMANY

**Yamaha Music Europe GmbH**  
Siemensstrasse 22-34, 25462 Rellingen, Germany  
Tel: +49-4101-303-0

### SWITZERLAND/LIECHTENSTEIN

**Yamaha Music Europe GmbH, Rellingen,  
Branch Switzerland in Zürich**  
Seefeldstrasse 94, 8008 Zürich, Switzerland  
Tel: +41-44-3878080

### AUSTRIA

**Yamaha Music Europe GmbH, Branch Austria**  
Schleiergasse 20, 1100 Wien, Austria  
Tel: +43-1-60203900

### CZECH REPUBLIC/HUNGARY/ ROMANIA/SLOVAKIA/SLOVENIA

**Yamaha Music Europe GmbH, Branch Austria**  
Schleiergasse 20, 1100 Wien, Austria  
Tel: +43-1-60203900

### POLAND/LITHUANIA/LATVIA/ ESTONIA

**Yamaha Music Europe GmbH**  
Sp.z o.o. Oddzial w Polsce  
ul. Wrotkowa 14, 02-553 Warsaw, Poland  
Tel: +48-22-880-08-88

### BULGARIA

**Dinacord Bulgaria LTD.**  
Bul. Iskarsko Schose 7 Targowski Zentar Ewropa  
1528 Sofia, Bulgaria  
Tel: +359-2-978-20-25

### MALTA

**Olimpus Music Ltd.**  
Valletta Road, Mosta MST9010, Malta  
Tel: +356-2133-2093

### NETHERLANDS/BELGIUM/ LUXEMBOURG

**Yamaha Music Europe, Branch Benelux**  
Clarissenhof 5b, 4133 AB Vianen, The Netherlands  
Tel: +31-347-358040

### FRANCE

**Yamaha Music Europe**  
7 rue Ambroise Croizat, Zone d'activités de Pariest,  
77183 Croissy-Beaubourg, France  
Tel: +33-1-6461-4000

### ITALY

**Yamaha Music Europe GmbH, Branch Italy**  
Viale Italia 88, 20020, Lainate (Milano), Italy  
Tel: +39-02-93577-1

### SPAIN/PORTUGAL

**Yamaha Music Europe GmbH Ibérica, Sucursal  
en España**  
Ctra. de la Coruna km. 17,200, 28231  
Las Rozas de Madrid, Spain  
Tel: +34-91-639-88-88

### GREECE

**Philippos Nakas S.A. The Music House**  
19th km. Leof. Lavriou 190 02 Peania - Attiki,  
Greece  
Tel: +30-210-6686260

### SWEDEN

**Yamaha Music Europe GmbH Germany filial  
Scandinavia**  
JA Wettergrensgata 1, 400 43 Göteborg, Sweden  
Tel: +46-31-89-34-00

### DENMARK

**Yamaha Music Denmark,  
Filial of Yamaha Music Europe GmbH, Tyskland**  
Generatorvej 8C, ST. TH., 2860 Søborg, Denmark  
Tel: +45-44-92-49-00

### FINLAND

**F-Musiikki Oy**  
Antaksentie 4  
FI-01510 Vantaa, Finland  
Tel: +358 (0)96185111

### NORWAY

**Yamaha Music Europe GmbH Germany -  
Norwegian Branch**  
Grini Næringspark 1, 1332 Østerås, Norway  
Tel: +47-6716-7800

### ICELAND

**Hljodfaerahusid Ehf.**  
Sidumula 20  
IS-108 Reykjavik, Iceland  
Tel: +354-525-5050

### CROATIA

**Euro Unit D.O.O.**  
Slakovec 73  
40305 Nedelisce  
Tel: +38540829400

### RUSSIA

**Yamaha Music (Russia) LLC.**  
Room 37, entrance 7, bld. 7, Kievskaya street,  
Moscow, 121059, Russia  
Tel: +7-495-626-5005

### OTHER EUROPEAN COUNTRIES

**Yamaha Music Europe GmbH**  
Siemensstrasse 22-34, 25462 Rellingen, Germany  
Tel: +49-4101-303-0

## AFRICA

**Yamaha Music Gulf FZE**  
JAFZA-16, Office 512, P.O.Box 17328,  
Jebel Ali FZE, Dubai, UAE  
Tel: +971-4-801-1500

## MIDDLE EAST

### TURKEY

**Yamaha Music Europe GmbH**  
Merkezi Almanya Türkiye Istanbul Şubesi  
Maslak Meydanı Sodalık, Spring Giz Plaza Bagimsiz  
Böl. No:3, Sariyer Istanbul, Turkey  
Tel: +90-212-999-8010

### CYPRUS

**Nakas Music Cyprus Ltd.**  
Nikis Ave 2k  
1086 Nicosia  
Tel: + 357-22-511080  
**Major Music Center**  
21 Ali Riza Ave. Ortakoy  
P.O.Box 475 Nicosia, Cyprus  
Tel: (392) 227 9213

### OTHER COUNTRIES

**Yamaha Music Gulf FZE**  
JAFZA-16, Office 512, P.O.Box 17328,  
Jebel Ali FZE, Dubai, UAE  
Tel: +971-4-801-1500

## ASIA

### THE PEOPLE'S REPUBLIC OF CHINA

**Yamaha Music & Electronics (China) Co., Ltd.**  
2F, Yunhedasha, 1818 Xinzha-lu, Jingan-qu,  
Shanghai, China  
Tel: +86-400-051-7700

### HONG KONG

**Tom Lee Music Co., Ltd.**  
11/F., Silvercord Tower 1, 30 Canton Road,  
Tsimshatsui, Kowloon, Hong Kong  
Tel: +852-2737-7688

### INDIA

**Yamaha Music India Private Limited**  
Spazedge Building, Ground Floor, Tower A,  
Sector-47, Gurgaon- Sohna Road, Gurgaon-122002,  
Haryana, India  
Tel: +91-124-485-3300

### INDONESIA

**PT. Yamaha Musik Indonesia (Distributor)**  
Yamaha Music Center Bldg. Jalan Jend. Gatot  
Subroto Kav. 4, Jakarta 12930, Indonesia  
Tel: +62-21-520-2577

### KOREA

**Yamaha Music Korea Ltd.**  
8F, Dongsung Bldg. 21, Teheran-ro 87-gil,  
Gangnam-gu, Seoul, 135-880, Korea  
Tel: +82-2-3467-3300

### MALAYSIA

**Yamaha Music (Malaysia) Sdn. Bhd.**  
No.8, Jalan Perbandaran, Kelana Jaya, 47301  
Petaling Jaya, Selangor, Malaysia  
Tel: +60-3-78030900

### SINGAPORE

**Yamaha Music (Asia) Private Limited**  
Block 202 Hougang Street 21, #02-00,  
Singapore 530202, Singapore  
Tel: +65-6740-9200

### TAIWAN

**Yamaha Music & Electronics Taiwan Co., Ltd.**  
2F., No.1, Yuandong Rd. Banqiao Dist.  
New Taipei City 22063, Taiwan, R.O.C.  
Tel: +886-2-7741-8888

### THAILAND

**Siam Music Yamaha Co., Ltd.**  
3, 4, 15, 16th Fl., Siam Motors Building,  
891/1 Rama 1 Road, Wangmai,  
Pathumwan, Bangkok 10330, Thailand  
Tel: +66-2215-2622

### VIETNAM

**Yamaha Music Vietnam Company Limited**  
15th Floor, Nam A Bank Tower, 201-203 Cach  
Mang Thang Tam St., Ward 4, Dist.3,  
Ho Chi Minh City, Vietnam  
Tel: +84-8-3818-1122

### OTHER ASIAN COUNTRIES

<http://asia.yamaha.com>

## OCEANIA

### AUSTRALIA

**Yamaha Music Australia Pty. Ltd.**  
Level 1, 99 Queensbridge Street, Southbank,  
VIC 3006, Australia  
Tel: +61-3-9693-5111

### NEW ZEALAND

**Musik Works LTD**  
P.O.Box 6246 Wellesley, Auckland 4680,  
New Zealand  
Tel: +64-9-634-0099

### COUNTRIES AND TRUST

**TERRITORIES IN PACIFIC OCEAN**  
<http://asia.yamaha.com>



**Yamaha Global Site**  
<http://www.yamaha.com/>

**Yamaha Downloads**  
<http://download.yamaha.com/>

Manual Development Department  
© 2015 Yamaha Corporation

Published 03/2016 MWGR\*.\*- \*\*B0  
Printed in Indonesia

**ZN76480**



ZN76480