

How to Assemble and Use the Mini Strandbeest

Assembly time: Approximately 1.5 hours

Parts in the Kit

Separate the parts from the plastic trees that they come attached to and arrange them as shown in the picture. Remove each of the rubber feet at the cut lines one at a time.

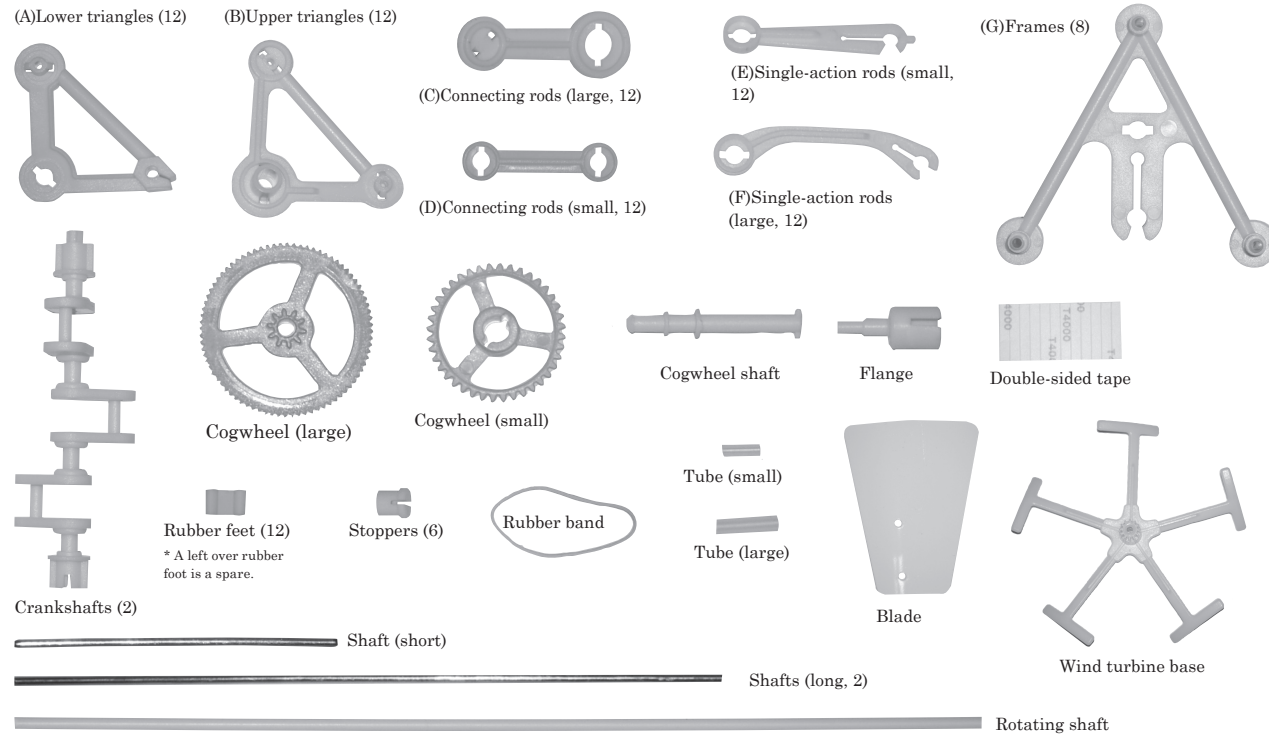

Things you will need

Scissors, utility knife, etc.

Materials used in this kit

Crankshafts, frames, lower triangles, and wind turbine base (beige): ABS
 Connecting rods, single-action rods, upper triangles, cogwheels, cogwheel shaft, stoppers, and flange (beige): POM
 Shafts: Iron Rubber feet, tubes: Silicon Blades: PET

CAUTION Please be sure to read the following instructions before assembling this kit.

- Take necessary caution when handling parts with pointed edges. There is a risk of injury.
- Be careful when using the smaller parts so that you do not put them in your mouth and accidentally swallow them. There is a risk of suffocation.
- Keep this kit out of the reach of small children when not in use.

* Please read the instructions and cautions thoroughly before use.
 * For your safety, be sure to follow the instructions in this manual. In addition, do not use any parts that have become damaged or deformed during use.

Assembling the Body

[1] Assembling the legs of the Mini Strandbeest

1. Attach the rubber feet to the ends of the lower triangles (A).

Line a rubber foot up with the slit on the end of one of the lower triangles (A), and then use the shaft (short) to push the rubber foot into the hole to attach it. Adjust the position of the rubber foot so that it lines up with the middle of the slit. Do the same for all twelve lower triangles (A) to attach a rubber foot to each.

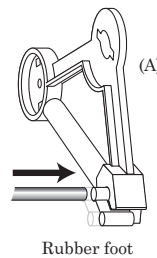

After inserting a rubber foot partway, push it all the way in using the shaft (short).

2. Attach a connecting rod (large) (C) to an upper triangle (B).

Attach the larger joint on (C) to the largest joint on (B), and then rotate (C) 90° downward.

Line the notches on (C) up with the protrusions on (B) to attach (C) to (B).

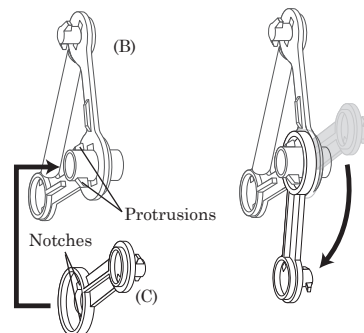

3. Attach a connecting rod (small) (D) to an upper triangle (B).

Arrange the joint on (D) and the joint on (B) so that the protrusions and notches line up as shown in the diagram to attach (D) to (B), and then rotate (D) 90° downward.

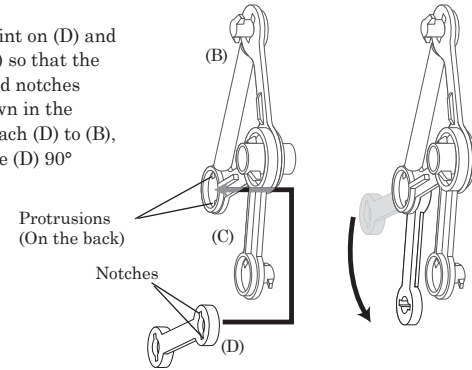

4. Attach a lower triangle (A) to two connecting rods.

First, attach the joint on (A) with the protrusion to the joint on (D), and then rotate (A) upward to attach the other joint on (A) to the joint on (C) with the protrusion. This completes one leg.

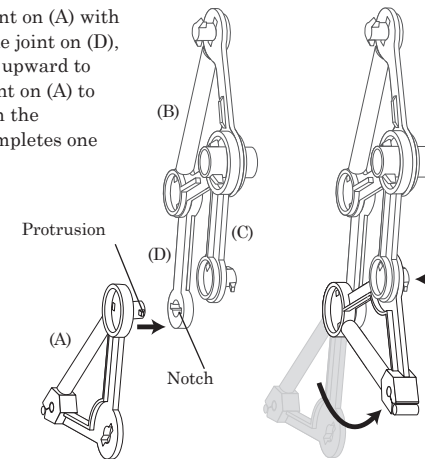

5. Complete all twelve legs.

Complete Steps 2 to 4 a total of twelve times to assemble the twelve sets of legs.

Make a total of twelve sets like this.

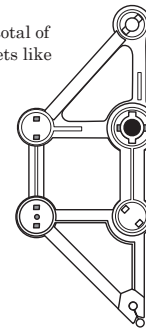

This is the same set as seen from the back.

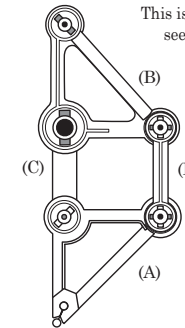

[2] Attaching the crank to the legs

1. Attach the crankshaft to the frame (G).

Insert the crankshaft into the slot in the middle of the frame. There are three protrusions on the frame and a protrusion on each end of the crankshaft. Make sure that the protrusion on the crankshaft is facing in the same direction as those on the frame. Make two sets like this.

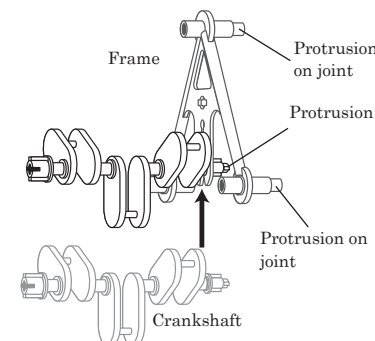

2. Connect the right leg and crank together with a single-action rod (small) (E).

Attach the largest joint on the leg to the joint on the right side of the frame so that the rubber foot on the leg is at the bottom. Attach (E) to the upper joint on the leg so that the protrusion and notch line up, and then push the key part on (E) down onto the crank as shown by the arrow so that it snaps into place.

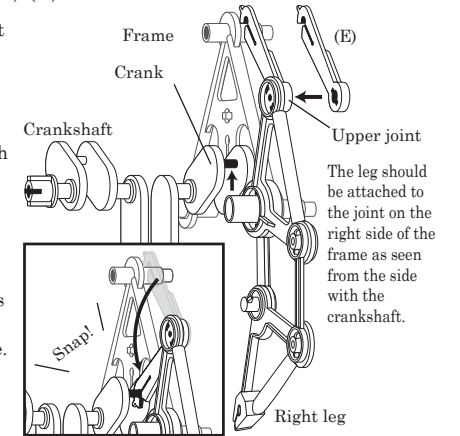

3. Connect the left leg and crank together with a single-action rod (large) (F).

Attach the largest joint on the leg to the joint on the left side of the frame so that it is opposite from the right side, and then attach (F) to the lower joint on the leg and push it down onto the crank that was attached in Step 2 so that it snaps into place. When completing this step, make sure to position the newly attached rod so that it is in front.

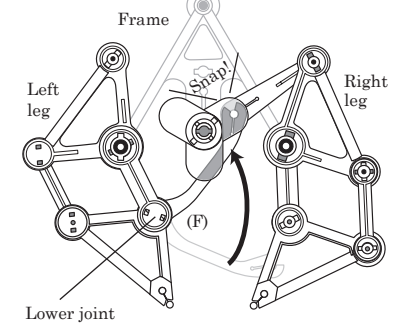

4. Connect the right leg and crank together with a single-action rod (large) (F).

Attach (F) to the lower joint on the right leg, and then push it onto the crank that was attached in Steps 2 and 3 until it snaps into place. Make sure to position the newly attached rod so that it is in front.

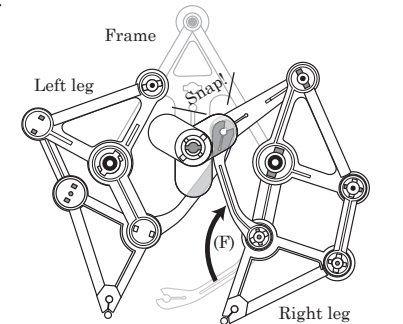

5. Connect the left leg and crank together with a single-action rod (small) (E).

Attach (E) to the upper joint on the left leg, and then push it onto the crank that was attached in Steps 2, 3, and 4 until it snaps into place. Make sure to position the newly attached rod so that it is in front.

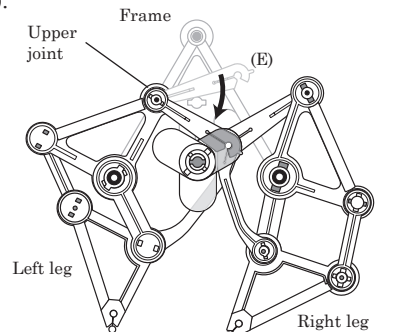

Once you have attached both legs, check to make sure that the rods attached to the crank are in the order of upper left, lower right, lower left, and upper right, as seen from the front. If the order is different, the legs may not move smoothly.

6. Attach the second frame.

Attach the second frame firmly to the first frame, so as to sandwich the legs that you put together in Steps 2 to 5. Line up the three joints on the frames, and position the slot in the middle of the frame so that it snaps into place on the central axis of the crankshaft.

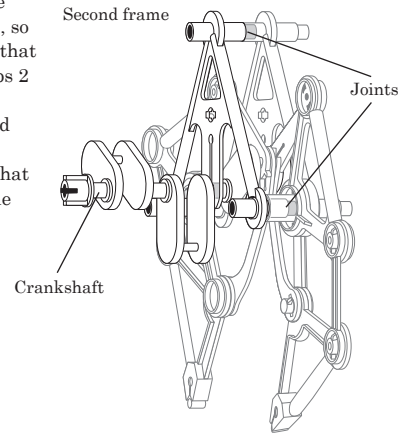

7. Attach legs to make three sets.

Repeat Steps 2 to 6 until you have assembled three pairs of legs for a total of six legs on four frames, connected to the crankshaft. This completes one half of the body of the Mini Strandbeest.

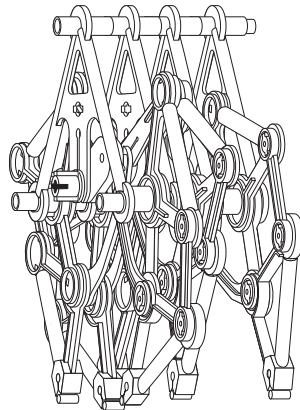

* Check to make sure that the legs move smoothly by turning the crankshaft. If the legs do not move correctly, go back to Step 5 and check to make sure that the rods are in the correct order.

* If the frames do not seem to be attached together properly, make sure that each frame is firmly attached to the crankshaft.

Use the remaining parts to make one more assembly just like this.

[3] Putting the body together

1. Attach the two body assemblies together.

Attach the two body assemblies together, oriented so that the joints on the frames and crankshaft face in the same direction. When attaching, fold the rubber band over into a double loop, and position the loops in between the joints on the tops of the frames on the assemblies.

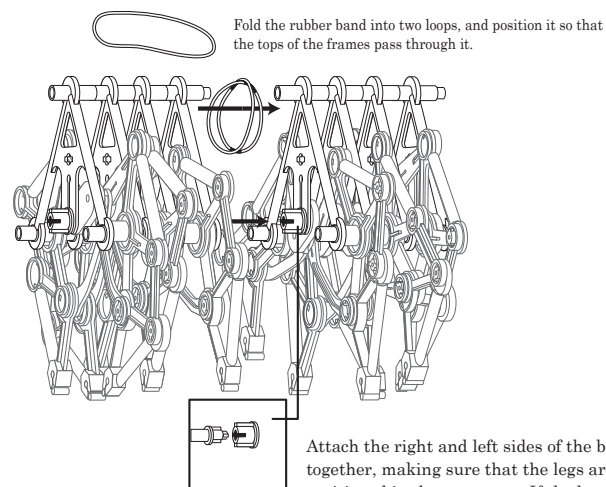

Attach the right and left sides of the body together, making sure that the legs are not positioned in the same way. If the legs are all positioned the same way, turn the joint on the crankshaft 180° on one side only.

2. Insert the shafts (long) into the frames.

Insert the shafts (long) into the holes on the frames shown in the diagram. Adjust the shafts (long) so that they stick out on either end by a small amount. After completing these adjustments, pull on each rubber band loop and hook them around the ends of the frames.

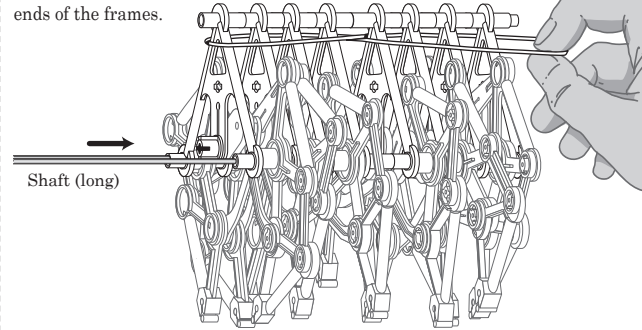

3. Attach the stoppers.

Attach stoppers to the protrusions on the frames on either end of the body (three on each side for a total of six).

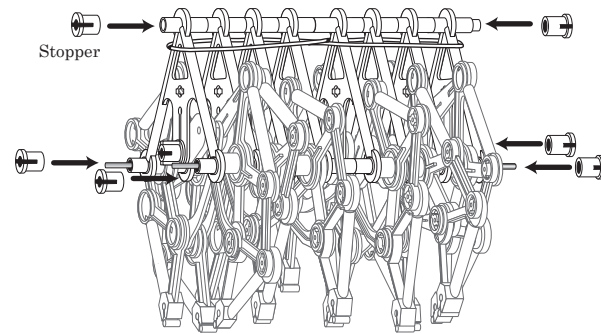

[4] Attaching the wind turbine

1. Attach the blades.

Affix two strips of double-sided tape to each of the T-shaped ends on the wind turbine base. Remove the paper on one side of the double-sided tape and affix the tape over the protrusions on the wind turbine base as shown in the diagram below, but leave the paper on the up side remaining for now. You will end up affixing a total of 10 strips of double-sided tape to the wind turbine base.

Double-sided tape



There are two extra strips used as spares.



Fold over about 1/3 of the double-sided tape to make it easier to remove it from the paper backing it comes on.

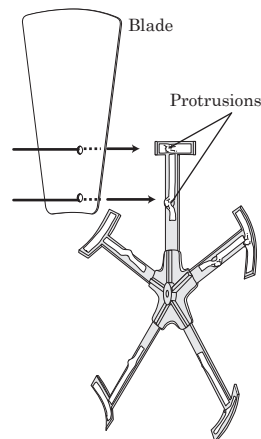

Wind turbine base

Remove the paper backing on the up side of each strip of double-sided tape, and attach each blade so that the two holes on each blade line up with the protrusions on the wind turbine base. Do the same for all five blades to attach them.

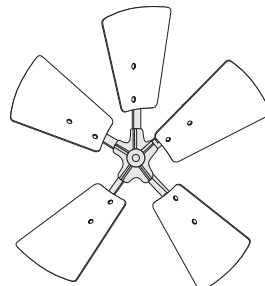

2. Insert the cogwheel shaft into the body.

Insert the cogwheel shaft into two frames on the body. Once you have inserted it into the second frame, turn the cogwheel shaft 90° so that it snaps into place.

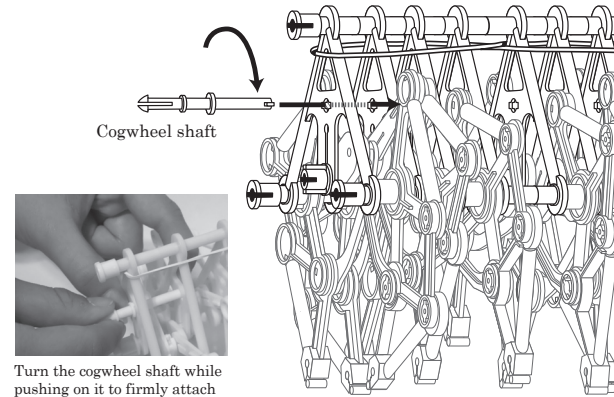

Turn the cogwheel shaft while pushing on it to firmly attach it.

3. Attach the cogwheels

After attaching the cogwheel (small) to the crankshaft axis, attach the cogwheel (large) to the cogwheel shaft and push it in until it snaps into place.

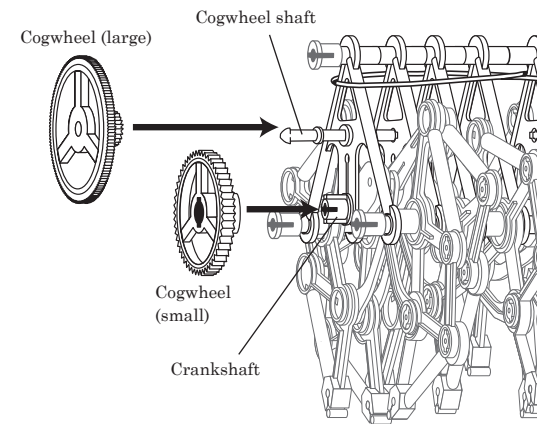

4. Attach the wind turbine.

Use the shaft (short) to attach the wind turbine to the stopper part on the top of the frame on the side on which the cogwheels are attached. Attach the tube (small) to the end of the shaft (short) to keep the wind turbine in place and prevent it from falling out.

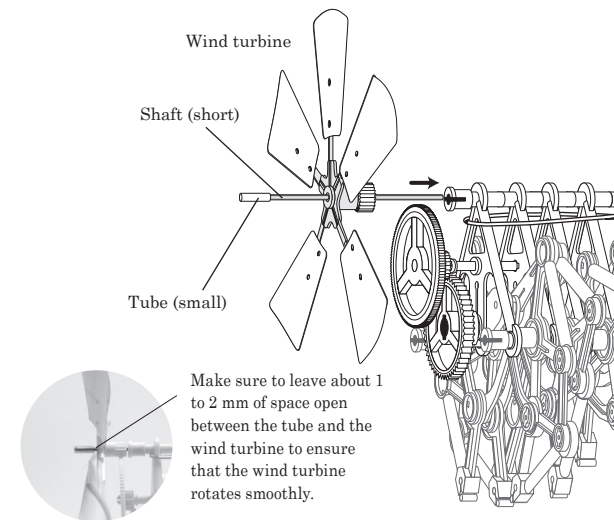

Make sure to leave about 1 to 2 mm of space open between the tube and the wind turbine to ensure that the wind turbine rotates smoothly.

Finished

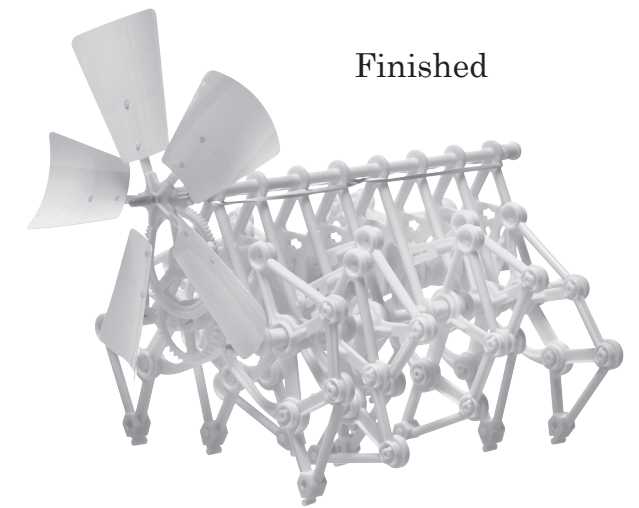

Getting the Mini Strandbeest to Walk

● Using wind to make it move

You can wave a round paper fan or a folding fan toward it or use an electric fan to blow air at it. Once wind hits it, the Mini Strandbeest will start walking toward the left as seen from the side of the wind turbine.

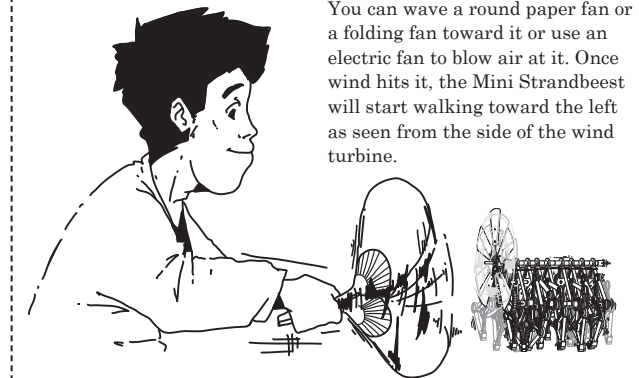

● Using the rotating shaft to make it move by hand

Use the tube (large) to connect the rotating shaft and flange together. Remove the wind turbine from the Mini Strandbeest as the weight will drag it down, and then insert the flange into the crankshaft. When you turn the rotating shaft, the Mini Strandbeest will start to walk.

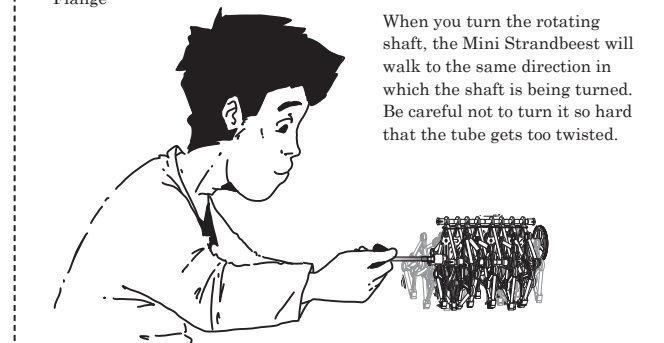
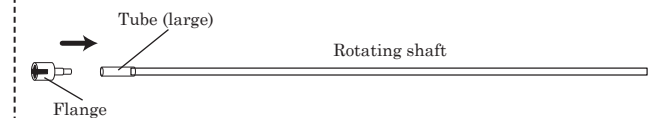

When you turn the rotating shaft, the Mini Strandbeest will walk to the same direction in which the shaft is being turned. Be careful not to turn it so hard that the tube gets too twisted.