

SHARP®

PN-H801

LCD MONITOR

OPERATION MANUAL

HDMI * **MHL**

IMPORTANT:

To aid reporting in case of loss or theft, please record the product's model and serial numbers in the space provided. The numbers are located in the rear of the product.



Model No.:

Serial No.:

U.S.A. ONLY

IMPORTANT INFORMATION

WARNING: TO REDUCE THE RISK OF FIRE OR ELECTRIC SHOCK, DO NOT EXPOSE THIS PRODUCT TO RAIN OR MOISTURE.

	CAUTION RISK OF ELECTRIC SHOCK DO NOT OPEN	
<p>CAUTION: TO REDUCE THE RISK OF ELECTRIC SHOCK, DO NOT REMOVE COVER. NO USER-SERVICEABLE PARTS INSIDE. REFER SERVICING TO QUALIFIED SERVICE PERSONNEL.</p>		



The lightning flash with arrowhead symbol, within a triangle, is intended to alert the user to the presence of uninsulated “dangerous voltage” within the product’s enclosure that may be of sufficient magnitude to constitute a risk of electric shock to persons.



The exclamation point within a triangle is intended to alert the user to the presence of important operating and maintenance (servicing) instructions in the literature accompanying the product.

WARNING:

FCC Regulations state that any unauthorized changes or modifications to this equipment not expressly approved by the manufacturer could void the user’s authority to operate this equipment.

NOTE:

This equipment has been tested and found to comply with the limits for Class A digital device, pursuant to Part 15 of the FCC Rules. These limits are designed to provide reasonable protection against harmful interference when the equipment is operated in a commercial environment. This equipment generates, uses, and can radiate radio frequency energy and, if not installed and used in accordance with the instruction manual, may cause harmful interference to radio communications. Operation of this equipment in a residential area is likely to cause harmful interference in which case the user will be required to correct the interference at his own expense.

U.S.A. ONLY

DEAR SHARP CUSTOMER

Thank you for your purchase of a SHARP LCD product. To ensure safety and many years of trouble-free operation of your product, please read the Safety Precautions carefully before using this product.

SAFETY PRECAUTIONS

Electricity is used to perform many useful functions, but it can also cause personal injuries and property damage if improperly handled. This product has been engineered and manufactured with the highest priority on safety. However, improper use can result in electric shock and/or fire. In order to prevent potential danger, please observe the following instructions when installing, operating and cleaning the product. To ensure your safety and prolong the service life of your LCD product, please read the following precautions carefully before using the product.

1. Read instructions — All operating instructions must be read and understood before the product is operated.
2. Keep this manual in a safe place — These safety and operating instructions must be kept in a safe place for future reference.
3. Observe warnings — All warnings on the product and in the instructions must be observed closely.
4. Follow instructions — All operating instructions must be followed.
5. Cleaning — Unplug the power cord from the AC outlet before cleaning the product. Use a dry cloth to clean the product. Do not use liquid cleaners or aerosol cleaners.
6. Attachments — Do not use attachments not recommended by the manufacturer. Use of inadequate attachments can result in accidents.
7. Water and moisture — Do not use the product near water. Do not install the product in a place where water may splash onto it. Be careful of equipment which drains water such as an air-conditioner.
8. Ventilation — The vents and other openings in the cabinet are designed for ventilation. Do not cover or block these vents and openings since insufficient ventilation can cause overheating and/or shorten the life of the product. Do not place the product on a sofa, rug or other similar surface, since they can block ventilation openings. Do not place the product in an enclosed place such as a bookcase or rack, unless proper ventilation is provided or the manufacturer's instructions are followed.
9. Power cord protection — The power cords must be routed properly to prevent people from stepping on them or objects from resting on them.
10. The LCD panel used in this product is made of glass. Therefore, it can break when the product is dropped or applied with impact. Be careful not to be injured by broken glass pieces in case the LCD panel breaks.
11. Overloading — Do not overload AC outlets or extension cords. Overloading can cause fire or electric shock.
12. Entering of objects and liquids — Never insert an object into the product through vents or openings. High voltage flows in the product, and inserting an object can cause electric shock and/or short internal parts. For the same reason, do not spill water or liquid on the product.
13. Servicing — Do not attempt to service the product yourself. Removing covers can expose you to high voltage and other dangerous conditions. Request a qualified service person to perform servicing.
14. Repair — If any of the following conditions occurs, unplug the power cord from the AC outlet, and request a qualified service person to perform repairs.
 - a. When the power cord or plug is damaged.
 - b. When a liquid was spilled on the product or when objects have fallen into the product.
 - c. When the product has been exposed to rain or water.
 - d. When the product does not operate properly as described in the operating instructions.

Do not touch the controls other than those described in the operating instructions. Improper adjustment of controls not described in the instructions can cause damage, which often requires extensive adjustment work by a qualified technician.
 - e. When the product has been dropped or damaged.
 - f. When the product displays an abnormal condition. Any noticeable abnormality in the product indicates that the product needs servicing.
15. Replacement parts — In case the product needs replacement parts, make sure that the service person uses replacement parts specified by the manufacturer, or those with the same characteristics and performance as the original parts. Use of unauthorized parts can result in fire, electric shock and/or other danger.
16. Safety checks — Upon completion of service or repair work, request the service technician to perform safety checks to ensure that the product is in proper operating condition.
17. Wall mounting — When mounting the product on a wall, be sure to install the product according to the method recommended by the manufacturer.
18. Heat sources — Keep the product away from heat sources such as radiators, heaters, stoves and other heat-generating products (including amplifiers).

SAFETY PRECAUTIONS (Continued)

19. Batteries — Incorrect use of batteries may cause the batteries to burst or ignite. A leaky battery may corrode the equipment, dirty your hands or spoil your clothing. In order to avoid these problems, make sure to observe the precautions below:
 - Use the specified batteries only.
 - Install the batteries with due attention to the plus (+) and minus (-) sides of the batteries according to the instructions in the compartment.
 - Do not mix old and new batteries.
 - Do not mix batteries of different types. Voltage specifications of batteries of the same shape may vary.
 - Replace an exhausted battery with a new one promptly.
 - If you will not use the remote control for a long time, remove the batteries.
 - If leaked battery fluid gets on your skin or clothing, rinse immediately and thoroughly. If it gets into your eye, bathe your eye well rather than rubbing and seek medical treatment immediately. Leaked battery fluid that gets into your eye or your clothing may cause a skin irritation or damage your eye.
20. Usage of the monitor must not be accompanied by fatal risks or dangers that, could lead directly to death, personal injury, severe physical damage or other loss, including nuclear reaction control in nuclear facility, medical life support system, and missile launch control in a weapon system.
21. Do not stay in contact with the parts of the product that become hot for long periods of time. Doing so may result in low-temperature burns. If you need to move the monitor after it has been in use, it may be hot. Turn off the power and make sure it has cooled sufficiently before moving.
22. Do not modify this product.
23. To prevent fire or shock hazard, do not expose this product to dripping or splashing.
No objects filled with liquids, such as vases, should be placed on the product.
24. This product must only be connected to a 100-240V, 50/60Hz, grounded (3-prong) outlet.

WARNING:

- 1) This is a Class A product. In a domestic environment this product may cause radio interference in which case the user may be required to take adequate measures.
- 2) Batteries shall not be exposed to excessive heat such as sunshine, fire or the like.
- 3) To prevent injury, this apparatus must be securely attached to the floor/wall in accordance with the installation instructions.
- 4) An apparatus with CLASS I construction shall be connected to a MAIN socket outlet with a protective earthing connection.

To maintain compliance with EMC regulations, use shielded cables to connect to the following terminals: HDMI input terminal and PC D-sub input terminal.

If a monitor is not positioned in a sufficiently stable location, it can be potentially hazardous due to falling. Many injuries, particularly to children, can be avoided by taking simple precautions such as:

- Using fixing devices like wall mount brackets recommended by the manufacturer.
- Only using furniture that can safely support the monitor.
- Ensuring the monitor is not overhanging the edge of the supporting furniture.
- Not placing the monitor on tall furniture (for example, cupboards or bookcases) without anchoring both the furniture and the monitor to a suitable support.
- Not standing the monitors on cloth or other materials placed between the monitor and supporting furniture.
- Educating children about the dangers of climbing on furniture to reach the monitor or its controls.
- This equipment is not suitable for use in locations where children are likely to be present unsupervised.

Especially for child safety

- Don't allow children to climb on or play with the monitor.
- Don't place the monitor on furniture that can easily be used as steps, such as a chest of drawers.
- Remember that children can become excited while watching a program, especially on a "larger than life" monitor. Care should be taken to place or install the monitor where it cannot be pushed, pulled over, or knocked down.
- Care should be taken to route all cords and cables connected to the monitor so that they cannot be pulled or grabbed by curious children.

IMPORTANT SAFETY INSTRUCTIONS

- 1) Read these instructions.
- 2) Keep these instructions.
- 3) Heed all warnings.
- 4) Follow all instructions.
- 5) Do not use this apparatus near water.
- 6) Clean only with dry cloth.
- 7) Do not block any ventilation openings. Install in accordance with the manufacturer's instructions.
- 8) Do not install near any heat sources such as radiators, heat registers, stoves, or other apparatus (including amplifiers) that produce heat.
- 9) Do not defeat the safety purpose of the polarized or grounding-type plug. A polarized plug has two blades with one wider than the other. A grounding type plug has two blades and a third grounding prong. The wide blade or the third prong are provided for your safety. If the provided plug does not fit into your outlet, consult an electrician for replacement of the obsolete outlet.
- 10) Protect the power cord from being walked on or pinched particularly at plugs, convenience receptacles, and the point where they exit from the apparatus.
- 11) Only use attachments/accessories specified by the manufacturer.
- 12) Use only with the cart, stand, tripod, bracket, or table specified by the manufacturer, or sold with the apparatus. When a cart is used, use caution when moving the cart/apparatus combination to avoid injury from tip-over.
- 13) Unplug this apparatus during lightning storms or when unused for long periods of time.
- 14) Refer all servicing to qualified service personnel. Servicing is required when the apparatus has been damaged in any way, such as power-supply cord or plug is damaged, liquid has been spilled or objects have fallen into the apparatus, the apparatus has been exposed to rain or moisture, does not operate normally, or has been dropped.



TIPS AND SAFETY INSTRUCTIONS

- The TFT color LCD panel used in this monitor is made with the application of high precision technology. However, there may be minute points on the screen where pixels never light or are permanently lit. Also, if the screen is viewed from an acute angle there may be uneven colors or brightness. Please note that these are not malfunctions but common phenomena of LCDs and will not affect the performance of the monitor.
- Do not display a still picture for a long period, as this could cause a residual image.
- Never rub or tap the monitor with hard objects.
- Please understand that SHARP CORPORATION bears no responsibility for errors made during use by the customer or a third party, nor for any other malfunctions or damage to this product arising during use, except where indemnity liability is recognized under law.
- This monitor and its accessories may be upgraded without advance notice.
- Do not use the monitor where there is a lot of dust, where humidity is high, or where the monitor may come into contact with oil or steam. Do not use in an environment where there are corrosive gases (sulfur dioxide, hydrogen sulfide, nitrogen dioxide, chlorine, ammonia, ozone, etc.). As this could lead to fire.
- Ensure that the monitor does not come into contact with water or other fluids. Ensure that no objects such as paper clips or pins enter the monitor as this could lead to fire or electric shock.
- Do not place the monitor on top of unstable objects or in unsafe places. Do not allow the monitor to receive strong shocks or to strongly vibrate. Causing the monitor to fall or topple over may damage it.
- Do not use the monitor near heating equipment or in places where there is likelihood of high temperature, as this may lead to generation of excessive heat and outbreak of fire.
- Do not use the monitor in places where it may be exposed to direct sunlight. Risk of cabinet deformation and failure if the monitor is used in direct sunlight.
- Please be sure to constantly remove dust and garbage that has attached to the ventilation opening. If dust collects in the ventilation opening or the inside of the monitor, it may lead to excessive heat, outbreak of fire, or malfunction. Please request a cleaning of the inside of the monitor from an authorized SHARP servicing dealer or service center.
- When using the monitor in portrait orientation, prepare portrait-oriented content. Landscape content cannot be rotated to portrait orientation on the monitor. Prepare portrait content in advance.
- The AC outlet shall be installed near the equipment and shall be easily accessible.

The Power Cord

- Use only the power cord supplied with the monitor.
- Do not damage the power cord nor place heavy objects on it, stretch it or over bend it. Also, do not add extension cords. Damage to the cord may result in fire or electric shock.
- Do not use the power cord with a power tap. Adding an extension cord may lead to fire as a result of overheating.
- Do not remove or insert the power plug with wet hands. Doing so could result in electric shock.
- Unplug the power cord if it is not used for a long time.
- Do not attempt to repair the power cord if it is broken or malfunctioning. Refer the servicing to the service representative.

Manual Scope

- Microsoft, Windows and Internet Explorer are either registered trademarks or trademarks of Microsoft Corporation in the United States and/or other countries.
- The terms HDMI and HDMI High-Definition Multimedia Interface, and the HDMI Logo are trademarks or registered trademarks of HDMI Licensing, LLC in the United States and other countries.
- Adobe, Acrobat, Adobe RGB, Adobe RGB (1998), and Reader are either registered trademarks or trademarks of Adobe Systems Incorporated in the United States and/or other countries.
- MHL, the MHL logo, and Mobile High-Definition Link are trademarks or registered trademarks of MHL, LLC in the United States and other countries.
- The monitor is manufactured based on a license from Dolby Laboratories.
- Dolby and Double D Signal are trademarks of Dolby Laboratories.
- All other brand and product names are trademarks or registered trademarks of their respective holders.
- Language of OSD menu used in this manual is English by way of example.
- Illustrations in this manual may not exactly represent the actual product or display.
- This manual assumes use in landscape orientation, except where specifically noted.

LED Backlight

- The LED backlight in this product has a limited lifetime.
 - * If the screen gets dark or does not turn on, it may be necessary to replace the LED backlight.
 - * This LED backlight is exclusive to this product and must be replaced by an authorized SHARP servicing dealer or service center. Please contact an authorized SHARP servicing dealer or service center for assistance.

MOUNTING PRECAUTIONS

- This product is for use indoors.
- A mounting bracket compliant with VESA specifications is required.
- Since the monitor is heavy, consult your dealer before installing, removing or moving the monitor.
- Mounting the monitor on the wall requires special expertise and the work must be performed by an authorized SHARP dealer. You should never attempt to perform any of this work yourself. Our company will bear no responsibility for accidents or injuries caused by improper mounting or mishandling.
- Use the monitor with the surface perpendicular to a level surface. If necessary, the monitor may be tilted up to 20 degrees upward or downward.
- When moving the monitor, be sure to hold it with the handles, the unit bottom and sides. Do not grasp the screen and corners. This may cause product damage, failure, or injury.
- This monitor should be used at an ambient temperature between 32°F (0°C) and 104°F (40°C). Provide enough space around the monitor to prevent heat from accumulating inside.

For the monitor in landscape orientation

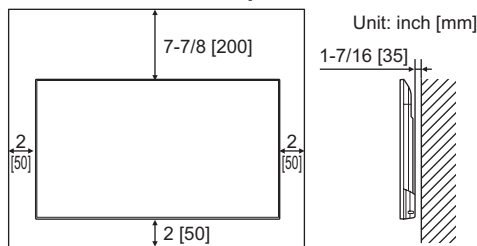

For the monitor in portrait orientation

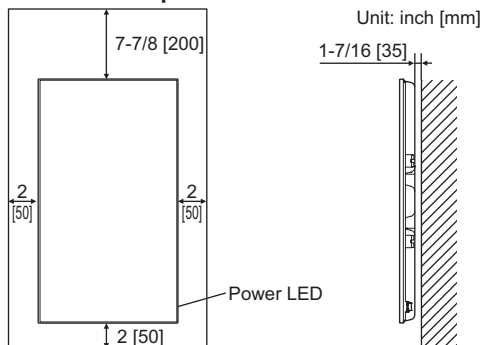

- If it is difficult to provide sufficient space for any reason such as the installation of the monitor inside a housing, or if the ambient temperature may be outside of the range of 32°F (0°C) to 104°F (40°C), install a fan or take other measures to keep the ambient temperature within the required range.
- Temperature condition may change when using the monitor together with the optional equipments recommended by SHARP. In such cases, please check the temperature condition specified by the optional equipments.
- Do not block any ventilation openings. If the temperature inside the monitor rises, this could lead to a malfunction.
- Do not place the monitor on a device which generates heat.

- Adhere to the following when installing the monitor in its portrait orientation. Failing to adhere to the following may cause malfunctions.
 - Install the monitor such that the power LED is located on the bottom side.
 - Set the MONITOR on the MONITOR menu to PORTRAIT. (See page 28.)
- Even when the ambient temperature is 104°F (40°C) or less in a portrait installation, the brightness of the backlight may automatically decrease if the temperature inside the monitor becomes too hot. This is to prevent further heating of the interior.
- Use the supplied sticker.

For the monitor in landscape orientation

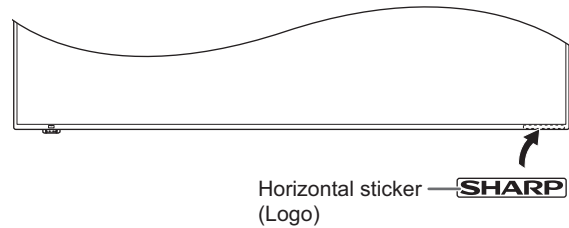

For the monitor in portrait orientation

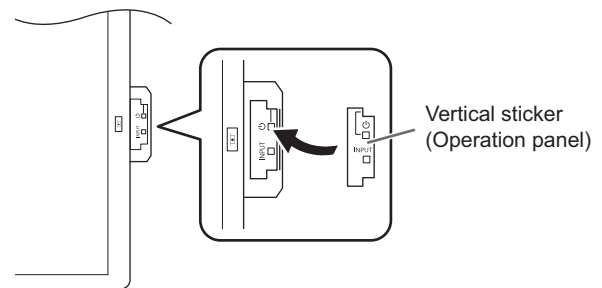

Be careful not to cover the remote control sensor or switches.

Contents

IMPORTANT INFORMATION	3	Menu Items	24
DEAR SHARP CUSTOMER	4	Displaying the menu screen.....	24
SAFETY PRECAUTIONS	4	Menu item details.....	25
IMPORTANT SAFETY INSTRUCTIONS	6	Character input.....	29
TIPS AND SAFETY INSTRUCTIONS	7	Adjustments for PC screen display.....	29
MOUNTING PRECAUTIONS	8	Functional Restriction Setting (FUNCTION)	30
Supplied Components	9	Controlling the Monitor with a PC (RS-232C)	31
Part Names	10	PC connection.....	31
Connecting Peripheral Equipment	12	Communication conditions.....	31
Connection with a PC or AV equipment.....	12	Communication procedure.....	31
Connecting the Power Cord	14	Control command table.....	33
Removing the Handles	14	Controlling the Monitor with a PC (LAN)	36
Binding Cables	15	Settings to connect to a LAN.....	36
Setting the USB flash drive cover	15	Command-based control.....	37
Preparing the Remote Control Unit	16	Troubleshooting	38
Installing the batteries.....	16	Specifications	39
Remote control operation range.....	16	Intellectual Property Rights and Other Matters	
Turning Power On/Off	17	that Apply to This Software	44
Turning on the main power.....	17	Mounting Precautions	
Turning power on/off.....	17	(For SHARP dealers and service engineers)	52
Disabling power on/off operations.....	17		
Basic Operation	18		
Playing files	20		
Playing files.....	20		
Auto playback.....	22		
Operations during play.....	22		
Function menu.....	23		

Supplied Components

If any component should be missing, please contact your dealer.

- Liquid Crystal Display Monitor: 1
- Remote control unit: 1
- Cable clamp: 4



- Cable clamp (insertion type): 1



- Cable clamp (for power cord): 1



- Power cord: 1
 - LR-6 battery ("AA" size): 2
 - CD-ROM (Utility Disk for Windows): 1
 - Setup Manual: 1
 - USB flash drive cover: 1
 - Horizontal sticker (Logo): 1
 - Vertical sticker (Operation panel): 1
 - RS-232C conversion cable (3.5 mm mini jack): 1
 - USB extension cable: 1
 - DisplayPort-HDMI conversion cable: 1
- Connect to the computer's DisplayPort, and connect to the monitor with a commercially available HDMI cable.

* SHARP Corporation holds authorship rights to the Utility Disk program. Do not reproduce it without permission.

* For environmental protection!

Do not dispose of batteries in household waste. Follow the disposal instructions for your area.

Part Names

■ Front view

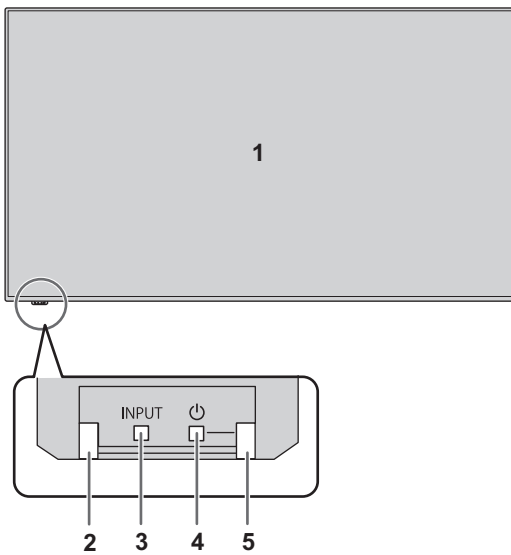

Accessing the operation panel

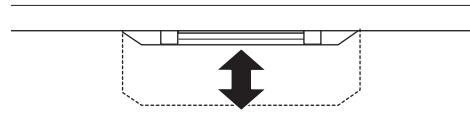

1. LCD panel
2. Remote control sensor (See page 16.)
3. Input switch (See page 18.)
4. Power switch (See page 17.)
5. Power LED (See page 17.)

TIPS

- Use a pointed object such as a pen tip to press the switches.

■ Rear view

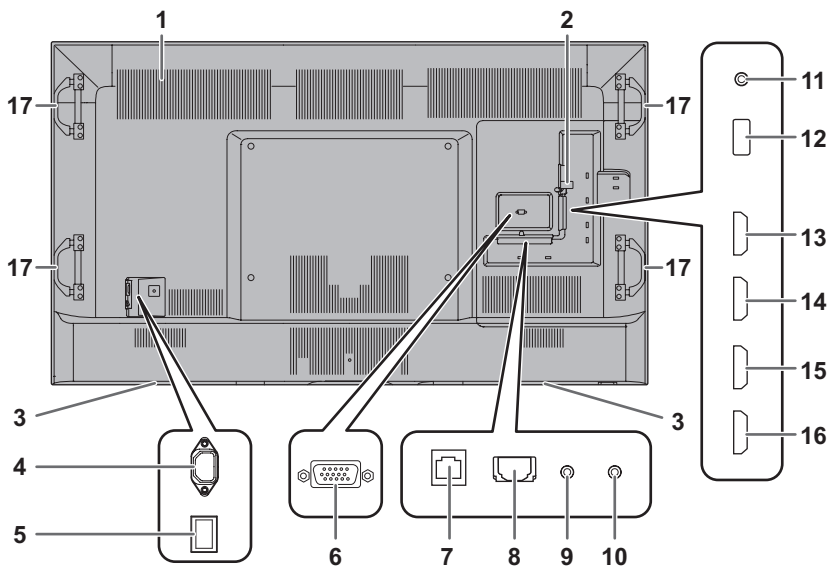

1. Vents
2. USB flash drive cover (See page 15.)
3. Speakers
4. AC input terminal (See page 14.)
5. Main power switch (See page 17.)
6. PC D-sub input terminal (See page 13.)
7. LAN terminal (See page 13.)
8. Digital audio output (optical) terminal (See page 13.)
9. Audio input terminal (See page 13.)
10. CONTROL terminal (RS-232C input terminal) (See page 13.)
11. Headphone terminal (See page 13.)
12. USB port (See page 13.)
13. HDMI1 input terminal (See page 12.)
14. HDMI2 input terminal (See page 12.)
15. HDMI3 input terminal (See page 12.)
16. HDMI4 input terminal (See page 12.)
17. Handles (See page 14.)

■ Remote control unit

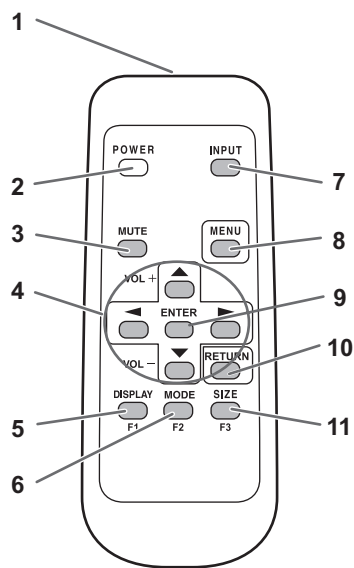

1. Signal transmitter
2. POWER button (See page 17.)
3. MUTE button (See page 18.)
4. VOL +/- buttons (See page 18.)
- Cursor control (▲ / ▼ / ◀ / ▶) buttons
5. DISPLAY/F1 button (See page 18.)
6. MODE/F2 button (See page 18.)
7. INPUT button (See page 18.)
8. MENU button (See page 18.)
9. ENTER button (See page 18.)
10. RETURN button (See page 18.)
11. SIZE/F3 button (See page 18.)

Connecting Peripheral Equipment

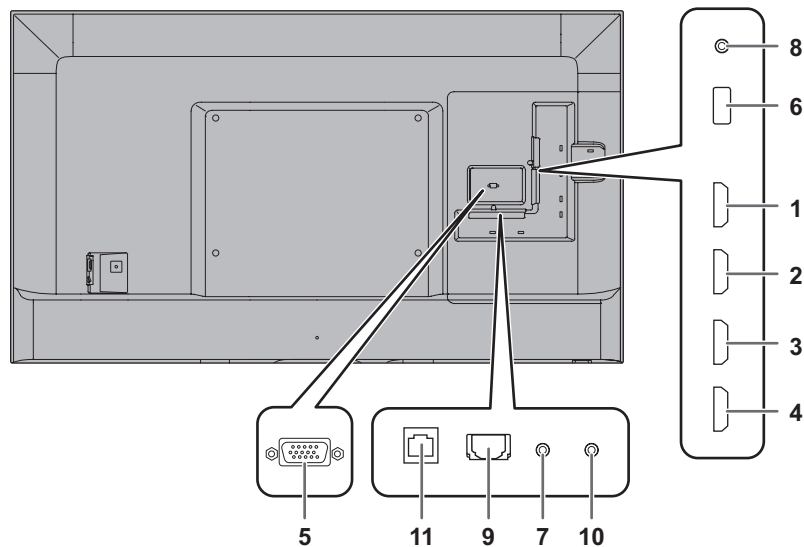

! Caution

- Be sure to turn off the main power switch and disconnect the plug from the power outlet before connecting/ disconnecting cables. Also, read the manual of the equipment to be connected.
- Be careful not to confuse the input terminal with the output terminal when connecting cables. Accidentally reversing cables connected to the input and output terminals may cause malfunctions and the other problems.
- Do not use any cable that has a damaged or deformed terminal. Using such cables may cause malfunctions.

TIPS

- Images may not be displayed properly depending on the computer (video card) to be connected.
- Perform automatic adjustment using SCREEN POSITION of INPUT SELECT in the SETUP menu when a PC screen is displayed using D-SUB, or when the setting of the PC is changed.
- If the audio output from the playback device is connected directly to speakers or other devices, the video on the monitor may appear delayed from the audio portion. Audio should be played through this monitor by connecting the playback device to the monitor's audio input, and connecting the monitor's audio output to the speakers or other devices.

Connection with a PC or AV equipment

1. HDMI1 input terminal
2. HDMI2 input terminal
3. HDMI3 input terminal
4. HDMI4 input terminal

	HDCP ^{*1}	ARC ^{*2}	MHL ^{*3}	Color format when a 3840 x 2160 (60Hz) video signal is used ^{*4}
HDMI1	1.4	Yes	No	4:4:4, 4:2:2, 4:2:0
HDMI2		No	No	
HDMI3		No	No	
HDMI4	2.2	No	Yes	4:2:0

*1 Compatible copyright protection signals

- HDMI1 - 3 input terminals: HDCP1.4
- HDMI4 input terminal: HDCP2.2

When the connection between HDMI1 to HDMI3 and HDMI4 is switched, it could be necessary to reconfigure the computer.

*2 The HDMI1 input terminal is compatible with ARC (Audio Return Channel).

To connect an ARC-compatible audio device using an HDMI cable, connect to the HDMI1 input terminal.

*3 The HDMI4 input terminal is compatible with MHL (Mobile High-Definition Link).

An MHL-compatible smartphone can be connected using a commercially available MHL cable to show video from the smartphone on the monitor while charging the smartphone. When a MHL is connect, the input is automatically switched to HDMI4.

This product supports MHL1.

*4 For a 3840 × 2160 (60 Hz) video signal

- HDMI1 - 3 input terminals are compatible with 4:4:4, 4:2:2, and 4:2:0 formats.
- HDMI4 input terminal is only compatible with 4:2:0 format.

If ARC connection is not necessary while inputting 4:2:0 format, use the HDMI4 input terminal. If an HDMI1 - 3 input terminal is used and a computer with significant noise in the signal is connected, the video or audio may not be output correctly.

- Connect with a commercially available HDMI certified cable (a high-speed type is recommended). For the following, use a high-speed HDMI cable:
 - When connecting a device that is compatible with 4K2K output.
 - When inputting a 1080p video signal
- When using the supplied DisplayPort-HDMI conversion cable, use the HDMI1 - 3 input terminal.
- When using the audio input terminal with HDMI input, use the HDMI3 input terminal and set AUDIO SELECT of INPUT SELECT in the SETUP menu to HDMI + ANALOG.
- Compatible audio signals
 - Type: Linear PCM (2 ch), AAC, Dolby Digital
 - Sampling frequency: 48kHz / 44.1kHz / 32kHz
- Use an HDMI cable connector with the following dimensions:

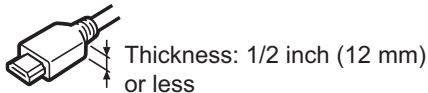

5. PC D-sub input terminal

- When using the audio input terminal with the PC D-sub input terminal, set AUDIO SELECT of INPUT SELECT in the SETUP menu to VIDEO + AUDIO.
- When using the PC D-sub input terminal, space is required behind the monitor.

6. USB port

- Connect a USB flash drive to the USB port.
- Do not connect a USB device other than a USB flash drive.
- Turn off the power of the monitor when removing a USB flash drive.

Supported USB flash drives

File System	FAT32
Capacity	Up to 32 GB (maximum file size 2 GB)

- Do not use a USB flash drive with a security function or a write protection function.
- Use a USB flash drive with a shape that can be inserted in the USB port. Some USB flash drives with special shapes cannot be inserted. Do not forcibly insert a USB flash drive. This may damage the connector and cause failure.

7. Audio input terminal

- This is used to input analog audio when video is shown using the HDMI3 input terminal or the PC D-sub input terminal. Check the setting in AUDIO SELECT of INPUT SELECT in the SETUP menu.
- Use an audio cable without resistance.

8. Headphone terminal

- Use commercially available headphones (mini stereo jack).
- The output sound varies depending on the input mode.
- The volume can be adjusted using the volume adjustment.
- When headphones are connected to the headphone terminal, sound is not output from the monitor speakers.

9. Digital audio output (optical) terminal

- You can output MPEG2 AAC / Dolby Digital audio format from the monitor.
- Use the following for the digital audio output (optical) terminal.

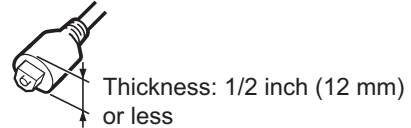

10. CONTROL terminal (RS-232C input terminal)

- The monitor can be connected to a PC using the RS-232C conversion cable (supplied) and a commercially available RS-232 straight cable to control the monitor from the PC.

11. LAN terminal

- You can control the monitor from a PC on a network by connecting a commercially available LAN cable between this terminal and a network.

Connecting the Power Cord

! Caution

- Use only the power cord supplied with the monitor.
1. Turn off the main power switch.
 2. Plug the power cord (supplied) into the AC input terminal.
 3. Plug the power cord (supplied) into the AC power outlet.

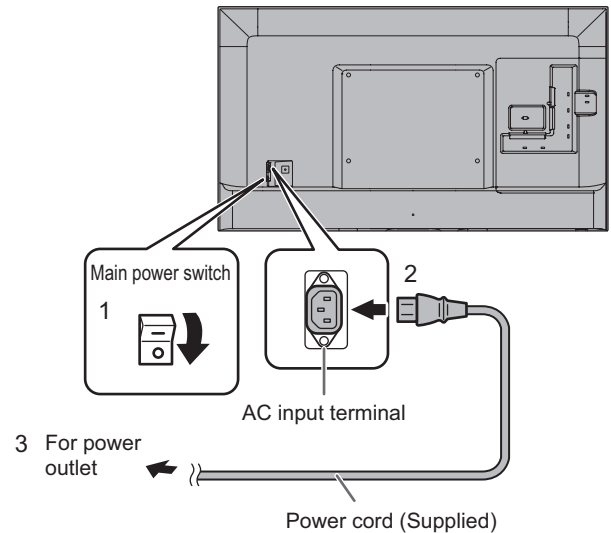

TIPS

- When installing the monitor in landscape orientation, be sure to clamp the power cord (supplied) onto the cable clamp attachment using the supplied cable clamp (for power cord). When clamping the power cord, take care not to stress the terminal of the power cord. Do not bend the power cord excessively. For information on how to attach the cable clamp, see page 15.

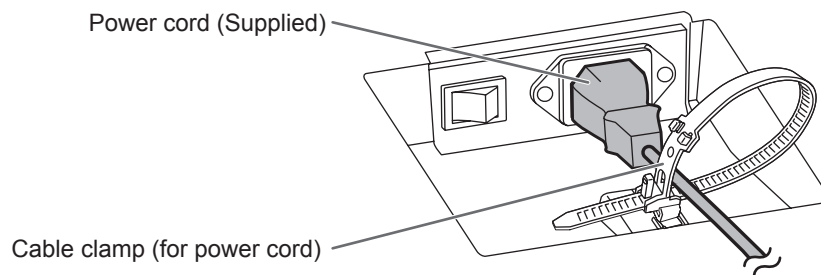

Removing the Handles

The handles can be removed.

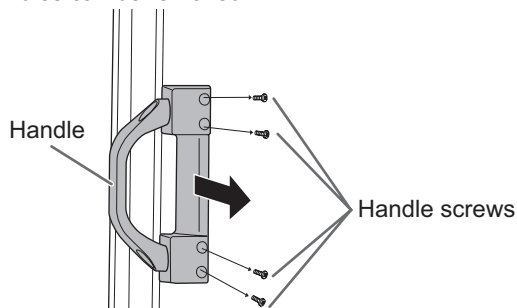

! Caution

- The removable handles and handle screws are for use with this monitor. Do not use them for any other devices.
- To attach handles, be sure to use the handles and handle screws which were removed from this monitor.
- Be sure the handles are attached securely.

Binding Cables

The cables connected to the terminals on the rear of the monitor can be fastened with the cable clamp.

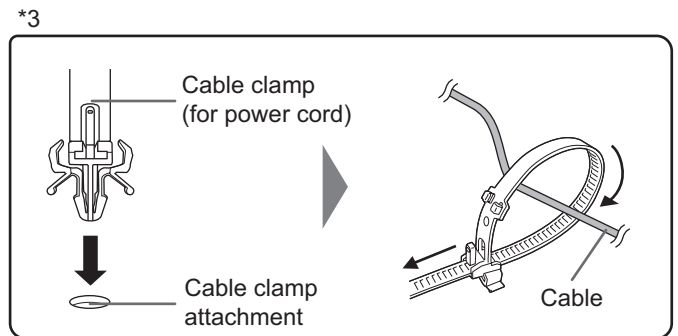
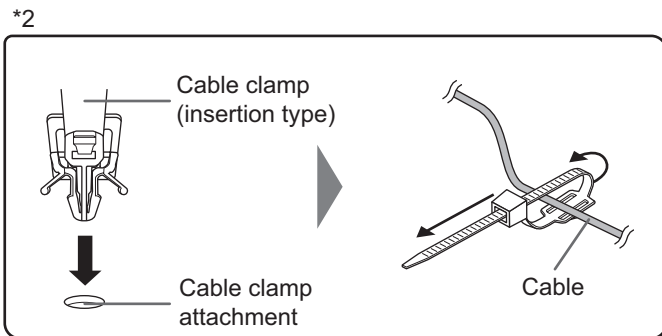
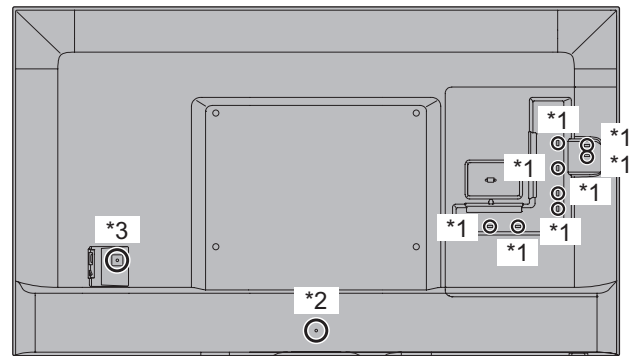
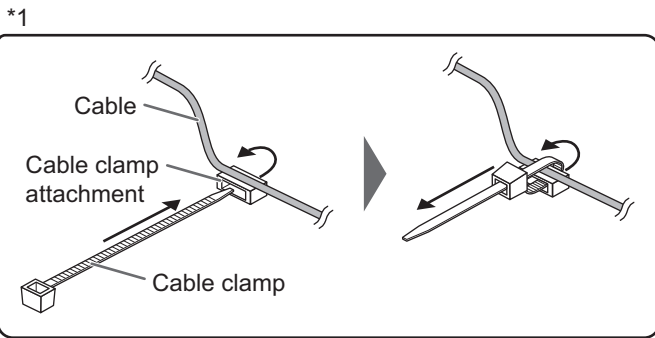

Setting the USB flash drive cover

1. Insert the USB flash drive into the USB port.

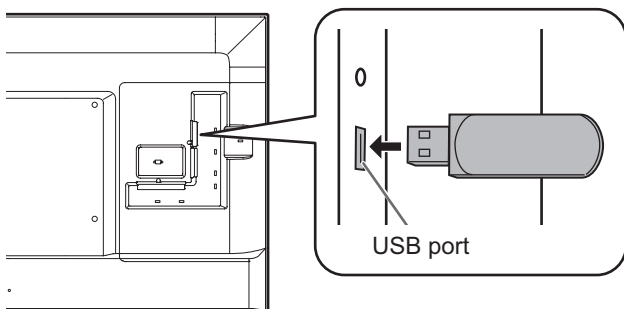

2. Remove the screw from the monitor, attach the USB flash drive cover, and fasten with the screw that you removed.

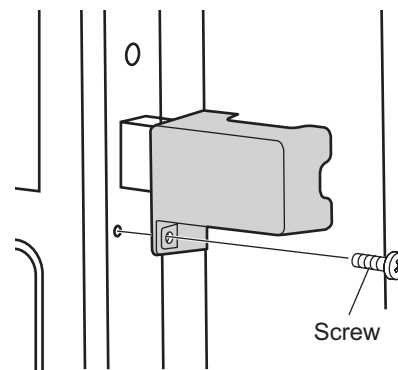

! Caution

- Do not tighten the screw excessively. Excessive tightening may damage the monitor.

TIPS

- If the USB flash drive cover will be attached, use a USB flash drive with dimensions no greater than 1-15/16 inch (50 mm) (L) × 13/16 inch (20 mm) (W) × 1/2 inch (12 mm) (H).

Preparing the Remote Control Unit

Installing the batteries

1. Press the cover gently and slide it in the direction of the arrow.

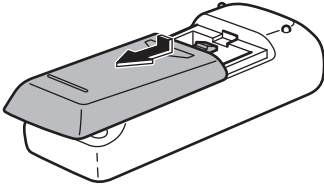

2. See the instructions in the compartment and put in the supplied batteries (LR-6 ("AA" size) x 2) with their plus (+) and minus (-) sides oriented correctly.
3. Close the cover.

TIPS

- When the batteries become exhausted, replace them with new (commercially available) batteries.
- The supplied batteries (LR-6 ("AA" size) x 2) may become exhausted quickly depending on how they are stored.
- If you will not be using the remote control for a long time, remove the batteries.
- Use manganese or alkaline batteries only.

Remote control operation range

Operation panel in

The remote control can be operated even when the operation panel is stored inside the monitor.

Point the remote control toward the remote control sensor on the bottom of the monitor (or the right side of the monitor if using portrait orientation).

For the monitor in landscape orientation

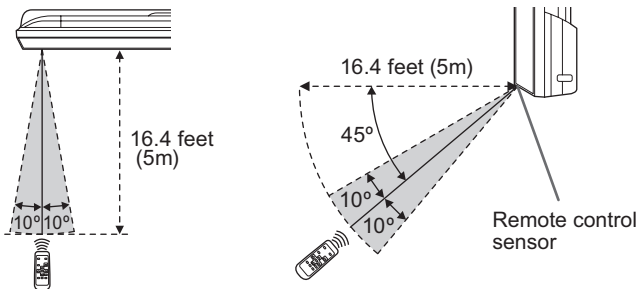

For the monitor in portrait orientation

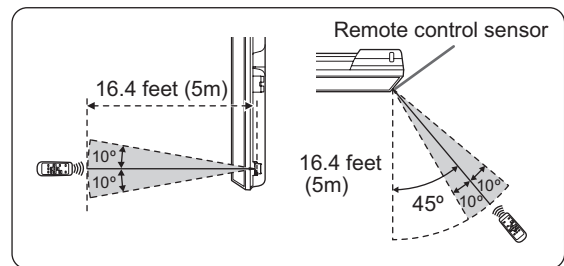

Operation panel out

Point the remote control toward the remote control sensor on the front of the monitor.

For the monitor in landscape orientation

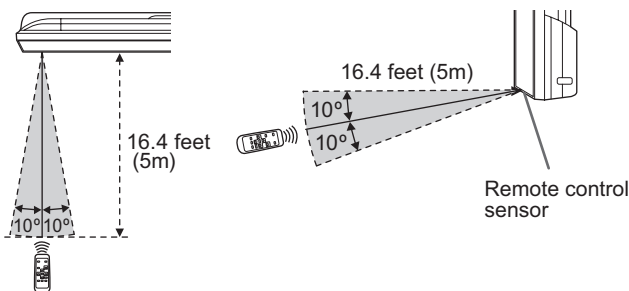

For the monitor in portrait orientation

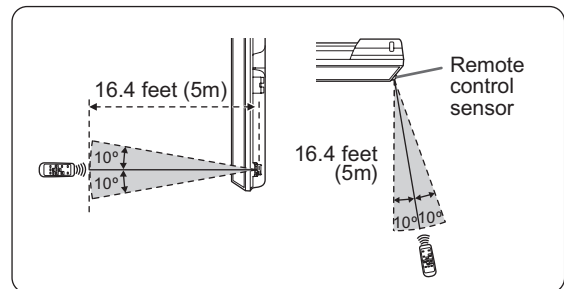

TIPS

- Do not expose the remote control unit to shock by dropping or stepping on it. This could lead to a malfunction.
- Do not expose the remote control unit to liquids, and do not place it in an area with high humidity.
- The remote control unit may not work properly if the remote control sensor is under direct sunlight or strong lighting.
- Objects between the remote control unit and the remote control sensor may prevent proper operation.
- Replace the batteries when they run low as this may shorten the remote control's operation range.
- If a fluorescent light is illuminated near the remote control unit, it may interfere with proper operation.
- Do not use it with the remote control of other equipment such as air conditioner, stereo components, etc.

Turning Power On/Off

! Caution

- Turn on the monitor first before turning on the PC or playback device.

Turning on the main power

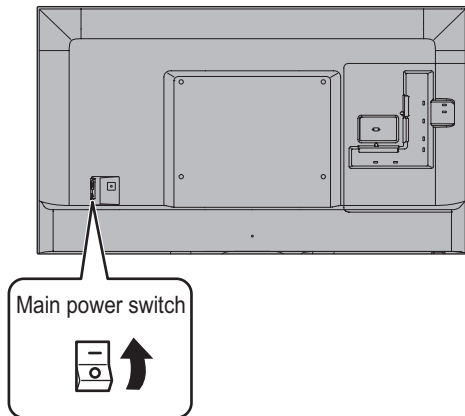

! Caution

- The main power must be turned on/off with the main power switch. Do not connect/disconnect the power cord or turn the breaker on/off while the main power switch is on.
- When turning the power off and back on, always wait for at least 5 seconds.
- For a complete electrical disconnection, pull out the main plug.

Turning power on/off

Press the POWER button or POWER switch to turn the power ON/OFF.

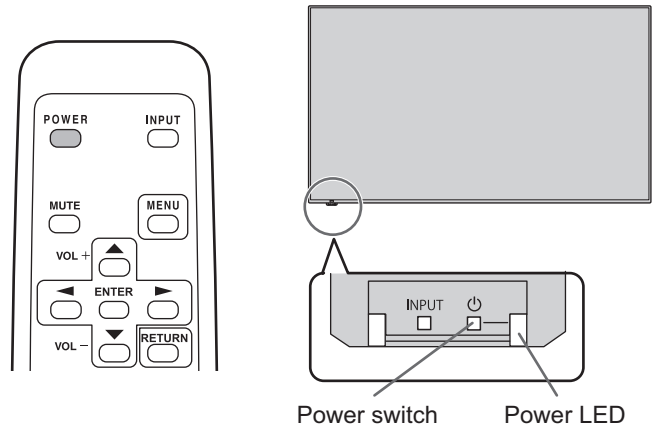

Status	Status of the monitor
Green lit	Power on
Orange lit	Power off (Standby mode)
Green flashing	Input signal waiting mode

It is possible to check the power LED even when the operation panel is stored inside the monitor.

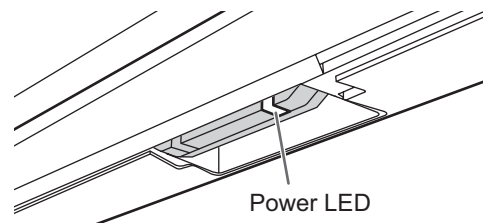

! Caution

- When turning the power off and back on, always wait for at least 5 seconds. A short interval may result in a malfunction.

TIPS

- When the main power switch is off, the monitor cannot be turned on.
- In the input signal waiting mode, the power turns on when the POWER button on the remote control or the POWER switch on the monitor is pressed. No other operations can be performed.
- The power on turns on from the input signal waiting mode (the power "on" state is entered) by signal input only when INPUT SIGNAL ON in MONITOR menu is set to YES and a when signal is input into the currently selected terminal.

Disabling power on/off operations

Power on/power off operations can be disabled in order to protect the monitor from an accidental power off. Set the POWER BUTTON LOCK in FUNCTION menu. (See page 30.)

Basic Operation

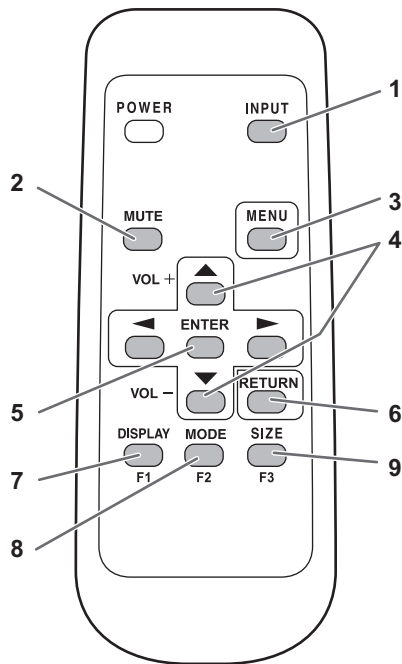

1. INPUT (Input mode selection)

The menu is displayed. Press or to select the input mode, and press to enter.

- * You can select the input mode that shows SELECTABLE.
- * You can select the input mode by pressing the input switch of the monitor.

Video and audio input terminals for each input mode are shown below.

Input mode	Video	Audio
HDMI1	HDMI1 input terminal	HDMI1 input terminal
HDMI2	HDMI2 input terminal	HDMI2 input terminal
HDMI3	HDMI3 input terminal	HDMI3 input terminal/ Audio input terminal *1
HDMI4	HDMI4 input terminal	HDMI4 input terminal
D-SUB	PC D-sub input terminal	Audio input terminal *2
MULTIMEDIA *3	USB port / Internal memory	USB port

*1 When using the audio input terminal with HDMI3, set AUDIO SELECT of INPUT SELECT in the SETUP menu to HDMI + ANALOG. (See page 27.)

*2 When using the audio input terminal, set AUDIO SELECT of INPUT SELECT in the SETUP menu to VIDEO + AUDIO. (See page 27.)

*3 MULTIMEDIA menu is displayed in landscape.

When a USB flash drive is connected, the input mode automatically changes to MULTIMEDIA.

2. MUTE

Turns off the volume temporarily.

Press the MUTE button again to turn the sound back to the previous level.

3. MENU

Displays and turns off the menu screen. (See page 24.)

4. VOL +/- (Volume adjustment)

Pressing or displays the volume menu when the menu screen is not displayed.



Press or to adjust the volume of the sound.

* If you do not press any buttons for about 3 seconds, the volume menu automatically disappears.

5. ENTER

Confirms the setting.

6. RETURN

Returns to the previous screen.

7. DISPLAY/F1

Displays monitor information (input mode, resolution, etc.).

8. MODE/F2 (Picture mode selection)

Each time you press this button, the picture mode changes in the following order:

PC* → PHOTO → sRGB → VIVID → Adobe RGB SIM.
→ AV → MOVIE → GAME → PC...

* PC applies to HDMI1 - HDMI4, D-SUB only.

- sRGB is international standard of color representation specified by IEC (International Electrotechnical Commission). Color conversion is made in taking account of liquid crystal's characteristics and represents color tone close to its original image.
- Adobe® RGB SIM. is a color space promoted by Adobe Systems Incorporated. This color space has a wider reproduction range than sRGB and enables the expression of nuanced color tones. Use this mode to express content that is compatible with Adobe RGB.

9. SIZE/F3 (Screen size selection)

The screen size menu is displayed.

Press or to select the screen size. (See page 19.)

TIPS

- 7 (F1), 8 (F2), and 9 (F3) are also used in MULTIMEDIA and during character entry.

■ Switching the screen size

Even when the screen size is changed, the display may remain the same depending on the input signal.

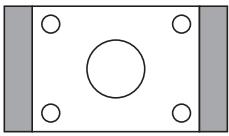
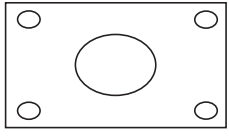
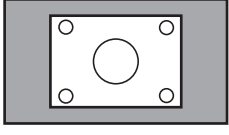
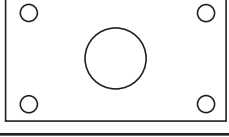
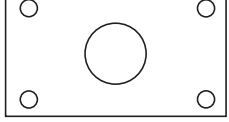
NORMAL		Displays image so it fills the screen without changing the aspect ratio of the input signals.
WIDE		Displays image so it fills the entire screen.
DOT BY DOT		Displays the dots of the signals input from the connected PC as the corresponding dots on the screen. When the image resolution is 1920x1080 pixels or lower, the image is expanded to twice the height and width of the original.
UNDERSCAN		Displays the image of the input signal without modification.
ZOOM		Displays a CinemaScope or 16:9 size video content in full-screen mode.

TIPS

- Using this monitor's screen-size switching to compress or expand the screen for commercial or public viewing in establishments like cafes or hotels may infringe on the rights of the creators, as protected by Copyright Law, so please be careful.
- The appearance of the original video may change if you select a screen size with a different aspect ratio than the original image (e.g. TV broadcast or video input from external equipment).
- When an ordinary non-wide image (4:3) is viewed with the whole screen using the screen-size switching function of this monitor, the edge of the image may be lost or appear distorted. If you wish to respect the creator's intentions, set the screen size to "NORMAL".
- When playing commercial software, parts of the image (like subtitles) may be cropped. In this case select the optimal screen size using the screen-size switching function of this monitor. With some software, there may be noise or distortion at the edges of the screen. This is due to the characteristics of the software, and is not a malfunction.
- Depending on the original image size, black bands may remain at the edges of the screen.
- Input signals under 4K2K resolution are displayed in 3840 x 2160 resolution level by upscaling. (Except for DOT BY DOT)

Playing files

You can play photo, music, and video files in a USB flash drive connected to the monitor, or photo files in internal memory. For information on USB flash drive, see page 13.

■ Supported formats

The types of files that can be played are as follows.

The operation of formats not indicated in the table is not guaranteed.

Photo files

Extension	Display size
.jpg (.jpeg, *.jpe)	32 x 32 - 8192 x 8192 (pixel)

- Progressive JPEG files are not supported.
- Supported color formats are YUV4:4:4/YUV4:2:2/YUV4:2:0.

Music files

Extension	Audio codec
*.mp3	MPEG-1 L3
*.wav	WAV (LPCM)
*.wma	WMA
*.m4a	AAC (MPEG4)

Video files

Video files up to Full HD can be played.

Extension	Video codec	Audio codec
*.m2ts	MPEG2/H.264	AAC, AC-3, MP3, LPCM
*.mp4	H.264	AAC, AC-3, MP3
*.3gp	H.264	AAC
*.mov	H.264	AAC, AC-3, MP3, LPCM

- Both video codec and audio codec need to be supported.
- The recommended frame rate for video 30 fps.

- In some cases it may not be possible to play the above files.
- Do not place files other than the above in memory for playback.
- When file names or folder names are long, some characters may not appear in the list screen.
- Do not use a file that is over 2 GB.

Playing files





Play files in a USB flash drive

- You can play photo, music, and video files in a USB flash drive connected to the monitor.
- You can have photo or video files play automatically when a USB flash drive is connected or the power is turned on. (See page 22.)

Play files in internal memory

- You can play photo files in internal memory. The photo file must first be copied to internal memory. (See page 21.)
- You can have photo files play automatically when the power is turned on. (See page 22.)

■ Select the media from which the file will play

1. **Change an input mode to MULTIMEDIA. (See page 18.)**
When a USB flash drive is connected, the input mode automatically changes to MULTIMEDIA.
2. Press  (F1).
3. Select the media with  or .
4. When you have finished, press .

■ Playing files

For the actions that you can take in each screen, see page 22 to 23.

1. Select the type of file to be played with or , and press .
2. Select the folder with or , and press .
3. Select and play the file.

Photo files

- To play a file, select the file with , , or and press .
- Move to the previous file during display with . Move to the next file with .
- You can play a slideshow.
 - (1) Press (F2) to show the slideshow photo selection screen.
 - (2) Select each file with , , or , and press (F3) to check or uncheck the checkbox. Files with checkmarks are played in the slideshow.
 - (3) To start the slideshow, press (F2).

Music files / Video files

- To play a file, select the file with or and press .
 - You can select a file and press (F3) to check or uncheck the checkbox. After playing a file, checked files are played in order. When playing an unchecked file, that file is played only one time.
4. End playback

Photo files / Video files

- Press .

Music files

- Press (F2).

Playing music files in slide show

When playing a slideshow using photos in a USB flash drive, you can play multiple music files.

1. Select PHOTO with or and press .
2. Select the folder with or and press .
3. Press (F2) to show the slideshow photo selection screen, and select photos.
4. Press (F1) in the slideshow photo selection screen, select SELECT SLIDE SHOW BGM with or , and then press .
5. Check the media, and press .
6. Select the folder that contains the files you want to play with or , and press .
7. Select files.

Select each file with or , and press (F3) to check or uncheck the checkbox. Files with checkmarks are played at the same time as the slideshow. When it is finished, press .
8. When you have finished selecting the files, press to return to the slideshow photo selection screen.
9. Press (F2) to start the slideshow.

When playing a slideshow using photos in a USB flash drive, you can play multiple music files.

TIPS

- To return to the previous item, press .
- The slideshow and auto play (see page 22) order is the same as the order of the files shown in the list. If the photo file order is changed, the play order will also change. (See page 23.)
- In a portrait installation, a portrait photo may occasionally appear in landscape orientation. If this occurs, set the EXIF information (rotation information) in the file to no rotation using an image processing program on your computer.
- If you stop a video file before it is finished playing and then press to play the file, the file will resume from the point where it was stopped. To play the file from the beginning, start playback with (F2).
- The preview view of the video list may take time to appear with some files. Wait until the previews appear before performing the next step.

■ Copy photo files to internal memory

You can copy photo files from a USB flash drive to internal memory and play the files.

1. Insert the USB flash drive into a USB port on the monitor. (See page 13.)
2. Set the media to USB flash drive. (See page 20.)
3. Select PHOTO with or and press .
4. Select the folder that contains the files to be copied with or and press .
5. Press (F1), select COPY PHOTO with or and press .
6. Select the file copy method and press .
 - **ALL FOLDER**
Copy all files in a USB flash drive to the internal memory.
 - **CURRENT FOLDER**
Copy all files in the selected folder to the internal memory.
 - **SELECTED FILE**
You can select files to be copied with , , or , and then press (F3). When you have finished selecting files, press (F2).
7. Press .
8. Select the folder where the file will be copied to.

You can select CREATE NEW FOLDER to create a new folder.
9. Select YES with or and press .











File copying starts. To cancel while the file is being copied, press (CANCEL).
10. When copying finishes, press .

TIPS

- Files cannot be copied from internal memory to a USB flash drive.

Playing files

■ Delete multiple photo files from internal memory

1. Set the media to INTERNAL MEMORY. (See page 20.)
2. Select PHOTO with  or  and press .
3. Select the folder that contains file you want to delete with  or , and press .
4. Press  (F1), select DELETE PHOTE with  or  and press , and then delete the file.

Auto playback











Photos or video in a USB flash drive or photos in the internal memory can be played automatically.

■ Preparations

Prepare the photo files.

1. Create a folder named “autoplay” in the root folder of a USB flash drive or the internal memory, and copy the files to be automatically played to the folder.

Select whether EXTERNAL STORAGE or INTERNAL MEMORY is used for auto play.

1. Press , select OTHERS with  or  and press .
 2. Select MULTIMEDIA AUTOPLAY with  or  and press .
 3. Select the media that is used with  or  and press .
- INTERNAL MEMORY(PHOTO) : Internal memory
EXTERNAL STORAGE(PHOTO) : USB flash drive
EXTERNAL STORAGE(VIDEO) : USB flash drive
4. Press .

■ Auto playback of files

Operation depends on the MULTIMEDIA AUTOPLAY setting.

• INTERNAL MEMORY

Turn on the monitor power.

Auto play starts.

• EXTERNAL STORAGE

Connect a USB flash drive (see page 13) and turn on the monitor power.

Auto play starts.

You can connect a USB flash drive (see page 13) after turning on the monitor power.

Auto play starts.

TIPS

- Photos and video cannot be played automatically at the same time.
- Auto play plays all photo or video files in the “autoplay” folder. The files that are played cannot be selected.
- The auto play order is the same as the order of the files shown in the list. If the photo file order is changed, the play order will also change (see page 23).
- If the folder or a file format does not meet the above conditions for the folder or file format (see page 20), or if MULTIMEDIA AUTOPLAY is not correctly set in the OTHERS menu, auto playback will not start.



■ To stop auto play

1. Press .

Operations during play

■ Photo files

Operation is possible using the buttons below.

 /  : Show the previous photo file / next photo file. (Single photo display only)

 (F1) : Show the Function menu. (See page 23.)

 (F2) : Show/hide guidance.



 (F3) : Rotate the display 90° clockwise. (Single photo display only)

If you use this function to rotate a photo with portrait resolution, the image may become grainier and the rotation setting will not be saved. When using a portrait photo in a portrait installation, use a photo that has been rotated in advance.

 : End playback.

■ Music files

Operation is possible using the buttons below.

 : Pause the file that is being played.
To resume playing the paused file, press .

 /  : Adjust the volume of the sound.

 (F1) : Show the Function menu. (See page 23.)





 (F2) : End playback.

■ Video files

Operation is possible using the buttons below.



 /  : Adjust the volume of the sound.

 (F1) : Show the Function menu. (See page 23.)



When the operation panel is displayed, you can perform the actions below. Select the action with    , and execute with . Play, stop, rewind, fast-forward, pause, play previous/next file, rewind about 10 seconds, fast-forward about 30 seconds.

 (F2) : Show/hide guidance.

 : End playback.

When a video file is stopped before it finished, press  to resume the video or press  (F2) to play the video from the beginning.



Function menu

Press **DISPLAY** (F1) while each screen is displayed.
 Select an item with  or  and press **ENTER**.

■ Photo files

Photo file is selected

VOLUME SETTING

Adjust the volume with  or .

COPY PHOTO

Copy photo files from a USB flash drive to the internal memory. (See page 21.)

DELETE PHOTO

Delete multiple photo files from the internal memory.

SCREEN SIZE

Changes the screen size. (See page 19.)
 TRIMMING trims the top and bottom of a 4:3 video to show it in full screen mode without changing the aspect ratio.

SLIDE SHOW PHOTO SELECT

Show the slideshow photo selection screen. (See page 21.)

SLIDE SHOW SETTING

Set slideshow settings.

SORT

Sort the files.
 The slideshow and auto play will play in the sorted order.

SELECT MEDIA

Change the media that is used. (See page 20.)

Photo file copy / delete screen is displayed

SELECT ALL



Select all files in the selected folder.

CANCEL ALL

Cancel all file selections in the selected folder.

Slideshow photo selection screen is displayed

VOLUME SETTING

Adjust the volume with  or .

SCREEN SIZE

Changes the screen size. (See page 19.)
 TRIMMING trims the top and bottom of a 4:3 video to show it in full screen mode without changing the aspect ratio.

SLIDE SHOW SETTING

Set slideshow settings.

SELECT SLIDE SHOW BGM

Show the slideshow BGM selection screen. (See page 21.)

SET ALL SLIDE SHOW IMAGE



Select all files in the selected folder.

RESET ALL SLIDE SHOW IMAGE

Cancel all file selections in the selected folder.

Single photo file is displayed / Playing slideshow

VOLUME SETTING

Adjust the volume with  or .

SCREEN SIZE

Changes the screen size. (See page 19.)
 TRIMMING trims the top and bottom of a 4:3 video to show it in full screen mode without changing the aspect ratio.

SLIDE SHOW SETTING (Show the slideshow only)

Set slideshow settings.



PICTURE MODE

Changes the picture mode on the screen. (See page 18.)

■ Music files

Include the slideshow BGM selection screen.

VOLUME SETTING

Adjust the volume with  or .

SET ALL AUTO PLAY / SET ALL BGM

Select all files in the selected folder.

RESET ALL AUTO PLAY / RESET ALL BGM

Cancel all file selections in the selected folder.



SELECT MEDIA

Change the media that is used. (See page 20.)

■ Video files

Video file is selected

VOLUME SETTING

Adjust the volume with  or .

SET ALL AUTO PLAY

Select all files in the selected folder.

RESET ALL AUTO PLAY



Cancel all file selections in the selected folder.

SELECT MEDIA





Change the media that is used. (See page 20.)

Playing video file

VOLUME SETTING

Adjust the volume with  or .

OPERATION PANEL

Shows the operation panel to let you perform the following actions. Select the action with     and execute with **ENTER** : play, stop, rewind, fast forward, pause, play previous/next file, rewind about 10 seconds, fast forward about 30 seconds.

PICTURE MODE

Changes the picture mode on the screen. (See page 18.)

WIDE MODE

Changes the screen size. (See page 19.)

Menu Items

Displaying the menu screen

Video and audio adjustment and settings of various functions are enabled. This section describes how to use the menu items. See pages 25 to 28 for details of each menu items.

! Caution

- Do not turn the main power switch off while the menu items are being displayed. Doing so may initialize the settings.

■ Example of operation

(Adjusting CONTRAST in the PICTURE menu)

1. Press  to display the menu screen.

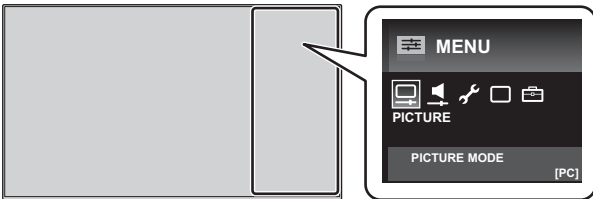

2. Press  or  to select PICTURE, and press .

3. Press  or  to select CONTRAST.

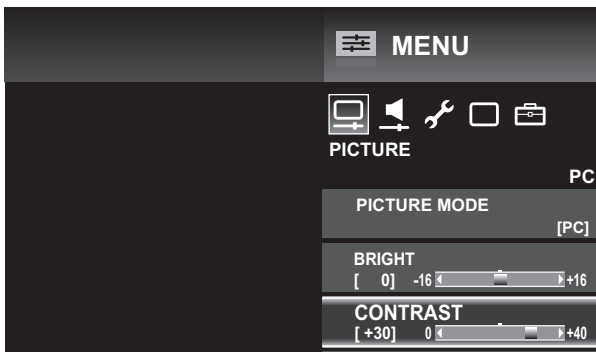

4. Press  or  to adjust the setting.

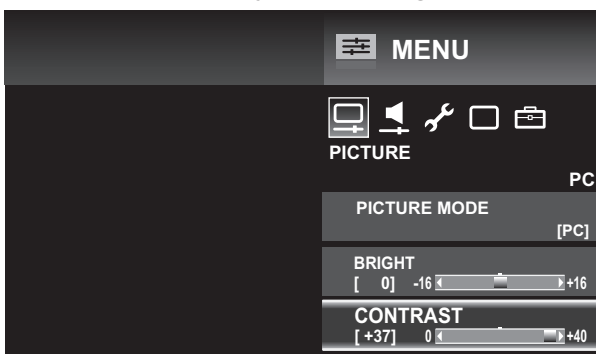

5. Press  to close the menu screen.

TIPS

- The menu will differ depending on the input mode.

■ Menu screen display

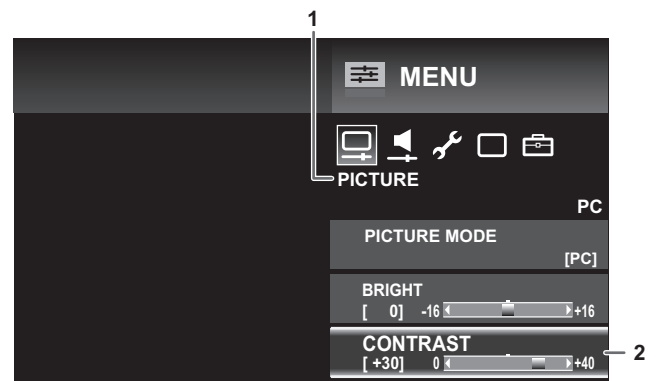

- 1 Name of the menu
- 2 An item being selected (highlighted)

Menu item details

The menu will differ depending on the input mode and the items that can be set vary depending on the mode.

■ PICTURE

PICTURE MODE

Changes the picture mode on the screen. The picture mode on the screen can also be changed using a remote control unit. (See page 18.)

BRIGHT

Adjusts the backlight brightness.

CONTRAST

Adjusts the difference between the bright and dark portions of the image.

BLACK LEVEL

Adjusts the entire brightness of the video signals.

TINT

Adjusts the hue. Selecting + changes the color towards green, and selecting - changes it towards magenta.

COLORS

Adjusts the color intensity.

SHARPNESS

Adjusts the sharpness of the image.

COLOR ADJUSTMENT

C.M.S.-HUE

Adjusts color tone with 6 colors of R (red), Y (yellow), G (green), C (cyan), B (blue), and M (magenta).

C.M.S.-SATURATION

Adjusts color vividness with 6 colors of R (red), Y (yellow), G (green), C (cyan), B (blue), and M (magenta).

C.M.S.-VALUE

Adjusts color brightness with 6 colors of R (red), Y (yellow), G (green), C (cyan), B (blue), and M (magenta).

WHITE BALANCE

Adjusts from a bluish white (color temperature: 12000K) to a reddish white (color temperature: 3000K). You can also change the R gain, G gain, and B gain values for each color temperature to perform fine adjustment of the white balance.

GAMMA ADJUSTMENT

Adjusts the gradation difference between bright parts and dark parts of video.

Menu Items

ADVANCED

QUICK SHOOT

- ADVANCED(HIGH), ADVANCED(LOW)..... Using interpolation, this shows video that is normally shown at 60 frames/sec at 120 frames/sec for a smoother picture. However, this may distort the picture of some videos. In this case, set to STANDARD or OFF.
- STANDARD..... This makes scenes with fast action clearer and easier to view.

ACTIVE CONTRAST

- Automatically adjusts the contrast according to the image.
The adjustment operation may not be smooth depending on the image. In this case select OFF.

RESOLUTION

- Adjusts the fineness of the image.

MULTI PIXEL DRIVE

- Adjusts the gradation to widen the angle of view.

PIXEL DIMMING

- Adjusts the contrast of the video.

FILM MODE

- Adjusts so the input signal is video at 24 frames per second.
ADVANCED(HIGH), ADVANCED(LOW).... Play at high-quality for smooth video movement.
STANDARD..... Play video with each frame shown an equal amount of time.

DIGITAL NR

- Reduces block noise caused by digital compression.

MONOCHROME

- Sets the video to black & white.

RESET

Resets the values of current picture mode items in PICTURE menu to factory default values.

■AUDIO

TREBLE

Adjusts the volume of treble-level sound.

BASS

Adjusts the volume of bass-level sound.

BALANCE

Adjusts the balance of the audio sound between right and left.

BAND EXTENSION

Adjusts so that low range and extended range audio from the speakers can be easily heard.

RESET

Resets the values of the AUDIO menu items to factory default values.

■SETUP**LANGUAGE**

Sets the display language for the menu screen.

SLEEP TIMER

When the set time elapses, the monitor automatically enters standby mode. This can be set to up to 23 hours in increments of one hour.

INPUT SELECT**HDMI SETTING**

- HDMI CEC LINKWhen AUTO is selected, HDMI CEC LINK is enabled and the HDMI input terminal changes when playback is started on an external device. When OFF is selected, AUTO POWER ON and AUDIO RETURN CHANNEL cannot be selected.
- AUTO POWER ONSets whether the monitor power turns on when the power of an external device is turned on.
- AUDIO RETURN CHANNEL.....When HDMI1 input is used, sets whether the monitor audio is output from compatible devices via HDMI cable.
- POSITIONAdjusts the horizontal and vertical position of the image.
- HDMI AUTO WIDE
 AUTO MODE.....Automatically changes the screen size to ZOOM if a black band appears at the top and bottom of the input video.
- HDMI SIGNALSets to ENABLE to have the screen size change automatically according to the screen size control signal included in the video signal input from the HDMI input terminal.

SCREEN POSITION (D-SUB)

- INPUT SIGNALWhen the input signal is 1024 x 768 or 1366 x 768 in PC D-sub, select to match the resolution.
- AUTO SYNC.When YES is selected, H-POS., V-POS., CLOCK, and PHASE are automatically adjusted. Use this automatic adjustment when you use the PC D-Sub to display a PC screen or when you change the setting of the PC. (See page 29.)
- SCREEN POSITION.....Adjusts H-POS. (Position of the longest direction), V-POS. (Position of the shortest direction), CLOCK, and PHASE. To restore factory default settings, use RESET.

INPUT SKIP

- AUTOSkips when the terminal is not connected.
- ON.....Always skips.
- OFFAlways enable selection of the input.
- INPUT SKIP is displayed on the input mode selection screen as SELECTABLE/NOT SELECTABLE.

INPUT LABEL

Changes the display names of input mode.
 To enter characters, see page 29.

AUDIO SELECT (HDMI3/D-SUB)

- Sets the audio input terminal used when HDMI3 or PC D-sub is input.
- HDMI3
 HDMIInputs audio from the HDMI3 input terminal.
 HDMI + ANALOGInputs audio from the audio input terminal.
- D-SUB
 VIDEODo not use audio.
 VIDEO + AUDIO.....Inputs audio from the audio input terminal.

DIGITAL AUDIO OUTPUT

Sets the audio that is output from the digital audio output (optical) terminal.
 When connecting a device that does not support AAC / Dolby Digital to the digital audio output (optical) terminal, set to PCM.
 When connecting an AV amplifier or other device that supports AAC / Dolby Digital, set to BIT STREAM.

Menu Items

COMMUNICATION SETTING

LAN SETUP

Configures the settings to control the monitor from the computer via LAN. (See page 36.)

IP CONTROL SETUP

To control the monitor from a computer via LAN, set this to ENABLE and configure the login ID and other settings. (See page 37.)

■MONITOR

MONITOR

Selects the installation direction of the monitor.

LANDSCAPELandscape orientation

PORTRAITPortrait orientation. MULTIMEDIA (see page 20) always remains in landscape orientation.

* If video is upside down when the monitor is installed in the portrait orientation, you can rotate the video 180 degrees with PORTRAIT ROTATE (see page 30) in the FUNCTION menu. When this is done, the MONITOR setting cannot be changed.

POWER SAVE MODE

When OFF is selected, startup time from standby mode is reduced. Note, however that, more power will be consumed in standby mode.

When ON is selected, current consumption is reduced while the monitor is in standby mode. Note, however, that the startup time from standby mode becomes longer.

If set to ON, control via LAN cannot be performed in standby mode.

If set to ON, INPUT SIGNAL ON is set to NO.

OFF IF NO OPERATION

Set whether or not the monitor goes into standby mode when there is no operation from the remote control or RS-232C / LAN. After setting this to YES, set the standby mode entry time. The entry time can be set to a maximum of 12 hours in increments of 1 hour.

OFF IF NO SIGNAL

Sets whether or not the monitor enters the standby mode when there is no input signal for more than 5 minutes. When INPUT SIGNAL ON is YES, the monitor changes to the input signal waiting mode. When INPUT SIGNAL ON is NO, the monitor changes to the standby mode.

If set to OFF, INPUT SIGNAL ON is set to NO.

INPUT SIGNAL ON

Set whether or not the monitor automatically recovers from the input signal waiting mode.

When this is set to YES and the monitor is in the input signal waiting mode, the power turns on (the power "on" state is entered) when a signal is input into the currently selected terminal.

If set to YES, POWER SAVE MODE automatically changes to OFF and OFF IF NO SIGNAL automatically changes to ON.

(The factory default setting for POWER SAVE MODE is ON. The factory default setting for OFF IF NO SIGNAL is OFF.)

When this is YES and POWER SAVE MODE is changed to ON or OFF IF NO SIGNAL is changed to OFF, INPUT SIGNAL ON automatically changes to NO.

If POWER SAVE MODE is set to OFF, more power will be consumed in standby mode than when set to ON.

■OTHERS

MULTIMEDIA AUTOPLAY

Sets the media used for auto play. (See page 22.)

SOFTWARE VERSION

Shows the software version, etc.

SOFTWARE UPDATE

You can update the software.





SETTING RESET





Resets the settings to factory default settings.

* Photo files copied to INTERNAL MEMORY with MULTIMEDIA will not be erased.

Character input

For items that require entry of text, press  to display the software keyboard.

Select a character with    , and press  to enter.

- To change the characters entered, select CHAR. SET or press  (F1).
- To switch between upper case and lower case, select CAPS and press .
- To delete characters, select CLEAR or DELETE and press . You can also perform DELETE by pressing  (F2).
- When you are done entering characters, select DONE and press .



You can also finish by pressing  (F3).

To cancel character entry, select CANCEL and press .

Adjustments for PC screen display

■ Automatic adjustment

When you use the PC D-sub to display a PC screen, or when you change the setting of the PC, use the automatic screen adjustment.

1. **Switch the input to D-SUB and display the adjustment pattern.** (See the description below.)
2. **Press  and select AUTO SYNC. of SCREEN POSITION of INPUT SELECT in the SETUP menu.** (See page 27.)
3. **Select YES.**
4. **Press .**
Wait until automatic adjustment finishes.
5. **Press  to close the menu screen.**

TIPS

- If the screen cannot be adjusted properly with one automatic adjustment, repeat the automatic adjustment two or three times. Try manual adjustment if necessary.
- When the input signal is 1024 x 768 or 1366 x 768, the input resolution must be set manually. Select the resolution with INPUT SIGNAL in SCREEN POSITION of INPUT SELECT in the SETUP menu. (See page 27.)

■ Screen display for adjustment

Before making adjustments in the SCREEN POSITION menu or PICTURE menu, display an image to brighten the entire screen. If you are using a Windows PC, use the adjustment pattern on the supplied CD-ROM.

Opening the adjustment pattern

The following example is performed in Windows 7.

1. **Load the supplied CD-ROM into the computer's CD-ROM drive.**
2. **Open [CD Drive] in [Computer].**
3. **Double-click [Adj_uty.exe].**

The adjustment pattern will appear.

Adjust the screen automatically or manually.

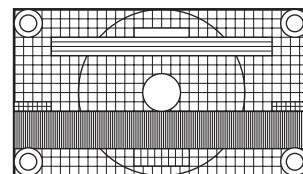

4. **When adjustment is finished, press the [Esc] on the computer's keyboard to quit the adjustment program.**
5. **Eject the CD-ROM from the CD-ROM drive.**



TIPS

- If the display mode on the computer you are using is 65,000 colors, the color levels in the color pattern may appear differently or grayscale may appear to be colored. (This is due to the specifications of the input signal and is not a malfunction.)

Functional Restriction Setting (FUNCTION)

You can restrict operations.

1. Hold  down until "F" appears in the left of the screen.
2. While "F" appears, press , , ,  in that order.

FUNCTION	
POWER BUTTON LOCK	[OFF]
RC LOCK	[OFF]
MONITOR LOCK	[OFF]
MENU LOCK	[OFF]
ON SCREEN DISPLAY	[ON 1]
LED	[ON]
PORTRAIT ROTATE	[OFF]
 SELECT  ENTER  EXIT	

3. Select and set the items.

POWER BUTTON LOCK

You can disable the remote control POWER button or the monitor POWER switch.

OFF Enables operation.

ALL LOCK Disables the power buttons on the monitor and remote control unit.

MONITOR LOCK... Disables the power switch on the monitor.

RC LOCK..... Disables the power button on the remote control unit.

RC LOCK

You can disable the remote control buttons other than power button.

MONITOR LOCK

You can disable the monitor switches other than power switch.

MENU LOCK

You can disable use of the remote control with .

ON SCREEN DISPLAY

Shows/hides the menu, modes and messages.

The FUNCTION screen cannot be hidden.

ON 1 Shows all menus, modes and messages.

ON 2 Hides messages automatically displayed by the display. Shows messages during operation.

OFF Hides all menus, modes and messages.

LED

Specifies whether to light the power LED.

PORTRAIT ROTATE

If video is upside down when the monitor is installed in portrait orientation, you can rotate the video 180 degrees.

This function is for the portrait installation only. Do not select this function for the landscape installation.

After changing a setting, turn the main power off and then on.

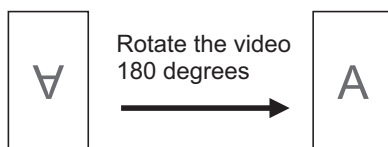

4. Press  to return to the normal screen.

Controlling the Monitor with a PC (RS-232C)

You can control this monitor from a PC via RS-232C (COM port) on the PC.

TIPS

- You cannot use RS-232C and LAN control simultaneously.

PC connection

Connect the COM port on the PC (RS-232C connector) to the CONTROL terminal (RS-232C input terminal) on the monitor using the RS-232C conversion cable (supplied) and an RS-232C straight cable (commercially available).

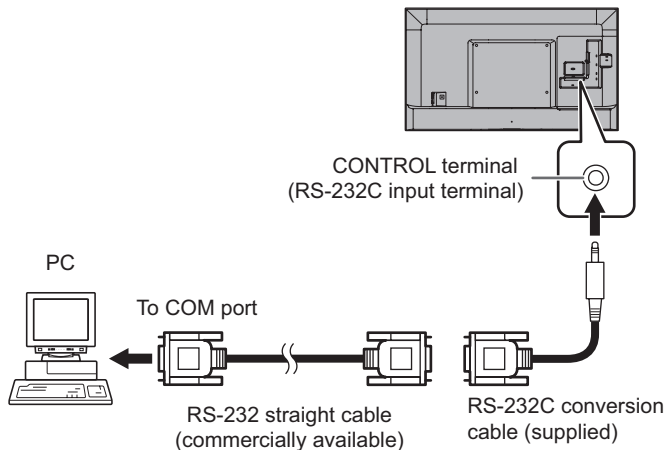

Communication conditions

Set the RS-232C communication settings on the PC to match the monitor's communication settings as follows:

Baud rate	9600 bps	Stop bit	1 bit
Data length	8 bits	Flow control	None
Parity bit	None		

Communication procedure

Command format

When a command is sent from the PC to the monitor, the monitor operates according to the received command and sends a response message to the PC.

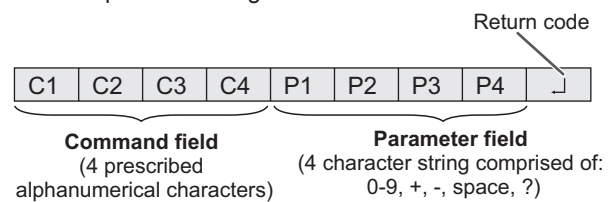

Example: VOLM0030
VOLM 30 _ _

- * Be sure to input 4 characters for the parameter. Pad with spaces (" _ ") if necessary. (" [Return code] " is a return code (0DH or 0AH))
Wrong : VOLM30[Return code]
Right : VOLM 30 _ _ [Return code]

When inputting a negative value, specify a numerical value in three digits.

Example: BLVL-005

If a command has "R" listed for "DIRECTION" in the "Control command table" on page 33, the current value can be returned by using "?" as the parameter.

Example:

VOLM ? ? ? ? ← From PC to monitor (How much is current volume setting?).

30 ← From monitor to PC (Current volume setting: 30).

Controlling the Monitor with a PC (RS-232C)

■Response code format

When a command has been executed correctly

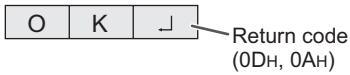

A response is returned after a command is executed.

When a command has not been executed

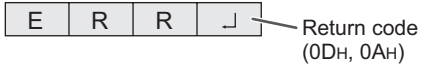

TIPS

- “ERR” is returned when there is no relevant command or when the command cannot be used in the current state of the monitor. “ERR” is also returned when return code only is sent without any command.
- If communication has not been established for reasons such as a bad connection between the PC and monitor, nothing is returned (not even ERR).
- “ERR” may be returned when a command cannot be received correctly due to interference from the surrounding environment.

Please ensure that the system or software retries the command if this occurs.

■Communication interval

- After OK or ERR is returned, you must send the following commands.
To set a timeout for the command response, specify 10 seconds or longer.
- Provide an interval of 100 ms or more between the command response and the transmission of the next command.

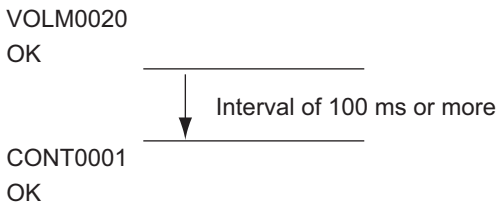

Control command table

How to read the command table

- Command: Command field (See page 31.)
- Direction: W When the "Parameter" is set in the parameter field (see page 31), the command functions as described under "Control/Response Contents".
 R The returned value indicated under "Reply" can be obtained by setting "???" or "?_ _ _" in the parameter field (see page 31).
- Parameter: Parameter field (See page 31.)
- Reply: Response (Returned value)

TIPS

- In standby mode, the only command that is used is POWER CONTROL.
- When POWER SAVE MODE is ON, control via LAN is not possible in standby mode.

Power control/Input mode selection

Function	Command	Direction	Parameter	Reply	Control/Response contents
POWER CONTROL	POWR	W	0		Switches to standby mode.
			1		Returns from standby mode.
		R		0	Standby mode
				1	Normal mode
				2	Input signal waiting mode
INPUT MODE SELECTION	ITGD	W	0		Toggle change for input mode.
	IAVD	WR	1	1	HDMI1
			2	2	HDMI2
			3	3	HDMI3
			4	4	HDMI4
			5	5	D-SUB
			6	6	MULTIMEDIA (USB port/Internal memory)

PICTURE menu

Function	Command	Direction	Parameter	Reply	Control/Response contents
PICTURE MODE	AVMD	W	0		Toggle change for input mode.
			1		AV
			2		MOVIE
			3		GAME
			6		VIVID
			7		PC
			9		sRGB
			11		PHOTO
			20		Adobe RGB SIM.
			R		1
				2	MOVIE
				3	GAME
				6	VIVID
				7	PC
				9	sRGB
				11	PHOTO
			20	Adobe RGB SIM.	
BRIGHT	VLMP	WR	-16-16	-16-16	
CONTRAST	CONT	WR	0-40	0-40	
BLACK LEVEL	BLVL	WR	-30-30	-30-30	
TINT	TINT	WR	-30-30	-30-30	
COLORS	COLR	WR	-30-30	-30-30	
SHARPNESS	SHRP	WR	0-20	0-20	

Controlling the Monitor with a PC (RS-232C)

AUDIO menu

Function	Command	Direction	Parameter	Reply	Control/Response contents
BALANCE	SBAL	WR	-30-30	-30-30	Audio output balance (Left 30 to right 30)

SETUP menu

Function	Command	Direction	Parameter	Reply	Control/Response contents	
LANGUAGE	LANG	WR	14	14	ENGLISH	
			1	1	DEUTSCH	
			2	2	FRANÇAIS	
			3	3	ITALIANO	
			4	4	ESPAÑOL	
			5	5	РУССКИЙ	
SLEEP TIMER	OFTM	WR	0	0	Cancel	
			1-23	1-23	Sets the time in hours before the monitor switches to standby mode.	
POSITIONING	POSITION OF THE LONGEST DIRECTION	HPOS	WR	-88-90	-88-90	Varies depending on the signal.
	POSITION OF THE SHORTEST DIRECTION	VPOS	WR	-26-36	-26-36	Varies depending on the signal.
CLOCK	CLCK	WR	-90-90	-90-90	Varies depending on the signal.	
PHASE	PHSE	WR	-20-20	-20-20		

MONITOR menu

Function	Command	Direction	Parameter	Reply	Control/Response contents
OFF IF NO OPERATION	NOPO	WR	0-12	0-12	0: NO, 1-12: Time until OFF IF NO OPERATION
OFF IF NO SIGNAL	NSPO	WR	0-1	0-1	0: OFF, 1: ON
INPUT SIGNAL ON	ISWM	WR	0-1	0-1	0: NO, 1: YES

Functional Restriction Setting (FUNCTION) menu

Function	Command	Direction	Parameter	Reply	Control/Response contents
BUTTON CONTROL LOCK	ALCK	WR	0ABC	0ABC	A: POWER BUTTON LOCK 0: OFF, 1: ALL LOCK, 2: MONITOR LOCK, 3: RC LOCK B: RC LOCK 0: OFF, 1: ON C: MONITOR LOCK 0: OFF, 1: ON

Others

Function	Command	Direction	Parameter	Reply	Control/Response contents
SCREEN SIZE	WIDE	W	0-1, 4-5, 8-9		0:Toggle change, 1: NORMAL, 4: ZOOM, 5: WIDE, 8: UNDERSCAN, 9: DOT BY DOT
		R		1, 4-5, 8-9	1: NORMAL, 4: ZOOM, 5: WIDE, 8: UNDERSCAN, 9: DOT BY DOT
VOLUME	VOLM	WR	0-100	0-100	
Remote control unit	IRCO	W	113		INPUT
			114		VOL +
			115		VOL -
			117		MUTE
			11B		DISPLAY / F1
			120		Cursor down
			139		MODE / F2
			152		ENTER
			157		Cursor up
			1C4		MENU
			1D5		SIZE / F3
			1D7		Cursor left
			1D8		Cursor right
			1E4		RETURN
MUTE	MUTE	W	0-2		0:Toggle change, 1: ON, 2: OFF
		R		1-2	1: ON, 2: OFF
MODEL	MNRD	W	1	Value	

TIPS

- Some menu setting items do not have a command. Set with the remote control during installation.

Controlling the Monitor with a PC (LAN)

Your monitor can be connected to a LAN allowing you to control it from a PC on the LAN.

The connection requires a commercially available LAN cable (UTP cable, Category 5, straight through).

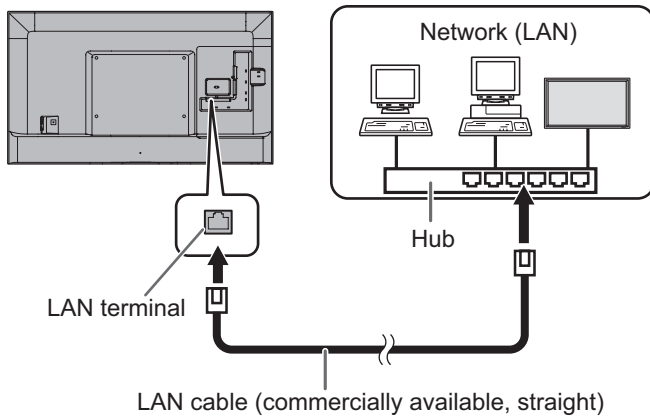

TIPS

- You must assign an IP address to the monitor by following the procedures in “Settings to connect to a LAN”. (See the description on the right.)
- To control the monitor via LAN, set IP CONTROL SETUP to ENABLE. (See page 37.)
- You cannot use RS-232C and LAN control simultaneously.
- When POWER SAVE MODE is ON, control is not possible in standby mode.

Settings to connect to a LAN

Set LAN SETUP and IP CONTROL SETUP in COMMUNICATION SETTING in the SETUP menu. (See page 28.)

The settings depend on the configuration of your LAN. Ask your LAN administrator for details.

LAN SETUP

1. Display the current LAN information.
2. If you need to change the setup, select **CHANGE** or **INITIALIZE** with or , and press .
CHANGE: Change the LAN setup. See the step 3.
INITIALIZE: Reset the current settings.

3. Set the IP address.

Select YES or NO with or , and press .

YES

Acquire the IP address automatically.

NO

Enter the IP ADDRESS, NETMASK, and GATEWAY with the software keyboard. (See page 29.)

When NO is selected, YES (auto acquisition of DNS IP address) cannot be selected in step 5.

4. Select **NEXT**, and press .

5. Set the IP address of the DNS server.

Select YES or NO with or , and press .

YES

Acquire the IP address of the DNS automatically. (Use the DHCP server function of your network environment.)

NO

Enter the PRIMARY and SECONDARY IP addresses with the software keyboard. (See page 29.) For the values to be entered in each field, check the specifications of your network environment.







6. Select **NEXT**, and press .

7. Select **TEST** with or , and press .







8. Check your settings, select **COMPLETE** with or , and press .

■ IP CONTROL SETUP

1. Set IP control setup to ENABLE.

Select IP CONTROL SETUP with  or  and press . Select CHANGE and press . Select ENABLE with  or  and press .

2. Configure advanced security settings.

Select DETAIL SETTING with  or  and press . Select CHANGE with  or  and press .

3. Set the login information.

Enter the LOGIN ID and PASSWORD with the software keyboard (see page 29).

4. Select NEXT and press .

5. Set the control port.

Enter the CONTROL PORT with the software keyboard (see page 29).

6. Select NEXT and press .

7. Check your settings, select COMPLETE with or , and press .

Command-based control

You can control the monitor using control commands (see page 33) via terminal software and other appropriate applications.

Read the manual for the terminal software for detailed instructions.

(1) Connect the PC to the monitor.

Use a commercially available LAN cable to connect a PC to the monitor. (See page 36.)

(2) Send commands to control the monitor.

- The commands used are the same as those for RS-232C. Refer to the communication procedure (see page 31) for operation.
- Usable commands are provided in the control command table (see page 33).

Troubleshooting

If you are experiencing any problem with your display, before calling for service, please review the following troubleshooting tips.

There is no picture or sound.

- Is the power cord disconnected? (See page 14.)
- Is the main power switch off? (See page 17.)
- Is the monitor in standby mode (the power LED illuminating in orange)? (See page 17.)
- Make sure correct input mode is selected. (See page 18.)
- If any external equipment is connected, make sure the equipment is operating (playing back).

Remote control does not work.

- Are the batteries inserted with polarity (+,-) aligned? (See page 16.)
- Are the batteries exhausted?
- Point the remote control unit toward the monitor's remote control sensor. (See page 16.)
- Is ON SCREEN DISPLAY set to OFF or is operation disabled? (See page 30.)

Sound is heard from only one side.

- Are audio cables connected properly?
- Check the setting of BALANCE for AUDIO menu. (See page 26.)

There is a picture but no sound.

- Is the sound muted?
- Make sure the volume is not set to minimum.
- Are audio cables connected properly?
- Is the setting of INPUT SELECT on the SETUP menu correct? (See page 27.)

Unstable video.

- The signal may be incompatible. (See page 41.)
- Try the automatic screen adjustment when the D-SUB are used. (See page 29.)

The video from the HDMI input terminal does not appear properly.

- Is the setting for HDMI SETTING of INPUT SELECT on the SETUP menu correct? (See page 27.)
- Is the HDMI cable HDMI standard compliant? The monitor will not work with cables that are not standard compliant.
- Is the input signal compatible with this monitor? (See page 41.)
- To show 4K2K video or 1080p video, use a high-speed HDMI cable.
- If connected to a HDMI1 - 3 input terminal while inputting 4:2:0 format, connect to the HDMI4 input terminal. The video and audio of some connected devices may not output correctly because the HDMI1 - 3 input terminals support 3840 x 2160 (60Hz) 4:4:4 or 4:2:2 format. (See page 12.)

The video from PC D-Sub input terminal does not appear correctly.

- Is the setting for SCREEN POSITION of INPUT SELECT on the SETUP menu correct? (See page 27.)
- Is the input signal compatible with this monitor? (See page 41.)

Control buttons do not work.

There is no picture.

- Load noises from outside may be interfering with normal operation. Turn off the power and turn it on after waiting at least 5 seconds, and then check the operation.

Power LED flashes red.

- Hardware has a problem. Turn off the monitor and request repair from your SHARP dealer.

The monitor makes a cracking sound.

- You may occasionally hear a cracking sound from the monitor. This happens when the cabinet slightly expands and contracts according to change in temperature. This does not affect the monitor's performance.

The Power LED is flashing in red and green alternately.

- When the internal temperature of the monitor rises excessively, the brightness of the backlight decreases automatically in order to prevent high-temperature-related problems. If the internal temperature rises further, the monitor automatically enters standby mode and the Power LED blinks red and green alternately.
- Remove the cause of the excessive temperature rise.
 - If the monitor enters standby mode due to a rise in temperature, to return to normal display, turn the power switch off and then back on again. The monitor, however, will enter standby mode again if the cause of the temperature rise is not eliminated. (See page 8.)
 - Check whether the monitor is placed at a location where a quick rise in temperature is likely. Internal temperature rises quickly if the vents on the monitor are blocked.
 - Internal temperature rises quickly if dust accumulates inside the monitor or around the vents. Remove dust if possible. Ask SHARP dealer about removing internal dust.

Specifications

■Product Specifications

Model		PN-H801
LCD component		80" Class [80-1/2 inch (204.4cm) diagonal] TFT LCD
Max. resolution	(pixels)	3840 x 2160
Max. colors		Approx. 1.06 billion colors
Pixel pitch		0.464 mm (H) × 0.464 mm (V)
Viewing angle		176° right/left/up/down (contrast ratio ≥ 10)
Screen active area		inch (mm) 70-1/8 x 39-7/16 (1781.76 x 1002.24)
Computer input signal		HDMI, Analog RGB (0.7 Vp-p) [75 Ω]
Sync signal		Horizontal/vertical separate (TTL: positive/negative)
Plug and play		VESA DDC2B
Input terminals	Video	HDMI x 4 - HDCP1.4 compatible (HDMI1 - HDMI3) HDCP2.2 compatible (HDMI4) - ARC compatible (HDMI1) - MHL compatible (HDMI4) Mini D-sub 15 pin, 3 rows x 1
	Audio	3.5 mm mini stereo jack x 1
	Serial (RS-232C)	3.5 mm mini stereo jack x 1
	USB flash drive	x 1
Output terminals	Audio	Digital audio output (optical) x 1 3.5 mm mini stereo jack x 1
LAN terminal		10 BASE-T/100 BASE-TX
Speaker output		10 W + 10 W
Internal memory		400 MB
Power requirement		AC 100 - 240 V, 5.6 A, 50/60 Hz
Operating temperature *1		32°F to 104°F (0°C to 40°C)
Operating humidity		20% to 80% (no condensation)
Power consumption (Maximum / input signal waiting mode / standby mode *2)		490 W/27 W/0.5 W
Dimensions (excluding protrusions)		inch (mm) Approx. 71-1/2 (W) x 4-1/2 (D) x 41-1/8 (H) (1816 x 114 x 1045)
Weight		lbs. (kg) Approx. 119.0 (54)

*1 Temperature condition may change when using the monitor together with the optional equipments recommended by SHARP. In such cases, please check the temperature condition specified by the optional equipments.

*2 When POWER SAVE MODE is set to ON. When POWER SAVE MODE is set to OFF: 27 W.

As a part of our policy of continuous improvement, SHARP reserves the right to make design and specification changes for product improvement without prior notice. The performance specification figures indicated are nominal values of production units. There may be some deviations from these values in individual units.

Specifications

■ Dimensional Drawings

Note that the values shown are approximate values.

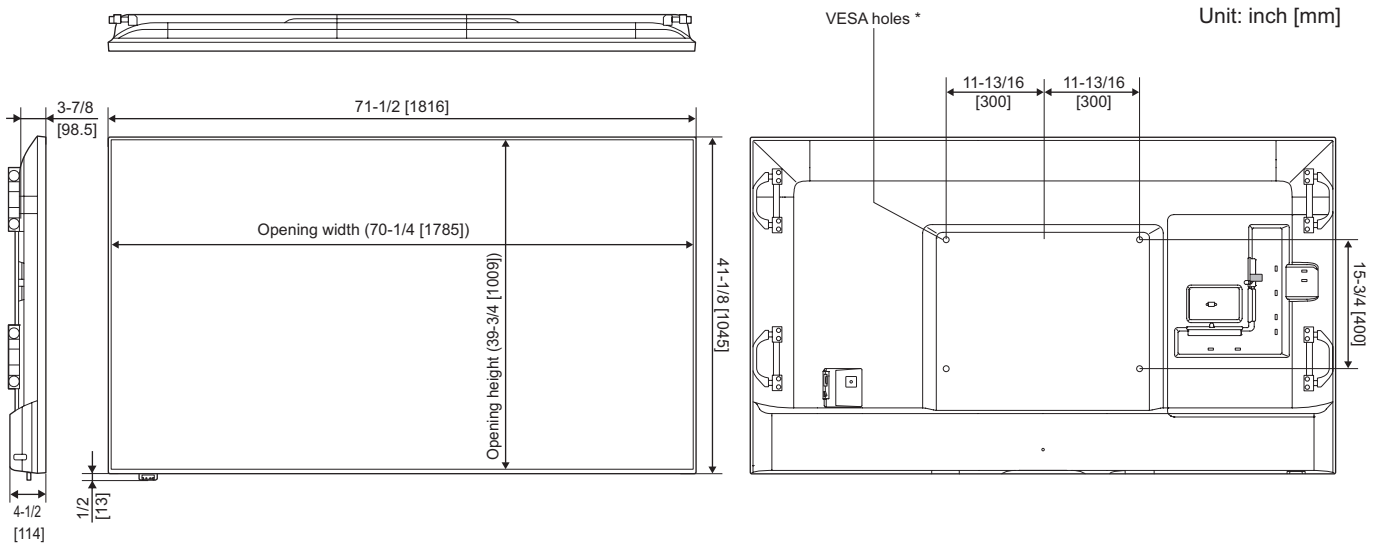

When mounting the monitor, be sure to use a wall-mount bracket that complies with the VESA-compatible mounting method. SHARP recommends using M6 screws and tighten the screws. (See page 52.)

Note that screw hole depth of the monitor is 3/8 inch (10 mm). Loose mounting may cause the product to fall, resulting in serious personal injuries as well as damage to the product. The screw and hole should come together with over 5/16 inch (8 mm) length of thread. Use a bracket which has been approved for UL1678 standard, and which can endure at least 4 times or more the weight of the monitor.

■Compatible signal timing (PC)

Screen resolution		Hsync	Vsync	Dot frequency	Digital (HDMI)	Analog (PC D-Sub)
VESA	640 × 480	31.5kHz	60Hz	25.175MHz	Yes	Yes
		37.9kHz	72Hz	31.5MHz	Yes	Yes
		37.5kHz	75Hz	31.5MHz	Yes	Yes
	800 × 600	35.1kHz	56Hz	36.0MHz	Yes	Yes
		37.9kHz	60Hz	40.0MHz	Yes	Yes
		48.1kHz	72Hz	50.0MHz	Yes	Yes
		46.9kHz	75Hz	49.5MHz	Yes	Yes
	1024 × 768	48.4kHz	60Hz	65.0MHz	Yes	Yes
		56.5kHz	70Hz	75.0MHz	Yes	Yes
		60.0kHz	75Hz	78.75MHz	Yes	Yes
1280 × 800	49.7kHz	60Hz	83.5MHz	Yes	Yes	
1280 × 1024	64.0kHz	60Hz	108.0MHz	Yes	Yes	
1400 × 1050	65.3kHz	60Hz	121.75MHz	Yes	Yes	
Wide	1366 × 768	47.7kHz	60Hz	85.5MHz	Yes	Yes
	1920 × 1080	67.5kHz	60Hz	148.5MHz	Yes	Yes
	3840 × 2160	54.0kHz	24Hz	297.0MHz	Yes	-
		56.3kHz	25Hz	297.0MHz	Yes	-
		67.5kHz	30Hz	297.0MHz	Yes	-
		112.5kHz	50Hz	594.0MHz	Yes	-
135.0kHz	60Hz	594.0MHz	Yes	-		
US TEXT	720 × 400	31.5kHz	70Hz	28.3MHz	Yes	Yes
Mac	1920 × 1080	67.5kHz	60Hz	148.5MHz	Yes	Yes
	3840 × 2160	67.5kHz	30Hz	297.0MHz	Yes	-

- Depending on the connected PC, images may not be displayed properly even if the compatible signal described above is input.

■Compatible signal timing (AV)

Screen resolution	Frequency	HDMI	PC D-sub
3840 × 2160p	24Hz	Yes	-
	25Hz	Yes	-
	30Hz	Yes	-
	50Hz	Yes	-
	60Hz	Yes	-
1920 × 1080p	24Hz	Yes	-
	30Hz	Yes	-
	50Hz	Yes	-
	60Hz	Yes	-
1920 × 1080i	60Hz	Yes	-
1280 × 720p	30Hz	Yes	-
	50Hz	Yes	-
	60Hz	Yes	-
720 × 576p	50Hz	Yes	-
640 × 480p	60Hz	Yes	-
720 × 480p	60Hz	Yes	-
720(1440) × 480i	60Hz	Yes	-

■DisplayPort-HDMI conversion cable (supplied) signal timing

Screen resolution	Hsync	Vsync	Dot frequency	HDMI1-3	HDMI4	Remarks
3840 × 2160	67.5kHz	30Hz	297.0MHz	Yes (8bit)	Yes (8bit)	Supports RGB 4:4:4 full-range output. YCbCr is not supported.
	135.0kHz	60Hz	594.0MHz	Yes (8bit)	-	

Specifications

■DDC (plug and play)

The monitor supports the VESA DDC (Display Data Channel) standard.

DDC is a signal standard for plug and play between monitors and computers. Information about resolution and other parameters is exchanged between the two. This function can be used if the computer supports DDC and it has been configured to detect plug-and-play monitors.

There are several types of DDC, depending on the communication method used. This monitor supports DDC2B.

■HDMI input terminal pins
(HDMI™ Connector)

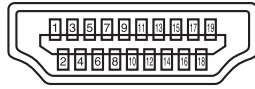

No.	Function	No.	Function
1	TMDS data 2+	11	TMDS clock shield
2	TMDS data 2 shield	12	TMDS clock-
3	TMDS data 2-	13	CEC
4	TMDS data 1+	14	N.C.
5	TMDS data 1 shield	15	SCL
6	TMDS data 1-	16	SDA
7	TMDS data 0+	17	DDC/CEC GND
8	TMDS data 0 shield	18	+5V
9	TMDS data 0-	19	Hot-plug detection
10	TMDS clock+		

■PC D-sub input terminal pins
(Mini D-sub 15 pin)

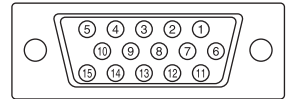

No.	Function	No.	Function
1	Red video signal input	9	+5V
2	Green video signal input	10	GND
3	Blue video signal input	11	N.C.
4	N.C.	12	DDC data
5	GND	13	Hsync signal input
6	GND for red video signal	14	Vsync signal input
7	GND for green video signal	15	DDC clock
8	GND for blue video signal		

Intellectual Property Rights and Other Matters that Apply to This Software

■ Information on the software license for this product

Software composition

The software included in this product is comprised of various software components whose individual copyrights are held by SHARP or by third parties.

Software developed by SHARP and open source software

The copyrights for the software components and various relevant documents included with this product that were developed or written by SHARP are owned by SHARP and are protected by the Copyright Act, international treaties, and other relevant laws. This product also makes use of freely distributed software and software components whose copyrights are held by third parties. These include software components covered by a GNU General Public License (hereafter GPL), a GNU Lesser General Public License (hereafter LGPL) or other license agreement.

Obtaining source code

Some of the open source software licensors require the distributor to provide the source code with the executable software components. GPL and LGPL include similar requirements. For information on obtaining the source code for the open source software and for obtaining the GPL, LGPL, and other license agreement information, visit the following website:

http://www.sharp.co.jp/business/lcd-display/support/download/source_e.html

We are unable to answer any questions about the source code for the open source software. The source code for the software components whose copyrights are held by SHARP is not distributed.

Acknowledgements

The following open source software components are included in this product:

linux kernel, glibc, DirectFB, OpenSSL, zlib, NTP, Expat, DHCPv6, dlmalloc, Simple IPv4 Link-Local address, libxml2, fontconfig, icu, cURL, freetype, coreutils, jpeg, libpng, SQLite, LVM2, device-mapper, xfsprogs, parted, util-linux, fetch, ALSA, fuse, SaWMan, FusionDale, u-boot, e2fsprogs, c-ares, pixman, dbus, pthread, gstreamer, iptables, libFLAC, udev, id3lib, busybox, iputils

■ Display of licenses for software used in the monitor

Requirement to display license

The copyrights of some software components incorporated in the monitor require that the license be displayed. The licenses of these software components are shown below.

BSD Licence

This product includes software developed by the University of California, Berkeley and its contributors.

OpenSSL Licence

This product includes software developed by the OpenSSL Project for use in the OpenSSL Toolkit.

(<http://www.openssl.org/>)

OpenSSL LICENSE ISSUES

The OpenSSL toolkit stays under a dual license, i.e. both the conditions of the OpenSSL License and the original SSLeay license apply to the toolkit. See below for the actual license texts. Actually both licenses are BSD-style Open Source licenses. In case of any license issues related to OpenSSL please contact openssl-core@openssl.org.

OpenSSL License

Copyright (c) 1998-2008 The OpenSSL Project. All rights reserved.

Redistribution and use in source and binary forms, with or without modification, are permitted provided that the following conditions are met:

1. Redistributions of source code must retain the above copyright notice, this list of conditions and the following disclaimer.
2. Redistributions in binary form must reproduce the above copyright notice, this list of conditions and the following disclaimer in the documentation and/or other materials provided with the distribution.
3. All advertising materials mentioning features or use of this software must display the following acknowledgment:
"This product includes software developed by the OpenSSL Project for use in the OpenSSL Toolkit. (<http://www.openssl.org/>)"
4. The names "OpenSSL Toolkit" and "OpenSSL Project" must not be used to endorse or promote products derived from this software without prior written permission. For written permission, please contact openssl-core@openssl.org.
5. Products derived from this software may not be called "OpenSSL nor may "OpenSSL" appear in their names without prior written permission of the OpenSSL Project.
6. Redistributions of any form whatsoever must retain the following acknowledgment:
"This product includes software developed by the OpenSSL Project for use in the OpenSSL Toolkit (<http://www.openssl.org/>)"

THIS SOFTWARE IS PROVIDED BY THE OpenSSL PROJECT "AS IS" AND ANY EXPRESSED OR IMPLIED WARRANTIES, INCLUDING, BUT NOT LIMITED TO, THE IMPLIED WARRANTIES OF MERCHANTABILITY AND FITNESS FOR A PARTICULAR PURPOSE ARE DISCLAIMED. IN NO EVENT SHALL THE OpenSSL PROJECT OR ITS CONTRIBUTORS BE LIABLE FOR ANY DIRECT, INDIRECT, INCIDENTAL, SPECIAL, EXEMPLARY, OR CONSEQUENTIAL DAMAGES (INCLUDING, BUT NOT LIMITED TO, PROCUREMENT OF SUBSTITUTE GOODS OR SERVICES; LOSS OF USE, DATA, OR PROFITS; OR BUSINESS INTERRUPTION) HOWEVER CAUSED AND ON ANY THEORY OF LIABILITY, WHETHER IN CONTRACT, STRICT LIABILITY, OR TORT (INCLUDING NEGLIGENCE OR OTHERWISE) ARISING IN ANY WAY OUT OF THE USE OF THIS SOFTWARE, EVEN IF ADVISED OF THE POSSIBILITY OF SUCH DAMAGE.

This product includes cryptographic software written by Eric Young (eyay@cryptsoft.com). This product includes software written by Tim Hudson (tjh@cryptsoft.com).

Original SSLeay License

Copyright (C) 1995-1998 Eric Young (eyay@cryptsoft.com)
All rights reserved.

This package is an SSL implementation written by Eric Young (eyay@cryptsoft.com).
The implementation was written so as to conform with Netscapes SSL.

Intellectual Property Rights and Other Matters that Apply to This Software

This library is free for commercial and non-commercial use as long as the following conditions are adhered to. The following conditions apply to all code found in this distribution, be it the RC4, RSA, lhash, DES, etc., code; not just the SSL code. The SSL documentation included with this distribution is covered by the same copyright terms except that the holder is Tim Hudson (tjh@cryptsoft.com).

Copyright remains Eric Young's, and as such any Copyright notices in the code are not to be removed.

If this package is used in a product, Eric Young should be given attribution as the author of the parts of the library used.

This can be in the form of a textual message at program startup or in documentation (online or textual) provided with the package.

Redistribution and use in source and binary forms, with or without modification, are permitted provided that the following conditions are met:

1. Redistributions of source code must retain the copyright notice, this list of conditions and the following disclaimer.
2. Redistributions in binary form must reproduce the above copyright notice, this list of conditions and the following disclaimer in the documentation and/or other materials provided with the distribution.
3. All advertising materials mentioning features or use of this software must display the following acknowledgement:
"This product includes cryptographic software written by Eric Young (eay@cryptsoft.com)
The word 'cryptographic' can be left out if the routines from the library being used are not cryptographic related :-)."
4. If you include any Windows specific code (or a derivative thereof) from the apps directory (application code) you must include an acknowledgement:
"This product includes software written by Tim Hudson (tjh@cryptsoft.com)"

THIS SOFTWARE IS PROVIDED BY ERIC YOUNG "AS IS" AND ANY EXPRESS OR IMPLIED WARRANTIES, INCLUDING, BUT NOT LIMITED TO, THE IMPLIED WARRANTIES OF MERCHANTABILITY AND FITNESS FOR A PARTICULAR PURPOSE ARE DISCLAIMED. IN NO EVENT SHALL THE AUTHOR OR CONTRIBUTORS BE LIABLE FOR ANY DIRECT, INDIRECT, INCIDENTAL, SPECIAL, EXEMPLARY, OR CONSEQUENTIAL DAMAGES (INCLUDING, BUT NOT LIMITED TO, PROCUREMENT OF SUBSTITUTE GOODS OR SERVICES; LOSS OF USE, DATA, OR PROFITS; OR BUSINESS INTERRUPTION) HOWEVER CAUSED AND ON ANY THEORY OF LIABILITY, WHETHER IN CONTRACT, STRICT LIABILITY, OR TORT (INCLUDING NEGLIGENCE OR OTHERWISE) ARISING IN ANY WAY OUT OF THE USE OF THIS SOFTWARE, EVEN IF ADVISED OF THE POSSIBILITY OF SUCH DAMAGE.

The licence and distribution terms for any publicly available version or derivative of this code cannot be changed. i.e. this code cannot simply be copied and put under another distribution licence [including the GNU Public Licence.]

NTP

Copyright (c) David L. Mills 1992-2009 Permission to use, copy, modify, and distribute this software and its documentation for any purpose with or without fee is hereby granted, provided that the above copyright notice appears in all copies and that both the copyright notice and this permission notice appear in supporting documentation, and that the name University of Delaware not be used in advertising or publicity pertaining to distribution of the software without specific, written prior permission. The University of Delaware makes no representations about the suitability this software for any purpose. It is provided "as is" without express or implied warranty.

Expat

Copyright (c) 1998, 1999, 2000 Thai Open Source Software Center Ltd and Clark Cooper
Copyright (c) 2001, 2002, 2003, 2004, 2005, 2006 Expat maintainers.

Permission is hereby granted, free of charge, to any person obtaining a copy of this software and associated documentation files (the "Software"), to deal in the Software without restriction, including without limitation the rights to use, copy, modify, merge, publish, distribute, sublicense, and/or sell copies of the Software, and to permit persons to whom the Software is furnished to do so, subject to the following conditions:

The above copyright notice and this permission notice shall be included in all copies or substantial portions of the Software.

THE SOFTWARE IS PROVIDED "AS IS", WITHOUT WARRANTY OF ANY KIND, EXPRESS OR IMPLIED, INCLUDING BUT NOT LIMITED TO THE WARRANTIES OF MERCHANTABILITY, FITNESS FOR A PARTICULAR PURPOSE AND NONINFRINGEMENT. IN NO EVENT SHALL THE AUTHORS OR COPYRIGHT HOLDERS BE LIABLE FOR ANY CLAIM, DAMAGES OR OTHER LIABILITY, WHETHER IN AN ACTION OF CONTRACT, TORT OR OTHERWISE, ARISING FROM, OUT OF OR IN CONNECTION WITH THE SOFTWARE OR THE USE OR OTHER DEALINGS IN THE SOFTWARE.

libfreetype

Portions of this software are copyright (C) 2006 The FreeType Project (www.freetype.org). All rights reserved.

libxml2

Except where otherwise noted in the source code (e.g. the files hash.c, list.c and the trio files, which are covered by a similar licence but with different Copyright notices) all the files are:

Copyright (C) 1998-2003 Daniel Veillard. All Rights Reserved.

Permission is hereby granted, free of charge, to any person obtaining a copy of this software and associated documentation files (the "Software"), to deal in the Software without restriction, including without limitation the rights to use, copy, modify, merge, publish, distribute, sublicense, and/or sell copies of the Software, and to permit persons to whom the Software is furnished to do so, subject to the following conditions:

The above copyright notice and this permission notice shall be included in all copies or substantial portions of the Software.

THE SOFTWARE IS PROVIDED "AS IS", WITHOUT WARRANTY OF ANY KIND, EXPRESS OR IMPLIED, INCLUDING BUT NOT LIMITED TO THE WARRANTIES OF MERCHANTABILITY, FITNESS FOR A PARTICULAR PURPOSE AND NONINFRINGEMENT. IN NO EVENT SHALL THE DANIEL VEILLARD BE LIABLE FOR ANY CLAIM, DAMAGES OR OTHER LIABILITY, WHETHER IN AN ACTION OF CONTRACT, TORT OR OTHERWISE, ARISING FROM, OUT OF OR IN CONNECTION WITH THE SOFTWARE OR THE USE OR OTHER DEALINGS IN THE SOFTWARE.

Except as contained in this notice, the name of Daniel Veillard shall not be used in advertising or otherwise to promote the sale, use or other dealings in this Software without prior written authorization from him.

Copyright (C) 2000 Bjorn Reese and Daniel Veillard.

Permission to use, copy, modify, and distribute this software for any purpose with or without fee is hereby granted, provided that the above copyright notice and this permission notice appear in all copies.

THIS SOFTWARE IS PROVIDED "AS IS" AND WITHOUT ANY EXPRESS OR IMPLIED WARRANTIES, INCLUDING, WITHOUT LIMITATION, THE IMPLIED WARRANTIES OF MERCHANTABILITY AND FITNESS FOR A PARTICULAR PURPOSE. THE AUTHORS AND CONTRIBUTORS ACCEPT NO RESPONSIBILITY IN ANY CONCEIVABLE MANNER.

Copyright (C) 2000 Gary Pennington and Daniel Veillard.

Permission to use, copy, modify, and distribute this software for any purpose with or without fee is hereby granted, provided that the above copyright notice and this permission notice appear in all copies.

THIS SOFTWARE IS PROVIDED "AS IS" AND WITHOUT ANY EXPRESS OR IMPLIED WARRANTIES, INCLUDING, WITHOUT LIMITATION, THE IMPLIED WARRANTIES OF MERCHANTABILITY AND FITNESS FOR A PARTICULAR PURPOSE. THE AUTHORS AND CONTRIBUTORS ACCEPT NO RESPONSIBILITY IN ANY CONCEIVABLE MANNER.

Copyright (C) 1998 Bjorn Reese and Daniel Stenberg.

Permission to use, copy, modify, and distribute this software for any purpose with or without fee is hereby granted, provided that the above copyright notice and this permission notice appear in all copies.

THIS SOFTWARE IS PROVIDED "AS IS" AND WITHOUT ANY EXPRESS OR IMPLIED WARRANTIES, INCLUDING, WITHOUT LIMITATION, THE IMPLIED WARRANTIES OF MERCHANTABILITY AND FITNESS FOR A PARTICULAR PURPOSE. THE AUTHORS AND CONTRIBUTORS ACCEPT NO RESPONSIBILITY IN ANY CONCEIVABLE MANNER.

fontconfig/COPYING

Copyright (C) 2001,2003 Keith Packard

Permission to use, copy, modify, distribute, and sell this software and its documentation for any purpose is hereby granted without fee, provided that the above copyright notice appear in all copies and that both that copyright notice and this permission notice appear in supporting documentation, and that the name of Keith Packard not be used in advertising or publicity pertaining to distribution of the software without specific, written prior permission. Keith Packard makes no representations about the suitability of this software for any purpose. It is provided "as is" without express or implied warranty.

THE AUTHOR(S) DISCLAIMS ALL WARRANTIES WITH REGARD TO THIS SOFTWARE, INCLUDING ALL IMPLIED WARRANTIES OF MERCHANTABILITY AND FITNESS, IN NO EVENT SHALL THE AUTHOR(S) BE LIABLE FOR ANY SPECIAL, INDIRECT OR CONSEQUENTIAL DAMAGES OR ANY DAMAGES WHATSOEVER RESULTING FROM LOSS OF USE, DATA OR PROFITS, WHETHER IN AN ACTION OF CONTRACT, NEGLIGENCE OR OTHER TORTIOUS ACTION, ARISING OUT OF OR IN CONNECTION WITH THE USE OR PERFORMANCE OF THIS SOFTWARE.

Intellectual Property Rights and Other Matters that Apply to This Software

ICU License - ICU 1.8.1 and later

COPYRIGHT AND PERMISSION NOTICE

Copyright (c) 1995-2010 International Business Machines Corporation and others

All rights reserved.

Permission is hereby granted, free of charge, to any person obtaining a copy of this software and associated documentation files (the "Software"), to deal in the Software without restriction, including without limitation the rights to use, copy, modify, merge, publish, distribute, and/or sell copies of the Software, and to permit persons to whom the Software is furnished to do so, provided that the above copyright notice(s) and this permission notice appear in all copies of the Software and that both the above copyright notice(s) and this permission notice appear in supporting documentation.

THE SOFTWARE IS PROVIDED "AS IS", WITHOUT WARRANTY OF ANY KIND, EXPRESS OR IMPLIED, INCLUDING BUT NOT LIMITED TO THE WARRANTIES OF MERCHANTABILITY, FITNESS FOR A PARTICULAR PURPOSE AND NONINFRINGEMENT OF THIRD PARTY RIGHTS. IN NO EVENT SHALL THE COPYRIGHT HOLDER OR HOLDERS INCLUDED IN THIS NOTICE BE LIABLE FOR ANY CLAIM, OR ANY SPECIAL INDIRECT OR CONSEQUENTIAL DAMAGES, OR ANY DAMAGES WHATSOEVER RESULTING FROM LOSS OF USE, DATA OR PROFITS, WHETHER IN AN ACTION OF CONTRACT, NEGLIGENCE OR OTHER TORTIOUS ACTION, ARISING OUT OF OR IN CONNECTION WITH THE USE OR PERFORMANCE OF THIS SOFTWARE.

Except as contained in this notice, the name of a copyright holder shall not be used in advertising or otherwise to promote the sale, use or other dealings in this Software without prior written authorization of the copyright holder.

All trademarks and registered trademarks mentioned herein are the property of their respective owners.

cURL
COPYRIGHT AND PERMISSION NOTICE

Copyright (c) 1996-2009, Daniel Stenberg,
<daniel@haxx.se>.

All rights reserved.

Permission to use, copy, modify, and distribute this software for any purpose with or without fee is hereby granted, provided that the above copyright notice and this permission notice appear in all copies.

THE SOFTWARE IS PROVIDED "AS IS", WITHOUT WARRANTY OF ANY KIND, EXPRESS OR IMPLIED, INCLUDING BUT NOT LIMITED TO THE WARRANTIES OF MERCHANTABILITY, FITNESS FOR A PARTICULAR PURPOSE AND NONINFRINGEMENT OF THIRD PARTY RIGHTS. IN NO EVENT SHALL THE AUTHORS OR COPYRIGHT HOLDERS BE LIABLE FOR ANY CLAIM, DAMAGES OR OTHER LIABILITY, WHETHER IN AN ACTION OF CONTRACT, TORT OR OTHERWISE, ARISING FROM, OUT OF OR IN CONNECTION WITH THE SOFTWARE OR THE USE OR OTHER DEALINGS IN THE SOFTWARE.

Except as contained in this notice, the name of a copyright holder shall not be used in advertising or otherwise to promote the sale, use or other dealings in this Software without prior written authorization of the copyright holder.

fetch
Copyright (c) 1998-2004 Dag-Erling CoyAan Smgrav
Copyright (c) 2008, 2010 Joerg
Sonnenberger <joerg@NetBSD.org>
All rights reserved.

Redistribution and use in source and binary forms, with or without modification, are permitted provided that the following conditions are met:

1. Redistributions of source code must retain the above copyright notice, this list of conditions and the following disclaimer in this position and unchanged.
2. Redistributions in binary form must reproduce the above copyright notice, this list of conditions and the following disclaimer in the documentation and/or other materials provided with the distribution.
3. The name of the author may not be used to endorse or promote products derived from this software without specific prior written permission

THIS SOFTWARE IS PROVIDED BY THE AUTHOR 'AS IS' AND ANY EXPRESS OR IMPLIED WARRANTIES, INCLUDING, BUT NOT LIMITED TO, THE IMPLIED WARRANTIES OF MERCHANTABILITY AND FITNESS FOR A PARTICULAR PURPOSE ARE DISCLAIMED.
IN NO EVENT SHALL THE AUTHOR BE LIABLE FOR ANY DIRECT, INDIRECT, INCIDENTAL, SPECIAL, EXEMPLARY, OR CONSEQUENTIAL DAMAGES (INCLUDING, BUT NOT LIMITED TO, PROCUREMENT OF SUBSTITUTE GOODS OR SERVICES; LOSS OF USE, DATA, OR PROFITS; OR BUSINESS INTERRUPTION) HOWEVER CAUSED AND ON ANY THEORY OF LIABILITY, WHETHER IN CONTRACT, STRICT LIABILITY, OR TORT (INCLUDING NEGLIGENCE OR OTHERWISE) ARISING IN ANY WAY OUT OF THE USE OF THIS SOFTWARE, EVEN IF ADVISED OF THE POSSIBILITY OF SUCH DAMAGE.

Free Type 2 font engine
Copyright 1996-2002, 2006 by David
Turner, Robert Wilhelm, and Werner Lemberg.
The software is based in part of the work of the FreeType Team.

c-ares
Copyright 1998 by the Massachusetts Institute of Technology.

Permission to use, copy, modify, and distribute this software and its documentation for any purpose and without fee is hereby granted, provided that the above copyright notice appear in all copies and that both that copyright notice and this permission notice appear in supporting documentation, and that the name of M.I.T. not be used in advertising or publicity pertaining to distribution of the software without specific, written prior permission. M.I.T. makes no representations about the suitability of this software for any purpose. It is provided "as is" without express or implied warranty.

pixman
The following is the 'standard copyright' agreed upon by most contributors, and is currently the canonical license, though a modification is currently under discussion. Copyright holders of new code should use this license statement where possible, and append their name to this list.

Copyright 1987, 1988, 1989, 1998 The Open Group
Copyright 1987, 1988, 1989 Digital Equipment Corporation
Copyright 1999, 2004, 2008 Keith Packard
Copyright 2000 SuSE, Inc.
Copyright 2000 Keith Packard, member of The XFree86 Project, Inc.
Copyright 2004, 2005, 2007, 2008 Red Hat, Inc.
Copyright 2004 Nicholas Miell
Copyright 2005 Lars Knoll & Zack Rusin, Trolltech
Copyright 2005 Trolltech AS
Copyright 2007 Luca Barbato
Copyright 2008 Aaron Plattner, NVIDIA Corporation
Copyright 2008 Rodrigo Kumpeta
Copyright 2008 Andre Tupinamba
Copyright 2008 Mozilla Corporation
Copyright 2008 Frederic Plourde
Copyright 2009 Sun Microsystems, Inc.

Permission is hereby granted, free of charge, to any person obtaining a copy of this software and associated documentation files (the "Software"), to deal in the Software without restriction, including without limitation the rights to use, copy, modify, merge, publish, distribute, sublicense, and/or sell copies of the Software, and to permit persons to whom the Software is furnished to do so, subject to the following conditions:

The above copyright notice and this permission notice (including the next paragraph) shall be included in all copies or substantial portions of the Software.

THE SOFTWARE IS PROVIDED "AS IS", WITHOUT WARRANTY OF ANY KIND, EXPRESS OR IMPLIED, INCLUDING BUT NOT LIMITED TO THE WARRANTIES OF MERCHANTABILITY, FITNESS FOR A PARTICULAR PURPOSE AND NONINFRINGEMENT. IN NO EVENT SHALL THE AUTHORS OR COPYRIGHT HOLDERS BE LIABLE FOR ANY CLAIM, DAMAGES OR OTHER LIABILITY, WHETHER IN AN ACTION OF CONTRACT, TORT OR OTHERWISE, ARISING FROM, OUT OF OR IN CONNECTION WITH THE SOFTWARE OR THE USE OR OTHER DEALINGS IN THE SOFTWARE.

libjpeg
This software is based in part on the work of the Independent JPEG Group.

Fraunhofer IIS and Thomson Multimedia
MPEG Layer-3 audio compression technology licensed by Fraunhofer IIS and Thomson Multimedia.

UPnP
Portions Copyright (C) 2004 Intel Corporation

GNU GENERAL PUBLIC LICENSE
Version 2, June 1991

Copyright (C) 1989, 1991 Free Software Foundation, Inc.,
51 Franklin Street, Fifth Floor, Boston, MA 02110-1301 USA
Everyone is permitted to copy and distribute verbatim copies of this license document, but changing it is not allowed.

Preamble

The licenses for most software are designed to take away your freedom to share and change it. By contrast, the GNU General Public License is intended to guarantee your freedom to share and change free software--to make sure the software is free for all its users. This General Public License applies to most of the Free Software Foundation's software and to any other program whose authors commit to using it. (Some other Free Software Foundation software is covered by the GNU Lesser General Public License instead.) You can apply it to your programs, too.

Intellectual Property Rights and Other Matters that Apply to This Software

When we speak of free software, we are referring to freedom, not price. Our General Public Licenses are designed to make sure that you have the freedom to distribute copies of free software (and charge for this service if you wish), that you receive source code or can get it if you want it, that you can change the software or use pieces of it in new free programs; and that you know you can do these things.

To protect your rights, we need to make restrictions that forbid anyone to deny you these rights or to ask you to surrender the rights. These restrictions translate to certain responsibilities for you if you distribute copies of the software, or if you modify it.

For example, if you distribute copies of such a program, whether gratis or for a fee, you must give the recipients all the rights that you have. You must make sure that they, too, receive or can get the source code. And you must show them these terms so they know their rights.

We protect your rights with two steps: (1) copyright the software, and (2) offer you this license which gives you legal permission to copy, distribute and/or modify the software.

Also, for each author's protection and ours, we want to make certain that everyone understands that there is no warranty for this free software. If the software is modified by someone else and passed on, we want its recipients to know that what they have is not the original, so that any problems introduced by others will not reflect on the original authors' reputations.

Finally, any free program is threatened constantly by software patents. We wish to avoid the danger that redistributors of a free program will individually obtain patent licenses, in effect making the program proprietary. To prevent this, we have made it clear that any patent must be licensed for everyone's free use or not licensed at all.

The precise terms and conditions for copying, distribution and modification follow.

GNU GENERAL PUBLIC LICENSE TERMS AND CONDITIONS FOR COPYING, DISTRIBUTION AND MODIFICATION

0. This License applies to any program or other work which contains a notice placed by the copyright holder saying it may be distributed under the terms of this General Public License. The "Program", below, refers to any such program or work, and a "work based on the Program" means either the Program or any derivative work under copyright law: that is to say, a work containing the Program or a portion of it, either verbatim or with modifications and/or translated into another language. (Hereinafter, translation is included without limitation in the term "modification".) Each licensee is addressed as "you".

Activities other than copying, distribution and modification are not covered by this License; they are outside its scope. The act of running the Program is not restricted, and the output from the Program is covered only if its contents constitute a work based on the Program (independent of having been made by running the Program).

Whether that is true depends on what the Program does.

1. You may copy and distribute verbatim copies of the Program's source code as you receive it, in any medium, provided that you conspicuously and appropriately publish on each copy an appropriate copyright notice and disclaimer of warranty; keep intact all the notices that refer to this License and to the absence of any warranty; and give any other recipients of the Program a copy of this License along with the Program.

You may charge a fee for the physical act of transferring a copy, and you may at your option offer warranty protection in exchange for a fee.

2. You may modify your copy or copies of the Program or any portion of it, thus forming a work based on the Program, and copy and distribute such modifications or work under the terms of Section 1 above, provided that you also meet all of these conditions:

- a) You must cause the modified files to carry prominent notices stating that you changed the files and the date of any change.
- b) You must cause any work that you distribute or publish, that in whole or in part contains or is derived from the Program or any part thereof, to be licensed as a whole at no charge to all third parties under the terms of this License.
- c) If the modified program normally reads commands interactively when run, you must cause it, when started running for such interactive use in the most ordinary way, to print or display an announcement including an appropriate copyright notice and a notice that there is no warranty (or else, saying that you provide a warranty) and that users may redistribute the program under these conditions, and telling the user how to view a copy of this License. (Exception: if the Program itself is interactive but does not normally print such an announcement, your work based on the Program is not required to print an announcement.)

These requirements apply to the modified work as a whole. If identifiable sections of that work are not derived from the Program, and can be reasonably considered independent and separate works in themselves, then this License, and its terms, do not apply to those sections when you distribute them as separate works. But when you distribute the same sections as part of a whole which is a work based on the Program, the distribution of the whole must be on the terms of this License, whose permissions for other licensees extend to the entire whole, and thus to each and every part regardless of who wrote it.

Thus, it is not the intent of this section to claim rights or contest your rights to work written entirely by you; rather, the intent is to exercise the right to control the distribution of derivative or collective works based on the Program.

In addition, mere aggregation of another work not based on the Program with the Program (or with a work based on the Program) on a volume of a storage or distribution medium does not bring the other work under the scope of this License.

3. You may copy and distribute the Program (or a work based on it, under Section 2) in object code or executable form under the terms of Sections 1 and 2 above provided that you also do one of the following:
 - a) Accompany it with the complete corresponding machine-readable source code, which must be distributed under the terms of Sections 1 and 2 above on a medium customarily used for software interchange; or,
 - b) Accompany it with a written offer, valid for at least three years, to give any third party, for a charge no more than your cost of physically performing source distribution, a complete machine-readable copy of the corresponding source code, to be distributed under the terms of Sections 1 and 2 above on a medium customarily used for software interchange; or,
 - c) Accompany it with the information you received as to the offer to distribute corresponding source code. (This alternative is allowed only for noncommercial distribution and only if you received the program in object code or executable form with such an offer, in accord with Subsection b above.)

The source code for a work means the preferred form of the work for making modifications to it. For an executable work, complete source code means all the source code for all modules it contains, plus any associated interface definition files, plus the scripts used to control compilation and installation of the executable. However, as a special exception, the source code distributed need not include anything that is normally distributed (in either source or binary form) with the major components (compiler, kernel, and so on) of the operating system on which the executable runs, unless that component itself accompanies the executable.

If distribution of executable or object code is made by offering access to copy from a designated place, then offering equivalent access to copy the source code from the same place counts as distribution of the source code, even though third parties are not compelled to copy the source along with the object code.

4. You may not copy, modify, sublicense, or distribute the Program except as expressly provided under this License. Any attempt otherwise to copy, modify, sublicense or distribute the Program is void, and will automatically terminate your rights under this License. However, parties who have received copies, or rights, from you under this License will not have their licenses terminated so long as such parties remain in full compliance.
5. You are not required to accept this License, since you have not signed it. However, nothing else grants you permission to modify or distribute the Program or its derivative works. These actions are prohibited by law if you do not accept this License. Therefore, by modifying or distributing the Program (or any work based on the Program), you indicate your acceptance of this License to do so, and all its terms and conditions for copying, distributing or modifying the Program or works based on it.
6. Each time you redistribute the Program (or any work based on the Program), the recipient automatically receives a license from the original licensor to copy, distribute or modify the Program subject to these terms and conditions. You may not impose any further restrictions on the recipients' exercise of the rights granted herein. You are not responsible for enforcing compliance by third parties to this License.
7. If, as a consequence of a court judgment or allegation of patent infringement or for any other reason (not limited to patent issues), conditions are imposed on you (whether by court order, agreement or otherwise) that contradict the conditions of this License, they do not excuse you from the conditions of this License. If you cannot distribute so as to satisfy simultaneously your obligations under this License and any other pertinent obligations, then as a consequence you may not distribute the Program at all. For example, if a patent license would not permit royalty-free redistribution of the Program by all those who receive copies directly or indirectly through you, then the only way you could satisfy both it and this License would be to refrain entirely from distribution of the Program.

Intellectual Property Rights and Other Matters that Apply to This Software

If any portion of this section is held invalid or unenforceable under any particular circumstance, the balance of the section is intended to apply and the section as a whole is intended to apply in other circumstances.

It is not the purpose of this section to induce you to infringe any patents or other property right claims or to contest validity of any such claims; this section has the sole purpose of protecting the integrity of the free software distribution system, which is implemented by public license practices. Many people have made generous contributions to the wide range of software distributed through that system in reliance on consistent application of that system; it is up to the author/donor to decide if he or she is willing to distribute software through any other system and a licensee cannot impose that choice.

This section is intended to make thoroughly clear what is believed to be a consequence of the rest of this License.

8. If the distribution and/or use of the Program is restricted in certain countries either by patents or by copyrighted interfaces, the original copyright holder who places the Program under this License may add an explicit geographical distribution limitation excluding those countries, so that distribution is permitted only in or among countries not thus excluded. In such case, this License incorporates the limitation as if written in the body of this License.
9. The Free Software Foundation may publish revised and/or new versions of the General Public License from time to time. Such new versions will be similar in spirit to the present version, but may differ in detail to address new problems or concerns.

Each version is given a distinguishing version number. If the Program specifies a version number of this License which applies to it and "any later version", you have the option of following the terms and conditions either of that version or of any later version published by the Free Software Foundation. If the Program does not specify a version number of this License, you may choose any version ever published by the Free Software Foundation.

10. If you wish to incorporate parts of the Program into other free programs whose distribution conditions are different, write to the author to ask for permission. For software which is copyrighted by the Free Software Foundation, write to the Free Software Foundation; we sometimes make exceptions for this. Our decision will be guided by the two goals of preserving the free status of all derivatives of our free software and of promoting the sharing and reuse of software generally.

NO WARRANTY

11. BECAUSE THE PROGRAM IS LICENSED FREE OF CHARGE, THERE IS NO WARRANTY FOR THE PROGRAM, TO THE EXTENT PERMITTED BY APPLICABLE LAW. EXCEPT WHEN OTHERWISE STATED IN WRITING THE COPYRIGHT HOLDERS AND/OR OTHER PARTIES PROVIDE THE PROGRAM "AS IS" WITHOUT WARRANTY OF ANY KIND, EITHER EXPRESSED OR IMPLIED, INCLUDING, BUT NOT LIMITED TO, THE IMPLIED WARRANTIES OF MERCHANTABILITY AND FITNESS FOR A PARTICULAR PURPOSE. THE ENTIRE RISK AS TO THE QUALITY AND PERFORMANCE OF THE PROGRAM IS WITH YOU. SHOULD THE PROGRAM PROVE DEFECTIVE, YOU ASSUME THE COST OF ALL NECESSARY SERVICING, REPAIR OR CORRECTION.
12. IN NO EVENT UNLESS REQUIRED BY APPLICABLE LAW OR AGREED TO IN WRITING WILL ANY COPYRIGHT HOLDER, OR ANY OTHER PARTY WHO MAY MODIFY AND/OR REDISTRIBUTE THE PROGRAM AS PERMITTED ABOVE, BE LIABLE TO YOU FOR DAMAGES, INCLUDING ANY GENERAL, SPECIAL, INCIDENTAL OR CONSEQUENTIAL DAMAGES ARISING OUT OF THE USE OR INABILITY TO USE THE PROGRAM (INCLUDING BUT NOT LIMITED TO LOSS OF DATA OR DATA BEING RENDERED INACCURATE OR LOSSES SUSTAINED BY YOU OR THIRD PARTIES OR A FAILURE OF THE PROGRAM TO OPERATE WITH ANY OTHER PROGRAMS), EVEN IF SUCH HOLDER OR OTHER PARTY HAS BEEN ADVISED OF THE POSSIBILITY OF SUCH DAMAGES.

END OF TERMS AND CONDITIONS

How to Apply These Terms to Your New Programs

If you develop a new program, and you want it to be of the greatest possible use to the public, the best way to achieve this is to make it free software which everyone can redistribute and change under these terms.

To do so, attach the following notices to the program. It is safest to attach them to the start of each source file to most effectively convey the exclusion of warranty; and each file should have at least the "copyright" line and a pointer to where the full notice is found.

```
<one line to give the program's name and a brief idea of what it does.>
Copyright (C) <year> <name of author>
```

This program is free software; you can redistribute it and/or modify it under the terms of the GNU General Public License as published by the Free Software Foundation; either version 2 of the License, or (at your option) any later version.

This program is distributed in the hope that it will be useful, but WITHOUT ANY WARRANTY; without even the implied warranty of MERCHANTABILITY or FITNESS FOR A PARTICULAR PURPOSE. See the GNU General Public License for more details.

You should have received a copy of the GNU General Public License along with this program; if not, write to the Free Software Foundation, Inc., 51 Franklin Street, Fifth Floor, Boston, MA 02110-1301 USA.

Also add information on how to contact you by electronic and paper mail.

If the program is interactive, make it output a short notice like this when it starts in an interactive mode:

```
Gnomovision version 69, Copyright (C) year name of author Gnomovision
comes with ABSOLUTELY NO WARRANTY; for details type `show w'.
```

```
This is free software, and you are welcome to redistribute it under certain
conditions; type `show c' for details.
```

The hypothetical commands `show w' and `show c' should show the appropriate parts of the General Public License. Of course, the commands you use may be called something other than `show w' and `show c'; they could even be mouse-clicks or menu items--whatever suits your program.

You should also get your employer (if you work as a programmer) or your school, if any, to sign a "copyright disclaimer" for the program, if necessary. Here is a sample; alter the names:

```
Yoyodyne, Inc., hereby disclaims all copyright interest in the program
`Gnomovision' (which makes passes at compilers) written by James Hacker.
```

```
<signature of Ty Coon>, 1 April 1989
Ty Coon, President of Vice
```

This General Public License does not permit incorporating your program into proprietary programs. If your program is a subroutine library, you may consider it more useful to permit linking proprietary applications with the library. If this is what you want to do, use the GNU Lesser General Public License instead of this License.

GNU LESSER GENERAL PUBLIC LICENSE

Version 2.1, February 1999

Copyright (C) 1991, 1999 Free Software Foundation, Inc.
51 Franklin Street, Fifth Floor, Boston, MA 02110-1301 USA
Everyone is permitted to copy and distribute verbatim copies of this license document, but changing it is not allowed.

[This is the first released version of the Lesser GPL. It also counts as the successor of the GNU Library Public License, version 2, hence the version number 2.1.]

Preamble

The licenses for most software are designed to take away your freedom to share and change it. By contrast, the GNU General Public Licenses are intended to guarantee your freedom to share and change free software--to make sure the software is free for all its users.

This license, the Lesser General Public License, applies to some specially designated software packages--typically libraries--of the Free Software Foundation and other authors who decide to use it. You can use it too, but we suggest you first think carefully about whether this license or the ordinary General Public License is the better strategy to use in any particular case, based on the explanations below.

When we speak of free software, we are referring to freedom of use, not price. Our General Public Licenses are designed to make sure that you have the freedom to distribute copies of free software (and charge for this service if you wish); that you receive source code or can get it if you want it; that you can change the software and use pieces of it in new free programs; and that you are informed that you can do these things.

To protect your rights, we need to make restrictions that forbid distributors to deny you these rights or to ask you to surrender these rights. These restrictions translate to certain responsibilities for you if you distribute copies of the library or if you modify it.

For example, if you distribute copies of the library, whether gratis or for a fee, you must give the recipients all the rights that we gave you. You must make sure that they, too, receive or can get the source code. If you link other code with the library, you must provide complete object files to the recipients, so that they can relink them with the library after making changes to the library and recompiling it. And you must show them these terms so they know their rights.

Intellectual Property Rights and Other Matters that Apply to This Software

We protect your rights with a two-step method: (1) we copyright the library, and (2) we offer you this license, which gives you legal permission to copy, distribute and/or modify the library.

To protect each distributor, we want to make it very clear that there is no warranty for the free library. Also, if the library is modified by someone else and passed on, the recipients should know that what they have is not the original version, so that the original author's reputation will not be affected by problems that might be introduced by others.

Finally, software patents pose a constant threat to the existence of any free program. We wish to make sure that a company cannot effectively restrict the users of a free program by obtaining a restrictive license from a patent holder. Therefore, we insist that any patent license obtained for a version of the library must be consistent with the full freedom of use specified in this license.

Most GNU software, including some libraries, is covered by the ordinary GNU General Public License. This license, the GNU Lesser General Public License, applies to certain designated libraries, and is quite different from the ordinary General Public License. We use this license for certain libraries in order to permit linking those libraries into non-free programs.

When a program is linked with a library, whether statically or using a shared library, the combination of the two is legally speaking a combined work, a derivative of the original library. The ordinary General Public License therefore permits such linking only if the entire combination fits its criteria of freedom. The Lesser General Public License permits more lax criteria for linking other code with the library.

We call this license the "Lesser" General Public License because it does Less to protect the user's freedom than the ordinary General Public License. It also provides other free software developers Less of an advantage over competing non-free programs. These disadvantages are the reason we use the ordinary General Public License for many libraries. However, the Lesser license provides advantages in certain special circumstances.

For example, on rare occasions, there may be a special need to encourage the widest possible use of a certain library, so that it becomes a de-facto standard. To achieve this, non-free programs must be allowed to use the library. A more frequent case is that a free library does the same job as widely used non-free libraries. In this case, there is little to gain by limiting the free library to free software only, so we use the Lesser General Public License.

In other cases, permission to use a particular library in non-free programs enables a greater number of people to use a large body of free software. For example, permission to use the GNU C Library in non-free programs enables many more people to use the whole GNU operating system, as well as its variant, the GNU/Linux operating system.

Although the Lesser General Public License is Less protective of the users' freedom, it does ensure that the user of a program that is linked with the Library has the freedom and the wherewithal to run that program using a modified version of the Library.

The precise terms and conditions for copying, distribution and modification follow. Pay close attention to the difference between a "work based on the library" and a "work that uses the library". The former contains code derived from the library, whereas the latter must be combined with the library in order to run.

GNU LESSER GENERAL PUBLIC LICENSE TERMS AND CONDITIONS FOR COPYING, DISTRIBUTION AND MODIFICATION

0. This License Agreement applies to any software library or other program which contains a notice placed by the copyright holder or other authorized party saying it may be distributed under the terms of this Lesser General Public License (also called "this License"). Each licensee is addressed as "you".

A "library" means a collection of software functions and/or data prepared so as to be conveniently linked with application programs (which use some of those functions and data) to form executables.

The "Library", below, refers to any such software library or work which has been distributed under these terms. A "work based on the Library" means either the Library or any derivative work under copyright law: that is to say, a work containing the Library or a portion of it, either verbatim or with modifications and/or translated straightforwardly into another language. (Hereinafter, translation is included without limitation in the term "modification".)

"Source code" for a work means the preferred form of the work for making modifications to it. For a library, complete source code means all the source code for all modules it contains, plus any associated interface definition files, plus the scripts used to control compilation and installation of the library.

Activities other than copying, distribution and modification are not covered by this License; they are outside its scope. The act of running a program using the Library is not restricted, and output from such a program is covered only if its contents constitute a work based on the Library (independent of the use of the Library in a tool for writing it). Whether that is true depends on what the Library does and what the program that uses the Library does.

1. You may copy and distribute verbatim copies of the Library's complete source code as you receive it, in any medium, provided that you conspicuously and appropriately publish on each copy an appropriate copyright notice and disclaimer of warranty; keep intact all the notices that refer to this License and to the absence of any warranty; and distribute a copy of this License along with the Library.

You may charge a fee for the physical act of transferring a copy, and you may at your option offer warranty protection in exchange for a fee.

2. You may modify your copy or copies of the Library or any portion of it, thus forming a work based on the Library, and copy and distribute such modifications or work under the terms of Section 1 above, provided that you also meet all of these conditions:

- a) The modified work must itself be a software library.
- b) You must cause the files modified to carry prominent notices stating that you changed the files and the date of any change.
- c) You must cause the whole of the work to be licensed at no charge to all third parties under the terms of this License.
- d) If a facility in the modified Library refers to a function or a table of data to be supplied by an application program that uses the facility, other than as an argument passed when the facility is invoked, then you must make a good faith effort to ensure that, in the event an application does not supply such function or table, the facility still operates, and performs whatever part of its purpose remains meaningful.

(For example, a function in a library to compute square roots has a purpose that is entirely well-defined independent of the application. Therefore, Subsection 2d requires that any application-supplied function or table used by this function must be optional: if the application does not supply it, the square root function must still compute square roots.)

These requirements apply to the modified work as a whole. If identifiable sections of that work are not derived from the Library, and can be reasonably considered independent and separate works in themselves, then this License, and its terms, do not apply to those sections when you distribute them as separate works. But when you distribute the same sections as part of a whole which is a work based on the Library, the distribution of the whole must be on the terms of this License, whose permissions for other licensees extend to the entire whole, and thus to each and every part regardless of who wrote it.

Thus, it is not the intent of this section to claim rights or contest your rights to work written entirely by you; rather, the intent is to exercise the right to control the distribution of derivative or collective works based on the Library.

In addition, mere aggregation of another work not based on the Library with the Library (or with a work based on the Library) on a volume of a storage or distribution medium does not bring the other work under the scope of this License.

3. You may opt to apply the terms of the ordinary GNU General Public License instead of this License to a given copy of the Library. To do this, you must alter all the notices that refer to this License, so that they refer to the ordinary GNU General Public License, version 2, instead of to this License. (If a newer version than version 2 of the ordinary GNU General Public License has appeared, then you can specify that version instead if you wish.) Do not make any other change in these notices.

Once this change is made in a given copy, it is irreversible for that copy, so the ordinary GNU General Public License applies to all subsequent copies and derivative works made from that copy.

This option is useful when you wish to copy part of the code of the Library into a program that is not a library.

4. You may copy and distribute the Library (or a portion or derivative of it, under Section 2) in object code or executable form under the terms of Sections 1 and 2 above provided that you accompany it with the complete corresponding machine-readable source code, which must be distributed under the terms of Sections 1 and 2 above on a medium customarily used for software interchange.

If distribution of object code is made by offering access to copy from a designated place, then offering equivalent access to copy the source code from the same place satisfies the requirement to distribute the source code, even though third parties are not compelled to copy the source along with the object code.

5. A program that contains no derivative of any portion of the Library, but is designed to work with the Library by being compiled or linked with it, is called a "work that uses the Library". Such a work, in isolation, is not a derivative work of the Library, and therefore falls outside the scope of this License.

Intellectual Property Rights and Other Matters that Apply to This Software

However, linking a "work that uses the Library" with the Library creates an executable that is a derivative of the Library (because it contains portions of the Library), rather than a "work that uses the library". The executable is therefore covered by this License. Section 6 states terms for distribution of such executables.

When a "work that uses the Library" uses material from a header file that is part of the Library, the object code for the work may be a derivative work of the Library even though the source code is not. Whether this is true is especially significant if the work can be linked without the Library, or if the work is itself a library. The threshold for this to be true is not precisely defined by law.

If such an object file uses only numerical parameters, data structure layouts and accessors, and small macros and small inline functions (ten lines or less in length), then the use of the object file is unrestricted, regardless of whether it is legally a derivative work. (Executables containing this object code plus portions of the Library will still fall under Section 6.)

Otherwise, if the work is a derivative of the Library, you may distribute the object code for the work under the terms of Section 6. Any executables containing that work also fall under Section 6, whether or not they are linked directly with the Library itself.

6. As an exception to the Sections above, you may also combine or link a "work that uses the Library" with the Library to produce a work containing portions of the Library, and distribute that work under terms of your choice, provided that the terms permit modification of the work for the customer's own use and reverse engineering for debugging such modifications.

You must give prominent notice with each copy of the work that the Library is used in it and that the Library and its use are covered by this License. You must supply a copy of this License. If the work during execution displays copyright notices, you must include the copyright notice for the Library among them, as well as a reference directing the user to the copy of this License. Also, you must do one of these things:

- a) Accompany the work with the complete corresponding machine-readable source code for the Library including whatever changes were used in the work (which must be distributed under Sections 1 and 2 above); and, if the work is an executable linked with the Library, with the complete machine-readable "work that uses the Library", as object code and/or source code, so that the user can modify the Library and then relink to produce a modified executable containing the modified Library. (It is understood that the user who changes the contents of definitions files in the Library will not necessarily be able to recompile the application to use the modified definitions.)
- b) Use a suitable shared library mechanism for linking with the Library. A suitable mechanism is one that (1) uses at run time a copy of the library already present on the user's computer system, rather than copying library functions into the executable, and (2) will operate properly with a modified version of the library, if the user installs one, as long as the modified version is interface-compatible with the version that the work was made with.
- c) Accompany the work with a written offer, valid for at least three years, to give the same user the materials specified in Subsection 6a, above, for a charge no more than the cost of performing this distribution.
- d) If distribution of the work is made by offering access to copy from a designated place, offer equivalent access to copy the above specified materials from the same place.
- e) Verify that the user has already received a copy of these materials or that you have already sent this user a copy.

For an executable, the required form of the "work that uses the Library" must include any data and utility programs needed for reproducing the executable from it. However, as a special exception, the materials to be distributed need not include anything that is normally distributed (in either source or binary form) with the major components (compiler, kernel, and so on) of the operating system on which the executable runs, unless that component itself accompanies the executable.

It may happen that this requirement contradicts the license restrictions of other proprietary libraries that do not normally accompany the operating system. Such a contradiction means you cannot use both them and the Library together in an executable that you distribute.

7. You may place library facilities that are a work based on the Library side-by-side in a single library together with other library facilities not covered by this License, and distribute such a combined library, provided that the separate distribution of the work based on the Library and of the other library facilities is otherwise permitted, and provided that you do these two things:

- a) Accompany the combined library with a copy of the same work based on the Library, uncombined with any other library facilities. This must be distributed under the terms of the Sections above.

b) Give prominent notice with the combined library of the fact that part of it is a work based on the Library, and explaining where to find the accompanying uncombined form of the same work.

8. You may not copy, modify, sublicense, link with, or distribute the Library except as expressly provided under this License. Any attempt otherwise to copy, modify, sublicense, link with, or distribute the Library is void, and will automatically terminate your rights under this License. However, parties who have received copies, or rights, from you under this License will not have their licenses terminated so long as such parties remain in full compliance.
9. You are not required to accept this License, since you have not signed it. However, nothing else grants you permission to modify or distribute the Library or its derivative works. These actions are prohibited by law if you do not accept this License. Therefore, by modifying or distributing the Library (or any work based on the Library), you indicate your acceptance of this License to do so, and all its terms and conditions for copying, distributing or modifying the Library or works based on it.
10. Each time you redistribute the Library (or any work based on the Library), the recipient automatically receives a license from the original licensor to copy, distribute, link with or modify the Library subject to these terms and conditions. You may not impose any further restrictions on the recipients' exercise of the rights granted herein. You are not responsible for enforcing compliance by third parties with this License.
11. If, as a consequence of a court judgment or allegation of patent infringement or for any other reason (not limited to patent issues), conditions are imposed on you (whether by court order, agreement or otherwise) that contradict the conditions of this License, they do not excuse you from the conditions of this License. If you cannot distribute so as to satisfy simultaneously your obligations under this License and any other pertinent obligations, then as a consequence you may not distribute the Library at all. For example, if a patent license would not permit royalty-free redistribution of the Library by all those who receive copies directly or indirectly through you, then the only way you could satisfy both it and this License would be to refrain entirely from distribution of the Library.

If any portion of this section is held invalid or unenforceable under any particular circumstance, the balance of the section is intended to apply, and the section as a whole is intended to apply in other circumstances.

It is not the purpose of this section to induce you to infringe any patents or other property right claims or to contest validity of any such claims; this section has the sole purpose of protecting the integrity of the free software distribution system which is implemented by public license practices. Many people have made generous contributions to the wide range of software distributed through that system in reliance on consistent application of that system; it is up to the author/donor to decide if he or she is willing to distribute software through any other system and a licensee cannot impose that choice.

This section is intended to make thoroughly clear what is believed to be a consequence of the rest of this License.

12. If the distribution and/or use of the Library is restricted in certain countries either by patents or by copyrighted interfaces, the original copyright holder who places the Library under this License may add an explicit geographical distribution limitation excluding those countries, so that distribution is permitted only in or among countries not thus excluded. In such case, this License incorporates the limitation as if written in the body of this License.
13. The Free Software Foundation may publish revised and/or new versions of the Lesser General Public License from time to time. Such new versions will be similar in spirit to the present version, but may differ in detail to address new problems or concerns.

Each version is given a distinguishing version number. If the Library specifies a version number of this License which applies to it and "any later version", you have the option of following the terms and conditions either of that version or of any later version published by the Free Software Foundation. If the Library does not specify a license version number, you may choose any version ever published by the Free Software Foundation.

14. If you wish to incorporate parts of the Library into other free programs whose distribution conditions are incompatible with these, write to the author to ask for permission. For software which is copyrighted by the Free Software Foundation, write to the Free Software Foundation; we sometimes make exceptions for this. Our decision will be guided by the two goals of preserving the free status of all derivatives of our free software and of promoting the sharing and reuse of software generally.

NO WARRANTY

15. BECAUSE THE LIBRARY IS LICENSED FREE OF CHARGE, THERE IS NO WARRANTY FOR THE LIBRARY, TO THE EXTENT PERMITTED BY APPLICABLE LAW.

Intellectual Property Rights and Other Matters that Apply to This Software

EXCEPT WHEN OTHERWISE STATED IN WRITING THE COPYRIGHT HOLDERS AND/OR OTHER PARTIES PROVIDE THE LIBRARY "AS IS" WITHOUT WARRANTY OF ANY KIND, EITHER EXPRESSED OR IMPLIED, INCLUDING, BUT NOT LIMITED TO, THE IMPLIED WARRANTIES OF MERCHANTABILITY AND FITNESS FOR A PARTICULAR PURPOSE. THE ENTIRE RISK AS TO THE QUALITY AND PERFORMANCE OF THE LIBRARY IS WITH YOU. SHOULD THE LIBRARY PROVE DEFECTIVE, YOU ASSUME THE COST OF ALL NECESSARY SERVICING, REPAIR OR CORRECTION.

16. IN NO EVENT UNLESS REQUIRED BY APPLICABLE LAW OR AGREED TO IN WRITING WILL ANY COPYRIGHT HOLDER, OR ANY OTHER PARTY WHO MAY MODIFY AND/OR REDISTRIBUTE THE LIBRARY AS PERMITTED ABOVE, BE LIABLE TO YOU FOR DAMAGES, INCLUDING ANY GENERAL, SPECIAL, INCIDENTAL OR CONSEQUENTIAL DAMAGES ARISING OUT OF THE USE OR INABILITY TO USE THE LIBRARY (INCLUDING BUT NOT LIMITED TO LOSS OF DATA OR DATA BEING RENDERED INACCURATE OR LOSSES SUSTAINED BY YOU OR THIRD PARTIES OR A FAILURE OF THE LIBRARY TO OPERATE WITH ANY OTHER SOFTWARE), EVEN IF SUCH HOLDER OR OTHER PARTY HAS BEEN ADVISED OF THE POSSIBILITY OF SUCH DAMAGES.

END OF TERMS AND CONDITIONS

How to Apply These Terms to Your New Libraries

If you develop a new library, and you want it to be of the greatest possible use to the public, we recommend making it free software that everyone can redistribute and change. You can do so by permitting redistribution under these terms (or, alternatively, under the terms of the ordinary General Public License).

To apply these terms, attach the following notices to the library. It is safest to attach them to the start of each source file to most effectively convey the exclusion of warranty; and each file should have at least the "copyright" line and a pointer to where the full notice is found.

```
<one line to give the library's name and a brief idea of what it does.>
Copyright (C) <year> <name of author>
```

This library is free software; you can redistribute it and/or modify it under the terms of the GNU Lesser General Public License as published by the Free Software Foundation; either version 2.1 of the License, or (at your option) any later version.

This library is distributed in the hope that it will be useful, but WITHOUT ANY WARRANTY; without even the implied warranty of MERCHANTABILITY or FITNESS FOR A PARTICULAR PURPOSE. See the GNU Lesser General Public License for more details.

You should have received a copy of the GNU Lesser General Public License along with this library; if not, write to the Free Software Foundation, Inc., 51 Franklin Street, Fifth Floor, Boston, MA 02110-1301 USA

Also add information on how to contact you by electronic and paper mail.

You should also get your employer (if you work as a programmer) or your school, if any, to sign a "copyright disclaimer" for the library, if necessary. Here is a sample; alter the names:

Yoyodyne, Inc., hereby disclaims all copyright interest in the library `Frob' (a library for tweaking knobs) written by James Random Hacker.

```
<signature of Ty Coon>, 1 April 1990
Ty Coon, President of Vice
```

That's all there is to it!

```
libFLAC
Copyright (C) 2000,2001,2002,2003,2004,2005,2006,2007 Josh Coalson
```

Redistribution and use in source and binary forms, with or without modification, are permitted provided that the following conditions are met:

- Redistributions of source code must retain the above copyright notice, this list of conditions and the following disclaimer.
- Redistributions in binary form must reproduce the above copyright notice, this list of conditions and the following disclaimer in the documentation and/or other materials provided with the distribution.
- Neither the name of the Xiph.org Foundation nor the names of its contributors may be used to endorse or promote products derived from this software without specific prior written permission.

THIS SOFTWARE IS PROVIDED BY THE COPYRIGHT HOLDERS AND CONTRIBUTORS "AS IS" AND ANY EXPRESS OR IMPLIED WARRANTIES, INCLUDING, BUT NOT LIMITED TO, THE IMPLIED WARRANTIES OF MERCHANTABILITY AND FITNESS FOR A PARTICULAR PURPOSE ARE DISCLAIMED. IN NO EVENT SHALL THE FOUNDATION OR CONTRIBUTORS BE LIABLE FOR ANY DIRECT, INDIRECT, INCIDENTAL, SPECIAL, EXEMPLARY, OR CONSEQUENTIAL DAMAGES (INCLUDING, BUT NOT LIMITED TO, PROCUREMENT OF SUBSTITUTE GOODS OR SERVICES; LOSS OF USE, DATA, OR PROFITS; OR BUSINESS INTERRUPTION) HOWEVER CAUSED AND ON ANY THEORY OF LIABILITY, WHETHER IN CONTRACT, STRICT LIABILITY, OR TORT (INCLUDING NEGLIGENCE OR OTHERWISE) ARISING IN ANY WAY OUT OF THE USE OF THIS SOFTWARE, EVEN IF ADVISED OF THE POSSIBILITY OF SUCH DAMAGE.

```
iputils
Copyright (c) 1989 The Regents of the University of California.
All rights reserved.
```

This code is derived from software contributed to Berkeley by Mike Muuss.

Redistribution and use in source and binary forms, with or without modification, are permitted provided that the following conditions are met:

1. Redistributions of source code must retain the above copyright notice, this list of conditions and the following disclaimer.
2. Redistributions in binary form must reproduce the above copyright notice, this list of conditions and the following disclaimer in the documentation and/or other materials provided with the distribution.
3. All advertising materials mentioning features or use of this software must display the following acknowledgement:
This product includes software developed by the University of California, Berkeley and its contributors.
4. Neither the name of the University nor the names of its contributors may be used to endorse or promote products derived from this software without specific prior written permission.

THIS SOFTWARE IS PROVIDED BY THE REGENTS AND CONTRIBUTORS "AS IS" AND ANY EXPRESS OR IMPLIED WARRANTIES, INCLUDING, BUT NOT LIMITED TO, THE IMPLIED WARRANTIES OF MERCHANTABILITY AND FITNESS FOR A PARTICULAR PURPOSE ARE DISCLAIMED. IN NO EVENT SHALL THE REGENTS OR CONTRIBUTORS BE LIABLE FOR ANY DIRECT, INDIRECT, INCIDENTAL, SPECIAL, EXEMPLARY, OR CONSEQUENTIAL DAMAGES (INCLUDING, BUT NOT LIMITED TO, PROCUREMENT OF SUBSTITUTE GOODS OR SERVICES; LOSS OF USE, DATA, OR PROFITS; OR BUSINESS INTERRUPTION) HOWEVER CAUSED AND ON ANY THEORY OF LIABILITY, WHETHER IN CONTRACT, STRICT LIABILITY, OR TORT (INCLUDING NEGLIGENCE OR OTHERWISE) ARISING IN ANY WAY OUT OF THE USE OF THIS SOFTWARE, EVEN IF ADVISED OF THE POSSIBILITY OF SUCH DAMAGE.

Mounting Precautions (For SHARP dealers and service engineers)

- When installing, removing or moving the monitor, ensure that this is carried out by at least 3 people.
- Be sure to use a wall-mount bracket designed or designated for mounting the monitor.
- This monitor is designed to be installed on a concrete wall or pillar. Reinforced work might be necessary for some materials such as plaster / thin plastic board / wood before starting installation.
- This monitor and bracket must be installed on a wall which can endure at least 4 times or more the weight of the monitor. Install by the most suitable method for the material and the structure.
- To attach a VESA-compliant mounting bracket, use M6 screws that are 5/16 inch (8 mm) to 3/8 inch (10 mm) longer than the thickness of the mounting bracket.

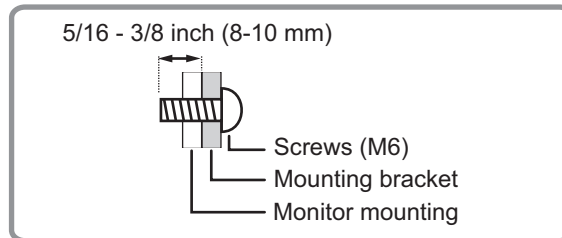

- Do not use an impact driver.
- When moving the monitor, be sure to hold it with the handles, the unit bottom and sides. Do not grasp the screen and corners. This may cause product damage, failure, or injury.
- If you need to move the monitor after it has been in use, it may be hot. Turn off the power and make sure it has cooled sufficiently before moving.
- After mounting, please carefully ensure the monitor is secure, and not able to come loose from the wall or mount.
- Do not use any screw holes other than VESA holes for installation.

SHARP[®]
SHARP CORPORATION