

GA18-2081-1
File No. S360/S370/S3/4300/8100-09

Systems

**IBM 3270
Information Display System**

**3276 Control Unit
Display Station
Description and
Programmer's Guide**

IBM

Systems

**IBM 3270
Information Display System**

**3276 Control Unit
Display Station
Description and
Programmer's Guide**

IBM

Warning: This equipment generates, uses, and can radiate radio frequency energy and, if not installed and used in accordance with the instructions manual, may cause interference to radio communications. It has been tested and found to comply with the limits for a Class A computing device pursuant to Subpart J of Part 15 of FCC Rules, which are designed to provide reasonable protection against such interference when operated in a commercial environment. Operation of this equipment in a residential area is likely to cause interference, in which case, the user, at his own expense, will be required to take whatever measures may be required to correct the interference.

Second Edition (May 1983)

This major revision obsoletes GA18-2081-0. Changes or additions to the text and illustrations are indicated by a vertical line to the left of the change.

Changes are made periodically to the information herein, before using this publication in connection with the operation of IBM systems, consult the latest *IBM System/370 Bibliography*, GC20-0001, for the editions that are applicable and current.

References in this publication to IBM products, programs, or services do not imply that IBM intends to make these available in all countries in which IBM operates. Any reference to an IBM program product in this publication is not intended to state or imply that only IBM's program product may be used. Any functionally equivalent program may be used instead.

Publications are not stocked at the address given below. Requests for IBM publications should be made to your IBM representative or to the IBM branch office serving your locality.

A form for readers' comments is provided at the back of this publication. If the form has been removed, comments may be addressed to IBM Corporation, Department 812J, 1133 Westchester Avenue, White Plains, New York, 10604, U.S.A. IBM may use or distribute whatever information you supply in any way it believes appropriate without incurring any obligation to you.

Preface

This publication provides management, programmers, and system analysts with detailed reference material relating to the IBM 3270 Information Display System 3276 Control Unit Display Station.

Organization of This Publication

This manual is organized into the following chapters:

Chapter 1, 3276 Control Unit and Data Streams.

Chapter 2, Terminals. This chapter, divided into two main sections, provides general information about displays and printers. The "Display" section presents detailed information about display fields, keyboards, selector-light-pen operations, the security keylock, and the magnetic card reading device. The "Printer" section discusses printer capabilities and control, including formatting, orders, buffered operation, SNA character string, and copy functions. (See also *IBM 3230 Printer Product Description*, GA24-3759, *IBM 3262 Printer Component Description*, GA24-3741, *IBM 3268 Printer Component Description*, GA27-3268, *IBM 3178 Display Station Description*, GA18-2127, *IBM 3270 Information Display System: Color and Programmed Symbols*, GA33-3056, *IBM 3287 Printer Component Description*, GA27-3135, and *IBM 3289 Line Printer Component Description*, GA27-3176.)

Chapter 3, Remote Operations—BSC, treats the 3276 Models 1, 2, 3, and 4.

Chapter 4, 3276 SNA/SDLC Communication, describes SNA and SDLC protocols for the 3276. It also presents SNA reference data applicable to the machine.

Chapter 5, Screen Design, introduces important 3270 concepts. Shows an example of what a 3270 display message might look like, what coding elements are required to write this message in your program, and how terminal operator input might be handled.

Chapter 6, Screen Management, suggests macro definitions and programming routines that might be written to encode and decode messages to and from the display.

Reference material is arranged in the following appendixes:

Appendix A. Indicators and Controls

Appendix B. Buffer Address I/O Interface Codes

Appendix C. Status Indicator Codes

Appendix D. APL/Text Feature

Appendix E. Katakana Feature

Appendix F. Encrypt/Decrypt Feature

Appendix G. Record Formatted Maintenance Statistics (RECFMS) Formats

Related Publications

Information concerning the Multiuse Communications Loop, used to attach 3270 devices to 8100 Information Systems, is contained in:

- *IBM 8100 Information System: Communications, Loop, and Display/Printer Attachment Description*, GA27-2883
- *IBM Multiuse Communications Loop Planning Guide*, GA23-0033
- *IBM Multiuse Communications Loop Installation Guide*, GA23-0039

The two Multiuse Communications Loop publications referred to above and the following IBM 4300 Processor publications provide information concerning attachment of the 3276 to the 4331 Processor via the 4331 loop adapter:

- *IBM 4300 Processors Summary and Input/Output & Data Communications Configurator*, GA33-1523
- *IBM 4331 Processor Functional Characteristics and Processor Complex Configurator*, GA33-1526

Publications describing the printers and displays attaching to the 3276, the 3270 data stream, the use of color, and programming information, are listed in the publication *IBM 3270 Information Display System, Library User's Guide*, GA23-0058.

Contents

| | | | |
|--|------|---|------|
| Chapter 1. 3276 Control Unit and Data Streams | 1-1 | ATTN (Attention) Key | 2-15 |
| Introduction | 1-1 | CURSR (Cursor) BLINK Key | 2-15 |
| Interface Codes | 1-3 | ALT CURSR (Alternate Cursor) Key | 2-15 |
| Device Addressing | 1-3 | TEST Key | 2-15 |
| Data Stream | 1-7 | (Click Key) | 2-16 |
| Commands | 1-8 | (Print Key) | 2-16 |
| Write Commands | 1-9 | IDENT Key | 2-16 |
| Write Command | 1-9 | Dead Keys, Canadian-French Keyboards | 2-17 |
| Erase/Write Command | 1-12 | Numeric Lock Feature Operation | 2-17 |
| Erase/Write Alternate Command | 1-12 | Keyboard Disabled (Do Not Enter Condition) | 2-18 |
| Write, Erase/Write, and Erase/Write Alternate | | Selector-Light-Pen Operations | 2-20 |
| Commands (LU Type 3) | 1-15 | Selector-Light-Pen Field Format | 2-20 |
| Read Commands | 1-17 | Designator Characters | 2-21 |
| Read Buffer Command | 1-17 | Security Keylock | 2-23 |
| Read Modified Command | 1-18 | Magnetic Slot Reader | 2-24 |
| Read Modified All Command | 1-22 | 10-Character Set | 2-25 |
| Inbound Transmissions | 1-22 | Magnetic-Stripe Format | 2-26 |
| Read States | 1-22 | Operational Differences because of Screen Format | 2-26 |
| Host Acknowledgments | 1-24 | Error Conditions | 2-30 |
| Processing of Read Commands | 1-25 | MSR Validity Test | 2-30 |
| Control Commands | 1-27 | MSR Operator Indicators and Alarm | 2-31 |
| Copy Command | 1-27 | Printers | 2-32 |
| Erase All Unprotected Command | 1-30 | Print Line Formatting | 2-32 |
| Orders | 1-30 | Printer Orders | 2-34 |
| Start Field (SF) Order | 1-31 | New Line (NL) and End of Message (EM) | |
| Set Buffer Address (SBA) Order | 1-32 | (All Printers) | 2-34 |
| Insert Cursor (IC) Order | 1-32 | Forms Feed (FF) (All Printers) | 2-34 |
| Program Tab (PT) Order | 1-32 | Carriage Return (CR) | |
| Repeat to Address (RA) Order | 1-33 | (All Printers) | 2-34 |
| Erase Unprotected to Address (EUA) Order | 1-33 | Buffered Printer Operations | 2-35 |
| Chapter 2. Terminals | 2-1 | Page Length Control Operations | 2-35 |
| Displays | 2-1 | SNA Characters String | |
| Display Images | 2-1 | (All Printers) | 2-36 |
| Display Fields | 2-4 | SCS Control Codes | 2-36 |
| Attributes | 2-5 | Program Attention (PA) and | |
| Field Attributes | 2-5 | Cancel Print Switches | 2-41 |
| Field Attribute Character | 2-5 | Print Format Control | 2-41 |
| Base Color Mode | 2-6 | Local Copy Function | 2-42 |
| Keyboard Operations | 2-7 | 3276 Default Matrix | 2-42 |
| Cursor | 2-7 | 3276 Local Copy Operation | 2-43 |
| Keyboards | 2-7 | Host-Initiated Local Copy Using SNA/SDLC | 2-45 |
| Key Functions | 2-8 | Local Copy Performed without SNA Protocol | 2-47 |
| Automatic Skip | 2-8 | Mono/Dual Case Control | 2-48 |
| Character-Oriented Keys | 2-9 | Format Control during Shared Printer Operations | 2-48 |
| Field-Oriented Keys | 2-9 | Error Conditions | 2-50 |
| Erase EOF (Erase to End of Field) Key | 2-10 | Chapter 3. Remote Operations - BSC | 3-1 |
| ERASE INPUT Key | 2-10 | Introduction | 3-1 |
| INS (Insert) Mode Key (3178, 3276, 3278, or 3279) | 2-10 | Code Structures | 3-1 |
| Delete Key (3178, 3276, 3278, or 3279) | 2-11 | Channel Program Concepts | 3-1 |
| RESET Key | 2-11 | Text Blocking | 3-1 |
| DUP (Duplicate) Key | 2-12 | Related Publications | 3-2 |
| FM (Field Mark) Key | 2-12 | Multipoint (Nonswitched Line) Data Link Control | 3-2 |
| Program Attention Keys | 2-12 | 3276 Modes of Operation | 3-2 |
| SYS (System) REQ Key | 2-13 | Control Mode | 3-3 |
| DEV CNCL (Device Cancel) Key | 2-13 | Text Mode | 3-3 |
| (SHIFT Key) - 3178, 3276, 3278, or 3279 | 2-14 | Transparent Monitor Mode | 3-3 |
| (LOCK Key) - 3178, 3276, 3278, or 3279 | 2-14 | Redundancy Checking | 3-4 |
| (NUM Key) - 3178, 3276, 3278, or 3279 | 2-14 | Data-Link Control Characters | 3-4 |
| (NUM LOCK Key) - 3178, 3276, 3278, or 3279 | 2-14 | Pad | 3-5 |
| (Alpha Key) - 3178, 3276, 3278, or 3279 | 2-14 | SYN (Synchronous Idle) | 3-5 |
| CURSR SEL (Cursor Select) Key | 2-14 | DLE (Data Link Escape) | 3-5 |

| | | | |
|--|------------|--|------------|
| ACK 0 (Even Acknowledge) | 3-6 | LU Types 2 and 3 | 4-20 |
| ACK 1 (Odd Acknowledge) | 3-6 | SNA Responses | 4-20 |
| NAK (Negative Acknowledgment) | 3-6 | Summary of SNA Commands | 4-21 |
| ENQ (Enquiry) | 3-6 | Sample SNA Command Sequences | 4-23 |
| WACK (Wait before Transmit) | 3-7 | Session Processing States | 4-29 |
| RVI (Reverse Interrupt) | 3-7 | Data Traffic (Reset/Active) State | 4-29 |
| STX (Start of Text) | 3-7 | Contention (CONT) State | 4-29 |
| SOH (Start of Heading) | 3-7 | Send (SEND) State | 4-29 |
| ETB (End of Transmission Block) | 3-7 | Receive (RCV) State | 4-30 |
| ETX (End of Text) | 3-8 | ERP1 State | 4-31 |
| EOT (End of Transmission) | 3-8 | Bracket States | 4-31 |
| ITB (End of Intermediate Transmission Block) | 3-8 | Between Bracket (BETB) State | 4-32 |
| ESC (Escape) | 3-8 | Pending Begin Bracket (PEND. BB) State | 4-32 |
| TTD (Temporary Text Delay) | 3-8 | In Bracket (INB) State | 4-32 |
| Operational Sequences (Nonswitched Line) | 3-8 | 3276 Bracket State Errors | 4-32 |
| Remote Chaining of 3276 Commands | 3-9 | RU Lengths | 4-33 |
| General and Specific Poll Sequences | 3-9 | Outbound to the 3276 | 4-33 |
| Selection Addressing Sequence | 3-15 | Inbound from the 3276 | 4-33 |
| Write-Type and Control-Type Command Sequences | 3-15 | Segmenting Description | 4-34 |
| Read-Type Command Sequences | 3-19 | Segmenting Outbound | 4-34 |
| Status and Sense (S/S) Bytes | 3-22 | Segmenting Inbound | 4-35 |
| Error-Recovery Procedures | 3-22 | The 3276 Errors | 4-35 |
| Supplementary Procedures | 3-28 | Data Link | 4-35 |
| NAK to a Text Block | 3-28 | LU-LU Session Error Reporting | 4-35 |
| EOT to a Text Block | 3-28 | 3276 Session Interaction | 4-36 |
| Errors Detected during a Specific or | | Setting the Screen Size | 4-38 |
| General Poll Sequence | 3-29 | Operation in SSCP-SLU Session | 4-38 |
| RVI to Selection Addressing Sequence | 3-29 | SSCP-SLU Contention Operation | 4-38 |
| | | Nonerror Operation | 4-38 |
| | | Error Operation | 4-38 |
| | | Outbound Message Handling | 4-39 |
| | | Inbound Message Handling | 4-39 |
| | | System Logon (3178, 3276; 3278 or 3279 Attached | |
| | | to 3276) | 4-40 |
| | | System Logoff (3178, 3276; 3278 or 3279 Attached | |
| | | to 3276) | 4-40 |
| | | SNA Printer Control Sessions | 4-41 |
| | | Remote Operations - SDLC | 4-42 |
| | | SDLC Transmission Frames | 4-42 |
| | | Response Modes | 4-42 |
| | | Control Field | 4-43 |
| | | Supervisory Commands | 4-43 |
| | | Nonsequenced Commands and Responses | 4-44 |
| | | Terminal Identification and Addressing | 4-47 |
| | | Terminal ID | 4-47 |
| | | SDLC Station Address | 4-47 |
| | | Information (I) Frame | 4-47 |
| | | Sequence Error Recovery Procedures | 4-47 |
| | | Abort Function | 4-47 |
| | | Timeout Controls | 4-48 |
| | | SNA Reference Data (3276) | 4-49 |
| | | Bind Default | 4-49 |
| | | Bind Check | 4-50 |
| | | SNA Sense Codes | 4-51 |
| | | Logical Unit Status (LUSTAT) | 4-55 |
| | | Error-Recovery Procedures | 4-58 |
| | | | |
| Chapter 4. 3276 SNA/SDLC Communications | 4-1 | Chapter 5. Screen Design | 5-1 |
| Transmission Formats | 4-1 | Introduction | 5-1 |
| Session Components | 4-2 | Field Concept | 5-1 |
| SNA Sessions | 4-2 | What Attributes May Be Assigned to a Field | 5-2 |
| SSCP-PU Session | 4-2 | Protection | 5-2 |
| SSCP-Secondary LU Session | 4-3 | Color | 5-2 |
| LU-LU Session | 4-3 | Character Content | 5-3 |
| Initiating an LU-LU Session | 4-3 | Visibility and Detectability | 5-4 |
| 3276 Attachment to a 3790 | 4-5 | Transmission | 5-4 |
| Terminating an LU-LU Session | 4-5 | | |
| Transmission Header | 4-6 | | |
| EFI=1 | 4-7 | | |
| EFI=0 | 4-7 | | |
| SNA Commands | 4-7 | | |
| Commands Supported | 4-8 | | |
| Command Description | 4-8 | | |
| Activate Physical Unit (ACTPU) | 4-8 | | |
| Deactivate Physical Unit (DACTPU) | 4-8 | | |
| Activate Logical Unit (ACTLU) | 4-9 | | |
| Deactivate Logical Unit (DACTLU) | 4-9 | | |
| Bind | 4-9 | | |
| Unbind | 4-13 | | |
| Clear | 4-13 | | |
| Start Data Traffic (SDT) | 4-13 | | |
| Cancel | 4-13 | | |
| Chase | 4-14 | | |
| Bid | 4-14 | | |
| Signal | 4-15 | | |
| LU Status (LUSTAT) | 4-15 | | |
| Ready to Receive (RTR) | 4-15 | | |
| REQMS | 4-15 | | |
| RECFMS | 4-16 | | |
| Shutdown | 4-16 | | |
| Shutdown Complete | 4-16 | | |
| FM Data | 4-16 | | |
| Pacing | 4-19 | | |
| LU Type 1 | 4-19 | | |

| | | | |
|---|------|--|------|
| Example of Field Definition | 5-5 | Appendix C. Status Indicator Code | C-1 |
| Planning the Panel | 5-9 | Appendix D. APL/Text Feature | D-1 |
| Using the Panel Layout Sheet | 5-9 | APL/Text and Text Printer Data Streams | D-2 |
| An Example of Laying Out a Panel | 5-10 | 3276 APL/Text | D-2 |
| Adding Orders to the Panel Layout Sheets | 5-12 | 3278-1, -2, -3, and -4 or 3279-2B and -3B APL/Text | D-9 |
| Coding the Panel | 5-18 | APL Keyboards | D-9 |
| Using the Repeat to Address Order | 5-26 | 87- and 88-Key Typewriter/APL Keyboards | D-9 |
| Using the Write Control Character (WCC) | 5-28 | 88-Key Katakana Typewriter/APL Keyboard | D-10 |
| An Example of a Sequence of Panels | 5-30 | APL Keyboard World Trade Considerations | D-10 |
| Analyzing Input Data | 5-35 | 87-Key Typewriter/Text Keyboard | D-11 |
| The Operator's Response | 5-35 | 3230-2, 3268-2, and 3287-1 and -2 with APL/Text | D-12 |
| Attention Identifier (AID) | 5-36 | 3262-13, 3289-1 and -2, and 5210 with Text Print | D-12 |
| Input Data | 5-36 | BSC Copy Command | D-12 |
| SBA Codes | 5-36 | Local Copy | D-13 |
| Program Attention (PA) Keys | 5-37 | Appendix E. Katakana Feature | E-1 |
| Program Function (PF) Keys | 5-37 | Interface Codes | E-1 |
| Selector Pen and Cursor Select Input and Output | 5-38 | Katakana Keyboards Shift Operations | |
| Selector Field Format | 5-38 | (3178, 3276, 3278, and 3279) | E-1 |
| Designator Characters | 5-39 | Katakana Shift Keys - 3278 and 3279 | E-1 |
| The Relationship of One Data Stream to Another | 5-40 | Appendix F. Encrypt/Decrypt Feature | F-1 |
| Modifying Existing Panels | 5-41 | Encrypt/Decrypt Products | F-1 |
| Using Erase Unprotected to Address (EUA) | 5-44 | IBM Programmed Cryptographic Facility | |
| Using Erase All Unprotected (EAU) Command | 5-45 | Program Product | F-1 |
| Repetitive Output | 5-47 | ACF/VTAM Encrypt/Decrypt Feature | F-1 |
| Using the Program Tab (PT) | 5-47 | 3276 Encrypt/Decrypt Feature | F-1 |
| Chapter 6. Screen Management | 6-1 | Establishing Cryptographic Sessions | F-2 |
| Decoding and Generating Data Streams | 6-2 | Appendix G. Request Formatted Maintenance | |
| Decoding Read Modified Input Data Stream | 6-2 | Statistics (RECFMS) Formats | G-1 |
| Nonselector Pen or Noncursor Select Data Streams | 6-4 | REQMS Request Type 1 - Link Test Statistics | G-1 |
| Immediate Selector Pen or Cursor Select Data Stream | 6-7 | REQMS Request Type 2 - Summary Counters | G-1 |
| Mixed Read Modified Input Data Streams | 6-9 | REQMS Request Type 3 - Communication | |
| Building Output Data Streams | 6-10 | Adapter Data Error Counts | G-1 |
| Static Data Streams | 6-10 | REQMS Request Type 5 - 3276 Machine Level | |
| Semidynamic Output Streams | 6-13 | Information | G-2 |
| Dynamic Output Streams | 6-14 | Abbreviations | H-1 |
| Large Screen Size | 6-15 | Index | X-1 |
| Appendix A. Indicators and Controls | A-1 | | |
| Appendix B. Buffer Address I/O Interface Codes | B-1 | | |

Figures

| | | | |
|---|------|---|------|
| 1-1. Host Control Unit and Device Combinations | 1-2 | 4-6. Summary of SNA Commands Sent | 4-22 |
| 1-2. United States EBCDIC I/O Interface Codes for 3276 Unit and Attached Display Stations and Terminal Printers | 1-4 | 4-7. Bracket/Chain - LU Type 2 Initiated (without Contention) | 4-23 |
| 1-3. United States ASCII I/O Interface Codes for 3276 Unit and Attached Display Stations and Terminal Printers | 1-5 | 4-8. Bracket/Chain - Host Initiated (without Contention) | 4-24 |
| 1-4. Control Character I/O Codes | 1-6 | 4-9. Bracket/Chain - Host/SLU Contention | 4-25 |
| 1-5. Data Flow between Data Processing System and the 3276 | 1-7 | 4-10. Signal from Host | 4-26 |
| 1-6. Command Codes | 1-8 | 4-11. Shutdown/Shutdown Complete | 4-27 |
| 1-7. Write Control Character (WCC) | 1-10 | 4-12. CANCEL, SLU Type 2 Sending | 4-28 |
| 1-8. LU Type 2 Screen Size Bind Format | 1-13 | 4-13. RTR - LU Type 1 or LU Type 3 Send | 4-28 |
| 1-9. LU Type 3 Buffer Size Bind Format | 1-16 | 4-14. State Diagram for Session Ownership of Device | 4-37 |
| 1-10. Attention ID (AID) Configurations | 1-19 | 4-15. Logical Subsystem | 4-41 |
| 1-11. Read State Transitions | 1-24 | 4-16. Automatic Disconnection Support by 3276 | 4-48 |
| 1-12. Copy Control Character (CCC) | 1-28 | 4-17. Summary Table of LUSTATs | 4-56 |
| 1-13. Buffer Transfers for 3276 Models 1 through 4 Copy Command Operation | 1-29 | 5-1. Example of Four Fields and Attribute Bytes | 5-2 |
| 1-14. Buffer Control Orders and Order Codes | 1-31 | 5-2. Results of Keyboard and Field Combinations | 5-3 |
| 2-1. Buffer Location and Display Screen Character Position Relationships | 2-1 | 5-3. Example of Attribute Specification | 5-5 |
| 2-2. Buffer Addressing Layouts for 480-, 960-, 1920, 2560-, and 3440- Character Terminals | 2-2 | 5-4. Block-Diagramming a Sequence of Panels | 5-9 |
| 2-3. Example of Formatted Display | 2-4 | 5-5. Sign-On Panel as Written Out on Layout Sheet | 5-10 |
| 2-4. Field Attribute Character Bit Assignment | 2-6 | 5-6. Panel Layout, Including Attribute and Cursor Positions | 5-11 |
| 2-5. Colors Derived from Field Attributes | 2-7 | 5-7. Laying Out Field Attributes | 5-13 |
| 2-6. Selector Light Pen | 2-20 | 5-8. Text Items on Panel Layout Sheet | 5-14 |
| 2-7. Sample Display Screen for Selector-Light-Pen Operations | 2-23 | 5-9. Attributes | 5-15 |
| 2-8. Magnetic Slot Reader (3276, 3278, and 3279 Attachments) | 2-24 | 5-10. Attribute Default Values | 5-16 |
| 2-9. Attachment of Magnetic Reading Devices to 3276, 3278, and 3279 | 2-24 | 5-11. Completed Order and Information, No SFAP Capability | 5-16 |
| 2-10. 10-Character Set Used with Magnetic Slot Reader | 2-25 | 5-12. Buffer Control Orders and Order Codes | 5-17 |
| 2-11. Magnetic-Stripe Format (MSR Using 10-Character Set) | 2-26 | 5-13. Sign-On Procedure Panel with Buffer Addresses | 5-20 |
| 2-12. Operation of the Display with an Unformatted Screen (MSR Using 10-Character Set) | 2-27 | 5-14. Attribute Combinations in Hexadecimal | 5-21 |
| 2-13. Operation of the Display with a Formatted Screen (Using 10-Character Set), Example 1 | 2-28 | 5-15. Assembler Language Statements for Sign-On Panel | 5-26 |
| 2-14. Operation of the Display with a Formatted Screen (Using 10-Character Set), Example 2 | 2-29 | 5-16. An Example of the RA Order | 5-27 |
| 2-15. Relationship between Buffer Data and Printed Data | 2-33 | 5-17. WCC Hexadecimal Codes | 5-29 |
| 3-1. Remote Control Unit and Device Addressing | 3-11 | 5-18. Panel 1 of an Accounts Receivable Application | 5-31 |
| 3-2. General Poll and Specific Poll, Sequence/Response Diagram | 3-12 | 5-19. Panel 2, Showing the Results of a Search on a Customer Name | 5-31 |
| 3-3. 3276 CU Message Response to Polling or Read Modified Command | 3-14 | 5-20. Panel 3, Showing the Customer's Open Invoices | 5-32 |
| 3-4. Selection Addressing, Sequence/Response Diagram | 3-16 | 5-21. Panel 4, Showing Use of the Calculator | 5-33 |
| 3-5. Write-Type and Control-Type Commands, Sequence/Response Diagram | 3-18 | 5-22. Panel 5, Showing Selection of Invoices after Using the Calculator | 5-34 |
| 3-6. Read-Type Commands, Sequence/Response Diagram | 3-20 | 5-23. Panel 6, Showing New Balance after Posting | 5-34 |
| 3-7. Remote Status and Sense Byte Definitions - BSC | 3-23 | 5-24. Sign-On Panel with Operator's Input | 5-35 |
| 3-8. Remote Error Status and Sense Responses - BSC | 3-24 | 5-25. Input Data Sequence | 5-35 |
| 3-9. Remote 3276 BSC Status and Sense Conditions | 3-26 | 5-26. Definition of Field for Selector Pen Operation | 5-38 |
| 4-1. Establishing a Session with a 3276 | 4-4 | 5-27. Sample Panel for Selector Pen or Cursor Select Detection | 5-39 |
| 4-2. Device Addressing for SNA Terminals | 4-6 | 5-28. Modifying an Existing Panel, Basic Panel | 5-42 |
| 4-3. SNA Commands Supported by the 3276 | 4-8 | 5-29. Existing Panel with Error Message | 5-42 |
| 4-4. Bind Command Session Parameters | 4-10 | 5-30. Panel Layout Changes for Error Message (Keyed to Text) | 5-43 |
| 4-5. Summary of SNA Commands Received | 4-21 | 5-31. Error Message Panel with Serial Number Field Erased | 5-44 |
| | | 5-32. Example of EUA Use | 5-45 |
| | | 5-33. Sign-On Panel with Three Erased Fields | 5-46 |
| | | 5-34. Erasing Multiple Fields with EUA | 5-46 |
| | | 5-35. Example of Data Entry Panel | 5-48 |
| | | 5-36. Data Entry Panel with Entered Data | 5-48 |
| | | 5-37. Employee Data Panel | 5-49 |
| | | 5-38. Panel Defined with Program Tab | 5-50 |
| | | 6-1. Relationship of Screen Management to Telecommunications Management and Application Program | 6-1 |
| | | 6-2. Table of Requirements | 6-6 |
| | | 6-3. Example of Selector Pen Panel | 6-8 |
| | | 6-4. Sample Mapping Table | 6-9 |

| | | |
|------|---|-----|
| A-1. | 3276 Operator Panel | A-1 |
| A-2. | 3276 Operator Drawer Panel | A-1 |
| D-1. | Diagram of APL/Text Devices | D-1 |
| D-2. | APL/Text Feature, 1-Byte I/O Interface Codes (3230/3268/3276/3278/3279/3287) | D-3 |
| D-3. | APL/Text Feature, 2-Byte I/O Interface Codes (3230/3268/3276/3278/3279/3287) | D-4 |
| D-4. | National Use Differences I/O Interface Code (3178/3230/3268/3276/3278/3279/3287) | D-5 |
| D-5. | Katakana/APL 1-Byte I/O Interface Codes (3230/3268/3276/3278/3279/3287) | D-6 |

| | | |
|-------|---|------|
| D-6. | Katakana/APL 2-Byte I/O Interface Codes (3230/3268/3276/3278/3279/3287) | D-7 |
| D-7. | Text Print I/O Interface Codes (3262/3289) | D-8 |
| D-8. | 87-Key Typewriter/APL Keyboard | D-9 |
| D-9. | 88-Key Katakana Typewriter/APL Keyboard | D-10 |
| D-10. | 87-Key Typewriter/Text Keyboard | D-11 |
| E-1. | Japanese Katakana EBCDIC I/O Interface Code for 3276 Units with 3178, 3230, 3262, 3268, 3278, 3279, 3287 (with 3276 Attachment Feature), and 3289 Terminals Attached | E-2 |

Chapter 1. 3276 Control Unit and Data Streams

Introduction

The IBM 3276 Control Unit Display Station is one of the basic units of the 3270 Information Display System Family. The 3276 offers the user a wide selection of components and configurations. Also available are a variety of features which improve performance, provide additional operational capability, and permit expansion of the display system. (The features are described in the publication *IBM 3270 Information Display System: Configurator*, GA27-2849.)

All models of the 3276 can be selected to form 3270 system configurations attachable to System/360, System/370, 303X Processor, 308X Processor, System/3, 4300 Processor, 8100 Information System, and 3790 Communication System configurations as host systems. (See *An Introduction to the IBM 3270 Information Display System*, GA27-2739, for possible system combinations.)

The 3276 is a table-top CRT display station and control unit used for displaying alphanumeric data up to a maximum of 3440 characters, and for entering data into, and retrieving data from, a host system. The 3276 can be ordered to control up to seven display stations and printers. The 3276 includes one self-contained display which allows a maximum 3276 cluster size of eight terminals.

The base 3276 provides one additional port for attachment of either display stations or printers. Up to three additional terminal adapters can be ordered. Each adapter has two ports which can attach display stations or printers in any combination. A keyboard is needed on every 3276.

The display station provides image display of data transmitted from the host system. A display station with an attached keyboard enables the user to enter, modify, or delete data on the display and to cause the revised data to be returned to the host system for storage or additional processing.

The 3276 can display up to 3440 characters per screen as follows:

- Models 1 and 11 display 960 characters.
- Models 2 and 12 display 1920 characters.
- Models 3 and 13 display 2560 characters.
- Models 4 and 14 display 3440 characters.

When operating in 3277-compatible format, the 3276 Model 1 will display 480 characters (40 characters per line), and Models 2, 3, and 4 will display 1920 characters (80 characters per line).

For EBCDIC and ASCII, the 3276 has a 94-character set (plus space and null).

The 3276 can be attached remotely to a host system (see Figure 1-1). Remote attachment employs common carrier (or equivalent customer) facilities of unlimited length to communicate between the host and the 3276. (The 3276 cannot be attached locally to a host system.) All models of the 3276 can also communicate with a 3704/3705 Communications Controller or a Communications Adapter feature installed in the 4331 without need for communication facilities or a modem (direct connection).

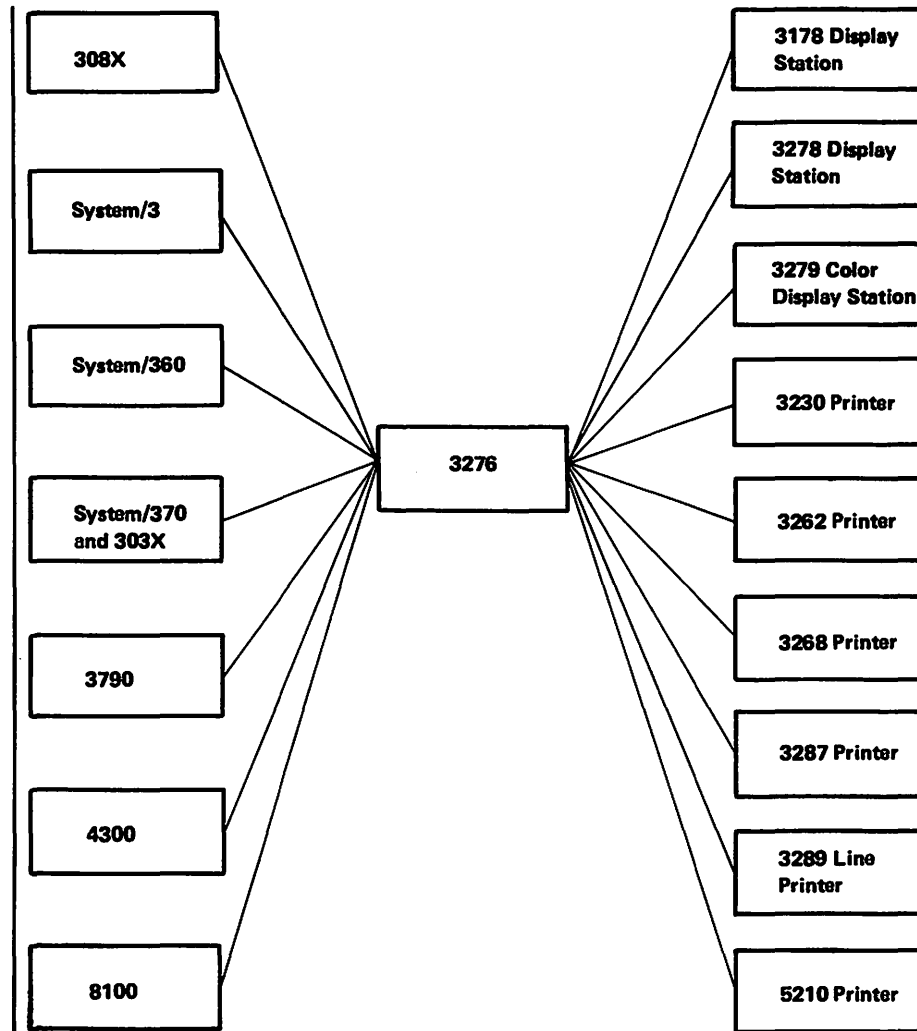

Figure 1-1. Host Control Unit and Device Combinations

The 3276 Models 1, 2, 3, and 4 attach via modems and operate via BSC line protocol at 1200, 2000, 2400, 4800, and 7200 bps. When the models are directly connected to a 3704/3705 Communications Controller, communication speed is limited to 1200 bps.

Models 11, 12, 13, and 14 attach via modems and operate via SDLC line protocol at 1200, 2000, 2400, 4800, 7200, and 9600 bps. When the models are directly connected to the 3704/3705 Communications Controller, communication speed is limited to 1200 bps.

Note: The 3276 Models 1, 2, 3, and 4 with the SDLC/BSC Switch feature installed can also operate via SDLC protocol at the same communication line speeds as the Models 11, 12, 13, and 14.

Models 11, 12, 13, and 14 communicate with the 8100 Information System or the 4300 System via modems and an SDLC data link, a directly attached loop, or a data-link-attached loop. Models 1, 2, 3, and 4 (with the SDLC/BSC switch set to SDLC) can communicate with the 8100 system or the 4300 System via modems and an SDLC data link.

The printer provides a printed copy of data displayed at a display station or transmitted from the host system. (In this document, the 3230, 3262, 3268, 3287, 3289, and 5210 Printers are referred to as "terminal printers.")

The 3276 Models 1, 2, 3, and 4 process the host-initiated BSC Copy command. The host-initiated Copy command is used to transfer buffer data from one device to another device via the 3276 to which both devices are attached. After accepting a Copy command addressed to the "to" device, the 3276 initiates the data transfer from the "from" device. Upon transfer of the data to the 3276, the 3276 processes the data and transfers it to the "to" device.

In addition to processing the host-initiated Copy command, the 3276 (all models) also provides an operator-initiated local copy function, which permits direct data transfer from a display station to a printer attached to the same 3276. The local copy function is initiated when the display station operator presses the print key on the display station keyboard. The printer selection is determined by a print-control matrix (called a printer default matrix) in the 3276. The printer default matrix is determined by the physical attachment of the printers to the 3276 at power-on time. In this matrix, each display station is associated with the printer that has the next higher terminal address.

Printer assignment can be changed by use of the IDENT key on the 3178, 3276, 3278, or 3279 keyboard.

If the 3276 Models 11, 12, 13, and 14, or the 3276 Models 1, 2, 3, and 4 are equipped with the BSC/SDLC Switch feature and the switch is in the SDLC position, the host-initiated copy function is executed when the host issues a write-type command with the WCC print bit set to 1. Printer selection and servicing of the local copy request proceed in much the same way as in the operator-initiated local copy function.

Interface Codes

Data, commands, and orders transmitted between the control unit and the host system are in the form of interface codes. Two different codes are used in the United States: extended binary-coded decimal interchange code (EBCDIC) and American National Standard Code for Information Interchange (ASCII). The EBCDIC codes are also used in the World Trade countries (ASCII is available only in the U.S.); refer to *IBM 3270 Information System: Character Set Reference, GA27-2837*, for details.

Figure 1-2 shows the United States EBCDIC interface codes for several control unit/device combinations. Figure 1-3 shows the United States ASCII codes. Figure 1-4 shows the control character codes. Refer to Appendix E for the Katakana codes.

Device Addressing

The port addresses on the 3276 control unit are 00-07 (ports 0-7) in non-SNA and 02-09 (ports 0-7) in SNA.

| | | 00 | | | | 01 | | | | 10 | | | | 11 | | | | Bits 0, 1 |
|--------------|---|-----|-----|-----|-----|----|----|----|----|----|----|----|----|----|----|----|----|--------------|
| Hex 1 | | 00 | 01 | 10 | 11 | 00 | 01 | 10 | 11 | 00 | 01 | 10 | 11 | 00 | 01 | 10 | 11 | 2, 3 |
| Bits 4567 | ↓ | 0 | 1 | 2 | 3 | 4 | 5 | 6 | 7 | 8 | 9 | A | B | C | D | E | F | Hex 0 |
| 0000 | 0 | NUL | | | | SP | & | - | | | | | | { | } | \ | 0 | |
| 0001 | 1 | | SBA | | | | / | | | a | j | ~ | | A | J | | 1 | |
| 0010 | 2 | | EUA | | | | | | | b | k | s | | B | K | S | 2 | |
| 0011 | 3 | | IC | | | | | | | c | l | t | | C | L | T | 3 | |
| 0100 | 4 | | | | | | | | | d | m | u | | D | M | U | 4 | |
| 0101 | 5 | PT | NL | | | | | | | e | n | v | | E | N | V | 5 | |
| 0110 | 6 | | | | | | | | | f | o | w | | F | O | W | 6 | |
| 0111 | 7 | | | | | | | | | g | p | x | | G | P | X | 7 | |
| 1000 | 8 | GE | | SA | | | | | | h | q | y | | H | Q | Y | 8 | |
| 1001 | 9 | | EM | SFE | | | | | | , | i | r | z | | I | R | Z | 9 |
| 1010 | A | | | | | ¢ | ! | ! | : | | | | | | | | | |
| 1011 | B | | | | | . | \$ | , | # | | | | | | | | | |
| 1100 | C | FF | DUP | MF | RA | < | * | % | @ | | | | | | | | | |
| 1101 | D | CR | SF | | | (|) | - | ' | | | | | | | | | |
| 1110 | E | | FM | | | + | ; | > | = | | | | | | | | | |
| 1111 | F | | | | SUB | | ¬ | ? | " | | | | | | | | | EO |

Notes:

1. Character code assignments other than those shown within all outlined areas of this chart are undefined. If an undefined character code is programmed, the character that will be displayed or printed is a hyphen (-); hex code 60 will be returned on a subsequent read operation. For control units with Configuration Support C installed, undefined control codes from X'00' to X'3F' cause a negative response (SNA) or an Op Chk (BSC). IBM reserves the right to change at any time the character displayed or printed and the I/O interface code returned for an undefined character code.
2. CR, NL, EM, and FF control characters are displayed and printed as blank characters. The DUP and FM control characters are displayed as * and ; respectively, and are displayed and printed as * and ; when operating in mono-case mode.
3. Bits 0 and 1 are assigned for the following characters: AID, attribute, write control (WCC), copy control (CCC), CU and device address, buffer address, sense, and status. Bits 0 and 1 are assigned so that each character can be represented by a graphic character within the solid outlined areas of the chart. See Figure 1-4.
4. For BSC data-link control characters, see Chapter 3. For the SCS control codes associated with the SNA Character String feature on terminal printers, see Chapter 2.
5. When operating in mono-case mode, the lowercase alphabetic characters are displayed or printed as uppercase characters.

Figure 1-2. United States EBCDIC I/O Interface Codes for 3276 Unit and Attached Display Stations and Terminal Printers

| Hex 1 Bits 4321 | Hex 0 | | | | | | | | |
|-----------------------|-------|-----|-----|-----|-----|-----|-----|-----|---|
| | 000 | 001 | 010 | 011 | 100 | 101 | 110 | 111 | |
| 0000 | 0 | NUL | | SP | 0 | @ | P | · | p |
| 0001 | 1 | | SBA | | 1 | A | Q | a | q |
| 0010 | 2 | | EUA | " | 2 | B | R | b | r |
| 0011 | 3 | | IC | # | 3 | C | S | c | s |
| 0100 | 4 | | RA | \$ | 4 | D | T | d | t |
| 0101 | 5 | | | % | 5 | E | U | e | u |
| 0110 | 6 | | | & | 6 | F | V | f | v |
| 0111 | 7 | | | ' | 7 | G | W | g | w |
| 1000 | 8 | | | { | 8 | H | X | h | x |
| 1001 | 9 | PT | EM | } | 9 | I | Y | i | y |
| 1010 | A | NL | | * | : | J | Z | j | z |
| 1011 | B | | | + | ; | K | [| k | { |
| 1100 | C | FF | DUP | > | < | L | \ | l | ! |
| 1101 | D | CR | SF | - | = | M |] | m | } |
| 1110 | E | | FM | . | > | N | ^ | n | ~ |
| 1111 | F | | | / | ? | O | - | o | |

Notes:

1. Character code assignments other than those shown within all outlined areas of this chart are undefined. If an undefined character code is programmed, the character that will be displayed or printed is a hyphen (-); code 2D will be returned on a subsequent read operation. IBM reserves the right to change at any time the character displayed or printed and the I/O interface code returned for an undefined character code.
2. CR, NL, EM, and FF control characters are displayed and printed as blank characters. The DUP and FM control characters are displayed as ¯ and ¸ respectively, and are displayed and printed as * and ; when operating in mono-case mode.
3. AID, attribute, write control (WCC), copy control (CCC), CU and device address, buffer address, sense, and status characters are assigned as specified in Figure 1-4 so that each character can be represented by a graphic character within the solid outlined portion of this chart.
4. For BSC data-link control characters, see Chapter 3.
5. When operating in mono-case mode, the lowercase alphabetic characters are displayed or printed as uppercase characters.

Figure 1-3. United States ASCII I/O Interface Codes for 3276 Unit and Attached Display Stations and Terminal Printers

| Bits 2-7 | Graphic | EBCDIC | ASCII |
|-----------|---------|--------|-------|
| 00 0000 | SP | 40 | 20 |
| 00 0001 | A | C1 | 41 |
| 00 0010 | B | C2 | 42 |
| 00 0011 | C | C3 | 43 |
| 00 0100 | D | C4 | 44 |
| 00 0101 | E | C5 | 45 |
| 00 0110 | F | C6 | 46 |
| 00 0111 | G | C7 | 47 |
| 00 1000 | H | C8 | 48 |
| 00 1001 | I | C9 | 49 |
| 00 1010 { | ⌘ | 4A | - |
| | [| - | 5B |
| 00 1011 | | 4B | 2E |
| 00 1100 | < | 4C | 3C |
| 00 1101 | (| 4D | 28 |
| 00 1110 | + | 4E | 2B |
| 00 1111 { | | 4F | - |
| | | - | 21 |
| 01 0000 | & | 50 | 28 |
| 01 0001 | J | D1 | 4A |
| 01 0010 | K | D2 | 4B |
| 01 0011 | L | D3 | 4C |
| 01 0100 | M | D4 | 4D |
| 01 0101 | N | D5 | 4E |
| 01 0110 | O | D6 | 4F |
| 01 0111 | P | D7 | 50 |
| 01 1000 | Q | D8 | 51 |
| 01 1001 | R | D9 | 52 |
| 01 1010 { | | 5A | - |
| |] | - | 5D |
| 01 1011 | \$ | 5B | 24 |
| 01 1100 | * | 5C | 2A |
| 01 1101 |) | 5D | 29 |
| 01 1110 | ; | 5E | 3B |
| 01 1111 { | ┘ | 5F | |
| | ^ | - | 5E |

| Bits 2-7 | Graphic | EBCDIC | ASCII |
|----------|------------|--------|-------|
| 10 0000 | - | 60 | 2D |
| 10 0001 | / | 61 | 2F |
| 10 0010 | S | E2 | 53 |
| 10 0011 | T | E3 | 54 |
| 10 0100 | U | E4 | 55 |
| 10 0101 | V | E5 | 56 |
| 10 0110 | W | E6 | 57 |
| 10 0111 | X | E7 | 58 |
| 10 1000 | Y | E8 | 59 |
| 10 1001 | Z | E9 | 5A |
| 10 1010 | ¡ (EBCDIC) | 6A | 7C |
| 10 1011 | , | 6B | 2C |
| 10 1100 | % | 6C | 25 |
| 10 1101 | - | 6D | 5F |
| 10 1110 | > | 6E | 3E |
| 10 1111 | ? | 6F | 3F |
| 11 0000 | 0 | F0 | 30 |
| 11 0001 | 1 | F1 | 31 |
| 11 0010 | 2 | F2 | 32 |
| 11 0011 | 3 | F3 | 33 |
| 11 0100 | 4 | F4 | 34 |
| 11 0101 | 5 | F5 | 35 |
| 11 0110 | 6 | F6 | 36 |
| 11 0111 | 7 | F7 | 37 |
| 11 1000 | 8 | F8 | 38 |
| 11 1001 | 9 | F9 | 39 |
| 11 1010 | : | 7A | 3A |
| 11 1011 | # | 7B | 23 |
| 11 1100 | @ | 7C | 40 |
| 11 1101 | , | 7D | 27 |
| 11 1110 | = | 7E | 3D |
| 11 1111 | " | 7F | 22 |

Note: The characters above are used as attribute, AID, write control (WCC), copy control (CCC), CU and device address, and buffer address. They are also used as status and sense, except by the 3274 and 3276 when operating in BSC. When any of these characters is transmitted to the program, the CU assigns the appropriate EBCDIC code. If transmission is in ASCII, the CU translates the EBCDIC code to ASCII code prior to transmission.

To use this table to determine the hex code transmitted for an address or control character, first determine the values of bits 2-7. Select this bit configuration from the "Bits 2-7" column. The hex code that will be transmitted (either in EBCDIC or in ASCII) is to the right of the bit configuration.

Use this table also to determine equivalent EBCDIC and ASCII hex codes and their associated graphic characters. Graphic characters for the United States I/O interface codes are shown. Graphic characters might differ for particular World Trade I/O interface codes. Refer to IBM 3270 Information Display System: Character Set Reference, GA27-2837, for possible graphic differences when these codes are used.

Figure 1-4. Control Character I/O Codes

Data Stream

The 3276 data stream consists of user-provided data, commands, and orders which are transmitted between the control unit and the host system (Figure 1-5). Control information, which governs the movement of the data stream, is also transmitted. The control units can differ as to the type of commands and/or transmission protocols employed.

Commands are issued to initiate such operations as the total or partial writing, reading, and erasing of data in a selected device buffer. Control commands initiate control unit and/or terminal operations not involved with data transfer (except for status information). Orders can be included in write data streams, either alone or intermixed with display or print data.

Two types of orders are available – buffer control orders and printer format orders. Buffer control orders are interpreted and executed as they are received by the control unit. They are used to position, define, modify, assign attributes on a field and character basis, and to format data being written to a display character buffer; to erase selected unprotected data in the buffer; and to reposition the cursor. Printer format orders are initially stored in the printer character buffer as data and are interpreted and executed by the printer logic when encountered in the print operation.

The balance of this chapter describes the 3270 data stream. In-depth definition and discussion of the 3270 data stream is provided in the publication *IBM 3270 Information Display System, 3270 Data Stream Programmer's Reference, GA23-0059*.

The 3276 can operate under SNA protocol using SDLC line discipline. In the SNA/SDLC environment, attached 3178s, 3278s, or 3279s function as LU type 2. The data stream RU for a write-type command, for example, consists of the command code, buffer orders, and display data.

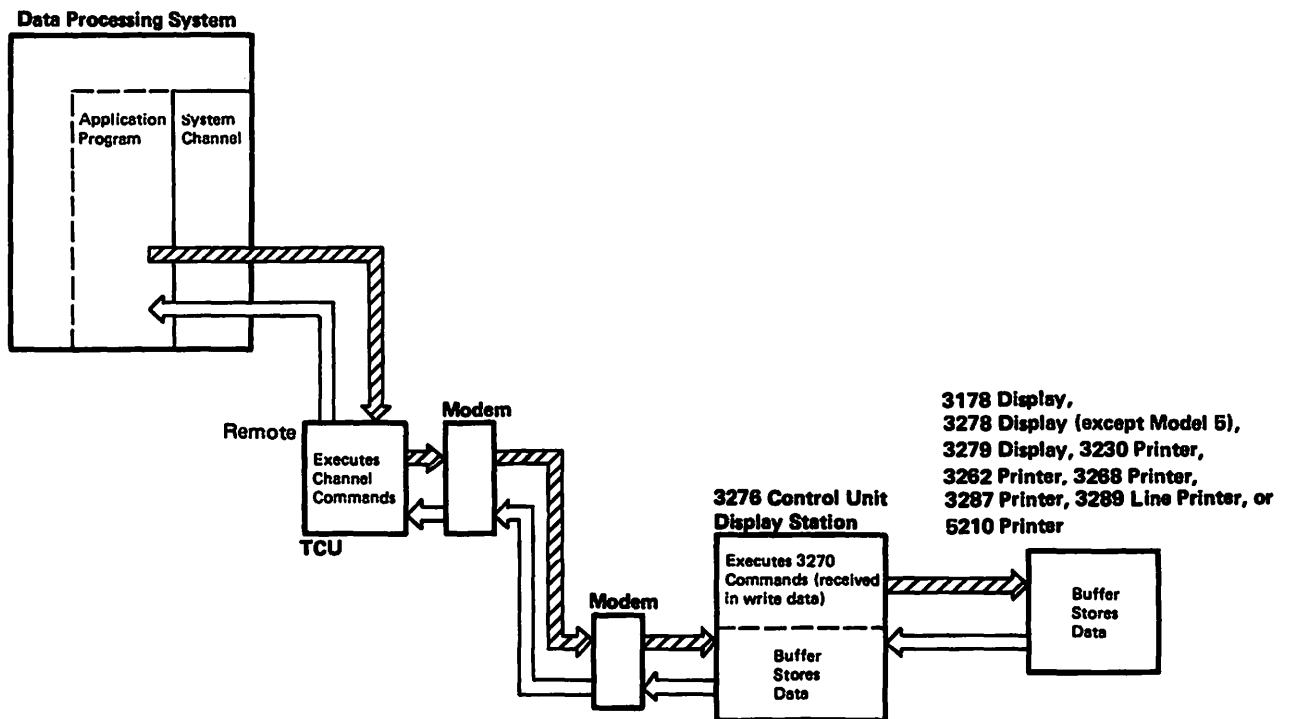

Figure 1-5. Data Flow between Data Processing System and the 3276

The terminal printers attached to a 3276 can also function in BSC or SNA/SDLC protocol. When operating in SNA/SDLC protocol, the terminal printers function as LU type 3. When SCS is installed, the printer functions as an LU type 1. The terminal printers can also operate as local copy devices; that is, data may be sent to a printer(s) from a display station attached to the same 3276, which functions in either BSC or SNA/SDLC discipline.

Commands

Three basic types of commands are used by the 3276:

1. Write commands, which are used to transfer data and orders from main storage to the 3276.
2. Read commands, which transfer 3276 buffer data, keyboard key data, and, for remote configurations, status information to main storage.
3. Control commands, which cause certain printer or display station operations.

Figure 1-6 lists the commands and associated codes that can be executed by the 3276.

| Command | 3276 | | |
|--------------------------------|------------|-----------|---------|
| | EBCDIC Hex | ASCII Hex | Graphic |
| Copy ¹ | F7 | 37 | 7 |
| Erase All Unprotected | 6F | 3F | ? |
| Erase/Write | F5 | 35 | 5 |
| Erase/Write Alternate | 7E | 3D | = |
| Read Buffer | F2 | 32 | 2 |
| Read Modified | F6 | 36 | 6 |
| Read Modified All ² | 6E | 3E | : |
| Write | F1 | 31 | 1 |

¹ Applicable to 3276-1 through -4 only.

² Applicable to 3276-11 through -14 only.

Figure 1-6. Command Codes

When a remotely attached 3276 is in operation, the rate at which data is transferred between the data processing system's main storage and the control unit depends on the type of transmission control unit and on the modems and communication facilities used. The 3276 accepts data from, and provides it to, the transmission control unit/communication facility at the byte rate established by the transmission control unit/communication facility.

All command operations that direct movement of data to and from the 3276 result in transfer of data between the control unit and a device buffer. When commands are not being performed, the control unit and the device buffer interact asynchronously, and the last image displayed by a previous command is continuously regenerated at a visible rate.

Write Commands

Two write-type commands, Write and Erase/Write, are used to load, format, and selectively erase device buffer data. These commands can also initiate certain device operations such as starting the printer, resetting the keyboard, and sounding the audible alarm. Write and erase/write operations are identical except that Erase/Write causes complete erasure of the device buffer before the write operation is started. Thus, Erase/Write is used to load the buffer with completely new data, whereas Write can be used to modify existing buffer data. Because of this, the 3276 initiates a device-to-control unit buffer transfer before Write command operations, but not before Erase/Write command operations.

A third write-type command, Erase/Write Alternate, performs the erase/write function for the display stations and the terminal printers. It is also used to switch the display or printer into large screen or expanded print capacity mode. The Erase/Write Alternate command is valid when sent to the 3276.

Write Command

The bytes received by the 3276 for Write command operation consist of a command code, a write control character (WCC), and any orders and/or new buffer data needed to modify the existing buffer contents. Remotely attached 3276s also receive appropriate data link control framing. The sequence of bytes is as follows:

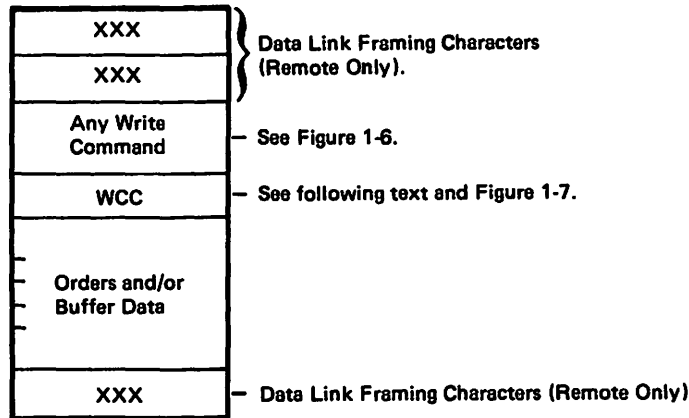

The minimum data stream following a Write command is a 1-byte WCC. This is ensured because the byte count field of the write channel control word (CCW) must be set to a minimum of 1 in BSC operations, or else the command code is not sent. The minimum Write command data stream to a remote 3276 consists of framing characters (e.g., in BSC, STX, ESC, and ETX) and the command code. To be meaningful, a WCC byte should follow the command code; if the BSC data link control character ETX follows the command code, an all-zero default WCC byte is generated by the control unit, and command execution is ended normally. An order or display/print data byte that immediately follows the command code is interpreted as a WCC by the control unit. The WCC byte format is as follows:

| * | Reset Bit | Printout Format | Start Print | Sound Alarm | Key-board Restore | Reset MDT Bits | |
|---|-----------|-----------------|-------------|-------------|-------------------|----------------|---|
| 0 | 1 | 2 | 3 | 4 | 5 | 6 | 7 |

*Determined by the configuration of bits 2 through 7. See Figure 1-4.

Figure 1-7 describes the function of each WCC bit. When the WCC specifies an operation that does not apply to the selected device (for example, if the Sound Alarm bit is set and the selected device does not have the Audible Alarm feature), the specified operation is ignored. When the WCC byte is followed by order or display/print data bytes, only the Reset MDT Bits function, if specified, is performed before the write operation; any other WCC function is deferred until all data is written and all orders are performed.

| Bit | Explanation |
|-----|---|
| 0 | Determined by the contents of bits 1 through 7 as shown in Figure 1-4. |
| 1 | WCC reset bit. |
| 2,3 | Define the printout format, as follows: = 00 – The NL, EM, and CR ¹ orders in the data stream determine print line length. Provides a 132-print position line when the orders are not present. = 01 – Specifies 40-character print line. = 10 – Specifies 64-character print line. = 11 – Specifies 80-character print line. |
| 4 | Start Printer bit. When set to 1, initiates a printout operation at completion of the write operation. |
| 5 | The Sound Alarm bit. When set to 1, sounds the audible alarm at the selected device at the end of the operation if that device has an audible alarm. |
| 6 | The Keyboard Restore bit. When set to 1, restores operation of the keyboard by resetting System Lock or Wait symbol on 3178, 3276, 3278, or 3279 displays. It also resets the AID byte at the termination of the I/O command. |
| 7 | Reset MDT bits. When set to 1, all MDT bits in the selected devices' existing buffer data are reset before any data is written or orders are executed. |

¹ The CR order is applicable to the terminal printers only.

Figure 1-7. Write Control Character (WCC)

Orders and buffer data can follow the WCC character. (Orders are described later in this chapter, following the "Commands" description.) Buffer data can be written into any specified location of the buffer without erasing or modifying data in the other buffer locations. Data characters are stored in successive buffer locations until an order is encountered in the data stream which alters the buffer address, or until all the data has been entered. During the write operation, the buffer address is advanced one location as each character is stored.

The buffer location where data entry starts depends upon the following considerations:

1. The starting location may be specified by a Set Buffer Address order that follows the WCC. (This order is described later in this chapter under "Orders.")
2. The starting location will be the buffer address containing the cursor if the Write command is not chained or if it is chained from a Copy or Erase All Unprotected command.
3. The starting location will be the current buffer address if the Write command is chained from a Read or another Write command.

The formatting and placement of write data and the modification of existing buffer data are described under "Orders."

Programming Notes:

1. If the commands are being chained, the Write or Erase/Write command with the Start Print WCC bit set must be the last command in the chain. If not, remote control units perform the print operation and abort the next command.
2. The Printout Format bits are honored only if the Start Print bit is set in the same WCC.
3. In remote operations, if a Write command that includes data is chained from a previous Write command, a Set Buffer Address (SBA) order should immediately follow the WCC to define the starting location at which data entry is to start; this permits recovery in case of an error condition that requires retransmission of that data.

Programming Restriction: A Write command should not be chained from an Erase All Unprotected command. If it is, the operation is undefined.

Erase/Write Command

Execution of the Erase/Write command performs two operations: an erase operation and a write operation. The erase operation clears the entire device buffer to nulls, positions the cursor to character location 0, and resets the buffer address to 0.

Erase/Write then performs the write and WCC operations in the same manner as a Write command. If no WCC is sent, the Erase/Write command will not erase the buffer.

An Erase/Write command can also return a display or printer to the default screen size or character print capacity (as described under "Erase/Write Alternate Command").

Erase/Write Alternate Command

The display stations and the terminal printers with a capacity of 960 characters can function as 480-character devices; 1920-, 2560-, and 3440-character displays and printers can function as 1920-character devices.

For the 3276 BSC, a unique instruction is required from the application program to enable a display or printer to function at greater than 480- or 1920-default-character capacity. The Erase/Write Alternate command is used to switch a display station's screen size or a terminal printer's print capacity to the alternate size indicated by the display model number or specified for the printer as follows:

| 3178 Model | 3230 and 3268 Model | 3262 Model | 3276 Model | 3278 Model | 3279 Model | 3287 and 3289 Model | 5210 Model | Default Character Capacity | Alternate Character Capacity |
|------------|---------------------|------------|------------|------------|------------|---------------------|------------|----------------------------|------------------------------|
| - | 2 | 13 | 1,11 | 1 | - | 1,2 | G01,G02 | 480 | 960 |
| C1,C2 | 2 | 13 | 2,12 | 2 | 2A,2B | 1,2 | G01,G02 | 1920 | 1920 |
| - | 2 | 13 | 3,13 | 3 | 3A,3B | 1,2 | G01,G02 | 1920 | 2560 |
| - | 2 | 13 | 4,14 | 4 | - | 1,2 | G01,G02 | 1920 | 3440 |

Note: For SDLC machines, the default and the alternate character capacity are defined by the BIND parameter. Thus, the default and the alternate can be exchanged.

The Erase/Write Alternate command also operates as an Erase/Write command. Once the display or printer is placed in alternate mode, operation continues in alternate mode until: the operator presses the CLEAR, SYS REQ (SNA only), or TEST key; or until an Erase/Write command is received, the SNA session is unbound, power fails at the control unit, display, or printer; or a system reset sequence occurs. Only these conditions return the display or printer to the default-value screen-size or character print capacity. For the 3276 SNA, the Erase/Write Alternate and Erase/Write commands are used to switch a display screen size, or a print capacity to alternate size, or vice versa, according to Bind parameter definition.

When in emulation mode, and with the display not in an LU-LU session, the operator may set the display to its maximum size by pressing the CLEAR key.

A 3178, 3276, 3278, or 3279 display operating as an LU type 2 requires the format shown in Figure 1-8 as part of the bind operation.

If an Erase/Write Alternate command is received while bound, it is processed as a normal Erase/Write command. No state change occurs within the display. Default screen sizes are as follows:

| 3178 Model | 3278 Model | 3279 Model | Default Screen Size Assumed with Byte 24 = b'0000000' |
|------------|------------|------------|---|
| - | 1 | - | 480 (12 x 40) |
| C1,C2 | 2 | 2A,2B | 1920 (24 x 80) |
| - | 3 | 3A,3B | 1920 (24 x 80) |
| - | 4 | - | 1920 (24 x 80) |

| Byte | Bit | Model | Content | Description |
|------|-----|-------|---------------|--|
| 20 | 0-7 | 1 | X'01' - X'0C' | Default number of rows 1-12 |
| | | 2 | X'01' - X'18' | 1-24 |
| | | 3 | X'01' - X'20' | 1-32 |
| | | 4 | X'01' - X'2B' | 1-43 |
| | | 5 | X'01' - X'1B' | 1-27 |
| 21 | 0-7 | 1 | X'28' | Default number of columns 40 |
| | | 1-5 | X'50' | 80 |
| | | 5 | X'84' | 132 |
| 22 | 0-7 | 1 | X'01' - X'0C' | Alternate number of rows 1-12 |
| | | 2 | X'01' - X'18' | 1-24 |
| | | 3 | X'01' - X'20' | 1-32 |
| | | 4 | X'01' - X'2B' | 1-43 |
| | | 5 | X'01' - X'1B' | 1-27 |
| 23 | 0-7 | 1 | X'28' | Alternate number of columns 40 |
| | | 1-5 | X'50' | 80 |
| | | 5 | X'84' | 132 |
| 24 | 0-7 | 0 | Reserved | Session screen size reserved |
| | | 1-7 | b'000 0000' | Base default (12 x 40 or 24 x 80) |
| | | 1 | b'000 0001' | Base Model 1 default (12 x 40) |
| | | 2-5 | b'000 0010' | Base Model 2 default (24 x 80) |
| | | 1-5 | b'111 1110' | Extended default (size specified in bytes 20 and 21) |
| | | 1-5 | b'111 1111' | Extended alternate (size specified in bytes 22 and 23) |

Note: Row values outside these ranges and column values other than those listed cause the Bind to be rejected with X'0821'.

Figure 1-8. LU Type 2 Screen Size Bind Format

Only a Model 1 display can be bound as b'0000001', a base LU type 2 with a 12 x 40 character screen. This coding of the Bind image is rejected with X'0821' on Models 2, 3, 4, and 5.

A Model 2, 3, 4, and 5 display can be bound as b'0000010', a Base LU type 2 with a 24 x 80 character screen. This Bind format, if used for a Model 1 display, causes the Bind to be rejected with X'0821'.

When operating with a screen size of 480 characters, sequential buffer addresses map to the 12 x 40 screen format in row major order. When operating in other screen sizes, sequential buffer addresses map to the defined screen format in row major order (Appendix B).

Byte 24 must be coded X'7E' or X'7F' to use displays in large-screen mode (2560 and 3440 characters) during the LU-LU session.

When bits 1 through 7 of byte 24 are coded X'7E', the screen size of the device is defined in bytes 20 and 21 of the Bind image, and bytes 22 and 23 are ignored. The device operates with the defined screen size during the entire session. An Erase/Write Alternate command is accepted by the device but is interpreted as an Erase/Write command. No state change occurs, and the screen size remains as defined in bytes 20 and 21 of the Bind image. Valid codings of bytes 20 and 21 are as follows:

| | | Model 1 | Model 2 | Model 3 | Model 4 |
|---------|-----|-------------|---------|---------|---------|
| Byte 20 | Hex | ≤X'0C' | ≤X'18' | ≤X'20' | ≤X'2B' |
| | Row | ≤12 | ≤24 | ≤32 | ≤43 |
| Byte 21 | Hex | X'28' X'50' | X'50' | X'50' | X'50' |
| | Col | 40 80 | 80 | 80 | 80 |

If the Bind specifies an invalid number of columns, or if the number of rows is greater than the maximum row specified (above) for each model, the Bind will be rejected. Buffer wrap will occur at the end of the row specified in byte 20.

When bits 1 through 7 of byte 24 are coded b'0111111', a dynamic switch can be made during the session between a default screen size and an alternate screen size. When byte 24 is coded in this way, bytes 20 through 23 define the default and alternate screen sizes.

Valid codings of these bytes are as follows:

| | | Model 1 | Model 2 | Model 3 | Model 4 |
|-----------------|-----|-------------|---------|---------|---------|
| Bytes 20 and 22 | Hex | ≤X'0C' | ≤X'18' | ≤X'20' | ≤X'2B' |
| | Row | ≤12 | ≤24 | ≤32 | ≤43 |
| Byte 21 and 23 | Hex | X'28' X'50' | X'50' | X'50' | X'50' |
| | Col | 40 80 | 80 | 80 | 80 |

The Bind is rejected if an invalid number of columns is coded in the Bind image or if the number of rows is greater than the maximum row value shown for each model (above). When in alternate-size mode, the display will wrap at the end of the row specified in byte 22 of the Bind image. When in default-size mode, the screen will wrap at the end of the row specified in byte 20 of the Bind image.

Once the Bind has taken place, the display is cleared and set to the default screen size and format. Request/Response Units (RUs) that contain SBA, RA, or EUA orders with addresses out of the range of the default screen size are rejected with -RSP (1005) (address out of range) response. Data will wrap at the default screen boundary whether input by the operator or from the outbound data stream, and wrapping will occur at the default screen boundary as defined for all other 3270 operations (for example, Erase All Unprotected, Read Buffer).

The Erase/Write Alternate command dynamically switches the display to the specified alternate screen size. Note that, on a Model 2 display, the Erase/Write Alternate command performs no meaningful function.

If bound to dynamically switch, the device assumes the characteristics of a display with the alternate screen size, upon receipt of an Erase/Write Alternate command. RUs that contain SBA, RA, or EUA orders that have addresses out of the range of the valid alternate screen size are rejected with -RSP (1005) (address out of range).

Write, Erase/Write, and Erase/Write Alternate Commands (LU Type 3)

The terminal printers can operate as LU type 3 and extended LU type 3. Commands and orders used by LU type 2 are applicable to LU type 3 and extended LU type 3 except for the read-type commands: Read Buffer, Read Modified, and Read Modified All. Read-type commands are rejected with -RSP (1003) (invalid command code.)

LU type 3 operations are directed by write-type commands. As specified in the Bind, printers that function as base LU type 3 operate as 480- or 1,920-character devices, and printers that function as extended LU type 3 operate with alternate buffer sizes of 960, 1920, 2560, 3440, or 3564 characters, or the full physical buffer. The alternate size is established by an Erase/Write Alternate command, and the default size is established by an Erase/Write command. Loss of power at the printer or the control unit or unbinding the session returns the printer to the default buffer size.

The WCC for LU type 3 and extended LU type 3 is shown in Figure 1-7. The function of bits 2, 3 (Printout Format), 5 (Sound Alarm), and 7 (Reset MDT bits) is the same as for LU type 2. When bit 4 (Start Print) is set to 1, the printer buffer content is printed after completion of the data transfer. Otherwise, printing does not occur after completion of the data transfer.

Buffered printers that operate as LU type 3 employ the format shown in Figure 1-9 as part of the Bind operation.

Byte 24 establishes the buffer size for both base and extended LU type 3 operations. The base LU type 3 operation supports a 480- or 1,920-character buffer only, using the Erase/Write command. To use larger printer buffer sizes, the Bind must specify Extended LU type 3 operation.

| Byte | Bit | Content | Description |
|------|-----|---|--|
| 19 | 0-7 | Reserved | |
| 20 | 0-7 | X'0C' X'18' X'1B' X'20' X'2B' | Default number of rows 12 24 27 32 43 |
| 21 | 0-7 | X'28' X'50' X'84' | Default number of columns 40 80 132 |
| 22 | 0-7 | X'0C' X'18' X'1B' X'20' X'2B' | Alternate number of rows 12 24 27 32 43 |
| 23 | 0-7 | X'50' X'84' | Alternate number of columns 80 132 |
| 24 | 0 | Reserved | |
| | 1-7 | Session Buffer Size b'0000000' b'0000001' b'0000010' b'1111110' b'1111111' | Extended LU3 uses all available buffer space. No size is specified. Base LU3, 12 x 40 Base LU3, 24 x 80 Extended LU3 static buffer size is defined in bytes 20, 21. Extended LU, alternate sizes are indicated in bytes 22, 23. |
| | | | All other values are reserved and cause the Bind to be rejected with X'0821'. |

Figure 1-9. LU Type 3 Buffer Size Bind Format

The Erase/Write Alternate command is accepted in base LU type 3, but it is processed as an Erase/Write command. No state change occurs. All terminal printers can be bound with b'0000001' or b'0000010'.

When bits 1 through 7 of byte 24 are coded b'0000000', the entire print buffer can be used, regardless of size. Buffer wrap occurs at the end of the physical buffer. An Erase/Write Alternate command is processed as a normal Erase/Write command. No state change occurs.

When coded b'1111110', byte 24 indicates extended LU type 3 operation with the buffer size coded in bytes 20 and 21. Buffer size switching is not allowed. Bytes 22 and 23 are ignored. When an Erase/Write Alternate command is encountered in the data stream, it is interpreted as a normal Erase/Write command.

When byte 24 is coded b'1111111', bytes 22 and 23 are inspected to determine the maximum alternate buffer size to be used during the session; for example, a Bind for 32 rows of 80 characters each permits the use of programs written for 960-, 1920-, and 2560- character buffer sizes. (If programs written for 132-character columns are used, byte 22 must be interpreted differently.) This assumes that programs do not depend upon buffer address wrap during write operations.

If the printer cannot support the required buffer size, the Bind is rejected with a -RSP (0821) response parameter error. A 3287 with a basic 2K buffer cannot, for example, accept an LU3 Bind specifying a 2560-character buffer. Valid Bind parameter values for the 3276 are column counts of 40 or 80, and the product of the row and column counts that are less than or equal to the physical buffer size minus 80. The row/column product determines the print buffer wrap point. Print control is managed by the WCC and not by the Bind parameter values.

For the 3276, other values coded into bytes 20-23 may cause unpredictable results, but the Bind will not be rejected.

Read Commands

Three read-type commands are executed by the 3276: Read Buffer, Read Modified, and Read Modified All. Read Buffer causes the entire buffer contents of the addressed terminal to be read into main storage. The operation initiated by Read Modified is determined by display station operator actions.

The information read during execution of Read Modified or Read Modified All could consist of fields of data modified by keyboard operations, data entered by magnetic reading devices, buffer addresses, or data of selector light-pen or CURSR SEL fields, or the code of a Program Function or Program Access key.

In remote BSC configurations, reading is normally accomplished by a General or Specific Poll sequence (described under "Remote Operations" in Chapter 3). In remote, the 3276 cannot generate attention interruption. Instead, the host program should issue poll sequences periodically. Upon receipt of a poll sequence, the 3276 BSC control unit initiates one of three operations:

1. If status and sense information is pending, this information is sent to the TCU.
2. If an operator action has occurred that requires reading by the program, and status and sense information is not pending, a control-unit-generated Read Modified command operation is performed.
3. If no operator action has occurred and status and sense information is not pending, the control unit sends End of Transmission (EOT) to the TCU, terminating the operation.

Programming Note: Unsolicited read commands are not recommended, because the information read by these commands may be incomplete.

During a read-buffer or read-modified operation, when BSC line discipline is used, a SUB character (3F in EBCDIC, 1A in ASCII) is sent in place of any byte that has bad parity. Also, a Data Check sense condition is recorded. Normal transmission of the read data then continues until the usual ending point. At that time, the operation is terminated with ENQ in place of ETX or ETB.

Read Buffer Command

Execution of the Read Buffer command causes all data in the addressed device buffer, from the buffer location at which reading starts through the last buffer location, to be transferred to main storage. This command is provided primarily for diagnostic purposes. The transfer of data begins:

1. From buffer address 0 if the Read Buffer command is unchained. Certain 3276 emulators also begin data transfer from buffer address 0 if the Read Buffer command is chained from a Copy command.
2. From the current buffer address if the Read Buffer command is chained. Certain 3276 emulators only begin data transfer from the current buffer address if the Read Buffer command is chained from a Write, Erase/Write, Read Modified, or another Read Buffer command. Regardless of where the transfer of data begins, data transfer from the buffer will terminate when the last character location in the buffer has been transferred, or before the last character location has been transferred, when the last character of a text block has been transferred (described under "Remote Operations" in Chapters 3 and 4).

The transferred data stream begins with a 3-character read heading consisting of the AID character followed by a 2-character cursor address. The contents of all buffer locations are transferred, including nulls. Start Field (SF) orders are inserted by the 3276 to identify the beginning of each field.

The possible cursor address byte configurations are shown in Appendix B. The possible Attention Identification (AID) byte configurations are shown in Figure 1-10. An AID configuration other than 60 or E8 is set when the operator at the selected display station has performed an operation that requires program intervention. These operations are (1) pressing a Program Function or Program Access key, (2) reading a magnetic stripe, or (3) detecting an attention field with the selector light pen or CURSR SEL key. The attribute character is shown in Figure 2-4.

Read Modified Command

Read Modified initiates one of three operations, as determined by operator actions at the display station: (1) Read Modified, (2) Short Read, or (3) Test or System Request Read: Figure 1-10 lists the operator actions and the resulting Read Modified command operation initiated by each action. Read Modified commands normally are not used for remote configurations since polling initiates a control-unit-generated read-modified operation if AID is generated and if status is not pending.

A major feature of Read Modified command operations is null suppression. The device buffer is cleared to all nulls when the operator turns power on or presses the CLEAR key, or when the erase portion of an Erase/Write command is executed at the selected device. Also, selected portions of a buffer can be cleared to nulls by the Erase All Unprotected command and certain orders. During Read Modified command operations, null codes are not sent.

Read Modified Operation. During a Read Modified command, if an AID other than selector-light-pen attention, the CURSR SEL key, a PA key, or the CLEAR key is generated, all fields that have been modified by a keyboard, the selector light pen, the CURSR SEL key, or the reading of a magnetic stripe are transferred to the program. All nulls are suppressed during data transfer and thus are not included in the read data stream. As a field is modified by the operator, the modified data tag (MDT) bit is set in the attribute byte for that field. Then, when a read-modified operation is performed, successive attribute bytes are examined for a set MDT bit. When the bit is found, the data in the associated field is read (with nulls suppressed) before the next attribute byte is examined.

The first 3 bytes of the read data stream are always the AID code (Figure 1-10) and the 2-byte cursor address; these bytes are called the "read heading."

| AID | Hex Character (EBCDIC) | Hex Character (ASCII) | Graphic Character | Read Modified Command Operation | Resultant Transfer to CPU |
|--|------------------------|-----------------------|-------------------|--|--|
| No AID generated (Display or Display Station) | 60 | 2D | — | Rd Mod (Unsolicited Read or Read Modified from Host) | If performing a remote polling operation, no read operation occurs; otherwise field addresses and text in the modified fields are transferred. |
| No AID generated (Printer) | E8 | 59 | Y | Rd Mod | |
| ENTER key and & (Selector-Light-Pen Attention) | 7D | 27 | ' | Rd Mod | AID code and cursor address, followed by an SBA order, attribute address +1, and text for each modified field. Nulls are suppressed. |
| PF 1 key | F1 | 31 | 1 | Rd Mod | |
| PF 2 key | F2 | 32 | 2 | Rd Mod | |
| PF 3 key | F3 | 33 | 3 | Rd Mod | |
| PF 4 key | F4 | 34 | 4 | Rd Mod | |
| PF 5 key | F5 | 35 | 5 | Rd Mod | |
| PF 6 key | F6 | 36 | 6 | Rd Mod | |
| PF 7 key | F7 | 37 | 7 | Rd Mod | |
| PF 8 key | F8 | 38 | 8 | Rd Mod | |
| PF 9 key | F9 | 39 | 9 | Rd Mod | |
| PF 10 key | 7A | 3A | : | Rd Mod | |
| PF 11 key | 7B | 23 } See Note. | # | Rd Mod | |
| PF 12 key | 7C | | @ | Rd Mod | |
| PF 13 key | C1 | 41 | A | Rd Mod | |
| PF 14 key | C2 | 42 | B | Rd Mod | |
| PF 15 key | C3 | 43 | C | Rd Mod | |
| PF 16 key | C4 | 44 | D | Rd Mod | |
| PF 17 key | C5 | 45 | E | Rd Mod | |
| PF 18 key | C6 | 46 | F | Rd Mod | |
| PF 19 key | C7 | 47 | G | Rd Mod | |
| PF 20 key | C8 | 48 | H | Rd Mod | |
| PF 21 key | C9 | 49 | I | Rd Mod | |
| PF 22 key | 4A | 5B | ¢ | Rd Mod | |
| PF 23 key | 4B | 2E | • | Rd Mod | |
| PF 24 key | 4C | 3C | < | Rd Mod | |
| Operator Identification Card Reader | E6 | 57 | W | Rd Mod | |
| Magnetic Slot Reader and Magnetic Hand Scanner | E7 | 58 | X | Rd Mod | |
| Selector-Light-Pen Attention space null | 7E | 3D | = | Rd Mod | AID code, cursor address, and field addresses only; no data. |
| PA 1 key | 6C | 25 | % | Short Rd | AID code only. |
| PA 2 (CÑCL) key | 6E | 3E | > | Short Rd | |
| PA 3 key | 6B | 2C | , | Short Rd | |
| CLEAR key | 6D | 5F | — | Short Rd | |
| TEST REQ and SYS REQ keys | F0 | 30 | 0 | Tst Req Rd | A test request message. AID transferred on Read Buffer only. |

Note: Graphic characters for the United States I/O interface codes are shown. If a World Trade country I/O interface code is used, refer to IBM 3270 Information Display System: Character Set Reference, GA27-2837, for possible graphic character differences.

Figure 1-10. Attention ID (AID) Configurations

Following the read heading is the alphanumeric data of each modified field. The data for each field is preceded in the data stream by a Set Buffer Address (SBA) order code followed by the 2-byte buffer address of the first character position in that field (the attribute address + 1). Thus, the read data stream when data has been modified is as follows:

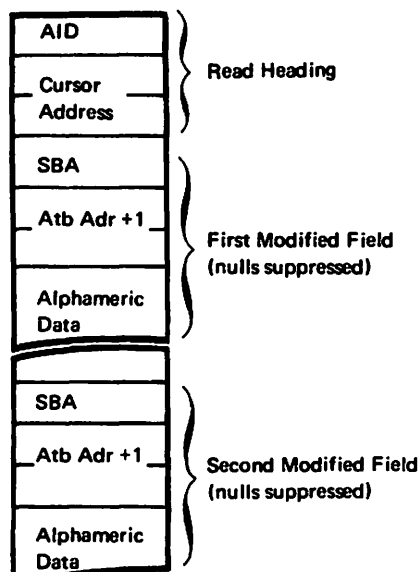

If a space or null selector-light-pen-attention AID is generated, fields are not transferred to main storage during the read-modified operation. Instead, when a set MDT bit is found (indicating selector-light-pen and/or keyboard activity), only the read heading, the SBA order code, and the attribute address +1 are transferred.

Note that if fields are modified by the keyboard but completion of the modification is signaled by a selector-light-pen-attention operation on other than ampersand character-designator fields, a resulting read-modified operation will read only the address of the modified fields; not the modified data. A Read Modified command can be used to obtain both the address of, and the data in, each field that has the MDT bit set to 1.

The buffer location at which the search begins for attribute bytes that define modified fields is a function of command chaining. This location is:

1. Buffer address 0 if Read Modified command is unchained or is chained from a Copy command.
2. The current address if the Read Modified command is chained from a Write, Erase/Write, Read Modified, Read Modified All, or Read buffer command.

The search for modified-field attribute bytes ends when the last buffer location is checked.

The transfer of read data is terminated as follows:

1. If the last modified field is wrapped from the last buffer location (for example, 479 or 1919) to the first location, the operation is terminated after all data in the field is transferred (nulls are suppressed). The buffer address at the end of the operation is the address of the next attribute byte in the buffer. For example, if a modified field extends from address 1900 (the attribute byte) to address 79 (wrapped field), the data from address 1901 through 79 is transferred (nulls are suppressed); in this case, the read operation is terminated with the buffer address set to 80 (the attribute byte of the next field).
2. If the buffer does not contain a wrapped modified field, and if the channel byte count has not reached zero (local operation only), the modified data stream is terminated when the last modified field is transferred; at the end of the operation, the buffer address is set to 0.

If the buffer is formatted (contains fields) but none of the fields have been modified, the read data stream consists of the 3-byte read heading only.

If the buffer is unformatted (contains no fields), the read data stream consists of the 3-byte read heading followed by all alphanumeric data in the buffer (nulls are suppressed), even when part or all of the data has not been modified. Since an unformatted buffer contains no attribute bytes, no SBA codes with associated addresses or address characters are included in the data stream, and the modification of data cannot be determined. Data transfer starts at address 0, regardless of command chaining, and continues to the end of the buffer. At the end of the operation, the buffer address is set to 0. This read operation can also be terminated by the channel byte count reaching zero before all data is read; in this case, the buffer address after termination is undefined.

Short Read. The Read Modified command causes a short read operation if the CLEAR, CNCL, or a PA key has been pressed at the selected device. During the Short Read operation, only an AID byte is transferred to main storage. This AID byte identifies the key that was pressed.

Test Request Read. This description applies only to units not using SNA protocol. The Read Modified command causes a Test Request Read operation if the SYS REQ key has been pressed at the selected device. The Test Request Read data stream sent to main storage is as follows:

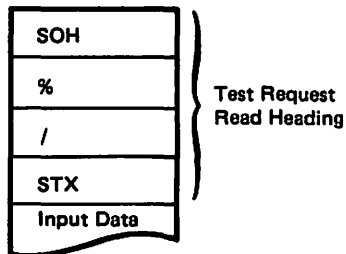

The Test Request Read heading is generated by the control unit. The remainder of the data stream is the same as described previously for read-modified operations, excluding the 3-byte read heading (AID and cursor address). If the buffer is unformatted, all alphameric data in the buffer is included in the data stream (nulls are suppressed), starting at address 0. If the buffer is formatted, each attribute byte is examined for a set MDT bit. Each time a set MDT bit is found, the alphameric data in the field associated with that bit is sent to main storage (nulls are suppressed); if no MDT bits are set, the read data stream consists of the Test Request Read heading only. The buffer location at which the search for MDT bits begins and the transfer of data ends is the same as described for read-modified operations.

Test Request Read function usage is determined by the access method. Normally, the operator would (1) clear the display, (2) enter test request data in a predefined format, and then (3) press the SYS REQ key.

Read Modified All Command

The Read Modified All command is used with the 3276 unit operating in SNA/SDLC protocol. This command operates like a Read Modified command except that both addresses and data from all modified fields are sent to the host, regardless of the AID byte generated. The Read Modified All command is not generated by the control unit in response to a poll sequence. It must be sent by the host.

Control Commands

Control commands initiate certain control unit and/or device operations not involved with the transfer of data (other than status). Two control-type commands are executed by the 3276: Copy and Erase All Unprotected. The applicable control units are identified within the description of each control command.

Copy Command

The Copy command is used to transfer buffer data from one device to another device attached to the same control unit. The selected device is the "to" device, the one to which buffer data will be transferred. The "from" device, the source of the buffer data to be copied, is identified in the second of 2 bytes that follow the Copy command code; the first byte, called the copy control character (CCC), identifies the type of data to be copied. The CCC can also, at the "to" device, start print operations, specify the printout format for those operations, and, when the device is a display station, sound the audible alarm.

The Copy data stream is as follows:

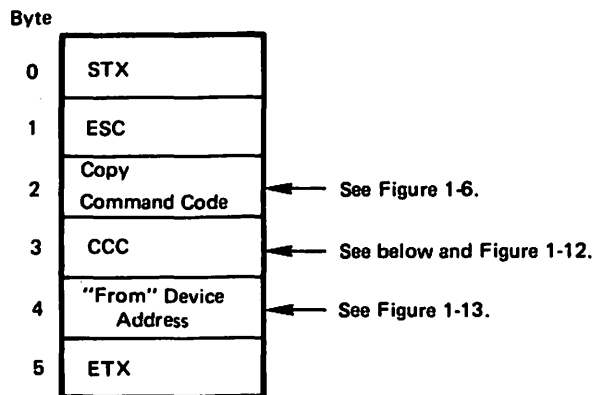

The CCC-byte format is as follows:

| • | 1 | Printout Format | Start Print | Sound Alarm | Type of Data to Be Copied | | |
|---|---|-----------------|-------------|-------------|---------------------------|---|---|
| 0 | 1 | 2 | 3 | 4 | 5 | 6 | 7 |

*Determined by the configuration of bits 2 through 7. See Figure 1-4.

Figure 1-12 describes the function of each CCC bit. A CCC and address byte must always follow the command code; if they do not, the control unit aborts the command and generates error status.

The 3276, when operating with SNA/SDLC protocol, does not support the Copy command. A Copy function is provided, however, which is discussed under "Local Copy Function" in Chapter 2.

| Bit | Explanation |
|-----|--|
| 0,1 | Determined by the contents of bits 2 through 7 as shown in Figure 1-4. |
| 2,3 | Define the printout format as follows: = 00 – The NL, EM, and CR ¹ orders in the data stream determine print line length. Provides a 132-print position line when the orders are not present. = 01 – Specifies a 40-character print line. = 10 – Specifies a 64-character print line. = 11 – Specifies an 80-character print line. |
| 4 | The Start Print bit. When set to 1, initiates a printout operation at the “to” device after buffer transfers are completed. |
| 5 | The Sound Alarm bit. When set to 1, sounds the audible alarm at the “to” device after buffer transfers are completed if that device has an audible alarm. |
| 6,7 | Define the type of data to be copied as follows: = 00 – Only attribute characters are copied. = 01 – Attribute characters and unprotected alphameric fields (including nulls) are copied. Nulls are transferred for the alphameric characters not copied from the protected fields. = 10 – All attribute characters and protected alphameric fields (including nulls) are copied. Nulls are transferred for the alphameric characters not copied from the unprotected fields. = 11 – The entire contents of the storage buffer (including nulls) are copied. |

¹ The CR order is applicable to the terminal printers only.

Figure 1-12. Copy Control Character (CCC)

Copy command operations are similar to Write command operations. After the 3276, for example, accepts the Copy data stream, it initiates the transfer of all 1920 bytes from the “from” device buffer to the 3276 buffer. Upon completion of this transfer, the 3276 inserts nulls in all character locations that do not contain the type of data specified by CCC bits 6 and 7. The updated control unit buffer contents are then transferred to the selected (“to”) device. At the completion of Copy command operations, the cursor is in the same character location at the “to” device as it was at the “from” device at the start of operations.

The “from” device buffer can be “locked” (made incapable of being copied) by writing a protected/alphameric attribute byte (bit 2=1 and 3=0) in address 0 (with BSC only).

The Copy command can specify as the “from” device the same device that is selected (the “to” device). This procedure provides a means of programming selective device buffer “erase” operations as specified by CCC bits 6 and 7. In this case, the device buffer contents are transferred to the control unit, nulls are inserted as determined by the CCC, and the resulting buffer contents are transferred back to the same device buffer.

When the “from” and “to” devices are attached to a 3276 Model 1, 2, 3, or 4, and when the buffer size of the “from” device is smaller than, or equal in size to, the buffer size of the “to” device, screen size switching occurs as listed in Figure 1-13. Invalid transfers are also indicated. The buffer of the “to” device is, in effect, cleared before the copy is performed. The same rules apply for copy-operation transfers to printer buffers.

| To | 3276 | | 3276 | | 3276/8-3 1920 | 3276/8-4 3440 | 3276/8-4 1920 | 3178 1920 |
|--------------------------|-----------------|-----------------|------------------------|------------------------|------------------|------------------|------------------|--------------|
| | 3276/8-1 960 | 3276/8-1 480 | 3278-2 3279 1920 | 3278-2 3279 2560 | | | | |
| 3276/8-1 960 | ○ | A | ● | ● | ● | ● | ● | ● |
| 3276/8-1 480 | V | ○ | ● | ● | ● | ● | ● | ● |
| 3178/3276 /8-2/9 1920 | — | — | ○ | V | ○ | V | ○ | ○ |
| 3276/8-2/9 2560 | — | — | — | ○ | A | ● | A ¹ | — |
| 3276/8-3 1920 | — | — | ○ | V | ○ | V | ○ | ○ |
| 3276/8-4 3440 | — | — | — | — | — | ○ | A | — |
| 3276/8-4 1920 | — | — | ○ | V | ○ | V | ○ | ○ |

Legend:

- Transfer allowed, no change in screen state required.
- Transfer not allowed, Operation Check returned to host.
- Transfer allowed, no change in screen state (appearance on "from" and "to" device may differ).
- A Transfer allowed, screen state changes to alternate size.
- V Transfer allowed, screen state changes to default size.

¹The 3440 screen does not have a 2560 mode; therefore, the screen size is set to 3440.

Figure 1-13. Buffer Transfers for 3276 Models 1 through 4 Copy Command Operation

Programming Notes:

1. Copy should not be chained from a Write, Erase/Write Alternate, Erase/Write Unprotected, or Erase All Unprotected command, since it will copy the data as modified by the Write or Erase command.
2. If the CCC Start Print bit is set and commands are being chained, Copy should be the last command of the chain. If not, the control unit aborts the subsequent command.
3. Copy can be executed from a smaller buffer size to a larger buffer size, but an attempt to copy from a larger to a smaller buffer size will cause an Operation Check.
4. An Operation Check will occur if copying from an APL device in APL mode to a device that does not have the APL feature installed.

Erase All Unprotected Command

This command performs five functions at the addressed device:

1. Clears all unprotected buffer character locations to nulls.
2. Resets to 0 the MDT bit for each unprotected field.
3. Unlocks the keyboard when either the System Lock or the Wait symbol is displayed on the 3178, 3276, 3278, or 3279.
4. Resets the AID byte.
5. Repositions the cursor to the first character location in the first unprotected field of the buffer. If no unprotected fields exist, the cursor is positioned to buffer location 0.

Programming Restriction: Erase All Unprotected should not be chained to a Write, Erase/Write, Erase/Write Alternate, Copy, or another Erase All Unprotected command. If it is, the resulting operation is not defined.

Orders

Orders can be included in Write, Erase/Write, or Erase/Write Alternate command data streams, either alone or intermixed with display or print data. Two types of orders are available: printout format orders and buffer control orders. Printout format orders are initially stored in the buffer as data and are subsequently executed only during a print operation.

The following paragraphs describe buffer control orders, which are executed as they are received in the write data stream by the 3270; these orders are not stored in the buffer. Six buffer control orders (see Figure 1-14) are provided to position, define, and format data being written into the buffer, to erase selected unprotected data in the buffer, and to reposition the cursor.

Notes:

1. *Figure 2-4 shows attribute byte, and Figure 1-4 shows coding of this byte.*
2. *Figures 1-2 through 1-4 show coding of this byte.*
3. *Appendix B lists the 2-byte code for each possible address. To be a valid address:*
 - a. *If the default size is used in BSC mode, the maximum buffer addresses are:*
3276-1, 3278-1: 479
3178-C1, -C2; 3276-2, -3, -4; 3278-2, -3, -4; 3279-2, -3: 1919
 - b. *If the alternate size is used in BSC mode, the maximum buffer addresses are specified by the device model number:*
Model 1: 959
Model 2: 1919
Model 3: 2559
Model 4: 3439
 - c. *If the SNA/SDLC mode is used, the maximum default size and alternate size are the display size minus 1. The display size is defined in the Bind parameter.*

Start Field (SF) Order

This order notifies the control unit that the next byte in the write data stream is an attribute character. The control unit then stores the next byte (the attribute character) at the current buffer address. As the attribute character is stored, the control unit sets a control bit at that address; this bit identifies the byte as an attribute character during subsequent program or device operations with the buffer data.

When received by control units and terminals supporting the extended field attributes, the SF order causes the default value (X'00') for the Color, Extended Highlighting, and Programmed Symbols attribute types to be set in the extended field attribute buffer.

Note: The byte immediately following the SF order in the data stream is always stored as an attribute character, even when the byte is intended as an order or an alphanumeric data character.

During execution of a Read Buffer command, the control unit automatically inserts SF order codes in the read data stream immediately before each attribute character. This permits identification of the attribute characters by the program and also permits correct storage of attribute characters in the buffer if the read data is used for subsequent write operations.

| Order Sequence | Byte 1 (Order Code) | | Byte 2 | Byte 3 | Byte 4 |
|------------------------------------|---------------------|-------------|----------------------------------|-------------------------------|---------------------------------------|
| | EBCDIC (Hex) | ASCII (Hex) | | | |
| Start Field (SF) | 1D | 1D | Attribute Character ¹ | | |
| Set Buffer Address (SBA) | 11 | 11 | 1st Address Byte ³ | 2nd Address Byte ³ | |
| Insert Cursor (IC) | 13 | 13 | | | |
| Program Tab (PT) | 05 | 09 | | | |
| Repeat to Address (RA) | 3C | 14 | 1st Address Byte ³ | 2nd Address Byte ³ | Character to Be Repeated ² |
| Erase Unprotected to Address (EUA) | 12 | 12 | 1st Address Byte ³ | 2nd Address Byte ³ | |

¹ Figure 2-4 shows attribute byte, and Figure 1-4 shows coding of this byte.

² Figures 1-2 through 1-4 show coding of this byte.

³ Appendix B lists the 2-byte code for each possible address. To be a valid address:

- a. If the default size is used in BSC mode, the maximum buffer addresses are:

3276-1, 3278-1: 479

3178-C1, -C2; 3276-2, -3, -4; 3278-2, -3, -4; 3279-2, -3; 1919

- b. If the alternate size is used in BSC mode, the maximum buffer addresses are specified by the device model number:

Model 1: 959

Model 2: 1919

Model 3: 2559

Model 4: 3439

- c. If the SNA/SDLC mode is used, the maximum default size and alternate size are the display size minus 1. The display size is defined in the Bind parameter.

Figure 1-14. Buffer Control Orders and Order Codes.

Set Buffer Address (SBA) Order

This 3-byte order specifies a new buffer address from which write operations are to start or continue. Set Buffer Address orders can be used to write data into various areas of the buffer. An SBA order can also precede another order in the data stream to specify the starting address for a PT, RA, or EUA order; to specify the address at which an attribute byte is to be stored by an SF order or modified by an MF order; or to specify the address at which the cursor is to be repositioned by an IC order.

If the SBA order specifies an invalid address, the write operation is terminated at this point.

When a Read Modified command is executed and an attribute character (initially sent to the device by writing an SF order) is detected with the MDT bit set, the CU inserts, in place of the attribute, an SBA code followed by the 2-byte buffer address of the first character in the modified field (attribute address +1). This permits identification by the control unit of fields that are modified. When a Read Modified command is executed in the 3276, this three-byte sequence is always sent in the same text block. The 3276 does not split this sequence between two successive blocks.

Insert Cursor (IC) Order

This order repositions the cursor to the location specified by the current buffer address. Execution of this order does not change the current buffer address. For example, if IC is issued when the current buffer address is 160 and the cursor is at location 80, the cursor is moved from location 80 and inserted at location 160. The current buffer address at the end of this operation would remain 160.

Program Tab (PT) Order

The PT order advances the current buffer address to the address of the first character position of the next unprotected field. If the PT is issued when the current buffer address is the location of an attribute byte of an unprotected field, the buffer address advances to the next location of that field (one location). In addition, if the PT order in the write data stream does not follow a control command, order, or order sequence such as WCC, IC, or RA (3-character sequence), nulls are inserted in the buffer from the current buffer address to the end of the field, regardless of the value of bit 2 (protected/unprotected) of the attribute character for the field. Whenever a character position is set to null by the PT order, the default value (X'00') for the Color, Extended Highlighting, and Programmed Symbols attribute types is set in the character attribute buffer. When the PT order follows a control command, order, or order sequence, the buffer content is not modified for that field.

The PT order stops its search at the last location in the buffer. If an attribute character for an unprotected field is not found by this point, the buffer address is set to location 0. (If the PT order finds an attribute character for an unprotected field in the last buffer location, the buffer address is also set to zero.)

To continue the search for an unprotected field, a second PT order must be issued immediately following the first one. Since the current buffer address was reset to 0 by the first PT order, the second PT order begins its search at buffer location 0. If the previous PT order was still inserting nulls in each character location when it terminated at the last buffer location, the new PT order will continue to insert nulls from buffer location 0 to the end of the current field.

Repeat to Address (RA) Order

The RA order stores a specified alphanumeric or null character in all buffer locations, starting at the current buffer address and ending at (but not including) the specified stop address. This stop address and the character to be repeated are identified by the 3 bytes immediately following the RA order in the write data stream, as follows:

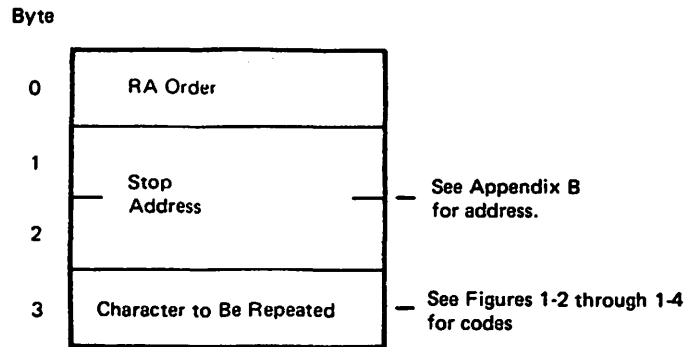

The third character following the RA order is always interpreted as the character that will be repeated. If an invalid stop address is specified, the write operation is terminated at this point without storing the character, and error status is generated. When Color, Extended Highlighting, or Programmed Symbols attributes are specified for the character, the attribute values are entered into the character attribute buffer as each repeated character is written in the data buffer.

When the stop address is lower than the current buffer address, the RA operation wraps from the bottom row of the buffer to the top row. When the stop address equals the current address, the specified character is stored in all buffer locations.

Attribute characters will be overwritten by the RA order if they occur before the RA order stop address.

Programming Note: If the RA order specifies X'ID' to indicate a 2-byte character code (for the Data Analysis/APL), only X'ID' will be repeated. See Figure D-2, Part 2.

Erase Unprotected to Address (EUA) Order

The EUA order inserts nulls in all unprotected buffer character locations, starting at the current buffer address and ending at, but not including, the specified stop address. This stop address is specified by 2 address bytes which immediately follow the EUA order in the write data stream. If an invalid address is specified, the write operation is terminated at this point and error status is generated. Whenever a character position is set to null by the PT order, the default value (X'00') for the Color, Extended Highlighting, and Programmed Symbols attribute types is set in the character attribute buffer.

When the stop address is lower than the current buffer address, the EUA operation wraps from the bottom row of the buffer to the top row. When the stop address equals the current address, all unprotected character locations in the buffer are erased.

Attribute characters are not affected by the EUA order.

Chapter 2. Terminals

This chapter describes the function of the display stations (including keyboard operation, selector light pen, and magnet stripe reader) and printers that can be attached to the 3276 Control Unit Display Station.

Displays

Display Images

Display stations for the 3276 Control Unit Display Station are buffered displays. Data displayed on the screen is stored in coded form in a display buffer; the buffer contains as many locations as there are character positions on the screen. The data may be loaded from the host system by the application program or from a keyboard attached to the display station. Figure 2-1 illustrates the concept of a buffered display.

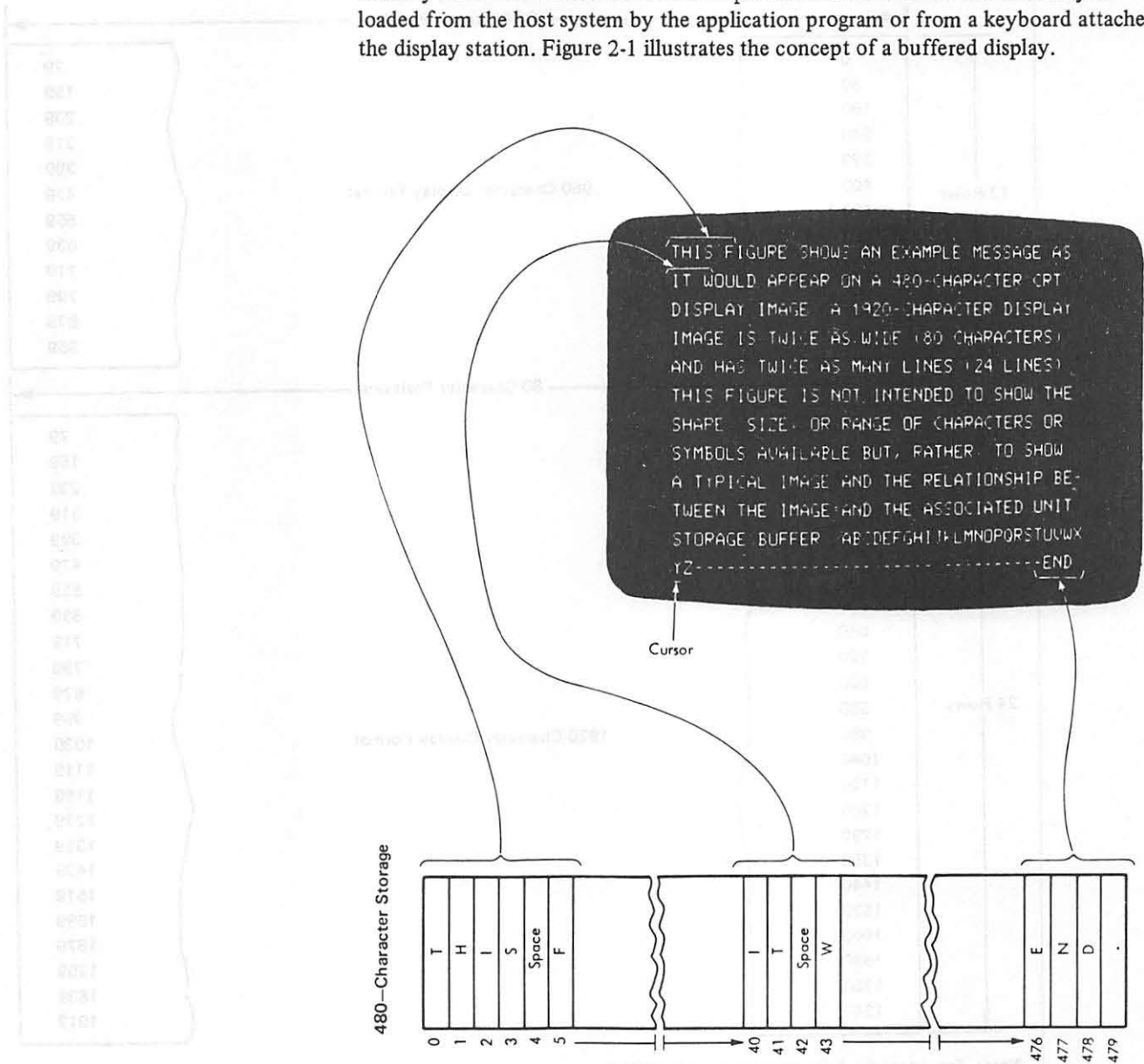
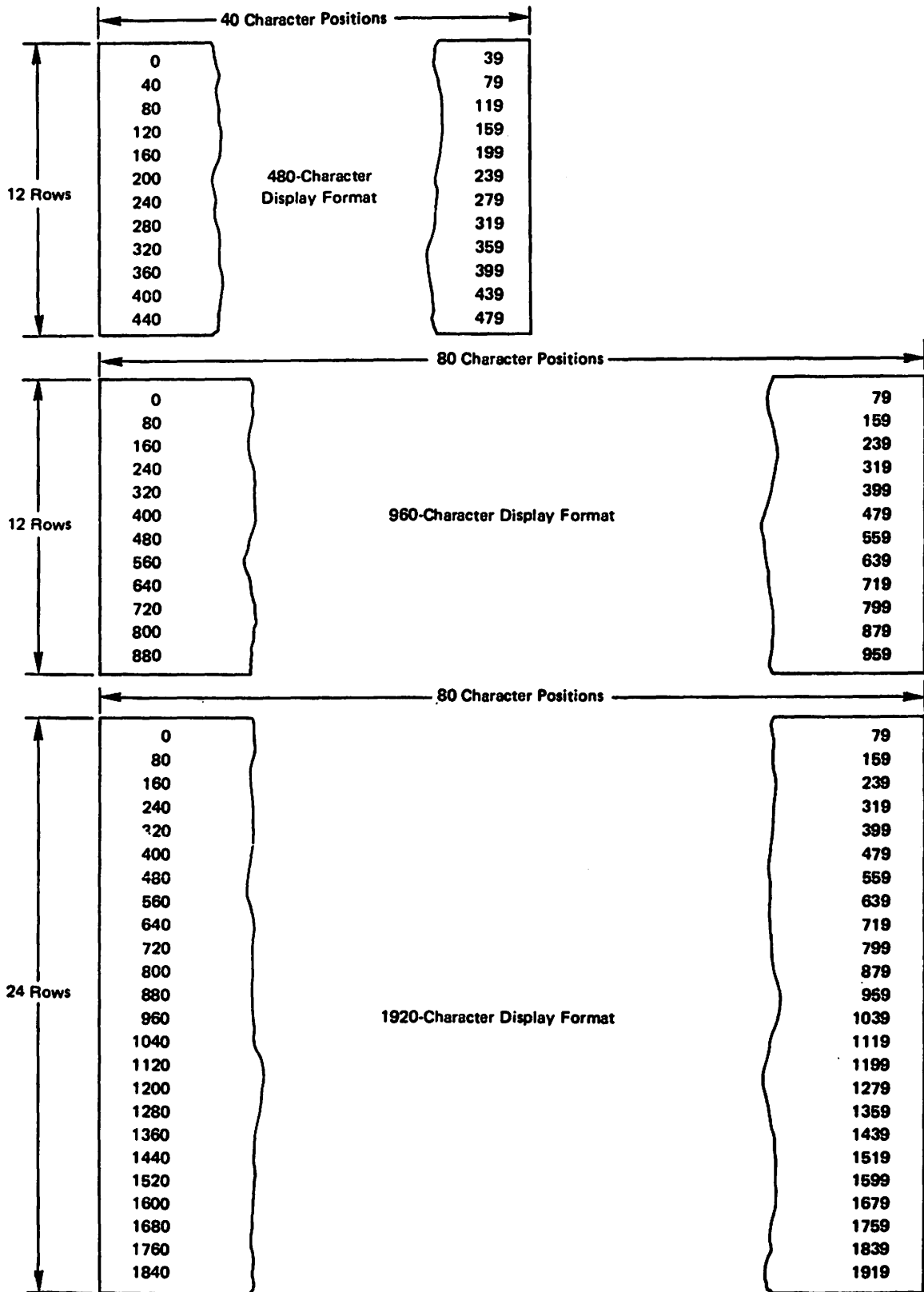

Figure 2-1. Buffer Location and Display Screen Character Position Relationships



Note: See Appendix B for hexadecimal equivalents.

Figure 2-2 (Part 1 of 2). Buffer Addressing Layouts for 480-, 960-, 1920-, 2560-, and 3440- Character Terminals

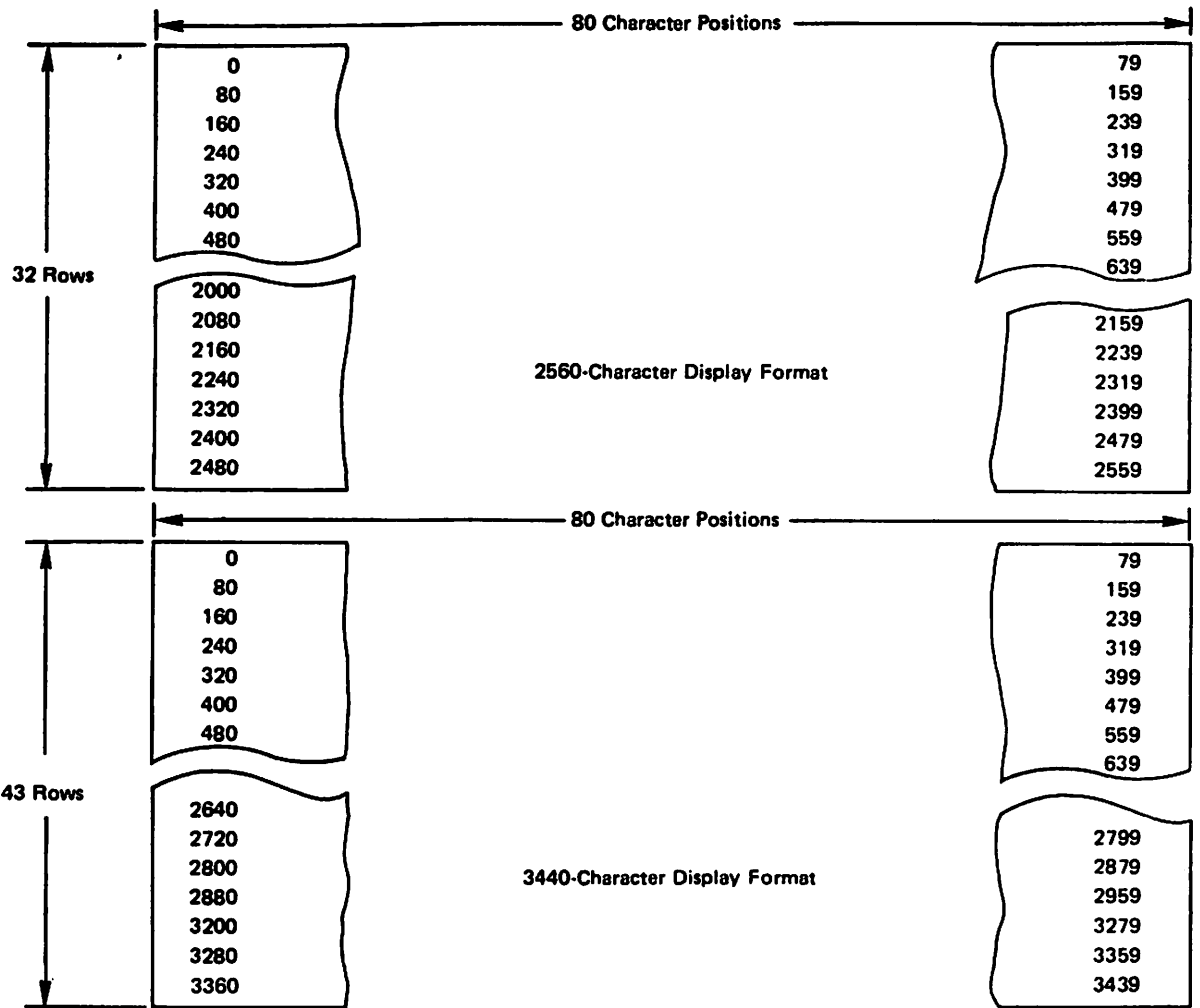

Figure 2-2 (Part 2 of 2). Buffer Addressing Layouts for 480-, 960-, 1920-, 2560-, and 3440- Character Terminals

The display image contains a fixed number of horizontal rows, with a fixed number of character positions in each row. The display station of the 3276 can support the following screen capacities:

- | | | |
|-----------------|--------------------------|--------------------------|
| Models 1 and 11 | 960 - character display | 12 rows of 80 characters |
| Models 2 and 12 | 1920 - character display | 24 rows of 80 characters |
| Models 3 and 13 | 2560 - character display | 32 rows of 80 characters |
| Models 4 and 14 | 3440 - character display | 43 rows of 80 characters |

There is a fixed relationship between each location in the display buffer and each character position on the display screen. Buffer addresses start from 0, for the character position at the left of the top row, and proceed sequentially along the rows and down the screen to the character position at the right of the bottom row (for example, an image with 960 character positions has buffer addresses from 0 to 959). Figure 2-2 shows the addresses of the first and last character positions in each row, depending upon the available screen capacity.

Each location in the buffer contains 1 byte of storage; codes loaded into the buffer are 2-digit hexadecimal codes. Write commands are used to load the display buffer locations with the code needed to display the required data on the display screen (see Chapter 1). Defined codes that are displayed as alphanumeric characters are shown in Figures 1-2 and 1-3.

Display images may be formatted or unformatted:

- **Formatted Display:** A formatted display is one that has separate fields defined by the program. The first character position in each field contains a control character that defines the characteristics of the field. See "Field Attributes," later in this chapter, for a description of the control character.
- **Unformatted Display:** An unformatted display is one that has no defined fields. An operator may input data into any position on the screen; to access the data, the program must issue a read command for the entire display buffer.

Display Fields

A formatted display contains display fields defined by the program. These fields consist of blocks of character positions bounded by control characters. The control character at the start of a field is set by the program to determine the characteristics of the field; this character contains the field attributes. (For details, see "Attributes," later in this chapter.) Fields containing character positions on more than one row "wrap" from the last character position on one row to the first character position on the next row. A field may wrap the screen; if the first character position on the screen does not contain a control character, the last field on the screen wraps from the last character position to the first. (Some field-oriented operations are terminated early if the field wraps the screen; this effect is noted in the descriptions of the specific operations.)

Display fields simplify operations both for the operator and for the programmer. Headings can be displayed to prompt the operator as to the data that should be entered, and the program can identify fields that contain entered data without reading the entire display buffer. When data is being entered into a formatted display, the presence of a control character acts as a tab stop; pressing the tab key advances the cursor from its current position to the first character position in the next unprotected field. (An unprotected field is one that accepts data input from the keyboard.)

The example in Figure 2-3 illustrates the versatility of formatted displays. In this example, the solid characters represent the displayed form of characters stored in the buffer. The dotted squares represent the character positions corresponding to control characters at the start of each field. The dotted characters represent fields of data that are stored in the buffer, but that have been defined by the program as non-displayable; that is, not to be displayed to the operator.

```
□NAME :□ JOHN B DOE
□SALARY □ 1 2 5 2 3
□JOB TITLE :□ WRITER
□PHONE #:□ 383-7628
```

Figure 2-3. Example of Formatted Display

To define the start of a field, the program may issue a Write command transferring a Set Buffer Address (SBA) order and a Start Field (SF) order to the display; the specified buffer address is selected, and the control character specified by the SF order is loaded into the addressed location. Only the start of a field is defined; starting a field ends the previous field at the character position prior to the new control character.

Attributes

Display stations may be programmed with formatted fields. The control character at the start of each field contains the field attributes. Attributes contained in this character apply to all the data contained in the field; for example, the attribute character for the field containing PHONE # in Figure 2-3 might define the field as protected to ensure that the operator does not enter data into that field, and the field containing 383-7628 might be defined as unprotected to allow the data to be changed.

Field Attributes

The field-attribute character occupies the first character position of each display field in a formatted display; the corresponding character position on the display screen is always blank. This 8-bit attribute character is loaded by a Start Field order to (1) define the start of a field and (2) assign characteristics to the field. Bit positions in the character are significant to the display; the value assigned to each bit or group of bits controls whether a specific attribute is applied.

Field Attribute Character

Figure 2-4 shows the significance of bits in the field-attribute character. Characteristics set by the field-attribute character are:

- **Protected/Unprotected:** An operator cannot enter data into or modify the content of a protected field. Input fields that require data from the operator must be unprotected.
- **Alphameric/Numeric:** In an unprotected input field, alphameric/numeric defines the type of data that an operator can enter into the field. This attribute has special meaning for protected fields, data entry keyboards, and the Numeric Lock feature.
- **Nondisplay/Display/Intensified:** Data contained in the field is either not displayed, displayed at normal intensity, or displayed at high intensity. The 3279 does not support two levels of intensity; if no extended attribute is defined, nonintensified fields and intensified fields are displayed in different colors. (The actual colors are determined by the position of the Base Color switch and the value of the Protected/Unprotected attribute.)

Programming Note: Refer to "Selector-Light-Pen Operations," later in this chapter, for the use of intensified field attributes when formatting selector-light-pen-detectable fields.

- **Detectable/Nondetectable:** Displayed data in a detectable field can be detected by the selector light pen. (The detectable field must contain a designator character as described under "Selector-Light-Pen Operations" in this chapter.)

Field attributes are protected against input from the keyboard; however, bit 7 (Modified Data Tag) is set to 1 when the operator enters data into the field defined by the attributes. Attribute characters are not protected against operation of the CLEAR key; pressing the CLEAR key erases all locations in the display buffer.

Attribute character bit assignments are summarized as follows:

| X | X | U/P | A/N | D/SPD | Reserved | MDT | |
|------------|---|---|-----|-------|----------|-----|---|
| 0 | 1 | 2 | 3 | 4 | 5 | 6 | 7 |
| EBCDIC Bit | | Field Description | | | | | |
| 0, 1 | | - Value determined by contents of bits 2-7. See Figure 1-8 for hexadecimal values. | | | | | |
| 2 | | - 0 = Unprotected 1 = Protected | | | | | |
| 3 | | - 0 = Alphameric 1 = Numeric (causes automatic upshift of data entry keyboard) | | | | | |
| | | <i>Note: Bits 2 and 3 equal to 11 causes an automatic skip. See text.</i> | | | | | |
| 4, 5 | | - 00 = Display/not selector-light-pen detectable. 01 = Display/selector-light-pen detectable. 10 = Intensified display/selector-light-pen detectable. 11 = Nondisplay, nonprint, nondetectable. | | | | | |
| 6 | | - Reserved. | | | | | |
| 7 | | - Modified Data Tag (MDT); identifies modified fields during Read Modified command operations. 0 = Field has not been modified. 1 = Field has been modified by the operator. Can also be set by program in data stream. | | | | | |

Figure 2-4. Field Attribute Character Bit Assignment

Base Color Mode

The 3279 uses the field attributes for the additional purpose of controlling color.

Models 2A and 3A of the 3279 always decode the field attributes to assign a color to each display field. If the operator sets the Base Color switch to base color (oooo), then the fields are colored in one of four colors - red, blue, green, or white - depending upon the protect and intensify bits. If the operator sets the Base Color switch to monochrome (oo), all data is displayed in green except for intensified fields; intensified data is displayed in white. The particular attributes examined are the protect and intensify attributes. Figure 2-5 shows how the value of these attributes determines the color of characters displayed in a field.

Note: *The integrity of the unprotected/protected attribute is preserved; the operator can enter data only into an unprotected field.*

| Field Attribute | Attribute Bit | | | | Base Color Switch | |
|-------------------------------|---------------|---|---|---|-------------------|-------|
| | 2 | 3 | 4 | 5 | oo | oooo |
| Unprotected, normal intensity | 0 | X | 0 | X | Green | Green |
| Unprotected, intensified | 0 | X | 1 | 0 | White | Red |
| Protected, normal intensity | 1 | X | 0 | X | Green | Blue |
| Protected, intensified | 1 | X | 1 | 0 | White | White |

Figure 2-5. Colors Derived from Field Attributes

Keyboard Operations

Keyboards, which may be attached to a display station, enable the operator to change, edit, or create character displays except within fields defined by attribute characters as protected from keyboard operations by the program. As messages are being composed or modified by keyboard operations, the changes are inserted in the buffer and then displayed. When the operator completes an operation and presses the ENTER or an AID generating key, an I/O pending interruption occurs.

Cursor

A special symbol, called a *cursor*, is displayed on the display screen to indicate where the next character entered from the keyboard will be stored. On 3178, 3276, 3278, and 3279 displays, the cursor may appear as an underscore, as a blinking underscore, or as a rectangular or blinking rectangular symbol imposed over a character. The character within the rectangular cursor remains visible. The operator may change the cursor from an underscore to a rectangular symbol, or vice versa, by pressing the Alternate Cursor (ALT CURSR) key. The same operator may cause either type cursor to blink by using the Cursor Blink (CURSR BLINK) key. When the cursor is displayed under one character in a line of characters (Figure 2-1), that character can be changed or deleted by keyboard action. Also, if the cursor is displayed under (or within) a position without a display character, a character can be entered in that position by keyboard action.

One, and only one, cursor must always be in the display buffer. A cursor check occurs when the display station circuitry detects no cursor or more than one cursor in the buffer. When the display is turned on, the cursor is automatically generated and displayed in the first location on the screen. The cursor can be repositioned by the keyboard operator and also by the program. The cursor is not affected by field attributes or by the Security Keylock special feature; it is displayed even when positioned in a nondisplayed/nonprint field and when the Security Keylock special feature (if installed) is turned off.

Keyboards

Six types of keyboards are available: typewriter, data entry, data entry keypunch layout, operator console, APL, and text keyboards. All keyboards have special symbol keys and control keys for entering data. The type of keyboard determines the characters and symbols that can be transmitted from the system for the display image.

Variations between keyboards include 75-key and 87-key versions for the 3178, 3276, 3278, and 3279. The 75-key keyboard provides all the basic operator keys. The 87-key keyboard provides expanded operator-to-program message flexibility with 12 additional keys that may be defined to fit the requirements of the application program. Refer to *3270 Information Display System: Character Set Reference, GA27-2837*, for key layouts and nomenclature.

Typewriter and APL 87-key and 88-key keyboards are available with extended function for the 12 program function keys on the right-hand side of the keyboards.

Key Functions

Alphabetic characters on typewriter keyboards attached to 3276 displays can be entered into the display buffer in either uppercase or lowercase code, depending upon the position of the Shift key. However, only uppercase alphabetic codes can be entered from data entry keyboards. On 3178, 3276, 3278, and 3279 displays, alphabetic characters in the buffer (uppercase or lowercase codes) are displayed as all uppercase or uppercase and lowercase characters, as determined by the setting of the Dual Case/Mono Case switch. The shift keys on the Katakana keyboards operate differently from the keys described here; refer to Appendix E for details.

Keyboard entry of an alphameric character into the display buffer occurs at the cursor location, provided the cursor is located in an alphameric character location within an unprotected data field. (An attempt to enter an alphameric character into a protected data field or into an attribute character location is blocked.)

Successful keyboard entry of the alphameric character causes the cursor to advance to the next character location within the unprotected data field.

Note: The following descriptions of key functions are applicable to all keyboards, except where noted. In some cases, descriptions of key functions contain SNA protocol terms, references to local copy operations, or Operator Information Area symbols. For a detailed description of these topics, refer to "Local Copy Function" later in this chapter, to "SNA/SDLC Communication" in Chapter 4, or to Figure A-3 in Appendix A. Operator Information Area symbols in this chapter are designated as "Do Not Enter" symbols in Appendix A.

The ALT key must be held to activate functions shown on the front of keys on the 3178-, 3276-, 3278-, and 3279- attached keyboards. These functions are SYS REQ, CLEAR, ERASE INPUT, IDENT, TEST, DEV CNCL, PF1-PF12, PA1, PA2, ALT CURSR, and HOME. The ALT key is also used with the >> (Right) and << (Left) key to move the cursor two locations at a time instead of one. Using the ALT key with a key that has no associated function produces no effect.

Automatic Skip

Upon entry of a character into the last character location of an unprotected data field, the cursor is repositioned according to the attribute character describing the next field.

If the field attribute character defines the next field as (1) alphameric and either unprotected or protected, or (2) numeric and unprotected, the cursor skips the attribute character and is positioned to the first character location in that field.

If the field attribute character defines the field as numeric and protected, the cursor automatically skips that field and is positioned to the first character location of the next unprotected field.

Character-Oriented Keys

A cluster of four keys (located to the right of the main keyboard) moves the cursor one location at a time into any character location. These are ↑ (Up), ↓ (Down), → (Right), and ← (Left). A fifth key, the Backspace key, occupies its normal position on the keyboard. It performs the same functions as the move-cursor-left key. The cursor may be moved into any character location, including unprotected and protected alphanumeric character and field attribute character locations, through the use of these keys. Operation of these keys does not affect the MDT bit. The ↑ (Up), ↓ (Down), → (Right), and ← (Left) keys move the cursor one location at a time. When the ALT (Alternate) key is pressed and held, the >> (Right) and << (Left) keys will move the cursor two locations at a time.

These keys are all capable of causing the cursor to wrap. Horizontal wrap always involves a vertical movement; the cursor repositions to the next or preceding row of characters. Vertical wrap due to operation of the Up or Down keys involves no horizontal movement; the cursor stays in the same character column.

These keys all have typamatic operation at a repeat rate of approximately 10 operations per second. (When a typamatic key is fully pressed, its function is repeated as long as the key is held pressed.)

Field-Oriented Keys

Any of four keys moves the cursor to the first position in a field on a formatted screen. All four key operations can cause the cursor to wrap from the end of the last line on the display and to continue at the beginning of the top line. Operation of these keys does not affect the MDT bit.

→| (Tab) Key: Moves the cursor to the first character location of the next unprotected data field. In a display with no unprotected fields, the cursor is repositioned to character location 0. The Tab key has typamatic capability at a repeat rate of approximately 10 operations per second.

|← (Back-tab) Key: When the cursor is located in the field attribute character position or the first alphanumeric character location of an unprotected data field or in any character location of a protected data field, this key moves the cursor to the first alphanumeric character location of the first preceding unprotected data field. When the cursor is located in any alphanumeric character location of an unprotected data field other than the first location, this key moves the cursor to the first alphanumeric character location of that field. In a display with no unprotected fields, the cursor is repositioned to character location 0. The Back-tab key on keyboards attached only to 3178, 3276, 3278, and 3279 units has typamatic capability.

←| (New Line) Key: Moves the cursor to the first unprotected character location of the next line. If the display has no unprotected data fields, the cursor is repositioned to character location 0. If the display contains no fields, the cursor is repositioned to the first character position of the next line. The New Line key has typamatic capability at a rate of approximately 10 operations per second.

|☐ (Home) Key: Moves the cursor to the first unprotected character position on a 3178, 3276, 3278, or 3279 display screen.

Erase EOF (Erase to End of Field) Key

If the cursor is located in an alphameric character location in an unprotected data field, this key clears the character location occupied by the cursor and all remaining character locations to the right in that field to nulls. The character attributes for all the erased characters are set to X'00'. The operation can wrap from the end of the last line on the display to the end of the field. The cursor does not move as a result of operating this key, and the MDT bit is set to 1.

Operation of this key when the cursor is located in an attribute character location or is within a protected data field causes an input-inhibit condition and disables the keyboard; no character locations are cleared, the cursor is not moved, and the MDT bit is not set.

ERASE INPUT Key

This key clears all unprotected character locations to nulls, resets the MDT bit to 0 in unprotected fields, and repositions the cursor to the first unprotected character location on the screen. The character attributes for all the erased characters are set to X'00'.

On 3178, 3276, 3278, and 3279 displays, the Alternate (ALT) key must be pressed and held first.

In a buffer with only protected data fields, no character locations are cleared and the cursor is repositioned to character location 0.

If the display contains no field, the entire buffer is cleared to nulls, all character attributes are set to X'00', and the cursor is repositioned to location 0.

INS (Insert) Mode Key (3178, 3276, 3278, or 3279)

The INS MODE key on 3178-, 3276-, 3278-, or 3279-attached keyboards places the keyboard in an insert mode of operation. The Insert symbol is displayed in the Operator Information Area on the 3178, 3276, 3278, or 3279 display screen.

If the cursor is located in an unprotected data field having a null character either in the character location identified by the cursor or in any character location in the field beyond the cursor, operation of an alphameric key causes that alphameric character to be entered at the cursor and the MDT bit to be set to 1. The character formerly occupying the cursor location and all remaining characters within the field (except for null characters or characters to the right of null characters) will be shifted one character location to the right. If the location identified by the cursor location at the time of the insert operation is a null, no character shifting occurs.

After all null characters at or beyond the cursor location in the field have been overwritten, or if there were no null characters, operation of an alphameric key causes the keyboard to become disabled. Field-attribute characters and extended field attributes are not shifted as part of the insert operation. On displays that support extended attributes, the character attributes are shifted with the characters. The character attributes for inserted characters are set to X'00', except where the application program allows attribute-selection and the operator has selected specific attributes.

If more than one row of characters is contained within the field, a character occupying the last character location in the row is shifted into the first character location of the next row.

Operation of an alphameric key while in insert mode when the cursor is located in a field-attribute character location or is within a protected data field disables the keyboard; no character locations are cleared, the cursor is not moved, and the MDT bit is not set.

On 3178, 3276, 3278, and 3279 displays, operation of the RESET key, ENTER key, or any other key that causes host communication returns the keyboard to normal mode. (Operation of the selector light pen or the CURSR SEL (Cursor Select) key also returns the keyboard to normal mode.)

Delete Key (3178, 3276, 3278, or 3279)

If the cursor is located in an alphameric character location in an unprotected field, operation of the Delete key (3178, 3276, 3278, or 3279) deletes the character from the character location identified by the cursor and sets the MDT bit to 1 (if not previously set). The cursor does not move. All remaining characters in the unprotected field, to the right of the cursor and on the same row, shift one character location to the left. If the display supports extended attributes, the character attributes for the deleted character are deleted and the other character attributes are shifted left; the character attributes of vacated character positions are set to X'00'. Vacated character locations at the end of the row are filled with nulls. If the unprotected field encompasses more than one row, characters in rows other than the row identified by the cursor are not affected.

Operation of this key when the cursor is located in a field attribute character location or is within a protected data field disables the keyboard; no character locations are cleared, the cursor is not moved, and the MDT bit is not set.

RESET Key

The RESET key is used to recover from an inhibited keyboard operation that has resulted in a disabled keyboard. When a keyboard is disabled, no other keyboard operations are honored. The RESET key will not reset a disabled keyboard when a command is being executed for the device to which the keyboard is attached, or when a parity error or cursor check is detected in the device buffer.

On 3178, 3276, 3278, and 3279 displays, when a keyboard is disabled, symbols are displayed on the bottom row of the screen. Pressing RESET restores the keyboard or other input devices, except for Printer Busy, Printer Very Busy, Printer Not Working, Time, or Security Key input-inhibited conditions. Pressing RESET once resets multiple input-inhibited conditions.

When operating in BSC after an AID generating key is pressed, the RESET key will be ignored during the period from poll to the end of a transmission to the host. Prior to the poll, a RESET action will cancel both the AID code and I/O pending. After transmission to the host is ended, RESET will reset the AID code.

RESET causes print ID mode to terminate. The cursor then reappears, and the old printer ID is displayed in the indicator row.

DUP (Duplicate) Key

Operation of this key causes a unique character code to be entered into the display buffer, a Tab key operation to be performed, and the MDT bit to be set to 1. The DUP key is provided on all keyboard types except operator console. The DUP character provides a means of informing the application program that a "duplicate" operation is indicated for the rest of the field in which it is located. The DUP character is transferred as a DUP code (Figures 1-2 and 1-3) when the data is read from the display to the program. No duplicate operation is performed at the 3276. The DUP character, when stored in a device buffer, is displayed as an asterisk (*) on 3178, 3276, 3278, and 3279 displays using mono-case mode and is printed as an asterisk (*) on a printer. On 3178, 3276, 3278, and 3279 displays using dual-case mode, DUP is displayed as an asterisk with an overscore ($\overline{*}$).

Pressing the DUP key does not affect the current status of extended attributes; however, the PS selection has no effect on a DUP character.

Operation of this key when the cursor is located in a field-attribute character location or is within a protected data field disables the keyboard; no character locations are cleared, the cursor is not moved, and the MDT bit is not set.

FM (Field Mark) Key

Operation of this key causes a unique character code to be entered into the display buffer and the MDT bit to be set to 1. The field mark character provides a means of informing the application program of the end of a field in an unformatted buffer or subfield in a formatted buffer. The field mark character is transferred as an FM code when the data is read from the display to the program. The field mark character, when stored in a device buffer, is displayed as a semicolon (;) on the 3178, 3276, 3278, and 3279 displays using mono-case mode, and is printed as an asterisk (*) on a printer. On the 3178, 3276, 3278, and 3279 displays using dual-case mode, FM is displayed as a semicolon with an overscore ($\overline{;}$). The Field Mark key is not provided on operator console type keyboards.

Pressing the FM key does not affect the current status of extended attributes; however, the PS selection has no effect on an FM character.

Operating this key when the cursor is located in a field-attribute character location or within a protected data field disables the keyboard; no character locations are cleared, the cursor is not moved, and the MDT bit is not set.

Program Attention Keys

The program attention keys for the 3178, 3276, 3278, and 3279 displays are CLEAR, ENTER, the Program Function (PF) keys, and the Program Access (PA) keys. The use of a PA or PF key during a System Services Control Point (SSCP) session results in an input-inhibited condition. Refer to "Keyboard Disabled (INPUT INHIBITED Indicator Is On)." On 3178, 3276, 3278, and 3279 displays, the operation of the CLEAR key also clears the display screen of all data to nulls (except the indicator row), sets all extended attributes to X'00', and positions the cursor at location 0,0 on the display.

Operation of the CLEAR key does not change shift status except that it will remove the NUM symbol, if displayed. It does not perform a reset function. If an alternate screen size has been selected, the CLEAR key will reset the screen to the default size. When SNA/SDLC is used, the action of the CLEAR key depends upon the type of session. In 3276 BSC, the CLEAR key AID code is sent to the host. When SNA/SDLC is used, the CLEAR key AID code is sent to the host when CLEAR is pressed while in the LU-LU session. While in test mode, the CLEAR key does not cause an AID to be sent to the host.

Note: Not all program attention keys are available on each type of 3276 keyboard.

SYS (System) REQ Key

When the 3276 operates in remote SNA/SDLC, the operator can use the SYS REQ key for SSCP-SLU and PLU-SLU session switch procedures. SYS REQ also simultaneously initiates keyboard reset and clear functions. SYS REQ performs these functions despite the presence of input-inhibited conditions except (1) when inbound processing is queued for the display station, in which case the Input Inhibited What symbol appears, and (2) when Printer Busy, Printer Very Busy, or Printer Not Working is displayed, which results in no response when SYS REQ is pressed. (Inbound processing queue is the time from when an AID generating key is pressed until regeneration to the line buffer transfer has been completed.)

In BSC operation, the SYS REQ key performs the test-request function. The automatic reset function is not available. Refer to "Test Request Read" under "Read Modified Command" in Chapter 1.

The ALT key must be pressed and held while the SYS REQ key is pressed.

DEV CNCL (Device Cancel) Key

The operator may use DEV CNCL to cancel a current outstanding print request to a terminal printer if input is inhibited because of a Printer Busy or Printer Very Busy condition. A request initiated by the Print key is dequeued, and the keyboard is restored. A host print request is dequeued, and a negative response is sent to the host. The printer Busy symbol is replaced by the Time symbol.

DEV CNCL is also used to remove Device Not Functional conditions. Any coexisting malfunction-while-printing symbol is also removed.

Following use of the Print key, the keyboard is restored. After a host-initiated print, the Printer Not Working symbol is replaced by the Time symbol.

During other input-inhibited conditions, DEV CNCL causes no response, except that it is queued or detected (with subsequent indication) during certain Time conditions in other situations. Use of DEV CNCL in other situations results in no indication.

The ALT key must be pressed and held while the DEV CNCL key is pressed, to cancel a request and restore the keyboard.

If DEV CNCL is used during a print ID operation at the 3276, the 3276 remains in print ID mode.

| ⤴ (SHIFT Key) - 3178, 3276, 3278, or 3279

Shift keys perform the upshift function. When the typewriter keyboard becomes ready initially, only characters located on the bottom position of the key tops can be entered from the keyboard. By pressing and holding the Shift key, characters shown on the top position of the key tops can be entered. On 3178, 3276, 3278, and 3279 displays, the shift "up" state is indicated to the operator in the Operator Information Area on the display screen. Pressing the Shift key will reset the Lock key.

| Ⓛ (LOCK Key) - 3178, 3276, 3278, or 3279

The Lock key fixes upshift character selection. It is deactivated by pressing the Shift key. When the Shift key on a 3178, 3276, 3278, and 3279 typewriter keyboard is used, the shift state is indicated to the operator in the Operator Information Area on the display screen.

| ⤴ (NUM Key) - 3178, 3276, 3278, or 3279

| The Numeric key on the equivalent 3178, 3276, 3278, and 3279 keyboards is used to perform the upshift function, equivalent to the Shift keys on the typewriter keyboards. The "up" shift state is indicated to the operator in the Operator Information Area on the display screen.

| Ⓛ (NUM LOCK Key) - 3178, 3276, 3278, or 3279

| The Numeric Lock key on the 3178 data entry, and 3276, 3278, 3279 data-entry/data-entry keypunch layout keyboards fixes the upshifted character selection, but will not disable the Numeric Lock feature. It is released by pressing the Numeric Lock key again. The keyboard then reverts to shift or to programmed control shift. The shift "up" state is indicated to the operator in the Operator Information Area on the display screen whenever the Numeric Lock key is pressed.

| ⤵ (Alpha Key) - 3178, 3276, 3278, or 3279

| When the data entry 3178, 3276, 3278, 3279 or data entry keypunch layout 3268, 3276, 3278 keyboards have been programmed for non-alpha shift, characters shown on the bottom of the key tops can be selected by holding the Alpha key and entering the desired characters. When power is applied, the keyboard is in lowercase alpha mode.

CURSR SEL (Cursor Select) Key

| The CURSR SEL key on 3178, 3276, 3278, and 3279 keyboards allows the selector-light-pen-detection function to be performed from the keyboard. The CURSR SEL key may be used on any field defined as a selector-light-pen-detectable field (as described under the heading "Selector-Light-Pen Operations"). However, a cursor-select field does not require the space or null character padding constraints associated with the selector-light-pen-detectable field and cursor-select can occur within the field on a line different from that of the attribute that describes the field.

Cursor-select operations may be immediate or deferred (as defined for selector-light-pen fields). The field used for a cursor-select operation may also be defined in the following format:

- Basic attribute character as defined for selector light pen.
- Designator character as defined for selector light pen.
- Data character(s) Optional
- Basic attribute character Next field.

This format is not applicable when using the selector light pen. When defining a cursor-select field, the attribute character may not be located in the last line of the display with the designator character in the first line.

ATTN (Attention) Key

| The ATTN key on the 3178, 3276, 3278, and 3279 keyboards is operable in SNA/SDLC in an SNA LU-LU session, with the following exceptions:

1. When inbound processing is queued for the display.
2. When in Shutdown condition.
3. When in Data Traffic Reset state.
4. When a second or successive ATTN that occurs prior to completion of processing for the first ATTN is ignored (with no indication).

Use of ATTN in any session except LU-LU causes an Input Inhibit Minus Function.

The ATTN key is inoperative in BSC and will cause an Input Inhibit Minus Function when pressed.

CURSR (Cursor) BLINK Key

Pressing the CURSR BLINK key causes the cursor (either the bar or the rectangular cursor) to blink. Activating the key again causes the blinking to stop. This key function is available on keyboards attached to the 3178, 3276, 3278, or 3279.

ALT CURSR (Alternate Cursor) Key

Pressing the ALT CURSR key while holding the ALT key changes the cursor display. The underlined type of cursor is changed to a rectangular cursor. Conversely, the rectangular cursor is changed to the underlined type of cursor by activating the ALT CURSR key. This key function is available on keyboards attached to the 3178, 3276, 3278, or 3279.

TEST Key

| The TEST key on the 3178, 3276, 3278, or 3279 keyboard is used to invoke test functions resident in the 3276. Pressing the TEST key (while holding ALT key) clears and resets the display screen, and the test mode indication turns on, despite any input-inhibited conditions, with the following exceptions: If Printer Busy, Printer Very Busy, or Printer Not Working is displayed, or if the security key is locked, use of TEST results in no response. The control unit places the device to be tested in test mode, and the operator identifies the test function desired. The operator terminates test mode by pressing the TEST key again.

When the 3276 uses SNA/SDLC, the control unit enters test ownership state. When the 3276 operates in remote BSC mode, Intervention Required is generated if a command is received for the display when in test mode. When test mode terminates normally, status with Device End is generated.

(Click Key)

A clicking sound may be produced as keys are pressed on keyboards attached to 3178, 3276, 3278, and 3279 displays. The clicking sound is controlled by operating conditions such as input inhibit. For example, if the clicking sound is enabled and an input-inhibited condition occurs, the key clock is then disabled, and vice versa. By pressing the Click key, the operator can activate the clicking sound if it has been turned off or prevent clicking if it has been activated.

(Print Key)

The Print key is used to initiate a local copy function from a keyboard attached to a 3178, 3276, 3278, or 3279 display.

IDENT Key

The IDENT key is used to assign a printer or printer class, while performing a local copy function. (The ALT key must be pressed to activate the IDENT key.) When the IDENT key is pressed, the cursor disappears from the screen, and the Printer Assignment symbol appears with two underlined characters in the "nn" position. The operator may then enter the ID in the "nn" position. (Display stations with one of the PS features always select the base character set for the printer ID; if a symbol set is active when the IDENT key is pressed, it is suppressed and then made active again at the end of the printer ID sequence.)

If the specified printer is not authorized (that is, the matrix does not permit the display to copy to the selected device or class of devices), the keyboard is locked and the Input Inhibited Operator Unauthorized symbol is displayed. If the print ID is not in the matrix, the keyboard is locked and the Input Inhibited What Number symbol is displayed. The contents of the printer status field are displayed for the input-inhibited condition, the cursor appears, and the keyboard is locked. The operator must reset and then retry the print ID sequence.

If the selected print class or printer is valid and authorized for this display, the connection indicator will change to indicate the new connection, and print ID mode is terminated. The cursor reappears, and the keyboard remains unlocked.

When in print ID mode, the following rules apply:

1. Numeric information is displayed at the "nn" position in the indicator row. Each character is then checked for validity.
2. The RESET key and other keys or functions that cause a reset operate normally and cause print ID mode to be terminated. The cursor reappears, and the contents of the printer status field are displayed.
3. The ATTN and DEV CNCL keys, the security key, and unsolicited host read and write operations operate normally in the 3276, except that the 3276 print ID mode is terminated when the Start Print bit in the WCC of the host write command is on. The cursor reappears, and the contents of the printer status field are displayed in the indicator row.

4. Other keys that function during a keyboard inhibit condition also function while in print ID mode without causing termination.
5. All other keys that are not honored during keyboard inhibit conditions cause the Input Inhibit-What symbol to be displayed and terminate print ID mode. In this case, the cursor reappears and the contents of the printer status field are displayed in the indicator row.

Dead Keys, Canadian-French Keyboards

When pressed, the accent keys which show individual accents on the Canadian-French keyboards appear on the display, but the cursor does not move. These accent keys are referred to as dead keys. A subsequent character which receives the accent must be keyed next. If the subsequent character is valid, a unique composite character is formed. Refer to the *3270 Character Set Reference* manual, GA27-2837, for keyboard layouts, I/O codes, and identification of valid accent characters.

Pressing an accent key places the keyboard in dead key mode until a valid second key is pressed. When the second character of a dead key sequence is invalid, only the Shift, DEV CNCL, ALT, Click, ALT CURSR keys, and the Dual Case/Mono Case switch and security key are operational. Use of ATTN in this case causes the Input Inhibited Minus symbol to appear. Use of any other key terminates the operation and causes an Input Inhibited Accent Plus What symbol to appear on the screen.

The selector light pen and the magnetic slot reader (MSR) do not function while in a dead key sequence. If used, they cause the dead key sequence to be aborted, and the keyboard is inhibited, with the What symbol displayed.

All other nonkeyboard-related functions that occur during a dead key sequence are performed normally. If performance of the function causes the dead key sequence to be aborted, the keyboard is inhibited and the What symbol is displayed after the function has been performed.

In all of these conditions, the dead key sequence is aborted, and an accent only is displayed at the cursor position. The operator must reset and rekey both the accent and the valid character.

Numeric Lock Feature Operation

When the Numeric Lock feature is installed, the character (0-9), decimal sign, minus sign (-), and DUP may be entered by the operator in a field identified in the field-attribute byte as numeric and unprotected. MSR input is also accepted. Operating any other key that can enter a displayable character causes an input-inhibited condition. In addition, the NUM symbol lights on the 3178, 3276, 3278, and 3279 displays. Operating the RESET key enables the keyboard (if disabled), and the NUM symbol (3178, 3276, 3278, 3279) goes out. The nondisplay/nonprint attribute bits 4 and 5 and MDT bit 7 operate normally.

| For 3178, Numeric Lock is a basic function.

The Numeric Lock feature can be overridden as follows:

1. On a data-entry keyboard, any character can be entered by pressing (and holding) the Numeric Shift key or the Alpha Key, depending upon the character to be keyed, and then pressing the desired key(s).

2. On a typewriter keyboard, any uppercase character or symbol can be entered by pressing (and holding) the Shift key and then pressing the desired key(s).
3. On an APL or a text keyboard, any non-APL or non-Text uppercase character or symbol can be entered by pressing (and holding) the shift key and then pressing the desired key(s); also, any APL or Text uppercase or ALT-Shift character can be entered by placing the keyboard in APL mode or text mode (pressing APL ON/OFF with ALT or TEST ON/OFF with ALT), pressing (and holding) the Shift key or the ALT key (depending upon the character to be keyed), and then pressing the desired key(s).

Note: *If any devices with attribute-select or overlay keyboards are attached to a control unit, numeric lock for those keyboards is set by an option taken during customizing. The option taken applies to all devices with attribute-select and overlay keyboards; if numeric lock is set off, all these devices have numeric lock off.*

Keyboard Disabled (Do Not Enter Condition)

When the Do Not Enter (X symbol) condition is indicated in the Operator Information Area, the keyboard and other input devices are disabled. In cases caused by operator key action, the input-inhibited condition can be cleared by using the RESET key unless one of the following Do Not Enter indications is present:

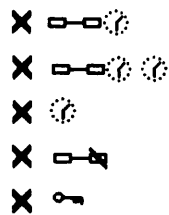

Do Not Enter is turned on by:

1. Operation of a Program Attention key.
2. A selector-light-pen attention that caused an I/O interruption or that resulted in an operator error.
3. A magnetic slot reader (MSR) that caused an I/O interruption.
4. Turning the security key to the off position when the Security Keylock feature is installed, when power is applied initially.
5. A system-initiated I/O operation addressed to that unit.
6. Operation of any alphameric key or of the DUP, FIELD MARK, ERASE EOF, or DEL key, when the cursor is in a protected field.
7. Operation of any alphameric key not included in the numeric key grouping when the cursor is in a numeric field, without simultaneously operating either the Alpha or Numeric shift key on a data entry keyboard or the Shift key on a typewriter keyboard, when the Numeric Lock feature is installed on a keyboard.

8. Copying of data in the refresh buffer to another terminal.
9. The occurrence of a Machine Check, Program Check, or Communications Check.
10. The terminal's being in receive state under SNA protocol.

Do Not Enter is turned off by:

1. On 3178, 3276, 3278, and 3279 displays: Receipt and execution of a WCC with the Keyboard Restore bit on when the System Lock or Time symbol is displayed.
2. On 3178, 3276, 3278, and 3279 displays: Receipt and execution of an Erase All Unprotected command when the System Lock or Time symbol is displayed.
3. Turning of the security key to the on position (if the Do Not Enter indicator was turned on because the security key was in the off position).
4. Operation of the RESET (except as noted under "Reset Key"), TEST, or SYS REQ key in BSC operation.
5. Depression of the DEV CNCL key after receipt of a Printer Not Working symbol.
6. Termination of a Time condition.

An I/O operation that leaves the 3276 in a send state but does not unlock the keyboard can be cleared by using the RESET key on the 3178-, 3276-, 3278-, or 3279- attached keyboards. When the Do Not Enter condition, INPUT INHIBITED, exists on a 3276, 3278, or 3279 display, manual input to the unit from the keyboard or selector light pen is inhibited, except for use of the Shift, ALT CURSR, CURSR BLINK, and Click keys.

Do Not Enter is cleared by a reset action from the control unit or the operator. During a buffer transfer when the 3276 is executing a Copy command in BSC, keystrokes are accepted for processing. The 3276 will queue at least two keystrokes and will process the input, if the queue is not exceeded, after the poll sequence to the keyboard is restored.

If the queue capacity is exceeded, all queued keystrokes are discarded, and the What symbol is displayed. The What symbol is also indicated if input is attempted during Time Symbol conditions or during Print Busy or Printer Not Working input-inhibited conditions.

If the input-inhibited condition is caused by a Machine Check, only an operator reset action can reset the device (if it can be reset). Only an operator reset action will reset a device that shows a Communication or Program Check condition. The Communications Check inhibit symbol does not reappear unless it is reencountered by pressing a host communication key on the display keyboard.

Selector-Light-Pen Operations

The selector light pen, shown in Figure 2-6, is a light-sensitive pen that can detect the light emitted from characters displayed on the 3276, 3278, or 3279 displays. With the selector light pen, the operator can select from a list or table of displayed items and can then cause those selections to be identified to the application program.

The selector light pen is operated by pressing the tip of the pen against the screen on fields programmed for selector-light-pen operations.

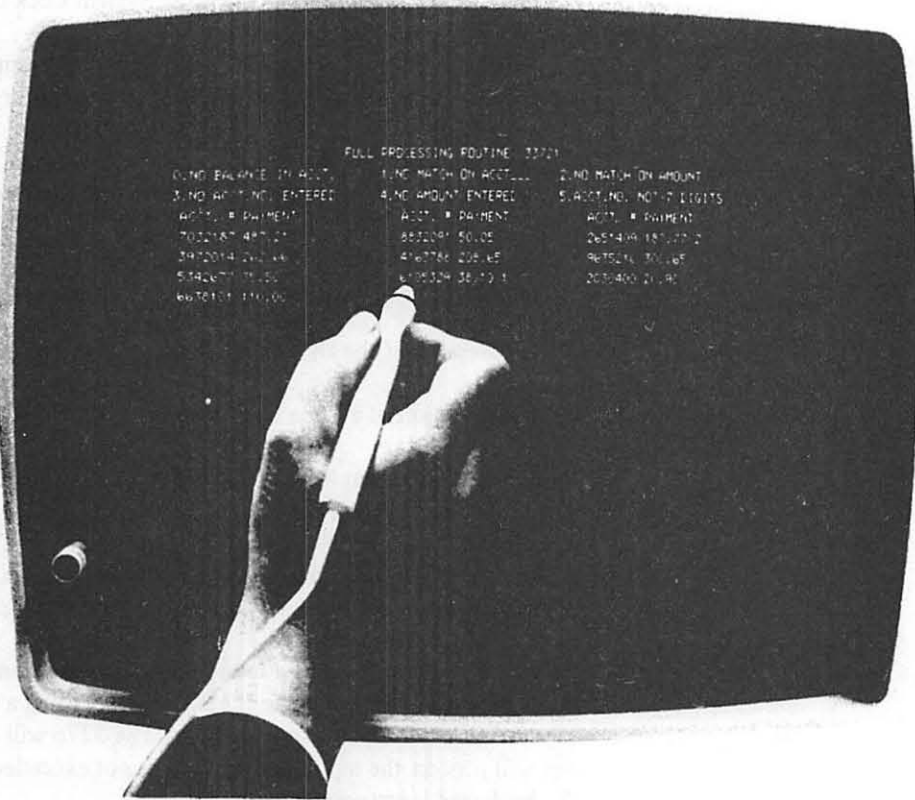
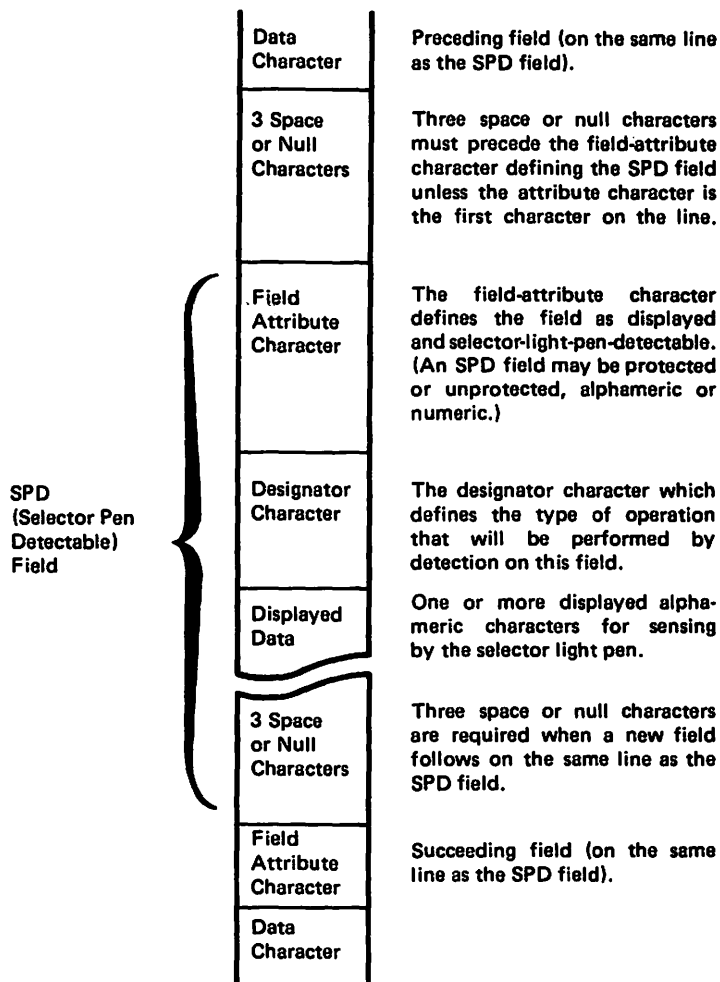

Figure 2-6. Selector Light Pen

Selector-Light-Pen Field Format

A field that is to be used for selector-light-pen operations must be defined in the following format:



The field-attribute character, the designator character, and displayed alphameric characters must be on the same line. If the field extends beyond one line, only those characters on the same line as the attribute character can be detected by the selector-light-pen. A maximum of 12 detectable fields in the 3276 may precede the last detectable field on any given line.

Designator Characters

Designator characters are used to define two types of selector light pen fields: selection fields and attention fields. Each type of field performs a different selector-light-pen operation.

The selection field is defined by a question mark (?) designator character. When the selector light pen detects on a selection field, the MDT bit in the field-attribute character for that field is set (1) in the display buffer. Also, the designator character is automatically changed on the screen to a greater than (>) sign to provide a visible indication to the operator that the detection was successful. If a mistake was made and the operator again detects on that same field, the > changes to a ? and the MDT bit for that field is reset (0).

The attention field is defined by a space or null designator character. A detection on an attention field causes an I/O pending (attention) at the display. This I/O pending indicates to the program that the selector-light-pen operation has been completed. The program may then issue a Read Modified command to obtain the address of each field that was selected or modified by the operator.

A second type of attention field for the 3276 is defined by an ampersand (&) designator character. A selector-light-pen detection on a field containing an ampersand designator sets the MDT bit and causes an ENTER key I/O pending condition at the 3276. The display responds to a poll or Read Modified command, and both the address and the data in each field that was modified by the operator are returned to the application program.

Programming Notes:

1. The application programmer should be aware that both normal intensity and high-intensity unprotected fields can be modified by the display station operator to become selector-light-pen-detectable fields.
2. Use of the Selector Light Pen feature without the ampersand (&) designator character is anticipated to be such that the program will correlate the address of each SPD field with the data associated with it. Therefore, to minimize TP line loading, channel loading, and buffer size requirements, only the addresses of selector-light-pen-detected fields are required to be sent to the application program; the field data is not included.
3. Users who wish to combine selector-light-pen-detect input with keyboard input must use the keyboard or the ampersand designator character to generate the I/O pending. Use of the selector light pen on a space or null designator field or on an attention field to generate the I/O pending will result in transmission of only the addresses of the fields in which the MDT bit was set.

Figure 2-7 shows a sample display with fields defined for selector-light-pen operation. In this sample, "FULL", "50MG", and "4 TIMES" are all preceded by > designator characters to indicate that they were selected by the operator. When the operator detects on the word "EXIT", which has no displayed designator character, an I/O pending occurs and the program obtains the addresses of the three selected fields.

```

R JONES 2-22-71, HOSPITAL VISIT
CARE-NORMAL, FOOD-SAME, --

DRUG-ASP:PIN

STRENGTH      > FULL          ? 1/2          ? BABY
DOSE           ? 20MG         > 50MG         ? 100MG
DAILY SCHEDULE ? 1 TIME       ? 2 TIMES     ? 3 TIMES
               > 4 TIMES     ? 6 TIMES     ? 8 TIMES
               ? 12 TIMES   ? 24 TIMES    ? AS REQUIRED

DRUG A        DRUG B        DRUG C        DRUG D
EXIT          FOOD          HISTORY

```

Figure 2-7. Sample Display Screen for Selector-Light-Pen Operations

Security Keylock

The Security Keylock is a security-enhancement special feature that provides a key-controlled lock for 3276 display. When the key is in the "off" position or is removed from the display station, the message buffer is "locked," which prevents entry, modification, and display of data. The display station is unavailable to programmed read or write operations and to operator inputs such as keyboard entry, card reader entry, and selector-light-pen operations.

Programmed attempts to access display stations that have the key turned off or removed from the lock result in responses being returned to the CPU by the 3276. 3276 responses are device- and operation-dependent. They are summarized in the following table:

| Device Attachment | Operation | Response |
|-----------------------------|-------------------------------|-----------------------------|
| 3276-1, -2, -3, -4 (Note 2) | Specific Poll | IR Status and Sense |
| | General Poll | EOT |
| | Selection Addressing Sequence | RV1 |
| 3276-11, -12, -13, -14 | Normal Flow Requests | IR (Negative Response 0802) |

Notes:

1. Each operation in the Operation column applies to each corresponding unit in the Device Attachment Column.
2. When the SDLC/BSC Switch feature is installed and the switch is in the SDLC position, the response from the terminal with the key off to normal flow requests is IR (neg resp 0802).

Magnetic Slot Reader

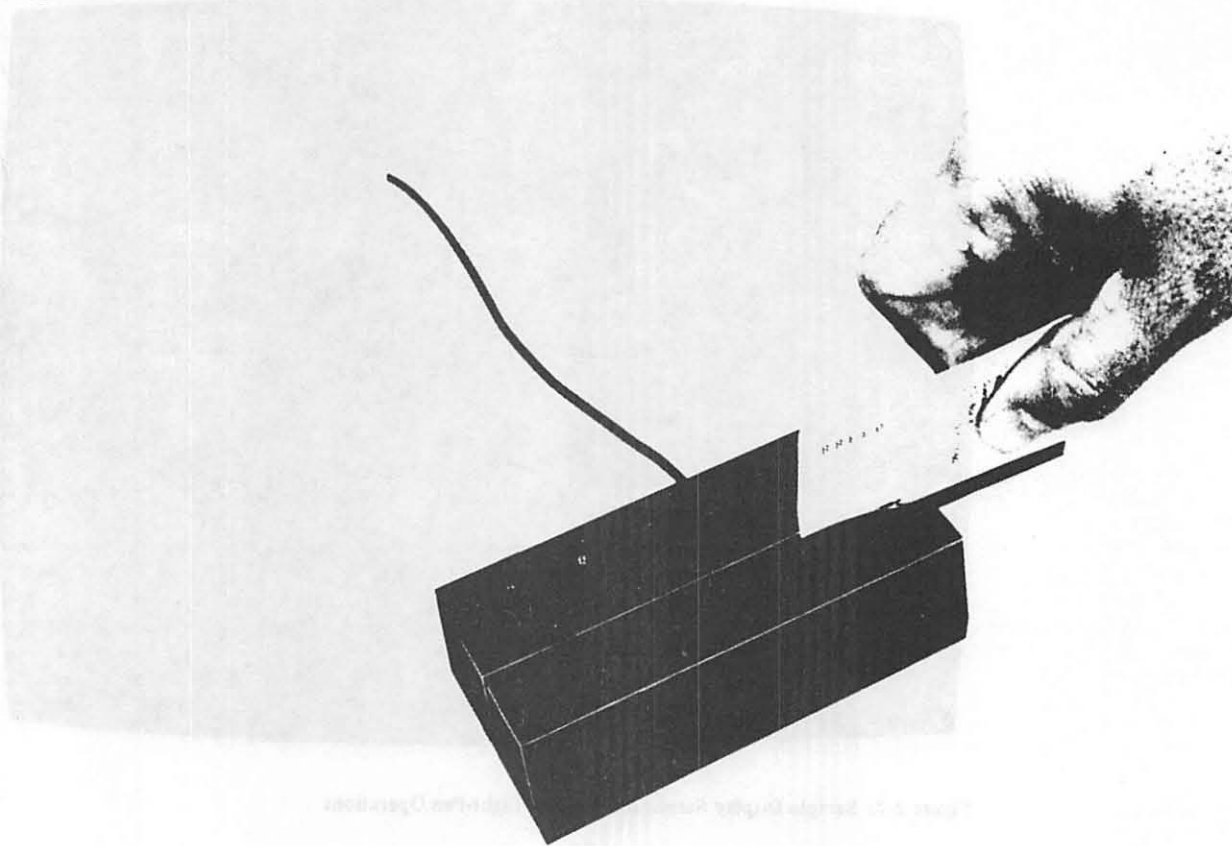

Figure 2-8. Magnetic Slot Reader (3276, 3278, and 3279 Attachments)

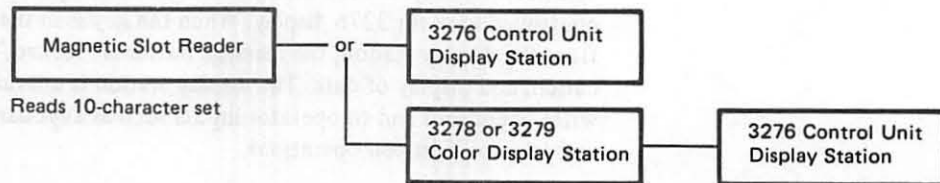

Figure 2-9. Attachment of Magnetic Reading Devices to 3276, 3278, and 3279.

The magnetic slot reader (MSR) (see Figure 2-8), which is attached by cable to a 3276, 3278, or 3279 connected to a 3276 (see Figure 2-9), reads information encoded on magnetic-striped cards such as job tickets, operator ID badges, and both large and small credit cards. The recorded information is read from the stripe as the operator passes the card through the slot of the reader. The data is written into the display buffer at the location specified by the cursor, but is not displayed on the screen. If the device supports the Structured Field and Attribute Processing option, the Extended Attribute Buffer (EAB) is updated. After the information is read, an I/O pending is generated at the display to inform the program that the data can be retrieved and transferred to main storage.

| Character | Bit Pattern | | | | | Hex Code | I/O Interface Code (Note 4) | | |
|-----------|------------------------|----------------|----------------|----------------|---|----------|-----------------------------|-------|----|
| | 2 ⁰ | 2 ¹ | 2 ² | 2 ³ | P | | EBCDIC | ASCII | |
| Data | 0 | 0 | 0 | 0 | 1 | 0 | F0 | 30 | |
| | 1 | 1 | 0 | 0 | 0 | 1 | F1 | 31 | |
| | 2 | 0 | 1 | 0 | 0 | 0 | F2 | 32 | |
| | 3 | 1 | 1 | 0 | 0 | 1 | F3 | 33 | |
| | 4 | 0 | 0 | 1 | 0 | 0 | F4 | 34 | |
| | 5 | 1 | 0 | 1 | 0 | 1 | F5 | 35 | |
| | 6 | 0 | 1 | 1 | 0 | 1 | F6 | 36 | |
| | 7 | 1 | 1 | 1 | 0 | 0 | F7 | 37 | |
| | 8 | 0 | 0 | 0 | 1 | 0 | F8 | 38 | |
| | 9 | 1 | 0 | 0 | 1 | 1 | F9 | 39 | |
| Control | (Special - See Note 1) | 0 | 1 | 0 | 1 | 1 | A | 7A | 3A |
| | SS, or RSS | 1 | 1 | 0 | 1 | 0 | B | 7B | 23 |
| | EOI (Note 2) | 0 | 0 | 1 | 1 | 1 | C | 7C | 40 |
| | Field Separator | 1 | 0 | 1 | 1 | 0 | D | 7D | 27 |
| | (Unassigned) | 0 | 1 | 1 | 1 | 0 | E | 7E | 3D |
| | ES (Note 3) | 1 | 1 | 1 | 1 | 1 | F | 7F | 22 |

Note:

1. This character is reserved for operator identification only and must be located in the first data character position.
2. MSR: SS (Start Sentinel); RSS (Reverse Start Sentinel).
3. EOI (End of Inquiry) is treated as an error by the MSR (3276, 3278, and 3279 displays). The card is rejected, and the MSR red light is turned on.
4. MSR: ES (End Sentinel).
5. Programmers use only the four least-significant bits of the I/O interface code.

Figure 2-10. 10-Character Set Used with Magnetic Slot Reader

With the 10-character set shown in Figure 2-10, the maximum number of characters that can be read is:

- 40 characters at 3 bits per millimeter (75 bits per inch) and at 8.3 bits per millimeter (210 bits per inch)
- 100 characters at 5 bits per millimeter (128 bits per inch)

Note: A minimum of seven characters must be encoded between the Start Sentinel and End Sentinel Characters.

The 10-character set may be used to log on and log off in SNA mode (LU-LU session only; not SSCP-LU session) or in a non-SNA mode.

10-Character Set

The 10-character set shown in Figure 2-10 comprises 10 numeric characters plus a Field Separator and control characters. Each character is composed of a 4-bit pattern plus an odd-parity bit. This bit pattern is recorded with the low-order bit recorded first. A longitudinal redundancy check (LRC) character is placed at the end and is protected by an odd-parity bit of its own.

Characters are recorded, low-order bit first, beginning at the left-hand side of the magnetic stripe when the stripe is at the bottom of the card or badge as you face the magnetic material. The characters are read in one direction only.

Magnetic-Stripe Format

The format used on the magnetic stripe is in the sequence shown in Figure 2-11.

When the SS character is read from the magnetic stripe, a field-attribute character is entered automatically into the cursor-identified location of the buffer (provided the cursor is at an unprotected character location). This attribute character defines the following data field as protected, alphameric, and nondisplay or nonprint. As the data characters are read into the buffer, they are stored starting at the first character location after the field-attribute character. As each data character is stored in the buffer, the cursor advances one buffer location. The cursor advancement is all the operator sees on the display screen when using the operator identification card reader. When the operator uses the magnetic slot reader, the cursor does not move as the card is passed through the slot, but is repositioned after the card has been read.

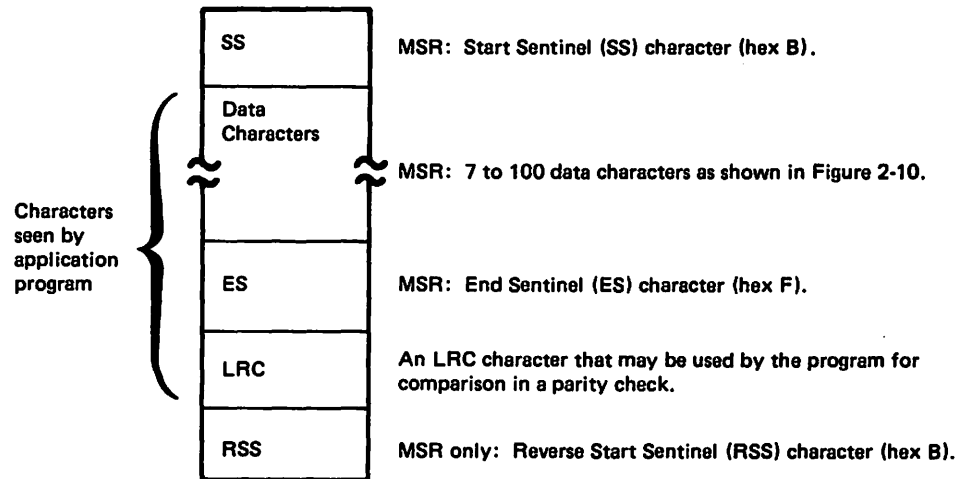

Figure 2-11. Magnetic-Stripe Format (MSR Using 10-Character Set)

Operational Differences because of Screen Format

When the 10-character set of Figure 2-10 is being used with the magnetic slot reader (MSR), differences exist in the content of the data stream sent to the application program, depending upon whether the display screen is unformatted or formatted.

When an unformatted screen (that is, a screen without attribute characters of fields) is being used, the operation of the display results in an inbound data stream as shown in Figure 2-12.

The reader operation formats the screen by the automatic generation of the field-attribute character at the cursor position by the reader.

A formatted screen has at least one field-attribute character defined at initial presentation. This may be the only field-attribute character, as in the instruction sequence ENTER ID; or one or more attributes may be required, as, for example, in the instruction sequence NAME, TITLE, ID CARD READER.

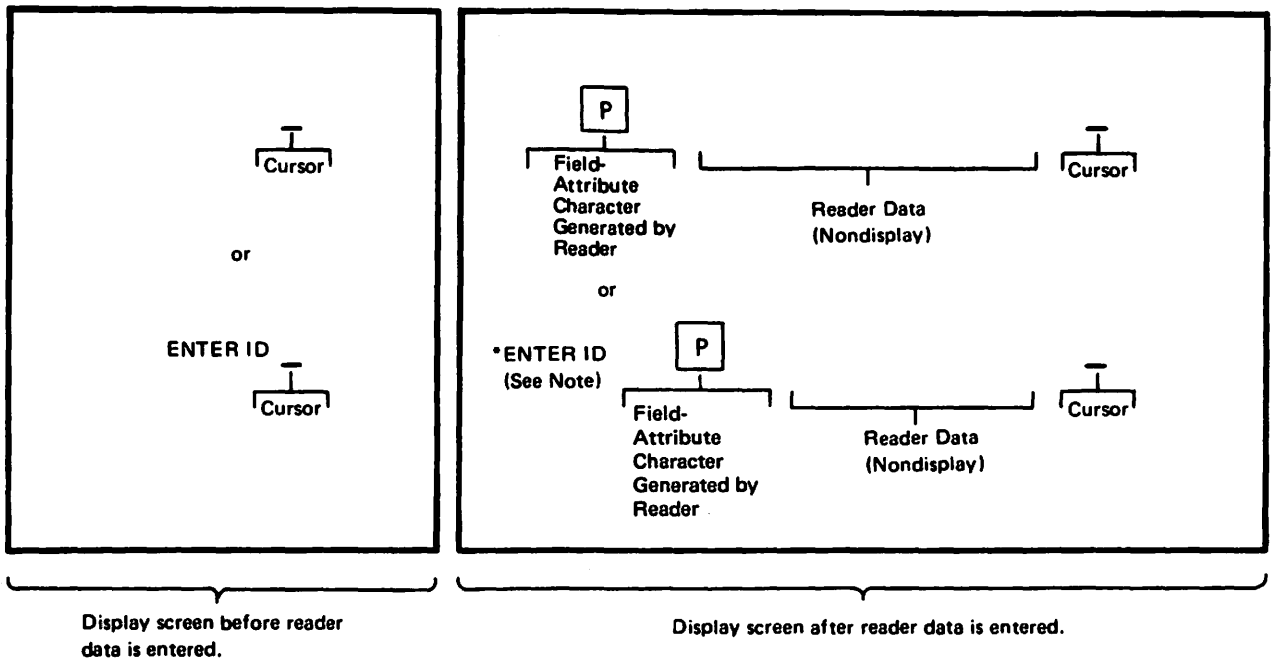

P = Protected field-attribute character

Inbound Data Stream

| |
|-----------------------|
| AID |
| Cursor Address |
| SBA |
| Start of Data Address |
| Data |

Set to indicate input from a magnetic-stripe reading device.

Address of the cursor upon completion of the reader operation.

Set Buffer Address.

Address of the first data character following the field-attribute character.

The reader data followed by any additional information present in the display buffer. The additional information can be initiated by the application program as ENTER ID (as shown in the example) or entered by the operator before the reader operation is started.

Note that with an unformatted screen the reader data is the first text in the data stream sent to the application program.

Figure 2-12. Operation of the Display with an Unformatted Screen (MSR Using 10-Character Set)

The operations of the 3276, 3278, and 3279 with the MSR are identical when formatted screens are used.

Two fields (new data field and previous data field), with the MDT bits set, are sent to the application program, because the displays treat all information from the reader as data until after the information is written into the display buffer. Also, the MDT bit is set in the reader-generated field-attribute character that was initiated when the data was entered.

The following examples are included to help clarify operation of the reader with a formatted screen.

Example 1:

If the MSR field is set up by the application program as an unprotected field and contains instruction information, the inbound data stream is as shown in Figure 2-13.

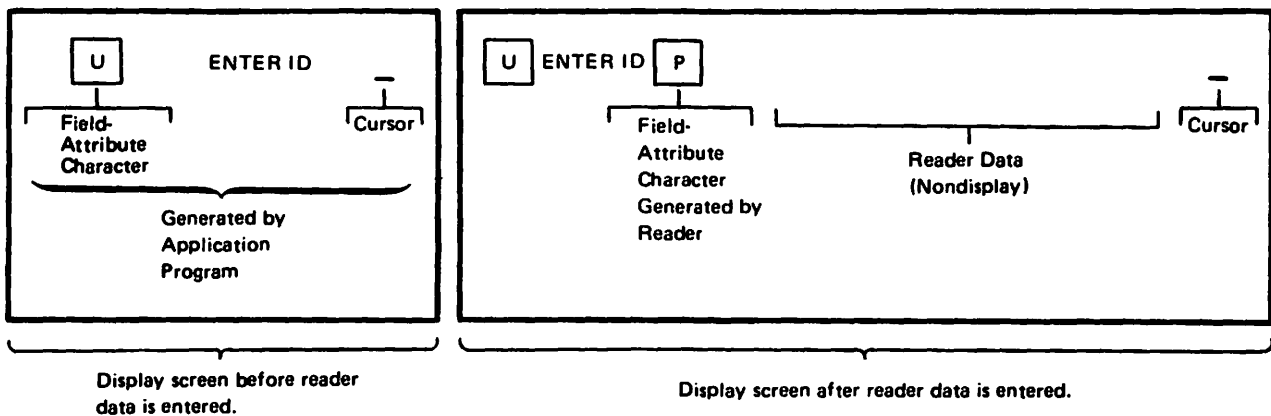

Inbound Data Stream

| |
|-----------------------|
| AID |
| Cursor Address |
| SBA |
| Start of Data Address |
| Data |
| SBA |
| Start of Data Address |
| Data |

Set to indicate input from a magnetic-stripe reading device.

Address of the cursor upon completion of the reader operation.

Set Buffer Address.

Address of the unprotected (U) field-attribute character + 1.

ENTER ID, in the example above.

Set Buffer Address.

Address of the protected field-attribute character + 1. In this case, the address of the first data character from the reader following the protected field-attribute character.

The reader data (and any data between the cursor and the next field-attribute character).

U = Unprotected field-attribute character

P = Protected field-attribute character

Figure 2-13. Operation of the Display with a Formatted Screen (Using 10-Character Set), Example 1

Example 2:

When the MSR field is set up by the application program as an unprotected field, with the cursor directly following an unprotected field-attribute character, the inbound data stream is as shown in Figure 2-14.

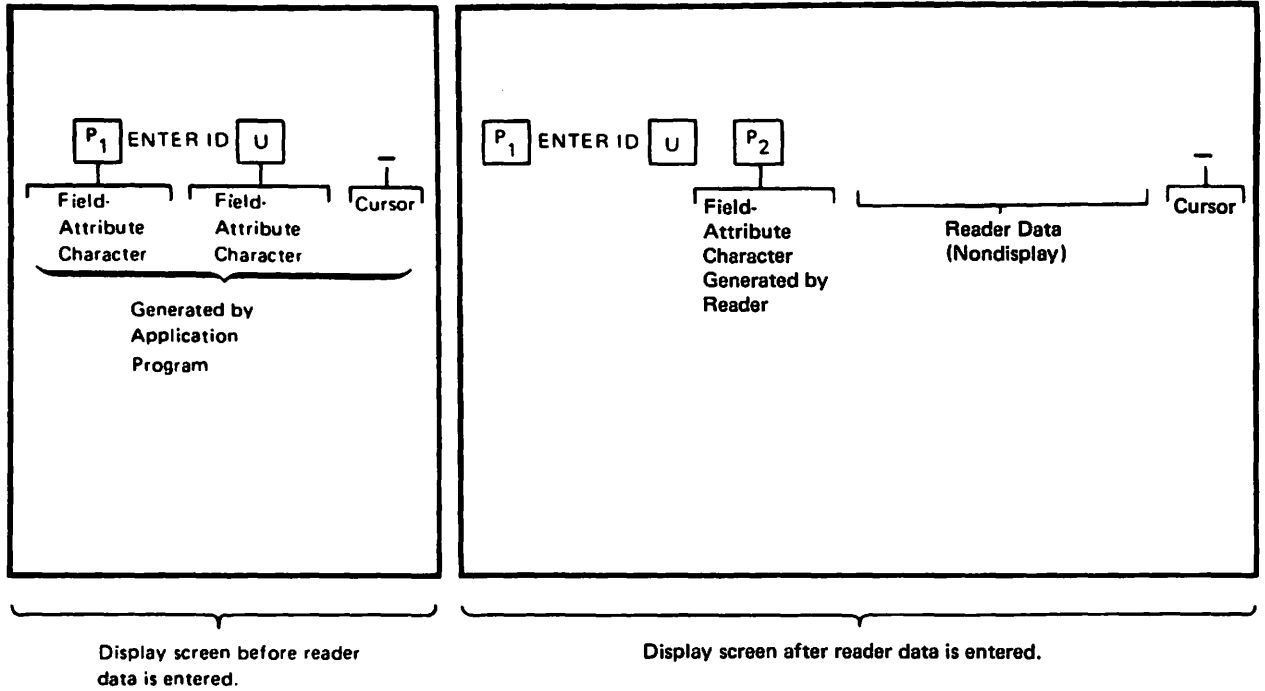

U = Unprotected field-attribute character
P = Protected field-attribute character

Note: Rules for positioning modified data on formatted screens apply. The position of reader data in the inbound data stream depends on the field position in the format.

Inbound Data Stream

| |
|-----------------------|
| AID |
| Cursor Address |
| SBA |
| Start of Data Address |
| SBA |
| Start of Data Address |
| Data |

Set to indicate input from magnetic-stripe reading device.

Address of cursor upon completion of reader operation.

Set Buffer Address.

Address of the unprotected (U) field-attribute character +1. In the example above, it will be the address of the P₂ field-attribute character.

Set Buffer Address.

Address of the P₂ field-attribute character +1. In this case, the address of the first data character from the reader following the P₂ field-attribute character.

The reader data (and any data between the cursor and the next field-attribute character).

Figure 2-14. Operation of the Display with a Formatted Screen (Using 10-Character Set), Example 2

Error Conditions

MSR data will not be written into the display buffer if any of the following error conditions exist when the magnetic stripe is read:

- The SS (MSR) character is not successfully connected to a field-attribute in the display buffer.
- The cursor is located in a protected field.
- The cursor is located in a field-attribute character location.
- The display is busy performing another operation.

MSR Validity Test

The proper use of the MSR as an identification and data-entry device requires that the application program perform certain validity tests. The following guidelines are recommended for proper operation:

1. No field should be accepted as reader input unless the reader AID code is set.
2. For preformatted displays, the application program must know the location of the field defined to receive the reader data and the exact location of the entered data, based upon the hardware operation that was previously defined. The use of the cursor address present in the inbound data stream, in combination with the AID byte to ensure reader input, is an additional technique that can be used to ensure the integrity of the data. For unformatted displays, the reader data is always presented as the first data entry in the input record to the application program.
3. For preformatted displays, it is advisable to terminate the reader data field with another attribute byte.
4. Upon completion of the reader operation, the application program should check for the presence of the ES character. Absence of this character means the reader data has not been transferred successfully. This condition can occur under the following error conditions:
 - a. The detection of a parity error in any data character in the ES character.
 - b. An interruption of normal data flow from the reader.
 - c. The cursor has been moved to a field-attribute character location. This means the field defined for reader input is too small or the cursor was not initially positioned at the beginning of a correct-length field.
5. Upon completion of the reader operation and a successful check for the ES character, the LRC character may be used for a parity check to ensure integrity of the data.

Because of the makeup of the 10-character set codes (4 bits plus parity bit), only the right-hand 4 bits are of concern. The application program should set up a 1-byte field initialized to X'0B'. This is the SS character, which is not included in the inbound data stream but which is used to compute the LRC. As each character is checked for validity, it is exclusively ORed into this field. This

operation should include the ES character and the LRC, resulting in the byte containing zero. If the byte is nonzero, it means the result of the check on the data characters, including ES, does not equal the LRC, and a parity error has occurred.

6. If the reader input field is to be reused, the application program must remove the hardware-generated field-attribute character and reader input data. The location of this character can be derived from the inbound data stream by using one less than the start of the data address preceding the input data. Additionally, the cursor is located one position beyond the end of the reader data field.

The card field may be reused if more than one card input is required or if the original attempt was unsuccessful and the application program desires to retry the operation.

7. Text for all fields having the MDT bit set is transferred to main storage when the reader data is retrieved in response to the reader-generated I/O pending.
8. The cursor must be moved out of the reader-generated field before further keyboard activity is allowed.
9. A test card, PN1742659, is delivered with each 3276/3278/3279 Magnetic Reader Control feature. The test card data placed in the display buffer is as follows:

0123456789987654321001234567F4

Care should be taken that the card is not accidentally auto-entered. The display should be placed in test mode to avoid auto-entering magnetic-stripe information to the host.

MSR Operator Indicators and Alarm

The magnetic MSR contains three operator indicators and a buzzer. The indicators are color-coded green, yellow, and red. When all indicators are off, power has not been applied to the MSR.

Green Indicator On: Indicates that the MSR is ready to read a magnetic stripe. This indicator is turned on when:

1. The 3276, 3278, or 3279 is turned on.
2. The 3276, 3278, or 3279 Test/Normal switch is operated.
3. The MSR data is placed in the 3276, 3278, or 3279 display buffer.

The green indicator is turned off when the yellow or the red indicator is turned on. At this time, the Time symbol is displayed in the Operator Information Area of the screen until turned off by the host.

Yellow Indicator On: Indicates that MSR data is being processed. This indicator is turned on when the magnetic stripe has been read successfully by the MSR hardware. Subsequent read operations are ignored while the yellow indicator is on.

The yellow indicator is turned off when either the red or the green indicator is turned on.

Red Indicator On: Indicates that the MSR data is rejected. The red indicator is turned on during an MSR red operation when:

1. Invalid magnetic-stripe information (for example, invalid character, LRC error, parity error) is detected by the MSR hardware.
2. The keyboard is already locked. The operator should check the symbols in the display's Operator Information Area and take the appropriate action. (See Appendix A.)
3. An unsuccessful read operation is detected. The keyboard is locked.

The red indicator is turned off when the yellow indicator is turned on.

The buzzer on the MSR gives a short tone (one quarter second) when the green indicator turns on and a longer tone (one second) when the red indicator turns on.

Printers

Printers for the 3276 Control Unit Display Station provide a printed copy of information that is displayed at a display station or of information written from the program. Printed data appears in the same alphameric characters and symbols that appear on a display, and printouts can be formatted. Cursor information is ignored by the printer.

The 3230 Model 2, 3262 Model 13, 3268 Models 2 and 2C, 3287 Models 1, 2, 1C, and 2C, the 3289 Models 1 and 2, and 5210 Models G01 and G02 can be attached to the 3276.

Print Line Formatting

Printout operations are specified by a Write command or a Copy command (the 3276 Models 1, 2, 3, and 4, using BSC only), addressed to the printer. The print line format in which the data is to be printed from the buffer can be specified as part of the command in one of three printer formats. These formats define the print line length: 40, 64, or 80 character positions per line. If a format is not specified, the print line length is 132 character positions on all terminal printers. Print line length can be set to values less than 132 character positions by the operator on all terminal printers.

When the 3178, 3276, 3278, or 3279 Print key is used to initiate a printout, or when the 3276 SNA host copy operation described under "Local Copy Functions" is executed, the print line length will be the same as that of the source display. Print line length formats are specified below.

| Operation | Command | Addressed Terminal | Format Specification |
|-------------------------|---------|--------------------|----------------------|
| Host Write (except SCS) | Write | Printer | WCC bits 2 and 3 |
| BSC Host Copy | Copy | Printer | CCC bits 2 and 3 |
| SNA Host Copy | Write | Display | Same as display |
| Print Key | NA | NA | Same as display |

The relationship between the printer buffer and a printout is shown in Figure 2-15.

Figure 2-15. Relationship between Buffer Data and Printed Data

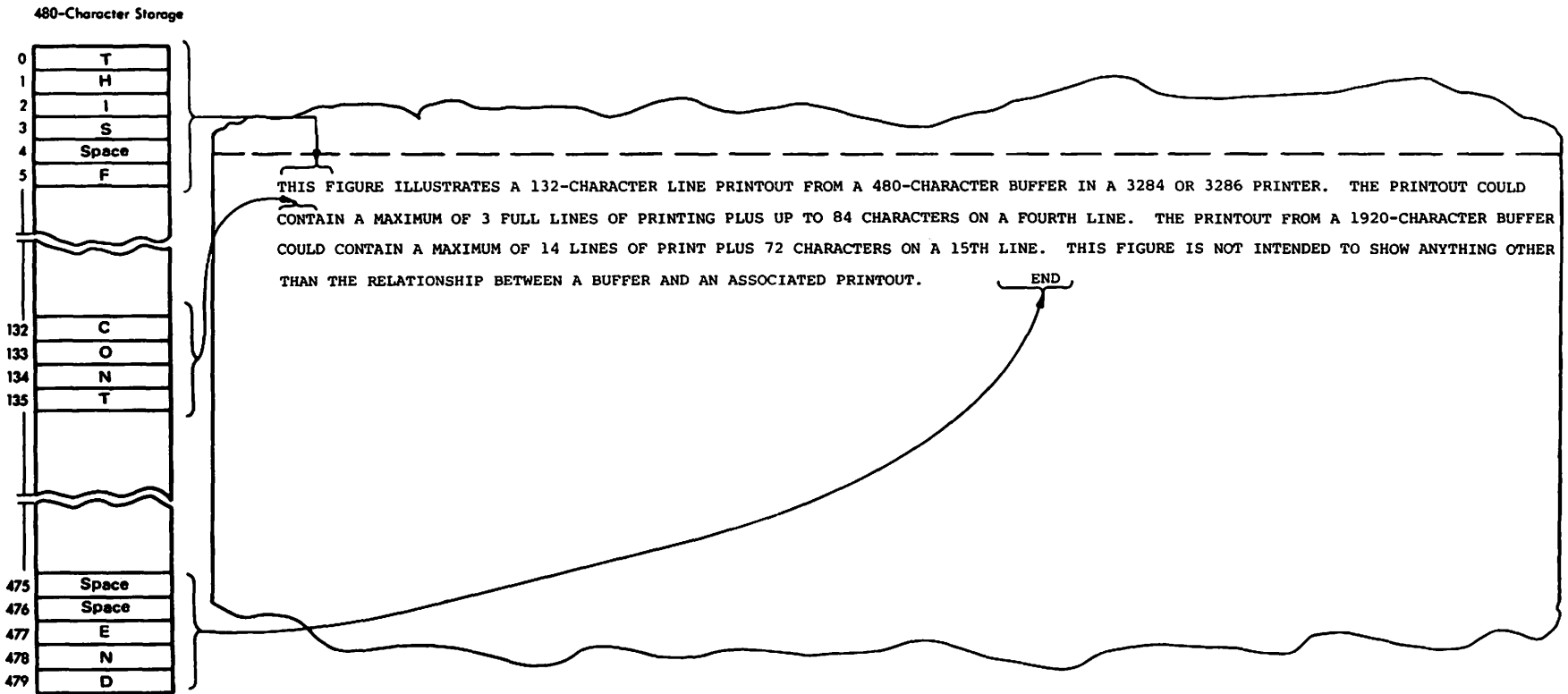

Printer Orders

Printer orders are transferred as part of the data stream from the application program. They are stored in the buffer as data.

Programming Note: Devices without the Extended Character Set Adapter (ECSA) feature support 182 characters in the base character set, while devices with the ECSA feature support 191 characters in the base character set. If characters from the 191-character set that are not supported by the 182-character set are directed to a device without the ECSA feature, then that device may interpret certain of these unsupported characters as control codes.

New Line (NL) and End of Message (EM) (All Printers)

The NL order is executed only when encountered during an unformatted printout, that is, a printout that does not have a line-length format specified. When an NL order is encountered in the buffer, the printer performs a new line function. If no NL order is encountered before the printer reaches the end of a line (as determined by the maximum print position), the printer automatically performs a new line function and continues printing. If an NL order is encountered at one character position past the maximum print position, 3230 and 3287 printers will perform two new line functions; the 3262, 3268, 3289, and 5210 printers will perform one new line function.

The NL order is not executed when located in a nondisplay/nonprint field; it is treated as an alphameric character and printed as a space. In addition, the NL order is not executed when encountered during formatted printout. Instead, it is printed by the terminal printers attached to 3276s as a space character.

For buffered printer operation (described under "Buffer Printer Operation") the EM order is executed only when encountered during an unformatted printout. The EM order is not executed when located in a nondisplay/nonprint field; it is treated as an alphameric character and printed as a space. In addition, the EM order is not executed when encountered during a formatted printout. Instead, it is printed by the terminal printers attached to 3276s as a space character.

Forms Feed (FF) (All Printers)

Valid Forms Feed (FF) orders are executed by the terminal printers during either formatted or unformatted printouts. (The FF order is described under "Page Length Control.") When a valid FF order is encountered in the first print position of a line, the print form indexes to a predetermined print line on the next form.

Carriage Return (CR) (All Printers)

When the Carriage Return (CR) order code is found in the data stream, the next print position will be the leftmost character position on the current print line. CR orders are not executed when they occur in nonprint fields and when the printout is formatted (printer format bits in the WCC indicate a line length). In both cases, the CR order is printed as a space character.

Buffered Printer Operations

When a command specifying a printout is received from the system, the contents of the addressed printer are transferred to the 3276 control unit buffer. If the WCC Start Print bit is set to 1, the printout starts after the control-unit-to-printer-buffer transfer is completed.

During a formatted print operation, data characters in the printer buffer are scanned one line at a time before they are printed. A line feed is executed after each line is printed. If a line contains one or more space characters only, a line feed is performed to cause a blank line in the printout. When null characters, attribute characters, or alphameric characters in nonprint field are encountered, they are treated as follows:

- If embedded in a print line, they are printed as spaces.
- If they constitute an entire line, they are ignored and the line feed is not performed; as a result, a blank line does not appear in the printout, and the data is compressed vertically one line.

During an unformatted operation, printout of the buffer data begins at buffer location 0 and continues until the last position of the buffer is printed or until a valid EM character is encountered. Each print line is left-justified. At the end of each printout, a final line feed is executed so that the printer is ready to start the next printout. When the print-terminating EM order appears in the first print position of the print line, a final line feed is not executed because the printer is already positioned at the left margin for the next printout.

Page Length Control Operations

The ability to index forms vertically under program control to a predetermined print line is provided by the Page Length Control function for the terminal printers, except the 3289 printer.

When a valid Forms Feed (FF) order is encountered in the buffer during a printout, the form skips to a predetermined line. Printing begins on the predetermined line; the first print position, the buffer location containing the FF character, is printed as a space character. Printing and skipping continue until the printout is terminated. The printer is "busy" while printing and skipping.

There is no limit on the number of FF orders that can be included in the printer buffer or on the frequency of their occurrence. However, for an FF order to be considered valid and thus initiate skipping, FF characters must be placed in buffer locations corresponding to the first position of a print line in a field designated either print or nonprint. This can be accomplished by placing the FF character (1) in the first character after the WCC in a write, erase/write, or erase/write alternate data stream to the printer (2) after a valid NL or CR order.

When an FF character is placed in the first character position of any print line (for example, in character position 41 in a buffer with a printout format of 40 characters per line specified, or in character position 133 in a buffer for an unformatted printout), the form skips to line 1, position 2.

An FF order in any other position (than the above) in the printer buffer is considered invalid; the skip operation is not executed, and the FF character prints as a space character on all terminal printers, except when the FF order is located in a nonprint field.

During a print operation, if a valid FF order is encountered when the form is located at the predetermined skip stop line (the first print line of each form) of a terminal printer, the terminal printer will not skip a blank form.

Programming Note: Placing the FF order at the end of a print buffer is not recommended. When a valid FF order is placed at the end of a print buffer and is followed by an EM order, the terminal printers will stop printing and skip to line 2 of the next form.

Before beginning Page Length Control operations, forms must be loaded in the printer and aligned to the print line where skipping should stop and printing begin. If the forms are not aligned properly while initially being loaded, all forms will be misaligned.

The two Selector switches must be set to the number corresponding to the total number of print lines from one skip stop line to the next for each Page Length Control application. There can be up to 99 lines between successive skip stop lines. When uniform length forms are used, the setting for the switches is computed by multiplying the forms length in inches by the lines-per-inch setting, 6 or 8 lines per inch for all terminal printers.

Programming Notes:

1. If an NL order and an FF order appear on the last line of a terminal printer's printout, subsequent printing will begin on a new form.
2. The value of the Page Length switch (Selector switch on 3287) when power is turned on or when the Form Feed switch is pressed, is interpreted as the operator-selected MPL value. (For 3289, pressing the Form Feed switch does not initialize the MPL value to the Selector switch value.)

SNA Character String (All Printers)

The SNA Character String (SCS) control codes provide printed page format control. They also can set modes of operation, define data to be used in a unique way, and allow communication between a terminal operator and an application program.

The SCS data stream consists of a sequential string of control and data characters.

Note: *To ensure format integrity, any change in print format control must be followed by the appropriate synchronizing event (CR, NL, FF, etc.).*

SCS Control Codes

SCS control codes are honored by the terminal printers when operating as LU type 1 attached to the 3276. The terminal printers using SCS support can perform a variety of page-editing functions. These are the SCS control codes and their definitions:

| Code | EBCDIC (hex) | Name |
|------|--------------|------------------------------|
| BS | 16 | Back Space |
| BEL | 2F | Bell Function |
| CR | 0D | Carriage Return |
| ENP | 14 | Enable Presentation |
| FF | 0C | Forms Feed |
| HT | 05 | Horizontal Tab |
| INP | 24 | Inhibit Presentation |
| IRS | 1E | Interchange-Record Separator |
| LF | 25 | Line Feed |
| NL | 15 | New Line |
| SHF | 2BC1 | Set Horizontal Format |
| SLD | 2BC6 | Set Line Density |
| SVF | 2BC2 | Set Vertical Format |
| TRN | 35 | Transparent |
| VCS | 04XX | Vertical Channel Select |
| VT | 0B | Vertical Tab |

Back Space (BS) – a format control that moves the print position horizontally one position to the left. If the print position is at column 1, the function is inoperative. Left margin settings are ignored.

Carriage Return (CR) – a format control that moves the print position horizontally to the left margin on the same line. If the print position is already at the left margin, the function is inoperative.

Enable Presentation (ENP) – a formatting control character used to enable the printing of keyboard input data on the presentation space. This code performs no function on the LU type 1 device, but it is accepted without error response and without affecting format.

Form Feed (FF) – a format control that moves the print position to the top and left margin of the next form. If the maximum presentation line (MPL) value has not been set and there is no default value, the MPL defaults to 1, and the print position moves to the left margin of the next line.

Horizontal Tab (HT) – a format control that moves the print position horizontally to the next tab stop setting. Horizontal tab stop values are set by using the Set Horizontal Format (SHF) function. If there are no horizontal tab stops set to the right of the current print position, the horizontal tab function results in a space.

Programming Note: Horizontal tab placed after the MPP will cause a space in the first print position on the next line.

Inhibit Presentation (INP) – a format control character used to inhibit the printing of keyboard input data. This code performs no function on the LU type 1 device, but it is accepted without error response and without affecting format.

Inter-Record Separator (IRS) – a separator character, normally used on the LU-SSCP session. If received on an LU-LU session, the IRS defaults to a New Line (NL) function.

Line Feed (LF) – a format control that moves the print position vertically down to the next line.

New Line (New Line) – a format control that moves the print position to the left margin and vertically down to the next line. NL is functionally equivalent to CR followed by LF.

Set Horizontal Format (SHF) – a data-defining control used to set the horizontal format controls. These include left and right margins and horizontal tab stops. A 1-byte binary count follows the SHF code that indicates the number of bytes to the end of the SHF string, including the count byte. The first 3 bytes following the count byte define the maximum presentation position (MPP), the left margin (LM), and the right margin (RM), respectively. Tab stop settings follow the right margin position. All values are expressed as 1-byte binary numbers.

The minimum SHF sequence is 1-byte length, which sets the horizontal format controls to their default conditions. The SHF sequence is:

(SHF)(cnt)(MPP)(LM)(RM)(T1)(T2) . . . (Tn)

This value is used to define a line length less than, or equal to, the maximum print position. The MPP default value is the maximum print position (132) or the value set up by the printer operator.

Programming Note: If the MPP is set to a value greater than the physical page width, data may be lost (for example, printing on the platen or print head jams at the right margin).

LM specifies the column value of the leftmost print position. The LM also serves as the first horizontal tab stop. Valid LM values are less than, or equal to, the MPP. The LM default value is 1.

RM is not used in printing operations.

T1 . . . (Tn) are horizontal tab stop settings. The tab stops do not have to be in order. Valid tab stop values are equal to or less than MPP.

Set Line Density (SLD) – specifies the distance to be moved for single-line vertical spacing, as in LF or NL. This function changes values that were previously set during printer initialization or by pressing the Change LPI switch (6LPI/8LPI switch for 3289) on the operator panel. The SLD code (X'2BC6') is followed by a one-byte count (CNT) and a one-byte line density parameter (LPI) as follows:

2BC6 CNT LPI

CNT = the number of bytes following the SLD code (01 or 02), including the count itself. If the value is not 01 or 02, an "invalid parameter" response is generated. Printing terminates immediately.

LPI = the line density parameter that specifies the distance (measured in lines per inch) to be moved for single-line vertical spacing (one inch equals 25.4 mm).

Acceptable values are:

2BC60218 = 3 lpi
2BC60212 = 4 lpi
2BC6020C = 6 lpi
2BC60209 = 8 lpi
2BC60200 = default to 6 lpi
2BC601 = default to 6 lpi (3287, 3289), or to operator panel setting
of 6 or 8 lpi (3230, 3262, 3268, 5210)

Programming Note: If the SLD is changed without a corresponding change in the MPL (and vice versa), printing may occur on the form fold, or the MPL may be defaulted.

Density values not implemented are rejected with a negative response of X'1005' parameter error.

Set Vertical Format (SVF) – sets vertical format controls, including the maximum presentation line (MPL), top margin (TM), bottom margin (BM), and vertical tab stops. A 1-byte count field follows the SVF character to indicate the number of bytes, including the count byte, in the SVF string.

The first three values following the count in an SVF string are the maximum presentation line, the top margin, and the bottom margin, in that order. A zero for any of these values results in the function assuming the default value. Vertical tab stop values follow the bottom margin. All values are expressed as 1-byte binary numbers.

The SVF sequence is:

(SVF)(cnt)(MPL)(TM)(RM)(T1)(T2)... (Tn)

MPL defines the page depth. All values between 0 and 102 (3287), 0 and 127 (3230/3262/3268/3289), and 0 and 255 (5210) are valid. A page depth defined by the SVF takes precedence over the device default value. The MPL default value for the 3287 is 1; the MPL default value for the 3230, 3262, 3268, and 3289 is 1 or the contents of the Selector switch. If the Selector switch is set to 00 and power is turned on, the MPL defaults to 1; if the Selector switch is set to 00 and the Reset switch is pressed, the MPL remains unchanged. For the 5210, the MPL defaults to 66.

Programming Note: If the MPL is set to a value greater than the physical page length, printing may occur on the form fold.

TM specifies the line value used as the top representation line on the page. The top margin is also the first vertical tab stop. Valid TMs are equal to, or less than, MPL.

The default TM value is 1.

Programming Note: After the TM is initialized, the TM should not be changed, because a TM change requires operator intervention to align the physical page. The printer cannot detect physical line 1; therefore, it is assumed the operator has aligned physical line 1 to the printer's logical line 1. If a printer must be used in an intermixed SCS/non-SCS environment, the operator should always set the physical page line 1 at the first line to be printed and should always set the TM to a value of 1.

TM may be changed on the 5210. When forms are initially loaded, they are aligned to the form fold. The 5210 automatically indexes to the TM upon receipt of the first non-25 control after having executed a form feed.

BM specifies the line value that, if exceeded, causes an automatic skip to a new page. BM must be greater than, or equal to, TM, and less than, or equal to, the MPL. The default BM value is the MPL value.

Transparent (TRN) – a data-definition character, which provides for the transmission of data in transparent mode. A 1-byte binary value follows the TRN code which specifies the number of bytes of transparent data to follow. The length does not include the length byte. Transparent data is user-defined and is not scanned for SCS control codes. As each data byte is interpreted, the print mechanism moves one character position. Valid graphics are printed. Invalid graphics are printed as hyphens (-).

Vertical Channel Select (VCS) – a device control code that allows selection of one of 12 vertical channels to control vertical format. The first character of the code is the select code, followed by a function value which selects the appropriate channel.

Vertical Tab (VT) – a format control that moves the print position vertically down to the next vertical tab stop setting. Vertical tab stops are set by using the Set Vertical Format (SVF) function. If there are no vertical tab stops below the current print position, the vertical tab function results in an LF function.

Graphic Escape (GE) – a character selection code that immediately precedes a codepoint. It is used to indicate that the character to be displayed or printed is to be selected from the character set stored in ROS 1. (The base character set for the machine is stored in ROS 0.)

Note: The 5210 does not support GE and prints a hyphen in its place. The codepoint interpreted as an SCS control or graphic.

Program Attention (PA) and Cancel Print Switches

The PA1/PA2 and Cancel Print switches are provided when SCS is installed on terminal printers attached to the 3276. (SCS is a specify feature for the 3287, and a standard feature for other terminal printers.) These switches allow the operator to communicate with the host system in SCS mode, and are used with the Hold Print/Enable Print switch. Operator- or host-initiated operations can be performed.

CANCEL PRINT. The Cancel Print switch causes the printer to terminate the current print operation. Portions of a chain which have not been passed to the printer are purged by the control unit.

Cancel print is meaningful when the printer is printing SCS data or waiting for the next data in a chaining operation. If the Cancel Print switch is pressed and the printer is not processing SCS print data, an invalid switch operation is indicated at the printer. The control unit is not made aware of this condition.

PA1/PA2. The PA1/PA2 switch causes an attention to be sent to the control unit. The status indicator on the printer will indicate acceptance of the code, and printing is resumed if it was in progress prior to the PA switch sequence. The two-digit code is then cleared from the status indicator.

The operator may then initiate another PA switch selection if the previous selection is overwritten. PA switch information is not stacked within the subsystem.

The control unit of an SCS printer transmits the PA switch codes to the PLU as FM data, as follows (note that there is a blank between APAK and the PA switch code digits):

| PA Switch | Text String Transmitted |
|-----------|-------------------------|
| 1 | APAK01 |
| 2 | APAK02 |

If the printer is not in SCS mode (for example, performing a local copy operation), an invalid switch operation is indicated, and no PA switch sequence can be initiated.

Print Format Control

The format of the printed data is determined by the following parameters:

Maximum Print Position-MPP
Maximum Page Length-MPL
Lines per Inch-LPI
Single/Double-space
Mono/Dual Case

The terminal printers, except 3287, allow the operator to change the machine default values of these parameters. They can be set by the host or controller in SCS and non-SCS print modes. See the terminal printer's Component Description for details.

When the 3287 is operating in SCS mode, the operator can change the machine default of only Single/Double-space. The default values are MPP = 132, MPL = 1, LPI = 6, and Mono/Dual Case = Dual.

Local Copy Function

In addition to processing the BSC Copy command in remote configurations, the 3276 Models 1, 2, 3, and 4 provide a local copy function which allows direct data transfer from a display station to a printer(s) attached to the same 3276. The local copy function is directed by a print-control matrix. The print-control matrix for the 3276 is called the *default matrix*.

The local copy function can be operator- or host-initiated. For operator-initiated copy, the Print key on a keyboard attached to a 3178, 3276, 3278, or 3279 may be used by the operator to initiate a local copy request. The local copy request is serviced by a printer selected under control of the print control matrix.

In SNA models, host-initiated local copy requests are initiated by issuing a write-type command with the WCC Print Bit set to 1; that is, systems using 3276 Models 11, 12, 13, and 14. Printer selection and servicing of the local copy request proceed in much the same way as for operator-initiated local copy requests.

Do not attempt to copy graphics dependent on more than one character position for their presentation. If the graphic data is not completely contained within one character position, the printout will be inaccurate because of the differing block matrix sizes and dot densities between display and printer. Also, attempting to copy to a printer not featured for Programmed Symbol operation, or not containing a matching symbol set (with the one in the display station), results in default to the I/O interface character set installed in the printer.

3276 Default Matrix

At the time the control unit is powered on, a reset is issued to each attached terminal. As each terminal responds positively, it is posted in the default matrix. The matrix identifies each terminal in ascending order, by port. For example:

| | | | | | | | | |
|------------|----|----|---|---|----|----|---|---|
| Port | 0 | 1 | 2 | 3 | 4 | 5 | 6 | 7 |
| Terminal | D | D | P | P | D | D | P | P |
| Assignment | 02 | 02 | X | X | 06 | 06 | X | X |

Note: *X = not applicable*

Displays (D) are assigned the first printer (P) occurring at a higher port number. In this example, display terminals at ports 0 and 1 will be assigned the printer on port 2. Display terminals on ports 4 and 5 are assigned the printer on port 6.

If power is off at a terminal when the control unit is powered on, nothing is posted in the matrix for that terminal. Therefore, the control unit assumes that the device at that port is a display. Power off at ports 1, 4, or 5 does not alter the definition of the matrix in this example. Power off at ports 2 and 3 (prints) results in display terminals at ports 0 and 1 being assigned to the printer at port 6.

If a terminal is powered off after it has been posted in the matrix, the terminal is considered "not ready." The matrix is not altered. Thus, if the printer at port 2 is powered off after being posted in the print matrix, a not-ready condition would be signaled if a local copy operation is attempted by the displays at ports 0 or 1. However, by switching power on the 3276 off and on again, printer 2 is removed from the default matrix, which then appears:

| | | | | | | | | |
|------------|----|----|---|---|----|----|---|---|
| Port | 0 | 1 | 2 | 3 | 4 | 5 | 6 | 7 |
| Terminal | D | D | X | P | D | D | P | P |
| Assignment | 03 | 03 | X | X | 06 | 06 | X | X |

If a terminal is initially powered off, and then powers on some time after the control unit has been powered on, the control unit is notified, and the matrix is updated. For example, if the printer attached to port 6 was not powered on, the default matrix appears as:

| | | | | | | | | |
|------------|----|----|---|---|----|----|---|---|
| Port | 0 | 1 | 2 | 3 | 4 | 5 | 6 | 7 |
| Terminal | D | D | P | P | D | D | X | P |
| Assignment | 02 | 02 | X | X | 07 | 07 | X | X |

Applying power to a printer at port 6 at a later time will change the assignments for displays 4 and 5 to printer 6, as in the previous examples.

As configured in the first example, the printers attached to ports 3 and 7 will not be used for local copy from display stations. They are available for uninterrupted use by the host for direct print and BSC Copy command operations. The printers on ports 2 and 6 may also be used by the host for direct print and BSC Copy command operations. In this case, such operations may have to wait or be interrupted by execution of local copy requests.

In 3271-compatible operations, host and local copy print requests are handled on a first-in, first-out basis; however, when using SNA protocol, local copy requests may be executed only when the host printer session is "between brackets."

Printer Selection. The IDENT key on the keyboard of the 3276, or on the keyboard of the attached 3178/3278/3279 display station, may be used to change the printer ID assigned by the default matrix as described under "IDENT Key" in Chapter 2. For example, by using the ALT key, and keying IDENT 03 at the display attached to port 1, the default matrix becomes:

| | | | | | | | | |
|------------|----|----|---|---|----|----|---|---|
| Port | 0 | 1 | 2 | 3 | 4 | 5 | 6 | 7 |
| Terminal | D | D | P | P | D | D | P | P |
| Assignment | 02 | 03 | X | X | 06 | 06 | X | X |

By switching 3276 power off and on again, the original default matrix is restored.

3276 Local Copy Operation

Operator-Initiated Copy. The operator may initiate a local copy operation by pressing the Print key on the display keyboard. The 3276 will then attempt to execute the local copy function on the printer with ID shown in the "connect" indicator in the Operator Information Area.

The Print key is active in an SNA environment under the following conditions:

1. No session has been established (prior to receipt of ACTLU, or after receipt of DACTLU).
2. Session owner is "Unowned."
3. The terminal is in Test mode, and the keyboard is unlocked.

4. Session owner is the SSCP, and the keyboard is unlocked.
5. Session owner is the PLU, the keyboard is unlocked, and the SLU is not in receive state.

The Print key is active in a BSC environment whenever the Time symbol is not displayed.

If the printer is busy doing local copy operations for other displays, the Input Inhibited Printer Busy (short term) symbol is displayed. In SNA, if the printer is busy because it is "in" brackets with a host application, or in BSC during a host write-type operation, the Printer Very Busy (long term) symbol is displayed. In either case, the request is queued, and the keyboard is locked until the copy can be performed or the operator cancels the print request. The RESET key has no effect while a print request is on the queue; however, the operator can cancel the local copy request by pressing the DEV CNCL key. This turns off the Input Inhibited symbol, unlocks the keyboard, and dequeues the print request. The operator is then free to perform another task.

In BSC, an operator-initiated local copy operation to a printer is not executed if the printer has status pending from a previous host-directed print operation. General or Specific polling will clear the printer status and free the printer for local copy usage.

If the printer is not functional because of an intervention-required or permanent-error condition, then the Input Inhibited Printer Not Working symbol is displayed and the keyboard is locked. The operator must depress the DEV CNCL key to continue. This action turns off the Input Inhibited symbol and unlocks the keyboard. The print request is not queued. The operator may then choose an alternative action. When the Printer Not Working symbol has been turned on as a result of an operator-initiated copy request, this symbol, and an associated Printer Failure symbol, if displayed, will be turned off by receipt of any outbound FM data request.

If the operator attempts to print again, and the selected printer is still not operational, the Input Inhibited Printer Not Working symbol reappears. Some operator action, for example, loading paper in the printer, may be required to clear a not-functional condition. If no connection indicator is displayed and the Print key is depressed, the Input Inhibited Operator Unauthorized symbol is displayed and the keyboard is locked. The symbol remains on until the operator presses the RESET key.

When a valid printer is selected, and the display-to-printer buffer transfer begins, the display keyboard is locked and the Input Inhibited Time symbol is displayed. This symbol remains on and the keyboard remains locked until the buffer transfer is completed successfully.

If the printer stops during a local copy operation (out of paper, paper jam, etc. - a data check on the printer does not fall in this category), the Printer Failure symbol replaces the Printer Printing symbol and the print is terminated. The keyboard locks and the Printer Not Working symbol is also displayed, calling the operator's attention to the failure. The Printer Failure symbol specifies the failing printer. In this state, the DEV CNCL key will remove both symbols from the display.

Operator-Unauthorized Condition. If the display cannot perform the copy operation because the most-available printer does not have a large enough buffer, the operator will be alerted by an inhibit condition with the Operator Unauthorized symbol. This may occur, for example, when the operator attempts to copy to a 1920-character buffer printer from a 3440-character display.

Host Interference with Operator Copy (SNA). Once the display operator has initiated a local copy operation, any outbound FM data request will be rejected with a busy indication, X'082D', during the time that the operator request is queued or the buffer is being transferred, and an outbound FM data request is received for the display. Once the buffer transfer has been completed the display is free to receive outbound FM data requests. If a negative response has been sent because of this condition, an LUSTAT of X'0001D000' will be sent at the completion of the buffer transfer to notify the host that the busy condition no longer exists. FM data may be written into the display buffer as soon as the buffer transfer is complete.

If the host is in session with the printer, the local copy operation will not change the selected size of the printer buffer as set by the host session.

Host-Initiated Local Copy Using SNA/SDLC

The host application program may initiate a local copy function in an SNA environment by sending to the display station a write-type command with the Start Print bit in the WCC turned on. (The copy function under SNA ignores WCC bits 2 and 3.) The control unit performs the local copy function as required, using the print class or printer assigned to the display and displayed in the Operator Information Area. When a write-type command is sent to the display with the Start Print bit on, the display first interprets the orders and data in the write data stream and updates the display buffer. During this time, the Input Inhibited Time symbol is displayed. Once the buffer write is completed, the control unit attempts to use the printer(s) it assigned to the display. The Time symbol remains on while the copy operation takes place. Once the buffer transfer is completed, the Printer Printing symbol replaces the Printer Assignment symbol. The Printer Printing symbol always shows the specific terminal address of the printer actually doing the print operation.

The keyboard remains locked, regardless of keyboard Restore, until the print operation is completed. When the print operation is completed, the keyboard unlocks according to the keyboard Restore in the WCC. The Time symbol is removed, and the Assignment symbol replaces the Printer Printing symbol.

To perform the host-initiated local copy described above, the host program must send a write-type command with the Start Print bit turned on in the WCC as an RQD chain or an RQE, CD, EB chain. Otherwise, the synchronization may be lost or the request rejected with response X'0843'.

Printer Busy Condition. If, after performing the display buffer update operation, the control unit finds that the connected printer or all printers in the selected print class are busy with other local copy operations, the print request will be queued.

If the 3276 LU repeats a previous host-initiated copy request, and is waiting for availability of a printer, further print requests will not be queued but are rejected. On displays attached to a 3276, the keyboard remains locked and the Input Inhibited Time symbol is replaced by the Input Inhibited Printer Busy (short term) symbol. The operator may cancel the request by operating the DEV CNCL key. This will dequeue the print request and replace the Printer Busy symbol with the Time symbol. A negative response X'0807', printer busy, is sent to the host. This allows the host to take an alternative action.

Similarly, on a 3276, if the selected printer or all printers in the selected class are found to be "in" brackets with the PLU, the copy operation is refused. After the write operation is complete, the control unit will respond negatively to the print request with X'0807', printer busy.

Once a print request has been refused with "printer busy," the SLU sends an LUSTAT of '0001B000' to the PLU when a printer becomes available. (Only one LUSTAT is returned per SLU, regardless of the number of times the PLU may have requested a local print operation.)

The PLU may choose not to wait for the LUSTAT but to continue with other display work. Even though the SLU is taken out of the ERP.1 state by the PLU, it is still bound to send in the LUSTAT at the first opportunity when the printer becomes available.

After sending the LUSTAT '0001B000', if obligated, the 3276 holds the printer until:

- It is released because a valid FM data request is received which does not specify start print.
- It is released because of a Clear request; the session is unbound.
- The copy is completed after the PLU sends a write type command with the Start Print bit turned on in the WCC.
- The copy fails and a negative response is returned to the host because of one of the following:
 - A permanent error in the printer is detected during printing.
 - The display operator turns off the security keylock.
 - The display operator turns off display power.
 - Ownership of the display is changed to other than the PLU.
 - A permanent error in the display is detected.
 - A temporary error in a printer or display is detected.
 - Intervention Required condition in a printer was detected.

Printer Not Assigned Condition. If a printer is not assigned to the SLU at the time the printer is selected, the control unit responds to the write-type command with negative response (0801) "printer not assigned."

"Printer not assigned" will also be sent to the PLU when a copy request is made, and the selected printer cannot perform the copy because of a feature mismatch between the display device and the printer.

In all cases mentioned above, once the negative response has been sent to the host, the 3276 enters the receive state.

Printer Not Functional Condition. If the most-available printer is not functional at the time the printer is selected, the Printer Not Working symbol replaces the Time symbol. The Write command is responded to with negative response (083E) intervention required, or negative response (082F) permanent printer error. The display LU goes into the ERP.1 state as defined for printer busy. When intervention-required is returned, recovery may require operator action, e.g., loading forms. When the intervention-required condition has been cleared, the control unit will generate an LUSTAT 0001B000 to the PLU in session with the display. After receiving the LUSTAT, the PLU may reinitiate the copy request by sending a Write command with the Start Print bit in the WCC and with no data.

If the operator operates the DEV CNCL key while the Printer Not Working symbol is being displayed, the Printer Not Working symbol is replaced by the Time symbol.

If the PLU transmits any FM data request to the display and the Printer Not Working symbol has not been cleared, the FM data request will remove the Printer Not Working symbol and an associated Printer Failure symbol, if displayed, and may take the SLU out of the ERP.1 state.

No LUSTAT is required when 082F (permanent error) is sent as a response to the Write command.

If the printer malfunctions during the print operation, both the Printer Not Working and the Printer Failure symbols are displayed. The print operation terminates, and the Write command is responded to with negative response (082E) or negative response (082F). The keyboard remains locked and the system waits for some recovery action as defined above.

Note that any FM data requests from the PLU will clear a Printer Not Working symbol. This requires careful planning by an installation in the use of host- and operator-initiated printing.

Local Copy Performed without SNA Protocol

In a BSC environment, host-initiated local copy is initiated through use of the Copy command (remote only). The description of operator indicators under "Host-Initiated Local Copy Using SNA/SDLC" does not apply to the Copy command. Operator-initiated copy in a non-SNA subsystem is the same as defined under "Operator-Initiated Copy."

When a printer or class of printers is in shared mode, the contention between host and local copy use of the printer is resolved according to the following procedure:

1. If, during processing of an operator-initiated copy operation, the host sends a selection addressing sequence to the printer, the control unit will respond with an RVI and will set Intervention Required. When the local copy queue no longer exists and the printer becomes available, Device End (DE) is sent in response to a poll (remote) or as asynchronous sense/status (local) to signal that the printer is then available.
2. To provide security in systems that operate in a non-SNA environment, the printer buffer is cleared after successful operator-initiated local copy operations are completed. A read-buffer or read-modified operation will not return the contents of a printer buffer just used in a local copy operation by another display operator.

3. A host program may use several messages to load a buffer with data to be printed or for temporary data storage. Once the program initiates loading of the buffer, operator-initiated local copy operations cannot be performed until print operation is completed, or until there is a permanent error. An operator-initiated print request via the Print key during this period is queued, and the Device Very Busy symbol is displayed. The host system should issue an Erase/Write command with the Start Print bit "on" to release the printer for local print operations.
4. The host application program can use the printer when there are no operator-initiated local copy requests outstanding. If it is required that the host have sole ownership of the printer for data integrity or performance considerations, the printer should be designated as a system mode printer in the printer authorization matrix.
5. If a host transmission to the display is received while an operator-initiated copy request is queued, the host transmission will be accepted and written to the display. No change will be made to the status of the operator-initiated copy. If the copy is queued and buffer transfer has not taken place, the new screen will be copied. If buffer transfer has started before arrival of the host transmission to the display, the transfer will be completed before writing to the display. In this case the old screen will be copied.
6. Each time the local copy queue is completed, a Device End will be transmitted to the CPU by the 3276, thereby signaling that the printer is available. The printer buffer is set to the default size after each copy queue is completed.

Mono/Dual Case Control

When power is applied, the 3287 is activated to print mono-case; other terminal printers are automatically activated to print the dual-case character set.

In dual-case operation, the alphabetic character codes sent by the host determine whether uppercase or lowercase characters are printed, provided that the print belt has the dual-case character set. In mono-case operation, the lowercase alphabetic character codes print equivalent uppercase characters.

The Change Case switch can be pressed to change the print case on the terminal printers. However, when operating with LU1 printers in SNA, the data character codes and the print belt character set determine whether mono- or dual-case characters are printed, regardless of the Change Case switch setting.

In a BSC environment, when using the Copy command to transfer data from a display to a printer, the setting of the Change Case switch on the "from" display determines mono- or dual-case in the "to" printer. When the Copy command transfers data from a display or a printer to a display, the Change Case switch on the "to" display determines whether mono- or dual-case is displayed.

Format Control during Shared Printer Operations

When shared printers respond to uncoordinated print requests, control of the horizontal and vertical print position format is governed by the operating mode(s) and the format selected.

In BSC printer operations, sharing occurs on a buffer load basis, between local copy requests and host-initiated printer output, by means of write-type or Copy commands. When using SNA protocol, local copy requests for display buffer data originating from an LU2 session may share a printer with either LU3 or LU1 host output. Sharing of LU2 and LU3 devices is comparable to BSC operation.

In BSC, and in SNA LU2 printer operations when performing local copy, the entire buffer content, including nulls, attribute, and buffer control characters of a "from" display or a "from" printer (non-SNA only), can be transferred to a printer buffer.

During formatted print operations, the data is scanned a line at a time. If a line contains one or more data characters (including Space, NL, EM, and CR) in a display/print field, the line is printed and a line feed is performed. To produce a blank line, at least one Space character must be present.

A valid FF character is executed regardless of the attribute of the field, except for the 3289-1 and -2. The 3289-1 and -2 do not execute or print any characters in a nonprint field, including the FF character. If the FF character is invalid, it is not executed and prints as a blank in a field that is not defined as nondisplay/nonprint.

If a line contains only nulls, attribute characters, or alphameric characters (including Space, NL, EM, FF, or CR) in a nonprint/nondisplay field, no line is printed and no line feed is performed. A screen facsimile can only be obtained by inserting at least one space character in the blank lines.

In BSC, and in SNA LU3 printer operations when directly printing from the host, the identical procedure is followed as described above once data has been loaded in the buffer and the print operation is started. Thus, when a print operation is completed, a line feed will have been automatically performed after printing of the last line (blank or not). Therefore, the next buffer load of data, regardless of the source, starts printing on the next line, ignores the previous horizontal position, and is contiguous with the previous output except for blank lines as provided in either or both buffer data.

A valid FF control character in the data at either the beginning or end of a form (one or more buffer loads) ensures synchronization of the forms with the data. Interleaving of a local copy operation within a host output print operation using VFC will usually cause local copy to be printed on part of a completed form or cause at least one form to be misprinted. This may best be avoided by configuring the printer in system mode, thus excluding its use for local copy.

In BSC unformatted print operations, the completed print operation terminates at a new line position. Thus, the next print operation is also contiguous with the previous output except for possible blank lines as specified in the data. (SNA LU type 1 devices do not perform unformatted printouts.)

When operating as an SNA LU type 1 device, an automatic LF, NL, etc., is not sent at the end of a bracket or a session. Therefore, the print position may be one position to the right of the last printed character. The first printed line resulting from a local copy operation performed with an LU2 device is printed on the line that is currently available. Overprinting may occur if the first line is not specified as a blank line. When the local copy operation is completed, the LU1 session resumes with a new bracket at the horizontal print established by the preceding LU1 bracket.

Error Conditions

Four error conditions may be encountered at the printers. In each of the following cases, when an error is detected, the program is notified.

Not Ready. A printer is defined as not ready when it is out of paper, its cover is open, or it is mechanically disabled (unable to advance to its proper position). For 15 seconds, the mechanism will automatically attempt to recover. If the recovery attempt is successful, the printer will return to the ready condition. If the recovery attempt is not successful after 15 seconds, the printer will become not ready, as indicated by Intervention Required (IR) status.

A 3262 displays an error code in the status indicator. The operator may be able to clear the error condition and continue printing.

If a printer (not the 3289) is not ready at the start of a printout, or if it becomes not ready during a printout operation, the print operation terminates. Error status is sent to the channel once when the condition occurs during a printout and, then, again each time a printout is initiated.

Parity Error. If a parity error is detected on a character about to be printed, an error graphic (prx 10T,L) (3287) is printed in place of the character with incorrect parity. The buffer continues printing until all printable characters have been printed. The printer prints a graphic X. The isolated X character (specify feature on the 3287) serves to indicate the detection of the parity error.

An x (an X overprinted with an O) prints in place of an incorrect character on all other terminal printers. An x also prints in the left margin of the next line.

Command-Chaining. In local operations, if any command is chained to a command that initiates a print operation, an error condition occurs: no printout is performed, the command is aborted, and the system channel is notified of the error. In remote operations, if command chaining is attempted, error status is sent to the system channel but the printout is completed.

Chapter 3. Remote Operations - BSC

Introduction

The 3276 Control Unit Display Station Models 1, 2, 3, and 4 use Binary Synchronous Communication (BSC) mode of operation and can communicate with the program via an IBM 2701, 2703, 3704, 3705, or an equivalent Integrated Communications Adapter (hereafter called *TCU*) and appropriate data sets as specified for the control unit.

The 3276 uses BSC procedures over duplex or half-duplex facilities (nonswitched or privately owned); these communications use the Multipoint Data Link mode of operation only.

Code Structures

The 3276 can operate with one or two code structures: EBCDIC (Extended Binary-Coded Decimal Interchange Code) or ASCII (American National Standard Code for Information Interchange). The choice of code depends on the application. However, for system compatibility, the same code must be chosen for all units on a particular communications line.

Channel Program Concepts

In remote configurations, the TCU becomes the intermediary between the 3276 and the channel program. As such, the TCU, not the 3276, executes channel commands and initiates I/O interrupts. At the start of each I/O operation involving the TCU, the Start I/O instruction addresses the TCU and a communications line attached to that TCU; it does not address an individual remote control unit on that line. Subsequent CCWs in the channel program initiate TCU operations; they specify TCU commands, not 3276 commands.

Selection of control unit and all subsequent command operations are specified by character sequences in TCU Write CCW data streams. Write CCW data to the TCU communications line selected by Start I/O can contain (1) address bytes to select a control unit on that line, (2) the code of a command (such as Erase/Write or Write) to initiate a control unit operation, or (3) orders and/or display/print data for the control unit buffer. In addition, this write data will contain the appropriate data-link control characters. Thus, all characters sent by the TCU to a 3276, with the exception of SYN, pad, and BCC characters, originate from the data stream of a Write CCW addressed to the TCU.

Programming Note: All Write commands should be set for CCW chaining to a Read command when a response is expected. This prevents a loss of data received by the TCU in response to Write command operations. An exception to this requirement is when the Write command is used to issue EOT to the 3276.

Text Blocking

The 3276 performs inbound text blocking. Each block of data can contain a maximum of 256 text characters. Of that total, each block contains the STX and ETB (or ETX) data link control characters. Two address bytes (CU poll address and device address) precede the read heading in the first block only and are included in the 256 character total. The last block of a message is terminated with ETX, which is also included in the 256 character total.

Programming Note: If the automatic polling facility (Auto Poll) is used by the TCU, the Auto Poll index byte will add 1 byte to the text block created by the 3276.

Block check characters (BCC) are transmitted as the last characters of a data stream. (See "Redundancy Checking.") BCC is not counted as text because it follows the ETX and ETB data link characters. Upon successful comparison of the received BCC with the accumulated BCC, the program should respond with ACK to read the next block of text; each subsequent block is preceded by STX to initiate BCC accumulation by the TCU.

Text blocking does not disjoin the 3-byte SBA order sequence (SBA code and 2-byte field address) generated during execution of a Read Modified command. Therefore, the last characters of a block ending with an SBA sequence would be . . . SBA, Address, Address, ETB (or ETX).

Related Publications

Readers who are unfamiliar with the binary synchronous method of communications should review the following publications, as applicable:

- *General Information - Binary Synchronous Communications*, GA27-3004
- *IBM 2701 Data Adapter Unit Component Description*, GA22-6864 (especially the section that describes the Synchronous Data Adapter - Type II)
- *IBM 2703 Transmission Control Component Description*, A27-2703 (especially the section on BSC capabilities)
- *Introduction to the IBM 3704 and 3705 Communications Controller*, GA27-3051

Multipoint (Nonswitched Line) Data Link Control

The 3276 can operate on a nonswitched communications line with multiple stations. Time-sharing of the line is accomplished by interleaving transmissions between the TCU and all units on the line. A 3276 operates multidropped on the same line with other properly featured units.

The TCU is the control station of the multipoint, centralized network. All units attached by communications lines to the TCU are called tributary stations. The control station is the focal point of the network and maintains, under program control, an orderly flow of network traffic by initiating all data transfers. The control station is either the transmitter or receiver of every communication.

3276 Modes of Operation

In the multipoint environment, the 3276 is always in one of three modes of operation: control mode, text mode, transparent-monitor mode. The 3276 does not provide transparent-mode.

Control Mode

The 3276 enters control mode whenever it transmits or receives a valid EOT sequence. While in control mode, the unselected 3270 CU monitors the communications line for the following:

1. A valid selection or poll addressing sequence, by which the 3276 will become selected for entry into text mode.
2. A DLE-STX sequence, placing the 3276 in transparent-monitor mode.

Text Mode

Once a 3276 is successfully selected, it enters text mode. In text mode, the 3276 is either a master station or a slave station, as is the TCU. This status depends on the operation being performed. The station that is transmitting a message is called the MASTER STATION, whereas the station that is receiving and acknowledging the message is called the SLAVE STATION.

The 3276 becomes the master station (and the TCU the slave station) once it sends STX to the TCU while executing a Read command or a poll operation. As the master station, it can (1) transmit text messages and (2) transmit ENQ to request a reply or retransmission from the TCU. After transmission of the message is completed, the 3276 returns to control mode.

The 3276 becomes the slave station (and the TCU the master station) when executing a write-type command. As a slave station, it responds appropriately to master-station (TCU) transmissions.

Transparent Monitor Mode

The 3276 does not operate in transparent mode, but can operate on a communications line with other types of terminals that can operate in transparent mode.

Transparent-monitor mode is provided with an EBCDIC 3276. It permits the transmission of data in any of the 256 possible EBCDIC bit patterns between the TCU and another unit on the same communications line with the 3276. This data may be independent of the selected transmission code (EBCDIC). Examples of such format-independent data are packed-decimal data, programs (both source and object), core images, and other binary data. Thus, link control characters within this data will not inadvertently initiate a 3276 operation.

When an EBCDIC 3276 decodes a DLE STX sequence while in control mode, it enters transparent-monitor mode. While in this mode, the 3276 disregards all data configurations that may appear on the communications line except for (1) a transparent text sync sequence (DLE SYN) or (2) a transparent text-terminating sequence (DLE ITB, DLE ETX, DLE ETB, or DLE ENQ). The 3276 leaves transparent-monitor mode and returns to control mode (1) if a transparent text sync sequence is not received within any 3-second period or (2) if a transparent text-terminating sequence is decoded.

Redundancy Checking

A redundancy check is performed on the following communications line data:

1. 3276 command-sequence characters (including the write data of a Write, Erase/Write, or Erase/Write Alternate command).
2. Data transmitted to the TCU in response to a read-type command or to a polling sequence.

A block check character (BCC) is accumulated for each block of data at both the TCU and the 3276. If EBCDIC code is used, a 2-byte BCC is generated (cyclic redundancy check accumulation); if ASCII code is used, a 1-byte BCC is generated (longitudinal redundancy check accumulation).

BCC accumulation is initiated by, but does not include, the first STX or SOH framing character. All characters following this STX or SOH, up to and including the end-of-block character (ETB or ETX), are part of the accumulation. Following the ETB or ETX character, the transmitting unit transmits its BCC character(s). The receiving unit then compares this character(s) with the BCC it has accumulated. If the redundancy accumulations are different, a transmission error has occurred.

When the 3276 is the receiving unit and detects a BCC error, it responds to the transmission by sending NAK to the TCU. When the TCU is the receiving unit, it will set Unit Check in the ending status for the TCU command being executed when the BCC error was detected; also, it will set Data Check in the sense byte.

Note: BCC characters are removed from the data stream when received for comparison by the TCU or by the 3276; they are not stored in main storage or in the 3276 buffer.

In both EBCDIC and ASCII, transmission formats (data link controls) are rigidly screened so that communication is orderly and accurate. Improper transmissions are ignored or rejected to avoid the acceptance of faulty messages. Received or transmitted data blocks are counted odd-even-odd-even, etc., by both the transmitter and receiver (by means of ACK 0's and ACK 1's), and their counts must agree at each block-check point.

Data-Link Control Characters

Two types of characters are transmitted between the TCU and the 3276: CU data-link control characters and 3276 message data. Data-link control characters are used for such purposes as message framing, acknowledgment that received message data was valid or invalid, and identification of the start- or end-of-text transmission. Data link control characters are used (singly or in sequences) by the TCU (under program control) and by the 3276 to establish and control all data link operations in an orderly fashion. The 3276 message data consists of all address, command, order, and display/print characters sent to the 3276 and of all buffer data, AID bytes, and status/sense bytes read from the 3276. Data-link control characters are described individually in the following paragraphs and are described with 3276 message data later in this section (under "Operational Sequences").

The data-link control characters, with their EBCDIC or ASCII codes, are as follows:

| Data-Link Control Character | EBCDIC (hex) | ASCII (hex) |
|-----------------------------|--------------|-------------|
| ACK 0 (two bytes) | 1070 | 1030 |
| ACK 1 (two bytes) | 1061 | 1031 |
| DLE | 10 | 10 |
| ENQ | 2D | 05 |
| EOT | 37 | 04 |
| ESC | 27 | 1B |
| ETB | 26 | 17 |
| ETX | 03 | 03 |
| ITB | 1F | 1F |
| NAK | 3D | 15 |
| RVI (two bytes) | 107C | 103C |
| SOH | 01 | 01 |
| STX | 02 | 02 |
| SYN | 32 | 16 |
| TTD | 022D | 0205 |
| WACK | 106B | 103B |

All control characters transmitted by the TCU (except pad and SYN) are issued by the channel program as part of a TCU Write CCW data stream. All control characters transmitted by the 3276 to the TCU are generated by the control unit; a Read command to the TCU is used to store these characters (except pad and SYN) into main storage for subsequent analysis by the access method.

Pad

Pad characters, leading and trailing, are generated by TCU or 3276 hardware to ensure complete transmission or reception of the first and last significant character of each transmission.

SYN (Synchronous Idle)

Two consecutive SYN characters are generated by TCU or 3276 hardware to establish character synchronization. The TCU can also embed SYN characters in text for time-fill to maintain synchronization; the 3276 discards these SYN characters (does not store them in the buffer). Once this synchronization is lost, a Poll or a Selection sequence to a 3276 must be preceded by an EOT.

DLE (Data Link Escape)

DLE is always the first byte in the following 2-byte control characters: ACK 0, ACK 1, WACK, and RVI. DLE is also used as the first character in several 2-character sequences that are used in transparent-monitor mode (described earlier in this chapter under "Transparent Monitor Mode").

ACK 0 (Even Acknowledge)

ACK 0 is a 2-byte character, as follows:

- EBCDIC: 1070 (hex)
- ASCII: 1030 (hex)

ACK 0 is transmitted by the 3276 after a successful selection addressing (not poll) sequence to indicate to the TCU that the 3276 is ready to accept transmission. ACK 0 is also transmitted by the 3276 or by the TCU upon receipt and validation of an even-numbered (second, fourth, etc.) text block.

ACK 1 (Odd Acknowledge)

ACK 1 is a 2-byte character, as follows:

- EBCDIC: 1061 (hex)
- ASCII: 1031 (hex)

ACK 1 is transmitted by the 3276 or TCU upon receipt and validation of an odd-numbered (first, third, etc.) text block.

NAK (Negative Acknowledgment)

NAK is transmitted by the 3276 in response to a TCU text transmission that (1) terminates with ENQ, (2) has ENQ embedded in text, (3) has invalid BCC, (4) contains a TTD sequence (STX ENQ), or (5) has ETX missing.

When NAK is received by the 3276 in response to a text transmission, the 3276 retransmits the last block of text.

Programming Note: The TCU should be programmed to respond with NAK to an ENQ (that ends a text block) from the 3276; this NAK causes the 3276 to send EOT and retain the status for error recovery.

ENQ (Enquiry)

The 3276 transmits ENQ (1) to request a reply from the TCU following a 3-second timeout, (2) to request retransmission of the previous reply from the TCU, or (3) as the last character of a text message in which a data check was detected by the 3276. (See Programming Note above.)

When the 3276 receives ENQ in response to a transmission, the last 3276 transmission to the TCU is repeated. The 3276 responds with NAK when ENQ is received (1) as the last character of a TCU-aborted text transmission, (2) embedded in text, or (3) as part of a TTD sequence (STX ENQ).

To be addressed successfully, the 3276 must receive ENQ as the last character of a polling or selection addressing sequence.

WACK (Wait before Transmit)

WACK is a 2-byte character, as follows:

- EBCDIC: 106B (hex)
- ASCII: 103B (hex)

WACK is generated by the 3276 (1) in response to a selection addressing (not poll) sequence when a printer is busy, and (2) in response to a Write or Copy command text transmission when the Start Printer bit is set in the WCC or CCC. The 3276 responds with ENQ to a WACK from the TCU.

RVI (Reverse Interrupt)

RVI is a 2-byte character, as follows:

- EBCDIC: 107C (hex)
- ASCII: 103C (hex)

RVI is generated by the 3276 in response to an attempted selection (not poll) by the TCU when the 3276 has a status and sense message to be transmitted. Whenever the 3276 accepts RVI from the TCU, the CU responds with EOT and resets all pending status and sense information. The 3276 accepts RVI in place of ACK 0 or ACK 1 and then only when they would have been valid. If RVI is received at the 3276 in response to RVI, a timeout occurs at the 3276 unit.

STX (Start of Text)

The 3276 receives STX as the first character of a command or TTD sequence. The STX causes the 3276 to clear its BCC and start accumulating a new BCC (STX is not included in the accumulation). Subsequent STX (and SOH) characters are included in the BCC accumulation. STX is transmitted by the 3276 to the TCU as the first character of a read-data text block except in a status or test-request message; this STX causes the TCU to start accumulating a new BCC (STX is not included in the accumulation).

The first character in status and test-request messages is SOH, with STX following two header characters. With a message of this type, the TCU starts BCC accumulation upon receipt of the first SOH; the subsequent STX character is included in the BCC accumulation.

SOH (Start of Heading)

The 3276 generates SOH in a 3-character heading sequence that identifies the accompanying data as a status message (SOH, %, R, STX, - - -) or as a test-request message (SOH, %, /, STX, data - - -). The TCU starts BCC accumulation upon receipt of SOH (SOH is not included in the accumulation).

ETB (End of Transmission Block)

During a message transfer operation, ETB informs the receiving unit that BCC follows. The 3276 treats ETB as though it were ETX by checking BCC and then generating the appropriate response; the 3276 does not accept conventionally blocked outbound text.

ETX (End of Text)

During a message transfer operation, ETX informs the receiving unit that BCC follows. The 3276 transmits ETX at the end of the last (or only) block of a text message. Then, upon successful comparison of the received BCC with the accumulated BCC, the program should respond with ACK to the 3276. If the BCC comparison is unsuccessful, the TCU interrupts the program (Channel End, Device End, and Unit Check status, with Data Check set in the sense byte); the program should respond with NAK to the 3276. Receipt of ETX by the 3276 initiates a BCC comparison, causes a line turnaround, and causes generation of an appropriate response to the TCU.

EOT (End of Transmission)

EOT is transmitted by the 3276 (1) when the 3276 is a slave station and is unable to perform an operation requested by the TCU; (2) when the 3276 is a master station, as normal termination of a read operation; (3) when the 3276 has completed General Poll operations with each attached device; (4) as an answer to RVI sent by the TCU. Line synchronization is dropped, and the 3276 is returned to control mode. Note that the program can also issue EOT to the 3276 in order to drop line synchronization and return the 3276 to control mode. EOT does not reset status and sense in the 3276; therefore, it should not be sent as a response to a status message.

Following receipt of a valid selection addressing sequence, if an error occurs during buffer transfer, the 3276 will provide a positive response to the selection sequence and internally set DC and US status. EOT is sent in response to the following 3276 command or poll.

ITB (End of Intermediate Transmission Block)

The 3276 does not accept conventionally blocked text. However, to coexist on a BSC multipoint line on which ITB may be used, the 3276 includes the ITB and associated BCC in its own BCC accumulation but then removes them from the data stream so that they are not stored in the buffer. The 3276 does not perform a BCC comparison at that time, but continues the receive operations until ETB or ETX is decoded.

ESC (Escape)

ESC must precede the command code in each command-sequence data stream transmitted to the 3276, as follows: STX, ESC, CMD, - - -. The 3276 does not generate ESC.

TTD (Temporary Text Delay)

TTD is a 2-character sequence: STX ENQ. The 3276 responds to TTD by transmitting NAK to the TCU. The 3276 does not generate TTD. TTD may also be used by the master station to terminate an operation (that is, initiate a forward abort). The 3276 (slave station) will always respond with a NAK, expecting the master station to transmit EOT. In this case, the slave station interprets this sequence as a controlled forward abort rather than an end of transmission.

Operational Sequences (Nonswitched Line)

The following paragraphs describe the various data and control sequences that can be performed with the 3276 operating on a nonswitched line. These sequences are divided into four categories:

1. Specific and General Poll.
2. Selection addressing.
3. Write and control type commands.
4. Read-type commands.

The description of each category is associated with a Sequence/Response Diagram, which shows (1) 3276 responses to program-generated transmissions by the TCU and (2) normal program-handling of 3276 transmissions. These diagrams show the I/O supervisor/access method as examining 3276 response to determine which operation to initiate next; however, for specific applications, additional usage of command chaining in the channel programs may be desirable.

A selection addressing sequence selects a 3276 and an attached device for subsequent command operations. Polling sequences are selection sequences used specifically to obtain pending status at a device. Either a Specific Poll sequence requesting status from a particular device or a General Poll sequence sent to all devices may be executed.

Remote Chaining of 3276 Commands

For remote operations, 3276 command codes are included in the data stream of a Write CCW to the TCU. Remote chaining of 3276 commands is defined as the transmission of more than one command sequence to a 3276 following a single selection addressing or poll sequence. This chaining normally is accomplished with separate Write CCWs in the channel program. For example, the channel program could (1) write a selection addressing sequence and read the response for evaluation by the I/O supervisor/access method, (2) write a 3276 Write command and text block and read the 3276 response for evaluation, and then (3) write a 3276 Write command followed by a second text block and read the 3276 response for evaluation.

The program may chain 3276 commands following a selection addressing sequence, provided that the BSC rules governing limited conversational mode are observed. (Refer to *General Information - Binary Synchronous Communications, GA27-3004.*) The 3276 permits any valid command to be chained following a poll sequence; however, Read Buffer or Read Modified should not be chained because the BSC rules for limited conversational mode (a maximum of two consecutive data transfers without an intervening ACK) will be violated.

Any 3276 command (except Erase All Unprotected) may be chained from a Write, Erase/Write, Erase/Write Alternate, or Copy command. However, if one of the commands has started a print operation, the 3276 will abort the subsequent chained command (the print is completed normally).

General and Specific Poll Sequences

When a General or Specific Poll sequence is issued (Figure 3-2), one of three possible results occurs:

1. If status and sense information is pending with or without an AID present, a status and sense message is generated.

2. If status and sense information is not pending and an AID is present, a Read Modified command is executed.
3. If there is no status or sense information or no AID pending, an EOT response is generated.

Figure 3-9 lists the conditions under which status and sense messages are transmitted.

Control unit and device address bytes transmitted for the General and Specific Poll sequences are as follows:

1. General Poll address byte sequence:

| | | |
|---------------------------|---|--|
| 3276 CU Poll Address | } | (See Figure 3-1.) |
| 3276 CU Poll Address | | |
| 7F (EBCDIC) or 22 (ASCII) | } | (Used in place of the two device-address bytes.) |
| 7F (EBCDIC) or 22 (ASCII) | | |

2. Specific Poll address byte sequence:

| | | |
|----------------------|---|-------------------|
| 3276 CU Poll Address | } | (See Figure 3-1.) |
| 3276 CU Poll Address | | |
| Device Address | | |
| Device Address | | |

The selected 3276 remains selected at the completion of a poll operation so that the program can issue a Write, Erase/Write, Erase/Write Alternate, Copy, or EAU command without reselecting the 3276 and the device; command operations will be with (1) the device that was selected by Specific Poll or (2) the device from which a response was last received during the General Poll operation. Selection is dropped when the 3276 transmits EOT; the 3276 transmits EOT when it has no pending status or messages or after it receives NAK from the TCU in response to a message that ends with ENQ.

Specific Poll addresses the 3276 and one device to determine if status and sense information or a manually entered message is awaiting transfer to the TCU. The pending status and sense information or message is transferred automatically by the 3276 upon receipt of the Specific Poll addressing sequence.

General Poll addresses the 3276 and examines each attached device in sequence (starting at a random device address) to determine if a status and sense or a manually entered message is awaiting transfer to the TCU. If a message is present, it is transferred to the TCU. Each message is accompanied by the address of the device from which it originated.

Upon completion of this transfer, an ACK response from the program causes the 3276 to continue the General Poll operation, either by transferring another block of a text message or by examining other attached devices for pending messages. The program could issue a command rather than ACK to the device from which the message was just received, only after inbound blocks that end with ETX. The 3276 will ignore any commands that are sent in response to a block of data that ends with ETB. Once the 3276 has examined all attached devices and has successfully transferred all pending messages, it generates EOT and returns to control mode. If the program wishes to terminate the General Poll, an RVI may be issued to the 3276, forcing an EOT response. A command issued rather than the ACK (after blocks that end with ETX) will also terminate the General Poll.

| Column 1 | | | | |
|--|------------------|---------------------|-----------------|-----------|
| Use this column for: | | | | |
| <ul style="list-style-type: none"> • Device Selection, • Specific Poll, • General Poll, and • Fixed Return Addresses | | | | |
| CU or Device Number | EBCDIC I/O Char. | EBCDIC Hex (Note 3) | ASCII I/O Char. | ASCII Hex |
| 0 | SP | 40 | SP | 20 |
| 1 | A | C1 | A | 41 |
| 2 | B | C2 | B | 42 |
| 3 | C | C3 | C | 43 |
| 4 | D | C4 | D | 44 |
| 5 | E | C5 | E | 45 |
| 6 | F | C6 | F | 46 |
| 7 | G | C7 | G | 47 |
| 8 | H | C8 | H | 48 |
| 9 | I | C9 | I | 49 |
| 10 | ⌘ | 4A | | 5B |
| 11 | . | 4B | . | 2E |
| 12 | < | 4C | < | 3C |
| 13 | { | 4D | { | 2B |
| 14 | + | 4E | + | 2B |
| 15 | or | 4F | | 21 |
| 16 | & | 50 | & | 26 |
| 17 | J | D1 | J | 4A |
| 18 | K | D2 | K | 4B |
| 19 | L | D3 | L | 4C |
| 20 | M | D4 | M | 4D |
| 21 | N | D5 | N | 4E |
| 22 | O | D6 | O | 4F |
| 23 | P | D7 | P | 50 |
| 24 | Q | D8 | Q | 51 |
| 25 | R | D9 | R | 52 |
| 26 | | 5A | | 5D |
| 27 | \$ | 5B | \$ | 24 |
| 28 | * | 5C | * | 2A |
| 29 |) | 5D |) | 29 |
| 30 | : | 5E | : | 3B |
| 31 | ⌘ or ^ | 5F | ^ | 5E |

| Column 2 | | | | |
|--|------------------|---------------------|-----------------|-----------|
| Use this column for: | | | | |
| <ul style="list-style-type: none"> • 3270 CU Selection Addresses • Test Requests | | | | |
| CU Number | EBCDIC I/O Char. | EBCDIC Hex (Note 3) | ASCII I/O Char. | ASCII Hex |
| 0 | . | 60 | . | 2D |
| 1 | / | 61 | / | 2F |
| 2 | S | E2 | S | 53 |
| 3 | T | E3 | T | 54 |
| 4 | U | E4 | U | 55 |
| 5 | V | E5 | V | 56 |
| 6 | W | E6 | W | 57 |
| 7 | X | E7 | X | 58 |
| 8 | Y | E8 | Y | 59 |
| 9 | Z | E9 | Z | 5A |
| 10 | | 6A | | 7C |
| 11 | . | 6B | . | 2C |
| 12 | % | 6C | % | 25 |
| 13 | - | 6D | - | 5F |
| 14 | > | 6E | > | 3E |
| 15 | ? | 6F | ? | 3F |
| 16 | 0 | F0 | 0 | 30 |
| 17 | 1 | F1 | 1 | 31 |
| 18 | 2 | F2 | 2 | 32 |
| 19 | 3 | F3 | 3 | 33 |
| 20 | 4 | F4 | 4 | 34 |
| 21 | 5 | F5 | 5 | 35 |
| 22 | 6 | F6 | 6 | 36 |
| 23 | 7 | F7 | 7 | 37 |
| 24 | 8 | F8 | 8 | 38 |
| 25 | 9 | F9 | 9 | 39 |
| 26 | : | 7A | : | 3A |
| 27 | # | 7B | # | 23 |
| 28 | @ | 7C | @ | 40 |
| 29 | ' | 7D | ' | 27 |
| 30 | " | 7E | " | 3D |
| 31 | " (Note 1) | 7F | " | 22 |

Examples:

| 3276 Addressing | | | |
|-------------------------------|------------|--------|-------|
| General Poll CU5 | CU Address | EBCDIC | ASCII |
| | | { C5 | 45 |
| Device Address | { C5 | 45 | |
| | { 7F | 22 | |
| Specific Poll Device 4 on CU5 | { 7F | 22 | |
| | { C5 | 45 | |
| CU Address | { C5 | 45 | |
| | { C4 | 44 | |
| Device Address | { C4 | 44 | |
| | { C4 | 44 | |
| Select Device 4 on CU5 | { E5 | 56 | |
| | { E5 | 56 | |
| CU Address | { E5 | 56 | |
| | { C4 | 44 | |
| Device Address | { C4 | 44 | |
| | { C4 | 44 | |

Notes:

1. I/O character address ("") is used as the device address to specify a General Poll operation.
2. Graphic character for the United States I/O interface codes are shown. Graphic characters for EBCDIC 4A, 5A, 5B, 7B, 7C, and 7F might differ for particular World Trade I/O interface codes. Refer to IBM 3270 Information Display System: Character Set Reference, GA27-2837, for possible graphic differences when these codes are used.

Figure 3-1. Remote Control Unit and Device Addressing

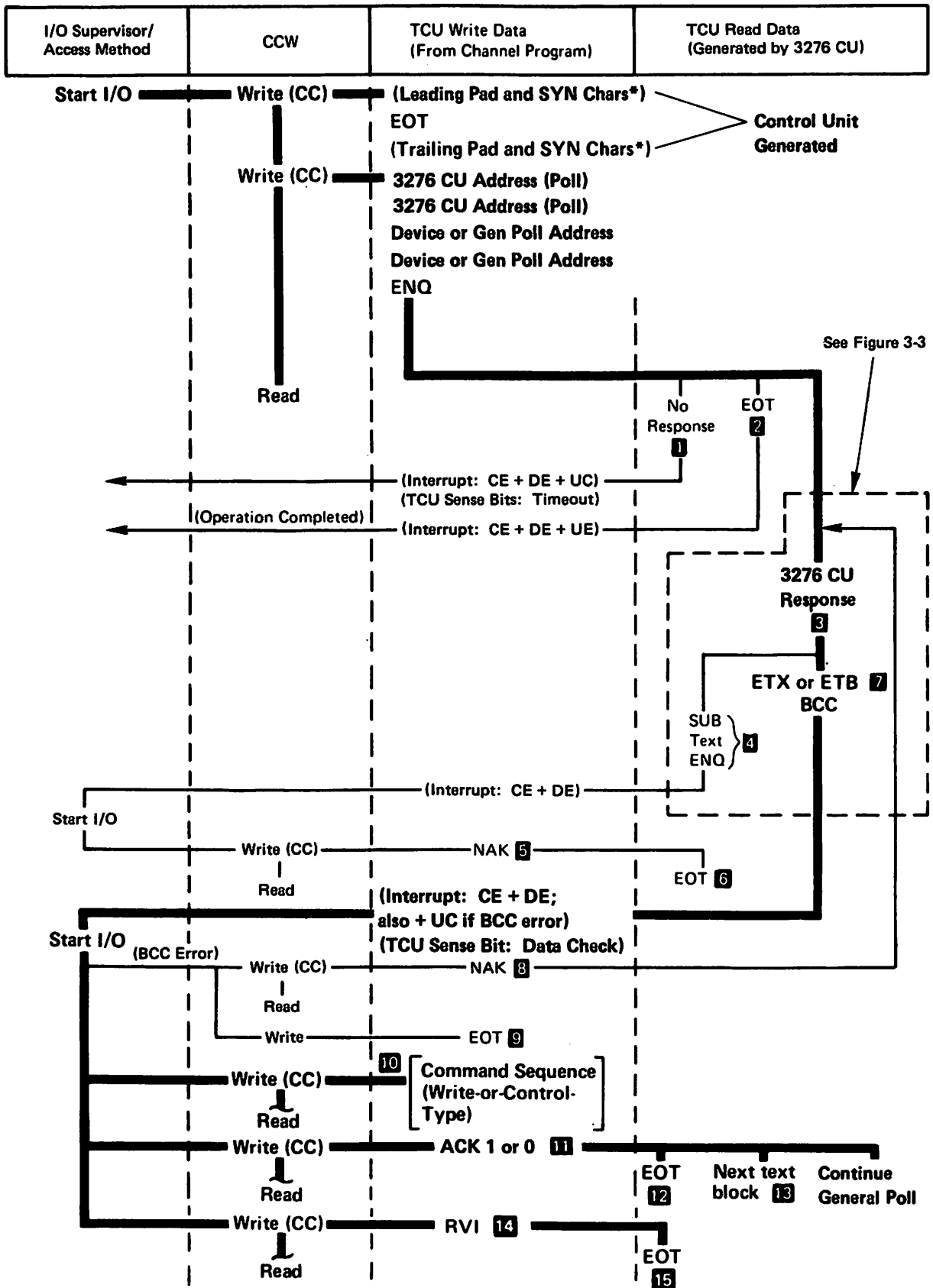

Figure 3-2 (Part 1 of 2). General Poll and Specific Poll, Sequence/Response Diagram

Notes:

- 1** *The 3270 CU will fail to respond to the addressing or polling sequence, causing a TCU timeout, for any of the following reasons:*
 - *The 3270 CU is "unavailable" (has power off, is "offline", or is not attached).*
 - *Any character in the polling sequence is invalid.*
 - *The characters in the polling sequence are out of order.*
 - *The polling sequence is incomplete (less than seven characters).*
 - *The 3276 CU address is incorrect in the write data stream.*
 - *The addressed 3276 CU was left selected from the previous transmission.*
- 2** *There is no I/O pending nor pending status. For General Poll, the CU sends EOT only after polling all devices.*
- 3** *The device response is a function of the kind of device and its status. Types of responses include: Text, Status, and Test Request messages. (Refer to Figure 3-3.)*

For General Poll, the search for a response starts at some random device address and continues sequentially (as long as ACKs are received in response to text transmissions) until all devices are given the opportunity to respond.
- 4** *Upon detection of an internal parity check or a cursor check, the 3276 CU (1) substitutes the SUB character for the character in error, (2) records Data Check status, and (3) transmits an ENQ in place of ETX (or ETB) and BCC at the end of the text block. The General Poll process is stopped.*
- 5** *Mandatory program response to a text block terminated in ENQ.*
- 6** *Terminates the operation. The nature of the error (parity or cursor check) does not warrant a retry. This response indicates that status and sense information is stored and that internal 3271/device polling is stopped. The status retrieval information included in Figure 3-6, Note 2, applies.*
- 7** *ETB is used to frame each block of a blocked text message, except the last block. ETX is used to frame the last block of a blocked text message.*
- 8** *BCC error has been detected. The program issues NAK to cause the 3276 CU to repeat its last transmission.*
- 9** *Response issued by the program to terminate the operation if the TCU is unsuccessful in receiving a valid BCC following "n" attempts by the 3276 CU to transmit the message. This response does not cause the 3270 CU to reset its sense/status information. Therefore, the same status message will be transmitted if a Specific Poll is immediately issued to the same device.*
- 10** *This transmission must be a write or control-type command sequence (described in Figure 3-5). A read-type command would violate BSC standards on limited conversational mode.*

For General Poll, this transmission stops the polling operation. The General Poll must be reinitiated to ensure receipt of all pending device messages.
- 11** *Positive acknowledgement. The text block has been successfully received by the TCU. The program issues ACK 1 in response to the first and all odd-numbered text blocks and issues ACK 0 in response to the second and all even-numbered text blocks.*
- 12** *Normal termination of a Specific Poll.*

Normal termination of a General Poll.
- 13** *The second and all succeeding text blocks are framed as the first except they do not include the 3270 CU/device address sequence.*
- 14** *RVI to terminate polling sequence.*
- 15** *Termination of polling sequence on receipt of RVI.*

Legend:

(CC) = Chain Command (CC) Flag in CCW is set to 1.

(Interrupt) = TCU-generated interrupt (CE = Channel End, DE = Device End, UE = Unit Exception, UC = Unit Check).

- 1** *Reversed numbers refer to notes.*

**Only the critical framing characters (sync pattern and pad) are shown. All other framing characters are also hardware-generated as required. See SL General Information - Binary Synchronous Communications, GA27-3004, for a complete description.*

Figure 3-2 (Part 2 of 2). General Poll and Specific Poll, Sequence/Response Diagram

Figure 3-3 shows the message formats. The Test Request, Read Modified, and Short Read operations and the resulting data are described under "Read Modified Command" in Chapter 1. Note that a device address is not provided in the heading of a Test Request message. An address must be manually entered by the operator as part of the text; this is because the operator may specify the address of another device for test operations with the program.

The status and sense bits are described later in this chapter under "Status and Sense (S/S) Bytes."

(Note: This figure is referenced in Figures 4-2 and 4-6.)

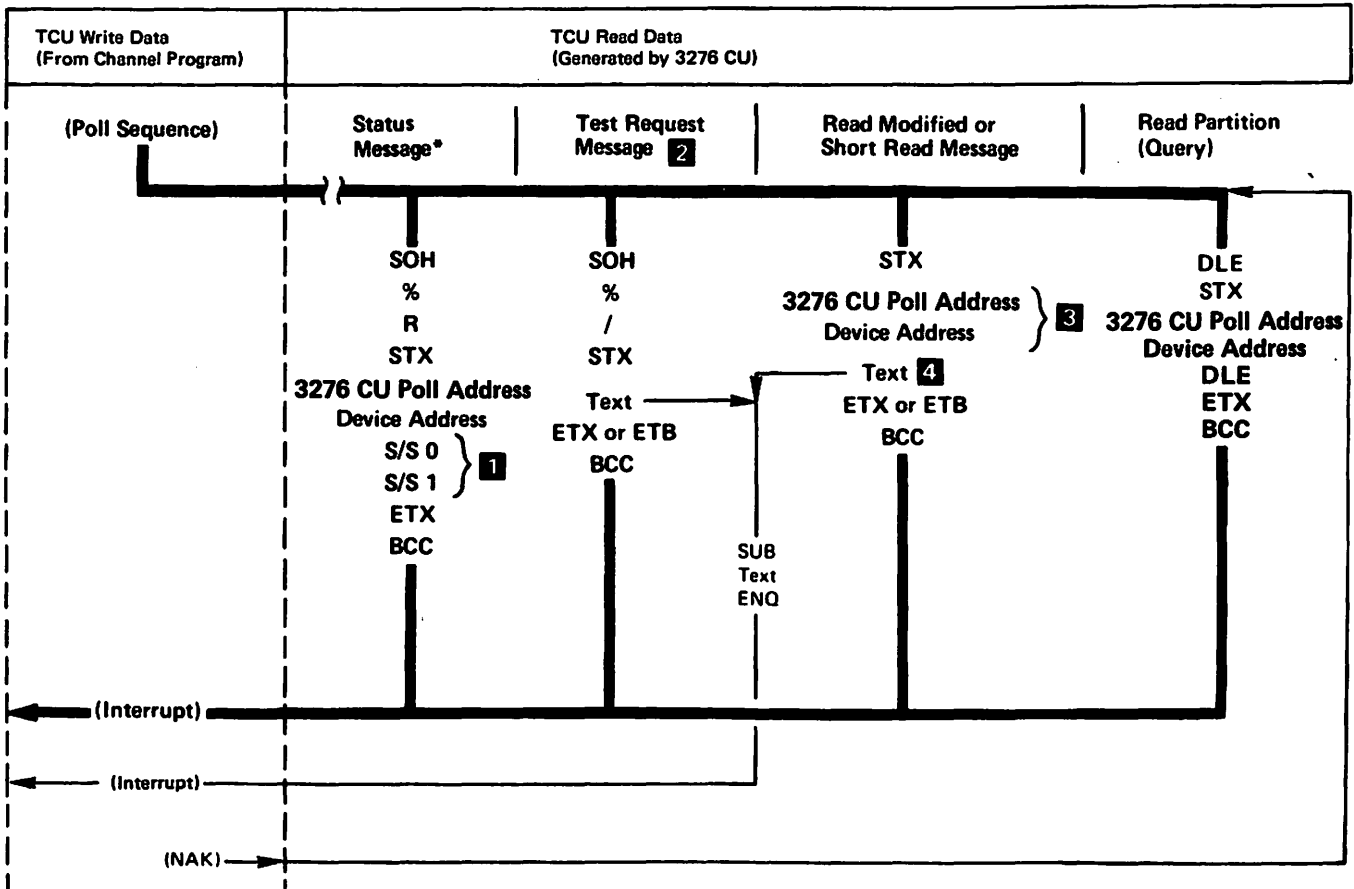

* Response to General Poll or Specific Poll only (not program-generated Read Modified command)

Notes:

- 1 A status message response is issued to a General or Specific Poll if (1) the 3276 CU has pending status (General Poll ignores Device Busy and device "unavailable" and, if the 3276 continues polling of next device), or (2) if error status develops during execution of the poll. Status and sense bit assignments are described in Figure 3-7.
- 2 A Test Request Message response is issued to a General or Specific Poll if a SYS REQ key is pressed at a 3278 or 3279 attached to a 3276.
- 3 This address is included only in the first block of a blocked text message.
- 4 The text portion of this message is the result of either a Read Modified or Short Read operation by the 3270 CU. Figure 3-5 lists each operator action and the resulting read operation that will be performed.

Legend:

(Interrupt) = TCU-generated interrupt.

- 1 Reversed numbers refer to notes.

Figure 3-3. 3276 CU Message Response to Polling or Read Modified Command

Selection Addressing Sequence

The selection addressing sequence (Figure 3-4) specifies a 3276 and an attached device in preparation for write-, control-, or read-type command sequences. It is similar in format to a Specific Poll sequence in that a CU address is sent, followed by a device address, but different I/O characters and hex codes are used to represent the CU address bytes.

Column 1 in Figure 3-1 lists the characters and hex codes used to complete the selection addressing sequence. Comparative examples showing CU and device address codes for General Poll, Specific Poll, and selection addressing sequences appear at the bottom of Figure 3-1.

For the 3276, the selection addressing sequence performs a function similar to a local Select command in that it causes a device-to-control unit buffer transfer. The 3276 provides a positive response to a selection sequence before transfer of a device buffer to the 3276. If an error occurs during buffer transfer, following receipt of a valid selection addressing sequence, a positive response to the selection sequence is provided by the 3276, and DC and US status are internally set. EOT is sent in response to the following 3276 command.

Write-Type and Control-Type Command Sequences

The program initiates a Write, Erase/Write, Erase/Write Alternate, Copy, or EAU operation (Figure 3-5) by first writing a command and, except for EAU, a data sequence to the selected 3276 and, then, reading the response. All write-type commands and Copy commands must be followed by a minimum of one data byte (the WCC or CCC byte). If the program reads a positive response (ACK) from the 3276, it can terminate the operation or continue with another command. The program can write blocks of text to the 3276 by initiating, after receipt of each ACK, a Write command sequence for each block to be written.

Write data is blocked to devices attached to a 3276 as follows: Each time the 3276 receives a selection addressing sequence, it begins to transfer the device buffer contents to the control unit buffer. As the Write command data is received by the control unit, updating occurs, and the result is asynchronously transferred to the buffer of the addressed device. The device buffer contents not affected by the write data stream remain unaltered in the device buffer. If the transmission of a block of data to the control unit is successful (ACK reply), a device-to-control-unit buffer transfer is begun. If the transmission of a block of write data to the control unit is unsuccessful (e.g., NAK reply), the buffer contents previously stored in the control unit buffer are immediately transferred to the device buffer before another Write command is received. These contents include any previous text blocks that were written successfully. Thus, the 3276 can receive retransmission of the block that was unsuccessfully received.

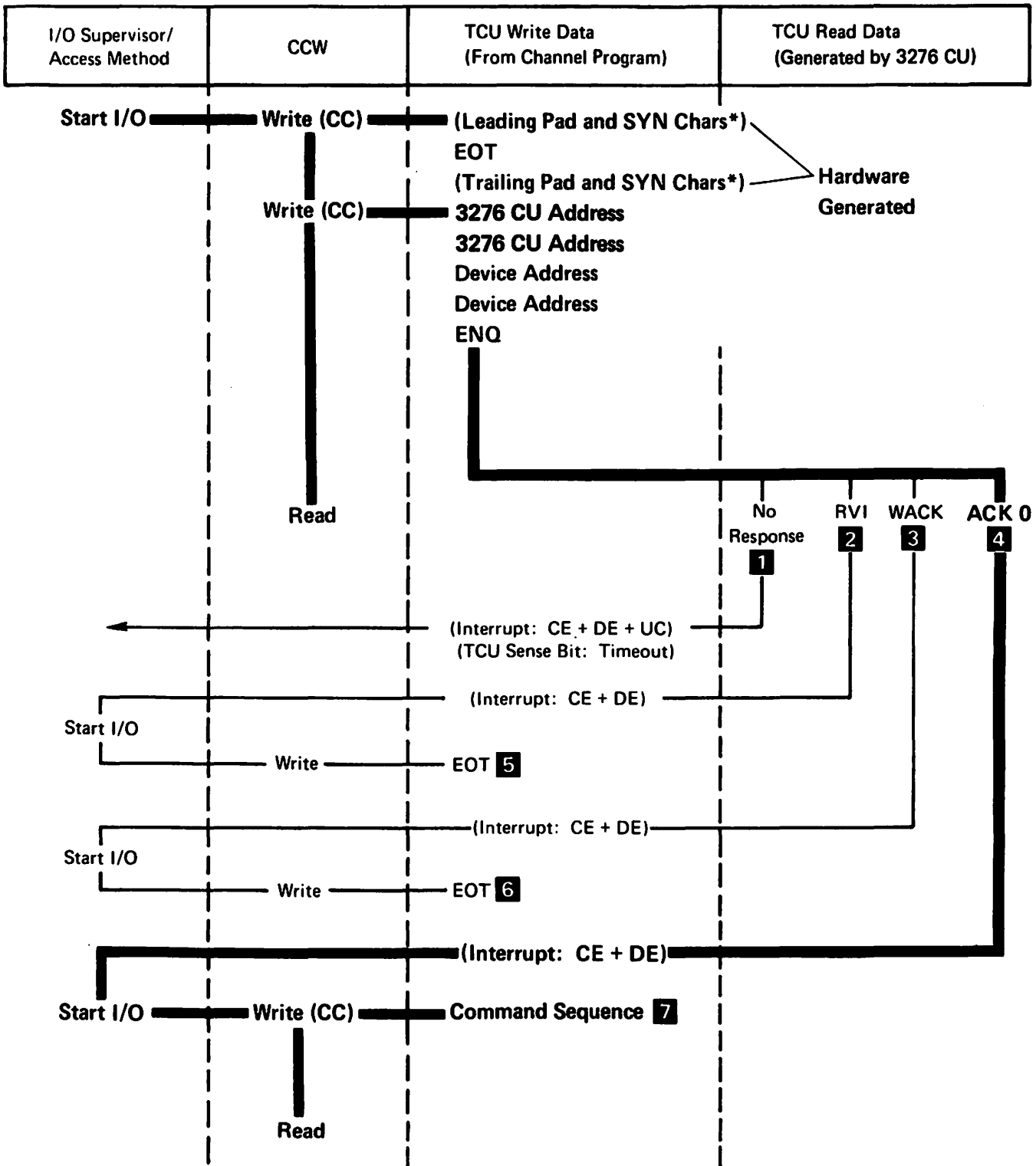

*Only the critical framing characters (sync pattern and pad) are shown. All other framing characters are also hardware-generated as required. See *SL General Information – Binary Synchronous Communications, GA27-3004*, for a complete description.

Figure 3-4 (Part 1 of 2). Selection Addressing, Sequence/Response Diagram

Notes:

- 1** *The 3276 CU will fail to respond to the addressing or polling sequence causing a TCU timeout, for any of the following reasons:*
 - *The 3276 CU is "unavailable" (has power off, is "offline", or is not attached).*
 - *Any character in the polling sequence is invalid.*
 - *The characters in the polling sequence are out of order.*
 - *The polling sequence is incomplete (less than seven characters).*
 - *The 3276 CU address is incorrect in the write data stream.*
 - *The addressed 3276 CU was left selected from the previous transmission.*
- 2** *The addressed device has pending status (excluding Device Busy or Device End).*
- 3** *The addressed 3276 device is busy. No S/S information is stored. An RVI response takes precedence over a WACK response.*
- 4** *The address has been successfully received, no status is pending.*
- 5** *Termination of attempted addressing sequence:*
Availability of valid status and sense information cannot be ensured unless a Specific Poll is issued to the responding device as the next addressing sequence issued to this 3276 CU.
- 6** *Termination of attempted addressing sequence.*
- 7** *Refer to Figure 3-5 or 3-6 for the desired command sequence.*

Legend:

(CC) = Chain Command (CC) Flag in CCW is set to 1.

(Interrupt) = TCU-generated interrupt (CE = Channel End, DE = Device End, and UC = Unit Check)

1 Reversed numbers refer to notes.

Figure 3-4 (Part 2 of 2). Selection Addressing, Sequence/Response Diagram

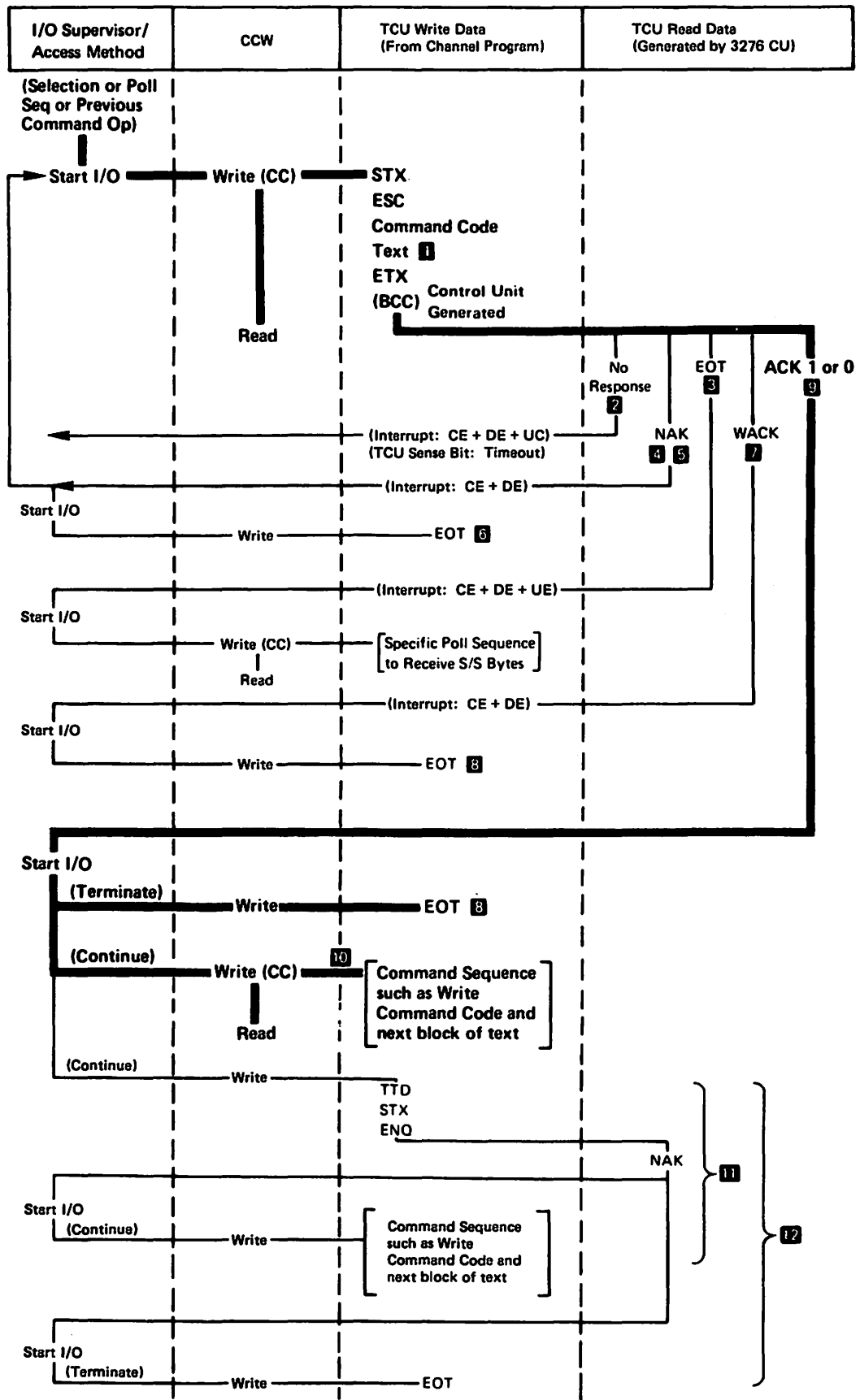

Figure 3-5 (Part 1 of 2). Write-Type and Control-Type Commands, Sequence/Response Diagram

Notes:

- 1** No text is transmitted on an EAU command transmission.
- 2** Command transmission was not successfully received because of invalid framing (STX missing). Causes a timeout at TCU.
- 3** The control unit is unable to perform the operation indicated in the command transmission because of a busy/unavailable/not ready device.
- 4** If a transmission problem causes both a 3276 CU detected check condition and a BCC error, the BCC error takes precedence over all other check conditions, and a NAK is transmitted to the TCU.
- 5** BCC error or missing ETX has been detected. The NAK response requests the program to repeat its last transmission.
- 6** Response issued by the program to terminate the operation if the 3276 CU is unsuccessful in receiving a valid BCC following "n" attempts by the program to transmit the message.
- 7** If the Start Printer bit is set in the WCC or CCC, a WACK response indicates that the text transmission was successfully received but that the printer is now busy and an additional chained command cannot be accepted.
If any of the conditions cited in Note **3** prevail, the EOT response takes precedence over the WACK response.
- 8** Normal termination of the operation by the program.
- 9** Command execution has been successfully completed.
- 10** Repeat the operation shown in this figure or in Figure 3-6 for the next command sequence.
- 11** Example of a Temporary Text Delay (TTD) sequence.
- 12** Example of terminating an operation using TTD (a forward abort sequence).

Legend:

(CC) = Chain Command (CC) Flag in CCW is set to 1.

(Interrupt) = TCU-generated interruption (CE = Channel End, DE = Device End, UE = Unit Exception, UC = Unit Check).

1 = Number in parentheses refers to note.

Figure 3-5 (Part 2 of 2). Write-Type and Control-Type Commands, Sequence/Response Diagram

Read-Type Command Sequences

Programming Note: Read Buffer is used primarily for diagnostic purposes, and Poll (General and Specific) is normally used in place of Read Modified for remote read operations.

The program initiates a read operation (Figure 3-6) by first writing a command sequence to the selected 3276, and then reading the response. If the 3276 responds with text followed by ETB, and if BCC comparison at the TCU is successful, the program should write ACK to retrieve the next text block. This should continue until an error is detected or until a text block is followed by ETX. After ETX is received, the program should write ACK to the 3276 and then read the EOT reply. The three types of Read Modified message responses are shown in Figure 3-3.

The 3276 will retransmit text up to 15 times when NAK or an incorrect ACK is received or when ENQ is received in response to a conversational text reply to a Read command. The 3276 supports limited-conversational-text mode. If the host transmits a text block following receipt of a text transmission which ends in ETB, a timeout occurs at the 3276 unit and ENQ is sent to the host.

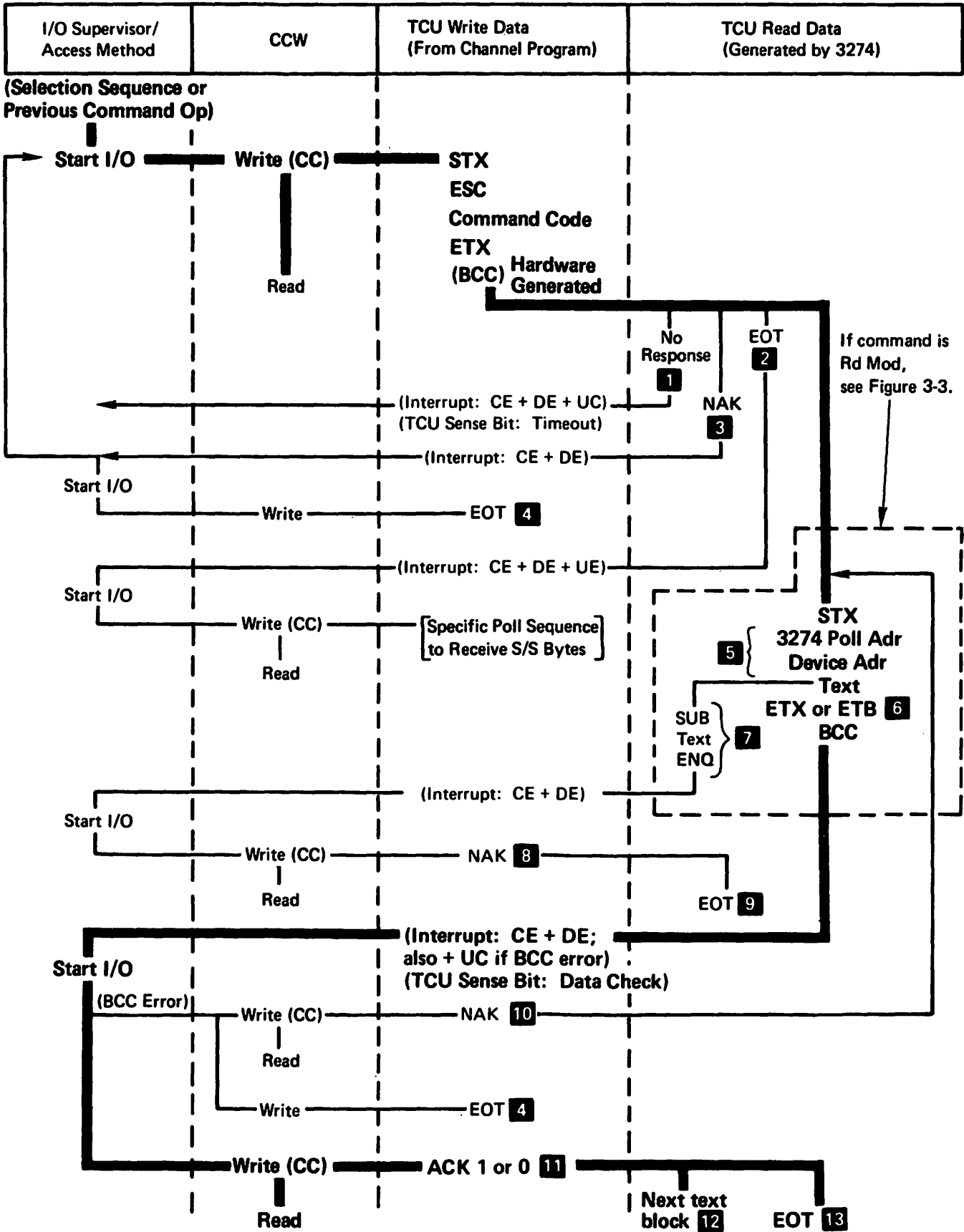

Figure 3-6 (Part 1 of 2). Read-Type Command, Sequence/Response Diagram

Notes:

- 1** Command transmission was not successfully received because of invalid framing (STX missing). Causes timeout at TCU.
- 2** The 3276 CU is unable to perform the operation indicated in the command transmission because of a busy/unavailable/not ready device or a 3276 CU-detected check condition (receipt of an illegal command/order sequence, failure to decode a valid command, or an I/O interface "overrun"). The EOT response to a command transmission indicates that status information is stored in the 3276 CU. To ensure retrieval of valid status, a Specific Poll must be issued to the device-responding EOT as the next addressing sequence issued to this 3276 CU.
- 3** If a transmission problem causes both a 3276 CU-detected check condition and a BCC error, the BCC error takes precedence over all other check conditions, and a NAK is transmitted to the TCU.
- 4** Response issued by the program to terminate the operation if the 3276 CU is unsuccessful in receiving a valid BCC following "n" attempts by the program to transmit the message.
- 5** This address sequence is included only in the first block of a blocked text message.
- 6** ETB is used to frame each block of a blocked text message, except for the last block. ETX is used to frame the last block of a blocked text message.
- 7** Upon detection of an internal parity check, the 3276 CU automatically substitutes the SUB character for the character in error. If a parity or cursor check is detected, ENQ 1, transmitted in place of ETX (or ETB) and BCC at the end of the text block and appropriate status and sense information is stored. This is also used by the 3276 if, after transmitting the first block, the transmission cannot be completed due to power being off at the terminal.
- 8** Mandatory program response to a text block terminated in ENQ.
- 9** Response to terminate the operation. The nature of the error (parity or cursor check) does not warrant a retry. This response indicates that appropriate status and sense information is stored. The status retrieval information included in Note **2** applies.
- 10** BCC error has been detected. The program issues NAK to cause the 3276 CU to repeat its last transmission.
- 11** Positive acknowledgement. The text block has been successfully received by the TCU. The program issued ACK 1 in response to the first and all odd-numbered text blocks and issued ACK 0 in response to the second and all even-numbered text blocks. This response to a text block terminated in ETX turns on the device SYSTEM AVAILABLE indicator.
- 12** The second and all succeeding text blocks are framed as the first except that they do not include the 3276 CU/device address sequence.
- 13** Normal termination of the operation following transmission of the last text block.

Legend:

(CC) = Chain Command (CC) Flag in CCW is set to 1.

(Interrupt) = TCU-generated interrupt (CE = Channel End, DE = Device End, UE = Unit Exception, UC = Unit Check)

- 1** Reversed numbers refer to notes.

Figure 3-6 (Part 2 of 2). Read-Type Commands, Sequence/Response Diagram

Status and Sense (S/S) Bytes

All remote status and sense conditions are combined into 2 bytes. These 2 bytes are always sent in a status message. In EBCDIC code, the bits are transmitted as indicated in Figure 3-7. If the sense bytes are transmitted in ASCII code, the EBCDIC code defined below is translated to ASCII before transmission.

Status and sense conditions are recorded by the 3276 for each device. These conditions may include busy or ready status or detected errors. Figure 3-8 shows how these status and sense conditions are interpreted for each error response transmitted by the 3276 in response to a poll sequence from the TCU.

Error-Recovery Procedures

Errors detected at the 3276 are indicated to the system processor by the following responses: RVI, NAK, EOT, or sense/status information. The meaning of the responses depends upon their sequences, as defined in Figures 3-2 through 3-6.

When errors occur in the 3178, 3278 and 3279, the error condition is reported once to a General Poll. The 3276 allows parts of messages to be transmitted to the host before all data is transferred from the 3178, 3278, and 3279 to the 3276. If a terminating condition prevents completion of data transfer from the 3178, 3278, and 3279 to the 3276 after inbound link transmission has started, the 3276 sends STX SUB ENQ. The 3276 responds to a Specific Poll with DC status. Following a selection addressing sequence, a write-type command is accepted but a read-type command is rejected, and DC status is returned by the 3276.

When the host selects the 3276 and issues a Read Modified command, the 3276 transmits a single block of text followed by ETX. If the host makes an error by starting a new command sequence with STX, the 3276 responds with ENQ. If more than one text block is transmitted to the host, with ACK received from the host after each ETB, the host may respond to ETX on the last block, with a new command sequence beginning with STX, ESC.

Figure 3-9 lists the various error combinations of sense/status bits (with the exception of Device Busy (DB), which is not an error) and the recommended error-recovery procedure for each combination. Although there are 256 possible combinations of status and sense bits, only a portion of this total is normally used. Combinations other than those listed may occur. For example, an unpredictable catastrophic hardware failure could induce an undefined combination of status and sense bits. Errors that occur at the "from" device during a Copy command are identified by an Operation Check (OC) sense bit in addition to the sense bit representing the detected error.

| Bit No. | Bit Definition |
|--|--|
| <p>S/S Byte 0:</p> <p>0</p> <p>1</p> <p>2</p> <p>3</p> <p>4</p> <p>5</p> <p>6</p> <p>7</p> | <p>Dependent upon setting of bits 2-7.</p> <p>Always a 1.</p> <p>Reserved.</p> <p>Reserved.</p> <p>Device Busy (DB) – This bit indicates that the addressed device (except the 3178, 3278, or 3279) is busy executing an operation or that a busy detection was previously made by a command or Specific Poll. The device is busy when it is executing an Erase All Unprotected command or a print operation, accepting data from the operator identification card reader, or performing various keyboard operations (ERASE INPUT, Backtab, and CLEAR). This bit is set with Operation Check when a Copy command is received which specifies a “busy” device with its “from” address. This bit is set with Unit Specify when a command is addressed to a busy device. This can occur by chaining a command to a Write, Erase/Write, Erase/Write Alternate, or Copy command which started a printer or by chaining a command to a Specific Poll addressed to a busy device. Note: DB is not returned for the 3178, 3278, or 3279 when executing an Erase All Unprotected command, accepting data from the MSR, or performing ERASE INPUT, Backtab, or CLEAR keyboard operations.</p> <p>Unit Specify (US) – This bit is set if any S/S bit is set as a result of a device-detected error or if a command is addressed to a busy device.</p> <p>Device End (DE) – This bit indicates that the addressed device has changed from unavailable to available and not ready to ready, or busy to not busy. This bit is included during a Specific or General Poll but is not considered pending status by a selection-addressing sequence. If a selection-addressing sequence detects that the addressed device has pending status and also detects one of the above status changes that warrants a Device End, then the Device End bit is set and preserved along with the other pending status, and an RVI response is made.</p> <p>Reserved.</p> |
| <p>S/S Byte 1:</p> <p>0</p> <p>1</p> <p>2</p> <p>3</p> <p>4</p> <p>5</p> <p>6</p> <p>7</p> | <p>Dependent upon setting of bits 2-7.</p> <p>Always a 1.</p> <p>Command Reject (CR) – This bit is set upon receipt of an invalid 3270 command.</p> <p>Intervention Required (IR) – This bit is set if:</p> <ul style="list-style-type: none"> • A Copy command contains a “from” address in its data stream which specifies an unavailable device. • A command attempted to start a printer but found it not ready. The printout is suppressed. • The 3276 receives a selection-addressing sequence or a Specific Poll sequence for a device which is unavailable or which became not ready during a printout. A General Poll sequence does not respond to the unavailable/not ready indication and proceeds to determine the state of the next device. • The 3276 receives a command for a device which has been logged as unavailable or not ready. <p>Equipment Check (EC) – This bit indicates a printer character generator or sync check error occurred, the printer became mechanically disabled, or a 3276 detected bad parity from the device.</p> <p>Data Check (DC) – This bit indicates the detection of bad parity from the device, or 3276 operation to a device was unsuccessful (i.e., the device was disabled with DC returned to the host; IR will be returned on subsequent retry by the host).</p> <p>Control Check (CC) – For the 3276, this bit indicates a timeout check. A timeout check occurs when a device fails to respond to 3276 communications within a specified time period or when a device fails to complete an operation within a specified time period.</p> <p>Operation Check (OC) – This bit, when set alone, indicates one of the following:</p> <ul style="list-style-type: none"> • Receipt of an illegal buffer address or of an incomplete order sequence on a Write, Erase/Write, or Erase/Write Alternate command. • The device did not receive a CCC or a “from” address on a Copy command. • Receipt of an invalid command sequence. (ECS is not received in the second data character position of the sequence.) • The internal buffering capability is exceeded on a 3276. This bit is set with Unit Specify to indicate that the “from” address on a Copy command specified a device with a “locked” buffer (the device data is secure). |

Figure 3-7. Remote Status and Sense Byte Definitions –BSC

| Device Response | Command | S/S Explanation |
|-----------------|----------------|---|
| RVI | Selection | <p>Outstanding Status – Pending information from a previous operation with the same device. (If the addressed device is busy, WACK is sent to the TCU instead of RVI, and no S/S bit is set.) <i>Note: A selection-addressing sequence does not recognize a Device End as pending status. If there is no other pending status, it resets this bit and proceeds with the selection. If the addressed device has other pending status, Device End remains set with it, and the RVI response is made as usual.</i></p> <p>CC – A timeout check is caused by the addressed device. The operation is tried twice before this bit is set.</p> <p>CC, IR – Power on reset occurs during selection.</p> <p>IR – The addressed device is unavailable.</p> <p>DE, IR – The addressed printer is out of paper, its power has been turned off, or its cover is open.</p> <p>DE, IR, EC, US – The addressed printer is mechanically disabled and cannot recover.</p> <p>DE, DC, US – A parity error is detected at the printer.</p> <p>DC, US – A parity check or cursor check is detected by the addressed device on the data it is sending to the control unit. For a 3276, an operation to a terminal was unsuccessful. The terminal was disabled and DC US returned to the host. On subsequent retry by the host, IR will be returned to the host.</p> |
| EOT | Read Commands | <p>CR – Invalid 3270 command is received.</p> <p>OC – Invalid command sequence (ESC is not in the second data character position), or data follows the command in the data stream received at the device.</p> <p>DB, US – The addressed device is busy. The command was chained to a Write, Erase/Write, Erase/Write Alternate, or Copy command which started a print, or it was chained to a Specific Poll.</p> <p>IR – A command is addressed to an unavailable device.</p> <p>DC – The 3276 is unable to complete a Read command operation after the first block has been sent to the host, because either there was an error in the terminal or the terminal was powered off after the first block was sent. A SUB character and an ENQ character are placed in the buffer.</p> <p>DC, US – A parity check or cursor check is detected by the addressed device on the data it is sending to the control unit. For a 3276, an operation to a terminal was unsuccessful. The terminal was disabled and DC US returned to the host. On subsequent retry by the host, IR will be returned to the host.</p> |
| EOT | Write Commands | <p>CR – An invalid or illegal 3270 command is received.</p> <p>OC – An invalid command sequence (ESC is not in the second data position), an illegal buffer address or an incomplete order sequence is received, or a data byte was sent to the device during the Write command before the operation required by the previous data byte was completed.</p> <p>DC, US – The device detects a parity or cursor check on its buffer during the command operation. For a 3276, an operation to a terminal was unsuccessful. The terminal was disabled and DC US returned to the host. On subsequent retry by the host, IR will be returned to the host.</p> <p>CC – The device fails to complete an operation.</p> <p>DB, US – The addressed device is busy. The message is accepted but not stored in the 3276 buffer. The command is aborted.</p> |

Figure 3-8 (Part 1 of 2). Remote Error Status and Sense Responses – BSC

| Device Response | Command | S/S Explanation |
|-----------------|--|---|
| EOT | Copy Command | <p>CC, OC – The "from" device fails to complete an operation or respond to the 3271 in a certain time (timeout check). (Not used for the 3274 or 3276.)</p> <p>DB, OC – The "from" device is busy. (The device is busy executing an operation, a printout, reading data from the operator identification card reader, or performing a keyboard operation.) The Copy command is aborted.</p> <p>IR, OC – The "from" device is not available.</p> <p>OC, US – The "from" device has a locked buffer.</p> <p>CC – The data stream contains other than two bytes (the CCC and the "from" address). The command is aborted.</p> <p>OC – The "from" device buffer is larger than the "to" device buffer.</p> <p>OC – The buffer of the "from" device (as APL/Text feature) contains APL/Text characters (entered since an Erase/Write or Erase/Write Alternate command or a CLEAR key operation) and the "to" device does not have the APL/Text feature.</p> <p>DC, OC, US – Set when "from" device detects an internal parity or cursor check. For 3274 or 3276, an operation to a terminal was unsuccessful. The terminal was disabled and DC US returned to the host. On subsequent retry by the host, IR will be returned to the host.</p> <p>DB, US – The addressed "to" device is busy.</p> |
| EOT | Write, Erase/Write, Erase/Write Alternate, Copy Commands | <p>IR – Addressed device is not available, or addressed printer is not ready.</p> |
| EOT | Erase All Unprotected Command Specific and General Poll | <p>OC – One or more data bytes followed the command (buffer overrun).</p> <p>DE, IR, EC, US – An unrecoverable mechanical failure is detected at the printer.</p> <p>DC, US – A parity check or cursor check is detected by the addressed device on the data it is sending to the control unit. For a 3276, an operation to a terminal was unsuccessful. The terminal was disabled and DC US returned to the host. On subsequent retry by the host, IR will be returned to the host.</p> <p>DC – The 3276 is unable to complete a Read Command operation after the first block has been sent to the host, because either there was an error in the terminal or the terminal was powered off after the first block was sent. A SUB character and an ENQ character are placed in the buffer.</p> <p>DE – The poll finds a device (1), previously recorded as busy, now not busy or, (2), previously recorded as unavailable or not ready, now available and ready.</p> <p>IR, DE – The poll finds a device, previously recorded as ready, available, and busy, now not ready and not busy, or the printer went not ready during a printout.</p> <p>DC, US, DE – A parity error is detected at printer.</p> <p>CC (Specific Poll only) – The poll finds a device, previously recorded as unavailable, still unavailable (timeout check).</p> |
| NAK | Read and Write Commands | <p>NAK is transmitted by the 3276 when it detects a block check character (BCC) error on the TCU transmission. A BCC error has priority over all other detectable error conditions. If, for example, a BCC error and parity error are detected during the same command transmission, the parity error condition is reset, and a NAK response is set by the 3276.</p> |

Figure 3-8 (Part 2 of 2). Remote Error Status and Sense Responses – BSC

| Sense/ Status Bits | Detected during 3270 Operation | | | | | | Transmitted in Response to: | | Error Recovery Procedure |
|--------------------------|--------------------------------|-------|-------------------------------------|------------------------------|-----------------------------|-------------------|-----------------------------------|-----------------|--------------------------------|
| | Hex | | Selection Addressing Sequence | Specific Poll Sequence | General Poll Sequence | A 3270 Command | Specific Poll | General Poll | 3276 |
| | EBCDIC | ASCII | | | | | | | |
| CR | 40 60 | 20 2D | | | | D, P | D, P | | 6 |
| OC | 40 C1 | 20 41 | | | | D, P | D, P | | 6 |
| OC, US | C4 C1 | 44 41 | | | | D, P | D, P | | 13 |
| IR | 40 50 | 20 26 | D, P | D, P | | D, P | D, P | | 4 |
| IR, OC | 40 D1 | 20 4A | | | | D, P | D, P | | 5 |
| DC | 40 C4 | 20 44 | D, P | D, P | D, P | D, P | D, P | D, P | 2 |
| DC, US | C4 C4 | 44 44 | D, P | D, P | D, P | D, P | D, P | D, P | 2 |
| DC, OC, US | C4 C5 | 44 45 | | | | D, P | D, P | | 3 |
| DC, US, DE | C6 C4 | 46 44 | | P | P | | P | P | 8 |
| IR, DE | C2 50 | 42 26 | | P | P | | P | P | 4 |
| IR, EC, US, DE | C6 D8 | 46 51 | | P | P | | P | P | 7 |
| DB | C8 40 | 48 20 | D, P | D, P | | | D, P | | 9 |
| DB, US* | 4C 40 | 3C 20 | | | | D, P | D, P | | 10 |
| OC, DB* | C8 C1 | 48 41 | | | | D, P | D, P | | 11 |
| DE | C2 40 | 42 20 | | D, P | D, P | | D, P | D, P | None |
| CC, IR | 40 D2 | 20 4B | | D, P | D, P | D, P | D, P | | 4 |

Note: The attached device errors that are detected asynchronously do not cause a sense bit to set until the device is polled for status during a selection-addressing, Specific Poll, or General Poll sequence. Those error S/S bit combinations that contain DE were detected during a printout.

*The DB, US, and OC S/S bits will be combined if a Copy command is addressed to a busy "to" device and the command also specifies the "from" device the same as the "to" device.

Legend:

- NA — Not Applicable
- D — Display (3178, 3276, 3278, 3279)
- P — Printer

Figure 3-9. Remote 3276 BSC Status and Sense Conditions

The error-recovery procedures recommended in Figure 3-9 are as follows:

1. Execute a new address selection addressing sequence and retransmit the message, starting with the command sequence that was being executed when the error occurred. If, after two retries, the operation is not successful, this should be considered a nonrecoverable error. Follow supplementary procedure B after two retries.
2. Reconstruct the entire device buffer if possible, and retry the failing chain of commands (within the BSC sequence of operations). The sequence of commands used to reconstruct the buffer should start with an Erase/Write or Erase/Write Alternate command. If the information in the screen buffer is such that it cannot, or need not, be reconstructed, the operation may still be retried. If an unrecoverable 3178, 3278, and 3279 buffer error or an error occurring on a transfer between the 3276 and the 3178, 3278, and 3279 is detected, the entire buffer is cleared and the host system is informed of the error by receiving DC, US status but is not informed of the clear operation. If, after three retries, the operation is not successful, this should be considered a nonrecoverable error. Follow supplementary procedure A.

3. The error occurred during execution of a Copy command. Execute procedure 2, except that it is the buffer of the "from" device specified by the Copy command that should be reconstructed. After three retries, follow supplementary procedure B, listed below under "Supplementary Procedures."
4. The error indicates that the printer is out of paper, has its cover open, or has a disabled print mechanism; or it indicates that the device is unavailable. Request (or wait for) either the display or system operator to ready the device. Then, retry the printout by issuing a Write command with the proper WCC and no data stream. (There is no data error, and the data is still intact in the device buffer and can be reused.) OR, follow procedure 2.
5. The error indicates that the "from" device specified by a Copy command is unavailable. Note that the device address associated with the error status and sense information does not indicate the device that actually required "readying." The device that requires the corrective action is the device specified by the "from" address in the Copy command. When the device is determined and made "ready," follow procedure 1.
6. The operation should be tried up to six times. Continued failure implies an application programming problem which can be detected by analyzing the failing write data stream.
7. The error occurred during a printout operation and indicates either a character-generator error or a disabled print mechanism. There is no data error. The proper error-recovery procedure is application-dependent since the user may or may not want a new printout. If a new printout is required, follow procedure 4.
8. A data error occurred in the device buffer during a printout; procedure 2 should be followed.
9. A Specific Poll detected that the addressed device is busy. Periodically issue a Specific Poll to pick up the Device End sense/status bit sent by the device when it becomes not-ready (unless this status change is detected on a selection addressing sequence).
10. Indicates that a command was erroneously addressed to a busy device. Periodically issue a General or Specific Poll to pick up the Device End sense/status bit sent by the device when it becomes not busy. Then follow procedure 1.
11. Indicates that, in attempting to execute a Copy command, the "from" device was found to be busy. Follow procedure 1 when the "from" device becomes not busy. Note that the device address associated with the status and sense message is the address of the "to" device and not that of the busy "from" device. The "from" device will transmit Device End via a Specific or General Poll when it becomes not busy.
12. An attempt was made to execute a Copy command, but access to the "from" device data was not authorized. The device address associated with the error sense/status bits is that of the copy "to" device.

Supplementary Procedures

- A. Request maintenance for the device that is giving trouble. After repair, reconstruct the screen buffer image. The sequence of commands used to reconstruct this image should start with an Erase/Write command. Retry the failing chain of commands according to the procedure that referred you to this supplementary procedure.
- B. The "from" device specified by the Copy command in the failing chain of commands (CCWs) is malfunctioning. The "from" device should be determined from the data-stream information, and maintenance should be requested for the device. After the repair, reconstruct the buffer image. The sequence of commands used to reconstruct this image should start with an Erase/Write command. Retry the failing chain of commands according to the procedure that referred you to this supplementary procedure.
- C. Same as procedure 1, except a new selection addressing sequence is not performed, and this message is transmitted as part of the present device selection.
- D. Same as procedure 1, except retransmit the entire failing chain of commands.

NAK to a Text Block

When the 3276 detects a BCC error at the end of a text transmission, it transmits a NAK. The following recovery action should be taken.

If the text is a write command sequence chained from a previous Write, Erase/Write, or Erase/Write Alternate command, and if the failing write command data stream contains more than one byte but does not contain an SBA order sequence immediately following the WCC, then procedure 2 (above) should be executed.

In all other cases, supplementary procedure C (above) should be executed, except the number of retries should be six. If after these six retries the problem is not corrected, the program should issue an EOT and follow supplementary procedure A (above).

Note: An FF (hex) character in a data field does not cause a BCC error when operating with the 3276 units.

EOT to a Text Block

The recommended recovery procedure depends upon the type of detected error. A Specific Poll must be issued immediately following the EOT to obtain the error sense/status information. Then the recovery procedures referenced in Figure 3-9 should be executed.

Errors Detected during a Specific or General Poll Sequence

Any errors that result from execution of the poll sequence itself are contained in Figure 3-9, and those recovery procedures apply. The detected error bits are transmitted to the TCU in a Status Message during the poll sequence.

RVI to Selection Addressing Sequence

A Specific Poll must be issued immediately following the RVI to a selection addressing sequence to obtain the error sense/status information. Then the recovery procedures defined in Figure 3-9 should be followed.

Chapter 4. 3276 SNA/SDLC Communications

This chapter provides information to aid the system analyst and the system programmer in establishing the host-to-3276 communications, using System Network Architecture (SNA) protocols. A knowledge of the Network Control Program (NCP), IBM access methods, and/or 3790 concepts, where the 3276 is attached to 3790, is assumed. The IBM access methods supporting SNA are VTAM, TCAM, and EXTM.

Additional information on SNA can be found in *Systems Network Architecture Format and Protocol Reference Manual: Architecture Logic*, SC30-3112. Information to assist the host programmer in planning the use of SNA commands and access method macros can be found in the following publications:

VTAM:

VTAM Concepts and Planning, GA27-6998.
VTAM Macro Language Reference, GC27-6995.
VTAM Macro Language Guide, GC27-6994.

TCAM:

TCAM Concepts and Application OS/VS, GA30-2049.
TCAM Programmer's Guide OS/VS1, GC30-2054.
TCAM Programmer's Guide OS/VS2, GA30-2041.

EXTM Option of CICS/DOS/VS:

EXTM Version 1.0 General Information, GH20-1597.
EXTM Version 2.0/3.0 General Information, GH20-1702.

3790 Communication System:

Introduction to the IBM 3790 Communication System, GA27-2807.

Network Control Program:

IBM 3704 and 3705 Communications Controller Network Control Program/VS Generation and Activities Guide and Reference Manual, GC30-3008.

Transmission Formats

The host program and the 3276 communicate using half-duplex, flip-flop, send-receive protocols. When the host program or the 3276 program is transmitting data, it assumes the role of the sending Logical Unit (LU). The LU to which the transmission is directed is the receiving LU. [An LU is the logical entity that communicates on behalf of an end user (such as a terminal or application program).] The term *outbound* refers to transmissions from the host to the 3276. The term *inbound* refers to transmissions from the 3276 to the host.

The portions of a transmission between the host and the 3276 that are discussed in this chapter are:

- Request/Response Header (RH). This header describes the type of message being transmitted and contains indicators that control SNA protocols.
- Request/Response Unit (RU). This contains the data or commands that flow in the transmission. (Note that occasional reference is made to a Null RU, that is, an RU that contains no data.)
- Transmission Header (TH). This header contains format identification, mapping fields, and an expedited flow indicator.

The 3276 can communicate with the host system by means of a teleprocessing network that uses the synchronous data link control (SDLC) transmission format. A description of SDLC transmission format is found in the *IBM Synchronous Data Link Control General Information* manual, GA27-3093.

Session Components

Within SNA, communication takes place between LUs. For 3276 operation, the host always contains the Primary Logical Unit (PLU), and the 3276 contains the Secondary Logical Unit (SLU). The 3276 can have from 1 to 8 SLUs (addresses 2 through 9).

A set of logical connections, called *sessions*, is required to control the exchange of data and control information between the host program and a 3276 SLU. At the host system, the access method provides the System Services Control Point (SSCP) function for all sessions that are established with the 3276. The SSCP maintains information that allows a PLU to establish and maintain an LU-LU session with a specific 3276 LU.

SNA Sessions

The sessions that must exist between the host system and the 3276, for an access method application program and the 3276 to exchange information, are as follows:

SSCP-PU [access method - 3276 Physical Unit (PU)]

SSCP-PLU (access method - host program)

SSCP-SLU (access method - 3276 SLU)

PLU-SLU (host program - 3276 SLU) (referred to as LU-LU)

The following paragraphs discuss the sessions individually and identify how they are established and terminated. The SNA commands that establish and terminate the sessions are identified. SNA commands are discussed in detail under the heading "SNA Commands."

SSCP-PU Session

Before establishing the SSCP-PU (access method - 3276 control unit) session, the physical transmission or channel connection to the host must be established.

The SSCP-PU session must be established before establishing the SSCP-SLU or LU-LU sessions. When the access method network operator activates a specific 3276, the access method issues the Activate Physical Unit (ACTPU) command to the control unit. A pre-defined start procedure for the access method may also request the activation of specific 3276 control units. The SSCP-PU session is the first session established between the host system and the 3276.

The SSCP-PU session is terminated when the access method network operator deactivates the 3276. When all SSCP-LU sessions for the control unit have been terminated, the access method issues the Deactivate Physical Unit (DACTPU) command. When the 3276 returns a positive response to the DACTPU command, the SSCP-PU session is terminated.

Figure 4-3 lists commands that are valid for the SSCP-PU session.

SSCP-Secondary LU Session

When the SSCP-PU session is established, an activate command may be issued to the access method to establish the SSCP-SLU session. The access method will issue an Activate Logical Unit (ACTLU) for the appropriate SLU or SLUs in the 3276. The SSCP-SLU session must be established before establishing the LU-LU session.

The SSCP-SLU session is terminated when the access method sends a Deactivate Logical Unit (DACTLU) command to the specified SLU. When the control unit returns a positive response to the DACTLU command, the SSCP-SLU session is terminated.

Figure 4-3 lists commands that are valid for the SSCP-SLU session.

LU-LU Session

Initiating an LU-LU Session

Three types of LU-LU sessions are supported by the 3276. Further description of these sessions is provided later in this section.

The LU-LU session types are:

- Type 1 — The device attached to the 3276 SLU is a printer, and the data stream is the SNA Character String (SCS).
- Type 2 — The device attached to the 3276 SLU is a keyboard/display, and the data stream is in the 3270 data stream compatibility (DSC) mode format.
- Type 3 — The device attached to the 3276 SLU is a printer, and the data stream is in the 3270 DSC mode format.

The SNA Bind command is used to differentiate these types of sessions.

The command flow sequence required to establish a session is summarized in Figure 4-1. The command flow nomenclature is generalized, and access method specific macro names are not used. The example assumes that no sessions are active between the host and the 3276. The access method sends the ACTPU command to establish the SSCP-PU session **1**. ACTLU commands **2** are then sent to establish SSCP-PLU and SSCP-SLU sessions. The SSCP-PLU session can be established by the host application any time prior to logon. The network is now ready for LU-LU sessions to be established.

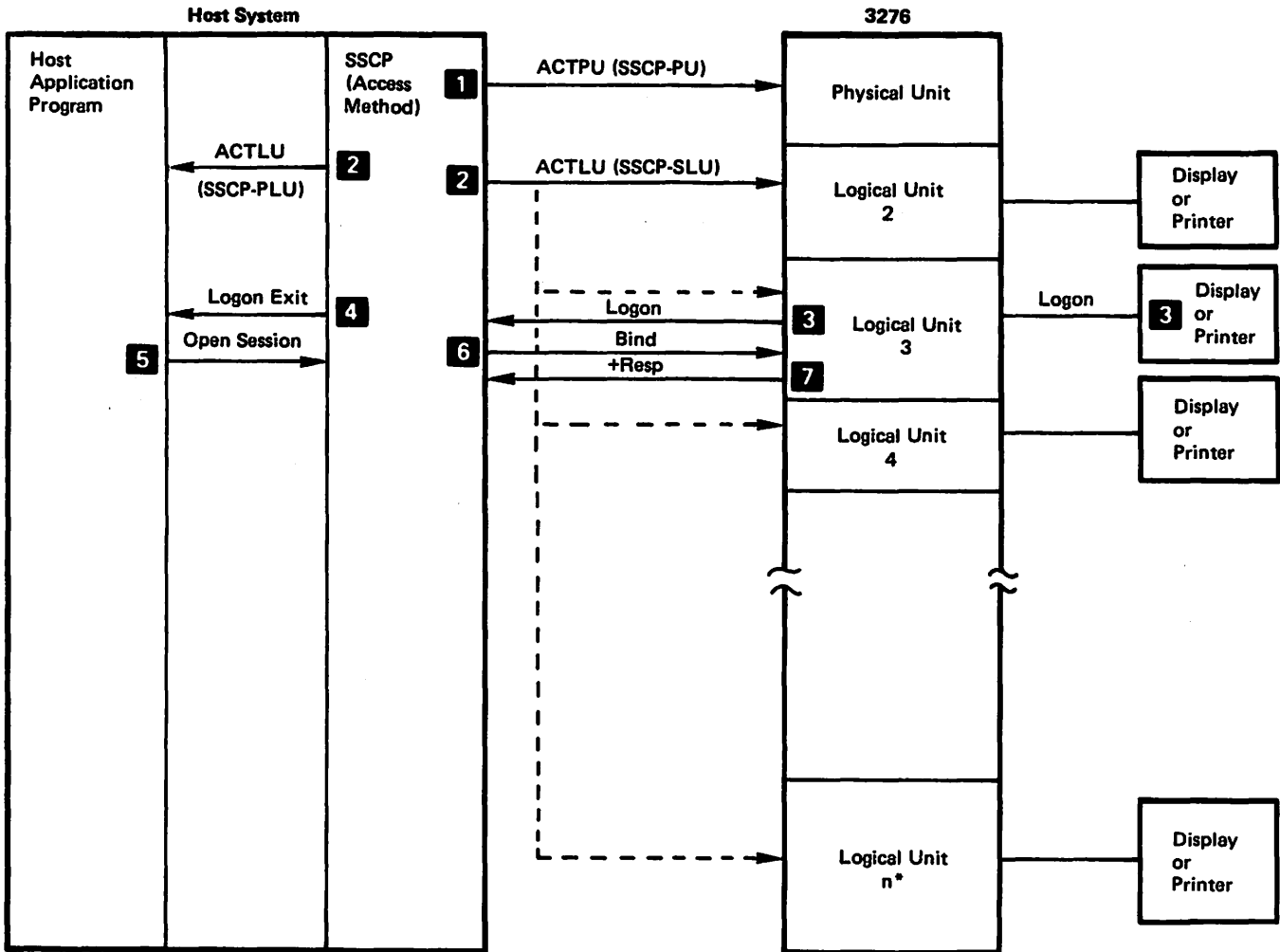

*The highest LU number for a 3276 is 9. (Note that LU1 is reserved for the 3276.)

Figure 4-1. Establishing a Session with a 3276

An LU-LU session is started by the host application program when it issues the Bind request. The LU-LU session may be initiated by the host application program (for example, acquiring the terminal or by a simulated logon) or by the display terminal operator **3** (a character-coded logon). If a character-coded logon is received by the access method, the access method translates the logon request and schedules a logon exit **4** for the PLU. After the PLU receives control at the logon exit, or when the PLU acquires a terminal, the PLU passes an open session request to the access method **5** which results in an SNA Bind **6** being passed to the SLU. The 3276 LU examines the session parameters of the Bind and, if they are acceptable, allows the session to be established by sending a positive response **7** to the Bind command. If the session parameters are not acceptable, the 3276 LU rejects the Bind command by returning a negative response, indicating that the session parameters are invalid (sense code X'0821'). Also, if power is not on at the device, a negative sense code X'080A' or X'0845' is returned to the Bind. Figure 4-4 identifies the bind parameters that can be specified for 3276 sessions.

After the Bind command has been accepted with a positive response, the host program can issue the Start Data Traffic command to allow data traffic to flow for the session.

The manner in which an LU-LU session may be initiated depends on the type of session being started. A type 1 or type 3 session must be initiated by the PLU. A type 2 session may be initiated by either the PLU or SLU.

3276 Attachment to a 3790

When the 3276 is attached to a 3790, the 3790 provides the services otherwise provided by the host access method. The logon message from the terminal operator is intercepted by the 3790 and examined to determine whether the session is to be established with the 3790 itself or with an application program in a host that is communicating with the 3790.

Terminating an LU-LU Session

The PLU can terminate an LU-LU session by requesting that the SSCP close the session. The SSCP then sends the Unbind command to the secondary LU and the LU-LU session is terminated.

Type 2 sessions can also be terminated by the display operator in either of two ways. The first method is to notify the PLU (where supported), on the LU-LU session, that termination is desired; the PLU then terminates the session. In the second method, the display operator changes from an LU-LU session to an SSCP-SLU session by use of the System Request (SYS REQ) key and enters a logoff message. The SSCP then passes the logoff request to the PLU, if the logoff message is conditional, or issues the Unbind for the PLU if the logoff message is unconditional. When the 3276 is attached to the 3790, all logoff requests are treated as unconditional.

A PLU may close the session in an orderly fashion by issuing a Shutdown command. When the host program issues the Shutdown command, the 3276 returns the Shutdown Complete command after completing any outstanding operation and entering the Between Bracket state. Note that the PLU must close a bracket with end bracket before the Shutdown command is effective.

Transmission Header

The 3276 terminals support FID2 transmission headers (TH). The transmission header consists of 6 bytes:

| | | |
|--------|-----------------|--|
| TH0: | FID (Bits 0-3) | Format Identification |
| | MPF (Bits 4,5) | Mapping Field |
| | RES (Bit 6) | Reserved |
| | EFI (Bit 7) | Expedited Flow Indicator |
| TH1: | RES (Bits 0-7) | Reserved |
| TH2: | DAF' (Bits 0-7) | Destination Address Field (See Figure 4-2 and "Device Addressing" in Chapter 1) |
| TH3: | OAF' (Bits 0-7) | Origin Address Field |
| TH4,5: | | Sequence Number on Normal, ID Number on expedited flow requests and responses |

| Device Number | Device Address Field | | | | | | | |
|---------------|----------------------|---|---|---|---|---|---|---|
| | Bits: 0 | 1 | 2 | 3 | 4 | 5 | 6 | 7 |
| PU | 0 | 0 | 0 | 0 | 0 | 0 | 0 | 0 |
| ** | 0 | 0 | 0 | 0 | 0 | 0 | 0 | 1 |
| 0 | 0 | 0 | 0 | 0 | 0 | 0 | 1 | 0 |
| 1 | 0 | 0 | 0 | 0 | 0 | 0 | 1 | 1 |
| 2 | 0 | 0 | 0 | 0 | 0 | 1 | 0 | 0 |
| 3 | 0 | 0 | 0 | 0 | 0 | 1 | 0 | 1 |
| 4 | 0 | 0 | 0 | 0 | 0 | 1 | 1 | 0 |
| 5 | 0 | 0 | 0 | 0 | 0 | 1 | 1 | 1 |
| 6 | 0 | 0 | 0 | 0 | 1 | 0 | 0 | 0 |
| 7 | 0 | 0 | 0 | 0 | 1 | 0 | 0 | 1 |

**Address reserved.

Figure 4-2. Device Addressing for SNA Terminals

The 3276 handles transmission headers received on outbound requests as follows:

1. All reserved parameters are ignored on requests.
2. MFP – The 3276 supports outbound segmenting for FM data.
3. EFI – The expedited flow indicator identifies normal (0) or expedited (1) flow requests.

EFI=1

The 3276 supports the following requests as outbound expedited flow requests:

| RU Category | Request |
|-------------|--|
| SC | ACTPU, DACTPU, ACTLU, DACTLU, BIND, UNBIND, CLEAR, SDT |
| NC | Not supported |
| DFC | SIGNAL, SHUTDOWN |
| FMD | Not supported |

When the 3276 receives any requests listed above with correct categories and EFI=1, they will be passed through for further processing. When the 3276 receives any requests listed above with incorrect categories and EFI=1 or any requests not listed above with EFI=1, it will reject them with the negative response sense code X'1003'. The 3276 handles all expedited flow requests as if they have ONLY-IN-CHAIN, NO BRACKET, NO CD, NO QRI, and NO PACING.

EFI=0

The 3276 supports the following requests as outbound normal flow requests:

| RU Category | Normal Request |
|-----------------|--------------------|
| SC | Not supported |
| NC | Not supported |
| DFC | CANCEL, BID, CHASE |
| FMD on PLU-SLU | Any request |
| FMD on SSCP-SLU | Any in SCS format |
| FMD on SSCP-SPU | REQMS |

When the 3276 receives any of the requests listed above associated with the correct categories and EFI=0, they will be passed through for further processing. When the 3276 receives any requests listed above with incorrect categories and EFI=0 or any requests not listed above with EFI=0, they will be rejected with the negative response code X'1003'.

SNA Commands

SNA commands define a set of controls to establish and terminate sessions, and to assist in the management of host-to-3276 data flow and sessions. Three types of SNA commands are discussed:

- Session Control (SC) commands – These commands establish and terminate sessions in the network.
- Data Flow Control (DFC) commands – These commands control the flow of data in an LU-LU session.
- Function Management Data (FMD) command – This command is used to transfer data in the LU-LU session.

Commands Supported

The SNA commands supported by the 3276 are listed in Figure 4-3.

| SNA Command | | | | | | | |
|-------------|------|------|----|------|-----|-----|----------------|
| Name | Type | SSCP | PU | SSCP | SLU | PLU | SLU |
| | | → | ← | → | ← | → | ← |
| ACTPU | SC | X | | | | | |
| DACTPU | SC | X | | | | | |
| ACTLU | SC | | | X | | | |
| DACTLU | SC | | | X | | | |
| BIND | SC | | | | | X | |
| UNBIND | SC | | | | | X | |
| SDT | SC | | | | | X | |
| CLEAR | SC | | | | | X | |
| CANCEL | DFC | | | | | X | X |
| CHASE | DFC | | | | | X | |
| LUSTAT | DFC | | | | | | X |
| SHUTD | DFC | | | | | X | |
| SHUTC | DFC | | | | | | X |
| RTR | DFC | | | | | | X ¹ |
| BID | DFC | | | | | X | |
| SIGNAL | DFC | | | | | X | X ² |
| DATA | FMD | | | | | X | |
| REQMS | FMD | X | | | | | |
| RECFMS | FMD | | X | | | | |

¹ Only SLU types 1 and 3

² Only SLU types 1 and 2

Figure 4-3. SNA Commands Supported by the 3276

Command Description

Activate Physical Unit (ACTPU)

The ACTPU command is sent by the access method to establish the SSCP-PU session with a 3276 control unit. The SSCP-PU session is established when the 3276 returns a positive response to the ACTPU command.

The ACTPU command can be transmitted when the SSCP-SLU and LU-LU sessions are active; for example, when an NCP restart procedure occurs. When the 3276 receives the ACTPU command, all active sessions are terminated immediately. The 3276 returns a positive response to the ACTPU command, and the SSCP-PU session is reestablished.

Deactivate Physical Unit (DACTPU)

When the 3276 receives the DACTPU command, all LU-LU and SSCP-SLU sessions and the SSCP-PU session are terminated. If a command other than ACTPU is received after a positive response has been returned for the DACTPU command, the 3276 returns a negative response with sense data indicating PU not active (sense code X'8008').

Activate Logical Unit (ACTLU)

The ACTLU command is sent by the access method to establish the SSCP-SLU session with each 3276 control unit LU. The SSCP-SLU session is established when the 3276 returns a positive response to the ACTLU command. The SSCP-PU session must be established prior to the receipt of ACTLU to allow the 3276 to return a positive response to this command. If the 3276 receives a command other than ACTPU, ACTLU, DACTPU, or DACTLU before the SSCP-LU session is established, a negative response is returned with sense data indicating LU not active (sense code X'8009'). Note that the SLU is in the 3276 and that the session can be activated without a display or printer being powered on or attached.

When an SSCP-SLU session has been previously established and the 3276 receives an ACTLU command for that LU, any active session between that LU and a host program is terminated. The 3276 returns a positive response to the ACTLU command, and the SSCP-LU session is reestablished.

Deactivate Logical Unit (DACTLU)

Receipt of this command terminates the SSCP-SLU session. If an LU-LU session is established when the DACTLU command is received, the session is terminated. When the 3276 receives a command other than DACTPU, ACTPU, or ACTLU after a positive response has been returned for the DACTLU command, a negative response is returned with sense data indicating SLU not active (sense code X'8009').

Bind

This command is sent by the access method to request an LU-LU session between an application program and a 3276 SLU. The 3276 returns a positive response to establish the LU-LU session. When the session cannot be established, the 3276 returns a negative response with sense data that describes the reason the session was rejected.

The 3276 examines session parameters that are received with the Bind command. The values required depend on the type of session established. Figure 4-4 provides a detailed description of the session parameters that are sent with the Bind command.

When the SSCP-SLU session is established and the 3276 receives a command that flows in the LU-LU session, other than Bind, a negative response is returned with sense data indicating no session established (sense code X'8005').

If the device attached does not have power on or is physically detached from the 3276 cable port, a negative response is returned with sense data indicating power off (sense code X'080A').

When an LU-LU session exists, that is, one Bind has been accepted, and the 3276 receives a subsequent Bind command for the LU, a negative response is returned with sense data indicating session already exists (sense code X'0815') if the Bind sender address is the same as the session already found. A negative response indicating function active (sense code X'0805') is returned if the Bind sender address differs from the session already found.

| <u>Byte</u> | <u>Hex Value</u> | <u>Bit Setting</u> | <u>Meaning</u> |
|-------------|------------------|--------------------|--|
| 0 | 31 | | Identifies this RU as a Bind command. |
| 1 | 01 | | Bind type and format. The only Bind type supported is Hex 01. |
| 2 | 03 | | Function management (FM) profile. Specifies that the data flow control commands and the request/response protocols that are to be used for this session conform to FM Profile 3. |
| 3 | 03 | | Transmission services (TS) profile. Specifies that the 3276 conforms to TS Profile 3, that is, pacing and sequence numbers are used with normal flow transmission and that data traffic is controlled by the Clear and Start Data Traffic commands. |
| 4 | | | Primary LU Protocols. |
| | | X | Chaining use: 0 The PLU can send only single-element chains. 1 The PLU can send single- or multiple-element chains. |
| | | . X | Request mode selection: 0 Immediate request mode is used. Only one definite response can be outstanding at a time. That response must be received before the PLU can send another RU. |
| | | . . XX | Chaining responses: 01 The PLU can only request exception-only responses. 10 The PLU can only request definite responses. 11 The PLU can request definite or exception-only responses. |
| | | 00 . . | Reserved. |
| | | X . | Compression indicator: 0 Must be 0. |
| | | X | Send End Bracket Indicator (EB): 1 The PLU can send the EB. |
| 5 | | | Secondary LU Protocols. |
| | | X | Chaining Use: 0 The 3276 can send only single-element chains. 1 The 3276 can send single- or multiple-element chains. <i>Note: 0 or 1 for LU type 1 or 3. 1 for LU type 2.</i> |
| | | . X | Request mode selection: 0 Immediate request mode is used. The 3276 can issue a request for a single definite response. No further transmissions are sent until the 3276 receives the requested response. |
| | | . . XX | Chaining responses: 01 The 3276 can only request exception-only responses. 10 The 3276 can only request definite responses. 11 The 3276 can request only exception-only response. |
| | | 00 . . | Reserved. |

Figure 4-4 (Part 1 of 3). Bind Command Session Parameters

| <u>Byte</u> | <u>Hex Value</u> | <u>Bit Setting</u> | <u>Meaning</u> |
|-------------|---|--|--|
| 6 | |X. | Compression indicator: 0 The 3276 cannot send compressed data. |
| | |X | Send End Bracket indicator (EB). 0 The 3276 cannot send the EB. |
| | | | Common Protocols. |
| | | 0... .. | Reserved. |
| | | .X.. .. | Function management (FM) header usage: 0 The PLU and the 3276 cannot exchange FM headers. |
| | | ..X. | Brackets usage: 1 Bracketed session is used. Both the PLU and the 3276 must use bracket protocols. |
| | | ...X | Bracket termination protocol: 1 Bracket termination rule 1 is used (refer to "Bracket Protocol" for a description of bracket termination rule 1). |
| | | X... | Alternate Code selection: 0 Both the PLU and the 3276 must use EBCDIC. 1 Both the host program and the 3276 can use an alternate code. An example of an alternate code is ASCII. |
| | |000 | Reserved. |
| | | 7 | |
| XX. | Normal Flow Send/Receive mode (selection): 10 This session uses half-duplex, flip-flop (HDX FF) transmissions. Refer to "Session Processing States." | | |
| ..X. | Recovery responsibility: 0 The PLU is responsible for error recovery. | | |
| ...X | Brackets first speaker: 0 The 3276 is always the first speaker. | | |
| 000. | Reserved. | | |
|X | Contention resolution: 0 Contention (simultaneous transmissions from the host program and the 3276) is resolved in favor of the 3276. | | |
| 8 | 00xx xxxx | Secondary-to-primary LU pacing count. If set to zeros, pacing is not used. | |
| 9 | 00xx xxxx | The primary-to-secondary pacing value defines the number of RUs that may be received by the 3276 before a pacing response must be returned to indicate readiness for another block of RUs. If set to zeros, pacing is not used. See "Pacing" for recommendations of pacing values. | |
| 10 | XX | Maximum RU size sent by the secondary LU. This value represents the largest RU that can be sent by the 3276. It is expressed as a mantissa (8 through F) and an exponent value of 2 by which the mantissa is multiplied. For example, when the mantissa is specified as 8 and the exponent of 2 is 5 (hex 85), the RU size represented is 256 bytes. Examples of mantissa and exponent values used by the 3276 are shown below with the RU size they represent: 85=256 86=512 C6=768 87=1024 A7=1280 C7=1536 E7=1792 88=2048 | |

Figure 4-4 (Part 2 of 3). Bind Command Session Parameters

| <u>Byte</u> | <u>Hex Value</u> | <u>Bit Setting</u> | <u>Meaning</u> |
|------------------------|------------------|--------------------|---|
| | | | See "RU Lengths Supported" for detailed information about values supported by the 3276. |
| 11 | XX | | Maximum RU size sent by the primary LU. This value represents the largest RU that can be sent by the PLU and is specified in the same format as for the secondary LU (byte 10). See "RU Lengths Supported" for detailed information about values supported by the 3276. |
| 12, 13 | 0000 | | Reserved. |
| For SLU Type 1: | | | |
| 14 | 01 | | Type 1 print function using SCS data stream. |
| 15-17 | 00 | | Reserved. |
| 18 | E1 | | Sent but not checked by the 3276 for LU type 1. |
| 19 | 00 | | Reserved. |
| 20-24 | | | Not supported for LU type 1. |
| For SLU Types 2 and 3: | | | |
| 14 | 02 | | Type 2 3270 data stream compatibility mode. |
| 14 | 03 | | Type 3 3270 print function using 3270 data stream. |
| 15-19 | 00 | | Reserved. |
| 20-24 | XX | | Refer to Figure 1-8 for LU type 2. Refer to Figure 1-9 for LU type 3. |
| For all SLU Types: | | | |
| 25+ | | | Reserved. |

Figure 4-4 (Part 3 of 3). Bind Command Session Parameters

Session parameters included in the Bind command RU define the protocols that govern the session. Figure 4-4 describes contents of a Bind command RU that are supported by the 3276 and explains how the session parameters are used. A generalized setting for the access method logmode table is listed under "Bind Default" later in this chapter. Also listed (under "Bind Check") are the checks that the 3276 makes when the Bind command is received. Specific customer optimization or device features may require changes for each installation.

Also listed in this chapter (under "Logical Unit Status") are the checks made by the 3276 for each logical unit type. Failure to properly specify the required session parameters results in rejection of the Bind command by the control unit because the session parameters are invalid (sense code X'0821').

Unbind

Receipt of this command directs the 3276 to terminate the LU-LU session between a host program and a 3276 SLU. The LU-LU session is terminated when the 3276 returns a positive response to the Unbind command.

Clear

Receipt of the Clear command causes the 3276 to enforce the data-traffic-reset state upon the LU-LU session. Clear also causes the 3276 to initialize all inbound and out-bound transmission buffers. When data-traffic-reset state is activated for an LU-LU session, only the following commands are valid for that session: Clear, Unbind, and Start Data Traffic (SDT).

Start Data Traffic (SDT)

This command allows data traffic to flow during an LU-LU session. The SDT command must be issued after a Bind command has established the LU-LU session. It is also sent after Clear to complete a session resynchronization sequence with the 3276. SDT is valid only when the data-traffic-reset state is active for an LU-LU session.

To complete a session resynchronization sequence, the host program must request transmission of the SDT command from the access method.

Cancel

When received, normal SNA usage of this command directs the receiver to discard all elements of the chained transmission being received. However, the 3276 processes data RUs to the display or printer as they are received without waiting until end-of-chain. Therefore, the Cancel command serves the purpose of providing a proper termination for an otherwise incomplete chain. A Cancel command received between chains only affects the 3276 state controlled by the change direction (CD) and end bracket (EB) bit settings carried in the RH with the Cancel command. Processing of a chained transmission is terminated when the Cancel command is received. EB or CD may be sent with the command.

When a chained transmission is in progress, and the 3276 returns a negative response to an element of that chain, the PLU should terminate that chained transmission and issue the Cancel command if the last chain element has not already been sent to the 3276.

When sent by the 3276 type 2 SLU, the Cancel command directs the PLU to stop processing a chained transmission and to discard all elements of the chain that are currently being received. The Cancel command is substituted for the end of the chain if a 3178, 3278, or 3279 failure or operator action prevents transfer of all data from the display to the 3276.

When the PLU returns a negative response for an element of a chain, the following will happen:

- For a 3276 when inbound pacing is not used, the entire chain will be transmitted before the PLU response is examined. Cancel will not be sent.
- For a 3276 when inbound pacing is used, the negative response from the PLU will be examined only if the 3276 must look for a pacing response. If the negative response is examined, the 3276 will send Cancel and will not transmit the remaining elements in the chain. If the negative response is not examined, the entire chain will be transmitted and Cancel will not be sent.

In either case, the PLU should discard all elements of a chained transmission after sending a negative response.

Chase

Chase is used to confirm that all preceding requests have passed through the network and have been processed. When this command is received, the 3276 returns a positive response to the PLU, indicating all previous chains have been processed.

The PLU should complete or cancel the current chained transmission before issuing the Chase command. When a chained transmission is sent with exception-only responses requested, the Chase command can be used to verify that all responses for that chain have been received. The EB or CD indicators can be issued with the Chase command.

Bid

The Bid command is sent by the PLU to a 3276 SLU to request permission to begin a bracket. The use of Bid avoids long chains of data using transmission time and then being discarded because SLU won bracket contention. If the Bid is accepted by the SLU, a positive response is returned and the SLU goes to begin-bracket-pending state and waits for the request containing BB.

A 3276 SLU can reject a Bid command by winning bracket contention for the following reasons:

1. LU Type 2

- The 3276 is already In Bracket (INB) and a PLU protocol error exists. The sense code returned is X'0813'.
- The operator has initiated an inbound data stream carrying Begin Bracket (BB). The sense code returned is X'0813'.
- An operator has started to enter data on the screen but has not initiated an inbound data stream. The sense code returned is X'081B'.

2. LU Type 1 or 3

- The SLU is already INB and a host program protocol error exists. The sense code is X'0813'.
- A printer attached to the 3276 is busy doing a local copy operation. The sense code returned is X'0814'. The 3276 will send the Ready to Receive (RTR) command to the host program when the printer becomes not-busy and a BB can be accepted by the secondary LU.

Signal

The PLU can send the Signal command to the 3276 SLU to request the Change Direction (CD) indicator. The SLU will complete any chained transmissions that are in progress and send the CD to the PLU. A request with CD but no data (a Null-RU) will be sent if the SLU is in send state but has not started transmitting. If the SLU is already in receive state, BETB, or ERP1 state (see "Session States"), the Signal is positively responded to but no SLU action is taken.

The 3276 will send the Signal command (X'00010000') when the terminal operator presses the keyboard ATTN key or, for an LU type 1, either of the printer PA switches. The command is expedited and has no effect on SLU states. Once Signal has been sent by an SLU, pressing the ATTN or PA keys will not cause a second Signal until the 3276 has received a response to the first Signal.

LU Status (LUSTAT)

The 3276 SLU sends the LUSTAT command to notify the PLU that a processing error has been detected or that a change in the operational status of a device has occurred. A 4-byte status code is sent by the 3276 SLU to describe the error condition or the device status change.

For LUSTAT codes and conditions that determine which LUSTAT is sent, refer to "Logical Unit Status" later in this chapter.

Ready to Receive (RTR)

A 3276 type 1 or 3 SLU sends this command to indicate when a previously rejected bracket (with sense code X'0814') can be initiated by the host program. The RTR command is allowed only when the session is ready to receive new bracket.

When the RTR command is sent and a positive response is received from the host program, the printer LU enters begin-bracket-pending state and expects the host program to begin a bracket.

REQMS

The Request Maintenance Statistics (REQMS) command is sent by the SSCP to a 3276 when the Network Determination Aid Processor (NDAP) requests PU performance statistics. Four types of requests can be made:

- Type 1 – Link Test Statistics
- Type 2 – Summary Counters
- Type 3 – Communication Adapter Data Error Counts
- Type 5 – 3276 Machine Level Information

The state of the RESET/NO RESET indicator in the REQMS request determines whether or not the log area where the transmitted maintenance statistics are stored is cleared.

An REQMS request that cannot be executed by the 3276 is rejected with a negative response; an accepted REQMS request receives a positive response and the requested statistics (formatted as RECFMS) as an inbound message.

RECFMS

Record Formatted Maintenance Statistics (RECFMS) is sent by the 3276 to the SSCP in response to an REQMS command (the 3276 will not send unsolicited RECFMS requests to the host). The RECFMS maintenance statistics are recorded at the host by the Network Communications Control Facility (NCCF).

When the 3276 accepts an REQMS request, it transmits the maintenance statistics requested. If the REQMS specified "RESET", the error log area referenced by the REQMS is reset by the 3276 after the 3276 receives a positive response to the RECFMS; otherwise, the error log area is not reset.

For descriptions of the RECFMS responses, refer to Appendix G.

Shutdown

The PLU sends the Shutdown command. Receipt of this command directs the 3276 SLU to prepare for a session termination sequence. The 3276 returns a positive response to the PLU, but data-transfer sequences are not inhibited.

The Shutdown command causes the session to enter shutdown-complete-pending state. The pending state is maintained until the SLU completes normal flow processing and goes between bracket (BETB). The SLU then sends the Shutdown Complete command to the PLU.

Shutdown Complete

This command is sent by the 3276 after the Shutdown command has been received from the host program and an End Bracket has caused the SLU to go to BETB state.

When the Shutdown Complete command is sent to the PLU, the session enters shutdown state. When shutdown state is active, no data transmissions can be sent to the PLU; the PLU, however, may continue to send data to the 3276.

The PLU may either terminate the session using Unbind when the Shutdown Complete command is received from the 3276, or use Shutdown as a means of quiescing traffic. Exit from Shutdown Complete requires a Clear and SDT if the command is used as a quiesce function.

FM Data

This command is used to transfer data in the LU-LU session or in SSCP-LU session. It may only be sent in LU-LU session when data traffic is allowed (SDT has been issued and received a positive response).

When communicating with a 3276 SLU, the following FM data protocols are used:

Bracket: Bracket protocol is used to delimit a series of related inbound and outbound FM data request units (RUs); for example, all the RUs required to complete a transaction.

Chaining: Chaining logically connects one or more RUs from a single LU; for example, all RUs required to complete a display image

Change Direction: Change direction informs the receiving LU that the sending LU has completed transmission and expects the next transmission to be from the receiving LU; for example, the PLU has transmitted a complete form image and expects the next transmission to be from the display operator when the blank fields in the form image are filled in.

Bracket Protocol. The 3276 provides a bracket protocol to delimit a series of related inbound and outbound requests. A bracket may consist of one input and one output, many sets of inputs and outputs, or a series of requests flowing in a single direction. The Begin Bracket (BB) and End Bracket (EB) indicators are used to delimit a bracket. References are made to bracket states (BETB and INB); these states are described under "Bracket States."

A bracket is initiated when the Begin Bracket (BB) indicator is accepted by the primary or secondary LU. The bracket is usually ended when the End Bracket indicator (EB) is received by the secondary LU. The specific conditions that end a bracket are defined by SNA bracket termination rule 1 (see below). Two commands, Bid and Ready to Receive (RTR), are implemented to further define the initiation of a bracketed session. These commands are described under "SNA Commands."

The following protocols apply for 3276 bracket processing.

For sessions with type 2 SLUs, the SLU may begin a bracket any time the session is between brackets. The PLU may request permission to begin a bracket using Bid. If the SLU returns a positive response, the PLU may begin a bracket. If the SLU returns a negative response, the PLU must wait for the next BB from the SLU.

For type 1 and 3 sessions, the PLU may begin a bracket any time the session is between brackets (the only time the SLU will begin a bracket is when the operator presses the PA key). The PLU may start a bracket by sending a transmission that contains BB or by sending Bid, waiting for a positive response, and then sending a transmission that contains BB.

The PLU may attempt to initiate a bracket by simply sending a transmission with BB. If a contention situation exists (the SLU begins a bracket before receiving BB from the PLU), the SLU returns a negative response to the PLU's transmission and then discards all portions of the chain from the PLU. The SLU assumes that its transmission will be accepted by the PLU.

If a Bid or BB from the PLU is rejected, the 3276 will do the following:

- For a session with a type 2 SLU, the SLU sends BB when it next has data to send. The PLU may return its data when it receives Change Direction (CD).
- For a type 1 or 3 session with a 3276, the SLU will only reject the PLU's Bid or BB if the printer is performing a local print function or when a protocol error is detected. When the local print is completed, the SLU will send RTR.

The host program can end a bracket. The 3276 cannot end a bracket.

Bracket protocol establishes the following restrictions on beginning and ending brackets:

1. BB and EB cannot be sent with response RUs.
2. The EB cannot be sent with the Bid or RTR command. All other normal flow DFC commands can end the bracket.
3. All outbound chains that begin a bracket but do not carry EB must be sent with definite response requested.

The 3276 supports bracket termination rule 1 as follows:

1. When EB is received and the last element of a chain required definite response, the 3276 will enter between-bracket (BETB) state from in-bracket (INB) state after +RSP to the chain or stay INB after -RSP.
2. When EB is received and the last element of a chain requires exception response, the 3276 will enter BETB from INB immediately.

The 3276 ignores the BB bit on all outbound requests except FM data, and ignores EB on all outbound requests except FM data and DFC commands Cancel and Chase.

Chaining Protocol Definition. A data chain is a complete unit of data that originates at a single LU. Data RU chaining provides a method of logically defining a complete unit of data regardless of whether the data is transmitted as a single RU or as a series of consecutive RUs. Each RU is associated with only one chain. An individual RU may be the beginning, middle, ending, or only (both beginning and ending) RU in the chain; the chaining indicators, Begin Chain (BC) and End Chain (EC), are contained in the request header. The following are definitions of each type of RU in a chain:

- First in Chain (FIC) – Identifies an RU that begins a chained transmission (RH=BC,EC).
- Middle in Chain (MIC) – Is transmitted with all RUs following the BC transmission, with the exception of the last RU in that chain (RH=BC,EC).
- Last in Chain (LIC) – Identifies the RU that completes a chained transmission (RH=EC,BC).
- Only in Chain (OIC) – Both the BC and EC indicators are included to indicate a transmission that consists of a single RU. That RU is termed a single-element chain (RH=BCEC).

A chain is correct if the RUs consist of:

1. FIC, LIC
or
2. FIC, MIC, . . . , LIC
or
3. OIC.

Any other sequence of chaining indicators will cause a chaining error.

Chaining Operations. When the 3276 receives a chain with chaining indicators in an improper sequence (for example, FIC, MIC, FIC), a negative response, with sense data indicating a chaining error (sense code X'2002'), is returned to the host program. The 3276 purges the chain, ignoring subsequent elements of the chain until a data RU with the LIC or a Cancel command is received. Receipt of an OIC data RU terminates the purging of a chain; the OIC message is also purged. Sending RUs having chaining indicators in the sequence FIC, MIC, OIC is a violation of chaining protocol. In this case, when the 3276 receives the OIC transmission, the chaining error is detected, the OIC transmission is purged, purging of chain elements is stopped, and a negative response is sent for the OIC transmission. The 3276 is now ready to normally process the next chain.

Change Direction. The 3276 uses a half-duplex, flip-flop (HDX-FF) mode to transfer normal flow data. Only one of the two LUs in the session may send at a given time. The flip-flop protocol demands that, when one LU is sending, the other must be prepared to receive. Therefore, the two states of send and receive (RCV) exist on each end of the session.

A bit in the request header, called the Change Direction (CD) indicator, is used to keep the two end-point LUs in synchronization. Each time an LU accepts this CD in a request, it means it is that LU's turn to send. Each time an LU sends the CD in a request, that LU must then be prepared to receive. The 3276 always sends CD with EC or OC in an FMD RU. Exceptions may occur following negative responses. See "ERP1" state.

Pacing

Inbound and outbound pacing is supported by the 3276. Pacing is used as a tuning parameter for the system. Usage comments are included here; however, control is under the user's discretion at NCP or equivalent definition time.

The pacing count (N) determines the number of normal flow request RUs that can flow before a pacing response is required to allow the next group of N RUs to continue. A special response designated as Isolated Pacing Response (IPR) is used to return the pacing response if a response to the outbound request is not required at the time the pacing response is required. The 3276 will indicate readiness with a pacing response as soon as printer buffers become available after receiving the pacing request. Thus, the number of normal flow RUs allowed in the network due to pacing is up to $2N-1$. RUs may vary in length as specified in the Bind parameter.

LU Type 1

For the 3276, device dependencies exist because the printer is slower than the displays. Care must be exercised in the use of pacing and/or definite response protocol so that waiting RUs and/or chains are not stacked in the 3276 link buffers.

Within a chain, the 3276 transfers RUs from the link buffer pool to the printer buffer as they are received. The pacing parameter is then used to ensure that there is adequate printer buffer space so that the link buffer pool does not fill and restrict data flow to the keyboard displays or other printers.

During the transmission of multiple chains, interaction occurs between pacing and the type of response requested. When a definite response is requested, a response for a chain must be received by the PLU before it can send the next chain. When exception response is requested, the PLU may send any number of consecutive chains without waiting for a response. Therefore, a definite response enforces a type of pacing.

When OIC RUs are used that are less than, or equal to, 256 bytes, it is redundant to specify both pacing and definite response; unnecessary network traffic will occur if both are specified. When chains with multiple RUs are used, pacing is necessary even though definite response is requested.

During the transmission of multiple chains, the 3276 waits for each chain to be processed by the terminal before removing the next chain from the link buffer pool. Therefore, while OIC RUs of 256 bytes or less may be acceptable (based on the available buffer capacity), the link buffer pool may be depleted and data flow to the keyboard displays restricted if the pacing count is greater than one and exception response is used. The pacing count should not be greater than two or three; one is recommended.

If 3276 SLU type 1 receives more normal flow requests than it is guaranteed by using the outbound pacing mechanism, and the printer buffer does not have enough space left to store the outbound data, a -RSP using sense code X'0801' will be returned. The 3276 will respond to the RU causing the overrun.

LU Type 2 and 3

For LU type 2, the 3276 will generally operate faster than the link, and pacing is not required for the controllers.

For LU type 3, the definite response required when the WCC Start Print bit is set is an effective alternative to pacing.

In telecommunication networks where RUs are processed through more than one communication controller (for example, a 3704 and a 3790 or two 3705s), outbound pacing may be required for type 2 and 3 LUs to prevent data traffic congestion in these controllers.

Inbound pacing is supported by the 3276. Usage in a tree-structured network may not be required. Usage in large telecommunication networks may require inbound pacing to prevent congestion at communication controllers in the network. If a 3276 is attached to a 3790, refer to 3790 documentation for detailed information about inbound pacing support.

SNA Responses

The RH contains indicators that describe the type of response given: Definite Response 1 (DR1) or Definite Response 2 (DR2). The RH also contains an Exception Response (EX) indication that is used when describing the response protocol. Definite response protocol (DR1,EX or DR2,EX) specifies that a response, either positive or negative, must be given. Exception response protocol (DR1 EX or DR2 EX) specifies that only a negative response may, or need be, returned.

The only definite response type requested by the 3276 is Definite Response 1 (DR1). The response protocol requested by the 3276 (definite response and/or exception response) is defined in the Bind.

The 3276 will respond to a message from the host with any requested response type (DR1, DR2, or both). The 3276 supports definite response or exception response protocols.

No distinction is made (within this chapter) between the specific response types. The term "positive response" indicates successful receipt of a command or data RU. The term "negative response" indicates that the receiving LU detected an error, which is reported to the sending LU.

Summary of SNA Commands

Figure 4-5 summarizes the validity of SNA commands received by the 3276 relative to the sessions (SSCP-PU, SSCP-LU, and LU-LU) to two LU-LU session processing states (Data Traffic Reset and In Brackets). Figure 4-6 shows the same for SNA commands sent by the 3276.

| SNA Command Received | SSCP-PU Session Active | SSCP-LU Session Active | LU-LU Session Active | LU-LU Session Processing States | | | |
|----------------------|------------------------|------------------------|----------------------|---------------------------------|-----|------------|-----|
| | | | | Data Traffic Reset | | In Bracket | |
| | | | | On | Off | On | Off |
| ACTLU | R | E | T | | | | |
| ACTPU | E | T | T | | | | |
| DACTLU | R | T | T | | | | |
| DACTPU | R, T | T | T | | | | |
| BIND | | | E, I | X | | | X |
| UNBIND | | | R, T | | | | |
| CANCEL | | | R | | R | | |
| CHASE | | | R | | | R | |
| CLEAR | | | R | X | | | X |
| SDT | | | R | | X | | |
| SIGNAL | | | R | | R | | |
| SHUTDOWN | | | R | | R | | |
| FM DATA | | | R | | R | R | |
| REQMS | R | | | | | | |

Legend:

- R — Required state for this command to be valid.
- I — Command invalid if in this processing state.
- E — Command establishes this session.
- T — Command terminates this session.
- X — Command sets the processing state to the indicated status.

Figure 4-5. Summary of SNA Commands Received

| SNA Command Sent | SSCP-PU Session Active | SSCP-LU Session Active | LU-LU Session Active | LU-LU Session Processing States | | | |
|-------------------|------------------------|------------------------|----------------------|---------------------------------|-----|------------|-----|
| | | | | Data Traffic Reset | | In Bracket | |
| | | | | On | Off | On | Off |
| LUSTAT | | | R | | R | | |
| SIGNAL | | | R | | R | | |
| CANCEL | | | R | | R | R | |
| READY TO REC. | | | R | | R | | R |
| SHUTDOWN COMPLETE | | | R | | R | | R |
| FM DATA | | | R | | R | R | |
| RECFMS | R | | | | | | |

Legend:

R – Required state for this command to be valid.

Figure 4-6. Summary of SNA Commands Sent

Sample SNA Command Sequences

Figures 4-7 through 4-13 illustrate the use of SNA commands. Responses to commands are not shown unless the response is a necessary part of the example.

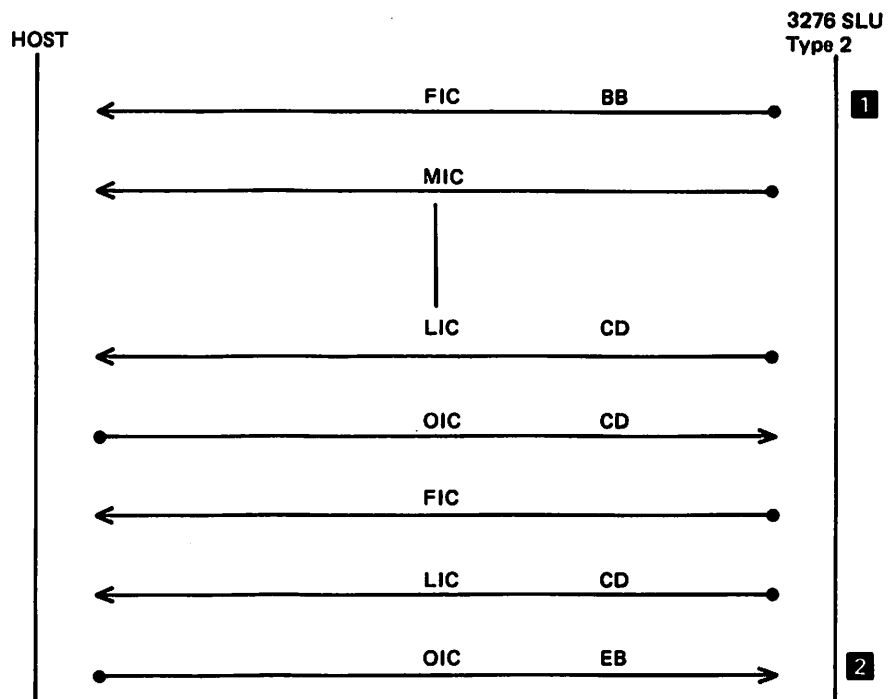

- 1** Initial conditions: Session established and both ends in contention-between-bracket state. SLU type 2 initiates a bracket and sends a chain as a result, for example, of Enter key depression.
- 2** After the required exchange of chains is completed, the host ends the 'unit of work' by sending EB (an LU type 2 cannot send EB). The EB chain may contain data: for example, a write to the screen; or it may be a Null RU chain, that is, only RHs.

Figure 4-7. Bracket/Chain – LU Type 2 Initiated (without Contention)

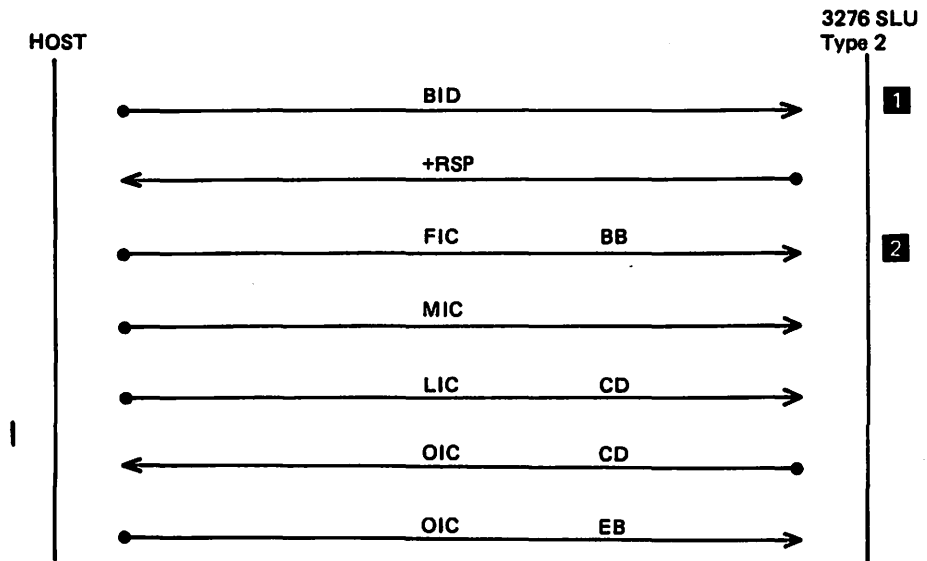

- 1 Initial conditions: Session established and both ends in contention between bracket state. Host sends Bid to indicate intention to begin a bracket.
- 2 The +RSP was SLU type 2, go ahead to the host. The host initiated the 'unit of work' with BB. Note: *the host has the option of going directly to 2, that is, skipping the Bid. However, there is a possibility of Bid rejection, which would result in resending the data associated with 2.*

Figure 4-8. Bracket/Chain – Host Initiated (without Contention)

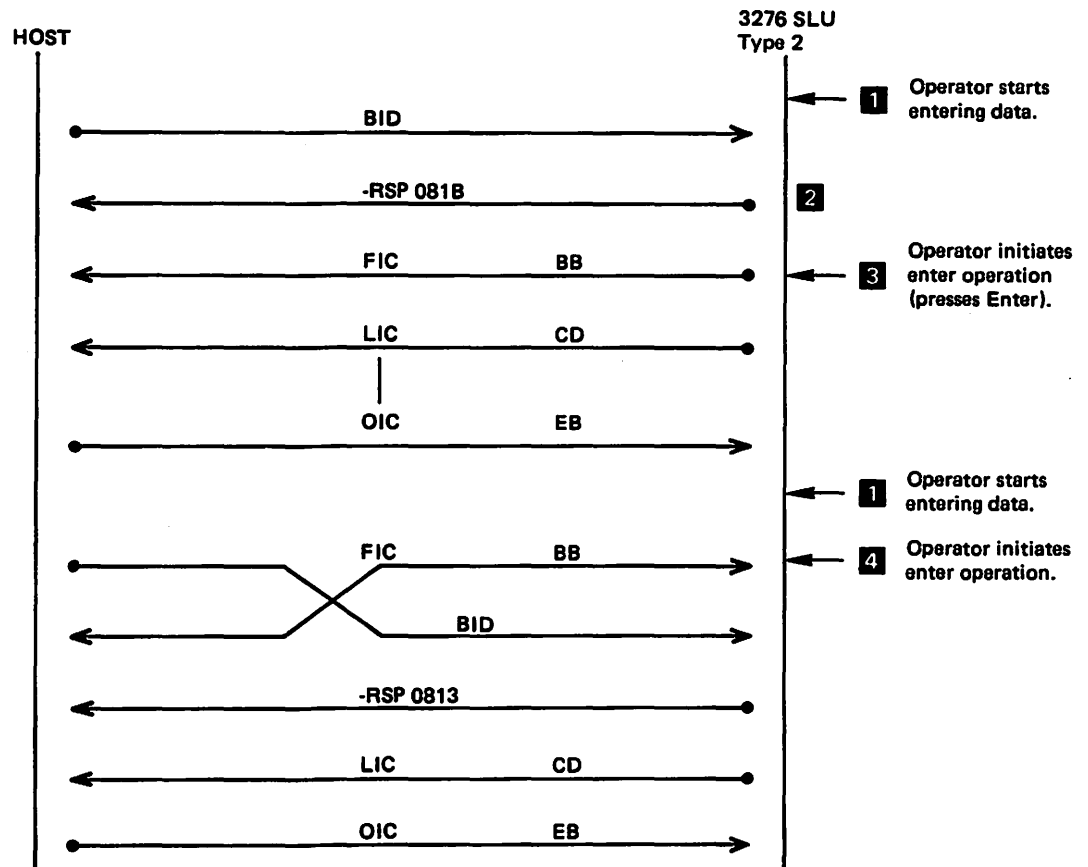

- 1** Initial conditions: Session established and both ends are in between-bracket state. The first operator keystroke puts the type 2 SLU in the send (but not transmitting) state. The type 2 SLU remains in BETB state.
- 2** The type 2 SLU will reject a Bid (or BB) with 081B. Receiver in transmit mode.
- 3** The operator initiates an enter operation; for example, he presses the ENTER key. The type 2 SLU begins a bracket and transmits the operator-entered data.
- 4** When the operator presses the ENTER key, type 2 SLU goes to in-bracket (INB) state. Type 2 SLU begins a bracket and starts sending data. The host end has sent a Bid (or BB) before the type 2 SLU first chain element was received. The type 2 SLU rejects the Bid (or BB) with 0813. The sense code differs from reference 2 because the bracket check is made before the HDX state check. In reference 2, the bracket check was good.

Figure 4-9. Bracket/Chain – Host/SLU Contention

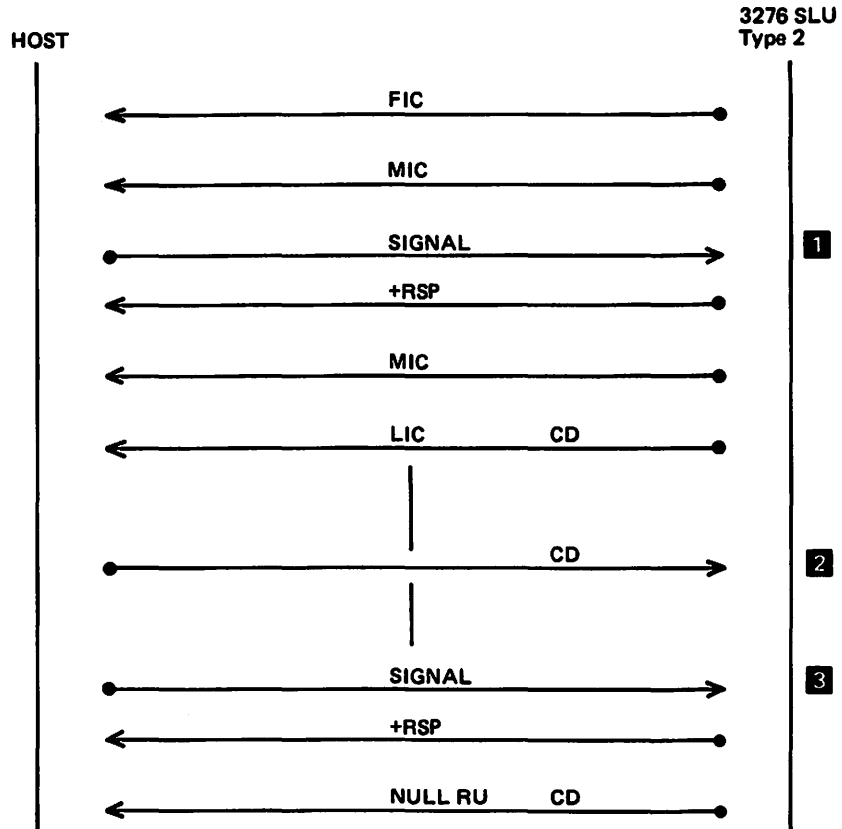

- 1** The SLU type 2 receives Signal while sending. The +RSP is returned to acknowledge receipt of Signal. The Signal is effectively treated as a NO-OP, and the SLU completes sending of the chain. The SLU type 2 always sends CD with the end of a data chain.
- 2** CD allows the SLU to send. The operator starts keying in data.
- 3** Before the operator initiates sending of data, for example, presses the ENTER key, the host sends Signal. The SLU sends +RSP to Signal, locks the keyboard, and sends CD.

Figure 4-10. Signal from Host

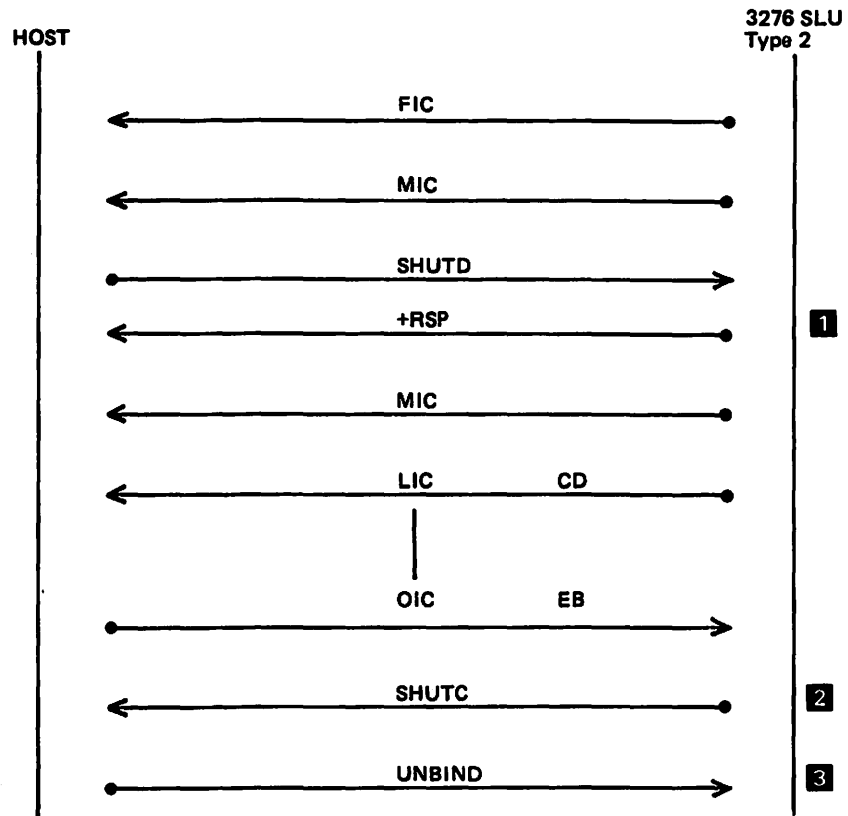

- 1** The SLU type 2 is alerted that the host wants to shut down. However, a synchronizing EB must be received before effecting shutdown.
- 2** The SLU goes into shutdown; that is, inbound normal flow (including Signal) is inhibited.
- 3** The host terminates the session. (Note: *The host could clear the condition and continue by sending Clear, SDT instead of terminating the session.*)

Figure 4-11. Shutdown/Shutdown Complete

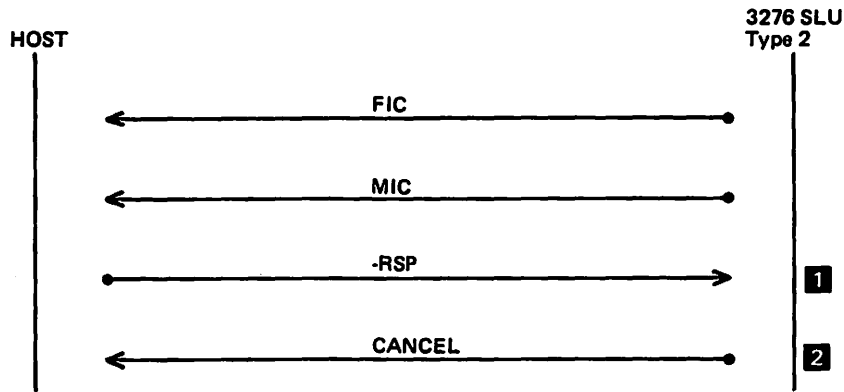

- 1** The type 2 SLU receives -RSP to a chain element. Note: Normally, the 3274 or 3276 will not examine any response until the entire chain has been sent and will therefore not send Cancel as the result of receiving a -RSP. However, when inbound pacing is in effect, responses are examined when the SLU must receive a pacing response before continuing transmission. A -RSP will then be detected and cause Cancel to be sent.
- 2** The type 2 SLU sends Cancel to direct the host to discard the chain elements already received. The SLU goes to receive state, waiting for host recovery action.

Figure 4-12. CANCEL, SLU Type 2 Sending

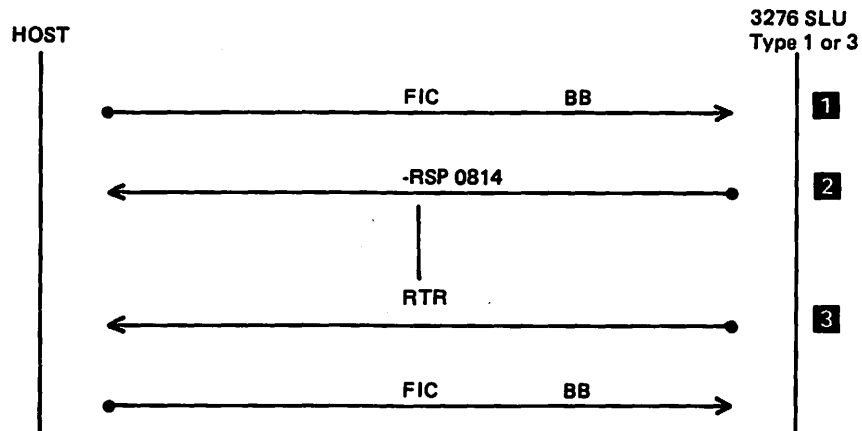

- 1** The printer associated with the SLU type 1 or 3 is not available because a local copy is being done. Consequently, the SLU type 1 or 3 cannot honor the host BB (or Bid).
- 2** The SLU type 1 or 3 rejects BB (or Bid) with -RSP X'0814' (Bracket Reject, RTR to follow).
- 3** The printer becomes available, and SLU type 1 or 3 send RTR to indicate to the host that a bracket may be started.

Figure 4-13. RTR – LU Type 1 or LU Type 3 Send

Session Processing States

The 3276 controls the processing of SNA commands, responses, and user data transmissions with a set of session states. Some of these states are defined by SNA and others are unique 3276 definitions that cause SNA state transitions. When the 3276 receives the Clear or Bind command, all 3276 session states are reset.

This section describes the processing states used by the 3276. When several states relate to a common processing function such as bracket or chain processing, they are described under a common heading. The remaining processing states are described individually.

Data Traffic (Reset/Active) State

Reset of all SNA LU-LU states in the 3276 is assured by entering Data Traffic Reset state. This state is entered when a Bind or Clear command is received from the PLU. When Data Traffic Reset state is turned off by SDT, the state is referred to as *Data Traffic Active*.

When in Data Traffic Reset state for any LU-LU session, the 3276 SLU cannot transmit data or commands to the host program. The host can send only session-recovery and session-termination commands when in this state. The 3276 accepts only data RUs for an LU-LU session during Data Traffic Active state.

When in Data Traffic Reset state and a data RU or a command other than SDT or Unbind is received from the host program, the 3276 returns a negative response with system sense data indicating that data traffic is inactive (sense code X'2005'). No other state, except Contention, can exist when the SLU is in Data Traffic Reset state.

Contention (CONT) State

The Contention state on the LU-LU session exists only between brackets. In this state, the LU resources are not allocated. All associated I/O devices are enabled and the SLU can accept data from either the terminal or the host, whichever occurs first. The first arrival triggers a change to Send or Receive state.

For the SSCP-SLU session, Contention state exists between the successful completion of all chains.

Send (SEND) State

The Send state is common to both contention and HDX FF modes of operation.

In Send state, the 3276 LU resources are allocated for inbound (to the primary) operations. Internally, there are two subdivisions of the Send state. These are referred to as Send-.xmit (Send-not-transmit) and Send-xmit (Send-transmit). Send-.xmit exists while the control unit is entering data from a keyboard, MSR, or selector light pen into the device buffers. The state is entered from contention by the first keystrokes capable of changing data on the display, or by initial input from the type 2 SLU MSR or selector light pen or the type 1 SLU PA key. The state is maintained until exited to Send-xmit by an action causing the data to be sent inbound, generally the ENTER key. The transition from Send-.xmit to Send-xmit also causes the transition to In Bracket (INB) state when leaving contention. The transition always causes the keyboard to be locked and the Input Inhibit (3276 keyboard/display, and 3278 and 3279)

| and Wait (3276 keyboard/display or 3178, 3278, and 3279) indicators to be turned on. When In Bracket, Send--xmit is entered from Receive state or ERP1 state after successfully processing an outbound chain carrying CD but not EB.

The type 2 SLU keyboard does not automatically unlock when the Send state is entered from either Receive state or ERP1 state. The keyboard is unlocked only if:

- A previous WCC specified keyboard restore, or
- The SLU is in Send state and the terminal operator presses the RESET key.

After going from Contention to Send--xmit state, any normal outbound requests received on that session will be discarded and a negative response "Receiver in Transmit Mode" with sense code X'081B' will be sent. Once INB, any normal outbound requests received on that session (FMD with BB or Bid) while in Send State will be discarded and a negative response "Bracket Bid Reject" with sense code X'0813' will be sent. Neither of these responses causes any state change in the 3276 SLU. If INB and in Send state, a request received that does not carry BB will be rejected by the 3276 with sense code X'081B'.

During Send-xmit state, the data is being transferred from the device buffer to the PLU. Except for a possible LUSTAT, all normal flow chains on the LU-LU session will carry the CD. The transition out of Send-xmit depends upon the response type carried with the inbound request. If a definite response is requested, the transition from Send-xmit to Receive takes place after the response to the inbound request is returned to the 3276. If an exception response is requested, the transition from Send to Receive takes place as soon as the end-of-chain has been successfully transferred to the transmission link.

The SSCP-SLU session operates in definite-response mode only. Therefore, the transition is from Send-xmit to Contention upon the receipt of a positive response, or from Send-xmit to Receive if a negative response is returned.

Receive (RCV) State

The Receive state is common to both contention and HDX-FF modes of operation. In this state, the 3276 LU resources are allocated for outbound (from the PLU) operations.

When RCV state is active, inbound normal flow requests cannot be sent. Responses, as requested, and control commands of the expedited flow can be sent inbound.

Input devices may be activated by a WCC character that specifies Keyboard Restore. However, an attempt to send data to the PLU by an operator, by using the selector light pen or MSR, or by pressing the ENTER, PA, or CURSR SEL key will not be allowed.

Normal flow traffic from the PLU is passed to the device when it is in Receive state. This is allowed to halt local device operations by causing the keyboard to be locked and the Input Inhibited and Wait indicator to be turned on. A request with a WCC containing the Keyboard Restore bit set to zero is treated as a NO-OP for the keyboard states; that is, if the keyboard was unlocked before the write, it will remain unlocked after a successful write. If the keyboard was locked before the write, it will remain locked after the write.

For the LU-LU session, Receive state is entered from Contention state if an outbound normal flow message is accepted for processing. It is entered from Send-xmit after receiving a response from an inbound request carrying CD and definite response, or after successfully transferring the chain to the data link when the request carries CD and exception response. For the SSCP-LU session, Receive state is entered from Contention if an outbound normal flow message is accepted for processing. It is entered from Send-xmit if a negative response is received for an inbound request.

For the LU-LU session, Receive state is changed to Send--xmit after successfully processing a last-of-chain carrying the CD. Receive state is changed to Contention state after successfully processing and responding to a chain carrying EB, or after receiving a chain carrying EB which carries exception response requested. Receive state is changed to ERP1 state if any negative response except X'0813', X'0814', or X'081B' is returned to the outbound request.

For the SSCP-LU session, Receive state is changed to Contention after returning the response to the outbound request.

ERP1 State

ERP1 is a special state created to allow for error recovery protocols. The PLU is always responsible for error recovery; therefore, the SLU state structure generally is awaiting an outbound request to correct the error condition. However, there are times when the SLU must first recover and notify the PLU of its recovery by use of LUSTAT command before the PLU can take action. Thus, the SLU ERP1 state allows a form of contention mode within brackets. This state has the characteristic of being able to receive any request, but only sending LUSTATs.

When an LUSTAT flows inbound, the SLU remains in ERP1 state. This allows successive LUSTATs to flow without requiring the general exchange of CD between each LUSTAT. LUSTAT does not request change direction when sent while in ERP1 state.

ERP1 state is entered by an SLU after responding with any negative response except X'0813', X'0814', and X'081B'. If the negative response does not change the state to between-brackets (BETB), the transition to ERP1 takes place at end-of-chain.

ERP1 state is changed by accepting an outbound chain carrying CD. Following processing of the CD bit, the transition is made to Send state.

When in ERP1 state, the keyboard is locked, except for the SYS REQ, ATTN, and TEST REQ keys.

Bracket States

The 3276 has three major states associated with bracket protocols. These states are Between Bracket (BETB), In Bracket (INB), and Pending Begin Bracket (PEND.BB). These states are used to ensure synchronization of traffic between the PLU and the SLU. Transitions between these states are controlled by the BB and EB bits and by the Bid command.

Between Bracket (BETB) State

BETB state exists when the PLU and SLU are in contention to begin a bracket. This is the state entered after the SDT command is accepted. When the Bid or BB is accepted from the PLU or sent by the SLU, BETB state ends. If the host program cancels the chain containing the Begin Bracket, or if the SLU sends negative response for the chain containing the Bid or BB, the 3276 returns to BETB state. BETB state is normally assumed when an EB has been processed successfully.

When a chain carrying both BB and EB is being processed, BETB state is not changed.

The 3276 sets BB on the first RU transmitted when the control unit enters INB from BETB.

BETB is terminated and INB is entered when the first (or only) element of a chain with BB bit on is ready to be transmitted; that is, an ENTER, PA, PF, or other attention key is pressed.

Pending Begin Bracket (PEND.BB) State

In the PEND.BB state, the 3276 is waiting for a bracket to be begun by the host system. The 3276 either has returned a positive response to a Bid command or has received a positive response to a Ready to Receive command. When the host program attempts to begin a bracket and the 3276 is in PEND.BB state, the 3276 will not reject the bracket with sense code X'0813' or X'0814'.

In Bracket (INB) State

INB state is entered when the 3276 receives a BB without the EB or when the 3276 begins a bracket. INB state is maintained by the 3276 until the positive definite response to the EB chain is returned to the host or until the 3276 receives the last element of the EB chain when exception response is requested.

3276 Bracket State Errors

Error codes generated for bracket error conditions are shown below; the bracket state conditions remain unchanged after sending the error code.

| Command State | CHASE & EB | CHASE & \neg EB | BID | CANCEL & EB | CANCEL & \neg EB | FMD & BB | FMD & \neg BB |
|------------------|---------------|----------------------|------|----------------|-----------------------|-------------|--------------------|
| BETB | 2003 | — | — | 2003 | — | — | 2003 |
| INB | — | — | 0813 | — | — | 0813 | — |
| PEND.BB | 2003 | — | — | 2003 | — | — | 2003 |

RU Lengths

Outbound to the 3276

The maximum RU length that a PLU is permitted to send is defined in byte 11 of Bind. The 3276 accepts a maximum RU size within the following constraints. Note that where multiple constraints apply, the maximum RU size is limited to the smallest size calculated by applying each constraint.

For a type 1 SLU in a 3276: The following formula applies:

$$\text{MRU} \leq 256 \times L \left[\frac{1}{\text{PC}} \times L \left(\frac{\text{BUFF}-80}{256} \right) \right]$$

where:

MRU is the maximum RU size specified in byte 11 of the Bind.

PC is the pacing count specified in byte 9 of the Bind.

BUFF is the device buffer size.

L is the symbol that means round down to the next integer.

Example: If the printer buffer size is 2048 bytes, and a pacing count of 2 is selected, then the maximum MRU that may be specified in Bind byte 11 is 768 bytes.

A Bind reject with sense code X'0821' will occur if the Bind specifications do not meet these limits.

For type 2 and 3 SLUs in a 3276: There are no 3276 restrictions.

Inbound from the 3276

The 3276 accepts only a 'Multiple Element Chains' Bind for inbound operation. The maximum RU size can be controlled by the PLU through byte 10 of the Bind request. For the 3276, the maximum RU size is 2048. If the value of byte 10 is greater than the 3276 capabilities, the Bind will be accepted, but the actual RU size will be limited to device capabilities.

The minimum value that may be specified by byte 10 of the Bind request is 256 bytes for the 3276. If lesser values are specified, the Bind will be rejected with a negative response, sense code X'0821'. For the 3276, if a mantissa value of byte 10 is less than 8, then minimum value is selected as a default.

Segmenting Description

RUs sent to network terminals are often larger than acceptable for optimum transfer of data by the link connecting the terminal to the network. Therefore, a Basic Information Unit (BIU) consisting of RH and RU may be divided into smaller elements, called *segments*, that are transmitted over the link. The 3276 supports inbound and outbound segmenting on the LU-LU session.

The segment elements are defined as follows. The First in Segment (FIS) element is equated to Begin-BIU, not End-BIU. The Last in Segment (LIS) element equates to End-BIU, not Begin BIU. The Middle in Segment (MIS) equates to not Begin-BIU, not End-BIU. An Only in Segment (OIS) contains the entire BIU.

Sequencing of segments is in the correct order if the sequence consists of:

1. FIS, LIS
2. FIS, MIS, . . . , LIS
3. OIS

Segmenting Outbound

Errors due to improper sequencing of the segment elements will cause the 3276 to enter normal disconnect mode. This action does not permit sending a negative response to the PLU. The 3276 will also deactivate the physical unit and all logical units. The 3276 Program Check indicator will be turned on and show the segmenting error. The 3276 will also turn off the ON LINE indicator. See Appendix C.

The 3276 passes segment elements through for processing and immediate display or printing when the terminal is attached using a Terminal Adapter Type A (for example, a 3278).

The maximum size for segment elements (the NCP MAX DATA SIZE parameter) delivered to the 3276 must not exceed 256 bytes of data plus 6 Transmission Header (TH) bytes and 3 Request/Response Header (RH) bytes for the FIS or OIS. The maximum size for MIS or LIS must not exceed 256 bytes of data plus 6 bytes of TH. (Because the maximum MIS or LIS length is 262 bytes, specify the MAX DATA value equal to 262 bytes for the 3276 control unit.)

Continuous rejection of a segment element that is too long is expected to cause a retry failure in the communication controller, and results in a station inoperative disconnect by the node. The 3276 will return a Command Reject for this condition. The 3276 depends on the sending node to limit the data length in a segment element to 256 or fewer bytes of data, and does not check for the overrun error that could occur in the MIS or LIS. The bytes of data exceeding 256 will be lost.

The Communication Check indicator showing buffer overflow is turned on for all operational 3178, 3278, or 3279 displays connected to the 3276 and the 3276 display, when the control unit detects buffer overflow.

When the 3276 is connected to NCP, the NCP buffer size should be set for one of the following byte sizes:

Optimum: 64, 128, or 256 bytes.

Second choice: 84, 124, 248, or 252 bytes.

Segmenting Inbound

Segmenting inbound is supported by the 3276 on the LU-LU session under the following conditions:

1. When maximum RU size is specified as 256 and accepted at Bind time, no segmenting is used by the 3276.
2. When maximum RU size is specified as greater than 256, the RUs are segmented into segment elements containing 256 data bytes each for FIS or MIS, provided sufficient data is transmitted to cause segmenting.

When the Bind maximum RU size is greater than 256 bytes, considerations other than maximum RU size and amount of data to be transmitted may determine the actual RU length (\leq max RU size) that is sent. The 3276 will never send an RU having more than 2048 bytes. The number of segment elements allocated to an RU by the 3276 is variable and depends on the availability of link buffers when the RU is assembled for transmission. For example, if the maximum RU size is set to 2000, a sequence of sending 2500 bytes of data might appear on the line as follows:

| | | |
|-----|------------------------------|-----------------------|
| FIC | FIS, LIS | ≤ 512 data bytes |
| MIC | FIS, MIS, MIS, MIS, MIS, LIS | ≤ 1280 |
| MIC | OIS | ≤ 256 |
| LIC | FIS, MIS, LIS | remainder |

The 3276 Errors

Data Link

For data link control, action is as discussed in the *IBM Synchronous Data Link Control General Information* manual, GA27-3093. Unique action is that the Set Normal Response Mode command causes the 3276 to reset from an Activated Physical Unit to a Deactivated Physical Unit. All sessions must be restarted by the sequence starting with ACTPU.

A segmenting error will not be reported by an SNA negative response, but will cause the 3276 to go to normal-disconnect mode and do an internal DACTPU.

LU-LU Session Error Reporting

A protocol has been established for the reporting of transmission errors and processing errors during sessions. When the host program or the 3276 SLU is the receiving LU, errors are reported by returning a negative response to the sending LU, with descriptive sense data included.

The format of the 4-byte sense data RU, sent with a negative response, is as follows:

| | | |
|------------|----------|---------|
| 0 | 1 | 2 and 3 |
| System | Sense | User |
| Major Code | Modifier | Sense |

Byte 0 of the sense data RU is bit-encoded to reflect one of six transmission error categories, as follows:

| Byte 0 in Hex | Major Code B |
|---------------|--------------------|
| '80' | Path Error |
| '40' | RH Error |
| '20' | State Error |
| '10' | Request Error |
| '08' | Request Reject |
| '00' | User-Defined Error |

Byte 1 of the sense data RU is a binary modifier that further defines the error condition. The modifier encoding is unique to each major code.

Bytes 2 and 3 are zeros for all negative responses sent by the 3276. The section "SNA Sense Codes" later in this chapter defines modifier encoding for each major code of system sense data issued by the 3276.

Note that the 3276 will not examine the sense data in a negative response from the host. All negative responses on the LU-LU session cause the 3276 to enter RCV state and await further action by the host.

3276 Session Interaction

Three sessions exist for the 3276 when operating with SNA protocols. These sessions are: SSCP-PU, SSCP-SLU, and LU-LU (PLU-SLU). The protocols and interactions between sessions are next described.

The three sessions can exist simultaneously. The SSCP-SLU and LU-LU sessions may wish to use the display simultaneously.

An interactive protocol is used with the 3276, in which, at any given time, only one of the sessions is defined as the device (display screen, keyboard, and data buffer) owner. During ownership, any attempts by the nonowner session to send FM data is rejected by the 3276.

The state diagram (Figure 4-14) shows the transfer of device ownership between the SSCP-SLU and the LU-LU session. Prior to ACTLU, or following DACTLU, no session can own a device. Local operations initiated by the TEST key are not defined as sessions.

Device ownership is indicated to the operator by symbols in column 3 of the Operator Information Area. (Refer to Figure A-4 for a detailed explanation of Operator Information Area symbols.) Prior to ACTLU or following DACTLU, this column is blank. ACTLU causes the Unowned symbol to appear.

After ACTLU is received, the SYS REQ key may be used by the operator to control which session owns the device. When the LU-LU session is not bound and the Unowned symbol appears in column 3, the SYS REQ key, or an RU from the SSCP, transfers device ownership to the SSCP-SLU session. At this time the System Operator Symbol appears in column 3. The operator can then communicate with the SSCP.

If the attached device is a printer or a display without a keyboard, an FM data request to the SLU from the SSCP while in the unowned state will be rejected with category not supported sense code X'1007'.

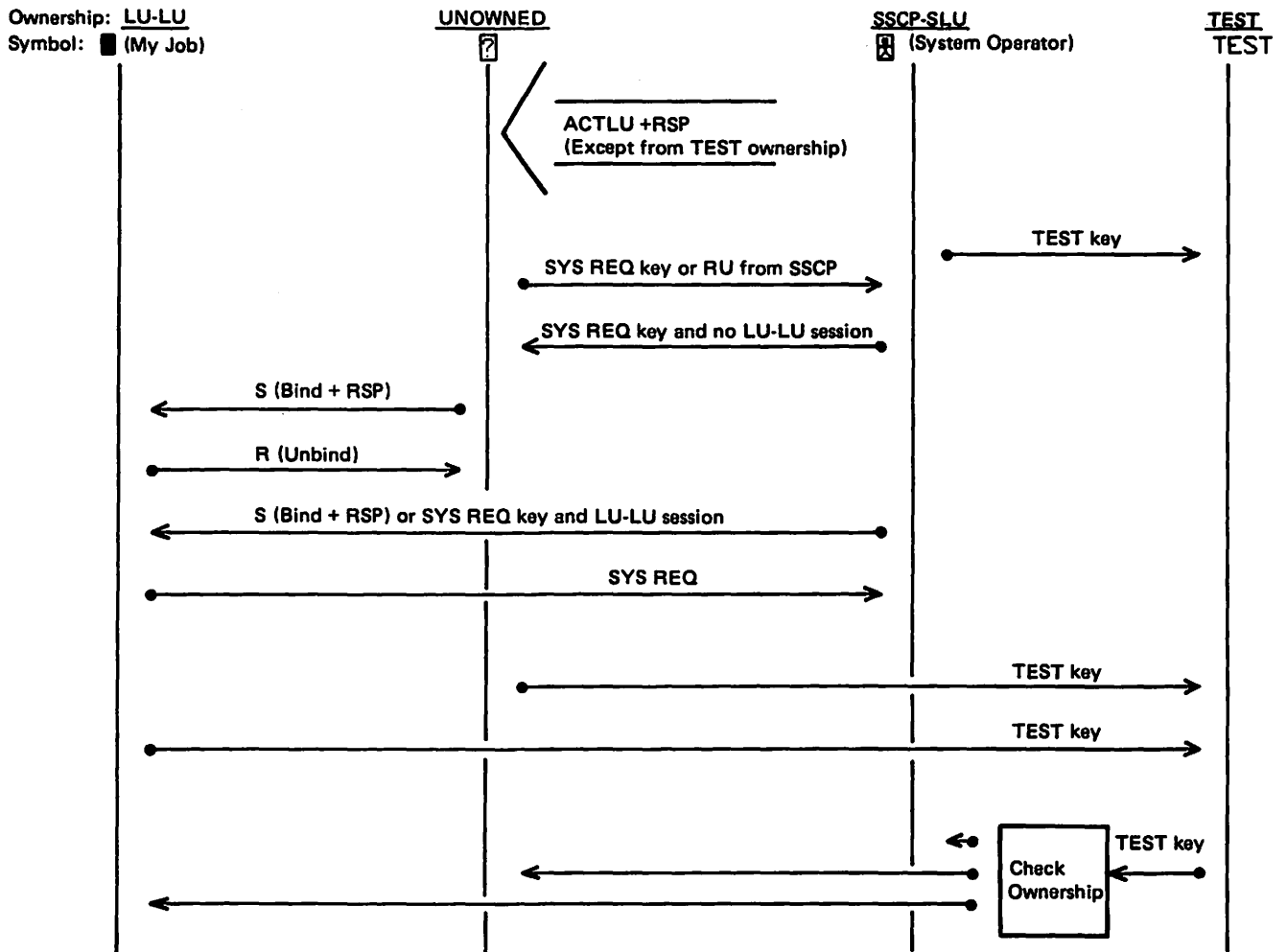

Figure 4-14. State Diagram for Session Ownership of Device

When a Bind command is received and positively responded to, ownership is transferred immediately from the SSCP-SLU session, or the unowned state, to the LU-LU session, and the My Job symbol appears in column 3. Note that Bind commands may be PLU-initiated without operator logon.

The SYS REQ key is also used to transfer ownership from the LU-LU session to the SSCP-SLU session. This transfer of ownership interrupts communications taking place during the LU-LU session without waiting for completion of outbound chains. Inbound chains will complete unless a test is made for a pacing response. As long as the LU-LU session remains bound, another depression of the SYS REQ key will cause ownership transfer back to the LU-LU session. Note that if the LU-LU session is not bound, the SYS REQ key will cause ownership transfer to the unowned state.

Pressing the TEST key causes the device to go into or leave the test ownership state. This state removes the device from the SLU and makes it unavailable to either the SSCP or PLU. If the PLU sends an FM request, the SLU sends -RSP X'082D'. If the SSCP sends an FM request, the SLU sends -RSP X'081B'. These responses assume that all other requirements for an active session have been met. When leaving the test state, a check is made for SSCP or PLU device ownership. Return will be to the session whose ownership is indicated by the check or to the unowned state if neither the PLU nor SSCP is the owner.

Setting the Screen Size

When ownership changes, the screen size may change. When changing from the unowned state to SSCP-SLU ownership, the screen size is set to the maximum physical size. When the screen enters the unowned or test state, the initial screen size is the size set by the previous owner; pressing the CLEAR key will set the screen to the maximum physical size. Operation and control of the screen size when the owner is the LU-LU session is discussed under "Erase/Write Alternate command" in Chapter 1.

Pressing the SYS REQ key causes the screen to be cleared. The screen also is cleared by the transfer of ownership from unowned to SSCP-owned when this state transfer is caused by an outbound RU from the SSCP.

Operation in SSCP-SLU Session

The following paragraphs describe the operational characteristics of the 3276 when exchanging display data on the SSCP-SLU session.

SSCP-SLU Contention Operation

The 3276 supports FM profile 0. Immediate control and immediate response is followed, and all requests are treated as definite requests.

HDX contention is implemented, and a normal flow request must be processed and acknowledged by a response before an opposite-direction normal flow request can be accepted or processed.

The 3276 SLU is in Contention state whenever SSCP-SLU session ownership mode is entered by use of the SYS REQ key.

Nonerror Operation

For nonerror operation, the receipt of a positive response, or transmission of the response, initiates the transition to Contention state. The transition from Contention to Receive state is initiated by the recognition of an outbound request. The transition from Contention to Send-not-xmit is made when the first data key pressed is accepted. Refer to "Send (SEND) State." The transition to Send-xmit is made when the ENTER key is accepted.

The keyboard is controlled by state conditions. It is unlocked when in Contention or Send-not-xmit, and locked when in Receive or Send-xmit. The operative keys that are locked or unlocked are the same as for the LU-LU session.

Error Operation

When a normal flow request has been transmitted inbound and a negative response is received, the SLU goes into Receive state and waits for an outbound request from the SSCP.

When the 3276 SLU detects a temporary or permanent error condition while in Send or Contention state, the SLU goes into Contention state. The SSCP is not notified of the error.

When a normal flow request is received but cannot be accepted because of error or a not-available condition, the SLU goes into Contention state following the negative response.

Outbound Message Handling

The SSCP may send messages to a display when the SSCP-SLU session owns the display. The messages are byte strings consisting of SCS control codes and SSCP-supported graphic codes. There is an outbound limit of 256 bytes of data. The only valid SCS control codes for the 3276 are NL and, when the APL/Text feature is installed, the Graphic Escape character. NULL, IFS, and IRS are treated as graphics and displayed as blank, *, and ; respectively. Any other binary combination in the SCS data stream will be treated as if it is a graphic. The characters appearing on the screen for code-points other than supported graphics are unpredictable.

Each message from the SSCP is displayed at the current cursor address. When the 3276 receives an NL control code in the SSCP message, it will insert nulls in the character positions remaining in the display line being written and position the cursor at the leftmost position of the next line. Characters following the NL code are displayed beginning at the new cursor position. The message wraps to the top of the screen if the last line on the screen is written and additional characters remain in the message.

After displaying the data in the received chain, the 3276 places the cursor in the position next to the last character if NL does not follow. If the message is ended by NL, the remainder of the line is set to nulls and the cursor appears in the first character position of the next line. This cursor position address is called the *initial cursor address* and is stored to identify the starting position of the operator's display input data.

Inbound Message Handling

When the System Operator symbol is displayed, an operator can enter the message bound for the SSCP from the character position occupied by the cursor.

After entering a message, the operator must press the ENTER key to initiate a transmission of the inbound message to the SSCP. Pressing other PA keys has no effect, except for the CLEAR key. Data transmission does not occur. If other PA or PF keys are depressed, Input Inhibited and Minus Function symbols are turned on. Pressing the CLEAR key causes the display screen to be cleared, and the initial cursor address is reset. The ERASE INPUT and ERASE EOF keys operate as defined under "Key Functions" in Chapter 2.

Chains sent on the SSCP-SLU session are OIC, and have a maximum RU length of 256 bytes. The 3276 will search the screen including and following cursor position to end of screen, or until a 256-byte RU has been assembled. Null characters are suppressed and not sent.

System Logon (3178; 3276; 3278; or 3279 Attached to 3276)

By means of the logon sequences, the terminal operator requests that a session be established with a PLU. The logon sequence is as follows:

1. The terminal operator checks the symbol displayed in column 3 of the Operator Information Area (see Appendix A). If the My Job symbol is displayed, the terminal is already connected to a PLU, and system logon is not required.
- 2a. If the Unowned symbol is displayed, the terminal operator presses the SYS REQ key to enter the SSCP-SLU owned session and then keys in a character-coded logon request in a syntax defined by the installation. The operator presses the ENTER key and the logon message is sent to SSCP.
- 2b. If the System Operator symbol is displayed, the display station is already owned by the SSCP-SLU session. In this case, the operator performs step 2a, except the SYS REQ key is not pressed.
3. SSCP receives the logon request and sends a positive response (X SYSTEM disappears).
4. SSCP may send a message, such as a prompting or error message, to the 3276 if necessary. When the 3276 receives this message, it sends a +RSP if accepted for display, or -RSP X'081B' if device ownership has been transferred to the LU-LU session.
5. A successful logon causes the My Job symbol to appear. An error message leaves the System Operator symbol displayed; the operator may retry, starting with step 2b.

Note: An SSCP-SLU message confirming LOGON should not be used since this may arrive after the Bind command and confuse the operator by displaying the Message Received symbol.

System Logoff (3178; 3276; 3278; or 3279 Attached to 3276)

By performing the logoff sequence, the terminal operator requests the SSCP to terminate a session with the PLU. The logoff sequence is as follows:

1. The terminal operator presses the SYS REQ key to enter the SSCP-SLU owned session and keys in a character-coded logoff request in a syntax defined by the installation. When the operator presses the ENTER key, the logoff message is sent to SSCP.
2. SSCP receives the logoff request and sends a DR response.
3. SSCP may send a message. When the 3276 receives the message, it sends a +RSP if accepted for display, or -RSP X'081B' if device ownership has been transferred.

SNA Printer Control Sessions

The following paragraphs describe the structure of the SNA session and the SNA control for printer operations. Details and constraints of subsystem operation are described under "3276 Local Copy Function" in Chapter 2.

Figure 4-15 shows a typical example of a logical subsystem and the point at which contention for the printer occurs.

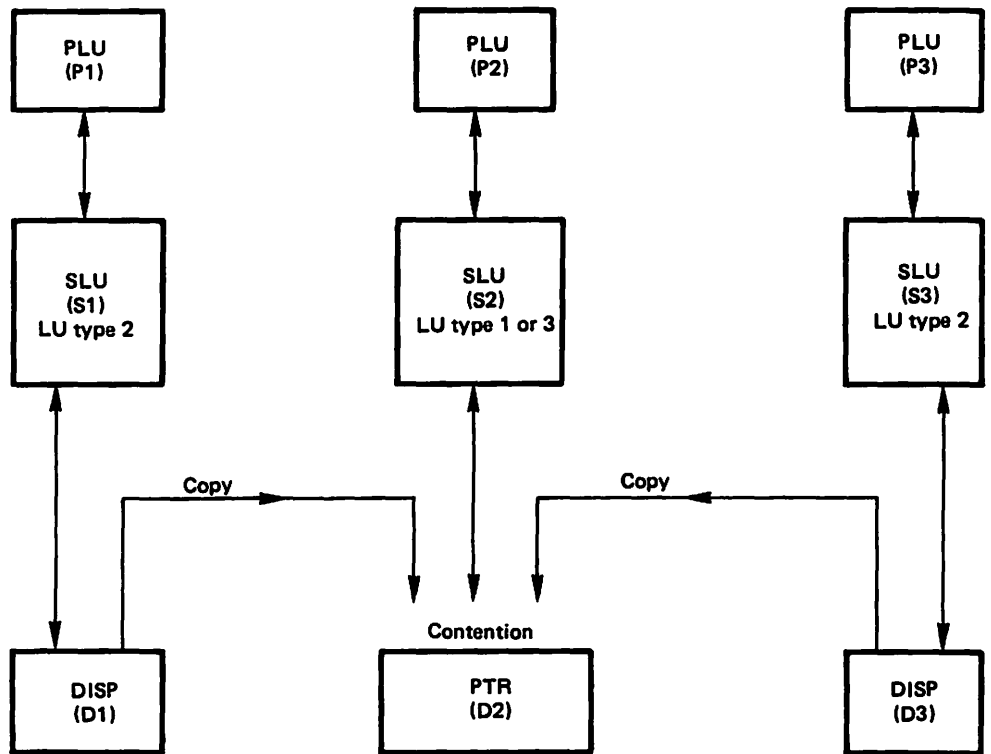

- P1, P2, P3 : PLUs at the host.
- S1, S3 : SLUs in the 3276 operating as LU type 2.
- S2 : SLU in the 3276 operating as LU type 1 or LU type 3.
- D1, D3 : Display device controlled by S1 and S3, respectively.
- D2 : Printer device controlled by S2 or copied to from D1 or D3

Figure 4-15. Logical Subsystem

Printers attached to the 3276 are always configured in shared mode. In shared mode, both the SLU type 2 and the SLU type 1 or 3 may compete for use of the printer. The printer is used by the SLU type 1 or 3 as a principal device and by the SLU type 2 as a subsidiary device. For the 3276, sharing may be done between brackets.

When in shared mode, printer contention is allowed to occur between brackets. When the printer's SLU enters BETB state (or if a session does not exist), the printer is available for either a local copy from an SLU type 2 or an SLU type 1 or 3 bracket, whichever occurs first. If a local copy function is being performed for either a single SLU type 2 or a queue of SLU type 2 requests, a BB request for the type 1 or 3 SLU will be rejected with sense code X'0814' (Bracket Reject, RTR to Follow). When all local copies are completed, the type 1 or 3 SLU acquires the printer and sends RTR to the PLU. If the type 1 or 3 SLU is in-bracket, the printer is not available for local copy functions. (See the description of the copy function for details.)

Remote Operations - SDLC

SDLC Transmission Frames

SDLC transmission frames are composed of a series of 8-bit binary-coded bytes which contain addressing, data, control, and checking information. Transmission between the controller and the 3276 units takes place according to a predefined frame format which consists of the following sequence of bytes:

- Flag (F) Sequence – 1 byte
- Secondary Station Address (A) – 1 byte
- Control (C) Field – 1 byte
- Information (I) Field – up to 256 bytes of message data, preceded by header information
- Frame Check Sequence (FCS) – 2 bytes
- Flag (F) Sequence – 1 byte

Bit synchronization preceding transmission of an initial flag and following a line turn-around is achieved by transmission of 16 zero bits, after the Clear to Send signal is turned on and the NRZI encoder (when used) is enabled.

When sending or receiving over an SDLC link, these units operate in modulo-8 mode—that is, up to seven frames at a time.

For a detailed description of the SDLC frame format, refer to *IBM Synchronous Data Link Control General Information, GA27-3093*. Support of the frame sequence, flag byte, address byte, and frame check sequence bytes conforms to the referenced document.

Response Modes

The 3276 unit functions in two link-operating modes: normal response mode (NRM) and normal disconnect mode (NDM). In NRM, the 3276 can initiate transmission only as a result of receiving a frame from the communication controller which contains the P bit set to 1. Single or multiple frames may be sent by the 3276. The last frame (or a single frame) transmitted by the 3276 in response to a command received with the P bit set to 1 must have the F bit set to 1. When the 3276 has completed a transmission, a new transmission cannot be initiated until a subsequent frame is received from the communication controller which contains the P bit set to 1. A response transmission initiated by the 3276, which requires acknowledgment from the communication controller, is repeated each time the communication controller polls until the acknowledgment is received. There is no limit to the number of transmissions. Responses that require acknowledgment from the communication controller are I frames, FRMR, and RR when transmitted with the F bit set to 0, to report clearing of a busy condition.

When in NDM, the 3276 cannot accept or transmit I or supervisory (S) frames. Non-sequenced responses are not transmitted unless the 3276 is solicited to reply. Invalid or nonimplemented commands received in NDM cause the 3276 to transmit a DM response at the next response opportunity. DM can be retransmitted until an SNRM or DISC command is received. Command reject conditions are not present in NDM.

The following paragraphs describe the 3276 support of the control and information fields.

Control Field

The control field designates the frames as supervisory (S), nonsequenced (NS), or information (I).

Supervisory Commands

The 3276 supports only the supervisory commands Receive Ready (RR) and Receive Not Ready (RNR).

The C-field formats are as follows:

| | | | | |
|----|-----|-----|----|----|
| RR | Nr | P/F | 00 | 01 |
| | 012 | 3 | 45 | 67 |

| | | | | |
|-----|-----|-----|----|----|
| RNR | Nr | P/F | 01 | 01 |
| | 012 | 3 | 45 | 67 |

The 3276 will transmit RNR when the control unit cannot accept further data from the link.

When the reported RNR condition is cleared, the control unit will transmit an I frame or RR with the F bit on after a frame with the P bit on is received.

If the 3276 has received an RNR, an I frame will not be transmitted until an RR or I frame with the poll bit on is received.

The transmission or receipt of an NS frame does not indicate the RNR condition has cleared.

Nonsequenced Commands and Responses

The following nonsequenced commands and responses are supported by the 3276:

| Command/Response | C-Field | Hex Code |
|---|--------------------------------------|----------|
| Set Normal Response Mode (SNRM) Command | 1 0 0 P 0 0 1 1 0 1 2 3 4 5 6 7 | 93 |
| Disconnect (DISC) Command | 0 1 0 P 0 0 1 1 0 1 2 3 4 5 6 7 | 53 |
| Unnumbered Acknowledgment (UA) Response | 0 1 1 F 0 0 1 1 0 1 2 3 4 5 6 7 | 73 |
| Disconnect Mode (DM) Response | 0 0 0 F 1 1 1 1 0 1 2 3 4 5 6 7 | 1F |
| Frame Reject (FRMR) Response | 1 0 0 F 0 1 1 1 0 1 2 3 4 5 6 7 | 97 |
| Test Command/Response | 1 1 1 P/F 0 0 1 1 0 1 2 3 4 5 6 7 | F3 |
| Exchange Station ID Command/Response | 1 0 1 P/F 1 1 1 1 0 1 2 3 4 5 6 7 | BF |

The SNRM command sets the 3276 in NRM. Receipt of SNRM causes the 3276 to deactivate the physical unit if it is in active state. The On-Line and Ownership symbols are turned off.

The DISC command sets the 3276 in NDM.

The UA response is sent by the 3276 to acknowledge receipt and acceptance of the SNRM and DISC commands.

The Test command is used to initiate one round-trip transmission of test data both in NRM and NDM. The 3276 station will return the Test response without data if buffering is not available to hold the complete test data, or with data if buffering is available.

The Disconnect Mode (DM) response is sent by the 3276 in normal disconnect mode (NDM) to request on-line status. DM is sent in response to any command except Test and XID. DM is sent in response to the SNRM command when the 3276 cannot enter NRM.

The FRMR response is implemented by the 3276 as described in GA27-3093. The FRMR will be sent in response to any poll until an SNRM or DISC is received to reset the control unit.

The exchange station identification (XID) number must be added to the host programs for a 3276 attached to a switched network, but the XID is not critical when the 3276 is attached to a nonswitched network.

The XID command and response contains additional data beyond the C byte. The 3276 responds to the XID command in NRM or NDM, except when an FRMR condition exists, in which case the FRMR response takes precedence over XID. The request/response unit (RU) of the XID response consists of 48 bits, defined as follows:

| Bits | Meaning |
|---------|------------------------|
| 0 – 3 | ID format B'0000' |
| 4 – 7 | PU type B'0010' |
| 8 – 15 | Self description X'00' |
| 16 – 27 | X'018' (3276) |
| 28 – 47 | Terminal ID |

Bits 28-47 are a unique terminal ID that can be obtained from the seven digits either shown in the machine history list supplied with the 3276 or engraved on the side frame of the 3276. These seven digits are the machine serial number and should be converted into the proper station ID by one of three methods:

- Method 1 if the first two digits of the machine serial number are 55 or 82, or if the first two digits are 00 or 23 and the remaining five digits of the machine serial number are less than 65536.
- Method 2 if the first two digits of the machine serial number are 00 or 23 and the remaining five digits of the machine serial number are from 65536 to 80535.
- Method 3 if the first two digits of the machine serial number are 00 or 23 and the remaining five digits of the machine serial number are greater than 80535.

Method 1: The first two digits of the machine serial number are converted into the following bits.

| | |
|-------------------|-----------------|
| First two digits: | Bits 28–31 |
| 00 or 23: | B'0000' or X'0' |
| 55: | B'1100' or X'C' |
| 82: | B'1111' or X'F' |

The remaining five digits are converted into bits 32–47 by use of the *IBM System Reference Card*, GX20-1850 or GX20-1703.

Example: If the seven digits of the machine serial number are 00–15263, 15263 is converted into hexadecimal. The result is X'3B9F'.

Bits

| | |
|-------|--------------------------------|
| 28–31 | X'0' or B'0000' |
| 32–47 | X'3B9F' or B'0011101110011111' |

The complete terminal ID is X'020001803B9F'.

Fixed Variable

Method 2: The first two digits of the machine serial number are converted into the following bits:

First two digits: Bits 28–31
00: B'0000' or X'0'
23: B'0000' or X'0'

The remaining five digits are converted by use of the *IBM System Reference Card*, GX20-1850 or GX20-1703. The highest bit of the binary is then removed. The remaining 16 bits are used for bits 32–47

Example: If the seven digits of the machine serial number are 00–71234, 71234 is converted into hexadecimal. The result is X'11642'. The highest digit is then removed. The result is X'1642'.

Bits

28–31 X'0' or B'0000'
32–47 X'1642' or B'0001011001000010'

The complete terminal ID is X'020001801642'.

Fixed Variable

Method 3: The first two digits are not converted. The last five digits of the machine serial number are converted into hexadecimal by use of the *IBM System Reference Card*, GX20-1850 or GX20-1703. The converted hexadecimal value is bits 28-47.

Example: If the seven digits of the machine serial number are 00–98765, 98765 is converted into hexadecimal. The result is X'181CD'.

Bits

28–47 X'181CD' or B'00011000000111001101'

The complete terminal ID is X'0200018181CD'.

Fixed Variable

Terminal Identification and Addressing

Terminal ID

Each 3276 control unit operating under SDLC has a permanent, unique, 6-byte identification that it will transmit in response to a request for its ID (XID command). This identification is fixed at the time of manufacture and is not selectable.

SDLC Station Address

The SDLC station address is a 1-byte address that must be selected by the customer at setup time.

For details, refer to *IBM 3270 Information Display System Planning and Setup Guide*, GA27-2827. An SDLC station address of either X'00' or X'FF' should not be assigned.

Information (I) Frame

The information frame is used to transmit message data. When transmitted, the I frame contains a maximum of 256 bytes of RU message data preceded by 6 bytes of transmission header (TH) and, optionally, 3 bytes of request/response header (RH). For further information, refer to "Segmenting Description" in this chapter.

Sequence Error Recovery Procedures

A sequence error occurs when the 3276 receives an I frame with an incorrect Ns sequence count and valid FCS bytes. The 3276 does not accept the I frame that caused the sequence error and rejects all following I frames until an I frame is received which contains the correct Ns value, at which time the sequence error condition is reset.

The 3276 transmits I frames in the sequence indicated by the last Nr count received, which may include retransmission of previously transmitted I frames that have not been acknowledged.

All I frames are transmitted in contiguous sequence according to the Ns value within the constraints of the modulo count.

Abort Function

The abort function is used by the communication controller or by the 3276 when a frame being transmitted is to be discarded. The abort function is performed by transmitting eight contiguous 1 bits without zero insertion at the earliest possible time following recognition of an abort situation. No FCS is transmitted. When, for example, the 3276 receives seven contiguous 1 bits, it discards the aborted frame. The 3276 employs the abort function when an equipment malfunction occurs that causes an erroneous transmission.

The 3276 supports automatic disconnection from the line as shown in Figure 4-16.

| | | 3276 | | |
|------------------|--------------|---|-----------------------|-----|
| | | Models 1, 2, 3, 4 | Models 11, 12, 13, 14 | |
| Integrated Modem | Switched | Auto Answer | No | Yes |
| | | Manual Answer | No | No |
| | Non-Switched | Without Switched Network Backup | No | No |
| | | With Switched Network Backup (Auto Answer) | Yes | Yes |
| | | With Switched Network Backup, Manual Answer (Auto Answer) | No | No |

Note: Automatic disconnection is supported for external modems whenever switched network is used. However, the line is not actually disconnected by this function when the CDT coupler, or its equivalent, is used between the modem and the line.

Figure 4-16. Automatic Disconnection Support by 3276

In SDLC mode, DTR is deactivated if no frames which address the station are received for 48 to 64 seconds. In BSC mode, DTR is deactivated if no link activity is detected for 40 to 50 seconds. DTR will be activated after DSR has been deactivated.

In SDLC mode, the DISC command will cause automatic disconnection from the line in case of switched network operation. In SNBU operation, this function will not take place.

When the 3276 is attached point to point or multipoint, and does not recognize any valid outbound frame for 8 seconds, the no-link activity timeout occurs. This timeout causes the Line Ready indicator to be turned off. The timer is reset to zero when the 3276 detects a valid outbound frame.

SNA Reference Data (3276)

Bind Default

The following is suggested as a setting for the access method logmode table for LU type 1:

| Byte | Binary Bits | Byte | Binary Bits |
|------|-------------|--------|-------------|
| — | 0123 4567 | 8 | 0000 0000 |
| 0 | 0011 0001 | 9 | 0000 0001 |
| 1 | 0000 0001 | 10 | 1000 0101 |
| 2 | 0000 0011 | 11 | 1000 0101 |
| 3 | 0000 0011 | 12, 13 | 0000 0000 |
| 4 | 1011 0001 | 14 | 0000 0001 |
| 5 | 1001 0000 | 15-17 | 0000 0000 |
| 6 | 0011 0000 | 18 | 1110 0001 |
| 7 | 1000 0000 | 19-26 | 0000 0000 |

The suggested settings for LU type 2 are the same as for LU type 1 except for:

| Byte | Binary Bits | |
|------|-------------|---------|
| — | 0123 4567 | |
| 9 | 0000 0000 | |
| 10 | 1000 0111 | |
| 14 | 0000 0010 | |
| 18 | 0000 0000 | |
| 24 | 0000 0001 | Model 1 |
| 24 | 0000 0010 | Model 2 |

The suggested settings for LU type 3 are the same as for LU type 1 except for:

| Byte | Binary Bits |
|------|-------------|
| — | 0123 4567 |
| 9 | 0000 0000 |
| 14 | 0000 0011 |
| 18 | 0000 0000 |

Bind Check

The Bind parameters sent to the 3276 will be checked according to the following table:

| Byte | Bit | LU Type 1 | | LU Type 2 | | LU Type 3 | |
|-------|-------------------|-----------|------------------|-----------|------------------|-------------------|------------------|
| | | Check | Reject if | Check | Reject if | Check | Reject if |
| 1 | 0-3 | C | ⌊ X'0' | C | ⌊ X'0' | C | ⌊ X'0' |
| | 4-7 | C | ⌊ X'1' | C | ⌊ X'1' | C | ⌊ X'1' |
| 2-3 | | C | ⌊ X'03' | C | ⌊ X'03' | C | ⌊ X'03' |
| 4 | 0 | NC | | NC | | NC | |
| | 1 | C | B'1' | C | B'1' | C | B'1' |
| | 2-3 | C | B'00' | C | B'00' | C | B'00' |
| | 4,5 | NC | | NC | | NC | B'01'(3274) |
| | 6 | C | B'1' | C | B'1' | C | B'1' |
| 5 | 7 | C | B'0' | C | B'0' | C | B'0' |
| | 0 | NC | | C | B'0' | NC | |
| | 1 | NC | | NC | | NC | |
| | 2-3 | C save | B'00' | C save | B'00' | C save | B'00' |
| | 4-7 | NC | | NC | | NC | |
| 6 | 0 | NC | | NC | | NC | |
| | 1 | C | B'1' | C | B'1' | C | B'1' |
| | 2 | C | B'0' | C | B'0' | C | B'0' |
| | 3 | C | B'0' | C | B'0' | C | B'0' |
| | 4 | C | ** | C | ** | C | ** |
| | 5-7 | NC | | NC | | NC | |
| 7 | 0,1 | C | ⌊ B'10' | C | ⌊ B'10' | C | ⌊ B'10' |
| | 2 | C | B'1' | C | B'1' | C | B'1' |
| | 3 | C | B'1' | C | B'1' | C | B'1' |
| | 4-7 | NC | | NC | | NC | |
| 8 | | NC | | NC | | NC | |
| 9 | 0,1 | NC | | NC | | NC | |
| | 2-7 | NC | | NC | | NC | |
| 10 | | C | | C | | NC | |
| 11 | | C | | NC | | NC | |
| 12,13 | | NC | | NC | | NC | |
| 14 | | C | ⌊ correct device | C | ⌊ correct device | C | ⌊ correct device |
| 15-19 | | NC | | NC | | NC | |
| 20-23 | | NC | | C* | | C* | |
| 24 | | NC | | C save | | C save Device Dep | |
| 25 | | NC | | NC | | NC | |
| 26† | | C | ⌊ X'00' | C | ⌊ X'00' | C | ⌊ X'00' |
| 27† | All bytes ignored | | | | | | |

Notes:

- † Bytes 26-35 are reserved for the Encrypt/Decrypt feature.
- * If byte 24 bits 4-7 has X'E' or X'F', these bytes are checked.
- ** Feature dependent
- C - Check
- NC - No check
- B - Bit
- ⌊ - Logical Not

SNA Sense Codes

Each major error code has modifiers for further description in sense byte 1. The modifier codes supported and the controller or terminal condition causing the negative response to be returned are described below.

Sense

Byte 1 Description

Path Error X'80'

X'04' Unrecognized DAF'
Controller does not have a terminal adapter for the DAF address.

X'05' – NO SESSION

- A Bind has not been received or accepted by the 3276.
- A request other than Bind is sent to an SLU which has already accepted a Bind, and the OAF' is not X'00' or the OAF in the accepted Bind.

X'08' – PU NOT Active

The 3276 has not received or accepted an ACTPU, or a control condition caused an internally generated DACTPU.

X'09' – LU NOT Active

The 3276 has not received or accepted an ACTLU, or a control condition caused an internally generated DACTLU.

X'0F' – Invalid Address Combination

A request was addressed to the PU (DAF'=X'00'), and the OAF was not SSCP (OAF'=X'00').

RH Error X'40'

X'0F' – Format Indicator Not Allowed

An FM request received by the 3276 indicated formatted header included.

State Error X'20'

X'01' – Sequence Number Error

The sequence number of the normal flow request did not match the number expected by the 3276.

X'02' – Chaining Error

Chain elements were out of protocol sequence.

X'03' – Bracket State Error

A bracket state error occurred.

**Sense
Byte 1 Description**

X'05' – Data Traffic Reset

An FM or DFC request was received before an SDT was received or accepted.

X'09' – Session control protocol violation (Encrypt/Decrypt feature)

An FM request was received prior to a valid CRV.

Request Error X'10'

X'02' – RU Length Error

RU size exceeds Bind specification (LUT1 only).

X'03' – Function Not Supported.

- Unsupported Session Control Request
- Unsupported Data Flow Control Request
- SIGNAL Code is not X'00010000'
- Network Control Request
- FM Data Stream
- Invalid Command
 - Data following a Read, RM, RMA, or EAU command.
 - For LU type 3, any Read, RM, or RMA command.
- Unsupported FM Data, SSCP → SPU.

X'05' – Parameter Error

Invalid address following SBA, RA, or EUA order (SBA, RA, or EUA order without parameters), or SCS parameter error.

X'07' – Category Not Supported

- An FMD request from the SSCP was received by an SLU which has an attached device without a keyboard (3276).
- An unsupported network service message received.
- An unsupported FM Data command received.

Request Reject X'08'

X'01' – Resource Not Available

- For LU type 1, outbound pacing algorithm is overrun.

**Sense
Byte 1 Description**

X'02' – Intervention Required (on principal device).

- For LU type 2, security keylock is turned off.
- For LU type 1 or 3, printer condition such as end of form, paper jam, printer cover up, or hold time out.

X'05' – Session Limit Exceeded

A Bind was received whose OAF' differs from the PLU already bound.

X'07' – Subsidiary Device Temporarily Not Available

For LU type 2, a printer to be copied to is In Bracket on an LU type 1 or 3 session, or an operator has pressed DEVCNCL key.

X'0A' – Permission Rejected

Display or printer power is off. The SSCP will not be notified when the device powers on.

X'0C' – Procedure Not Supported

An unsupported REQMS type request was received.

X'11' – Break

Sent on LU type 1 when the operator presses the printer Hold Print key followed by Cancel key, if a chain has not completed printing.

X'13' – Bracket Bid Reject – (No RTR)

- Returned by LU types 1 and 2 to a BID or BID with Begin Bracket if the display has won contention and started a bracket.
- Returned by all LU types, when a BID or Begin Bracket was received, and INB state already exists. This may be a protocol error.

X'14' – Bracket Bid Reject – (RTR to follow).

For LU type 1 or 3, the printer is busy doing local copy from a display. RTR will be returned when the printer becomes not busy with local copy.

X'15' – Function Active

- Bind reject if the same OAF' already has an accepted Bind to the SLU.
- REQMS request is in process.

X'1B' – Receiver in Transmit Mode

- The SLU is between bracket but a data key has been depressed.
- An FM message was received from the SSCP while the display was owned by the PLU-SLU session or is in test mode.
- An SSCP FM message is rejected if local copy is taking place while the SSCP-SLU session owns the display.

**Sense
Byte 1 Description**

X'1C' – Request Not Executable

The 3276 has a nonrecoverable error.

X'21' – Invalid Session Parameters

- Bind parameters do not match the 3276 Bind checks.
- 3276 rejection of ACTPU or ACTLU if FM/TS profile byte is not X'01'.

X'29' – Change Direction Required

A 3276 read-type command was received without a Change Direction or an End Bracket.

X'2B' – Presentation Space Integrity Lost

- A temporary error has occurred; for example, parity check in device.
- An operator has cleared the display by switching to SSCP-SLU session or test mode and returned to PLU-SLU session.

X'2D' – SLU Busy

- LU type 2 Display is owned by SSCP-SLU session or test mode.
- LU type 2 Display is busy doing an operator-initiated local copy.

X'2E' – Intervention Required at Subsidiary Device.

For LU type 2, a printer being copied to from a host-initiated print has intervention-required type error. Refer X'0802'. Printer power off or not attached to the controller is included in this category.

X'2F' – Request Not Executable Because of LU Subsidiary Device.

For LU type 2, a printer being copied to has a nonrecoverable error.

X'31' – LU Component Disconnected

This response is returned if the device attached to the 3276 cannot be contacted by a device poll. This is due to device power off, cable detached from the controller port, or connecting cable broken.

Note: *This response is also returned on the SSCP-SLU session by the 3276.*

X'43' – Required Function Manager Synchronization Not Supplied

For LU type 2 or 3, chains having the print bit on, must be definite response or exception response chain must carry CD.

Logical Unit Status (LUSTAT)

LUSTAT provides a means for the SLU to report exception conditions or status when the SLU is not in Receive state (a negative response is used when the SLU is in Receive state). The following are the CD settings that accompany LUSTAT and the state changes, if any, that occur:

| SLU State When LUSTAT Sent | CD Setting | State Change |
|-------------------------------|-------------------------------------|-----------------|
| BETB | CD may be set | None |
| ERP1 | CD not set | None |
| Send | CD set for principal device | to Receive |
| | CD not set for subsidiary device | None |

Inbound LUSTATs are sent with a definite response by the 3276. The 3276 must receive the response to an LUSTAT before it will send any further normal flow requests on that session; however, it will accept outbound requests prior to receiving the response to LUSTAT.

Programming Note: An LUSTAT that shows power off that is sent while in Send state carries CD. An LUSTAT that shows power on cannot be sent until the PLU causes an SLU state change to (S, *R).

The following status codes will be used by the 3276 to send information to the PLU, on the PLU-SLU session:

| Value | Explanation |
|--------------|---|
| X'0001Z000'* | Device now available; presentation space not destroyed. |
| X'00020000' | Device has received CD, but has no input mechanism. |
| X'081CZ000'* | Component failure; permanent error. |
| X'082B0000' | Device available; presentation space integrity lost. |
| X'08310000' | Principal device is powered off or disconnected. |
| X'0801Z000'* | Printer has been removed from configured status. |

*Where Z specifies whether the status refers to the principal or subsidiary device. (Refer to "SNA Printer Control Sessions" (Figure 4-15) for a description of principal and subsidiary devices.) The value of Z is defined as follows:

| | | |
|----------------------|-----------|-----|
| LU type 1 Principal | (printer) | Z=0 |
| LU type 2 Principal | (display) | Z=D |
| LU type 2 Subsidiary | (printer) | Z=B |
| LU type 3 Principal | (printer) | Z=0 |

The priority of these status codes, in low to high order, is assigned as:

X'0002', X'0001', X'082B', X'0831', X'0801', X'081C'

The 3276 will send the highest level of priority status when an opportunity allows its transmission.

Definition: (S, *R) = Send state, ERP1 state, or BETB state.

The upper section of Figure 4-17 shows the LUSTAT codes that are returned to clear the negative response condition listed in the left column. The lower section lists the LUSTAT codes that are used to report an SLU error condition instead of a negative response. The X's show the sessions that use the code points.

LUSTAT Returned

| Negative Response Code | LU Type | | | |
|------------------------|--|--|--|----------|
| | T1 | T2 | T3 | SSCP |
| 0802 | 00010000 082B0000 081C0000 08310000 | 0001D000 082B0000 081CD000 08310000 | 00010000 082B0000 081C0000 08310000 | NA |
| 0807 | NA | 0001B000 0801B000 081CB000 081CD000 | NA | NA |
| 082D | NA | 0001D000 082B0000 081CD000 | NA | NA |
| 082E | NA | 0001B000 0801B000 081CB000 081CD000 | NA | NA |
| 0831 | 082B0000 081C0000 | 082B0000 081CD000 | 082B0000 081C0000 | NA NA |

Sent By

| LUSTAT | LU Type | | |
|----------|---------|----|----|
| | T1 | T2 | T3 |
| SEND | | | |
| BETB | | | |
| ERP.1 | | | |
| 00020000 | X | X | X |
| 081C0000 | X | | X |
| 081CB000 | | X | |
| 081CD000 | | X | |
| 082B0000 | X | X | X |
| 08310000 | X | X | X |
| 0801B000 | | X | |

Figure 4-17. Summary Table of LUSTATs

LUSTAT is used as follows:

For all LU types, when the 3276 has sent -RSP with X'0802' or X'082E' and this condition is reset, LUSTAT with X'0001P000' will be sent: Where the value P is X'0' for LU type 1 or 3, X'D' for LU type 2 principal (display), and X'B' for LU type 2 subsidiary device (printer).

If the presentation integrity is lost while an X'0802' condition exists, LUSTAT with X'082B0000' will be sent instead of X'0001P000' when the X'0802' condition is reset.

For LU type 2, when the 3276 SLU has sent -RSP with secondary component not available (X'0807') and this condition is reset, LUSTAT with X'0001B000' will be sent.

For all LU types supported by the 3276, the LUSTAT X'00020000' will be sent to the PLU when the 3276 accepts a normal flow request carrying CD, but no input components (keyboard, light pen, MSR, etc.) are attached to the device.

For all LU types, LUSTAT with X'082B0000' will be sent to the PLU when the 3276 SLU detects presentation integrity lost (for example, regeneration buffer parity error), and is in Send or Contention state for the 3276.

For LU type 2, when the 3276 has sent -RSP (Device Busy) (X'082D') to a PLU request because of session ownership change from PLU to SSCP or TEST, LUSTAT with X'082B0000' will be sent to the PLU when returning to PLU-SLU session.

For LU type 2, when 3276 has sent -RSP (Device Busy) (X'082D') to a PLU because the SLU is busy executing a local copy, the 3276 sends LUSTAT X'0001D000' component now available to the PLU when the busy condition clears.

For all LU types, if a principal device is powered off or unplugged from the controller port and a session exists which is in (S, *R) state, LUSTAT X'08310000' will be sent to the PLU.

For all LU types, when a principal device has sent -RSP or LUSTAT X'0831000' and then power is restored, LUSTAT with X'082B0000' will be sent to the PLU.

For all LU types, if 3276 finds a permanent error in the principal device and is in (S, *R) state, LUSTAT with X'081CP000' will be sent to the PLU. The value of P is the same as defined in item 1.

For LU type 2, the 3276 will send LUSTAT with X'081CB000' when it detects a permanent error in the subsidiary device and is in (S, *R) state only if an LUSTAT for the subsidiary device is owed.

Error-Recovery Procedures

The following sense codes are returned by a negative response or an LUSTAT. Suggested recovery procedures are indicated for each error code and must be evaluated for the needs of each user.

Negative Response Codes:

| Error Code | Recovery Procedures (See "Recovery Notes") |
|---------------------------|--|
| Path errors X'80xx' | 1 |
| RH errors X'40xx' | 2 |
| State errors X'20xx' | 2,3 |
| Request errors X'10xx' | 2,21 |

Request Reject: X'08xx'

| Hex 'xx' | LU Type 1 | LU Type 2 | LU Type 3 |
|----------|-----------|-----------|-----------|
| 01 | 5 | 5 or 6 | 5 |
| 02 | 8 | 7 | 8 |
| 05 | 4 | 4 | 4 |
| 07 | NA | 07 | NA |
| 0A | 4 | 4 | 4 |
| 11 | 9 | NA | NA |
| 13 | 10,11 | 10,11 | 10,11 |
| 14 | 12 | NA | 12 |
| 15 | 4 | 4 | 4 |
| 1B | NA | 13 | NA |
| 1C | 3,4 | 3,4 | 3,4 |
| 21 | 1 | 1 | 1 |
| 29 | 3,4 | 3,4 | 3,4 |
| 2A | NA | 14 | NA |
| 2B | 16 | 16 | 16 |
| 2D | NA | 7 | NA |
| 2E | NA | 7 | NA |
| 2F | NA | 17 | NA |
| 31 | 7 | 7,18 | 7 |
| 43 | NA | 7,19 | 7,19 |
| 45 | 1 | 1 | 1 |

See Recovery
Note(s)
indicated.

LUSTAT Sense Codes:

| Hex Code | Recovery Procedure (See "Recovery Notes") |
|-----------|---|
| 0001 0000 | 9a |
| 0001 B000 | 9a |
| 0001 D000 | 9a |
| 0002 0000 | 21 |
| 082B 0000 | 16 |
| 081C 0000 | 3 |
| 081C B000 | 17 |
| 081C D000 | 3 |
| 0831 0000 | 7,18,20 |
| 0801 B000 | 6,17 |

Recovery Notes:

1. *No recovery action can be taken until the 'xx' condition reported is corrected.*
2. *Unbind and correct program code.*
3. *Retry the operation up to three times by sending Clear, SDT, and starting traffic at a program check-point restart. Terminate the operation if the retries are not successful.*
4. *No recovery; look for an alternate terminal or terminate the operation.*
5. *Unbind, and look for an alternate terminal, or terminate the operation.*
6. *Read the display, and save for later printout.*
7. *Wait for LUSTAT; recovery based on LUSTAT code.*
8. *Wait for LUSTAT; retransmit chain.*
9. *User options:*
 - a. *Resend chain.*
 - b. *Send next chain.*
 - c. *Send query to printer operator for PA key response.*
10. *Check the input queue for inbound data with BB and CD.*
11. *Protocol error occurred. Retry without BID or BB.*
12. *Wait for RTR to begin bracket*
13. *a. Check the input queue, and wait for data.*
 - b. *Send SIGNAL to get CD.*

14. *Retry with CD and not EB.*
15. *User options:*
 - a. *Send Null or comment RU with CD to give control to operator.*
 - b. *Send Read Modified command with CD to obtain display AIDs and modified data.*
 - c. *Reformat display from check-point restart.*
16. *Reformat display or printer from check-point restart.*
17. *Retry the operation up to three times by use of Write command and WCC with Start Print bit set to 1. An alternate printer may become available.*
18. *Unbind to force user identification by entering new logon.*
19. *Retry with correct bit settings.*
20. *When received, the user must be sure the secondary logical unit is in ERP1 or Send state, to allow sending the LUSTAT which indicates a power-on condition. The 3276 requires user action to change state if it has sent LUSTAT 08310000 while BETB.*
21. *Program dependent:*
 - a. *If input is required from terminal, unbind and select an alternate terminal.*
 - b. *If input is not required, data output may continue. CD should be suppressed.*

Chapter 5. Screen Design

Introduction

To use whatever you have created for display or printing, your information must be communicated to a 3270 device by means of the 3270 data stream, which is made up of commands, control characters, orders, attributes, and data.

Commands control such things as whether you write to or read from a display and whether the screen is erased before new data is written.

Control characters are used with certain commands to perform such functions as sounding the audible alarm, formatting the printer, and restoring or enabling the keyboard.

Orders are instructions written to the 3270 to tell the display unit how to format your panel.

Attributes determine the characteristics of the fields and characters within a field.

Data is the information you are displaying or printing.

The 3270 data stream is based upon the presence of a mapped character buffer in the device. There is a fixed one-to-one relationship between each character storage location in the buffer and each character position on the display. For instance, consider a display for which the display screen is composed of 12 rows of 40 columns each. Row 1 maps to the first 40 character storage positions in the character buffer, row 2 maps to the second 40 character storage positions, and so on. This sequence is the same whether the display is 12 rows and 40 columns or up to 27 rows of 132 columns.

When an Erase/Write command is transmitted to the device, the character buffer is first cleared to nulls (X'00') and subsequent text is written into the character buffer sequentially. The format of the data stream is as follows:

| | | |
|------------------|-----|-----------------|
| Write Command | WCC | Orders and Text |
|------------------|-----|-----------------|

Field Concept

People dealing with information see it as a collection of individual elements. For example, what we know about John Smith's employment may be a collection of individual elements: his name, serial number, location, and date of hire. The size of the element is the amount of data required to convey useful information. You do not think of J and O and H and N as useful individually, but collectively, as the name JOHN. You do not think of JOHNSMITH963981BOSTON070262 as being useful collectively, but see the elements individually: name: JOHN SMITH, serial number: 963981, location: BOSTON, date of hire: 07/02/62.

Each data element has its own characteristics. In this example, the serial number is six numeric digits and varies from employee to employee. The word NAME is 4 characters, is alphabetic, is all uppercase, and does not change. When people record these elements of data on paper, they take on such additional characteristics as position (where on the sheet of paper the item is written), color (what ink or medium is used), size of the letters, and writing style.

In the past, when information was handled by a data processing device, it was generally handled as an artificial entity called a *record*. The contents and characteristics of a record were primarily determined by device requirements, and little or no attention was given to the individual information elements. Data processing users had to adjust their thought pattern to conform to the machine requirements.

The IBM 3270 Information Display System recognizes that people deal with individual units of information. The system has been designed to conform to human needs and requirements, and enables you to deal with data by individual elements or fields, each with its own characteristics.

You may describe data to the 3270 on a field or character basis and specify the characteristics or attributes of each individual field or character. The 3270 then provides program and data control based on your individual field and character definitions.

What Attributes May Be Assigned to a Field

Besides length, which is controlled by the position of field attributes, you may specify the following additional characteristics with the attributes.

Protection

A field is either protected or unprotected. When it is protected, the operator cannot enter or modify data in any location within that field.

In an unprotected field, the operator can enter characters or can delete or modify characters that are already there. Headings, labels, titles, and formats are commonly specified as protected. Any field in which the 3270 operator should enter or modify data must be specified as unprotected.

In Figure 5-1, NAME: would most likely be specified as protected. JOHN B DOE would be specified as protected if it was written by the application program and is to remain unchanged. If JOHN B DOE is to be entered or modified by the operator, the attribute must specify unprotected.

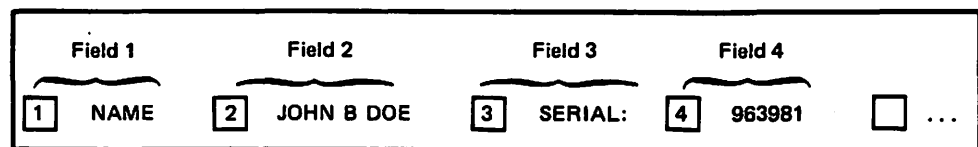

Figure 5-1. Example of Four Fields and Attribute Bytes

Color

If the device has the capability of displaying or printing in color, then the fields or individual characters may be defined in four colors, depending on whether the device has base-color capability.

Terminals with base color can display or print fields in one of four colors, depending on the definition of the field by the field-intensity/field-protection bits in the field attribute character. Base color can be produced on color displays using existing 3270 programs.

Character Content

A field is either alphanumeric, numeric, or user-defined symbols. An operator can enter alphanumeric, numeric, or special characters in an alphanumeric field.

The numeric attribute is more complex; it depends upon whether the numeric Lock feature is present and which keyboard is attached to the display. Figure 5-2 shows what characters may be entered with various combinations of keyboards and field types.

| Keyboard Type | Keyboard Numeric Lock | Shift Key Pressed | Field Type | Protected | Resulting Characters | | |
|---------------|-----------------------|-------------------|------------------|-----------|---|---------------------|-------------------|
| | | | | | In Buffer | Displayed On Screen | Read Into Storage |
| Typewriter | No | No | Alpha or Numeric | No | Lowercase | Uppercase | Lowercase |
| Typewriter | No | Yes | Alpha or Numeric | No | Uppercase | Uppercase | Uppercase |
| Typewriter | Yes | No | Alpha | No | Lowercase | Uppercase | Lowercase |
| Typewriter | Yes | Yes | Alpha | No | Uppercase | Uppercase | Uppercase |
| Typewriter | Yes | No | Numeric | No | Can only enter 0-9, period, and minus sign; any other characters lock keyboard. | | |
| Typewriter | Yes | Yes | Numeric | No | Can only press dup key; any other action locks keyboard (3277). Shift key overrides on 3178, 3278, and 3279. See Numeric Lock discussion in Appendix C. | | |
| Data Entry | No | - | Alpha | No | Alpha keys produce uppercase alpha characters. Numeric shift key produces numeric characters. Alpha shift key has no effect. | | |
| Data Entry | No | - | Numeric | No | Numeric shift key has no effect. Alpha shift key overrides numeric specification and allows alpha character entry. | | |
| Data Entry | Yes | - | Alpha | No | Alpha keys produce uppercase alpha characters. Numeric shift allows numeric character entry. Alpha shift key has no effect. | | |
| Data Entry | Yes | - | Numeric | No | Can only enter 0-9, period, dup, and minus sign. Any other characters lock all keys except for RESET key. Numeric shift key allows numeric character entry. Alpha shift key allows alpha character entry. | | |

Figure 5-2. Results of Keyboard and Field Combinations

Visibility and Detectability

A field is either displayable or nondisplayable. When it is displayable and contains characters, those characters are visible to the operator. When it is nondisplayable, any characters within that field are not visible to the operator. The nondisplayable attribute is useful for entering classified or security information at a display unit that is in public view.

To maintain security, make sure that programs:

- Send a nondisplay attribute byte prior to sending the intended new nondisplayable data to preclude its momentary appearance on the screen.
- Do not overwrite a field attribute of nondisplay for the currently displayed image when partially changing field formats.

All characters within a displayable field can be displayed at regular brightness, at a high intensity, in color, so that they stand out among regular display fields. Color or high intensity can be used to call attention to error conditions or to emphasize protected fields or format fields. Normal intensity or underscore may be used for all input fields, so the terminal operator can tell at a glance which fields require operator action. When used on a color display, high intensity causes the field or character to be displayed in white. However, if the color property is defined, it will override the high-intensity property.

High intensity on a monochrome display results in the field or character so defined to be displayed at a brighter level than those defined as regular intensity.

You should not specify unprotected fields as high intensity since such fields may become selector-pen-detectable (if this feature is installed) if the operator enters a question mark, ampersand, or blank as the first input character. Fields are specified as either detectable or nondetectable. When a field is detectable, it can be used for selector-pen operations. A nondetectable field location cannot be detected by the selector-pen or cursor select. It is good practice to designate all detectable fields as protected to prevent the operator from changing the content of the sensitive field.

Transmission

The fields that have been entered or modified by the operator are sent to the application program by a Read Modified operation. The 3270 keeps track of such modifications and uses that information to select data to send to the application program. If you wish to pass a field into the computer regardless of modification, you may assign the "modified" or "modified data tag" (MDT) property. However, you should note that the operator can change the MDT property unless you also assign the protected property.

You can decide which combination of attributes you want within the limitations specified. Certain attribute combinations produce additional characteristics. For example, the numeric (limiting keyboard use) and protected (eliminating keyboard use) attributes seem contradictory, but, when specified together, automatically skip the cursor past the field.

You should also be aware that the application program is not limited by attributes. The application program can, for example, place alphabetic information in a field defined as numeric, or protected, or both. The operator does not have such liberty.

If you do not specify any combination of attributes, a field is assumed to have the following attributes:

- Alphameric
- Unprotected
- Displayable (at regular brightness)
- Nondetectable by the selector pen or cursor select
- Not modified

The field attribute in the 3270 data stream uses a single nondisplayed and protected character position on the screen and serves as a visual separation between successive fields.

Example of Field Definition

A typical sign-on procedure illustrates how you might define fields. Figure 5-3 illustrates a simple procedure in which the application program requests the operator to provide his name, location, and serial number.

Field 1: SIGN-ON PROCEDURE:

This field is a heading which the operator should not be able to alter. It is unnecessary for the words SIGN-ON PROCEDURE to be returned to the computer when the ENTER key is pressed. This field should be protected, alphameric, displayed at normal intensity, not detectable by the selector pen or cursor select, and not modified. All default attributes can be assumed, except that you must specify this field as protected.

Field 2: PLEASE ENTER . . . INFORMATION

You should specify this field as protected. Remember that the characteristics of a field are determined by the field attribute at the beginning of the field. Fields 1 and 2 have identical attributes and are adjacent to each other. You may choose to define them separately and use two field attributes, or you may choose to omit the field attribute at the beginning of field 2. In the latter case the two headings combine to become a single field of greater length.

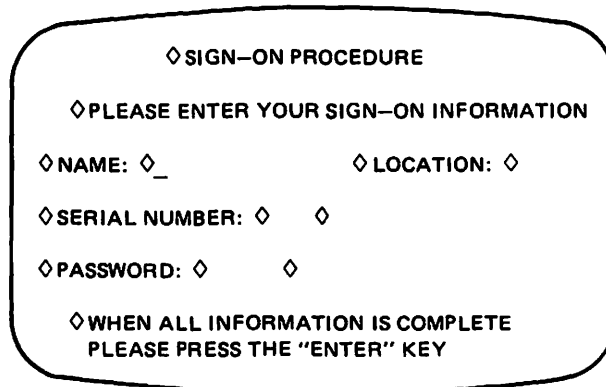

Figure 5-3. Example of Attribute Specification

Field 3: NAME:

This field should be protected, alphameric, not modified, and not detectable by the selector pen. The heading could be displayed at high intensity. Specify the protected and high-intensity attributes (the two deviations from the default attributes).

Field 4: The area following NAME:

The null area following NAME: is an input area for the operator and must therefore be unprotected. The display marks this field as modified if anything is entered into it, so you should not specify the modified attribute. The default attributes (alphameric, unprotected, displayable at normal intensity, not detectable by the selector pen or cursor select, and not modified) apply. Use a default attribute at the beginning of this field.

The maximum number of characters the operator can enter is determined by the length of this field. The length is equivalent to the number of nulls, or available positions on the screen, between the field attribute for field 4 and the field attribute for field 5.

Field 5: LOCATION:

The field attribute for this field is the same as that specified for field 3; protected and high intensity should be specified. This field attribute prevents the operator from keying a name longer than the maximum length desired. If the name is shorter than the maximum field size, the operator presses the TAB key when the name is complete. The TAB key automatically skips the cursor past protected fields, such as this one, and stops at the first character position in which data can be entered (the next unprotected field). In this example, the cursor would be positioned for entry of location. If the operator attempts to key too many characters (a name greater than 17 characters in the example), the cursor is positioned under this attribute for the 18th character. The next keystroke attempts to destroy this field attribute but fails to do so because field attributes are protected. The keyboard is inhibited, the clicker shuts off, and the "input inhibited" indicator is turned on. The operator's attention is assured since this condition requires pressing the RESET key to continue.

If the field attribute for this field were omitted, the word LOCATION: would become part of field 4 and would be normal intensity and unprotected. This is undesirable since the operator could continue entering name information beyond the desired maximum length and could modify the heading information by entering data in the screen locations occupied by LOCATION:.

Field 6: The area following LOCATION:

This field is for operator input and therefore must be unprotected. The rest of the default attribute values apply and so a default attribute may be used. You need specify only that a field is to begin following LOCATION: This field ends with the field attribute at the beginning of field 7, which determines the length of the field.

Field 7: SERIAL NUMBER:

This field, like NAME: and LOCATION:, should be specified as protected and high intensity. This also limits the location field length to 5 characters. Note that if field 6, the input field for location, were defined as always being a 5-character code, field 7, SERIAL NUMBER:, could be defined as auto-skip to save the operator from having to press TAB after filling in the location code.

Field 8: The area following SERIAL NUMBER:

The null area following SERIAL NUMBER: is an input area for the operator and must be unprotected. It should also be specified as numeric so that if the operator tries to enter alphabetic data in the field (and the keyboard has the Numeric Lock feature), the keyboard inhibits entry of the incorrect character, the keyboard clicker shuts off, and the DO NOT ENTER (X) indicator appears to notify the operator of the error. The improper character does not appear on the screen, and the correct digit may be entered after the operator presses the RESET key.

The serial number in the example always contains a fixed number of digits and is the last field entered. The maximum length of the field is determined by the location of the field attribute for the next field. But the next field in the example is too far away (PASSWORD).

By placing an additional field attribute following input field 8, the operator cannot enter a serial number that is too long.

Field 9: The area between the additional attribute described in field 8 and PASSWORD:

By definition, the additional field attribute you used to delimit the serial number field begins a new field. The protected attribute alone is sufficient for this field, and this attribute limits length for the serial number field. Normally, however, protected (output) fields that follow fixed-length input fields should be defined as *protected* and *numeric*. The protected and numeric field attribute defines a field as *auto-skip*. Auto-skip automatically positions the cursor at the location following the field attribute for the next unprotected field, which is the next place you want to key data. This technique saves keystrokes for the operator.

When the operator keys the last character of the preceding fixed-length field, the cursor normally enters the next field, which may be protected. But since the next field is auto-skip, the cursor skips this intervening protected field, and automatically positions itself for entry of the next field, without an extra keystroke.

Field 10: PASSWORD:

This would be exactly like the serial number field, protected and intensified.

Field 11: The input field for PASSWORD:

This field, like the input field for serial number, should be unprotected and numeric. But, one additional characteristic should be added, that of non-display. This allows the operator to input his or her password without anyone in the area being able to read it since it will not be visible on the display surface, thereby allowing for security. Again you would place an additional field attribute following input field 11 to ensure that the number entered would be of proper length.

This additional length check is used here because this is the last field to be entered. If you had another field to enter after PASSWORD:, it might be more advantageous to omit this length check, as explained in field 9.

Field 12: The area between the additional attribute described in field 11 and WHEN . . . COMPLETE:

This field should be protected since it is not an operator input area. The rest of the default values apply.

Field 13: WHEN ALL . . . KEY.

This field is a heading which the operator should not be allowed to change. It need not be high intensity and thus it may be defined as protected only. Field 13 does not automatically terminate when the last screen position is reached. The field definition continues from the bottom right screen position to the upper left screen position until the next field attribute is reached. This is called *wraparound*. Keep this in mind, particularly if you define the last field on a screen as *unprotected*.

Since fields 13 and 1 are adjacent (by wraparound) and both have the same attributes, they may be combined into a single field by the omission of field attributes before WHEN and SIGN-ON. The result is a single protected field beginning after the input area for password, wrapping around the screen, and terminating either at PLEASE or at NAME if fields 1 and 2 have been previously combined.

Combining fields in the above manner may be convenient but may cause confusion and error if you change the screen layout later. It is a better practice to specify separate fields in all cases.

The panel is completely formatted when the fields are positioned, the field attributes are all defined, and the cursor is placed. You must now begin the transition from the visual image, or human-oriented panel, to the detailed data necessary for the 3270 to implement your panel design.

Planning the Panel

You can think of a panel as a single display screen image created by your program. After an application program has been defined, the information that will be passed between the program and the terminal operator must be defined. This information can be thought of as output panels and input responses to panels. Usually, you will be able to approximate the sequence of the panels needed. The exact sequence of output panels often depends on the input responses to them.

Assuming you have a good understanding of the type of application program (such as data entry, order entry, or inquiry) and the kind of information that must be exchanged and processed (such as customer name, invoices, and check amounts), you can consider which panels come first. Suppose the first panel required is a sign-on panel, as shown in Figure 5-4. After sign-on, the next panel might allow the terminal operator to choose one of several different applications or procedures that he would use. But what if the name or word entered was not an authorized sign-on? Another panel might tell the terminal operator about this and ask him to reenter a sign-on name. Figure 5-4 illustrates a technique, sometimes called *block diagramming*, that may help in laying out a sequence of panels.

Using the Panel Layout Sheet

After block-diagramming the panels in the application or procedure, you are ready to decide on the exact contents of each panel: the fields that will be in the panel, what attributes each field will have, and what words will be displayed in the panel. This can be done on graph paper. The *IBM 3270 Information Display System Layout Sheet*, GX27-2951 or GX27-0014, is useful for layout.

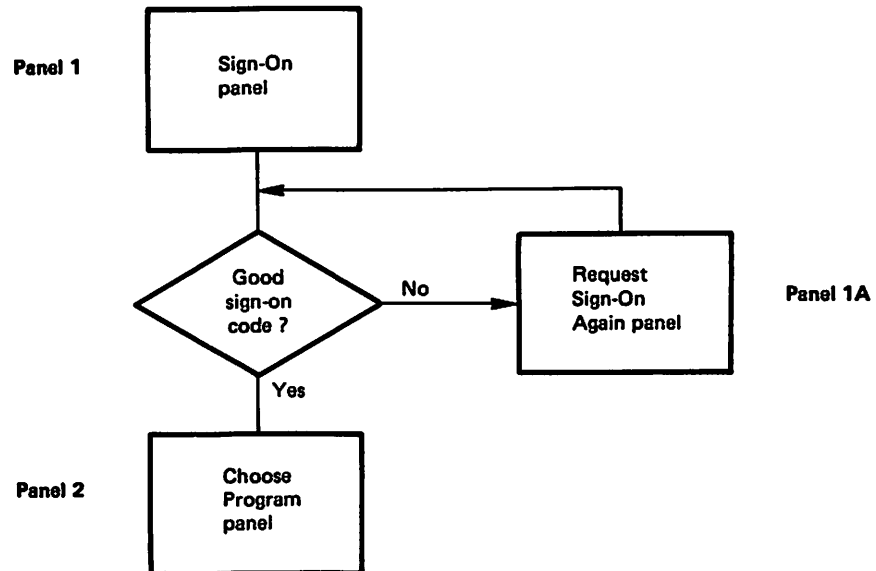



Figure 5-4. Block-Diagramming a Sequence of Panels.

One of these sheets can be used for each panel. After laying out a sequence of panels, you have a collection of panel layout sheets. Using the information on these sheets and the block diagram showing the relationship between panels, the program can be written to send the panels to a terminal and handle an operator's response to them.

An Example of Laying Out a Panel

To lay out a panel, consider the sign-on panel shown in Figure 5-3. You might jot down on a piece of paper the information required for the panel, or you might write it directly on the panel layout sheet. Figure 5-5 shows what the panel part of the layout sheet might look like after you put the text you wanted for your sign-on panel on the layout sheet. A 1920-character display is shown here.



**3270 Information Display System
Layout Sheet**

Panel ID _____ Subject _____

Job No. _____ Sheet _____

Originated by _____ Date _____ of _____

| | | COLUMN | | | | | | | | | | | | | | | | | | | | | | | | | | | | | | | | | | | | | | | | | | | | | | | | | | | | | | | | | | | | | | | | | | | | | | | | | | | | | | | |
|----|--|---------------------------------------|-------|-------|-------|-------|-------|-------|-------|--|--|--|--|--|--|--|--|--|--|--|--|--|--|--|--|--|--|--|--|--|--|--|--|--|--|--|--|--|--|--|--|--|--|--|--|--|--|--|--|--|--|--|--|--|--|--|--|--|--|--|--|--|--|--|--|--|--|--|--|--|--|--|--|--|--|--|--|--|--|--|--|
| | | 1-10 | 11-20 | 21-30 | 31-40 | 41-50 | 51-60 | 61-70 | 71-80 | | | | | | | | | | | | | | | | | | | | | | | | | | | | | | | | | | | | | | | | | | | | | | | | | | | | | | | | | | | | | | | | | | | | | | | | |
| 01 | | | | | | | | | | | | | | | | | | | | | | | | | | | | | | | | | | | | | | | | | | | | | | | | | | | | | | | | | | | | | | | | | | | | | | | | | | | | | | | | | |
| 02 | | SIGN ON PROCEDURE | | | | | | | | | | | | | | | | | | | | | | | | | | | | | | | | | | | | | | | | | | | | | | | | | | | | | | | | | | | | | | | | | | | | | | | | | | | | | | | |
| 03 | | | | | | | | | | | | | | | | | | | | | | | | | | | | | | | | | | | | | | | | | | | | | | | | | | | | | | | | | | | | | | | | | | | | | | | | | | | | | | | | | |
| 04 | | PLEASE ENTER YOUR SIGN-ON INFORMATION | | | | | | | | | | | | | | | | | | | | | | | | | | | | | | | | | | | | | | | | | | | | | | | | | | | | | | | | | | | | | | | | | | | | | | | | | | | | | | | |
| 05 | | | | | | | | | | | | | | | | | | | | | | | | | | | | | | | | | | | | | | | | | | | | | | | | | | | | | | | | | | | | | | | | | | | | | | | | | | | | | | | | | |
| 06 | | | | | | | | | | | | | | | | | | | | | | | | | | | | | | | | | | | | | | | | | | | | | | | | | | | | | | | | | | | | | | | | | | | | | | | | | | | | | | | | | |
| 07 | | | | | | | | | | | | | | | | | | | | | | | | | | | | | | | | | | | | | | | | | | | | | | | | | | | | | | | | | | | | | | | | | | | | | | | | | | | | | | | | | |
| 08 | | | | | | | | | | | | | | | | | | | | | | | | | | | | | | | | | | | | | | | | | | | | | | | | | | | | | | | | | | | | | | | | | | | | | | | | | | | | | | | | | |
| 09 | | NAME: | | | | | | | | | | | | | | | | | | | | | | | | | | | | | | | | | | | | | | | | | | | | | | | | | | | | | | | | | | | | | | | | | | | | | | | | | | | | | | | |
| 10 | | LOCATIONS | | | | | | | | | | | | | | | | | | | | | | | | | | | | | | | | | | | | | | | | | | | | | | | | | | | | | | | | | | | | | | | | | | | | | | | | | | | | | | | |
| 11 | | | | | | | | | | | | | | | | | | | | | | | | | | | | | | | | | | | | | | | | | | | | | | | | | | | | | | | | | | | | | | | | | | | | | | | | | | | | | | | | | |
| 12 | | | | | | | | | | | | | | | | | | | | | | | | | | | | | | | | | | | | | | | | | | | | | | | | | | | | | | | | | | | | | | | | | | | | | | | | | | | | | | | | | |
| 13 | | SERIAL NUMBER: | | | | | | | | | | | | | | | | | | | | | | | | | | | | | | | | | | | | | | | | | | | | | | | | | | | | | | | | | | | | | | | | | | | | | | | | | | | | | | | |
| 14 | | | | | | | | | | | | | | | | | | | | | | | | | | | | | | | | | | | | | | | | | | | | | | | | | | | | | | | | | | | | | | | | | | | | | | | | | | | | | | | | | |
| 15 | | | | | | | | | | | | | | | | | | | | | | | | | | | | | | | | | | | | | | | | | | | | | | | | | | | | | | | | | | | | | | | | | | | | | | | | | | | | | | | | | |
| 16 | | PASSWORD: | | | | | | | | | | | | | | | | | | | | | | | | | | | | | | | | | | | | | | | | | | | | | | | | | | | | | | | | | | | | | | | | | | | | | | | | | | | | | | | |
| 17 | | | | | | | | | | | | | | | | | | | | | | | | | | | | | | | | | | | | | | | | | | | | | | | | | | | | | | | | | | | | | | | | | | | | | | | | | | | | | | | | | |
| 18 | | | | | | | | | | | | | | | | | | | | | | | | | | | | | | | | | | | | | | | | | | | | | | | | | | | | | | | | | | | | | | | | | | | | | | | | | | | | | | | | | |
| 19 | | WHEN ALL INFORMATION IS COMPLETE | | | | | | | | | | | | | | | | | | | | | | | | | | | | | | | | | | | | | | | | | | | | | | | | | | | | | | | | | | | | | | | | | | | | | | | | | | | | | | | |
| 20 | | | | | | | | | | | | | | | | | | | | | | | | | | | | | | | | | | | | | | | | | | | | | | | | | | | | | | | | | | | | | | | | | | | | | | | | | | | | | | | | | |
| 21 | | PLEASE PRESS THE "ENTER" KEY | | | | | | | | | | | | | | | | | | | | | | | | | | | | | | | | | | | | | | | | | | | | | | | | | | | | | | | | | | | | | | | | | | | | | | | | | | | | | | | |
| 22 | | | | | | | | | | | | | | | | | | | | | | | | | | | | | | | | | | | | | | | | | | | | | | | | | | | | | | | | | | | | | | | | | | | | | | | | | | | | | | | | | |

Figure 5-5. Sign-On Panel as Written Out on Layout Sheet

Now that you have written out what you want the terminal operator to see, you can define as fields the separate items of displayed text and spaces you are allowing for operator input. Remember that a field is always preceded by a field attribute. The field attribute occupies a space on the panel even though it appears as a blank space to the operator. Before deciding the attributes of a field, insert some character such as \diamond on the layout sheet to indicate the space for the field attribute. As you get used to creating panels, you may want to enter the \diamond at the same time you are laying out the text. You should also show the cursor location on the panel layout sheet to indicate to the operator where to start his response. The cursor position can be indicated by an underscore () under the space where you want it to appear, or you might enclose the space or characters in a rectangle. After the indications for field attributes and the cursor position have been added, the sign-on panel appears as shown in Figure 5-6.

Having decided on these attributes, you can use the columns on the back of the layout sheet to record the locations and attributes of the fields you have created. Your recording in these columns might appear as in Figure 5-7.

The use of these columns depends on whether the panel designer also codes the panels or only designs them. The information now on the layout sheet can be used to write a line of code that, when sent to the display, displays your panel with its specified field characteristics.

Adding Orders to the Panel Layout Sheets

The back of the panel layout sheet is used for writing the panel orders. The headings indicate what the columns should contain.

The first six columns, as shown in Figure 5-8, identify items in the text, their addresses, and the orders required to format them. The column headings are explained below:

- **Item:** Refers to any part of the panel that requires one or more orders to the control unit to format it. There are 14 items in the sign-on panel.
 1. **SIGN-ON PROCEDURE**
 2. **PLEASE ENTER YOUR SIGN-ON INFORMATION**
 3. **NAME**
 4. **Input field**
 5. **LOCATION:**
 6. **Input field**
 7. **SERIAL NUMBER:**
 8. **Input field**
 9. **Field to limit size of serial number input**
 10. **PASSWORD**
 11. **Input field**
 12. **Field to limit the size of the password field**
 13. **WHEN ALL INFORMATION IS COMPLETE**
 14. **PLEASE PRESS THE ENTER KEY**

| Item | Display Printer | | Buffer Address | | Orders | Prot | No. |
|------|-----------------|-----|----------------|-----|---------------|------|-----|
| | Row | Col | Dec | Hex | | | |
| 1 | 2 | 30 | | | SBA SF ATT | | |
| 2 | 4 | 20 | | | SBA SF ATT | | |
| 3 | 9 | 10 | | | SBA SF ATT | | |
| 4 | 9 | 16 | | | SF ATT IC | | |
| 5 | 9 | 41 | | | SBA SF ATT | | |
| 6 | 9 | 51 | | | SF ATT | | |
| | 9 | 80 | | | SBA SF ATT | | |
| 7 | 13 | 16 | | | SBA SF ATT | | |
| 8 | 13 | 25 | | | SF ATT | | |
| 9 | 13 | 22 | | | SBA SF ATT | | |
| 10 | 16 | 10 | | | SBA SF ATT | | |
| 11 | 16 | 20 | | | SF ATT | | |
| 12 | 16 | 27 | | | SBA SF ATT | | |
| 13 | 19 | 15 | | | SBA SF ATT | | |
| 14 | 21 | 16 | | | SBA | | |

Figure 5-7. Laying Out Field Attributes

| Item | Display Printer | | Buffer Address | | Orders |
|------|-----------------|-----|----------------|-----|--------|
| | Row | Col | Dec | Hex | |
| | | | | | |
| | | | | | |
| | | | | | |
| | | | | | |
| | | | | | |
| | | | | | |
| | | | | | |
| | | | | | |
| | | | | | |
| | | | | | |

Figure 5-8. Text Items on Panel Layout Sheet

Since each field requires an SF order, there are always at least as many items as fields. There are more items than fields when, for example, the SBA order is used to space over unused positions within a single large field, as in Item 14.

- Row, Col: Contain the starting location (row, column) address of each item.
- Dec, Hex: Are for a different addressing format which you do not need if you use the row, column addressing format. Therefore, you may use these columns for any notes to yourself or leave them blank.
- Orders: Contains the orders you are writing, such as SBA, SF, SFE, and so forth.

As shown in Figure 5-9, the columns under the heading Attribute provide the field or character attributes that can be defined. The programmer checks the appropriate columns of the attributes he is changing from the default values. The meaning of abbreviations used in Figure 5-9 follows:

- Prot: Protected
- No.: Numeric
- High Int: High Intensity
- Sel Det: Selector-pen-detectable or cursor selectable
- Non-Disp Prt: Not displayed (nor printed at printer)
- MDT On: Modified data tag on

| Note: The 3276 does not support the 7-Color Extended Highlighting, and PS sets.

The layout sheet contains all the orders and attributes to be sent with the sign-on panel. The hexadecimal order values are discussed under "Coding the Panel" and are shown in Figure 5-12. Each item on the panel has been assigned an item number to help correlate the text with its associated orders. The sign-on panel will be designed for 1920-character screen capacity displays.

| Order Sequence Order | Byte 1 (Order Code) | | Byte 2 | Byte 3 | Byte 4 | Byte n | Byte n+1 |
|------------------------------------|------------------------|-----------|-----------|---------|--------------------|--------|----------|
| | EBCDIC Hex | ASCII Hex | | | | | |
| Start Field (SF) | 1D | 1D | Attribute | | | | |
| Set Buffer Address (SBA) | 11 | 11 | Address | Address | | | |
| Insert Cursor (IC) | 13 | 13 | | | | | |
| Program Tab (PT) | 05 | 09 | | | | | |
| Repeat To Address (RA) | 3C | 14 | Address | Address | Char. ¹ | | |
| Erase Unprotected to Address (EUA) | 12 | 12 | Address | Address | | | |

¹ When graphic escape is used in the RA order, the fourth byte will be the graphic escape character and the fifth byte will be the character to be repeated.

Figure 5-12. Buffer Control Orders and Order Codes

Coding the Panel

To write a panel in assembler language so that it can be part of the application program, you must transfer the panel's text and orders to the appropriate programming coding sheet or any other form you find suitable.

On the coding sheet (and in your program), a panel is represented by a series of programming statements, each with a name to which your program can refer. In the following example, SIGNPANL is the name of the sign-on panel. When the application program wants to send the sign-on panel to a display unit, it issues an Erase/Write or Erase/Write Alternate command and designates SIGNPANL as the panel for display.

The display orders must be written in the programming statements using the hexadecimal codes listed in Figure 5-12. Thus, SF is represented by 1D, SBA by 11, IC by 13, and so on.

Item 1. SIGN-ON PROCEDURE.

Begin coding the first item on the panel layout sheet: the title, SIGN-ON PROCEDURE. Start with the orders for the panel text which must precede the text itself so that the control unit knows what to do with the text. To write this title, you must tell the control unit:

- Where the title is displayed on the panel. The SBA order will be used to set the buffer address location to row 2 (R2) and column 30 (C30).
- That this location is the start of a field. The Start Field (SF) order tells the control unit that the location contains a field attribute and not a text character. The field attribute defines the properties of this field up to the next field attribute encountered. In this case, the field is protected. The remaining properties of the field are default attributes and do not have to be defined.

The first order for the title is the SBA order. Figure 5-12 shows that the SBA hexadecimal code is 11, so this code is used in the program statement. Figure 5-12 also shows that the SBA order must be accompanied by 2 bytes of address information. This address is also in hexadecimal.

Now refer to Appendix B for the address row 2 (R2) and column 30 (C30) that must follow the SBA order. The EBCDIC address is C16D and it follows the SBA code in the programming statement. This address should also be recorded on the layout sheet in the Buffer Address Hex column for future reference. If you prefer, you may look up all the addresses and record them in a similar manner before writing the programming statements. See Figure 5-13 for an example.

The next order for the title is the SF order, which is followed by the field attribute. Attribute definitions are shown in Figure 5-14. The SF code (1D) and the attribute code (60) are read from Figures 5-12 and 5-14 respectively and added to the programming statement. The data stream would be coded as follows:

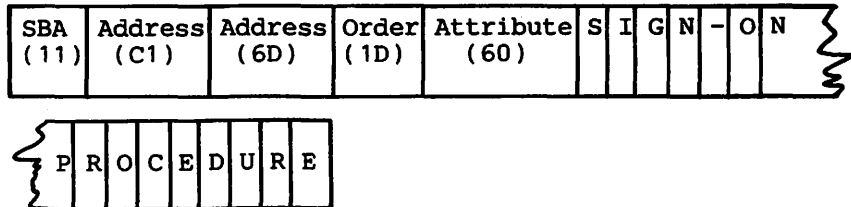

Note: *The meanings for the abbreviations used in these and the following data stream format examples are:*

- SBA = Set Buffer Address
- Addr = Address
- Attr = Attribute
- A/T = Attribute type
- A/V = Attribute value
- # Pairs = Number of attribute type/value pairs
- Prot = protected
- HI = High intensity
- SF = Start Field
- FA = Field Attribute
- IC = Insert cursor

Each item contained in the block is 1 byte of the data in the program.

| Item | Display Printer | | Buffer Address | | Orders |
|------|-----------------|-----|----------------|------|---------------|
| | Row | Col | Dec | Hex | |
| 1 | 2 | 30 | | C16D | SBA SF ATT |
| 2 | 4 | 20 | | C4C3 | SBA SF ATT |
| 3 | 9 | 10 | | 4AC9 | SBA SF ATT |
| 4 | 9 | 16 | | 4A4F | SF ATT IC |
| 5 | 9 | 41 | | 4AEB | SBA SF ATT |
| 6 | 9 | 51 | | | SF ATT |
| | 9 | 80 | | 4B4F | SBA SF ATT |
| 7 | 13 | 10 | | 4FC9 | SBA SF ATT |
| | 13 | 25 | | | SF ATT |
| 9 | 13 | 32 | | 4A5F | SBA SF ATT |
| | 16 | 10 | | D3F9 | SBA SF ATT |
| 11 | 16 | 20 | | | SF ATT |
| 12 | 16 | 27 | | D34A | SBA SF ATT |
| | 19 | 15 | | D66E | SBA SF ATT |
| 14 | 21 | 16 | | D94A | SBA |

Figure 5-13. Sign-On Procedure Panel with Buffer Addresses

Field Attribute Bit Definitions

| ATTRIBUTE | | | | | | Hex |
|-----------|-----|-----------|----------------|------------|--------------------|-----|
| Prot | A/N | MDT ON | High Intens | Sel Det | Non Disp PRT | |
| U | | Y | | | | 40 |
| U | | | | Y | | C1 |
| U | | Y | | Y | | C4 |
| U | | Y | | Y | | C5 |
| U | | Y | H | Y | | C8 |
| U | | | H | Y | | C9 |
| U | | Y | - | - | Y | 4C |
| U | | Y | - | - | Y | 4D |
| U | N | Y | | | | 50 |
| U | N | | | | | D1 |
| U | N | Y | | Y | | D4 |
| U | N | Y | | Y | | D5 |
| U | N | Y | H | Y | | D8 |
| U | N | | H | Y | | D9 |
| U | N | Y | - | - | Y | 5C |
| U | N | Y | - | - | Y | 5D |
| P | | Y | | | | 60 |
| P | | | | | | 61 |
| P | | Y | | Y | | E4 |
| P | | Y | | Y | | E5 |
| P | | Y | H | Y | | E8 |
| P | | | H | Y | | E9 |
| P | | Y | - | - | Y | 6C |
| P | | Y | - | - | Y | 6D |
| P | S | Y | | | | F0 |
| P | S | | | | | F1 |
| P | S | Y | | Y | | F4 |
| P | S | Y | | Y | | F5 |
| P | S | Y | H | Y | | F8 |
| P | S | | H | Y | | F9 |
| P | S | Y | - | - | Y | 7C |
| P | S | Y | - | - | Y | 7D |

S = Skip Y = Yes
 U = Unprotected H = High
 P = Protected N = Numeric

Figure 5-14. Attribute Combinations in Hexadecimal

Item 2. PLEASE ENTER YOUR SIGN-ON INFORMATION

To write this information, the control unit must know only where the text is located. Therefore, you must use an SBA instruction followed by the address for R4, C20. This is also the beginning of a protected field, so you should include an SF order and a protected attribute.

The code for this field, except for the address, is identical with the code for field 1 SIGN-ON PROCEDURE and will not be repeated here.

Item 3. NAME:

As with Item 2, the location where the text is to be displayed must be identified. Write an SBA order followed by the EBCDIC buffer address X'hex 4AC9'. This is the beginning of a protected, high-intensity field. The data stream would be coded as follows:

| | | | | | | | | | | |
|--------|---------|---------|------------------|-----------|---|---|---|---|---|--|
| SBA | Address | Address | Order | Attribute | | | | | | |
| (11) | (4A) | (C9) | (SF) (1D) | (E8) | N | A | M | E | : | |

Item 4. Input Field for Operator's Name.

Since this item immediately follows Item 3, the control unit already knows the correct address. Therefore, there is no reason to issue an SBA order. Item 4 is the start of a new field, however, so you must issue an SF order to instruct the display to expect a field attribute next. The field attribute defines the input field as unprotected (U), alphameric (A), normal intensity, not detectable by selector pen, and no MDT on. Because these are the default attributes, you do not have to check anything in the attribute definition columns.

The cursor should follow the field attribute to indicate where the operator should begin to enter information. The Insert Cursor (IC) order displays the cursor at this current buffer address. After the display has stored the field attribute in location R9, C16, the new current address is R9, C17; this is the place where the cursor appears on the panel.

To code an input field that contains no text, such as the input field for NAME:, write just one programming statement that contains the orders for that field. The "hex" values are:

X'1D4013'

The data stream would be coded as follows:

| | | |
|--------|-----------|--------|
| Order | Attribute | Order |
| SF | | IC |
| (1D) | (40) | (13) |

Item 5. LOCATION

The control unit must have two orders for this item which (1) give the starting buffer address (SBA) of the field as R9, C41, and (2) indicate that it is the start of a new field (SF), is protected, and has high intensity. The "hex" values are:

X'114AE81DE8'

The data stream would be coded as follows:

| | | | | | | | | | | | | | |
|------------------------|----------------|----------------|-----------------------|----------------|---|---|---|---|---|---|---|---|---|
| Order SBA (11) | Addr (4A) | Addr (E8) | Order SF (1D) | Attr (E8) | L | O | C | A | T | I | O | N | : |
|------------------------|----------------|----------------|-----------------------|----------------|---|---|---|---|---|---|---|---|---|

Note: The previous examples show how the text follows in the data stream to be coded. Hereafter only the word "Text" will be used rather than the actual words.

Item 6. Input Field for Operator's Location Code

This item immediately follows the text of the last item so there is no need to set the buffer address. Write only the SF order to indicate the start of a new unprotected field, and use default attributes.

If the field is not terminated by an additional SBA order at location column 80, the underscore property would wrap the line and continue until the next SF order is encountered. Since only the field for operator input should be underscored, terminate the field at the proper location using the proper orders. The "hex" values are:

X'1D40114B4F1D60'

The data stream would be coded as follows:

| | | | | | | |
|-----------------------|----------------|------------------------|----------------|----------------|-----------------------|----------------|
| Order SF (1D) | Attr (40) | Order SBA (11) | Addr (4B) | Addr (4F) | Order SF (1D) | Addr (60) |
|-----------------------|----------------|------------------------|----------------|----------------|-----------------------|----------------|

Item 7. SERIAL NUMBER

This field requires an SBA order to location R13, C10 and an SF order to begin a new field. The attributes are specified the same as that for Item 5. The "hex" values are:

X'114FC91DE8, text "SERIAL NUMBER:"

The data stream would be coded as follows:

| | | | | | |
|------------------------|----------------|----------------|-----------------------|----------------|------|
| Order SBA (11) | Addr (4F) | Addr (C9) | Order SF (1D) | Attr (E8) | Text |
|------------------------|----------------|----------------|-----------------------|----------------|------|

Item 8. Input Field for Serial Number.

Because the field attribute for this input field immediately follows the last character of the previous field, an SBA is not required. The attribute is numeric. The "hex" values are:

X'1D50'

The data stream would be coded as follows:

| | |
|-----------------------|---------------------|
| Order SF (1D) | Attribute (50) |
|-----------------------|---------------------|

Item 9. An Extra Field Created to Limit the Size of the Serial Number Input Field

This field follows the input field and is protected and numeric. This field is an auto skip field which will place the cursor at the next location for operator input, the password input field. An SBA is required for location R13, C32, for proper placement of the attribute. The "hex" values are:

X'114F5F1DF0'

The data stream would be coded as follows:

| | | | | |
|------------------------|----------------|----------------|-----------------------|---------------------|
| Order SBA (11) | Addr (4F) | Addr (5F) | Order SF (1D) | Attribute (F0) |
|------------------------|----------------|----------------|-----------------------|---------------------|

Note: The previous format examples are representative of all those for the sign-on panel fields. The following item explanations will not show formats unless there are differences.

Item 10. PASSWORD

The control unit must have two orders for this item: an SBA order that gives the starting address of R16, C10 and an SF order to indicate that it is the start of a new field. The field attribute defines a protected and intensified field. The "hex" values are:

X'11D2F91DE8'

Item 11. Input Field for Password

Because the field attribute for this input field immediately follows the last character of the previous field, an SBA order is not required. The attribute is numeric and non-displayable. The "hex" values are:

X'1D5C'

Item 12. Extra Field

This is another extra field created to limit the size of the password, identical with the field created to limit the size of the serial number. This follows an input field and is protected only. An SBA is required for location R16, C27, for proper placement of the field attribute byte. The "hex" values are:

X'11D34A1D60'

Item 13. "WHEN ALL INFORMATION IS COMPLETE"

The control unit must have two orders for this item: an SBA order that gives the starting address of R19, C16 and an SF order to indicate that it is the start of a new field. The field attribute defines a protected field, and the rest of the field attributes take the default value. The "hex" values are:

X'11D66E1D60'

Following each of the above statements in the program would be the text "WHEN ALL INFORMATION IS COMPLETE."

Item 14. "PLEASE PRESS THE 'ENTER' KEY."

All the words from "WHEN ALL" through "KEY" could have been treated as a single item, but the proper number of blank spaces would have to be sent between "COMPLETE" and "PLEASE" to position "PLEASE" properly at R21, C16. It is easier, and with less chance of error, to use the three characters required for the SBA order and its associated address, breaking the field into two items, to position "PLEASE" at R21, C16. The "hex" values are: X'11D94F' followed by the text "PLEASE PRESS THE 'ENTER' KEY."

Each item from the panel layout sheet is coded in this fashion. Figure 5-15 shows the assembler language code required to display the sign-on panel for a display with no SFAP capability. Except for one control character, it consists entirely of the panel text, preceded by the display orders for that text.

The SIGN-ON panel is now complete and can be sent to the display unit by the application program.

SIGNPANL (NO EXTENDED ATTRIBUTES)

JOHN DOE

11/11/80

```
SIGNPANL DC X'F5' ERASE/WRITE
          DC X'C7' WCC
          DC X'11C16E1D60' SBA R2C31 ATT P
          DC C'SIGN-ON PROCEDURE'
          DC X'11C4C41D60' SBA R4C21 ATT P
          DC C'PLEASE ENTER YOUR SIGN-ON INFORMATION'
          DC X'114A4A1DE8' SBA R9C11 ATT P HI-INT
          DC C'NAME:'
          DC X'1D4013' ATT U CURSOR
          DC X'114AE91DE8' SBA R9C42 ATT P HI-INT
          DC C'LOCATION:' ATT U
          DC X'1D40'
          DC X'114F4A1DE8' SBA R13C11 ATT P HI-INT
          DC C'SERIAL NUMBER:'
          DC X'1D50' ATT U NUM
          DC X'114FSF1D60' SBA R13C32 ATT P
          DC X'11D27A1DE8' SBA R16C11 ATT P HI-INT
          DC C'PASSWORD:'
          DC X'1D5C' ATT U NUM NON-DISPLAY
          DC X'11D34A1D60' SBA R16C27 ATT P
          DC X'11D66F1D60' SBA R19C16 ATT P
          DC C'WHEN ALL INFORMATION IS COMPLETE'
          DC X'11D94F' SBA R21C16
          DC C'PLEASE PRESS THE "ENTER" KEY'
```

Figure 5-15. Assembler Language Statements for Sign-On Panel

Using the Repeat to Address Order

The Repeat to Address (RA) order stores a specified alphameric or null character in buffer locations, starting at the current buffer address and ending at (but not including) the specified stop address. The specified stop address then becomes the current buffer address.

RA is 3C in hexadecimal. RA can repeat null characters and can erase selected parts of the screen. You may also use it to repeat any other character. To put a row of asterisks under the last title in the sign-on panel, after the DC statement for "PLEASE PRESS THE ENTER KEY," you specify an SBA for R22, C1. The RA order should repeat the asterisk character to location R1, C1 (the address after the last *). This is noted on the layout form as shown in Figure 5-16.

The order in the example is coded as:

```
DC X'3C4040'
DC C'*'
```

If you want to delete a field already on the screen, repeat the "null" character.

| Item | Display Printer | | Buffer Address | | Orders |
|------|-----------------|-----|----------------|------|---------------|
| | Row | Col | Dec | Hex | |
| 1 | 2 | 30 | | C16D | SBA SF ATT |
| 2 | 4 | 20 | | C4C3 | SBA SF ATT |
| 3 | 9 | 10 | | 4A69 | SBA SF ATT |
| 4 | 9 | 16 | | 4A4F | SF ATT IC |
| 5 | 9 | 41 | | 4AEB | SBA SF ATT |
| 6 | 9 | 51 | | | SF ATT |
| | 9 | 80 | | 4B4F | SBA SF ATT |
| 7 | 13 | 10 | | 4FC9 | SBA SF ATT |
| 8 | 13 | 05 | | | SF ATT |
| 9 | 13 | 32 | | 4F5F | SBA SF ATT |
| 10 | 16 | 10 | | D2F9 | SBA SF ATT |
| 11 | 16 | 20 | | | SF ATT |
| 12 | 16 | 27 | | D34A | SBA SF ATT |
| 13 | 19 | 15 | | D66E | SBA SF ATT |
| 14 | 21 | 16 | | D94F | SBA |
| 15 | 23 | 01 | | 5B6A | RA * |

Figure 5-16. An Example of the RA Order

Using the Write Control Character (WCC)

The control unit to which the display unit is attached uses the orders to format the panel. One control character for the control unit must be included following the write commands for every panel you write: the Write Control Character (WCC). The WCC is a hexadecimal code that provides control information for the control unit and defines printer information for printing panels. The other information in the WCC specifies:

- Whether to sound the audible alarm. The audible alarm is an optional display unit and printer feature that sounds a tone at the display unit upon program request. You can request this function by selecting the appropriate WCC hexadecimal code. If this feature is not installed on a display unit, the request is ignored.
- Whether to restore the keyboard at the end of your panel operation. If this option is requested, the keyboard, which locks when the operator completes a panel operation, is automatically unlocked when the program has finished processing the operator's input. Keyboard restoration means the operator does not have to press the RESET key.

You might not want to unlock the keyboard after each panel is displayed. For example, if you plan to write out another panel before you want to accept input, locking the keyboard prevents the operator from entering data before it is needed. Also, after writing an incorrect panel, you may want to force the operator to press the RESET key to make sure you have gained his attention.

- Whether to reset the modified data tag (MDT). If this option is specified, the field attributes of all modified fields are reset. This function resets all input fields to their original (unmodified) status when an operation is completed so they are ready for the next operation.

Each panel written to a display unit or printer must begin with the WCC to identify whether these functions are requested. The hexadecimal code for each possible WCC combination is shown in Figure 5-17. See the *IBM 3270 Data Stream Programmer's Reference Manual*, GA23-0059, for more information on the WCC.

WCCs for the Display

| Start Printer | Sound Audible Alarm | Restore Keyboard | Reset MDTs | Code This Hex Value |
|---------------|---------------------|------------------|------------|---------------------|
| No | Yes | Yes | Yes | C7 |
| No | Yes | Yes | No | C6 |
| No | Yes | No | Yes | C5 |
| No | Yes | No | No | C4 |
| No | No | Yes | Yes | C3 |
| No | No | Yes | No | C2 |
| No | No | No | Yes | C1 |
| No | No | No | No | 40 |

WCCs for the Printer

| Start Printer | Sound Audible Alarm | Restore Keyboard | Reset MDTs | Code This Hex Value If You Want | | | |
|---------------|---------------------|------------------|------------|---------------------------------|---------------|---------------|---------------|
| | | | | NL and EM Codes Honored | 40-Char. Line | 64-Char. Line | 80-Char. Line |
| Yes | Yes | Yes | Yes | 4F | 5F | 6F | 7F |
| Yes | Yes | Yes | No | 4E | 5E | 6E | 7E |
| Yes | Yes | No | Yes | 4D | 5D | 6D | 7D |
| Yes | Yes | No | No | 4C | 5C | 6C | 7C |
| Yes | No | Yes | Yes | 4B | 5B | 6B | 7B |
| Yes | No | Yes | No | 4A | 5A | 6A | 7A |
| Yes | No | No | Yes | C9 | D9 | E9 | F9 |
| Yes | No | No | No | C8 | D8 | E8 | F8 |

Figure 5-17. WCC Hexadecimal Codes

An Example of a Sequence of Panels

Assume you are given the assignment of designing the panels for an accounts receivable application. You are to create the panels that will allow a terminal operator to post a customer payment against his unpaid invoices. The terminal operator will be sitting at a 3270 work station, removing checks and invoice copies from envelopes. If the invoice copies are returned with the check, the terminal operator will for each invoice enter the customer number, payment, and invoice number. If the invoice copies are not returned, the terminal operator will have to find the customer number based on the customer name and then decide which open invoices to apply the payment against. It will be helpful if the operator has some way of adding various open invoices to find a combination that totals the payment. The 1920-character panels that follow show one possible solution.

The first panel in the application is shown in Figure 5-18. If the invoice copies come with the check, the terminal operator can enter the customer number, amount, and invoice number, and press the ENTER key. This posts the payment against the specified invoice. The terminal operator can then post the next payment and so forth; as long as the customer number and invoice number are known, only Panel 1 is displayed.

If, however, no invoice is returned and the customer number is not known, the customer name can be entered. The name need not be the complete name of the company; it can be the first name of the company. In our example, the check says only CAPITOL so that is what the operator enters. When the name has been entered, the terminal operator presses the ENTER key. The customer number is missing, so Panel 2 is displayed.

Panel 2, shown in Figure 5-19, shows all customers and customer numbers phonetically similar to the name entered in response to Panel 1. Item numbers in Panel 2 allow the terminal operator to select one by using the corresponding Program Function (PF) key (see "Program Function Keys" later in this chapter).

As a result of terminal operator response to Panel 2, Panel 3 (shown in Figure 5-20) displays all open invoices for the identified customer. The terminal operator can now use the selector pen or cursor select to specify the open invoices to which the payment applies. He does this by touching the selector pen to the question mark adjacent to each desired invoice number or by positioning the cursor in the invoice number field and processing the cursor select keys; selection is verified immediately by the question mark changing to a > character. To post the payment against the selected invoice numbers, the operator can select APPLY. If, however, the operator cannot easily tell the invoices to which the payment is applied, he can select CALC instead of APPLY.

Selecting CALC displays Panel 4 (Figure 5-21); this is the same as Panel 3 except that ACCOUNTS RECEIVABLE, which was high intensity in Panel 3, is now normal intensity in Panel 4. A new line with CALCULATOR in high intensity indicates the screen mode and explains the functions of the PF keys. The terminal operator can now use the lower right quadrant of the screen as a scratch pad to figure out a combination of open invoices that will total the payment check. This use of one part of the screen for a separate function is sometimes called a *split-screen capability*.



ACCOUNTS RECEIVABLE

ENTER CUSTOMER # — CHECK AMOUNT INVOICE #
 OR CUSTOMER NAME —

PANEL 1

Figure 5-18. Panel 1 of an Accounts Receivable Application

| ITEM | CUST # | NAME/ADDRESS | ITEM | CUST # | NAME/ADDRESS |
|------|---------|---|------|---------|---|
| 1 | 0010341 | CAPITAL AVIATION 711 HILLSBOROUGH ST. RALEIGH, N.C. 27611 | 5 | 0052693 | CAPITOL ELECTRIC 56 STATE ST. MONTPELIER, VT. 05602 |
| 2 | 0028472 | CAPITOL BAKERIES 1800 MAIN ST. COLUMBIA, S.C. 29201 | 6 | 0084362 | CAPITOL FEATHER CO. 899 LOGAN ST. DENVER, COLO. 80217 |
| 3 | 0034020 | CAPITOL COLA CORP 1439 PEACHTREE ST. NE ATLANTA, GA. 30309 | 7 | 0048729 | CAPITAL GLASS CO. 121 STATE ST. ALBANY, N.Y. 12201 |
| 4 | 0041938 | CAPITAL DRUG CO. 201 NORTH 9TH ST. RICHMOND, VA. 23219 | 8 | 0038492 | CAPITOL HOLDING CO. 1609 SHOAL CREEK B AUSTIN, TEXAS 78701 |

PANEL 2

Figure 5-19. Panel 2, Showing the Results of a Search on a Customer Name

| ACCOUNTS RECEIVABLE | | | | | | |
|---------------------|------------------|-----------|----------|-----|------------|------------|
| CUST # | NAME | INVOICE # | DATE | (D) | GROSS | NET |
| 0028472 | CAPITOL BAKERIES | ? A984632 | 11/01/71 | | \$182.50 | \$182.50 |
| | | ? B000312 | 12/05/71 | | \$778.00 | \$778.00 |
| CHK AMT | \$4,000.00 | ? B000418 | 12/07/71 | | \$98.50 | \$98.50 |
| TOT DUE | \$5,358.40 | ? B000964 | 12/11/71 | | \$1,250.00 | \$1,250.00 |
| | | ? B001200 | 12/21/71 | | \$682.40 | \$682.40 |
| | | ? B001439 | 12/25/71 | | \$395.00 | \$395.00 |
| | | ? B001800 | 01/11/72 | * | \$1,029.75 | \$1,009.15 |
| | | ? B002015 | 01/15/72 | * | \$982.50 | \$962.85 |
| MANUAL CALC | APPLY NEXT | | | | | |

PANEL 3

Figure 5-20. Panel 3, Showing the Customer's Open Invoices

The calculator could be programmed a number of different ways. It could, as our example illustrates, show in one column in the CALCULATOR quadrant all invoice numbers selected (shown with > in Figure 5-21) prior to selecting CALC and in another column show any balance remaining from the check amount after subtracting the selected invoice numbers. In Figure 5-21, Panel 4 is shown as it would appear if the terminal operator had first selected four invoice numbers and then selected CALC. In this example, the selected invoices equal the check amount so .00 is shown as the balance after subtracting the selected invoices.

Panel 4 shows that the CALCULATOR could also allow the operator to key in amounts and to add or subtract them from the check amount (pressing PF1 in our example adds keyed-in amounts; PF2 subtracts one keyed-in amount from another). To start over at any point, the operator can press PF3 to clear the calculator quadrant. In our example, the selected invoices equal the check amount, so they can now be posted. But first the terminal operator must leave the CALCULATOR routine by pressing PF4 (RETURN). This displays Panel 5, shown in Figure 5-22.

Panel 5 is the same as Panel 4 except that, with the operator having signaled completion of the CALCULATOR, the word now appears in normal intensity and ACCOUNTS RECEIVABLE once again appears in high intensity. The terminal operator can now, using the selector pen or cursor select, select the invoices against which to apply the payment and then select APPLY to post the payment.

Panel 6 (in Figure 5-23) shows the ACCOUNTS RECEIVABLE file for the customer after posting the payment, with the new balance and the total amount applied. To continue to the next customer, the operator selects NEXT and returns to Panel 1.

| ACCOUNTS RECEIVABLE | | | | | | |
|---------------------|------------------|------------|------------|---------------|------------|------------|
| CUST # | NAME | INVOICE # | DATE | (D) | GROSS | NET |
| 0028472 | CAPITOL BAKERIES | ? A984632 | 11/01/71 | | \$182.50 | \$182.50 |
| | | > B000312 | 12/05/71 | | \$778.00 | \$778.00 |
| CHK AMT | \$4,000.00 | ? B000418 | 12/07/71 | | \$98.50 | \$98.50 |
| TOT DUE | \$5,358.40 | > B000964 | 12/11/71 | | \$1,250.00 | \$1,250.00 |
| | | ? B001200 | 12/21/71 | | \$682.40 | \$682.40 |
| | | ? B001439 | 12/25/71 | | \$395.00 | \$395.00 |
| | | > B001800 | 01/11/72 * | | \$1,029.75 | \$1,009.15 |
| | | > B002015 | 01/15/72 * | | \$982.50 | \$962.85 |
| MANUAL | APPLY | CALCULATOR | | PF1= + PF2= - | PF3= CLEAR | PF4= RET |
| CALC | NEXT | | | | | |
| | | | | | \$778.00 | .00 |
| | | | | | \$1,250.00 | |
| | | | | | \$1,009.15 | |
| | | | | | \$962.85 | |
| PANEL 5 | | | | | | |

Figure 5-22. Panel 5, Showing Selection of Invoices after Using the Calculator.

| ACCOUNTS RECEIVABLE | | | | | | |
|---------------------|------------------|------------|----------|---------------|------------|----------|
| CUST # | NAME | INVOICE # | DATE | (D) | GROSS | NET |
| 0028472 | CAPITOL BAKERIES | ? A984632 | 11/01/71 | | \$182.50 | \$182.50 |
| CHK AMT | \$4,000.00 | ? B000418 | 12/07/71 | | \$98.50 | \$98.50 |
| TOT DUE | \$5,358.40 | ? B001200 | 12/21/71 | | \$682.40 | \$682.40 |
| NEW BAL | \$1,358.40 | ? B001439 | 12/25/71 | | \$395.00 | \$395.00 |
| SEL INV | \$4,000.00 | | | | | |
| MANUAL | APPLY | CALCULATOR | | PF1= + PF2= - | PF3= CLEAR | PF4= RET |
| CALC | NEXT | | | | | |
| PANEL 6 | | | | | | |

Figure 5-23. Panel 6, Showing New Balance after Posting

Analyzing Input Data

The Operator's Response

When a sign-on panel is displayed, the operator responds by entering name, location, and serial number as shown in Figure 5-24. As the operator keys this information, the entered data characters are stored in the display unit's buffer and are displayed as part of the panel. Data that is entered in a nondisplayable field is stored in the buffer, but does not appear on the panel.

```

SIGN-ON PROCEDURE
PLEASE ENTER YOUR SIGN-ON INFORMATION

NAME: JOHN SMITH      LOCATION: BOSTN
SERIAL NUMBER: 963981

WHEN ALL INFORMATION IS COMPLETE
YOU MAY PRESS THE ENTER KEY
    
```

Figure 5-24. Sign-On Panel with Operator's Input

When the operator finishes entering the requested data, he indicates the end of this operation by pressing the ENTER key, which causes an automatic Read Modified command execution and sends the following information to your program:

- An attention code to identify that the ENTER key was pressed.
- The address of the cursor's location.
- The start buffer address code to identify the next 2 characters as addresses.
- The starting addresses of every modified field, followed by the data in the modified field.

Figure 5-25 shows this sequence of input data, which is explained below.

| | | | | | | | | |
|---------------------|-------------------|-----|------------------------------------|---|-----|--|--|--|
| AID for Enter | Cursor address | SBA | Addr first modified field | Text from first modified field | SBA | Addr of second modified field | Text from second modified field | |
|---------------------|-------------------|-----|------------------------------------|---|-----|--|--|--|

Figure 5-25. Input Data Sequence

Attention Identifier (AID)

The Attention Identifier (AID) is a hexadecimal code. By identifying this code, your program can determine in which of several possible ways the operator contacted the program and determine what request is being made. For example, pressing the ENTER key requests "Please enter this data."

For a Read Modified, the AID code is followed by the cursor address, which is the hexadecimal code for the row and column location of the cursor when the operator contacted your program.

Input Data

All the modified fields from the panel follow the AID code and the cursor address. A modified field is any field whose field attribute has the MDT on. A modified field can be one that was modified by the operator or one that was defined by you in your program with the MDT on in its field attribute.

When any character location in an input field is modified by the operator, the MDT in the field attribute for that field is automatically turned on. An input field is not necessarily a modified field. If the operator made no entry in the SERIAL field, for example, only his name, location, and the date would be sent as modified fields to your program.

The display unit sends all the data in a modified field except nulls. When an operator finishes an operation, the display unit reads through the buffer for every field attribute whose code indicates its MDT is on. Each time one is found, the display unit provides an SBA code and the starting address (the field attribute's address plus 1) of the modified field. The SBA code identifies to your program that an address follows. It is the same X'11' code that you coded in your panel to identify the starting locations of the panel's text.

SBA Codes

SBA codes identify the incoming data by cross-referencing it to the correct input field.

For the sign-on panel, your program knows that row 6, column 8 (X'C34F') is the start of the name input field. When it receives the first SBA code (X'11'), it checks the address that follows to see if it is (X'C34F'). If it is, your program knows the text that follows it (until the next SBA code) is the operator's name and can process the input accordingly.

The first part of the input from the sign-on panel is as follows:

| | | | | | | | | | | | | | | | |
|----|----|----|----|----|----|---|---|---|---|---|---|---|---|---|-----|
| 7D | C4 | C6 | 11 | C3 | 4F | J | O | H | N | S | M | I | T | H | ... |
|----|----|----|----|----|----|---|---|---|---|---|---|---|---|---|-----|

The hexadecimal codes are:

- 7D: The AID code for the ENTER key
- C4C6: The cursor address R7, C23. The cursor is at the next character location after the entered serial number.
- 11: The SBA order code which tells the program the next 2 characters are addresses. (See Figure 5-12.)
- C34F: The location (R6, C8) where the following text is located on the panel.
JOHN SMITH.: The first modified field containing the operator's name.

Program Attention (PA) Keys

Each 3270 keyboard has at least one program attention (PA) key that the operator can use to request program attention without sending any input data.

The AID codes for the PA keys are shown under a separate heading in Figure 1-17, because they are not followed by input data even though there may be modified fields on the panel when a PA key is pressed. All four short read codes consist of just the AID code.

Your program should use these keys for operator requests for immediate action such as trouble alerts or requests for termination. For example, the assignment of several PA keys might be:

- PA1: Terminate current application
- PA2: Return to starting (master) panel
- PA3: Explain system message

Program Function (PF) Keys

Program function (PF) keys are a keyboard feature. Your program defines the function that each key requests when it is pressed by the operator.

There is a separate AID code for each PF key so that your program can quickly identify which key was pressed and consequently which function was requested. When a PF key is pressed, all modified fields on the panel and their addresses are sent with the AID code and cursor address, the same as the ENTER key. For this reason, a PF key can be a valuable time-saving device for the operator. For example, the assignment of several PF keys might be:

- PF1: Return to previous panel
- PF2: Clear (without using data) and repeat current panel
- PF3: Set up next panel
- PF4: Page forward
- PF5: Page backward
- PF6: Return to page 1

Selector Pen and Cursor Select Input and Output

Positioning data for selector pen (optional feature) or cursor select (basic feature on the 3276, 3278, and 3279) use and setting the attribute characters are the same as for any other type of data, but the select function has additional data-stream requirements.

Selector Field Format

A field for selector pen operations must be defined as shown in Figure 5-26. The cursor select does not require the three-part character that must precede the selector pen field, although it can be present. Also, the cursor selection can be on any character in the field.

The field attribute, the designator character (described in the next section), and displayed alphanumeric characters must be on the same line. If the field is longer than one line, only those characters on the same line as the field attribute can be detected by the selector.

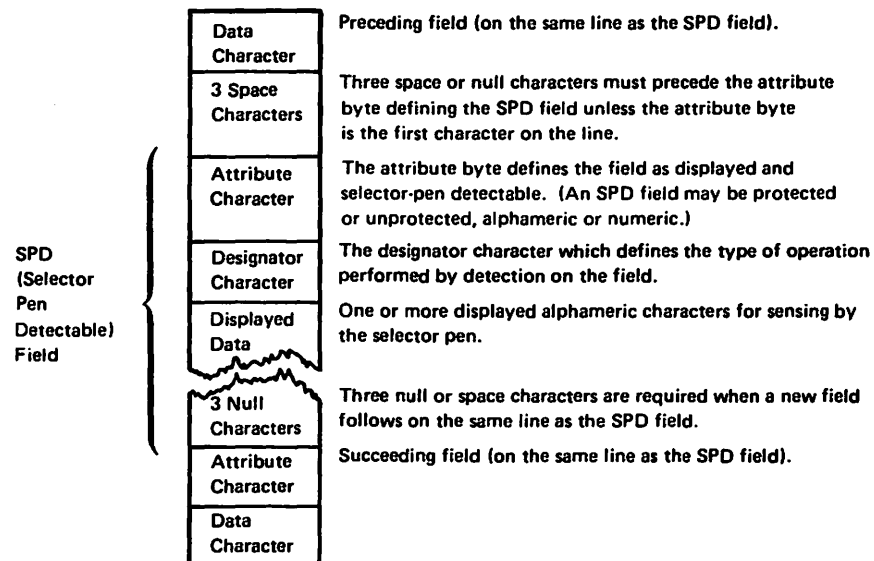

Figure 5-26. Definition of Field for Selector Pen Operation

Designator Characters

Designator characters define three types of selector fields: selection and two types of attention. Each type of field performs a different operation.

The selection field is defined by a question mark (?) designator character. When the selector can detect a selection field, the MDT bit in the field attribute for that field is set in the display buffer. Also, the designator character is automatically changed on the screen to a greater than (>) sign to provide a visible indication to the operator that the detection was successful. If a mistake was made and the operator again detects on that same field, the > reverts to a ? and the MDT is reset. The first type of attention field is defined by a space or null designator character. Probing an attention field or selecting it with the cursor is similar to using an ENTER key. The input information is released to be read by the application program when it is ready to do so. The second type of attention field is the ampersand (&) with the 3276. Probing this field causes the program to issue a Read Modified command and obtain both the address and data of each field.

Figure 5-27 shows a sample selector pen panel that illustrates some of the special input and output data stream considerations.

For output, an Erase/Write creates the panel. In the WCC, you enable input and optionally reset the MDTs. Next you specify an SBA sequence to get you to R1, C7, followed by an SF with a protected attribute.

| | | COLUMN | | | | | | | | | | | | | | | | | | | | | | | | | | | | | | | | | | | | | | | | | | | | | | | | | |
|----|--|--------|---|---|---|---|---|---|---|---|---|---------|---|---|---|---|---|---|---|---|---|---------|---|---|---|---|---|---|---|---|---|---------|---|---|---|---|---|---|---|---|---|---|---|--|--|--|--|--|--|--|--|
| | | 1 - 10 | | | | | | | | | | 11 - 20 | | | | | | | | | | 21 - 30 | | | | | | | | | | 31 - 40 | | | | | | | | | | | | | | | | | | | |
| | | 1 | 2 | 3 | 4 | 5 | 6 | 7 | 8 | 9 | 0 | 1 | 2 | 3 | 4 | 5 | 6 | 7 | 8 | 9 | 0 | 1 | 2 | 3 | 4 | 5 | 6 | 7 | 8 | 9 | 0 | 1 | 2 | 3 | 4 | 5 | 6 | 7 | 8 | 9 | 0 | 1 | 2 | | | | | | | | |
| 01 | | | | | | | | | | | | | | | | | | | | | | | | | | | | | | | | | | | | | | | | | | | | | | | | | | | |
| 02 | | | | | | | | | | | | | | | | | | | | | | | | | | | | | | | | | | | | | | | | | | | | | | | | | | | |
| 03 | | | | | | | | | | | | | | | | | | | | | | | | | | | | | | | | | | | | | | | | | | | | | | | | | | | |
| 04 | | | | | | | | | | | | | | | | | | | | | | | | | | | | | | | | | | | | | | | | | | | | | | | | | | | |
| 05 | | | | | | | | | | | | | | | | | | | | | | | | | | | | | | | | | | | | | | | | | | | | | | | | | | | |
| 06 | | | | | | | | | | | | | | | | | | | | | | | | | | | | | | | | | | | | | | | | | | | | | | | | | | | |
| 07 | | | | | | | | | | | | | | | | | | | | | | | | | | | | | | | | | | | | | | | | | | | | | | | | | | | |
| 08 | | | | | | | | | | | | | | | | | | | | | | | | | | | | | | | | | | | | | | | | | | | | | | | | | | | |
| 09 | | | | | | | | | | | | | | | | | | | | | | | | | | | | | | | | | | | | | | | | | | | | | | | | | | | |
| 10 | | | | | | | | | | | | | | | | | | | | | | | | | | | | | | | | | | | | | | | | | | | | | | | | | | | |
| 11 | | | | | | | | | | | | | | | | | | | | | | | | | | | | | | | | | | | | | | | | | | | | | | | | | | | |
| 12 | | | | | | | | | | | | | | | | | | | | | | | | | | | | | | | | | | | | | | | | | | | | | | | | | | | |
| 13 | | | | | | | | | | | | | | | | | | | | | | | | | | | | | | | | | | | | | | | | | | | | | | | | | | | |

Figure 5-27. Sample Panel for Selector Pen or Cursor Select Detection

This should be followed by the heading "PICK . . . COLUMN" and another SBA to R3, C9. Then specify an SF order, followed by a protected (detectable fields may be protected) and detectable attribute. Next you need the designator "?" followed by "RED":

| | | | | | | | | | | | | | |
|---|---|---|---|---|---|---|----|----|---|---|---|---|---|
| C | O | L | U | M | N | S | R3 | C9 | P | ? | R | E | D |
| | | | | | | B | | | + | | | | |
| | | | | | | A | | | F | | | | |

An SBA after "RED" to R3, C25, provides more than the three required null characters and positions the SF field attribute and designator for "2 DOOR." This type of sequence is repeated for the remaining fields to location R7, C28. The designator here must be a null or a blank so that probing or selecting by the cursor causes the "ENTER" field to release the selection to the application program.

As the operator uses the selector pen or cursor select, the program correlates the address of each selector pen detectable field with the data associated with it.

To combine selector pen or cursor select detectable input with keyboard or cursor select input, use the keyboard to release the data to the application program by pressing the ENTER key or a PF key. Use of the selector pen or cursor select to release the data, such as by selecting "ENTER" in our example, transmits only the addresses of the fields in which the MDT was set unless you are using a 3276 control unit, in which case the address and data are transmitted.

In the example, if you pick RED and 4 DOOR, the symbolic input would appear as follows.

| | | | | | | | |
|-----|--------|---|----|-----|---|----|-----|
| Pen | | | | | | | |
| A | Cursor | S | R3 | C10 | S | R4 | C26 |
| I | ADDR | B | | | B | | |
| D | | A | | | A | | |

Shortening transmissions by eliminating unnecessary data requires some caution. If you design a panel requiring both pen selection and keyboard entry, do not put an attention designator (space or null) on the panel. An attention designator after keyboard entry transmits only the address of the keyboard input field and causes the loss of its contents. Not having an attention designator on the panel assures you that an ENTER or PF key will be used, and the modified field contents will be transmitted (and the words "RED" and "4 DOOR" in the example).

The Relationship of One Data Stream to Another

The examples used so far have assumed that you started with a blank screen and that you built the entire panel into your data stream with Erase or Write commands. This approach may lead to tedious work and lengthy data streams, which you can avoid if the panel you wish to display differs only slightly from the one that is presently displayed. The following discussion deals with modification of existing data streams.

Modifying Existing Panels

Suppose the displayed panel is the sign-on panel in the previous sections. If the operator keys an invalid serial number, you may wish to notify him of his error and request reentry of the serial number field only. You could create a new error message panel, write it to the display, require that the operator acknowledge its receipt, create a special serial number entry panel, write it, and finally read the corrected serial number. A better way might be to use the existing sign-on panel.

After the operator has keyed the data and it has been read into the computer, the screen appears as shown in Figure 5-28. You would like the screen to look like Figure 5-29. Most of the information you want displayed is already there. An Erase/Write or Erase/Write Alternate command would clear the screen and require writing a data stream containing all the information for the new panel. You could use a Write command which modifies existing data in the 3270's buffer.

To change the panel in Figure 5-28 to look like Figure 5-29:

1. Position the cursor at R7, C17.
2. Replace the message beginning at R10, C5 with the error message.
3. Change the attribute at R10, C4 to high intensity for the error message.

To make these changes, the right side of your panel layout for the error panel might (in abbreviated form) look like Figure 5-30:

- Item 1. Repositions the cursor to R7, C17.
- Item 2. Changes the attribute at R10, C4 to protected and high intensity.

Note: If the designer of the sign-on panel had combined the original field at this location with the previous field, with the field "SIGN-ON PROCEDURE," and with the following field by omitting the attributes at R10, C4; R2, C11; and R4, C2, the result would be undesirable. The attribute placed at R10, C4 would begin a new field. This would not affect the preceding field but, by wraparound, would cause "SIGN-ON PROCEDURE" and "PLEASE . . . INFORMATION" to be high intensity even though they were neither intended to be so nor rewritten. For this reason you should adhere closely to the "Field Concept" and not combine fields unless necessary for efficiency; if you must combine fields, be very careful to avoid undesired results.

- Item 3. Repositions the data flow to correctly place the second line of the error message. Three characters are used instead of 6 null characters.
- Item 4. Repositions the data flow for the third line of the error message.

| ROW | COLUMN | | | | | | | | | | | | | | | | | | | | | | | | | | | | | | | | | | | | | | | |
|-----|--------|---|---|---|---|---|---|---|---|---|---------|---|---|---|---|---|---|---|---|---|---------|---|---|---|---|---|---|---|---|---|---------|---|---|---|---|---|---|---|-----|---|
| | 1 - 10 | | | | | | | | | | 11 - 20 | | | | | | | | | | 21 - 30 | | | | | | | | | | 31 - 40 | | | | | | | | | |
| | 1 | 2 | 3 | 4 | 5 | 6 | 7 | 8 | 9 | 0 | 1 | 2 | 3 | 4 | 5 | 6 | 7 | 8 | 9 | 0 | 1 | 2 | 3 | 4 | 5 | 6 | 7 | 8 | 9 | 0 | 1 | 2 | 3 | 4 | 5 | 6 | 7 | 8 | 9 | 0 |
| 01 | | | | | | | | | | | | | | | | | | | | | | | | | | | | | | | | | | | | | | | | |
| 02 | | | | | | | | | | | | | | | | | | | | | | | | | | | | | | | | | | | | | | | | |
| 03 | | | | | | | | | | | | | | | | | | | | | | | | | | | | | | | | | | | | | | | | |
| 04 | | | | | | | | | | | | | | | | | | | | | | | | | | | | | | | | | | | | | | | | |
| 05 | | | | | | | | | | | | | | | | | | | | | | | | | | | | | | | | | | | | | | | | |
| 06 | | | | | | | | | | | | | | | | | | | | | | | | | | | | | | | | | | | | | | | | |
| 07 | | | | | | | | | | | | | | | | | | | | | | | | | | | | | | | | | | | | | | | | |
| 08 | | | | | | | | | | | | | | | | | | | | | | | | | | | | | | | | | | | | | | | | |
| 09 | | | | | | | | | | | | | | | | | | | | | | | | | | | | | | | | | | | | | | | | |
| 10 | | | | | | | | | | | | | | | | | | | | | | | | | | | | | | | | | | | | | | | | |
| 11 | | | | | | | | | | | | | | | | | | | | | | | | | | | | | | | | | | | | | | | | |
| 12 | | | | | | | | | | | | | | | | | | | | | | | | | | | | | | | | | | | | | | | 480 | |
| 13 | | | | | | | | | | | | | | | | | | | | | | | | | | | | | | | | | | | | | | | | |

Figure 5-28. Modifying an Existing Panel, Basic Panel

| ROW | COLUMN | | | | | | | | | | | | | | | | | | | | | | | | | | | | | | | | | | | | | | | |
|-----|--------|---|---|---|---|---|---|---|---|---|---------|---|---|---|---|---|---|---|---|---|---------|---|---|---|---|---|---|---|---|---|---------|---|---|---|---|---|---|---|-----|---|
| | 1 - 10 | | | | | | | | | | 11 - 20 | | | | | | | | | | 21 - 30 | | | | | | | | | | 31 - 40 | | | | | | | | | |
| | 1 | 2 | 3 | 4 | 5 | 6 | 7 | 8 | 9 | 0 | 1 | 2 | 3 | 4 | 5 | 6 | 7 | 8 | 9 | 0 | 1 | 2 | 3 | 4 | 5 | 6 | 7 | 8 | 9 | 0 | 1 | 2 | 3 | 4 | 5 | 6 | 7 | 8 | 9 | 0 |
| 01 | | | | | | | | | | | | | | | | | | | | | | | | | | | | | | | | | | | | | | | | |
| 02 | | | | | | | | | | | | | | | | | | | | | | | | | | | | | | | | | | | | | | | | |
| 03 | | | | | | | | | | | | | | | | | | | | | | | | | | | | | | | | | | | | | | | | |
| 04 | | | | | | | | | | | | | | | | | | | | | | | | | | | | | | | | | | | | | | | | |
| 05 | | | | | | | | | | | | | | | | | | | | | | | | | | | | | | | | | | | | | | | | |
| 06 | | | | | | | | | | | | | | | | | | | | | | | | | | | | | | | | | | | | | | | | |
| 07 | | | | | | | | | | | | | | | | | | | | | | | | | | | | | | | | | | | | | | | | |
| 08 | | | | | | | | | | | | | | | | | | | | | | | | | | | | | | | | | | | | | | | | |
| 09 | | | | | | | | | | | | | | | | | | | | | | | | | | | | | | | | | | | | | | | | |
| 10 | | | | | | | | | | | | | | | | | | | | | | | | | | | | | | | | | | | | | | | | |
| 11 | | | | | | | | | | | | | | | | | | | | | | | | | | | | | | | | | | | | | | | | |
| 12 | | | | | | | | | | | | | | | | | | | | | | | | | | | | | | | | | | | | | | | 480 | |
| 13 | | | | | | | | | | | | | | | | | | | | | | | | | | | | | | | | | | | | | | | | |

Figure 5-29. Existing Panel with Error Message

| Item | Display Printer | | Buffer Address | | Orders | Prot | No. | High Int | Sel Dat | Non-Disp Prt | MDT On |
|------|-----------------|-----|----------------|-----|---------------------------|------|-----|----------|---------|--------------|--------|
| | Row | Col | Dec | Hex | | | | | | | |
| 1 | 07 | 17 | | | SBA | | | | | | |
| | | | | | IC | | | | | | |
| 2 | 10 | 04 | | | SBA | | | | | | |
| | | | | | SF | | | | | | |
| | | | | | "LINE 1 OF ERROR MESSAGE" | | | | | | |
| 3 | 11 | 05 | | | SBA | | | | | | |
| | | | | | "LINE 2 OF ERROR MESSAGE" | | | | | | |
| 4 | 12 | 05 | | | SBA | | | | | | |
| | | | | | "LINE 3 OF ERROR MESSAGE" | | | | | | |

Figure 5-30. Panel Layout Changes for Error Message (Keyed to Text)

Since there are two different types of Write commands for the 3276 you must tell the I/O portion of your program which type to use for the data stream. You may want to indicate the type you want in a comment in the data stream. It is suggested that you establish some convention for indicating command selection by discussing it at your installation with the people responsible for the I/O portion of the program.

In Figure 5-28, assume that the operator now keys "9" and presses the ENTER key. The "9" corrects the original entry error and the serial number field now reads "963981." What goes into the application program? The prior discussion of input data streams shows the basic format, but which fields can you expect? You know that the serial number input field will be received in its entirety, since keying the "9" caused the display to turn on the MDT for this field, and any field which has been modified is transmitted in its entirety (except nulls).

The input field MDTs for NAME, LOCATION, and SERIAL NUMBER were all turned on by the data entered into those fields in the sign-on panel. While an Erase/Write or Erase/Write Alternate resets all MDTs, a Write does not: therefore, if you do not reset them, all three input fields are returned to the application program. Because not all of them have changed, all three should not return to the application program. You may specify in the WCC that all MDTs in the device are reset "off" or "not modified" (you should do so here).

You may also want to sound the audible alarm, if you have one, with the error panel. A WCC to reset the keyboard, reset all MDTs, and sound the alarm is defined as DC X'C7' (see Figure 5-17). You can now use the Write command to change the sign-on panel into the error message panel.

Warning: As you have seen, the Write command allows you to modify an existing screen image while retaining all or a portion of the information already displayed. With the Write command, you can treat the 3270 as a typewriter-type terminal and write your panel line by line or field by field. Using multiple Write commands to create a panel, while technically possible, may create problems.

The operator might start keying data into the panel before you have finished writing it all to the screen. You can prevent this problem by not enabling the keyboard until the last Write in the series.

Using successive Write commands to accomplish what one Write command can do is an inefficient use of the communication line on remote 3270s and unnecessary I/O overhead on local 3270s.

Wherever possible, use a single Write command to avoid the inconveniences noted above.

Using Erase Unprotected to Address (EUA)

The error panel shown in Figure 5-29 displayed the erroneous serial number. All the operator had to do was to key over the incorrect digits. This may sometimes be confusing. You might instead want to erase only the serial number input field as shown in Figure 5-31.

Begin again with the desired WCC. Place the cursor at R7, C17 with an SBA to R7, C17, followed by an IC order. To erase what was entered in the serial number input field, use the EUA order (watch the sequence of these letters so you do not confuse them with EAU, which is discussed next). EUA inserts nulls (erases all unprotected positions) from the current buffer address up to, but not including, the specified stop address. It will also set any character attributes of the nulled characters to X'00'.

The specified stop address then becomes the current buffer address. The format of the order is similar to an SBA; the code for the order itself (X'12' for EUA) is immediately followed by a row and column address.

| | | COLUMN | | | | | | | | | | | | | | | | | | | | | | | | | | | | | | | | | | | | | | | | | | | | | | | | | | | | | | |
|----|--|--------|---|---|---|---|---|---|---|---|---|---------|---|---|---|---|---|---|---|---|---|---------|---|---|---|---|---|---|---|---|---|---------|---|---|---|---|---|---|---|---|---|---|---|--|--|--|--|--|--|--|--|--|--|--|--|--|
| | | 1 - 10 | | | | | | | | | | 11 - 20 | | | | | | | | | | 21 - 30 | | | | | | | | | | 31 - 40 | | | | | | | | | | | | | | | | | | | | | | | | |
| | | 1 | 2 | 3 | 4 | 5 | 6 | 7 | 8 | 9 | 0 | 1 | 2 | 3 | 4 | 5 | 6 | 7 | 8 | 9 | 0 | 1 | 2 | 3 | 4 | 5 | 6 | 7 | 8 | 9 | 0 | 1 | 2 | 3 | 4 | 5 | 6 | 7 | 8 | 9 | 0 | 1 | 2 | | | | | | | | | | | | | |
| 01 | | | | | | | | | | | | | | | | | | | | | | | | | | | | | | | | | | | | | | | | | | | | | | | | | | | | | | | | |
| 02 | | | | | | | | | | | | | | | | | | | | | | | | | | | | | | | | | | | | | | | | | | | | | | | | | | | | | | | | |
| 03 | | | | | | | | | | | | | | | | | | | | | | | | | | | | | | | | | | | | | | | | | | | | | | | | | | | | | | | | |
| 04 | | | | | | | | | | | | | | | | | | | | | | | | | | | | | | | | | | | | | | | | | | | | | | | | | | | | | | | | |
| 05 | | | | | | | | | | | | | | | | | | | | | | | | | | | | | | | | | | | | | | | | | | | | | | | | | | | | | | | | |
| 06 | | | | | | | | | | | | | | | | | | | | | | | | | | | | | | | | | | | | | | | | | | | | | | | | | | | | | | | | |
| 07 | | | | | | | | | | | | | | | | | | | | | | | | | | | | | | | | | | | | | | | | | | | | | | | | | | | | | | | | |
| 08 | | | | | | | | | | | | | | | | | | | | | | | | | | | | | | | | | | | | | | | | | | | | | | | | | | | | | | | | |
| 09 | | | | | | | | | | | | | | | | | | | | | | | | | | | | | | | | | | | | | | | | | | | | | | | | | | | | | | | | |
| 10 | | | | | | | | | | | | | | | | | | | | | | | | | | | | | | | | | | | | | | | | | | | | | | | | | | | | | | | | |
| 11 | | | | | | | | | | | | | | | | | | | | | | | | | | | | | | | | | | | | | | | | | | | | | | | | | | | | | | | | |
| 12 | | | | | | | | | | | | | | | | | | | | | | | | | | | | | | | | | | | | | | | | | | | | | | | | | | | | | | | | |
| 13 | | | | | | | | | | | | | | | | | | | | | | | | | | | | | | | | | | | | | | | | | | | | | | | | | | | | | | | | |

Figure 5-31. Error Message Panel with Serial Number Field Erased

At the first position to be erased (a result of prior operation), you should include an EUA order. For a terminating address, you may use R7, C23 (the first position after the last to be erased). There is a better stop address, however. Since EUA erases only unprotected fields, and since the field beginning at R7, C23 is protected, it can be included in the range covered by the EUA. If R10, C4 is used as the stop address, nothing additional is erased, but you can then write the next attribute without using an SBA, saving three characters of transmission (see Figure 5-32). The current buffer address is the stop address. Any data or SF order that follows goes into the buffer at this address.

EUA erases all unprotected fields within its range and can erase multiple fields. Suppose you wanted all three input fields erased on the error panel, as shown in Figure 5-33. First place the cursor at R7, C17; then "back up" with an SBA to R6, C8 (the name input field) before issuing the EUA to R10, C4 (see Figure 5-34).

You could have started at R6, C8 with an SBA to R6, C8, followed by the EUA to R10, C4. However, sometime later in the data stream you would have had to "back up," probably with an SBA to insert the cursor.

Using Erase All Unprotected (EAU) Command

In the preceding example, you wanted to erase all unprotected data, reposition the cursor, and add some new titles to the sign-on panel to make it an error panel. The EAU command:

- Clears all unprotected character locations and associated character attributes to nulls.
- Resets MDTs in all unprotected fields.
- Unlocks the keyboard.
- Resets the AID.
- Repositions the cursor to the first character of the first unprotected field.

| Item | Display Printer | | Buffer Address | | Orders | Prot | No. | High Int | Sel Det | Non-Disp Prt | MDT On |
|------|---------------------------|-----|----------------|-----|--------|------|-----|----------|---------|--------------|--------|
| | Row | Col | Dec | Hex | | | | | | | |
| 1 | 07 | 17 | | | SBA | | | | | | |
| | | | | | IC | | | | | | |
| | 10 | 04 | | | EUA | | | | | | |
| 2 | | | | | SF | ATT | ✓ | | ✓ | | |
| | "LINE 1 OF ERROR MESSAGE" | | | | | | | | | | |
| | | | | | . | | | | | | |
| | | | | | . | | | | | | |
| | | | | | . | | | | | | |

Figure 5-32. Example of EUA Use

| ROW | COLUMN | | | | | | | | | | | | | | | | | | | | | | | | | | | | | | | | | | | | | | | | | |
|-----|---------------------------------------|---|---|---|---|---|---|---|---|---|---------|---|---|---|---|---|---|---|---|---|-------------|---|---|---|---|---|---|---|---|---|---------|---|---|---|---|---|---|---|-----|---|---|---|
| | 1 - 10 | | | | | | | | | | 11 - 20 | | | | | | | | | | 21 - 30 | | | | | | | | | | 31 - 40 | | | | | | | | | | | |
| | 1 | 2 | 3 | 4 | 5 | 6 | 7 | 8 | 9 | 0 | 1 | 2 | 3 | 4 | 5 | 6 | 7 | 8 | 9 | 0 | 1 | 2 | 3 | 4 | 5 | 6 | 7 | 8 | 9 | 0 | 1 | 2 | 3 | 4 | 5 | 6 | 7 | 8 | 9 | 0 | 1 | 2 |
| 01 | | | | | | | | | | | | | | | | | | | | | | | | | | | | | | | | | | | | | | | | | | |
| 02 | SIGN-ON PROCEDURE | | | | | | | | | | | | | | | | | | | | | | | | | | | | | | | | | | | | | | | | | |
| 03 | | | | | | | | | | | | | | | | | | | | | | | | | | | | | | | | | | | | | | | | | | |
| 04 | PLEASE ENTER YOUR SIGN-ON INFORMATION | | | | | | | | | | | | | | | | | | | | | | | | | | | | | | | | | | | | | | | | | |
| 05 | | | | | | | | | | | | | | | | | | | | | | | | | | | | | | | | | | | | | | | | | | |
| 06 | NAME: @ | | | | | | | | | | | | | | | | | | | | LOCATION: @ | | | | | | | | | | | | | | | | | | | | | |
| 07 | SERIAL NUMBER: @ | | | | | | | | | | | | | | | | | | | | | | | | | | | | | | | | | | | | | | | | | |
| 08 | | | | | | | | | | | | | | | | | | | | | | | | | | | | | | | | | | | | | | | | | | |
| 09 | | | | | | | | | | | | | | | | | | | | | | | | | | | | | | | | | | | | | | | | | | |
| 10 | | | | | | | | | | | | | | | | | | | | | | | | | | | | | | | | | | | | | | | | | | |
| 11 | | | | | | | | | | | | | | | | | | | | | | | | | | | | | | | | | | | | | | | | | | |
| 12 | | | | | | | | | | | | | | | | | | | | | | | | | | | | | | | | | | | | | | | | | | |
| 13 | | | | | | | | | | | | | | | | | | | | | | | | | | | | | | | | | | | | | | | 480 | | | |

Figure 5-33. Sign-On Panel with Three Erased Fields

| Item | Display Printer | | Buffer Address | | Orders | Prot | No. | High Int | Sel Det | Non-Disp Prt | MDT On |
|------|-----------------|-----|----------------|-----|--------|------|-----|----------|---------|--------------|--------|
| | Row | Col | Dec | Hex | | | | | | | |
| 01 | 07 | 17 | | | SBA | | | | | | |
| | 06 | 08 | | | IC | | | | | | |
| | 10 | 04 | | | SBA | | | | | | |
| | | | | | EUA | | | | | | |
| | | | | | SF | ATT | ✓ | | ✓ | | |
| | | | | | . | | | | | | |
| | | | | | . | | | | | | |
| | | | | | . | | | | | | |

Figure 5-34. Erasing Multiple Fields with EUA

This command appears to do what you want (it even does what the WCC would have done), but it does not write any data to the screen. You could issue an EAU command before the Write command. Then you would just write the new titles in their proper positions. You have then issued two commands to create one panel. What, then, is EAU for? It logically resets the panel for repetitive input using the same panel. Do not use EAU to change panels.

Data Entry Example: You can use the EAU command to change a sign-on panel slightly and make it a data entry panel. When the operator just keys in NAME, LOCATION, and SERIAL NUMBER for the first employee. If an error is made, an error panel is shown. If there is no error, you may want to clear the input, reset the MDTs, unlock the keyboard, and reposition the cursor. The data entry panel might appear as shown in Figure 5-35.

The operator keys JOHN SMITH, presses TAB, keys BOSTN, presses TAB, keys 963981, and presses ENTER (Figure 5-36). You simply send the 3270 an EAU command to unlock the keyboard. The operator then sees the same panel as in Figure 5-35 and may now key data for the next employee. You have used your knowledge of what is already displayed to arrive at the next panel or to re-create the present panel.

Repetitive Output

In the data entry example, you used one panel repetitively for input of employee information. You can reverse the requirement and design an employee data screen. For this example, assume the application is inquiry with "browsing" capability. Assume also that the operator has previously used another panel to request the information for employee number 963981. The display might appear as shown in Figure 5-37.

At the bottom of the panel, the operator is instructed to use the PA1 key to see the next employee page, probably number 963982. The PA2 key is assigned to page backward. Remember, PA keys are assigned by the program. Program attention keys cause a short transmission; they do not even transmit the contents of changed fields. For an inquiry and browsing application, there should be no input. The PA key assures there is no input even if the operator changes one of the unprotected fields, so its use is preferred to the ENTER or PF keys.

Using the Program Tab (PT)

The input fields in the previous examples are output fields in this example. You could designate them as *protected*, but if you did, you could not use another 3270 function called *Program Tab*. The Program Tab (PT) order advances the current buffer address to the address of the first character location of the next unprotected field. When the PT order immediately follows an alphameric or null character (not another order) in the Write data stream (other than the character specified by the Repeat to Address order, which is discussed earlier), it also inserts nulls in all the character positions from the current buffer address to the end of the current field. The PT order can be used to page through the employee data file.

| ROW | COLUMN | | | | | | | | | | | | | | | | | | | | | | | | | | | | | | | | | | | | | | | | | | | |
|-----|--------|---|---|---|---|---|---|---|---|---|---------|---|---|---|---|---|---|---|---|---|---------|---|---|---|---|---|---|---|---|---|---------|---|---|---|---|---|---|---|---|-----|---|---|--|--|
| | 1 - 10 | | | | | | | | | | 11 - 20 | | | | | | | | | | 21 - 30 | | | | | | | | | | 31 - 40 | | | | | | | | | | | | | |
| | 1 | 2 | 3 | 4 | 5 | 6 | 7 | 8 | 9 | 0 | 1 | 2 | 3 | 4 | 5 | 6 | 7 | 8 | 9 | 0 | 1 | 2 | 3 | 4 | 5 | 6 | 7 | 8 | 9 | 0 | 1 | 2 | 3 | 4 | 5 | 6 | 7 | 8 | 9 | 0 | 1 | 2 | | |
| 01 | | | | | | | | | | | | | | | | | | | | | | | | | | | | | | | | | | | | | | | | | | | | |
| 02 | | | | | | | | | | | | | | | | | | | | | | | | | | | | | | | | | | | | | | | | | | | | |
| 03 | | | | | | | | | | | | | | | | | | | | | | | | | | | | | | | | | | | | | | | | | | | | |
| 04 | | | | | | | | | | | | | | | | | | | | | | | | | | | | | | | | | | | | | | | | | | | | |
| 05 | | | | | | | | | | | | | | | | | | | | | | | | | | | | | | | | | | | | | | | | | | | | |
| 06 | | | | | | | | | | | | | | | | | | | | | | | | | | | | | | | | | | | | | | | | | | | | |
| 07 | | | | | | | | | | | | | | | | | | | | | | | | | | | | | | | | | | | | | | | | | | | | |
| 08 | | | | | | | | | | | | | | | | | | | | | | | | | | | | | | | | | | | | | | | | | | | | |
| 09 | | | | | | | | | | | | | | | | | | | | | | | | | | | | | | | | | | | | | | | | | | | | |
| 10 | | | | | | | | | | | | | | | | | | | | | | | | | | | | | | | | | | | | | | | | | | | | |
| 11 | | | | | | | | | | | | | | | | | | | | | | | | | | | | | | | | | | | | | | | | | | | | |
| 12 | | | | | | | | | | | | | | | | | | | | | | | | | | | | | | | | | | | | | | | | 480 | | | | |
| 13 | | | | | | | | | | | | | | | | | | | | | | | | | | | | | | | | | | | | | | | | | | | | |

Figure 5-35. Example of Data Entry Panel

| ROW | COLUMN | | | | | | | | | | | | | | | | | | | | | | | | | | | | | | | | | | | | | | | | | | | |
|-----|--------|---|---|---|---|---|---|---|---|---|---------|---|---|---|---|---|---|---|---|---|---------|---|---|---|---|---|---|---|---|---|---------|---|---|---|---|---|---|---|---|-----|---|---|--|--|
| | 1 - 10 | | | | | | | | | | 11 - 20 | | | | | | | | | | 21 - 30 | | | | | | | | | | 31 - 40 | | | | | | | | | | | | | |
| | 1 | 2 | 3 | 4 | 5 | 6 | 7 | 8 | 9 | 0 | 1 | 2 | 3 | 4 | 5 | 6 | 7 | 8 | 9 | 0 | 1 | 2 | 3 | 4 | 5 | 6 | 7 | 8 | 9 | 0 | 1 | 2 | 3 | 4 | 5 | 6 | 7 | 8 | 9 | 0 | 1 | 2 | | |
| 01 | | | | | | | | | | | | | | | | | | | | | | | | | | | | | | | | | | | | | | | | | | | | |
| 02 | | | | | | | | | | | | | | | | | | | | | | | | | | | | | | | | | | | | | | | | | | | | |
| 03 | | | | | | | | | | | | | | | | | | | | | | | | | | | | | | | | | | | | | | | | | | | | |
| 04 | | | | | | | | | | | | | | | | | | | | | | | | | | | | | | | | | | | | | | | | | | | | |
| 05 | | | | | | | | | | | | | | | | | | | | | | | | | | | | | | | | | | | | | | | | | | | | |
| 06 | | | | | | | | | | | | | | | | | | | | | | | | | | | | | | | | | | | | | | | | | | | | |
| 07 | | | | | | | | | | | | | | | | | | | | | | | | | | | | | | | | | | | | | | | | | | | | |
| 08 | | | | | | | | | | | | | | | | | | | | | | | | | | | | | | | | | | | | | | | | | | | | |
| 09 | | | | | | | | | | | | | | | | | | | | | | | | | | | | | | | | | | | | | | | | | | | | |
| 10 | | | | | | | | | | | | | | | | | | | | | | | | | | | | | | | | | | | | | | | | | | | | |
| 11 | | | | | | | | | | | | | | | | | | | | | | | | | | | | | | | | | | | | | | | | | | | | |
| 12 | | | | | | | | | | | | | | | | | | | | | | | | | | | | | | | | | | | | | | | | 480 | | | | |
| 13 | | | | | | | | | | | | | | | | | | | | | | | | | | | | | | | | | | | | | | | | | | | | |

Figure 5-36. Data Entry Panel with Entered Data

Chapter 6. Screen Management

A screen management program module is a set of subroutines physically separate from application programs and from the telecommunications management program module of an online 3270 system. Figure 6-1 illustrates this relationship.

Support functions in a screen management program may reduce the amount of detail work required by the application programs and effectively use the features of the 3270. The separation of screen management from the other programs also allows screen management to be modified with little or no impact on application programs or on telecommunications management programs.

Screen management might include:

- Decoding input data streams.
- Dynamic building of output data streams.
- Generating multiple I/O requests to the Line Control Module based upon a single request from an application program (that is, WRITE then READ).
- Automatic paging; the application program passes multiple pages to screen management, which asks the line control module to write a particular page to a display, depending on the display operator's request.
- Automatic copying (providing a hard copy of a display image).

The BSC COPY function supports data movement between any types of device attached to the same control unit: display to display, display to printer, printer to display, and printer to printer. To prevent copying information from an unauthorized device, the control unit provides a program-controlled copy-lock for devices attached to it. If the first position of a device buffer contains a field attribute character with the protected option, the control unit rejects any attempt to copy from that device.

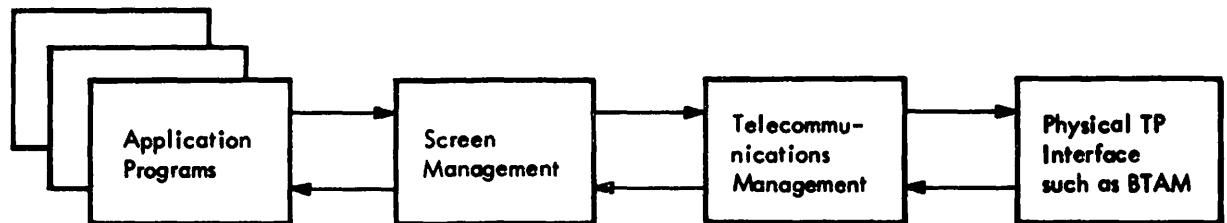

Figure 6-1. Relationship of Screen Management to Telecommunications Management and Application Program

Decoding and Generating Data Streams

The data streams sent between application programs and the 3270 contain unique orders that request particular operations by the 3270 displays and printers. Generalized sub-routines can be written to assist the application programmer's interface with the 3270 system, and an interface can be built to simplify online programs.

This chapter discusses several approaches to the development of a screen management module whose functions can be used by the application programmer to prepare output data streams and to decode input data streams. The approaches demonstrate how some 3270 device-dependent considerations can be removed from the application programmer's responsibility. The different techniques for 3270 input or output data stream manipulation can be used in various combinations to suit the needs of the installation.

This discussion assumes that the device management routines (line control) make the local and remote 3270 transparent to the application program. Therefore, discussion of data streams in this chapter ignores all header data in the input stream up to and including the AID character and all header data in the output stream up to but not including the Write Control Character (WCC).

Decoding Read Modified Input Data Stream

A Read Modified command for a display station with a formatted screen (a screen with at least one attribute character defined) produces a data stream consisting of the data from each field whose modified data tag has been turned on (either by program control or by data entered in the field). Each transmitted data field is preceded by the 3270 buffer address where that data is located on the display. The order of the fields transmitted from the screen is from left to right for each line, starting at the top of the screen and ending at the bottom of the screen. All null characters in a transmitted field are stripped out by the control unit during transmission.

The data stream, ignoring the header information up to and including the AID character, appears as:

| | | | | | | | |
|---|---|---|------|---|---|---|-------|
| S | A | A | | S | A | A | |
| B | 1 | 2 | DATA | B | 1 | 2 | . . . |
| A | | | | A | | | |

If the data entered in a field is of variable length or if a field can be skipped by the terminal operator, the data from a particular field on a given panel can appear in a different location within the data stream for each set of operator input. A Read Modified command produces a variable-length data stream of fixed-length fields and variable-length fields concatenated together.

Each 2-character screen address in the data stream is immediately preceded by a Set Buffer Address (SBA) order. The detection of each SBA order in the data stream identifies the next 2 characters in the stream as a 3270 screen address and also indicates the end of the preceding data field. The System/360 and System/370 Translate and Test instruction (TRT) can be used to scan the data stream and to stop at each main storage address containing an SBA order. If the detected main storage address of the current SBA order is known, the following calculations can be performed for a given data stream:

```
SBA (1) , ADD (1A) , ADD (1B) , DATA FIELD (1) ,
SBA (2) , ADD (2A) , ADD (2B) , DATA FIELD (2) ,
SBA (3) ,
```

The numbers in parentheses are used as subscripts to provide unique identification:

- The length of data field (1) = (Address of SBA(2) - Address of SBA(1)) - 3.
- The 2-character 3270 screen address of data field (1) can be found at the address of SBA(1) + 1.
- The length of data field(2) = (Address of SBA(3) - Address of SBA(2)) - 3.
- The 2-character screen address of data field(2) can be found at the address of SBA(2) + 1.

The 2-character 3270 screen address as it appears in the input stream does not provide a direct decimal or binary numeric value that can be used to calculate the relative position in the 3270 buffer from which the data was read. However, you can use the following routine to convert the 3270 address as it appears in the input data stream to a binary value which directly indicates the position (relative to zero) of the data in the 3270 buffer.

Assume that R3 contains the address of SBA(1) and that R4 and R5 are work registers. R5 will contain the result at the end of the routine.

```
ADDCNVRT    EQU *
            SR  R4, R4          CLEAR WORK REG
            SR  R5, R5          CLEAR WORK REG
            IC  R4, 0(R3)       GET FIRST ADDRESS CHAR (ADD (1A))
            N   R4, = F'63'     TURN OFF ALL BITS EXCEPT LAST SIX
            IC  R5, 1(R3)       GET SECOND ADDRESS CHAR (ADD (1B))
            N   R5, = F'63'     TURN OFF ALL BITS EXCEPT LAST SIX
            SLL R4, 6           SHIFT FIRST ADDRESS SIX BITS TO THE LEFT
            AR  R5, R4          ADD THE RESULTS TOGETHER
```

By using the above technique, several approaches may be developed to a general purpose subroutine that decodes the variable-field-length data stream for the application program, and returns the data in a more easily processed format.

Nonselector Pen or Noncursor Select Data Streams

DISPLAY BUFFER IMAGE TECHNIQUE: By using the Read Buffer command you can use the display buffer image technique to return to the application program a main storage buffer area the same size as the display buffer (480, 960, 1920, 2560, 3440). The data read from the display is placed in the same relative position in the main storage buffer as it occupied in the display buffer, with all other positions in the returned buffer cleared to spaces.

For this technique, use the TRT instruction and the 3270 address conversion routine. You must know the relative locations in the display buffer where data can be entered by the operator, so that the decoded buffer can be processed when returned by the mapping subroutine. The completed layout sheet for the panel in which the operator enters data will give you the required addresses relative to the respective buffers.

Using the image technique, all data received from the 3270 is left-justified in its respective fields. This has no effect on fixed-length fields, variable-length alphanumeric fields (which are normally left-justified), or on omitted input fields. However, you must be aware of variable-length numeric fields where the operator can omit leading zeros.

Although the image technique requires little main storage for the mapping subroutine, main storage can be wasted if the routine returns a complete buffer with little data. To help overcome this problem, the decoding routine can pass back to the application program a field at the beginning of the buffer. The field indicates the total length of the buffer, which allows the decoding routine to use a buffer area just large enough to accommodate the relative address of the last data field read.

MAPPING FROM A TABLE OF REQUIREMENTS: This mapping technique requires a table assembly for each unique input panel that the mapping subroutine decodes for the application program. The table provides information to the subroutine so that the input data stream in one main storage buffer can be decoded a field at a time and moved to a specified relative offset in another main storage buffer (the target buffer) according to the directions assembled in the table. The preassembled table could be used to specify the following information to the mapping subroutines:

1. The 3270 buffer address preceding each field, which could be read from a particular panel. This is the buffer address as it appears in the data stream which corresponds to the first data position in a field, not to the buffer location of the field attribute byte that defines the field. Any data fields in the 3270 input stream that do not have a matching buffer address in the table would be ignored by the typical mapping routine using the table approach.
2. An offset relative to zero that provides the starting position of each field in the target buffer. This information allows the application programmer to order the fields in the target buffer in a sequence that may or may not agree with the field sequence in the transmitted data stream.
3. A value that indicates the maximum length of each field in the target buffer. This information allows the mapping routine to truncate data stream fields that are too long for the target fields. The maximum field length value is also required if the mapping routine supports right-justification of fields during mapping.

4. A flag byte consisting of bit switches that could indicate:

- Whether left justification with low-order blank padding is requested.
- Whether right justification with high-order zero fill is requested.
- Whether the field should be translated to ensure uppercase characters only.
- Any additional functions the installation wishes to implement in the mapping routine.

Figure 6-2 shows some typical logical contents of the table. The order of the elements within each table entry is optional.

Assume that you map the following input data stream in hexadecimal using the sample table in Figure 6-2:

```
1140D4F1F2F31140E8818283848511C1C6E385A7A3
```

The following target buffer, also in hexadecimal, would be returned to the application program:

```
C1C2C3C4C54040404040F0F0F1F2F3E385A7A34040
```

This approach to mapping makes the application program's input processing routine device-independent.

Instead of the mapping table, you could write a macro instruction to prepare the table; the macro would convert written requests into the proper machine language constants.

A typical format for a macro instruction to build the sample table shown in Figure 6-2 might be:

```
MAP      NAME=TABLE,MODEL=2
MAP      ADD=(1,21),OFFSET=11,MAXL=5,JUST=RIGHT
MAP      ADD=(1,41),OFFSET=1,MAXL=10,JUST=LEFT,TRAN=YES
MAP      ADD=(1,71),OFFSET=16,MAXL=6,JUST=LEFT
```

Note: The ADD parameter specifies the 3270 buffer in row and column notation relative to 1. For example, buffer position 0 equals row 1, column 1. The offset values are expressed relative to 1. The macro instruction can have default options; for example, if JUST=RIGHT is not specified, JUST=LEFT can be assumed.

| | | |
|----------|------------|----------------------------------|
| TABLE | DS OH | |
| ENTRY 1 | DC X'40D4' | ACTUAL 3270 ADDRESS FOR POS 20 |
| | DC H'10' | RELATIVE OFFSET IN TARGET BUFFER |
| | DC HL1'5' | MAX FIELD LENGTH OF TARGET FIELD |
| | DC X'80' | RIGHT JUSTIFY, NO TRANSLATE FLAG |
| ENTRY 2 | DC X'40E8' | ACTUAL 3270 ADDRESS FOR POS 40 |
| | DC H'0' | RELATIVE OFFSET IN TARGET BUFFER |
| | DC HL1'10' | MAX FIELD LENGTH OF TARGET FIELD |
| | DC X'40' | LEFT JUSTIFY, TRANSLATE FLAG |
| ENTRY 3 | DC X'C1C6' | ACTUAL 3270 ADDRESS FOR POS 70 |
| | DC H'15' | RELATIVE OFFSET IN TARGET BUFFER |
| | DC HL1'6' | MAX FIELD LENGTH OF TARGET FIELD |
| | DC X'00' | LEFT JUSTIFY, NO TRANSLATE FLAG |
| ENDOLIST | DC X'FF' | END OF LIST INDICATOR |

Note: 3270 buffer addresses in the table are shown relative to buffer location 0; relative offsets in the target buffer are shown relative to 0.

Figure 6-2. Table of Requirements

The following example shows the logic flow for a table-driven input mapping technique:

1. Find the 3270 buffer address of a data field to be processed in the input data stream using the TRT instruction.
2. Determine the length of the data field in the data stream using the techniques discussed in this section.
3. Search the table of requirements, using the 3270 buffer address found in step 1 as a search argument to find a matching entry.
4. Add the offset value from the entry found in the table to the starting address of the main storage map buffer to produce the main storage address of the start of the receiving field.
5. If the length of the data field determined in step 2 is greater than the maximum field length value in the entry found in the table, go to step 10.
6. Check the flag byte in the entry found in the table. If left justification is requested, go to step 10. Otherwise proceed to step 7 for right justification.
7. Move zoned decimal zeros to the receiving field, using the field starting address determined in step 4. Use the maximum field length value in the entry found in the table as the length for the move.
8. Develop a new main storage address for the start of the receiving field to accommodate the request for right justification. The right-justified starting address for the receiving field = (field starting address determined in step 4 + maximum field length value in the entry found in the table) - length of the data field in the data stream found in step 2.
9. Move the data field from the data stream to the main storage address developed in step 8, using the length of the data in the data stream determined in step 2. Return to the start of this routine to find the next data field in the data stream.

10. Move blanks to the receiving field using the starting address of the field as determined in step 4. Use the maximum field length value in the entry found in the table as the length for the move.
11. Move the data field from the data stream to the receiving field using the field address determined in step 4. Use the length of the data in the data stream (determined in step 2) as the length for the move.
12. Check the flag byte in the entry found in the table to determine if uppercase translation is requested. If it is not requested, return to the start of this routine to find the next data field in the data stream.
13. Translate the data in the receiving field to uppercase; then return to the start of this routine to find the next data field in the data stream. The translation can be done in two ways:
 - Use the Translate instruction with the translation table built to convert lowercase alphabetic characters to uppercase.
 - Use the OR instruction to place blanks in the field. This will change the DUP and FM characters. The FM appears as a semi-colon (;) on the screen, but appears in the data stream as X'1E'. It will be converted to a true semi-colon (;), that is, X'5E'. The DUP appears as an asterisk (*) on the screen, but appears in the data stream as X'1C'. It will be converted to a true asterisk (*), (X'5C').

Immediate Selector Pen or Cursor Select Data Stream

When a Read Modified command is executed for a display station as a result of an immediate detection by the selector pen or cursor select, the resulting data stream consists of address strings that identify which fields on the screen have the modified data tag set; the 3276 control unit also transmits the modified data if the proper designator character is used.

The data stream, ignoring the header information up to and including the AID character, appears as:

| | | | | | | |
|---|---|---|---|---|---|-----|
| S | A | A | S | A | A | |
| B | 1 | 2 | B | 1 | 2 | |
| A | | | A | | | ... |

If the operator keys into a field and an immediate selector field is selected, the keyed data is not transmitted. However, if keyed data is entered by the operator, delayed selector fields are selected, and the ENTER key or a PF key is pressed; then the address and data for all fields, whether selected or keyed, are included in the data stream.

You can use a subroutine to free the application program from determining which fields were selected on a panel. A table can be built that consists of the 3270 buffer addresses, giving the location of each selectable field on a panel. The mapping routine can then compare the addresses in the table, and return to the application program a list of indicators that identifies the selected fields.

The list of indicators can be returned to the application program. A string of one-position fields can be used, and each position can indicate with a unique character that a field was selected. The first position in the returned list can be marked if a field in the data stream has the same address as the first element in the address table; the second position in the returned list can be marked if a field in the data stream has the same address as the second element in the address table. The application program can then determine which relative positions in the list have been marked to determine which fields have been selected by the operator.

Because the input from a display using selector pen or cursor select detection is a series of fixed-length addresses, the mapping routine can analyze the input stream and decode it.

For example, using the selector panel illustration in Figure 6-3, assume that the operator has selected the delayed-detectable fields located at row 5, column 10 and row 3, column 26 and the immediate-detectable field located at row 7, column 18. The input data stream transmitted in hexadecimal from the display would be:

11C1E911C2E911C4C1

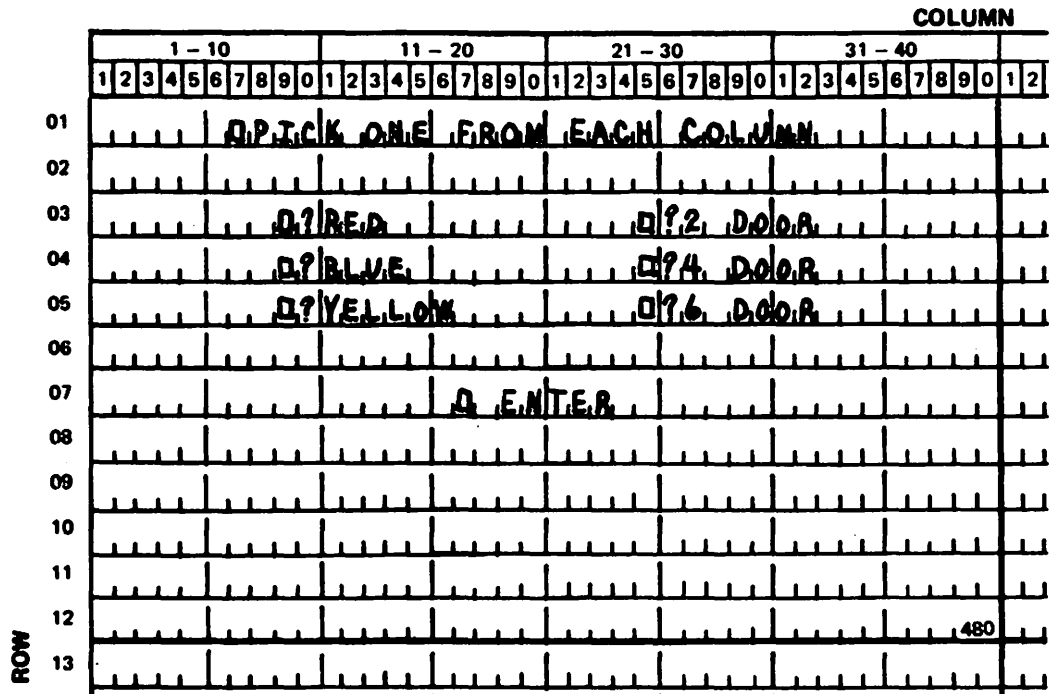

Figure 6-3. Example of Selector Pen Panel

Using the sample table in Figure 6-4, the mapping routine returns a list in hexadecimal to the application program:

406F40406F406F

This list indicates that the second, fifth, and seventh fields were selected. Note that the addresses of the selected fields appear in the data stream in the same sequence as the fields appear in the display buffer. When a selector pen panel is designed by columns, the address of the field selected from the first column may not occur before the address of the field selected from the second column in the input data stream.

You can write a macro instruction similar to the one used to build the table in Figure 6-2 to build the selector pen table:

```
MAP      NAME=SELTABLE,MODEL=1
MAP      ADD=(3,10)
MAP      ADD=(3,26)
MAP      ADD=(4,10)
. . .
```

| SELTABLE | EQU * | FOR MODEL 1 DISPLAY |
|----------|------------|----------------------|
| | DC X'C1D9' | ROW 3 COL 10 |
| | DC X'C1E9' | ROW 3 COL 26 |
| | DC X'C2C1' | ROW 4 COL 10 |
| | DC X'C2D1' | ROW 4 COL 26 |
| | DC X'C2E9' | ROW 5 COL 10 |
| | DC X'C2F9' | ROW 5 COL 26 |
| | DC X'C4C1' | ROW 7 COL 18 |
| | DC X'FF' | TABLE STOP INDICATOR |

Note: The 3270 addresses used in the above table correspond to the buffer position of the Selector Pen designator character in a field, not to the location of the field attribute character which defines the field.

Figure 6-4. Sample Mapping Table

Mixed Read Modified Input Data Streams

When some keyed input and some delayed selector pen or cursor select detection occur in a panel during the same input operation from a display, you can use the table-driven mapping technique for nonselector pen or cursor select panels. Specify the table elements so that all delayed selector fields have a maximum length of one character. The mapping routine places the first character from the appropriate data stream field into the target field. The first character in a delayed selector field that has been selected is always a (>); that is, X'6E'. The application program can examine the target buffer for that character in the proper target field to determine if the field has been selected.

Building Output Data Streams

The 3270 requires specific bit patterns for order sequences, control characters, and buffer addressing. The data streams can be prepared in several different ways. A data stream to build a static panel (a panel which will always be displayed in exactly the same manner) can be assembled in an application program as a set of data constants. A semidynamic panel, which may occasionally be modified or added to, can have the static portion assembled in the application program and have the program dynamically modify or add to the data stream. A data stream for a dynamic panel (a panel with a high degree of change) must be created or assembled as a unit at execution. This section discusses how to reduce the considerations of device-dependency required to support static, semidynamic, and dynamic output data streams.

Static Data Streams

You can write macro instructions to simplify the preparation of static data streams for the 3270. One approach is to write a set of macro instructions in which each macro instruction prepares a single order sequence. Another approach is to write one macro instruction that can prepare all types of order sequences, but prepares only one sequence for each execution of the macro instruction in a program.

A sample macro instruction of the first type might be:

```
$MOD MODEL = 1, 2, 3, 4, 5
```

This macro instruction sets a global value so that the specified model number is used until another \$MOD macro instruction is encountered. The model number is required to correctly calculate 3270 buffer addresses. The buffer address X'C2D5' represents column 4, row 30 for a Model 1 display, and column 2, row 70 for a Model 2 display.

The following are also examples of the first type of macro instruction:

\$SBA (1,10) generates the SBA order sequence X'1140C9'

\$SF (PROT,NUM,SKIP,MDT,HI,DET,NONDISP)

generates an SF order (X'1D') followed by the appropriate attribute character defined by the options selected in parentheses. Notice that if PROT is not specified, unprotected is assumed; if numeric is not specified, alphameric is assumed.

\$RA (1,10,'*') generates the RA order sequence X'3C40C95C'.

\$EUA (1, 10) generates an EUA order sequence X'1240C9'.

\$WCC (RESET,RESTORE,ALARM,PRINT,40CHAR,64CHAR,80CHAR,NLEM)

generates the proper WCC, depending on the options selected in parentheses.

\$CCC (PRINT,40CHAR,64CHAR,80CHAR,ALARM,ATTR,UNPROT,PROT,ALL)

generates the proper copy control character (CCC), depending on the options selected in parentheses. (The CCC identifies the type of data to be copied.)

\$IC generates X'13'

\$KBD KEYBOARD = APL or Text

Used with the Data Analysis feature to identify the keyboard providing 3277-2 display input.

\$SI generates the Suppress Index character, valid for the 3289 printer. Other printers receive | (the or bar) in place of the Suppress Index character.

After you have defined the macro instruction, the data stream required to build the sign-on panel shown in Figure 5-6 could be created as follows:

```
SIGNON      $MOD      MODEL=1
            $WCC      (RESET,RESTORE)
            $SBA      (2,11)
            $SF       (PROT)
            DC        C'SIGN-ON PROCEDURE '
            $SBA      (4,2)
            $SF       (PROT)
            DC        C'PLEASE ENTER YOUR SIGN-ON INFORMATION '
            $SBA      (6,1)
            $SF       (PROT,HI)
            DC        C'NAME: '
            $SF
            $IC
            $SBA      (6,25)
            $SF       (PROT,HI)
            DC        C'LOCATION: '
            $SF
            $SBA      (7,1)
            $SF       (PROT,HI)
            DC        C'SERIAL NUMBER: '
            $SF       (NUM)
            $SBA      (7,23)
            $SF       (PROT)
            $SBA      (10,4)
            $SF       (PROT)
            DC        C'WHEN ALL ... ENTER KEY'
```

You could also write the second type of instruction, a single 3270 data stream macro instruction, which might have the format:

| | | | |
|----------|-------|--|------------------|
| {symbol} | \$MAC | op-type ,(attributes) ,(row,column) [,character] ,MODEL= | 1 2 3 4 |
|----------|-------|--|------------------|

symbol

specifies a symbol that refers to the data stream

op-type

specifies the type of screen control operation to generate. Valid values are: SF, SBA, IC, RA, EUA, WCC, and CCC.

(row,column)

specifies the row (1 to 43) and column (1 to 132) where the operation starts or ends (depending on the op-type). This parameter is required for op-types SBA, RA, and EUA.

(attributes)

indicates attributes or control bits for SF, WCC, and CCC.

Some valid values for SF are: PROT, SKIP, NUM, MDT, HI, DET, NONDISP.

Some valid values for WCC are: RESET, RESTORE, ALARM, PRINT, 40CHAR, 64CHAR, 80CHAR, NLEM.

Some valid values for CCC are: PRINT, 40CHAR, 64CHAR, 80CHAR, ALARM, ATTR, UNPROT, PROT, ALL.

character

specifies the character used in the RA function.

MODEL=

indicates the model of 3270. This model number is used to calculate the buffer address. This parameter is specified once in the first macro instruction of a data stream series or whenever the data stream to be generated is for a different model than the preceding series. Model numbers 3 and 4 can be specified only for the 3278 Display Station.

After you have defined the macro instruction, the data stream required to create the sign-on panel shown in Figure 5-6 could be as follows:

```
SIGNON      $MAC      WCC, (RESET, RESTORE), MODEL=1
            $MAC      SBA, (2,11)
            $MAC      SF, (PROT)
            DC        C 'SIGN-ON PROCEDURE '
            $MAC      SBA, (4,2)
            $MAC      SF, (PROT)
            DC        C 'PLEASE ENTER YOUR SIGN-ON INFORMATION '
            $MAC      SBA, (6,1)
            $MAC      SF, (PROT,HI)
            DC        C 'NAME: '
            $MAC      SF
            $MAC      IC
            $MAC      SBA, (6,25)
            $MAC      SF, (PROT,HI)
            DC        C 'LOCATION: '
            $MAC      SF
            $MAC      SBA, (7,1)
            $MAC      SF, (PROT,HI)
            DC        C 'SERIAL NUMBER: '
            $MAC      SF(NUM)
            $MAC      SBA, (7,23)
            RMAC      SF, (PROT)
            $MAC      SBA, (10,4)
            $MAC      SF, (PROT)
            DC        C 'WHEN ALL ... ENTER KEY'
```

These two types of macro instructions can generate either a total static data stream or static sections of data streams that can be dynamically assembled at execution by the application program.

Semidynamic Output Streams

A semidynamic panel requires some dynamic modification. Perhaps an error message must be written to a particular part of the panel and the cursor must be moved to the input field in which an error was detected during editing. The application program can concatenate preassembled static data stream segments into the program, such as field error messages. The same macro instructions that build static data streams can build partial static streams. As the input from a panel is edited, the standard error message for each field can be assembled in the output buffer, thus allowing multiple brief messages to be sent to the display in one operation.

You may have to change one or two attribute characters from high intensity to low intensity and erase the unprotected fields on a display. For example, an error message segment may have changed a field to high intensity to call the operator's attention to the field; the operator has recognized the error and reentered the correct information. The display must now be made ready for the next input on the panel. Concatenate the order stream segments to change the attribute characters and use the Erase Unprotected to Address (EUA) order to restore the panel; do not transmit all the data and orders to completely refresh the panel.

Dynamic Output Streams

It may become physically impossible to hold in main storage all possible output data and order stream combinations that could occur during execution of an application. You can incorporate a subroutine into screen management to accept parameters from an application program to decode the parameters and to create the data stream. You can also write for the application program a macro instruction that builds a parameter list inline from entries you specify in the macro instruction, and then branches to the screen management routine to build the required orders and data in the buffer area.

The macro instruction could appear as follows:

```
$BUILD ADD=ADDFIELD,ATTR=(R3),DATA=(R4),LEN=(R5)
```

The ADDFIELD contains the 3270 buffer address in either row-column format, binary offset, or 3270 address form. R3 contains the address of the attribute byte, R4 contains the address of the data to be entered in the field, and R5 contains the length of the data. The attribute character parameter is optional.

The subroutine could convert row and column buffer addresses relative to 1 to decimal offsets relative to 0 with the following formula:

```
Model 1 Buffer:          ((R-1) X40)+(C-1)
Model 2, 3, 4 Buffer:    ((R-1) X80)+(C-1)
```

If the row and column buffer addresses relative to 1 are in two single-byte areas in binary, the conversion to binary offsets relative to 0 can be coded as follows:

```
SR      R3,R3
IC      R3,COLUMN
BCTR    R3,C
SR      R4,R4
IC      R4,ROW
BCTR    R4,0
MH      R4,=H'40' USE VALUE OF 80 FOR MODEL 2
AR      R4,R3  RESULT IN R4
```

The following subroutine converts a binary halfword that represents the offset relative to 0 of a position in a 3270 buffer to an equivalent 2-character 3270 address. R3 is a work register, and R4 points to the binary halfword to be converted. The converted result is found at ANSWER.

```

LH      R3,0 (R4)
STC     R3,ANSWER+1
SRL     R3,6
STC     R3,ANSWER
NI      ANSWER+1,X'3F'
TR      ANSWER(2),TAB
.
.
.
ANSWER  DC      X'0000'
TAB     DC      X'40C1C2C3C4C5C6C7C8C94A4B'
        DC      X'4C4D4F4F50D1D2D3D4D5D6D7'
        DC      X'D8D95A5B5C5D5E5F6061E2E3'
        DC      X'E4E5E6E7E8E96A6B6C6D6E6F'
        DC      X'F0F1F2F3F4F5F6F7F8F97A'
        DC      X'7B7C7D7E7F'

```

Large Screen Size

Application programs written for systems that use 480- or 1920-character screen size will run on large screen displays with the same width but with a greater number of lines. Terminals with large screen capacity (960, 2560, and 3440 characters) will automatically default to smaller screen size unless the large screen size has been specified explicitly by the application program. The Erase Write Alternate command is used to switch a display into large screen mode.

Since buffer address wrapping is screen-size-dependent, application programs should not depend on buffer wrap during write operations. Also, field attributes must be appropriately placed to delimit the end of the screen image.

Appendix A. Indicators and Controls

This appendix describes the function of switches, controls, and lights on the operator's panel, and symbols displayed in the Operator Information Area (Figure A-1 and A-2).

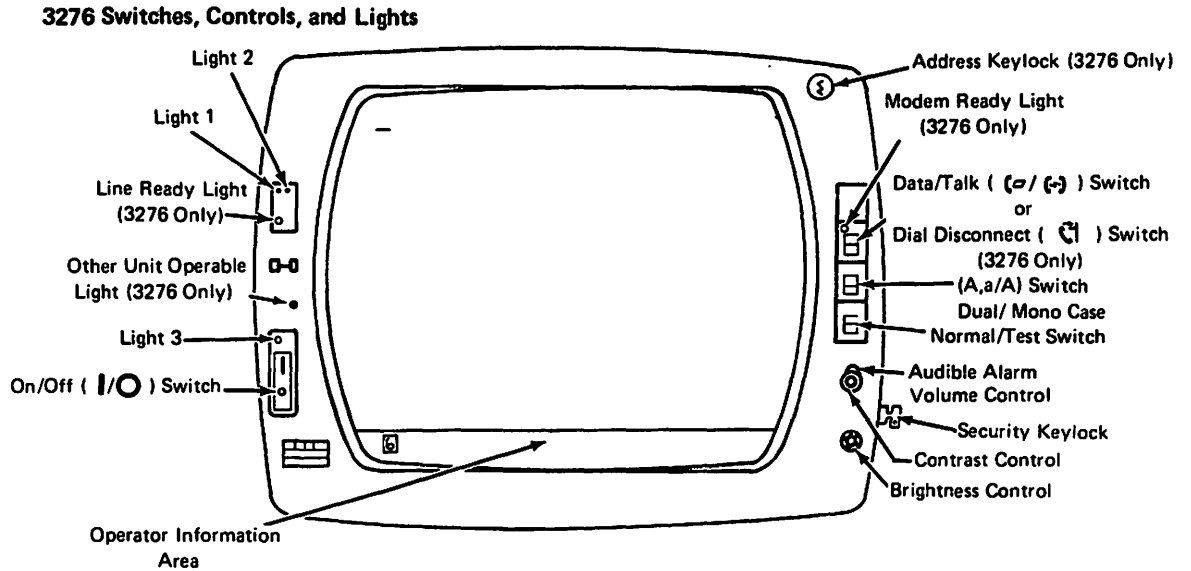

Figure A-1. 3276 Operator Panel

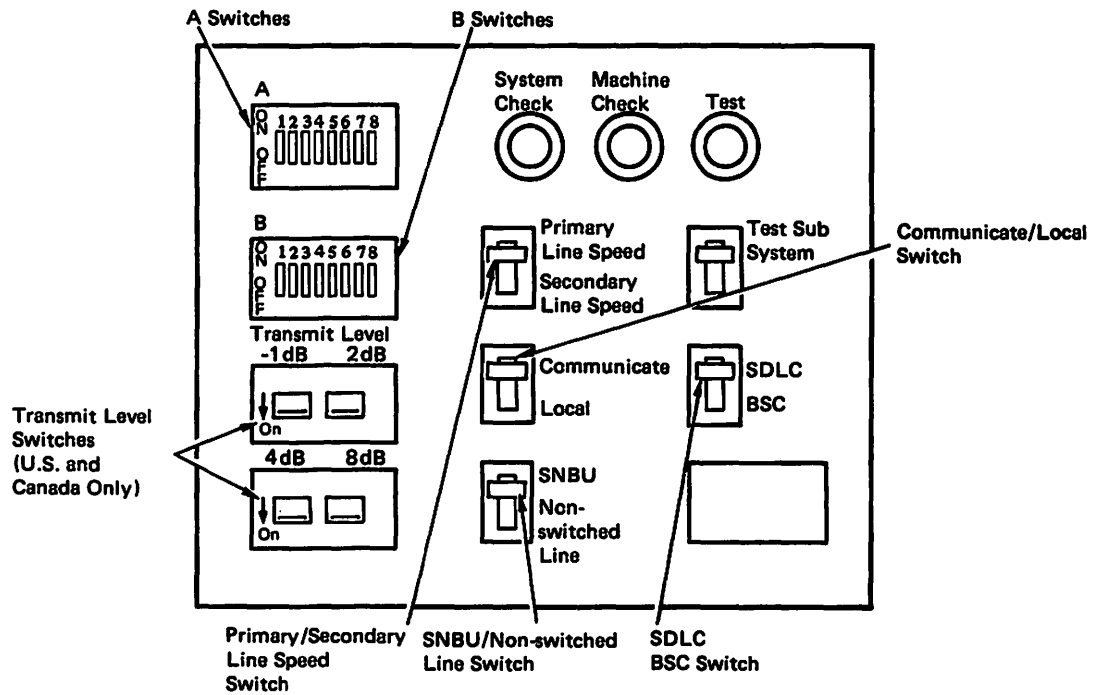

Figure A-2. 3276 Operator Drawer Panel

The following listing describes the function of the indicators and controls shown in Figure A-1 and Figure A-2.

Audible Alarm Volume Control. This control allows adjustment of the audible alarm, when the Audible Alarm feature has been installed on the 3276. The audible alarm tone amplifier control is attached to the Contrast Control, located below the Normal/Test switch near the lower-right corner of the CRT.

Brightness Control. This is a dual-function control. Rotating the control clockwise increases CRT brightness. On the 3276 display, rotating the control completely clockwise and holding the control places the control in test intensity override position, which unblanks the CRT screen. The Brightness Control is located near the lower-right corner of the CRT.

Contrast Control. The Contrast Control controls CRT contrast and is located above the Brightness Control.

Modem Ready Light. This indicator is turned on when the Data Set Ready signal is received from the modem. It is located above the Dial Disconnect switch or Data/Talk switch on the right side of the CRT.

Data/Talk. This switch, located on the right side of the CRT, is used to switch from talk mode to data mode, or vice versa, when integrated modem is operated in the switched network.

Dial Disconnect Switch. This switch is used to terminate a switched network call.

Dual/Mono Case Switch. When in the Mono Case (A) position, only uppercase characters are displayed. When in the Dual Case (A,a) position, uppercase and lowercase characters can be displayed. This switch is located on the right side of the CRT.

Light 2. This indicator should light after power is applied. It is located in the upper-right position on the left side of the CRT.

Line Ready: This indicator lights when the communication line is functioning correctly. In BSC operating mode, it is turned on when a polling or selection sequence is received and is turned off after 3 seconds if character synchronization is not achieved in control mode, or when a Machine Check condition caused by an integrated modem is detected. The Line Ready indicator is located below the Light 2 indicator on the left side of the CRT. The light is turned off when 8 seconds elapse without receiving the controller address. It is also turned off by depressing Test Subsystem (3276), or when a Machine Check condition is caused by MC/PC error except DTA card or caused by CCA or a modem error.

Normal/Test. This switch, when placed in the Test position, disconnects the 3178, 3278, 3279, or 3276 display from the attached 3276 to allow testing operations. The Normal/Test switch is located on the right side of the CRT.

Light 3. This indicator lights when normal power is available in the unit. It is located above the Power On/Power Off switch on the left side of the CRT.

Other Units Operable. This indicator lights when at least one display station or terminal printer, attached to the 3276 is operable. The indicator is turned off when all attached devices are powered off or are disconnected from the 3276 because of a malfunction.

Power On/Power Off. This switch applies and removes internal power.

Light 1. This indicator is located to the left of the Light 2 indicator on the upper-left side of the CRT. It should light after power is applied.

The following listing describes the function of the indicators and controls shown in Figure A-2:

BSC Address. The BSC address is established by the setting of five switches, positions 1 through 5 of switch B on the operator panel drawer on the right side of the CRT.

Communicate/Local. This switch connects or disconnects the 3276 to or from a loop of the 8100 Information System and the 4300 Processor. When this switch is in the Communicate position, the 3276 is connected to a loop; when it is in Local, the 3276 is disconnected from a loop and the Line Ready indicator turns off. Whenever this switch is turned to Communicate, a wrap test is performed for the 3276 loop adapter.

Half Duplex/Full Duplex. This switch is located at position 6 of switch B on the operator drawer. With the switch in the on position (full duplex), the Request to Send (RTS) signal is held on in SNA/SDLC operation. When operating in BSC, the RTS signal is turned on when the End of Transmission (EOT) signal is received and is turned off upon transmission of the EOT signal. When the switch is in the off position (half duplex), the RTS signal is turned on when the EOT signal is received, and is turned off at the beginning and end of each transmission of the text block.

Machine Check. This indicator lights when a nonprogramming recoverable error is detected in the 3276.

NRZ/NRZI. This switch is located at position 8 of switch B on the operator drawer. When the switch is in the ON position, transmission and reception are in NRZ mode. When in the OFF position, NRZI mode is used.

Primary Line Speed/Secondary Line Speed. This switch is used to select secondary speed.

SDLC Address. The SDLC address is established by the setting of eight switches, positions 1 through 8, on switch panel A, on the operator panel drawer.

SDLC/BSC. This switch is set according to the line discipline selected.

Set Primary/Secondary Loop Speeds. The primary and secondary loop speeds are set by the combination of the settings of switch positions 6 through 8, which are located on switch panel B on the operator panel drawer. The following combinations are provided:

| Switch Position | | | Primary/Secondary Speeds |
|-----------------|-----|-----|--------------------------|
| 6 | 7 | 8 | |
| OFF | OFF | OFF | 9600/4800 |
| OFF | ON | OFF | 9600/2400 |
| OFF | OFF | ON | 4800/2400 |
| ON | OFF | OFF | 2400/1200 |
| ON | OFF | ON | 1200/ 600 |

Note: Loop speeds depend on the 8100 system. A decal is provided below switch panel B.

Switched Network Backup (SNBU). This switch is used to switch from nonswitched line operation to switched line backup mode.

System Check. This indicator is turned on when a program check or communication check is detected.

Test Indicator. This indicator lights under two conditions:

1. When the 3276 and attached devices have been placed in test mode, the Test indicator lights and remains on while in test mode.
2. When the 3276 detects a loss-of-carrier condition, the Test indicator blinks and the Line Ready indicator goes off.

Test Subsystem. This momentary switch is used to test the 3276 subsystem. Pressing and releasing the switch starts the subsystem test.

Transmit Level (U.S. and Canada only). These four switches are used to match the transmit level between an integrated modem and the protective coupler that is attached to the telephone line.

The following lists and explains the symbols displayed in the 3178, 3276, 3278, and 3279 Operator Information Area.

Readiness and System Connection Symbols (locations 1 through 6)

| Symbol | Name | Explanation |
|----------------------|----------------------|---|
| 6 | 3276 Ready | The appropriate ready symbol is displayed in location 1 of the Operator Information Area when the 3276 6 control unit to which the display is attached is ready (functional) and the display is ready. |
| <u>A</u> <u>B</u> | Online A Online B | <p>The Online <u>A</u> and Online <u>B</u> symbols govern transactions with the host system. Certain keyboard functions and the meaning of some Operator Information Area symbols differ depending upon which set of rules are applicable.</p> <p><u>Online A.</u> The control unit is connected to the system under <u>A</u> rules. The <u>A</u> symbol appears in remote systems using BSC protocol. It is turned on by receipt of the following commands: Write, Erase/Write, Erase All Unprotected, Copy, Read Modified, and Read Buffer.</p> <p>The <u>A</u> symbol is turned off when:</p> <ol style="list-style-type: none"> 1. An operator action causes host communication. 2. The display station is turned off. 3. The Normal/Test switch is placed in Test. <p><u>Online B.</u> The control unit is connected to the system under <u>B</u> rules. The <u>B</u> symbol appears in systems that use SNA protocol. It is turned on by completion of an ACTPU/ACTLU command sequence, and is turned off by execution of DACTPU or DACTLU, including an internal DACTPU sequence, and when the Normal/Test switch is placed in Test or the TEST key is pressed.</p> |
| ■ | My Job | The display station is connected to the operator's application program. This symbol is displayed in position 3. This symbol appears in systems that use BSC or SNA protocol. In systems using BSC, it is turned on with the <u>A</u> symbol, and is turned off when power is removed, and when the Normal/Test switch is placed in Test. When using SNA protocol, it is turned on when the operator's application session owns the screen. |
| ⓧ | System Operator | This symbol is used with SNA protocol and indicates that the system operator (SSCP Control Program) session owns the display screen. Except for the ENTER key, the Program Attention keys are not functional when this symbol is displayed. |
| Ⓜ | Unowned | The display station is connected to the system (using SNA only), but not to the operator's application program or to the system operator (control program). The SYS REQ key is used if LOGON is required. This symbol is displayed in position 3. |
| TEST | Test | The display station is in test mode. Test mode is initiated or terminated by pressing the TEST key while holding the ALT key. TEST is displayed in positions 3 through 6. Test procedures are described in the <i>IBM 3270 Information Display System: IBM 3178 Display Station Operator Reference Guide, GA18-2128, 3276 Control Unit Display Station; Problem Determination Guide, GA18-2014, the IBM 3270 Information Display System: 3278 Display Station; Problem Determination Guide, GA27-2639, and the IBM 3270 Information Display System: Problem Determination Guide, GA33-3051.</i> |

Do Not Enter (Input Inhibited), locations 9 through 17: All these symbols contain an "X" in position 9 (do not enter), combined with other symbols in positions 11 through 17, which define why input is disabled. The keyboard does not lock mechanically, but a change in state of the keyboard clicker (on to off, or off to on) indicates that the keyboard is disabled.

The following keys are not disabled: RESET, SYS REQ, ATTN, TEST, DEV CNCL, shift keys, ALT CURSR, CURSR BLINK, and Click keys.



During buffer transfer while executing a BSC Copy command (3274 and 3276), a limited number of keystrokes will be accepted for processing, and input is not disabled. The 3276 will queue at least two keystrokes and, if the queue is not exceeded, the keystrokes will be processed when communication with the keyboard is restored. In either case, if the capacity of the queue is exceeded, all queued keystrokes will be discarded and the What symbol is displayed.

RESET will remove the input disabled condition and restore the keyboard except when the following symbols are displayed: Time, Printer Busy, Printer Very Busy, Printer Not Working, and Security Key.



For a 3278 or 3279 display without a keyboard, a selector-light-pen or MSR operation will remove the same input disabled conditions as the RESET key. A selector-light-pen or MSR operation will not cause a reset on a 3278 or 3279 display that has a keyboard attached.





The following symbols are arranged in order of probability.

| Symbol | Name | Explanation |
|---|------|---|
| X  | Time | <p>Time is required for the system to perform a function. This symbol is displayed due to:</p> <ol style="list-style-type: none"> 1. Line protocol requirements. 2. A keyboard that has been locked by the host; for example, during a host-initiated print operation. 3. Internal processing constraints of the control unit. <p>When operating with SNA protocol, the keyboard will be restored and the Time symbol is removed by a WCC which contains the keyboard restore bit set to 1.</p> <p>If a "Change Direction" was also received, the 3276 will enter send state. However, if a CD was not received, the session will remain in receive state when the WCC contains the Keyboard Restore bit set to 1.</p> <p>In this state, all keys can be used except the Program Attention and Print keys. Use of a Program Attention key will result in display of the Minus Function symbol. If a WCC which contains a Keyboard Restore bit set is not received, display of the Time symbol is determined by whether the CD has been received as follows:</p> <ol style="list-style-type: none"> 1. If CD has not been received, the session will remain in receive state and the Time symbol remains displayed with keyboard locked. 2. If CD has been received, the 3274 and 3276 will enter send state; and, if the keyboard was unlocked prior to receipt of the command, the Time symbol is removed and the keyboard is restored. Otherwise, the Time symbol is replaced by the System Lock symbol. <p>If End Bracket is received, the Time symbol is removed, the session enters contention state, and the keyboard is restored regardless of the WCC setting.</p> |

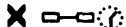
| Symbol | Name | Explanation |
|--|---------------|---|
| | | When using BSC protocol, the keyboard will be unlocked, and the Time symbol removed, if the WCC keyboard restore bit is on, or if the keyboard had been unlocked prior to receipt of the command. Otherwise, Time will be replaced by the System Lock symbol. |
| X SYSTEM | System Lock | <p>The program has disabled the keyboard following an entry. The operator may receive a message and then press RESET to restore the keyboard. In systems that use SNA protocol, the System Lock symbol appears when the application program has replied to the last message sent by the operator and is requesting the operator to send the next message. At this time, however, the host has not unlocked the keyboard. (The Keyboard Restore bit is not set in any WCC that follows the last message from the operator.)</p> <p>When the System Lock symbol appears in BSC systems, the host is notified of the last AID generated.</p> |
| X  nn | Machine Check | <p>The display station is not working properly. The symbol is accompanied by up to two digits [nn(3178, 3276, 3278, or 3279 attached to 3276)], which define the probable cause of the problem. Recovery procedures depend upon the type of error.</p> <p>Refer to Appendix C for a description of the machine-check codes. Machine check symbols are almost always reset by the operator using the RESET, SYS REQ (SNA only), or TEST keys. If the 3278 or 3279 does not have a keyboard, a selector light pen, an MSR, can be used to reset the Machine Check symbol.</p> |
| X  nn | Communication | <p>An attempt is made to cause host communication or to use the MSR, or selector light pen that causes host communication, and a communication link error was detected while the Communications Reminder is displayed. Data cannot be sent. The RESET, TEST, or SYS REQ (SNA) key should be pressed. This symbol is accompanied by up to two digits [nn (3178, 3276, 3278, or 3279 attached to 3276)], which define the probable cause of the problem. (The Communication Reminder symbol is displayed as long as the condition exists.) Refer to Appendix C for a description of the communication-check codes.</p> |
| X PROGnn | Program | <p>A programming error was detected in the data received by the control unit. RESET should be pressed and the operation should be retried. This symbol is accompanied by up to two digits [nn (3178, 3276, 3278, or 3279 attached to 3276)], which define the probable cause of the problem. Refer to Appendix C for a description of the program-check codes.</p> |
| X ?+ | What? | <p>The last input was not accepted. The What symbol appears when:</p> <ol style="list-style-type: none"> 1. Keystrokes are being queued during an unsolicited write or buffer transfer, and the capacity of the queue is exceeded. (The queue is not processed in this case.) 2. SYS REQ was pressed while inbound processing was queued for the device. |

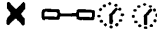
| Symbol | Name | Explanation |
|-----------|--|--|
| | | <ol style="list-style-type: none"> 3. ATTN, SYS REQ, or TEST was pressed during a Time condition which was caused by internal processing constraints of the 3276. 4. The operator continued to key while the Time, Printer Busy, or Printer Not Working symbol was displayed. 5. Two conflicting operations have been attempted "simultaneously" with one operation not serviced. (For example, CLEAR and selector light pen.) 6. A dead key operation has been aborted, and a standalone accent created at the cursor location. 7. Print ID mode has been aborted. The RESET key restores the keyboard. <p>Because of uncertainty about what was accepted, the operator should check the contents of the screen before repeating the operation. In addition:</p> <ol style="list-style-type: none"> 1. If ALT or a shift key was used, press the key again and then press RESET and retry the operation. 2. When retrying SYS REQ or ATTN, repeated use of these keys may be necessary if inbound processing [Ⓞ] is queued. |
| X - f | Minus Function | <p>A currently unavailable function was requested. RESET should be pressed to restore the keyboard. Conditions that cause a Minus Function are:</p> <ol style="list-style-type: none"> 1. Use of an ATTN, PF, or PA key while in SSCP session or in "unowned state," or prior to ACTLU. Also use of the ENTER key in the "unowned state" or prior to ACTLU. 2. Use of SYS REQ prior to receipt of ACTLU in SNA. 3. Any of the following actions in receive state with the keyboard unlocked: Print and all AID generating keys. 4. Use of ATTN while operating with remote systems that use BSC. 5. Use of SYS REQ, ATTN, and any PA or PF key that is not specified for test mode. 6. When invoking concurrent test 0, the control terminal is not the test terminal and the latter is either in session (SNA), or has the Time indicator on in systems that use BSC. 7. When using the IDENT key during a printing operation. 8. MSR in "receive state" or in "unowned state." 9. MSR in SSCP-LU session with 10-character set. <p>The security key is turned off and no operator input</p> |
| X - f * X | Minus Function Operator Unauthorized | <p>This symbol means that the display operator has tried to change the Programmed Symbols, Color, or Extended Highlighting attributes when disallowed by the host program. The keyboard is locked as a result. Pressing the Reset key restores the keyboard.</p> |

| Symbol | Name | Explanation |
|---|---------------------|--|
| | | The indicator is also displayed when a Programmed Symbols terminal storage is referenced (PS-A – PS-F attribute keys) but the storage has no symbol set currently associated with it, or the symbol set is marked not keyboard-selectable. |
|  | Security Key | <p>The security key is turned off and no operator input can be accepted. When the key is turned on; this symbol disappears, but any other pre-existing do-not-enter condition may then be displayed.</p> <p>RESET does not remove the Security Key symbol. The Shift key, ALT CURSR, CURSR BLINK, and Click key, and associated symbols, and all other noninput disabled symbols will function when the Security Key symbol is displayed. The Security Key has priority over other input disabled symbols except when machine checks prevent communication between the control unit and the terminal.</p> |
|  | Printer Not Working | <p>The printer assigned to the display station is not functioning, and no other printers in the class are available. If this symbol appears after the Print key was pressed, and if the Printer Failure symbol is not displayed, the printer assigned to the display (or the most available printer in the class) is not functional. The print request is canceled, and the DEV CNCL key should be pressed to restore the keyboard. (RESET has no effect.) Restoration of the printer will not automatically remove the Printer Not Working symbol. If the Printer Failure symbol is displayed in the printer status area, the printer stopped during the last print operation. If the print operation was initiated by the Print key, DEV CNCL should be pressed to restore the keyboard. The display terminal indicator may precede a comparable indicator on the printer by as much as 2 minutes.</p> <p>The Printer Not Working symbol may also appear for a host-initiated print operation. Operators are not instructed to use DEV CNCL, but, if used, the Printer Not Working symbol is replaced with the Time symbol, and the host must continue the operation. Subsequent receipt of outbound FM data will remove the Printer Not Working symbol.</p> |
|  | Printer Busy | <p>The printer assigned to the display station is busy. The operator may either wait for the printer to become available or press the DEV CNCL key. For print requests initiated by the Print key, DEV CNCL will cancel the request, remove the Device Busy symbol, and restore the keyboard.</p> <p>For host-initiated requests, DEV CNCL will cause Device Busy to be replaced by the Wait symbol, and a negative response will be sent to the host. If the Print key was used, it may be possible to select another printer.</p> |

| Symbol | Name | Explanation |
|---|-----------------------|---|
| X  | Printer Very Busy | <p>This symbol applies only to operator-initiated requests via the Printer key and means the same as Printer Busy except that more time than usual is anticipated before the print request is accepted. It is displayed when the requested printer is allocated to the host as follows:</p> <ol style="list-style-type: none"> 1. If 6 B is displayed, the printer is currently "in bracket" with a host PLU. 2. If 6 A is displayed, a host Write, Erase/Write, or Copy command has been addressed to the printer, and the print operation has not yet been started by the host (via a command with the Start Print bit on in the WCC). |
| X  | Operator Unauthorized | <p>This symbol means that the operator has requested a printer for which the terminal or attached device is not authorized. RESET should be pressed to restore the keyboard.</p> <p>This symbol appears when:</p> <ol style="list-style-type: none"> 1. The Print key is pressed while the Printer Assignment columns of the Operator Information Area show no printer assignment or show question marks. 2. During a print ID sequence, the operator enters a number which is in the printer authorization matrix, but is not authorized for the display. 3. During a local print operation initiated by the Print key, the "printer" assigned is really a display. This can occur if an invalid device description is loaded into the printer authorization matrix. 4. The print buffer is unable to store the contents of a display buffer (for example when the display buffer is too large) during an operator-initiated local copy operation. |
| X  | Go Elsewhere | <p>An action has been attempted which is invalid for the display screen location. RESET should be pressed and either the cursor should be moved or some other action taken.</p> <p>The Go Elsewhere symbol appears when:</p> <ol style="list-style-type: none"> 1. An attempt has been made to enter, insert, erase, or delete a character when the cursor is in a protected field or at an attribute location. 2. An attempt has been made to use the CURSR SEL key while the cursor is not in a cursor select or selector-light-pen field. |
| X  | More Than | <p>This symbol means that the operator has attempted to enter too much information into a field. RESET should be pressed to restore the keyboard, and the operation should be retried and the entry corrected.</p> |
| X  | Numeric | <p>This symbol appears when the Numeric Lock feature is installed. A non-numeric entry was made at a display screen location reserved for numeric information. RESET should be pressed to restore the keyboard, and the operation should be retried.</p> |

| Symbol | Name | Explanation |
|--|-------------------|---|
| X 1#? | What Number | The operator has entered a number which is unacceptable at the display screen location. This message appears when a selected print ID is not numeric or is not in the matrix, or an incorrect entry is made in test mode. (Refer to description of IDENT key in Chapter 3 for further information.) RESET should be pressed to restore the keyboard and to make the correct entry. |
| X 1E? | Questionable Card | The operator tried to read an inappropriate magnetic stripe card. RESET should be pressed and the correct MSR card should be used. If a keyboard is not available, repeat the operation using a valid MSR card. This symbol will also appear if the End of Inquiry (EOI) character is present on the magnetic card. Cards with EOI are applicable to the operator identification card reader for the 3275 and 3277 only. |
| X 1^+? X 1^+? X 1^+? X 1^+? X 1^+? | Accent Plus What | These messages indicate that an invalid dead key/character key combination was entered (Canadian French keyboard only). RESET should be pressed to restore the keyboard, and a valid dead key/character key combination should be entered. Valid combinations are as follows: ` a À è È ù Ù ´ é É ^ a Â ê Ê î Î ô Ô û Û ¨ e Ě ě ě ů Ů Ç Ç Ç For further information, refer to "Dead Keys, Canadian French Keyboards" in Chapter 2. |
| X -S | Minus Symbol | The symbol keyed is not available. The RESET key should be pressed to restore the keyboard. |
| X □←⊠ | Message Received | A message from the system operator (SSCP control program) was received and rejected. RESET should be pressed to restore the keyboard. This symbol appears only on displays attached to a 3276 unit that uses SNA protocol. |
| Reminders (locations 21 through 27) → z nn | Communication | The communication link connecting the control unit to the system is producing errors. Refer to Appendix C for a description of the error codes. The Communication Reminder appears when: 1. The control unit detects a permanent error condition in the connection to the host. (Attempts to retry have ceased.) In this case, the reminder symbol is sent to all terminals attached to the control unit. 2. In BSC mode, a line error is detected which results in the original contents of the screen being restored and a request for retransmission made to the host. In this case, the reminder symbol is sent only to the affected terminal. |
| □←⊠ | Reserved | This symbol (3178, 3276, 3278, or 3279 attached to a 3276 only) is reserved for future use and should be ignored if it is displayed. |

Shifts and Modes (locations 37 through 41):

Note: *Display stations that support the Extended Data Stream feature use locations 36 through 44 for Shifts and Modes and the insert-mode symbol transfers to location 52.*

| | | |
|------|---------|---|
| NUM | Numeric | The Numeric Lock feature is installed and the keyboard is in numeric shift, which allows use of the 0 through 9 keys, and the decimal sign, minus (-), and DUP keys only. |
| ⇧ | Upshift | The keyboard is in upshift. |
| ^ | Insert | The keyboard is in insert mode. A character may be inserted at the cursor location. Characters beyond the cursor position move to make room for the inserted character. |
| APL | | The keyboard is in APL mode. |
| TEXT | | The keyboard is in TEXT mode. |

Printer Status (locations 60 through 64)

| | | |
|---------------------|--------------------|---|
| □-□nn | Printer Assignment | The display station is authorized to use printer address number nn. Individual printers may be assigned address numbers 1 through 7 when attached to the 3276. |
| □-□?? | What Printer | The printer IDENT has changed. Pressing the IDENT key causes display of a new printer assignment. |
| □-□nn | Printer Printing | The printer identified by nn is printing information from the display station. |
| □-□nn | Printer Failure | The printer identified by nn has stopped while printing information from the display station. This symbol will remain on until: <ol style="list-style-type: none">1. The condition is cleared following operator intervention.2. The operator uses DEV CNCL following a printer-not-functional condition.3. Receipt of outbound FM data.4. Printer assignment is changed because power is applied to another printer (3276 default printer authorization matrix). |
| □-□_ _ | Assign Printer | When the operator changes the assigned printer using the IDENT key, the two numbers appear in the assignment columns, replacing the underlines. |
| (nothing displayed) | | If the display is attached to a 3276 (6 displayed in location 1), there is no automatic printer authorization. The operator may be able to assign a printer using the IDENT key. |

Appendix B. Buffer Address I/O Interface Codes

| 40 Col | | 80 Col | | Position | | Buffer Address (Hex) | | | |
|--------|----|--------|----|----------|-----|----------------------|----|-------|----|
| R | C | R | C | Dec | Hex | EBCDIC | | ASCII | |
| 01 | 01 | 01 | 01 | 0000 | 000 | 40 | 40 | 20 | 20 |
| 01 | 02 | 01 | 02 | 0001 | 001 | 40 | C1 | 20 | 41 |
| 01 | 03 | 01 | 03 | 0002 | 002 | 40 | C2 | 20 | 42 |
| 01 | 04 | 01 | 04 | 0003 | 003 | 40 | C3 | 20 | 43 |
| 01 | 05 | 01 | 05 | 0004 | 004 | 40 | C4 | 20 | 44 |
| 01 | 06 | 01 | 06 | 0005 | 005 | 40 | C5 | 20 | 45 |
| 01 | 07 | 01 | 07 | 0006 | 006 | 40 | C6 | 20 | 46 |
| 01 | 08 | 01 | 08 | 0007 | 007 | 40 | C7 | 20 | 47 |
| 01 | 09 | 01 | 09 | 0008 | 008 | 40 | C8 | 20 | 48 |
| 01 | 10 | 01 | 10 | 0009 | 009 | 40 | C9 | 20 | 49 |
| 01 | 11 | 01 | 11 | 0010 | 00A | 40 | 4A | 20 | 5B |
| 01 | 12 | 01 | 12 | 0011 | 00B | 40 | 4B | 20 | 2E |
| 01 | 13 | 01 | 13 | 0012 | 00C | 40 | 4C | 20 | 3C |
| 01 | 14 | 01 | 14 | 0013 | 00D | 40 | 4D | 20 | 28 |
| 01 | 15 | 01 | 15 | 0014 | 00E | 40 | 4E | 20 | 2B |
| 01 | 16 | 01 | 16 | 0015 | 00F | 40 | 4F | 20 | 21 |
| 01 | 17 | 01 | 17 | 0016 | 010 | 40 | 50 | 20 | 26 |
| 01 | 18 | 01 | 18 | 0017 | 011 | 40 | D1 | 20 | 4A |
| 01 | 19 | 01 | 19 | 0018 | 012 | 40 | D2 | 20 | 4B |
| 01 | 20 | 01 | 20 | 0019 | 013 | 40 | D3 | 20 | 4C |
| 01 | 21 | 01 | 21 | 0020 | 014 | 40 | D4 | 20 | 4D |
| 01 | 22 | 01 | 22 | 0021 | 015 | 40 | D5 | 20 | 4E |
| 01 | 23 | 01 | 23 | 0022 | 016 | 40 | D6 | 20 | 4F |
| 01 | 24 | 01 | 24 | 0023 | 017 | 40 | D7 | 20 | 50 |
| 01 | 25 | 01 | 25 | 0024 | 018 | 40 | D8 | 20 | 51 |
| 01 | 26 | 01 | 26 | 0025 | 019 | 40 | D9 | 20 | 52 |
| 01 | 27 | 01 | 27 | 0026 | 01A | 40 | 5A | 20 | 5D |
| 01 | 28 | 01 | 28 | 0027 | 01B | 40 | 5B | 20 | 24 |
| 01 | 29 | 01 | 29 | 0028 | 01C | 40 | 5C | 20 | 2A |
| 01 | 30 | 01 | 30 | 0029 | 01D | 40 | 5D | 20 | 29 |
| 01 | 31 | 01 | 31 | 0030 | 01E | 40 | 5E | 20 | 3B |
| 01 | 32 | 01 | 32 | 0031 | 01F | 40 | 5F | 20 | 5E |
| 01 | 33 | 01 | 33 | 0032 | 020 | 40 | 60 | 20 | 2D |
| 01 | 34 | 01 | 34 | 0033 | 021 | 40 | 61 | 20 | 2F |
| 01 | 35 | 01 | 35 | 0034 | 022 | 40 | E2 | 20 | 53 |
| 01 | 36 | 01 | 36 | 0035 | 023 | 40 | E3 | 20 | 54 |
| 01 | 37 | 01 | 37 | 0036 | 024 | 40 | E4 | 20 | 55 |
| 01 | 38 | 01 | 38 | 0037 | 025 | 40 | E5 | 20 | 56 |
| 01 | 39 | 01 | 39 | 0038 | 026 | 40 | E6 | 20 | 57 |
| 01 | 40 | 01 | 40 | 0039 | 027 | 40 | E7 | 20 | 58 |
| 02 | 01 | 01 | 41 | 0040 | 028 | 40 | E8 | 20 | 59 |
| 02 | 02 | 01 | 42 | 0041 | 029 | 40 | E9 | 20 | 5A |
| 02 | 03 | 01 | 43 | 0042 | 02A | 40 | 6A | 20 | 7C |
| 02 | 04 | 01 | 44 | 0043 | 02B | 40 | 6B | 20 | 2C |
| 02 | 05 | 01 | 45 | 0044 | 02C | 40 | 6C | 20 | 25 |
| 02 | 06 | 01 | 46 | 0045 | 02D | 40 | 6D | 20 | 5F |
| 02 | 07 | 01 | 47 | 0046 | 02E | 40 | 6E | 20 | 3E |
| 02 | 08 | 01 | 48 | 0047 | 02F | 40 | 6F | 20 | 3F |
| 02 | 09 | 01 | 49 | 0048 | 030 | 40 | F0 | 20 | 30 |
| 02 | 10 | 01 | 50 | 0049 | 031 | 40 | F1 | 20 | 31 |
| 02 | 11 | 01 | 51 | 0050 | 032 | 40 | F2 | 20 | 32 |
| 02 | 12 | 01 | 52 | 0051 | 033 | 40 | F3 | 20 | 33 |
| 02 | 13 | 01 | 53 | 0052 | 034 | 40 | F4 | 20 | 34 |
| 02 | 14 | 01 | 54 | 0053 | 035 | 40 | F5 | 20 | 35 |
| 02 | 15 | 01 | 55 | 0054 | 036 | 40 | F6 | 20 | 36 |
| 02 | 16 | 01 | 56 | 0055 | 037 | 40 | F7 | 20 | 37 |
| 02 | 17 | 01 | 57 | 0056 | 038 | 40 | F8 | 20 | 38 |
| 02 | 18 | 01 | 58 | 0057 | 039 | 40 | F9 | 20 | 39 |
| 02 | 19 | 01 | 59 | 0058 | 03A | 40 | 7A | 20 | 3A |

| 40 Col | | 80 Col | | Position | | Buffer Address (Hex) | | | |
|----------|----------|----------|----------|------------|------------|----------------------|----|--------------|----|
| <u>R</u> | <u>C</u> | <u>R</u> | <u>C</u> | <u>Dec</u> | <u>Hex</u> | <u>EBCDIC</u> | | <u>ASCII</u> | |
| 02 | 20 | 01 | 60 | 0059 | 03B | 40 | 7B | 20 | 23 |
| 02 | 21 | 01 | 61 | 0060 | 03C | 40 | 7C | 20 | 40 |
| 02 | 22 | 01 | 62 | 0061 | 03D | 40 | 7D | 20 | 27 |
| 02 | 23 | 01 | 63 | 0062 | 03E | 40 | 7E | 20 | 3D |
| 02 | 24 | 01 | 64 | 0063 | 03F | 40 | 7F | 20 | 22 |
| 02 | 25 | 01 | 65 | 0064 | 040 | C1 | 40 | 41 | 20 |
| 02 | 26 | 01 | 66 | 0065 | 041 | C1 | C1 | 41 | 41 |
| 02 | 27 | 01 | 67 | 0066 | 042 | C1 | C2 | 41 | 42 |
| 02 | 28 | 01 | 68 | 0067 | 043 | C1 | C3 | 41 | 43 |
| 02 | 29 | 01 | 69 | 0068 | 044 | C1 | C4 | 41 | 44 |
| 02 | 30 | 01 | 70 | 0069 | 045 | C1 | C5 | 41 | 45 |
| 02 | 31 | 01 | 71 | 0070 | 046 | C1 | C6 | 41 | 46 |
| 02 | 32 | 01 | 72 | 0071 | 047 | C1 | C7 | 41 | 47 |
| 02 | 33 | 01 | 73 | 0072 | 048 | C1 | C8 | 41 | 48 |
| 02 | 34 | 01 | 74 | 0073 | 049 | C1 | C9 | 41 | 49 |
| 02 | 35 | 01 | 75 | 0074 | 04A | C1 | 4A | 41 | 5B |
| 02 | 36 | 01 | 76 | 0075 | 04B | C1 | 4B | 41 | 2E |
| 02 | 37 | 01 | 77 | 0076 | 04C | C1 | 4C | 41 | 3C |
| 02 | 38 | 01 | 78 | 0077 | 04D | C1 | 4D | 41 | 28 |
| 02 | 39 | 01 | 79 | 0078 | 04E | C1 | 4E | 41 | 2B |
| 02 | 40 | 01 | 80 | 0079 | 04F | C1 | 4F | 41 | 21 |
| 03 | 01 | 02 | 01 | 0080 | 050 | C1 | 50 | 41 | 26 |
| 03 | 02 | 02 | 02 | 0081 | 051 | C1 | D1 | 41 | 4A |
| 03 | 03 | 02 | 03 | 0082 | 052 | C1 | D2 | 41 | 4B |
| 03 | 04 | 02 | 04 | 0083 | 053 | C1 | D3 | 41 | 4C |
| 03 | 05 | 02 | 05 | 0084 | 054 | C1 | D4 | 41 | 4D |
| 03 | 06 | 02 | 06 | 0085 | 055 | C1 | D5 | 41 | 4E |
| 03 | 07 | 02 | 07 | 0086 | 056 | C1 | D6 | 41 | 4F |
| 03 | 08 | 02 | 08 | 0087 | 057 | C1 | D7 | 41 | 50 |
| 03 | 09 | 02 | 09 | 0088 | 058 | C1 | D8 | 41 | 51 |
| 03 | 10 | 02 | 10 | 0089 | 059 | C1 | D9 | 41 | 52 |
| 03 | 11 | 02 | 11 | 0090 | 05A | C1 | 5A | 41 | 5D |
| 03 | 12 | 02 | 12 | 0091 | 05B | C1 | 5B | 41 | 24 |
| 03 | 13 | 02 | 13 | 0092 | 05C | C1 | 5C | 41 | 2A |
| 03 | 14 | 02 | 14 | 0093 | 05D | C1 | 5D | 41 | 29 |
| 03 | 15 | 02 | 15 | 0094 | 05E | C1 | 5E | 41 | 3B |
| 03 | 16 | 02 | 16 | 0095 | 05F | C1 | 5F | 41 | 5E |
| 03 | 17 | 02 | 17 | 0096 | 060 | C1 | 60 | 41 | 2D |
| 03 | 18 | 02 | 18 | 0097 | 061 | C1 | 61 | 41 | 2F |
| 03 | 19 | 02 | 19 | 0098 | 062 | C1 | E2 | 41 | 53 |
| 03 | 20 | 02 | 20 | 0099 | 063 | C1 | E3 | 41 | 54 |
| 03 | 21 | 02 | 21 | 0100 | 064 | C1 | E4 | 41 | 55 |
| 03 | 22 | 02 | 22 | 0101 | 065 | C1 | E5 | 41 | 56 |
| 03 | 23 | 02 | 23 | 0102 | 066 | C1 | E6 | 41 | 57 |
| 03 | 24 | 02 | 24 | 0103 | 067 | C1 | E7 | 41 | 58 |
| 03 | 25 | 02 | 25 | 0104 | 068 | C1 | E8 | 41 | 59 |
| 03 | 26 | 02 | 26 | 0105 | 069 | C1 | E9 | 41 | 5A |
| 03 | 27 | 02 | 27 | 0106 | 06A | C1 | 6A | 41 | 7C |
| 03 | 28 | 02 | 28 | 0107 | 06B | C1 | 6B | 41 | 2C |
| 03 | 29 | 02 | 29 | 0108 | 06C | C1 | 6C | 41 | 25 |
| 03 | 30 | 02 | 30 | 0109 | 06D | C1 | 6D | 41 | 5F |
| 03 | 31 | 02 | 31 | 0110 | 06E | C1 | 6E | 41 | 3E |
| 03 | 32 | 02 | 32 | 0111 | 06F | C1 | 6F | 41 | 3F |
| 03 | 33 | 02 | 33 | 0112 | 070 | C1 | F0 | 41 | 30 |
| 03 | 34 | 02 | 34 | 0113 | 071 | C1 | F1 | 41 | 31 |
| 03 | 35 | 02 | 35 | 0114 | 072 | C1 | F2 | 41 | 32 |
| 03 | 36 | 02 | 36 | 0115 | 073 | C1 | F3 | 41 | 33 |
| 03 | 37 | 02 | 37 | 0116 | 074 | C1 | F4 | 41 | 34 |
| 03 | 38 | 02 | 38 | 0117 | 075 | C1 | F5 | 41 | 35 |
| 03 | 39 | 02 | 39 | 0118 | 076 | C1 | F6 | 41 | 36 |
| 03 | 40 | 02 | 40 | 0119 | 077 | C1 | F7 | 41 | 37 |
| 04 | 01 | 02 | 41 | 0120 | 078 | C1 | F8 | 41 | 38 |
| 04 | 02 | 02 | 42 | 0121 | 079 | C1 | F9 | 41 | 39 |

| 40 Col | | 80 Col | | Position | | Buffer Address (Hex) | | | |
|----------|----------|----------|----------|------------|------------|----------------------|----|--------------|----|
| <u>R</u> | <u>C</u> | <u>R</u> | <u>C</u> | <u>Dec</u> | <u>Hex</u> | <u>EBCDIC</u> | | <u>ASCII</u> | |
| 04 | 03 | 02 | 43 | 0122 | 07A | C1 | 7A | 41 | 3A |
| 04 | 04 | 02 | 44 | 0123 | 07B | C1 | 7B | 41 | 23 |
| 04 | 05 | 02 | 45 | 0124 | 07C | C1 | 7C | 41 | 40 |
| 04 | 06 | 02 | 46 | 0125 | 07D | C1 | 7D | 41 | 27 |
| 04 | 07 | 02 | 47 | 0126 | 07E | C1 | 7E | 41 | 3D |
| 04 | 08 | 02 | 48 | 0127 | 07F | C1 | 7F | 41 | 22 |
| 04 | 09 | 02 | 49 | 0128 | 080 | C2 | 40 | 42 | 20 |
| 04 | 10 | 02 | 50 | 0129 | 081 | C2 | C1 | 42 | 41 |
| 04 | 11 | 02 | 51 | 0130 | 082 | C2 | C2 | 42 | 42 |
| 04 | 12 | 02 | 52 | 0131 | 083 | C2 | C3 | 42 | 43 |
| 04 | 13 | 02 | 53 | 0132 | 084 | C2 | C4 | 42 | 44 |
| 04 | 14 | 02 | 54 | 0133 | 085 | C2 | C5 | 42 | 45 |
| 04 | 15 | 02 | 55 | 0134 | 086 | C2 | C6 | 42 | 46 |
| 04 | 16 | 02 | 56 | 0135 | 087 | C2 | C7 | 42 | 47 |
| 04 | 17 | 02 | 57 | 0136 | 088 | C2 | C8 | 42 | 48 |
| 04 | 18 | 02 | 58 | 0137 | 089 | C2 | C9 | 42 | 49 |
| 04 | 19 | 02 | 59 | 0138 | 08A | C2 | 4A | 42 | 5B |
| 04 | 20 | 02 | 60 | 0139 | 08B | C2 | 4B | 42 | 2E |
| 04 | 21 | 02 | 61 | 0140 | 08C | C2 | 4C | 42 | 3C |
| 04 | 22 | 02 | 62 | 0141 | 08D | C2 | 4D | 42 | 28 |
| 04 | 23 | 02 | 63 | 0142 | 08E | C2 | 4E | 42 | 2B |
| 04 | 24 | 02 | 64 | 0143 | 08F | C2 | 4F | 42 | 21 |
| 04 | 25 | 02 | 65 | 0144 | 090 | C2 | 50 | 42 | 26 |
| 04 | 26 | 02 | 66 | 0145 | 091 | C2 | D1 | 42 | 4A |
| 04 | 27 | 02 | 67 | 0146 | 092 | C2 | D2 | 42 | 4B |
| 04 | 28 | 02 | 68 | 0147 | 093 | C2 | D3 | 42 | 4C |
| 04 | 29 | 02 | 69 | 0148 | 094 | C2 | D4 | 42 | 4D |
| 04 | 30 | 02 | 70 | 0149 | 095 | C2 | D5 | 42 | 4E |
| 04 | 31 | 02 | 71 | 0150 | 096 | C2 | D6 | 42 | 4F |
| 04 | 32 | 02 | 72 | 0151 | 097 | C2 | D7 | 42 | 50 |
| 04 | 33 | 02 | 73 | 0152 | 098 | C2 | D8 | 42 | 51 |
| 04 | 34 | 02 | 74 | 0153 | 099 | C2 | D9 | 42 | 52 |
| 04 | 35 | 02 | 75 | 0154 | 09A | C2 | 5A | 42 | 5D |
| 04 | 36 | 02 | 76 | 0155 | 09B | C2 | 5B | 42 | 24 |
| 04 | 37 | 02 | 77 | 0156 | 09C | C2 | 5C | 42 | 2A |
| 04 | 38 | 02 | 78 | 0157 | 09D | C2 | 5D | 42 | 29 |
| 04 | 39 | 02 | 79 | 0158 | 09E | C2 | 5E | 42 | 3B |
| 04 | 40 | 02 | 80 | 0159 | 09F | C2 | 5F | 42 | 5E |
| 05 | 01 | 03 | 01 | 0160 | 0A0 | C2 | 60 | 42 | 2D |
| 05 | 02 | 03 | 02 | 0161 | 0A1 | C2 | 61 | 42 | 2F |
| 05 | 03 | 03 | 03 | 0162 | 0A2 | C2 | E2 | 42 | 53 |
| 05 | 04 | 03 | 04 | 0163 | 0A3 | C2 | E3 | 42 | 54 |
| 05 | 05 | 03 | 05 | 0164 | 0A4 | C2 | E4 | 42 | 55 |
| 05 | 06 | 03 | 06 | 0165 | 0A5 | C2 | E5 | 42 | 56 |
| 05 | 07 | 03 | 07 | 0166 | 0A6 | C2 | E6 | 42 | 57 |
| 05 | 08 | 03 | 08 | 0167 | 0A7 | C2 | E7 | 42 | 58 |
| 05 | 09 | 03 | 09 | 0168 | 0A8 | C2 | E8 | 42 | 59 |
| 05 | 10 | 03 | 10 | 0169 | 0A9 | C2 | E9 | 42 | 5A |
| 05 | 11 | 03 | 11 | 0170 | 0AA | C2 | 6A | 42 | 7C |
| 05 | 12 | 03 | 12 | 0171 | 0AB | C2 | 6B | 42 | 2C |
| 05 | 13 | 03 | 13 | 0172 | 0AC | C2 | 6C | 42 | 25 |
| 05 | 14 | 03 | 14 | 0173 | 0AD | C2 | 6D | 42 | 5F |
| 05 | 15 | 03 | 15 | 0174 | 0AE | C2 | 6E | 42 | 3E |
| 05 | 16 | 03 | 16 | 0175 | 0AF | C2 | 6F | 42 | 3F |
| 05 | 17 | 03 | 17 | 0176 | 0B0 | C2 | F0 | 42 | 30 |
| 05 | 18 | 03 | 18 | 0177 | 0B1 | C2 | F1 | 42 | 31 |
| 05 | 19 | 03 | 19 | 0178 | 0B2 | C2 | F2 | 42 | 32 |
| 05 | 20 | 03 | 20 | 0179 | 0B3 | C2 | F3 | 42 | 33 |
| 05 | 21 | 03 | 21 | 0180 | 0B4 | C2 | F4 | 42 | 34 |
| 05 | 22 | 03 | 22 | 0181 | 0B5 | C2 | F5 | 42 | 35 |
| 05 | 23 | 03 | 23 | 0182 | 0B6 | C2 | F6 | 42 | 36 |
| 05 | 24 | 03 | 24 | 0183 | 0B7 | C2 | F7 | 42 | 37 |

| 40 Col | | 80 Col | | Position | | Buffer Address (Hex) | | | |
|--------|----|--------|----|----------|-----|----------------------|----|-------|----|
| R | C | R | C | Dec | Hex | EBCDIC | | ASCII | |
| 05 | 25 | 03 | 25 | 0184 | 0B8 | C2 | F8 | 42 | 38 |
| 05 | 26 | 03 | 26 | 0185 | 0B9 | C2 | F9 | 42 | 39 |
| 05 | 27 | 03 | 27 | 0186 | 0BA | C2 | 7A | 42 | 3A |
| 05 | 28 | 03 | 28 | 0187 | 0BB | C2 | 7B | 42 | 23 |
| 05 | 29 | 03 | 29 | 0188 | 0BC | C2 | 7C | 42 | 40 |
| 05 | 30 | 03 | 30 | 0189 | 0BD | C2 | 7D | 42 | 27 |
| 05 | 31 | 03 | 31 | 0190 | 0BE | C2 | 7E | 42 | 3D |
| 05 | 32 | 03 | 32 | 0191 | 0BF | C2 | 7F | 42 | 22 |
| 05 | 33 | 03 | 33 | 0192 | 0C0 | C3 | 40 | 43 | 20 |
| 05 | 34 | 03 | 34 | 0193 | 0C1 | C3 | C1 | 43 | 41 |
| 05 | 35 | 03 | 35 | 0194 | 0C2 | C3 | C2 | 43 | 42 |
| 05 | 36 | 03 | 36 | 0195 | 0C3 | C3 | C3 | 43 | 43 |
| 05 | 37 | 03 | 37 | 0196 | 0C4 | C3 | C4 | 43 | 44 |
| 05 | 38 | 03 | 38 | 0197 | 0C5 | C3 | C5 | 43 | 45 |
| 05 | 39 | 03 | 39 | 0198 | 0C6 | C3 | C6 | 43 | 46 |
| 05 | 40 | 03 | 40 | 0199 | 0C7 | C3 | C7 | 43 | 47 |
| 06 | 01 | 03 | 41 | 0200 | 0C8 | C3 | C8 | 43 | 48 |
| 06 | 02 | 03 | 42 | 0201 | 0C9 | C3 | C9 | 43 | 49 |
| 06 | 03 | 03 | 43 | 0202 | 0CA | C3 | 4A | 43 | 5B |
| 06 | 04 | 03 | 44 | 0203 | 0CB | C3 | 4B | 43 | 2E |
| 06 | 05 | 03 | 45 | 0204 | 0CC | C3 | 4C | 43 | 3C |
| 06 | 06 | 03 | 46 | 0205 | 0CD | C3 | 4D | 43 | 28 |
| 06 | 07 | 03 | 47 | 0206 | 0CE | C3 | 4E | 43 | 2B |
| 06 | 08 | 03 | 48 | 0207 | 0CF | C3 | 4F | 43 | 21 |
| 06 | 09 | 03 | 49 | 0208 | 0D0 | C3 | 50 | 43 | 26 |
| 06 | 10 | 03 | 50 | 0209 | 0D1 | C3 | D1 | 43 | 4A |
| 06 | 11 | 03 | 51 | 0210 | 0D2 | C3 | D2 | 43 | 4B |
| 06 | 12 | 03 | 52 | 0211 | 0D3 | C3 | D3 | 43 | 4C |
| 06 | 13 | 03 | 53 | 0212 | 0D4 | C3 | D4 | 43 | 4D |
| 06 | 14 | 03 | 54 | 0213 | 0D5 | C3 | D5 | 43 | 4E |
| 06 | 15 | 03 | 55 | 0214 | 0D6 | C3 | D6 | 43 | 4F |
| 06 | 16 | 03 | 56 | 0215 | 0D7 | C3 | D7 | 43 | 50 |
| 06 | 17 | 03 | 57 | 0216 | 0D8 | C3 | D8 | 43 | 51 |
| 06 | 18 | 03 | 58 | 0217 | 0D9 | C3 | D9 | 32 | 52 |
| 06 | 19 | 03 | 59 | 0218 | 0DA | C3 | 5A | 43 | 5D |
| 06 | 20 | 03 | 60 | 0219 | 0DB | C3 | 5B | 43 | 24 |
| 06 | 21 | 03 | 61 | 0220 | 0DC | C3 | 5C | 43 | 2A |
| 06 | 22 | 03 | 62 | 0221 | 0DD | C3 | 5D | 43 | 29 |
| 06 | 23 | 03 | 63 | 0222 | 0DE | C3 | 5E | 43 | 3B |
| 06 | 24 | 03 | 64 | 0223 | 0DF | C3 | 5F | 43 | 5E |
| 06 | 25 | 03 | 65 | 0224 | 0E0 | C3 | 60 | 43 | 2D |
| 06 | 26 | 03 | 66 | 0225 | 0E1 | C3 | 61 | 43 | 2F |
| 06 | 27 | 03 | 67 | 0226 | 0E2 | C3 | E2 | 43 | 53 |
| 06 | 28 | 03 | 68 | 0227 | 0E3 | C3 | E3 | 43 | 54 |
| 06 | 29 | 03 | 69 | 0228 | 0E4 | C3 | E4 | 43 | 55 |
| 06 | 30 | 03 | 70 | 0229 | 0E5 | C3 | E5 | 43 | 56 |
| 06 | 31 | 03 | 71 | 0230 | 0E6 | C3 | E6 | 43 | 57 |
| 06 | 32 | 03 | 72 | 0231 | 0E7 | C3 | E7 | 43 | 58 |
| 06 | 33 | 03 | 73 | 0232 | 0E8 | C3 | E8 | 43 | 59 |
| 06 | 34 | 03 | 74 | 0233 | 0E9 | C3 | E9 | 43 | 5A |
| 06 | 35 | 03 | 75 | 0234 | 0EA | C3 | 6A | 43 | 7C |
| 06 | 36 | 03 | 76 | 0235 | 0EB | C3 | 6B | 43 | 2C |
| 06 | 37 | 03 | 77 | 0236 | 0EC | C3 | 6C | 43 | 25 |
| 06 | 38 | 03 | 78 | 0237 | 0ED | C3 | 6D | 43 | 5F |
| 06 | 39 | 03 | 79 | 0238 | 0EE | C3 | 6E | 43 | 3E |
| 06 | 40 | 03 | 80 | 0239 | 0EF | C3 | 6F | 43 | 3F |
| 07 | 01 | 04 | 01 | 0240 | 0F0 | C3 | F0 | 43 | 30 |
| 07 | 02 | 04 | 02 | 0241 | 0F1 | C3 | F1 | 43 | 31 |
| 07 | 03 | 04 | 03 | 0242 | 0F2 | C3 | F2 | 43 | 32 |
| 07 | 04 | 04 | 04 | 0243 | 0F3 | C3 | F3 | 32 | 33 |
| 07 | 05 | 04 | 05 | 0244 | 0F4 | C3 | F4 | 43 | 34 |
| 07 | 06 | 04 | 06 | 0245 | 0F5 | C3 | F5 | 43 | 35 |

| 40 Col | | 80 Col | | Position | | Buffer Address (Hex) | | | |
|----------|----------|----------|----------|------------|------------|----------------------|----|--------------|----|
| <u>R</u> | <u>C</u> | <u>R</u> | <u>C</u> | <u>Dec</u> | <u>Hex</u> | <u>EBCDIC</u> | | <u>ASCII</u> | |
| 07 | 07 | 04 | 07 | 0246 | 0F6 | C3 | F6 | 43 | 36 |
| 07 | 08 | 04 | 08 | 0247 | 0F7 | C3 | F7 | 43 | 37 |
| 07 | 09 | 04 | 09 | 0248 | 0F8 | C3 | F8 | 43 | 38 |
| 07 | 10 | 04 | 10 | 0249 | 0F9 | C3 | F9 | 43 | 39 |
| 07 | 11 | 04 | 11 | 0250 | 0FA | C3 | 7A | 43 | 3A |
| 07 | 12 | 04 | 12 | 0251 | 0FB | C3 | 7B | 43 | 23 |
| 07 | 13 | 04 | 13 | 0252 | 0FC | C3 | 7C | 43 | 40 |
| 07 | 14 | 04 | 14 | 0253 | 0FD | C3 | 7D | 43 | 27 |
| 07 | 15 | 04 | 15 | 0254 | 0FE | C3 | 7E | 43 | 3D |
| 07 | 16 | 04 | 16 | 0255 | 0FF | C3 | 7F | 43 | 22 |
| 07 | 17 | 04 | 17 | 0256 | 100 | C4 | 40 | 44 | 20 |
| 07 | 18 | 04 | 18 | 0257 | 101 | C4 | C1 | 44 | 41 |
| 07 | 19 | 04 | 19 | 0258 | 102 | C4 | C2 | 44 | 42 |
| 07 | 20 | 04 | 20 | 0259 | 103 | C4 | C3 | 44 | 43 |
| 07 | 21 | 04 | 21 | 0260 | 104 | C4 | C4 | 44 | 44 |
| 07 | 22 | 04 | 22 | 0261 | 105 | C4 | C5 | 44 | 45 |
| 07 | 23 | 04 | 23 | 0262 | 106 | C4 | C6 | 44 | 46 |
| 07 | 24 | 04 | 24 | 0263 | 107 | C4 | C7 | 44 | 47 |
| 07 | 25 | 04 | 25 | 0264 | 108 | C4 | C8 | 44 | 48 |
| 07 | 26 | 04 | 26 | 0265 | 109 | C4 | C9 | 44 | 49 |
| 07 | 27 | 04 | 27 | 0266 | 10A | C4 | 4A | 44 | 5B |
| 07 | 28 | 04 | 28 | 0267 | 10B | C4 | 4B | 44 | 2E |
| 07 | 29 | 04 | 29 | 0268 | 10C | C4 | 4C | 44 | 3C |
| 07 | 30 | 04 | 30 | 0269 | 10D | C4 | 4D | 44 | 28 |
| 07 | 31 | 04 | 31 | 0270 | 10E | C4 | 4E | 44 | 2B |
| 07 | 32 | 04 | 32 | 0271 | 10F | C4 | 4F | 44 | 21 |
| 07 | 33 | 04 | 33 | 0272 | 110 | C4 | 50 | 44 | 26 |
| 07 | 34 | 04 | 34 | 0273 | 111 | C4 | D1 | 44 | 4A |
| 07 | 35 | 04 | 35 | 0274 | 112 | C4 | D2 | 44 | 4B |
| 07 | 36 | 04 | 36 | 0275 | 113 | C4 | D3 | 44 | 4C |
| 07 | 37 | 04 | 37 | 0276 | 114 | C4 | D4 | 44 | 4D |
| 07 | 38 | 04 | 38 | 0277 | 115 | C4 | D5 | 44 | 4E |
| 07 | 39 | 04 | 39 | 0278 | 116 | C4 | D6 | 44 | 4F |
| 07 | 40 | 04 | 40 | 0279 | 117 | C4 | D7 | 44 | 50 |
| 08 | 01 | 04 | 41 | 0280 | 118 | C4 | D8 | 44 | 51 |
| 08 | 02 | 04 | 42 | 0281 | 119 | C4 | D9 | 44 | 52 |
| 08 | 03 | 04 | 43 | 0282 | 11A | C4 | 5A | 44 | 5D |
| 08 | 04 | 04 | 44 | 0283 | 11B | C4 | 5B | 44 | 24 |
| 08 | 05 | 04 | 45 | 0284 | 11C | C4 | 5C | 44 | 2A |
| 08 | 06 | 04 | 46 | 0285 | 11D | C4 | 5D | 44 | 29 |
| 08 | 07 | 04 | 47 | 0286 | 11E | C4 | 5E | 44 | 3B |
| 08 | 08 | 04 | 48 | 0287 | 11F | C4 | 5F | 44 | 5E |
| 08 | 09 | 04 | 49 | 0288 | 120 | C4 | 60 | 44 | 2D |
| 08 | 10 | 04 | 50 | 0289 | 121 | C4 | 61 | 44 | 2F |
| 08 | 11 | 04 | 51 | 0290 | 122 | C4 | E2 | 44 | 53 |
| 08 | 12 | 04 | 52 | 0291 | 123 | C4 | E3 | 44 | 54 |
| 08 | 13 | 04 | 53 | 0292 | 124 | C4 | E4 | 44 | 55 |
| 08 | 14 | 04 | 54 | 0293 | 125 | C4 | E5 | 44 | 56 |
| 08 | 15 | 04 | 55 | 0294 | 126 | C4 | E6 | 44 | 57 |
| 08 | 16 | 04 | 56 | 0295 | 127 | C4 | E7 | 44 | 58 |
| 08 | 17 | 04 | 57 | 0296 | 128 | C4 | E8 | 44 | 59 |
| 08 | 18 | 04 | 58 | 0297 | 129 | C4 | E9 | 44 | 5A |
| 08 | 19 | 04 | 59 | 0298 | 12A | C4 | 6A | 44 | 7C |
| 08 | 20 | 04 | 60 | 0299 | 12B | C4 | 6B | 44 | 2C |
| 08 | 21 | 04 | 61 | 0300 | 12C | C4 | 6C | 44 | 25 |
| 08 | 22 | 04 | 62 | 0301 | 12D | C4 | 6D | 44 | 5F |
| 08 | 23 | 04 | 63 | 0302 | 12E | C4 | 6E | 44 | 3E |
| 08 | 24 | 04 | 64 | 0303 | 12F | C4 | 6F | 44 | 3F |
| 08 | 25 | 04 | 65 | 0304 | 130 | C4 | F0 | 44 | 30 |
| 08 | 26 | 04 | 66 | 0305 | 131 | C4 | F1 | 44 | 31 |
| 08 | 27 | 04 | 67 | 0306 | 132 | C4 | F2 | 44 | 32 |
| 08 | 28 | 04 | 68 | 0307 | 133 | C4 | F3 | 44 | 33 |

| 40 Col | | 80 Col | | Position | | Buffer Address (Hex) | | | |
|----------|----------|----------|----------|------------|------------|----------------------|----|--------------|----|
| <u>R</u> | <u>C</u> | <u>R</u> | <u>C</u> | <u>Dec</u> | <u>Hex</u> | <u>EBCDIC</u> | | <u>ASCII</u> | |
| 08 | 29 | 04 | 69 | 0308 | 134 | C4 | F4 | 44 | 34 |
| 08 | 30 | 04 | 70 | 0309 | 135 | C4 | F5 | 44 | 35 |
| 08 | 31 | 04 | 71 | 0310 | 136 | C4 | F6 | 44 | 36 |
| 08 | 32 | 04 | 72 | 0311 | 137 | C4 | F7 | 44 | 37 |
| 08 | 33 | 04 | 73 | 0312 | 138 | C4 | F8 | 44 | 38 |
| 08 | 34 | 04 | 74 | 0313 | 139 | C4 | F9 | 44 | 39 |
| 08 | 35 | 04 | 75 | 0314 | 13A | C4 | 7A | 44 | 3A |
| 08 | 36 | 04 | 76 | 0315 | 13B | C4 | 7B | 44 | 23 |
| 08 | 37 | 04 | 77 | 0316 | 13C | C4 | 7C | 44 | 40 |
| 08 | 38 | 04 | 78 | 0317 | 13D | C4 | 7D | 44 | 27 |
| 08 | 39 | 04 | 79 | 0318 | 13E | C4 | 7E | 44 | 3D |
| 08 | 40 | 04 | 80 | 0319 | 13F | C4 | 7F | 44 | 22 |
| 09 | 01 | 05 | 01 | 0320 | 140 | C5 | 40 | 45 | 20 |
| 09 | 02 | 05 | 02 | 0321 | 141 | C5 | C1 | 45 | 41 |
| 09 | 03 | 05 | 03 | 0322 | 142 | C5 | C2 | 45 | 42 |
| 09 | 04 | 05 | 04 | 0323 | 143 | C5 | C3 | 45 | 43 |
| 09 | 05 | 05 | 05 | 0324 | 144 | C5 | C4 | 45 | 44 |
| 09 | 06 | 05 | 06 | 0325 | 145 | C5 | C5 | 45 | 45 |
| 09 | 07 | 05 | 07 | 0326 | 146 | C5 | C6 | 45 | 46 |
| 09 | 08 | 05 | 08 | 0327 | 147 | C5 | C7 | 45 | 47 |
| 09 | 09 | 05 | 09 | 0328 | 148 | C5 | C8 | 45 | 48 |
| 09 | 10 | 05 | 10 | 0329 | 149 | C5 | C9 | 45 | 49 |
| 09 | 11 | 05 | 11 | 0330 | 14A | C5 | 4A | 45 | 5B |
| 09 | 12 | 05 | 12 | 0331 | 14B | C5 | 4B | 45 | 2E |
| 09 | 13 | 05 | 13 | 0332 | 14C | C5 | 4C | 45 | 3C |
| 09 | 14 | 05 | 14 | 0333 | 14D | C5 | 4D | 45 | 28 |
| 09 | 15 | 05 | 15 | 0334 | 14E | C5 | 4E | 45 | 2B |
| 09 | 16 | 05 | 16 | 0335 | 14F | C5 | 4F | 45 | 21 |
| 09 | 17 | 05 | 17 | 0336 | 150 | C5 | 50 | 45 | 46 |
| 09 | 18 | 05 | 18 | 0337 | 151 | C5 | D1 | 45 | 4A |
| 09 | 19 | 05 | 19 | 0338 | 152 | C5 | D2 | 45 | 4B |
| 09 | 20 | 05 | 20 | 0339 | 153 | C5 | D3 | 45 | 4C |
| 09 | 21 | 05 | 21 | 0340 | 154 | C5 | D4 | 45 | 4D |
| 09 | 22 | 05 | 22 | 0341 | 155 | C5 | D5 | 45 | 4E |
| 09 | 23 | 05 | 23 | 0342 | 156 | C5 | D6 | 45 | 4F |
| 09 | 24 | 05 | 24 | 0343 | 157 | C5 | D7 | 45 | 50 |
| 09 | 25 | 05 | 25 | 0344 | 158 | C5 | D8 | 45 | 51 |
| 09 | 26 | 05 | 26 | 0345 | 159 | C5 | D9 | 45 | 52 |
| 09 | 27 | 05 | 27 | 0346 | 15A | C5 | 5A | 45 | 5D |
| 09 | 28 | 05 | 28 | 0347 | 15B | C5 | 5B | 45 | 24 |
| 09 | 29 | 05 | 29 | 0348 | 15C | C5 | 5C | 45 | 2A |
| 09 | 30 | 05 | 30 | 0349 | 15D | C5 | 5D | 45 | 29 |
| 09 | 31 | 05 | 31 | 0350 | 15E | C5 | 5E | 45 | 3B |
| 09 | 32 | 05 | 32 | 0351 | 15F | C5 | 5F | 45 | 5E |
| 09 | 33 | 05 | 33 | 0352 | 160 | C5 | 60 | 45 | 2D |
| 09 | 34 | 05 | 34 | 0353 | 161 | C5 | 61 | 45 | 2F |
| 09 | 35 | 05 | 35 | 0354 | 162 | C5 | E2 | 45 | 53 |
| 09 | 36 | 05 | 36 | 0355 | 163 | C5 | E3 | 45 | 54 |
| 09 | 37 | 05 | 37 | 0356 | 164 | C5 | E4 | 45 | 55 |
| 09 | 38 | 05 | 38 | 0357 | 165 | C5 | E5 | 45 | 56 |
| 09 | 39 | 05 | 39 | 0358 | 166 | C5 | E6 | 45 | 57 |
| 09 | 40 | 05 | 40 | 0359 | 167 | C5 | E7 | 45 | 58 |
| 10 | 01 | 05 | 41 | 0360 | 168 | C5 | E8 | 45 | 59 |
| 10 | 02 | 05 | 42 | 0361 | 169 | C5 | E9 | 45 | 5A |
| 10 | 03 | 05 | 43 | 0362 | 16A | C5 | 6A | 45 | 7C |
| 10 | 04 | 05 | 44 | 0363 | 16B | C5 | 6B | 45 | 2C |
| 10 | 05 | 05 | 45 | 0364 | 16C | C5 | 6C | 45 | 25 |
| 10 | 06 | 05 | 46 | 0365 | 16D | C5 | 6D | 45 | 5F |
| 10 | 07 | 05 | 47 | 0366 | 16E | C5 | 6E | 45 | 3E |
| 10 | 08 | 05 | 48 | 0367 | 16F | C5 | 6F | 45 | 3F |
| 10 | 09 | 05 | 49 | 0368 | 170 | C5 | F0 | 45 | 30 |
| 10 | 10 | 05 | 50 | 0369 | 171 | C5 | F1 | 45 | 31 |

| 40 Col | | 80 Col | | Position | | Buffer Address (Hex) | | | |
|----------|----------|----------|----------|------------|------------|----------------------|----|--------------|----|
| <u>R</u> | <u>C</u> | <u>R</u> | <u>C</u> | <u>Dec</u> | <u>Hex</u> | <u>EBCDIC</u> | | <u>ASCII</u> | |
| 10 | 11 | 05 | 51 | 0370 | 172 | C5 | F2 | 45 | 32 |
| 10 | 12 | 05 | 52 | 0371 | 173 | C5 | F3 | 45 | 33 |
| 10 | 13 | 05 | 53 | 0372 | 174 | C5 | F4 | 45 | 34 |
| 10 | 14 | 05 | 54 | 0373 | 175 | C5 | F5 | 45 | 35 |
| 10 | 15 | 05 | 55 | 0374 | 176 | C5 | F6 | 45 | 36 |
| 10 | 16 | 05 | 56 | 0375 | 177 | C5 | F7 | 45 | 37 |
| 10 | 17 | 05 | 57 | 0376 | 178 | C5 | F8 | 45 | 38 |
| 10 | 18 | 05 | 58 | 0377 | 179 | C5 | F9 | 45 | 39 |
| 10 | 19 | 05 | 59 | 0378 | 17A | C5 | 7A | 45 | 3A |
| 10 | 20 | 05 | 60 | 0379 | 17B | C5 | 7B | 45 | 23 |
| 10 | 21 | 05 | 61 | 0380 | 17C | C5 | 7C | 45 | 40 |
| 10 | 22 | 05 | 62 | 0381 | 17D | C5 | 7D | 45 | 27 |
| 10 | 23 | 05 | 63 | 0382 | 17E | C5 | 7E | 45 | 3D |
| 10 | 24 | 05 | 64 | 0383 | 17F | C5 | 7F | 45 | 22 |
| 10 | 25 | 05 | 65 | 0384 | 180 | C6 | 40 | 46 | 20 |
| 10 | 26 | 05 | 66 | 0385 | 181 | C6 | C1 | 46 | 41 |
| 10 | 27 | 05 | 67 | 0386 | 182 | C6 | C2 | 46 | 42 |
| 10 | 28 | 05 | 68 | 0387 | 183 | C6 | C3 | 46 | 43 |
| 10 | 29 | 05 | 69 | 0388 | 184 | C6 | C4 | 46 | 44 |
| 10 | 30 | 05 | 70 | 0389 | 185 | C6 | C5 | 46 | 45 |
| 10 | 31 | 05 | 71 | 0390 | 186 | C6 | C6 | 46 | 46 |
| 10 | 32 | 05 | 72 | 0391 | 187 | C6 | C7 | 46 | 47 |
| 10 | 33 | 05 | 73 | 0392 | 188 | C6 | C8 | 46 | 48 |
| 10 | 34 | 05 | 74 | 0393 | 189 | C6 | C9 | 46 | 49 |
| 10 | 35 | 05 | 75 | 0394 | 18A | C6 | 4A | 46 | 5B |
| 10 | 36 | 05 | 76 | 0395 | 18B | C6 | 4B | 46 | 2E |
| 10 | 37 | 05 | 77 | 0396 | 18C | C6 | 4C | 46 | 3C |
| 10 | 38 | 05 | 78 | 0397 | 18D | C6 | 4D | 46 | 28 |
| 10 | 39 | 05 | 79 | 0398 | 18E | C6 | 4E | 46 | 2B |
| 10 | 40 | 05 | 80 | 0399 | 18F | C6 | 4F | 46 | 21 |
| 11 | 01 | 06 | 01 | 0400 | 190 | C6 | 50 | 46 | 26 |
| 11 | 02 | 06 | 02 | 0401 | 191 | C6 | D1 | 46 | 4A |
| 11 | 03 | 06 | 03 | 0402 | 192 | C6 | D2 | 46 | 4B |
| 11 | 04 | 06 | 04 | 0403 | 193 | C6 | D3 | 46 | 4C |
| 11 | 05 | 06 | 05 | 0404 | 194 | C6 | D4 | 46 | 4D |
| 11 | 06 | 06 | 06 | 0405 | 195 | C6 | D5 | 46 | 4E |
| 11 | 07 | 06 | 07 | 0406 | 196 | C6 | D6 | 46 | 4F |
| 11 | 08 | 06 | 08 | 0407 | 197 | C6 | D7 | 46 | 50 |
| 11 | 09 | 06 | 09 | 0408 | 198 | C6 | D8 | 46 | 51 |
| 11 | 10 | 06 | 10 | 0409 | 199 | C6 | D9 | 46 | 52 |
| 11 | 11 | 06 | 11 | 0410 | 19A | C6 | 5A | 46 | 5D |
| 11 | 12 | 06 | 12 | 0411 | 19B | C6 | 5B | 46 | 24 |
| 11 | 13 | 06 | 13 | 0412 | 19C | C6 | 5C | 46 | 2A |
| 11 | 14 | 06 | 14 | 0413 | 19D | C6 | 5D | 46 | 29 |
| 11 | 15 | 06 | 15 | 0414 | 19E | C6 | 5E | 46 | 3B |
| 11 | 16 | 06 | 16 | 0415 | 19F | C6 | 5F | 46 | 5E |
| 11 | 17 | 06 | 17 | 0416 | 1A0 | C6 | 60 | 46 | 2D |
| 11 | 18 | 06 | 18 | 0417 | 1A1 | C6 | 61 | 46 | 2F |
| 11 | 19 | 06 | 19 | 0418 | 1A2 | C6 | E2 | 46 | 53 |
| 11 | 20 | 06 | 20 | 0419 | 1A3 | C6 | E3 | 46 | 54 |
| 11 | 21 | 06 | 21 | 0420 | 1A4 | C6 | E4 | 46 | 55 |
| 11 | 22 | 06 | 22 | 0421 | 1A5 | C6 | E5 | 46 | 56 |
| 11 | 23 | 06 | 23 | 0422 | 1A6 | C6 | E6 | 46 | 57 |
| 11 | 24 | 06 | 24 | 0423 | 1A7 | C6 | E7 | 46 | 58 |
| 11 | 25 | 06 | 25 | 0424 | 1A8 | C6 | E8 | 46 | 59 |
| 11 | 26 | 06 | 26 | 0425 | 1A9 | C6 | E9 | 46 | 5A |
| 11 | 27 | 06 | 27 | 0426 | 1AA | C6 | 6A | 46 | 7C |
| 11 | 28 | 06 | 28 | 0427 | 1AB | C6 | 6B | 46 | 2C |
| 11 | 29 | 06 | 29 | 0428 | 1AC | C6 | 6C | 46 | 25 |
| 11 | 30 | 06 | 30 | 0429 | 1AD | C6 | 6D | 46 | 5F |
| 11 | 31 | 06 | 31 | 0430 | 1AE | C6 | 6E | 46 | 3E |
| 11 | 32 | 06 | 32 | 0431 | 1AF | C6 | 6F | 46 | 3F |
| 11 | 33 | 06 | 33 | 0432 | 1B0 | C6 | F0 | 46 | 30 |

| 40 Col | | 80 Col | | Position | | Buffer Address (Hex) | | | |
|--------|----|--------|----|----------|-----|----------------------|----|-------|----|
| R | C | R | C | Dec | Hex | EBCDIC | | ASCII | |
| 11 | 34 | 06 | 34 | 0433 | 1B1 | C6 | F1 | 46 | 31 |
| 11 | 35 | 06 | 35 | 0434 | 1B2 | C6 | F2 | 46 | 32 |
| 11 | 36 | 06 | 36 | 0435 | 1B3 | C6 | F3 | 46 | 33 |
| 11 | 37 | 06 | 37 | 0436 | 1B4 | C6 | F4 | 46 | 34 |
| 11 | 38 | 06 | 38 | 0437 | 1B5 | C6 | F5 | 46 | 35 |
| 11 | 39 | 06 | 39 | 0438 | 1B6 | C6 | F6 | 46 | 36 |
| 11 | 40 | 06 | 40 | 0439 | 1B7 | C6 | F7 | 46 | 37 |
| 12 | 01 | 06 | 41 | 0440 | 1B8 | C6 | F8 | 46 | 38 |
| 12 | 02 | 06 | 42 | 0441 | 1B9 | C6 | F9 | 46 | 39 |
| 12 | 03 | 06 | 43 | 0442 | 1BA | C6 | 7A | 46 | 3A |
| 12 | 04 | 06 | 44 | 0443 | 1BB | C6 | 7B | 46 | 23 |
| 12 | 05 | 06 | 45 | 0444 | 1BC | C6 | 7C | 46 | 40 |
| 12 | 06 | 06 | 46 | 0445 | 1BD | C6 | 7D | 46 | 27 |
| 12 | 07 | 06 | 47 | 0446 | 1BE | C6 | 7E | 46 | 3D |
| 12 | 08 | 06 | 48 | 0447 | 1BF | C6 | 7F | 46 | 22 |
| 12 | 09 | 06 | 49 | 0448 | 1C0 | C7 | 40 | 47 | 20 |
| 12 | 10 | 06 | 50 | 0449 | 1C1 | C7 | C1 | 47 | 41 |
| 12 | 11 | 06 | 51 | 0450 | 1C2 | C7 | C2 | 47 | 42 |
| 12 | 12 | 06 | 52 | 0451 | 1C3 | C7 | C3 | 47 | 43 |
| 12 | 13 | 06 | 53 | 0452 | 1C4 | C7 | C4 | 47 | 44 |
| 12 | 14 | 06 | 54 | 0453 | 1C5 | C7 | C5 | 47 | 45 |
| 12 | 15 | 06 | 55 | 0454 | 1C6 | C7 | C6 | 47 | 46 |
| 12 | 16 | 06 | 56 | 0455 | 1C7 | C7 | C7 | 47 | 47 |
| 12 | 17 | 06 | 57 | 0456 | 1C8 | C7 | C8 | 47 | 48 |
| 12 | 18 | 06 | 58 | 0457 | 1C9 | C7 | C9 | 47 | 49 |
| 12 | 19 | 06 | 59 | 0458 | 1CA | C7 | 4A | 47 | 5B |
| 12 | 20 | 06 | 60 | 0459 | 1CB | C7 | 4B | 47 | 2E |
| 12 | 21 | 06 | 61 | 0460 | 1CC | C7 | 4C | 47 | 3C |
| 12 | 22 | 06 | 62 | 0461 | 1CD | C7 | 4D | 47 | 28 |
| 12 | 23 | 06 | 63 | 0462 | 1CE | C7 | 4E | 47 | 2B |
| 12 | 24 | 06 | 64 | 0463 | 1CF | C7 | 4F | 47 | 21 |
| 12 | 25 | 06 | 65 | 0464 | 1D0 | C7 | 50 | 47 | 26 |
| 12 | 26 | 06 | 66 | 0465 | 1D1 | C7 | D1 | 47 | 4A |
| 12 | 27 | 06 | 67 | 0466 | 1D2 | C7 | D2 | 47 | 4B |
| 12 | 28 | 06 | 68 | 0467 | 1D3 | C7 | D3 | 47 | 4C |
| 12 | 29 | 06 | 69 | 0468 | 1D4 | C7 | D4 | 47 | 4D |
| 12 | 30 | 06 | 70 | 0469 | 1D5 | C7 | D5 | 47 | 4E |
| 12 | 31 | 06 | 71 | 0470 | 1D6 | C7 | D6 | 47 | 4F |
| 12 | 32 | 06 | 72 | 0471 | 1D7 | C7 | D7 | 47 | 50 |
| 12 | 33 | 06 | 73 | 0472 | 1D8 | C7 | D8 | 47 | 51 |
| 12 | 34 | 06 | 74 | 0473 | 1D9 | C7 | D9 | 47 | 52 |
| 12 | 35 | 06 | 75 | 0474 | 1DA | C7 | 5A | 47 | 5D |
| 12 | 36 | 06 | 76 | 0475 | 1DB | C7 | 5B | 47 | 24 |
| 12 | 37 | 06 | 77 | 0476 | 1DC | C7 | 5C | 47 | 2A |
| 12 | 38 | 06 | 78 | 0477 | 1DD | C7 | 5D | 47 | 29 |
| 12 | 39 | 06 | 79 | 0478 | 1DE | C7 | 5E | 47 | 3B |
| 12 | 40 | 06 | 80 | 0479 | 1DF | C7 | 5F | 47 | 5E |
| | | 07 | 01 | 0480 | 1E0 | C7 | 60 | 47 | 2D |
| | | 07 | 02 | 0481 | 1E1 | C7 | 61 | 47 | 2F |
| | | 07 | 03 | 0482 | 1E2 | C7 | E2 | 47 | 53 |
| | | 07 | 04 | 0483 | 1E3 | C7 | E3 | 47 | 54 |
| | | 07 | 05 | 0484 | 1E4 | C7 | E4 | 47 | 55 |
| | | 07 | 06 | 0485 | 1E5 | C7 | E5 | 47 | 56 |
| | | 07 | 07 | 0486 | 1E6 | C7 | E6 | 47 | 57 |
| | | 07 | 08 | 0487 | 1E7 | C7 | E7 | 47 | 58 |
| | | 07 | 09 | 0488 | 1E8 | C7 | E8 | 47 | 59 |
| | | 07 | 10 | 0489 | 1E9 | C7 | E9 | 47 | 5A |
| | | 07 | 11 | 0490 | 1EA | C7 | 6A | 47 | 7C |
| | | 07 | 12 | 0491 | 1EB | C7 | 6B | 47 | 2C |
| | | 07 | 13 | 0492 | 1EC | C7 | 6C | 47 | 25 |
| | | 07 | 14 | 0493 | 1ED | C7 | 6D | 47 | 5F |
| | | 07 | 15 | 0494 | 1EE | C7 | 6E | 47 | 3E |

| 80 Col | | Position | | Buffer Address (Hex) | | | |
|----------|----------|------------|------------|----------------------|----|--------------|----|
| <u>R</u> | <u>C</u> | <u>Dec</u> | <u>Hex</u> | <u>EBCDIC</u> | | <u>ASCII</u> | |
| 07 | 16 | 0495 | 1EF | C7 | 6F | 47 | 3F |
| 07 | 17 | 0496 | 1F0 | C7 | F0 | 47 | 30 |
| 07 | 18 | 0497 | 1F1 | C7 | F1 | 47 | 31 |
| 07 | 19 | 0498 | 1F2 | C7 | F2 | 47 | 32 |
| 07 | 20 | 0499 | 1F3 | C7 | F3 | 47 | 33 |
| 07 | 21 | 0500 | 1F4 | C7 | F4 | 47 | 34 |
| 07 | 22 | 0501 | 1F5 | C7 | F5 | 47 | 35 |
| 07 | 23 | 0502 | 1F6 | C7 | F6 | 47 | 36 |
| 07 | 24 | 0503 | 1F7 | C7 | F7 | 47 | 37 |
| 07 | 25 | 0504 | 1F8 | C7 | F8 | 47 | 38 |
| 07 | 26 | 0505 | 1F9 | C7 | F9 | 47 | 39 |
| 07 | 27 | 0506 | 1FA | C7 | 7A | 47 | 3A |
| 07 | 28 | 0507 | 1FB | C7 | 7B | 47 | 23 |
| 07 | 29 | 0508 | 1FC | C7 | 7C | 47 | 40 |
| 07 | 30 | 0509 | 1FD | C7 | 7D | 47 | 27 |
| 07 | 31 | 0510 | 1FE | C7 | 7E | 47 | 3D |
| 07 | 32 | 0511 | 1FF | C7 | 7F | 47 | 22 |
| 07 | 33 | 0512 | 200 | C8 | 40 | 48 | 20 |
| 07 | 34 | 0513 | 201 | C8 | C1 | 48 | 41 |
| 07 | 35 | 0514 | 202 | C8 | C2 | 48 | 42 |
| 07 | 36 | 0515 | 203 | C8 | C3 | 48 | 43 |
| 07 | 37 | 0516 | 204 | C8 | C4 | 48 | 44 |
| 07 | 38 | 0517 | 205 | C8 | C5 | 48 | 45 |
| 07 | 39 | 0518 | 206 | C8 | C6 | 48 | 46 |
| 07 | 40 | 0519 | 207 | C8 | C7 | 48 | 47 |
| 07 | 41 | 0520 | 208 | C8 | C8 | 48 | 48 |
| 07 | 42 | 0521 | 209 | C8 | C9 | 48 | 49 |
| 07 | 43 | 0522 | 20A | C8 | 4A | 48 | 5B |
| 07 | 44 | 0523 | 20B | C8 | 4B | 48 | 2E |
| 07 | 45 | 0524 | 20C | C8 | 4C | 48 | 3C |
| 07 | 46 | 0525 | 20D | C8 | 4D | 48 | 28 |
| 07 | 47 | 0526 | 20E | C8 | 4E | 48 | 2B |
| 07 | 48 | 0527 | 20F | C8 | 4F | 48 | 21 |
| 07 | 49 | 0528 | 210 | C8 | 50 | 48 | 26 |
| 07 | 50 | 0529 | 211 | C8 | D1 | 48 | 4A |
| 07 | 51 | 0530 | 212 | C8 | D2 | 48 | 4B |
| 07 | 52 | 0531 | 213 | C8 | D3 | 48 | 4C |
| 07 | 53 | 0532 | 214 | C8 | D4 | 48 | 4D |
| 07 | 54 | 0533 | 215 | C8 | D5 | 48 | 4E |
| 07 | 55 | 0534 | 216 | C8 | D6 | 48 | 4F |
| 07 | 56 | 0535 | 217 | C8 | D7 | 48 | 50 |
| 07 | 57 | 0536 | 218 | C8 | D8 | 48 | 51 |
| 07 | 58 | 0537 | 219 | C8 | D9 | 48 | 52 |
| 07 | 59 | 0538 | 21A | C8 | 5A | 48 | 5D |
| 07 | 60 | 0539 | 21B | C8 | 5B | 48 | 24 |
| 07 | 61 | 0540 | 21C | C8 | 5C | 48 | 2A |
| 07 | 62 | 0541 | 21D | C8 | 5D | 48 | 29 |
| 07 | 63 | 0542 | 21E | C8 | 5E | 48 | 3B |
| 07 | 64 | 0543 | 21F | C8 | 5F | 48 | 5E |
| 07 | 65 | 0544 | 220 | C8 | 60 | 48 | 2D |
| 07 | 66 | 0545 | 221 | C8 | 61 | 48 | 2F |
| 07 | 67 | 0546 | 222 | C8 | E2 | 48 | 53 |
| 07 | 68 | 0547 | 223 | C8 | E3 | 48 | 54 |
| 07 | 69 | 0548 | 224 | C8 | E4 | 48 | 55 |
| 07 | 70 | 0549 | 225 | C8 | E5 | 48 | 56 |
| 07 | 71 | 0550 | 226 | C8 | E6 | 48 | 57 |
| 07 | 72 | 0551 | 227 | C8 | E7 | 48 | 58 |
| 07 | 73 | 0552 | 228 | C8 | E8 | 48 | 59 |
| 07 | 74 | 0553 | 229 | C8 | E9 | 48 | 5A |
| 07 | 75 | 0554 | 22A | C8 | 6A | 48 | 7C |
| 07 | 76 | 0555 | 22B | C8 | 6B | 48 | 2C |
| 07 | 77 | 0556 | 22C | C8 | 6C | 48 | 25 |

| 80 Col | | Position | | Buffer Address (Hex) | |
|--------|----|----------|-----|----------------------|-------|
| R | C | Dec | Hex | EBCDIC | ASCII |
| 07 | 78 | 0557 | 22D | C8 6D | 48 5F |
| 07 | 79 | 0558 | 22E | C8 6E | 48 3E |
| 07 | 80 | 0559 | 22F | C8 6F | 48 3F |
| 08 | 01 | 0560 | 230 | C8 F0 | 48 30 |
| 08 | 02 | 0561 | 231 | C8 F1 | 48 31 |
| 08 | 03 | 0562 | 232 | C8 F2 | 48 32 |
| 08 | 04 | 0563 | 233 | C8 F3 | 48 33 |
| 08 | 05 | 0564 | 234 | C8 F4 | 48 34 |
| 08 | 06 | 0565 | 235 | C8 F5 | 48 35 |
| 08 | 07 | 0566 | 236 | C8 F6 | 48 36 |
| 08 | 08 | 0567 | 237 | C8 F7 | 48 37 |
| 08 | 09 | 0568 | 238 | C8 F8 | 48 38 |
| 08 | 10 | 0569 | 239 | C8 F9 | 48 39 |
| 08 | 11 | 0570 | 23A | C8 7A | 48 3A |
| 08 | 12 | 0571 | 23B | C8 7B | 48 23 |
| 08 | 13 | 0572 | 23C | C8 7C | 48 40 |
| 08 | 14 | 0573 | 23D | C8 7D | 48 27 |
| 08 | 15 | 0574 | 23E | C8 7E | 48 3D |
| 08 | 16 | 0575 | 23F | C8 7F | 48 22 |
| 08 | 17 | 0576 | 240 | C9 40 | 49 20 |
| 08 | 18 | 0577 | 241 | C9 C1 | 49 41 |
| 08 | 19 | 0578 | 242 | C9 C2 | 49 42 |
| 08 | 20 | 0579 | 243 | C9 C3 | 49 43 |
| 08 | 21 | 0580 | 244 | C9 C4 | 49 44 |
| 08 | 22 | 0581 | 245 | C9 C5 | 49 45 |
| 08 | 23 | 0582 | 246 | C9 C6 | 49 46 |
| 08 | 24 | 0583 | 247 | C9 C7 | 49 47 |
| 08 | 25 | 0584 | 248 | C9 C8 | 49 48 |
| 08 | 26 | 0585 | 249 | C9 C9 | 49 49 |
| 08 | 27 | 0586 | 24A | C9 4A | 49 5B |
| 08 | 28 | 0587 | 24B | C9 4B | 49 2E |
| 08 | 29 | 0588 | 24C | C9 4C | 49 3C |
| 08 | 30 | 0589 | 24D | C9 4D | 49 28 |
| 08 | 31 | 0590 | 24E | C9 4E | 49 2B |
| 08 | 32 | 0591 | 24F | C9 4F | 49 21 |
| 08 | 33 | 0592 | 250 | C9 50 | 49 26 |
| 08 | 34 | 0593 | 251 | C9 D1 | 49 4A |
| 08 | 35 | 0594 | 252 | C9 D2 | 49 4B |
| 08 | 36 | 0595 | 253 | C9 D3 | 49 4C |
| 08 | 37 | 0596 | 254 | C9 D4 | 49 4D |
| 08 | 38 | 0597 | 255 | C9 D5 | 49 4E |
| 08 | 39 | 0598 | 256 | C9 D6 | 49 4F |
| 08 | 40 | 0599 | 257 | C9 D7 | 49 50 |
| 08 | 41 | 0600 | 258 | C9 D8 | 49 51 |
| 08 | 42 | 0601 | 259 | C9 D9 | 49 52 |
| 08 | 43 | 0602 | 25A | C9 5A | 49 5D |
| 08 | 44 | 0603 | 25B | C9 5B | 49 24 |
| 08 | 45 | 0604 | 25C | C9 5C | 49 2A |
| 08 | 46 | 0605 | 25D | C9 5D | 49 29 |
| 08 | 47 | 0606 | 25E | C9 5E | 49 3B |
| 08 | 48 | 0607 | 25F | C9 5F | 49 5E |
| 08 | 49 | 0608 | 260 | C9 60 | 49 2D |
| 08 | 50 | 0609 | 261 | C9 61 | 49 2F |
| 08 | 51 | 0610 | 262 | C9 E2 | 49 53 |
| 08 | 52 | 0611 | 263 | C9 E3 | 49 54 |
| 08 | 53 | 0612 | 264 | C9 E4 | 49 55 |
| 08 | 54 | 0613 | 265 | C9 E5 | 49 56 |
| 08 | 55 | 0614 | 266 | C9 E6 | 49 57 |
| 08 | 56 | 0615 | 267 | C9 E7 | 49 58 |
| 08 | 57 | 0616 | 268 | C9 E8 | 49 59 |
| 08 | 58 | 0617 | 269 | C9 E9 | 49 5A |
| 08 | 59 | 0618 | 26A | C9 6A | 49 7C |
| 08 | 60 | 0619 | 26B | C9 6B | 49 2C |

| 80 R | Col C | Position | | Buffer Address (Hex) | |
|---------|----------|----------|-----|----------------------|-------|
| | | Dec | Hex | EBCDIC | ASCII |
| 08 | 61 | 0620 | 26C | C9 6C | 49 25 |
| 08 | 62 | 0621 | 26D | C9 6D | 49 5F |
| 08 | 63 | 0622 | 26E | C9 6E | 49 3E |
| 08 | 64 | 0623 | 26F | C9 6F | 49 3F |
| 08 | 65 | 0624 | 270 | C9 F0 | 49 30 |
| 08 | 66 | 0625 | 271 | C9 F1 | 49 31 |
| 08 | 67 | 0626 | 272 | C9 F2 | 49 32 |
| 08 | 68 | 0627 | 273 | C9 F3 | 49 33 |
| 08 | 69 | 0628 | 274 | C9 F4 | 49 34 |
| 08 | 70 | 0629 | 275 | C9 F5 | 49 35 |
| 08 | 71 | 0630 | 276 | C9 F6 | 49 36 |
| 08 | 72 | 0631 | 277 | C9 F7 | 49 37 |
| 08 | 73 | 0632 | 278 | C9 F8 | 49 38 |
| 08 | 74 | 0633 | 279 | C9 F9 | 49 39 |
| 08 | 75 | 0634 | 27A | C9 7A | 49 3A |
| 08 | 76 | 0635 | 27B | C9 7B | 49 23 |
| 08 | 77 | 0636 | 27C | C9 7C | 49 40 |
| 08 | 78 | 0637 | 27D | C9 7D | 49 27 |
| 08 | 79 | 0638 | 27E | C9 7E | 49 3D |
| 08 | 80 | 0639 | 27F | C9 7F | 49 22 |
| 09 | 01 | 0640 | 280 | 4A 40 | 5B 20 |
| 09 | 02 | 0641 | 281 | 4A C1 | 5B 41 |
| 09 | 03 | 0642 | 282 | 4A C2 | 5B 42 |
| 09 | 04 | 0643 | 283 | 4A C3 | 5B 43 |
| 09 | 05 | 0644 | 284 | 4A C4 | 5B 44 |
| 09 | 06 | 0645 | 285 | 4A C5 | 5B 45 |
| 09 | 07 | 0646 | 286 | 4A C6 | 5B 46 |
| 09 | 08 | 0647 | 287 | 4A C7 | 5B 47 |
| 09 | 09 | 0648 | 288 | 4A C8 | 5B 48 |
| 09 | 10 | 0649 | 289 | 4A C9 | 5B 49 |
| 09 | 11 | 0650 | 28A | 4A 4A | 5B 5B |
| 09 | 12 | 0651 | 28B | 4A 4B | 5B 2E |
| 09 | 13 | 0652 | 28C | 4A 4C | 5B 3C |
| 09 | 14 | 0653 | 28D | 4A 4D | 5B 28 |
| 09 | 15 | 0654 | 28E | 4A 4E | 5B 2B |
| 09 | 16 | 0655 | 28F | 4A 4F | 5B 21 |
| 09 | 17 | 0656 | 290 | 4A 50 | 5B 26 |
| 09 | 18 | 0657 | 291 | 4A D1 | 5B 4A |
| 09 | 19 | 0658 | 292 | 4A D2 | 5B 4B |
| 09 | 20 | 0659 | 293 | 4A D3 | 5B 4C |
| 09 | 21 | 0660 | 294 | 4A D4 | 5B 4D |
| 09 | 22 | 0661 | 295 | 4A D5 | 5B 4E |
| 09 | 23 | 0662 | 296 | 4A D6 | 5B 4F |
| 09 | 24 | 0663 | 297 | 4A D7 | 5B 50 |
| 09 | 25 | 0664 | 298 | 4A D8 | 5B 51 |
| 09 | 26 | 0665 | 299 | 4A D9 | 5B 52 |
| 09 | 27 | 0666 | 29A | 4A 5A | 5B 5D |
| 09 | 28 | 0667 | 29B | 4A 5B | 5B 24 |
| 09 | 29 | 0668 | 29C | 4A 5C | 5B 2A |
| 09 | 30 | 0669 | 29D | 4A 5D | 5B 29 |
| 09 | 31 | 0670 | 29E | 4A 5E | 5B 3B |
| 09 | 32 | 0671 | 29F | 4A 5F | 5B 5E |
| 09 | 33 | 0672 | 2A0 | 4A 60 | 5B 2D |
| 09 | 34 | 0673 | 2A1 | 4A 61 | 5B 2F |
| 09 | 35 | 0674 | 2A2 | 4A E2 | 5B 53 |
| 09 | 36 | 0675 | 2A3 | 4A E3 | 5B 54 |
| 09 | 37 | 0676 | 2A4 | 4A E4 | 5B 55 |
| 09 | 38 | 0677 | 2A5 | 4A E5 | 5B 56 |
| 09 | 39 | 0678 | 2A6 | 4A E6 | 5B 57 |
| 09 | 40 | 0679 | 2A7 | 4A E7 | 5B 58 |
| 09 | 41 | 0680 | 2A8 | 4A E8 | 5B 59 |
| 09 | 42 | 0681 | 2A9 | 4A E9 | 5B 5A |

| 80 Col | | Position | | Buffer Address (Hex) | | | |
|--------|----|----------|-----|----------------------|----|-------|----|
| R | C | Dec | Hex | EBCDIC | | ASCII | |
| 09 | 43 | 0682 | 2AA | 4A | 6A | 5B | 7C |
| 09 | 44 | 0683 | 2AB | 4A | 6B | 5B | 2C |
| 09 | 45 | 0684 | 2AC | 4A | 6C | 5B | 26 |
| 09 | 46 | 0685 | 2AD | 4A | 6D | 5B | 5F |
| 09 | 47 | 0686 | 2AE | 4A | 6E | 5B | 3E |
| 09 | 48 | 0687 | 2AF | 4A | 6F | 5B | 3F |
| 09 | 49 | 0688 | 2B0 | 4A | F0 | 5B | 30 |
| 09 | 50 | 0689 | 2B1 | 4A | F1 | 5B | 31 |
| 09 | 51 | 0690 | 2B2 | 4A | F2 | 5B | 32 |
| 09 | 52 | 0691 | 2B3 | 4A | F3 | 5B | 33 |
| 09 | 53 | 0692 | 2B4 | 4A | F4 | 5B | 34 |
| 09 | 54 | 0693 | 2B5 | 4A | F5 | 5B | 35 |
| 09 | 55 | 0694 | 2B6 | 4A | F6 | 5B | 36 |
| 09 | 56 | 0695 | 2B7 | 4A | F7 | 5B | 37 |
| 09 | 57 | 0696 | 2B8 | 4A | F8 | 5B | 38 |
| 09 | 58 | 0697 | 2B9 | 4A | F9 | 5B | 39 |
| 09 | 59 | 0698 | 2BA | 4A | 7A | 5B | 3A |
| 09 | 60 | 0699 | 2BB | 4A | 7B | 5B | 23 |
| 09 | 61 | 0700 | 2BC | 4A | 7C | 5B | 40 |
| 09 | 62 | 0701 | 2BD | 4A | 7D | 5B | 27 |
| 09 | 63 | 0702 | 2BE | 4A | 7E | 5B | 3D |
| 09 | 64 | 0703 | 2BF | 4A | 7F | 5B | 22 |
| 09 | 65 | 0704 | 2C0 | 4B | 40 | 2E | 20 |
| 09 | 66 | 0705 | 2C1 | 4B | C1 | 2E | 41 |
| 09 | 67 | 0706 | 2C2 | 4B | C2 | 2E | 42 |
| 09 | 68 | 0707 | 2C3 | 4B | C3 | 2E | 43 |
| 09 | 69 | 0708 | 2C4 | 4B | C4 | 2E | 44 |
| 09 | 70 | 0709 | 2C5 | 4B | C5 | 2E | 45 |
| 09 | 71 | 0710 | 2C6 | 4B | C6 | 2E | 46 |
| 09 | 72 | 0711 | 2C7 | 4B | C7 | 2E | 47 |
| 09 | 73 | 0712 | 2C8 | 4B | C8 | 2E | 48 |
| 09 | 74 | 0713 | 2C9 | 4B | C9 | 2E | 49 |
| 09 | 75 | 0714 | 2CA | 4B | 4A | 2E | 5B |
| 09 | 76 | 0715 | 2CB | 4B | 4B | 2E | 2E |
| 09 | 77 | 0716 | 2CC | 4B | 4C | 2E | 3C |
| 09 | 78 | 0717 | 2CD | 4B | 4D | 2E | 28 |
| 09 | 79 | 0718 | 2CE | 4B | 4E | 2E | 2B |
| 09 | 80 | 0719 | 2CF | 4B | 4F | 2E | 21 |
| 10 | 01 | 0720 | 2D0 | 4B | 50 | 2E | 26 |
| 10 | 02 | 0721 | 2D1 | 4B | D1 | 2E | 4A |
| 10 | 03 | 0722 | 2D2 | 4B | D2 | 2E | 4B |
| 10 | 04 | 0723 | 2D3 | 4B | D3 | 2E | 4C |
| 10 | 05 | 0724 | 2D4 | 4B | D4 | 2E | 4D |
| 10 | 06 | 0725 | 2D5 | 4B | D5 | 2E | 4E |
| 10 | 07 | 0726 | 2D6 | 4B | D6 | 2E | 4F |
| 10 | 08 | 0727 | 2D7 | 4B | D7 | 2E | 50 |
| 10 | 09 | 0728 | 2D8 | 4B | D8 | 2E | 51 |
| 10 | 10 | 0729 | 2D9 | 4B | D9 | 2E | 52 |
| 10 | 11 | 0730 | 2DA | 4B | 5A | 2E | 5D |
| 10 | 12 | 0731 | 2DB | 4B | 5B | 2E | 24 |
| 10 | 13 | 0732 | 2DC | 4B | 5C | 2E | 2A |
| 10 | 14 | 0733 | 2DD | 4B | 5D | 2E | 29 |
| 10 | 15 | 0734 | 2DE | 4B | 5E | 2E | 38 |
| 10 | 16 | 0735 | 2DF | 4B | 5F | 2E | 5E |
| 10 | 17 | 0736 | 2E0 | 4B | 60 | 2E | 2D |
| 10 | 18 | 0737 | 2E1 | 4B | 61 | 2E | 2F |
| 10 | 19 | 0738 | 2E2 | 4B | E2 | 2E | 53 |
| 10 | 20 | 0739 | 2E3 | 4B | E3 | 2E | 54 |
| 10 | 21 | 0740 | 2E4 | 4B | E4 | 2E | 55 |
| 10 | 22 | 0741 | 2E5 | 4B | E5 | 2E | 56 |
| 10 | 23 | 0742 | 2E6 | 4B | E6 | 2E | 57 |
| 10 | 24 | 0743 | 2E7 | 4B | E7 | 2E | 58 |

| 80 Col | | Position | | Buffer Address (Hex) | | | |
|----------|----------|------------|------------|----------------------|----|--------------|----|
| <u>R</u> | <u>C</u> | <u>Dec</u> | <u>Hex</u> | <u>EBCDIC</u> | | <u>ASCII</u> | |
| 10 | 25 | 0744 | 2E8 | 4B | E8 | 2E | 59 |
| 10 | 26 | 0745 | 2E9 | 4B | E9 | 2E | 5A |
| 10 | 27 | 0746 | 2EA | 4B | 6A | 2E | 7C |
| 10 | 28 | 0747 | 2EB | 4B | 6B | 2E | 2C |
| 10 | 29 | 0748 | 2EC | 4B | 6C | 2E | 25 |
| 10 | 30 | 0749 | 2ED | 4B | 6D | 2E | 5F |
| 10 | 31 | 0750 | 2EE | 4B | 6E | 2E | 3E |
| 10 | 32 | 0751 | 2EF | 4B | 6F | 2E | 3F |
| 10 | 33 | 0752 | 2F0 | 4B | F0 | 2E | 30 |
| 10 | 34 | 0753 | 2F1 | 4B | F1 | 2E | 31 |
| 10 | 35 | 0754 | 2F2 | 4B | F2 | 2E | 32 |
| 10 | 36 | 0755 | 2F3 | 4B | F3 | 2E | 33 |
| 10 | 37 | 0756 | 2F4 | 4B | F4 | 2E | 34 |
| 10 | 38 | 0757 | 2F5 | 4B | F5 | 2E | 35 |
| 10 | 39 | 0758 | 2F6 | 4B | F6 | 2E | 36 |
| 10 | 40 | 0759 | 2F7 | 4B | F7 | 2E | 37 |
| 10 | 41 | 0760 | 2F8 | 4B | F8 | 2E | 38 |
| 10 | 42 | 0761 | 2F9 | 4B | F9 | 2E | 39 |
| 10 | 43 | 0762 | 2FA | 4B | 7A | 2E | 3A |
| 10 | 44 | 0763 | 2FB | 4B | 7B | 2E | 23 |
| 10 | 45 | 0764 | 2FC | 4B | 7C | 2E | 40 |
| 10 | 46 | 0765 | 2FD | 4B | 7D | 2E | 27 |
| 10 | 47 | 0766 | 2FE | 4B | 7E | 2E | 3D |
| 10 | 48 | 0767 | 2FF | 4B | 7F | 2E | 22 |
| 10 | 49 | 0768 | 300 | 4C | 40 | 3C | 20 |
| 10 | 50 | 0769 | 301 | 4C | C1 | 3C | 41 |
| 10 | 51 | 0770 | 302 | 4C | C2 | 3C | 42 |
| 10 | 52 | 0771 | 303 | 4C | C3 | 3C | 43 |
| 10 | 53 | 0772 | 304 | 4C | C4 | 3C | 44 |
| 10 | 54 | 0773 | 305 | 4C | C5 | 3C | 45 |
| 10 | 55 | 0774 | 306 | 4C | C6 | 3C | 46 |
| 10 | 56 | 0775 | 307 | 4C | C7 | 3C | 47 |
| 10 | 57 | 0776 | 308 | 4C | C8 | 3C | 48 |
| 10 | 58 | 0777 | 309 | 4C | C9 | 3C | 49 |
| 10 | 59 | 0778 | 30A | 4C | 4A | 3C | 5B |
| 10 | 60 | 0779 | 30B | 4C | 4B | 3C | 2E |
| 10 | 61 | 0780 | 30C | 4C | 4C | 3C | 3C |
| 10 | 62 | 0781 | 30D | 4C | 4D | 3C | 28 |
| 10 | 63 | 0782 | 30E | 4C | 4E | 3C | 2B |
| 10 | 64 | 0783 | 30F | 4C | 4F | 3C | 21 |
| 10 | 65 | 0784 | 310 | 4C | 50 | 3C | 26 |
| 10 | 66 | 0785 | 311 | 4C | D1 | 3C | 4A |
| 10 | 67 | 0786 | 312 | 4C | D2 | 3C | 4B |
| 10 | 68 | 0787 | 313 | 4C | D3 | 3C | 4C |
| 10 | 69 | 0788 | 314 | 4C | D4 | 3C | 4D |
| 10 | 70 | 0789 | 315 | 4C | D5 | 3C | 4E |
| 10 | 71 | 0790 | 316 | 4C | D6 | 3C | 4F |
| 10 | 72 | 0791 | 317 | 4C | D7 | 3C | 50 |
| 10 | 73 | 0792 | 318 | 4C | D8 | 3C | 51 |
| 10 | 74 | 0793 | 319 | 4C | D9 | 3C | 52 |
| 10 | 75 | 0794 | 31A | 4C | 5A | 3C | 5D |
| 10 | 76 | 0795 | 31B | 4C | 5B | 3C | 24 |
| 10 | 77 | 0796 | 31C | 4C | 5C | 3C | 2A |
| 10 | 78 | 0797 | 31D | 4C | 5D | 3C | 29 |
| 10 | 79 | 0798 | 31E | 4C | 5E | 3C | 3B |
| 10 | 80 | 0799 | 31F | 4C | 5F | 3C | 5E |
| 11 | 01 | 0800 | 320 | 4C | 60 | 3C | 2D |
| 11 | 02 | 0801 | 321 | 4C | 61 | 3C | 2F |
| 11 | 03 | 0802 | 322 | 4C | E2 | 3C | 53 |
| 11 | 04 | 0803 | 323 | 4C | E3 | 3C | 54 |
| 11 | 05 | 0804 | 324 | 4C | E4 | 3C | 55 |
| 11 | 06 | 0805 | 325 | 4C | E5 | 3C | 56 |

| 80 Col | | Position | | Buffer Address (Hex) | | | |
|----------|----------|------------|------------|----------------------|----|--------------|----|
| <u>R</u> | <u>C</u> | <u>Dec</u> | <u>Hex</u> | <u>EBCDIC</u> | | <u>ASCII</u> | |
| 11 | 07 | 0806 | 326 | 4C | E6 | 3C | 57 |
| 11 | 08 | 0807 | 327 | 4C | E7 | 3C | 58 |
| 11 | 09 | 0808 | 328 | 4C | E8 | 3C | 59 |
| 11 | 10 | 0809 | 329 | 4C | E9 | 3C | 5A |
| 11 | 11 | 0810 | 32A | 4C | 6A | 3C | 7C |
| 11 | 12 | 0811 | 32B | 4C | 6B | 3C | 2C |
| 11 | 13 | 0812 | 32C | 4C | 6C | 3C | 25 |
| 11 | 14 | 0813 | 32D | 4C | 6D | 3C | 5F |
| 11 | 15 | 0814 | 32E | 4C | 6E | 3C | 3E |
| 11 | 16 | 0815 | 32F | 4C | 6F | 3C | 3F |
| 11 | 17 | 0816 | 330 | 4C | F0 | 3C | 30 |
| 11 | 18 | 0817 | 331 | 4C | F1 | 3C | 31 |
| 11 | 19 | 0818 | 332 | 4C | F2 | 3C | 32 |
| 11 | 20 | 0819 | 333 | 4C | F3 | 3C | 33 |
| 11 | 21 | 0820 | 334 | 4C | F4 | 3C | 34 |
| 11 | 22 | 0821 | 335 | 4C | F5 | 3C | 35 |
| 11 | 23 | 0822 | 336 | 4C | F6 | 3C | 36 |
| 11 | 24 | 0823 | 337 | 4C | F7 | 3C | 37 |
| 11 | 25 | 0824 | 338 | 4C | F8 | 3C | 38 |
| 11 | 26 | 0825 | 339 | 4C | F9 | 3C | 39 |
| 11 | 27 | 0826 | 33A | 4C | 7A | 3C | 3A |
| 11 | 28 | 0827 | 33B | 4C | 7B | 3C | 23 |
| 11 | 29 | 0828 | 33C | 4C | 7C | 3C | 40 |
| 11 | 30 | 0829 | 33D | 4C | 7D | 3C | 27 |
| 11 | 31 | 0830 | 33E | 4C | 7E | 3C | 3D |
| 11 | 32 | 0831 | 33F | 4C | 7F | 3C | 22 |
| 11 | 33 | 0832 | 340 | 4D | 40 | 28 | 20 |
| 11 | 34 | 0833 | 341 | 4D | C1 | 28 | 41 |
| 11 | 35 | 0834 | 342 | 4D | C2 | 28 | 42 |
| 11 | 36 | 0835 | 343 | 4D | C3 | 28 | 43 |
| 11 | 37 | 0836 | 344 | 4D | C4 | 28 | 44 |
| 11 | 38 | 0837 | 345 | 4D | C5 | 28 | 45 |
| 11 | 39 | 0838 | 346 | 4D | C6 | 28 | 46 |
| 11 | 40 | 0839 | 347 | 4D | C7 | 28 | 47 |
| 11 | 41 | 0840 | 348 | 4D | C8 | 28 | 48 |
| 11 | 42 | 0841 | 349 | 4D | C9 | 28 | 49 |
| 11 | 43 | 0842 | 34A | 4D | 4A | 28 | 5B |
| 11 | 44 | 0843 | 34B | 4D | 4B | 28 | 2E |
| 11 | 45 | 0844 | 34C | 4D | 4C | 28 | 3C |
| 11 | 46 | 0845 | 34D | 4D | 4D | 28 | 28 |
| 11 | 47 | 0846 | 34E | 4D | 4E | 28 | 2B |
| 11 | 48 | 0847 | 34F | 4D | 4F | 28 | 21 |
| 11 | 49 | 0848 | 350 | 4D | 50 | 28 | 26 |
| 11 | 50 | 0849 | 351 | 4D | D1 | 28 | 4A |
| 11 | 51 | 0850 | 352 | 4D | D2 | 28 | 4B |
| 11 | 52 | 0851 | 353 | 4D | D3 | 28 | 4C |
| 11 | 53 | 0852 | 354 | 4D | D4 | 28 | 4D |
| 11 | 54 | 0853 | 355 | 4D | D5 | 28 | 4E |
| 11 | 55 | 0854 | 356 | 4D | D6 | 28 | 4F |
| 11 | 56 | 0855 | 357 | 4D | D7 | 28 | 50 |
| 11 | 57 | 0856 | 358 | 4D | D8 | 28 | 51 |
| 11 | 58 | 0857 | 359 | 4D | D9 | 28 | 52 |
| 11 | 59 | 0858 | 35A | 4D | 5A | 28 | 5D |
| 11 | 60 | 0859 | 35B | 4D | 5B | 28 | 24 |
| 11 | 61 | 0860 | 35C | 4D | 5C | 28 | 2A |
| 11 | 62 | 0861 | 35D | 4D | 5D | 28 | 29 |
| 11 | 63 | 0862 | 35E | 4D | 5E | 28 | 3B |
| 11 | 64 | 0863 | 35F | 4D | 5F | 28 | 5E |
| 11 | 65 | 0864 | 360 | 4D | 60 | 28 | 2D |
| 11 | 66 | 0865 | 361 | 4D | 61 | 28 | 2F |
| 11 | 67 | 0866 | 362 | 4D | E2 | 28 | 53 |
| 11 | 68 | 0867 | 363 | 4D | E3 | 28 | 54 |

| 80 Col | | Position | | Buffer Address (Hex) | | | |
|--------|----|----------|-----|----------------------|----|-------|----|
| R | C | Dec | Hex | EBCDIC | | ASCII | |
| 11 | 69 | 0868 | 364 | 4D | E4 | 28 | 55 |
| 11 | 70 | 0869 | 365 | 4D | E5 | 28 | 56 |
| 11 | 71 | 0870 | 366 | 4D | E6 | 28 | 57 |
| 11 | 72 | 0871 | 367 | 4D | E7 | 28 | 58 |
| 11 | 73 | 0872 | 368 | 4D | E8 | 28 | 59 |
| 11 | 74 | 0873 | 369 | 4D | E9 | 28 | 5A |
| 11 | 75 | 0874 | 36A | 4D | 6A | 28 | 7C |
| 11 | 76 | 0875 | 36B | 4D | 6B | 28 | 2C |
| 11 | 77 | 0876 | 36C | 4D | 6C | 28 | 25 |
| 11 | 78 | 0877 | 36D | 4D | 6D | 28 | 5F |
| 11 | 79 | 0878 | 36E | 4D | 6E | 28 | 3E |
| 11 | 80 | 0879 | 36F | 4D | 6F | 28 | 3F |
| 12 | 01 | 0880 | 370 | 4D | F0 | 28 | 30 |
| 12 | 02 | 0881 | 371 | 4D | F1 | 28 | 31 |
| 12 | 03 | 0882 | 372 | 4D | F2 | 28 | 32 |
| 12 | 04 | 0883 | 373 | 4D | F3 | 28 | 33 |
| 12 | 05 | 0884 | 374 | 4D | F4 | 28 | 34 |
| 12 | 06 | 0885 | 375 | 4D | F5 | 28 | 35 |
| 12 | 07 | 0886 | 376 | 4D | F6 | 28 | 36 |
| 12 | 08 | 0887 | 377 | 4D | F7 | 28 | 37 |
| 12 | 09 | 0888 | 378 | 4D | F8 | 28 | 38 |
| 12 | 10 | 0889 | 379 | 4D | F9 | 28 | 39 |
| 12 | 11 | 0890 | 37A | 4D | 7A | 28 | 3A |
| 12 | 12 | 0891 | 37B | 4D | 7B | 28 | 23 |
| 12 | 13 | 0892 | 37C | 4D | 7C | 28 | 40 |
| 12 | 14 | 0893 | 37D | 4D | 7D | 28 | 27 |
| 12 | 15 | 0894 | 37E | 4D | 7E | 28 | 3D |
| 12 | 16 | 0895 | 37F | 4D | 7F | 28 | 22 |
| 12 | 17 | 0896 | 380 | 4E | 40 | 2B | 20 |
| 12 | 18 | 0897 | 381 | 4E | C1 | 2B | 41 |
| 12 | 19 | 0898 | 382 | 4E | C2 | 2B | 42 |
| 12 | 20 | 0899 | 383 | 4E | C3 | 2B | 43 |
| 12 | 21 | 0900 | 384 | 4E | C4 | 2B | 44 |
| 12 | 22 | 0901 | 385 | 4E | C5 | 2B | 45 |
| 12 | 23 | 0902 | 386 | 4E | C6 | 2B | 46 |
| 12 | 24 | 0903 | 387 | 4E | C7 | 2B | 47 |
| 12 | 25 | 0904 | 388 | 4E | C8 | 2B | 48 |
| 12 | 26 | 0905 | 389 | 4E | C9 | 2B | 49 |
| 12 | 27 | 0906 | 38A | 4E | 4A | 2B | 5B |
| 12 | 28 | 0907 | 38B | 4E | 4B | 2B | 2E |
| 12 | 29 | 0908 | 38C | 4E | 4C | 2B | 3C |
| 12 | 30 | 0909 | 38D | 4E | 4D | 2B | 28 |
| 12 | 31 | 0910 | 38E | 4E | 4E | 2B | 2B |
| 12 | 32 | 0911 | 38F | 4E | 4F | 2B | 21 |
| 12 | 33 | 0912 | 390 | 4E | 50 | 2B | 26 |
| 12 | 34 | 0913 | 391 | 4E | D1 | 2B | 4A |
| 12 | 35 | 0914 | 392 | 4E | D2 | 2B | 4B |
| 12 | 36 | 0915 | 393 | 4E | D3 | 2B | 4C |
| 12 | 37 | 0916 | 394 | 4E | D4 | 2B | 4D |
| 12 | 38 | 0917 | 395 | 4E | D5 | 2B | 4E |
| 12 | 39 | 0918 | 396 | 4E | D6 | 2B | 4F |
| 12 | 40 | 0919 | 397 | 4E | D7 | 2B | 50 |
| 12 | 41 | 0920 | 398 | 4E | D8 | 2B | 51 |
| 12 | 42 | 0921 | 399 | 4E | D9 | 2B | 52 |
| 12 | 43 | 0922 | 39A | 4E | 5A | 2B | 5D |
| 12 | 44 | 0923 | 39B | 4E | 5B | 2B | 24 |
| 12 | 45 | 0924 | 39C | 4E | 5C | 2B | 2A |
| 12 | 46 | 0925 | 39D | 4E | 5D | 2B | 29 |
| 12 | 47 | 0926 | 39E | 4E | 5E | 2B | 3B |
| 12 | 48 | 0927 | 39F | 4E | 5F | 2B | 5E |
| 12 | 49 | 0928 | 3A0 | 4E | 60 | 2B | 2D |
| 12 | 50 | 0929 | 3A1 | 4E | 61 | 2B | 2F |

| 80 Col | | Position | | Buffer Address (Hex) | | | |
|----------|----------|------------|------------|----------------------|----|--------------|----|
| <u>R</u> | <u>C</u> | <u>Dec</u> | <u>Hex</u> | <u>EBCDIC</u> | | <u>ASCII</u> | |
| 12 | 51 | 0930 | 3A2 | 4E | E2 | 2B | 53 |
| 12 | 52 | 0931 | 3A3 | 4E | E3 | 2B | 54 |
| 12 | 53 | 0932 | 3A4 | 4E | E4 | 2B | 55 |
| 12 | 54 | 0933 | 3A5 | 4E | E5 | 2B | 56 |
| 12 | 55 | 0934 | 3A6 | 4E | E6 | 2B | 57 |
| 12 | 56 | 0935 | 3A7 | 4E | E7 | 2B | 58 |
| 12 | 57 | 0936 | 3A8 | 4E | E8 | 2B | 59 |
| 12 | 58 | 0937 | 3A9 | 4E | E9 | 2B | 5A |
| 12 | 59 | 0938 | 3AA | 4E | 6A | 2B | 7C |
| 12 | 60 | 0939 | 3AB | 4E | 6B | 2B | 2C |
| 12 | 61 | 0940 | 3AC | 4E | 6C | 2B | 25 |
| 12 | 62 | 0941 | 3AD | 4E | 6D | 2B | 5F |
| 12 | 63 | 0942 | 3AE | 4E | 6E | 2B | 3E |
| 12 | 64 | 0943 | 3AF | 4E | 6F | 2B | 3F |
| 12 | 65 | 0944 | 3B0 | 4E | F0 | 2B | 30 |
| 12 | 66 | 0945 | 3B1 | 4E | F1 | 2B | 31 |
| 12 | 67 | 0946 | 3B2 | 4E | F2 | 2B | 32 |
| 12 | 68 | 0947 | 3B3 | 4E | F3 | 2B | 33 |
| 12 | 69 | 0948 | 3B4 | 4E | F4 | 2B | 34 |
| 12 | 70 | 0949 | 3B5 | 4E | F5 | 2B | 35 |
| 12 | 71 | 0950 | 3B6 | 4E | F6 | 2B | 36 |
| 12 | 72 | 0951 | 3B7 | 4E | F7 | 2B | 37 |
| 12 | 73 | 0952 | 3B8 | 4E | F8 | 2B | 38 |
| 12 | 74 | 0953 | 3B9 | 4E | F9 | 2B | 39 |
| 12 | 75 | 0954 | 3BA | 4E | 7A | 2B | 3A |
| 12 | 76 | 0955 | 3BB | 4E | 7B | 2B | 23 |
| 12 | 77 | 0956 | 3BC | 4E | 7C | 2B | 40 |
| 12 | 78 | 0957 | 3BD | 4E | 7D | 2B | 27 |
| 12 | 79 | 0958 | 3BE | 4E | 7E | 2B | 3D |
| 12 | 80 | 0959 | 3BF | 4E | 7F | 2B | 22 |
| 13 | 01 | 0960 | 3C0 | 4F | 40 | 21 | 20 |
| 13 | 02 | 0961 | 3C1 | 4F | C1 | 21 | 41 |
| 13 | 03 | 0962 | 3C2 | 4F | C2 | 21 | 42 |
| 13 | 04 | 0963 | 3C3 | 4F | C3 | 21 | 43 |
| 13 | 05 | 0964 | 3C4 | 4F | C4 | 21 | 44 |
| 13 | 06 | 0965 | 3C5 | 4F | C5 | 21 | 45 |
| 13 | 07 | 0966 | 3C6 | 4F | C6 | 21 | 46 |
| 13 | 08 | 0967 | 3C7 | 4F | C7 | 21 | 47 |
| 13 | 09 | 0968 | 3C8 | 4F | C8 | 21 | 48 |
| 13 | 10 | 0969 | 3C9 | 4F | C9 | 21 | 49 |
| 13 | 11 | 0970 | 3CA | 4F | 4A | 21 | 5B |
| 13 | 12 | 0971 | 3CB | 4F | 4B | 21 | 2E |
| 13 | 13 | 0972 | 3CC | 4F | 4C | 21 | 3C |
| 13 | 14 | 0973 | 3CD | 4F | 4D | 21 | 28 |
| 13 | 15 | 0974 | 3CE | 4F | 4E | 21 | 2B |
| 13 | 16 | 0975 | 3CF | 4F | 4F | 21 | 21 |
| 13 | 17 | 0976 | 3D0 | 4F | 50 | 21 | 26 |
| 13 | 18 | 0977 | 3D1 | 4F | D1 | 21 | 4A |
| 13 | 19 | 0978 | 3D2 | 4F | D2 | 21 | 4B |
| 13 | 20 | 0979 | 3D3 | 4F | D3 | 21 | 4C |
| 13 | 21 | 0980 | 3D4 | 4F | D4 | 21 | 4D |
| 13 | 22 | 0981 | 3D5 | 4F | D5 | 21 | 4E |
| 13 | 23 | 0982 | 3D6 | 4F | D6 | 21 | 4F |
| 13 | 24 | 0983 | 3D7 | 4F | D7 | 21 | 50 |
| 13 | 25 | 0984 | 3D8 | 4F | D8 | 21 | 51 |
| 13 | 26 | 0985 | 3D9 | 4F | D9 | 21 | 52 |
| 13 | 27 | 0986 | 3DA | 4F | 5A | 21 | 5D |
| 13 | 28 | 0987 | 3DB | 4F | 5B | 21 | 24 |
| 13 | 29 | 0988 | 3DC | 4F | 5C | 21 | 2A |
| 13 | 30 | 0989 | 3DD | 4F | 5D | 21 | 29 |
| 13 | 31 | 0990 | 3DE | 4F | 5E | 21 | 3B |
| 13 | 32 | 0991 | 3DF | 4F | 5F | 21 | 5E |

| 80 Col | | Position | | Buffer Address (Hex) | | | |
|--------|----|----------|-----|----------------------|----|-------|----|
| R | C | Dec | Hex | EBCDIC | | ASCII | |
| 13 | 33 | 0992 | 3E0 | 4F | 60 | 21 | 2D |
| 13 | 34 | 0993 | 3E1 | 4F | 61 | 21 | 2F |
| 13 | 35 | 0994 | 3E2 | 4F | E2 | 21 | 53 |
| 13 | 36 | 0995 | 3E3 | 4F | E3 | 21 | 54 |
| 13 | 37 | 0996 | 3E4 | 4F | E4 | 21 | 55 |
| 13 | 38 | 0997 | 3E5 | 4F | E5 | 21 | 56 |
| 13 | 39 | 0998 | 3E6 | 4F | E6 | 21 | 57 |
| 13 | 40 | 0999 | 3E7 | 4F | E7 | 21 | 58 |
| 13 | 41 | 1000 | 3E8 | 4F | E8 | 21 | 59 |
| 13 | 42 | 1001 | 3E9 | 4F | E9 | 21 | 5A |
| 13 | 43 | 1002 | 3EA | 4F | 6A | 21 | 7C |
| 13 | 44 | 1003 | 3EB | 4F | 6B | 21 | 2C |
| 13 | 45 | 1004 | 3EC | 4F | 6C | 21 | 25 |
| 13 | 46 | 1005 | 3ED | 4F | 6D | 21 | 5F |
| 13 | 47 | 1006 | 3EE | 4F | 6E | 21 | 3E |
| 13 | 48 | 1007 | 3EF | 4F | 6F | 21 | 3F |
| 13 | 49 | 1008 | 3F0 | 4F | F0 | 21 | 30 |
| 13 | 50 | 1009 | 3F1 | 4F | F1 | 21 | 31 |
| 13 | 51 | 1010 | 3F2 | 4F | F2 | 21 | 32 |
| 13 | 52 | 1011 | 3F3 | 4F | F3 | 21 | 33 |
| 13 | 53 | 1012 | 3F4 | 4F | F4 | 21 | 34 |
| 13 | 54 | 1013 | 3F5 | 4F | F5 | 21 | 35 |
| 13 | 55 | 1014 | 3F6 | 4F | F6 | 21 | 36 |
| 13 | 56 | 1015 | 3F7 | 4F | F7 | 21 | 37 |
| 13 | 57 | 1016 | 3F8 | 4F | F8 | 21 | 38 |
| 13 | 58 | 1017 | 3F9 | 4F | F9 | 21 | 39 |
| 13 | 59 | 1018 | 3FA | 4F | 7A | 21 | 3A |
| 13 | 60 | 1019 | 3FB | 4F | 7B | 21 | 23 |
| 13 | 61 | 1020 | 3FC | 4F | 7C | 21 | 40 |
| 13 | 62 | 1021 | 3FD | 4F | 7D | 21 | 27 |
| 13 | 63 | 1022 | 3FE | 4F | 7E | 21 | 3D |
| 13 | 64 | 1023 | 3FF | 4F | 7F | 21 | 22 |
| 13 | 65 | 1024 | 400 | 50 | 40 | 26 | 20 |
| 13 | 66 | 1025 | 401 | 50 | C1 | 26 | 41 |
| 13 | 67 | 1026 | 402 | 50 | C2 | 26 | 42 |
| 13 | 68 | 1027 | 403 | 50 | C3 | 26 | 43 |
| 13 | 69 | 1028 | 404 | 50 | C4 | 26 | 44 |
| 13 | 70 | 1029 | 405 | 50 | C5 | 26 | 45 |
| 13 | 71 | 1030 | 406 | 50 | C6 | 26 | 46 |
| 13 | 72 | 1031 | 407 | 50 | C7 | 26 | 47 |
| 13 | 73 | 1032 | 408 | 50 | C8 | 26 | 48 |
| 13 | 74 | 1033 | 409 | 50 | C9 | 26 | 49 |
| 13 | 75 | 1034 | 40A | 50 | 4A | 26 | 5B |
| 13 | 76 | 1035 | 40B | 50 | 4B | 26 | 2E |
| 13 | 77 | 1036 | 40C | 50 | 4C | 26 | 3C |
| 13 | 78 | 1037 | 40D | 50 | 4D | 26 | 28 |
| 13 | 79 | 1038 | 40E | 50 | 4E | 26 | 2B |
| 13 | 80 | 1039 | 40F | 50 | 4F | 26 | 21 |
| 14 | 01 | 1040 | 410 | 50 | 50 | 26 | 26 |
| 14 | 02 | 1041 | 411 | 50 | D1 | 26 | 4A |
| 14 | 03 | 1042 | 412 | 50 | D2 | 26 | 4B |
| 14 | 04 | 1043 | 413 | 50 | D3 | 26 | 4C |
| 14 | 05 | 1044 | 414 | 50 | D4 | 26 | 4D |
| 14 | 06 | 1045 | 415 | 50 | D5 | 26 | 4E |
| 14 | 07 | 1046 | 416 | 50 | D6 | 26 | 4F |
| 14 | 08 | 1047 | 417 | 50 | D7 | 26 | 50 |
| 14 | 09 | 1048 | 418 | 50 | D8 | 26 | 51 |
| 14 | 10 | 1049 | 419 | 50 | D9 | 26 | 52 |
| 14 | 11 | 1050 | 41A | 50 | 5A | 26 | 5D |
| 14 | 12 | 1051 | 41B | 50 | 5B | 26 | 24 |
| 14 | 13 | 1052 | 41C | 50 | 5C | 26 | 2A |
| 14 | 14 | 1053 | 41D | 50 | 5D | 26 | 29 |

| 80 Col | | Position | | Buffer Address (Hex) | | | |
|--------|----|----------|-----|----------------------|----|-------|----|
| R | C | Dec | Hex | EBCDIC | | ASCII | |
| 14 | 15 | 1054 | 41E | 50 | 5E | 26 | 3B |
| 14 | 16 | 1055 | 41F | 50 | 5F | 26 | 5E |
| 14 | 17 | 1056 | 420 | 50 | 60 | 26 | 2D |
| 14 | 18 | 1057 | 421 | 50 | 61 | 26 | 2F |
| 14 | 19 | 1058 | 422 | 50 | E2 | 26 | 53 |
| 14 | 20 | 1059 | 423 | 50 | E3 | 26 | 54 |
| 14 | 21 | 1060 | 424 | 50 | E4 | 26 | 55 |
| 14 | 22 | 1061 | 425 | 50 | E5 | 26 | 56 |
| 14 | 23 | 1062 | 426 | 50 | E6 | 26 | 57 |
| 14 | 24 | 1063 | 427 | 50 | E7 | 26 | 58 |
| 14 | 25 | 1064 | 428 | 50 | E8 | 26 | 59 |
| 14 | 26 | 1065 | 429 | 50 | E9 | 26 | 5A |
| 14 | 27 | 1066 | 42A | 50 | 6A | 26 | 7C |
| 14 | 28 | 1067 | 42B | 50 | 6B | 26 | 2C |
| 14 | 29 | 1068 | 42C | 60 | 6C | 26 | 25 |
| 14 | 30 | 1069 | 42D | 50 | 6D | 26 | 5F |
| 14 | 31 | 1070 | 42E | 50 | 6E | 26 | 3E |
| 14 | 32 | 1071 | 42F | 50 | 6F | 26 | 3F |
| 14 | 33 | 1072 | 430 | 50 | F0 | 26 | 30 |
| 14 | 34 | 1073 | 431 | 50 | F1 | 26 | 31 |
| 14 | 35 | 1074 | 432 | 50 | F2 | 26 | 32 |
| 14 | 36 | 1075 | 433 | 50 | F3 | 26 | 33 |
| 14 | 37 | 1076 | 434 | 50 | F4 | 26 | 34 |
| 14 | 38 | 1077 | 435 | 50 | F5 | 26 | 35 |
| 14 | 39 | 1078 | 436 | 50 | F6 | 26 | 36 |
| 14 | 40 | 1079 | 437 | 50 | F7 | 26 | 37 |
| 14 | 41 | 1080 | 438 | 50 | F8 | 26 | 38 |
| 14 | 42 | 1081 | 439 | 50 | F9 | 26 | 39 |
| 14 | 43 | 1082 | 43A | 50 | 7A | 26 | 3A |
| 14 | 44 | 1083 | 43B | 50 | 7B | 26 | 23 |
| 14 | 45 | 1084 | 43C | 50 | 7C | 26 | 40 |
| 14 | 46 | 1085 | 43D | 50 | 7D | 26 | 27 |
| 14 | 47 | 1086 | 43E | 50 | 7E | 26 | 3D |
| 14 | 48 | 1087 | 43F | 50 | 7F | 26 | 22 |
| 14 | 49 | 1088 | 440 | D1 | 40 | 4A | 20 |
| 14 | 50 | 1089 | 441 | D1 | C1 | 4A | 41 |
| 14 | 51 | 1090 | 442 | D1 | C2 | 4A | 42 |
| 14 | 52 | 1091 | 443 | D1 | C3 | 4A | 43 |
| 14 | 53 | 1092 | 444 | D1 | C4 | 4A | 44 |
| 14 | 54 | 1093 | 445 | D1 | C5 | 4A | 45 |
| 14 | 55 | 1094 | 446 | D1 | C6 | 4A | 46 |
| 14 | 56 | 1095 | 447 | D1 | C7 | 4A | 47 |
| 14 | 57 | 1096 | 448 | D1 | C8 | 4A | 48 |
| 14 | 58 | 1097 | 449 | D1 | C9 | 4A | 49 |
| 14 | 59 | 1098 | 44A | D1 | 4A | 4A | 5B |
| 14 | 60 | 1099 | 44B | D1 | 4B | 4A | 2E |
| 14 | 61 | 1100 | 44C | D1 | 4C | 4A | 3C |
| 14 | 62 | 1101 | 44D | D1 | 4D | 4A | 28 |
| 14 | 63 | 1102 | 44E | D1 | 4E | 4A | 2B |
| 14 | 64 | 1103 | 44F | D1 | 4F | 4A | 21 |
| 14 | 65 | 1104 | 450 | D1 | 50 | 4A | 26 |
| 14 | 66 | 1105 | 451 | D1 | D1 | 4A | 4A |
| 14 | 67 | 1106 | 452 | D1 | D2 | 4A | 4B |
| 14 | 68 | 1107 | 453 | D1 | D3 | 4A | 4C |
| 14 | 69 | 1108 | 454 | D1 | D4 | 4A | 4D |
| 14 | 70 | 1109 | 455 | D1 | D5 | 4A | 4E |
| 14 | 71 | 1110 | 456 | D1 | D6 | 4A | 4F |
| 14 | 72 | 1111 | 457 | D1 | D7 | 4A | 50 |
| 14 | 73 | 1112 | 458 | D1 | D8 | 4A | 51 |
| 14 | 74 | 1113 | 459 | D1 | D9 | 4A | 52 |
| 14 | 75 | 1114 | 45A | D1 | 5A | 4A | 5D |
| 14 | 76 | 1115 | 45B | D1 | 5B | 4A | 24 |

| 80 Col | | Position | | Buffer Address (Hex) | | | |
|--------|----|----------|-----|----------------------|----|-------|----|
| R | C | Dec | Hex | EBCDIC | | ASCII | |
| 14 | 77 | 1116 | 45C | D1 | 5C | 4A | 2A |
| 14 | 78 | 1117 | 45D | D1 | 5D | 4A | 29 |
| 14 | 79 | 1118 | 45E | D1 | 5E | 4A | 3B |
| 14 | 80 | 1119 | 45F | D1 | 5F | 4A | 5E |
| 15 | 01 | 1120 | 460 | D1 | 60 | 4A | 2D |
| 15 | 02 | 1121 | 461 | D1 | 61 | 4A | 2F |
| 15 | 03 | 1122 | 462 | D1 | E2 | 4A | 53 |
| 15 | 04 | 1123 | 463 | D1 | E3 | 4A | 54 |
| 15 | 05 | 1124 | 464 | D1 | E4 | 4A | 55 |
| 15 | 06 | 1125 | 465 | D1 | E5 | 4A | 56 |
| 15 | 07 | 1126 | 466 | D1 | E6 | 4A | 57 |
| 15 | 08 | 1127 | 467 | D1 | E7 | 4A | 58 |
| 15 | 09 | 1128 | 468 | D1 | E8 | 4A | 59 |
| 15 | 10 | 1129 | 469 | D1 | E9 | 4A | 5A |
| 15 | 11 | 1130 | 46A | D1 | 6A | 4A | 7C |
| 15 | 12 | 1131 | 46B | D1 | 6B | 4A | 2C |
| 15 | 13 | 1132 | 46C | D1 | 6C | 4A | 25 |
| 15 | 14 | 1133 | 46D | D1 | 6D | 4A | 5F |
| 15 | 15 | 1134 | 46E | D1 | 6E | 4A | 3E |
| 15 | 16 | 1135 | 46F | D1 | 6F | 4A | 3F |
| 15 | 17 | 1136 | 470 | D1 | F0 | 4A | 30 |
| 15 | 18 | 1137 | 471 | D1 | F1 | 4A | 31 |
| 15 | 19 | 1138 | 472 | D1 | F2 | 4A | 32 |
| 15 | 20 | 1139 | 473 | D1 | F3 | 4A | 33 |
| 15 | 21 | 1140 | 474 | D1 | F4 | 4A | 34 |
| 15 | 22 | 1141 | 475 | D1 | F5 | 4A | 35 |
| 15 | 23 | 1142 | 476 | D1 | F6 | 4A | 36 |
| 15 | 24 | 1143 | 477 | D1 | F7 | 4A | 37 |
| 15 | 25 | 1144 | 478 | D1 | F8 | 4A | 38 |
| 15 | 26 | 1145 | 479 | D1 | F9 | 4A | 39 |
| 15 | 27 | 1146 | 47A | D1 | 7A | 4A | 3A |
| 15 | 28 | 1147 | 47B | D1 | 7B | 4A | 23 |
| 15 | 29 | 1148 | 47C | D1 | 7C | 4A | 40 |
| 15 | 30 | 1149 | 47D | D1 | 7D | 4A | 27 |
| 15 | 31 | 1150 | 47E | D1 | 7E | 4A | 3D |
| 15 | 32 | 1151 | 47F | D1 | 7F | 4A | 22 |
| 15 | 33 | 1152 | 480 | D2 | 40 | 4B | 20 |
| 15 | 34 | 1153 | 481 | D2 | C1 | 4B | 41 |
| 15 | 35 | 1154 | 482 | D2 | C2 | 4B | 42 |
| 15 | 36 | 1155 | 483 | D2 | C3 | 4B | 43 |
| 15 | 37 | 1156 | 484 | D2 | C4 | 4B | 44 |
| 15 | 38 | 1157 | 485 | D2 | C5 | 4B | 45 |
| 15 | 39 | 1158 | 486 | D2 | C6 | 4B | 46 |
| 15 | 40 | 1159 | 487 | D2 | C7 | 4B | 47 |
| 15 | 41 | 1160 | 488 | D2 | C8 | 4B | 48 |
| 15 | 42 | 1161 | 489 | D2 | C9 | 4B | 49 |
| 15 | 43 | 1162 | 48A | D2 | 4A | 4B | 5B |
| 15 | 44 | 1163 | 48B | D2 | 4B | 4B | 2E |
| 15 | 45 | 1164 | 48C | D2 | 4C | 4B | 3C |
| 15 | 46 | 1165 | 48D | D2 | 4D | 4B | 28 |
| 15 | 47 | 1166 | 48E | D2 | 4E | 4B | 2B |
| 15 | 48 | 1167 | 48F | D2 | 4F | 4B | 21 |
| 15 | 49 | 1168 | 490 | D2 | 50 | 4B | 26 |
| 15 | 50 | 1169 | 491 | D2 | D1 | 4B | 4A |
| 15 | 51 | 1170 | 492 | D2 | D2 | 4B | 4B |
| 15 | 52 | 1171 | 493 | D2 | D3 | 4B | 4C |
| 15 | 53 | 1172 | 494 | D2 | D4 | 4B | 4D |
| 15 | 54 | 1173 | 495 | D2 | D5 | 4B | 4E |
| 15 | 55 | 1174 | 496 | D2 | D6 | 4B | 4F |
| 15 | 56 | 1175 | 497 | D2 | D7 | 4B | 50 |
| 15 | 57 | 1176 | 498 | D2 | D8 | 4B | 51 |
| 15 | 58 | 1177 | 499 | D2 | D9 | 4B | 52 |

| 80 Col | | Position | | Buffer Address (Hex) | |
|--------|----|----------|-----|----------------------|-------|
| R | C | Dec | Hex | EBCDIC | ASCII |
| 15 | 59 | 1178 | 49A | D2 5A | 4B 5D |
| 15 | 60 | 1179 | 49B | D2 5B | 4B 24 |
| 15 | 61 | 1180 | 49C | D2 5C | 4B 2A |
| 15 | 62 | 1181 | 49D | D2 5D | 4B 29 |
| 15 | 63 | 1182 | 49E | D2 5E | 4B 3B |
| 15 | 64 | 1183 | 49F | D2 5F | 4B 5E |
| 15 | 65 | 1184 | 4A0 | D2 60 | 4B 2D |
| 15 | 66 | 1185 | 4A1 | D2 61 | 4B 2F |
| 15 | 67 | 1186 | 4A2 | D2 E2 | 4B 53 |
| 15 | 68 | 1187 | 4A3 | D2 E3 | 4B 54 |
| 15 | 69 | 1188 | 4A4 | D2 E4 | 4B 55 |
| 15 | 70 | 1189 | 4A5 | D2 E5 | 4B 56 |
| 15 | 71 | 1190 | 4A6 | D2 E6 | 4B 57 |
| 15 | 72 | 1191 | 4A7 | D2 E7 | 4B 58 |
| 15 | 73 | 1192 | 4A8 | D2 E8 | 4B 59 |
| 15 | 74 | 1193 | 4A9 | D2 E9 | 4B 5A |
| 15 | 75 | 1194 | 4AA | D2 6A | 4B 7C |
| 15 | 76 | 1195 | 4AB | D2 6B | 4B 2C |
| 15 | 77 | 1196 | 4AC | D2 6C | 4B 25 |
| 15 | 78 | 1197 | 4AD | D2 6D | 4B 5F |
| 15 | 79 | 1198 | 4AE | D2 6E | 4B 3E |
| 15 | 80 | 1199 | 4AF | D2 6F | 4B 3F |
| 16 | 01 | 1200 | 4B0 | D2 F0 | 4B 30 |
| 16 | 02 | 1201 | 4B1 | D2 F1 | 4B 31 |
| 16 | 03 | 1202 | 4B2 | D2 F2 | 4B 32 |
| 16 | 04 | 1203 | 4B3 | D2 F3 | 4B 33 |
| 16 | 05 | 1204 | 4B4 | D2 F4 | 4B 34 |
| 16 | 06 | 1205 | 4B5 | D2 F5 | 4B 35 |
| 16 | 07 | 1206 | 4B6 | D2 F6 | 4B 36 |
| 16 | 08 | 1207 | 4B7 | D2 F7 | 4B 37 |
| 16 | 09 | 1208 | 4B8 | D2 F8 | 4B 38 |
| 16 | 10 | 1209 | 4B9 | D2 F9 | 4B 39 |
| 16 | 11 | 1210 | 4BA | D2 7A | 4B 3A |
| 16 | 12 | 1211 | 4BB | D2 7B | 4B 23 |
| 16 | 13 | 1212 | 4BC | D2 7C | 4B 40 |
| 16 | 14 | 1213 | 4BD | D2 7D | 4B 27 |
| 16 | 15 | 1214 | 4BE | D2 7E | 4B 3D |
| 16 | 16 | 1215 | 4BF | D2 7F | 4B 22 |
| 16 | 17 | 1216 | 4C0 | D3 40 | 4C 20 |
| 16 | 18 | 1217 | 4C1 | D3 C1 | 4C 41 |
| 16 | 19 | 1218 | 4C2 | D3 C2 | 4C 42 |
| 16 | 20 | 1219 | 4C3 | D3 C3 | 4C 43 |
| 16 | 21 | 1220 | 4C4 | D3 C4 | 4C 44 |
| 16 | 22 | 1221 | 4C5 | D3 C5 | 4C 45 |
| 16 | 23 | 1222 | 4C6 | D3 C6 | 4C 46 |
| 16 | 24 | 1223 | 4C7 | D3 C7 | 4C 47 |
| 16 | 25 | 1224 | 4C8 | D3 C8 | 4C 48 |
| 16 | 26 | 1225 | 4C9 | D3 C9 | 4C 49 |
| 16 | 27 | 1226 | 4CA | D3 4A | 4C 5B |
| 16 | 28 | 1227 | 4CB | D3 4B | 4C 2E |
| 16 | 29 | 1228 | 4CC | D3 4C | 4C 3C |
| 16 | 30 | 1229 | 4CD | D3 4D | 4C 28 |
| 16 | 31 | 1230 | 4CE | D3 4E | 4C 2B |
| 16 | 32 | 1231 | 4CF | D3 4F | 4C 21 |
| 16 | 33 | 1232 | 4D0 | D3 50 | 4C 26 |
| 16 | 34 | 1233 | 4D1 | D3 D1 | 4C 4A |
| 16 | 35 | 1234 | 4D2 | D3 D2 | 4C 4B |
| 16 | 36 | 1235 | 4D3 | D3 D3 | 4C 4C |
| 16 | 37 | 1236 | 4D4 | D3 D4 | 4C 4D |
| 16 | 38 | 1237 | 4D5 | D3 D5 | 4C 4E |
| 16 | 39 | 1238 | 4D6 | D3 D6 | 4C 4F |
| 16 | 40 | 1239 | 4D7 | D3 D7 | 4C 50 |

| 80 Col | | Position | | Buffer Address (Hex) | | | |
|--------|----|----------|-----|----------------------|----|-------|----|
| R | C | Dec | Hex | EBCDIC | | ASCII | |
| 16 | 41 | 1240 | 4D8 | D3 | D8 | 4C | 51 |
| 16 | 42 | 1241 | 4D9 | D3 | D9 | 4C | 52 |
| 16 | 43 | 1242 | 4DA | D3 | 5A | 4C | 53 |
| 16 | 44 | 1243 | 4DB | D3 | 5B | 4C | 24 |
| 16 | 45 | 1244 | 4DC | D3 | 5C | 4C | 2A |
| 16 | 46 | 1245 | 4DD | D3 | 5D | 4C | 29 |
| 16 | 47 | 1246 | 4DE | D3 | 5E | 4C | 3B |
| 16 | 48 | 1247 | 4DF | D3 | 5F | 4C | 5E |
| 16 | 49 | 1248 | 4E0 | D3 | 60 | 4C | 2D |
| 16 | 50 | 1249 | 4E1 | D3 | 61 | 4C | 2F |
| 16 | 51 | 1250 | 4E2 | D3 | E2 | 4C | 53 |
| 16 | 52 | 1251 | 4E3 | D3 | E3 | 4C | 54 |
| 16 | 53 | 1252 | 4E4 | D3 | E4 | 4C | 55 |
| 16 | 54 | 1253 | 4E5 | D3 | E5 | 4C | 56 |
| 16 | 55 | 1254 | 4E6 | D3 | E6 | 4C | 57 |
| 16 | 56 | 1255 | 4E7 | D3 | E7 | 4C | 58 |
| 16 | 57 | 1256 | 4E8 | D3 | E8 | 4C | 59 |
| 16 | 58 | 1257 | 4E9 | D3 | E9 | 4C | 5A |
| 16 | 59 | 1258 | 4EA | D3 | 6A | 4C | 7C |
| 16 | 60 | 1259 | 4EB | D3 | 6B | 4C | 2C |
| 16 | 61 | 1260 | 4EC | D3 | 6C | 4C | 25 |
| 16 | 62 | 1261 | 4ED | D3 | 6D | 4C | 5F |
| 16 | 63 | 1262 | 4EE | D3 | 6E | 4C | 3E |
| 16 | 64 | 1263 | 4EF | D3 | 6F | 4C | 3F |
| 16 | 65 | 1264 | 4F0 | D3 | F0 | 4C | 30 |
| 16 | 66 | 1265 | 4F1 | D3 | F1 | 4C | 31 |
| 16 | 67 | 1266 | 4F2 | D3 | F2 | 4C | 32 |
| 16 | 68 | 1267 | 4F3 | D3 | F3 | 4C | 33 |
| 16 | 69 | 1268 | 4F4 | D3 | F4 | 4C | 34 |
| 16 | 70 | 1269 | 4F5 | D3 | F5 | 4C | 35 |
| 16 | 71 | 1270 | 4F6 | D3 | F6 | 4C | 36 |
| 16 | 72 | 1271 | 4F7 | D3 | F7 | 4C | 37 |
| 16 | 73 | 1272 | 4F8 | D3 | F8 | 4C | 38 |
| 16 | 74 | 1273 | 4F9 | D3 | F9 | 4C | 39 |
| 16 | 75 | 1274 | 4FA | D3 | 7A | 4C | 3A |
| 16 | 76 | 1275 | 4FB | D3 | 7B | 4C | 23 |
| 16 | 77 | 1276 | 4FC | D3 | 7C | 4C | 40 |
| 16 | 78 | 1277 | 4FD | D3 | 7D | 4C | 27 |
| 16 | 79 | 1278 | 4FE | D3 | 7E | 4C | 3D |
| 16 | 80 | 1279 | 4FF | D3 | 7F | 4C | 22 |
| 17 | 01 | 1280 | 500 | D4 | 40 | 4D | 20 |
| 17 | 02 | 1281 | 501 | D4 | C1 | 4D | 41 |
| 17 | 03 | 1282 | 502 | D4 | C2 | 4D | 42 |
| 17 | 04 | 1283 | 503 | D4 | C3 | 4D | 43 |
| 17 | 05 | 1284 | 504 | D4 | C4 | 4D | 44 |
| 17 | 06 | 1285 | 505 | D4 | C5 | 4D | 45 |
| 17 | 07 | 1286 | 506 | D4 | C6 | 4D | 46 |
| 17 | 08 | 1287 | 507 | D4 | C7 | 4D | 47 |
| 17 | 09 | 1288 | 508 | D4 | C8 | 4D | 48 |
| 17 | 10 | 1289 | 509 | D4 | C9 | 4D | 49 |
| 17 | 11 | 1290 | 50A | D4 | 4A | 4D | 5B |
| 17 | 12 | 1291 | 50B | D4 | 4B | 4D | 2E |
| 17 | 13 | 1292 | 50C | D4 | 4C | 4D | 3C |
| 17 | 14 | 1293 | 50D | D4 | 4D | 4D | 28 |
| 17 | 15 | 1294 | 50E | D4 | 4E | 4D | 2B |
| 17 | 16 | 1295 | 50F | D4 | 4F | 4D | 21 |
| 17 | 17 | 1296 | 510 | D4 | 50 | 4D | 26 |
| 17 | 18 | 1297 | 511 | D4 | D1 | 4D | 4A |
| 17 | 19 | 1298 | 512 | D4 | D2 | 4D | 4B |
| 17 | 20 | 1299 | 513 | D4 | D3 | 4D | 4C |
| 17 | 21 | 1300 | 514 | D4 | D4 | 4D | 4D |
| 17 | 22 | 1301 | 515 | D4 | D5 | 4D | 4E |

| 80 Col | | Position | | Buffer Address (Hex) | | | |
|--------|----|----------|-----|----------------------|----|-------|----|
| R | C | Dec | Hex | EBCDIC | | ASCII | |
| 17 | 23 | 1302 | 516 | D4 | D6 | 4D | 4F |
| 17 | 24 | 1303 | 517 | D4 | D7 | 4D | 50 |
| 17 | 25 | 1304 | 518 | D4 | D8 | 4D | 51 |
| 17 | 26 | 1305 | 519 | D4 | D9 | 4D | 52 |
| 17 | 27 | 1306 | 51A | D4 | 5A | 4D | 5D |
| 17 | 28 | 1307 | 51B | D4 | 5B | 4D | 24 |
| 17 | 29 | 1308 | 51C | D4 | 5C | 4D | 2A |
| 17 | 30 | 1309 | 51D | D4 | 5D | 4D | 29 |
| 17 | 31 | 1310 | 51E | D4 | 5E | 4D | 3B |
| 17 | 32 | 1311 | 51F | D4 | 5F | 4D | 5E |
| 17 | 33 | 1312 | 520 | D4 | 60 | 4D | 2D |
| 17 | 34 | 1313 | 521 | D4 | 61 | 4D | 2F |
| 17 | 35 | 1314 | 522 | D4 | E2 | 4D | 53 |
| 17 | 36 | 1315 | 523 | D4 | E3 | 4D | 54 |
| 17 | 37 | 1316 | 524 | D4 | E4 | 4D | 55 |
| 17 | 38 | 1317 | 525 | D4 | E5 | 4D | 56 |
| 17 | 39 | 1318 | 526 | D4 | E6 | 4D | 57 |
| 17 | 40 | 1319 | 527 | D4 | E7 | 4D | 58 |
| 17 | 41 | 1320 | 528 | D4 | E8 | 4D | 59 |
| 17 | 42 | 1321 | 529 | D4 | E9 | 4D | 5A |
| 17 | 43 | 1322 | 52A | D4 | 6A | 4D | 7C |
| 17 | 44 | 1323 | 52B | D4 | 6B | 4D | 2C |
| 17 | 45 | 1324 | 52C | D4 | 6C | 4D | 25 |
| 17 | 46 | 1325 | 52D | D4 | 6D | 4D | 5F |
| 17 | 47 | 1326 | 52E | D4 | 6E | 4D | 3E |
| 17 | 48 | 1327 | 52F | D4 | 6F | 4D | 3F |
| 17 | 49 | 1328 | 530 | D4 | F0 | 4D | 30 |
| 17 | 50 | 1329 | 531 | D4 | F1 | 4D | 31 |
| 17 | 51 | 1330 | 532 | D4 | F2 | 4D | 32 |
| 17 | 52 | 1331 | 533 | D4 | F3 | 4D | 33 |
| 17 | 53 | 1332 | 534 | D4 | F4 | 4D | 34 |
| 17 | 54 | 1333 | 535 | D4 | F5 | 4D | 35 |
| 17 | 55 | 1334 | 536 | D4 | F6 | 4D | 36 |
| 17 | 56 | 1335 | 537 | D4 | F7 | 4D | 37 |
| 17 | 57 | 1336 | 538 | D4 | F8 | 4D | 38 |
| 17 | 58 | 1337 | 539 | D4 | F9 | 4D | 39 |
| 17 | 59 | 1338 | 53A | D4 | 7A | 4D | 3A |
| 17 | 60 | 1339 | 53B | D4 | 7B | 4D | 23 |
| 17 | 61 | 1340 | 53C | D4 | 7C | 4D | 40 |
| 17 | 62 | 1341 | 53D | D4 | 7D | 4D | 27 |
| 17 | 63 | 1342 | 53E | D4 | 7E | 4D | 3D |
| 17 | 64 | 1343 | 53F | D4 | 7F | 4D | 22 |
| 17 | 65 | 1344 | 540 | D5 | 40 | 4E | 20 |
| 17 | 66 | 1345 | 541 | D5 | C1 | 4E | 41 |
| 17 | 67 | 1346 | 542 | D5 | C2 | 4E | 42 |
| 17 | 68 | 1347 | 543 | D5 | C3 | 4E | 43 |
| 17 | 69 | 1348 | 544 | D5 | C4 | 4E | 44 |
| 17 | 70 | 1349 | 545 | D5 | C5 | 4E | 45 |
| 17 | 71 | 1350 | 546 | D5 | C6 | 4E | 46 |
| 17 | 72 | 1351 | 547 | D5 | C7 | 4E | 47 |
| 17 | 73 | 1352 | 548 | D5 | C8 | 4E | 48 |
| 17 | 74 | 1353 | 549 | D5 | C9 | 4E | 49 |
| 17 | 75 | 1354 | 54A | D5 | 4A | 4E | 5B |
| 17 | 76 | 1355 | 54B | D5 | 4B | 4E | 2E |
| 17 | 77 | 1356 | 54C | D5 | 4C | 4E | 3C |
| 17 | 78 | 1357 | 54D | D5 | 4D | 4E | 28 |
| 17 | 79 | 1358 | 54E | D5 | 4E | 4E | 2B |
| 17 | 80 | 1359 | 54F | D5 | 4F | 4E | 21 |
| 18 | 01 | 1360 | 550 | D5 | 50 | 4E | 26 |
| 18 | 02 | 1361 | 551 | D5 | D1 | 4E | 4A |
| 18 | 03 | 1362 | 552 | D5 | D2 | 4E | 4B |
| 18 | 04 | 1363 | 553 | D5 | D3 | 4E | 4C |
| 18 | 05 | 1364 | 554 | D5 | D4 | 4E | 4D |

| 80 Col | | Position | | Buffer Address (Hex) | | | |
|--------|----|----------|-----|----------------------|----|-------|----|
| R | C | Dec | Hex | EBCDIC | | ASCII | |
| 18 | 06 | 1365 | 555 | D5 | D5 | 4E | 4E |
| 18 | 07 | 1366 | 556 | D5 | D6 | 4E | 4F |
| 18 | 08 | 1367 | 557 | D5 | D7 | 4E | 50 |
| 18 | 09 | 1368 | 558 | D5 | D8 | 4E | 51 |
| 18 | 10 | 1369 | 559 | D5 | D9 | 4E | 52 |
| 18 | 11 | 1370 | 55A | D5 | 5A | 4E | 5D |
| 18 | 12 | 1371 | 55B | D5 | 5B | 4E | 24 |
| 18 | 13 | 1372 | 55C | D5 | 5C | 4E | 2A |
| 18 | 14 | 1373 | 55D | D5 | 5D | 4E | 29 |
| 18 | 15 | 1374 | 55E | D5 | 5E | 4E | 3B |
| 18 | 16 | 1375 | 55F | D5 | 5F | 4E | 5E |
| 18 | 17 | 1376 | 560 | D5 | 60 | 4E | 2D |
| 18 | 18 | 1377 | 561 | D5 | 61 | 4E | 2F |
| 18 | 19 | 1378 | 562 | D5 | E2 | 4E | 53 |
| 18 | 20 | 1379 | 563 | D5 | E3 | 4E | 54 |
| 18 | 21 | 1380 | 564 | D5 | E4 | 4E | 55 |
| 18 | 22 | 1381 | 565 | D5 | E5 | 4E | 56 |
| 18 | 23 | 1382 | 566 | D5 | F6 | 4E | 57 |
| 18 | 24 | 1383 | 567 | D5 | E7 | 4E | 58 |
| 18 | 25 | 1384 | 568 | D5 | E8 | 4E | 59 |
| 18 | 26 | 1385 | 569 | D5 | E9 | 4E | 5A |
| 18 | 27 | 1386 | 56A | D5 | 6A | 4E | 7C |
| 18 | 28 | 1387 | 56B | D5 | 6B | 4E | 2C |
| 18 | 29 | 1388 | 56C | D5 | 6C | 4E | 25 |
| 18 | 30 | 1389 | 56D | D5 | 6D | 4E | 5F |
| 18 | 31 | 1390 | 56E | D5 | 6E | 4E | 3E |
| 18 | 32 | 1391 | 56F | D5 | 6F | 4E | 3F |
| 18 | 33 | 1392 | 570 | D5 | F0 | 4E | 30 |
| 18 | 34 | 1393 | 571 | D5 | F1 | 4E | 31 |
| 18 | 35 | 1394 | 572 | D5 | F2 | 4E | 32 |
| 18 | 36 | 1395 | 573 | D5 | F3 | 4E | 33 |
| 18 | 37 | 1396 | 574 | D5 | F4 | 4E | 34 |
| 18 | 38 | 1397 | 575 | D5 | F5 | 4E | 35 |
| 18 | 39 | 1398 | 576 | D5 | F6 | 4E | 36 |
| 18 | 40 | 1399 | 577 | D5 | F7 | 4E | 37 |
| 18 | 41 | 1400 | 578 | D5 | F8 | 4E | 38 |
| 18 | 42 | 1401 | 579 | D5 | F9 | 4E | 39 |
| 18 | 43 | 1402 | 57A | D5 | 7A | 4E | 3A |
| 18 | 44 | 1403 | 57B | D5 | 7B | 4E | 23 |
| 18 | 45 | 1404 | 57C | D5 | 7C | 4E | 40 |
| 18 | 46 | 1405 | 57D | D5 | 7D | 4E | 27 |
| 18 | 47 | 1406 | 57E | D5 | 7E | 4E | 3D |
| 18 | 48 | 1407 | 57F | D5 | 7F | 4E | 22 |
| 18 | 49 | 1408 | 580 | D6 | 40 | 4F | 20 |
| 18 | 50 | 1409 | 581 | D6 | C1 | 4F | 41 |
| 18 | 51 | 1410 | 582 | D6 | C2 | 4F | 42 |
| 18 | 52 | 1411 | 583 | D6 | C3 | 4F | 43 |
| 18 | 53 | 1412 | 584 | D6 | C4 | 4F | 44 |
| 18 | 54 | 1413 | 585 | D6 | C5 | 4F | 45 |
| 18 | 55 | 1414 | 586 | D6 | C6 | 4F | 46 |
| 18 | 56 | 1415 | 587 | D6 | C7 | 4F | 47 |
| 18 | 57 | 1416 | 588 | D6 | C8 | 4F | 48 |
| 18 | 58 | 1417 | 589 | D6 | C9 | 4F | 49 |
| 18 | 59 | 1418 | 58A | D6 | 4A | 4F | 5B |
| 18 | 60 | 1419 | 58B | D6 | 4B | 4F | 2E |
| 18 | 61 | 1420 | 58C | D6 | 4C | 4F | 3C |
| 18 | 62 | 1421 | 58D | D6 | 4D | 4F | 28 |
| 18 | 63 | 1422 | 58E | D6 | 4E | 4F | 2B |
| 18 | 64 | 1423 | 58F | D6 | 4F | 4F | 21 |
| 18 | 65 | 1424 | 590 | D6 | 50 | 4F | 26 |
| 18 | 66 | 1425 | 591 | D6 | D1 | 4F | 4A |

| 80 Col | | Position | | Buffer Address (Hex) | | | |
|--------|----|----------|-----|----------------------|----|-------|----|
| R | C | Dec | Hex | EBCDIC | | ASCII | |
| 18 | 67 | 1426 | 592 | D6 | D2 | 4F | 4B |
| 18 | 68 | 1427 | 593 | D6 | D3 | 4F | 4C |
| 18 | 69 | 1428 | 594 | D6 | D4 | 4F | 4D |
| 18 | 70 | 1429 | 595 | D6 | D5 | 4F | 4E |
| 18 | 71 | 1430 | 596 | D6 | D6 | 4F | 4F |
| 18 | 72 | 1431 | 597 | D6 | D7 | 4F | 50 |
| 18 | 73 | 1432 | 598 | D6 | D8 | 4F | 51 |
| 18 | 74 | 1433 | 599 | D6 | D9 | 4F | 52 |
| 18 | 75 | 1434 | 59A | D6 | 5A | 4F | 5D |
| 18 | 76 | 1435 | 59B | D6 | 5B | 4F | 24 |
| 18 | 77 | 1436 | 59C | D6 | 5C | 4F | 2A |
| 18 | 78 | 1437 | 59D | D6 | 5D | 4F | 29 |
| 18 | 79 | 1438 | 59E | D6 | 5E | 4F | 3B |
| 18 | 80 | 1439 | 59F | D6 | 5F | 4F | 5E |
| 19 | 01 | 1440 | 5A0 | D6 | 60 | 4F | 2D |
| 19 | 02 | 1441 | 5A1 | D6 | 61 | 4F | 2F |
| 19 | 03 | 1442 | 5A2 | D6 | E2 | 4F | 53 |
| 19 | 04 | 1443 | 5A3 | D6 | E3 | 4F | 54 |
| 19 | 05 | 1444 | 5A4 | D6 | E4 | 4F | 55 |
| 19 | 06 | 1445 | 5A5 | D6 | E5 | 4F | 56 |
| 19 | 07 | 1446 | 5A6 | D6 | E6 | 4F | 57 |
| 19 | 08 | 1447 | 5A7 | D6 | E7 | 4F | 58 |
| 19 | 09 | 1448 | 5A8 | D6 | E8 | 4F | 59 |
| 19 | 10 | 1449 | 5A9 | D6 | E9 | 4F | 5A |
| 19 | 11 | 1450 | 5AA | D6 | 6A | 4F | 7C |
| 19 | 12 | 1451 | 5AB | D6 | 6B | 4F | 2C |
| 19 | 13 | 1452 | 5AC | D6 | 6C | 4F | 25 |
| 19 | 14 | 1453 | 5AD | D6 | 6D | 4F | 5F |
| 19 | 15 | 1454 | 5AE | D6 | 6E | 4F | 3E |
| 19 | 16 | 1455 | 5AF | D6 | 6F | 4F | 3F |
| 19 | 17 | 1456 | 5B0 | D6 | F0 | 4F | 30 |
| 19 | 18 | 1457 | 5B1 | D6 | F1 | 4F | 31 |
| 19 | 19 | 1458 | 5B2 | D6 | F2 | 4F | 32 |
| 19 | 20 | 1459 | 5B3 | D6 | F3 | 4F | 33 |
| 19 | 21 | 1460 | 5B4 | D6 | F4 | 4F | 34 |
| 19 | 22 | 1461 | 5B5 | D6 | F5 | 4F | 35 |
| 19 | 23 | 1462 | 5B6 | D6 | F6 | 4F | 36 |
| 19 | 24 | 1463 | 5B7 | D6 | F7 | 4F | 37 |
| 19 | 25 | 1464 | 5B8 | D6 | F8 | 4F | 38 |
| 19 | 26 | 1465 | 5B9 | D6 | F9 | 4F | 39 |
| 19 | 27 | 1466 | 5BA | D6 | 7A | 4F | 3A |
| 19 | 28 | 1467 | 5BB | D6 | 7B | 4F | 23 |
| 19 | 29 | 1468 | 5BC | D6 | 7C | 4F | 40 |
| 19 | 30 | 1469 | 5BD | D6 | 7D | 4F | 27 |
| 19 | 31 | 1470 | 5BE | D6 | 7E | 4F | 3D |
| 19 | 32 | 1471 | 5BF | D6 | 7F | 4F | 22 |
| 19 | 33 | 1472 | 5C0 | D7 | 40 | 50 | 20 |
| 19 | 34 | 1473 | 5C1 | D7 | C1 | 50 | 41 |
| 19 | 35 | 1474 | 5C2 | D7 | C2 | 50 | 42 |
| 19 | 36 | 1475 | 5C3 | D7 | C3 | 50 | 43 |
| 19 | 37 | 1476 | 5C4 | D7 | C4 | 50 | 44 |
| 19 | 38 | 1477 | 5C5 | D7 | C5 | 50 | 45 |
| 19 | 39 | 1478 | 5C6 | D7 | C6 | 50 | 46 |
| 19 | 40 | 1479 | 5C7 | D7 | C7 | 50 | 47 |
| 19 | 41 | 1480 | 5C8 | D7 | C8 | 50 | 48 |
| 19 | 42 | 1481 | 5C9 | D7 | C9 | 50 | 49 |
| 19 | 43 | 1482 | 5CA | D7 | 4A | 50 | 5B |
| 19 | 44 | 1483 | 5CB | D7 | 4B | 50 | 2E |
| 19 | 45 | 1484 | 5CC | D7 | 4C | 50 | 3C |
| 19 | 46 | 1485 | 5CD | D7 | 4D | 50 | 28 |
| 19 | 47 | 1486 | 5CE | D7 | 4E | 50 | 2B |
| 19 | 48 | 1487 | 5CF | D7 | 4F | 50 | 21 |

| 80 Col | | Position | | Buffer Address (Hex) | | | |
|--------|----|----------|-----|----------------------|----|-------|----|
| R | C | Dec | Hex | EBCDIC | | ASCII | |
| 19 | 49 | 1488 | 5D0 | D7 | 50 | 50 | 26 |
| 19 | 50 | 1489 | 5D1 | D7 | D1 | 50 | 4A |
| 19 | 51 | 1490 | 5D2 | D7 | D2 | 50 | 4B |
| 19 | 52 | 1491 | 5D3 | D7 | D3 | 50 | 4C |
| 19 | 53 | 1492 | 5D4 | D7 | D4 | 50 | 4D |
| 19 | 54 | 1493 | 5D5 | D7 | D5 | 50 | 4E |
| 19 | 55 | 1494 | 5D6 | D7 | D6 | 50 | 4F |
| 19 | 56 | 1495 | 5D7 | D7 | D7 | 50 | 50 |
| 19 | 57 | 1496 | 5D8 | D7 | D8 | 50 | 51 |
| 19 | 58 | 1497 | 5D9 | D7 | D9 | 50 | 52 |
| 19 | 59 | 1498 | 5DA | D7 | 5A | 50 | 5D |
| 19 | 60 | 1499 | 5DB | D7 | 5B | 50 | 24 |
| 19 | 61 | 1500 | 5DC | D7 | 5C | 50 | 2A |
| 19 | 62 | 1501 | 5DD | D7 | 5D | 50 | 29 |
| 19 | 63 | 1502 | 5DE | D7 | 5E | 50 | 3B |
| 19 | 64 | 1503 | 5DF | D7 | 5F | 50 | 5E |
| 19 | 65 | 1504 | 5E0 | D7 | 60 | 50 | 2D |
| 19 | 66 | 1505 | 5E1 | D7 | 61 | 50 | 2F |
| 19 | 67 | 1506 | 5E2 | D7 | E2 | 50 | 53 |
| 19 | 68 | 1507 | 5E3 | D7 | E3 | 50 | 54 |
| 19 | 69 | 1508 | 5E4 | D7 | E4 | 50 | 55 |
| 19 | 70 | 1509 | 5E5 | D7 | E5 | 50 | 56 |
| 19 | 71 | 1510 | 5E6 | D7 | E6 | 50 | 57 |
| 19 | 72 | 1511 | 5E7 | D7 | E7 | 50 | 58 |
| 19 | 73 | 1512 | 5E8 | D7 | E8 | 50 | 59 |
| 19 | 74 | 1513 | 5E9 | D7 | E9 | 50 | 5A |
| 19 | 75 | 1514 | 5EA | D7 | 6A | 50 | 7C |
| 19 | 76 | 1515 | 5EB | D7 | 6B | 50 | 2C |
| 19 | 77 | 1516 | 5EC | D7 | 6C | 50 | 25 |
| 19 | 78 | 1517 | 5ED | D7 | 6D | 50 | 5F |
| 19 | 79 | 1518 | 5EE | D7 | 6E | 50 | 3E |
| 19 | 80 | 1519 | 5EF | D7 | 6F | 50 | 3F |
| 20 | 01 | 1520 | 5F0 | D7 | F0 | 50 | 30 |
| 20 | 02 | 1521 | 5F1 | D7 | F1 | 50 | 31 |
| 20 | 03 | 1522 | 5F2 | D7 | F2 | 50 | 32 |
| 20 | 04 | 1523 | 5F3 | D7 | F3 | 50 | 33 |
| 20 | 05 | 1524 | 5F4 | D7 | F4 | 50 | 34 |
| 20 | 06 | 1525 | 5F5 | D7 | F5 | 50 | 35 |
| 20 | 07 | 1526 | 5F6 | D7 | F6 | 50 | 36 |
| 20 | 08 | 1527 | 5F7 | D7 | F7 | 50 | 37 |
| 20 | 09 | 1528 | 5F8 | D7 | F8 | 50 | 38 |
| 20 | 10 | 1529 | 5F9 | D7 | F9 | 50 | 39 |
| 20 | 11 | 1530 | 5FA | D7 | 7A | 50 | 3A |
| 20 | 12 | 1531 | 5FB | D7 | 7B | 50 | 23 |
| 20 | 13 | 1532 | 5FC | D7 | 7C | 50 | 40 |
| 20 | 14 | 1533 | 5FD | D7 | 7D | 50 | 27 |
| 20 | 15 | 1534 | 5FE | D7 | 7E | 50 | 3D |
| 20 | 16 | 1535 | 5FF | D7 | 7F | 50 | 22 |
| 20 | 17 | 1536 | 600 | D8 | 40 | 51 | 20 |
| 20 | 18 | 1537 | 601 | D8 | C1 | 51 | 41 |
| 20 | 19 | 1538 | 602 | D8 | C2 | 51 | 42 |
| 20 | 20 | 1539 | 603 | D8 | C3 | 51 | 43 |
| 20 | 21 | 1540 | 604 | D8 | C4 | 51 | 44 |
| 20 | 22 | 1541 | 605 | D8 | C5 | 51 | 45 |
| 20 | 23 | 1542 | 606 | D8 | C6 | 51 | 46 |
| 20 | 24 | 1543 | 607 | D8 | C7 | 51 | 47 |
| 20 | 25 | 1544 | 608 | D8 | C8 | 51 | 48 |
| 20 | 26 | 1545 | 609 | D8 | C9 | 51 | 49 |
| 20 | 27 | 1546 | 60A | D8 | 4A | 51 | 5B |
| 20 | 28 | 1547 | 60B | D8 | 4B | 51 | 2E |
| 20 | 29 | 1548 | 60C | D8 | 4C | 51 | 3C |
| 20 | 30 | 1549 | 60D | D8 | 4D | 51 | 28 |

| 80 Col | | Position | | Buffer Address (Hex) | | | |
|--------|----|----------|-----|----------------------|----|-------|----|
| R | C | Dec | Hex | EBCDIC | | ASCII | |
| 20 | 31 | 1550 | 60E | D8 | 4E | 51 | 2B |
| 20 | 32 | 1551 | 60F | D8 | 4F | 51 | 21 |
| 20 | 33 | 1552 | 610 | D8 | 50 | 51 | 26 |
| 20 | 34 | 1553 | 611 | D8 | D1 | 51 | 4A |
| 20 | 35 | 1554 | 612 | D8 | D2 | 51 | 4B |
| 20 | 36 | 1555 | 613 | D8 | D3 | 51 | 4C |
| 20 | 37 | 1556 | 614 | D8 | D4 | 51 | 4D |
| 20 | 38 | 1557 | 615 | D8 | D5 | 51 | 4E |
| 20 | 39 | 1558 | 616 | D8 | D6 | 51 | 4F |
| 20 | 40 | 1559 | 617 | D8 | D7 | 51 | 50 |
| 20 | 41 | 1560 | 618 | D8 | D8 | 51 | 51 |
| 20 | 42 | 1561 | 619 | D8 | D9 | 51 | 52 |
| 20 | 43 | 1562 | 61A | D8 | 5A | 51 | 5D |
| 20 | 44 | 1563 | 61B | D8 | 5B | 51 | 24 |
| 20 | 45 | 1564 | 61C | D8 | 5C | 51 | 2A |
| 20 | 46 | 1565 | 61D | D8 | 5D | 51 | 29 |
| 20 | 47 | 1566 | 61E | D8 | 5E | 51 | 3B |
| 20 | 48 | 1567 | 61F | D8 | 5F | 51 | 5E |
| 20 | 49 | 1568 | 620 | D8 | 60 | 51 | 2D |
| 20 | 50 | 1569 | 621 | D8 | 61 | 51 | 2F |
| 20 | 51 | 1570 | 622 | D8 | E2 | 51 | 53 |
| 20 | 52 | 1571 | 623 | D8 | E3 | 51 | 54 |
| 20 | 53 | 1572 | 624 | D8 | E4 | 51 | 55 |
| 20 | 54 | 1573 | 625 | D8 | E5 | 51 | 56 |
| 20 | 55 | 1574 | 626 | D8 | E6 | 51 | 57 |
| 20 | 56 | 1575 | 627 | D8 | E7 | 51 | 58 |
| 20 | 57 | 1576 | 628 | D8 | E8 | 51 | 59 |
| 20 | 58 | 1577 | 629 | D8 | E9 | 51 | 5A |
| 20 | 59 | 1578 | 62A | D8 | 6A | 51 | 7C |
| 20 | 60 | 1579 | 62B | D8 | 6B | 51 | 2C |
| 20 | 61 | 1580 | 62C | D8 | 6C | 51 | 25 |
| 20 | 62 | 1581 | 62D | D8 | 6D | 51 | 5F |
| 20 | 63 | 1582 | 62E | D8 | 6E | 51 | 3E |
| 20 | 64 | 1583 | 62F | D8 | 6F | 51 | 3F |
| 20 | 65 | 1584 | 630 | D8 | F0 | 51 | 30 |
| 20 | 66 | 1585 | 631 | D8 | F1 | 51 | 31 |
| 20 | 67 | 1586 | 632 | D8 | F2 | 51 | 32 |
| 20 | 68 | 1587 | 633 | D8 | F3 | 51 | 33 |
| 20 | 69 | 1588 | 634 | D8 | F4 | 51 | 34 |
| 20 | 70 | 1589 | 635 | D8 | F5 | 51 | 35 |
| 20 | 71 | 1590 | 636 | D8 | F6 | 51 | 36 |
| 20 | 72 | 1591 | 637 | D8 | F7 | 51 | 37 |
| 20 | 73 | 1592 | 638 | D8 | F8 | 51 | 38 |
| 20 | 74 | 1593 | 639 | D8 | F9 | 51 | 39 |
| 20 | 75 | 1594 | 63A | D8 | 7A | 51 | 3A |
| 20 | 76 | 1595 | 63B | D8 | 7B | 51 | 23 |
| 20 | 77 | 1596 | 63C | D8 | 7C | 51 | 40 |
| 20 | 78 | 1597 | 63D | D8 | 7D | 51 | 27 |
| 20 | 79 | 1598 | 63E | D8 | 7E | 51 | 3D |
| 20 | 80 | 1599 | 63F | D8 | 7F | 51 | 22 |
| 21 | 01 | 1600 | 640 | D9 | 40 | 52 | 20 |
| 21 | 02 | 1601 | 641 | D9 | C1 | 52 | 41 |
| 21 | 03 | 1602 | 642 | D9 | C2 | 52 | 42 |
| 21 | 04 | 1603 | 643 | D9 | C3 | 52 | 43 |
| 21 | 05 | 1604 | 644 | D9 | C4 | 52 | 44 |
| 21 | 06 | 1605 | 645 | D9 | C5 | 52 | 45 |
| 21 | 07 | 1606 | 646 | D9 | C6 | 52 | 46 |
| 21 | 08 | 1607 | 647 | D9 | C7 | 52 | 47 |
| 21 | 09 | 1608 | 648 | D9 | C8 | 52 | 48 |
| 21 | 10 | 1609 | 649 | D9 | C9 | 52 | 49 |
| 21 | 11 | 1610 | 64A | D9 | 4A | 52 | 5B |
| 21 | 12 | 1611 | 64B | D9 | 4B | 52 | 2E |

| 80 Col | | Position | | Buffer Address (Hex) | | | |
|--------|----|----------|-----|----------------------|----|-------|----|
| R | C | Dec | Hex | EBCDIC | | ASCII | |
| 21 | 13 | 1612 | 64C | D9 | 4C | 52 | 3C |
| 21 | 14 | 1613 | 64D | D9 | 4D | 52 | 28 |
| 21 | 15 | 1614 | 64E | D9 | 4E | 52 | 2B |
| 21 | 16 | 1615 | 64F | D9 | 4F | 52 | 21 |
| 21 | 17 | 1616 | 650 | D9 | 50 | 52 | 26 |
| 21 | 18 | 1617 | 651 | D9 | D1 | 52 | 4A |
| 21 | 19 | 1618 | 652 | D9 | D2 | 52 | 4B |
| 21 | 20 | 1619 | 653 | D9 | D3 | 52 | 4C |
| 21 | 21 | 1620 | 654 | D9 | D4 | 52 | 4D |
| 21 | 22 | 1621 | 655 | D9 | D5 | 52 | 4E |
| 21 | 23 | 1622 | 656 | D9 | D6 | 52 | 4F |
| 21 | 24 | 1623 | 657 | D9 | D7 | 52 | 50 |
| 21 | 25 | 1624 | 658 | D9 | D8 | 52 | 51 |
| 21 | 26 | 1625 | 659 | D9 | D9 | 52 | 52 |
| 21 | 27 | 1626 | 65A | D9 | 5A | 52 | 5D |
| 21 | 28 | 1627 | 65B | D9 | 5B | 52 | 24 |
| 21 | 29 | 1628 | 65C | D9 | 5C | 52 | 2A |
| 21 | 30 | 1629 | 65D | D9 | 5D | 52 | 29 |
| 21 | 31 | 1630 | 65E | D9 | 5E | 52 | 3B |
| 21 | 32 | 1631 | 65F | D9 | 5F | 52 | 5E |
| 21 | 33 | 1632 | 660 | D9 | 60 | 52 | 2D |
| 21 | 34 | 1633 | 661 | D9 | 61 | 52 | 2F |
| 21 | 35 | 1634 | 662 | D9 | E2 | 52 | 53 |
| 21 | 36 | 1635 | 663 | D9 | E3 | 52 | 54 |
| 21 | 37 | 1636 | 664 | D9 | E4 | 52 | 55 |
| 21 | 38 | 1637 | 665 | D9 | E5 | 52 | 56 |
| 21 | 39 | 1638 | 666 | D9 | E6 | 52 | 57 |
| 21 | 40 | 1639 | 667 | D9 | E7 | 52 | 58 |
| 21 | 41 | 1640 | 668 | D9 | E8 | 52 | 59 |
| 21 | 42 | 1641 | 669 | D9 | E9 | 52 | 5A |
| 21 | 43 | 1642 | 66A | D9 | 6A | 52 | 7C |
| 21 | 44 | 1643 | 66B | D9 | 6B | 52 | 2C |
| 21 | 45 | 1644 | 66C | D9 | 6C | 52 | 25 |
| 21 | 46 | 1645 | 66D | D9 | 6D | 52 | 5F |
| 21 | 47 | 1646 | 66E | D9 | 6E | 52 | 3E |
| 21 | 48 | 1647 | 66F | D9 | 6F | 52 | 3F |
| 21 | 49 | 1648 | 670 | D9 | F0 | 52 | 30 |
| 21 | 50 | 1649 | 671 | D9 | F1 | 52 | 31 |
| 21 | 51 | 1650 | 672 | D9 | F2 | 52 | 32 |
| 21 | 52 | 1651 | 673 | D9 | F3 | 52 | 33 |
| 21 | 53 | 1652 | 674 | D9 | F4 | 52 | 34 |
| 21 | 54 | 1653 | 675 | D9 | F5 | 52 | 35 |
| 21 | 55 | 1654 | 676 | D9 | F6 | 52 | 36 |
| 21 | 56 | 1655 | 677 | D9 | F7 | 52 | 37 |
| 21 | 57 | 1656 | 678 | D9 | F8 | 52 | 38 |
| 21 | 58 | 1657 | 679 | D9 | F9 | 52 | 39 |
| 21 | 59 | 1658 | 67A | D9 | 7A | 52 | 3A |
| 21 | 60 | 1659 | 67B | D9 | 7B | 52 | 23 |
| 21 | 61 | 1660 | 67C | D9 | 7C | 52 | 40 |
| 21 | 62 | 1661 | 67D | D9 | 7D | 52 | 27 |
| 21 | 63 | 1662 | 67E | D9 | 7E | 52 | 3D |
| 21 | 64 | 1663 | 67F | D9 | 7F | 52 | 22 |
| 21 | 65 | 1664 | 680 | 5A | 40 | 5D | 20 |
| 21 | 66 | 1665 | 681 | 5A | C1 | 5D | 41 |
| 21 | 67 | 1666 | 682 | 5A | C2 | 5D | 42 |
| 21 | 68 | 1667 | 683 | 5A | C3 | 5D | 43 |
| 21 | 69 | 1668 | 684 | 5A | C4 | 5D | 44 |
| 21 | 70 | 1669 | 685 | 5A | C5 | 5D | 45 |
| 21 | 71 | 1670 | 686 | 5A | C6 | 5D | 46 |
| 21 | 72 | 1671 | 687 | 5A | C7 | 5D | 47 |
| 21 | 73 | 1672 | 688 | 5A | C8 | 5D | 48 |
| 21 | 74 | 1673 | 689 | 5A | C9 | 5D | 49 |

| 80 Col | | Position | | Buffer Address (Hex) | | | |
|--------|----|----------|-----|----------------------|----|-------|----|
| R | C | Dec | Hex | EBCDIC | | ASCII | |
| 21 | 75 | 1674 | 68A | 5A | 4A | 5D | 5B |
| 21 | 76 | 1675 | 68B | 5A | 4B | 5D | 2E |
| 21 | 77 | 1676 | 68C | 5A | 4C | 5D | 3C |
| 21 | 78 | 1677 | 68D | 5A | 4D | 5D | 28 |
| 21 | 79 | 1678 | 68E | 5A | 4E | 5D | 2B |
| 21 | 80 | 1679 | 68F | 5A | 4F | 5D | 21 |
| 22 | 01 | 1680 | 690 | 5A | 50 | 5D | 26 |
| 22 | 02 | 1681 | 691 | 5A | D1 | 5D | 4A |
| 22 | 03 | 1682 | 692 | 5A | D2 | 5D | 4B |
| 22 | 04 | 1683 | 693 | 5A | D3 | 5D | 4C |
| 22 | 05 | 1684 | 694 | 5A | D4 | 5D | 4D |
| 22 | 06 | 1685 | 695 | 5A | D5 | 5D | 4E |
| 22 | 07 | 1686 | 696 | 5A | D6 | 5D | 4F |
| 22 | 08 | 1687 | 697 | 5A | D7 | 5D | 50 |
| 22 | 09 | 1688 | 698 | 5A | D8 | 5D | 51 |
| 22 | 10 | 1689 | 699 | 5A | D9 | 5D | 52 |
| 22 | 11 | 1690 | 69A | 5A | 5A | 5D | 5D |
| 22 | 12 | 1691 | 69B | 5A | 5B | 5D | 24 |
| 22 | 13 | 1692 | 69C | 5A | 5C | 5D | 2A |
| 22 | 14 | 1693 | 69D | 5A | 5D | 5D | 29 |
| 22 | 15 | 1694 | 69E | 5A | 5E | 5D | 3B |
| 22 | 16 | 1695 | 69F | 5A | 5F | 5D | 5E |
| 22 | 17 | 1696 | 6A0 | 5A | 60 | 5D | 2D |
| 22 | 18 | 1697 | 6A1 | 5A | 61 | 5D | 2F |
| 22 | 19 | 1698 | 6A2 | 5A | E2 | 5D | 53 |
| 22 | 20 | 1699 | 6A3 | 5A | E3 | 5D | 54 |
| 22 | 21 | 1700 | 6A4 | 5A | E4 | 5D | 55 |
| 22 | 22 | 1701 | 6A5 | 5A | E5 | 5D | 56 |
| 22 | 23 | 1702 | 6A6 | 5A | E6 | 5D | 57 |
| 22 | 24 | 1703 | 6A7 | 5A | E7 | 5D | 58 |
| 22 | 25 | 1704 | 6A8 | 5A | E8 | 5D | 59 |
| 22 | 26 | 1705 | 6A9 | 5A | E9 | 5D | 5A |
| 22 | 27 | 1706 | 6AA | 5A | 6A | 5D | 7C |
| 22 | 28 | 1707 | 6AB | 5A | 6B | 5D | 2C |
| 22 | 29 | 1708 | 6AC | 5A | 6C | 5D | 25 |
| 22 | 30 | 1709 | 6AD | 5A | 6D | 5D | 5F |
| 22 | 31 | 1710 | 6AE | 5A | 6E | 5D | 3E |
| 22 | 32 | 1711 | 6AF | 5A | 6F | 5D | 3F |
| 22 | 33 | 1712 | 6B0 | 5A | F0 | 5D | 30 |
| 22 | 34 | 1713 | 6B1 | 5A | F1 | 5D | 31 |
| 22 | 35 | 1714 | 6B2 | 5A | F2 | 5D | 32 |
| 22 | 36 | 1715 | 6B3 | 5A | F3 | 5D | 33 |
| 22 | 37 | 1716 | 6B4 | 5A | F4 | 5D | 34 |
| 22 | 38 | 1717 | 6B5 | 5A | F5 | 5D | 35 |
| 22 | 39 | 1718 | 6B6 | 5A | F6 | 5D | 36 |
| 22 | 40 | 1719 | 6B7 | 5A | F7 | 5D | 37 |
| 22 | 41 | 1720 | 6B8 | 5A | F8 | 5D | 38 |
| 22 | 42 | 1721 | 6B9 | 5A | F9 | 5D | 39 |
| 22 | 43 | 1722 | 6BA | 5A | 7A | 5D | 3A |
| 22 | 44 | 1723 | 6BB | 5A | 7B | 5D | 23 |
| 22 | 45 | 1724 | 6BC | 5A | 7C | 5D | 40 |
| 22 | 46 | 1725 | 6BD | 5A | 7D | 5D | 27 |
| 22 | 47 | 1726 | 6BE | 5A | 7E | 5D | 3D |
| 22 | 48 | 1727 | 6BF | 5A | 7F | 5D | 22 |
| 22 | 49 | 1728 | 6C0 | 5B | 40 | 24 | 20 |
| 22 | 50 | 1729 | 6C1 | 5B | C1 | 24 | 41 |
| 22 | 51 | 1730 | 6C2 | 5B | C2 | 24 | 42 |
| 22 | 52 | 1731 | 6C3 | 5B | C3 | 24 | 43 |
| 22 | 53 | 1732 | 6C4 | 5B | C4 | 24 | 44 |
| 22 | 54 | 1733 | 6C5 | 5B | C5 | 24 | 45 |
| 22 | 55 | 1734 | 6C6 | 5B | C6 | 24 | 46 |
| 22 | 56 | 1735 | 6C7 | 5B | C7 | 24 | 47 |

| 80 Col | | Position | | Buffer Address (Hex) | | | |
|--------|----|----------|-----|----------------------|----|-------|----|
| R | C | Dec | Hex | EBCDIC | | ASCII | |
| 22 | 57 | 1736 | 6C8 | 5B | C8 | 24 | 48 |
| 22 | 58 | 1737 | 6C9 | 5B | C9 | 24 | 49 |
| 22 | 59 | 1738 | 6CA | 5B | 4A | 24 | 5B |
| 22 | 60 | 1739 | 6CB | 5B | 4B | 24 | 2E |
| 22 | 61 | 1740 | 6CC | 5B | 4C | 24 | 3C |
| 22 | 62 | 1741 | 6CD | 5B | 4D | 24 | 28 |
| 22 | 63 | 1742 | 6CE | 5B | 4E | 24 | 2B |
| 22 | 64 | 1743 | 6CF | 5B | 4F | 24 | 21 |
| 22 | 65 | 1744 | 6D0 | 5B | 50 | 24 | 26 |
| 22 | 66 | 1745 | 6D1 | 5B | D1 | 24 | 4A |
| 22 | 67 | 1746 | 6D2 | 5B | D2 | 24 | 4B |
| 22 | 68 | 1747 | 6D3 | 5B | D3 | 24 | 4C |
| 22 | 69 | 1748 | 6D4 | 5B | D4 | 24 | 4D |
| 22 | 70 | 1749 | 6D5 | 5B | D5 | 24 | 4E |
| 22 | 71 | 1750 | 6D6 | 5B | D6 | 24 | 4F |
| 22 | 72 | 1751 | 6D7 | 5B | D7 | 24 | 50 |
| 22 | 73 | 1752 | 6D8 | 5B | D8 | 24 | 51 |
| 22 | 74 | 1753 | 6D9 | 5B | D9 | 24 | 52 |
| 22 | 75 | 1754 | 6DA | 5B | 5A | 24 | 5D |
| 22 | 76 | 1755 | 6DB | 5B | 5B | 24 | 24 |
| 22 | 77 | 1756 | 6DC | 5B | 5C | 24 | 2A |
| 22 | 78 | 1757 | 6DD | 5B | 5D | 24 | 29 |
| 22 | 79 | 1758 | 6DE | 5B | 5E | 24 | 3B |
| 22 | 80 | 1759 | 6DF | 5B | 5F | 24 | 5E |
| 23 | 01 | 1760 | 6E0 | 5B | 60 | 24 | 2D |
| 23 | 02 | 1761 | 6E1 | 5B | 61 | 24 | 2F |
| 23 | 03 | 1762 | 6E2 | 5B | E2 | 24 | 53 |
| 23 | 04 | 1763 | 6E3 | 5B | E3 | 24 | 54 |
| 23 | 05 | 1764 | 6E4 | 5B | E4 | 24 | 55 |
| 23 | 06 | 1765 | 6E5 | 5B | E5 | 24 | 56 |
| 23 | 07 | 1766 | 6E6 | 5B | E6 | 24 | 57 |
| 23 | 08 | 1767 | 6E7 | 5B | E7 | 24 | 58 |
| 23 | 09 | 1768 | 6E8 | 5B | E8 | 24 | 59 |
| 23 | 10 | 1769 | 6E9 | 5B | E9 | 24 | 5A |
| 23 | 11 | 1770 | 6EA | 5B | 6A | 24 | 7C |
| 23 | 12 | 1771 | 6EB | 5B | 6B | 24 | 2C |
| 23 | 13 | 1772 | 6EC | 5B | 6C | 24 | 25 |
| 23 | 14 | 1773 | 6ED | 5B | 6D | 24 | 5F |
| 23 | 15 | 1774 | 6EE | 5B | 6E | 24 | 3E |
| 23 | 16 | 1775 | 6EF | 5B | 6F | 24 | 3F |
| 23 | 17 | 1776 | 6F0 | 5B | F0 | 24 | 30 |
| 23 | 18 | 1777 | 6F1 | 5B | F1 | 24 | 31 |
| 23 | 19 | 1778 | 6F2 | 5B | F2 | 24 | 32 |
| 23 | 20 | 1779 | 6F3 | 5B | F3 | 24 | 33 |
| 23 | 21 | 1780 | 6F4 | 5B | F4 | 24 | 34 |
| 23 | 22 | 1781 | 6F5 | 5B | F5 | 24 | 35 |
| 23 | 23 | 1782 | 6F6 | 5B | F6 | 24 | 36 |
| 23 | 24 | 1783 | 6F7 | 5B | F7 | 24 | 37 |
| 23 | 25 | 1784 | 6F8 | 5B | F8 | 24 | 38 |
| 23 | 26 | 1785 | 6F9 | 5B | F9 | 24 | 39 |
| 23 | 27 | 1786 | 6FA | 5B | 7A | 24 | 3A |
| 23 | 28 | 1787 | 6FB | 5B | 7B | 24 | 23 |
| 23 | 29 | 1788 | 6FC | 5B | 7C | 24 | 40 |
| 23 | 30 | 1789 | 6FD | 5B | 7D | 24 | 27 |
| 23 | 31 | 1790 | 6FE | 5B | 7E | 24 | 3D |
| 23 | 32 | 1791 | 6FF | 5B | 7F | 24 | 22 |
| 23 | 33 | 1792 | 700 | 5C | 40 | 2A | 20 |
| 23 | 34 | 1793 | 701 | 5C | C1 | 2A | 41 |
| 23 | 35 | 1794 | 702 | 5C | C2 | 2A | 42 |
| 23 | 36 | 1795 | 703 | 5C | C3 | 2A | 43 |
| 23 | 37 | 1796 | 704 | 5C | C4 | 2A | 44 |
| 23 | 38 | 1797 | 705 | 5C | C5 | 2A | 45 |

| 80 Col | | Position | | Buffer Address (Hex) | | | |
|----------|----------|------------|------------|----------------------|----|--------------|----|
| <u>R</u> | <u>C</u> | <u>Dec</u> | <u>Hex</u> | <u>EBCDIC</u> | | <u>ASCII</u> | |
| 23 | 39 | 1798 | 706 | 5C | C6 | 2A | 46 |
| 23 | 40 | 1799 | 707 | 5C | C7 | 2A | 47 |
| 23 | 41 | 1800 | 708 | 5C | C8 | 2A | 48 |
| 23 | 42 | 1801 | 709 | 5C | C9 | 2A | 49 |
| 23 | 43 | 1802 | 70A | 5C | 4A | 2A | 5B |
| 23 | 44 | 1803 | 70B | 5C | 4B | 2A | 2E |
| 23 | 45 | 1804 | 70C | 5C | 4C | 2A | 3C |
| 23 | 46 | 1805 | 70D | 5C | 4D | 2A | 28 |
| 23 | 47 | 1806 | 70E | 5C | 4E | 2A | 2B |
| 23 | 48 | 1807 | 70F | 5C | 4F | 2A | 21 |
| 23 | 49 | 1808 | 710 | 5C | 50 | 2A | 26 |
| 23 | 50 | 1809 | 711 | 5C | D1 | 2A | 4A |
| 23 | 51 | 1810 | 712 | 5C | D2 | 2A | 4B |
| 23 | 52 | 1811 | 713 | 5C | D3 | 2A | 4C |
| 23 | 53 | 1812 | 714 | 5C | D4 | 2A | 4D |
| 23 | 54 | 1813 | 715 | 5C | D5 | 2A | 4E |
| 23 | 55 | 1814 | 716 | 5C | D6 | 2A | 4F |
| 23 | 56 | 1815 | 717 | 5C | D7 | 2A | 50 |
| 23 | 57 | 1816 | 718 | 5C | D8 | 2A | 51 |
| 23 | 58 | 1817 | 719 | 5C | D9 | 2A | 52 |
| 23 | 59 | 1818 | 71A | 5C | 5A | 2A | 5D |
| 23 | 60 | 1819 | 71B | 5C | 5B | 2A | 24 |
| 23 | 61 | 1820 | 71C | 5C | 5C | 2A | 2A |
| 23 | 62 | 1821 | 71D | 5C | 5D | 2A | 29 |
| 23 | 63 | 1822 | 71E | 5C | 5E | 2A | 3B |
| 23 | 64 | 1823 | 71F | 5C | 5F | 2A | 5E |
| 23 | 65 | 1824 | 720 | 5C | 60 | 2A | 2D |
| 23 | 66 | 1825 | 721 | 5C | 61 | 2A | 2F |
| 23 | 67 | 1826 | 722 | 5C | E2 | 2A | 53 |
| 23 | 68 | 1827 | 723 | 5C | E3 | 2A | 54 |
| 23 | 69 | 1828 | 724 | 5C | E4 | 2A | 55 |
| 23 | 70 | 1829 | 725 | 5C | E5 | 2A | 56 |
| 23 | 71 | 1830 | 726 | 5C | E6 | 2A | 57 |
| 23 | 72 | 1831 | 727 | 5C | E7 | 2A | 58 |
| 23 | 73 | 1832 | 728 | 5C | E8 | 2A | 59 |
| 23 | 74 | 1833 | 729 | 5C | E9 | 2A | 5A |
| 23 | 75 | 1834 | 72A | 5C | 6A | 2A | 7C |
| 23 | 76 | 1835 | 72B | 5C | 6B | 2A | 2C |
| 23 | 77 | 1836 | 72C | 5C | 6C | 2A | 25 |
| 23 | 78 | 1837 | 72D | 5C | 6D | 2A | 5F |
| 23 | 79 | 1838 | 72E | 5C | 6E | 2A | 3E |
| 23 | 80 | 1839 | 72F | 5C | 6F | 2A | 3F |
| 24 | 01 | 1840 | 730 | 5C | F0 | 2A | 30 |
| 24 | 02 | 1841 | 731 | 5C | F1 | 2A | 31 |
| 24 | 03 | 1842 | 732 | 5C | F2 | 2A | 32 |
| 24 | 04 | 1843 | 733 | 5C | F3 | 2A | 33 |
| 24 | 05 | 1844 | 734 | 5C | F4 | 2A | 34 |
| 24 | 06 | 1845 | 735 | 5C | F5 | 2A | 35 |
| 24 | 07 | 1846 | 736 | 5C | F6 | 2A | 36 |
| 24 | 08 | 1847 | 737 | 5C | F7 | 2A | 37 |
| 24 | 09 | 1848 | 738 | 5C | F8 | 2A | 38 |
| 24 | 10 | 1849 | 739 | 5C | F9 | 2A | 39 |
| 24 | 11 | 1850 | 73A | 5C | 7A | 2A | 3A |
| 24 | 12 | 1851 | 73B | 5C | 7B | 2A | 23 |
| 24 | 13 | 1852 | 73C | 5C | 7C | 2A | 40 |
| 24 | 14 | 1853 | 73D | 5C | 7D | 2A | 27 |
| 24 | 15 | 1854 | 73E | 5C | 7E | 2A | 3D |
| 24 | 16 | 1855 | 73F | 5C | 7F | 2A | 22 |
| 24 | 17 | 1856 | 740 | 5D | 40 | 29 | 20 |
| 24 | 18 | 1857 | 741 | 5D | C1 | 29 | 41 |
| 24 | 19 | 1858 | 742 | 5D | C2 | 29 | 42 |
| 24 | 20 | 1859 | 743 | 5D | C3 | 29 | 43 |

| 80 Col | | Position | | Buffer Address (Hex) | | | |
|--------|----|----------|-----|----------------------|----|-------|----|
| R | C | Dec | Hex | EBCDIC | | ASCII | |
| 24 | 21 | 1860 | 744 | 5D | C4 | 29 | 44 |
| 24 | 22 | 1861 | 745 | 5D | C5 | 29 | 45 |
| 24 | 23 | 1862 | 746 | 5D | C6 | 29 | 46 |
| 24 | 24 | 1863 | 747 | 5D | C7 | 29 | 47 |
| 24 | 25 | 1864 | 748 | 5D | C8 | 29 | 48 |
| 24 | 26 | 1865 | 749 | 5D | C9 | 29 | 49 |
| 24 | 27 | 1866 | 74A | 5D | 4A | 29 | 5B |
| 24 | 28 | 1867 | 74B | 5D | 4B | 29 | 2E |
| 24 | 29 | 1868 | 74C | 5D | 4C | 29 | 3C |
| 24 | 30 | 1869 | 74D | 5D | 4D | 29 | 28 |
| 24 | 31 | 1870 | 74E | 5D | 4E | 29 | 2B |
| 24 | 32 | 1871 | 74F | 5D | 4F | 29 | 21 |
| 24 | 33 | 1872 | 750 | 5D | 50 | 29 | 26 |
| 24 | 34 | 1873 | 751 | 5D | D1 | 29 | 4A |
| 24 | 35 | 1874 | 752 | 5D | D2 | 29 | 4B |
| 24 | 36 | 1875 | 753 | 5D | D3 | 29 | 4C |
| 24 | 37 | 1876 | 754 | 5D | D4 | 29 | 4D |
| 24 | 38 | 1877 | 755 | 5D | D5 | 29 | 4E |
| 24 | 39 | 1878 | 756 | 5D | D6 | 29 | 4F |
| 24 | 40 | 1879 | 757 | 5D | D7 | 29 | 50 |
| 24 | 41 | 1880 | 758 | 5D | D8 | 29 | 51 |
| 24 | 42 | 1881 | 759 | 5D | D9 | 29 | 52 |
| 24 | 43 | 1882 | 75A | 5D | 5A | 29 | 5D |
| 24 | 44 | 1883 | 75B | 5D | 5B | 29 | 24 |
| 24 | 45 | 1884 | 75C | 5D | 5C | 29 | 2A |
| 24 | 46 | 1885 | 75D | 5D | 5D | 29 | 29 |
| 24 | 47 | 1886 | 75E | 5D | 5E | 29 | 3B |
| 24 | 48 | 1887 | 75F | 5D | 5F | 29 | 5E |
| 24 | 49 | 1888 | 760 | 5D | 60 | 29 | 2D |
| 24 | 50 | 1889 | 761 | 5D | 61 | 29 | 2F |
| 24 | 51 | 1890 | 762 | 5D | E2 | 29 | 53 |
| 24 | 52 | 1891 | 763 | 5D | E3 | 29 | 54 |
| 24 | 53 | 1892 | 764 | 5D | E4 | 29 | 55 |
| 24 | 54 | 1893 | 765 | 5D | E5 | 29 | 56 |
| 24 | 55 | 1894 | 766 | 5D | E6 | 29 | 57 |
| 24 | 56 | 1895 | 767 | 5D | E7 | 29 | 58 |
| 24 | 57 | 1896 | 768 | 5D | E8 | 29 | 59 |
| 24 | 58 | 1897 | 769 | 5D | E9 | 29 | 5A |
| 24 | 59 | 1898 | 76A | 5D | 6A | 29 | 7C |
| 24 | 60 | 1899 | 76B | 5D | 6B | 29 | 2C |
| 24 | 61 | 1900 | 76C | 5D | 6C | 29 | 25 |
| 24 | 62 | 1901 | 76D | 5D | 6D | 29 | 5F |
| 24 | 63 | 1902 | 76E | 5D | 6E | 29 | 3E |
| 24 | 64 | 1903 | 76F | 5D | 6F | 29 | 3F |
| 24 | 65 | 1904 | 770 | 5D | F0 | 29 | 30 |
| 24 | 66 | 1905 | 771 | 5D | F1 | 29 | 31 |
| 24 | 67 | 1906 | 772 | 5D | F2 | 29 | 32 |
| 24 | 68 | 1907 | 773 | 5D | F3 | 29 | 33 |
| 24 | 69 | 1908 | 774 | 5D | F4 | 29 | 34 |
| 24 | 70 | 1909 | 775 | 5D | F5 | 29 | 35 |
| 24 | 71 | 1910 | 776 | 5D | F6 | 29 | 36 |
| 24 | 72 | 1911 | 777 | 5D | F7 | 29 | 37 |
| 24 | 73 | 1912 | 778 | 5D | F8 | 29 | 38 |
| 24 | 74 | 1913 | 779 | 5D | F9 | 29 | 39 |
| 24 | 75 | 1914 | 77A | 5D | 7A | 29 | 3A |
| 24 | 76 | 1915 | 77B | 5D | 7B | 29 | 23 |
| 24 | 77 | 1916 | 77C | 5D | 7C | 29 | 40 |
| 24 | 78 | 1917 | 77D | 5D | 7D | 29 | 27 |
| 24 | 79 | 1918 | 77E | 5D | 7E | 29 | 3D |
| 24 | 80 | 1919 | 77F | 5D | 7F | 29 | 22 |
| 25 | 01 | 1920 | 780 | 5E | 40 | 3B | 20 |
| 25 | 02 | 1921 | 781 | 5E | C1 | 3B | 41 |

| 80 Col | | Position | | Buffer Address (Hex) | | | |
|----------|----------|------------|------------|----------------------|----|--------------|----|
| <u>R</u> | <u>C</u> | <u>Dec</u> | <u>Hex</u> | <u>EBCDIC</u> | | <u>ASCII</u> | |
| 25 | 03 | 1922 | 782 | 5E | C2 | 3B | 42 |
| 25 | 04 | 1923 | 783 | 5E | C3 | 3B | 43 |
| 25 | 05 | 1924 | 784 | 5E | C4 | 3B | 44 |
| 25 | 06 | 1925 | 785 | 5E | C5 | 3B | 45 |
| 25 | 07 | 1926 | 786 | 5E | C6 | 3B | 46 |
| 25 | 08 | 1927 | 787 | 5E | C7 | 3B | 47 |
| 25 | 09 | 1928 | 788 | 5E | C8 | 3B | 48 |
| 25 | 10 | 1929 | 789 | 5E | C9 | 3B | 49 |
| 25 | 11 | 1930 | 78A | 5E | 4A | 3B | 5B |
| 25 | 12 | 1931 | 78B | 5E | 4B | 3B | 2E |
| 25 | 13 | 1932 | 78C | 5E | 4C | 3B | 3C |
| 25 | 14 | 1933 | 78D | 5E | 4D | 3B | 28 |
| 25 | 15 | 1934 | 78E | 5E | 4E | 3B | 2B |
| 25 | 16 | 1935 | 78F | 5E | 4F | 3B | 21 |
| 25 | 17 | 1936 | 790 | 5E | 50 | 3B | 26 |
| 25 | 18 | 1937 | 791 | 5E | D1 | 3B | 4A |
| 25 | 19 | 1938 | 792 | 5E | D2 | 3B | 4B |
| 25 | 20 | 1939 | 793 | 5E | D3 | 3B | 4C |
| 25 | 21 | 1940 | 794 | 5E | D4 | 3B | 4D |
| 25 | 22 | 1941 | 795 | 5E | D5 | 3B | 4E |
| 25 | 23 | 1942 | 796 | 5E | D6 | 3B | 4F |
| 25 | 24 | 1943 | 797 | 5E | D7 | 3B | 50 |
| 25 | 25 | 1944 | 798 | 5E | D8 | 3B | 51 |
| 25 | 26 | 1945 | 799 | 5E | D9 | 3B | 52 |
| 25 | 27 | 1946 | 79A | 5E | 5A | 3B | 5D |
| 25 | 28 | 1947 | 79B | 5E | 5B | 3B | 24 |
| 25 | 29 | 1948 | 79C | 5E | 5C | 3B | 2A |
| 25 | 30 | 1949 | 79D | 5E | 5D | 3B | 29 |
| 25 | 31 | 1950 | 79E | 5E | 5E | 3B | 3B |
| 25 | 32 | 1951 | 79F | 5E | 5F | 3B | 5E |
| 25 | 33 | 1952 | 7A0 | 5E | 60 | 3B | 2D |
| 25 | 34 | 1953 | 7A1 | 5E | 61 | 3B | 2F |
| 25 | 35 | 1954 | 7A2 | 5E | E2 | 3B | 53 |
| 25 | 36 | 1955 | 7A3 | 5E | E3 | 3B | 54 |
| 25 | 37 | 1956 | 7A4 | 5E | E4 | 3B | 55 |
| 25 | 38 | 1957 | 7A5 | 5E | E5 | 3B | 56 |
| 25 | 39 | 1958 | 7A6 | 5E | E6 | 3B | 57 |
| 25 | 40 | 1959 | 7A7 | 5E | E7 | 3B | 58 |
| 25 | 41 | 1960 | 7A8 | 5E | E8 | 3B | 59 |
| 25 | 42 | 1961 | 7A9 | 5E | E9 | 3B | 5A |
| 25 | 43 | 1962 | 7AA | 5E | 6A | 3B | 7C |
| 25 | 44 | 1963 | 7AB | 5E | 6B | 3B | 2C |
| 25 | 45 | 1964 | 7AC | 5E | 6C | 3B | 25 |
| 25 | 46 | 1965 | 7AD | 5E | 6D | 3B | 5F |
| 25 | 47 | 1966 | 7AE | 5E | 6E | 3B | 3E |
| 25 | 48 | 1967 | 7AF | 5E | 6F | 3B | 3F |
| 25 | 49 | 1968 | 7B0 | 5E | F0 | 3B | 30 |
| 25 | 50 | 1969 | 7B1 | 5E | F1 | 3B | 31 |
| 25 | 51 | 1970 | 7B2 | 5E | F2 | 3B | 32 |
| 25 | 52 | 1971 | 7B3 | 5E | F3 | 3B | 33 |
| 25 | 53 | 1972 | 7B4 | 5E | F4 | 3B | 34 |
| 25 | 54 | 1973 | 7B5 | 5E | F5 | 3B | 35 |
| 25 | 55 | 1974 | 7B6 | 5E | F6 | 3B | 36 |
| 25 | 56 | 1975 | 7B7 | 5E | F7 | 3B | 37 |
| 25 | 57 | 1976 | 7B8 | 5E | F8 | 3B | 38 |
| 25 | 58 | 1977 | 7B9 | 5E | F9 | 3B | 39 |
| 25 | 59 | 1978 | 7BA | 5E | 7A | 3B | 3A |
| 25 | 60 | 1979 | 7BB | 5E | 7B | 3B | 23 |
| 25 | 61 | 1980 | 7BC | 5E | 7C | 3B | 40 |
| 25 | 62 | 1981 | 7BD | 5E | 7D | 3B | 27 |
| 25 | 63 | 1982 | 7BE | 5E | 7E | 3B | 3D |
| 25 | 64 | 1983 | 7BF | 5E | 7F | 3B | 22 |

| 80 Col | | Position | | Buffer Address (Hex) | |
|--------|----|----------|-----|----------------------|-------|
| R | C | Dec | Hex | EBCDIC | ASCII |
| 25 | 65 | 1984 | 7C0 | 5F 40 | 5E 20 |
| 25 | 66 | 1985 | 7C1 | 5F C1 | 5E 41 |
| 25 | 67 | 1986 | 7C2 | 5F C2 | 5E 42 |
| 25 | 68 | 1987 | 7C3 | 5F C3 | 5E 43 |
| 25 | 69 | 1988 | 7C4 | 5F C4 | 5E 44 |
| 25 | 70 | 1989 | 7C5 | 5F C5 | 5E 45 |
| 25 | 71 | 1990 | 7C6 | 5F C6 | 5E 46 |
| 25 | 72 | 1991 | 7C7 | 5F C7 | 5E 47 |
| 25 | 73 | 1992 | 7C8 | 5F C8 | 5E 48 |
| 25 | 74 | 1993 | 7C9 | 5F C9 | 5E 49 |
| 25 | 75 | 1994 | 7CA | 5F 4A | 5E 5B |
| 25 | 76 | 1995 | 7CB | 5F 4B | 5E 2E |
| 25 | 77 | 1996 | 7CC | 5F 4C | 5E 3C |
| 25 | 78 | 1997 | 7CD | 5F 4D | 5E 28 |
| 25 | 79 | 1998 | 7CE | 5F 4E | 5E 2B |
| 25 | 80 | 1999 | 7CF | 5F 4F | 5E 21 |
| 26 | 01 | 2000 | 7D0 | 5F 50 | 5E 26 |
| 26 | 02 | 2001 | 7D1 | 5F D1 | 5E 4A |
| 26 | 03 | 2002 | 7D2 | 5F D2 | 5E 4B |
| 26 | 04 | 2003 | 7D3 | 5F D3 | 5E 4C |
| 26 | 05 | 2004 | 7D4 | 5F D4 | 5E 4D |
| 26 | 06 | 2005 | 7D5 | 5F D5 | 5E 4E |
| 26 | 07 | 2006 | 7D6 | 5F D6 | 5E 4F |
| 26 | 08 | 2007 | 7D7 | 5F D7 | 5E 50 |
| 26 | 09 | 2008 | 7D8 | 5F D8 | 5E 51 |
| 26 | 10 | 2009 | 7D9 | 5F D9 | 5E 52 |
| 26 | 11 | 2010 | 7DA | 5F 5A | 5E 5D |
| 26 | 12 | 2011 | 7DB | 5F 5B | 5E 24 |
| 26 | 13 | 2012 | 7DC | 5F 5C | 5E 2A |
| 26 | 14 | 2013 | 7DD | 5F 5D | 5E 29 |
| 26 | 15 | 2014 | 7DE | 5F 5E | 5E 3B |
| 26 | 16 | 2015 | 7DF | 5F 5F | 5E 5E |
| 26 | 17 | 2016 | 7E0 | 5F 60 | 5E 2D |
| 26 | 18 | 2017 | 7E1 | 5F 61 | 5E 2F |
| 26 | 19 | 2018 | 7E2 | 5F E2 | 5E 53 |
| 26 | 20 | 2019 | 7E3 | 5F E3 | 5E 54 |
| 26 | 21 | 2020 | 7E4 | 5F E4 | 5E 55 |
| 26 | 22 | 2021 | 7E5 | 5F E5 | 5E 56 |
| 26 | 23 | 2022 | 7E6 | 5F E6 | 5E 57 |
| 26 | 24 | 2023 | 7E7 | 5F E7 | 5E 58 |
| 26 | 25 | 2024 | 7E8 | 5F E8 | 5E 59 |
| 26 | 26 | 2025 | 7E9 | 5F E9 | 5E 5A |
| 26 | 27 | 2026 | 7EA | 5F 6A | 5E 7C |
| 26 | 28 | 2027 | 7EB | 5F 6B | 5E 2C |
| 26 | 29 | 2028 | 7EC | 5F 6C | 5E 25 |
| 26 | 30 | 2029 | 7ED | 5F 6D | 5E 5F |
| 26 | 31 | 2030 | 7EE | 5F 6E | 5E 3E |
| 26 | 32 | 2031 | 7EF | 5F 6F | 5E 3F |
| 26 | 33 | 2032 | 7F0 | 5F F0 | 5E 30 |
| 26 | 34 | 2033 | 7F1 | 5F F1 | 5E 31 |
| 26 | 35 | 2034 | 7F2 | 5F F2 | 5E 32 |
| 26 | 36 | 2035 | 7F3 | 5F F3 | 5E 33 |
| 26 | 37 | 2036 | 7F4 | 5F F4 | 5E 34 |
| 26 | 38 | 2037 | 7F5 | 5F F5 | 5E 35 |
| 26 | 39 | 2038 | 7F6 | 5F F6 | 5E 36 |
| 26 | 40 | 2039 | 7F7 | 5F F7 | 5E 37 |
| 26 | 41 | 2040 | 7F8 | 5F F8 | 5E 38 |
| 26 | 42 | 2041 | 7F9 | 5F F9 | 5E 39 |
| 26 | 43 | 2042 | 7FA | 5F 7A | 5E 3A |
| 26 | 44 | 2043 | 7FB | 5F 7B | 5E 23 |
| 26 | 45 | 2044 | 7FC | 5F 7C | 5E 40 |
| 26 | 46 | 2045 | 7FD | 5F 7D | 5E 27 |

| 80 Col | | Position | | Buffer Address (Hex) | | | |
|--------|----|----------|-----|----------------------|----|-------|----|
| R | C | Dec | Hex | EBCDIC | | ASCII | |
| 26 | 47 | 2046 | 7FE | 5F | 7E | 5E | 3D |
| 26 | 48 | 2047 | 7FF | 5F | 7F | 5E | 22 |
| 26 | 49 | 2048 | 800 | 60 | 40 | 2D | 20 |
| 26 | 50 | 2049 | 801 | 60 | C1 | 2D | 41 |
| 26 | 51 | 2050 | 802 | 60 | C2 | 2D | 42 |
| 26 | 52 | 2051 | 803 | 60 | C3 | 2D | 43 |
| 26 | 53 | 2052 | 804 | 60 | C4 | 2D | 44 |
| 26 | 54 | 2053 | 805 | 60 | C5 | 2D | 45 |
| 26 | 55 | 2054 | 806 | 60 | C6 | 2D | 46 |
| 26 | 56 | 2055 | 807 | 60 | C7 | 2D | 47 |
| 26 | 57 | 2056 | 808 | 60 | C8 | 2D | 48 |
| 26 | 58 | 2057 | 809 | 60 | C9 | 2D | 49 |
| 26 | 59 | 2058 | 80A | 60 | 4A | 2D | 5B |
| 26 | 60 | 2059 | 80B | 60 | 4B | 2D | 2E |
| 26 | 61 | 2060 | 80C | 60 | 4C | 2D | 3C |
| 26 | 62 | 2061 | 80D | 60 | 4D | 2D | 28 |
| 26 | 63 | 2062 | 80E | 60 | 4E | 2D | 2B |
| 26 | 64 | 2063 | 80F | 60 | 4F | 2D | 21 |
| 26 | 65 | 2064 | 810 | 60 | 50 | 2D | 26 |
| 26 | 66 | 2065 | 811 | 60 | D1 | 2D | 4A |
| 26 | 67 | 2066 | 812 | 60 | D2 | 2D | 4B |
| 26 | 68 | 2067 | 813 | 60 | D3 | 2D | 4C |
| 26 | 69 | 2068 | 814 | 60 | D4 | 2D | 4D |
| 26 | 70 | 2069 | 815 | 60 | D5 | 2D | 4E |
| 26 | 71 | 2070 | 816 | 60 | D6 | 2D | 4F |
| 26 | 72 | 2071 | 817 | 60 | D7 | 2D | 50 |
| 26 | 73 | 2072 | 818 | 60 | D8 | 2D | 51 |
| 26 | 74 | 2073 | 819 | 60 | D9 | 2D | 52 |
| 26 | 75 | 2074 | 81A | 60 | 5A | 2D | 5D |
| 26 | 76 | 2075 | 81B | 60 | 5B | 2D | 24 |
| 26 | 77 | 2076 | 81C | 60 | 5C | 2D | 2A |
| 26 | 78 | 2077 | 81D | 60 | 5D | 2D | 29 |
| 26 | 79 | 2078 | 81E | 60 | 5E | 2D | 3B |
| 26 | 80 | 2079 | 81F | 60 | 5F | 2D | 5E |
| 27 | 01 | 2080 | 820 | 60 | 60 | 2D | 2D |
| 27 | 02 | 2081 | 821 | 60 | 61 | 2D | 2F |
| 27 | 03 | 2082 | 822 | 60 | E2 | 2D | 53 |
| 27 | 04 | 2083 | 823 | 60 | E3 | 2D | 54 |
| 27 | 05 | 2084 | 824 | 60 | E4 | 2D | 55 |
| 27 | 06 | 2085 | 825 | 60 | E5 | 2D | 56 |
| 27 | 07 | 2086 | 826 | 60 | E6 | 2D | 57 |
| 27 | 08 | 2087 | 827 | 60 | E7 | 2D | 58 |
| 27 | 09 | 2088 | 828 | 60 | E8 | 2D | 59 |
| 27 | 10 | 2089 | 829 | 60 | E9 | 2D | 5A |
| 27 | 11 | 2090 | 82A | 60 | 6A | 2D | 7C |
| 27 | 12 | 2091 | 82B | 60 | 6B | 2D | 2C |
| 27 | 13 | 2092 | 82C | 60 | 6C | 2D | 25 |
| 27 | 14 | 2093 | 82D | 60 | 6D | 2D | 5F |
| 27 | 15 | 2094 | 82E | 60 | 6E | 2D | 3E |
| 27 | 16 | 2095 | 82F | 60 | 6F | 2D | 3F |
| 27 | 17 | 2096 | 830 | 60 | F0 | 2D | 30 |
| 27 | 18 | 2097 | 831 | 60 | F1 | 2D | 31 |
| 27 | 19 | 2098 | 832 | 60 | F2 | 2D | 32 |
| 27 | 20 | 2099 | 833 | 60 | F3 | 2D | 33 |
| 27 | 21 | 2100 | 834 | 60 | F4 | 2D | 34 |
| 27 | 22 | 2101 | 835 | 60 | F5 | 2D | 35 |
| 27 | 23 | 2102 | 836 | 60 | F6 | 2D | 36 |
| 27 | 24 | 2103 | 837 | 60 | F7 | 2D | 37 |
| 27 | 25 | 2104 | 838 | 60 | F8 | 2D | 38 |
| 27 | 26 | 2105 | 839 | 60 | F9 | 2D | 39 |
| 27 | 27 | 2106 | 83A | 60 | 7A | 2D | 3A |
| 27 | 28 | 2107 | 83B | 60 | 7B | 2D | 23 |

| 80 Col | | Position | | Buffer Address (Hex) | | | |
|----------|----------|------------|------------|----------------------|----|--------------|----|
| <u>R</u> | <u>C</u> | <u>Dec</u> | <u>Hex</u> | <u>EBCDIC</u> | | <u>ASCII</u> | |
| 27 | 29 | 2108 | 83C | 60 | 7C | 2D | 40 |
| 27 | 30 | 2109 | 83D | 60 | 7D | 2D | 27 |
| 27 | 31 | 2110 | 83E | 60 | 7E | 2D | 3D |
| 27 | 32 | 2111 | 83F | 60 | 7F | 2D | 22 |
| 27 | 33 | 2112 | 840 | 61 | 40 | 2F | 20 |
| 27 | 34 | 2113 | 841 | 61 | C1 | 2F | 41 |
| 27 | 35 | 2114 | 842 | 61 | C2 | 2F | 42 |
| 27 | 36 | 2115 | 843 | 61 | C3 | 2F | 43 |
| 27 | 37 | 2116 | 844 | 61 | C4 | 2F | 44 |
| 27 | 38 | 2117 | 845 | 61 | C5 | 2F | 45 |
| 27 | 39 | 2118 | 846 | 61 | C6 | 2F | 46 |
| 27 | 40 | 2119 | 847 | 61 | C7 | 2F | 47 |
| 27 | 41 | 2120 | 848 | 61 | C8 | 2F | 48 |
| 27 | 42 | 2121 | 849 | 61 | C9 | 2F | 49 |
| 27 | 43 | 2122 | 84A | 61 | 4A | 2F | 5B |
| 27 | 44 | 2123 | 84B | 61 | 4B | 2F | 2E |
| 27 | 45 | 2124 | 84C | 61 | 4C | 2F | 3C |
| 27 | 46 | 2125 | 84D | 61 | 4D | 2F | 28 |
| 27 | 47 | 2126 | 84E | 61 | 4E | 2F | 2B |
| 27 | 48 | 2127 | 84F | 61 | 4F | 2F | 21 |
| 27 | 49 | 2128 | 850 | 61 | 50 | 2F | 26 |
| 27 | 50 | 2129 | 851 | 61 | D1 | 2F | 4A |
| 27 | 51 | 2130 | 852 | 61 | D2 | 2F | 4B |
| 27 | 52 | 2131 | 853 | 61 | D3 | 2F | 4C |
| 27 | 53 | 2132 | 854 | 61 | D4 | 2F | 4D |
| 27 | 54 | 2133 | 855 | 61 | D5 | 2F | 4E |
| 27 | 55 | 2134 | 856 | 61 | D6 | 2F | 4F |
| 27 | 56 | 2135 | 857 | 61 | D7 | 2F | 50 |
| 27 | 57 | 2136 | 858 | 61 | D8 | 2F | 51 |
| 27 | 58 | 2137 | 859 | 61 | D9 | 2F | 52 |
| 27 | 59 | 2138 | 85A | 61 | 5A | 2F | 5D |
| 27 | 60 | 2139 | 85B | 61 | 5B | 2F | 24 |
| 27 | 61 | 2140 | 85C | 61 | 5C | 2F | 2A |
| 27 | 62 | 2141 | 85D | 61 | 5D | 2F | 29 |
| 27 | 63 | 2142 | 85E | 61 | 5E | 2F | 3B |
| 27 | 64 | 2143 | 85F | 61 | 5F | 2F | 5E |
| 27 | 65 | 2144 | 860 | 61 | 60 | 2F | 2D |
| 27 | 66 | 2145 | 861 | 61 | 61 | 2F | 2F |
| 27 | 67 | 2146 | 862 | 61 | E2 | 2F | 53 |
| 27 | 68 | 2147 | 863 | 61 | E3 | 2F | 54 |
| 27 | 69 | 2148 | 864 | 61 | E4 | 2F | 55 |
| 27 | 70 | 2149 | 865 | 61 | E5 | 2F | 56 |
| 27 | 71 | 2150 | 866 | 61 | E6 | 2F | 57 |
| 27 | 72 | 2151 | 867 | 61 | E7 | 2F | 58 |
| 27 | 73 | 2152 | 868 | 61 | E8 | 2F | 59 |
| 27 | 74 | 2153 | 869 | 61 | E9 | 2F | 5A |
| 27 | 75 | 2154 | 86A | 61 | 6A | 2F | 7C |
| 27 | 76 | 2155 | 86B | 61 | 6B | 2F | 2C |
| 27 | 77 | 2156 | 86C | 61 | 6C | 2F | 25 |
| 27 | 78 | 2157 | 86D | 61 | 6D | 2F | 5F |
| 27 | 79 | 2158 | 86E | 61 | 6E | 2F | 3E |
| 27 | 80 | 2159 | 86F | 61 | 6F | 2F | 3F |
| 28 | 01 | 2160 | 870 | 61 | F0 | 2F | 30 |
| 28 | 02 | 2161 | 871 | 61 | F1 | 2F | 31 |
| 28 | 03 | 2162 | 872 | 61 | F2 | 2F | 32 |
| 28 | 04 | 2163 | 873 | 61 | F3 | 2F | 33 |
| 28 | 05 | 2164 | 874 | 61 | F4 | 2F | 34 |
| 28 | 06 | 2165 | 875 | 61 | F5 | 2F | 35 |
| 28 | 07 | 2166 | 876 | 61 | F6 | 2F | 36 |
| 28 | 08 | 2167 | 877 | 61 | F7 | 2F | 37 |
| 28 | 09 | 2168 | 878 | 61 | F8 | 2F | 38 |
| 28 | 10 | 2169 | 879 | 61 | F9 | 2F | 39 |

| 80 Col | | Position | | Buffer Address (Hex) | | | |
|--------|----|----------|-----|----------------------|----|-------|----|
| R | C | Dec | Hex | EBCDIC | | ASCII | |
| 28 | 11 | 2170 | 87A | 61 | 7A | 2F | 3A |
| 28 | 12 | 2171 | 87B | 61 | 7B | 2F | 23 |
| 28 | 13 | 2172 | 87C | 61 | 7C | 2F | 40 |
| 28 | 14 | 2173 | 87D | 61 | 7D | 2F | 27 |
| 28 | 15 | 2174 | 87E | 61 | 7E | 2F | 3D |
| 28 | 16 | 2175 | 87F | 61 | 7F | 2F | 22 |
| 28 | 17 | 2176 | 880 | E2 | 40 | 53 | 20 |
| 28 | 18 | 2177 | 881 | E2 | C1 | 53 | 41 |
| 28 | 19 | 2178 | 882 | E2 | C2 | 53 | 42 |
| 28 | 20 | 2179 | 883 | E2 | C3 | 53 | 43 |
| 28 | 21 | 2180 | 884 | E2 | C4 | 53 | 44 |
| 28 | 22 | 2181 | 885 | E2 | C5 | 53 | 45 |
| 28 | 23 | 2182 | 886 | E2 | C6 | 53 | 46 |
| 28 | 24 | 2183 | 887 | E2 | C7 | 53 | 47 |
| 28 | 25 | 2184 | 888 | E2 | C8 | 53 | 48 |
| 28 | 26 | 2185 | 889 | E2 | C9 | 53 | 49 |
| 28 | 27 | 2186 | 88A | E2 | 4A | 53 | 5B |
| 28 | 28 | 2187 | 88B | E2 | 4B | 53 | 2E |
| 28 | 29 | 2188 | 88C | E2 | 4C | 53 | 3C |
| 28 | 30 | 2189 | 88D | E2 | 4D | 53 | 28 |
| 28 | 31 | 2190 | 88E | E2 | 4E | 53 | 2B |
| 28 | 32 | 2191 | 88F | E2 | 4F | 53 | 21 |
| 28 | 33 | 2192 | 890 | E2 | 50 | 53 | 26 |
| 28 | 34 | 2193 | 891 | E2 | D1 | 53 | 4A |
| 28 | 35 | 2194 | 892 | E2 | D2 | 53 | 4B |
| 28 | 36 | 2195 | 893 | E2 | D3 | 53 | 4C |
| 28 | 37 | 2196 | 894 | E2 | D4 | 53 | 4D |
| 28 | 38 | 2197 | 895 | E2 | D5 | 53 | 4F |
| 28 | 39 | 2198 | 896 | E2 | D6 | 53 | 4F |
| 28 | 40 | 2199 | 897 | E2 | D7 | 53 | 50 |
| 28 | 41 | 2200 | 898 | E2 | D8 | 53 | 51 |
| 28 | 42 | 2201 | 899 | E2 | D9 | 53 | 52 |
| 28 | 43 | 2202 | 89A | E2 | 5A | 53 | 5D |
| 28 | 44 | 2203 | 89B | E2 | 5B | 53 | 24 |
| 28 | 45 | 2204 | 89C | E2 | 5C | 53 | 2A |
| 28 | 46 | 2205 | 89D | E2 | 5D | 53 | 29 |
| 28 | 47 | 2206 | 89E | E2 | 5E | 53 | 3B |
| 28 | 48 | 2207 | 89F | E2 | 5F | 53 | 5E |
| 28 | 49 | 2208 | 8A0 | E2 | 60 | 53 | 2D |
| 28 | 50 | 2209 | 8A1 | E2 | 61 | 53 | 2F |
| 28 | 51 | 2210 | 8A2 | E2 | E2 | 53 | 53 |
| 28 | 52 | 2211 | 8A3 | E2 | E3 | 53 | 54 |
| 28 | 53 | 2212 | 8A4 | E2 | E4 | 53 | 55 |
| 28 | 54 | 2213 | 8A5 | E2 | E5 | 53 | 56 |
| 28 | 55 | 2214 | 8A6 | E2 | E6 | 53 | 57 |
| 28 | 56 | 2215 | 8A7 | E2 | E7 | 53 | 58 |
| 28 | 57 | 2216 | 8A8 | E2 | E8 | 53 | 59 |
| 28 | 58 | 2217 | 8A9 | E2 | E9 | 53 | 5A |
| 28 | 59 | 2218 | 8AA | E2 | 6A | 53 | 7C |
| 28 | 60 | 2219 | 8AB | E2 | 6B | 53 | 2C |
| 28 | 61 | 2220 | 8AC | E2 | 6C | 53 | 25 |
| 28 | 62 | 2221 | 8AD | E2 | 6D | 53 | 5F |
| 28 | 63 | 2222 | 8AE | E2 | 6E | 53 | 3E |
| 28 | 64 | 2223 | 8AF | E2 | 6F | 53 | 3F |
| 28 | 65 | 2224 | 8B0 | E2 | F0 | 53 | 30 |
| 28 | 66 | 2225 | 8B1 | E2 | F1 | 53 | 31 |
| 28 | 67 | 2226 | 8B2 | E2 | F2 | 53 | 32 |
| 28 | 68 | 2227 | 8B3 | E2 | F3 | 53 | 33 |
| 28 | 69 | 2228 | 8B4 | E2 | F4 | 53 | 34 |
| 28 | 70 | 2229 | 8B5 | E2 | F5 | 53 | 35 |
| 28 | 71 | 2230 | 8B6 | E2 | F6 | 53 | 36 |
| 28 | 72 | 2231 | 8B7 | E2 | F7 | 53 | 37 |
| 28 | 73 | 2232 | 8B8 | E2 | F8 | 53 | 38 |

| 80 Col | | Position | | Buffer Address (Hex) | | | |
|--------|----|----------|-----|----------------------|----|-------|----|
| R | C | Dec | Hex | EBCDIC | | ASCII | |
| 28 | 74 | 2233 | 889 | E2 | F9 | 53 | 39 |
| 28 | 75 | 2234 | 88A | E2 | 7A | 53 | 3A |
| 28 | 76 | 2235 | 88B | E2 | 7B | 53 | 23 |
| 28 | 77 | 2236 | 88C | E2 | 7C | 53 | 40 |
| 28 | 78 | 2237 | 88D | E2 | 7D | 53 | 27 |
| 28 | 79 | 2238 | 88E | E2 | 7E | 53 | 3D |
| 28 | 80 | 2239 | 88F | E2 | 7F | 53 | 22 |
| 29 | 01 | 2240 | 8C0 | E3 | 40 | 54 | 20 |
| 29 | 02 | 2241 | 8C1 | E3 | C1 | 54 | 41 |
| 29 | 03 | 2242 | 8C2 | E3 | C2 | 54 | 42 |
| 29 | 04 | 2243 | 8C3 | E3 | C3 | 54 | 43 |
| 29 | 05 | 2244 | 8C4 | E3 | C4 | 54 | 44 |
| 29 | 06 | 2245 | 8C5 | E3 | C5 | 54 | 45 |
| 29 | 07 | 2246 | 8C6 | E3 | C6 | 54 | 46 |
| 29 | 08 | 2247 | 8C7 | E3 | C7 | 54 | 47 |
| 29 | 09 | 2248 | 8C8 | E3 | C8 | 54 | 48 |
| 29 | 10 | 2249 | 8C9 | E3 | C9 | 54 | 49 |
| 29 | 11 | 2250 | 8CA | E3 | 4A | 54 | 5B |
| 29 | 12 | 2251 | 8CB | E3 | 4B | 54 | 2E |
| 29 | 13 | 2252 | 8CC | E3 | 4C | 54 | 3C |
| 29 | 14 | 2253 | 8CD | E3 | 4D | 54 | 28 |
| 29 | 15 | 2254 | 8CE | E3 | 4E | 54 | 2B |
| 29 | 16 | 2255 | 8CF | E3 | 4F | 54 | 21 |
| 29 | 17 | 2256 | 8D0 | E3 | 50 | 54 | 26 |
| 29 | 18 | 2257 | 8D1 | E3 | D1 | 54 | 4A |
| 29 | 19 | 2258 | 8D2 | E3 | D2 | 54 | 4B |
| 29 | 20 | 2259 | 8D3 | E3 | D3 | 54 | 4C |
| 29 | 21 | 2260 | 8D4 | E3 | D4 | 54 | 4D |
| 29 | 22 | 2261 | 8D5 | E3 | D5 | 54 | 4E |
| 29 | 23 | 2262 | 8D6 | E3 | D6 | 54 | 4F |
| 29 | 24 | 2263 | 8D7 | E3 | D7 | 54 | 50 |
| 29 | 25 | 2264 | 8D8 | E3 | D8 | 54 | 51 |
| 29 | 26 | 2265 | 8D9 | E3 | D9 | 54 | 52 |
| 29 | 27 | 2266 | 8DA | E3 | 5A | 54 | 5D |
| 29 | 28 | 2267 | 8DB | E3 | 5B | 54 | 24 |
| 29 | 29 | 2268 | 8DC | E3 | 5C | 54 | 2A |
| 29 | 30 | 2269 | 8DD | E3 | 5D | 54 | 29 |
| 29 | 31 | 2270 | 8DE | E3 | 5E | 54 | 3B |
| 29 | 32 | 2271 | 8DF | E3 | 5F | 54 | 5E |
| 29 | 33 | 2272 | 8E0 | E3 | 60 | 54 | 2D |
| 29 | 34 | 2273 | 8E1 | E3 | 61 | 54 | 2F |
| 29 | 35 | 2274 | 8E2 | E3 | E2 | 54 | 53 |
| 29 | 36 | 2275 | 8E3 | E3 | E3 | 54 | 54 |
| 29 | 37 | 2276 | 8E4 | E3 | E4 | 54 | 55 |
| 29 | 38 | 2277 | 8E5 | E3 | E5 | 54 | 56 |
| 29 | 39 | 2278 | 8E6 | E3 | E6 | 54 | 57 |
| 29 | 40 | 2279 | 8E7 | E3 | E7 | 54 | 58 |
| 29 | 41 | 2280 | 8E8 | E3 | E8 | 54 | 59 |
| 29 | 42 | 2281 | 8E9 | E3 | E9 | 54 | 5A |
| 29 | 43 | 2282 | 8EA | E3 | 6A | 54 | 7C |
| 29 | 44 | 2283 | 8EB | E3 | 6B | 54 | 2C |
| 29 | 45 | 2284 | 8EC | E3 | 6C | 54 | 25 |
| 29 | 46 | 2285 | 8ED | E3 | 6D | 54 | 5F |
| 29 | 47 | 2286 | 8EE | E3 | 6E | 54 | 3E |
| 29 | 48 | 2287 | 8EF | E3 | 6F | 54 | 3F |
| 29 | 49 | 2288 | 8F0 | E3 | F0 | 54 | 30 |
| 29 | 50 | 2289 | 8F1 | E3 | F1 | 54 | 31 |
| 29 | 51 | 2290 | 8F2 | E3 | F2 | 54 | 32 |
| 29 | 52 | 2291 | 8F3 | E3 | F3 | 54 | 33 |
| 29 | 53 | 2292 | 8F4 | E3 | F4 | 54 | 34 |
| 29 | 54 | 2293 | 8F5 | E3 | F5 | 54 | 35 |
| 29 | 55 | 2294 | 8F6 | E3 | F6 | 54 | 36 |

| 80 Col | | Position | | Buffer Address (Hex) | | | |
|--------|----|----------|-----|----------------------|----|-------|----|
| R | C | Dec | Hex | EBCDIC | | ASCII | |
| 29 | 56 | 2295 | 8F7 | E3 | F7 | 54 | 37 |
| 29 | 57 | 2296 | 8F8 | E3 | F8 | 54 | 38 |
| 29 | 58 | 2297 | 8F9 | E3 | F9 | 54 | 39 |
| 29 | 59 | 2298 | 8FA | E3 | 7A | 54 | 3A |
| 29 | 60 | 2299 | 8FB | E3 | 7B | 54 | 23 |
| 29 | 61 | 2300 | 8FC | E3 | 7C | 54 | 40 |
| 29 | 62 | 2301 | 8FD | E3 | 7D | 54 | 27 |
| 29 | 63 | 2302 | 8FE | E3 | 7E | 54 | 3D |
| 29 | 64 | 2303 | 8FF | E3 | 7F | 54 | 22 |
| 29 | 65 | 2304 | 900 | E4 | 40 | 55 | 20 |
| 29 | 66 | 2305 | 901 | E4 | C1 | 55 | 41 |
| 29 | 67 | 2306 | 902 | E4 | C2 | 55 | 42 |
| 29 | 68 | 2307 | 903 | E4 | C3 | 55 | 43 |
| 29 | 69 | 2308 | 904 | E4 | C4 | 55 | 44 |
| 29 | 70 | 2309 | 905 | E4 | C5 | 55 | 45 |
| 29 | 71 | 2310 | 906 | E4 | C6 | 55 | 46 |
| 29 | 72 | 2311 | 907 | E4 | C7 | 55 | 47 |
| 29 | 73 | 2312 | 908 | E4 | C8 | 55 | 48 |
| 29 | 74 | 2313 | 909 | E4 | C9 | 55 | 49 |
| 29 | 75 | 2314 | 90A | E4 | 4A | 55 | 5B |
| 29 | 76 | 2315 | 90B | E4 | 4B | 55 | 2E |
| 29 | 77 | 2316 | 90C | E4 | 4C | 55 | 3C |
| 29 | 78 | 2317 | 90D | E4 | 4D | 55 | 28 |
| 29 | 79 | 2318 | 90E | E4 | 4E | 55 | 2B |
| 29 | 80 | 2319 | 90F | E4 | 4F | 55 | 21 |
| 30 | 01 | 2320 | 910 | E4 | 50 | 55 | 26 |
| 30 | 02 | 2321 | 911 | E4 | D1 | 55 | 4A |
| 30 | 03 | 2322 | 912 | E4 | D2 | 55 | 4B |
| 30 | 04 | 2323 | 913 | E4 | D3 | 55 | 4C |
| 30 | 05 | 2324 | 914 | E4 | D4 | 55 | 4D |
| 30 | 06 | 2325 | 915 | E4 | D5 | 55 | 4E |
| 30 | 07 | 2326 | 916 | E4 | D6 | 55 | 4F |
| 30 | 08 | 2327 | 917 | E4 | D7 | 55 | 50 |
| 30 | 09 | 2328 | 918 | E4 | D8 | 55 | 51 |
| 30 | 10 | 2329 | 919 | E4 | D9 | 55 | 52 |
| 30 | 11 | 2330 | 91A | E4 | 5A | 55 | 5D |
| 30 | 12 | 2331 | 91B | E4 | 5B | 55 | 24 |
| 30 | 13 | 2332 | 91C | E4 | 5C | 55 | 2A |
| 30 | 14 | 2333 | 91D | E4 | 5D | 55 | 29 |
| 30 | 15 | 2334 | 91E | E4 | 5E | 55 | 3B |
| 30 | 16 | 2335 | 91F | E4 | 5F | 55 | 5E |
| 30 | 17 | 2336 | 920 | E4 | 60 | 55 | 2D |
| 30 | 18 | 2337 | 921 | E4 | 61 | 55 | 2F |
| 30 | 19 | 2338 | 922 | E4 | E2 | 55 | 53 |
| 30 | 20 | 2339 | 923 | E4 | E3 | 55 | 54 |
| 30 | 21 | 2340 | 924 | E4 | E4 | 55 | 55 |
| 30 | 22 | 2341 | 925 | E4 | E5 | 55 | 56 |
| 30 | 23 | 2342 | 926 | E4 | E6 | 55 | 57 |
| 30 | 24 | 2343 | 927 | E4 | E7 | 55 | 58 |
| 30 | 25 | 2344 | 928 | E4 | E8 | 55 | 59 |
| 30 | 26 | 2345 | 929 | E4 | E9 | 55 | 5A |
| 30 | 27 | 2346 | 92A | E4 | 6A | 55 | 7C |
| 30 | 28 | 2347 | 92B | E4 | 6B | 55 | 2C |
| 30 | 29 | 2348 | 92C | E4 | 6C | 55 | 25 |
| 30 | 30 | 2349 | 92D | E4 | 6D | 55 | 5F |
| 30 | 31 | 2350 | 92E | E4 | 6E | 55 | 3E |
| 30 | 32 | 2351 | 92F | E4 | 6F | 55 | 3F |
| 30 | 33 | 2352 | 930 | E4 | F0 | 55 | 30 |
| 30 | 34 | 2353 | 931 | E4 | F1 | 55 | 31 |
| 30 | 35 | 2354 | 932 | E4 | F2 | 55 | 32 |
| 30 | 36 | 2355 | 933 | E4 | F3 | 55 | 33 |
| 30 | 37 | 2356 | 934 | E4 | F4 | 55 | 34 |

| 80 Col | | Position | | Buffer Address (Hex) | | | |
|--------|----|----------|-----|----------------------|----|-------|----|
| R | C | Dec | Hex | EBCDIC | | ASCII | |
| 30 | 38 | 2357 | 935 | E4 | F5 | 55 | 35 |
| 30 | 39 | 2358 | 936 | E4 | F6 | 55 | 36 |
| 30 | 40 | 2359 | 937 | E4 | F7 | 55 | 37 |
| 30 | 41 | 2360 | 938 | E4 | F8 | 55 | 38 |
| 30 | 42 | 2361 | 939 | E4 | F9 | 55 | 39 |
| 30 | 43 | 2362 | 93A | E4 | 7A | 55 | 3A |
| 30 | 44 | 2363 | 93B | E4 | 7B | 55 | 23 |
| 30 | 45 | 2364 | 93C | E4 | 7C | 55 | 40 |
| 30 | 46 | 2365 | 93D | E4 | 7D | 55 | 27 |
| 30 | 47 | 2366 | 93E | E4 | 7E | 55 | 3D |
| 30 | 48 | 2367 | 93F | E4 | 7F | 55 | 22 |
| 30 | 49 | 2368 | 940 | E5 | 40 | 56 | 20 |
| 30 | 50 | 2369 | 941 | E5 | C1 | 56 | 41 |
| 30 | 51 | 2370 | 942 | E5 | C2 | 56 | 42 |
| 30 | 52 | 2371 | 943 | E5 | C3 | 56 | 43 |
| 30 | 53 | 2372 | 944 | E5 | C4 | 56 | 44 |
| 30 | 54 | 2373 | 945 | E5 | C5 | 56 | 45 |
| 30 | 55 | 2374 | 946 | E5 | C6 | 56 | 46 |
| 30 | 56 | 2375 | 947 | E5 | C7 | 56 | 47 |
| 30 | 57 | 2376 | 948 | E5 | C8 | 56 | 48 |
| 30 | 58 | 2377 | 949 | E5 | C9 | 56 | 49 |
| 30 | 59 | 2378 | 94A | E5 | 4A | 56 | 5B |
| 30 | 60 | 2379 | 94B | E5 | 4B | 56 | 2E |
| 30 | 61 | 2380 | 94C | E5 | 4C | 56 | 3C |
| 30 | 62 | 2381 | 94D | E5 | 4D | 56 | 28 |
| 30 | 63 | 2382 | 94E | E5 | 4E | 56 | 2B |
| 30 | 64 | 2383 | 94F | E5 | 4F | 56 | 21 |
| 30 | 65 | 2384 | 950 | E5 | 50 | 56 | 26 |
| 30 | 66 | 2385 | 951 | E5 | D1 | 56 | 4A |
| 30 | 67 | 2386 | 952 | E5 | D2 | 56 | 4B |
| 30 | 68 | 2387 | 953 | E5 | D3 | 56 | 4C |
| 30 | 69 | 2388 | 954 | E5 | D4 | 56 | 4D |
| 30 | 70 | 2389 | 955 | E5 | D5 | 56 | 4E |
| 30 | 71 | 2390 | 956 | E5 | D6 | 56 | 4F |
| 30 | 72 | 2391 | 957 | E5 | D7 | 56 | 50 |
| 30 | 73 | 2392 | 958 | E5 | D8 | 56 | 51 |
| 30 | 74 | 2393 | 959 | E5 | D9 | 56 | 52 |
| 30 | 75 | 2394 | 95A | E5 | 5A | 56 | 5D |
| 30 | 76 | 2395 | 95B | E5 | 5B | 56 | 24 |
| 30 | 77 | 2396 | 95C | E5 | 5C | 56 | 2A |
| 30 | 78 | 2397 | 95D | E5 | 5D | 56 | 29 |
| 30 | 79 | 2398 | 95E | E5 | 5E | 56 | 3B |
| 30 | 80 | 2399 | 95F | E5 | 5F | 56 | 5E |
| 31 | 01 | 2400 | 960 | F5 | 60 | 56 | 2D |
| 31 | 02 | 2401 | 961 | E5 | 61 | 56 | 2F |
| 31 | 03 | 2402 | 962 | F5 | E2 | 56 | 53 |
| 31 | 04 | 2403 | 963 | E5 | E3 | 56 | 54 |
| 31 | 05 | 2404 | 964 | E5 | E4 | 56 | 55 |
| 31 | 06 | 2405 | 965 | E5 | E5 | 56 | 56 |
| 31 | 07 | 2406 | 966 | E5 | E6 | 56 | 57 |
| 31 | 08 | 2407 | 967 | E5 | E7 | 56 | 58 |
| 31 | 09 | 2408 | 968 | E5 | E8 | 56 | 59 |
| 31 | 10 | 2409 | 969 | E5 | E9 | 56 | 5A |
| 31 | 11 | 2410 | 96A | E5 | 6A | 56 | 7C |
| 31 | 12 | 2411 | 96B | E5 | 6B | 56 | 2C |
| 31 | 13 | 2412 | 96C | E5 | 6C | 56 | 25 |
| 31 | 14 | 2413 | 96D | E5 | 6D | 56 | 5F |
| 31 | 15 | 2414 | 96E | E5 | 6E | 56 | 3E |
| 31 | 16 | 2415 | 96F | E5 | 6F | 56 | 3F |
| 31 | 17 | 2416 | 970 | E5 | F0 | 56 | 30 |
| 31 | 18 | 2417 | 971 | E5 | F1 | 56 | 31 |
| 31 | 19 | 2418 | 972 | E5 | F2 | 56 | 32 |

| 80 Col | | Position | | Buffer Address (Hex) | | | |
|----------|----------|------------|------------|----------------------|----|--------------|----|
| <u>R</u> | <u>C</u> | <u>Dec</u> | <u>Hex</u> | <u>EBCDIC</u> | | <u>ASCII</u> | |
| 31 | 20 | 2419 | 973 | E5 | F3 | 56 | 33 |
| 31 | 21 | 2420 | 974 | E5 | F4 | 56 | 34 |
| 31 | 22 | 2421 | 975 | E5 | F5 | 56 | 35 |
| 31 | 23 | 2422 | 976 | E5 | F6 | 56 | 36 |
| 31 | 24 | 2423 | 977 | E5 | F7 | 56 | 37 |
| 31 | 25 | 2424 | 978 | E5 | F8 | 56 | 38 |
| 31 | 26 | 2425 | 979 | E5 | F9 | 56 | 39 |
| 31 | 27 | 2426 | 97A | E5 | 7A | 56 | 3A |
| 31 | 28 | 2427 | 97B | E5 | 7B | 56 | 23 |
| 31 | 29 | 2428 | 97C | E5 | 7C | 56 | 40 |
| 31 | 30 | 2429 | 97D | E5 | 7D | 56 | 27 |
| 31 | 31 | 2430 | 97E | E5 | 7E | 56 | 3D |
| 31 | 32 | 2431 | 97F | E5 | 7F | 56 | 22 |
| 31 | 33 | 2432 | 980 | E6 | 40 | 57 | 20 |
| 31 | 34 | 2433 | 981 | E6 | C1 | 57 | 41 |
| 31 | 35 | 2434 | 982 | E6 | C2 | 57 | 42 |
| 31 | 36 | 2435 | 983 | E6 | C3 | 57 | 43 |
| 31 | 37 | 2436 | 984 | E6 | C4 | 57 | 44 |
| 31 | 38 | 2437 | 985 | E6 | C5 | 57 | 45 |
| 31 | 39 | 2438 | 986 | E6 | C6 | 57 | 46 |
| 31 | 40 | 2439 | 987 | E6 | C7 | 57 | 47 |
| 31 | 41 | 2440 | 988 | E6 | C8 | 57 | 48 |
| 31 | 42 | 2441 | 989 | E6 | C9 | 57 | 49 |
| 31 | 43 | 2442 | 98A | E6 | 4A | 57 | 5B |
| 31 | 44 | 2443 | 98B | E6 | 4B | 57 | 2E |
| 31 | 45 | 2444 | 98C | E6 | 4C | 57 | 3C |
| 31 | 46 | 2445 | 98D | E6 | 4D | 57 | 28 |
| 31 | 47 | 2446 | 98E | E6 | 4E | 57 | 2B |
| 31 | 48 | 2447 | 98F | E6 | 4F | 57 | 21 |
| 31 | 49 | 2448 | 990 | E6 | 50 | 57 | 26 |
| 31 | 50 | 2449 | 991 | E6 | D1 | 57 | 4A |
| 31 | 51 | 2450 | 992 | E6 | D2 | 57 | 4B |
| 31 | 52 | 2451 | 993 | E6 | D3 | 57 | 4C |
| 31 | 53 | 2452 | 994 | E6 | D4 | 57 | 4D |
| 31 | 54 | 2453 | 995 | E6 | D5 | 57 | 4E |
| 31 | 55 | 2454 | 996 | E6 | D6 | 57 | 4F |
| 31 | 56 | 2455 | 997 | E6 | D7 | 57 | 50 |
| 31 | 57 | 2456 | 998 | E6 | D8 | 57 | 51 |
| 31 | 58 | 2457 | 999 | E6 | D9 | 57 | 52 |
| 31 | 59 | 2458 | 99A | E6 | 5A | 57 | 5D |
| 31 | 60 | 2459 | 99B | E6 | 5B | 57 | 24 |
| 31 | 61 | 2460 | 99C | E6 | 5C | 57 | 2A |
| 31 | 62 | 2461 | 99D | E6 | 5D | 57 | 29 |
| 31 | 63 | 2462 | 99E | E6 | 5E | 57 | 3B |
| 31 | 64 | 2463 | 99F | E6 | 5F | 57 | 5E |
| 31 | 65 | 2464 | 9A0 | E6 | 60 | 57 | 2D |
| 31 | 66 | 2465 | 9A1 | E6 | 61 | 57 | 2F |
| 31 | 67 | 2466 | 9A2 | E6 | E2 | 57 | 53 |
| 31 | 68 | 2467 | 9A3 | E6 | E3 | 57 | 54 |
| 31 | 69 | 2468 | 9A4 | E6 | E4 | 57 | 55 |
| 31 | 70 | 2469 | 9A5 | E6 | E5 | 57 | 56 |
| 31 | 71 | 2470 | 9A6 | E6 | E6 | 57 | 57 |
| 31 | 72 | 2471 | 9A7 | E6 | E7 | 57 | 58 |
| 31 | 73 | 2472 | 9A8 | E6 | E8 | 57 | 59 |
| 31 | 74 | 2473 | 9A9 | E6 | E9 | 57 | 5A |
| 31 | 75 | 2474 | 9AA | E6 | 6A | 57 | 7C |
| 31 | 76 | 2475 | 9AB | E6 | 6B | 57 | 2C |
| 31 | 77 | 2476 | 9AC | E6 | 6C | 57 | 25 |
| 31 | 78 | 2477 | 9AD | E6 | 6D | 57 | 5F |
| 31 | 79 | 2478 | 9AE | E6 | 6E | 57 | 3E |
| 31 | 80 | 2479 | 9AF | E6 | 6F | 57 | 3F |

| 80 Col | | Position | | Buffer Address (Hex) | | | |
|--------|----|----------|-----|----------------------|----|-------|----|
| R | C | Dec | Hex | EBCDIC | | ASCII | |
| 32 | 01 | 2480 | 9B0 | E6 | F0 | 57 | 30 |
| 32 | 02 | 2481 | 9B1 | E6 | F1 | 57 | 31 |
| 32 | 03 | 2482 | 9B2 | E6 | F2 | 57 | 32 |
| 32 | 04 | 2483 | 9B3 | E6 | F3 | 57 | 33 |
| 32 | 05 | 2484 | 9B4 | E6 | F4 | 57 | 34 |
| 32 | 06 | 2485 | 9B5 | E6 | F5 | 57 | 35 |
| 32 | 07 | 2486 | 9B6 | E6 | F6 | 57 | 36 |
| 32 | 08 | 2487 | 9B7 | E6 | F7 | 57 | 37 |
| 32 | 09 | 2488 | 9B8 | E6 | F8 | 57 | 38 |
| 32 | 10 | 2489 | 9B9 | E6 | F9 | 57 | 39 |
| 32 | 11 | 2490 | 9BA | E6 | 7A | 57 | 3A |
| 32 | 12 | 2491 | 9BB | E6 | 7B | 57 | 23 |
| 32 | 13 | 2492 | 9BC | E6 | 7C | 57 | 40 |
| 32 | 14 | 2493 | 9BD | E6 | 7D | 57 | 27 |
| 32 | 15 | 2494 | 9BE | E6 | 7E | 57 | 3D |
| 32 | 16 | 2495 | 9BF | E6 | 7F | 57 | 22 |
| 32 | 17 | 2496 | 9C0 | E7 | 40 | 58 | 20 |
| 32 | 18 | 2497 | 9C1 | E7 | C1 | 58 | 41 |
| 32 | 19 | 2498 | 9C2 | E7 | C2 | 58 | 42 |
| 32 | 20 | 2499 | 9C3 | E7 | C3 | 58 | 43 |
| 32 | 21 | 2500 | 9C4 | E7 | C4 | 58 | 44 |
| 32 | 22 | 2501 | 9C5 | E7 | C5 | 58 | 45 |
| 32 | 23 | 2502 | 9C6 | E7 | C6 | 58 | 46 |
| 32 | 24 | 2503 | 9C7 | E7 | C7 | 58 | 47 |
| 32 | 25 | 2504 | 9C8 | E7 | C8 | 58 | 48 |
| 32 | 26 | 2505 | 9C9 | E7 | C9 | 58 | 49 |
| 32 | 27 | 2506 | 9CA | E7 | 4A | 58 | 5B |
| 32 | 28 | 2507 | 9CB | E7 | 4B | 58 | 2E |
| 32 | 29 | 2508 | 9CC | E7 | 4C | 58 | 3C |
| 32 | 30 | 2509 | 9CD | E7 | 4D | 58 | 28 |
| 32 | 31 | 2510 | 9CE | E7 | 4E | 58 | 2B |
| 32 | 32 | 2511 | 9CF | E7 | 4F | 58 | 21 |
| 32 | 33 | 2512 | 9D0 | E7 | 50 | 58 | 26 |
| 32 | 34 | 2513 | 9D1 | E7 | D1 | 58 | 4A |
| 32 | 35 | 2514 | 9D2 | E7 | D2 | 58 | 4B |
| 32 | 36 | 2515 | 9D3 | E7 | D3 | 58 | 4C |
| 32 | 37 | 2516 | 9D4 | E7 | D4 | 58 | 4D |
| 32 | 38 | 2517 | 9D5 | E7 | D5 | 58 | 4E |
| 32 | 39 | 2518 | 9D6 | E7 | D6 | 58 | 4F |
| 32 | 40 | 2519 | 9D7 | E7 | D7 | 58 | 50 |
| 32 | 41 | 2520 | 9D8 | E7 | D8 | 58 | 51 |
| 32 | 42 | 2521 | 9D9 | E7 | D9 | 58 | 52 |
| 32 | 43 | 2522 | 9DA | E7 | 5A | 58 | 5D |
| 32 | 44 | 2523 | 9DB | E7 | 5B | 58 | 24 |
| 32 | 45 | 2524 | 9DC | E7 | 5C | 58 | 2A |
| 32 | 46 | 2525 | 9DD | E7 | 5D | 58 | 29 |
| 32 | 47 | 2526 | 9DE | E7 | 5E | 58 | 3B |
| 32 | 48 | 2527 | 9DF | E7 | 5F | 58 | 5E |
| 32 | 49 | 2528 | 9E0 | E7 | 60 | 58 | 2D |
| 32 | 50 | 2529 | 9E1 | E7 | 61 | 58 | 2F |
| 32 | 51 | 2530 | 9E2 | E7 | E2 | 58 | 53 |
| 32 | 52 | 2531 | 9E3 | E7 | E3 | 58 | 54 |
| 32 | 53 | 2532 | 9E4 | E7 | E4 | 58 | 55 |
| 32 | 54 | 2533 | 9E5 | E7 | E5 | 58 | 56 |
| 32 | 55 | 2534 | 9E6 | E7 | E6 | 58 | 57 |
| 32 | 56 | 2535 | 9E7 | E7 | E7 | 58 | 58 |
| 32 | 57 | 2536 | 9E8 | E7 | E8 | 58 | 59 |
| 32 | 58 | 2537 | 9E9 | E7 | E9 | 58 | 5A |
| 32 | 59 | 2538 | 9EA | E7 | 6A | 58 | 7C |
| 32 | 60 | 2539 | 9EB | E7 | 6B | 58 | 2C |
| 32 | 61 | 2540 | 9EC | E7 | 6C | 58 | 25 |
| 32 | 62 | 2541 | 9ED | E7 | 6D | 58 | 5F |

| 80 Col | | Position | | Buffer Address (Hex) | | | |
|--------|----|----------|-----|----------------------|----|-------|----|
| R | C | Dec | Hex | EBCDIC | | ASCII | |
| 32 | 63 | 2542 | 9EE | E7 | 6E | 58 | 3E |
| 32 | 64 | 2543 | 9EF | E7 | 6F | 58 | 3F |
| 32 | 65 | 2544 | 9F0 | E7 | F0 | 58 | 30 |
| 32 | 66 | 2545 | 9F1 | E7 | F1 | 58 | 31 |
| 32 | 67 | 2546 | 9F2 | E7 | F2 | 58 | 32 |
| 32 | 68 | 2547 | 9F3 | E7 | F3 | 58 | 33 |
| 32 | 69 | 2548 | 9F4 | E7 | F4 | 58 | 34 |
| 32 | 70 | 2549 | 9F5 | E7 | F5 | 58 | 35 |
| 32 | 71 | 2550 | 9F6 | E7 | F6 | 58 | 36 |
| 32 | 72 | 2551 | 9F7 | E7 | F7 | 58 | 37 |
| 32 | 73 | 2552 | 9F8 | E7 | F8 | 58 | 38 |
| 32 | 74 | 2553 | 9F9 | E7 | F9 | 58 | 39 |
| 32 | 75 | 2554 | 9FA | E7 | 7A | 58 | 3A |
| 32 | 76 | 2555 | 9FB | E7 | 7B | 58 | 23 |
| 32 | 77 | 2556 | 9FC | E7 | 7C | 58 | 40 |
| 32 | 78 | 2557 | 9FD | E7 | 7D | 58 | 27 |
| 32 | 79 | 2558 | 9FE | E7 | 7E | 58 | 3D |
| 32 | 80 | 2559 | 9FF | E7 | 7F | 58 | 22 |
| 33 | 01 | 2560 | A00 | E8 | 40 | 59 | 20 |
| 33 | 02 | 2561 | A01 | E8 | C1 | 59 | 41 |
| 33 | 03 | 2562 | A02 | E8 | C2 | 59 | 42 |
| 33 | 04 | 2563 | A03 | E8 | C3 | 59 | 43 |
| 33 | 05 | 2564 | A04 | E8 | C4 | 59 | 44 |
| 33 | 06 | 2565 | A05 | E8 | C5 | 59 | 45 |
| 33 | 07 | 2566 | A06 | E8 | C6 | 59 | 46 |
| 33 | 08 | 2567 | A07 | E8 | C7 | 59 | 47 |
| 33 | 09 | 2568 | A08 | E8 | C8 | 59 | 48 |
| 33 | 10 | 2569 | A09 | E8 | C9 | 59 | 49 |
| 33 | 11 | 2570 | A0A | E8 | 4A | 59 | 5B |
| 33 | 12 | 2571 | A0B | E8 | 4B | 59 | 2E |
| 33 | 13 | 2572 | A0C | E8 | 4C | 59 | 3C |
| 33 | 14 | 2573 | A0D | E8 | 4D | 59 | 28 |
| 33 | 15 | 2574 | A0E | E8 | 4E | 59 | 2B |
| 33 | 16 | 2575 | A0F | E8 | 4F | 59 | 21 |
| 33 | 17 | 2576 | A10 | E8 | 50 | 59 | 26 |
| 33 | 18 | 2577 | A11 | E8 | D1 | 59 | 4A |
| 33 | 19 | 2578 | A12 | E8 | D2 | 59 | 4B |
| 33 | 20 | 2579 | A13 | E8 | D3 | 59 | 4C |
| 33 | 21 | 2580 | A14 | E8 | D4 | 59 | 4D |
| 33 | 22 | 2581 | A15 | E8 | D5 | 59 | 4E |
| 33 | 23 | 2582 | A16 | E8 | D6 | 59 | 4F |
| 33 | 24 | 2583 | A17 | E8 | D7 | 59 | 50 |
| 33 | 25 | 2584 | A18 | E8 | D8 | 59 | 51 |
| 33 | 26 | 2585 | A19 | E8 | D9 | 59 | 52 |
| 33 | 27 | 2586 | A1A | E8 | 5A | 59 | 5D |
| 33 | 28 | 2587 | A1B | E8 | 5B | 59 | 24 |
| 33 | 29 | 2588 | A1C | E8 | 5C | 59 | 2A |
| 33 | 30 | 2589 | A1D | E8 | 5D | 59 | 29 |
| 33 | 31 | 2590 | A1E | E8 | 5E | 59 | 3B |
| 33 | 32 | 2591 | A1F | E8 | 5F | 59 | 5E |
| 33 | 33 | 2592 | A20 | E8 | 60 | 59 | 2D |
| 33 | 34 | 2593 | A21 | E8 | 61 | 59 | 2F |
| 33 | 35 | 2594 | A22 | E8 | E2 | 59 | 53 |
| 33 | 36 | 2595 | A23 | E8 | E3 | 59 | 54 |
| 33 | 37 | 2596 | A24 | E8 | E4 | 59 | 55 |
| 33 | 38 | 2597 | A25 | E8 | E5 | 59 | 56 |
| 33 | 39 | 2598 | A26 | E8 | E6 | 59 | 57 |
| 33 | 40 | 2599 | A27 | E8 | E7 | 59 | 58 |
| 33 | 41 | 2600 | A28 | E8 | E8 | 59 | 59 |
| 33 | 42 | 2601 | A29 | E8 | E9 | 59 | 5A |
| 33 | 43 | 2602 | A2A | E8 | 6A | 59 | 7C |
| 33 | 44 | 2603 | A2B | E8 | 6B | 59 | 2C |

| 80 Col | | Position | | Buffer Address (Hex) | |
|--------|----|----------|-----|----------------------|-------|
| R | C | Dec | Hex | EBCDIC | ASCII |
| 33 | 45 | 2604 | A2C | E8 6C | 59 25 |
| 33 | 46 | 2605 | A2D | E8 6D | 59 5F |
| 33 | 47 | 2606 | A2E | E8 6E | 59 3E |
| 33 | 48 | 2607 | A2F | E8 6F | 59 3F |
| 33 | 49 | 2608 | A30 | E8 F0 | 59 30 |
| 33 | 50 | 2609 | A31 | E8 F1 | 59 31 |
| 33 | 51 | 2610 | A32 | E8 F2 | 59 32 |
| 33 | 52 | 2611 | A33 | E8 F3 | 59 33 |
| 33 | 53 | 2612 | A34 | E8 F4 | 59 34 |
| 33 | 54 | 2613 | A35 | E8 F5 | 59 35 |
| 33 | 55 | 2614 | A36 | E8 F6 | 59 36 |
| 33 | 56 | 2615 | A37 | E8 F7 | 59 37 |
| 33 | 57 | 2616 | A38 | E8 F8 | 59 38 |
| 33 | 58 | 2617 | A39 | E8 F9 | 59 39 |
| 33 | 59 | 2618 | A3A | E8 7A | 59 3A |
| 33 | 60 | 2619 | A3B | E8 7B | 59 23 |
| 33 | 61 | 2620 | A3C | E8 7C | 59 40 |
| 33 | 62 | 2621 | A3D | E8 7D | 59 27 |
| 33 | 63 | 2622 | A3E | E8 7E | 59 3D |
| 33 | 64 | 2623 | A3F | E8 7F | 59 22 |
| 33 | 65 | 2624 | A40 | E9 40 | 5A 20 |
| 33 | 66 | 2625 | A41 | E9 C1 | 5A 41 |
| 33 | 67 | 2626 | A42 | E9 C2 | 5A 42 |
| 33 | 68 | 2627 | A43 | E9 C3 | 5A 43 |
| 33 | 69 | 2628 | A44 | E9 C4 | 5A 44 |
| 33 | 70 | 2629 | A45 | E9 C5 | 5A 45 |
| 33 | 71 | 2630 | A46 | E9 C6 | 5A 46 |
| 33 | 72 | 2631 | A47 | E9 C7 | 5A 47 |
| 33 | 73 | 2632 | A48 | E9 C8 | 5A 48 |
| 33 | 74 | 2633 | A49 | E9 C9 | 5A 49 |
| 33 | 75 | 2634 | A4A | E9 4A | 5A 5B |
| 33 | 76 | 2635 | A4B | E9 4B | 5A 2E |
| 33 | 77 | 2636 | A4C | E9 4C | 5A 3C |
| 33 | 78 | 2637 | A4D | E9 4D | 5A 28 |
| 33 | 79 | 2638 | A4E | E9 4E | 5A 2B |
| 33 | 80 | 2639 | A4F | E9 4F | 5A 21 |
| 34 | 01 | 2640 | A50 | E9 50 | 5A 26 |
| 34 | 02 | 2641 | A51 | F9 D1 | 5A 4A |
| 34 | 03 | 2642 | A52 | E9 D2 | 5A 4B |
| 34 | 04 | 2643 | A53 | E9 D3 | 5A 4C |
| 34 | 05 | 2644 | A54 | E9 D4 | 5A 4D |
| 34 | 06 | 2645 | A55 | E9 D5 | 5A 4E |
| 34 | 07 | 2646 | A56 | E9 D6 | 5A 4F |
| 34 | 08 | 2647 | A57 | E9 D7 | 5A 50 |
| 34 | 09 | 2648 | A58 | E9 D8 | 5A 51 |
| 34 | 10 | 2649 | A59 | E9 D9 | 5A 52 |
| 34 | 11 | 2650 | A5A | E9 5A | 5A 5D |
| 34 | 12 | 2651 | A5B | E9 5B | 5A 24 |
| 34 | 13 | 2652 | A5C | E9 5C | 5A 2A |
| 34 | 14 | 2653 | A5D | E9 5D | 5A 29 |
| 34 | 15 | 2654 | A5E | E9 5E | 5A 3B |
| 34 | 16 | 2655 | A5F | E9 5F | 5A 5E |
| 34 | 17 | 2656 | A60 | E9 60 | 5A 2D |
| 34 | 18 | 2657 | A61 | E9 61 | 5A 2F |
| 34 | 19 | 2658 | A62 | E9 E2 | 5A 53 |
| 34 | 20 | 2659 | A63 | E9 E3 | 5A 54 |
| 34 | 21 | 2660 | A64 | E9 E4 | 5A 55 |
| 34 | 22 | 2661 | A65 | E9 E5 | 5A 56 |
| 34 | 23 | 2662 | A66 | E9 E6 | 5A 57 |
| 34 | 24 | 2663 | A67 | E9 E7 | 5A 58 |
| 34 | 25 | 2664 | A68 | E9 E8 | 5A 59 |
| 34 | 26 | 2665 | A69 | E9 E9 | 5A 5A |

| 80 Col | | Position | | Buffer Address (Hex) | | | |
|--------|----|----------|-----|----------------------|----|-------|----|
| R | C | Dec | Hex | EBCDIC | | ASCII | |
| 34 | 27 | 2666 | A6A | E9 | 6A | 5A | 7C |
| 34 | 28 | 2667 | A6B | E9 | 6B | 5A | 2C |
| 34 | 29 | 2668 | A6C | E9 | 6C | 5A | 25 |
| 34 | 30 | 2669 | A6D | E9 | 6D | 5A | 5F |
| 34 | 31 | 2670 | A6E | E9 | 6E | 5A | 3E |
| 34 | 32 | 2671 | A6F | E9 | 6F | 5A | 3F |
| 34 | 33 | 2672 | A70 | E9 | F0 | 5A | 30 |
| 34 | 34 | 2673 | A71 | E9 | F1 | 5A | 31 |
| 34 | 35 | 2674 | A72 | E9 | F2 | 5A | 32 |
| 34 | 36 | 2675 | A73 | E9 | F3 | 5A | 33 |
| 34 | 37 | 2676 | A74 | E9 | F4 | 5A | 34 |
| 34 | 38 | 2677 | A75 | E9 | F5 | 5A | 35 |
| 34 | 39 | 2678 | A76 | E9 | F6 | 5A | 36 |
| 34 | 40 | 2679 | A77 | E9 | F7 | 5A | 37 |
| 34 | 41 | 2680 | A78 | E9 | F8 | 5A | 38 |
| 34 | 42 | 2681 | A79 | E9 | F9 | 5A | 39 |
| 34 | 43 | 2682 | A7A | E9 | 7A | 5A | 3A |
| 34 | 44 | 2683 | A7B | E9 | 7B | 5A | 23 |
| 34 | 45 | 2684 | A7C | E9 | 7C | 5A | 40 |
| 34 | 46 | 2685 | A7D | E9 | 7D | 5A | 27 |
| 34 | 47 | 2686 | A7E | E9 | 7E | 5A | 3D |
| 34 | 48 | 2687 | A7F | E9 | 7F | 5A | 22 |
| 34 | 49 | 2688 | A80 | 6A | 40 | 7C | 20 |
| 34 | 50 | 2689 | A81 | 6A | C1 | 7C | 41 |
| 34 | 51 | 2690 | A82 | 6A | C2 | 7C | 42 |
| 34 | 52 | 2691 | A83 | 6A | C3 | 7C | 43 |
| 34 | 53 | 2692 | A84 | 6A | C4 | 7C | 44 |
| 34 | 54 | 2693 | A85 | 6A | C5 | 7C | 45 |
| 34 | 55 | 2694 | A86 | 6A | C6 | 7C | 46 |
| 34 | 56 | 2695 | A87 | 6A | C7 | 7C | 47 |
| 34 | 57 | 2696 | A88 | 6A | C8 | 7C | 48 |
| 34 | 58 | 2697 | A89 | 6A | C9 | 7C | 49 |
| 34 | 59 | 2698 | A8A | 6A | 4A | 7C | 5B |
| 34 | 60 | 2699 | A8B | 6A | 4B | 7C | 2E |
| 34 | 61 | 2700 | A8C | 6A | 4C | 7C | 3C |
| 34 | 62 | 2701 | A8D | 6A | 4D | 7C | 28 |
| 34 | 63 | 2702 | A8E | 6A | 4E | 7C | 2B |
| 34 | 64 | 2703 | A8F | 6A | 4F | 7C | 21 |
| 34 | 65 | 2704 | A90 | 6A | 50 | 7C | 26 |
| 34 | 66 | 2705 | A91 | 6A | D1 | 7C | 4A |
| 34 | 67 | 2706 | A92 | 6A | D2 | 7C | 4B |
| 34 | 68 | 2707 | A93 | 6A | D3 | 7C | 4C |
| 34 | 69 | 2708 | A94 | 6A | D4 | 7C | 4D |
| 34 | 70 | 2709 | A95 | 6A | D5 | 7C | 4E |
| 34 | 71 | 2710 | A96 | 6A | D6 | 7C | 4F |
| 34 | 72 | 2711 | A97 | 6A | D7 | 7C | 50 |
| 34 | 73 | 2712 | A98 | 6A | D8 | 7C | 51 |
| 34 | 74 | 2713 | A99 | 6A | D9 | 7C | 52 |
| 34 | 75 | 2714 | A9A | 6A | 5A | 7C | 5D |
| 34 | 76 | 2715 | A9B | 6A | 5B | 7C | 24 |
| 34 | 77 | 2716 | A9C | 6A | 5C | 7C | 2A |
| 34 | 78 | 2717 | A9D | 6A | 5D | 7C | 29 |
| 34 | 79 | 2718 | A9E | 6A | 5E | 7C | 3B |
| 34 | 80 | 2719 | A9F | 6A | 5F | 7C | 5E |
| 35 | 01 | 2720 | AA0 | 6A | 60 | 7C | 2D |
| 35 | 02 | 2721 | AA1 | 6A | 61 | 7C | 2F |
| 35 | 03 | 2722 | AA2 | 6A | E2 | 7C | 53 |
| 35 | 04 | 2723 | AA3 | 6A | E3 | 7C | 54 |
| 35 | 05 | 2724 | AA4 | 6A | E4 | 7C | 55 |
| 35 | 06 | 2725 | AA5 | 6A | E5 | 7C | 56 |
| 35 | 07 | 2726 | AA6 | 6A | E6 | 7C | 57 |
| 35 | 08 | 2727 | AA7 | 6A | E7 | 7C | 58 |

| 80 Col | | Position | | Buffer Address (Hex) | | | |
|--------|----|----------|-----|----------------------|----|-------|----|
| R | C | Dec | Hex | EBCDIC | | ASCII | |
| 35 | 09 | 2728 | AA8 | 6A | E8 | 7C | 59 |
| 35 | 10 | 2729 | AA9 | 6A | E9 | 7C | 5A |
| 35 | 11 | 2730 | AAA | 6A | 6A | 7C | 7C |
| 35 | 12 | 2731 | AAB | 6A | 6B | 7C | 2C |
| 35 | 13 | 2732 | AAC | 6A | 6C | 7C | 25 |
| 35 | 14 | 2733 | AAD | 6A | 6D | 7C | 5F |
| 35 | 15 | 2734 | AAE | 6A | 6E | 7C | 3E |
| 35 | 16 | 2735 | AAF | 6A | 6F | 7C | 3F |
| 35 | 17 | 2736 | AB0 | 6A | F0 | 7C | 30 |
| 35 | 18 | 2737 | AB1 | 6A | F1 | 7C | 31 |
| 35 | 19 | 2738 | AB2 | 6A | F2 | 7C | 32 |
| 35 | 20 | 2739 | AB3 | 6A | F3 | 7C | 33 |
| 35 | 21 | 2740 | AB4 | 6A | F4 | 7C | 34 |
| 35 | 22 | 2741 | AB5 | 6A | F5 | 7C | 35 |
| 35 | 23 | 2742 | AB6 | 6A | F6 | 7C | 36 |
| 35 | 24 | 2743 | AB7 | 6A | F7 | 7C | 37 |
| 35 | 25 | 2744 | AB8 | 6A | F8 | 7C | 38 |
| 35 | 26 | 2745 | AB9 | 6A | F9 | 7C | 39 |
| 35 | 27 | 2746 | ABA | 6A | 7A | 7C | 3A |
| 35 | 28 | 2747 | ABB | 6A | 7B | 7C | 23 |
| 35 | 29 | 2748 | ABC | 6A | 7C | 7C | 40 |
| 35 | 30 | 2749 | ABD | 6A | 7D | 7C | 27 |
| 35 | 31 | 2750 | ABE | 6A | 7E | 7C | 3D |
| 35 | 32 | 2751 | ABF | 6A | 7F | 7C | 22 |
| 35 | 33 | 2752 | AC0 | 6B | 40 | 2C | 20 |
| 35 | 34 | 2753 | AC1 | 6B | C1 | 2C | 41 |
| 35 | 35 | 2754 | AC2 | 6B | C2 | 2C | 42 |
| 35 | 36 | 2755 | AC3 | 6B | C3 | 2C | 43 |
| 35 | 37 | 2756 | AC4 | 6B | C4 | 2C | 44 |
| 35 | 38 | 2757 | AC5 | 6B | C5 | 2C | 45 |
| 35 | 39 | 2758 | AC6 | 6B | C6 | 2C | 46 |
| 35 | 40 | 2759 | AC7 | 6B | C7 | 2C | 47 |
| 35 | 41 | 2760 | AC8 | 6B | C8 | 2C | 48 |
| 35 | 42 | 2761 | AC9 | 6B | C9 | 2C | 49 |
| 35 | 43 | 2762 | ACA | 6B | 4A | 2C | 5B |
| 35 | 44 | 2763 | ACB | 6B | 4B | 2C | 2E |
| 35 | 45 | 2764 | ACC | 6B | 4C | 2C | 3C |
| 35 | 46 | 2765 | ACD | 6B | 4D | 2C | 28 |
| 35 | 47 | 2766 | ACE | 6B | 4E | 2C | 2B |
| 35 | 48 | 2767 | ACF | 6B | 4F | 2C | 21 |
| 35 | 49 | 2768 | AD0 | 6B | 50 | 2C | 26 |
| 35 | 50 | 2769 | AD1 | 6B | D1 | 2C | 4A |
| 35 | 51 | 2770 | AD2 | 6B | D2 | 2C | 4B |
| 35 | 52 | 2771 | AD3 | 6B | D3 | 2C | 4C |
| 35 | 53 | 2772 | AD4 | 6B | D4 | 2C | 4D |
| 35 | 54 | 2773 | AD5 | 6B | D5 | 2C | 4E |
| 35 | 55 | 2774 | AD6 | 6B | D6 | 2C | 4F |
| 35 | 56 | 2775 | AD7 | 6B | D7 | 2C | 50 |
| 35 | 57 | 2776 | AD8 | 6B | D8 | 2C | 51 |
| 35 | 58 | 2777 | AD9 | 6B | D9 | 2C | 52 |
| 35 | 59 | 2778 | ADA | 6B | 5A | 2C | 5D |
| 35 | 60 | 2779 | ADB | 6B | 5B | 2C | 24 |
| 35 | 61 | 2780 | ADC | 6B | 5C | 2C | 2A |
| 35 | 62 | 2781 | ADD | 6B | 5D | 2C | 29 |
| 35 | 63 | 2782 | ADE | 6B | 5E | 2C | 3B |
| 35 | 64 | 2783 | ADF | 6B | 5F | 2C | 5E |
| 35 | 65 | 2784 | AE0 | 6B | 60 | 2C | 2D |
| 35 | 66 | 2785 | AE1 | 6B | 61 | 2C | 2F |
| 35 | 67 | 2786 | AE2 | 6B | E2 | 2C | 53 |
| 35 | 68 | 2787 | AE3 | 6B | E3 | 2C | 54 |
| 35 | 69 | 2788 | AE4 | 6B | E4 | 2C | 55 |
| 35 | 70 | 2789 | AE5 | 6B | E5 | 2C | 56 |

| 80 Col | | Position | | Buffer Address (Hex) | | | |
|--------|----|----------|-----|----------------------|----|-------|----|
| R | C | Dec | Hex | EBCDIC | | ASCII | |
| 35 | 71 | 2790 | AE6 | 6B | E6 | 2C | 57 |
| 35 | 72 | 2791 | AE7 | 6B | E7 | 2C | 58 |
| 35 | 73 | 2792 | AE8 | 6B | E8 | 2C | 59 |
| 35 | 74 | 2793 | AE9 | 6B | E9 | 2C | 5A |
| 35 | 75 | 2794 | AEA | 6B | 6A | 2C | 7C |
| 35 | 76 | 2795 | AEB | 6B | 6B | 2C | 2C |
| 35 | 77 | 2796 | AEC | 6B | 6C | 2C | 25 |
| 35 | 78 | 2797 | AED | 6B | 6D | 2C | 5F |
| 35 | 79 | 2798 | AEE | 6B | 6E | 2C | 3E |
| 35 | 80 | 2799 | AEF | 6B | 6F | 2C | 3F |
| 36 | 01 | 2800 | AF0 | 6B | F0 | 2C | 30 |
| 36 | 02 | 2801 | AF1 | 6B | F1 | 2C | 31 |
| 36 | 03 | 2802 | AF2 | 6B | F2 | 2C | 32 |
| 36 | 04 | 2803 | AF3 | 6B | F3 | 2C | 33 |
| 36 | 05 | 2804 | AF4 | 6B | F4 | 2C | 34 |
| 36 | 06 | 2805 | AF5 | 6B | F5 | 2C | 35 |
| 36 | 07 | 2806 | AF6 | 6B | F6 | 2C | 36 |
| 36 | 08 | 2807 | AF7 | 6B | F7 | 2C | 37 |
| 36 | 09 | 2808 | AF8 | 6B | F8 | 2C | 38 |
| 36 | 10 | 2809 | AF9 | 6B | F9 | 2C | 39 |
| 36 | 11 | 2810 | AFA | 6B | 7A | 2C | 3A |
| 36 | 12 | 2811 | AFB | 6B | 7B | 2C | 23 |
| 36 | 13 | 2812 | AFC | 6B | 7C | 2C | 40 |
| 36 | 14 | 2813 | AFD | 6B | 7D | 2C | 27 |
| 36 | 15 | 2814 | AFE | 6B | 7E | 2C | 3D |
| 36 | 16 | 2815 | AFF | 6B | 7F | 2C | 22 |
| 36 | 17 | 2816 | B00 | 6C | 40 | 25 | 20 |
| 36 | 18 | 2817 | B01 | 6C | C1 | 25 | 41 |
| 36 | 19 | 2818 | B02 | 6C | C2 | 25 | 42 |
| 36 | 20 | 2819 | B03 | 6C | C3 | 25 | 43 |
| 36 | 21 | 2820 | B04 | 6C | C4 | 25 | 44 |
| 36 | 22 | 2821 | B05 | 6C | C5 | 25 | 45 |
| 36 | 23 | 2822 | B06 | 6C | C6 | 25 | 46 |
| 36 | 24 | 2823 | B07 | 6C | C7 | 25 | 47 |
| 36 | 25 | 2824 | B08 | 6C | C8 | 25 | 48 |
| 36 | 26 | 2825 | B09 | 6C | C9 | 25 | 49 |
| 36 | 27 | 2826 | B0A | 6C | 4A | 25 | 5B |
| 36 | 28 | 2827 | B0B | 6C | 4B | 25 | 2E |
| 36 | 29 | 2828 | B0C | 6C | 4C | 25 | 3C |
| 36 | 30 | 2829 | B0D | 6C | 4D | 25 | 28 |
| 36 | 31 | 2830 | B0E | 6C | 4E | 25 | 2B |
| 36 | 32 | 2831 | B0F | 6C | 4F | 25 | 21 |
| 36 | 33 | 2832 | B10 | 6C | 50 | 25 | 26 |
| 36 | 34 | 2833 | B11 | 6C | D1 | 25 | 4A |
| 36 | 35 | 2834 | B12 | 6C | D2 | 25 | 4B |
| 36 | 36 | 2835 | B13 | 6C | D3 | 25 | 4C |
| 36 | 37 | 2836 | B14 | 6C | D4 | 25 | 4D |
| 36 | 38 | 2837 | B15 | 6C | D5 | 25 | 4E |
| 36 | 39 | 2838 | B16 | 6C | D6 | 25 | 4F |
| 36 | 40 | 2839 | B17 | 6C | D7 | 25 | 50 |
| 36 | 41 | 2840 | B18 | 6C | D8 | 25 | 51 |
| 36 | 42 | 2841 | B19 | 6C | D9 | 25 | 52 |
| 36 | 43 | 2842 | B1A | 6C | 5A | 25 | 5D |
| 36 | 44 | 2843 | B1B | 6C | 5B | 25 | 24 |
| 36 | 45 | 2844 | B1C | 6C | 5C | 25 | 2A |
| 36 | 46 | 2845 | B1D | 6C | 5D | 25 | 29 |
| 36 | 47 | 2846 | B1E | 6C | 5E | 25 | 3B |
| 36 | 48 | 2847 | B1F | 6C | 5F | 25 | 5E |
| 36 | 49 | 2848 | B20 | 6C | 60 | 25 | 2D |
| 36 | 50 | 2849 | B21 | 6C | 61 | 25 | 2F |
| 36 | 51 | 2850 | B22 | 6C | E2 | 25 | 53 |

| 80 Col | | Position | | Buffer Address (Hex) | | | |
|----------|----------|------------|------------|----------------------|----|--------------|----|
| <u>R</u> | <u>C</u> | <u>Dec</u> | <u>Hex</u> | <u>EBCDIC</u> | | <u>ASCII</u> | |
| 36 | 52 | 2851 | B23 | 6C | E3 | 25 | 54 |
| 36 | 53 | 2852 | B24 | 6C | E4 | 25 | 55 |
| 36 | 54 | 2853 | B25 | 6C | E5 | 25 | 56 |
| 36 | 55 | 2854 | B26 | 6C | E6 | 25 | 57 |
| 36 | 56 | 2855 | B27 | 6C | E7 | 25 | 58 |
| 36 | 57 | 2856 | B28 | 6C | E8 | 25 | 59 |
| 36 | 58 | 2857 | B29 | 6C | E9 | 25 | 5A |
| 36 | 59 | 2858 | B2A | 6C | 6A | 25 | 7C |
| 36 | 60 | 2859 | B2B | 6C | 6B | 25 | 2C |
| 36 | 61 | 2860 | B2C | 6C | 6C | 25 | 25 |
| 36 | 62 | 2861 | B2D | 6C | 6D | 25 | 5F |
| 36 | 63 | 2862 | B2E | 6C | 6E | 25 | 3E |
| 36 | 64 | 2863 | B2F | 6C | 6F | 25 | 3F |
| 36 | 65 | 2864 | B30 | 6C | F0 | 25 | 30 |
| 36 | 66 | 2865 | B31 | 6C | F1 | 25 | 31 |
| 36 | 67 | 2866 | B32 | 6C | F2 | 25 | 32 |
| 36 | 68 | 2867 | B33 | 6C | F3 | 25 | 33 |
| 36 | 69 | 2868 | B34 | 6C | F4 | 25 | 34 |
| 36 | 70 | 2869 | B35 | 6C | F5 | 25 | 35 |
| 36 | 71 | 2870 | B36 | 6C | F6 | 25 | 36 |
| 36 | 72 | 2871 | B37 | 6C | F7 | 25 | 37 |
| 36 | 73 | 2872 | B38 | 6C | F8 | 25 | 38 |
| 36 | 74 | 2873 | B39 | 6C | F9 | 25 | 39 |
| 36 | 75 | 2874 | B3A | 6C | 7A | 25 | 3A |
| 36 | 76 | 2875 | B3B | 6C | 7B | 25 | 23 |
| 36 | 77 | 2876 | B3C | 6C | 7C | 25 | 40 |
| 36 | 78 | 2877 | B3D | 6C | 7D | 25 | 27 |
| 36 | 79 | 2878 | B3E | 6C | 7E | 25 | 3D |
| 36 | 80 | 2879 | B3F | 6C | 7F | 25 | 22 |
| 37 | 01 | 2880 | B40 | 6D | 40 | 5F | 20 |
| 37 | 02 | 2881 | B41 | 6D | C1 | 5F | 41 |
| 37 | 03 | 2882 | B42 | 6D | C2 | 5F | 42 |
| 37 | 04 | 2883 | B43 | 6D | C3 | 5F | 43 |
| 37 | 05 | 2884 | B44 | 6D | C4 | 5F | 44 |
| 37 | 06 | 2885 | B45 | 6D | C5 | 5F | 45 |
| 37 | 07 | 2886 | B46 | 6D | C6 | 5F | 46 |
| 37 | 08 | 2887 | B47 | 6D | C7 | 5F | 47 |
| 37 | 09 | 2888 | B48 | 6D | C8 | 5F | 48 |
| 37 | 10 | 2889 | B49 | 6D | C9 | 5F | 49 |
| 37 | 11 | 2890 | B4A | 6D | 4A | 5F | 5B |
| 37 | 12 | 2891 | B4B | 6D | 4B | 5F | 2E |
| 37 | 13 | 2892 | B4C | 6D | 4C | 5F | 3C |
| 37 | 14 | 2893 | B4D | 6D | 4D | 5F | 28 |
| 37 | 15 | 2894 | B4E | 6D | 4E | 5F | 2B |
| 37 | 16 | 2895 | B4F | 6D | 4F | 5F | 21 |
| 37 | 17 | 2896 | B50 | 6D | 50 | 5F | 26 |
| 37 | 18 | 2897 | B51 | 6D | D1 | 5F | 4A |
| 37 | 19 | 2898 | B52 | 6D | D2 | 5F | 4B |
| 37 | 20 | 2899 | B53 | 6D | D3 | 5F | 4C |
| 37 | 21 | 2900 | B54 | 6D | D4 | 5F | 4D |
| 37 | 22 | 2901 | B55 | 6D | D5 | 5F | 4E |
| 37 | 23 | 2902 | B56 | 6D | D6 | 5F | 4F |
| 37 | 24 | 2903 | B57 | 6D | D7 | 5F | 50 |
| 37 | 25 | 2904 | B58 | 6D | D8 | 5F | 51 |
| 37 | 26 | 2905 | B59 | 6D | D9 | 5F | 52 |
| 37 | 27 | 2906 | B5A | 6D | 5A | 5F | 5D |
| 37 | 28 | 2907 | B5B | 6D | 5B | 5F | 24 |
| 37 | 29 | 2908 | B5C | 6D | 5C | 5F | 2A |
| 37 | 30 | 2909 | B5D | 6D | 5D | 5F | 29 |
| 37 | 31 | 2910 | B5E | 6D | 5E | 5F | 3B |
| 37 | 32 | 2911 | B5F | 6D | 5F | 5F | 5E |
| 37 | 33 | 2912 | B60 | 6D | 60 | 5F | 2D |

| 80 Col | | Position | | Buffer Address (Hex) | | | |
|--------|----|----------|-----|----------------------|----|-------|----|
| R | C | Dec | Hex | EBCDIC | | ASCII | |
| 37 | 34 | 2913 | B61 | 6D | 61 | 5F | 2F |
| 37 | 35 | 2914 | B62 | 6D | E2 | 5F | 53 |
| 37 | 36 | 2915 | B63 | 6D | E3 | 5F | 54 |
| 37 | 37 | 2916 | B64 | 6D | E4 | 5F | 55 |
| 37 | 38 | 2917 | B65 | 6D | E5 | 5F | 56 |
| 37 | 39 | 2918 | B66 | 6D | E6 | 5F | 57 |
| 37 | 40 | 2919 | B67 | 6D | E7 | 5F | 58 |
| 37 | 41 | 2920 | B68 | 6D | E8 | 5F | 59 |
| 37 | 42 | 2921 | B69 | 6D | E9 | 5F | 5A |
| 37 | 43 | 2922 | B6A | 6D | 6A | 5F | 7C |
| 37 | 44 | 2923 | B6B | 6D | 6B | 5F | 2C |
| 37 | 45 | 2924 | B6C | 6D | 6C | 5F | 25 |
| 37 | 46 | 2925 | B6D | 6D | 6D | 5F | 5F |
| 37 | 47 | 2926 | B6E | 6D | 6E | 5F | 3E |
| 37 | 48 | 2927 | B6F | 6D | 6F | 5F | 3F |
| 37 | 49 | 2928 | B70 | 6D | F0 | 5F | 30 |
| 37 | 50 | 2929 | B71 | 6D | F1 | 5F | 31 |
| 37 | 51 | 2930 | B72 | 6D | F2 | 5F | 32 |
| 37 | 52 | 2931 | B73 | 6D | F3 | 5F | 33 |
| 37 | 53 | 2932 | B74 | 6D | F4 | 5F | 34 |
| 37 | 54 | 2933 | B75 | 6D | F5 | 5F | 35 |
| 37 | 55 | 2934 | B76 | 6D | F6 | 5F | 36 |
| 37 | 56 | 2935 | B77 | 6D | F7 | 5F | 37 |
| 37 | 57 | 2936 | B78 | 6D | F8 | 5F | 38 |
| 37 | 58 | 2937 | B79 | 6D | F9 | 5F | 39 |
| 37 | 59 | 2938 | B7A | 6D | 7A | 5F | 3A |
| 37 | 60 | 2939 | B7B | 6D | 7B | 5F | 23 |
| 37 | 61 | 2940 | B7C | 6D | 7C | 5F | 40 |
| 37 | 62 | 2941 | B7D | 6D | 7D | 5F | 27 |
| 37 | 63 | 2942 | B7E | 6D | 7E | 5F | 3D |
| 37 | 64 | 2943 | B7F | 6D | 7F | 5F | 22 |
| 37 | 65 | 2944 | B80 | 6E | 40 | 3E | 20 |
| 37 | 66 | 2945 | B81 | 6E | C1 | 3E | 41 |
| 37 | 67 | 2946 | B82 | 6E | C2 | 3E | 42 |
| 37 | 68 | 2947 | B83 | 6E | C3 | 3E | 43 |
| 37 | 69 | 2948 | B84 | 6E | C4 | 3E | 44 |
| 37 | 70 | 2949 | B85 | 6E | C5 | 3E | 45 |
| 37 | 71 | 2950 | B86 | 6E | C6 | 3E | 46 |
| 37 | 72 | 2951 | B87 | 6E | C7 | 3E | 47 |
| 37 | 73 | 2952 | B88 | 6E | C8 | 3E | 48 |
| 37 | 74 | 2953 | B89 | 6E | C9 | 3E | 49 |
| 37 | 75 | 2954 | B8A | 6E | 4A | 3E | 5B |
| 37 | 76 | 2955 | B8B | 6E | 4B | 3E | 2E |
| 37 | 77 | 2956 | B8C | 6E | 4C | 3E | 3C |
| 37 | 78 | 2957 | B8D | 6E | 4D | 3E | 28 |
| 37 | 79 | 2958 | B8E | 6E | 4E | 3E | 2B |
| 37 | 80 | 2959 | B8F | 6E | 4F | 3E | 21 |
| 38 | 01 | 2960 | B90 | 6E | 50 | 3E | 26 |
| 38 | 02 | 2961 | B91 | 6E | D1 | 3E | 4A |
| 38 | 03 | 2962 | B92 | 6E | D2 | 3E | 4B |
| 38 | 04 | 2963 | B93 | 6E | D3 | 3E | 4C |
| 38 | 05 | 2964 | B94 | 6E | D4 | 3E | 4D |
| 38 | 06 | 2965 | B95 | 6E | D5 | 3E | 4E |
| 38 | 07 | 2966 | B96 | 6E | D6 | 3E | 4F |
| 38 | 08 | 2967 | B97 | 6E | D7 | 3E | 50 |
| 38 | 09 | 2968 | B98 | 6E | D8 | 3E | 51 |
| 38 | 10 | 2969 | B99 | 6E | D9 | 3E | 52 |
| 38 | 11 | 2970 | B9A | 6E | 5A | 3E | 5D |
| 38 | 12 | 2971 | B9B | 6E | 5B | 3E | 24 |
| 38 | 13 | 2972 | B9C | 6E | 5C | 3E | 2A |
| 38 | 14 | 2973 | B9D | 6E | 5D | 3E | 29 |
| 38 | 15 | 2974 | B9E | 6E | 5E | 3E | 3B |

| 80 Col | | Position | | Buffer Address (Hex) | | | |
|--------|----|----------|-----|----------------------|----|-------|----|
| R | C | Dec | Hex | EBCDIC | | ASCII | |
| 38 | 16 | 2975 | B9F | 6E | 5F | 3E | 5E |
| 38 | 17 | 2976 | BA0 | 6E | 60 | 3E | 2D |
| 38 | 18 | 2977 | BA1 | 6E | 61 | 3E | 2F |
| 38 | 19 | 2978 | BA2 | 6E | E2 | 3E | 53 |
| 38 | 20 | 2979 | BA3 | 6E | E3 | 3E | 54 |
| 38 | 21 | 2980 | BA4 | 6E | E4 | 3E | 55 |
| 38 | 22 | 2981 | BA5 | 6E | E5 | 3E | 56 |
| 38 | 23 | 2982 | BA6 | 6E | E6 | 3E | 57 |
| 38 | 24 | 2983 | BA7 | 6E | E7 | 3E | 58 |
| 38 | 25 | 2984 | BA8 | 6E | E8 | 3E | 59 |
| 38 | 26 | 2985 | BA9 | 6E | E9 | 3E | 5A |
| 38 | 27 | 2986 | BAA | 6E | 6A | 3E | 7C |
| 38 | 28 | 2987 | BAB | 6E | 6B | 3E | 2C |
| 38 | 29 | 2988 | BAC | 6E | 6C | 3E | 25 |
| 38 | 30 | 2989 | BAD | 6E | 6D | 3E | 5F |
| 38 | 31 | 2990 | BAE | 6E | 6E | 3E | 3E |
| 38 | 32 | 2991 | BAF | 6E | 6F | 3E | 3F |
| 38 | 33 | 2992 | BB0 | 6E | F0 | 3E | 30 |
| 38 | 34 | 2993 | BB1 | 6E | F1 | 3E | 31 |
| 38 | 35 | 2994 | BB2 | 6E | F2 | 3E | 32 |
| 38 | 36 | 2995 | BB3 | 6E | F3 | 3E | 33 |
| 38 | 37 | 2996 | BB4 | 6E | F4 | 3E | 34 |
| 38 | 38 | 2997 | BB5 | 6E | F5 | 3E | 35 |
| 38 | 39 | 2998 | BB6 | 6E | F6 | 3E | 36 |
| 38 | 40 | 2999 | BB7 | 6E | F7 | 3E | 37 |
| 38 | 41 | 3000 | BB8 | 6E | F8 | 3E | 38 |
| 38 | 42 | 3001 | BB9 | 6E | F9 | 3E | 39 |
| 38 | 43 | 3002 | BBA | 6E | 7A | 3E | 3A |
| 38 | 44 | 3003 | BBB | 6E | 7B | 3E | 23 |
| 38 | 45 | 3004 | BBC | 6E | 7C | 3E | 40 |
| 38 | 46 | 3005 | BBD | 6E | 7D | 3E | 27 |
| 38 | 47 | 3006 | BBE | 6E | 7E | 3E | 3D |
| 38 | 48 | 3007 | BBF | 6E | 7F | 3E | 22 |
| 38 | 49 | 3008 | BC0 | 6F | 40 | 3F | 20 |
| 38 | 50 | 3009 | BC1 | 6F | C1 | 3F | 41 |
| 38 | 51 | 3010 | BC2 | 6F | C2 | 3F | 42 |
| 38 | 52 | 3011 | BC3 | 6F | C3 | 3F | 43 |
| 38 | 53 | 3012 | BC4 | 6F | C4 | 3F | 44 |
| 38 | 54 | 3013 | BC5 | 6F | C5 | 3F | 45 |
| 38 | 55 | 3014 | BC6 | 6F | C6 | 3F | 46 |
| 38 | 56 | 3015 | BC7 | 6F | C7 | 3F | 47 |
| 38 | 57 | 3016 | BC8 | 6F | C8 | 3F | 48 |
| 38 | 58 | 3017 | BC9 | 6F | C9 | 3F | 49 |
| 38 | 59 | 3018 | BCA | 6F | 4A | 3F | 5B |
| 38 | 60 | 3019 | BCB | 6F | 4B | 3F | 2E |
| 38 | 61 | 3020 | BCC | 6F | 4C | 3F | 3C |
| 38 | 62 | 3021 | BCD | 6F | 4D | 3F | 28 |
| 38 | 63 | 3022 | BCE | 6F | 4E | 3F | 2B |
| 38 | 64 | 3023 | BCF | 6F | 4F | 3F | 21 |
| 38 | 65 | 3024 | BD0 | 6F | 50 | 3F | 26 |
| 38 | 66 | 3025 | BD1 | 6F | D1 | 3F | 4A |
| 38 | 67 | 3026 | BD2 | 6F | D2 | 3F | 4B |
| 38 | 68 | 3027 | BD3 | 6F | D3 | 3F | 4C |
| 38 | 69 | 3028 | BD4 | 6F | D4 | 3F | 4D |
| 38 | 70 | 3029 | BD5 | 6F | D5 | 3F | 4E |
| 38 | 71 | 3030 | BD6 | 6F | D6 | 3F | 4F |
| 38 | 72 | 3031 | BD7 | 6F | D7 | 3F | 50 |
| 38 | 73 | 3032 | BD8 | 6F | D8 | 3F | 51 |
| 38 | 74 | 3033 | BD9 | 6F | D9 | 3F | 52 |
| 38 | 75 | 3034 | BDA | 6F | 5A | 3F | 5D |
| 38 | 76 | 3035 | BDB | 6F | 5B | 3F | 24 |
| 38 | 77 | 3036 | BDC | 6F | 5C | 3F | 2A |

| 80 Col | | Position | | Buffer Address (Hex) | | | |
|--------|----|----------|-----|----------------------|----|-------|----|
| R | C | Dec | Hex | EBCDIC | | ASCII | |
| 38 | 78 | 3037 | BDD | 6F | 5D | 3F | 29 |
| 38 | 79 | 3038 | BDE | 6F | 5E | 3F | 3B |
| 38 | 80 | 3039 | BDF | 6F | 5F | 3F | 5E |
| 39 | 01 | 3040 | BE0 | 6F | 60 | 3F | 2D |
| 39 | 02 | 3041 | BE1 | 6F | 61 | 3F | 2F |
| 39 | 03 | 3042 | BE2 | 6F | E2 | 3F | 53 |
| 39 | 04 | 3043 | BE3 | 6F | E3 | 3F | 54 |
| 39 | 05 | 3044 | BE4 | 6F | E4 | 3F | 55 |
| 39 | 06 | 3045 | BE5 | 6F | E5 | 3F | 56 |
| 39 | 07 | 3046 | BE6 | 6F | E6 | 3F | 57 |
| 39 | 08 | 3047 | BE7 | 6F | E7 | 3F | 58 |
| 39 | 09 | 3048 | BE8 | 6F | E8 | 3F | 59 |
| 39 | 10 | 3049 | BE9 | 6F | E9 | 3F | 5A |
| 39 | 11 | 3050 | BEA | 6F | 6A | 3F | 7C |
| 39 | 12 | 3051 | BEB | 6F | 6B | 3F | 2C |
| 39 | 13 | 3052 | BEC | 6F | 6C | 3F | 25 |
| 39 | 14 | 3053 | BED | 6F | 6D | 3F | 5F |
| 39 | 15 | 3054 | BEE | 6F | 6E | 3F | 3E |
| 39 | 16 | 3055 | BEF | 6F | 6F | 3F | 3F |
| 39 | 17 | 3056 | BF0 | 6F | F0 | 3F | 30 |
| 39 | 18 | 3057 | BF1 | 6F | F1 | 3F | 31 |
| 39 | 19 | 3058 | BF2 | 6F | F2 | 3F | 32 |
| 39 | 20 | 3059 | BF3 | 6F | F3 | 3F | 33 |
| 39 | 21 | 3060 | BF4 | 6F | F4 | 3F | 34 |
| 39 | 22 | 3061 | BF5 | 6F | F5 | 3F | 35 |
| 39 | 23 | 3062 | BF6 | 6F | F6 | 3F | 36 |
| 39 | 24 | 3063 | BF7 | 6F | F7 | 3F | 37 |
| 39 | 25 | 3064 | BF8 | 6F | F8 | 3F | 38 |
| 39 | 26 | 3065 | BF9 | 6F | F9 | 3F | 39 |
| 39 | 27 | 3066 | BFA | 6F | 7A | 3F | 3A |
| 39 | 28 | 3067 | BFB | 6F | 7B | 3F | 23 |
| 39 | 29 | 3068 | BFC | 6F | 7C | 3F | 40 |
| 39 | 30 | 3069 | BFD | 6F | 7D | 3F | 27 |
| 39 | 31 | 3070 | BFE | 6F | 7E | 3F | 3D |
| 39 | 32 | 3071 | BFF | 6F | 7F | 3F | 22 |
| 39 | 33 | 3072 | C00 | F0 | 40 | 30 | 20 |
| 39 | 34 | 3073 | C01 | F0 | C1 | 30 | 41 |
| 39 | 35 | 3074 | C02 | F0 | C2 | 30 | 42 |
| 39 | 36 | 3075 | C03 | F0 | C3 | 30 | 43 |
| 39 | 37 | 3076 | C04 | F0 | C4 | 30 | 44 |
| 39 | 38 | 3077 | C05 | F0 | C5 | 30 | 45 |
| 39 | 39 | 3078 | C06 | F0 | C6 | 30 | 46 |
| 39 | 40 | 3079 | C07 | F0 | C7 | 30 | 47 |
| 39 | 41 | 3080 | C08 | F0 | C8 | 30 | 48 |
| 39 | 42 | 3081 | C09 | F0 | C9 | 30 | 49 |
| 39 | 43 | 3082 | C0A | F0 | 4A | 30 | 5B |
| 39 | 44 | 3083 | C0B | F0 | 4B | 30 | 2E |
| 39 | 45 | 3084 | C0C | F0 | 4C | 30 | 3C |
| 39 | 46 | 3085 | C0D | F0 | 4D | 30 | 28 |
| 39 | 47 | 3086 | C0E | F0 | 4E | 30 | 2B |
| 39 | 48 | 3087 | C0F | F0 | 4F | 30 | 21 |
| 39 | 49 | 3088 | C10 | F0 | 50 | 30 | 26 |
| 39 | 50 | 3089 | C11 | F0 | D1 | 30 | 4A |
| 39 | 51 | 3090 | C12 | F0 | D2 | 30 | 4B |
| 39 | 52 | 3091 | C13 | F0 | D3 | 30 | 4C |
| 39 | 53 | 3092 | C14 | F0 | D4 | 30 | 4D |
| 39 | 54 | 3093 | C15 | F0 | D5 | 30 | 4E |
| 39 | 55 | 3094 | C16 | F0 | D6 | 30 | 4F |
| 39 | 56 | 3095 | C17 | F0 | D7 | 30 | 50 |
| 39 | 57 | 3096 | C18 | F0 | D8 | 30 | 51 |
| 39 | 58 | 3097 | C19 | F0 | D9 | 30 | 52 |
| 39 | 59 | 3098 | C1A | F0 | 5A | 30 | 5D |

| 80 Col | | Position | | Buffer Address (Hex) | | | |
|----------|----------|------------|------------|----------------------|----|--------------|----|
| <u>R</u> | <u>C</u> | <u>Dec</u> | <u>Hex</u> | <u>EBCDIC</u> | | <u>ASCII</u> | |
| 39 | 60 | 3099 | C1B | F0 | 5B | 30 | 24 |
| 39 | 61 | 3100 | C1C | F0 | 5C | 30 | 2A |
| 39 | 62 | 3101 | C1D | F0 | 5D | 30 | 29 |
| 39 | 63 | 3102 | C1E | F0 | 5E | 30 | 3B |
| 39 | 64 | 3103 | C1F | F0 | 5F | 30 | 5E |
| 39 | 65 | 3104 | C20 | F0 | 60 | 30 | 2D |
| 39 | 66 | 3105 | C21 | F0 | 61 | 30 | 2F |
| 39 | 67 | 3106 | C22 | F0 | E2 | 30 | 53 |
| 39 | 68 | 3107 | C23 | F0 | E3 | 30 | 54 |
| 39 | 69 | 3108 | C24 | F0 | E4 | 30 | 55 |
| 39 | 70 | 3109 | C25 | F0 | E5 | 30 | 56 |
| 39 | 71 | 3110 | C26 | F0 | E6 | 30 | 57 |
| 39 | 72 | 3111 | C27 | F0 | E7 | 30 | 58 |
| 39 | 73 | 3112 | C28 | F0 | E8 | 30 | 59 |
| 39 | 74 | 3113 | C29 | F0 | E9 | 30 | 5A |
| 39 | 75 | 3114 | C2A | F0 | 6A | 30 | 7C |
| 39 | 76 | 3115 | C2B | F0 | 6B | 30 | 2C |
| 39 | 77 | 3116 | C2C | F0 | 6C | 30 | 25 |
| 39 | 78 | 3117 | C2D | F0 | 6D | 30 | 5F |
| 39 | 79 | 3118 | C2E | F0 | 6E | 30 | 3E |
| 39 | 80 | 3119 | C2F | F0 | 6F | 30 | 3F |
| 40 | 01 | 3120 | C30 | F0 | F0 | 30 | 30 |
| 40 | 02 | 3121 | C31 | F0 | F1 | 30 | 31 |
| 40 | 03 | 3122 | C32 | F0 | F2 | 30 | 32 |
| 40 | 04 | 3123 | C33 | F0 | F3 | 30 | 33 |
| 40 | 05 | 3124 | C34 | F0 | F4 | 30 | 34 |
| 40 | 06 | 3125 | C35 | F0 | F5 | 30 | 35 |
| 40 | 07 | 3126 | C36 | F0 | F6 | 30 | 36 |
| 40 | 08 | 3127 | C37 | F0 | F7 | 30 | 37 |
| 40 | 09 | 3128 | C38 | F0 | F8 | 30 | 38 |
| 40 | 10 | 3129 | C39 | F0 | F9 | 30 | 39 |
| 40 | 11 | 3130 | C3A | F0 | 7A | 30 | 3A |
| 40 | 12 | 3131 | C3B | F0 | 7B | 30 | 23 |
| 40 | 13 | 3132 | C3C | F0 | 7C | 30 | 40 |
| 40 | 14 | 3133 | C3D | F0 | 7D | 30 | 27 |
| 40 | 15 | 3134 | C3E | F0 | 7E | 30 | 3D |
| 40 | 16 | 3135 | C3F | F0 | 7F | 30 | 22 |
| 40 | 17 | 3136 | C40 | F1 | 40 | 31 | 20 |
| 40 | 18 | 3137 | C41 | F1 | C1 | 31 | 41 |
| 40 | 19 | 3138 | C42 | F1 | C2 | 31 | 42 |
| 40 | 20 | 3139 | C43 | F1 | C3 | 31 | 43 |
| 40 | 21 | 3140 | C44 | F1 | C4 | 31 | 44 |
| 40 | 22 | 3141 | C45 | F1 | C5 | 31 | 45 |
| 40 | 23 | 3142 | C46 | F1 | C6 | 31 | 46 |
| 40 | 24 | 3143 | C47 | F1 | C7 | 31 | 47 |
| 40 | 25 | 3144 | C48 | F1 | C8 | 31 | 48 |
| 40 | 26 | 3145 | C49 | F1 | C9 | 31 | 49 |
| 40 | 27 | 3146 | C4A | F1 | 4A | 31 | 5B |
| 40 | 28 | 3147 | C4B | F1 | 4B | 31 | 2E |
| 40 | 29 | 3148 | C4C | F1 | 4C | 31 | 3C |
| 40 | 30 | 3149 | C4D | F1 | 4D | 31 | 28 |
| 40 | 31 | 3150 | C4E | F1 | 4E | 31 | 2B |
| 40 | 32 | 3151 | C4F | F1 | 4F | 31 | 21 |
| 40 | 33 | 3152 | C50 | F1 | 50 | 31 | 26 |
| 40 | 34 | 3153 | C51 | F1 | D1 | 31 | 4A |
| 40 | 35 | 3154 | C52 | F1 | D2 | 31 | 4B |
| 40 | 36 | 3155 | C53 | F1 | D3 | 31 | 4C |
| 40 | 37 | 3156 | C54 | F1 | D4 | 31 | 4D |
| 40 | 38 | 3157 | C55 | F1 | D5 | 31 | 4E |
| 40 | 39 | 3158 | C56 | F1 | D6 | 31 | 4F |
| 40 | 40 | 3159 | C57 | F1 | D7 | 31 | 50 |
| 40 | 41 | 3160 | C58 | F1 | D8 | 31 | 51 |

| 80 Col | | Position | | Buffer Address (Hex) | | | |
|----------|----------|------------|------------|----------------------|----|--------------|----|
| <u>R</u> | <u>C</u> | <u>Dec</u> | <u>Hex</u> | <u>EBCDIC</u> | | <u>ASCII</u> | |
| 40 | 42 | 3161 | C59 | F1 | D9 | 31 | 52 |
| 40 | 43 | 3162 | C5A | F1 | 5A | 31 | 5D |
| 40 | 44 | 3163 | C5B | F1 | 5B | 31 | 24 |
| 40 | 45 | 3164 | C5C | F1 | 5C | 31 | 2A |
| 40 | 46 | 3165 | C5D | F1 | 5D | 31 | 29 |
| 40 | 47 | 3166 | C5E | F1 | 5E | 31 | 38 |
| 40 | 48 | 3167 | C5F | F1 | 5F | 31 | 5E |
| 40 | 49 | 3168 | C60 | F1 | 60 | 31 | 2D |
| 40 | 50 | 3169 | C61 | F1 | 61 | 31 | 2F |
| 40 | 51 | 3170 | C62 | F1 | E2 | 31 | 53 |
| 40 | 52 | 3171 | C63 | F1 | E3 | 31 | 54 |
| 40 | 53 | 3172 | C64 | F1 | E4 | 31 | 55 |
| 40 | 54 | 3173 | C65 | F1 | E5 | 31 | 56 |
| 40 | 55 | 3174 | C66 | F1 | E6 | 31 | 57 |
| 40 | 56 | 3175 | C67 | F1 | E7 | 31 | 58 |
| 40 | 57 | 3176 | C68 | F1 | E8 | 31 | 59 |
| 40 | 58 | 3177 | C69 | F1 | E9 | 31 | 5A |
| 40 | 59 | 3178 | C6A | F1 | 6A | 31 | 7C |
| 40 | 60 | 3179 | C6B | F1 | 6B | 31 | 2C |
| 40 | 61 | 3180 | C6C | F1 | 6C | 31 | 25 |
| 40 | 62 | 3181 | C6D | F1 | 6D | 31 | 5F |
| 40 | 63 | 3182 | C6E | F1 | 6E | 31 | 3E |
| 40 | 64 | 3183 | C6F | F1 | 6F | 31 | 3F |
| 40 | 65 | 3184 | C70 | F1 | F0 | 31 | 30 |
| 40 | 66 | 3185 | C71 | F1 | F1 | 31 | 31 |
| 40 | 67 | 3186 | C72 | F1 | F2 | 31 | 32 |
| 40 | 68 | 3187 | C73 | F1 | F3 | 31 | 33 |
| 40 | 69 | 3188 | C74 | F1 | F4 | 31 | 34 |
| 40 | 70 | 3189 | C75 | F1 | F5 | 31 | 35 |
| 40 | 71 | 3190 | C76 | F1 | F6 | 31 | 36 |
| 40 | 72 | 3191 | C77 | F1 | F7 | 31 | 37 |
| 40 | 73 | 3192 | C78 | F1 | F8 | 31 | 38 |
| 40 | 74 | 3193 | C79 | F1 | F9 | 31 | 39 |
| 40 | 75 | 3194 | C7A | F1 | 7A | 31 | 3A |
| 40 | 76 | 3195 | C7B | F1 | 7B | 31 | 23 |
| 40 | 77 | 3196 | C7C | F1 | 7C | 31 | 40 |
| 40 | 78 | 3197 | C7D | F1 | 7D | 31 | 27 |
| 40 | 79 | 3198 | C7E | F1 | 7E | 31 | 3D |
| 40 | 80 | 3199 | C7F | F1 | 7F | 31 | 22 |
| 41 | 01 | 3200 | C80 | F2 | 40 | 32 | 20 |
| 41 | 02 | 3201 | C81 | F2 | C1 | 32 | 41 |
| 41 | 03 | 3202 | C82 | F2 | C2 | 32 | 42 |
| 41 | 04 | 3203 | C83 | F2 | C3 | 32 | 43 |
| 41 | 05 | 3204 | C84 | F2 | C4 | 32 | 44 |
| 41 | 06 | 3205 | C85 | F2 | C5 | 32 | 45 |
| 41 | 07 | 3206 | C86 | F2 | C6 | 32 | 46 |
| 41 | 08 | 3207 | C87 | F2 | C7 | 32 | 47 |
| 41 | 09 | 3208 | C88 | F2 | C8 | 32 | 48 |
| 41 | 10 | 3209 | C89 | F2 | C9 | 32 | 49 |
| 41 | 11 | 3210 | C8A | F2 | 4A | 32 | 5B |
| 41 | 12 | 3211 | C8B | F2 | 4B | 32 | 2E |
| 41 | 13 | 3212 | C8C | F2 | 4C | 32 | 3C |
| 41 | 14 | 3213 | C8D | F2 | 4D | 32 | 28 |
| 41 | 15 | 3214 | C8E | F2 | 4E | 32 | 2B |
| 41 | 16 | 3215 | C8F | F2 | 4F | 32 | 21 |
| 41 | 17 | 3216 | C90 | F2 | 50 | 32 | 26 |
| 41 | 18 | 3217 | C91 | F2 | D1 | 32 | 4A |
| 41 | 19 | 3218 | C92 | F2 | D2 | 32 | 4B |
| 41 | 20 | 3219 | C93 | F2 | D3 | 32 | 4C |
| 41 | 21 | 3220 | C94 | F2 | D4 | 32 | 4D |
| 41 | 22 | 3221 | C95 | F2 | D5 | 32 | 4E |

| 80 Col | | Position | | Buffer Address (Hex) | | | |
|--------|----|----------|-----|----------------------|----|-------|----|
| R | C | Dec | Hex | EBCDIC | | ASCII | |
| 41 | 23 | 3222 | C96 | F2 | D6 | 32 | 4F |
| 41 | 24 | 3223 | C97 | F2 | D7 | 32 | 50 |
| 41 | 25 | 3224 | C98 | F2 | D8 | 32 | 51 |
| 41 | 26 | 3225 | C99 | F2 | D9 | 32 | 52 |
| 41 | 27 | 3226 | C9A | F2 | 5A | 32 | 5D |
| 41 | 28 | 3227 | C9B | F2 | 5B | 32 | 24 |
| 41 | 29 | 3228 | C9C | F2 | 5C | 32 | 2A |
| 41 | 30 | 3229 | C9D | F2 | 5D | 32 | 29 |
| 41 | 31 | 3230 | C9E | F2 | 5E | 32 | 3B |
| 41 | 32 | 3231 | C9F | F2 | 5F | 32 | 5E |
| 41 | 33 | 3232 | CA0 | F2 | 60 | 32 | 2D |
| 41 | 34 | 3233 | CA1 | F2 | 61 | 32 | 2F |
| 41 | 35 | 3234 | CA2 | F2 | E2 | 32 | 53 |
| 41 | 36 | 3235 | CA3 | F2 | E3 | 32 | 54 |
| 41 | 37 | 3236 | CA4 | F2 | E4 | 32 | 55 |
| 41 | 38 | 3237 | CA5 | F2 | E5 | 32 | 56 |
| 41 | 39 | 3238 | CA6 | F2 | E6 | 32 | 57 |
| 41 | 40 | 3239 | CA7 | F2 | E7 | 32 | 58 |
| 41 | 41 | 3240 | CA8 | F2 | E8 | 32 | 59 |
| 41 | 42 | 3241 | CA9 | F2 | E9 | 32 | 5A |
| 41 | 43 | 3242 | CAA | F2 | 6A | 32 | 7C |
| 41 | 44 | 3243 | CAB | F2 | 6B | 32 | 2C |
| 41 | 45 | 3244 | CAC | F2 | 6C | 32 | 25 |
| 41 | 46 | 3245 | CAD | F2 | 6D | 32 | 5F |
| 41 | 47 | 3246 | CAE | F2 | 6E | 32 | 3E |
| 41 | 48 | 3247 | CAF | F2 | 6F | 32 | 3F |
| 41 | 49 | 3248 | CB0 | F2 | F0 | 32 | 30 |
| 41 | 50 | 3249 | CB1 | F2 | F1 | 32 | 31 |
| 41 | 51 | 3250 | CB2 | F2 | F2 | 32 | 32 |
| 41 | 52 | 3251 | CB3 | F2 | F3 | 32 | 33 |
| 41 | 53 | 3252 | CB4 | F2 | F4 | 32 | 34 |
| 41 | 54 | 3253 | CB5 | F2 | F5 | 32 | 35 |
| 41 | 55 | 3254 | CB6 | F2 | F6 | 32 | 36 |
| 41 | 56 | 3255 | CB7 | F2 | F7 | 32 | 37 |
| 41 | 57 | 3256 | CB8 | F2 | F8 | 32 | 38 |
| 41 | 58 | 3257 | CB9 | F2 | F9 | 32 | 39 |
| 41 | 59 | 3258 | CBA | F2 | 7A | 32 | 3A |
| 41 | 60 | 3259 | CBB | F2 | 7B | 32 | 23 |
| 41 | 61 | 3260 | CBC | F2 | 7C | 32 | 40 |
| 41 | 62 | 3261 | CBD | F2 | 7D | 32 | 27 |
| 41 | 63 | 3262 | CBE | F2 | 7E | 32 | 3D |
| 41 | 64 | 3263 | CBF | F2 | 7F | 32 | 22 |
| 41 | 65 | 3264 | CC0 | F3 | 40 | 33 | 20 |
| 41 | 66 | 3265 | CC1 | F3 | C1 | 33 | 41 |
| 41 | 67 | 3266 | CC2 | F3 | C2 | 33 | 42 |
| 41 | 68 | 3267 | CC3 | F3 | C3 | 33 | 43 |
| 41 | 69 | 3268 | CC4 | F3 | C4 | 33 | 44 |
| 41 | 70 | 3269 | CC5 | F3 | C5 | 33 | 45 |
| 41 | 71 | 3270 | CC6 | F3 | C6 | 33 | 46 |
| 41 | 72 | 3271 | CC7 | F3 | C7 | 33 | 47 |
| 41 | 73 | 3272 | CC8 | F3 | C8 | 33 | 48 |
| 41 | 74 | 3273 | CC9 | F3 | C9 | 33 | 49 |
| 41 | 75 | 3274 | CCA | F3 | 4A | 33 | 5B |
| 41 | 76 | 3275 | CCB | F3 | 4B | 33 | 2E |
| 41 | 77 | 3276 | CCC | F3 | 4C | 33 | 3C |
| 41 | 78 | 3277 | CCD | F3 | 4D | 33 | 28 |
| 41 | 79 | 3278 | CCE | F3 | 4E | 33 | 2B |
| 41 | 80 | 3279 | CCF | F3 | 4F | 33 | 21 |
| 42 | 01 | 3280 | CD0 | F3 | 50 | 33 | 26 |
| 42 | 02 | 3281 | CD1 | F3 | D1 | 33 | 4A |
| 42 | 03 | 3282 | CD2 | F3 | D2 | 33 | 4B |
| 42 | 04 | 3283 | CD3 | F3 | D3 | 33 | 4C |

| 80 Col | | Position | | Buffer Address (Hex) | | | |
|--------|----|----------|-----|----------------------|----|-------|----|
| R | C | Dec | Hex | EBCDIC | | ASCII | |
| 42 | 05 | 3284 | CD4 | F3 | D4 | 33 | 4D |
| 42 | 06 | 3285 | CD5 | F3 | D5 | 33 | 4E |
| 42 | 07 | 3286 | CD6 | F3 | D6 | 33 | 4F |
| 42 | 08 | 3287 | CD7 | F3 | D7 | 33 | 50 |
| 42 | 09 | 3288 | CD8 | F3 | D8 | 33 | 51 |
| 42 | 10 | 3289 | CD9 | F3 | D9 | 33 | 52 |
| 42 | 11 | 3290 | CDA | F3 | 5A | 33 | 5D |
| 42 | 12 | 3291 | CDB | F3 | 5B | 33 | 24 |
| 42 | 13 | 3292 | CDC | F3 | 5C | 33 | 2A |
| 42 | 14 | 3293 | CDD | F3 | 5D | 33 | 29 |
| 42 | 15 | 3294 | CDE | F3 | 5E | 33 | 3B |
| 42 | 16 | 3295 | CDF | F3 | 5F | 33 | 5E |
| 42 | 17 | 3296 | CE0 | F3 | 60 | 33 | 2D |
| 42 | 18 | 3297 | CE1 | F3 | 61 | 33 | 2F |
| 42 | 19 | 3298 | CE2 | F3 | E2 | 33 | 53 |
| 42 | 20 | 3299 | CE3 | F3 | E3 | 33 | 54 |
| 42 | 21 | 3300 | CE4 | F3 | E4 | 33 | 55 |
| 42 | 22 | 3301 | CE5 | F3 | E5 | 33 | 56 |
| 42 | 23 | 3302 | CE6 | F3 | E6 | 33 | 57 |
| 42 | 24 | 3303 | CE7 | F3 | E7 | 33 | 58 |
| 42 | 25 | 3304 | CE8 | F3 | E8 | 33 | 59 |
| 42 | 26 | 3305 | CE9 | F3 | E9 | 33 | 5A |
| 42 | 27 | 3306 | CEA | F3 | 6A | 33 | 7C |
| 42 | 28 | 3307 | CEB | F3 | 6B | 33 | 2C |
| 42 | 29 | 3308 | CEC | F3 | 6C | 33 | 25 |
| 42 | 30 | 3309 | CED | F3 | 6D | 33 | 5F |
| 42 | 31 | 3310 | CEE | F3 | 6E | 33 | 3E |
| 42 | 32 | 3311 | CEF | F3 | 6F | 33 | 3F |
| 42 | 33 | 3312 | CF0 | F3 | F0 | 33 | 30 |
| 42 | 34 | 3313 | CF1 | F3 | F1 | 33 | 31 |
| 42 | 35 | 3314 | CF2 | F3 | F2 | 33 | 32 |
| 42 | 36 | 3315 | CF3 | F3 | F3 | 33 | 33 |
| 42 | 37 | 3316 | CF4 | F3 | F4 | 33 | 34 |
| 42 | 38 | 3317 | CF5 | F3 | F5 | 33 | 35 |
| 42 | 39 | 3318 | CF6 | F3 | F6 | 33 | 36 |
| 42 | 40 | 3319 | CF7 | F3 | F7 | 33 | 37 |
| 42 | 41 | 3320 | CF8 | F3 | F8 | 33 | 38 |
| 42 | 42 | 3321 | CF9 | F3 | F9 | 33 | 39 |
| 42 | 43 | 3322 | CFA | F3 | 7A | 33 | 3A |
| 42 | 44 | 3323 | CFB | F3 | 7B | 33 | 23 |
| 42 | 45 | 3224 | CFC | F3 | 7C | 33 | 40 |
| 42 | 46 | 3325 | CFD | F3 | 7D | 33 | 27 |
| 42 | 47 | 3326 | CFE | F3 | 7E | 33 | 3D |
| 42 | 48 | 3327 | CFE | F3 | 7F | 33 | 22 |
| 42 | 49 | 3328 | D00 | F4 | 40 | 34 | 20 |
| 42 | 50 | 3329 | D01 | F4 | C1 | 34 | 41 |
| 42 | 51 | 3330 | D02 | F4 | C2 | 34 | 42 |
| 42 | 52 | 3331 | D03 | F4 | C3 | 34 | 43 |
| 42 | 53 | 3332 | D04 | F4 | C4 | 34 | 44 |
| 42 | 54 | 3333 | D05 | F4 | C5 | 34 | 45 |
| 42 | 55 | 3334 | D06 | F4 | C6 | 34 | 46 |
| 42 | 56 | 3335 | D07 | F4 | C7 | 34 | 47 |
| 42 | 57 | 3336 | D08 | F4 | C8 | 34 | 48 |
| 42 | 58 | 3337 | D09 | F4 | C9 | 34 | 49 |
| 42 | 59 | 3338 | D0A | F4 | 4A | 34 | 5B |
| 42 | 60 | 3339 | D0B | F4 | 4B | 34 | 2E |
| 42 | 61 | 3340 | D0C | F4 | 4C | 34 | 3C |
| 42 | 62 | 3341 | D0D | F4 | 4D | 34 | 28 |
| 42 | 63 | 3342 | D0E | F4 | 4E | 34 | 2B |
| 42 | 64 | 3343 | D0F | F4 | 4F | 34 | 21 |
| 42 | 65 | 3344 | D10 | F4 | 50 | 34 | 26 |

| 80 Col | | Position | | Buffer Address (Hex) | | | |
|--------|----|----------|-----|----------------------|----|-------|----|
| R | C | Dec | Hex | EBCDIC | | ASCII | |
| 42 | 66 | 3345 | D11 | F4 | C1 | 34 | 4A |
| 42 | 67 | 3346 | D12 | F4 | D2 | 34 | 4B |
| 42 | 68 | 3347 | D13 | F4 | D3 | 34 | 4C |
| 42 | 69 | 3348 | D14 | F4 | D4 | 34 | 4D |
| 42 | 70 | 3349 | D15 | F4 | D5 | 34 | 4E |
| 42 | 71 | 3350 | D16 | F4 | D6 | 34 | 4F |
| 42 | 72 | 3351 | D17 | F4 | D7 | 34 | 50 |
| 42 | 73 | 3352 | D18 | F4 | D8 | 34 | 51 |
| 42 | 74 | 3353 | D19 | F4 | D9 | 34 | 52 |
| 42 | 75 | 3354 | D1A | F4 | 5A | 34 | 5D |
| 42 | 76 | 3355 | D1B | F4 | 5B | 34 | 24 |
| 42 | 77 | 3356 | D1C | F4 | 5C | 34 | 2A |
| 42 | 78 | 3357 | D1D | F4 | 5D | 34 | 29 |
| 42 | 79 | 3358 | D1E | F4 | 5E | 34 | 3B |
| 42 | 80 | 3359 | D1F | F4 | 5F | 34 | 5E |
| 43 | 01 | 3360 | D20 | F4 | 60 | 34 | 2D |
| 43 | 02 | 3361 | D21 | F4 | 61 | 34 | 2F |
| 43 | 03 | 3362 | D22 | F4 | E2 | 34 | 53 |
| 43 | 04 | 3363 | D23 | F4 | E3 | 34 | 54 |
| 43 | 05 | 3364 | D24 | F4 | E4 | 34 | 55 |
| 43 | 06 | 3365 | D25 | F4 | E5 | 34 | 56 |
| 43 | 07 | 3366 | D26 | F4 | E6 | 34 | 57 |
| 43 | 08 | 3367 | D27 | F4 | E7 | 34 | 58 |
| 43 | 09 | 3368 | D28 | F4 | E8 | 34 | 59 |
| 43 | 10 | 3369 | D29 | F4 | E9 | 34 | 5A |
| 43 | 11 | 3370 | D2A | F4 | 6A | 34 | 7C |
| 43 | 12 | 3371 | D2B | F4 | 6B | 34 | 2C |
| 43 | 13 | 3372 | D2C | F4 | 6C | 34 | 25 |
| 43 | 14 | 3373 | D2D | F4 | 6D | 34 | 5F |
| 43 | 15 | 3374 | D2E | F4 | 6E | 34 | 3E |
| 43 | 16 | 3375 | D2F | F4 | 6F | 34 | 3F |
| 43 | 17 | 3376 | D30 | F4 | F0 | 34 | 30 |
| 43 | 18 | 3377 | D31 | F4 | F1 | 34 | 31 |
| 43 | 19 | 3378 | D32 | F4 | F2 | 34 | 32 |
| 43 | 20 | 3379 | D33 | F4 | F3 | 34 | 33 |
| 43 | 21 | 3380 | D34 | F4 | F4 | 34 | 34 |
| 43 | 22 | 3381 | D35 | F4 | F5 | 34 | 35 |
| 43 | 23 | 3382 | D36 | F4 | F6 | 34 | 36 |
| 43 | 24 | 3383 | D37 | F4 | F7 | 34 | 37 |
| 43 | 25 | 3384 | D38 | F4 | F8 | 34 | 38 |
| 43 | 26 | 3385 | D39 | F4 | F9 | 34 | 39 |
| 43 | 27 | 3386 | D3A | F4 | 7A | 34 | 3A |
| 43 | 28 | 3387 | D3B | F4 | 7B | 34 | 23 |
| 43 | 29 | 3388 | D3C | F4 | 7C | 34 | 40 |
| 43 | 30 | 3389 | D3D | F4 | 7D | 34 | 27 |
| 43 | 31 | 3390 | D3E | F4 | 7E | 34 | 3D |
| 43 | 32 | 3391 | D3F | F4 | 7F | 34 | 22 |
| 43 | 33 | 3392 | D40 | F5 | 40 | 35 | 20 |
| 43 | 34 | 3393 | D41 | F5 | C1 | 35 | 41 |
| 43 | 35 | 3394 | D42 | F5 | C2 | 35 | 42 |
| 43 | 36 | 3395 | D43 | F5 | C3 | 35 | 43 |
| 43 | 37 | 3396 | D44 | F5 | C4 | 35 | 44 |
| 43 | 38 | 3397 | D45 | F5 | C5 | 35 | 45 |
| 43 | 39 | 3398 | D46 | F5 | C6 | 35 | 46 |
| 43 | 40 | 3399 | D47 | F5 | C7 | 35 | 47 |
| 43 | 41 | 3400 | D48 | F5 | C8 | 35 | 48 |
| 43 | 42 | 3401 | D49 | F5 | C9 | 35 | 49 |
| 43 | 43 | 3402 | D4A | F5 | 4A | 35 | 5B |
| 43 | 44 | 3403 | D4B | F5 | 4B | 35 | 2E |
| 43 | 45 | 3404 | D4C | F5 | 4C | 35 | 3C |
| 43 | 46 | 3405 | D4D | F5 | 4D | 35 | 28 |
| 43 | 47 | 3406 | D4E | F5 | 4E | 35 | 2B |

| 80 Col | | Position | | Buffer Address (Hex) | | | |
|--------|----|----------|-----|----------------------|----|-------|----|
| R | C | Dec | Hex | EBCDIC | | ASCII | |
| 43 | 48 | 3407 | D4F | F5 | 4F | 35 | 21 |
| 43 | 49 | 3408 | D50 | F5 | 50 | 35 | 26 |
| 43 | 50 | 3409 | D51 | F5 | D1 | 35 | 4A |
| 43 | 51 | 3410 | D52 | F5 | D2 | 35 | 48 |
| 43 | 52 | 3411 | D53 | F5 | D3 | 35 | 4C |
| 43 | 53 | 3412 | D54 | F5 | D4 | 35 | 4D |
| 43 | 54 | 3413 | D55 | F5 | D5 | 35 | 4E |
| 43 | 55 | 3414 | D56 | F5 | D6 | 35 | 4F |
| 43 | 56 | 3415 | D57 | F5 | D7 | 35 | 50 |
| 43 | 57 | 3416 | D58 | F5 | D8 | 35 | 51 |
| 43 | 58 | 3417 | D59 | F5 | D9 | 35 | 52 |
| 43 | 59 | 3418 | D5A | F5 | 5A | 35 | 5D |
| 43 | 60 | 3419 | D5B | F5 | 5B | 35 | 24 |
| 43 | 61 | 3420 | D5C | F5 | 5C | 35 | 2A |
| 43 | 62 | 3421 | D5D | F5 | 5D | 35 | 29 |
| 43 | 63 | 3422 | D5E | F5 | 5E | 35 | 3B |
| 43 | 64 | 3423 | D5F | F5 | 5F | 35 | 5E |
| 43 | 65 | 3424 | D60 | F5 | 60 | 35 | 2D |
| 43 | 66 | 3425 | D61 | F5 | 61 | 35 | 2F |
| 43 | 67 | 3426 | D62 | F5 | E2 | 35 | 53 |
| 43 | 68 | 3427 | D63 | F5 | E3 | 35 | 54 |
| 43 | 69 | 3428 | D64 | F5 | E4 | 35 | 55 |
| 43 | 70 | 3429 | D65 | F5 | E5 | 35 | 56 |
| 43 | 71 | 3430 | D66 | F5 | E6 | 35 | 57 |
| 43 | 72 | 3431 | D67 | F5 | E7 | 35 | 58 |
| 43 | 73 | 3432 | D68 | F5 | E8 | 35 | 59 |
| 43 | 74 | 3433 | D69 | F5 | E9 | 35 | 5A |
| 43 | 75 | 3434 | D6A | F5 | 6A | 35 | 7C |
| 43 | 76 | 3435 | D6B | F5 | 6B | 35 | 2C |
| 43 | 77 | 3436 | D6C | F5 | 6C | 35 | 25 |
| 43 | 78 | 3437 | D6D | F5 | 6D | 35 | 5F |
| 43 | 79 | 3438 | D6E | F5 | 6E | 35 | 3E |
| 43 | 80 | 3439 | D6F | F5 | 6F | 35 | 3F |
| | | 3440 | D70 | F5 | F0 | 35 | 30 |
| | | 3441 | D71 | F5 | F1 | 35 | 31 |
| | | 3442 | D72 | F5 | F2 | 35 | 32 |
| | | 3443 | D73 | F5 | F3 | 35 | 33 |
| | | 3444 | D74 | F5 | F4 | 35 | 34 |
| | | 3445 | D75 | F5 | F5 | 35 | 35 |
| | | 3446 | D76 | F5 | F6 | 35 | 36 |
| | | 3447 | D77 | F5 | F7 | 35 | 37 |
| | | 3448 | D78 | F5 | F8 | 35 | 38 |
| | | 3449 | D79 | F5 | F9 | 35 | 39 |
| | | 3450 | D7A | F5 | 7A | 35 | 3A |
| | | 3451 | D7B | F5 | 7B | 35 | 23 |
| | | 3452 | D7C | F5 | 7C | 35 | 40 |
| | | 3453 | D7D | F5 | 7D | 35 | 27 |
| | | 3454 | D7E | F5 | 7E | 35 | 3D |
| | | 3455 | D7F | F5 | 7F | 35 | 22 |
| | | 3456 | D80 | F6 | 40 | 36 | 20 |
| | | 3457 | D81 | F6 | C1 | 36 | 41 |
| | | 3458 | D82 | F6 | C2 | 36 | 42 |
| | | 3459 | D83 | F6 | C3 | 36 | 43 |
| | | 3460 | D84 | F6 | C4 | 36 | 44 |
| | | 3461 | D85 | F6 | C5 | 36 | 45 |
| | | 3462 | D86 | F6 | C6 | 36 | 46 |
| | | 3463 | D87 | F6 | C7 | 36 | 47 |
| | | 3464 | D88 | F6 | C8 | 36 | 48 |
| | | 3465 | D89 | F6 | C9 | 36 | 49 |
| | | 3466 | D8A | F6 | 4A | 36 | 5B |
| | | 3467 | D8B | F6 | 4B | 36 | 2E |
| | | 3468 | D8C | F6 | 4C | 36 | 3C |

Appendix C. Status Indicator Code

This appendix lists the error status indications of the 3276, possible causes of errors, the handling of each error by the 3276, and the recommended recovery technique.

The symbol that appears in the Operator Information Area for each error is shown in parentheses in the "Indicator" column and is described in Appendix A.

For Test Subsystem switch (see Figure A-2) operation, when operated in the external modem configuration, the Test Operate switch of the DCE side of the modem cable connector should be set to Test.

An indication consists of a symbol and a numeric code, as shown in the "Indicator" column of Figure C-1, and is described as follows:

✕ PRG nn Program Check.

This symbol is displayed when a programming error is detected in the data received by the control unit.

✕ ↯ nn Communication Check.

A communication reminder symbol (↯ nn) is displayed when a communication link error is detected; it indicates that data cannot be sent. The reminder is automatically cleared when the error condition is removed. If the operator attempts to communicate with the host when a communication error reminder is displayed, a communication check (✕ ↯ nn) condition occurs and is not cleared until the operator presses the RESET key.

✕ M nn Machine Check.

This symbol is displayed when the problem is located in the display station.

The numeric codes consist of two digits, if the display unit is attached to the 3276. (When the display unit is attached to the 3276, the **6** symbol is displayed in the Readiness location of the Operator Information Area.) These codes and their meaning are subject to change.

| Error Code | Indicator | Probable Cause | Effect | Recovery |
|--------------|---|--|---|---|
| 11 (SDLC) | Sys Chk Light Program Chk: (X PROG 11) | 3276 received a negative response from host. | Display error condition at affected display station. | System Check light is turned off when 3276 receives any I-frame, valid PIU, or an SNRM. Press RESET to reset Program Check symbol. Wait for host error recovery if  is indicated. If problem persists and 3276 is in Encrypt/Decrypt session, log off and then log on. |
| 12 (BSC) | Sys Chk Light Program Chk: (X PROG 12) | Invalid command received; host programming problem in write data stream. | Display error indication at affected display station. Set BSC Sense: CR. Send EOT. Go to Control mode. | Receipt of poll or selection with 3276 address resets System Check light. Press RESET to reset Program Check symbol. Call host-support programmer if problem persists. |
| 13 (BSC) | Sys Chk Light Program Chk: (X PROG 13) | Invalid buffer address received or incomplete order sequence in Write, Erase/Write, or Erase/Write Alternate command received. | Display error indication at affected display station. Set BSC Sense: OC. Send EOT. Got to control mode. | |
| 14 (BSC) | Sys Chk Light Program Chk: (X PROG 14) | Invalid Copy command received. | | |
| 15 (BSC) | Sys Chk Light Program Chk: (X PROG 15) | Invalid command sequence. | | |
| 16 (BSC) | Sys Chk Light Program Chk: (X PROG 16) | Line buffer overflow. | Display error indication at affected display station. Set BSC Sense: OC. Send EOT. Got to control mode. | |
| 20 (BSC) | Sys Chk Light Comm Reminder: (*Z 20) | 3276 has sent a NAK because: ● Block-character-checking error was detected, or ● Three seconds elapsed during a read operation without receiving Syn, ETX, or ETB. | Display error indication at affected display station. Replace display image with image displayed before receive operation began. | Host recovery (Host should retransmit the last transmission). Receipt of poll, selection, or data resets System Check light and Communication Reminder symbol. If switched network, redial; if SNBU is installed, use it. |
| 22 (BSC) | Sys Chk Light Comm Reminder: (*Z 22) | No SYN characters received for 3 seconds and this occurred 7 times while monitoring selection or polling. | Display error indication at all display stations. Continue to monitor the line. | Verify the operational status of the communication network. Host recovery. Receipt of poll or selection with 3276 address resets System Check light and Communication Reminder symbol. |
| 22 (SDLC) | Sys Chk Light Comm Reminder: (*Z 22) | No flags received for about 24 to 32 seconds, and the host communication adapter has not been in Sync during this period. | Display error indication at all display stations. | Verify the operational status of the communication network. Host recovery. Receipt of valid frame resets System Check light and Communication Reminder symbol. |
| 23 (BSC) | Sys Chk Light Comm Reminder: (*Z 23) | Fifteen 3-second timeouts occurred when the host expected the 3276 to send a text block as a response to a read-type command. | Display error indication at all display stations. Go to control mode. | Host recovery. Receipt of poll or selection with 3276 address resets System Check light and Communication Reminder symbol. If problem persists, press Test Subsystem. |
| 24 (BSC) | Sys Chk Light Comm Reminder: (*Z 24) | Fifteen 3-second timeouts occurred when PAD, SYN, and data were not received after sending ACK or RVI. | | |

| Error Code | Indicator | Probable Cause | Effect | Recovery |
|----------------------|---|--|---|--|
| 25 (SDLC) | Sys Chk Light Comm Reminder: (*Z 25) | Something in the link is preventing establishment or reestablishment of communication. | Display error indication at all display stations. | Verify the operational status of the communication network. Host recovery. System Check light and Communication Reminder symbol are reset when an SNRM or a DISC is received or when write operation is completed. If problem persists, press Test Subsystem. |
| 26 (BSC) | Sys Chk Light Comm Reminder: (*Z 26) | Fifteen continuous ACK0 received, instead of ACK1—or vice versa (Wrong ACK - ENQ exchange). Wrong ACK receptions or 3-second timeouts occurred 15 times in a row | Display error indication at affected display station. Go to control mode. | Host recovery Receipt of poll or selection with 3276 address resets System Check light and Communication Reminder symbol. If problem persists, call host operator. |
| 27 (BSC) | Sys Chk Light Comm Reminder: (*Z 27) | Fifteen continuous NAKs received for transmitted/retransmitted text. | | |
| 29 (SDLC) | Sys Chk Light Comm Reminder: (*Z 29) | Command reject caused by: a. Detection of an NR sequence error, or b. Receipt of a command that has no data field defined, or c. Receipt of an invalid command. | Display error indication at all display stations. | Host recovery. Receipt of valid SNRM or DISC command from host resets System Check light and Communication Reminder symbol. If problem persists, call host-support programmer. |
| 31 (SDLC) | Sys Chk Light Comm Reminder: (*Z 31) | Loop Adapter did not receive RLSD for more than 4 seconds. | Display error indication at all display stations. | Host recovery. Call host operator. |
| 33 (BSC and SDLC) | Sys Chk Light Comm Reminder: (*Z 33) | Data Set Ready (DSR) signal from modem has dropped. | Display error indication at all display stations. BSC: Go to control mode. SDLC: Go to line-monitor mode. | Check modem. Host recovery. BSC: Receipt of poll or selection resets System Check light and Communication Reminder symbol. SDLC: Receipt of valid SDLC frame resets System Check light and Communication Reminder symbol. If problem persists, press Test Subsystem. |
| 34 (BSC and SDLC) | Sys Chk Light Comm Reminder: (*Z 34) | Write timeout caused by: a. Modem clocking missing, or b. Dropping of CTS. | | |
| 35 (BSC) | Sys Chk Light Comm Reminder: (*Z 35) | Fifteen 3-second timeouts occurred with no response received for the transmitted text to the host. 3276 component or host facility problem, or host is busy. | Display error indication at all display stations. Continue operation. | Receipt of poll or selection with 3276 address resets System Check light and Communication Reminder symbol. If problem persists, call host operator. |
| 36 (BSC) | Sys Chk Light Comm Reminder: (*Z 36) | Fifteen continuous ACK0s received instead of ACK1s, or vice versa. | Display error indication at all display stations. Continue operation. | Receipt of poll or selection with 3276 address resets System Check light and Communication Reminder symbol. If problem persists, call host operator. |

| Error Code | Indicator | Probable Cause | Effect | Recovery |
|------------------|--|--|--|---|
| 41 (Keyboard) | Mach Chk: (X \Rightarrow 41) | Internal malfunction. | Display error indication at affected display station. | Press RESET. Retry operation. |
| 42 (Keyboard) | Retry: (X \Rightarrow +42) | Keystroke lost because of temporary system overload. Keying was attempted when device was busy or not functioning. Conflicting operations were attempted simultaneously, for example, the CLEAR key was pressed during selector-light-pen operation. | | (If ALT or Alpha was struck just prior to error, restrike to remove keyboard from ALT or Alpha shift status before pressing RESET.) Press RESET, and retry the operation. |
| 43 (Feature) | Mach Chk: (X \Rightarrow 43) | Internal malfunction. | | Press RESET. Retry operation. |
| 44 (Feature) | Mach Chk: (X \Rightarrow 44) | | | |
| 45 (Feature) | Retry: (X \Rightarrow +45) | No response/receive parity error from MSR or MHS read command. | | |
| 55 (Feature) | Mach Chk: (X \Rightarrow 55) | Battery in the 3279 is discharged, or internal malfunction. | Display error indication at affected 3279 display station. | Set Normal/Test switch from Normal to Test, then back to Normal. If no indication displayed, check the battery, and replace it if necessary. If indication displayed, call service representative. |
| 56 (Feature) | Mach Chk: (X \Rightarrow 56) | Internal malfunction. | Display error indication at affected 3279 display station. | Press RESET. Retry operation. If operation cannot be continued, call service representative. |
| 59 | Mach Chk Light Mach Chk: (X \Rightarrow 59) | Bad parity in master key of Encrypt/Decrypt feature. | Display error indication at affected display station. Disable Encrypt/Decrypt function if RESET is pressed. | Check the battery, and replace it if necessary. |
| 60 (Feature) | Mach Chk: (X \Rightarrow 60) | Internal malfunction. | Display error indication at affected display station. Disable MSR/MHS function. | Press RESET. Retry operation. |
| 61 (Feature) | Mach Chk: (X \Rightarrow 61) | | Disable Selector Light-Pen feature. Display error indication at affected display station. | Set Normal/Test switch from Normal to Test, then back to Normal. |
| 63 | Mach Chk Light Mach Chk: (X \Rightarrow 63) | Error in Encrypt/Decrypt function. | Display error indication at affected display station. Disable Encrypt/Decrypt function if RESET is pressed. | Press and release Test Subsystem. |
| 65 (Feature) | Mach Chk: (X \Rightarrow 65) | Internal malfunction. | Display error indication at affected display station. Disable display. Set sense: BSC : DC/US SNA: 081C Issue hardware poll and accept only POR from station. | At 3276/3278, set Normal/Test from Normal to Test and back again (or switch power off, then on). At 3230/3268, press Test switch, or switch printer power off, then on. At 3287: 1. Press and hold Test switch. 2. Press and release Reset switch. 3. Release Test switch. Or switch 3287 power off, then on. At 5210, press START. Or switch 5210 power off, wait 10 seconds, and switch 5210 power on. |
| 66 (Feature) | Mach Chk: (X \Rightarrow 66) | Internal malfunction. | Display error indication at affected display station. Disable display. Set sense: BSC : DC/US - IR SNA: 082B - 081C Issue hardware poll and accept only POR from station. | Set Normal/Test switch from Normal to Test, then back to Normal (or switch power off, then on). |

| Error Code | Indicator | Probable Cause | Effect | Recovery |
|----------------------------|---|--|--|---|
| 69 (Display or Printer) | Mach Chk: (X & 69) | Internal malfunction. | Display error indication at affected display station. Disable display. Set sense: BSC : DC/US SNA: 081C Issue hardware poll and accept only POR from station. | At 3276/3278, set Normal/Test from Normal to Test and back again (or switch power off, then on). At 3230/3262/3268, press Test switch, or switch printer power off, then on. |
| 70 (Display or Printer) | Mach Chk: (X & 70) | | Display error indication at affected display station (display may not be successful because of display failure). Disable display. Set sense: BSC : IR SNA: 081C Issue hardware poll and accept only POR from station. | At 3287: 1. Press and hold Test switch. 2. Press and release Reset switch. 3. Release Test switch. Or switch 3287 power off, then on. At 3289, press Reset. At 5210, press START. Or switch 5210 power off, wait 10 seconds, and switch 5210 power on. |
| 71 (Display or Printer) | Mach Chk: (X & 71) | | Display error indication at affected display station. Disable display. Set sense: BSC : DC/US SNA: 081C Issue hardware poll and accept only POR from station. | |
| 72 (Display or Printer) | Mach Chk: (X & 72) | | | |
| 73 (Display or Printer) | Mach Chk: (X & 73) | | | |
| | | Wrong configuration: 3276 has a 3278 Model 5 in subsystem. | | Disconnect 3278 Model 5 |
| 74 (Feature) | Mach Chk: (X & 74) | Internal malfunction. | Display error indication at affected display station. Disable display. Set sense: BSC : DC/US or IR SNA: 081C Issue hardware poll and accept only POR from station. | At 3276/3278, set Normal/Test from Normal to Test and back again (or switch power off, then on). At 3230/3262/3268, press Test switch, or switch printer power off, then on. At 3287: 1. Press and hold Test switch. 2. Press and release Reset switch. 3. Release Test switch. Or switch 3287 power off, then on. At 3289, press Reset. At 5210, press START. Or switch 5210 power off, wait 10 seconds, and switch 5210 power on. |
| 75 (MC) | Mach Chk Light Mach Chk: (X & 75) | | Display error indication at affected display station. Disable terminal. Set sense: BSC : DC/US or IR SNA: 081C Poll is not issued and POR from station cannot be received. | Press and release Test Subsystem. |
| 76 (MC) | Mach Chk Light Mach Chk: (X & 76) | | Display error indication at affected display station. Disable terminal. Set sense: BSC : DC/US or IR SNA: 081C Poll is not issued, and power on reset (POR) from terminals cannot be received. | |

| Error Code | Indicator | Probable Cause | Effect | Recovery |
|----------------------------|---|------------------------------------|--|--|
| 77 (Display) | Mach Chk: (X 77) | | Clear display. Display error indication at affected display station. Set sense: BSC : DC/US or IR SNA : 082B or 081C Disable display; set sense: BSC : DC/US SNA : 081C | Set Normal/Test switch from Normal to Test, then back to Normal (or switch power off, then on). |
| 78 (BSC or SDLC) | Mach Chk Light Mach Chk: (X 78) | Internal malfunction. | Display error indication at affected display station. Disable terminal. Set sense: BSC : DC/US or IR SNA : 081C | Press and release Text/ Subsystem. |
| 79 (BSC or SDLC) | Mach Chk Light Mach Chk: (X 79) | | | |
| 81 (SDLC) | Mach Chk Light Mach Chk: (X 81) | | | |
| 82 (MC) | Mach Chk Light Mach Chk: (X 82) | Error in Encrypt/Decrypt function. | Display error indication at affected display station. Disable Encrypt/Decrypt function if RESET is pressed. | |
| 83 (MC) | Mach Chk Light Mach Chk: (X 83) | | | |
| 85 (BSC or SDLC) | Mach Chk Light Mach Chk: (X 85) | Internal malfunction. | Display error indication at all display stations. Turn off Line Ready (OK). Stop machine. | Press and release Test/ Subsystem. |
| 86 (SDLC) Loop | Mach Chk Light Mach Chk: (X 86) | | Display error indication at all display stations. Turn off Line Ready (OK). Stop machine | |
| 87 (BSC and SDLC) | Mach Chk Light Mach Chk: (X 87) | | | |
| 88 (BSC and SDLC) | Mach Chk Light Mach Chk: (X 88) | | | Display error indication at all display stations. Turn off Line Ready (OK) and other Unit Operable lights. Stop machine. |
| 89 (MC) | Mach Chk Light Mach Chk: (X 89) | | | |
| 90 (MC) | Mach Chk Light Mach Chk: (X 90) | | | |
| 91 (MC) | Mach Chk Mach Chk: (X 91) | | | |
| 92-98 (MC) | Mach Chk Light Mach Chk: (X 92-98) | | | |
| 99 (MC) | Mach Chk Light Mach Chk: (X 99) | | | |

| Error Code | Indicator | Probable Cause | Effect | Recovery |
|-----------------|--|---|---|---|
| 21-87 (SDLC) | Sys Chk Light Program Chk: (X PROG 21-87) | <ul style="list-style-type: none"> 21: EXR from upstream node. 22: Invalid OAF for PU (sense bits 800F). 23: PU Not Active (sense bits 8008). 24: Unrecognized DAF (sense bits 8004). 25: Segmenting Error. 26: LU is not active (sense bits 8009). 27: No LU-LU session (sense bits 8005). 28: Invalid ACTPU parameter (0821). 29: REQMS error (sense bits 080C, 0815, 1003, 1007). 30: Data Traffic Reset state (sense bits 2005). 31: Sequence number error (sense bits 2001). 32: FM data chaining error (sense bits 2002). 33: Normal flow DFC in INC state (sense bits 2002). 34: BB is not found on FM data request (sense bits 2003). 35: DFC carries EB in BETB (sense bits 2003). 40: Invalid 3270 command (sense bits 1003). 41: Data follows READ type command (sense bits 1003). 42: Nonsupported SNA command (sense bits 1003). 43: Control Function carries Null RU (sense bits 1003). 44: Invalid Signal request code (sense bits 1003). 50: ORDER with invalid buffer address (sense bits 1005). 51: Incomplete order sequence (sense bits 1005). 59: FI bit in RH0 is not supported (sense bits 400F). 60: CD in RH2 is required (sense bits 0829). 61: Exception Mode is not allowed for copy (sense bits 0843). 68: Invalid ACTLU parameter (sense bits 0821). 69: Second BIND is received from current PLU (sense bits 0815). 70: Session limit exceeded (sense bits 0805). 71: Bind RU is incomplete (sense bits 0821). 72: Invalid support level (RU1-3) (sense bits 0821). 73: Invalid PLU protocol (RU4) (sense bits 0821). 74: Invalid SLU protocol (RU5) (sense bits 0821). 75: Invalid common protocol (RU6, 7) (sense bits 0821). 76: Too small RU length (RU10) (sense bits 0821). 77: Too large buffer size (RU9, 11) (sense bits 0821). 78: Invalid LU type (RU14) (sense bits 0821). 79: Invalid screen size (RU20-24) (sense bits 0821). 80: Encrypt/Decrypt not supported; BIND parameter error (RU26) (sense bits 0821). 82: Encrypt/Decrypt session (BIND) parameter error (sense bits 0821). 85: Encrypt/Decrypt state error (sense bits 2009). 86: Encrypt/Decrypt CRV failure (sense bits 0821). 87: Encrypt/Decrypt RU data error (sense bits 1001). | <p>Display error indication at affected display station; if it cannot be displayed there, display it at all other display stations.</p> <p>Set sense bits XXXX (as indicated in adjacent column).</p> | <p>Press RESET. Await recovery from host.</p> <p>43: If 3276 is in Encrypt/Decrypt session, log off and then log on.</p> <p>86: Verify the master key value. 87: Log off and then log on.</p> |

Note: Program checks 22, 23, 24, 26, 27, or 59 will not be displayed by some 3276s.

Appendix D. APL/Text Feature

The APL/Text processing capabilities of the IBM 3270 Information Display System are available on the devices shown in Figure D-1 when attached to a 3276 Control Unit Display Station. These devices must be equipped with the appropriate APL/Text and Extended Character Set Adapter or Text Print features, and must be attached to an APL/Text-feathered 3276 Control Unit Display Station.

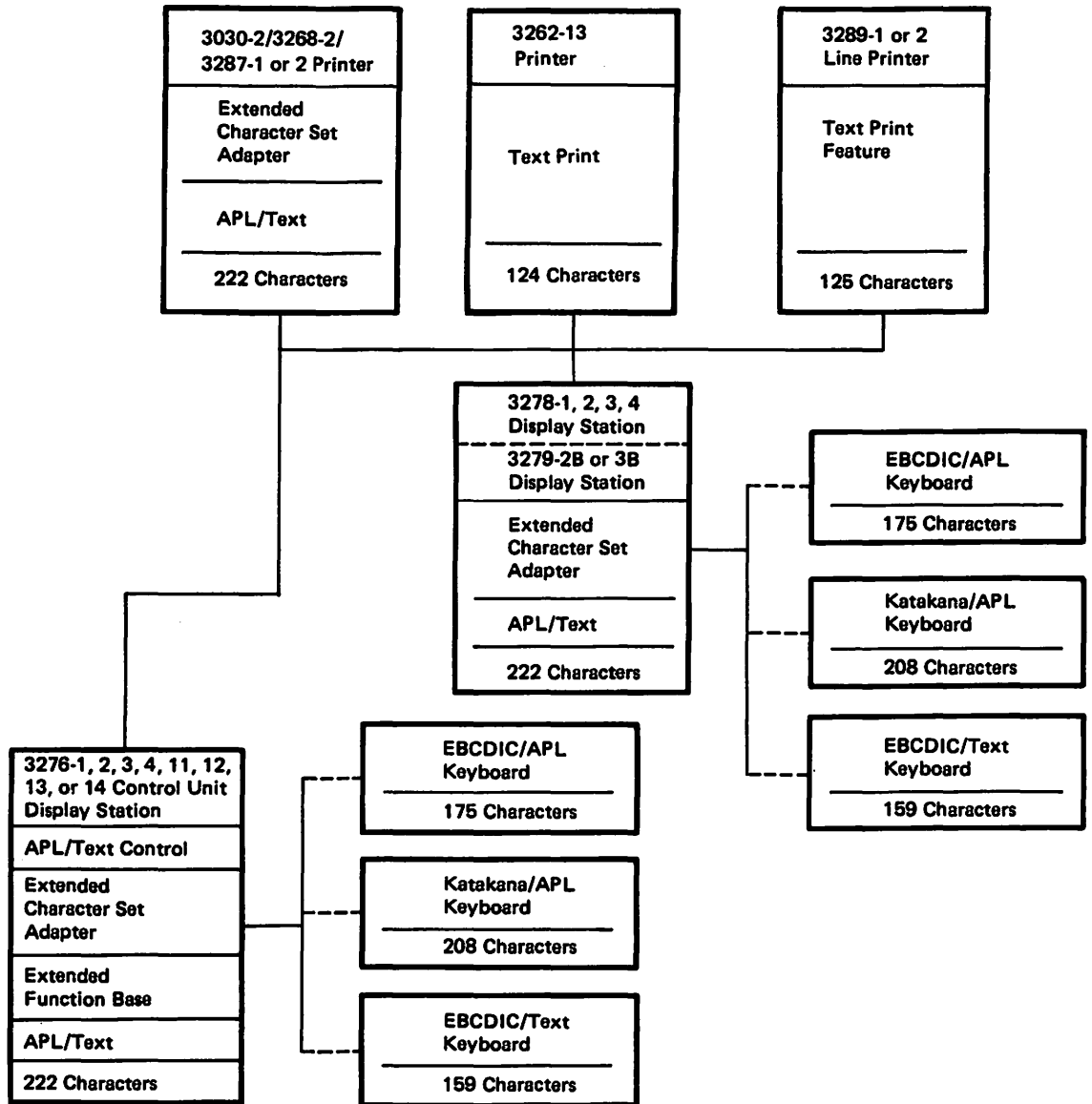

Figure D-1. Diagram of APL/Text Devices

APL/Text and Text Printer Data Streams

The I/O interface codes used by the APL/Text-featured 3276, the 3230, 3268, 3278, and 3287 with APL/Text and Extended Character Set Adapter features, and the 3279 Models 2B and 3B are shown in Figures D-2 and D-3. I/O interface codes with National Use differences are shown in Figure D-4. Codes used with Katakana/APL and Extended Character Set Adapter features are shown in Figures D-5 and D-6. The I/O interface codes used by the APL/Text-featured 3276 and 3262/3289 with the Text-Print feature are shown in Figure D-7. The 3230/3268/3278/3279/3287 APL/Text and the 3262/3289 Text print I/O interface codes do not affect the operation of any 3276 data stream commands, orders, or control characters. All 3230/3268/3278/3279/3287 APL-specific and Text-specific characters are specified by 2-byte sequences; each 2-byte sequence consists of a Graphic Escape (GE) (hex '08') control character followed by a character code.

The 3276 APL/Text data streams:

- Contain 94 EBCDIC characters (plus space).
- Specify all APL- and Text-specific characters by using a 2-byte sequence consisting of a hex 08 control character followed by a character code.
- Contain 10 graphic plot characters.

The 3276 Text print data streams:

- Contain 93 U.S. English set characters (plus space).

3276 APL/Text

The 3276 APL/Text Control special feature, the Extended Function Base special feature (prerequisite for the APL/Text Control feature), the APL/Text special feature, and the Extended Character Set Adapter special feature (prerequisite for the APL/Text feature) enable the 3276 to control 3230s, 3268s, 3278s, 3279s, and 3287s that have APL/Text capability and 3262s and 3289s that have text-print capability.

Attachment of the appropriate APL or Text keyboard to an APL/Text-featured 3276 enables the 3276 operator to interact with either APL or text applications as well as existing applications.

| | | 00 | | | | 01 | | | | 10 | | | | 11 | | | | Bits 0,1 |
|-----------------|-------|----|----|----|----|----------|----------|----------|----|----|----|----|----|----|----|----|----|-------------|
| | | 00 | 01 | 10 | 11 | 00 | 01 | 10 | 11 | 00 | 01 | 10 | 11 | 00 | 01 | 10 | 11 | Bits 2,3 |
| Bits 4,5,6,7 | Hex 1 | 0 | 1 | 2 | 3 | 4 | 5 | 6 | 7 | 8 | 9 | A | B | C | D | E | F | Hex 0 |
| 0000 | 0 | | | | | | | | | ~ | □ | - | α | { | } | | ⊙ | |
| 0001 | 1 | | | | | <u>A</u> | <u>J</u> | | Λ | | | ◻ | ° | ε | (|) | 1 | |
| 0010 | 2 | | | | | <u>B</u> | <u>K</u> | <u>S</u> | .. | | ◻ | - | \ | + | - | 2 | | |
| 0011 | 3 | | | | | <u>C</u> | <u>L</u> | <u>T</u> | | | ◻ | • | ρ | ■ | + | 3 | | |
| 0100 | 4 | | | | | <u>D</u> | <u>M</u> | <u>U</u> | | | ◻ | n | ω | L | J | 4 | | |
| 0101 | 5 | | | | | <u>E</u> | <u>N</u> | <u>V</u> | | | ◻ | | | Γ | ┘ | 5 | | |
| 0110 | 6 | | | | | <u>F</u> | <u>O</u> | <u>W</u> | | | | | x | T | - | 6 | | |
| 0111 | 7 | | | | | <u>G</u> | <u>P</u> | <u>X</u> | | | | | \ | ⊥ | T | 7 | | |
| 1000 | 8 | | | | | <u>H</u> | <u>Q</u> | <u>Y</u> | V | | | | ÷ | § | ¶ | 8 | | |
| 1001 | 9 | | | | | <u>I</u> | <u>R</u> | <u>Z</u> | | | | | | | | 9 | | |
| 1010 | A | | | | | | | | | ↑ | ∩ | ∩ | ∇ | ∧ | I | / | | |
| 1011 | B | | | | | | | | | ↓ | C | U | Δ | ∨ | ! | × | ▽ | |
| 1100 | C | | | | | | | | | ≤ | ≠ | ⊥ | T | | ∇ | | △ | |
| 1101 | D | | | | | | | | | Γ | ○ | [|] | φ | Δ | ⊖ | ⊕ | |
| 1110 | E | | | | | | | | | L | ± | ≥ | ≠ | | ⊖ | ⊕ | ⊕ | |
| 1111 | F | | | | | | | | | → | ← | . | | ∅ | A | ∅ | | |

Notes:

-  Subscripts
-  Superscripts

1. These codes, preceded by a hex 08 control character, transmit the graphics shown.
2. No control characters are shown in this chart.
3. All codes within the solid outlined areas of this chart can be entered from the keyboard; the 10 graphic plot characters within the dashed outlined area cannot be entered from the keyboard.
4. Character code assignments other than those shown within all outlined areas of this chart are undefined. If an undefined character code is programmed, the character that will be displayed or printed is a hyphen (hex 60) (3287 prints a blank); also, a hex 60 will be returned on a subsequent read operation. For control units with Configuration Support C installed, undefined control codes from X'00' to X'3F' cause a negative response (SNA) or an Op Chk (BSC). The character displayed or printed for a given undefined character code may be different for other devices. IBM reserves the right to change at any time the character displayed or printed for any undefined character code.

Figure D-3. APL/Text Feature, 2-Byte I/O Interface Codes (3230/3268/3276/3278/3279/3287)

| Character Set ↓ | Code Key (Note 1) → | | | | | | | | | | | | | |
|------------------------------|---------------------|----|----|-----|----|----|----|----|----|----|----|----|----|----|
| | EBCDIC | 1 | 2 | 3 | 4 | 5 | 6 | 7 | 8 | 9 | 10 | 11 | 12 | 13 |
| | 4A | 4F | 5A | 5B | 5F | 6A | 79 | 7B | 7C | 7F | A1 | C0 | D0 | E0 |
| English (US) | ¢ | | | \$ | ¬ | | ' | # | @ | " | ~ | { | } | \ |
| Austrian/German | Ä | | Ü | \$ | ^ | ö | ' | # | § | " | β | ä | ü | Ö |
| Austrian/German (Alternate) | ö | | ü | Ü | ¬ | β | | Ä | Ö | ä | | | | |
| Danish/Norwegian | # | | ⌘ | Å | ^ | φ | ' | Æ | ø | " | ü | æ | å | \ |
| Danish/Norwegian (Alternate) | φ | | å | Å | ¬ | | | Æ | ø | æ | | | | |
| Finnish/Swedish | § | | ⌘ | Å | ^ | ö | é | Ä | Ö | " | ü | ä | å | É |
| Finnish/Swedish (Alternate) | ö | | å | Å | ¬ | | | Ä | Ö | ä | | | | |
| French | ° | | § | \$ | ^ | ù | ' | £ | à | " | .. | e | è | ç |
| Italian | ° | | é | \$ | ^ | ò | ù | £ | § | " | ì | à | è | ç |
| Portuguese (Note 2) | [| |] | \$ | ^ | õ | ' | Ã | Õ | " | ç | ã | ' | Ç |
| Spanish | [| |] | Pts | ¬ | ñ | ' | Ñ | @ | " | .. | { | } | \ |
| Spanish (Alternate) | ¢ | | | Pts | ¬ | | | Ñ | @ | ñ | | | | |
| English (UK) | \$ | | | £ | ¬ | | ' | # | @ | " | - | { | } | \ |
| Belgian | [| |] | \$ | ^ | ù | ' | # | à | " | .. | é | è | ç |
| Brazilian/Portuguese | É | | \$ | Ç | ^ | ç | ã | Õ | Ã | " | - | õ | é | \ |
| Japanese (English) | £ | | | ¥ | ¬ | | ' | # | @ | " | - | { | } | \$ |
| Spanish Speaking | [| |] | \$ | ¬ | ñ | ' | Ñ | @ | " | .. | { | } | \ |
| Canadian (French) | à | | ' | \$ | ^ | ù | ' | # | @ | " | .. | é | è | ç |
| International | [| |] | \$ | ^ | | ' | # | @ | " | ~ | { | } | \ |

Notes:

1. See Figure D-2 for code points.
2. Portugal
 - a. Host system to control unit -4C or EO is Ç
 - b. Control unit to host system -EO is Ç
 - c. Control unit to host system -4C (<) is removed.

Figure D-4. National Use Differences I/O Interface Code (3230/3268/3276/3278/3279/3287)

| | | 00 | | | | 01 | | | | 10 | | | | 11 | | | | Bits |
|-------|------|----|----|----|----|----|----|----|----|----|----|----|----|----|----|----|----|-------|
| | | 00 | 01 | 10 | 11 | 00 | 01 | 10 | 11 | 00 | 01 | 10 | 11 | 00 | 01 | 10 | 11 | 0,1 |
| Hex 1 | | 0 | 1 | 2 | 3 | 4 | 5 | 6 | 7 | 8 | 9 | A | B | C | D | E | F | 2,3 |
| Bits | 4567 | | | | | | | | | | | | | | | | | Hex 0 |
| 0000 | 0 | | | | | SP | & | - | | | ソ | | | | | \$ | 0 | |
| 0001 | 1 | | | | | . | エ | / | | ア | タ | - | | A | J | | 1 | |
| 0010 | 2 | | | | | 「 | オ | | | イ | チ | へ | | B | K | S | 2 | |
| 0011 | 3 | | | | | 」 | ヤ | | | ウ | ツ | ホ | | C | L | T | 3 | |
| 0100 | 4 | | | | | 、 | ユ | | | エ | テ | マ | | D | M | U | 4 | |
| 0101 | 5 | | | | | . | ヨ | | | オ | ト | ミ | | E | N | V | 5 | |
| 0110 | 6 | | | | | ヲ | ツ | | | カ | ナ | ム | | F | O | W | 6 | |
| 0111 | 7 | | | | | ア | | | | キ | ニ | メ | | G | P | X | 7 | |
| 1000 | 8 | | | | | イ | - | | | ク | ヌ | モ | | H | Q | Y | 8 | |
| 1001 | 9 | | | | | ウ | | | | ケ | ネ | ヤ | | I | R | Z | 9 | |
| 1010 | A | | | | | £ | ! | | : | コ | ノ | ユ | レ | | | | | |
| 1011 | B | | | | | | ¥ | , | # | | | | ロ | | | | | |
| 1100 | C | | | | | < | * | % | @ | サ | | ヨ | ワ | | | | | |
| 1101 | D | | | | | (|) | - | ' | シ | ハ | ラ | ン | | | | | |
| 1110 | E | | | | | + | ; | > | = | ス | ヒ | リ | . | | | | | |
| 1111 | F | | | | | | 「 | ? | ” | セ | フ | ル | . | | | | | |

Notes:

1. No control characters are shown in this chart.
2. All codes can be entered from the keyboard.
3. Character code assignments other than those shown within all outlined areas of this chart are undefined. If an undefined character code is programmed, the character that will be displayed or printed is a hyphen (hex 60) (3287 prints a blank); also, a hex 60 will be returned on a subsequent read operation. The character displayed or printed for a given undefined character code may be different for other devices. IBM reserves the right to change at any time the character displayed or printed for any undefined character code.
4. NL (hex 15), EM (hex 19), FF (hex 0C), and NUL (hex 00) are not displayed or printed. The DUP (hex 1C) and FM (hex 1E) control characters on dual case terminals are displayed as * and ; respectively, and are printed as * and ;.
5. DUP (hex 1C) and FM (hex 1E) control characters on mono case terminals are displayed as * and ; respectively, and are printed as * and ;.

Figure D-5. Katakana/APL 1-Byte I/O Interface Codes (3230/3268/3276/3278/3279/3287)

| | | 00 | | | | 01 | | | | 10 | | | | 11 | | | | Bits |
|-----------|-------|----|----|----|----|----------|----------|----------|----|----|----|----|----|----|----|----|----|-------|
| | | 00 | 01 | 10 | 11 | 00 | 01 | 10 | 11 | 00 | 01 | 10 | 11 | 00 | 01 | 10 | 11 | 0,1 |
| Hex 1 | | 0 | 1 | 2 | 3 | 4 | 5 | 6 | 7 | 8 | 9 | A | B | C | D | E | F | 2,3 |
| Bits 4567 | Hex 0 | | | | | | | | | | | | | | | | | Hex 0 |
| 0000 | 0 | | | | | | | | | ~ | □ | - | α | { | } | | ⊙ | |
| 0001 | 1 | | | | | <u>A</u> | <u>J</u> | | Λ | | | ° | ε | (|) | 1 | 1 | |
| 0010 | 2 | | | | | <u>B</u> | <u>K</u> | <u>S</u> | .. | — | — | - | \ | + | - | 2 | 2 | |
| 0011 | 3 | | | | | <u>C</u> | <u>L</u> | <u>T</u> | | | — | • | ρ | ■ | + | 3 | 3 | |
| 0100 | 4 | | | | | <u>D</u> | <u>M</u> | <u>U</u> | | | — | n | ω | L | ┘ | | 4 | |
| 0101 | 5 | | | | | <u>E</u> | <u>N</u> | <u>V</u> | | | — | | | ┌ | ┐ | | 5 | |
| 0110 | 6 | | | | | <u>F</u> | <u>O</u> | <u>W</u> | | | | | x | ┌ | ┐ | | 6 | |
| 0111 | 7 | | | | | <u>G</u> | <u>P</u> | <u>X</u> | | | | | \ | ┌ | ┐ | | 7 | |
| 1000 | 8 | | | | | <u>H</u> | <u>Q</u> | <u>Y</u> | V | | | | ÷ | § | ¶ | | 8 | |
| 1001 | 9 | | | | | <u>I</u> | <u>R</u> | <u>Z</u> | | | | | | | | | 9 | |
| 1010 | A | | | | | | | | | ↑ | ∩ | ∩ | ∇ | ~ | I | / | | |
| 1011 | B | | | | | | | | | ↓ | ∩ | ∩ | Δ | ~ | ! | λ | ▽ | |
| 1100 | C | | | | | | | | | ≤ | ▣ | ┌ | ┐ | | ▽ | | △ | |
| 1101 | D | | | | | | | | | ┌ | ○ | [|] | φ | Δ | e | ⊙ | |
| 1110 | E | | | | | | | | | ┌ | ± | ≥ | ≠ | | ▣ | ▣ | Φ | |
| 1111 | F | | | | | | | | | → | ← | . | | ∅ | A | Φ | | |

Notes:

-  Subscripts
-  Superscripts

1. These codes, preceded by a hex 08 control character, transmit the graphics shown.
2. No control characters are shown in this chart.
3. All codes within the solid outlined areas of this chart can be entered from the keyboard; the 10 graphic plot characters within the dashed outlined area cannot be entered from the keyboard.
4. Character code assignments other than those shown within all outlined areas of this chart are undefined. If an undefined character code is programmed, the character that will be displayed or printed is a hyphen (hex 60) (3287 prints a blank); also, a hex 60 will be returned on a subsequent read operation. For control units with Configuration Support C installed, undefined control codes from X'00' to X'3F' cause a negative response (SNA) or an Op Chk (BSC). The character displayed or printed for a given undefined character code may be different for other devices. IBM reserves the right to change at any time the character displayed or printed for any undefined character code.

Figure D-6. Katakana/APL 2-Byte I/O Interface Codes (3230/3268/3276/3278/3279/3287)

| Bits 4567 | | 00 | | | | 01 | | | | 10 | | | | 11 | | | | Bits 0,1 | | |
|--------------|---|----|----|----|----|----|----|----|----|----|----|----|----|----|----|----|----|-------------|---|---|
| | | 00 | 01 | 10 | 11 | 00 | 01 | 10 | 11 | 00 | 01 | 10 | 11 | 00 | 01 | 10 | 11 | Bits 2,3 | | |
| | | 0 | 1 | 2 | 3 | 4 | 5 | 6 | 7 | 8 | 9 | A | B | C | D | E | F | Hex 0 | | |
| 0000 | 0 | | | | | SP | & | - | | | | - | 0 | { | } | \ | 0 | | | |
| 0001 | 1 | | | | | | / | | | | | a | j | ° | 1 | A | J | 1 | | |
| 0010 | 2 | | | | | | | | | | | b | k | s | 2 | B | K | S | 2 | |
| 0011 | 3 | | | | | | | | | | | c | l | t | 3 | C | L | T | 3 | |
| 0100 | 4 | | | | | | | | | | | d | m | u | 4 | D | M | U | 4 | |
| 0101 | 5 | | | | | | | | | | | e | n | v | 5 | E | N | V | 5 | |
| 0110 | 6 | | | | | | | | | | | f | o | w | 6 | F | O | W | 6 | |
| 0111 | 7 | | | | | | | | | | | g | p | x | 7 | G | P | X | 7 | |
| 1000 | 8 | | | | | | | | | | | h | q | y | 8 | H | Q | Y | 8 | |
| 1001 | 9 | | | | | | | | | | | . | i | r | z | 9 | I | R | Z | 9 |
| 1010 | A | | | | | | | | | | | ¢ | ! | ! | : | | | | | |
| 1011 | B | | | | | | | | | | | . | \$ | , | # | { | } | L | J | |
| 1100 | C | | | | | | | | | | | < | * | % | @ | ≤ | ≠ | ∟ | ∟ | |
| 1101 | D | CR | | | | | | | | | | (|) | - | ' | (|) | [|] | |
| 1110 | E | | | | | | | | | | | + | ; | > | = | + | ± | ≥ | ≠ | |
| 1111 | F | | | | | | | | | | | | ∟ | ? | " | + | ■ | ● | - | |

Notes:

 *Superscripts*

1. No control characters except CR (hex 0D) are shown in this chart. The CR control character provides the capability to inhibit line advance after a line of characters is printed.
2. Character code hex A1 causes a ° (degree) character to print when the 3289 text print belt is installed and a ~ (tilde) character to print when a U.S. English 3289 print belt is installed.
3. Character code assignments other than those shown within the outlined areas of this chart are undefined. If an undefined character code is programmed, the character that will be printed is a hyphen (hex 60); also, a hex 60 will be returned on a subsequent read operation. IBM reserves the right to change at any time the character printed for an undefined character code.
4. NL (hex 15), EM (hex 19), FF (hex 0C), and NUL (hex 00) are not printed. The DUP (hex 1C) and FM (hex 1E) control characters are printed as * and ; respectively.

Figure D-7. Text Print I/O Interface Codes (3262/3289)

3278-1, -2, -3, and -4 or 3279-2B and -3B APL/Text

The APL/Text special feature, the Extended Character Set Adapter special feature (prerequisite for the APL/Text feature), and the appropriate APL or Text keyboard enable a 3278 or 3279 operator to interact with either APL or text applications as well as existing applications.

APL Keyboards

The 3276 and 3278/3279 APL keyboards are typewriter-like keyboards with keys that contain both APL and the featured-language characters. The APL characters are colored orange (on white keys). The PF1 through PF12 keys on the APL keyboards are located on the right side of the keyboard instead of on the front of the top row of keys as on non-APL keyboards; PF13 through PF24 keys are not available on APL keyboards. The Numeric Lock feature is available for all APL keyboards.

87- and 88-Key Typewriter/APL Keyboards

The 87-key typewriter/APL (U.S. English) keyboard is shown in Figure D-8 (the Japanese English typewriter/APL keyboard has 88 keys). This keyboard is available in all 3276 and 3278/3279 keyboard languages.

The typewriter/APL keyboard enables a 3276 or 3278/3279 operator to enter the 81 APL-specific characters as well as the 94-character-plus-space EBCDIC dual-case character set. The following characters can be entered:

With APL "off" — 94 EBCDIC characters plus space

With APL "on" — 81 APL-specific characters plus:
10 numerics (0 through 9)
26 uppercase alphabet characters
16 invariant symbols (excluding & and %)

When the display station is first turned on, the typewriter/APL keyboard operates similarly to the 75-key typewriter keyboard without APL, with the exception of the PF1 through PF12 keys. Pressing the APL ON/OFF key (with the ALT key held down) causes the keyboard to enter APL mode (the letters APL display in the Operator Information Area); in this mode the APL characters on the right half of the keys may be entered (the Shift, Lock, and ALT keys are used to select the desired character on a key). The keyboard is returned to normal (non-APL) mode by pressing the APL ON/OFF key again.

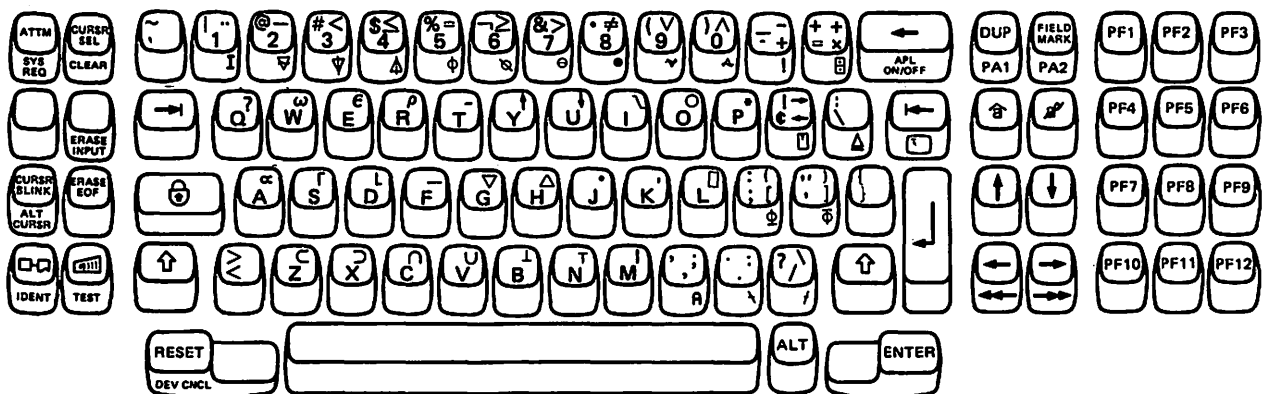

Figure D-8. 87-Key Typewriter/APL Keyboard

88-Key Katakana Typewriter/APL Keyboard

The 88-key Katakana typewriter/APL keyboard (available for IBM World Trade Americas/Far East only) is shown in Figure D-9.

The Katakana typewriter/APL keyboard enables a 3276 or 3278/3279 operator to enter the 81 APL-specific characters as well as the 127-plus-space Japanese Katakana character set. The following characters can be entered:

- With APL "off" — 127-character Japanese Katakana set plus space
- With APL "on" — 81 APL-specific characters plus:
 - 10 numerics (0 through 9)
 - 26 uppercase alphabet characters
 - 16 invariant symbols (excluding & and %)

When the display station is first turned on, the typewriter/APL keyboard operates like the 88-key Katakana typewriter keyboard without APL, with the exception of the PF1 through PF12 keys. Momentarily pressing the APL ON/OFF key (with the ALT key held down) places the keyboard in APL downshift mode (the letters APL display in the Operator Information Area). APL upshift characters can be entered either by pressing and holding either ⤴ (upshift) key or by pressing the Ⓛ (Lock) key; when the keyboard is locked in APL upshift mode, pressing either ⤴ key returns the keyboard to APL downshift mode. The APL characters on the right front of keys can be entered by pressing and holding the ALT key. The keyboard is returned to non-APL mode (ALPHA downshift) by pressing the APL ON/OFF key again.

APL Keyboard World Trade Considerations

The APL programming support does not support certain Canadian-French and Katakana characters on the Canadian-French and Katakana typewriter/APL keyboards. The unsupported Canadian-French characters are all those enterable by a dead key sequence except à, è, é, and u. The unsupported Katakana characters are those with I/O interface codes that are not included in the 94-character-plus-space EBCDIC character set. However, the 3276 control unit does not block these unsupported codes when they are sent inbound to the host system.

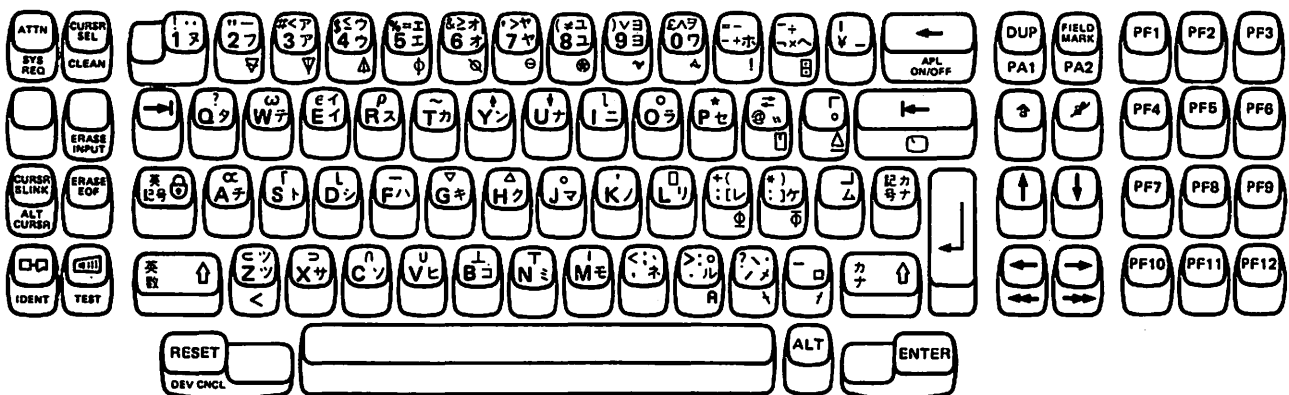

Figure D-9. 88-Key Katakana Typewriter/APL Keyboard

87-Key Typewriter/Text Keyboard

The 87-key typewriter/Text keyboard (shown in Figure D-10) is a typewriter-like keyboard with keys that contain both U.S. English and Text-specific characters. This keyboard is available for U.S. English only (the Text keyboard is not available in IBM Europe/Middle East/Africa countries).

The Text-specific characters are colored green (on white keys). The PF1 through PF12 keys on the typewriter/Text keyboard are located on the right side of the keyboard instead of on the front of the top row of keys as on non-Text keyboards: PF13 through PF24 are not available on the typewriter/Text keyboard.

The 3276 or 3278/3279 operator can use the typewriter/Text keyboard to enter the 65 Text-specific characters as well as the 94-character-plus-space U.S. English character set. The following characters can be entered:

| | | |
|-------------------|----|------------------------------------|
| With Text "off" — | 94 | U.S. English characters plus space |
| With Text "on" — | 65 | Text-specific characters plus: |
| | 10 | numerics (0 through 9) |
| | 26 | uppercase alphabet characters |
| | 26 | lowercase alphabet characters |
| | 9 | symbols (. < ; , > ? : !) |

When the display station is first turned on, the typewriter/Text keyboard operates like the 75-key typewriter keyboard without Text, with the exception of the PF1 through PF12 keys. Pressing the TEXT ON/OFF key causes the keyboard to enter Text mode (the letters TEXT display in the Operator Information Area); in this mode the text characters on the right half of the keys may be entered (the Shift, Lock, and ALT keys are used to select the desired character on a key). The keyboard is returned to normal (non-Text) mode by pressing the TEXT ON/OFF key again.

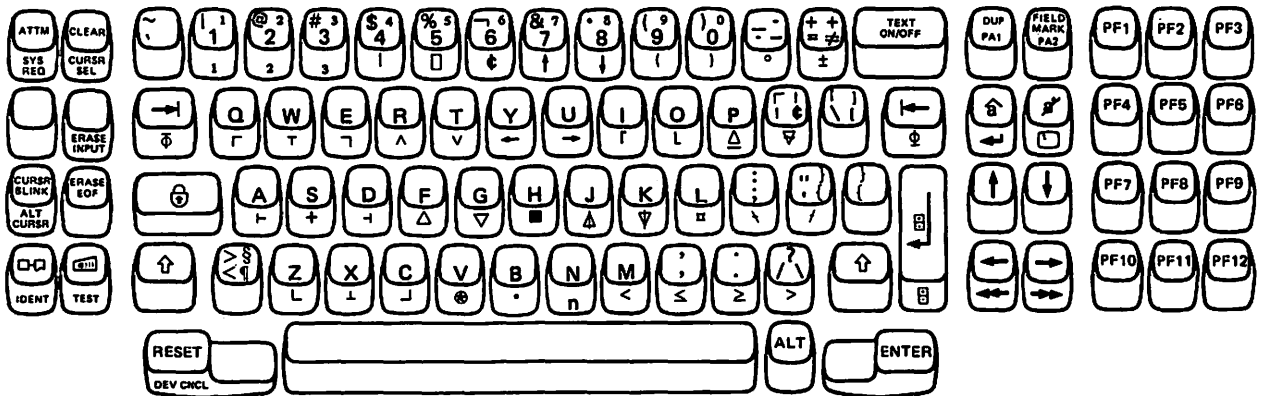

Figure D-10. 87-Key Typewriter/Text Keyboard

3230-2, 3268-2, and 3287-1 and -2 with APL/Text

The APL/Text feature for 3230, 3268, and 3287 (standard feature for 3230 and 3268, special feature for 3287), and its prerequisite Extended Character Set Adapter enable the 3230, 3268, and 3287 to print the following characters:

- 94 EBCDIC characters plus space
- 81 APL-specific characters
- 37 Text-unique characters
- 10 graphic plot characters

3262-13, and 3289-1 and -2 with Text Print

The 3289 Text Print special feature (not available in IBM Europe/Middle East/Africa countries) and the 3262 Text Print standard feature print the following characters:

| 3262-13 | 3289-1 and 2 |
|--|---|
| <ul style="list-style-type: none"> ● 94 U.S. English characters ● 30 TN characters | <ul style="list-style-type: none"> ● 93 U.S. English characters plus space ● 32 TN characters |

Note: The 93-character U.S. English set for 3289 is identical with the normal 94-character U.S. English set except the tilde (~) symbol is not included.

The printing speed in lines per minute (1pm) varies with the size of the character set as follows:

| Print Bands Characters per Set | Nominal Speed (1pm) | | |
|-----------------------------------|---------------------|--------|--------|
| | 3262-13 | 3289-1 | 3289-2 |
| 48 | 325 | 155 | 400 |
| 64 | 230 | 120 | 300 |
| 94 | | 80 | 230 |
| 96 | 180 | | |
| 125 | | 40 | 160 |
| 128 | 125 | | |

Note: Actual printer throughput depends upon operational and system characteristics. The print speed may be affected by such factors as communication line speed, control unit load, character set, and application program.

Local or host-initiated copy operations from a 3278/3279 to a 3262/3289, with or without the Text Print feature installed, are limited to the normal 94-character U.S. English set.

BSC Copy Command

For control units operating under BSC, if APL-or TEXT-specific characters reside in the device buffer, a copy operation initiated by the BSC Copy command will be allowed only to another ECSA-featured device. If the "to" device is not equipped with an ECSA feature, an operation check will be returned to the host.

Local Copy

A local copy from an ECSA featured display with APL/Text characters on the screen will print correctly on an ECSA-featured 3287 printer with APL ROS installed. Local copy from an ECSA-featured display with APL/Text characters on the screen will be allowed to print on a non-ECSA-featured 3287 printer. The standard EBCDIC character set will print correctly, but APL/Text-specific characters will print as EBCDIC characters or hyphens.

Appendix E. Katakana Feature

This appendix contains Katakana unique information interface codes and the keyboard shift operations.

Interface Codes

Figure E-1 shows the Japanese Katakana EBCDIC interface codes for several control unit/device combinations.

Katakana Keyboards Shift Operations (3178, 3276, 3278, and 3279)

The Katakana keyboards shift operations are different from the EBCDIC keyboards described in Chapter 2. The following paragraphs discuss the unique keys and operations.

Katakana Shift Keys (3178, 3278, and 3279)

Four shifts [upper and lower left (UL and LL) and upper and lower right (UR and LR)] on the Katakana keyboards are used with the 3178, 3276, 3278, and 3279 displays:

| Shift | Typewriter Keyboard | | Data Entry Keyboard | | Operator Message |
|-------|---------------------|--------------|---------------------|----------------------|------------------|
| UL | 英記号 | Alpha Symbol | 数字 | Alpha Symbol Numeric | ALPHA ↑ |
| LL | 英数 | Alphameric | 英字 | Alpha | ALPHA |
| UR | カナ記号 | KANA Symbol | カナ記号 | KANA Symbol | カナ ↑ |
| LR | カナ | Katakana | カナ | Katakana | カナ |

The characters associated with each shift level are shown in the corresponding position of the key tops. In normal operation, the appropriate shift key is pressed and released to enter the required shift level; the keyboard remains in that shift level until another is selected. However, in a programmed numeric field (program attribute), the keyboard is automatically set to the upper left (UL) shift, and all characters for that shift are valid unless a keyboard with the Numeric Lock feature is being used. The Numeric Lock feature limits the entries to 0-9, minus (-), decimal sign, and DUP. This automatic UL shift may be overridden by pressing and holding the desired shift key; releasing the shift key returns the keyboard to the UL shift.

Holding a shift key when leaving the programmed numeric field causes the keyboard to enter and remain in that shift level until another shift key is pressed.

On a data entry of data-entry keypunch layout keyboard, the Numeric Lock feature is disabled while the Alpha, Numeric, Latin Shift, Lock, or upper left shift (3178, 3276, or 3278) key is operated.

| | | 00 | | | | 01 | | | | 10 | | | | 11 | | | | Bits 0,1 |
|------|---|-----|-----|----|----|----|----|----|----|----|----|----|----|----|----|----|----|-------------|
| | | 00 | 01 | 10 | 11 | 00 | 01 | 10 | 11 | 00 | 01 | 10 | 11 | 00 | 01 | 10 | 11 | ← 2,3 |
| | | 0 | 1 | 2 | 3 | 4 | 5 | 6 | 7 | 8 | 9 | A | B | C | D | E | F | ← Hex 0 |
| 0000 | 0 | NUL | | | | SP | & | - | | | ソ | | | | | \$ | 0 | |
| 0001 | 1 | | SBA | | | . | エ | / | | ア | タ | - | | A | J | | 1 | |
| 0010 | 2 | | EUA | | | 「 | オ | | | イ | チ | へ | | B | K | S | 2 | |
| 0011 | 3 | | IC | | | 」 | ヤ | | | ウ | ツ | ホ | | C | L | T | 3 | |
| 0100 | 4 | | | | | 、 | ユ | | | エ | テ | マ | | D | M | U | 4 | |
| 0101 | 5 | PT | NL | | | . | ヨ | | | オ | ト | ミ | | E | N | V | 5 | |
| 0110 | 6 | | | | | ヲ | ツ | | | カ | ナ | ム | | F | O | W | 6 | |
| 0111 | 7 | | | | | ア | | | | キ | ニ | メ | | G | P | X | 7 | |
| 1000 | 8 | GE | | | | イ | - | | | ク | ヌ | モ | | H | Q | Y | 8 | |
| 1001 | 9 | | EM | | | ウ | | | | ケ | ネ | ヤ | | I | R | Z | 9 | |
| 1010 | A | | | | | £ | ! | | : | コ | ノ | ユ | レ | | | | | |
| 1011 | B | | | | | . | ¥ | , | # | | | | ロ | | | | | |
| 1100 | C | FF | DUP | | RA | < | * | % | @ | サ | | ヨ | ワ | | | | | |
| 1101 | D | CR | SF | | | (|) | - | ' | シ | ハ | ラ | ン | | | | | |
| 1110 | E | | FM | | | + | ; | > | = | ス | ヒ | リ | ・ | | | | | |
| 1111 | F | | | | | | 「 | ? | ” | セ | フ | ル | ・ | | | | | |

Notes:

1. Character code assignments other than those shown within all outlined areas of this chart are undefined. If an undefined character code is programmed, the character that will be displayed or printed is a hyphen (-); hex code 60 will be returned on a subsequent read operation. IBM reserves the right to change at any time the character displayed for an undefined character code.
2. CR, NL, EM, and FF control characters are displayed or printed as blank characters. The DUP and FM control characters are displayed as * and ; respectively.
3. Hex code 6A is used for CU addressing, device addressing, buffer addressing, and control purposes (for example, WCC and CCC), but has no associated graphic character.
4. For AID, attribute, write control (WCC), copy control (CCC), CU and device address, buffer address, sense, and status characters, bits 0 and 1 are assigned so that each character can be represented by a graphic character in Figure 1-4.
5. For BSC data-link control characters, see Chapter 3. For the SCS control codes associated with the SNA Character String feature on 3230, 3262, 3268, 3287 (with the 3274/3276 Attachment feature) and 3289 printers, see Chapter 2.

Figure E-1. Japanese Katakana EBCDIC I/O Interface Code for 3276 Units with 3178, 3230, 3262, 3268, 3278, 3279, 3287 (with 3276 Attachment Feature), 3289, and 5210 Terminals Attached

Appendix F. Encrypt/Decrypt Feature

Encrypt/Decrypt Products

The IBM Cryptographic Subsystem is a combination hardware and programming implementation of cryptography for data security. It consists of the following separate products:

- IBM Programmed Cryptographic Facility Program Product (OS/VS1 and OS/VS2 MVS only).
- ACF/VTAM (Level 3.0 or higher) Encrypt/Decrypt feature.
- 3276 Encrypt/Decrypt feature.

The first two products reside at the host processor; the third resides in the control unit.

IBM Programmed Cryptographic Facility Program Product

This product contains the following functions: encrypt/decrypt, key generation, and key management. The encrypt/decrypt function is an IBM programmed implementation of the Federal Data Encryptions Standard (DES) algorithm as published by the National Bureau of Standards in January 1977 and adopted as the United States Federal Information Processing Standard (FIPS 46) in July 1977.

The other functions of the IBM Programmed Cryptographic Facility generate new keys upon request and in general manage all the keys used throughout the network. Under the IBM key management concept, since the enciphering algorithm is published, protection is derived from keeping the keys secret.

ACF/VTAM Encrypt/Decrypt Feature

This feature provides cryptographic support in ACF/VTAM by:

- Allowing the specification of a physical cryptographic feature on a Logical Unit (LU) basis.
- Being an interface with the Programmed Cryptographic Facility Program Product for enciphering and deciphering messages and key management.
- Supporting cryptographic changes to SNA.

3276 Encrypt/Decrypt Feature

This feature provides hardware implementation of the DES algorithm for encrypting and decrypting data on a TP line. It is applicable to the 3276 Models 11-14 only. When used with the ACF/VTAM Encrypt/Decrypt feature described above, data transmitted via the transmission subsystem can be safeguarded through cryptography from modification, disclosure, or both. Installed in the control unit with SDLC line control, this feature provides encrypt/decrypt services for up to 8 attached terminals. Included in the feature are:

- A single secondary LU key (terminal master key) storage element and logic to perform enciphering and deciphering operations for secondary LUs by block-chaining.
- A security keylock located in the customer access area of the control units.
- A mercury battery, IBM PN 1743456, to sustain the terminal master key when the control unit power is off.

When the Encrypt/Decrypt feature is used in conjunction with other IBM Cryptographic Subsystem products and is operating in an SNA/SDLC environment, data may be transmitted between the control unit and the host computer in a form that precludes accidental or intentional disclosure; neither can the data be modified without detection.

In SNA terminology, communication occurs between network nodes (application programs and terminals), each node being an LU. Data may be transmitted between the host computer (the primary LU) and a terminal attached to the control unit (the secondary LU) once the LUs have established an LU-LU session. When the cryptographic function is not used, the data is transmitted in the clear, that is, not enciphered. When the cryptographic function is used, the data is enciphered, thus permitting the end-users to communicate the data between the LUs in a secure manner.

It is important to note that only the data transmitted via the transmission subsystem between the host computer and the control unit may be protected by cryptography. Data passing between the control unit and its attached terminals (display stations and printers) is not enciphered.

Two types of cryptographic LU-LU sessions may be established: required cryptographic and selective cryptographic sessions. In the first type, all data transmitted between the host computer and the control units is enciphered during the LU-LU session. In the second type, data is enciphered at the option of the application program; thus, enciphering of data can be selected or suppressed by the host LU, but not by the control unit LU.

Establishing Cryptographic Sessions

Before a cryptographic session can be established, the ACF/VTAM Encrypt/Decrypt feature must recognize a request for a cryptographic session and determine the cryptographic capability of the host processor and the control unit. The ACF/VTAM Encrypt/Decrypt feature calls the IBM Programmed Cryptographic Facility Program Product to generate a cryptographic session key in two versions. The first version is enciphered under the host master key and is stored in the host processor. From this first version, the program product produces a second version enciphered under the secondary LU key. The secondary LU key is a key-encrypting key associated with the secondary LU and is used to protect the cryptographic session key during transmission to the secondary LU. The cryptographic session key is used to encipher and decipher data that will be transmitted between the primary and secondary LUs once a cryptographic session has been established.

To establish a cryptographic session, the host processor transmits the enciphered cryptographic session key to the control unit as part of the Bind command. The control unit can decipher the session key, since the secondary LU key is known (having previously been installed in the control unit by a security officer).

In addition to storing the encrypted session key, the control unit takes part in the following cryptographic protocol:

A pseudo-random value (N) is encrypted under the just-received session key (KS), and this 8-byte quantity $EKS(N)$ is sent to the host as part of the Bind response.

A valid host will decrypt $EKS(N)$, invert 4 bytes of N , re-encipher the value, and send this 8-byte quantity $EKS(N)$ to the control unit as part of the crypto verification (CRV) command.

The control unit decrypts $EKS(\bar{N})$, inverts \bar{N} , and compares this value N with the original N . If the values are identical, a positive response is sent to the host, and the conditions of a cryptographic protocol have been met. This cryptographic protocol serves two purposes:

It verifies that both host and control unit are using the same data-encrypting key (KS).

It validates the host's cryptographic capability, thus preventing an active wire-tapper from using the control unit to decipher captured enciphered data.

The following chart illustrates how the cryptographic protocol fits in with the SNA commands which invoke and terminate a cryptographic session:

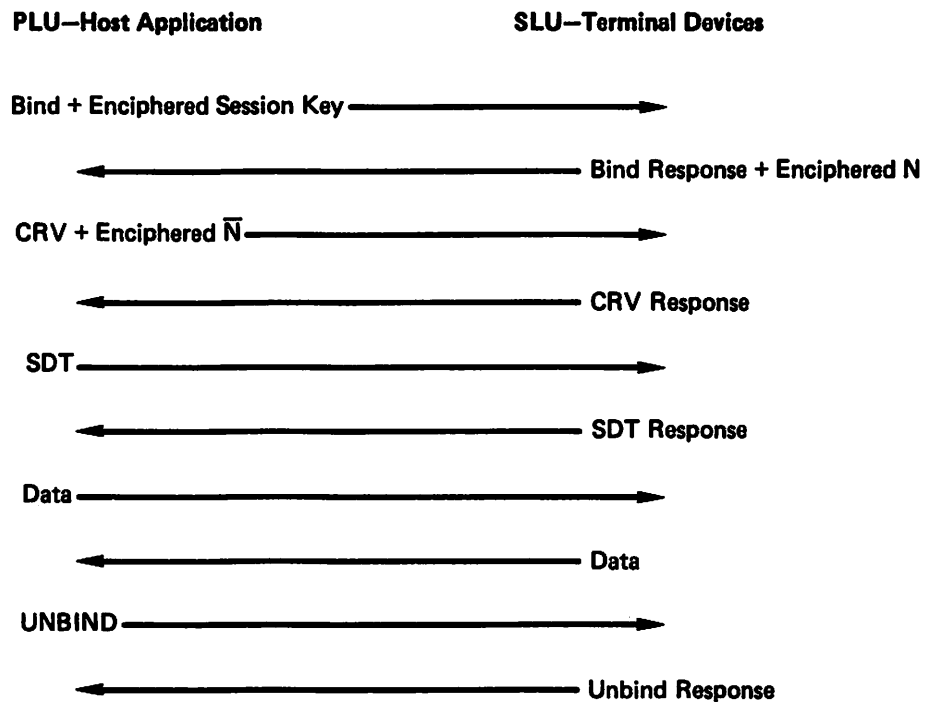

Appendix G. Record Formatted Maintenance Statistics (RECFMS) Formats

This appendix describes the formats of the four RECFMS responses the 3276 Control Unit Display Station can send to the host system in response to an REQMS command.

Counters in type 1, 2, and 3 responses do not wrap when they exceed their maximum value; they maintain the maximum value.

The log areas are reset when:

- The 3276 is turned off (types 1, 2, and 3).
- The execution of RECFMS is completed normally as the response to an REQMS with a "RESET" request (types 1, 2, and 3).

REQMS Request Type 1 - Link Test Statistics

Bytes 14, 15 = Number of times the Test command was received.

Bytes 16, 17 = Number of times the Test response was transmitted.

REQMS Request Type 2 - Summary Counters

Byte 14 = Mask bits of the summary counters supported.
All supported counters, including those containing zero count, are sent to the host by RECFMS.

Bit 0 = 1 = Machine Check.

Bit 1 = 1 = Communication Check.

Bit 2 = 1 = Program Check.

Bit 3 - 7 = Reserved.

Bytes 15, 16 = Reserved.

Bytes 17, 18 = Machine Check Summary Counter.

Bytes 19, 20 = Communication Check Summary Counter.

Bytes 21, 22 = Program Check Summary Counter.

REQMS Request Type 3 - Communication Adapter Data Error Counts

Byte 14 = Adapter Type.
= X'01' = CCA Link Adapter.
= X'02' = (not applicable to the 3276).
= X'03' - X'FF' = Reserved.

Byte 15 = Mask bits of the Communication Adapter Error Counters supported.
All supported counters, including those containing zero count, are sent to the host by RECFMS.

Bit 0 = 1 = Nonproductive Timeout.

Bit 1 = 1 = Idle Timeout.

Bit 2 = 1 = Write Retry.

Bit 3 = 1 = Overrun.

Bit 4 = 1 = Underrun.

Bit 5 = 1 = Connection Problem.

Bit 6 = 1 = FCS Error.

Bit 7 = 1 = Primary Abort.

- Byte 16 = Mask bits of the Communication Adapter Error Counters supported.
All supported counters, including those containing zero count, are sent to the host by RECFMS.
- Bit 0 = 1 = Command Reject.
- Bit 1 = 1 = DCE Error.
- Bit 2 = 1 = Write Timeout.
- Bit 3 - 7 = Reserved.
- Byte 17 = Reserved.
- Byte 18 = Nonproductive Timeout Counter.
- Byte 19 = Idle Timeout Counter.
- Byte 20 = Write Retry Counter.
- Byte 21 = Overrun Counter.
- Byte 22 = Underrun Counter.
- Byte 23 = Connection Problem Counter.
- Byte 24 = FCS Error Counter.
- Byte 25 = Primary Abort Counter.
- Byte 26 = Command Reject Counter.
- Byte 27 = DCE Error Counter.
- Byte 28 = Write Timeout Counter.

REQMS Request Type 5 - 3276 Machine Level Information

Bytes 14–229 = 3276 Machine Level Information.

Bytes 14–205 = ROS chip part number information; each is made up of two 4-byte chip part numbers.

Refer to ROS EC History (SY18-2023) to cross-reference chip PNs and machine EC level.

| Byte | Chip PNs |
|---------|-----------------|
| 14- 21 | = K2 – Module 1 |
| 22- 29 | = K2 – Module 2 |
| 30- 37 | = K2 – Module 3 |
| 38- 45 | = K2 – Module 4 |
| 46- 53 | = J2 – Module 1 |
| 54- 61 | = J2 – Module 2 |
| 62- 69 | = J2 – Module 3 |
| 70- 77 | = J2 – Module 4 |
| 78- 85 | = H2 – Module 1 |
| 86- 93 | = H2 – Module 2 |
| 94-101 | = H2 – Module 3 |
| 102-109 | = H2 – Module 4 |
| 110-117 | = K2 – Module 5 |
| 118-125 | = K2 – Module 6 |
| 126-133 | = K2 – Module 7 |
| 134-141 | = K2 – Module 8 |
| 142-149 | = J2 – Module 5 |
| 150-157 | = J2 – Module 6 |
| 158-165 | = J2 – Module 7 |
| 166-173 | = J2 – Module 8 |
| 174-181 | = H2 – Module 5 |
| 182-189 | = H2 – Module 6 |
| 190-197 | = H2 – Module 7 |
| 198-205 | = H2 – Module 8 |

Note: Zeros for a chip PN means there is no ROS chip for that position.

Abbreviations

A

A. Attention
ACK. Positive acknowledge
ACTLU. Activate logical unit
ACTPU. Activate physical unit
ADDCNVRT. Add Converter
ADDR, adr. Address
AID. Attention Identifier
ALPHA. Alphameric
ALT. Alternate
A/N. Alphameric/numeric
APL. A programming language
ASCII. American National Standard Code for Information Interchange
async. Asynchronous
atb, Atb. Attribute
ATT. Attribute
ATTN. Attention

B

B. Busy
BB. Begin bracket
BC. Begin chain
BCC. Block check character
BCEC. Begin chain/end chain
BETB. Between-bracket
BIU. Basic information unit
BOC. Bus-out check
bps. Bits per second
BS. Back space
BSC. Binary synchronous communication

C

C. Column
CA. Character Attribute
CALC. Calculator
CAW. Channel address word
CC. Control check, Chain Command (flag)
CCC. Copy control character
CCW. Channel control word
CD. Change direction
CE. Channel End
char. Character
Chk. Check

cmd. Command
CNCL. Cancel
cnt. Count
COL. Column
CONT. Contention
cps. Characters per second
CPU. Central processing unit
CR. Command Reject, carriage return
CRT. Cathode-ray tube
CRV. Crypto Verification
CSW. Channel status word
ctl. Control
CTS. Clear to Send
CU. Control unit
CUE. Control Unit End
CURSR. Cursor

D

D. Display
DAA. Data access arrangement
DACTLU. Deactivate logical unit
DACTPU. Deactivate physical unit
DAF. Destination address field
DB. Device Busy
DC. Data Check
DE. Device End
Dec. Decimal
DEL. Delete
DES. Data encryption standard
DEV. Device
DFC. Data flow control
DISC. Disconnect
DLE. Data link escape
DM. Disconnect mode
DR. Definite response
DS. Data Set
DSC. Data stream compatibility
DSR. Data Set Ready
DTR. Data Terminal Ready
DUP. Duplicate

E

EAU. Erase All Unprotected
EB. End brackets
EBCDIC. Extended binary-coded decimal interchange code
EC. Equipment Check
ECSA. Extended character set adapter

EFA. Extended Field Attribute
EFL. Expedited flow indicator
EIA. Electronic Industries Association
EM. End of Message
ENP. Enable Presentation
ENQ. Enquiry
EOF. End of Field
EOL. End of Inquiry
EOR. End of Record
EOT. End of Transmission
ERP. Error recovery procedure(s)
ESC. Escape
ETB. End of Transmission Block
ETX. End of Text
EUA. Erase Unprotected to Address
EW, E/W. Erase Write (command)
EWA. Erase Write Alternate (command)
EX (response). Exception

F

FA. Field Attribute
FF. Forms feed, flip-flop
FIC. First in chain
FID. Format identifier
FIE. Function interpret error
FIPS. Federal Information Processing Standard
FIS. First in Segment
FM. Field mark, function management
FMD. Function management data
FRMR. Frame reject

G

GE. Graphic escape
GP. General Poll

H

HDX. Half-duplex
Hex. Hexadecimal
HT. Horizontal tab
Hz. Hertz

I

I (format). Information
IC. Insert Cursor
ID. Identification
ident. Identification
IML. Initial machine load, initial microprogram load

INB. In Bracket
Ind. Indicator
INOP. Inbound Operation Device Characteristic
INP. Inhibit presentation
INS. Insert
IOS. Input/Output Supervisor
IPR. Isolated pacing response
IR. Intervention Required
IRS. Interrecord separator
ITB. End of intermediate transmission block

K

kbd. Keyboard

L

LEN. Length
LF. Line feed
LIC. Last in chain
LIS. Last in segment
LL. Lower left
LM. Left margin
LPI. Lines per inch
LPM. Lines per minute
LR. Lower right
LRC. Longitudinal redundancy check
LU/SSCP. Logical unit/system services control point
LUSTAT. Logical-Unit Status
LUT. Logical Unit Type

M

MAX. Maximum
MAXL. Maximum Length
MC. Machine check
MCL. Multituse Communication Loop
MDT. Modified data tag
MF. Modify Field
MHS. Magnetic hand scanner
MIC. Middle in chain
MIS. Middle in segment
mm. Millimeter
MOD. Model
MPF. Mapping field
MPL. Maximum Page Length
MPP. Maximum Print Position
MRU. Maximum request/response unit
MSR. Magnetic slot reader

N

NA, N/A. Not applicable
NAK. Negative acknowledge
NC. Not supported
NCCF. Network communication control facility
NCP. Network control program
NDAP. Network determination aid processor
NDM. Normal disconnect mode
neg. Negative
NL. New Line
Nr. Number
NRM. Normal response mode
NS (format). Nonsequenced
NUL. Null
NUM. Numeric

O

OAF. Origin address field
OC. Operation Check
OIC. Only in chain
OIS. Only in segment
OP. Operator, operation

P

P. Printer, protected
PA. Program access, program attention
PC. Pacing count
PEND.BB. Pending Begin Bracket
PF. Program function
PLU. Primary Logical Unit
PN. Part number
POS. Position
PROT. Protect
PS. Programmed Symbols
PSI. Primary to secondary indicator
PT. Program Tab
PU. Physical unit

R

R. Row
RA. Repeat to Address
RB. Read Buffer
RBM. Read Buffer Modified
RCV. Receive
Rd Mod. Read Modified
RECFSM. Record Formatted Maintenance Statistics

REG. Register
Req, REQ. Request
REQMS. Request Maintenance Statistics
RES. Reserved
resp. Response
Rev. Reverse
RH. Request/response header
RM. Read Modified, right margin
RMA. Read Modify All
RNR. Request not ready
RPQ. Read Partition-Query
R/R. Request/response
RR. Request ready
RSP. Response
RTR. Ready to receive
RTS. Request to send
RU. Request/response unit
RVI. Reverse interrupt

S

S (format). Sequenced, supervisory
SA. Selection addressing, Set Attribute
SBA. Set Buffer Address
SC. Session control
SCS. SNA Character String
SDLC. Synchronous data link control
SDT. Start data traffic
SEL. Select
SF. Start Field
SFE. Start Field Extended
SHF. Set Horizontal Format
SI. Suppress Index
SIOF. Start I/O Fast Release
SLD. Set line density
SLU. Secondary logical unit
SM. Status Modifier
SNA. Systems network architecture
SNBU. Switched network backup
SNRM. Set normal response mode
SOH. Start of heading
SOR. Start of record
SP. Space, Specific Poll
SPD. Selector pen detect
S/S. Status and sense
SSCP. System services control point

SSR. Secure string record
STX. Start of text
SUB. Substitute
SVF. Set Vertical Format
sw. Switch
SYN. Synchronous idle
SYS. System

T

TC. Transmission Check
TCU. Transmission control unit
TH. Transmission header
TM. Top margin
TRN. Transparent
TTD. Temporary text delay

U

U. Unprotected
UA. Unnumbered acknowledgment
UC. Unit Check
UE. Unit Exception
UL. Upper left
UNPROT. Unprotect
UR. Upper right
US. Unit Specify

V

V. Volts
VCS. Vertical channel select
VFC. Vertical forms control
VID. Video
VT. Vertical tab
VTAM. Virtual Telecommunications Access Method

W

WACK. Wait before transmit
WCC. Write control character
WRT. Write
WSF. Write Structured Field

X

XID. Exchange Station Identification
XMIT. Transmit

Index

- abort function 4-47
- ACK 0 (even acknowledge) 3-6
- ACK 1 (odd acknowledge) 3-6
- Activate Logical Unit (ACTLU) command 4-9
- Activate Physical Unit (ACTPU) command 4-8
- Alpha key 2-14
- ALT CURSR (Alternate Cursor) key 2-15
- APL/Text feature D-1
- ATTN (Attention) key 2-15

- Base Color mode 2-6
- Between Bracket (BETB) state 4-32
- Bid command 4-14
- Bind check 4-50
- Bind command 4-9
- Bind default 4-49
- bracket states 4-31
- buffered printer operations 2-35
- building output data streams 6-10

- Cancel command 4-13
- Cancel Print switches 2-41
- Carriage Return (CR) order 2-34
- character content 5-3
- character-oriented keys 2-9
- Chase command 4-14
- Clear command 4-13
- Click key 2-16
- code structures 3-1
- coding the panel 5-18
- color 5-2
- command sequences
 - control-type 3-15
 - read-type 3-19
 - write-type 3-15
- commands 1-8
 - Copy 1-27
 - Erase 1-12
 - Erase All Unprotected (EAU) 1-30, 5-45
 - Erase/Write 1-12
 - Erase/Write Alternate 1-12
 - Read 1-17
 - Read Buffer 1-17
 - Read Modified 1-18
 - Read Modified All 1-22
 - Write 1-9
 - Write Alternate 1-9
- Contention (CONT) state 4-29
- control commands 1-27
- control field 4-43
- control mode 3-3
- control-type command sequences 3-15
- Copy command 1-27
- cursor 2-7
- cursor select
 - input 5-38
 - output 5-38
- CURSR (Cursor) BLINK key 2-15
- CURSR SEL (Cursor Select) key 2-14

- data link 4-35
- data-link control characters 3-4
- data streams 1-7
 - APL/Text D-2
 - building output 6-10
 - decoding 6-2
 - dynamic output 6-14
 - generating 6-2
 - immediate selector pen or cursor select 6-7
 - mixed read-modified input 6-9
 - nonselector pen or noncursor select 6-4
 - read-modified input 6-2
 - static 6-10
 - text printer D-2
- Data Traffic (Reset/Active) state 4-29
- Deactivate Logical Unit (DACTLU) command 4-9
- Deactivate Physical Unit (DACTPU) command 4-8
- dead keys 2-17
- decoding data streams 6-2
- decoding read-modified input data stream 6-2
- Delete key (3276, 3278, 3279) 2-11
- designator characters 2-21, 5-39
- DEV CNCL (Device Cancel) key 2-13
- device addressing 1-3
- display fields 2-4
- display images 2-1
- displays 2-1
- DLE (data link escape) 3-5
- DUP (Duplicate) key 2-12
- dynamic output streams 6-14

- EFI=0 4-7
- EFI=1 4-7
- 88-key Katakana typewriter/APL keyboard D-10
- 87-key typewriter/Text keyboard D-11
- 87- and 88-key typewriter/APL keyboards D-9
- Encrypt/Decrypt feature F-1
- End of Message (EM) (all printers) order 2-34
- ENQ (enquiry) 3-6
- EOT (end of transmission) 3-8
- EOT to a text block 3-28
- Erase All Unprotected (EAU) command 1-30, 5-45
- Erase EOF (Erase to End of Field) key 2-10
- ERASE INPUT key 2-10
- Erase Unprotected to Address (EUA) order 1-33, 5-44
- Erase/Write Alternate command 1-12
- Erase/Write command 1-12
- ERP1 state 4-31
- error conditions 2-30, 2-50
- error-recovery procedures 3-22, 4-58
- ESC (escape) 3-8
- establishing cryptographic sessions F-2
- ETB (end of transmission block) 3-7
- ETX (end of text) 3-8

- field-attribute character 2-5
- field attributes 2-5
- field concept 5-1
- field-oriented keys 2-9

FM data 4-16
FM (Field Mark) key 2-12
format control (shared printer operations) 2-48
Forms Feed (FF) order 2-34

General Poll sequences 3-9
generating data streams 6-2

host-initiated local copy using SNA/SDLC 2-45

IDENT key 2-16
immediate cursor select data stream 6-7
immediate selector pen data stream 6-7
In Bracket (INB) state 4-32
inbound from the 3276, operation 4-33
inbound message handling 4-39
indicators A-1
information (I) frame 4-47
initiating an LU-LU session 4-3
INS (Insert) Mode key 2-10
Insert Cursor (IC) order 1-32
interface codes 1-3
ITB (end of intermediate transmission block) 3-8

Katakana shift keys E-1
key functions 2-8
keyboard disabled (Do Not Enter condition) 2-18
keyboard operations 2-7
keys

- Alpha 2-14
- ALT CURSR 2-15
- ATTN 2-15
- Click 2-16
- CURSR BLINK 2-15
- CURSR SEL 2-15
- Dead 2-17
- Delete 2-11
- DEV CNCL 2-13
- Duplicate (DUP) 2-12
- Erase EOF 2-10
- field-oriented 2-9
- FM 2-12
- IDENT 2-16
- INS Mode 2-10
- LOCK 2-14
- NUM 2-14
- NUM LOCK 2-14
- Print 2-16
- Program Attention 2-12
- Program Function 3-37
- RESET 2-11
- SHIFT 2-14
- SYS REQ 2-13
- TEST 2-15

large screen size 6-15
local copy D-13

local copy function 2-42
LOCK key 2-14
logical unit status (LUSTAT) 4-55
LU-LU session 4-3
LU-LU session error reporting 4-35
LU status (LUSTAT) 4-15
LU types

- 1 4-19
- 2 and 3 4-20

magnetic slot reader (MSR)

- description 2-24
- operator alarm 2-31
- operator indicators 2-31
- validity test 2-30

magnetic-stripe format 2-26
mixed read-modified input data stream 6-9
modifying existing panels 5-41
mono/dual case control 2-48
MSR (*see* magnetic slot reader)
multipoint (nonswitched line) data link control 3-2

NAK (Negative Acknowledgment) 3-6
NAK to a text block 3-28
New Line (NL) (all printers) order 2-34
noncursor select data stream 6-4
nonselector pen data stream 6-4
nonsequenced commands and responses 4-44
NUM key 2-14
NUM LOCK key 2-14
Numeric Lock feature, operation of 2-17

operational sequences (nonswitched line) 3-8
orders 1-30

- EUA 1-33, 5-44
- Program Tab (PT) 1-32
- Repeat to Address (RA) 1-33
- Set Buffer Address (SBA) 1-32
- Start Field (SF) 1-31

outbound message handling 4-39
outbound to the 3276, operation 4-33

padding 4-19
pad 3-5
page length control operations 2-35
panel layout sheet 5-9, 5-12
Pending Begin Bracket (PEND.BB) state 4-32
planning the panel 5-9
poll sequences

- General 3-9
- Specific 3-9

print format control 2-41
Print key 2-16
print line formatting 2-32
printer orders 2-34
printers 2-32
Program Attention (PA) keys 2-12, 5-37
Program Function (PF) keys 5-37
Program Tab (PT) order 1-32, 5-47
protection 5-2

- Read Buffer command 1-17
- Read commands 1-17
- Read Modified All command 1-22
- Read Modified command 1-18
- read-type command sequences 3-19
- Ready to Receive (RTR) command 4-15
- Receive (RCV) state 4-30
- REFCMS (Record Formatted Maintenance Statistics) command 4-16
- redundancy checking 3-4
- remote chaining 3-9
- remote operations
 - BSC 3-1
 - SDLC 4-42
- Repeat to Address (RA) order 1-33
- repetitive output 5-47
- REQMS (Request Maintenance Statistics) command 4-15
- Record Formatted Maintenance Statistics (REFCMS) formats
 - G-1, G-2
- RESET key 2-11
- RESET key 2-11
- response modes 4-42
- RU lengths 4-33
- RVI (reverse interrupt) 3-7
- RVI to selection addressing sequence 3-29

- sample SNA command sequences 4-23
- SBA codes 5-36
- screen design 5-1
- screen management 6-1
- SCS control codes 2-36
- SDLC (synchronous data link control)
 - station address 4-47
 - transmission frames 4-42
- security keylock 2-23
- segmenting
 - inbound 4-35
 - outbound 4-34
- selection addressing sequence 3-15
- selector field format 5-38
- selector light pen
 - field format 2-20
 - operations 2-20
- selector pen
 - input 5-38
 - output 5-38
- Send (SEND) state 4-29
- sequence error recovery procedures 4-47
- session components 4-2
- session processing states 4-29
- Set Buffer Address (SBA) order 1-32
- setting the screen size 4-38
- SHIFT key 2-14
- Shutdown command 4-16
- Shutdown Complete command 4-16
- Signal command 4-15
- SNA (systems network architecture)
 - character string 2-36
 - commands 4-7
 - printer control sessions 4-41
 - reference data (3276) 4-49
 - responses 4-20
 - sense codes 4-51
 - sessions 4-2
- SOH (start of heading) 3-7
- Specific Poll sequences 3-9
- SSCP-PU session 4-2
- SSCP-secondary LU session 4-3
- SSCP-SLU
 - contention operation 4-38
 - session 4-38
- Start Data Traffic (SDT) command 4-13
- Start Field (SF) order 1-31
- static data streams 6-10
- status and sense (S/S) bytes 3-22
- status indicator code C-1
- STX (start of text) 3-7
- summary of SNA commands 4-21
- supervisory commands 4-43
- supplementary procedures 3-28
- SYN (synchronous idle) 3-5
- synchronous data link control (see SDLC)
- SYS (System) REQ key 2-13
- system logoff 4-40
- system logon 4-40
- systems network architecture (see SNA)

- 10-character set 2-25
- terminal addressing 4-46
- terminal ID 4-47
- terminal identification 4-47
- terminals 2-1
- TEST key 2-15
- text blocking 3-1
- text mode 3-3
- timeout controls 4-48
- transmission 5-4
- transmission formats 4-1
- transmission header 4-6
- transparent-monitor mode 3-3
- TTD (temporary text delay) 3-8

- Unbind 4-13

- WACK (wait before transmit) 3-7
- Write Alternate command 1-12
- Write command 1-9
- write control character (WCC) 5-27
- write-type command sequences 3-15

- XID 4-44

- 10-character set 2-25
- 87-key typewriter/Text keyboard D-11
- 87- and 88-key typewriter/APL keyboards D-9
- 88-key Katakana typewriter/APL keyboard D-10
- 3276
 - APL/Text D-2
 - attachment to a 3790 4-5
 - bracket state errors 4-32
 - Control Unit 1-1
 - data stream 1-1
 - default matrix 2-42
 - Encrypt/Decrypt feature F-1
 - local copy operation 2-43
 - modes of operation 3-2
 - session interaction 4-36
 - SNA/SDLC communications 4-1
- 3278-1, -2, -3, and -4 APL/Text D-9
- 3279-2B and -3B APL/Text D-9
- 3230-2, 3268-2, and 3287-1 and -2 with APL/Text D-12
- 3262-13, and 3289-1 and -2 with Text Print D-12

IBM 3270 Information Display System

GA18-2081-1

**READER'S
COMMENT
FORM**

This manual is part of a library that serves as a reference source for systems analysts, programmers, and operators of IBM systems. This form may be used to communicate your views about this publication. They will be sent to the author's department for whatever review and action, if any, is deemed appropriate. Comments may be written in your own language; use of English is not required.

IBM may use or distribute any of the information you supply in any way it believes appropriate without incurring any obligation whatever. You may, of course, continue to use the information you supply.

Note: Copies of IBM publications are not stocked at the location to which this form is addressed.

Please direct any requests for copies of publications, or for assistance in using your IBM system, to your IBM representative or to the IBM branch office serving your locality.

Possible topics for comment are:

Clarity Accuracy Completeness Organization Coding Retrieval Legibility

If you wish a reply, give your name and mailing address:

Note: Staples can cause problems with automated mail sorting equipment.
Please use pressure sensitive or other gummed tape to seal this form.

Cut or Fold Along Line

What is your occupation? _____

Number of latest Technical Newsletter (if any) concerning this publication: _____

Thank you for your cooperation. No postage stamp necessary if mailed in the U.S.A. (Elsewhere, an IBM office or representative will be happy to forward your comments.)

Reader's Comment Form

Cut or Fold Along Line

IBM 3270 Information Display System (File No. S360/S370/S3/4300/8100-09) Reprinted in Japan GA18-2081-1

Fold and tape

Please Do Not Staple

Fold and tape



NO POSTAGE
NECESSARY
IF MAILED
IN THE
UNITED STATES

BUSINESS REPLY MAIL
FIRST CLASS PERMIT NO. 40 ARMONK, N.Y. U.S.A.

POSTAGE WILL BE PAID BY ADDRESSEE



INTERNATIONAL BUSINESS MACHINES CORPORATION
DEPARTMENT 825J
1133 WESTCHESTER AVENUE
WHITE PLAINS, NEW YORK 10604 U.S.A.

Fold and tape

Please Do Not Staple

Fold and tape



IBM 3270 Information Display System

GA18-2081-1

**READER'S
COMMENT
FORM**

This manual is part of a library that serves as a reference source for systems analysts, programmers, and operators of IBM systems. This form may be used to communicate your views about this publication. They will be sent to the author's department for whatever review and action, if any, is deemed appropriate. Comments may be written in your own language; use of English is not required.

IBM may use or distribute any of the information you supply in any way it believes appropriate without incurring any obligation whatever. You may, of course, continue to use the information you supply.

Note: *Copies of IBM publications are not stocked at the location to which this form is addressed.*

Please direct any requests for copies of publications, or for assistance in using your IBM system, to your IBM representative or to the IBM branch office serving your locality.

Possible topics for comment are:

Clarity Accuracy Completeness Organization Coding Retrieval Legibility

If you wish a reply, give your name and mailing address:

Note: Staples can cause problems with automated mail sorting equipment. Please use pressure sensitive or other gummed tape to seal this form.

Cut or Fold Along Line

What is your occupation? _____

Number of latest Technical Newsletter (if any) concerning this publication: _____

Thank you for your cooperation. No postage stamp necessary if mailed in the U.S.A. (Elsewhere, an IBM office or representative will be happy to forward your comments.)

Reader's Comment Form

Cut or Fold Along Line

IBM 3270 Information Display System (File No. S360/S370/S3/4300/8100-09) Reprinted in Japan GA18-2081-1

Fold and tape

Please Do Not Staple

Fold and tape



BUSINESS REPLY MAIL
 FIRST CLASS PERMIT NO. 40 ARMONK, N.Y. U.S.A.

POSTAGE WILL BE PAID BY ADDRESSEE

NO POSTAGE
 NECESSARY
 IF MAILED
 IN THE
 UNITED STATES



INTERNATIONAL BUSINESS MACHINES CORPORATION
 DEPARTMENT 825J
 1133 WESTCHESTER AVENUE
 WHITE PLAINS, NEW YORK 10604 U.S.A.

Fold and tape

Please Do Not Staple

Fold and tape



IBM 3270 Information Display System

GA18-2081-1

**READER'S
COMMENT
FORM**

This manual is part of a library that serves as a reference source for systems analysts, programmers, and operators of IBM systems. This form may be used to communicate your views about this publication. They will be sent to the author's department for whatever review and action, if any, is deemed appropriate. Comments may be written in your own language; use of English is not required.

IBM may use or distribute any of the information you supply in any way it believes appropriate without incurring any obligation whatever. You may, of course, continue to use the information you supply.

Note: Copies of IBM publications are not stocked at the location to which this form is addressed.

Please direct any requests for copies of publications, or for assistance in using your IBM system, to your IBM representative or to the IBM branch office serving your locality.

Possible topics for comment are:

Clarity Accuracy Completeness Organization Coding Retrieval Legibility

If you wish a reply, give your name and mailing address:

Note: Staples can cause problem. With automated mail sorting equipment. Please use pressure sensitive or other gummed tape to seal this form.

Cut or Fold Along Line

What is your occupation? _____

Number of latest Technical Newsletter (if any) concerning this publication: _____

Thank you for your cooperation. No postage stamp necessary if mailed in the U.S.A. (Elsewhere, an IBM office or representative will be happy to forward your comments.)

Reader's Comment Form

Cut or Fold Along Line

IBM 3270 Information Display System (File No. S360/S370/S3/4300/8100-09) Reprinted in Japan GA18-2081-1

Fold and tape

Please Do Not Staple

Fold and tape



BUSINESS REPLY MAIL
 FIRST CLASS PERMIT NO. 40 ARMONK, N.Y. U.S.A.
 POSTAGE WILL BE PAID BY ADDRESSEE

NO POSTAGE
 NECESSARY
 IF MAILED
 IN THE
 UNITED STATES



INTERNATIONAL BUSINESS MACHINES CORPORATION
 DEPARTMENT 825J
 1133 WESTCHESTER AVENUE
 WHITE PLAINS, NEW YORK 10604 U.S.A.

Fold and tape

Please Do Not Staple

Fold and tape



IBM 3270 Information Display System

GA18-2081-1

**READER'S
COMMENT
FORM**

This manual is part of a library that serves as a reference source for systems analysts, programmers, and operators of IBM systems. This form may be used to communicate your views about this publication. They will be sent to the author's department for whatever review and action, if any, is deemed appropriate. Comments may be written in your own language; use of English is not required.

IBM may use or distribute any of the information you supply in any way it believes appropriate without incurring any obligation whatever. You may, of course, continue to use the information you supply.

Note: Copies of IBM publications are not stocked at the location to which this form is addressed.

Please direct any requests for copies of publications, or for assistance in using your IBM system, to your IBM representative or to the IBM branch office serving your locality.

Possible topics for comment are:

Clarity Accuracy Completeness Organization Coding Retrieval Legibility

If you wish a reply, give your name and mailing address:

Note: Staples can cause problems. In automated mail sorting equipment. Please use pressure sensitive or other gummed tape to seal this form.

Cut or Fold Along Line

What is your occupation? _____

Number of latest Technical Newsletter (if any) concerning this publication: _____

Thank you for your cooperation. No postage stamp necessary if mailed in the U.S.A. (Elsewhere, an IBM office or representative will be happy to forward your comments.)

Reader's Comment Form

Cut or Fold Along Line

IBM 3270 Information Display System (File No. S360/S370/S3/4300/8100-09) Reprinted in Japan GA18-2081-1

Fold and tape

Please Do Not Staple

Fold and tape



BUSINESS REPLY MAIL
 FIRST CLASS PERMIT NO. 40 ARMONK, N.Y. U.S.A.

POSTAGE WILL BE PAID BY ADDRESSEE

NO POSTAGE
 NECESSARY
 IF MAILED
 IN THE
 UNITED STATES



INTERNATIONAL BUSINESS MACHINES CORPORATION
 DEPARTMENT 825J
 1133 WESTCHESTER AVENUE
 WHITE PLAINS, NEW YORK 10604 U. S. A.

Fold and tape

Please Do Not Staple

Fold and tape



