

MESA/BOOGIE

LONE STAR
Special™

Owner's Manual

Hello from the Tone Farm

...You, smart player and all around intuitive human, have put your trust in us to be your amplifier company. This is something we do not take lightly. By purchasing and choosing this unit to be a part of your musical voice, you have become part of the Mesa family...WELCOME! Our goal is to never let you down. Your reward is that you are now the owner of a great amp, bred of fine all tube amp heritage...benefiting from the many pioneering and patented Mesa circuits that led to the refinement of your new instrument. Feel confident, as we do, this amp will inspire many hours of musical satisfaction and lasting enjoyment. It was built with you in mind, by players who know the value of a fine musical instrument and the commitment it takes to make great music. The same commitment to quality, value and support we make to you...our new friend.



TABLE OF CONTENTS

Precautions	
OVERVIEW	1-4
HELPFUL HINTS	3
INSTANT GRATIFICATION	4
FRONT PANEL CONTROLS & FEATURES	
INPUT	4
FOOTSWITCH	4
DRIVE	5
CHANNEL SELECT	5
DRIVE / CLEAN	5
THICK / NORMAL / THICKER	6
GAIN	6-7
TREBLE / MID / BASS / PRESENCE	7-8
MASTER	9
30 WATTS / 15 / 5 WATTS: Channel Power Select	9-10
OUTPUT & SOLO CONTROLS	10
POWER ON / STANDBY ON	11
REAR PANEL CONTROLS, SWITCHES & JACKS	
FUSE	12
FX LOOP: Series	12-13
REVERB	13
CHANNEL & SOLO: External Switch Jacks & FAN ON/OFF Switch	13
SPEAKERS & SLAVE	14
REVERB REMOTE JACK	14
FACTORY SAMPLE SETTINGS & PERSONAL SETTINGS SHEET	15-17
TUBE MAINTENANCE & DIAGNOSING TUBE FAILURE	18-19
TUBE DESCRIPTION & TASK CHARTS	20
SPEAKER IMPEDANCE & POSSIBLE HOOK-UP SCHEMES - Amps to Speaker Cabs	21-26
BIAS ADJUSTMENT: A feature article by Randall Smith	27-29
TRIODES, PENTODES & IRISHMEN: A feature article on the workings of tubes	30-32
PART SHEET	33

PRECAUTIONS & WARNINGS

Your MESA/Boogie Amplifier is a professional instrument. Please treat it with respect and operate it properly.

USE COMMON SENSE AND ALWAYS OBSERVE THESE PRECAUTIONS:

WARNING: EU: permission from the Supply Authority is needed before connection.

WARNING: Vacuum tube amplifiers generate heat. To insure proper ventilation always make certain there is at least four inches (100mm) of space behind the rear of the amplifier cabinet. Keep away from curtains or any flammable objects.

WARNING: Do not block any ventilation openings on the rear or top of the amplifier. Do not impede ventilation by placing objects on top of the amplifier which extend past the rear edge of its cabinet.

WARNING: Do not expose the amplifier to rain, moisture, dripping or splashing water. Do not place objects filled with liquids on or nearby the amplifier.

WARNING: Always make certain proper load is connected before operating the amplifier. Failure to do so could pose a shock hazard and may result in damage to the amplifier.

Do not expose amplifier to direct sunlight or extremely high temperatures.

Always insure that amplifier is properly grounded. Always unplug AC power cord before changing fuse or any tubes. When replacing fuse, use only same type and rating.

Avoid direct contact with heated tubes. Keep amplifier away from children.

Be sure to connect to an AC power supply that meets the power supply specifications listed on the rear of the unit. Remove the power plug from the AC mains socket if the unit is to be stored for an extended period of time. If there is any danger of lightning occurring nearby, remove the power plug from the wall socket in advance.

To avoid damaging your speakers and other playback equipment, turn off the power of all related equipment before making the connections.

Do not use excessive force in handling control buttons, switches and controls. Do not use solvents such as benzene or paint thinner to clean the unit. Wipe off the exterior with soft cloth.

YOUR AMPLIFIER IS LOUD! EXPOSURE TO HIGH SOUND VOLUMES MAY CAUSE PERMANENT HEARING DAMAGE !

No user serviceable parts inside. Refer service to qualified personnel. Always unplug AC power before removing chassis.

EXPORT MODELS: Always insure that unit is wired for proper voltage. Make certain grounding conforms with local standards.

READ AND FOLLOW INSTRUCTIONS OF PROPER USAGE.

LONE STAR Special™

Instruction Manual

Overview:

Congratulations on your choice of the **Lone Star Special** as your amplifier and Welcome to the *Mesa/Boogie* Family! This hand-built instrument was crafted with the finest quality components and designed to provide you with years of musical inspiration and toneful satisfaction.

From a glance you can see the **Lone Star Special** is laid out simply and logically. Its clean, two channel layout provides a platform for ultimate expression with a minimal learning curve. Though you have probably experienced the magic of its character already, this guide will help you to understand the interaction of the controls and features...allowing you to find your sound more quickly and deviate from there easily in new musical environments.

The two channels provide the entire range of gain, from sparkling clean to totally saturated, and anywhere in between. Channel 1 (top) is based on a traditional gain structure to produce angelic and warm clean sounds in its low to medium gain ranges. Like most great amps, this channel can be driven to clip and produces incredible solo possibilities for blues or roots chording styles.

Channel 2 has a split personality and can either be set to achieve a slightly gainier clone of Channel 1 or, with the flick of a switch become a high gain preamp. Switching in the DRIVE control adds 2 more triode stages and an additional gain control to meter in the exact blend of smooth singing saturation. The bipolar nature of Channel 2 allows the **Lone Star Special** to roam effortlessly through both vintage and modern territory with full channel switching accuracy and an emphasis on soul and simplicity. You can set up the amp for two low gain channels, one for sparkling clean and the other driven into an old school clip or, one for low gain clean and the other for high gain singing sustain.

The **Lone Star Special** takes channel switching further and allows you to choose the amount of power and type of rectification you want to combine with each preamp channel. The EL84 powered Special takes this concept to a new dimension and provides three choices for power that feature two different types of power tube configuration within the realm of its pure Class A design!

FRONT VIEW : Lone Star Special

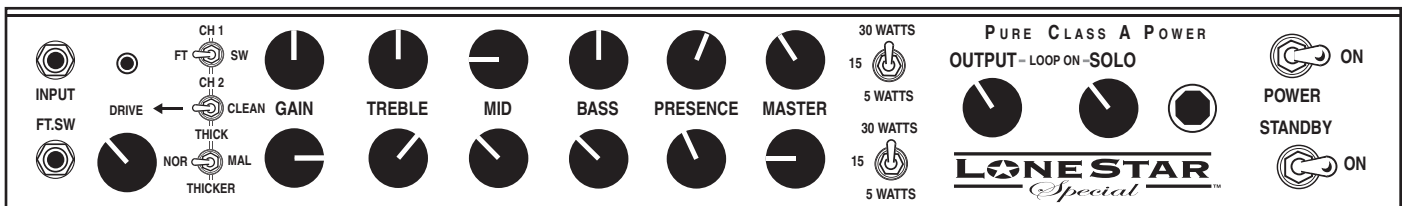

REAR VIEW : Lone Star Special

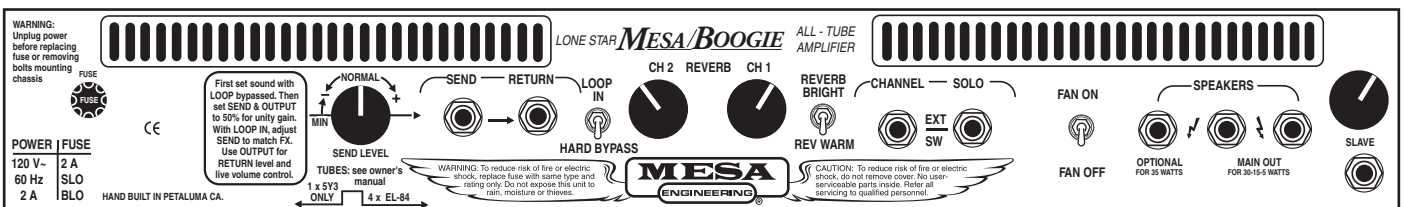

Overview: *(Continued)*

The power choices range from 30 watts (using 4 x EL84) to 15 watts (using 2 x EL84) to 5 watts (using 1 x EL84), allowing the Special to soulfully cover any situation from mid-size clubs to combo rehearsals to bedroom recording - while always staying in a power-optimized range. The power tube wiring configuration is changed to accommodate these different wattage ratings and offer the sweetest sound and best feel for each of the three choices. The 30 and 15 watt selections utilize a Push-Pull configuration for its quicker response and greater power efficiency characteristics. The 5 watt setting introduces a unique new Single-Ended design for the ultimate warm, furry vintage voice.

Single-ended circuits do not split the waveform into two separate out-of-phase halves to be amplified separately. Therefore, the precious and musically beautiful 2nd harmonic (one octave above the notes being played) is not cancelled out like it is when the opposite phased waveforms are combined in the output transformer in a push-pull circuit. The gorgeous 2nd harmonic remains intact in the Special's 5 watt Single-Ended setting. Though subtle, most players hearing this magic for the first time are instantly hooked... asking why everything they play sounds so much better than they have ever heard it sound before. The 2nd harmonic is truly a beautiful part of the spectrum and when present, adds a warm glow and a halo around each note - so don't be surprised if the 5 watt setting becomes your favorite...especially for practicing alone or recording nuances.

The 30 and 15 watt push-pull settings accentuate the 3rd harmonic (an octave and a 5th above the notes played) which tends to sound punchier and tighter and cuts through a mix a little better. This is sonically perfect for using these two power ranges to play with a band or record in a complex mix. Bass frequencies will track tighter and higher gain settings especially in the DRIVE mode of Channel 2 will respond more accurately with the blend of the 3rd harmonic in the mix.

To take Channel Specific power selection even further the **Lone Star Special** incorporates our patented Rectifier Tracking™ feature. This ingenious feature auto-selects the tight tracking authority and maximum headroom of the SILICON DIODES when the 30 watt setting is called up and brings up the 5Y3 rectifier tube for increased dynamic character and a juicy feeling sag when either 15 or 5 watts is chosen.

However you choose to utilize your channels, these power-selectable-per-preamp choices are incredibly intuitive and allow for extreme stylistic accuracy when dedicating the two channels to your footswitching needs.

The OUTPUT control is joined by our SOLO feature that provides an additional master output that you can trigger remotely for a footswitchable boost when you want to feature a part. These two Front Panel controls are brought on line with the activation of the Effects Loop. When the Loop is not active, the individual Channel Master controls serve as final output controls. When the Loop is set to HARD BYPASS, all associated circuitry is removed (for you purists) from the signal path. Since the OUTPUT and SOLO controls are wired as Loop Returns, at the end of the preamp and Loop signal path, they are defeated when the Loop is bypassed.

As mentioned above the Effects Loop handles outboard processing with finesse. The ability to HARD BYPASS the loop entirely assures the purist in you will be satisfied in the studio where every nuance of tone is crucial and you don't need the SOLO feature.

The pure, all tube Reverb is fitted with a Bright/Warm switch that enables you to tailor the reverb sound to the style you are playing. Bright delivers a vintage-inspired sound complete with the identifiable haze of harmonics associated with older amp circuits, while WARM produces a more pure, studio quality character. Individual blend controls for each channel allow you to get the mix just right for each of the sounds you have designated to the two channels.

External switch ports are provided to assure that you can interface the **Lone Star Special** with larger rack or multiple amp setups. The Channels and SOLO feature will respond to any tip-to-ground latching type logic at their corresponding jacks. You can control these features via external and/or midi commands with any switcher that supports grounding type logic within their programmable menus. The **Lone Star Special** chassis can be retrofitted to a **Lone Star** Rackmount Kit available from your local Mesa Retailer or directly from the factory.

And finally, a SLAVE Output jack and Level control round out the Rear Panel enabling you to use the **Lone Star Special** as the "dry" master amp for a stereo setup, drive an external rack of outboard processing or, simply add additional power for larger venues. Unlike

Overview: *(Continued)*

the EFFECTS SEND jack, this output captures the entire sound of the preamp and power section and is generated by padding down the signal at the speaker output.

NOTE: *Once you have taken a signal from the SLAVE Output - do not go back in to the EFFECTS LOOP RETURN jack. Doing so will create a feedback loop and squealing will occur.*

That covers the features of the **Lone Star Special**, so let's move on to the individual controls and how they interact so you can find your sound. First though, here are a few helpful hints to get you started.

HELPFUL HINTS:

- 1.) After unpacking your new amplifier, save the packing material and box should you move or ever want to ship you amplifier.
 - 2.) Remove the plastic webbing from the power tubes before connecting the A.C. power cable!
 - 3.) Make sure the A.C. power cable is connected to a grounded (3 hole) socket.
 - 4.) Make all speaker connections with unshielded speaker cable.
 - 5.) Make all external processing connections to the Effects Loop with shielded cable.
 - 6.) When the Footswitch is not available or desired, use the Front Panel mini toggle to select the two channels.
 - 7.) The Front Panel OUTPUT and SOLO controls are not active until the Effects Loop is switched to the LOOP IN position. Use the Channel MASTER controls for output volume level when the LOOP is set to HARD BYPASS. If using the amp with LOOP IN without effects, **ALWAYS** make sure the SEND LEVEL is Set to the NORMAL(12:00) position.
- NOTE:** *If the SEND LEVEL is set below NORMAL(12:00) with LOOP IN, SEND & RETURN are not at unity gain and output will be diminished.*
- 8.) As with all **MESA** amplifiers, the **Lone Star Special** controls really work and are extremely powerful. You will find most of the best sounds will be produced by setting the controls in their middle ranges, and very rarely higher than 3:00. The balance between them is the important part and they are most interactive when no one dominates the mix. Adhering to this scheme will avoid excessive tube noise and possible microphonic preamp tube problems.
 - 9) When connecting your processing to the Effects Loop follow these steps; **1.** Set up your two Channels for the desired sounds **2.** Balance the volume of the Channels with the Channel Masters **3.** Connect your processor Input to the Effects Loop SEND **4.** Connect processor Output to the Return **5.** Activate Effects Loop (LOOP IN) **6.** Set processor Input Level control for unity gain (0db) **7.** Adjust the overall Effects Loop SEND LEVEL control to fine tune the processors Input signal. **8.** Adjust overall playing volume with the **Lone Star Special's** Front Panel OUTPUT control.
 - 10.) If you are using the amplifier with both Channels set to the 30 watt output setting, try connecting an 8 ohm load to the OPTIONAL (8 ohm) jack. This scheme provides a bolder, snappier response and increases overall power and headroom making this scheme preferable for certain styles. If you are using the amplifier with both Channels set to the 15 or 5 watt output setting, try connecting an 8 ohm load to one of the MAIN OUT (4 ohm) jacks. This scheme provides a softer, warmer response and may be preferable for certain styles.

Overview: *(Continued)*

SAMPLE #1. Sparkling Clean / Singing Lead

Instant Gratification Demo Settings

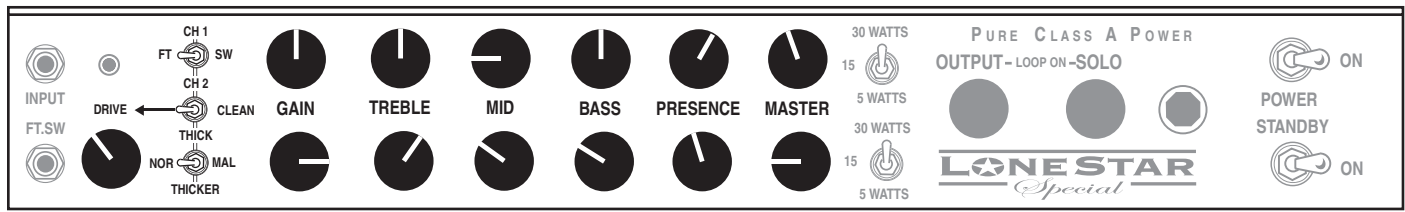

SAMPLE #2. Roots Clean / Old School Clip

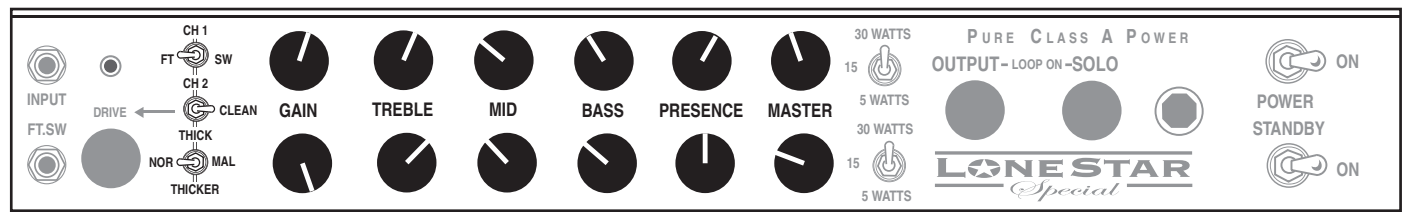

Now let's move on to understanding the individual controls and their interactive roles in shaping the sounds *you* want to hear.

FRONT PANEL: Controls & Features

INPUT: This is the instrument **INPUT** jack. This jack feeds the preamp and since the **Lone Star Special** is a high gain amplifier and therefore very sensitive, always use a high quality shielded cable between the instrument and the amplifier. This will prevent unwanted noise and microphonic cable sounds.

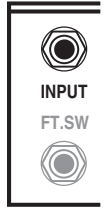

FOOTSWITCH: This 1/4 inch stereo jack is for connection of the Channel Select Footswitch. When the **FOOTSWITCH** is connected here with the provided stereo cable, the Channels and SOLO feature may be controlled remotely.

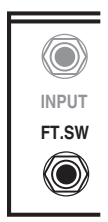

FRONT PANEL: Controls & Features *(Continued)*

DRIVE:

This is the pre-drive control for the high gain preamp in Channel 2. It may be switched out of the circuit, along with its associated tube stages, to create a slightly higher gain clone of Channel 1 in (this bottom) Channel 2. When the **DRIVE** control is activated (switch left, towards **DRIVE**), this control operates in conjunction with the GAIN control to meter the amount of preamp drive that will be introduced into the circuit.

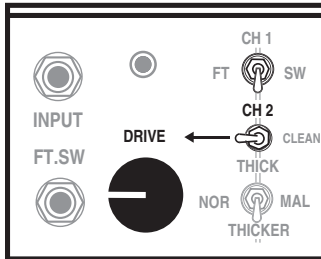

Generally speaking, you will find better response and dynamics combined with smoother saturation by setting the GAIN control higher than **DRIVE**. In fact you might try leaving the GAIN set to 2:00 or 3:00 and just playing with the **DRIVE** to learn the regions of saturation.

You will probably find the more blues oriented sounds between 9:00 and 11:00, while the really saturated high gain sounds appear between 1:00 and 3:00.

Setting the GAIN control slightly higher than the **DRIVE** will produce a warmer quality to the sound and in most cases this is preferable. By all means experiment with setting the GAIN lower than the **DRIVE**, as the brighter, thinner character may be desirable for your application.

Learning the relationship between these two controls is probably the most important element to finding your signature lead sound. They are extremely powerful, as they control how your guitar feeds the preamp and also determine the signal strength that is pumped through the tone control string. This in turn affects how the tone controls will respond. At extremely high settings you will be hearing mostly gain saturation as the tone controls become recessive due to over-saturation.

This is fine if complete saturation is the desired effect, but remember, many of the best sounds are found with more moderate settings where the gain controls interact with the tone control string to produce a balance of frequencies.

CHANNEL SELECT:

This 3 position mini toggle allows manual selection of the Channels when the Footswitch is not connected. Set it to the center FT-SW position to use the Channel Select Footswitch.



DRIVE / CLEAN:

This switch is responsible for activating the **DRIVE** circuitry in Channel 2. Set to **DRIVE**, the overdrive circuitry is active and additional tube stages are added in front of the normal “rhythm” circuitry to produce a multi-stage high gain lead channel.

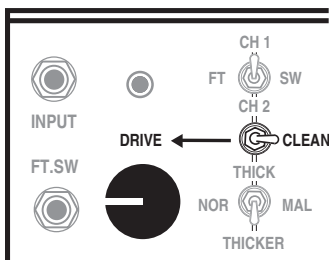

Set to **CLEAN**, all overdrive circuitry is removed and Channel 2 is a slightly higher gain clone of Channel 1. Because of this additional gain in what is otherwise a “rhythm” circuit, Channel 2 is an amazing solo channel for Roots style rhythm work or howling blues solo sounds.

Cranking the GAIN control in Channel 2 **CLEAN** is a wonderful alternative to the more saturated sound of the **DRIVE** circuit.

You will find ample gain to get notes to sound fat and singing, and still retain all of the urgent dynamics of a clean sound that is driven to clip.

FRONT PANEL: Controls & Features *(Continued)*

THICK / NORMAL / THICKER:

This 3 position mini toggle allows you to select between three different voicings. It selects what frequency the Treble control will enhance. By lowering the frequency of the treble capacitor, additional gain in these frequencies is added. This allows you to shape the sound for either sparkling clean sounds, or fatten up the Treble region and thicken the sound for more voice like single note solo sounds. Spend some time experimenting with this switch as it can be crucial to attain the lead sound you are searching for as well as allowing you to cop the vibe of several classic amp styles.

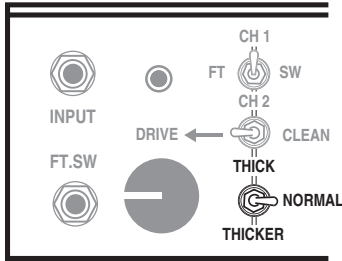

NORMAL is the best choice for clean chording and traditional blues style single note solo sounds. In this position the highest frequencies are passed through with the best balance between the three tone controls gain wise. In other words, the gain of the Treble region is in line with that of the Bass and Mid. Here the most sparkle and shimmer will appear and a beautiful blend will be easy to achieve for all your clean work. The **NORMAL** selection will also let the true character of your individual guitar shine through more than the gain enhanced character of the other two choices.

When searching for identifiable signature sounds, **NORMAL** would be the best choice for traditional "black face" style clean or clipped sounds due to this lack of alteration of the classic treble frequencies.

THICK lowers the frequency of the Treble region while keeping the gain closer to that of the **NORMAL** setting. This selection fattens the upper region and smears the line between Mid and Treble to achieve a more robust, throatier sound. **THICK** is the best choice when searching for classic British style response for either chording or overdriven sounds. You might think of it as a "plexi" switch.

THICKER lowers the Treble frequency even further and adds considerable gain in that region. It can enhance high gain solo work by saturating the sound and covering up fret buzz, weak pickups or other nuances that will appear as holes in a high gain lead sound. It allows you to retain focus at extreme gain settings while at the same time reducing the dreaded buzziness that can appear with certain guitars or speaker choices. This setting has appeared in various clothing on virtually all **MESA** amplifiers through the years and is classic **Boogie**. **THICKER** is the choice for the trademark singing sustain that has long been associated with our amplifiers.

GAIN:

This control adjusts the predominant gain stage in each channel's circuit with the function and taper being optimized for each individual channel. Remember that your **Lone Star Special** is really two amplifiers built onto one chassis, so though each channel looks identical, the **GAIN** control for each channel comes in a different place and adjusts a different point in that channel's circuit.

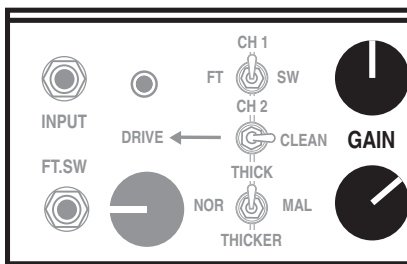

In most guitar amplifiers, and especially in all-tube circuits, the **GAIN** control is the most powerful control in the preamp. It shapes the overall style and character of the sound and is responsible for whether the sound is clean, overdriven or anywhere in between. In your **Lone Star Special** the **GAIN** control is even more powerful. It not only determines the amount of drive, but also acts as an integral part of the tone control string as well.

To simplify the **GAIN** controls' role in shaping the overall tone of the sound we will look at it in two ways - **1)** alone and **2)** in conjunction with the tone controls.

1) By itself the **GAIN** control has basically three tonal regions -

Low (7:00 - 11:00) provides the cleanest, least saturated sounds and in this region the sound will be brighter and contain more upper harmonics lending a three dimensional character to the sound.

Middle (11:15 - 2:00) enhances the saturation and replaces some of the upper harmonics with a richer, warmer quality and a fuller

FRONT PANEL: Controls & Features *(Continued)*

GAIN: *(Continued)*

bottom end response. Not yet fully saturated, this region is the easiest place to get a great sound in both channels. This region contains many of the **Lone Star Special's** best sounds...especially for soloing due to the crucial blend of an expressive attack combined with ample sustain.

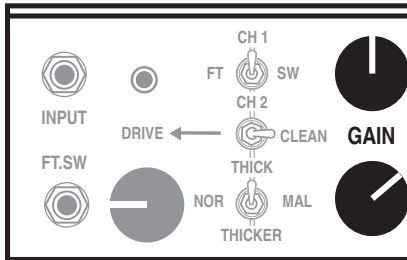

High (2:15 - 5:00) Saturates the signal, enhances and expands low and low mid frequencies. While this region provides the maximum saturation and therefore sustain, it also compresses and softens the attack characteristics. For this reason we suggest using this higher region of the **GAIN** control sparingly and only when maximum sustain is needed.

NOTE: Due to the **Lone Star Special's** extreme gain potential, the highest regions of the **GAIN** control may possibly push the pre-amp tubes past what they can handle, producing microphonic squealing. While we screen and test the tubes your amplifier was shipped with and the tubes in your amp passed our rigorous testing, we can't predict how the tubes

will respond over time exposed to extreme gain settings. Your tubes are warranted for a period of 6 months under normal use, but you can save yourself the present and future inconvenience of having to deal with annoying microphonic tube problems by simply using **a little common sense...Use the Gain sparingly at the higher end of its range!**

If you must for a specific part or at very low volumes, back down the **TREBLE** and **PRESENCE** controls. The **Lone Star Special** was designed to provide amazing gain and tone at less than extreme settings removing the need for you to crank everything all the way up. If you are not able to achieve the sound you want at sensible settings on any or all of the controls, your problem may lie elsewhere in the signal chain, i.e. pick-ups, cabinetry, processing etc. Keep in mind you can always call on one of our product specialist Monday through Thursday and seek some advice should you find yourself struggling to get the sound you want.

2.) GAIN - In conjunction with the Tone Controls - Basically, a simple rule applies...as the Gain is increased the Tone control string has less and less effect on the signal until at 5:00 the signal is so saturated that you are *getting mostly Gain and very little Tone*. Again, this is the reason we suggest using the **GAIN** control in its middle region. Here the Tone control string is very active and provides maximum shaping power - allowing you to dial virtually any sound you desire.

TREBLE:

As in most tube guitar amplifiers, the **TREBLE** control (in both channels of your **Lone Star Special**) is the most powerful of the rotary controls and is next in line only to the **GAIN** control as a shaping tool. Because it is first in the signal path of the tone controls - and from here the Middle and Bass receive their signal - it is by far the dominant tone control. For this reason the setting of the **TREBLE** control is very important for equal representation of the three frequency regions to appear at their respective controls. Like most of the controls on your **Lone Star Special**, there is an optimum region of the **TREBLE** control where ample top end is mixed in and yet enough signal is still passed on to the **MIDDLE** and **BASS** controls.

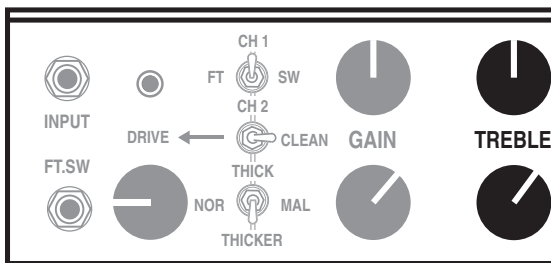

As you might surmise, here is the *sweet spot*. There are definitely great sounds above and below this middle region (11:00 - 1:30), but the balance between

the **TREBLE** control and the other two tone controls is compromised.

The **TREBLE** control can be used to dump extra gain into the mix. This is especially effective in Channel 1 and Channel 2 with the **DRIVE** bypassed. When doing so, use the **PRESENCE** control to roll off some of the more than ample top end for a more compressed feel and fatter voice. As you might surmise, the **BASS** control's effectiveness will be reduced, so you may have to run a much higher setting than you are used to seeing to achieve a balance.

FRONT PANEL: Controls & Features *(Continued)*

MID: The **MID** control is responsible for the blend of midrange frequencies in the mix and though its effect is not as dramatic as that of the **TREBLE** control, it plays an integral part in achieving any sound in your **Lone Star Special**. It is capable of changing the feel dramatically as it blends in a group of frequencies that tend to soften or stiffen the way a sound feels to play.

Most players tend to lean in the direction of lower **MID** control settings (7:00 - 11:00) where a scoop in this region produces *girth* (by letting the Bass become a little more dominant) and a lack of punch lends a more compressed, *even* feel to the strings and therefore

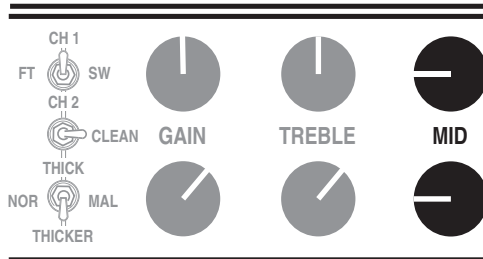

less apparent resistance to the pick. As the **MID** control is increased, (11:30 - 1:30) the sound is rounded-out and filled-in with a focused mid attack appearing rather quickly. As you would guess, the feel starts to change - becoming more resistant. Above this region the **MID** control could be used to compensate for either weaker pick-ups or for times when a specific deficiency is produced by either an extremely high setting of other tone controls, or a physical anomaly in the room. While these **MID** control settings (2:00 - 5:00) can introduce added gain and create enhanced focus, the trade-off will be a stiffer, more forward, less compressed feel.

BASS: The **BASS** control in your new **Lone Star Special** works similarly in both channels in that it determines the amount of low frequencies present in a sound. However, the *style of lows* it mixes in changes from channel to channel. Like the **MID** control, it falls in line signal-wise *after* the **TREBLE** control and the same scheme applies. When the **TREBLE** control is set high, the effectiveness of the **BASS** and **MID** controls is reduced. If the **TREBLE** control is set low these two controls become dominant.

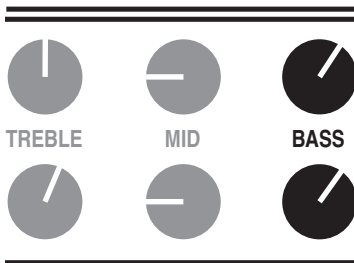

For the most balanced sound and a balance of power between the three rotary tone controls, try to use the **TREBLE** control in its middle ranges. This scenario produces nearly equal representation of all the frequencies on the tone controls and provides a great neutral starting point for further tweaking.

Note: The **BASS** control in both channels of your **Lone Star Special** is very powerful and though we have taken steps to ensure a balanced tone is easy to achieve, it is wise to blend with subtle nuance in mind. This is especially true in Channel 2 when using either the regular Channel 1 style gain circuitry cranked, or the **DRIVE** circuitry for higher gain lead sounds. A good rule to follow is this; as you increase the **GAIN** reduce the **BASS**. Following this scheme will retain balance and keep the attack of the notes dynamic, tight and touch sensitive.

PRESENCE: The **PRESENCE** control is a high frequency attenuator that is placed at the end of each channels pre-amp stage and affects frequencies higher than those of the **TREBLE** control. It acts independently of the other rotary tone controls and is crucial in voicing the Channel. It is a powerful global tone control. Lower **PRESENCE** control settings darken and, in fact compress the signal which works well to fatten single note solo sounds, giving them *girth* and focus.

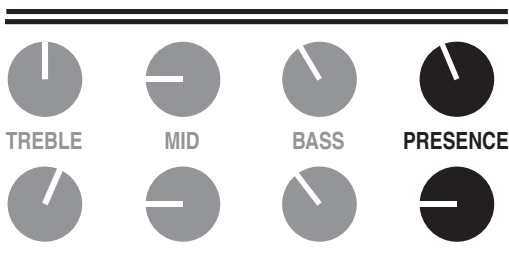

Some of the best lead sounds in your **Lone Star Special** will find the **PRESENCE** control in it's lower regions, where a balanced, vocal response is achieved.

FRONT PANEL: Controls & Features *(Continued)*

MASTER:

This control is the master feed from the end of the pre-amp to the driver stage and the Effects Loop. As you can see each Channel is fitted with its own **MASTER** control, enabling both channels relative volumes to be matched regardless of their extremely different sound styles and gain signatures. The **MASTER** control makes possible a wide range of sounds through its ability to use very low Gain sounds at high volumes and conversely, high Gain sounds at low volumes and everywhere between.

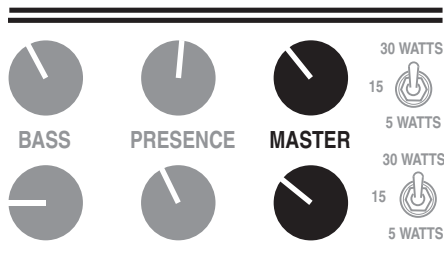

Again, we suggest using the **MASTER** control in its *sensible* ranges (9:00 - 2:00). Here, the channels will be easier to match with each other and the Effects Loop will see more reasonable signal levels.

NOTE: Because the **MASTER** control creates the send to the Effects Loop, extreme settings will cause a large signal to be sent to the Loop for that Channel. Not only may this cause possible overloading of the processors Input stage, but will make balancing both channel's Effect Send level difficult.

NOTE: When the Effects Loop is set to HARD BYPASS, the individual Channel MASTER controls act as the final output controls. This is a result of removing all associated Loop circuitry - and since the OUTPUT and SOLO controls are part of the Effects Return stage - they are bypassed as well.

30 WATTS / 15 / 5 WATTS: Channel Power Select

These channel specific mini toggle switches allow you to preset the output power of each channel. In the 30 watt setting (up) all four EL84s are on line, delivering maximum power and punch. The 15 watt setting runs only the outside (far left & far right) pair of tubes to achieve a bubbly elastic bounce. The 5 watt setting uses 1 x EL84 (far left facing rear) to produce the ultimate low power setting. This powerful feature can be crucial to the sound style you wish to dedicate to each of your two channels.

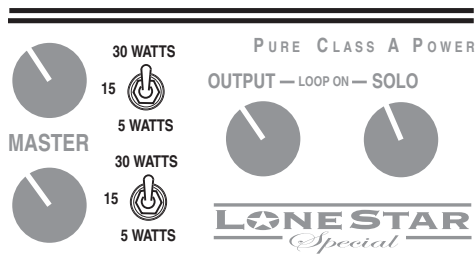

For example you might want to use Channel 1 set to 30 watts and use all four EL's to achieve the ultimate clean headroom and power. Meanwhile, Channel 2 could be cranked and dedicated to a power clip solo sound by setting the power select switch to 15 watts and bypassing the DRIVE circuitry for an awesome old school power section pushed tone.

Or, you might want the opposite and set Channel 1 to 15 watts of sparkling, yet forgiving clean performance and go for the bold authority of 30 watt power for Channel 2 set to a soaring high gain voice using the DRIVE circuitry.

As mentioned earlier in the OVERVIEW, the power tube wiring configuration switches between Push-Pull in the 30 and 15 watt settings and Single-Ended in the 5 watt setting. The class of operation remains pure Class A in all three of the power selections.

Again, Push-Pull circuits are more efficient, producing more power and emphasizing the punchier 3rd harmonic (an octave and a 5th above the notes played) which is preferable for playing with ensembles or recording in complex mixes. The character of the sound with this element of the 3rd harmonic present cuts much better and is tighter and more defined, especially when using the DRIVE circuit for high gain sounds. Single-Ended circuits retain the precious 2nd harmonic (an octave above the notes played) because the waveform is never split into two out-of-phase halves to be later combined in the output transformer (as in push-pull circuits) canceling out the 2nd harmonic. This emphasis of the beautiful 2nd harmonic in a Single-Ended amplifier makes the 5 watt selection the obvious choice for any styles that require a sound rich with delicate nuance. When pushed to clip, this circuit produces a lush smooth overdrive, purring with silkiness that is truly beyond-vintage.

Whatever power scheme you choose to use, the ability to select the power rating of each channel adds incredible footswitching power to the Lone Star. Now the **Lone Star Special** takes this flexibility to an altogether new realm of possibilities for personal expression

FRONT PANEL: Controls & Features *(Continued)*

30 WATTS / 15 / 5 WATTS: Channel Power Select *(Continued)*

offering 3 choices that showcase the two classic wiring configurations per channel!

NOTE: At some point in your experimentation with the Channel Power Select switches, try setting one or both of the Channels to 30W and moving the Speaker Load to the OPTIONAL (8 ohm) jack. This produces a bolder, snappier response and a little more power and headroom that is great for certain applications, especially clean sounds. There is no right way, but the difference in response is definitely worth investigating for both clean and overdriven sounds.

OUTPUT & SOLO CONTROLS:

OUTPUT: This control determines the overall output volume level of the amplifier. After the GAIN controls have been set for the desired sound style and the two channels levels have been balanced with the channel MASTER controls, the **OUTPUT** control allows you to change the playing level by adjusting a single control. The **OUTPUT** control is also wired as the Effects Loop Return Level control. Should you ever use your **Lone Star Special** amplifier as a power amp alone by inserting a signal into the RETURN jack, the **OUTPUT** control will serve as the master level control.

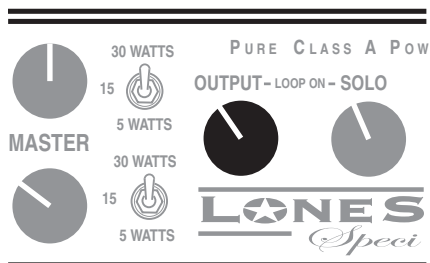

NOTE: To use the **Lone Star Special** amplifier as a power amp - use the **EFFECTS RETURN** as an input. The **SOLO** control can be used to attain a footswitchable boost if the Footswitch is connected. It is wired in parallel to the **OUTPUT** control and therefore also controls the volume of the power section.

NOTE: The Effects Loop **RETURN** jack can serve as a power amp input so that you may use the **Lone Star Special** amplifier as a power amp for either stereo reproduction or to incorporate additional pre-amps. Here are a few things to remember that will help you when interfacing to the **Lone Star Special** for use as a power amp only;

- 1.) The **OUTPUT** Level will be the only active control on the Front Panel (the **PRESENCE** control of Channel 1 will be active only when that channel is engaged - see #2)
- 2.) The **SOLO** control may be used to footswitch to a pre-determined amount of boost when the footswitch is connected.

NOTE: Therefore, we recommend selecting Channel 1 when you wish to use the **Lone Star Special** as a power amp.

SOLO: This control can only be activated if the correct Footswitch is connected to the Footswitch DIN jack. **SOLO** is an additional final output level control wired in parallel with the **OUTPUT** control. It is capable of a setting above that of the **OUTPUT** control and can not be set below. The amount of apparent boost also depends on that of the **OUTPUT** control - in that if the amplifier is at either the extreme low or extreme high levels of the **OUTPUT**, its effectiveness is minimized. It has been optimized for live performance volume levels.

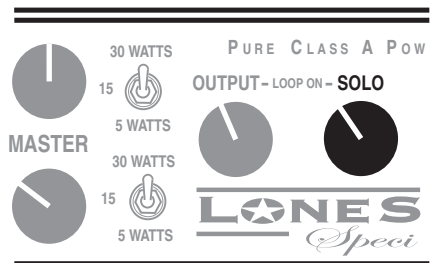

If the power section is either not a part of the sound (super quiet), or producing all its rated wattage (super loud), there is very little signal for the **SOLO** control to work with. By using the Footswitch and selecting **SOLO**, a pre-settable boost in overall levels is possible on the fly...giving you some control over your levels when it's time to step out. Engineers may give you a bit of a frown the first time you use it...but isn't it time you heard yourself. It might even prevent them from punishing you with the dreaded monitor or sidefill version of your tone.

FRONT PANEL: Controls & Features *(Continued)*

POWER ON: This sideways 2 position toggle switch determines the status of the incoming AC power. During power up it is important that you turn the POWER switch on first and allow at least 30 seconds of warm up time for the power tubes before flipping the STANDBY to the ON position.

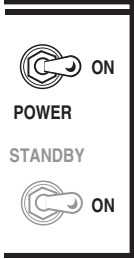

Following this start up procedure will lessen the shock on cold tubes and increase their toneful service life.

STANDBY: Perfect for set breaks... this toggle switch also serves an even more important purpose. In the Standby position the tubes are at idle so that during power up they may warm up before being put to use. Before power is switched on make sure the **STANDBY** switch is in the Standby position.



Wait at least 30 seconds and then flip the **STANDBY** switch to the ON position. This prevents tube problems and increases their toneful life substantially.

Now that we have reviewed the features and controls of the Front Panel and you have a handle on how they interact to achieve the sound *you* want, let's move to the Rear Panel and cover the controls and features found there.

REST AREA



REAR PANEL: Controls & Features

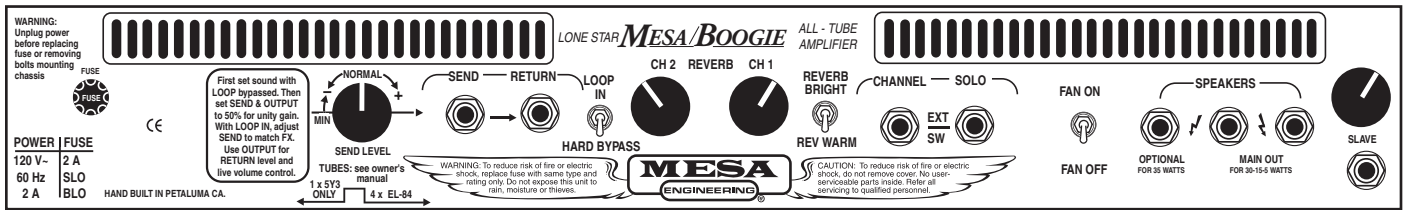

FUSE: This is the A.C.'s (Alternating Current) main fuse and provides protection from outside A.C. fluctuations as well as power tube failure damage. Should the **FUSE** blow, replace it with the same rating in a Slo-Blo type package. The domestic U.S. version requires a 2 amp Slo-Blo **FUSE**. A power tube short or failure is often the cause of a blown **FUSE**...Follow the cold start procedure mentioned in the ON/STANDBY switch section and watch the power tubes as you flip the STANDBY to the ON position. If a power tube is going bad or is arcing you will see it! Flip the STANDBY switch to Standby immediately and replace the faulty power tube and the **FUSE** if necessary.

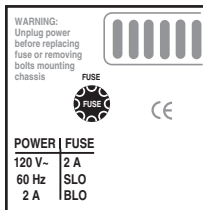

If you see nothing abnormal as you switch the STANDBY on, it is possible that a power tube shorted temporarily and blew the **FUSE**. If this is the case it may work again normally. To be safe, you might want to replace just the adjacent tube or all power tubes in the "shotgun" troubleshooting tradition and save the replaced set as spares. Spare fuses are a must for the fabled cord bag along with your spare tubes. Always carry both for they could be worth their weight in gold someday.

FX LOOP: Series The **Lone Star Special** handles outboard processing by providing an on-board patch point between the preamp and power section. This loop is wired such that the dry signal is in series with the effected (wet) signal. The circuit also incorporates a **SEND LEVEL** control allowing you to fine tune the output of the preamp circuit to match the input sensitivity of your processor (or first processor in a rack system). The **EFFECTS LOOP** circuitry can be completely removed from the signal path with the **HARD BYPASS/LOOP IN** mini toggle. This removes all associated loop circuitry and two tubes from the chain and ensures the purest signal path and maximum sonic performance when outboard processing is not being used. The **SEND** and **RETURN** jacks incorporate switching elements so that you may use the **LOOP IN** selection and activate the Front Panel **OUTPUT** and **SOLO** controls with nothing connected to the Loop.

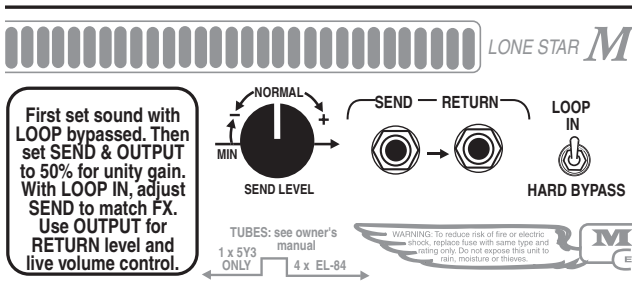

NOTE: The Front Panel **OUTPUT** and **SOLO** controls are both part of the Loop and therefore active only when the Effects Loop is engaged. They are both part of the Return stage and will remain inactive as long as the loop bypass mini toggle is set to **HARD BYPASS**.

To connect your outboard processor(s) to the Effects Loop;

- 1.) Connect the **SEND** jack on the **Lone Star Special** Rear Panel to your processor's INPUT using a high quality shielded cable of the shortest possible length.
- 2.) Connect the **RETURN** jack of the **Lone Star Special** to your processor's OUTPUT also using a high quality shielded cable of the shortest possible length.
- 3.) Adjust the **SEND LEVEL** control on the Rear Panel of the **Lone Star Special** to achieve an adequate match on the INPUT level indicator of your processor. Adjust the processor Output level stage (hopefully your processor has an OUTPUT LEVEL control) to

REAR PANEL: Controls & Features (Continued)

FX LOOP: Series (Continued) match the volume present before connecting the device(s) to the **Lone Star Special**. You can check this by simply removing both the cables from the **SEND** and **RETURN** simultaneously.

4.) Use the Front Panel OUTPUT control to raise and lower the overall volume as it is essentially an Effects Return Stage volume control.

NOTE: It is normal to experience some amount of change to the sound when using the **EFFECTS LOOP**. Normally this is minimal and most often appears as a subtle roll off in top end characteristics. This is a series loop and therefore the results you get using it greatly depend upon the quality of the devices you insert into the loop. We strongly suggest taking your amplifier and trying any processor before buying it to make sure it is compatible with the **Lone Star Special**. Normally, the more professional series lines of most companies building outboard gear work well. However we have seen even so called pro stuff produce less than satisfactory results in terms of tonal thievery.

NOTE: Engaging the **EFFECTS LOOP** circuitry adds a substantial amount of circuitry and two tubes and this additional circuit reverses the phase of the entire amp. This is no cause for alarm and if we hadn't told you of this, you probably would never have known. Sonically there is no difference other than the incredibly subtle difference in the sound the circuit itself adds.

The only time you will ever need to consider this reversal of overall phase is if you ever run the **Lone Star Special** in Stereo with another amp (not another **Lone Star Special** as it would be in phase with its Loop activated). In this case you would probably want to separate the two amplifiers by at least a few feet if not on the other side of the stage.

REVERB: The **Lone Star Special** incorporates a stunning analog Reverb circuit that is fitted with individual Channel Mix controls and a unique Reverb Voicing feature that offers a choice between two classic reverb sounds.

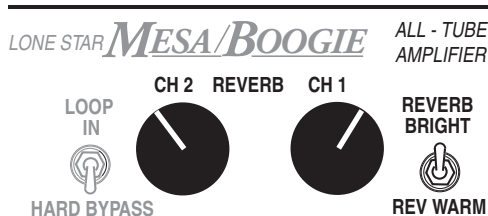

REVERB BRIGHT produces a vintage guitar amp style brighter sound filled with canyons of harmonics and the classic spring resonance, while **REV WARM** features a smoother, warmer character often associated with large plate studio reverbs. You will quickly see why we think the **Lone Star Special** Reverb is possibly our best reverb to date. *Enjoy!*

CHANNEL / SOLO: External Switch Jacks & FAN ON/OFF Switch **CHANNEL / SOLO:** These two 1/4" jacks provide an interface for remote control of the Channel Select function as well as activation of the SOLO control. These jacks may be connected to an external control unit that stores a grounding logic switch function under a midi program number, thereby removing the need to use the included **Lone Star Special** Footswitch in larger stage rigs.

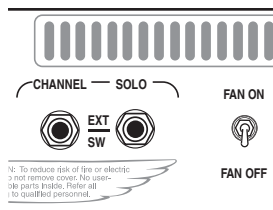

The **EXTERNAL SWITCH** jacks respond to any tip-to-ground latching type logic for their triggering. This type of switching logic can be found on most midi master control switching units on the market.

FAN ON/OFF: This mini toggle switch defeats the onboard cooling fan.

WE RECOMMEND LEAVING THE FAN ON AT ALL TIMES. It may be switched off for short periods if its noise compromises a recording environment.

REAR PANEL: Controls & Features (Continued)

SPEAKER:

The **Lone Star Special** provides one **OPTIONAL / 35 WATTS (8 ohm)** and two **MAIN /30-15-5 (4 ohm)** speaker outputs and this enables you to use many different combinations of speaker setups. The **MAIN** jack is preferred for most vintage inspired sounds where a smoother, warmer character will be noted in all three power selections and an impedance correct match will be achieved for the 15 and 5 watt selections and a slight mismatch will occur in the 30 watt setting where maximum power will be about 30 watts. Using the **OPTIONAL** jack will produce a correct match for the 30 watt selection boosting overall power to about 35 watts and producing a slight mismatch in the 15 and 5 watt settings (which is fine and may be preferable) giving all three selections a little more punch in the midrange frequencies.

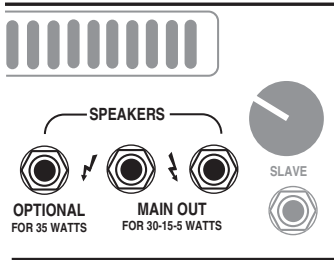

The 1x12 combo uses an 8 ohm speaker while the 2 x 12 combo uses two 16 ohm speakers wired in parallel and this harness connects to the **OPTIONAL (8 ohm)** speaker output. You should experiment with different loading conditions as there may be a certain impedance mismatch that produces a sound you may prefer to the correct load condition. This will not hurt the amplifier,

however mismatching a lower impedance speaker in a higher jack will wear the power tubes faster. There are sample speaker wiring diagrams later in this manual. You may find it beneficial to browse this section to understand more about different ways you can use your **Lone Star Special** with alternate speaker combinations. We build many different types of Extension Speaker Cabinets, all with unique characteristics, as well as a line of matching *Classic* cabinets to enhance both the sound and the appearance of your new **Lone Star Special**.

SLAVE:

The **SLAVE** Output and its accompanying Level control provide an output for capturing the sound of both preamp and power section. This feature may be used to drive additional slave power amplifiers for big venue applications or to drive a string of outboard processors when using the **EFFECTS LOOP** is not desirable. It is not a direct recording output as it derives its signal from the speaker jacks and is much too strong a signal to connect to the input of a console. Also there is no roll off of high frequencies or shaping, as the speaker does this, so the sound would be less than desirable for recording applications. Should you need a direct recording sound, check out one of our Rectifier Recording Preamp's which are designed specifically for this application and has the necessary circuitry to achieve this difficult task with stunning results.

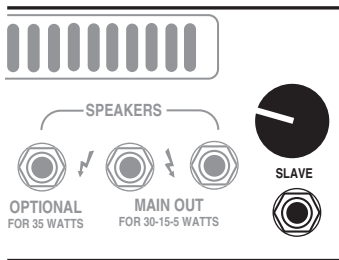

NOTE: The signal from the **SLAVE** Output is powerful. Always start with the **LEVEL** control set to its lowest position (7:00) when connecting to anything and bring the level up slowly to avoid damaging gear (and ears) downstream of the **Lone Star Special**.

NOTE: Once a signal has been taken from the **SLAVE** Output, it can not be routed back into the amplifier (**INPUT** or **EFFECTS LOOP RETURN**). Doing so will produce a feedback loop resulting in a high pitched squeal much like holding a microphone up to a monitor.

REVERB REMOTE JACK:

The Reverb feature contains a **REMOTE SWITCH JACK** that allows you to control the Reverb effect from a separate footswitch. The 1/4" jack is located on the underside of the chassis just below where the **SLAVE** jack is located on the extreme right side of the Back Panel. Connecting any tip-to-ground, latching-type footswitch will allow you to toggle on and off the Reverb effect. Use a shielded cable for this application. You should be able to find this type of footswitch at most music stores or, you can call our Customer Service department and order one for a nominal charge.

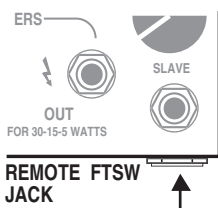

If you have any questions or concerns unanswered in this guide, please feel free to call our Customer Service department and ask for a Product Specialist who will be glad to help you get the answers you need.
Cheers and Enjoy!

FACTORY SAMPLE SETTINGS

SAMPLE # 1 LONESTAR STATE

Control panel for **SAMPLE # 1 LONESTAR STATE**. The panel includes the following settings:

- INPUT:** FT.SW (top)
- DRIVE:** FT SW (top), CH 2 CLEAN THICK (middle), NOR MAL THICKER (bottom)
- GAIN:** 10 o'clock
- TREBLE:** 12 o'clock
- MID:** 10 o'clock
- BASS:** 10 o'clock
- PRESENCE:** 10 o'clock
- MASTER:** 10 o'clock
- Power:** 30 WATTS (top), 5 WATTS (middle), 30 WATTS (bottom), 5 WATTS (bottom)
- OUTPUT:** LOOP ON - SOLO (middle)
- POWER:** ON (top), STANDBY (bottom)

SAMPLE # 2 CLEAN CLONES

Control panel for **SAMPLE # 2 CLEAN CLONES**. The panel includes the following settings:

- INPUT:** FT.SW (top)
- DRIVE:** FT SW (top), CH 2 CLEAN THICK (middle), NOR MAL THICKER (bottom)
- GAIN:** 10 o'clock
- TREBLE:** 12 o'clock
- MID:** 10 o'clock
- BASS:** 10 o'clock
- PRESENCE:** 10 o'clock
- MASTER:** 10 o'clock
- Power:** 30 WATTS (top), 5 WATTS (middle), 30 WATTS (bottom), 5 WATTS (bottom)
- OUTPUT:** LOOP ON - SOLO (middle)
- POWER:** ON (top), STANDBY (bottom)

SAMPLE # 3 TWANG & BANGIN'

Control panel for **SAMPLE # 3 TWANG & BANGIN'**. The panel includes the following settings:

- INPUT:** FT.SW (top)
- DRIVE:** FT SW (top), CH 2 CLEAN THICK (middle), NOR MAL THICKER (bottom)
- GAIN:** 10 o'clock
- TREBLE:** 12 o'clock
- MID:** 10 o'clock
- BASS:** 10 o'clock
- PRESENCE:** 10 o'clock
- MASTER:** 10 o'clock
- Power:** 30 WATTS (top), 5 WATTS (middle), 30 WATTS (bottom), 5 WATTS (bottom)
- OUTPUT:** LOOP ON - SOLO (middle)
- POWER:** ON (top), STANDBY (bottom)

SAMPLE # 4 PURR & GRIND

Control panel for **SAMPLE # 4 PURR & GRIND**. The panel includes the following settings:

- INPUT:** FT.SW (top)
- DRIVE:** FT SW (top), CH 2 CLEAN THICK (middle), NOR MAL THICKER (bottom)
- GAIN:** 10 o'clock
- TREBLE:** 12 o'clock
- MID:** 10 o'clock
- BASS:** 10 o'clock
- PRESENCE:** 10 o'clock
- MASTER:** 10 o'clock
- Power:** 30 WATTS (top), 5 WATTS (middle), 30 WATTS (bottom), 5 WATTS (bottom)
- OUTPUT:** LOOP ON - SOLO (middle)
- POWER:** ON (top), STANDBY (bottom)

FACTORY SAMPLE SETTINGS

SAMPLE # 5 PASS THE SAUCE

Control panel for SAMPLE # 5 PASS THE SAUCE. The panel includes the following settings:

- INPUT: CH 1 selected
- FT.SW: OFF
- DRIVE: OFF
- CLEAN: CH 1 selected
- GAIN: 10 o'clock
- TREBLE: 12 o'clock
- MID: 10 o'clock
- BASS: 10 o'clock
- PRESENCE: 10 o'clock
- MASTER: 10 o'clock
- 30 WATTS: 30 WATTS selected
- 15 WATTS: OFF
- 5 WATTS: OFF
- 30 WATTS: 30 WATTS selected
- 15 WATTS: OFF
- 5 WATTS: OFF
- PURE CLASS A POWER: ON
- OUTPUT - LOOP ON - SOLO: LOOP ON selected
- POWER: ON
- STANDBY: ON

SAMPLE # 6 BARBEQUE

Control panel for SAMPLE # 6 BARBEQUE. The panel includes the following settings:

- INPUT: CH 1 selected
- FT.SW: OFF
- DRIVE: OFF
- CLEAN: CH 1 selected
- GAIN: 10 o'clock
- TREBLE: 12 o'clock
- MID: 10 o'clock
- BASS: 10 o'clock
- PRESENCE: 10 o'clock
- MASTER: 10 o'clock
- 30 WATTS: 30 WATTS selected
- 15 WATTS: OFF
- 5 WATTS: OFF
- 30 WATTS: 30 WATTS selected
- 15 WATTS: OFF
- 5 WATTS: OFF
- PURE CLASS A POWER: ON
- OUTPUT - LOOP ON - SOLO: LOOP ON selected
- POWER: ON
- STANDBY: ON

SAMPLE # 7 AUSTIN - TACEOUS

Control panel for SAMPLE # 7 AUSTIN - TACEOUS. The panel includes the following settings:

- INPUT: CH 1 selected
- FT.SW: OFF
- DRIVE: OFF
- CLEAN: CH 1 selected
- GAIN: 10 o'clock
- TREBLE: 12 o'clock
- MID: 10 o'clock
- BASS: 10 o'clock
- PRESENCE: 10 o'clock
- MASTER: 10 o'clock
- 30 WATTS: 30 WATTS selected
- 15 WATTS: OFF
- 5 WATTS: OFF
- 30 WATTS: 30 WATTS selected
- 15 WATTS: OFF
- 5 WATTS: OFF
- PURE CLASS A POWER: ON
- OUTPUT - LOOP ON - SOLO: LOOP ON selected
- POWER: ON
- STANDBY: ON

































SAMPLE # 8 ARMADILLO

Control panel for SAMPLE # 8 ARMADILLO. The panel includes the following settings:

































- INPUT: CH 1 selected
- FT.SW: OFF
- DRIVE: OFF
- CLEAN: CH 1 selected
- GAIN: 10 o'clock
- TREBLE: 12 o'clock
- MID: 10 o'clock
- BASS: 10 o'clock
- PRESENCE: 10 o'clock
- MASTER: 10 o'clock
- 30 WATTS: 30 WATTS selected
- 15 WATTS: OFF
- 5 WATTS: OFF
- 30 WATTS: 30 WATTS selected
- 15 WATTS: OFF
- 5 WATTS: OFF
- PURE CLASS A POWER: ON
- OUTPUT - LOOP ON - SOLO: LOOP ON selected
- POWER: ON
- STANDBY: ON

PERSONAL SETTINGS SHEET

































SETTING # 1 _____

 INPUT										
 FT.SW										
								PURE CLASS A POWER OUTPUT - LOOP ON - SOLO		
										
										
										
										
										
										

































SETTING # 2 _____

 INPUT										
 FT.SW										
								PURE CLASS A POWER OUTPUT - LOOP ON - SOLO		
										
										
										
										
										
										

































SETTING # 3 _____

 INPUT										
 FT.SW										
								PURE CLASS A POWER OUTPUT - LOOP ON - SOLO		
										
										
										
										
										
										

SETTING # 4 _____

 INPUT										
 FT.SW										
								PURE CLASS A POWER OUTPUT - LOOP ON - SOLO		
										
										
										
										
										
										

SETTING # 5 _____

 INPUT										
 FT.SW										
								PURE CLASS A POWER OUTPUT - LOOP ON - SOLO		
										
										
										
										
										
										

TUBE NOISE & MICROPHONICS

You may occasionally experience some form of tube noise or microphonics. Certainly no cause for alarm, this quirky behavior comes with the territory and the Tone. Much like changing a light bulb, you don't need a technician to cure these types of minor user serviceable annoyances and in fact, you'll be amazed at how easy it is to cure tube problems... by simply swapping out a pre-amp or power tube!

First may we suggest that you set the amplifier up on something so that you can get to the tubes comfortably without having to bend down. It also helps to have adequate lighting as you will need to see the tube sockets clearly to swap tubes. Use caution and common sense when touching the tubes after the amplifier has been on as they may be extremely hot! If they are hot and you don't want to wait for them to cool off, try grasping them with a rag and also note that the glass down around the bulbous silvery tip is considerably less hot which makes it easier to handle. Gently rock the tube back and forth as you pull it away from its socket.

DIAGNOSING POWER TUBE FAILURES:

There are two main types of tube faults: shorts and noise. Both large and small tubes may fall prey to either of these problems but diagnosis and remedy is usually simple.

If a fuse blows, the problem is most likely a shorted power tube and shorts can either be mild or severe. In a mildly shorted tube the electron flow has overcome the control grid and excess current flows to the plate. You will usually hear the amp become distorted and begin to hum slightly. If this occurs, quickly look at the power tubes as you switch the amp to STANDBY and try to identify one as glowing red hot. It is likely that two of a pair will be glowing since the "shorted" tube will pull down the bias for its adjacent mates, but one tube may be glowing hotter — and that one is the culprit. The other two are often fine — unless they've been glowing bright red for several minutes.

Because there is no physical short inside the tube (just electrons rioting out of control) merely switching to STANDBY for a few moments then back to ON will usually cure the problem...at least temporarily. Watch the tubes carefully now. Should the problem recur, the intermittent tube will visibly start to over heat before the others and thus it can be identified. It should be replaced with one from the same color batch, shown on its label. Call us and we will send one out to you.

The severe short is not nearly so benign. In the worst cases, a major arcing short occurs between the plate and the cathode with visible lightning inside the glass and a major noise through the speaker. If this is seen to happen, IMMEDIATELY turn the amp to STANDBY. By this time the fuse probably will have blown. Such a short is usually caused by a physical breakdown inside the tube including contaminate coming loose or physical contact (or near contact) between the elements. Replace it and the fuse with the proper slo-blo type and power up the amp using the power up procedure as we described earlier in this manual.

TUBE NOISE:

Often caused by contamination within a tube, the culprit can usually be identified, and by lightly tapping on the glass, you will probably hear the noise change. Hearing some noise through the speakers while tapping on the 12AX7's is normal however. And the one nearer the INPUT will always sound louder because its output is being further amplified by the second 12AX7.

The power tubes should be all but quiet when they are tapped. If crackling or hissing changes with the tapping, you have probably found the problem. To confirm a noisy power tube, merely put the **Lone Star Special** on Standby, remove it from its socket and turn it back on. It will cause no damage to run the **Lone Star Special** briefly with one power tube missing. You may notice a slight background hum, however, as the push-pull becomes unbalanced. Whenever you are trying to diagnose a suspect tube, keep your other hand on the POWER and STANDBY switches ready to shut them off instantly in the unlikely case you provoke a major short.

If you think you've located a problem tube but aren't sure, we recommend substituting the suspect with a new one just to be sure of your diagnoses. You will be doing yourself and us a big favor by just following the simple guidelines previously mentioned regarding tube replacement. You'll probably be successful with much less effort than is required to disconnect everything and haul the unit to a technician who will basically perform the same simple tests. If the tubes are still within their six-month warranty period, we will happily send you a replacement. Just note the color designation on the tube label so that we can send you the appropriate match.

DIAGNOSING PRE-AMP TUBE PROBLEMS:

Because your amplifier is an all tube design, it is quite possible that you will at some point experience minor pre-amp tube noise. Rest assured - this is no cause for alarm and you can take care of the problem yourself in a matter of minutes by simply swapping tubes.

Let us begin by saying; It is a "very good" idea to keep at least a couple of spare pre-amp tubes on hand at all times to insure uninterrupted performance. These minor pre-amp tube problems can take many forms but can generally be described in two categories: Noise and Microphonics. Noise can be in the form of crackling, sputtering, white noise/hiss and/or hum. Microphonic problems usually appear in the form of a ringing or high pitched squealing that gets worse as the gain or volume is increased thus are more noticeable in the higher gain "HI" modes. Microphonic problems are easily identified because the problem is still present even with the instruments' volume off or unplugged altogether - unlike pick-up feedback which ceases as the instrument is turned down. Microphonic noise is caused by mechanical vibration and shock: think of banging a microphone around and you'll understand where the word came from.

The best way to approach a pre-amp tube problem is to see if it occurs only in one specific mode or channel. This should lead you to the tube needing replacement. Then all that remains is to swap the suspect tube for a known good performer.

If you cannot narrow down the trouble to a specific mode or channel, the problem may be the small tube that drives the power tubes which is operational in all modes and channels. Though rare, a problem with the driver tube would show up in all aspects of performance - so if you can't narrow the problem down to being mode or channel specific, you may want to try replacing the driver tube. Driver problems generally show themselves in the form of crackling or hum in all modes of performance and/or weak overall output from the amplifier. Occasionally an anemic driver tube will cause the amplifier to sound flat and lifeless, but this is somewhat uncommon, as worn power tubes are a more likely suspect for this type of problem.

Sometimes making the diagnosis is more trouble than it's worth and it's faster and easier to merely replace the small pre-amp tubes ONE AT A TIME with a replacement known to be good. But MAKE SURE you keep returning the tubes to their original socket until you hit the one that cures the problem. You'll notice that tubes located nearer to the INPUT jack always sound noisier...but this is because they are at the start of the chain and their noise gets amplified over and over by the tubes that follow. The tube that goes into this "input socket" (usually labeled V1) needs to be the least noisy of the bunch. The tube that goes at the end of the preamp chain - just ahead of the power tubes - can be quite noisy without causing any problem at all. The tubes in your amp have already been located in the most appropriate sockets and this is why you should NEVER pull them all out at once and ALWAYS swap them one at a time. ALWAYS return a perfectly good tube to its original socket. Also it's a good idea to put the amp on STANDBY when swapping tubes to reduce the heat build up in the tubes themselves and to prevent explosive noises (which can still occur even if you are pulling the tubes away from their sockets gently) from coming through the speaker.

Remember, take your time, be patient and chances are real good that you can fix your amp yourself by finding and replacing the bad tube. It kills us to see someone who has shipped their amp back to us...and all it needed was a simple tube replacement! If you must send back your amp, unplug the power cord, speaker and reverb cables then remove the chassis from the cabinet by unscrewing the four mounting bolts on top. The chassis then slides back like a drawer and comes out. Remove the big power tubes and mark them according to their location from left to right 1, 2 etc. They need to be wrapped separately with plenty of wadded up newspaper around them and put in a smaller box within the larger carton.

To wrap the chassis, use plenty of tightly wadded up newspaper so there is at least six inches of "crush space" between the chassis and the cardboard box. Bubble wrap also works well, but please DON'T use styrene peanuts - they will shift during transit and get lodged inside your electronics as well as allowing your amp to end up at the bottom of the box unprotected and possibly damaged. Pre-amp tubes don't normally wear out as a rule.

Therefore, it is not a good idea to change them just for the sake of changing them. If there isn't a problem - don't fix it. If there is no result from your substitutions, it may be possible that you have more than one problematic tube. Though rare, this does happen and though it makes the troubleshooting process a little more intimidating, it is still possible to cure the problem yourself.

NOTE: *It is normal to hear a slight metallic ringing sound when tapping on the preamp tubes. As long as the tube does not break into oscillation or start crackling or any other form of bizarre noise, it is considered normal and functional.*

LONE STAR SPECIAL

TUBE TASK CHART

NOTE: POWER TUBES ARE HOT ! BEFORE CHANGING TUBES TURN POWER SWITCH TO OFF AND LET COOL OR USE A RAG FOR PROTECTION.

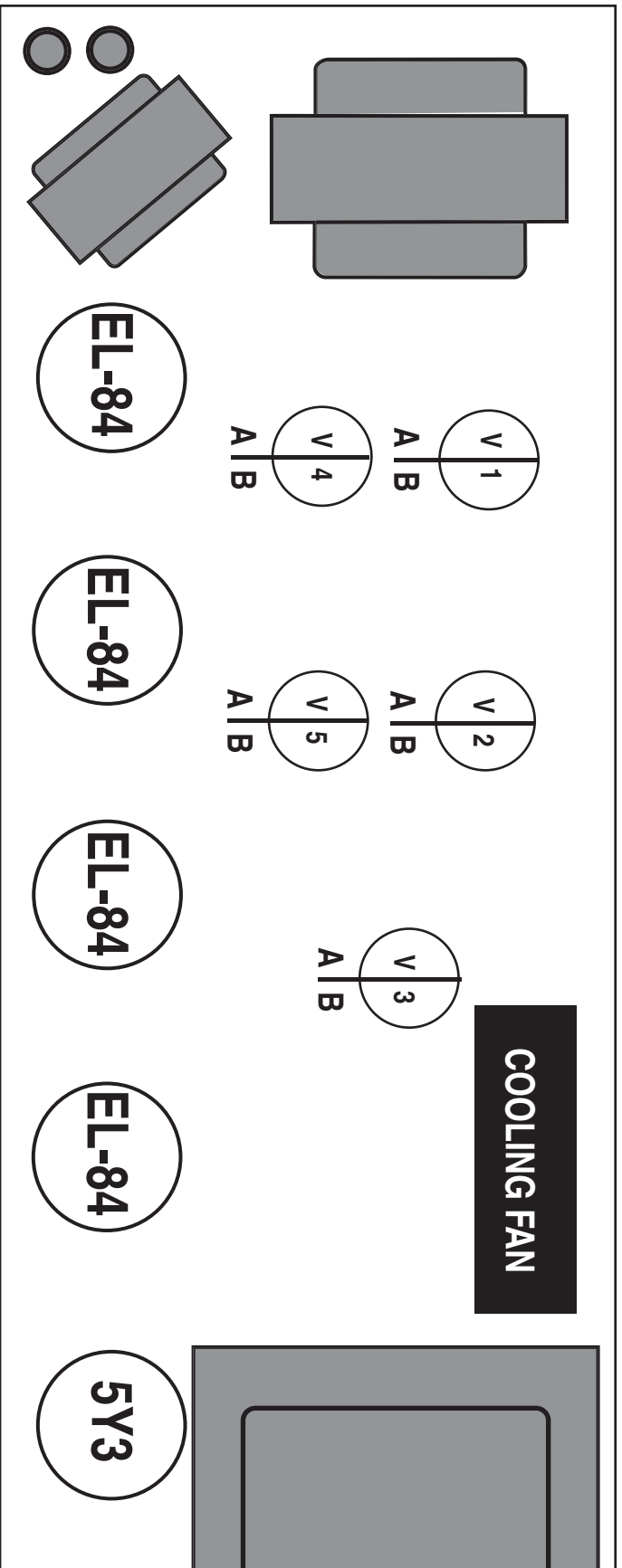

→ RCA Jacks for Reverb

REAR OF CHASSIS - viewing chassis from its bottom side

Description of Tube Functions

- | | |
|-------------------------|-------------------------|
| V1 A = CH2 Drive Stage | V3 B = FX Loop Return |
| V1 B = Input Gain Stage | V4 A = Reverb Return |
| V2 A = 3rd Gain Stage | V4 B = Reverb Drive |
| V2 B = 2nd Gain Stage | V5 A = Phase inv/driver |
| V3 A = FX Loop Send | V5 B = Phase inv/driver |

SPEAKER IMPEDANCE MATCHING & HOOK-UP GUIDE:

IMPEDANCE: Wiring up speakers to provide the most effective load and making sure that all of them are in phase will help in creating the best sound possible. This is not too difficult, as long as you understand a few things about loading and how to connect your speakers to provide an optimal resistive load.

MESA/Boogie amplifiers can handle 4 and 8 ohms effectively. Never run below 4 ohms in a tube amplifier unless you are absolutely certain that the system can handle it properly; this can cause damage to the Output transformer. A few amplifiers can handle 2 ohms effectively without damaging them (for example the *MESA's Bass 400+*). You can always have a higher resistance (16 ohms, for example) without damaging results, but too low of a resistance will likely cause problems.

MIS-MATCHING: When running a higher resistance (for example: 8 ohm output into 16 ohm cabinet), a slightly different feel and response will be eminent. A slight mismatch can provide a darker smoother tone with a little less output and attack. This response is a result of the amplifier running a bit cooler. Sometimes when using more than one cabinet a mismatch will be the only option.

WHAT IS MY CABINETS IMPEDANCE: If you have only a single speaker, you just match that single speakers impedance to the amplifier, and you are done. In many cases, you will have a number of speakers, and then you must calculate the "load" that the amplifier will need to support. There are generally three ways to wire multiple speakers together. They are as follows:

SERIES: When you wire (hook-up) speakers in Series, the speakers resistance (as measured in ohms) is additive - i.e. putting two 8 ohm speakers in Series results in a 16 ohm load.

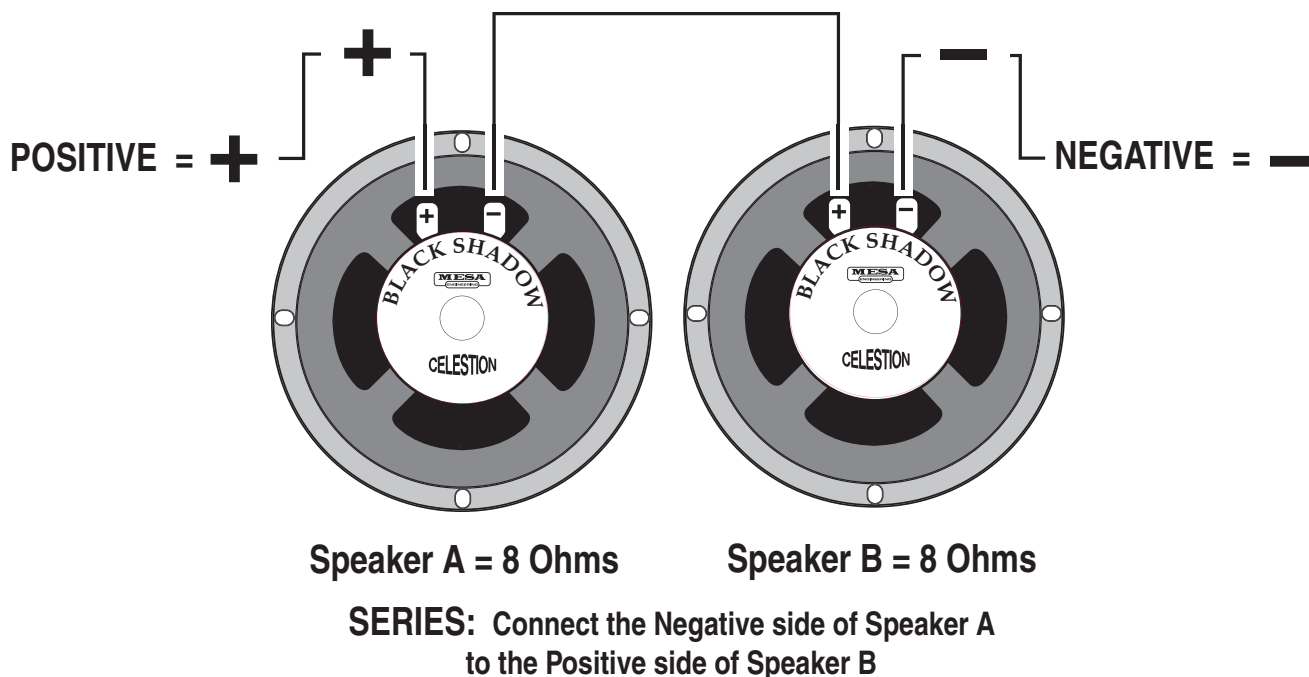

SPEAKER IMPEDANCE MATCHING & HOOK-UP GUIDE: (Continued)

PARALLEL: When wiring in parallel, the resistance of the speakers decreases. Two 8 ohm speakers wired in (hooked-up) Parallel results in a 4 ohm load. It's easy to calculate the effect of a resistive load when all the speakers are all the same resistance. It is really not suggested to wire different resistive load values in Parallel (8 and 4, 16 and 8 etc.) The formula for figuring the total impedance in Parallel is the multiplication of the two loads divided by the sum of the two loads - i.e. putting two 8 ohm speakers in Parallel results in a 4 ohm load. Connect the Positive side of Speaker A to the Positive side of Speaker B - Connect the Negative side of Speaker A to the Negative side of Speaker B.

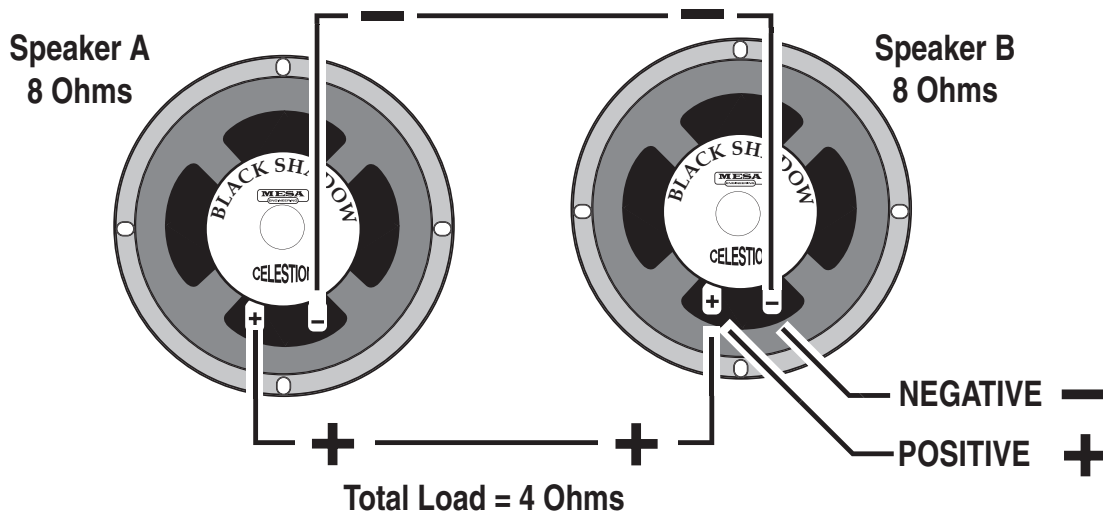

COMBINATION OF SERIES & PARALLEL: This is really just two sets of Series wired speakers connected in Parallel. This is how you maintain a consistent load with multiple speakers. The importance of this is more evident when you have more than one cabinet to connect to your amplifier. This is when you need to figure out the loads and how to wire them up without applying too low of a resistance on the amplifier.

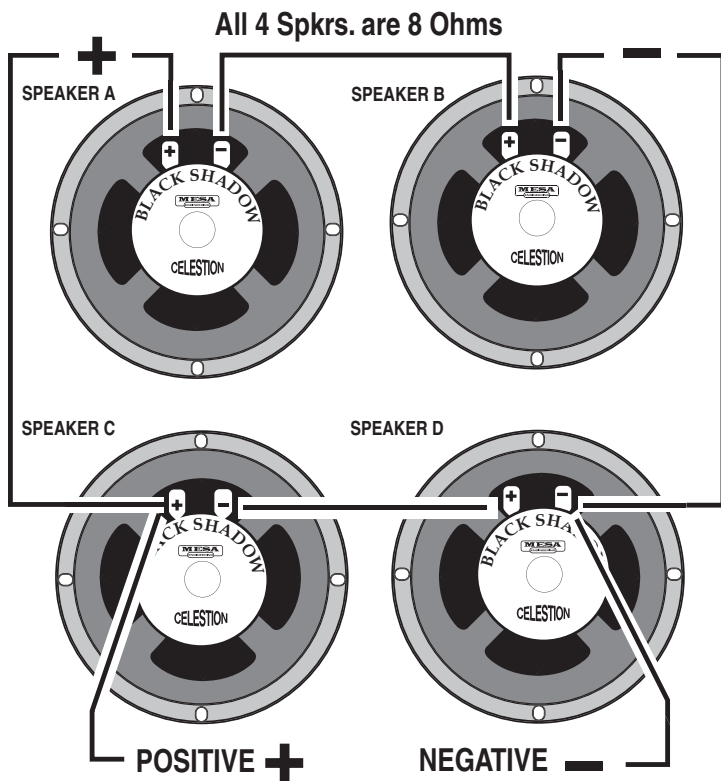

Simply connect the Positive side of Speaker A to the Positive side of Speaker C.

Connect the Negative side of Speaker A to the Positive side of Speaker B. Next, connect the Negative side of Speaker C to the Positive side of Speaker D.

And lastly, connect the Negative side of Speaker B to the Negative side of Speaker D.

4 Eight (8) Ohm speakers wired in Series Parallel = a Total Load of 8 Ohms.

WIRING SCHEMES...Amplifier to Speaker Cabinets

1

2

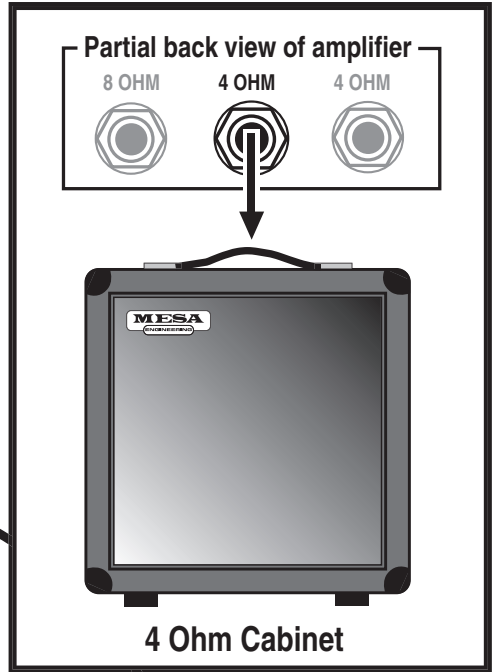
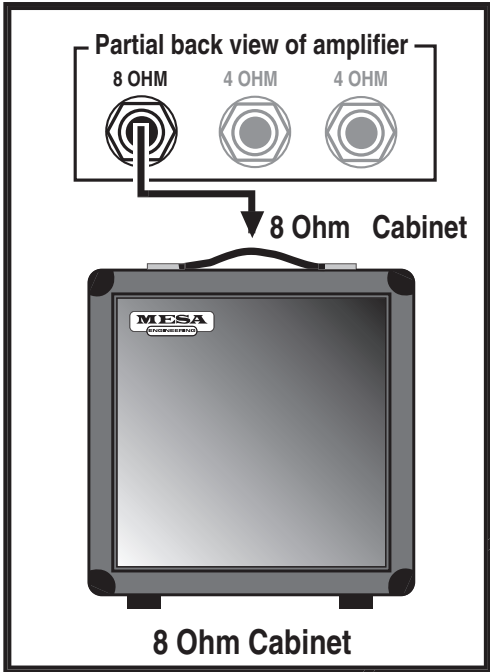

3

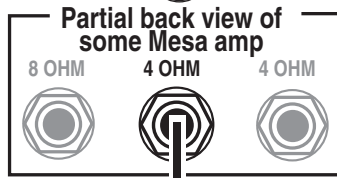

4

5

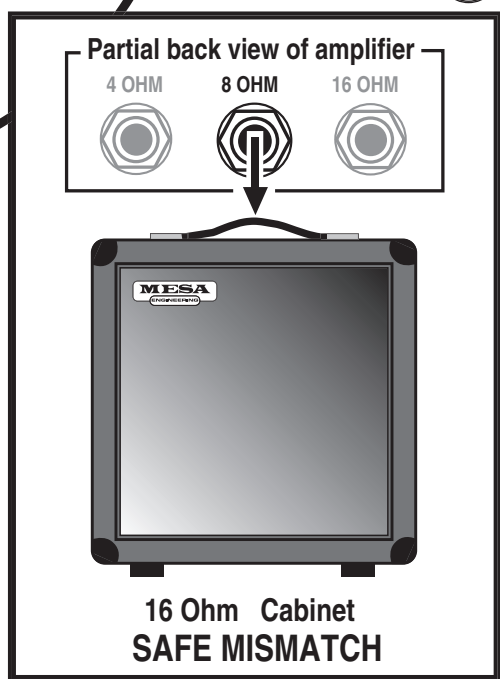
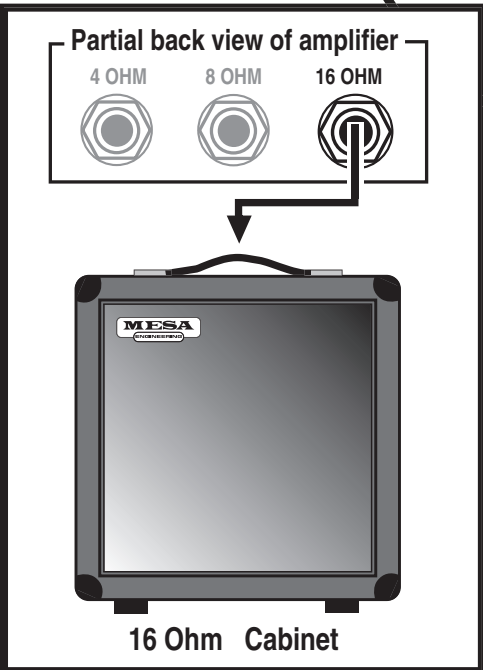

WIRING SCHEMES...Amplifier to Speaker Cabinets

6

7

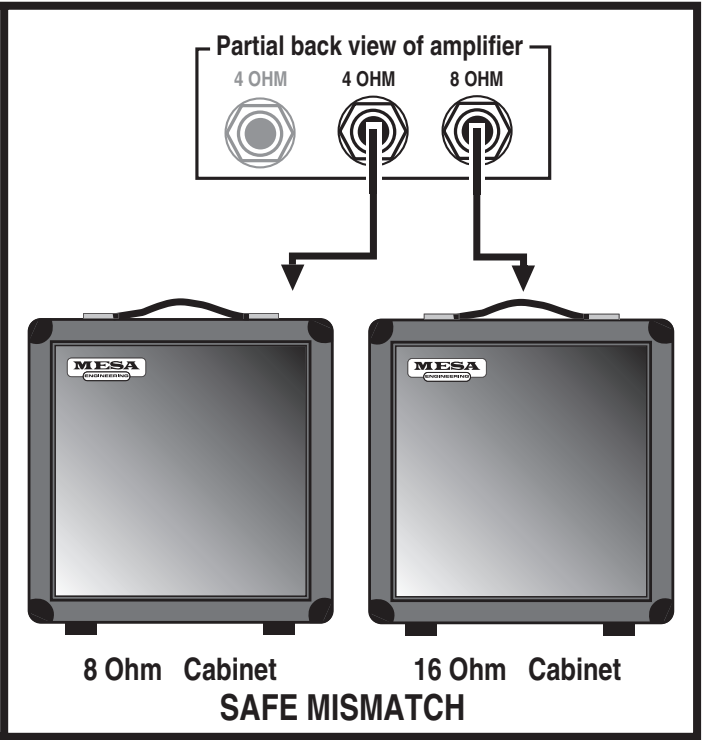
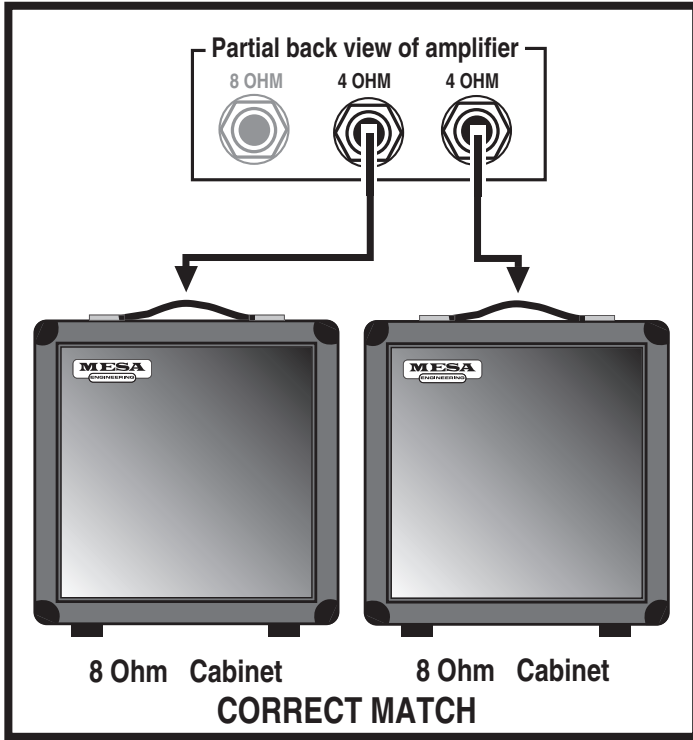

8

9

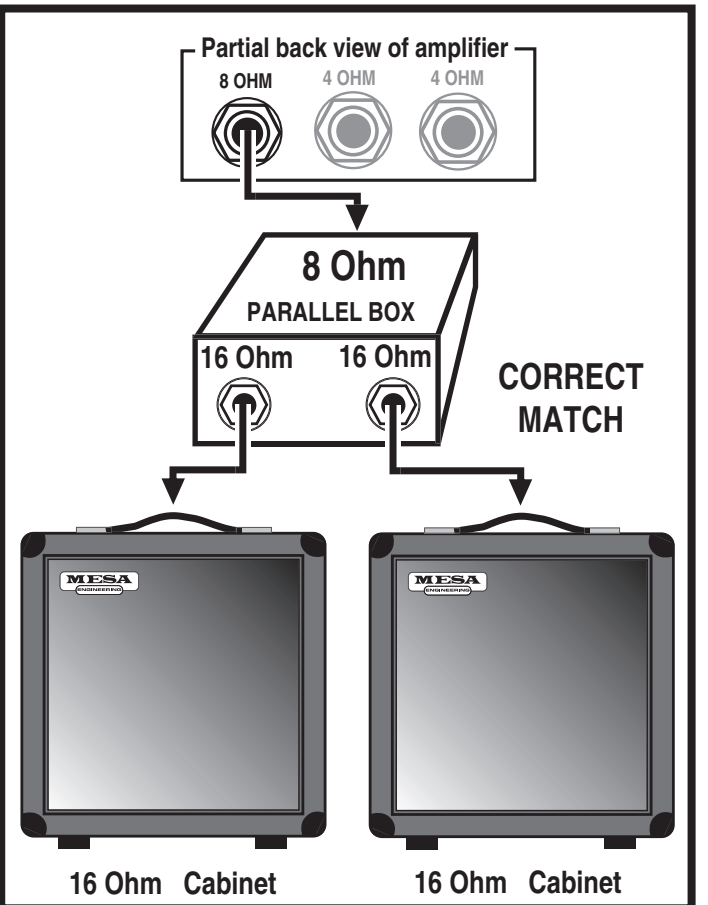
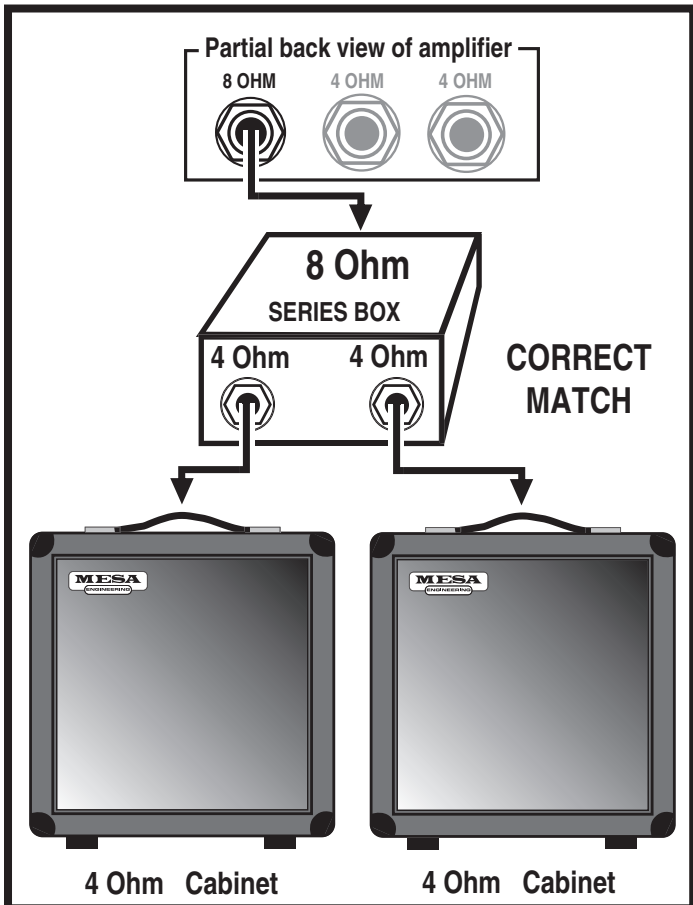

WIRING SCHEMES...Amplifier to Speaker Cabinets

10

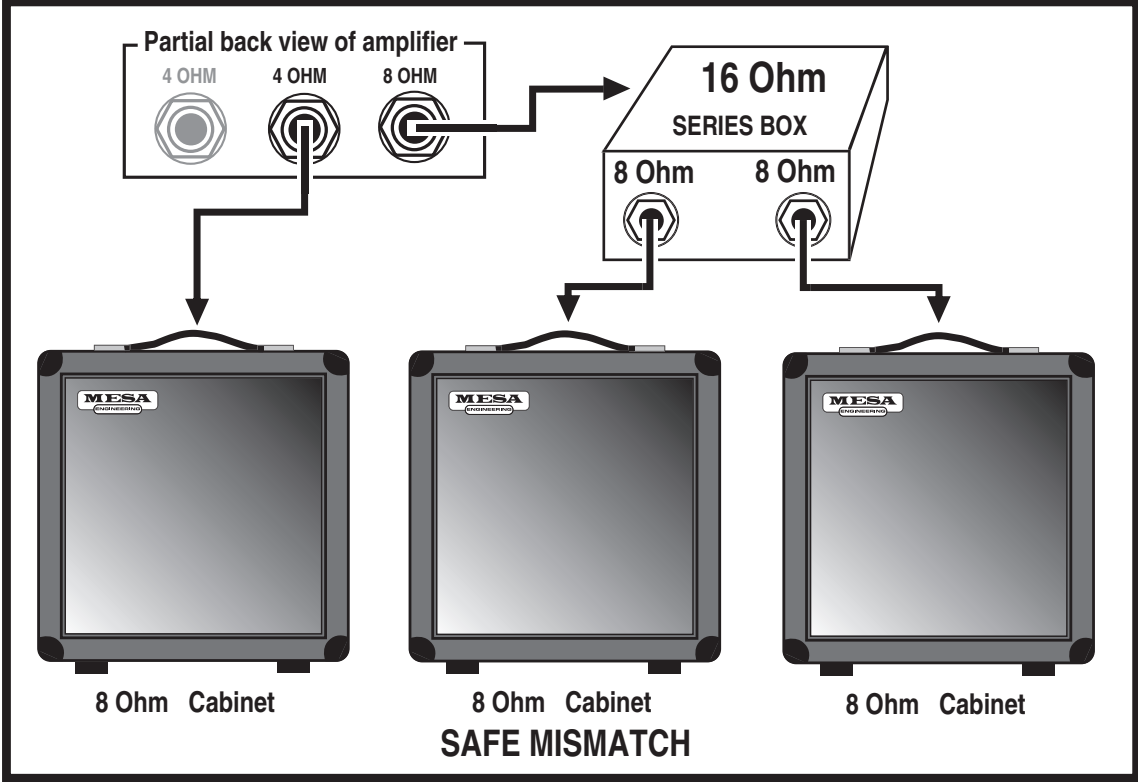

11

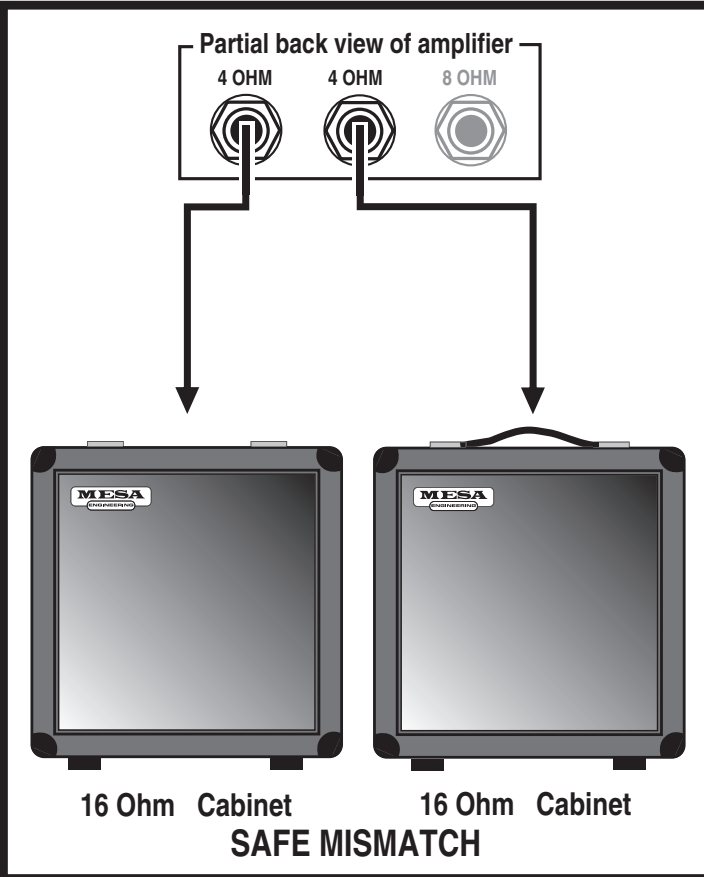

12

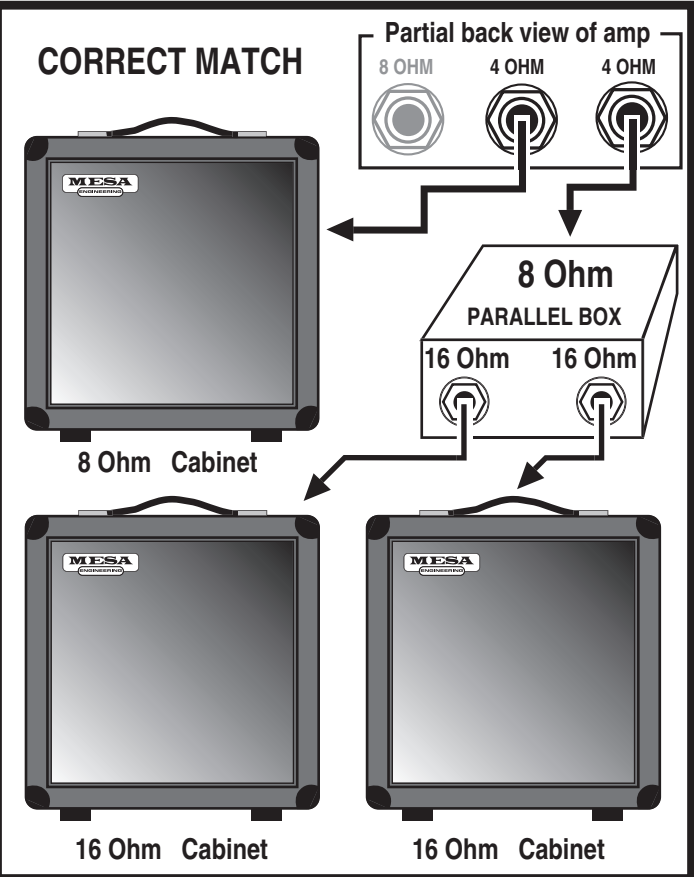

WIRING SCHEMES...Amplifier to Speaker Cabinets

13

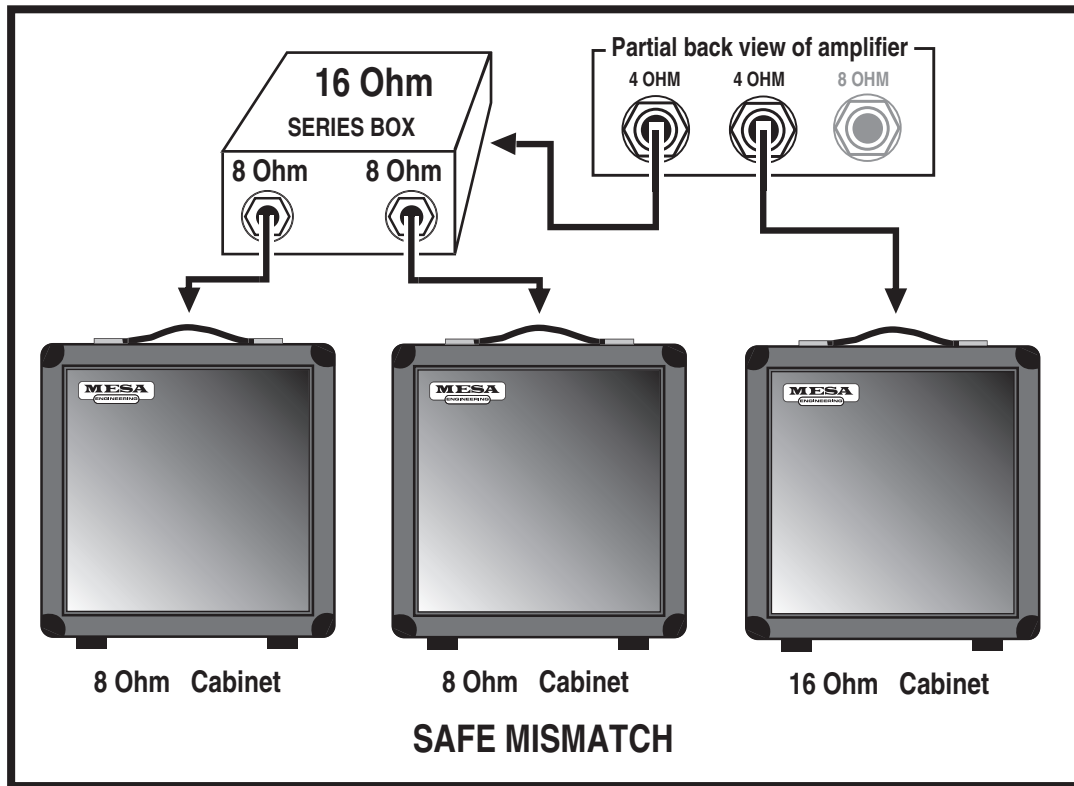

14

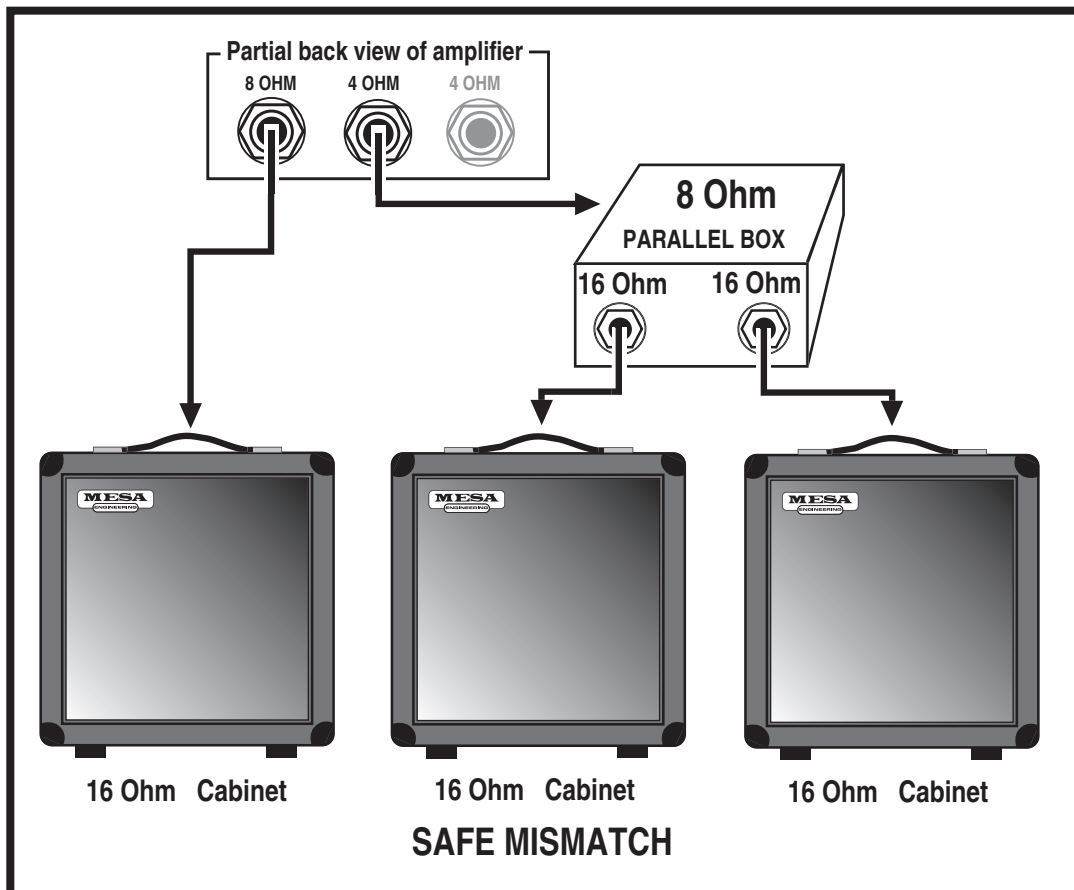

BIAS ADJUSTMENT: (Part of a continuing series)

NOTE: An article written by Randall Smith that we thought you might find interesting.

Here's a question we often hear:

"Why doesn't *MESA* put bias adjustments in their amplifiers?"

Well, there's a short answer and a long answer to this question.

The short answer is that during my 12 years of repairing Fenders, one of the most frequent problems I saw was bias controls that were either set wrong or that had wandered out of adjustment due to vibration. As any honest tech will tell you, there's lot's of easy money to be made by sprinkling "holy water" on amplifiers ... uh, what I meant to say is "Your amp needed biasing." See what I mean? What customer is going to argue with that?

It only takes a moment and a volt meter: The Fender diagram shows how: "Adjust this trim pot for - 52 volts." That's it. Nothing more.

Now don't be fooled into thinking that tubes "draw" more or less bias, they don't. The way a bias supply is connected to a tube is akin to a dead end road, it just trails off to nowhere without really completing a circuit. It's a static voltage and regardless of what tube is in the socket — or even if the tubes aren't plugged in at all, it doesn't change the bias voltage a bit.

So the end of the short answer is this: Since a bias supply needs to put out the right voltage and never vary, I wanted to build amplifiers that were individually hard wired to the correct values and NEVER needed adjustment. And for 25 years, that's how *MESA/Boogies* have been built. Time to change tubes? Just plug our tubes into any one of our amps and you're DONE. No tech needed. NO bills and no BS about biasing. And most important: The bias is RIGHT because it can't change!

Now, you want the long answer? Here's more information on how our hard-wired bias avoids trouble. Please read on.

But first, let's make an important distinction. Our business is designing and building high performance amplifiers. And for this we need tubes whose variance is within a narrow range. Our warehouse is full of rejects ...oh, they work — they just don't perform within our tolerance range. We have a very sophisticated computer - based tube testing system (nicknamed "Robotube") that matches and measures tubes over seven important parameters. It can even predict which tubes are likely to have a shortened lifetime — even though they work perfectly during the test.

Because our business is building quality amps, we can afford to reject a lot of wayward tubes. The guys you hear complaining because *Boogies* don't have bias adjusters are primarily in the business of selling tubes - not amps. They don't want to throw away 30 percent of their inventory, so they promote the idea that tubes outside our parameters can be used to "customize" amplifiers and they criticize us because our amps can't be adjusted to accommodate their out-of-*MESA* tolerance tubes.

Now you might be thinking, "But I thought you just said that tubes don't "draw" bias, therefore they don't effect the bias supply and thus it doesn't need to be adjustable."

When you set the bias (whether it's by selecting the right resistors, as we do, or adjusting a trimmer — which is quicker) what you are doing is establishing the correct amount of idle CURRENT that flows through the power tubes. But you can't adjust the current directly, you can only change it by adjusting the amount of bias VOLTAGE that goes onto the tubes' control grids.

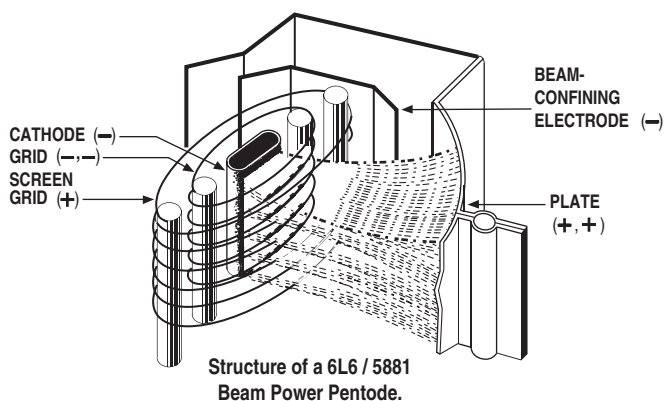

BIAS ADJUSTMENT *(Continued)*

Voltage and current are NOT the same. Current is the AMOUNT of electricity, the “quantity” — and is measured in amperes. Voltage is the degree of electric charge — like the “pressure” to use the old water analogy. Let me illustrate how different voltage and current are: When you scrape your feet across a carpeted floor in dry, wintery conditions, your body can become charged with 50,000 to 100,000 volts of electricity. And when you reach for the door knob, a spark jumps and you feel it! The voltage is super high but the current (measured in micro-amps) is tiny - otherwise you would die from electrocution.

Contrast this with your car battery, which puts out a mere 12 volts. You can lay your hands right across the terminals and not feel a thing. Yet the amount of current available can run to several hundred amperes .. enough to turn over a cold engine and get it started.

So current and voltage are two totally separate electrical parameters — though when you multiply them together, you get POWER, which is measured in watts.

When you set the bias of an amplifier, you are adjusting the static VOLTAGE at the control grid of the tube in order to produce a desired amount of idle CURRENT flowing to the tube’s plate. A small change in grid voltage, produces a large change in the amount of current flowing — and that’s basically how a tube works. Say that again because it’s super important: A small change in voltage at the grid causes a large change in current flowing to the plate. See, that’s the essence of amplification: A small change causing a large change. And here it’s a small voltage change causing a large current change.

The bias conditions are what determines how much current flows through the big power tubes when you’re not playing. And what drives your speakers is fluctuations in that current flow when you ARE playing. If the amount of current increases and decreases 440 times per second, then you’ll hear an A note. If the fluctuations in current flow are large and still at 440 per second, you’ll hear an A that is LOUD!

But for purposes of biasing, it’s the amount of “plate current” flowing with no signal applied that’s important. Unfortunately current is hard to measure because the circuit must be interrupted — as in “cut the wire” — and the meter spliced “in series” with the broken circuit. But measuring VOLTAGE is easy. It is not necessary to interrupt the circuit because a voltage reading can be taken in PARALLEL with the circuit intact.

Thus, as a matter of convenience, most bias settings are given in volts at the grid ... even though current through the plate is the important factor. In fact plate current is so inconvenient (and dangerous) to measure that Fender doesn’t even state what the correct value should be. They only give the grid voltage that will produce that current. (That’s the minus 52.) But that only happens if the tubes being used are “in spec.”

As long as the tubes ARE “in spec”, the right bias voltage will always give the correct plate “CURRENT” — but then there’s no need for the bias voltage to be adjustable!

If the tubes are NOT in spec, then the only proper way to re-set the bias is to cut the circuit and measure the current while adjusting the bias ... but no manufacturer I know even STATES the desired current value! Be that as it may, when the original bias voltage is altered far enough, it will compensate for the tube’s abnormal performance and the correct amount of idle current flow may then be restored. Clearly this is something most repair techs should not attempt.

Some newer amps have LED indicators connected to the circuit which will turn on when the right threshold of current flow has been reached. This is an improvement, and almost worthy if you’re willing to except resistors and lights added into your amplifier’s audio path — which we aren’t.

The other “advantage” of this system is that it allows some amp manufacturers to avoid matching their power tubes. The thinking is that adjusting the bias to each tube separately eradicates the inherent differences between the tubes by insuring that the same current flows through each one.

Again, this has some merit .. but it’s still not as good as using tubes that are matched in the first place because compensating for the mis-match causes the push-pull circuit itself to become unbalanced. Two wrongs don’t really make a right.

BIAS ADJUSTMENT *(Continued)*

Some of the other recommended biasing, “methods” — such as “.. tubes running red hot, increase the bias .. sounds harsh and runs too cool, turn it down ...” are guesswork at best. Luckily, one of the great things about tube amps is that they can usually stand some abuse without causing any real harm ... at least not immediately. But don’t these alterations imply that you are second-guessing the amp designer and that there’s a better set of operating conditions that the designer missed but the tube sellers have discovered?

Now some players may like the sound of their amp altered by tubes with extreme characteristics and with the bias set to help compensate. But often it is the mere novelty of change that they’re really responding to and when the amp goes back to the proper original way, we’ve seen them be far happier still!

Because every part in every one of our designs has been meticulously evaluated, compared and stressed over — no matter how seemingly insignificant it might be. And with every design we look for a “sweet spot” where all the parameters — including the bias — come together to give the best sonic performance, consistently and reliably. Every part and voltage is important — yet no one complains that these other parameters aren’t available for tinkering.

Consider our patented *Simul-Class* circuitry where there are two different bias voltages used for separate pairs of power tubes ... and changing one voltage also changes the other. Great care goes into getting this just right and we think we’d be asking for trouble to have it adjustable for the world to play with ... unless you like paying to have your amp messed up. Sorry, I meant to say, “Uh, ... your amp needed biasing.”

If that doesn’t appeal to you, then merely plug a matched set of *MESA* tubes into one of our amps and you’re ready for tone. Guaranteed. You’d be amazed at the number of service calls we field every day that lead to a diagnosis of out-of-tolerance, non-spec tube problems. To think these would be prevented by including a bias adjustment is something of an insult to you and us. If you put the wrong size tires on your car, do you think changing the pressure will make them right?

Please, don’t think this is a blanket indictment of the other guys selling tubes — it isn’t. And their tubes aren’t all bad either. It just doesn’t make sense to pay more of your hard earned cash for tubes that were probably made in the same Russian or Chinese factory and which have the possibility of being outside the performance window we select for your amp. And it pains us to hear the hype and mystique built up around biasing when twenty-five years of evidence affirms our decision to make bias circuits that “never need adjustment”. How much money and trouble that has saved *MESA/Boogie* players you couldn’t estimate.

Our rigorously tested and hand selected tubes are available at your nearest *MESA/Boogie* Pro Center or from us directly. Nobody offers better price, quality or warranty than we do ... so why swerve?

Next time we’ll talk about our part in developing the great Sylvania STR 415 type 6L6 and how we’re on the verge of seeing something fairly close reappear on the market. Remember, we still have some of these super rugged mondo-bottles available for older amps — *Boogies* only please! Until then, Relax, Breathe and Nourish your soul!

Cheers!

MESA/Boogie Ltd.

Randall Smith
President & Designer

With apologies to Friends and Relatives from the Emerald Isle - who will make their appearance soon enough - the humor which follows is dedicated to the memories of Spec McAuliff and Fae (Rafael) McNally, two of the True Greats.

As their numerical references suggest, the terms Diode, Triode and Pentode indicate the number of elements within the vacuum tube i.e. two, three or five. All tubes also require a filament or heater which is not included in the count. Its purpose is to excite electrons from the cathode coating by raising the temperature such that they are able to boil out of the electron-rich coating material and form a cloud of free electrons in the vacuum space surrounding the cathode.

Although the term filament and heater are often used interchangeably, there are specific differences: A filament is a directly heated cathode where cathode coating is applied directly to the heating element. Examples are 5U4 twin diode rectifier and 300B triode amplifier tubes. A heater, on the other hand, is a heating element which is separate from the cathode and is usually inserted within the tubular cathode sleeve. Examples are 12AX7 twin triode amplifier and 6V6 or EL84 beam power pentode tubes. In all cases this fundamental aspect of each tube's construction is clearly visible, especially when the heating element is glowing red hot.

The cathode, then, would be considered the first numbered element because it is the source of the electrons. The word itself is from the Greek literally meaning completely down, which implies a sense of central origin - like the center of the earth where Tone begins. It might be said that an ecstatic audiophile experiences a positive catharsis, his soul being purified when his system transports him to Audio Nirvana. The only trouble with taking this positive imagery too far is that the cathode is, unfortunately, negative... at least electrically speaking. However this is easily remembered since virtually all musicians and audiophiles have also experienced the more common negative catharsis when they emerge from the emotional rebirth kicking and screaming in rage and frustration.

Once heated, the intrinsically negative electrons are energetic little fellows of almost no mass. Thus they may be accelerated almost instantaneously and will travel through a vacuum a nearly the speed of light. Being of like, negative charge, they tend to repel one another and thus within the electron cloud surrounding the cathode, there is much jostling and elbowing as each one tries to maintain his distance from all the others... unless there is a strong and universal attraction from an outside influence.

Visualize, if you will, a group of sub-atomic Irishmen milling about and in a repellent, negative state of mind. All are scowling and none wants to have anything to do with the other. Now introduce a strong attraction say, a public bar, and you can easily picture an orderly, if rapid movement of the lot in a single direction. This is what happens when a positively charged element called the anode or plate is introduced into the vacuum.

The plate is the large metal element most prominently visible through the glass of an electron tube. It is the outermost element of a tube's structure and it surrounds all the others. The cathode is at the center radiating electrons outwards. As higher and higher positive voltage is applied to the plate, the attraction for the electrons surrounding the cathode is increased and with nothing standing in the way, full uninhibited flow to the plate occurs... sort of like removing the doors and offering free drinks to the crowd of surly Irishmen milling around outside. As electrons flow to the plate, the space charge will continually be replenished by further 'boiling' of the hot, electron-rich cathode as you can easily imagine other Irishmen impatiently taking up the places of those who've gone inside - until the entire village is deserted.

Now, where do they come from and how do they emerge? Well, a grand and elegant lady once showed me how to revive flat champagne: She dropped a raisin into the glass. There was a dramatic and immediate increase in effervescence with the introduction of a cathoding surface. Thousands of tiny bubbles suddenly appeared - and continued to flow from the raisin. Of course the bubbles were made up of gas dissolved in the beverage, but the analogy makes it easy to visualize the loosely bound electrons dissolved in the rich cathode coating as they effervesce from its heated surface.

But back to the electron flow. If the electrons are strongly attracted to a positively charged plate, then it follows that they are strongly repelled by a negatively charged plate and they are. Thus, if an alternating current - such as comes from a transformer - is applied to the plate, electrons will flow only during the times when the plate is positively charged. During periods of negative plate charge, electron flow is stopped and the space charge of electrons remains compressed in the area around the cathode.

ON TRIODES, PENTODES & IRISHMEN: (Continued)

Thus a diode tube - one with a cathode and an anode - is mostly used to rectify alternating current into direct current by passing it without restriction, but in one direction only. This also explains why closing time is strictly enforced at Irish pubs: During normal operation, the traffic flow is similarly unimpeded and uni-directional toward the bar and this process rectifies the work-day negativity. It goes without saying that no one leaves as long as the atmosphere around the bar remains positively charged.

TRIODES:

This section is a continuing technical treatise on the workings of Irish Pubs but to make it easier for the layman to understand, it is explained in terms of vacuum tube technology. Enter the original bar - free beer and no doors. Well, it turns out that some control over the flow can be a necessary and useful advantage. This led to the invention of those swinging louvered saloon doors which are open at the top and bottom. They are patterned after the control grid of the vacuum tube, which is a loosely wound coil of thin wire located between the cathode and the plate.

In a Triode the plate is always positively charged with high voltage D.C. and even though the grid is blocking the path, those negative electrons can still FEEL the strong attraction - just as the Irishmen can see in through the louvers of the bar doors. They know what pleasures lie beyond, but to get there requires overcoming the negative influences controlling the access. This negative influence is typically called a Bias. In electronic terms that means the grid is supplied with a voltage which is slightly MORE NEGATIVE than the already negative electrons. The more negative the Bias, the more it tends to neutralize the attraction of the plate and repel the electrons back toward the cathode.

The Irish can be similarly charged with Bias, but unless you are Irish yourself, this type of Biasing may be more difficult to understand. The effect is similar though: The more negative the Bias, the more it impedes forward progress. Generally speaking though, the electronic Bias of the grid is easiest to overcome, and for two main reasons: First, the Bias is set - like the bar doors - to allow some passage. Second, the grid is mostly NOT THERE, like the louvered doors which are mostly open spaces. Unlike the plate which is solid, the grid is like a coiled bed spring. It can create a repelling field but mostly it's empty space in between widely separated windings of wire. It's very easy to control the electrons as they pass through the grid's force field: Changing the grid voltage only slightly will have an enormous effect on how much current flows through... and that's what AMPLIFICATION is: a small change in voltage at the grid causing a large change in current flowing to the plate.

The purpose of the louvered bar doors is similar to that of the grid, namely, to give momentary pause while still revealing the promise within. Hesitation mostly gives way to temptation, but there are those few stalwart Irishmen who think twice and decide to come back later. Most just pause slightly then go on through. That is the purpose of the bar doors: to prevent everyone from crowding in all at once - and as the door is made less of a barrier, wider spaces between the louvers, more of the bar's attractive influence is felt outside thus amplifying the customer flow and increasing the crowd at the bar.

PENTODES:

Occasionally though, bar doors - even the louvered type - were found to be too effective, and too many customers turned away. Something further was needed to increase the attraction of the bar and overcome the resistance created by the door. Thus the cocktail waitress was invented.

Once again the idea was inspired by the vacuum tube. It had been discovered in some tubes, often large power types, that the distance to the plate was too great to attract enough electrons past the negative influence of the control grid. So another grid coil of fine wire was inserted between the first grid and the plate. This was called the screen grid and carrying a highly positive charge, it functioned as a "bait" for the plate.

In a properly designed power tube such as an EL84 or a 6V6, the windings of the screen grid are precisely aligned to fall in the shadow of the control grid. This way the electrons responding to the pull of the screen grid are lined up in sheets as they pass between windings of the inner control grid... only to find that they have been fooled! Once past the control grid and drawn toward the screen grid, they discover...there's almost nothing there. The path they're on has them aligned to zing straight through the spaces BETWEEN screen grid windings. So rather than a close and personal encounter, they just fly on past - and once they're out that far, there's no stopping them. The influence of the plate takes over and - being solid metal and of the highest positive attraction - it is at this final destination that the electrons congregate.

ON TRIODES, PENTODES & IRISHMEN: (Continued)

PENTODES: (Continued)

Thus the proper cocktail waitress - visible through the louvers - is scantily clad so as to be all the more effective at reinforcing the attractive influence of her bar and by being located in between the door and the bar, she serves as bait to lure customers past the door's negative influence. Once through the door however, it is the rare Irishman who actually comes in personal contact with the cocktail waitress as, for all intents and purposes, she - like the screen grid - turns out to be a vanishing illusion. Yet, having come this far, the solid influence of the bar itself now takes over and attracts the customers to congregate, having happily reached their destination.

If you're still following this and haven't lost track of the count, you'll know we're still one element short of the five needed to make a Pentode. This last part is a pair of beam-confining shields which being negatively charged, serve to direct the flow right toward the plate. This is much the way a short entrance hall to the bar prevents wandering accidentally into the Men's room on the way.

Once at the bar though, the circuit is complete and the process of soul-nourishing works its ritual magic. Biases having been overcome, illusory nightingales having vanished, the spirits truly soar and the once surly Irishmen now are filled with warmth, wit and kindred friendship, enjoying the music and glowing nicely with their heaters on.

With appreciative thanks to the inhabitants of the Land of the Leprechaun, we have now concluded our little diversion into the mechanics of proper bar lay-out.

A feature article by Randall Smith
Designer / President

FRONT VIEW : Lone Star Special

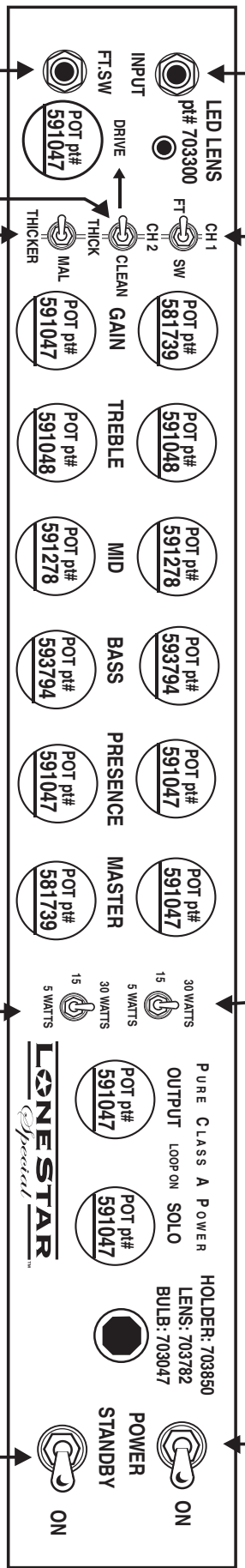

JACK pt# 610120

SWITCH pt# 607313

SWITCH pt# 607313

SWITCH pt# 600631

JACK pt# 610123

SWITCH pt# 607111

SWITCH pt# 607313

SWITCH pt# 607313

SWITCH pt# 600631

REAR VIEW : Lone Star Special

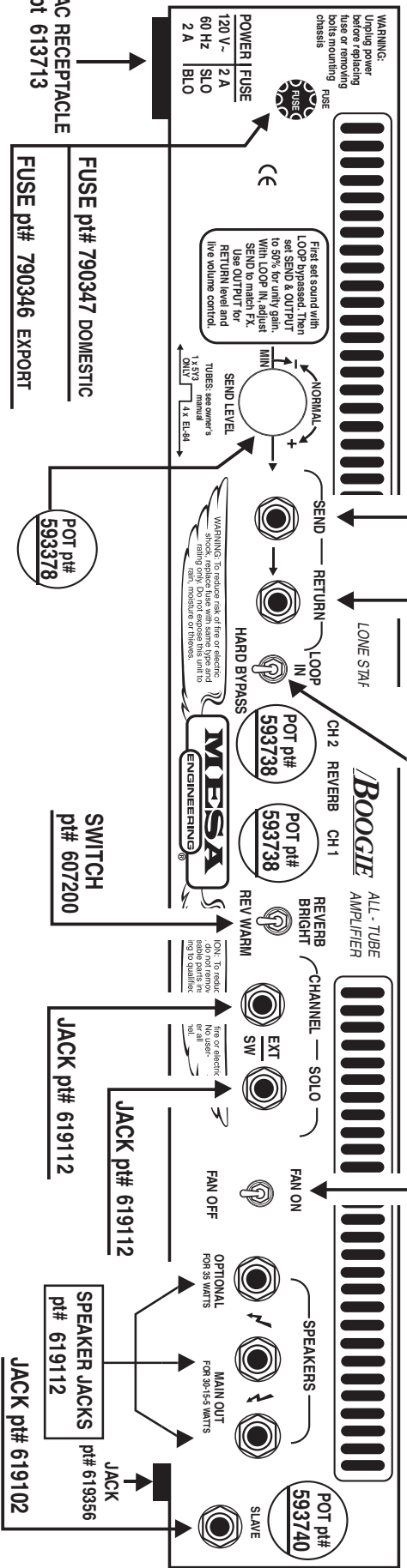

JACK pt# 619112

JACK pt# 619112

SWITCH pt# 607200

SWITCH pt# 607200

AC RECEPTACLE pt 613713

FUSE pt# 790347 DOMESTIC
FUSE pt# 790346 EXPORT

SWITCH pt# 607200

JACK pt# 619112

JACK pt# 619112

SPEAKER JACKS pt# 619356

JACK pt# 619102

NOTES:

MESA/BOOGIE

The Spirit of Art in Technology

Thank you for trusting MESA/Boogie to be your amplifier company and we wish you many years of toneful enjoyment from this handbuilt all tube instrument.



The Spirit of Art in Technology



(707) 778-6565 FAX NO. (707) 765-1503

1317 Ross Street Petaluma, CA 94954

USA