

DWUNI

User Manual

DWUNI
Wired Controller



Thank you for choosing the DWUNI Wired Controller. Please read this user manual carefully before operation and retain it for future reference.

Lit 12012504

User Notices

For correct installation and operation, please read all instructions carefully. Before reading the instructions, please be aware of the following items:

- (1) It is prohibited to install the wired controller at wet places or direct sunlight.
- (2) Do not frequently disassemble the wired controller.
- (3) Do not operate the wired controller with wet hands.
- (4) Do not remove or install the wired controller by yourself. If there are any questions, please contact Tech Support at 844-873-4445.

(5) The wired controller is a generic model, applicable for several kinds of units. Some functions of the wired controller are not available for certain kinds of units, for more details please refer to the owner's manual of unit. The setting of unavailable will not affect unit's operation.

(6) The wired controller is universal. The remote receiver is either in the indoor unit or in the wired controller. Please refer to the specific models.

Contents

1 Display	1
1.1 Appearance.....	1
1.2 Instructions for Related Displayed Symbols	2
2 Buttons	3
2.1 Button Graphics	3
2.2 Function Instructions of Buttons	3
3 Operation Instructions.....	3
3.1 Menu Structure.....	3
3.2 On/Off	5
3.3 Mode Setting.....	5
3.4 Temperature Setting	5
3.5 Fan Setting	5
3.6 SWING (Louver) Setting.....	6
3.7 Functions Setting	8
3.8 Unit Status View	12
3.9 Current Error View	13
3.10 Timer Setting.....	15
3.11 Clock Setting	20
3.12 Lock Setting	21
4 Installation Instructions	22
4.1 Parts and Dimensions of Wired Controller	22
4.2 Installation Requirements.....	23
4.3 Installation Methods	23
4.4 Disassembly	26





















1 Display

1.1 Appearance



Fig.1 Appearance of wired controller

1.2 Instructions for Related Displayed Symbols

No.	Symbols	Instructions
1		Up and down louver function
2		Left and right louver function
3	<i>This row left intentionally blank</i>	
4		Sleep function
5		Auto mode
6		Cooling mode
7		Dry mode
8		Fan mode
9		Heating mode
10	<i>This row left intentionally blank</i>	
11		I-Demand function
12		Absence function
13		Shielding status (Buttons, temperature, ON/OFF, mode or energy savings are shielded by remote monitor)
14		Current set fan speed
15		Memory function (Memory in power failure)
16		DRED function
17		Save function
18		X-fan function
19		Remind to clean the filter
20		Timer on status
21		Gate card pulled-off status or nobody presented status
22		Quiet function
23		Function lock

2 Buttons

2.1 Button Graphics

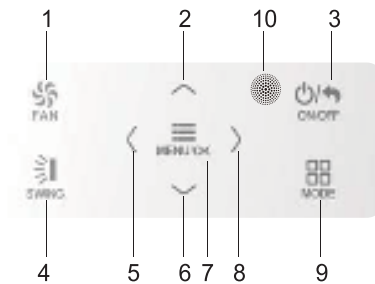

Fig. 2 Button graphics

2.2 Function Instructions of Buttons

No.	Button name	Button Function
1	FAN	Set low speed, medium speed, high speed, turbo and auto speed.
2	^	(1) Set temperature (2) Set parameter
6	v	(3) Move option cursor
3	ON/OFF/BACK	(1) Turn on or turn off unit (2) Return to last page
4	SWING	Set up&down SWING (louver) and set left&right louver
5	<	(1) Set related function on or off (2) Move option cursor
8	>	(3) Set parameter
7	MENU/OK	(1) Enter menu page (2) Confirm setting
9	MODE	Set auto, cooling, dry, fan and heating modes for indoor unit.
10	Remote control receiver window	

3 Operation Instructions

3.1 Menu Structure

Normal setting of wired controller can be set directly on the main page, including fan speed, SWING (louver), set temperature, mode, and ON/OFF. The setting and status view of other functions can be set in corresponding sub-menu. Detailed menu structure is shown in Fig. 3.

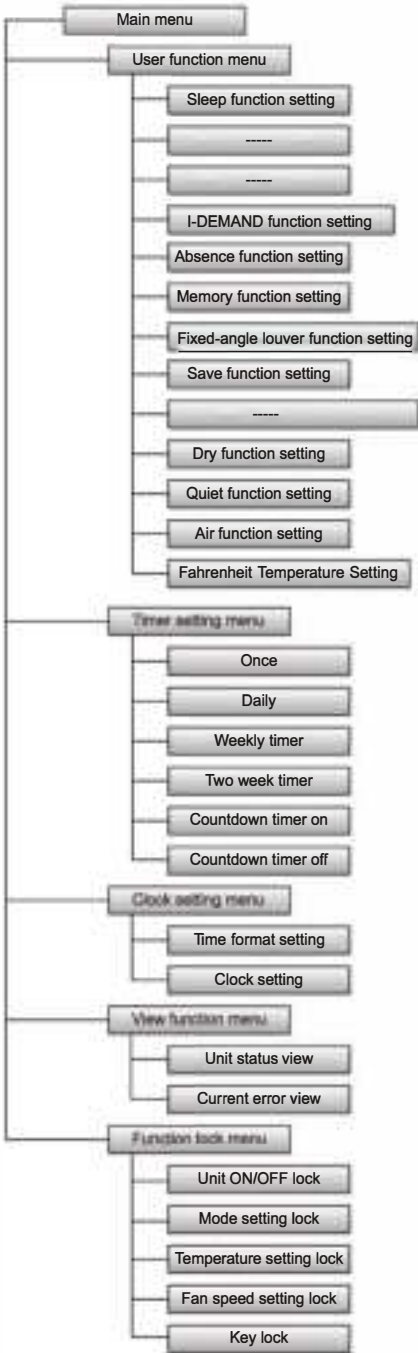

Fig. 3 Menu structure

3.2 On/Off

When the wired control is on main page, press ON/OFF button to turn on the unit. Press ON/OFF button again to turn off the unit. The interfaces of On/Off status are shown in Fig. 4 and Fig. 5.



Fig. 4 Off interface



Fig. 5 On interface

3.3 Mode Setting

Under On status, pressing MODE button can set mode circularly as:

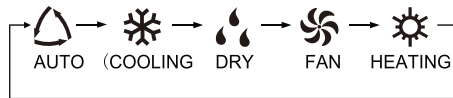

Note: If save function is on, auto mode is not available.

3.4 Temperature Setting

Under unit on status, pressing “^” or “v” button on the main page increases or decreases set temperature by 1°F(1°C); holding “^” or “v” button increases or decreases set temperature by 1°F(1°C) every 0.3s.

In cooling, dry, fan, and heating modes, the temperature setting range is 61°F~86°F (16°C~30°C). Under auto mode, set temperature cannot be adjusted.

3.5 Fan Setting

Under On status, pressing FAN button can set fan speed circularly as:

Low→Medium→High→Turbo→Auto→Low

Symbols displayed are as shown in Fig. 6.



Fig. 6 Fan setting

3.6 SWING (Louver) Setting

When unit is in ON status, press SWING button for louver setting. Two louver modes are available: fixed-angle louver and simple louver.

When fixed-angle louver mode is set, louver operation is as follows:

When unit is in ON status, press SWING button to select . Up&down





Select up&down and left&right louver by the “<” or “>” button. Select left&right louver to adjust the louver angle as follows:



Note:

- ① Turn on fixed-angle louver mode  function setting page;
- ② If fixed-angle louver is not available for the model, fixed-angle louver is invalid when the wired controller turns on fixed-angle louver mode.

Simple louver mode: when fixed-angle louver mode is turned off, louver operation is as below:

Pressing SWING button under unit on status, up&down louver frame occurs. Press SWING button to turn on or off up&down louver.  is displayed when up&down louver is on and is not displayed when up&down louver is off. If up&down louver frame does not disappear, press “<” or “>” button to switch to left&right louver setting. Left&right louver frame occurs. Press SWING button to turn on or off left&right louver.  is displayed when left&right louver is on and is not displayed when left&right louver is off. For detailed operation, please refer to Fig. 7.

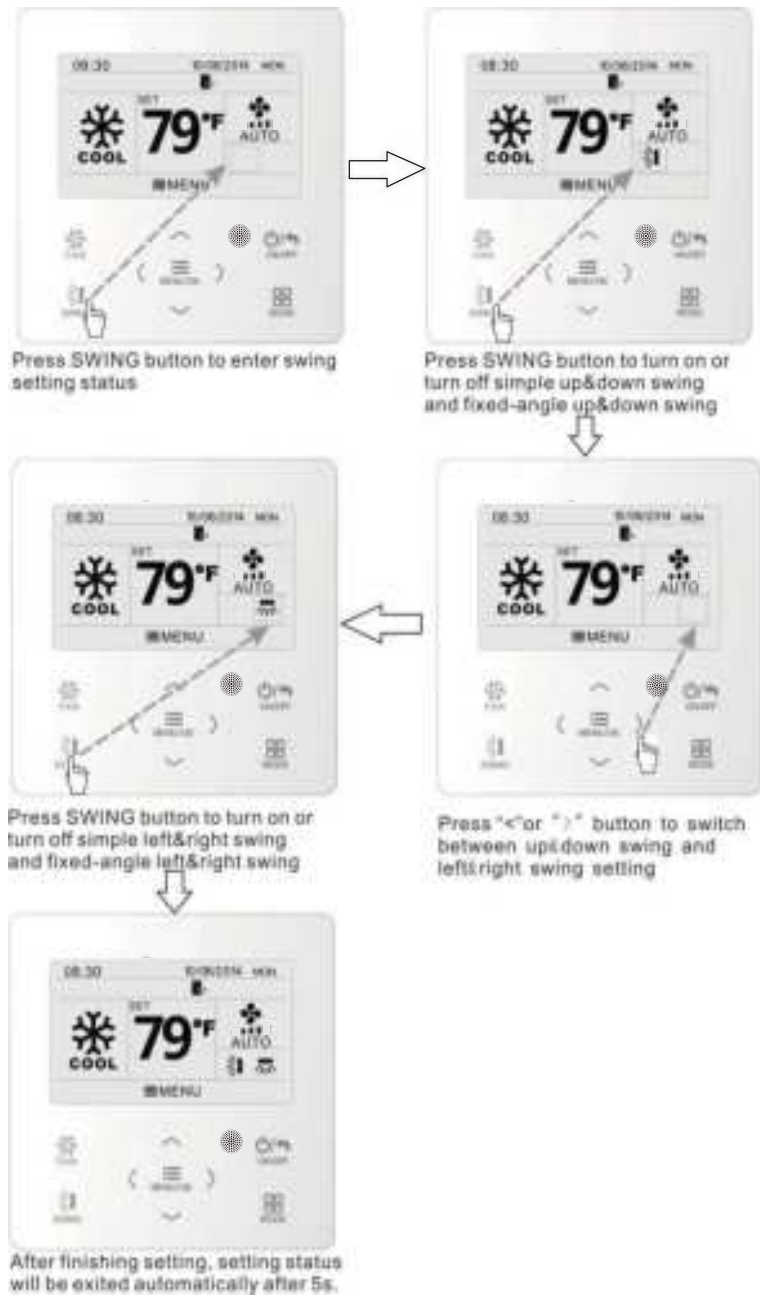

Fig. 7 Louver setting

3.7 Function Settings

Press MENU/OK button on main page to enter main menu page. Press “^” or “v” or “<” or “>” button to select the function setting symbol. Then press MENU/OK button to enter user function setting page. Press “^” or “v” button to select specific function item. Press “<” or “>” button to turn on or turn off this function. If the function item can't be set, it will display as gray. Please refer to Fig. 8.

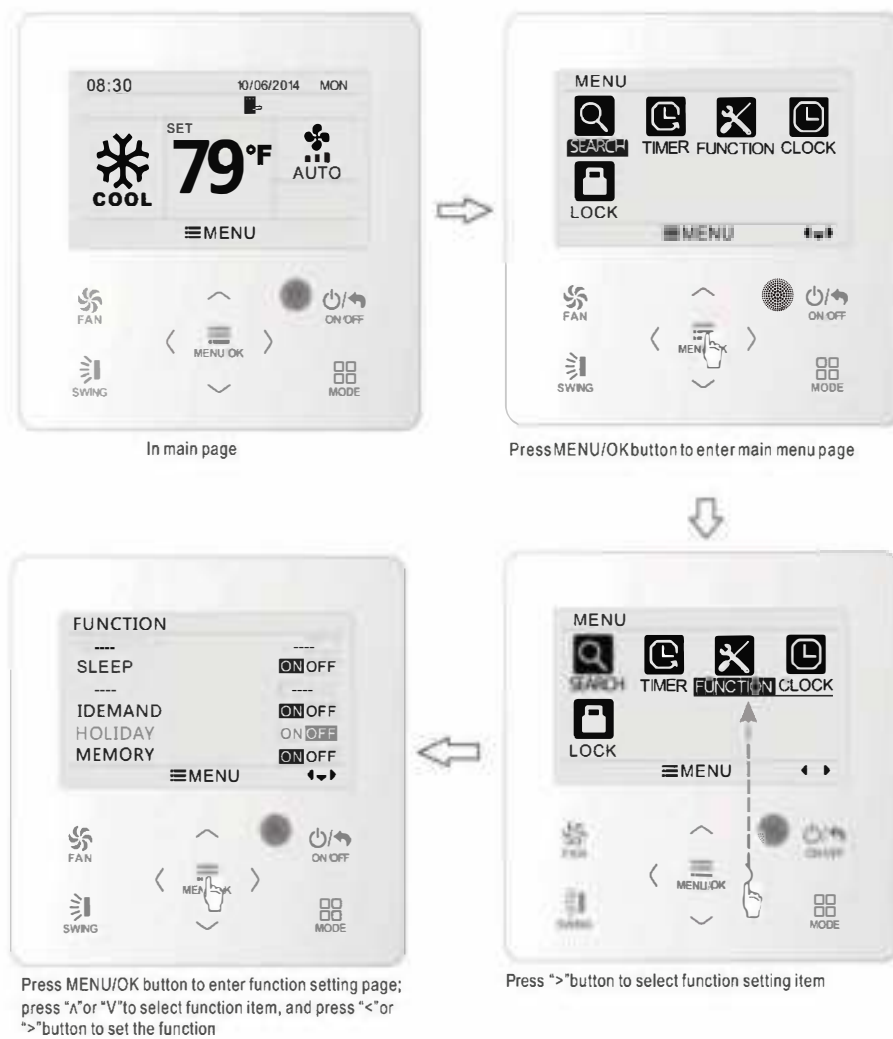

Fig. 8 Function settings

3.7.1 Sleep Function Setting

After entering user function page, press “^” or “v” button to select sleep function and press “<” or “>” button to turn on or turn off sleep function with auto saving.

If this function is turned on, the unit will operate according to the preset sleep curve to provide a comfortable sleep environment.

Note:

- In fan or auto mode, sleep function is not available.
- Sleep function is canceled when turning off the unit or switching modes.

3.7.2 *This section left intentionally blank*

3.7.3 I-DEMAND Function Setting

After entering user function page, press “^” or “v” button to select IDEMAND function option and press “<” or “>” button to turn on or turn off this function with auto saving.

Note:

- This function is only available in cooling mode.
- When this function has been set, set temperature is displayed in 81°F(27°C). In this case, temperature setting and fan speed setting are disabled.
- This function is canceled when turning off the unit or switching modes.
- This function and sleep function cannot be on simultaneously. If I-Demand function is set first and then Sleep function is set, I-Demand function is canceled while Sleep function is valid, and vice versa.

3.7.4 Absence Function Setting

After entering user function page, press “^” or “v” button to select Holiday function option and press “<” or “>” button to turn on or turn off this function with auto saving.

This function is used to maintain indoor temperature so that unit can recover fast heating.

Note:

- This function is only available in heating mode.
- When this function has been set, set temperature is displayed as 46°F(8°C) (46°F). In this case, temperature setting and fan speed setting are disabled.
- This function is canceled when switching modes.
- This function and Sleep function cannot be on simultaneously. If Absence function is set first and then Sleep function is set, Absence function is canceled while Sleep function is valid, and vice versa.

3.7.5 Memory Function Setting

After entering user function page, press “^” or “v” button to select Memory function and press “<” or “>” button to turn on or turn off Memory function with auto saving.

3.7.6 Fixed-angle SWING (Louver) Mode Setting

After entering user function page, press “^” or “v” button to select Lock swing function option and press “<” or “>” button to turn on or turn off this function with auto saving.

Note: If Fixed-angle swing function is not available for the connected unit, this function is canceled automatically after setting.

3.7.7 Save Function Setting

After entering user function page, press “^” or “v” button to select save function and press “<” or “>” button to turn on or turn off save function. Press MENU button to enter save function setting page.

After entering save function setting page, press “<” or “>” button to select cooling or heating temperature limits. After selecting cooling or heating temperature limits, press “^” or “v” button to adjust temperature limits value. After setting, press MENU button to save the setting.

Note: When save function has been set, auto mode cannot be set.

3.7.8 *This section left intentionally blank*

3.7.9 X-fan Function Setting

After entering User Function page, press “^” or “v” button to select Dry function option and press “<” or “>” button to turn on or turn off this function with auto saving.

Note:

- This function is only available in cooling mode and dry mode.
- When this function is on, if the air conditioner is turned off, the indoor fan will still operate at low speed for a while to dry the residual water inside the unit.

3.7.10 Quiet Function Setting

After entering user function page, press “^” or “v” button to select Quiet function and press “<” or “>” button to turn on or turn off this function with auto saving.

Note: This function is only available in cooling mode, heating mode and auto mode.

3.7.11 Fahrenheit Temperature Setting

After entering user function page, press “^” or “v” button to select Fahrenheit temperature function and press “<” or “>” button to turn on or turn off this function with auto saving. After closing this function, Fahrenheit temperature is displayed.

3.7.12 Air Function Setting

After entering user function page, press “^” or “v” button to select Air Function and press “<” or “>” button to turn on or turn off Air Function. Press MENU button to adjust the mode of Air Function .

After entering Air Function mode setting, press “^” or “v” button to adjust the mode in the range of 1~2 (1 is return air and 2 is discharge air). After setting, press MENU button to save the setting.

3.8 Unit Status View

Press MENU button to enter the menu and select the function symbol to be viewed. Then press MENU button to enter view function page. Press “^” or “v” button to select status view function. Press MENU button to enter unit status view page. Press BACK to return to last page.

3.9 Current Error View

When error occurs in the unit, error symbol is displayed on the main page of wired controller to indicate that the unit has an error. In this case, you can enter error view page to view the current error.

Press MENU button to enter the menu and select the function symbol to be viewed. Then press MENU button to enter view function page. Press “^” or “v” button to select error information. Press MENU button to enter error view page. If there are too many errors, press “^” or “v” to turn pages. Press BACK button to return to the last page. Please refer to Fig. 9.

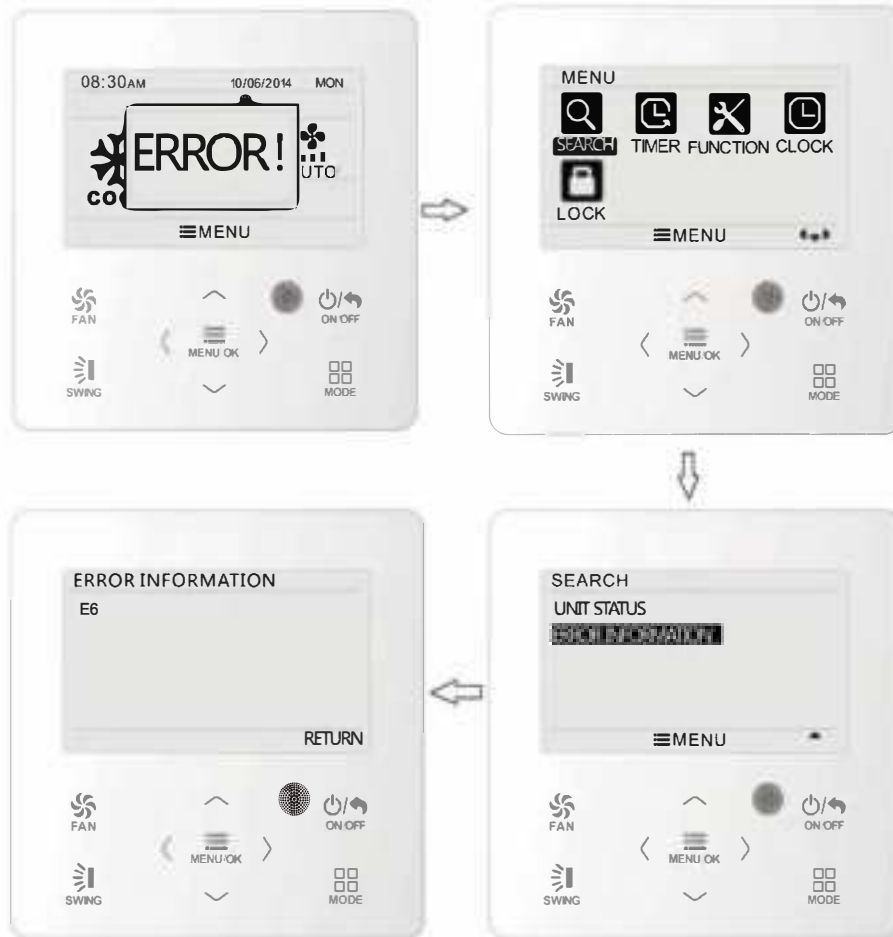

Fig. 9 Current Error View

Error	Error Code	Error	Error Code
Return air temperature sensor open/short circuited	F1	Drive board communication error	P6
evaporator temperature sensor open/short circuited	F2	Compressor overheating protection	H3
Indoor unit liquid valve temperature sensor open/short circuited	b5	Indoor and outdoor units unmatched	LP
Indoor gas valve temperature sensor open/short circuited	b7	Communication line misconnected or expansion valve error	dn
IPM temperature sensor open/short circuited	P7	Running mode conflict	E7
Outdoor ambient temperature sensor open/short circuited	F3	Pump-down	Fo
Outdoor unit condenser mid-tube temperature sensor open/short circuited	F4	Jumper error	C5
Discharge temperature sensor open/short circuited	F5	Forced defrosting	H1
Indoor and outdoor communication error	E6	Compressor startup failure	Lc
DC bus under-voltage protection	PL	High discharge temperature protection	E4
DC bus over-voltage protection	PH	Overload protection	E8
Compressor phase current sensing circuit error	U1	Whole unit over-current protection	E5
Compressor demagnetization protection	HE	Over phase current protection	P5
PFC protection	Hc	Compressor desynchronizing	H7
IPM Temperature Protection	P8	IPM Current protection	H5
Over-power protection	L9	Compressor phase loss/reversal protection	Ld
System charge shortage or blockage protection	F0	Frequency restricted/reduced with whole unit current protection	F8
Capacitor charging error	PU	Frequency restricted/reduced with IPM current protection	En
High pressure protection	E1	Frequency restricted/reduced with high discharge temperature	F9
Low pressure protection	E3	Frequency restricted/reduced with anti-freezing protection	FH
Compressor stalling	LE	Frequency restricted/reduced with overload protection	F6
Over-speeding	LF	Frequency restricted/reduced with IPM temperature protection	EU
Drive board temperature sensor error	PF	Indoor unit full water error	E9
AC contactor protection	P9	Anti-freezing protection	E2
Temperature drift protection	PE	AC input voltage abnormal	PP
Sensor connection protection	Pd	Whole unit current sensing circuit error	U5
DC bus voltage drop error	U3	4-way valve reversing error	U7
Outdoor fan 1 error protection	L3	Motor stalling	H6
Outdoor fan 2 error protection	LA	PG motor zero-crossing protection	U8

3.10 Timer Setting

The wired controller can set 6 kinds of timers: one time clock timer, everyday timer, one week timer, two week timer, countdown timer ON, and countdown timer OFF. Select timer symbol after entering menu page. Press MENU button to enter timer setting page. Press “^” or “v” button to select one kind of timer. Press “<” or “>” button to turn on or turn off this timer. Please refer to Fig. 11.



Fig. 11 Turn on or turn off timer

3.10.1 One Time Clock Timer

The wired controller can set one time clock timer. If the unit is OFF, timer ON can be set. If the unit is ON, the timer OFF can be set. The timer is carried out just once when the timer time is reached and then the timer turns OFF automatically.

In timer function setting page, when one time timer is selected, press “<” or “>” button to turn ON or turn OFF this timer function. Press MENU button to enter timer time setting page, as shown in Fig. 12.

Press “<” or “>” button to select timer hour or minute and press “^” or “v” button to adjust time. Holding “^” or “v” button increases or decreases time rapidly. After finishing setting, press MENU button to save timer time.



Fig. 12 Setting page of one time clock timer

Note: When the Timer Function is turned ON and the unit is turned ON or turned OFF, this Timer Function is canceled automatically.

3.10.2 Daily Timer

In daily timer, user can set eight segments of timer individually. The individual segment is valid only when it is turned ON. In each segment, you can set time, unit ON/OFF, set temperature in Cooling (it is valid only when the current mode is in cooling), set temperature in Heating (it is valid only when the current mode is heating).

Please refer to Fig. 13 to select setting. After entering daily timer setting page, press “<” or “>” button item. Press “^” or “v” button to adjust the value. Press MENU button to save setting.



Fig. 13 Daily timer setting

3.10.3 Weekly Timer

You can set the everyday timer content for a week. For each day, you can set eight segments of timer content. The unit executes the corresponding timer setting for the week.

After entering weekly timer setting page, press “<” or “>” button to select the day to be set. Then press MENU button to enter the timer programming for that day. Press “<” or “>” button to select the item to be set. Press “^” or “v” button to adjust the content. Press MENU button to save setting. Please refer to Fig. 14.

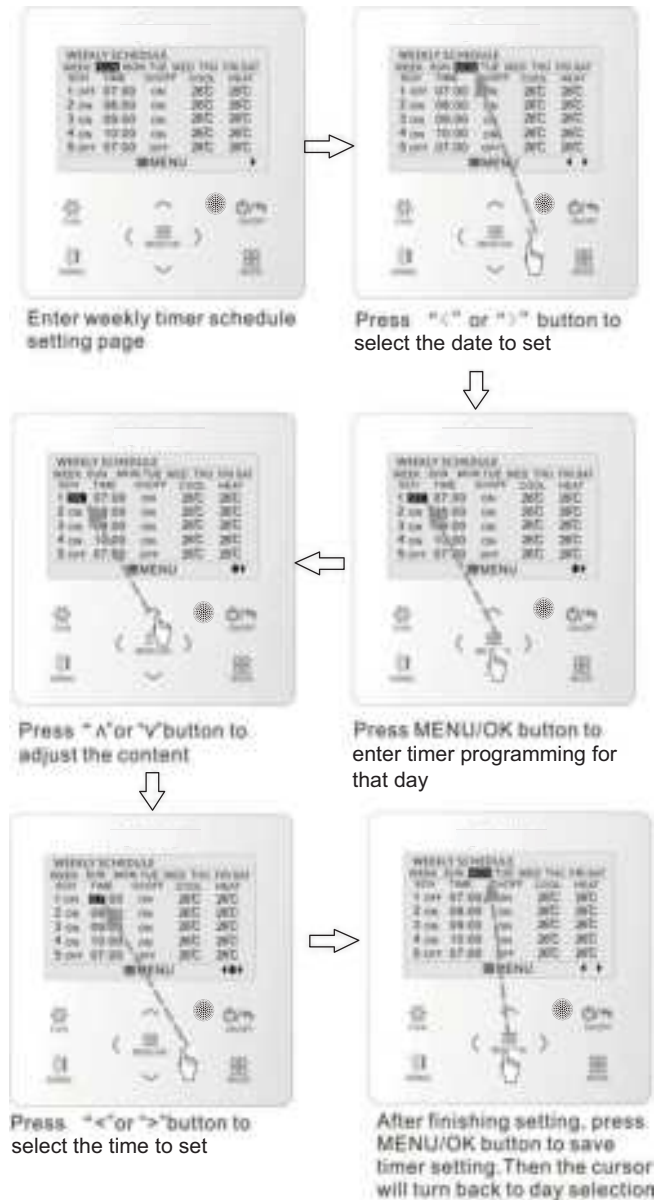

Fig. 14 Weekly timer setting

3.10.4 Two Week Timer

You can set the everyday timer content for two weeks. For each day, you can set eight segments of timer content. The unit will execute the corresponding timer setting for two weeks.

In timer function setting page, press “^” or “v” button to select two week timer setting and then press MENU button to enter two week timer menu page. Press “^” or “v” button to select current week option and then press “<” or “>” button to set current week as first week or second week. Press MENU button to save current week setting. Please refer to Fig. 15.

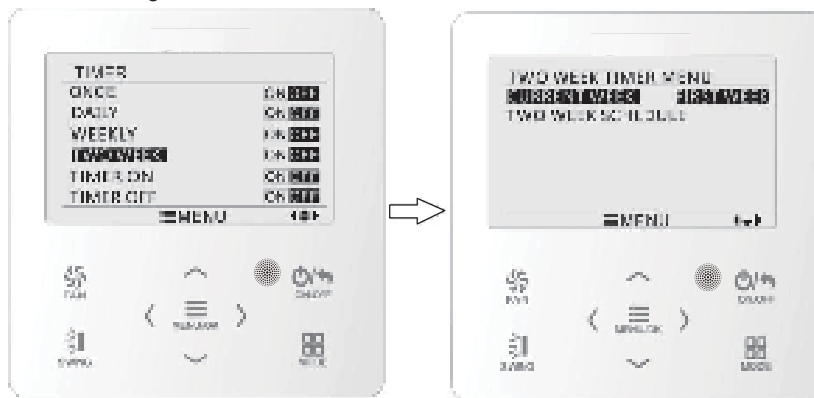

Fig. 15 Setting of current week

After entering two week timer menu page, press “^” or “v” button to select the two week schedule option and then press MENU button to enter two week timer programming. After entering two week timer setting page, press “<” or “>” button to select the day to be set. Then press MENU button to enter timer programming of that day. Press “<” or “>” button to select the item to be set. Press “^” or “v” button to adjust the content. Press MENU button to save setting. Press BACK button to exit this page. The setting symbols please refer to weekly timer setting.

3.10.5 Countdown Timer

Countdown timer includes timer ON and timer OFF. Unit ON/OFF after a desired hour can be set. In unit ON status, the timer OFF can be set, or timer OFF and timer ON can be set simultaneously. In unit OFF status, timer ON can be set, or timer OFF and timer ON can be set simultaneously. If timer OFF in x hours and timer ON in y hours are set simultaneously in unit ON status, the unit will turn OFF in x hours and then the unit will turn ON in y hours after timer OFF.

After entering timer on setting page, press “^” or “v” button to increase or decrease timer time by 0.5h. Press MENU button to save setting. Press BACK button to return to the last page. Please refer to Fig. 16.



Fig. 16 Countdown timer on

After entering timer offsetting page, press “^” or “v” button to increase or decrease timer time by 0.5h. Press MENU button to save setting. Press BACK button to return to the last page. Please refer to Fig. 17.



Fig. 17 Countdown timer off

If Timer Function is ON, the set hours will decrease as the unit operation time increases. In this case, residual hours can be viewed after entering timer setting page.

The Timer Function is carried out just once and then it is canceled automatically.

Note: If this Timer Function is turned ON, when the unit is turned ON or turned OFF, this Timer Function is canceled automatically.

3.11 Clock Setting

3.11.1 Time Format Setting

The user can set the time format for a 12-hour or 24-hour system. Select clock symbol in menu page and then press MENU button to enter clock setting page. Press “^” or “v” button to select time format and then press “<” or “>” button to select 12-hour system or 24-hour system. Please refer to Fig. 18.



Fig. 18 Time format selection

3.11.2 Clock Setting

Select clock symbol in menu page and then press MENU button to enter clock setting page. Press “^” or “v” button to select time set and then press MENU button to enter time setting.

Press “<” or “>” button to select setting items: hour, minute, year, month, day; press “^” or “v” button to set the value and then press MENU button to save setting. Please refer to Fig. 19.

Note: If you need to use both the wired controller and remote controller, please set the same time on both.

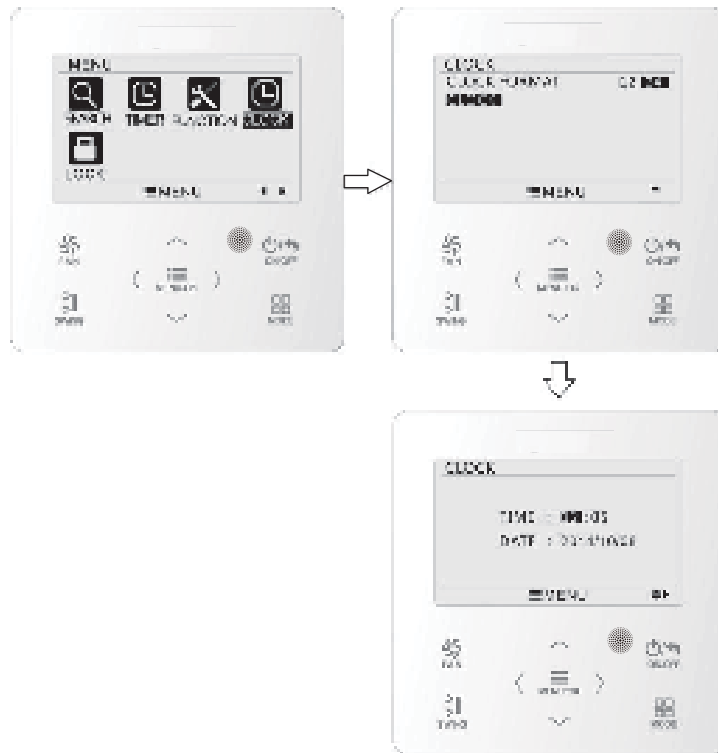

Fig. 19 Clock setting

3.12 Lock Setting

Select lock symbol in menu page and then press MENU button to enter lock setting page. Press “^” or “v” button to select the item to be locked and then press “<” or “>” button to lock or unlock. Please refer to Fig. 20.

Items that can be locked: ON/OFF, mode setting, temperature setting, fan speed setting, and key lock. After locking, the corresponding item cannot be set with buttons.

If the keys are locked, all keys cannot be operated after returning to the main page. Please unlock according to the instructions on main page. During unlocking, press MENU button, press “<” button and then press “>” button to unlock keys.

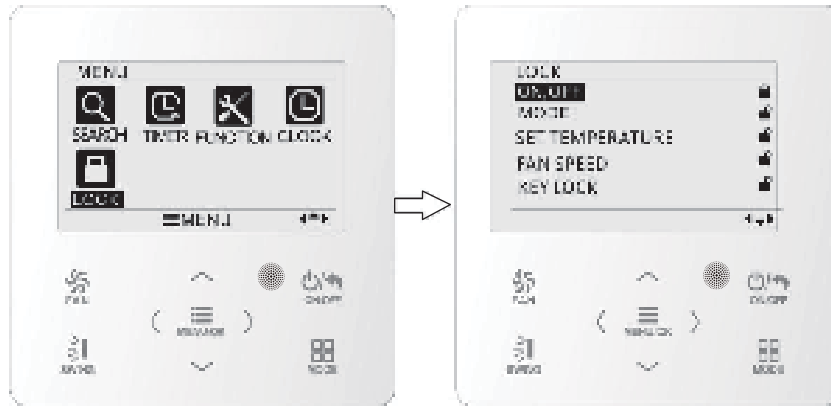

Fig. 20 Lock setting

4 Installation Instructions

4.1 Parts and Dimension of Wired Controller

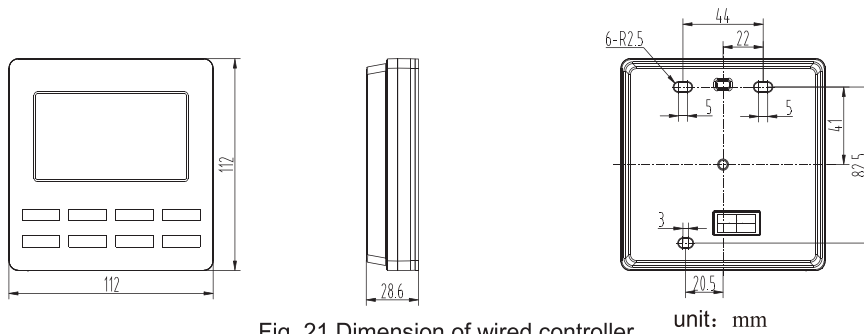

Fig. 21 Dimension of wired controller

unit: mm

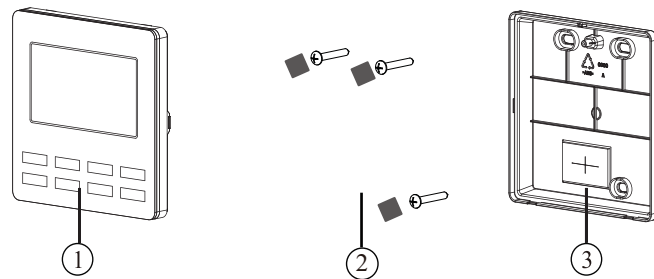

Fig. 22 Parts of wired controller

No.	1	2	3
Name	Panel of wired controller	Sponge 20×20×3 mm Screw M4×25	Soleplate of wired controller
Quantity	1	3	1

4.2 Installation Requirements

- (1) DO NOT install the wired controller in wet places.
- (2) DO NOT install the wired controller in places with direct sunshine.
- (3) DO NOT install the wired controller near high temperature objects or water-splashing places.

4.3 Installation Methods

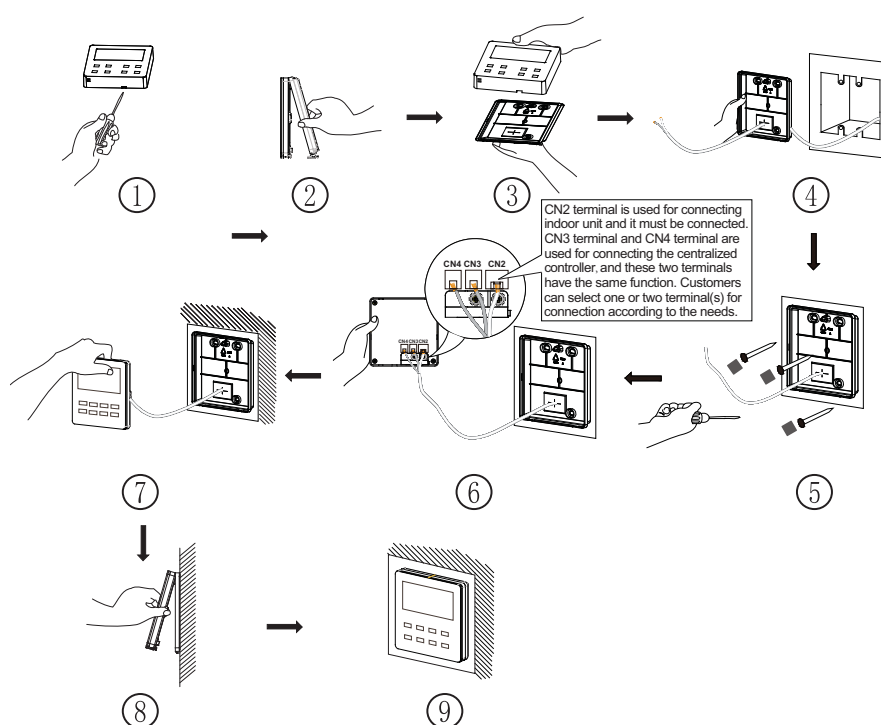

Fig. 23 Installation diagram for wired controller

Fig. 23 is the simple installation process of wired controller; please pay attention to the following items:

- (1) Before installation, please cut off the power for indoor unit;
- (2) Pull out the four-core twisted pair line from the installation holes and then let it go through the rectangular hole behind the back plate of the wired controller.

- (3) Stick the back plate of wired controller on the wall and then use screw M4×25 to fix back plate and installation hole on wall together, attach the sponge 20×20×3 at the screw hole and then press it with fingers to make sure it's attached firmly.
- (4) Insert four-pin cable twisted pair line into the slot of the wired controller and then buckle the front panel and the back plate of the wired controller together.
- (5) Block the four-core wire into the groove at the left side of wiring column; bundle the front panel of wired controller to its back plate.

Note:

- Separate the signal and communication lines of the wired controller from the power cord and connection lines between the indoor and outdoor unit, with a minimum interval of 20cm, otherwise the communication of the unit will probably work abnormally.
- If the air conditioning unit is installed where is vulnerable to electromagnetic interference, then the signal and communication lines of the wired controller must be the shielding twisted pair lines.
- The 4-core terminal connects the air conditioner, while the 2-core terminal connects the centralized controller. The connecting method for the 2-core connection wire is same as that of 4-core connection wire.
- No need to set the wire of wired controller into the clasp.

For matching with different models, the patch cord and the connection wire are provided in the packaging box of wired controller. As shown in fig. A.



Fig. A: Schematic diagram of patch cord and connection wire

- If the air conditioner has been installed with the patch cord (fig. C) connecting the wired controller.

Only use the connection wire (fig. B) in the packing box of wired controller. Connect the terminal ② to the terminal ④ of patch cord which has been installed on the air conditioner; insert terminal ① four pin terminal of wired controller. Remove connector cap "3" prior to installing cable.



Fig. B: Schematic diagram of connection wire: Connect terminal ① with wired controller CN2; connect terminal ② with the terminal ④ of patch cord



Fig. C: Schematic diagram of patch cord: Terminal ③ is the protection terminal; connect terminal ④ to the terminal ② of connection wire ; connect terminal ⑤ to the terminal of wired controller of air conditioner

● If the air conditioner hasn't been installed with the patch cord used for connecting the wired controller.

Use the connection wire and patch cord in the packing box of wired controller. Pull out the protection terminal of patch cord at first, connect the connection wire with the patch cord according to fig. D, and then insert the terminal ① of connection wire into the needle stand CN2 of wired controller and insert the terminal ⑤ of patch cord into the terminal of wired controller of air conditioner as well.



Fig. D: Schematic diagram after the connection wire and the patch cord have been connected: connect the terminal ② of connection wire and the terminal ④ of patch cord

4.4 Disassembly

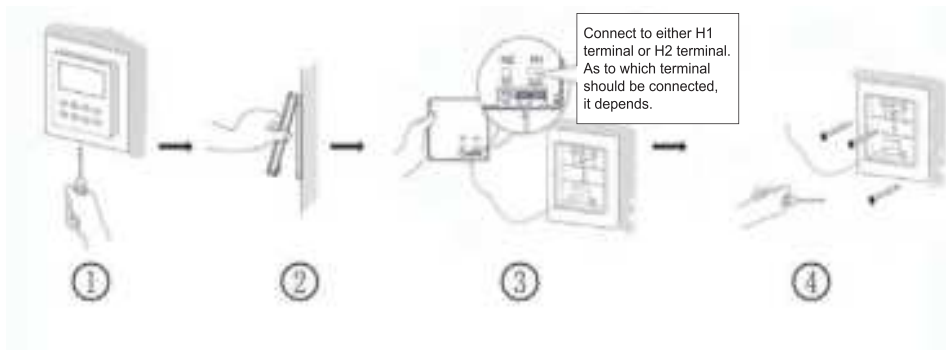

Fig. 24 Disassembly diagram for wired controller

