

# Electronic Design

THE MAGAZINE OF ESSENTIAL NEWS, PRODUCTS AND TECHNOLOGY

VOL.

FEB. 15

Today's electronics can't cure arteriosclerosis. But neither could D'Arsonval with this apparatus he designed in 1900. Nowadays, however, medical electronics is diagnosing and treating diseases which 19th-century sufferers didn't even know they had. For an engineer's prognosis of this fascinating field, turn to p. 50

# Daily Herald

Vol. XLVII, No. 17,020

February 15, 1900

New York, N.Y.

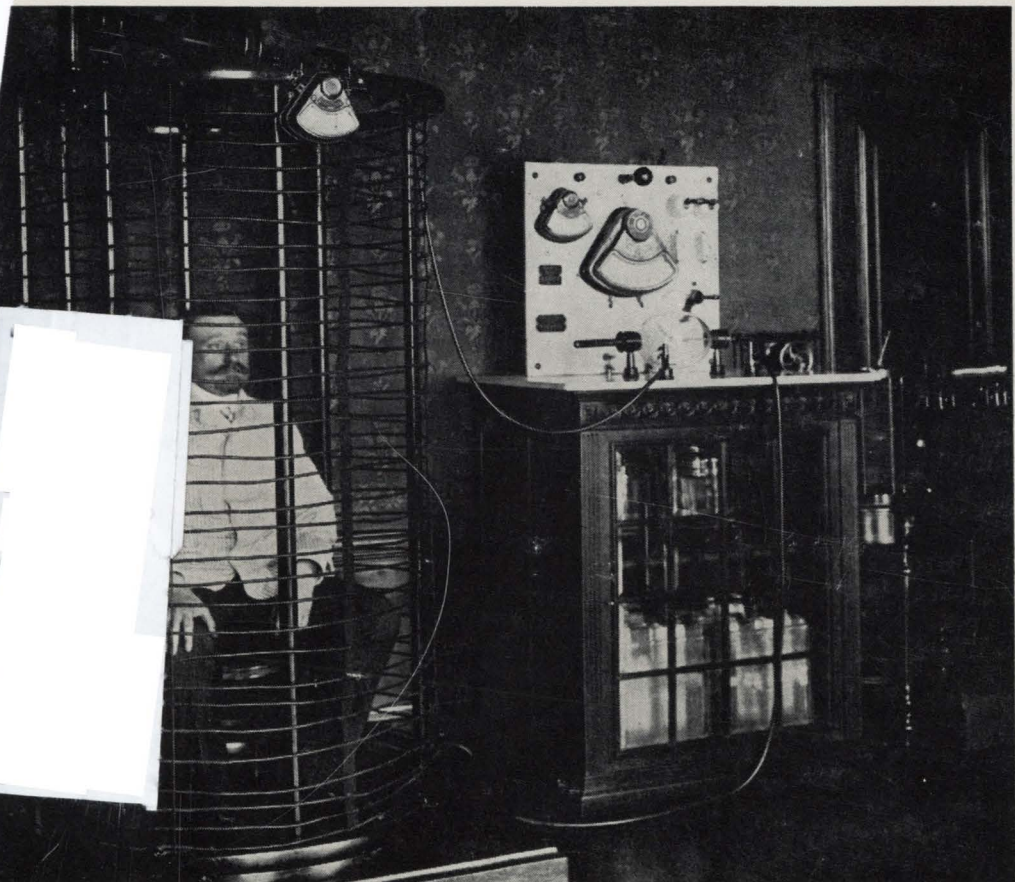

## JOHNS HOPKINS NEEDS MONEY

ANNAPOLIS, Feb. 14.—President Gilm of the Johns Hopkins University made strong plea before the Finance Committee in the Senate to-day for a State appropriation of \$50,000 annually for two years. After enumerating the losses sustained by the university in the depreciation of Baltimore and Ohio Railroad stock values and the suspension of dividends, he said:

"The expense of maintaining the university is not far from \$200,000. The income from investments is \$100,000 and income from tuition, \$50,000. These are around numbers, varying a little year by year. Unless the deficit of \$50,000 is made up, contraction must follow. Contraction will bring great discredit, will be known throughout the land and the students will drop out and a period of a year will follow."

"The university has no debts. Its investment in land, buildings, books, and apparatus, is \$1,000,000. It has friends, wide reputation, and the prospect of large gifts. But it cannot anticipate the legacies which are being made in its favor. What is needed is a continuation of the aid which the last Legislature gave for two years more."

No great opposition has yet made its appearance to the appropriation, but it is expected from the county members.

## FIGHT FOR TORRENCE'S

CHICAGO, Feb. 14.—The first fight on behalf of David Tod Torrence, the late Gen. Joseph T. Torrence, seeks to break his father's will. The late Gen. Joseph T. Torrence is doing become entitled to one-half million-dollar estate left by the late Gen. Joseph T. Torrence. The will was taken before Judge Dunne at 11 o'clock noon. The witness was H. T. Youngstown, Ohio.

Mr. Fisher's testimony was to the effect that Gen. Torrence was mentally incapable of making a will at the time the instrument was signed, and that he was laboring under the insane delusion that David Tod Torrence was not his nephew.

Under the terms of the will, the late Gen. Joseph T. Torrence was left in trust to the Illinois Savings Bank, that institution being the General's daughter. Mrs. Fisher lives in New York, \$20,000 per year. She is thirty years old, at the time the estate is to be her absolute property. In case his daughter die, the fortune is to be distributed to the General's brothers and sister. David Tod Torrence he bequeathed the sum of \$250,000.

## CARNEGIE REFUSES TO TALK.

ST. PETERSBURG, Fla., Feb. 14.—Andrew Carnegie refused to talk to his sister-in-law.

Andrew Carnegie refused to talk to his sister-in-law.

Andrew Carnegie refused to talk to his sister-in-law.

The use of electricity to treat hardening of the arteries. Technique, developed by... based on phenomenon known as high-frequency electromagnetic



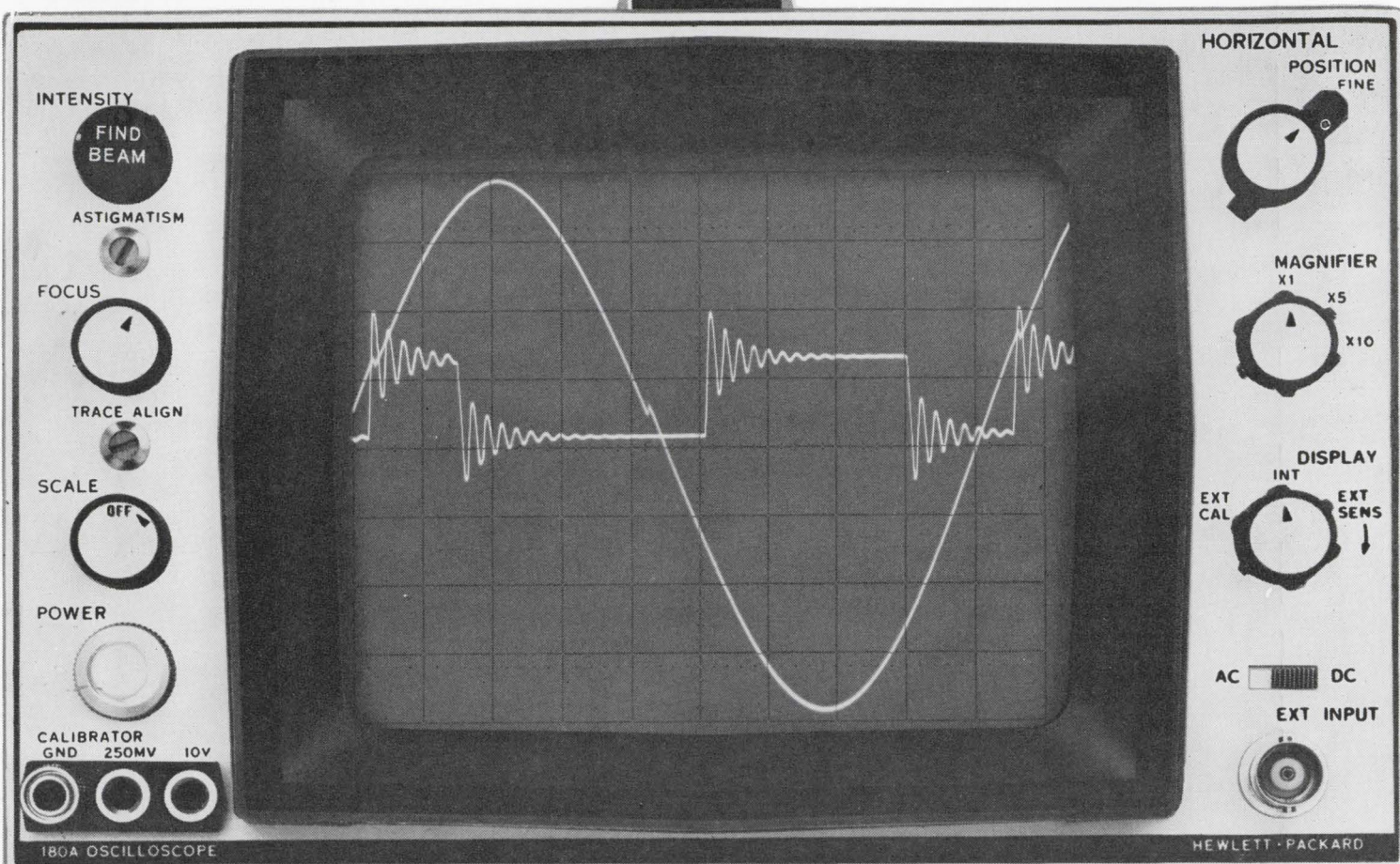

*See More! Do More!*

## LARGE AREA 8x10 cm CRT MAKES ACCURATE MEASUREMENTS—EASIER!

• 50 MHz at 5 mv/cm • 30 POUNDS • ALL-SOLID-STATE • PLUG-IN VERSATILITY

Accurate measurements are easier to read . . . easier to make on the new hp 180A *Big-Picture* Oscilloscope. New hp design breakthrough offers an extra-large 8 x 10 cm CRT display area—30% to 100% greater than any other high-frequency scope! You get sharp, crisp traces for resolution of waveform details. The black internal graticule, calibrated in centimeters, and bright trace — give you maximum contrast, make measurements easier to read, more accurate. Parallax error is eliminated. The 12 kv accelerating potential produces bright, easy-to-see traces, even at 5 nsec/cm sweeps. Flood guns in the CRT allow variable background illumination for optimum contrast of graticule and trace for excellent photographic recording.

Mainframe and plug-ins of the hp 180A are all-solid-state. Mainframe is the first with power supplies specifically designed for solid-state circuitry — gives you full performance benefits from solid-state devices in all present and future plug-ins.

The dual channel 50 MHz at 5 mv/cm vertical amplifiers have low-drift FET input stages for accurate DC measurement—plus quick 15-second warm-up. Vertical plug-in amplifiers drive the CRT vertical deflection plates directly requiring only 3 v/cm. This allows even greater bandwidth capabilities in future plug-ins.

Time base plug-ins offer new easy-to-use delayed sweep. Tunnel diode triggering circuits lock-in complex waveforms to beyond 90 MHz. Exclusive hp mixed sweep features combine display of first portion of trace at normal sweep speeds, and simultaneously expands trailing portion of trace at faster delayed sweep speed to allow magnified examination.

Get the BIG picture! Ask your nearest hp field representative for a demonstration of how you can see more, do more with the new versatile, go-anywhere, 30-pound hp 180A Oscilloscope. Or, write to Hewlett-Packard, Palo Alto, California 94304, Tel. (415) 326-7000; Europe: 54 Route des Acacias, Geneva. Price: hp Model 180A Oscilloscope, \$825.00; hp Model 180AR (rack) Oscilloscope, \$900.00; hp Model 1801A Dual Channel Vertical Amplifier, \$650.00; hp Model 1820A Time Base, \$475.00; hp Model 1821A Time Base and Delay Generator, \$800.00, f.o.b. factory.

**HEWLETT**  **PACKARD**  
An extra measure of performance

ACTUAL SIZE



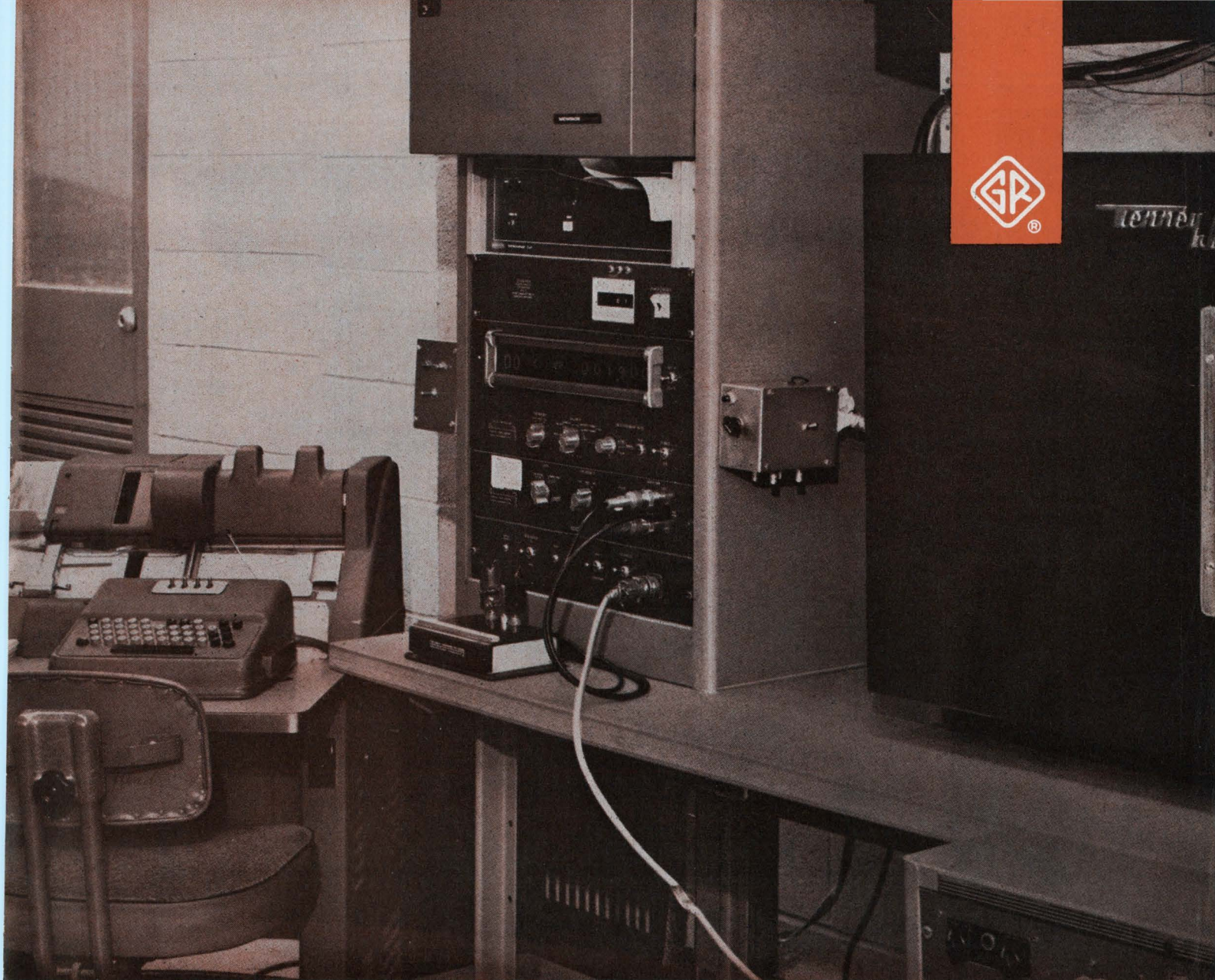

Photo courtesy of Electronics Products Division of Corning Glass Works.

## Customer Report:

### 1680-A Eliminates Human Error



Type 1680-A Automatic Capacitance Bridge Assembly, \$4975 in U.S.A.

Corning Glass Works' Electronics Products Division uses a GR automatic capacitance-measuring and recording system in its Quality Control Laboratory to log data of capacitors under test in an environmental chamber. The brains of the system is a GR 1680-A Automatic Capacitance Bridge Assembly, which is used with an automatic component indexer and an IBM 526 Card Punch. Each capacitor is placed across the bridge's input terminals by the indexer; almost instantly the measured values are automatically punched on an IBM card. Human error is thus eliminated, and data acquisition is made rapidly, accurately, efficiently, and in a form suitable for computer processing.

The 1680-A automatically selects C and D (or G) ranges, balances, and displays measurements in digital form,

showing decimal point and units of measurement. Measurement takes only 0.5 second at 1 kHz under worst conditions. Basic accuracy is 0.1% of reading for C and G, 1% of reading  $\pm 0.001$  for D. Measurement range is 0.01 pF to 1000  $\mu$ F.

For complete information, write General Radio Company, 22 Baker Avenue, W. Concord, Massachusetts 01781; telephone: (617) 369-4400; TWX: 710 347-1051.

## GENERAL RADIO

ON READER-SERVICE CARD CIRCLE 3



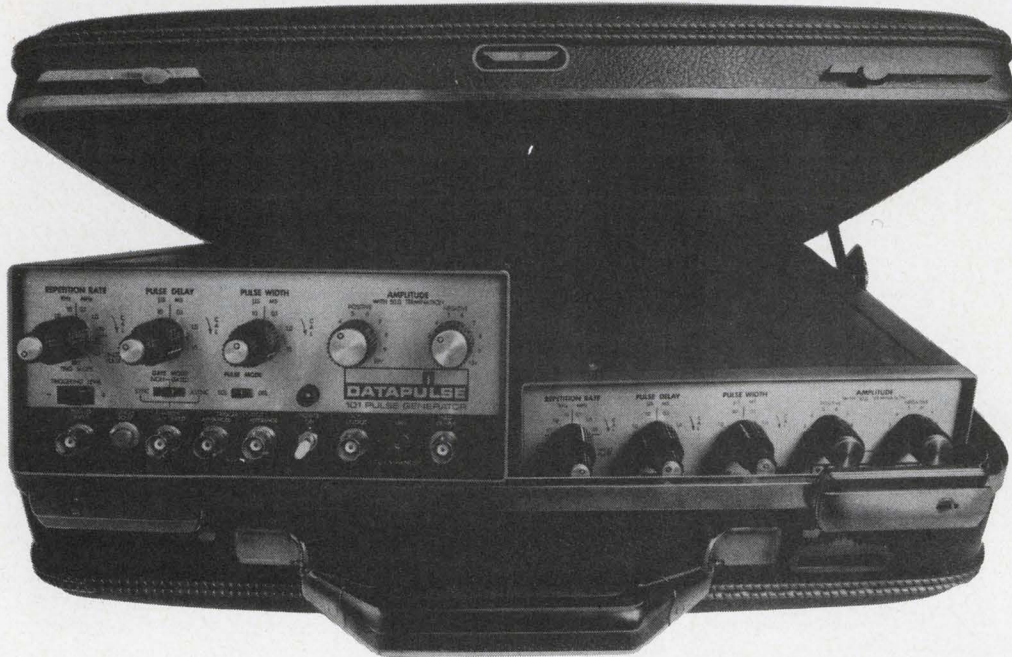

## A Brief Case for a New Pulse Generator

MODEL: 101. PRICE: \$395.00. DELIVERY: 4 weeks. MAJOR SPECS: rep. rates from 10 Hz to 10 MHz, single or double pulses, 5 ns rise time, simultaneous  $\pm 10V$  output, variable width and delay from 35 ns to 10 ms, duty cycles to 70%,  $\pm 250$  mV trigger sensitivity, and both synchronous and asynchronous gating. ■ TYPICAL APPLICATIONS:

### STABLE GENERATION OF PULSE BURSTS

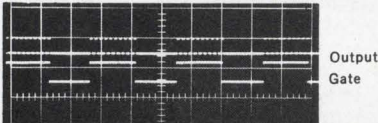

Output synchronously gated. 10 kHz pulse burst.

### GATED DIGITAL SIGNALS

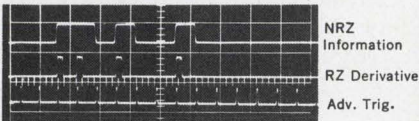

Output asynchronously gated against NRZ digital signals. Provides full control over RZ derivative. Advanced trigger outputs also serve as uninterrupted system clock.

### REP RATE COUNTDOWN

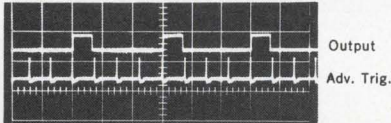

Output counted down from internal clock (or external triggers) for frequency division.

### DESIGN OF POWER CONTROL CIRCUITRY

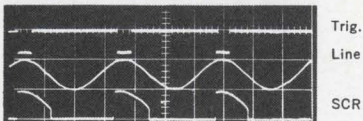

Output may be triggered from any point on an AC line voltage waveform. Allows phase control of SCRs, thyratrons, etc.

### STORAGE AND RECOVERY TIME STUDIES

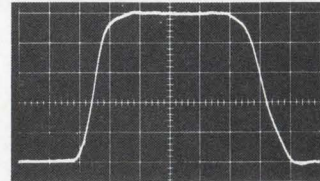

Clean pulses at 5 ns rise time. Horiz., 5ns/cm.

### BEACON INTERROGATION

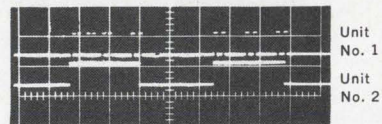

Outputs of two 101s shown. First unit determines pulse separation and pair separation. Second unit determines burst rate and pairs per burst.

EXTRA BENEFITS: Weight: 8 lbs. Height: 3½ inches. Width: 8½ inches. Rack mount two in 3½ inches of panel height. Rack mount for one unit leaves space for a data source or system control. ■ Convinced that the 101 offers champagne pulses on a beer budget? Ask for more evidence! See our Technical Bulletin 101 or a demonstration.

Datapulse welcomes technical employment inquiries.

**DATAPULSE**®



## NEWS

- 13 News Scope
- 17 **Integrated circuits shed their wires**  
Bonding connections will be replaced by solder bumps and beam leads.
- 24 **Skeletal arrays will use computers to fill gaps**  
Air Force antenna units will have fewer elements than conventional designs.
- 29 Washington Report
- 32 **Infrared unit spots circuit production flaws**  
Scanner compares thermal patterns of modules with those on a master tape.
- 49 Letters
- 50 **Staff Report: Medical electronics**
- 52 The outlook is rosy—for the initiated
- 56 It's largely a field of measurement
- 64 Many technical disciplines are involved
- 75 **Editorial: Needed: A way to tame the gypsy in us.**

## TECHNOLOGY

- 78 **Design a better integrated circuit** than those available off the shelf. A computer program can help you suggest circuit changes without using a breadboard.
- 84 **Explore thin-laminate properties** and limitations to find the proper combination of materials and processing steps for multilayer board design.
- 92 **Measure capacitance and resistance** of forward-biased diodes simply and accurately with standard laboratory test equipment.
- 98 **Switch from hot to cool** with one of these three solid-state motor speed control circuits. Thermistors team up with Diacs and Triacs to do the job.
- 104 **Pinpoint your profits** during the negotiation of incentive contracts. A nomograph enables you to evaluate any contract variable quickly.
- 110 NASA Tech Briefs
- 112 Ideas for Design

## PRODUCTS

- 122 **Semiconductors:** Plastic-packaged planar unijunctions leak less.
- 126 **Components:** Active filter design is duck soup with a hybrid RC module.
- 168 **Systems:** PC boards wire PC boards: costs cut across the board.
- 148 Test Equipment
- 152 Power Equipment
- 154 Microwaves
- 162 Materials
- 164 Microelectronics

## Departments

- 172 Design Aids
- 174 Application Notes
- 176 New Literature
- 180 Reprints
- 182 Advertisers' Index
- 184 Designer's Datebook

Reader Service Card inside back cover

**ELECTRONIC DESIGN** is published biweekly by Hayden Publishing Company, Inc., 850 Third Avenue, New York, N. Y. 10022. James S. Mulholland, Jr., President. Printed at Poole Bros., Inc., Chicago, Ill. Controlled-circulation postage paid at Chicago, Ill., Cleveland, Ohio, and New York, N. Y. Application to mail at controlled postage rates pending at St. Louis, Mo. Copyright © 1967, Hayden Publishing Company, Inc. 61,409 copies this issue.



# Best Op Amp

## Prices Dropped, Specs Raised on 5 Economy Models.

New Model 111 Is \$9.75 in 1,000 Lots

Did you view Analog Devices as innovator of industry's most advanced units? You're right. But we also offer best price and performance for economy amplifiers.

Don't take our word for it. Shop around and see for yourself. And look into ICs while you're at it. Then contact us for a sample to evaluate in your own circuit.

Model 111—\$13  
20  $\mu\text{V}/^\circ\text{C}$   
15,000 Gain  
2  $\text{nA}/^\circ\text{C}$

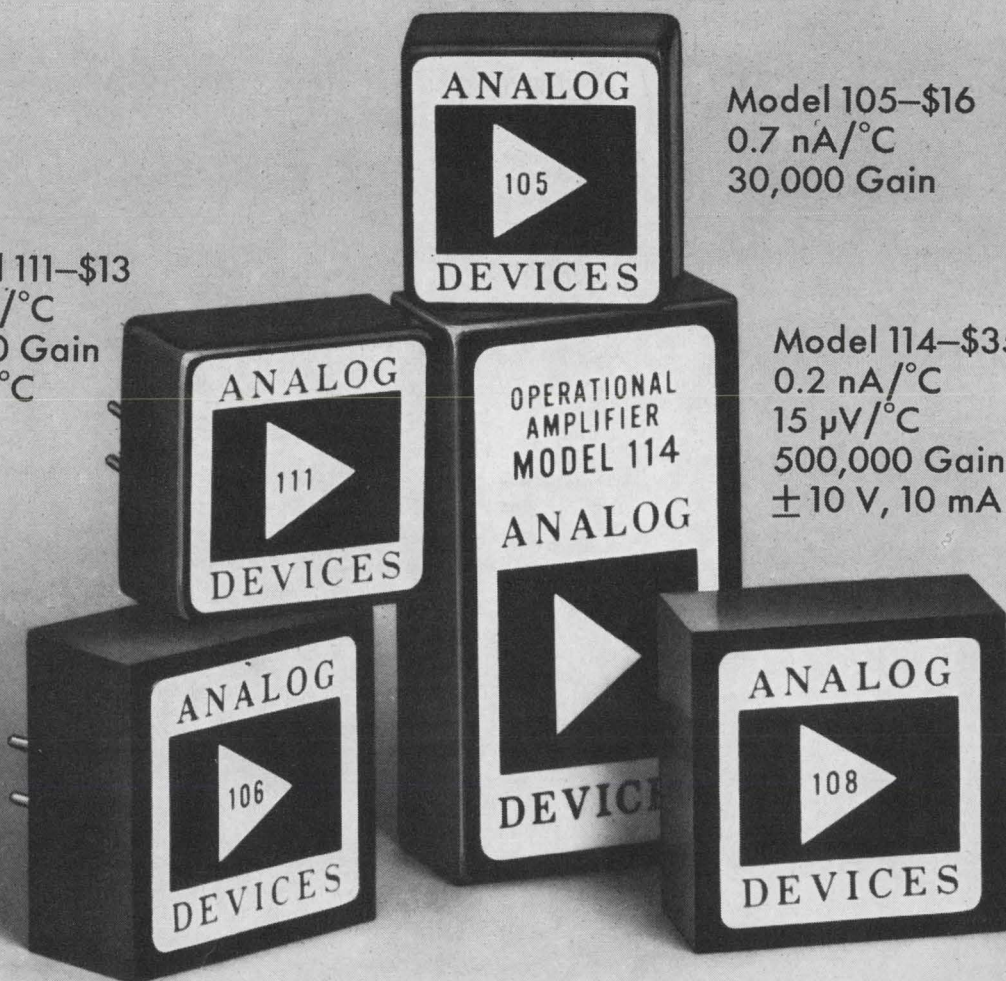

Model 105—\$16  
0.7  $\text{nA}/^\circ\text{C}$   
30,000 Gain

Model 114—\$35  
0.2  $\text{nA}/^\circ\text{C}$   
15  $\mu\text{V}/^\circ\text{C}$   
500,000 Gain  
 $\pm 10\text{ V}$ , 10 mA

Model 106—\$21  
0.7  $\text{nA}/^\circ\text{C}$   
 $\pm 10\text{ V}$ , 5 mA

Model 108—\$28  
0.2  $\text{nA}/^\circ\text{C}$   
100,000 Gain



# Values Ever!

Max. drift and min. gain values for  $-25^{\circ}\text{C}$  to  $+85^{\circ}\text{C}$  range contrast with "typical" values given by many op amp manufacturers. Selection of  $10\ \mu\text{V}/^{\circ}\text{C}$  and  $5\ \mu\text{V}/^{\circ}\text{C}$  drift offered in B & C models.

Parameter	Model 111	Model 105	Model 106	Model 108	Model 114
<b>Open-Loop Gain—min.</b>	15,000	30,000	250,000	100,000	500,000
<b>Rated Output—min.</b>	10 V, 2.5 mA	10 V, 2.5 mA	10 V, 5 mA	10 V, 2.5 mA	10 V, 10 mA
<b>Bias Current—max.</b>	200 nA	50 nA	50 nA	2 nA	2 nA
<b>vs. temp.—max.</b>	2 nA/ $^{\circ}\text{C}$	0.7 nA/ $^{\circ}\text{C}$	0.7 nA/ $^{\circ}\text{C}$	0.2 nA/ $^{\circ}\text{C}$	0.2 nA/ $^{\circ}\text{C}$
<b>Offset Current—max.</b>	20 nA	5 nA	5 nA	2 nA	2 nA
<b>vs. temp.—max.</b>	1 nA/ $^{\circ}\text{C}$	0.2 nA/ $^{\circ}\text{C}$	0.2 nA/ $^{\circ}\text{C}$	0.05 nA/ $^{\circ}\text{C}$	0.05 nA/ $^{\circ}\text{C}$
<b>Input Impedance</b>					
<b>differential</b>	200 k $\Omega$	1 m $\Omega$	1 m $\Omega$	4 m $\Omega$	4 m $\Omega$
<b>common mode</b>	50 m $\Omega$	100 m $\Omega$	100 m $\Omega$	500 m $\Omega$	500 m $\Omega$
<b>Bandwidth</b>	1.5 mHz	2 mHz	2 mHz	0.5 mHz	0.5 mHz
<b>Voltage Drift—max.</b>					
<b>Model A</b>	20 $\mu\text{V}/^{\circ}\text{C}$	20 $\mu\text{V}/^{\circ}\text{C}$	20 $\mu\text{V}/^{\circ}\text{C}$	20 $\mu\text{V}/^{\circ}\text{C}$	20 $\mu\text{V}/^{\circ}\text{C}$
<b>Model B</b>	—	10 $\mu\text{V}/^{\circ}\text{C}$	10 $\mu\text{V}/^{\circ}\text{C}$	10 $\mu\text{V}/^{\circ}\text{C}$	10 $\mu\text{V}/^{\circ}\text{C}$
<b>Model C</b>	—	5 $\mu\text{V}/^{\circ}\text{C}$	5 $\mu\text{V}/^{\circ}\text{C}$	5 $\mu\text{V}/^{\circ}\text{C}$	5 $\mu\text{V}/^{\circ}\text{C}$
<b>Price (1-9)</b>	\$13	A B C \$16 \$21 \$26	A B C \$21 \$26 \$31	A B C \$28 \$33 \$38	A B C \$35 \$40 \$45

**Price Performance Breakthrough**—Analog Devices has introduced a step-function improvement in price-performance ratio for low-cost op amps . . . not just a token advance over present-day standards.

**Consider**—Who else offers an op amp with Model 111's specs at \$9.75 in 1,000 quantities? Who else has a unit (Model 105) with bias current drift below  $0.7\ \text{nA}/^{\circ}\text{C}$  for only \$16? Where could you get a \$21 amplifier (Model 106) with 250,000 gain and 5 mA output? Or an amplifier (Model 108) with  $0.2\ \text{nA}/^{\circ}\text{C}$  maximum bias current drift and 100,000 gain for only \$28?

**Versus ICs**—The new price-performance standards set by

Analog Devices economy line clearly resolves the controversy between discrete-component and integrated-circuit operational amplifiers (except where size is the critical factor). Today, and for the foreseeable future, ICs just can't match the current-drift, gain, and input impedance values achieved by these new amplifiers. Model 111, at \$9.75 in 1,000-lots, shows that they can't compare in price for a given performance, either.

**No Excuses**—No longer can you justify a *make* rather than a *buy* decision, even when production runs into thousands of units. Now you can use op amps where they would have been uneconomical only last month.

**Catalog**—Mark bingo-card to get Economy Line Catalog with full details on these 5 units.



Catalog also gives specs on 6 further economy amplifiers. We'll send you a short-form catalog on our advanced units too.

**Sample**—Contact Don Belanger, Applications Engineer, for a unit to try out in your own circuit.

ANALOG

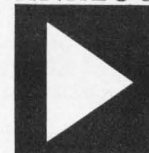

DEVICES

221 FIFTH STREET  
CAMBRIDGE,  
MASS. 02142  
617/491-1650

ON READER-SERVICE CARD CIRCLE 5



# MIL-T-713 calls for 22% to 32% wax coating on LACING TAPE.

• But what really is the right amount  
for trouble-free, tight-knot lacing?

• GUDEBROD KNOWS. They make yard after  
yard after yard exactly right!

• GUDEBROD TAPE cuts harness costs!

• Send for a sample.

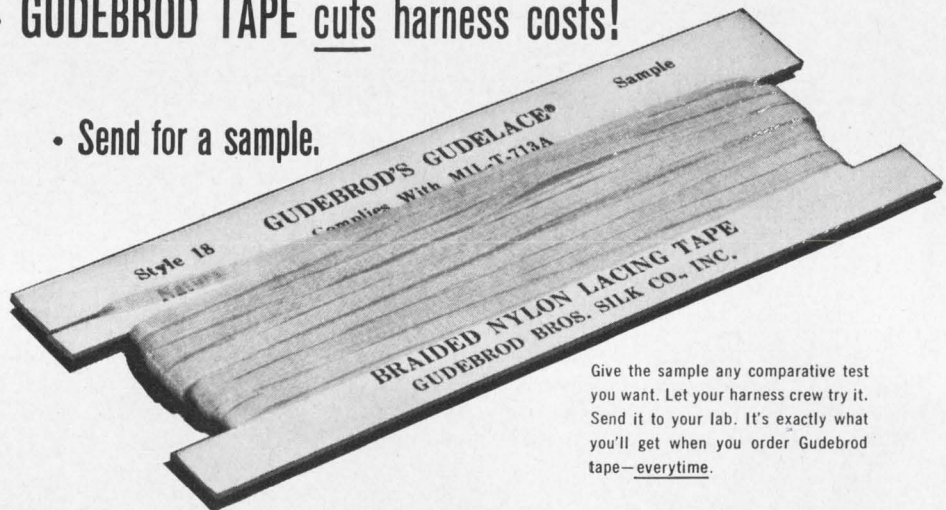

Give the sample any comparative test  
you want. Let your harness crew try it.  
Send it to your lab. It's exactly what  
you'll get when you order Gudebrod  
tape—everytime.

You are often required to lace with tape that meets MIL-T Specs—  
with a specified range of wax content. But that's no assurance that  
you are using a tape that ties tight, holds tight, that probably won't  
be rejected—unless, of course, you have Gudebrod Gudelace. Like  
all Gudebrod Lacing Tapes it's manufactured under strict quality  
control including the wax coating. Every yard of Gudelace is im-  
pregnated exactly the same, exactly right. You can count on that—and on  
speedier, easier, better harnessing. That's where you save real  
money. Want to know more? Get in touch with Gudebrod.

#### GUDEBROD CABLE-LACER

The first hand tool engineered for wire harnessing.  
Handle holds bobbins, feeds tape as needed,  
grips tape for knotting. Speeds, eases  
harnessing. Pays for  
itself in time saving.



Area Code 215, WA 2-1122



## GUDEBROD BROS. SILK CO., INC.

FOUNDED IN 1870

*Electronics Division*

12 SOUTH 12th STREET, PHILADELPHIA, PENNSYLVANIA 19107

ON READER-SERVICE CARD CIRCLE 6

ELECTRONIC DESIGN 4, February 15, 1967



**"Last month we said we had  
the world's finest  
integrated circuit operational amplifier.  
The proof is in this chart."**

Compare the specifications for our MC1533 in the chart below with any other high performance Op Amp. We're sure that the facts speak for themselves:

CHARACTERISTIC:	HIGH PERFORMANCE OPERATIONAL AMPLIFIERS						
	MC1533	MC1433	807B	$\mu$ A709	$\mu$ A709C	SN525	WM174Q
Temperature Range ( $^{\circ}$ C)	-55 to +125	0 to +75	-55 to +125	-55 to +125	0 to +75	*	-55 to +125
Open Loop Voltage Gain (min)	40,000	30,000	25,000	25,000	15,000	25,000 (typ) <sup>†</sup>	20,000
Input Impedance (min) *	500 K $\Omega$	300 K $\Omega$	500 K $\Omega$	150 K $\Omega$	50 K $\Omega$	80 K $\Omega$ (typ) <sup>†</sup>	100 K $\Omega$
Input Offset Current (max)	150 nA	500 nA	50 nA	200 nA	500 nA	50 nA (typ) <sup>†</sup>	500 nA
Input Offset Voltage (max)	5 mV	7.5 mV	2.5 mV	5 mV	7.5 mV	1 mV (typ) <sup>†</sup>	*
Temperature Drift, Voltage $\mu$ V/ $^{\circ}$ C Current nA/ $^{\circ}$ C	5 (typ) 0.05 (Typ)	8 (typ) 1 (typ)	10 (max) .5 (typ)	6 (typ) 2 (typ)	6 (typ)	*	*
Output Voltage Swing (min) @ Load of	$\pm$ 11 V 2 K $\Omega$	$\pm$ 10 V 2 K $\Omega$	$\pm$ 10 V 1 K $\Omega$	$\pm$ 10 V 2 K $\Omega$	$\pm$ 10 V 2 K $\Omega$	$\pm$ 6 V (typ) <sup>†</sup> 600 $\Omega$	$\pm$ 10 V —
Input Common Mode Swing (min)	+9 -8 V	$\pm$ 8 V	$\pm$ 7 V	$\pm$ 8 V	$\pm$ 8 V	$\pm$ 6 V (typ) <sup>†</sup>	—
Slew Rate (typ)	11 V/ $\mu$ sec	11 V/ $\mu$ sec	*	*	*	*	*
Package	10 Pin TO-5 and Flat	10 Pin TO-5 and Flat	TO-5 and Flat	8 Pin TO-5 and Flat	8 Pin TO-5 and Flat	10 Pin Flat	12 Pin Flat
Price @ 100 quantity							
TO-5	34.00	15.00	45.00	50.00	15.00	*	*
Flat	40.00	19.00	45.00	65.33	32.50	38.50	49.30

\* — Parameter not specified or unknown  
† Min-Max specifications unavailable

Choose the one with the highest gain.  
Choose the one with the fastest slew rate.  
Choose the one with the highest stability.  
Choose the one with the largest output voltage swing.

**SEE WHAT WE MEANT LAST MONTH?**

Now that you've chosen, on the basis of comparative specifications, Motorola's MC1533 Integrated Circuit Operational Amplifier, here's the clincher: We have a whole series of Application Notes designed to help you to better understand its use. We'll send them to you, gratis, with our data sheets, including a data sheet for the new MC1433 (\$15.00, 100-up version of the MC1533). Just drop us a line on your company letterhead.

*where the priceless ingredient is care!*



**MOTOROLA Semiconductors**

MOTOROLA SEMICONDUCTOR PRODUCTS INC. / P.O. BOX 955 / PHOENIX, ARIZONA 85001 / (602) 273-6900 / TWX 910-951-1334

ON READER-SERVICE CARD CIRCLE 7



# lumber sorting—the modern way

Allen-Bradley control panel—  
incorporating A-B dry reed switching units—  
substantially increased “output”!



■ Here's a lumber sorting operation where Allen-Bradley dry reed switching solved a serious problem. It provides not only the required high speed switching for rapid sorting but also the required reliability to insure continuous operation. The unavoidable operating conditions—extreme dust with wide temperature variations—can be ignored in reed switching.

The reason for the success of this installation is self-evident. To begin with, each individual dry reed contact in the Allen-Bradley system is hermetically sealed within an inert gas filled glass tube—contact contamination cannot occur. Consequently, the A-B reed devices will provide hundreds of millions of faultless operations.

Allen-Bradley dry reed switching is in the millisecond range. Unlike solid state devices, it is insensitive to “transients” or wide temperature variations. Also, A-B dry

reed switching consists of simple relay circuits, with which electricians are well acquainted.

All Allen-Bradley units are of rugged modular construction, uniform in height and depth and arranged for panel mounting. Terminals—all accessible from the front and individually identified—simplify wiring and circuit tracing.

Allen-Bradley dry reed switching units are available in a variety of types, as described at the right, to make possible complete design flexibility. Allen-Bradley engineers will be pleased to work with you on the application of these dry reed switching units. Please let us hear from you. Allen-Bradley Co., 1344 South Second Street, Milwaukee, Wisconsin 53204. In Canada: Allen-Bradley Canada Ltd. Export Office: 630 Third Ave., N.Y., N.Y., U.S.A. 10017.



# Allen-Bradley has available a complete line of dry reed switching units

## BULLETIN 1610L Magnetically Latched Dry Reed Relays

Latching contacts have permanent magnet bias not strong enough to operate the contacts, but strong enough to hold them in position once they have been operated even if coil power is removed. Relays have coils with separate "latch" and "unlatch" windings. Available with 2, 4, 6, and 8 poles.

## BULLETIN 1614L Flip-Flop Units

Consist of prewired magnetically latched input and output relays. Output relays have four contacts. Units can be assembled to perform counting functions: binary, binary coded decimal, and decimal counters. No power is required to maintain steady state condition.

## BULLETIN 1610 Dry Reed Relays

All A-B dry reed switching units are similar in appearance and construction. Enclosures are identical in height and depth—only the width varies. The dry reed relays consist of individual hermetically sealed contacts, either N.O., N.C., or various combinations of both. A single coil surrounds all the switches in the relay. The steel enclosure completes the magnetic circuit and shields the switches from external fields. Available in four basic enclosure sizes. Standard coil voltages 24 v and 125 v dc.

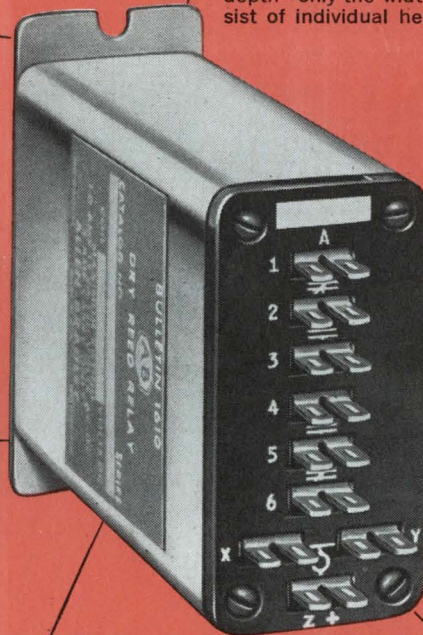

## BULLETIN 1612L Shift Register Units

These are self-contained shift register stages consisting of magnetically latched storage and transfer relays. A dual coil surrounds the magnetically biased dry reed switches. Two isolated contacts are available for signal outputs. Can be furnished with various contact arrangements.

Bulletin 1610

## BULLETIN 1618 Diode Units

Are assemblies of hermetically sealed high quality silicon diodes conveniently enclosed. The units are internally wired in three ways: separate terminals for each diode, pairs of diodes with a common anode terminal or with a common cathode terminal. Number of diodes: 7 or 13; pairs of diodes: 5 or 9.

## BULLETIN 1616 Logic Units

Contain double-wound coils with the windings in opposition. Each winding will cause contact operation when energized alone. Various logic functions can be performed: nor, and exclusive-or, inclusive-or, and comparator. A variety of output contact combinations can be furnished.

Allen-Bradley has many other components and accessories to round out the complete dry reed switching line, such as:

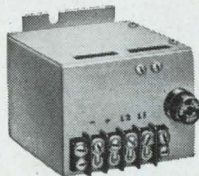

## BULLETIN 1690 Power Supply

It furnishes filtered direct current for proper operation of the high speed dry reed devices.



## BULLETIN 1691

**Resistor-Capacity Network**  
Provides arc suppression for contact protection when switching inductive loads.

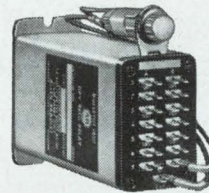

Compact clip-on pilot light units are also available. Readily visible, lights are easy to mount by slipping bracket into a recess at the top of the terminal block.



# ALLEN-BRADLEY

Member of NEMA

## QUALITY MOTOR CONTROL

ON READER-SERVICE CARD CIRCLE 8



# Now from Sprague!

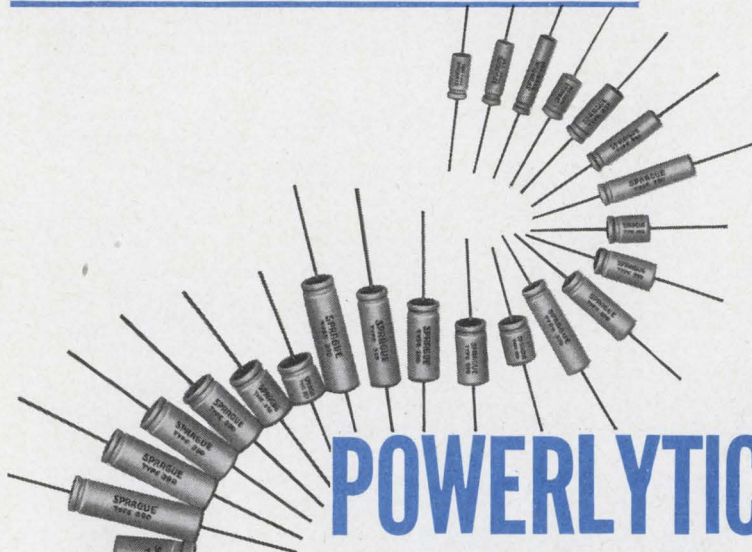

## POWERLYTIC® CAPACITORS IN 42 CASE SIZES...



for maximum capacitance in minimum space!

### Type 36D Cylindrical Case

Designed specifically for space economy, in applications such as computer power supplies, industrial controls, high gain amplifiers, etc. Case sizes from  $1\frac{3}{8}$ " x  $2\frac{1}{8}$ " to 3" x  $5\frac{5}{8}$ ". Improved temperature capabilities—may now be operated at 85 C. Low equivalent series resistance, low leakage current, excellent shelf life, high ripple current capability. Superior seal employs molded cover with recessed rubber gasket. Reliable safety vents. Solder lug or tapped terminals. Standard ratings from 3 to 450 VDC, capacitance values to 270,000  $\mu$ F.

### Type 39D Tubular Case

Smaller companion to proven 36D capacitor, possessing same outstanding performance. Case sizes from  $\frac{1}{2}$ " x  $1\frac{1}{8}$ " to 1" x  $3\frac{5}{8}$ ". Designed for operation at temperatures up to 85 C. Unique construction—anode and cathode terminals are welded—no riveted or pressure connections—prevents open circuits, even in microvolt signal range. Improved molded phenolic end seals contribute to unusually long life (expectancy, 10 years or more). Low effective series resistance, low leakage current. Standard ratings include capacitance values to 18,000  $\mu$ F, voltages from 3 to 450 VDC.

For complete technical data on Type 36D or Type 39D Powerlytic Capacitors, write for Engineering Bulletins 3431B and 3415, respectively, to Technical Literature Service, Sprague Electric Co., 347 Marshall Street, North Adams, Mass. 01247.

Popular ratings are now available for fast delivery from your Sprague Industrial Distributor.

### SPRAGUE COMPONENTS

CAPACITORS  
TRANSISTORS  
RESISTORS  
INTEGRATED CIRCUITS  
THIN-FILM MICROCIRCUITS  
45C-5131R2

PULSE TRANSFORMERS  
INTERFERENCE FILTERS  
PULSE-FORMING NETWORKS  
TOROIDAL INDUCTORS  
ELECTRIC WAVE FILTERS

CERAMIC-BASE PRINTED NETWORKS  
PACKAGED COMPONENT ASSEMBLIES  
BOBBIN and TAPE WOUND MAGNETIC CORES  
SILICON RECTIFIER GATE CONTROLS  
FUNCTIONAL DIGITAL CIRCUITS

**SPRAGUE®**  
THE MARK OF RELIABILITY

'Sprague' and '®' are registered trademarks of the Sprague Electric Co.

ON READER-SERVICE CARD CIRCLE 9



# News

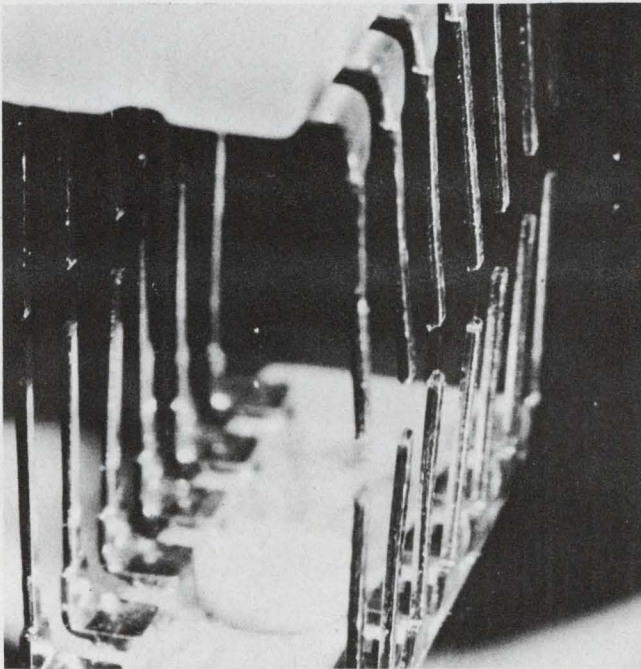

Beam leads and bumps start to take the place of frail bonding wires in IC packages. Page 17



Computers teach the Morse code to 24 Army pupils at once, each at his own pace. Page 36

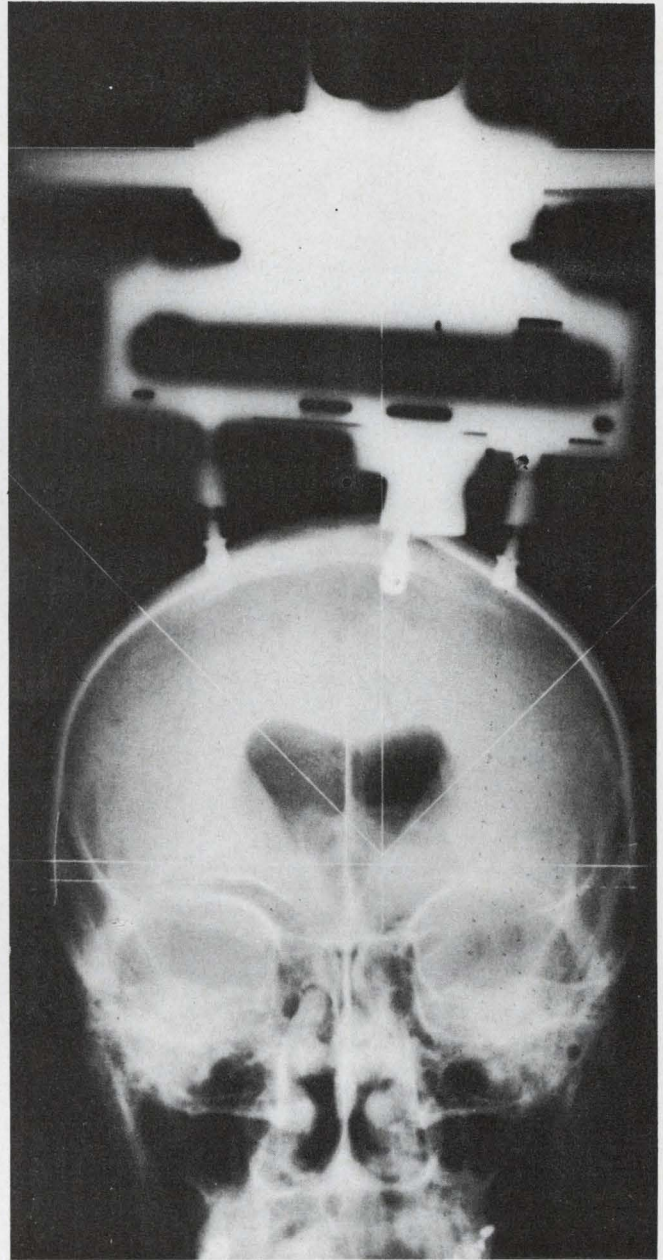

The science of electronics opens new fields of opportunity to the art of medicine. Page 50

## Also in this section:

Skeletal arrays use fewer elements with no loss of resolution. Page 22

Automatic infrared scanner spots flaws in the production of circuit modules. Page 32

News Scope, Page 13 . . . Washington Report, Page 29 . . . Editorial, Page 75



# gigacycle counters

Only Systron-Donner can give you microwave frequency measuring systems, fully contained in one cabinet, that read directly in gigacycles. Just like this 11 gigacycle reading.

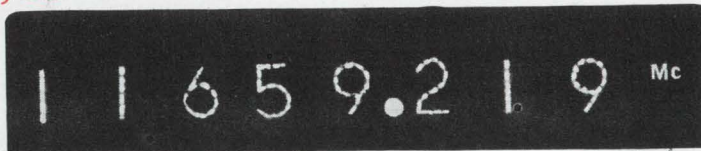

This one reads gigacycles instantly and automatically—eliminating all risk of human error. It's made possible by our unique plug-in, an Automatic Computing Transfer Oscillator called ACTO® for short.

There are three ACTOs, but you need only the one for the range you're working in: 0.3 to 3 GHz, 3 to 8 GHz, or 8 to 12.4 GHz.

The one at right requires simple tuning, but it measures FM, FM deviation, and pulsed RF as well as CW. The plug-in is our semi-automatic transfer oscillator with phase lock to get counter accuracy. The T.O. range is so wide that this cabinet will measure the entire spectrum from dc to 15 GHz.



This group illustrates the Systron-Donner philosophy of advanced counter instrumentation. A basic counter or counter-timer measures to 100 MHz. Plug-ins add functions or extend the frequency range with unequalled convenience and economy.



Send for this instructive booklet.

Systron-Donner Corporation, 888 Galindo Street, Concord, California

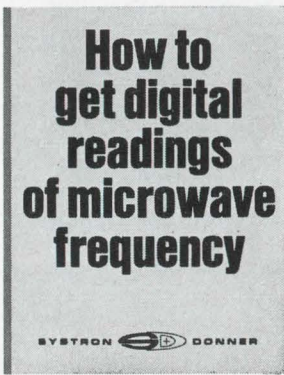

**SYSTRON**  **DONNER**

ON READER-SERVICE CARD CIRCLE 10



# News Scope

## U.S. missile designers Seek harder hardware

Redesign of U.S. ICBM warheads is being pushed, amid widespread speculation that the Soviet antimissile defense is relying on the energy of X-rays to knock out incoming hardware. But American concern over the "hardness" of its atomic missiles is hardly new.

This country has known since August, 1958—when it conducted high-altitude nuclear explosions over the Pacific—that an electromagnetic defense against missiles is theoretically possible. The effects of thermonuclear blasts in the upper atmosphere, it was found, are not confined just to tremendous blast, heat, and gamma and neutron radiation effects. A U.S. Army report, *The Effects of Nuclear Weapons*, published in April, 1962 described the added punch this way:

"The ionization produced by thermal X-ray and ultraviolet light, which is small at lower levels, becomes significant for nuclear detonations in the 40-to-70 mile range."

The X-rays at this height, the report said, "carry as much as two thirds of the explosion energy," and "the electron values they produce will be high and will extend out to some distance from the point of burst."

"Immediately after the time of the burst," the report said, "the thermal X-rays deposit about half the total energy of the detonation

within a few miles of the burst point. If the energy yield is in the megaton range, this energy will be sufficient to dissociate and ionize essentially all of the molecules of oxygen and nitrogen in the air and raise the temperature of the region by several thousand degrees."

Under these conditions, the guidance and electronic systems in missile warheads may be disabled. But heavier shielding and added protection for circuits increase weight critically and cut the payload of the missile.

Pentagon concern has been increasing, because in one Soviet test in 1961 a single thermonuclear explosion succeeded in destroying two incoming missiles.

Modification of U.S. missiles, with the aim of "further decreasing warhead vulnerability to nuclear environments generated by antiballistic missile counter-measures," has been a continuing program, according to the Atomic Energy Commission's latest annual report. The rub, however, is this: with atmospheric atomic blasts now banned under a U.S.-Soviet agreement, there is no effective way for the U.S. to test whether its redesigns have solved the problem.

The Soviet antimissile system is reported under construction around such major cities as Moscow and Leningrad. So far the U.S. has shied away from building a similar network.

In an effort to avoid escalation of the world armaments race, the U.S. has initiated talks with the Soviet Union, aimed at freezing the status quo in missile defense.

### Physics show abounds in electronic devices

Electronics has become an integral part of physics research that one exhibitor at the annual American Physical Society show in New York remarked, "You can't be a

physicist today without handling electronic instruments."

Some of the chief factors in this blossoming instrumentation market were apparent on a tour of the four-day show that ended on Feb. 2.

Microcircuits are moving very quickly into the wide range of counting and timing instruments physicists use to tally up and analyze the outputs of various detectors. The biggest use of these instruments is in nuclear research, but other applications range from cell studies to space.

Computers are moving from a passive analytical role into closer touch with actual experiments. Reasonably priced, smaller scientific computers and the time-shared systems being installed by large research organizations are the primary influences. Instrumentation is showing up that is suitable for programming from a computer and sending outputs to the computer.

Lasers are proving to be versatile research tools. For physics and biological research, the market for pulsed lasers alone is now about \$3-4 million annually, one exhibitor estimated. A typical system sells in the \$20,000 range.

Manufacturers such as Hewlett-Packard, EG&G, Electro-Mechanical research, Keithley Instruments, RCA and Varian showed ranges of product lines. Many small companies showed devices or instruments that had a high degree of design ingenuity. Competition for the physicists' dollars is obviously keen, but the potential for further expansion seems to warrant the effort.

### Lack of magnetic field may hurt lunar explorers

By now it is conclusively established that there is no magnetic field on the moon. An article in the Soviet equivalent of *Aviation Week (Aviation and Cosmonautics)*, July, 1966) by Dr. V. Lebedev sees this as a possible source of danger for lunar explorers.

The author cites experimental evidence indicating that our time perception (the biological clock) is dependent on the frequency of the earth's magnetic field. Thus, the frequencies of the major brain biopotentials (the so-called alpha rhythm) vary between 8 and 16 Hz, which is in the range of the fre-

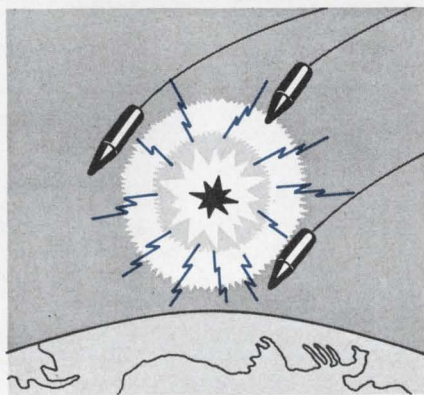

Can X-rays knock out missiles?



# News Scope

CONTINUED

quencies of fluctuation in the earth's magnetic field.

Experiments with human beings show that our perception of time is inversely proportional to the frequency of the alpha rhythm.

The importance of the accuracy of our "clocks" is not fully understood at this time. Two assumptions about the possible effects of zero magnetic field environment on humans can be stated, however, as:

Either the absence of magnetic field will have no effect on the physiological activity of a body provided that its intercellular processes, after millions of years of "experience," require no external timing;

Or the functioning of a body will be adversely affected. In this case the astronauts will have to have generators of slow electromagnetic signals added to their headgear.

## Study of frequency shift stirs walkie-talkie static

Confusion in the walkie-talkie market is now almost as bad as reception sometimes is with the popular radio sets.

Some manufacturers have reacted with wounded outrage to the news that the Federal Communications Commission is considering shifting the frequency for walkie-talkie transmissions from the citizens' band of 27 MHz to the area between 49.9 and 50 MHz. Such a move would make most of the walkie-talkies on the market today obsolete, since most are inexpensive units that cannot readily be converted.

One manufacturer told *The New York Times* that a \$500,000 order was in jeopardy.

The Chief Engineer's Office of the FCC, which is studying the question of a shift in frequencies, says that there have been "a lot of complaints" about interference on the citizens' band. The low-power walkie-talkies have become troublesome because they are one of the fastest-growing toys on the market. It has been estimated that at least 10 million children and adults in the nation use them for diver-

sion. Many of the sets are imported from Japan.

According to FCC table of frequency allocations, the area from 49.9 to 50 megahertz is now allocated to broadcasting, mobile and fixed services. The code stations of amateur radio operators are also in the vicinity, and some pessimists fear that any shift in the frequency of one hobby might only impinge on the other.

## Physicist envisions the end of time

There may well exist a scale of distances and events so small that time loses its meaning, according to Dr. John A. Wheeler, professor of physics at Princeton University.

Dr. Wheeler described how scientists, probing ever deeper into the nature of matter, have always found evidence of yet deeper strata beyond their reach. To this, he suggested to the annual meeting of the American Physical Society in New York, there must be an ultimate end. He envisioned a final geometric unit that would be approximately  $10^{-33}$  centimeters in length.

On this infinitesimal and so far unattainable scale, there would be a change in the quality of everyday phenomena, much as happens at velocities great enough for the effects of relativity to be evident. On this least scale, he said, "time would have no meaning; there would be no such thing as before and after."

## Three firms unite to bid for Voyager contract

A consortium has been set up to bid for a NASA contract to make the preliminary design of an unmanned space capsule to be landed on Mars.

The capsule would be the main component of the Voyager interplanetary vehicle, which may be lobbed toward Mars atop a Saturn V rocket as early 1973. The automaton would collect data on possible life forms, the atmosphere and geophysics of the planet.

Martin Marietta Corp.'s Denver division would be the prime contractor of the consortium. It would undertake total program management and over-all systems engineering and integration.

The Autonetics Div. of North

American Aviation, Anaheim, Calif., would deal with the electronics of the capsule's flight-control system and its sensor apparatus. RCA's Astro-Electronics Div. at Princeton, N.J., would handle Voyager's telemetry and communications equipment.

## Computer programs available from NASA

Twenty-two computer programs that can be adapted for industrial and educational use are being offered by the National Aeronautics and Space Administration at "a nominal charge."

The programs, the result of space research, are described in a catalog, *Mathematical Computer Programs: A Compilation*. The catalog can be ordered for \$1 (specify "NASA SP-5069") from the Clearinghouse for Federal Scientific and Technical Information, Springfield, Va. 22151.

## IBM confirms probe of computer market

International Business Machines Corp. has confirmed reports that it was advised by the Justice Dept. that "a preliminary investigation" of the whole computer industry is under way. The company was also advised that, "depending on the facts, a more comprehensive investigation may follow in the future."

Justice Dept. officials refused to discuss the probe, but there was speculation that there will be an intensive investigation of sales and pricing practices of IBM and of other computer manufacturers. As IBM holds a lion's share of the market, it is naturally expected to be the main target.

It is estimated that IBM manufactured about 60 to 70 per cent of the more than 40,000 computers in operation in the U.S. The company may also account for as much as three-quarters of the more than 23,000 unfilled orders in the industry—some 18,000 machines. Practically all these are System/360 models.

It is believed that the Justice Dept. investigation was instigated by other computer manufacturers' complaints about IBM. Many firms feel that antitrust proceedings are overdue against a company that commands so large a proportion of the market.



# Westinghouse makes IC's faster than you can buy them



18 gate circuits with 1 to 6 gates per package in a variety of input arrangements, 3 RS flip-flops, 2 JK flip-flops, 1 pulse binary counter, plus diode expanders, and a variety of interface circuits...all available in dual-in-line pack, flat-pak, or TO can. For technical data, write Westinghouse Molecular Electronics Division, P.O. Box 7377, Elkridge, Maryland 21227.

**Call your Westinghouse Electronic Distributor now.**

You can be sure if it's Westinghouse

J-09136





Two years ago, Varian introduced an exceptional new line of diodes — **Bimode® diodes**. They are still the best frequency multiplier diodes in their class!

**STANDARD SERIES ELECTRICAL SPECIFICATIONS**

Type Number	Output Frequency Range Mc	Output Power Range W	Minimum Reverse Breakdown Voltage V	Junction Capacitance at -6 Volts pf	Minimum Cutoff Frequency or Maximum series Resistance GHz or (Ω)	Maximum Transition Time ns	Maximum Thermal Resistance °C/W
VAB800	300- 750	3- 30	200	18- 25	(0.35)	10.0	3
VAB810	500- 1000	2- 24	175	18- 25	(.35)	8.0	3
VAB820	600- 1200	2- 16	150	10- 20	40	5.0	5
VAB801	750- 1500	1- 10	120	8- 10	60	3.0	7
VAB811	1000- 2500	1- 10	100	8- 10	60	2.0	7
VAB802	1500- 3000	1- 6	120	4- 5	90	3.0	10
VAB812	2000- 4000	1- 6	100	4- 5	90	2.0	11
VAB803	3000- 5000	0.5- 4	80	2.5-3.5	120	1.0	13
VAB804	5000- 7000	0.5-2.5	80	1.5-2.5	150	0.70	15
VAB814	5000- 8000	0.3-1.5	60	1.5-2.5	150	0.40	15
VAB824	6000- 9000	0.3-1.4	50	1.0-1.5	160	0.30	30
VAB805	8000-12000	0.1-1.0	40	0.5-0.7	175	0.15	50
VAB806	12000-15000	0.05-0.5	30	0.3-0.5	200	0.10	75
VAB807	15000-25000	0.05	6	0.15-0.2	350	0.05	300

Now Varian introduces **Super Power Bimode® diodes — 3 db power improvement**

over the standard series, not to mention 70% efficiencies. No other comparable diodes can match their performance!

Varian's new Super Power Bimodes offer complete static characterization, plus guaranteed dynamic performance. (Over 20 case styles to choose from.)

For a bulletin describing Super Power Bimode® diodes, write VARIAN BOMAC, Salem Road, Beverly, Massachusetts. In Europe: Varian A. G., Zug, Switzerland. In Canada: Varian Associates of Canada, Ltd., Georgetown, Ontario.  
**"AT THE IEEE SHOW DON'T MISS THE WORLD OF VARIAN"**



ON READER-SERVICE CARD CIRCLE 12



# Integrated circuits shed their wires

**Bonding connections, cause of many headaches, are being replaced by solder bumps and beam leads**

**Roger Kenneth Field**  
Microelectronics Editor

The ideal integrated-circuit package is small, cheap, reliable and capable of dissipating heat easily. But it is not easy to attain. For one thing, the extremely fine wires that connect the chip's bonding pad to the package's terminal studs are frail, unreliable and expensive, and the assembly takes many times the space of the chip.

Some of the sharpest device designers are creating new packages that will bring the ideal closer to the distributors' shelves. Naturally the new generation of integrated-circuit packages will not have those troublesome wires.

Here are some of the interesting new wireless packages:

- A new production machine, developed by Fairchild Semiconductor, Mountain View, Calif., bonds a chip in one motion, into a dual, in-line package. The chip is prepared with aluminum bumps on its bonding pads, and the package—a ceramic substrate with legs—has a matching gold-plated lead pattern (see Fig. 1).

- A tiny monolithic memory that has beam leads for structural support has been fabricated by Bell Telephone Laboratories, Murray Hill, N. J. The memory, packaged and equipped with 24 leads, measures only 30 by 36 mils. All its 32 active elements are isolated one from another by air.

- Integrated circuits prepared by the decal method—in which a layer of glass holds together the air-isolated elements—have been developed by RCA Laboratories, Princeton, N. J. The glass-protected circuits have a bump of solder on each of their bonding pads. The circuits can be soldered directly to the copper plating on a printed-circuit board, according to the scientists who developed the process.

All three processes eliminate the troublesome wires. Only one-third

the diameter of a human hair, these wires often break loose from their pads when the devices are subjected to extreme accelerations. And they are expensive to put on. The bond at each end of the wires must be positioned by hand, with a micro-manipulator, by a production worker who peers at the wires through a microscope. A worker can connect only about 350 integrated circuits a day.

The wires also introduce production problems. The wirer must center the bond on its pad. A misplaced weld can short out two terminals. Or it can ruin working devices near the bonding pad. Even if the weld is perfectly centered, visual inspection cannot always determine whether or not it is mechanically secure and electrically sound.

## Any chip is fair game

The new processes can be used with any integrated circuit.

The Fairchild machine is already at work on the production line. It bonds a 14-lead chip into a ceramic package (called the Fairpak) in 20 seconds instead of the minute and a half required to hand-wire the same chip. The Fairpak looks like, and is interchangeable with, the dual, in-line pack that is in common use.

The company expects to package 10 per cent of its dual in-lines in Fairpaks this year. The first units will contain DTL. They should reach distributors' shelves by the end of this month. After the cost of developing the Fairpak is written off, the company expects to pass the savings along to the customer.

## Beam leads and decals coming

It will be a while before Bell Laboratory's beam lead and RCA's decal, integrated circuits are in production and available off the shelf. When they are, however, they will offer the designer many advantages. The air-isolated elements of both

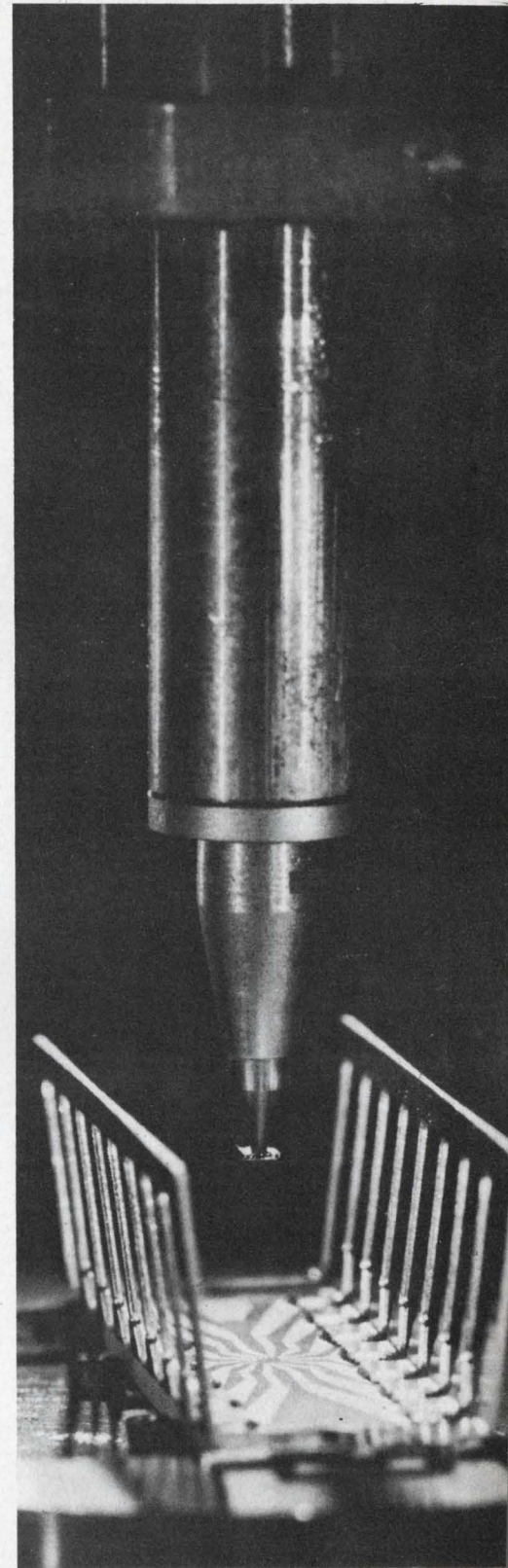

1. The shaft is poised, ready to lower the chip to the heated substrate. Fairchild's wireless bonder is on the production line.



**(IC wires, continued)**

circuits can perform as well as discrete-component circuits.

"Speeds of monolithic circuits are limited by interelement parasitic capacitances," says Martin Lepselter, inventor of the beam lead. "But air isolation allows the circuit designer to breadboard a circuit with discrete components and rest assured that its integrated form will perform as well."

The beam-lead circuit is just slightly bigger than the working surface of the ship, and its critics contend that it is unprotected and fragile. But Lepselter disagrees.

"The beam lead circuit is nearly indestructible," he says. "Acids that can easily corrode a metal can, metal lead wires and an aluminum interconnection pattern of an ordinary device are foiled by the beam-lead package; it exposes only silicon nitride, silicon and gold to its environment."

It is also mechanically almost in-

destructible, Lepselter adds. He has run the devices up to accelerations of 300,000 G in a special centrifuge, and they show no signs of damage.

"They're tough because they're small," he observes. "A beam lead is only half a mil thick, but it's one mil wide and about six mils long. Half a mil may sound thin, but bring those dimensions up to a human scale. Imagine trying to break a beam that is six feet long, six inches thick and a foot wide. And gold is malleable. The lead can be bent through a 90° angle 20 times before it breaks."

Above all, of course, the attraction is the package's small size. A 24-lead memory, completely packaged, fits on the end of a standard flatpack's lead (see Fig. 2). The finished beam-leaded device is little larger than the working surface of the microcircuit (see Fig. 3).

The leads connect the chip internally and externally and the idea of using them for structural support is simple. The problem is to fabricate such a chip—and, harder yet,

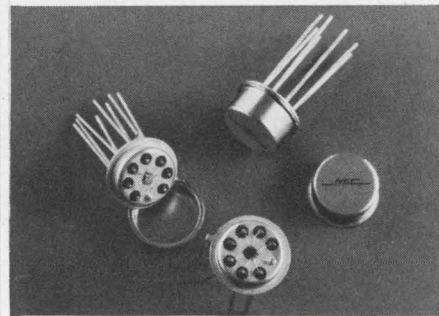

Available from your

**NSC**  
distributor

**WESTERN DISTRIBUTORS:**

Fortune Electronics  
695 Veterans Blvd.  
Redwood City, California 94063  
(415) 365-4000

Kierulff Electronics  
3969 East Bayshore Road  
Palo Alto, California 94303  
(415) 968-6292

Arco Pacific  
Bohamon Drive  
Menlo Park, Calif. 94025  
(415) 324-1356

Liberty Electronics Corp.  
339 South Isis Avenue  
Inglewood, California  
(213) 678-8111

Spectronics  
131 Garnet  
Ridgecrest, California 93555  
(714) 378-2831

Western Electronic Components  
4301 Birch St.  
Newport Beach, California  
(714) 540-1322  
(213) 631-6119

Newark-Denver Electronics Supply  
P. O. Box 22045  
Denver, Colorado  
(303) 757-3351

Pacific Electronics  
1336-4 Dillingham Blvd.  
Honolulu, Hawaii 96817  
817-118

Sterling Electronics, Inc.  
1712 Lomas Blvd., N.E.  
Albuquerque, New Mexico  
(505) 247-2486

Kierulff Electronics  
2585 Commerce Way  
Los Angeles, California 90022  
(213) 685-5511

Ballard Supply Company  
3109 Washington Blvd.  
Ogden, Utah 84400  
(801) 394-5541

Ballard Supply Company  
44 East 6th Street, South  
Salt Lake City, Utah 84100  
(801) 364-6541

Kierulff Electronics  
6133 Maynard Ave., S.  
Seattle, Wash. 98108  
(206) PA 5-1550

Kierulff Electronics  
8137 Engineer Road  
San Diego, California  
(714) 278-2112

ON READER-SERVICE CARD CIRCLE 14

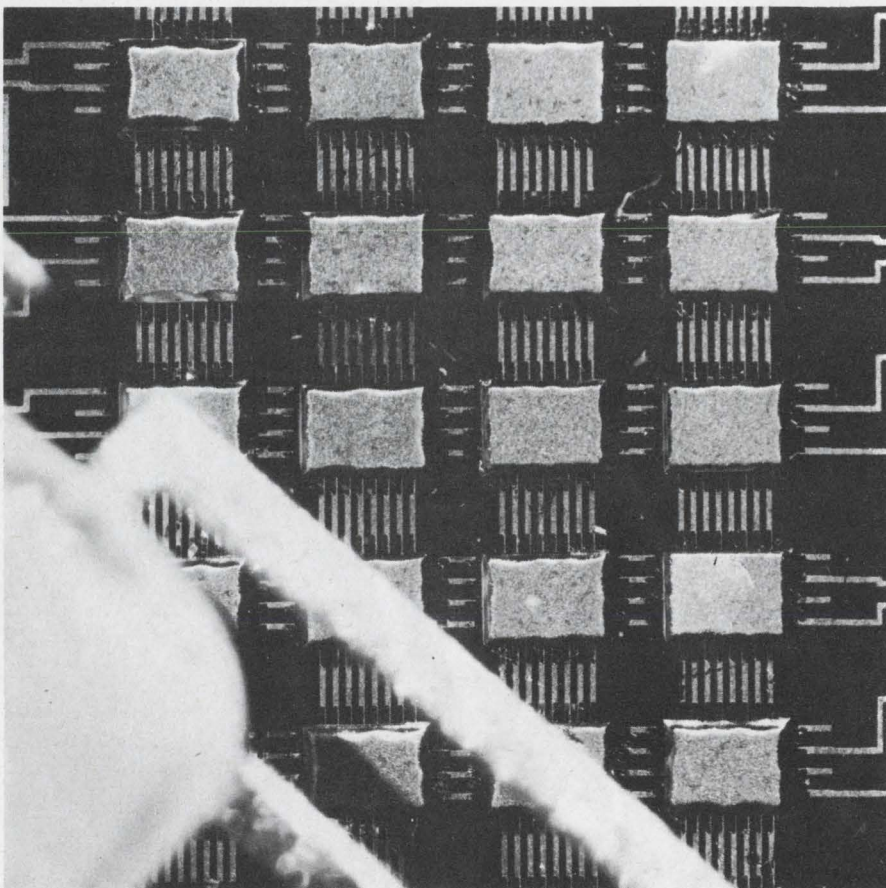

2. The tiny beam-lead flat packs are dwarfed by a conventional flat pack. This silicon slab, the size of a matchbook, contains the bipolar memory chips and their drivers—a total of 128 flat packs.



# MONOLITHIC VOLTAGE REGULATOR

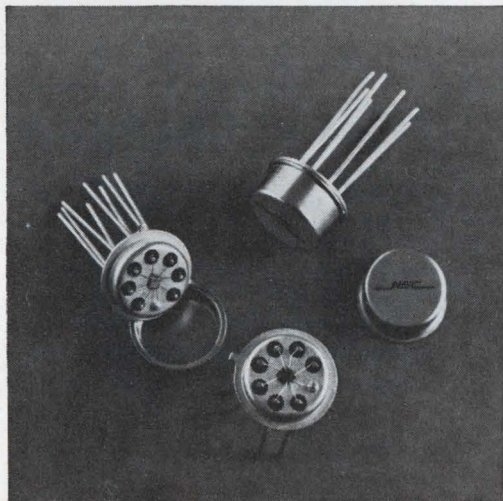

- Output adjustable from 2V to 30V.
- Output currents in excess of 5A using external power transistors.
- Can be used as either a linear or a high-efficiency switching regulator.

## The first of a new line of monolithic linear integrated circuits

This versatile regulator features regulation better than 1 percent for widely varying load and line conditions. Temperature stability is better than 1 percent over the full military temperature range. As a linear regulator, the LM100 provides current limiting, excellent transient response

and unconditional stability with any combination of resistive or reactive loads. As a switching regulator the circuit will operate at frequencies up to 100KHZ with efficiencies better than 85 percent.

The LM100 is immediately available from distributor stock.

ON READER-SERVICE CARD CIRCLE 16

**NSC**  
MICROCIRCUITS DIVISION  
NATIONAL SEMICONDUCTOR CORPORATION  
2950 SAN YSIDRO WAY, SANTA CLARA  
CALIFORNIA 95051 (408) 245-4320



# New from Sprague!

**5 Times the Resistance of  
a Conventional Metal-Film Resistor  
of Equal Size!**

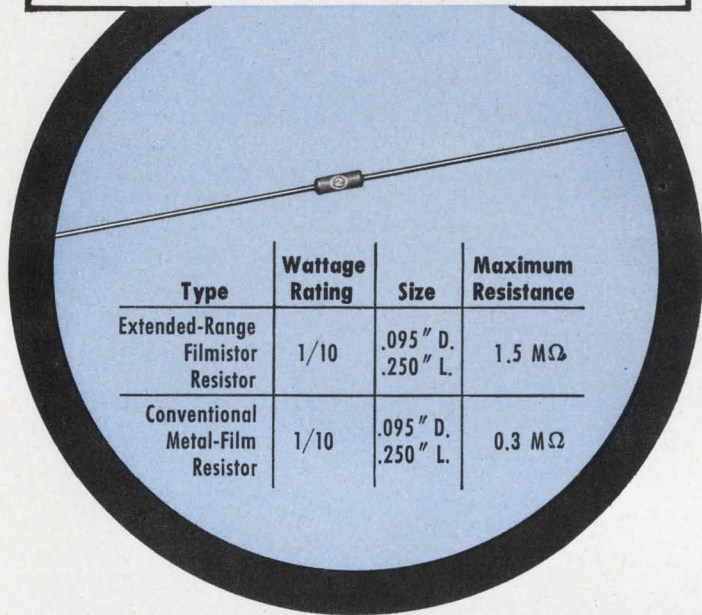

## EXTENDED-RANGE FILMISTOR<sup>®</sup> METAL-FILM RESISTORS

**Substantial saving of space in all wattage ratings —  
1/20, 1/10, 1/8, 1/4 1/2, and 1 watt —with  
absolutely NO SACRIFICE IN STABILITY!**

Extended-Range Filmistor Resistors now offer, in addition to accuracy . . . stability . . . reliability . . . resistance values in size reductions which were previously unobtainable. Size and weight advantages of Filmistor Resistors now make them ideal for applications in high-impedance circuits, field-effect transistor circuits, etc. Many designs which previously had to settle for the higher temperature coefficients of carbon-film resistors in order to obtain required resistance values can now utilize the low and controlled temperature coefficients of Filmistor Metal-Film Resistors.

Other key features are  $\pm 1\%$  standard resistance tolerance, low inherent noise level, negligible voltage coefficient of resistance, and tough molded case for protection against mechanical damage and humidity.

For complete technical data, write for Engineering Bulletin 7025C to Technical Literature Service, Sprague Electric Co., 347 Marshall Street, North Adams, Massachusetts 01247.

### SPRAGUE COMPONENTS

RESISTORS  
CAPACITORS  
TRANSISTORS  
INTEGRATED CIRCUITS  
THIN-FILM MICROCIRCUITS  
INTERFERENCE FILTERS  
45R-6139

PACKAGED COMPONENT ASSEMBLIES  
FUNCTIONAL DIGITAL CIRCUITS  
MAGNETIC COMPONENTS  
PULSE TRANSFORMERS  
CERAMIC-BASE PRINTED NETWORKS  
PULSE-FORMING NETWORKS



<sup>®</sup> 'Sprague' and <sup>®</sup> 'THE MARK OF RELIABILITY' are registered trademarks of the Sprague Electric Co.

ON READER-SERVICE CARD CIRCLE 17

### NEWS

(IC wires, continued)

to make them in production quantities.

The fabrication of beam leads requires sputtering and back-sputtering, which are not normal production techniques. But Lepselter and his collaborator, Donald D'Stefan, feel that there is nothing to prevent the sputtering process from being used successfully on the production line.

"We do it easily with fairly junky vacuum equipment," Lepselter explains, "the kind of stuff you wouldn't give a second thought to if you saw it in a semiconductor plant. I mean we have some pretty snazzy equipment at the lab, but we don't need it to make beam leads."

Last June, General Instruments put the technique into production and started delivering beam-leaded diodes. The company's director of research, Dr. Leland Seely, says that he and his colleagues should soon be developing a beam-leaded MOS array for the U.S. Air Force.

One particularly attractive feature of the beam leads is that the chip is packaged while it is still on the wafer. One major manufacturer estimates that nearly a third of the total labor involved in making an integrated circuit goes into its wiring and packaging.

### Decal devices transfer to glass

RCA's Dr. Nikolaus Wolff and his colleagues are putting soft solder bumps on the bond pads of chips made by an extremely interesting process. Like the beam lead, their chips are packaged while the wafer is still intact, and the silicon islands that contain the devices are isolated by air from one another. But instead of using thick leads for structural support, the RCA process uses a thick layer of glass (see Fig. 4).

The silicon devices are transferred to the glass just as a decal is transferred to a window pane. Because of this resemblance, the scientists at RCA call it the decal process. Unlike the beam-leaded circuits, the chips made by the decal process must be mechanically separated by scribing or sawing.



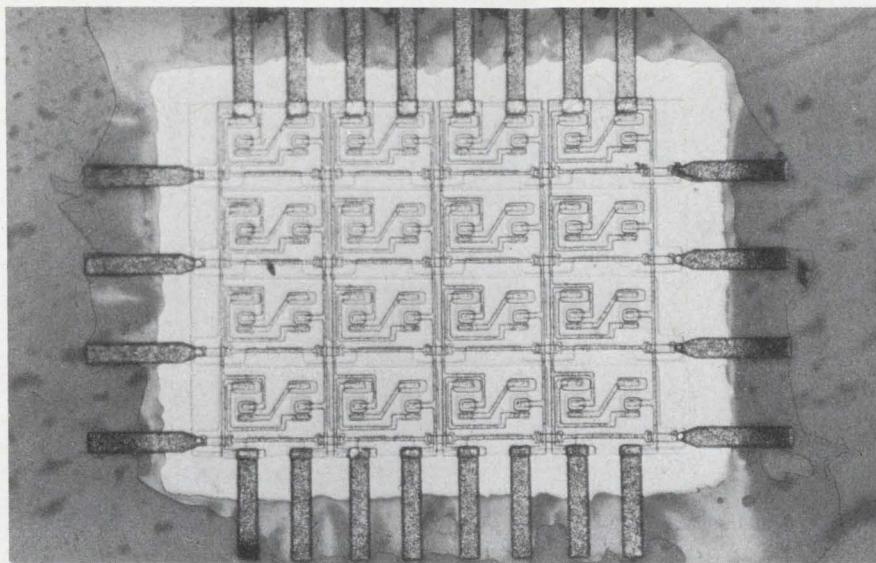

3. The beam leads are tough. When they were tested in a centrifuge to 300,000 G, the substrate on which they were mounted broke, but the beam-lead circuits held the pieces of ceramic together.

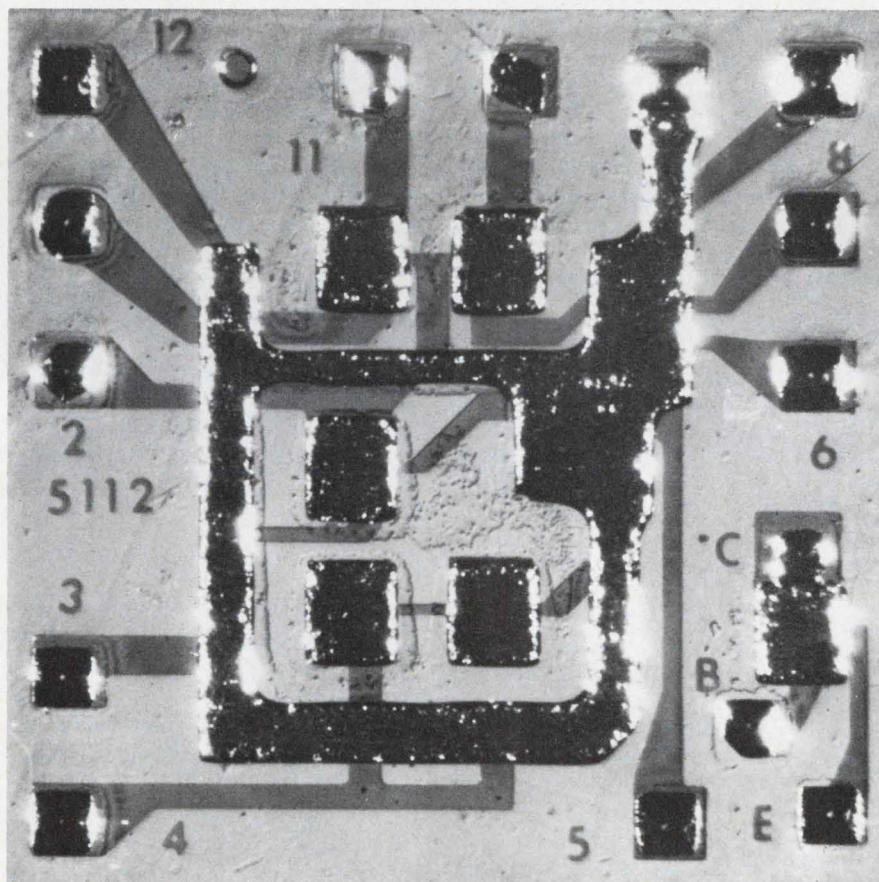
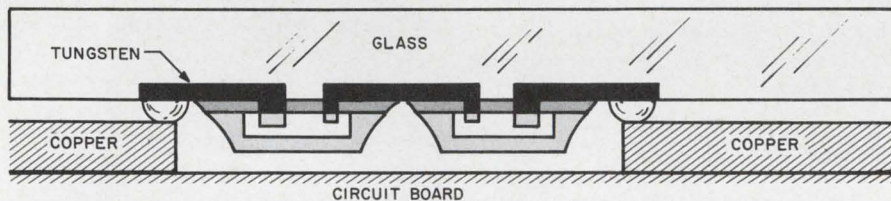

4. The silicon devices float like little islands on the glass layer that holds them together. Bumps of solder adhere to the nickel-plated tungsten bonding pads. The RCA decal circuit goes right onto a circuit board.

The decal circuits use a tungsten interconnection pattern. Though the scientists will not say how they managed to deposit it on the wafer, tungsten was substituted for the more usual aluminum because it can withstand the 700°C temperature required to melt the glass at the wafer's surface.

Though tungsten will not accept solder, the bonding pads can be plated with nickel, which does accept solder. With bumps of solder on its pads, the chip can be ultrasonically bonded to a pattern of any metal to which solder will adhere.

Other manufacturers have made transistors and integrated circuits with bonding-pad bumps but without these exotic packages. Hughes Aircraft has pioneered the ultrasonically bonded aluminum-bump flip-chip. And Sperry has put solder bumps on conventional chips.

The tiny circuits made by Bell Labs and RCA raise one problem: How will their users handle and install them? Lepselter has an idea.

"We'll make them in strings that contain maybe a hundred integrated circuits in a row," he says. "Then they can be dispensed in a little holder—or even automatically installed by a machine that welds one in place and then tears it off."

It is easy to see that all of the wireless packages lend themselves to semiautomatic, or even automatic, installation. The bond pads and the beam leads are located photographically. So the leads of circuits made with the same set of masks are always formed in precisely the same position. The Fairchild machine depends on its operator only for optical alignment of the chip because the bond pads match the photoetched conductor pattern on the substrate. It would take a huge volume of a particular circuit to justify the development of an automatic machine that could assemble it to a substrate. But the Bell System is faced with just such a demand. When push buttons start to replace the trusty old dial, each phone will have an integrated, multi-tone oscillator. It will be a beam lead circuit. And Bell is hoping to automatically attach it to its substrate.

Many ways will undoubtedly be found to install the new generation of microcircuits. And no one will wonder where the wires went! ■ ■



# Skeletal arrays will use computer to fill gaps

## Air Force antenna units will have fewer elements than conventional designs, with no resolution loss

Neil Sclater  
East Coast Editor

Antenna arrays can be costly, complicated structures. But two arrays being built by the U. S. Air Force promise not only to cut costs and the elements in such installations but also to do so without loss in meaningful data.

A digital computer will fill in the data that the extra antenna elements would have supplied. It will construct the missing data from fundamental information furnished by the skeletal arrays.

A team of scientists under Dr. Allen C. Schell at the Air Force Cambridge Research Laboratories, Bedford, Mass., designed one system to receive at the quasioptical wavelength of 2 mm (140 GHz). It has four receiving elements but is intended to perform as well as a seven-element array. The other system will operate at 6.5 MHz. It has 103 receiving elements but is to give performance equal to that of a 1000-element array.

The 2-mm-wavelength array is a

linear grouping of parabolic receiving dishes in a protective shelter. The 6.5-MHz array is a large, circular grouping of dipoles set on poles. But a design concept links both of these antenna groupings: arrays can be built at any frequency with far fewer than the conventional number of receiving elements if a data-processing method is used to reconstruct the missing information from what is available.

Dr. Schell designed his antennas in frequency ranges that are almost at opposite ends of the radio-frequency spectrum to meet the requirements of Air Force aerospace physicists.

### Tiltable mount used

The four parabolic dishes for the millimeter-band receiver are being mounted on a tiltable steel frame, 28 feet long. This frame is set on a heavy, vibration-free concrete footing set deep in the ground.

The dominant feature of the array is the spacing of the parabolic dishes. There are spaces for seven

dishes, but only the first, second, fifth and seventh have dishes.

This, according to Dr. Schell, is where the computer comes in. With a special program, it can fill in the gaps, using data obtained from the elements that are present.

"The computer now becomes an integral part of the receiver," Dr. Schell says, "and in addition, its use permits a saving of cost while keeping the system less complicated.

"With this concept the computer now becomes the true observer, for we have eliminated the man on the oscilloscope along with redundant, costly elements."

The reception pattern of the linear array will be a narrow fan, one minute of arc wide and seven minutes high. Gain has been calculated at 68 dB, and the complete array can be scanned through an angle of 90° about the vertical in the north-south plane.

The 2-mm wavelength was selected because experiments have shown that the band between about 130 and 150 GHz is a "window," less susceptible to atmospheric water-vapor attenuation than neighboring regions. The selected wavelength is approximately centered in this region.

The receiver will be used primarily for radio astronomy, in particular, to monitor sunspot and solar radiation activity. For these investigations, the antenna-array frame will be tilted, so that the narrow receiving band can monitor the entire visible surface of the sun. The moon will be used as a calibration source. Both sun and moon subtend approximately 30 minutes of arc.

A sensitive, double-channel, stabilized radiometer will be used for the radio-source measurements. The four dishes will be fed by a beam structure that includes feed horns, mirrors and quartz lenses. Power division and phasing will be provided for each element. Control over each reflector will be obtained by changing the geometry of the lenses and mirrors, thus varying the modes of the waves within each beam waveguide.

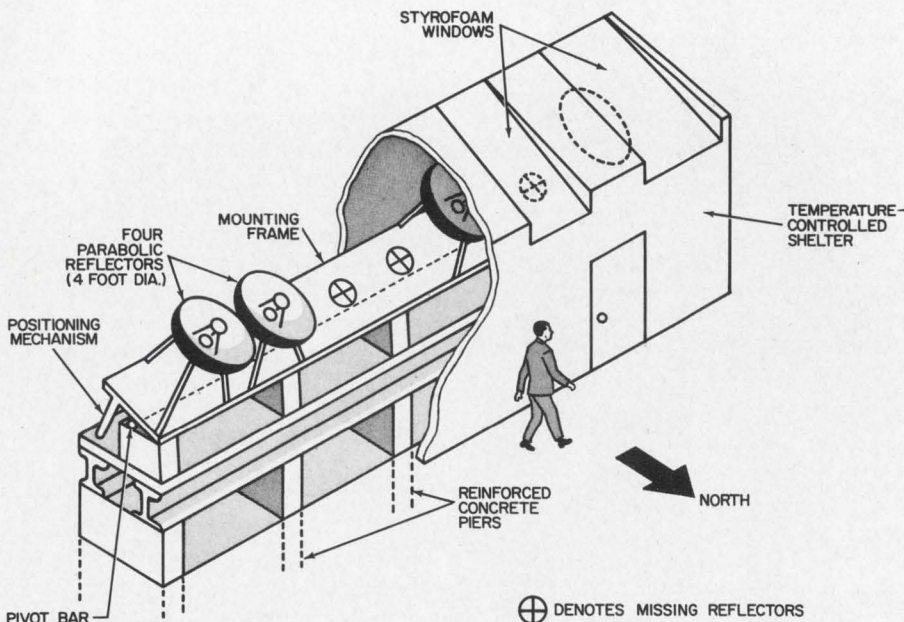

**Skeletal antenna array** that will receive signals at 140 GHz will use four dishes to furnish as much data as seven. A computer will restore the missing data. The array, in a van-sized, weatherproof housing, will monitor solar activity.



## Protected from weather

The entire antenna array is being housed in a van-sized shelter, to protect the beam waveguide from wide temperature variations. The dish reflectors will receive their signals through styrofoam windows that can be protected by sliding covers during rain or snow.

Since the scientists are not concerned with real-time operation but only with angular data, the output from the antenna array will be recorded on chart paper, both for data reduction and for enhancement of the receiving pattern. This work will be done at a computer placed a distance from the array.

The output from the antenna data recorder will be a temperature-analog plot. Energy at the 2-mm wavelength will be shown vertically, and angular information will be on the base line. Even without processing, the raw data will have meaning for the scientists, because successive records in the same format can be compared. However, for enhancement, the data will be converted to a digital format, which will be fed into the computer.

The computer program will reconstruct the data, adding the missing information derived from the raw data. The output of the computer will then be converted back again to a complete analog picture.

## Ring of poles set up

In the second array, under construction at Sudbury, Mass., a ring of tall poles, 2040 feet in diameter, has been set in marshland to support the dipoles of a radio telescope. The poles are being fitted with 103 half-wavelength dipoles that will be the receiving elements for the 5-to-7.5-MHz receiver.

According to Dr. Schell, the antenna will have the same resolving-ability as 1000 dipoles. He says that, although the design is more complex than that for the millimeter-wave antenna array, it is based on the same concept of omitting redundant dipoles and restoring data with a computer. In this case, though, one must think in two dimensions, the scientist says.

The array has been laid out with quadrature symmetry. Since it is to be used as a radio telescope, the symmetry has been set out along an east-west, north-south set of axes. The dipoles, which are strung near

*basic measuring tools from*

**HEWLETT  
PACKARD**



## hp 3439A Plug-in Digital Voltmeter

versatile, 4-digit DVM—for only \$950 plus plug-in accuracy better than  $\pm 0.05\%$  of reading  $\pm 1$  digit,  $\pm 15^\circ\text{C}$  to  $\pm 40^\circ\text{C}$  with line voltage variation of  $\pm 10\%$   
5% overranging, high ac rejection (30 db at 60 Hz)  
signal common floatable up to 500 v dc from chassis ground  
automatic ranging

### Use it for:

mv to kv dc autoranging voltage measurements: thermocouple, bridge measurements, production and maintenance testing  
 $\mu\text{a}$  to a dc current measurements: power supply currents, collector and base currents, leakage currents  
mv to kv ac voltage measurements: average responding (rms with hp 3440A), servo measurements, turns ratios  
ohms to megohms resistance measurements  
programmable ac, dc voltage ranges

Plug-in capability makes this DVM an economical bench instrument with a wide range of uses. The basic instrument, priced at \$950, offers high accuracy, dc isolation, speed (readings in a fraction of a second), ac rejection, economy, reliability. Plug-ins permit manual range selection 10 v to 1000 v full scale (3441A); automatic range selection with remote range feature (3442A); measurement ranges 100 mv to 1000 v full scale, with automatic and remote ranging (3443A); voltage (100 mv to 1000 v), current (100  $\mu\text{a}$  to 1 amp) and resistance (1000  $\Omega$  to 10 M $\Omega$ ) measurements (3444A); ac/dc measurements, 10 v to 1000 v full scale with manual, automatic

and remote ranging (3445A), and remote function and/or ranging (3446A). Plug-ins priced from \$40 for the manual ranging unit (required) to \$525 for the ac unit and \$575 for the multi-function unit. Your Hewlett-Packard field engineer will give you a demonstration of the voltmeter and the plug-ins most useful for your application. Just give him a call. Or write for complete specifications to Hewlett-Packard, Palo Alto, California 94304, Tel. (415) 326-7000; Europe: 54 Route des Acacias, Geneva.

*Data subject to change without notice. Prices f.o.b. factory.*

**HEWLETT**  **PACKARD**  
An extra measure of quality

908



3439A with 3445A plugged in

ON READER-SERVICE CARD CIRCLE 18



**(Skeletal arrays, continued)**

the tops of the circular forest of poles, are aligned north and south.

As in the millimeter-wavelength antenna array, the output of the antenna will be recorded on chart paper as a plot of incident energy vs angular position. There will be no scanning or nodding of this antenna, however. It will wait passively for the earth's rotation to bring sky areas under study to the three-degree conical receiving beam.

Reconstruction of the data to account for the missing elements will take place at the Cambridge Research Laboratories' digital computer, several miles away.

**Signals to pierce ionosphere**

The Air Force scientists selected 6 MHz because of the ability of signals at this frequency to penetrate the earth's ionosphere. Dr. Schell says that the frequency is at about the lower limit of those able to pass through the ionosphere barrier without reflection. Most observations will be made at night, when reception conditions are better than in the daytime and there is less interference from adjacent bands.

The scan angle of the antenna array can be changed by making individual adjustments at each of the 103 dipoles. Peter Franchi, an Air Force engineer responsible for the details in the design, estimates that this operation will require about an hour. The adjustments will be calculated by a computer, and technicians will make them in a control shelter that is located on the ground at the center of the circular array.

Air Force space physicists will conduct the first test on this antenna next month.

While the Air Force is financing the development of the two prototype antenna arrays purely for scientific purposes, it is mindful of the application of the concept to various types of airborne and ground radar systems. Dr. Schell says that digital computers can be programmed to synthesize data as well as to form and switch antenna beams virtually in real time. This means that economies in size, weight and cost can be achieved without loss in resolving power.

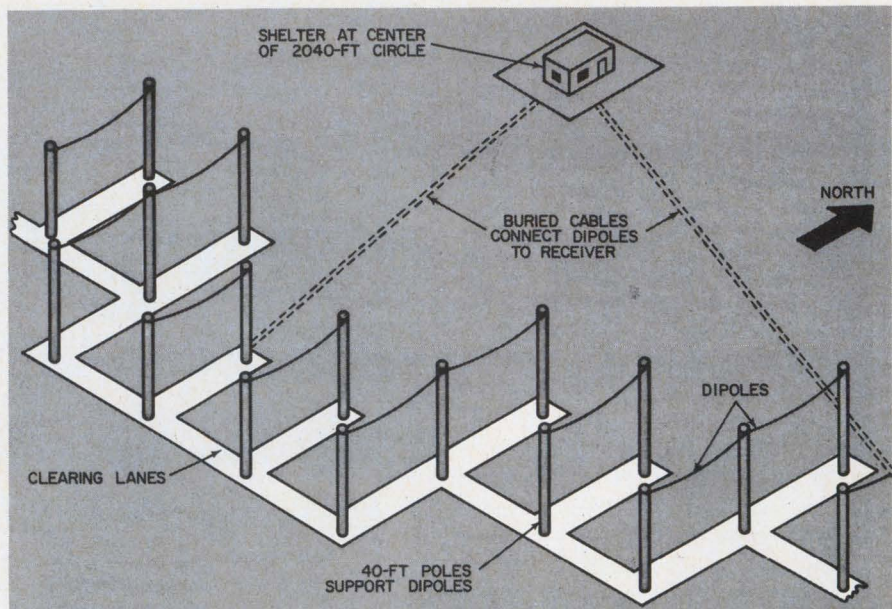

A portion of the 6.5-MHz antenna array being built by the Air Force at Sudbury, Mass., looks like this. The complete radio-astronomy array consists of 103 dipoles mounted on supporting poles. The poles are positioned in a circle with a diameter of 2040 feet. With the help of a computer, the 103 dipoles will have a resolution comparable to that of an array of 1000 dipoles.

**A case of 4 equals 7 on a 6-inch ruler**

In its simplest form, the design concept of the skeletal antenna can be compared to a problem in simple geometry:

What is the minimum number of marks that must be made on a piece of wood more than six inches long to permit it to be used to measure all increments from one to six inches?

The answer is four marks, positioned as shown in the diagram below. These four marks can do the work of seven.

The first graduation is at the

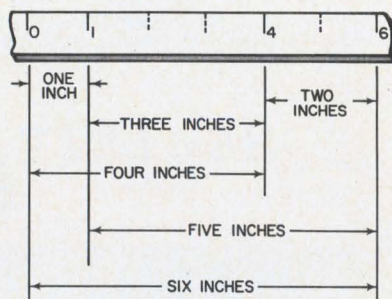

origin, the second at the one-inch distance, the third at four inches and the fourth at six inches. Using these four graduations, one can make all measurements from one to six inches, as shown.

To use the rule effectively, one must know the reasoning behind the marking and apply it. In an analogous manner, a computer can be used to construct the data that would have been obtained from missing antenna elements, provided the program is written to permit it to make use of the minimal information available.

Dr. Schell says his design concept is based on a branch of mathematics known as integral numbers theory. The application of this theory to antennas was first proposed by the French astronomer J. Arzac in 1955.

According to Dr. Schell, the theory can be applied to all types of phased-array systems, including those for aircraft and antimissile radar applications.

A scientist, Dr. Ronald Bracewell at Stanford University, Palo Alto, Calif., is also working on antennas with missing elements. His designs, like Dr. Schell's, depend on data processing to reconstruct missing information.

A linear X-band antenna for ra-

dio astronomy is being constructed at Stanford under the sponsorship of the Air Force Office of Scientific Research. The array, which will receive at 10 GHz, has five parabolic dishes, each 60 feet in diameter. It is said to be capable of a resolution equivalent to 10 dishes. ■ ■





# SCR SERIES POWER SUPPLIES

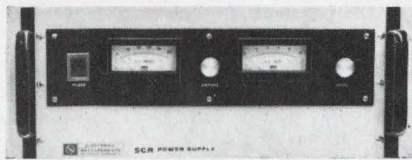

**NEW styling...**

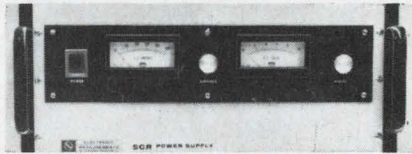

**SMALLER size...**



**LESS ripple...**

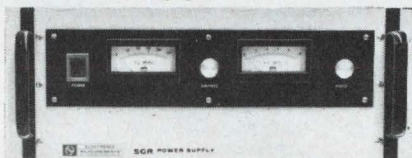

Brand new design and a new concept and production of proprietary electronic filtering, all in the SCR from the oldest sole-manufacturer of power supplies, guarantees quality, highest performance and lowest cost.

Model No.	Voltage Range	Current Range	Voltage Regulation Line or Load
SCR 10-1000	0 to 10	0 to 1000	0.1% or 5MV
SCR 10-500	0 to 10	0 to 500	0.1% or 5MV
SCR 10-250	0 to 10	0 to 250	0.1% or 5MV
SCR 20-500	0 to 20	0 to 500	0.1% or 10MV
SCR 20-250	0 to 20	0 to 250	0.1% or 10MV
SCR 20-125	0 to 20	0 to 125	0.1% or 10MV
SCR 40-250	0 to 40	0 to 250	0.1% or 20MV
SCR 40-125	0 to 40	0 to 125	0.1% or 20MV
SCR 40-60	0 to 40	0 to 60	0.1% or 20MV
SCR 120-80	0 to 120	0 to 80	0.1% or 60MV
SCR 120-40	0 to 120	0 to 40	0.1% or 60MV
SCR 120-20	0 to 120	0 to 20	0.1% or 60MV
SCR 160-60	0 to 160	0 to 60	0.1% or 80MV
SCR 160-30	0 to 160	0 to 30	0.1% or 80MV
SCR 160-15	0 to 160	0 to 15	0.1% or 80MV
SCR 500-20	0 to 500	0 to 20	0.1% or 250MV
SCR 500-10	0 to 500	0 to 10	0.1% or 250MV
SCR 500-5	0 to 500	0 to 5	0.1% or 250MV

RMS Ripple: 10MV      Transient Resp: to within 2% in 50 M/S



*Write for more information.*

**THE ROWAN CONTROLLER COMPANY**

OCEANPORT, N. J. 07757

ON READER-SERVICE CARD CIRCLE 19



## 'Fly's-eye' lens array snaps hologram images in natural light

A "fly's-eye" lens installed in a camera is permitting scientists to photograph hologram images in natural white light outside the laboratory. Heretofore all recording of holograms was performed in the laboratory with coherent light from a laser.

The surface of the lens, rather like a fly's eye, is covered with hundreds of minute, densely packed, spherical glass lenses, each capable of photographing an independent image. This array records the hologram image. A second step is then required in the laboratory to com-

plete the formation of the hologram.

Scientists at the International Business Machines Corp., Yorktown Heights, N. Y., devised the fly's eye technique. They say the quality of the hologram is nearly as good as that obtained with the more conventional Fresnel laser-illumination method and could be adapted for amateur photography in the future.

Each spherical lens in the array forms an individual image from a lightly different angle—a requirement for all hologram formation. The minute lenses sample and record both the intensity of light and

the curvature and direction of light waves, coming from every point on the object being photographed.

The picture taken is then converted to a Fresnel hologram in a laboratory, with the aid of a laser and conventional holographic apparatus, which includes mirrors and beam splitters.

To take a picture of an object with the fly's-eye lens, a photographic plate is placed behind the lens. The curvatures of individual light wavefronts coming from the object and the absolute positions of the wavefronts are recorded in code.

The coded film is developed in the laboratory as a photographic positive and replaced in its original position behind another, identical fly's-eye lens array. It is illuminated with both a direct and a reference laser beam, and a three-dimensional image of the object is formed.

Any hologram records all the information in light waves, whereas ordinary photographs record only the intensity of light from various points in a scene. A holographic image is truly three-dimensional, in that a viewer can "see around" objects in the foreground by moving his head, just as if he were looking at the original scene. ■ ■

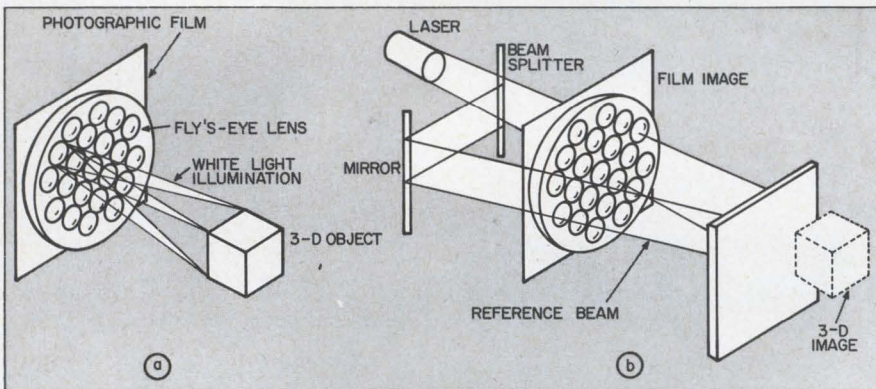

Each lens of a glass "fly's-eye" produces an image on film as the first step in making holograms with ordinary white light. In the second step, laser light, shining through both the film and another lens, is combined with light from a reference laser beam to form the hologram.

## Nuclear-powered relay-satellites station proved feasible

Nuclear-powered orbiting antennas may serve as two-way communication relays for probes to the planet Jupiter in the next decade, according to a recent NASA study.

The use of orbiting relay stations is considered one solution to the problem of reducing spacecraft transmitter power requirements for deep space probes. In addition, the relay would hold down the number of ground stations needed.

The unmanned station would be placed in a slightly modified polar orbit at 500 to 750 miles above the earth. It would permit line-of-sight communication with a spacecraft as far away as Jupiter. One relay satellite would be used for each space mission.

A ground station would transmit

to the orbiting antenna, using the conventional S-band or L-band frequencies, and the signals would be retransmitted to the spacecraft at more efficient frequencies, possibly as high as 100 MHz.

The feasibility of such antenna satellites was established in a study for NASA's Ames Research Center by the Space General Div. of the Aero-jet-General Corp., El Monte, Calif. A petal-leaf design would allow the satellite to unfold from an 18-foot-diameter to one of 30 feet.

Nuclear power would be provided by three canister-shaped, radioisotope thermoelectric generators, 5 feet in diameter and 5 feet long. They would provide several thousand watts of electric power. ■ ■

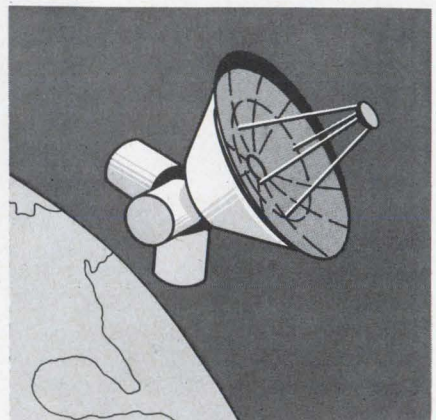

Orbiting antenna would use a nuclear power supply. The three drums would house radioisotope thermoelectric generators. Such a satellite relay station could help reduce spacecraft power requirements for deep space probes.



# NEW

## semi-automatic integrated circuit analyzer

# MICA 150

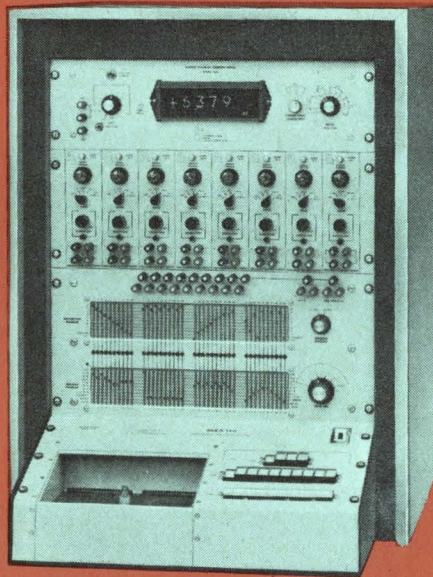

COMPUTER TEST  
CORPORATION

Now the integrated circuit user can get all the flexibility and performance of an expensive, large scale IC test system in an accurate and reliable DC bench top analyzer.

**The new MICA-150 Modular Integrated Circuit Analyzer tests all IC configurations of up to 40 pins with unique programming, fast pushbutton sequencing and built-in DVM readout.**

**Fast, Versatile Programming** Two independent 10x40 crossbar switches and rapid pushbutton sequencing provide up to 40 tests on a single device without re-programming. For example, it's now quick and easy to check a 10 pin device using four completely different test programs without resetting any switches to advance the test from pin-to-pin or program-to-program. Additional flexibility allows the built-in DVM to measure current on one pin of the device and voltage on another—all pre-programmed.

**Universal Test Adapters** Through use of universal test adapters, the MICA-150 is designed to check ICs according to the number of pins of a particular package, not device or circuit type. Adapters are available for diode, transistor, TO-5, flat-pack, dual in-line and other package configurations, and can also be provided for Kelvin connections.

**Accurate Digital Readout** Specifically designed for the MICA-150 analyzer, the built-in Digital Volt/Ammeter has a conservatively rated readout accuracy of 0.1% with a four digit display. Other features include automatic ranging and polarity selection, self-calibration, automatic voltage or current readout selection. Measures currents as low as 1 nanoamp, voltages to 1 mv.

**Modular Design** Modular construction allows users to select an economical, customized tester without obsolescence problems. Maximum capacity of eight function generators permits later expansion, including modules for AC and pulse testing, without additional modifications.

**Variable Soak Time** Marginal device operation can be easily detected through use of an adjustable test time control which provides a period for thermal stabilization prior to measurement. A continuous position on the control allows parameters to be varied while observing results.

**Precision, Wide Range Power Supplies** Highly precise supplies utilize multi-turn calibrated potentiometer controls with high resolution and repeatability. Constant current supplies are continuously variable from 0-100 ma with voltage compliance adjustable to 100v. Constant voltage supplies are variable from 0-100v with automatic current limiting to 100 ma to provide device protection.

### QUICK ACTION REPLY

Detailed technical literature on the MICA-150 will be mailed immediately upon receipt of this request.

Attn.: A. Norman Into, Marketing Manager  
Computer Test Corporation, Three Computer Drive  
Cherry Hill, N.J. 08034 • Phone: (609) 424-2400

Name \_\_\_\_\_

Company \_\_\_\_\_

Address \_\_\_\_\_

City \_\_\_\_\_ State \_\_\_\_\_ Zip \_\_\_\_\_



**Only  
Honeywell Offers  
A Family of  
Compatible  
High Speed\*  
I/C Core Memories**

$\mu$ -STORE ICM core memories are fast, reliable, and able to store more words in less space than any other core memories on the market. They are field-proven and in high volume production . . . yet offer a flexible design which meets a wide range of system requirements.

ICM-47 — 750 nanoseconds full cycle time; capacities from 4K to 32K words in a single 5 $\frac{1}{4}$ " high module (like the one shown below). ICM-40 — 1 microsecond full cycle time; capacities from 4K to 32K words. In addition, multiple module capability allows ICM's to be expanded to larger capacities. Both models feature high noise protection, data retention in case of power failure and maximum use of integrated circuits to achieve high reliability. In brief, you'll find the ICM-40 and ICM-47 designed to perform

comfortably in a wide variety of operating environments and to fit easily into almost any system requirement.

Because ICM's come from Honeywell, Computer Control Division, you know they're backed by more than eight years' experience in the design and production of standard core memories . . . and by some pretty intensive special purpose memory systems experience as well. Add to this our I/C capabilities, logic module capabilities, and digital computer capabilities, and you can be sure of dependable support in solving your core memory applications and systems design problems.

Write today! Ask for our  $\mu$ -STORE summary brochure. Honeywell, Computer Control Division, Old Connecticut Path, Framingham, Massachusetts 01701.

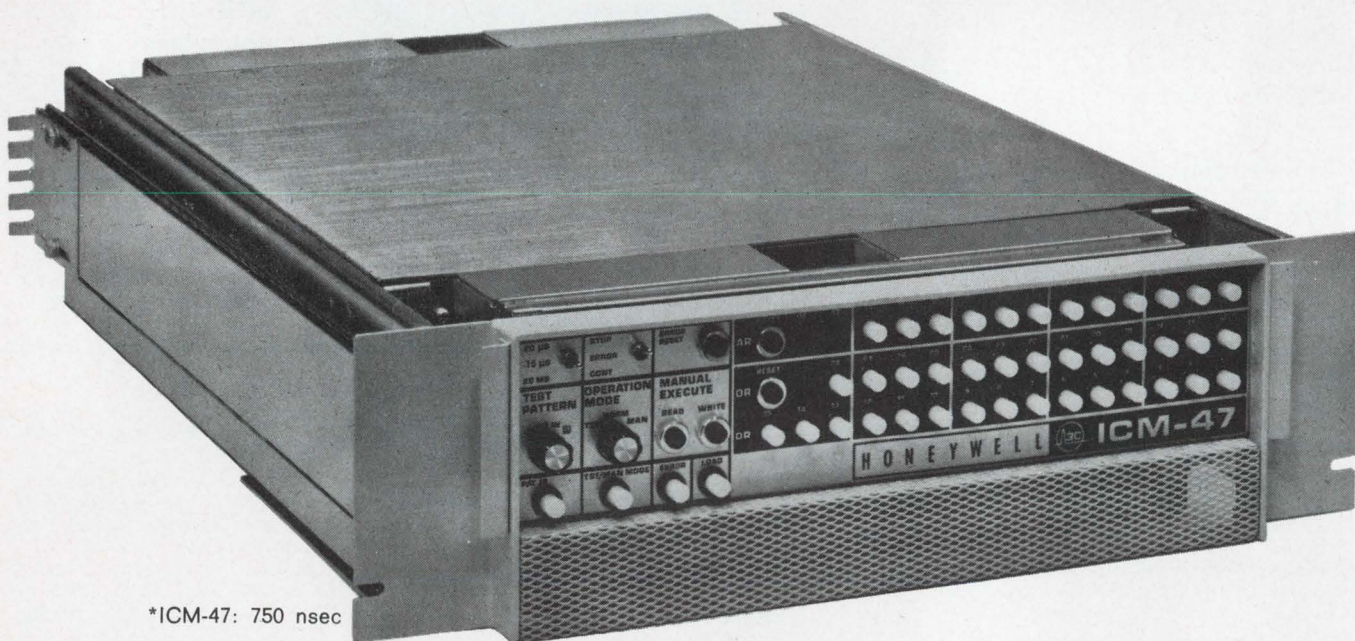

\*ICM-47: 750 nsec

**Honeywell**





The focus on missiles remains sharp

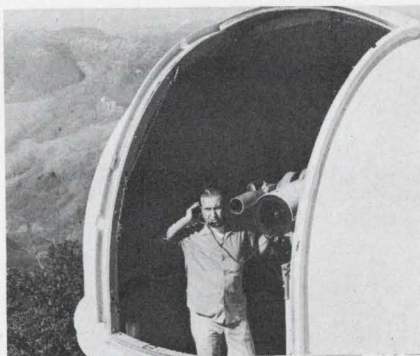

### Electronics shares warily in '68 budget

In some respects the United States Government budget for fiscal 1968 gives engineering industry observers the warm feeling that it was drafted in a kind of electronics rose garden. There are these key provisions for spending on electronics:

- A start toward an unmanned Voyager landing on Mars.
- Increased activity in civilian and military manned space laboratory programs.
- Continued heavy emphasis on communications and special equipment for limited warfare.
- Further development of antisubmarine warfare equipment.
- A challenging drive to upgrade missile penetration aids.
- Further research on the use of computers in the classroom.
- Plans by the Presidential Science Adviser, Donald Hornig, to automate scientific information systems.

### Setbacks due in some areas

But along with these roses there are some thorns:

- Few new ideas from NASA. Much of the space agency's small increase in funds over last year will go to take over programs that the military has been running.
- A slowdown in development of the Atomic Energy Commission's 200-GeV accelerator. After much ballyhoo over the choice of a site (Weston, Ill., was finally picked), the facts are that the accelerator will take longer to build than promised and will not be capable of operation under the 1968 budget.
- Indecision over the supersonic transport. Any funds that might materialize later in the year to support development of the SST will have to come from President Johnson's general "contingency fund." The Presidential Science Adviser concedes that a decision on how far to proceed with the aircraft "will have to be made by spring, or the program will run out of gas

# Washington Report

S. DAVID PURSGLOVE,  
WASHINGTON EDITOR

and the contractors will have to start dismantling."

### Hedging is apparent on R&D

In general, Government spending for research is up about 5 or 6 per cent. With allowance for the annual cost increase factor, the net gain for research—mostly small programs—is about 3 per cent. But development—involving mostly larger and more advanced programs—is down slightly.

As usual, the Defense Dept. and NASA account for the major share of the R&D spending. But other agencies are bidding for attention. The Post Office Dept., for example, has increased its "research and engineering" on systems that rely heavily on electronics from \$7 million five years ago to \$23 million in fiscal 1968. And these areas with more money to spend in the new budget will look to electronics, too: pollution control; education research; mass transportation systems; weather data and weather modification; laser tunneling and excavation techniques; crime control; computer simulation of urban problems.

### Manned Orbiting Lab gets increase

A surprise in the budget is the increase in military astronautics, mostly for the Air Force's Manned Orbiting Laboratory (MOL). For the second consecutive year, military astronautics is above the \$1-billion mark, rising to \$1,061,135,000. The Army and Navy will receive only token allotments, but the Air Force jumps from \$983.47 million to \$1.03 billion in this category. Besides the MOL, work on Titan III is scheduled to pick up. Many observers are fearful, though, that the allocation for the MOL, in particular, may be cut back later by appropriations committees and shunted to other military fields.

Increases are also listed for antisubmarine warfare and new missile penetration aids. The military's science program, on the other hand,



# Washington Report

CONTINUED

is marked down for a cut—from \$614.9 million in fiscal 1967 to \$611 million in the new budget. Much of the research at the Naval Research Laboratory, the Air Force Cambridge Research Laboratory and the Rand Corp. comes from this Pentagon budget category.

One of the largest military categories in recent years—aircraft and related equipment—is headed for a slight fall. It drops from nearly \$1.3 billion to just over \$1 billion. But despite this, work will continue on several versions of the F-111 and on competitive designs for a possible advanced manned strategic bomber.

Missiles and related equipment—another glamour category—will continue upward. A shakeout in planning is under way, with some programs reaching their expiration and others, like Poseidon, Minuteman III and penetration aids, soaring toward their zenith. Work is expected to advance at the various test ranges.

Ships and small-craft military expenditures will go up a bit, but the reward for electronic designers should be more than slight. All the increase is earmarked for electronics-oriented programs: ship and submarine sonars, navigation systems, command and control equipment. Antisubmarine warfare communications and systems for river warfare boats have two of the highest priorities. Work will pick up considerably at the Naval Electronics Laboratory.

For procurement of equipment already operational, the Army's spending for communications and electronics products will jump from \$295.5 million to \$540 million. Purchases will be made largely for limited warfare operations, especially to press the war in Vietnam. The Army will spend heavily to maintain command control over widely dispersed forces and weapons systems.

## NASA absorbs some military costs

The National Aeronautics and Space Administration budget is not quite as large as it looks. Funds and projects were transferred from the Defense Dept. to make the huge military budget appear smaller than it is. For instance, NASA is taking over the operation

and maintenance of the hypersonic X-15 at a cost of \$8 million a year, reducing the Air Force budget by that amount. NASA's small aeronautics budget has nearly doubled, in large measure because of a substantial jump in funds for vertical and short take-off and landing (V/STOL) aircraft. But the fine print shows that \$7.1 million will be spent by NASA largely for the Pentagon—to evaluate new military V/STOL configurations.

Major aerospace companies that would be prime contractors for any major manned post-Apollo program have expressed some disappointment at NASA's plans. A White House technology specialist, asked about this program, said: "The funds requested and that we plan to request in the next few years will just about match the decline in R&D and procurement funding in the Apollo program itself." There will, however, be an allocation for work on the Voyager spacecraft for Mars.

Full-scale development of the Voyager system for unmanned exploration of the nearer planets, Mars and Venus, is scheduled to begin in 1968. Funds have also been allocated to begin development of the Mariner spacecraft that will take measurements of the Martian atmosphere in 1971, two years before the first Voyager mission is expected to take place. Finally, the budget allows for further work in the field of weather prediction using applications technology Satellites and Nimbus weather observatories.

The Atomic Energy's Commission's planned 200-GeV accelerator is shaping up as a major disappointment. For several years physicists have been hearing that the accelerator would have a proton flux intensity of  $10^{13}$ ; that it would cost \$288 million; that it would have a \$30 million bubble chamber (which is necessary before any actual physics can be performed), and that work on the whole installation would get under way next year.

The AEC has doused the program with ice water. It has announced that Vietnam budget pressures have cut the accelerator's intensity to  $10^{12}$ ; that no bubble chamber funds at all are included in the 1968 budget request, and that instead of starting to build the entire installation next year, it will start to put up a \$240 million facility that, according to a senior official, will be but the plant for an "eventual" accelerator. Asked whether there was not a risk that the accelerator might turn out to be the biggest white elephant that the science world has yet seen, the AEC official replied bluntly: "Yes."



# This integrating DVM *still* offers better performance than any other of its kind.

Measure low-level signals even in the presence of extreme noise with Hewlett-Packard's 2401C Integrating Digital Voltmeter. It has a floating and guarded input for minimizing the effects of common mode noise; and integration averages out all noise superimposed on the signal.

But the 2401 DVM could do that when it was first introduced. Since then there have been two new models and many additional features to keep the 2401 the industry's most useful bench and system DVM.

Here's why:

5 ranges, 100 mV, 1 V and the 3 usuals; 300% over-ranging on the 4 most sensitive ranges, 6th digit for overrange display; integration through zero; full programmability; BCD output for systems use; independent internal calibrate source stable to 0.006% / 6 mo.; 300 kHz frequency counting ability; optional autoranger with 34 msec maximum change time.

If this isn't enough, a full repertoire of options and compatible systems instruments is available to satisfy your measurement needs.

Price: still \$3950.

Call your local Hewlett-Packard field engineer or write direct to Dymec Division of Hewlett-Packard, 395 Page Mill Rd., Palo Alto, California 94306, Tel. (415) 326-1755; Europe: 54 Route des Acacias, Geneva.

HEWLETT  
PACKARD  DYMEC  
DIVISION





# Infrared unit spots circuit production flaws

## Automatic scanner compares thermal patterns of modules with those on a master check tape

Heat profiles given off by production-line electronic circuits as they pass under an infrared scanner are being analyzed automatically to judge the quality of the circuits.

The pattern of each production circuit is compared with profiles from a unit of a known quality, to determine if the production unit should be accepted or rejected.

The thermal, nondestructive test system, under study for a couple of years by the Raytheon Co. Equipment Div. at Wayland, Mass., has been installed in the company's communication and data-processing plant at North Deighton, Mass.

Circuit-module boards containing hundreds of components are placed in trays on a circular table. The table rotates like a "lazy Susan" beneath the high-resolution scanner.

Before the check begins, the production operator inserts in the test system a mylar tape that contains master data encoded in a digital

format. The tape contains up to 128 profiles of the standard module, classified by number. Each number represents conditions, ranging from a perfect match to a variety of errors on the module.

As the detector scans a circuit board, the output signal is converted to a digital format and stored in a magnetic-core memory. The full scanning action takes 45 seconds. Then a 55-second comparison-and-classification stage begins.

The memory is compared with the master check tape, and a code number is displayed on the equipment panel. If the number is zero, the module has passed the test and can be sent on for assembly. If another number turns up, the module is marked with it and shunted to a repair area. The number gives the repair technician a clue to the location and nature of the flaw. After repair, the module is again passed through the detector process to

confirm that it is in good order.

The infrared scanner test differs from other production checks, according to Dr. Riccardo Vanzetti, manager of infrared techniques and systems in Raytheon's Equipment Div.

"Conventional production tests," he says, "are based on electrical measurements taken at pre selected points, whereas the infrared comparison test actually measures the entire circuit and every component."

Dr. Vanzetti says that frequently a substandard intermediate stage in the circuit can go undetected with conventional tests, because the checkpoints may be screening the stage beyond.

Experience at the Raytheon plant, he says, indicates that the infrared detector picks out flaws in about 3 per cent of the modules that have passed all conventional electrical tests.

The scanner detects three basic faults in circuit boards that may cause early failure, Dr. Vanzetti says. They are:

- Installation of components with the wrong performance values, such as the ratings for power, gain and capacity.
- Poor mechanical connections to heat sinks.
- Reverse wiring of components or wiring to the wrong terminals.

The detector in Raytheon's system is made of mercury-doped germanium, selected because its characteristics match the range of heat expected from electronic modules and components. The detection region peaks at about nine microns, or roughly 85° F.

The detector is positioned so that it receives thermal energy from a scanning mirror system. This system scans the nine square inches of the module tray at the rate of four lines a second. The area of resolution is said to be one-half-square millimeter, or a spot of approximately 0.02 inch.

The Raytheon system is a prototype and is not being offered for commercial sale at present. ■ ■



Infrared scanner detects any flaws in circuit production at Raytheon plant. Heat profiles of modules are compared with a standard as units rotate beneath the scanner on a "lazy Susan." Operator punches in circuit identification.



# Integrated Circuit

SYLVANIA  
Electronic Components Group

# IDEAS

## Build binary counters with fast (to 50 MHz) J-Ks

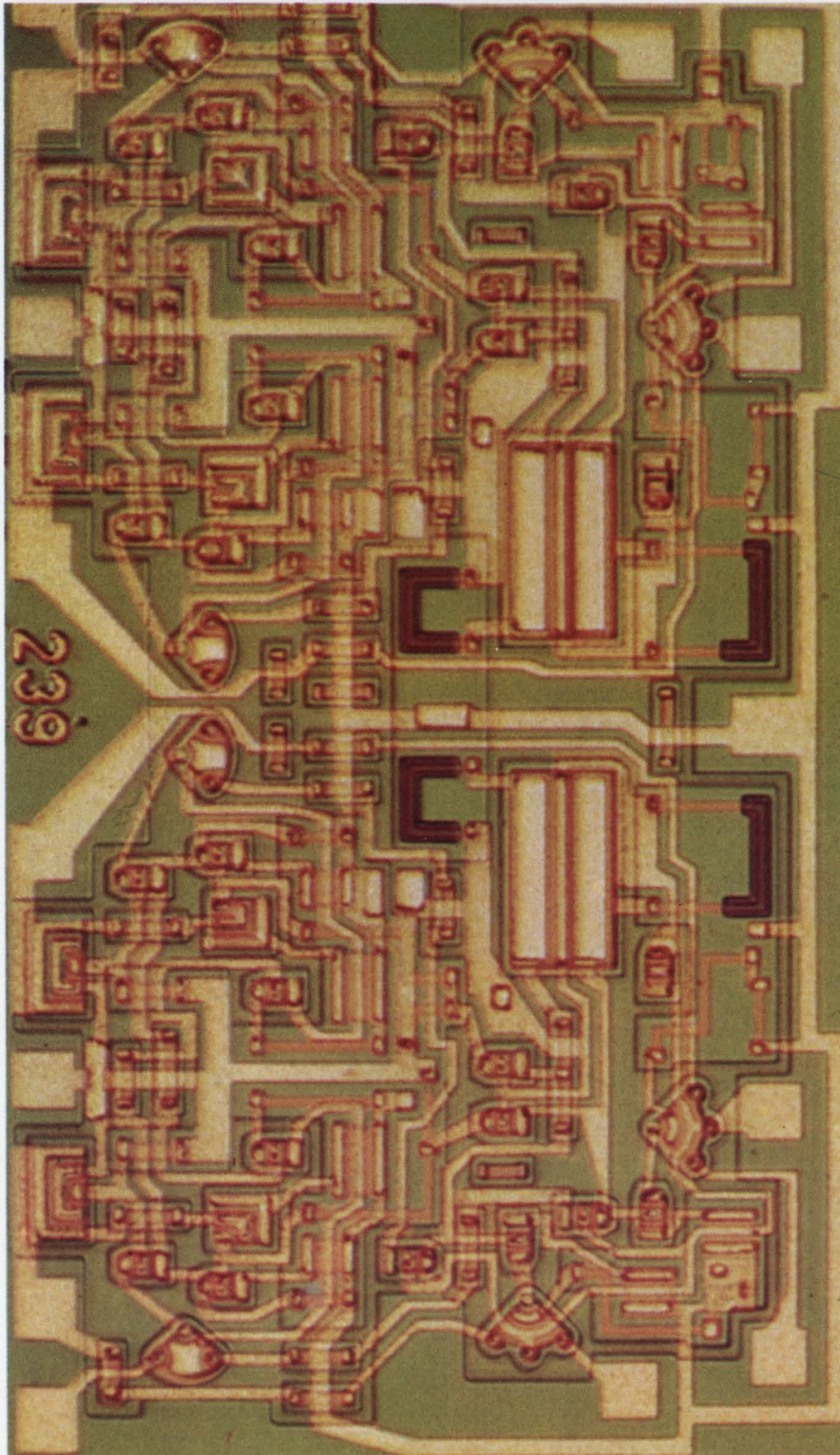

Sylvania's 50MHz J-K

Whether it's ripple or synchronous binary counting, Sylvania has the right J-K flip-flop. Ten types (single and dual) go to 50 MHz.

Flexibility provides the optimum design! That's the best description of how the wide range of J-K flip-flops available from Sylvania can solve your binary counting problems. Here's how two techniques, ripple and synchronous counting, can be implemented with Sylvania's J-Ks to get rates of 5.5, 7.5, 14, 15, 18, 25, 38 MHz in a binary counter.

Ripple type binary counters are sequential in nature: the designated clock pulse drives the first stage flip-flop with each subsequent stage being driven in turn by the preceding flip-flop. As seen in Figure 1, at the 8th clock pulse, the 4th flip-flop settles at a time  $t_1 + t_2 + t_3 + t_4$  after the initial clock pulse. Also note, it is possible that the 4th stage flip-flop might not be settled before clock pulse #9 occurs.

The speed of a ripple counter, however, is limited because decoding can't begin until the last flip-flop in the counter has settled down. As a result, the maximum frequency is:

$$f_{\max} = \frac{1}{\text{clock width} + t_1 + t_2 + t_3 + t_4}$$

For Figure 1, SUHL J-K flip-flops would be capable of the following typical decoding rates:

$$\text{SF-50 (20MHz)} = \frac{1}{35\text{ns} + (4\text{bits} \times 37\text{ns})} = 5.5\text{MHz}$$

$$\text{SF-250 (30MHz)} = \frac{1}{30\text{ns} + (4\text{bits} \times 25\text{ns})} = 7.5\text{MHz}$$

$$\text{SF-200 (50MHz)} = \frac{1}{12\text{ns} + (4\text{bits} \times 14\text{ns})} = 15\text{MHz}$$

*(Continued on next page)*

## This issue in capsule

### SUHL I & II

The largest high-level TTL line on the market: 41 functions, 164 types.

### Full adders

With 8 adders and 9 SUHL units you can build an 8-stage parallel add/subtract subsystem using ripple carry.

### Wideband amplifiers

100 MHz linear devices for video and pulse applications.

### IC reliability

How Sylvania makes certain that product quality levels are maintained.

### Functional arrays

Monolithic digital devices that reduce power, delays, and connections.



The semi-ripple counter in Figure 2 shows how SUHL SF-110 and 130 series dual J-K flip-flops can be used to obtain even higher decoding rates:

$$SF-110, 130 = \frac{1}{[12ns + (4bits \times 14ns/2)]} = 25MHz$$

High-speed applications invariably call for synchronous binary counters. In a synchronous counter each flip-flop is triggered simultaneously and is driven separately by the clock. Therefore, all the counter's outputs occur simultaneously. This type counter must be designed so that each flip-flop is properly set ahead of clock time in order that the proper output appears when triggered by the clock. Therefore, each flip-flop must have a gate stage at its input end to set the flip-flop for triggering.

Figure 3 shows a four-bit synchronous binary counter using SUHL flip-flops which have input gate structures. Each flip-flop has the output of all previous flip-flops fed into its J and K terminals. The maximum time at any clock pulse is  $t_1$ . All outputs appear simultaneously and reading or decoding can be performed in  $t_1$  nanoseconds after the clock trigger. Maximum frequency is:  $f_{max} = \frac{1}{(\text{Clock width} + t_1)}$ .

Typical SUHL J-K flip-flops would be capable of:

$$SF-50 (20MHz) = \frac{1}{(35ns + 37ns)} = 14MHz$$

$$*SF-250 (30MHz) = \frac{1}{(30ns + 25ns)} = 18MHz$$

$$SF-200 (50MHz) = \frac{1}{(12ns + 14ns)} = 38MHz$$

With synchronous counters, the number of inputs increases as the number of bits increases. For example, a 5-bit synchronous counter requires 4 inputs at the last flip-flop stage and a 10-bit counter requires 9 inputs at the last flip-flop stage.

Figure 4 shows a synchronous counter greater than 4-bits in length. It is completely synchronous. Using SUHL J-K flip-flops, this counter can operate at:

- SF-50 with SUHL I gates = 11.0 MHz
- SF-250 with SUHL II gates = 13.5 MHz
- SF-200 with SUHL II gates = 22.0 MHz

\*For new designs, the SF-200, SF-210 series are recommended replacements for the SF-250, SF-260 series.

CIRCLE NUMBER 300

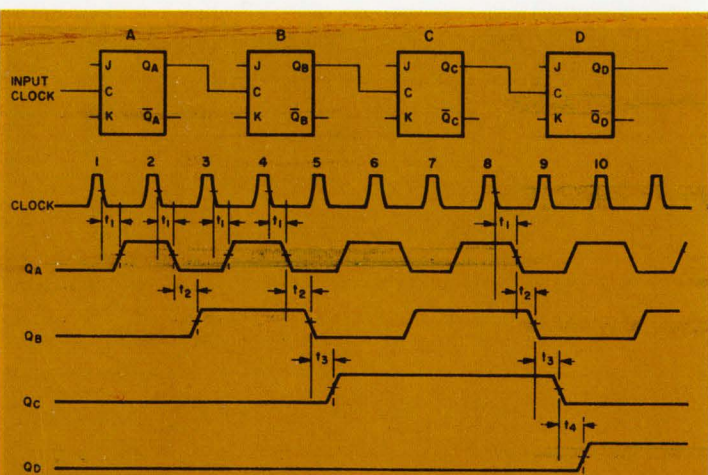

Fig. 1. Ripple Counter

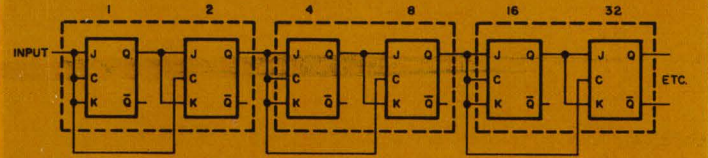

Fig. 2. Semi-Ripple Counter Using SF-110 or SF-130 Dual J-K F-F with Common Clock

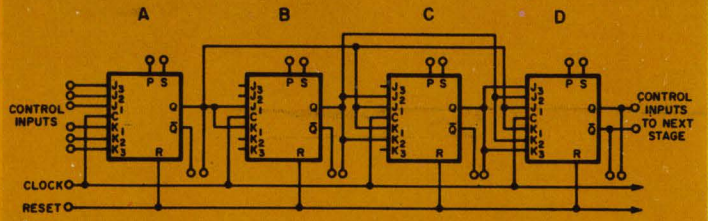

Fig. 3. Synchronous Binary Counter

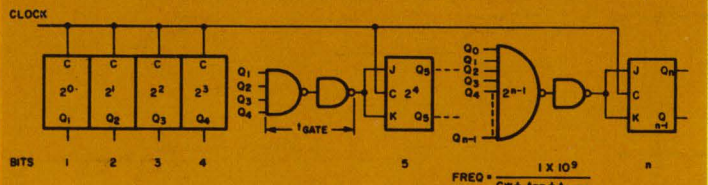

Fig. 4. Straight Synchronous-Gate Expanders Per Bit

## 100 MHz wideband amplifiers for video and pulse applications

Sylvania's high-performance, three-stage, direct-coupled linear amplifiers have low output, high signal voltage outputs, and excellent linearity.

While configurations of Sylvania's SA-20 and SA-21 wideband amplifiers are the same, the SA-20 is for applications requiring higher signal swing and tighter performance tolerances. Here's how you can use them.

Figure 1 shows the circuit diagram for the SA-20 series amplifier. Negative feedback is applied from output stage to first stage emitter through the divider consisting of  $R_4$  and  $R_6$ . Typical voltage gain of the device is 21 db. An external capacitor connected from the collector to base of  $Q_2$  provides local high-frequency feedback. This feedback shapes the roll-off of gain at high frequencies. Values ranging from 2.5 to 5.0 pF normally give the most uniform high-frequency response.

Tests with resistive loads show that a feedback capacitance ( $C_f$ ) of 3.6 pF gives a voltage gain essentially constant to 50 MHz. Gain is down 3 db at frequencies approaching 100 MHz. Increasing  $C_f$  to 6.5 pF reduces the -3 db frequency by 30 to 50 MHz.

**SA-20 Typical Electrical Characteristics**

Power Supply	+24 volts
Voltage Gain	21 db
Input Impedance	1.6K
Output Impedance	5 ohms
Max. Output Voltage Swing	14 volts p-to-p
3 db Frequency Response	100 mc: 17 db 30 mc: 20 db
2nd order Intermodulation Product	-65 db Po = 0 dbm
3rd order Intermodulation Product	-75 db Po = 0 dbm

Fig. 1. Sylvania Wideband Linear Amplifier

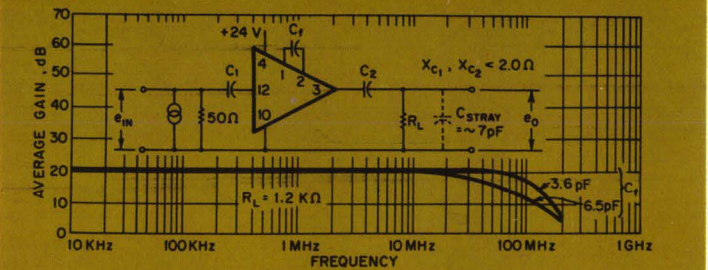

Fig. 2. SA-20 Typical Gain vs. Frequency

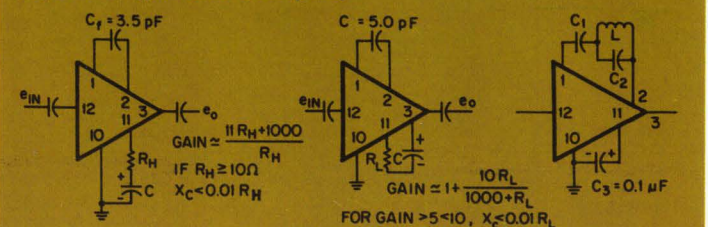

Fig. 3. High Gain Configuration

Fig. 4. Low Gain Configuration

Fig. 5. Selective Amplifier



Figure 2 shows how the voltage gain varies with frequency.

Amplifier gain can be changed by resistive shunting of feedback resistors (Figures 3 and 4). It is necessary to connect a dc blocking capacitor in series with the external resistor to prevent shifting of the normal quiescent voltages.

Maximum amplifier gain is realized when all forms of feedback are removed. This is done by not connecting a feedback capacitor between base and collector of  $Q_2$  and by bypassing the emitter resistor of  $Q_1$ . In this configuration, the amplifier has a typical voltage

gain of 60 db and a  $-3$  db gain frequency of about 4.5 MHz with an  $R_L$  of 1.2K.

Connecting the circuit as shown in Figure 5 gives bandpass characteristics. Voltage gain at the resonant frequency of L and  $C_2$  approaches the gain realized in the maximum gain configuration. Capacitor  $C_1$  blocks dc and should be large enough to prevent series resonance with inductor L. A notch characteristic is obtained when  $C_2$  is removed and L and  $C_1$  are series resonant. Selectivity of bandpass and notch circuits can be improved by replacing the tuned circuits with piezoelectric crystals. CIRCLE NUMBER 301

## Reliability: engineering superior circuits with superior packages

In short, the reliability of integrated circuits depends on how well the circuit chip is made and how well it is packaged.

Sylvania's integrated circuit Quality Assurance and Reliability Department recently completed evaluation of data compiled on 400 four-input NAND gates after 10,000 hours of life test (a total of 4 million component hours). Failure rate was a low 0.009% per 1,000 hours at 25° C.

The circuits tested were basic SUHL four-input NAND gates produced throughout 1964 and early 1965. Thus, they do not represent the improved products made since either the completion of Sylvania's new facilities, or the introduction of newer integrated circuit processing improvements. The improved devices are now undergoing life tests.

The NAND gates were life tested in the ring counter configuration. Life test sockets were placed in an oven where ambient temperature was maintained at 125° C. The graph relates failure rates and confidence limits to temperature.

Sylvania's in-house life and performance tests are supplemented by users' testing programs. A leading manufacturer of aerospace equipment recently completed an extensive testing of Sylvania's TO-85 packaged ICs. The manufacturer performed these key tests per MIL-STD 750 and 202 on SUHL devices and their packages: (1) 10-day JAN moisture resistance, (2) Radiflo leak test, (3) Shock, (4) Centrifuge, (5) Vibration fatigue, (6) Vibration-variable frequency (7) Lead fatigue, (8) Lead bending, (9) Salt atmosphere, (10) Storage life at 150° C, and (11) Operating life at 125° C. The package passed these qualification tests which led to the selection of Sylvania ICs for use in the firm's equipment.

To insure continued improvement in reliability and maintain product quality levels,

Sylvania has an extensive quality assurance test program. In addition to in-process testing of wafers, all Sylvania integrated circuits also go through a sequence of reliability tests after being sealed in packages. These tests insure that

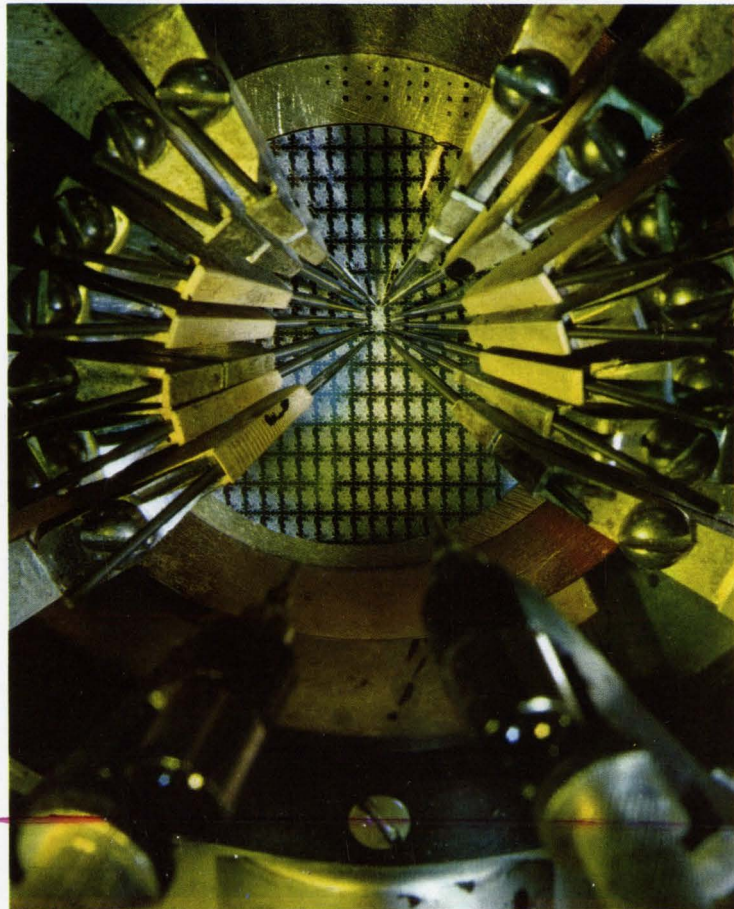
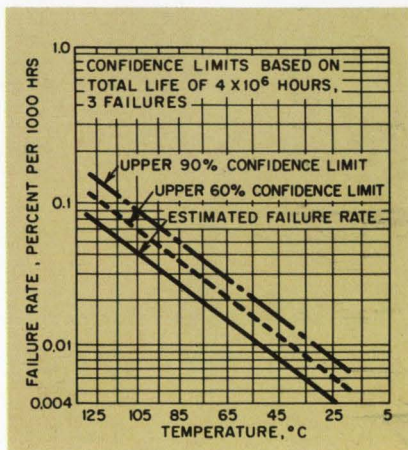

Mechanized wafer-level dc testing

both the actual circuit and the package maintain their integrity.

Each IC first goes through five cycles of  $-65^{\circ}$  C to  $+200^{\circ}$  C cycling with a fifteen-minute soak time at each temperature extreme. A 20,000 G centrifuge test, while units are in the  $Y_1$  plane, insures that the wire bonds are properly connected. Bubble-testing in  $150^{\circ}$  C glycerine points out leaks which may have resulted from the first two tests or from previous processing.

Next, units are baked at  $300^{\circ}$  C for 48 to 60 hours to stabilize them. Then all circuits must meet worst-case tests at the temperature extremes guaranteed in addition to all parameters called for on the Sylvania data sheet or in the customer's qualifications. Electrical capability of each IC is tested at  $75^{\circ}$  C,  $125^{\circ}$  C,  $-55^{\circ}$  C and  $0^{\circ}$  C for dc parameters.

Finally, each unit is tested for all switching characteristics at  $25^{\circ}$  C. This is done by Sylvania's fully automatic test equipment at the rate of one circuit every two seconds. Only at this point is differentiation made between military and industrial capability.

This 100% testing program is in addition to extensive tests of random samples from each lot of circuits. These samples are subjected to electrical, environmental and life testing. CIRCLE NUMBER 302



# SUHL I & II, the most efficient, most complete TTL lines

SUHL ICs are high-level TTL units and more. Designers get flexibility from a wide variety of functions without sacrificing performance.

Sylvania's IC pioneering has led to the highest quality and most complete lines of high-level TTL ICs in the industry. With each of 41 separate functions now available in four different versions (for a total of 164

types), SUHL I and II represent the largest high-level TTL lines on the market.

SUHL units combine propagation delay times as low as 6 nanoseconds with high noise margin, high logic swing, high fan-out, low power and high capacitance drive capability (see Table).

Advantages of SUHL integrated circuits are not limited to electrical performance characteristics. Because Sylvania provides more logic per package, you can build a computer, or other digital equipment, with 25% less packages. The savings in system cost which result from lower package count are not eaten up in higher initial costs because SUHL units are competitively priced.

Sylvania's head start in TTL integrated circuit de-

SUHL I TYPICAL CHARACTERISTICS (+25°C, +5.0 Volts)									
Function	Type Nos.	t <sub>pd</sub> (nsec)	Avg. Power (mw)	Noise Immunity +(volts)-	**Military (-55°C to +125°C)		**Industrial (0°C to +75°C)		
					Prime FO	Std. FO	Prime FO	Std. FO	FO
<b>NAND/NOR Gates</b>									
Dual 4-Input NAND/NOR Gate	SG-40, SG-41, SG-42, SG-43	10	15	1.1	1.5	15	7	12	6
Single 8-Input NAND/NOR Gate	SG-60, SG-61, SG-62, SG-63	12	15	1.1	1.5	15	7	12	6
Expandable Single 8-Input NAND/NOR Gate	SG-120, SG-121, SG-122, SG-123	18	15	1.1	1.5	15	7	12	6
Dual 4-Input Line Driver	SG-130, SG-131, SG-132, SG-133	25	30	1.1	1.5	30	15	24	12
Quad 2-Input NAND/NOR Gate	SG-140, SG-141, SG-142, SG-143	10	15	1.1	1.5	15	7	12	6
Triple 2-Input Bus Driver	SG-160, SG-161, SG-162, SG-163	15	15	1.1	1.5	15	7	12	6
Triple 3-Input NAND/NOR Gate	SG-190, SG-191, SG-192, SG-193	10	15	1.1	1.5	15	7	12	6
<b>AND-NOR Gates</b>									
Expandable Quad 2-Input OR Gate	SG-50, SG-51, SG-52, SG-53	12	30	1.1	1.5	15	7	12	6
Expandable Dual Output, Dual 2-Input OR Gate	SG-70, SG-71, SG-72, SG-73	12	20/gate	1.1	1.5	15	7	12	6
Exclusive-OR with Complement	SG-90, SG-91, SG-92, SG-93	11	35	1.1	1.5	15	7	12	6
Expandable Triple 3-Input OR Gate	SG-100, SG-101, SG-102, SG-103	12	25	1.1	1.5	15	7	12	6
Expandable Dual 4-Input OR Gate	SG-110, SG-111, SG-112, SG-113	12	20	1.1	1.5	15	7	12	6
<b>Non-Inverting Gates</b>									
Dual Pulse Shaper/Delay-AND Gate	SG-80, SG-81, SG-82, SG-83	11	30/gate	1.1	1.5	15	7	12	6
Dual 4-Input AND/OR Gate	SG-280, SG-281, SG-282, SG-283	11	38/gate	1.0	1.5	10	5	8	4
<b>AND Expanders</b>									
Dual 4-Input AND Expander	SG-180, SG-181, SG-182, SG-183	< 1	0.9/gate	1.1	1.5				
Dual 2 + 3 Input AND/OR Expander	SG-290, SG-291, SG-292, SG-293	7	15/gate	1.0	1.5				
<b>OR Expanders</b>									
Quad 2-Input OR Expander	SG-150, SG-151, SG-152, SG-153	4	20	1.1	1.5				
Dual 4-Input OR Expander	SG-170, SG-171, SG-172, SG-173	3	5	1.1	1.5				
<b>Flip-Flops</b>									
Set-Reset Flip-Flop	SF-10, SF-11, SF-12, SF-13	20MHz*	30	1.1	1.5	15	7	12	6
Two Phase SR Clocked Flip-Flop	SF-20, SF-21, SF-22, SF-23	20MHz*	30	1.1	1.5	15	7	12	6
Single Phase SRT Flip-Flop	SF-30, SF-31, SF-32, SF-33	15MHz*	30	1.1	1.5	15	7	12	6
J-K Flip-Flop (AND Inputs)	SF-50, SF-51, SF-52, SF-53	20MHz*	50	1.1	1.5	15	7	12	6
J-K Flip-Flop (OR Inputs)	SF-60, SF-61, SF-62, SF-63	20MHz*	55	1.1	1.5	15	7	12	6
Dual 35MHz J-K Flip-Flop (Separate Clock)	SF-100, SF-101, SF-102, SF-103	35MHz*	55/FF	1.0	1.5	11	6	9	5
Dual 35MHz J-K Flip-Flop (Common Clock)	SF-110, SF-111, SF-112, SF-113	35MHz*	55/FF	1.0	1.5	11	6	9	5
<b>SUHL II TYPICAL CHARACTERISTICS (+25°C, +5.0 Volts)</b>									
<b>NAND/NOR Gates</b>									
Expandable Single 8-Input NAND/NOR Gate	SG-200, SG-201, SG-202, SG-203	8	22	1.0	1.5	11	6	9	5
Quad 2-Input NAND/NOR Gate	SG-220, SG-221, SG-222, SG-223	6	22	1.0	1.5	11	6	9	5
Dual 4-Input NAND/NOR Gate	SG-240, SG-241, SG-242, SG-243	6	22	1.0	1.5	11	6	9	5
Single 8-Input NAND/NOR Gate	SG-260, SG-261, SG-262, SG-263	8	22	1.0	1.5	11	6	9	5
<b>AND-NOR Gates</b>									
Expandable Dual 4-Input OR Gate	SG-210, SG-211, SG-212, SG-213	7	30	1.0	1.5	11	6	9	5
Expandable Quad 2-Input OR Gate	SG-250, SG-251, SG-252, SG-253	7.5	43	1.0	1.5	11	6	9	5
Expandable Triple 3-Input OR Gate	SG-300, SG-301, SG-302, SG-303	7	36	1.0	1.5	11	6	9	5
Expandable Dual Output Dual 2-Input OR Gate	SG-310, SG-311, SG-312, SG-313	7	30/gate	1.0	1.5	11	6	9	5
<b>AND Expanders</b>									
Dual 4-Input AND Expander	SG-180, SG-181, SG-182, SG-183	< 1	0.9/gate	1.1	1.5				
<b>OR Expanders</b>									
Quad 2-Input OR Expander	SG-230, SG-231, SG-232, SG-233	2	28	1.0	1.5				
Dual 4-Input OR Expander	SG-270, SG-271, SG-272, SG-273	2	6.7	1.0	1.5				
<b>Flip-Flops</b>									
Dual 50 MHz J-K Flip-Flop (Separate Clock)	SF-120, SF-121, SF-122, SF-123	50MHz*	55/FF	1.0	1.5	11	6	9	5
Dual 50MHz J-K Flip-Flop (Common Clock)	SF-130, SF-131, SF-132, SF-133	50MHz*	55/FF	1.0	1.5	11	6	9	5
50MHz J-K Flip-Flop (AND Inputs)	SF-200, SF-201, SF-202, SF-203	50MHz*	55	1.0	1.5	11	6	9	5
50MHz J-K Flip-Flop (OR Inputs)	SF-210, SF-211, SF-212, SF-213	50MHz*	55	1.0	1.5	11	6	9	5

\*Minimum toggle frequency \*\*Minimum fan-out



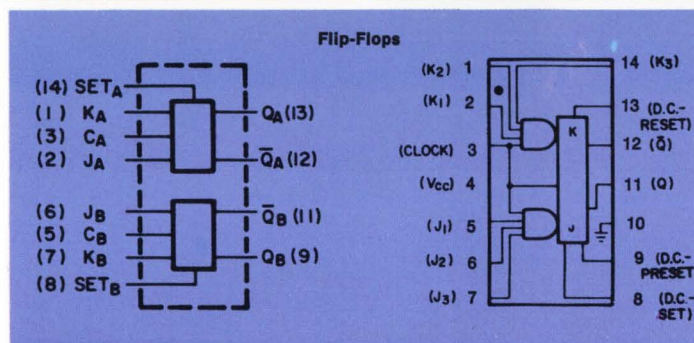
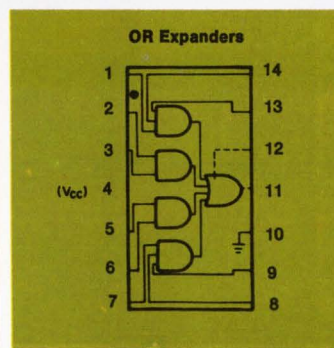
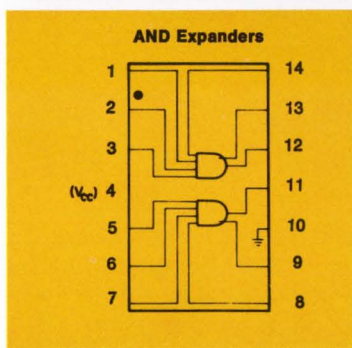
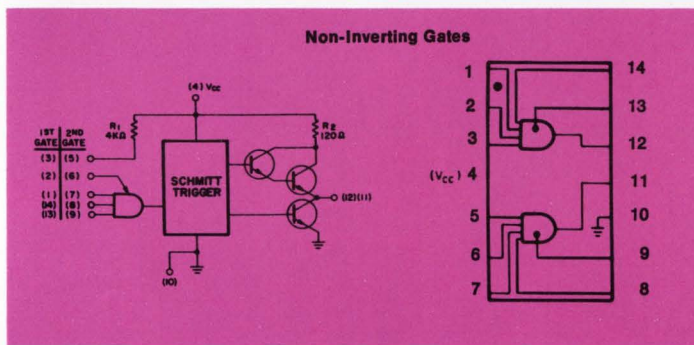
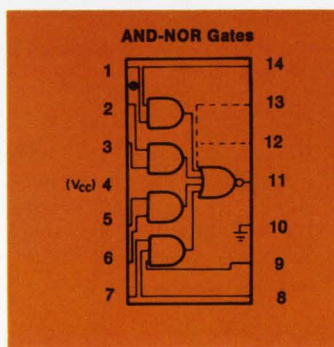
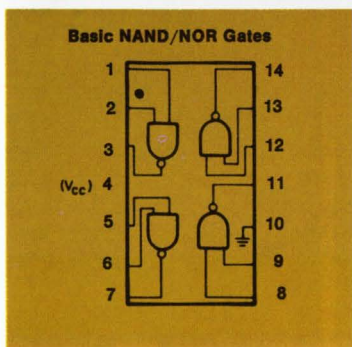
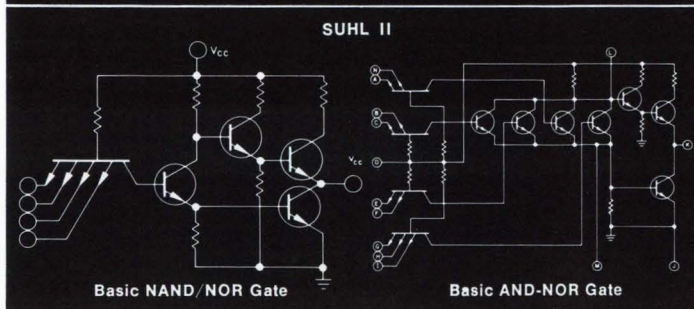
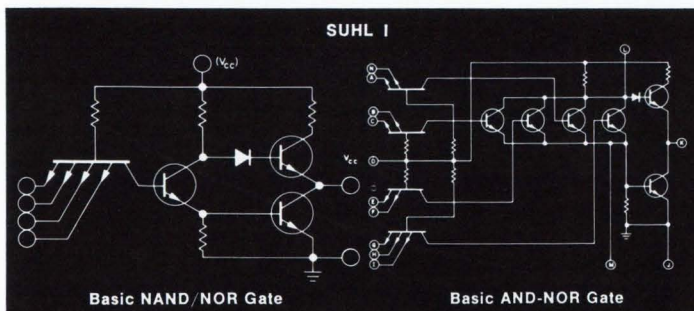

sign, manufacturing and testing is reflected in the superior quality of the SUHL lines. Patented active pull-up networks allow high output logic levels. Use of smaller device geometries not only gives better electrical characteristics, but also cuts device cost. Aluminum to aluminum ultrasonic bonding improves reliability two ways, better bonds and less heat applied to the silicon chip. Automatic testing by Sylvania's specially designed Multiple Rapid Automatic Test Of Monolithic Integrated Circuit (MR. ATOMIC) equipment insures that the units you get meet the specification to which they're bought. Tested here are all dc parameters at temperature and all switching parameters at 25° C.

The continuing leadership in TTL innovation and manufacturing exemplified by the SUHL lines makes Sylvania the prime source for high-level TTL devices.

CIRCLE NUMBER 303

## This is Sylvania's DTL line

The 930 series of DTL ICs now available from your Sylvania distributor comes in flat and dual in-line plug-in versions.

Sylvania's DTL circuits are a low-power logic family with high noise immunity and moderate speed capabilities. Operating over a temperature range of -55° C to +125° C, these units are ideal replacements for similar units designed into digital systems already in production. They are electrically interchangeable and have pin for pin compatibility with other 930 series devices. Prices are competitive with those of other manufacturers.

Type*	Description
S9301/S9303	Dual 4-Input Expandable NAND Gate
S9321/S9323	Dual 4-Input Expandable Buffer
S9331/S9333	Dual 4-Input Expandable
S9441/S9443	Dual 4-Input Expandable Power Gate
S9461/S9463	Quadruple 2-Input NAND Gate
S9621/S9623	Triple 3-Input NAND Gate
S9311/S9313	J-K/R-S Flip-Flop
S9451/S9453	High Performance J-K/R-S Flip-Flop
S9481/S9483	Fast Rise Time J-K/R-S Flip-Flop

\*A number ending in "1" indicates the MIL version (-55°C to +125°C temperature range); those ending in "3" are industrial types (0°C to 75°C).

TYPICAL CHARACTERISTICS		
Parameter	Basic Gate	FLIP-FLOP
Supply Voltage	4.5 to 5.5V	4.5 to 5.5V
Temperature Range	-55° to +125°C 0° to +75°C	-55° to +125°C 0° to +75°C
Propagation Delay	25 nsec	50 nsec
Power Dissipation at 4.5V Supply	5 mw	20 mw
Noise Margin	750 mv	750 mv
Input Unit Load	"0" 1.1* mA "1" 0.5µA	"0" 1.1* mA "1" 0.5µA
Fan-out	8	8
Output Logic Levels	"0" 0.3V "1" 4.65V	"0" 0.3V "1" 4.65V

\*V<sub>IN</sub> = 0V; 0.9 mA V<sub>IN</sub> = 0.75V

The added plus in this DTL line is the availability of devices housed in Sylvania's dual in-line plug-in package. With this package, designers get an extremely effective hermetic seal, circular leads with tapered shoulders, leads which can be flexed close to the package body, and a package of very small total volume.

CIRCLE NUMBER 304



# 8-stage parallel add/subtract system uses only 17 ICs

Here's an example of compatible devices—a system using units from three Sylvania IC families: functional arrays, SUHL I and SUHL II.

An eight-stage parallel add/subtract subsystem using ripple carry techniques can be made with 17 packages—eight SM-10 series full adders, eight SG-110 series expandable dual 4-input OR gates, and one SG-280 series dual 4-input AND/OR gate. The full adder is one of Sylvania's family of monolithic digital functional arrays. The SG-110 and SG-280 are SUHL family high-level TTL gates.

In the ripple adder configuration shown, control for the subsystem is represented by a mechanical switch. When the switch is in the SUBTRACT position, complement binary addition is performed. With the switch in the ADD position, straight binary addition is performed. It is assumed that only positive numbers will be added or subtracted, and that the most significant digit is the sign (0 = Positive, 1 = Negative).

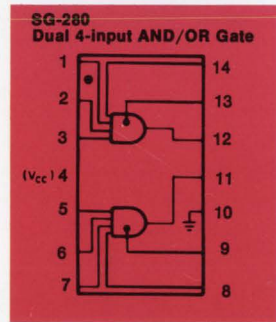
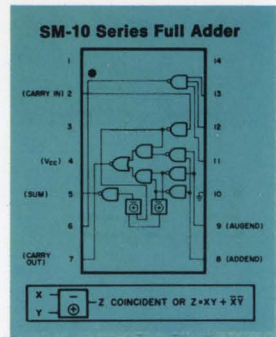
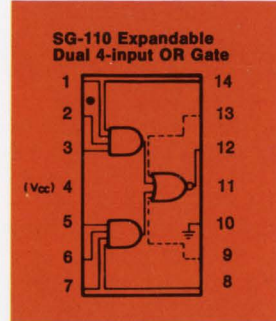

The independent three-input NAND gate included in each SM-10 full adder package provides the complement of the SUM for subsequent operations. This includes such operations as complementing the answer in subtraction (depending on the sign bit in the answer). Enabling of the SG-280 AND gate during the subtraction process provides end around carry.

Typical propagation delay times are found by assuming that the number to be added or subtracted (the B inputs) is present in both true and complemented form, and that all A and B inputs are presented simultaneously. Then propagation delay times can be calculated with these equations:

### Addition

$$\text{Final Sum} = (N-1)t_{pd\text{carry}} + t_{sum} + t_{pd\text{gate}}$$

where N = Number of adder stages

$t_{pd\text{carry}}$  = one carry delay or 15 ns (typ.)

$t_{sum}$  = one sum delay or 25 ns (typ.)

$t_{pd\text{gate}}$  = propagation delay of SG-110 or 15 ns (typ.)

### Subtraction

$$\text{Final Difference} = (N-1)t_{pd\text{carry}} + t_{sum} + 2 t_{pd\text{gate}}$$

where  $t_{pd\text{gate}}$  includes the propagation delay through the SG-280 (15 ns, typ.)

Thus, for an 8-stage add/subtract unit:

$$\text{Final Sum} = [(8-1) \times (15)] + 25 + 15 = 145 \text{ nsec}$$

$$\text{Final Difference} = [(8-1) \times (15)] + 25 + (2 \times 15) = 160 \text{ nsec}$$

Average Power Dissipation for a complete 8-stage unit is 880 milliwatts.

If a faster subsystem is needed, an eight-stage anticipated carry adder using SM-20, SM-30 and SM-40 digital functional array adders can be employed to replace the SM-10 devices.

CIRCLE NUMBER 305

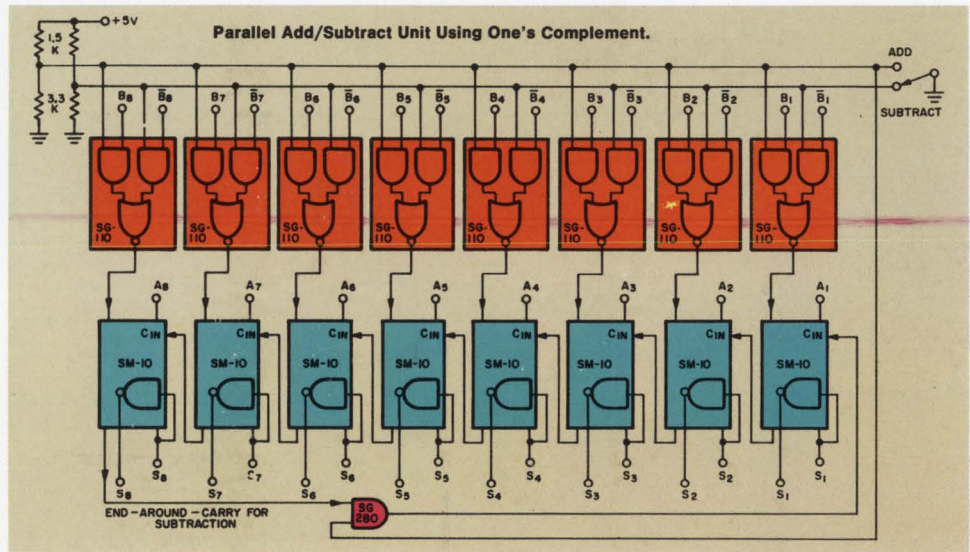

# These functional arrays reduce power, delay, and connections

This line of monolithic digital functional arrays provides computer and communications system designers with a powerful design tool.

Sylvania's line of monolithic digital functional arrays represents a significant advance over conventional integrated circuits. You can get typical computer subsystems such as adders, frequency dividers, registers, and memories which work at faster speeds, use less power and need fewer external connections.

For example, in a decade frequency divider with a frequency range of dc to 30 MHz, power can be reduced to one-fourth of that required by conventional

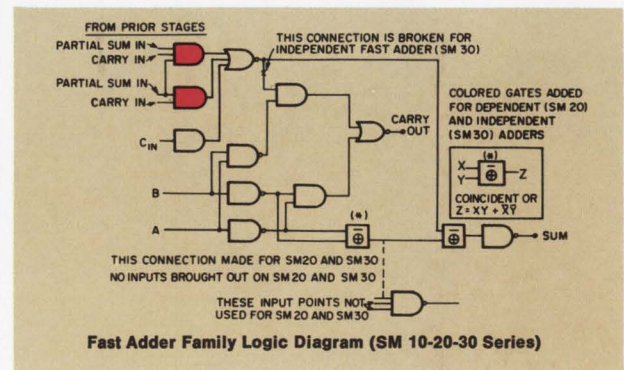



MONOLITHIC DIGITAL FUNCTIONAL ARRAYS VS. CONVENTIONAL ICs

Typical Computer Subsystems	Sylvania Monolithic Digital Functional Arrays					Conventional Integrated Circuits		
	Number of Packages	Number of Equivalent Discrete Components	Speed (nsec)	Power (Milliwatts)	Number of External Connect'ns	Equivalent Number of IC Gates	(A) Power (Milliwatts)	(B) No. of External Connect'ns
Basic Single Stage Fast Adder With Anticipated Carry	1	73	14	120	14	18	180	64
Four Bit Anticipated Carry Adder	4	292	35	480	56	72	720	252
Four Bit Ripple Carry Adder	4	264	60	400	32	36	540	132
Eight Bit Anticipated Carry Adder	12	704	45	1040	168	172	1460	602
Eight Bit Ripple Carry Adder	8	528	120	800	112	72	1080	252
Decade Frequency Divider	1	116	DC to 30 MHz	150	6	40 <sup>(C)</sup>	600 <sup>(C)</sup>	140 <sup>(C)</sup>
Four Bit Register (Bus Transfer Output)	1	87	15	120	12	25	350	89
Four Bit Register (Cascode Pullup Output)	1	94	15	120	11	25	350	89

(A) Based on Average of 15mw per NAND/NOR and Average of 5mw per AND-NOR Expansion.  
 (B) Based on Average of 4 Gates per 14-Lead Package.  
 (C) Using 4 Sylvania JKs and a Pulse Shaping Gate, the Package Count would be 5 and Interconnections 37. Average Power Drain would be 190mw.

ICs while cutting external connections from 140 to 6. The table shows other examples — four-bit and eight-bit fast adders, and four-bit registers.

The functional arrays used in such circuits combine as many as 40 conventional integrated circuit functions in a single package while providing greater reliability and less costly system assembly.

The fast adder family of arrays contains the equivalent of 70 discrete components. Its basic integrated circuit is interconnected by three standard metal patterns to form the SM-30 single-stage independent fast adder, the SM-20 single-stage dependent fast adder, and the SM-10 single-stage full adder. The independent and dependent fast adders, in conjunction with the SM-40 carry decoder, can form parallel anticipated-carry fast-adder subsystems of any size.

Sylvania's SM-50 series decade frequency divider accepts both analog and digital inputs and produces a symmetrical square wave output. Digital signals from dc to 30 MHz and analog signals from 5 Hz to 30 MHz can be processed. This frequency divider is a six-stage circuit with the first a buffer which shapes the input. The following three stages perform a synchronous division by five. The next divides by two to complete the decade division. An output buffer in the final stage provides high ac and dc fan-out.

Four-bit storage registers, Series SM-60 and SM-70, are used as high-speed storage elements in con-

(Continued on next page)

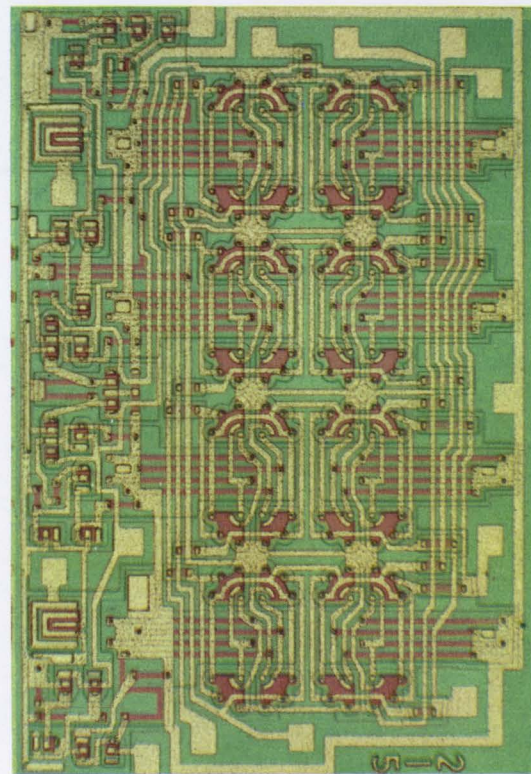

SM-80 16-bit scratch pad memory



Use Sylvania's "Hot Line" inquiry service, especially if you require full particulars on any item in a hurry. It's easy and it's free. Circle the reader service number(s) you're most interested in; then fill in your name, title, company and address. We'll do the rest and see you get further information almost by return mail.

FIRST CLASS  
 Permit No. 2833  
 Buffalo, N. Y.

BUSINESS REPLY MAIL  
 No Postage Stamp Necessary if Mailed in the United States

POSTAGE WILL BE PAID BY  
**SYLVANIA ELECTRONIC COMPONENTS GROUP**  
 Sylvania Electric Products Inc.  
 1100 Main Street  
 Buffalo, New York 14200

Dept. No. B 2 2 2

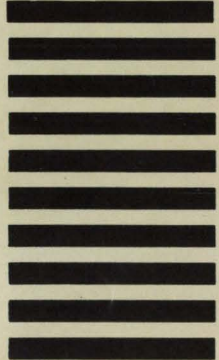



trol and arithmetic sections of computers. The SM-60 series has clock input as well as clock output. Further, SM-60 output has wired-OR capability which means outputs can be tied together to perform the logic OR function. The SM-70 series is similar to the SM-60 but has a SUHL type output network and is not clocked with an enable signal. This means information set in the device is available at the output after a delay of 20 nanoseconds.

The SM-80 series 16-bit memory is for high-speed scratch pad memory systems with cycle times in the 100 nanosecond range. This single chip memory consists of 16 solid-state set/reset flip-flops arranged to form an addressable four-by-four memory matrix. This structure permits nondestructive readout of all 16 bits. Reading and writing is through four X and four Y lines which are brought out to eight external terminals, one for each line. Read and write control is by four internal amplifiers. Each flip-flop in the four-by-four matrix is logically connected to its own  $X_M$ ,  $Y_N$  address combination and to the sense and write amplifiers.

All these monolithic digital functional arrays are compatible with SUHL ICs. The arrays are rated for operation in the temperature ranges up to  $-55^\circ\text{C}$  to  $+125^\circ\text{C}$  and are available in the standard Sylvania 14-lead dual in-line plug-in package and the TO-85 flat pack.

CIRCLE NUMBER 306

of a line of high-level transistor-transistor logic which we called SUHL, for Sylvania Universal High-level Logic.

These high-level TTL circuits were originally available in a limited number of logic configurations. However, customers required a wider variety of circuits to implement their logic designs. Our various solutions to their requests resulted in our present SUHL lines; one operating at 20 megahertz, the other at 40 megahertz with some 40 different logic configurations available to designers.

The next step was to develop functional arrays such as storage registers, counters, and adder circuits which satisfied customer requirements for more logic per package and for complete interfacing capability with SUHL circuits.

Our production philosophy was equally customer-oriented. We met the requirements for a dual in-line plug-in package with a ceramic/Kovar 14-pin enclosure using the same construction as was proven out in the TO-85 flat pack. The dual in-line package was developed and met customer needs including stringent military requirements. In conjunction with such development, Sylvania decided the best way to produce highly reliable integrated circuits was to concentrate on a single process. This included a series of 100% production tests and final 100% testing of all dc parameters at temperature extremes and ac parameters at room temperature.

We did this and now we're able to state that all our circuits, regardless of grade, are identical in construction. Any improvements are always immediately incorporated in the total line. Further, such upgrading is an intrinsic part of our manufacturing process. For example, when we added a Kovar base plate to the flat pack to improve its heat dissipation capabilities, we made a similar change in our dual in-line plug-in package.

We intend to continue pursuing this philosophy which permits us to assure all our customers that our circuits, regardless of grade, represent the best in performance and construction available.

*Harry Luhrs*

H. M. LUHRS

#### MARKETING MANAGER'S CORNER

## Sylvania's commitment to IC upgrading

Fifty years of manufacturing electronic components has taught us that it pays to give our customers what they want.

Five years ago, when we started our integrated circuit facility, we polled our customers and, based on their reaction, initiated design on transistor-transistor logic to meet their need for faster integrated circuits. When this new line was introduced, some of our customers asked for buffered outputs to handle higher capacitive loads. The result was a development

# SYLVANIA

SUBSIDIARY OF

GENERAL TELEPHONE & ELECTRONICS GTE

NEW CAPABILITIES IN: ELECTRONIC TUBES • SEMICONDUCTORS • MICROWAVE DEVICES • SPECIAL COMPONENTS • DISPLAY DEVICES

This information in Sylvania Ideas is furnished without assuming any obligations.

I am especially interested in ICs for the following application(s) \_\_\_\_\_

NAME \_\_\_\_\_

TITLE \_\_\_\_\_

COMPANY \_\_\_\_\_

ADDRESS \_\_\_\_\_

CITY \_\_\_\_\_ STATE \_\_\_\_\_

#### Circle Numbers Corresponding to Product Item

300      301      302      303      304      305      306

Please have a Sales Engineer call



#### HOT LINE INQUIRY SERVICE

Need information in a hurry? Clip the card and mail it. Be sure to fill in all information requested. We'll rush you full particulars on any item indicated.

You can also get information using the publication's card elsewhere in this issue. Use of the card shown here will simplify handling and save time.



## Radio-relay system can be carried easily

Most Army tactical radio-relay systems are so bulky that they're mounted on a truck for mobility. A new unit, scheduled to undergo field testing soon, is light enough for one or two men to haul it at will.

The system, composed of a radio set (CXL-5) on a tripod and a multiplex (WC-101B) on the ground, is for communications on the battlefield. The radio equipment weighs only 23 pounds. The battery power supply weighs 10 to 15 pounds.

ITT Federal Laboratories of Nutley, N. J., developer of the integrated-circuit system, says it will be delivered to the Army's Electronics Command at Fort Monmouth, N. J., for testing.

The CXL-5 radio set can deliver 125 mW over a frequency range of 7.125 to 8.5 GHz, according to the company. The WC-101B multiplexer can handle 12 voice channels with the use of PCM techniques.

The radio set antenna consists of a flat, planar array with the elements imbedded in fiberglass and fixed to the rear of the radio cabinet. The antenna is "aimed" by rotating the entire cabinet.

Power for the system can range from flashlight batteries to a toolbox-sized unit for operation from a vehicle's electrical system. ■ ■

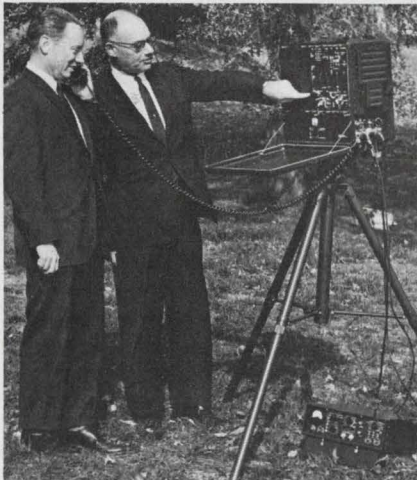

Tactical microminiature radio relay system is checked out by Lawrence G. Forbes (left) engineering team leader of the Army Electronics Command, and Herbert Sheer, marketing manager of ITT Federal Laboratories, which built the system.

µsec/millisecond delays

VIDEO
TRIPLE

5 to 500MHz
TRAVEL

MULTI-CHANNEL

PROPORTIONAL CONTROL

analog

ISOTHERMAL

WIDEBAND
LOW

AMPLIFIERS
LOSS

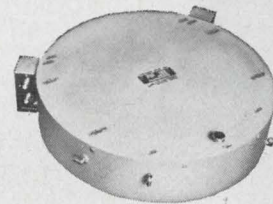
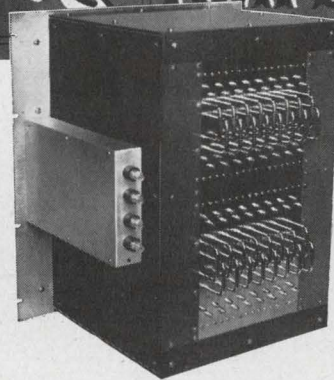

In a word, LFE  
for quartz or glass  
ultrasonic delay lines

You'll find the complete text — applications information — theory — technical data — specifying information for standard and custom delay lines for your application — in these authoritative LFE Catalog-Handbooks. Get them, now!



ELECTRONICS DIVISION

Laboratory For Electronics, Inc.  
WALTHAM, MASSACHUSETTS 02154  
Tel: 617-894-6600 • TWX: 710-324-0681

ON READER-SERVICE CARD CIRCLE 27



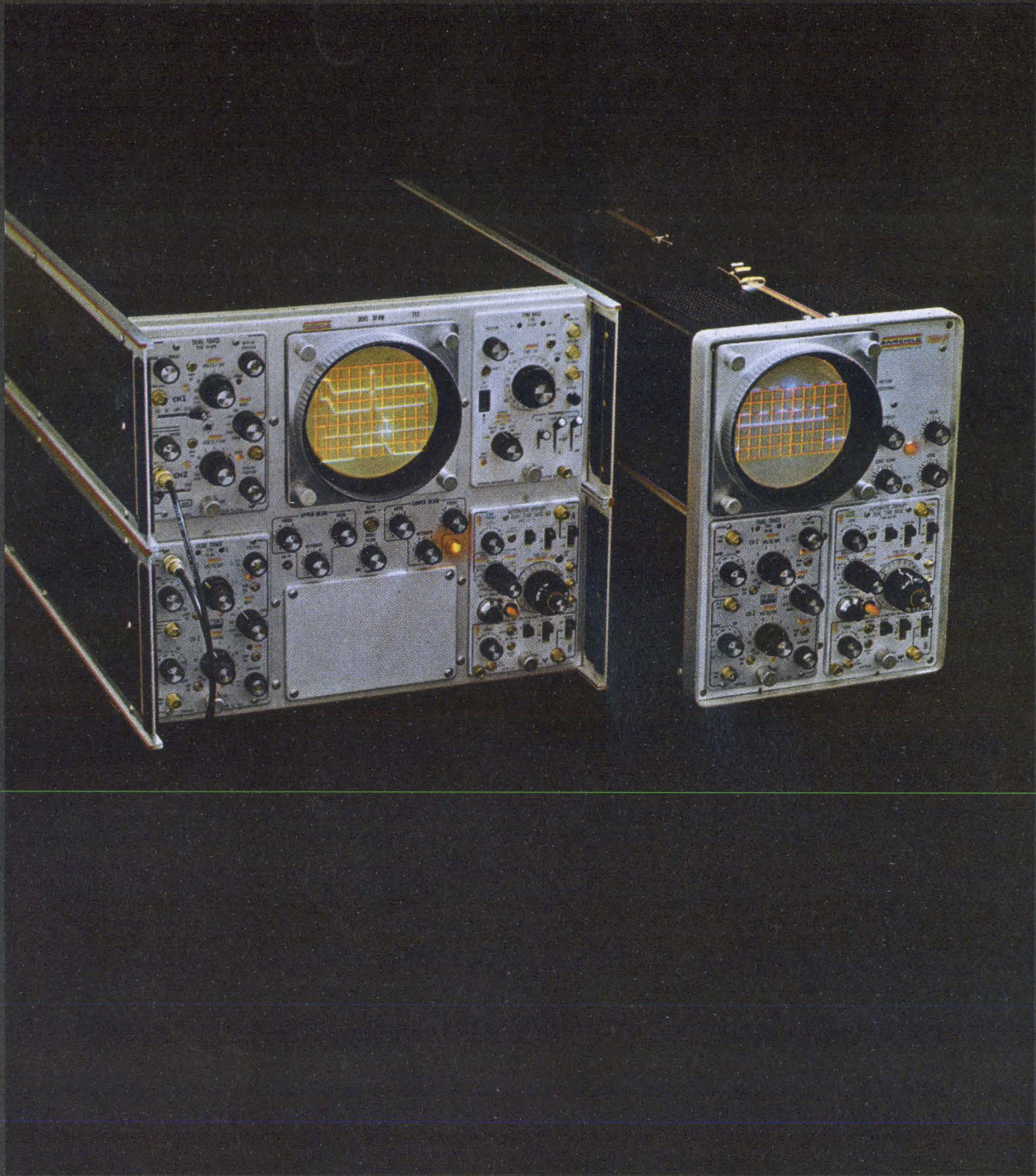



**These are our  
100MHz scopes.  
The 777 is a  
dual-beam scope.  
The 766 H/F is a  
single-beam scope  
that acts like  
a dual-beam.  
The same plug-ins  
fit both. Look at  
one soon.**

**FAIRCHILD**  
INSTRUMENTATION



## Electronic display offers clearer view of stock quotations

A stock-market quotation display, formed by luminescent disks against a black background, has been developed to give brokers and investors a clearer view of transactions.

Solid-state logic converts telegraphed price information from stock exchanges to signals that control air jets. Escaping air flips the disks that spell out the market information. They travel across an eight-foot screen on a continuous band, then re-enter the mechanism where a new message is spelled out.

The new method eliminates the need to print the quotations on paper tape and then project them onto a screen, as most stock displays do now.

According to Charles Holloman, chief engineer of the Trans-Lux Corp., New York, N. Y., designers

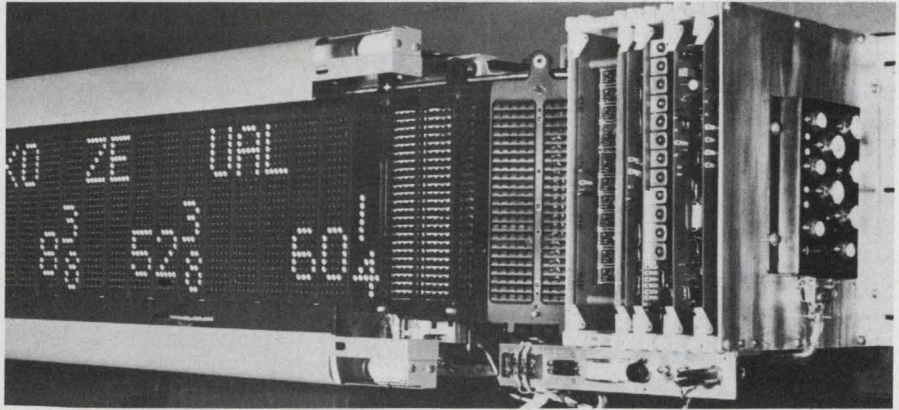

**Stock-quotation display**, controlled by solid-state electronics, signals the latest price data with luminescent disks on a moving eight-foot screen.

and builders of the Trans Jet display, it can be seen at greater distances in all conditions of background lighting and is less subject to mechanical breakdown than the projector.

Circuitry for the display occupies only five circuit boards, because of the extensive use of integrated circuits. All of the semiconductors used in the stock display were made by Texas Instruments in Dallas. ■ ■

## Computer to speed Army's teaching of — • — • — — — — • •

With a computer for an instructor, the Army will be able to teach Morse code to 24 students at once and pace the lessons to their individual learning abilities.

An audio-visual system being produced by Sylvania Electric Products, Inc., is divided into 24 training consoles, all controlled by one computer.

"The computer analyzes the accuracy of each trainee," explains Dr. James E. Storer, director of Sylvania's applied research laboratory. "If a student makes mistakes on certain letters, these are repeated more frequently. Speeds are adjusted automatically to the capabilities of the individual."

Each trainee is equipped with earphones, a typewriter keyboard with unmarked keys and an electronic display of a typewriter keyboard. A Morse code letter is transmitted to the student through the earphones and flashed on the display keyboard. When the student recognizes the letter, he depresses the proper key on his typewriter. Gradually the display lights are delayed, so the trainee is responding to the audio signals alone. ■ ■



**Computer-controlled Morse code training system** will let the Army give individualized instruction to 24 students at once. The system is being tested here by its maker, Sylvania Electric Products, Inc.



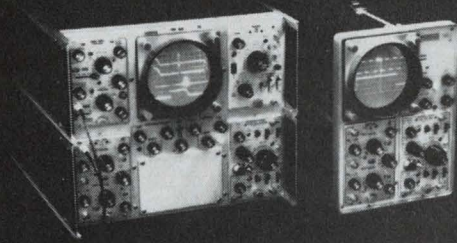

**These are our  
100MHz scopes.  
The 777 is a  
dual-beam scope.  
The 766 H/F is a  
single-beam scope  
that acts like  
a dual-beam.  
The same plug-ins  
fit both. Look at  
one soon.**

**FAIRCHILD**  
INSTRUMENTATION

## The Scopes:

### 766 H/F Main Frame:

Single beam, solid-state scope with 6 x 10 cm scan, 13kV accelerating potential and algebraic add. The 766 H/F accepts any of the plug-ins listed to the right, but the 79-02A amplifier and 74-17 beam switching and delaying sweep time base are recommended. With these plug-ins the scope has 100MHz bandwidth, 100mV/div sensitivity, 3.5nsec. risetime, and a 5nsec. sweep.

### 777 Main Frame:

The 777 is a true dual-beam scope, with a dual gun CRT. It has a 13kV accelerating potential and a 6 x 10 cm display area for each beam, with a 4 cm overlap. Each gun can be independently blanked or intensified. The 777 accepts any four of the plug-ins listed to the right.

For detailed information, call us, or write.

## The Plug-ins:

### Time Base Modules:

- 74-03A General purpose, 5nsec.
- 74-13A Delaying sweep with calibrated delay
- 74-14 General Purpose time base
- 74-17A Automatic beam switching delaying sweep with calibrated delay

### Vertical Amplifier Modules:

- 74-12 1mV/cm differential amplifier, 850kHz
- 74-15 20mV, 1MHz amplifier
- 74-19A Single trace, DC to 5MHz, 50mV/cm
- 76-01A Single trace, 5mV/cm, 25MHz
- 76-02A Dual trace, 5mV/cm, 25MHz
- 76-05 Single trace, 100MHz, 50 ohms input
- 76-06 Four trace, 20mV/cm, 20MHz
- 76-08 Dual trace, 5mV/cm, 50MHz
- 79-02A Dual trace, 100mV/cm, 100MHz

**Where to get them:** For immediate assistance or for the name and address of the representative or distributor in your area, contact any of these Fairchild Instrumentation Field Sales Offices:

#### U.S.A.

4546 El Camino Real  
Los Altos, California 94022  
(415) 941-3111

5410 West Imperial Boulevard  
Los Angeles, California 90045  
(213) 678-3166  
TWX: 910-328-6177

50 Jericho Turnpike  
Jericho, L. I., New York 11753  
(516) 333-9311

TWX: 510-222-4479  
2105 Gulf-To-Bay Boulevard  
Suite #4  
Clearwater, Florida  
(813) 446-4619  
TWX: 810-866-0436

8517 39th Avenue, North  
New Hope, Minnesota  
(612) 544-5220

113 Gentry Road  
Hoffman Estates  
Roselle, Illinois 60172  
(312) 894-2060

#### EUROPE

FAIRCHILD INSTRUMENTATION LTD.  
Grove House, 551 London Road  
Isleworth, Middlesex, England  
Tel: 560-0838  
TELEX: 24693  
Grunwalderstrasse 99  
Munich 90, West Germany  
Tel: 49 18 47  
Cable: FAIRINTA MUNICH

**FAIRCHILD**  
INSTRUMENTATION

FAIRCHILD INSTRUMENTATION / A Division of Fairchild Camera and Instrument Corporation ■ 475 Ellis, Mountain View, California 94040, (415) 962-2011 ■ TWX: 910-379-6944

ON READER-SERVICE CARD CIRCLE 28



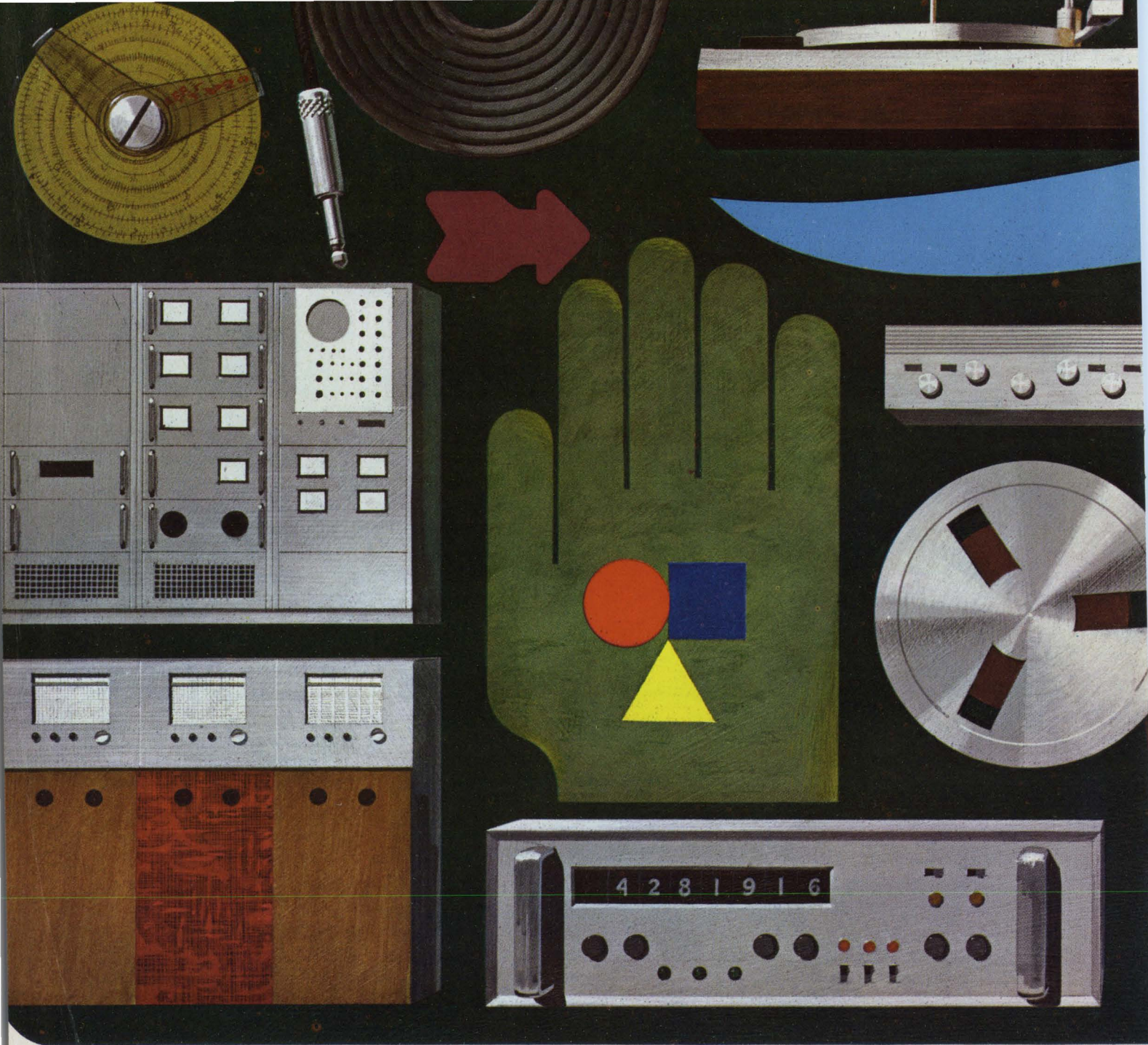

## Better styling by design with Alcoa Aluminum

Electronic equipment looks better and sells easier when it's designed with aluminum, Alcoa® Aluminum.

That's why designers everywhere use aluminum for styling cabinets, racks, decks, frames, panels, housings, grills, inserts or trim—practically any place where permanent good looks are important.

Aluminum gives the designer more to work with—more colors, more textures, more forms—in virtually any size or configuration. It can be easily and accurately fabricated by stamping, forging, extruding or casting; easily joined

by welding, brazing, soldering, or by various mechanical production systems.

Striking textures can be developed by mechanical finishing, such as embossing or coining, with surfaces ranging from smooth lustrous to rough matte. Subtle colors can be added by using any one or a combination of techniques—chemical, electrochemical, paint, enamel, lacquer, porcelain enamel, or Vynalate\* Sheet (a permanently bonded laminate of aluminum sheet and vinyl). And, aluminum is naturally light, uncommonly strong and cor-





rosion-resistant. Its applications are unlimited. That's why it's called "the designer's ally."

For your demanding design applications, particularly where the problem is one of cost and competitive styling, change for the better with Alcoa Aluminum. Call your nearest Alcoa sales office or write: Aluminum Company of America, 1730-B Alcoa Building, Pittsburgh, Pennsylvania 15219.



\*Trademark of Aluminum Company of America



**ALCOA**

**Change for the better with Alcoa Aluminum**

ON READER-SERVICE CARD CIRCLE 29



# simplify waveform measurements

## Tektronix Type 502A

100  $\mu\text{V}/\text{cm}$  dual-beam oscilloscope

- Measure stimulus and reaction on the same time base.
- Measure transducer outputs, such as pressure vs. volume.
- Measure phase angles and frequency differences.
- Measure characteristics of low-level signals.

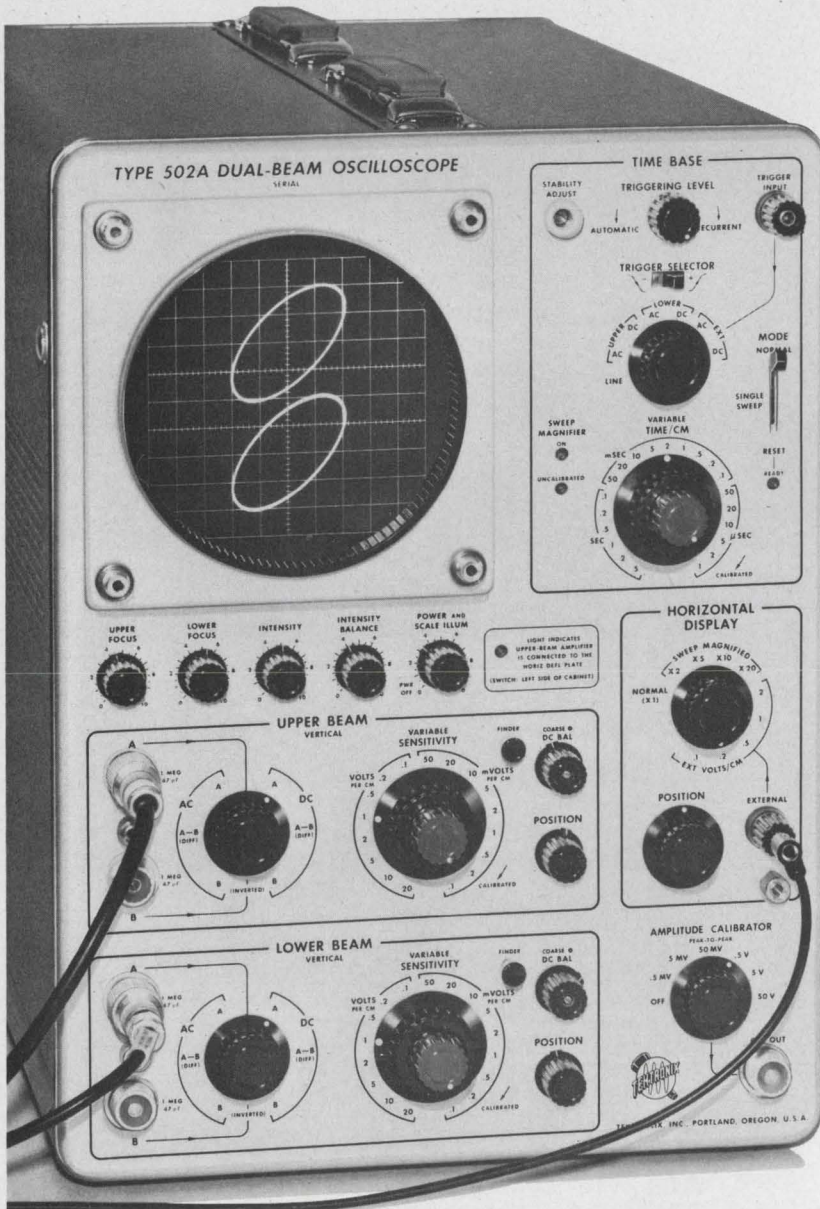

The Type 502A combines the performance capabilities unique to dual-beam oscilloscopes with operational features designed to simplify and speed up your measurements.

You can examine two waveforms simultaneously by applying input signals to both of the identical vertical amplifiers. You can use each vertical amplifier in a differential display mode to examine the difference between two signals. You can also use the Type 502A as a single-beam X-Y oscilloscope or as a dual-beam X-Y oscilloscope with both traces plotted on the same X scale.

This performance is combined with operating conveniences which include pushbutton beam finders for quick location of off-screen signals, vertical signal outputs, intensity balance for identification of upper and lower beams, single-sweep operation, Z-axis input, variable control of vertical and horizontal deflection factors, electronically-regulated power supplies for stable operation, and other refinements.

### performance characteristics include:

Bandwidth from DC to 100 kHz at 100  $\mu\text{V}/\text{cm}$ , increasing to DC to 1 MHz from 5  $\text{mV}/\text{cm}$  to 20  $\text{V}/\text{cm}$  • Calibrated deflection factors from 100  $\mu\text{V}/\text{cm}$  to 20  $\text{V}/\text{cm}$  in 17 steps; continuously variable between steps, uncalibrated, and to 50  $\text{V}/\text{cm}$  • Common-mode rejection of at least 50,000:1 from DC to 50 kHz • Phase difference between amplifiers less than 1 degree from DC to 100 kHz • Calibrated sweep rates from 1  $\mu\text{s}/\text{cm}$  to 5  $\text{s}/\text{cm}$  in 21 steps • 2X, 5X, 10X, 20X sweep magnification • Flexible trigger facilities • Amplitude Calibrator • 10 cm by 10 cm display area.

Type 502A Dual-Beam Oscilloscope . . . \$1050  
Rack Mount Type RM502A Oscilloscope . . \$1150

U.S. Sales Prices FOB Beaverton, Oregon

**Tektronix, Inc.**



For complete information, contact your nearby Tektronix field engineer or write: Tektronix, Inc., P.O. Box 500, Beaverton, Oregon 97005



for  
sophisticated crystal filters  
in  
miniaturization

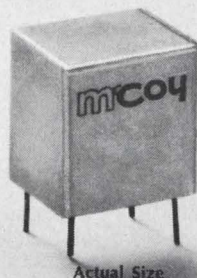

insist on M<sup>c</sup>Coy

Sophisticated filters demand sophisticated design—  
Miniaturization requires manufacturing know-how—  
M<sup>c</sup>Coy has both.

In ten years of manufacturing crystal filters—from 5 kc to 125 mc—M<sup>c</sup>Coy has accumulated a wealth of filter manufacturing knowledge. Coupled with complete crystal manufacturing facilities, this background of filter know-how has established M<sup>c</sup>Coy as a leader in the industry.

When sophisticated designs and miniaturization are required, practically everyone insists on M<sup>c</sup>Coy, where sophisticated filters are routine.

Why not put your filter requirements in capable hands?

Contact M<sup>c</sup>Coy for quotations on your specific requirements.



**M<sup>c</sup>COY ELECTRONICS COMPANY**

A SUBSIDIARY OF OAK ELECTRO/NETICS CORP.

MT. HOLLY SPRINGS, PA. 17065

TELEPHONE: 717-488-3411 • TWX 717-488-3400

ON READER-SERVICE CARD CIRCLE 31



## Laser pulses timed at four picoseconds

A coincidence technique for measuring the duration of extremely short laser bursts is reported effective down to four-trillionths of a second.

The speed is said to be about 100 times faster than that measured with techniques using photodetectors and traveling-wave oscilloscopes.

The new technique was developed by Dr. John Armstrong, physicist at the IBM Research Div. in Yorktown Heights, N. Y. He said his method would be useful in studying the interactions of ultra-short, ultra intense laser pulses with matter.

In the coincidence technique (see diagram), the polarized beam from a neodymium-glass laser—operated in the phase-locked condition to produce extremely short pulses—is split into two beams. The plane of polarization of one is rotated 90 degrees in a Z-cut crystal. The two beams are merged and directed to the surface of a gallium-arsenide crystal. The movable prism can change the path length of one of the beams and thus the arrival time between pulses of the two beams.

The planes of polarization of the two impinging beams are at right angles and aligned with certain crystal directions for which no second harmonic light is generated. Thus if either pulse arrives by itself, no harmonic is produced. However, if the pulses overlap in time, the resultant field is in a direction for which harmonic light is produced.

By analysis of the variation of harmonic intensity as a function of the path length introduced by the prism, the width and shape of the laser pulse can be determined. ■ ■

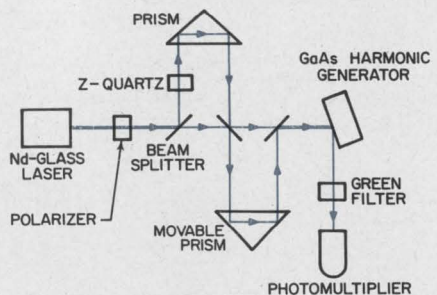

New technique times laser pulses

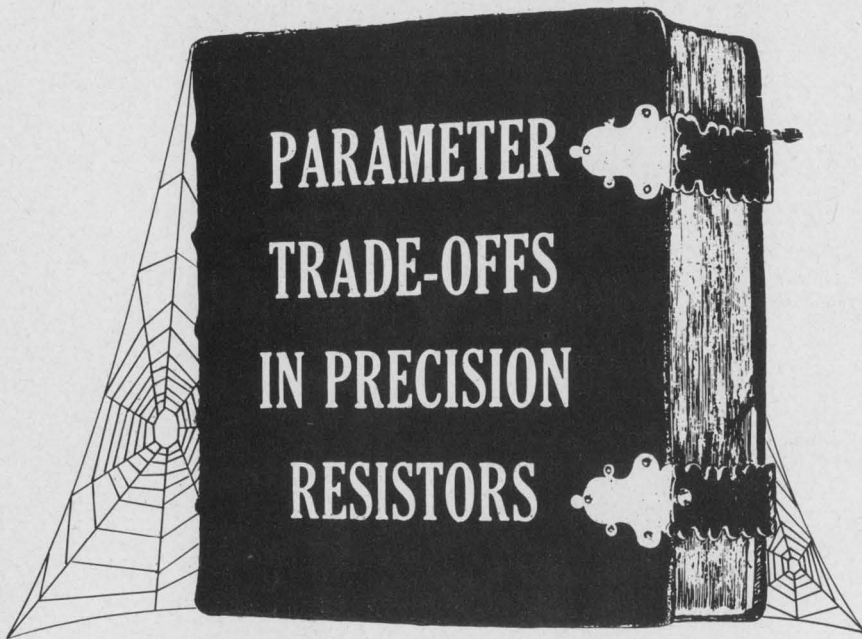

**Vishay Closes It, For Good! Forget** traditional precision resistor trade-offs. Have 0.01% or better absolute tolerance **with** guaranteed shelf life stability of 25ppm/yr. (50 for 3 yrs.) **with** load life stability of 0.030% (125°C., 2000 hrs.) **with** TC's below 1ppm/°C. (0 to +60°C.) **with** one ns. (1) response time **without** ringing **without** noise. And with resistors this fine, think of the networks they make! If you've been working with resistors a while, it's hard to break the habit, but for new design freedom, better total system performance, these free brochures belong on your desk. Write today.  Vishay Resistor Products  
63 Lincoln Hwy., Malvern, Pa. 19355

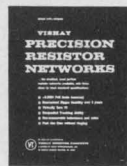



# It pays to pick the fastest... in the computer race, it's SUHL/TTL.

We became deeply involved in TTL before anyone. That's why in TTL we're way ahead with SUHL, the fastest IC line in the industry.

Our SUHL line keeps breaking speed records—now down to 5 nsec—without compromising noise immunity and power dissipation. That's why we're the prime source for TTL and why Sylvania Universal High-level Logic ICs are being second-sourced. Several of the largest electronic equipment manufacturers standardized on SUHL ICs, even though we were the only source.

Sylvania can really deliver too. We have the most modern manufacturing facilities in the industry. We make all of our ICs with one optimum process, so we can maximize performance characteristics of every unit. Advanced automated test equipment insures the ultimate in production monitoring, final testing, and quality control.

So get SUHL's speed and reliability. Sylvania Semiconductor Division, Electronic Components Group, Woburn, Massachusetts 01801. Learn all the reasons *Sylvania really delivers ICs.*

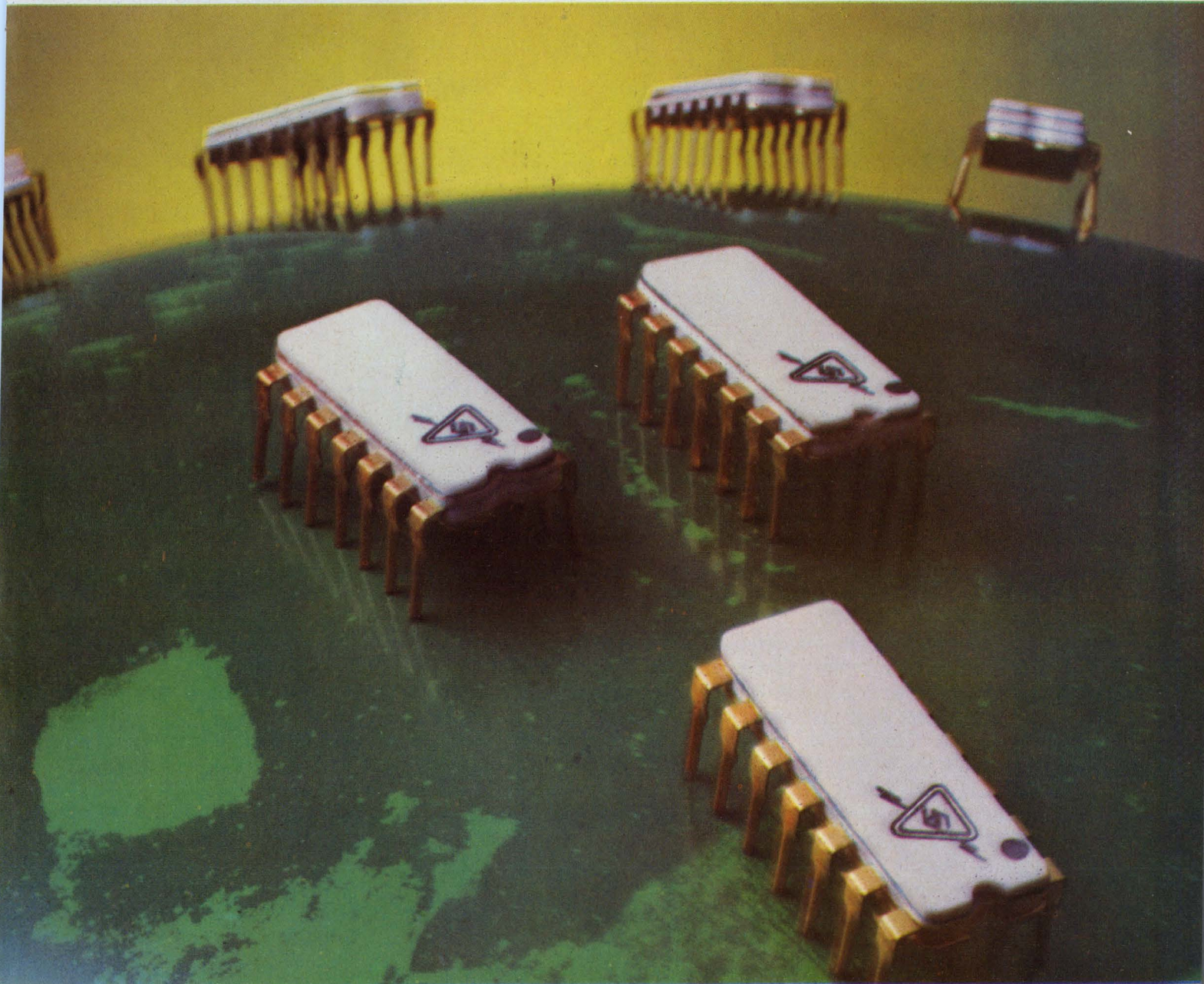

**SYLVANIA**  
SUBSIDIARY OF  
GENERAL TELEPHONE & ELECTRONICS **GTE**



# Price conscious about 2N3055's?

That's why the Bendix 2N3055 is one of the most widely used and best known power transistors in the business.

You don't pay a premium for Bendix quality. We offer sound and truly competitive pricing on the 2N3055—and on its entire related silicon mesa family as well. It's a direct result of our efficient, highly mechanized production of these types.

And to insure sound, rugged operation in your circuit, Bendix has SOAR (Safe Operating Area) specified the 2N3055. SOAR protects you against second breakdown (see typical SOAR chart).

Need more flexibility? Consider the B170000 Series we've developed in conjunction with the 2N3055. These NPN power transistors are



specified and grouped by application. Thus, you may select a device optimized for amplifying, regulating or switching use. This means you avoid paying for parameters not pertinent in your particular circuit. Selections are available on VCEO up to 100 volts, hFE at IC up to 5 amps and Pc up to 120 watts.

Looking for equally good values in higher current transistors? Look our way again. The Bendix 30-amp 2N3771 and 2N3772 merit your attention for power supply and power amplifier work.

In fact, why not check into the complete line of Bendix power transistors? They'll help you hit a new high in performance and reliability. Call your Bendix distributor. Or write Bendix Semiconductor Division, Holmdel, N. J. 07733.

Atlanta—Grady Duckett Sales Co., (404) 451-3529; Baltimore (Towson), Md.—(301) 828-6877; Chicago—(312) 637-6929; Dallas—(214) 357-1972; Detroit—(313) 548-2120; Greenwich, Conn.—(203) 869-7797; Holmdel, N. J.—(201) 946-9400; Los Angeles—(213) 776-4100; Minneapolis—(612) 926-4633; Los Altos, Calif.—W. W. Posey Co., (415) 948-7771; Seattle—Ray Johnston Co., Inc. (206) LA 4-5170; Syracuse, N. Y.—(315) 474-7531; Waltham, Mass.—(617) 899-0770; Export—Cable: "Bendixint," 605 Third Avenue, New York, (212) 973-2121; Ottawa, Ont.—Computing Devices of Canada, P.O. Box 508—(613) TAlbot 8-2711.



# Bendix knows you are!

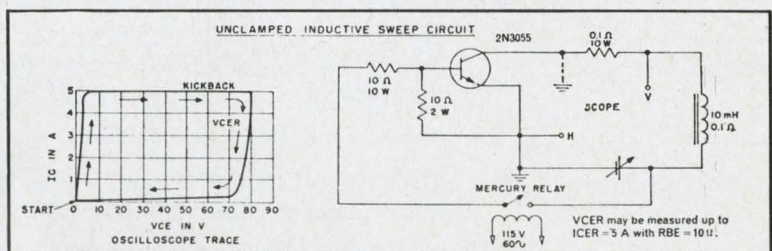
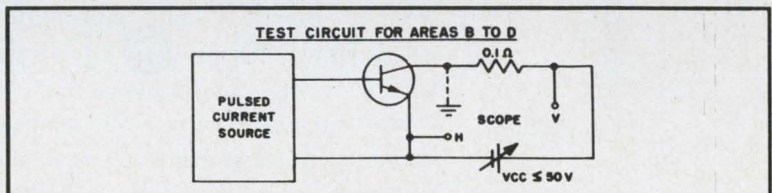
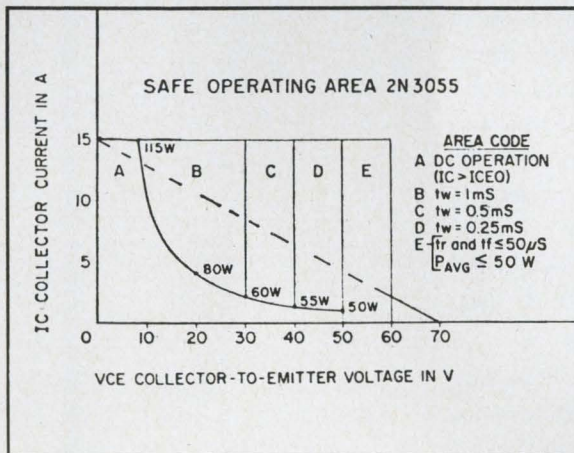

ON READER-SERVICE CARD CIRCLE 34



do we  
have to change  
our name  
from  
WEMS to  
HYBRID MICROCIRCUITS, INC.?

For years, WEMS has been the word for Welded Electronic Modules and Systems. The name fit . . . . beautifully. But what do we do now that we're in the hybrid microcircuit business? **W** Guess we really should have planned ahead knowing we'd eventually turn to this market. After all, what could be more logical.

We have **E** over 10 years of experience in circuit design, microwelding techniques and packaging, so today, in response to your growing demands, we're producing hybrid micro-**W** circuits as well. Custom tailored to your specifications, these hybrid microcircuits are the result of the same research and development talent that made us number one in the module business. The same skilled microwelding and fabrication techniques are used, and the same precise quality control assures you that our hybrid microcircuits will give you the **M** same high reliability as our electronic modules.

Do we have to change our name? We hope not. We'd prefer to make the name WEMS synonymous with hybrid **S** microcircuits as well as with Welded Electronic Modules and Systems.

Like to learn more about this new capability? Just give us a call.

4650 West Rosecrans Avenue  
Hawthorne, California 90252  
(213) 679-9181



**W E M S**

ON READER-SERVICE CARD CIRCLE 35





**First full-range\***  
**DC Voltage Calibrator**  
**with .01% accuracy for under \$1000 —**

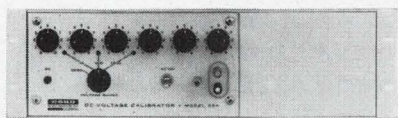

**Cohu's new Model 324!**

\*Output voltage ranges: 10-V Range: 0 to 11.11110 volts (10  $\mu$ V steps)  
 100-V Range: 0 to 111.1110 volts (100  $\mu$ V steps)  
 1000-V Range: 0 to 1111.110 volts (1 mV steps)

Output current capability: 0 to 25 milliamperes nominal at any voltage setting.

Accuracy: 0.01% of setting.

Stability: Within 30 PPM for 24 hours, 50 PPM for 30 days.

Dimensions: Cabinet: 10½" W x 5¼" H x 15½" D.  
 Rackmount: 19" W x 5¼" H x 15½" D.

Price: Cabinet (324): \$995. Rackmount (324R): \$1050.  
 F.O.B. San Diego. Additional export charge.

Delivery: Immediate, from stock.

For full details, contact your Cohu engineering representative.

**COHU**  
 ELECTRONICS, INC  
 SAN DIEGO DIVISION

Box 623  
 San Diego, California 92112  
 Phone: 714-277-6700

ON READER-SERVICE CARD CIRCLE 36



# Replace 80% of all FET types with one!

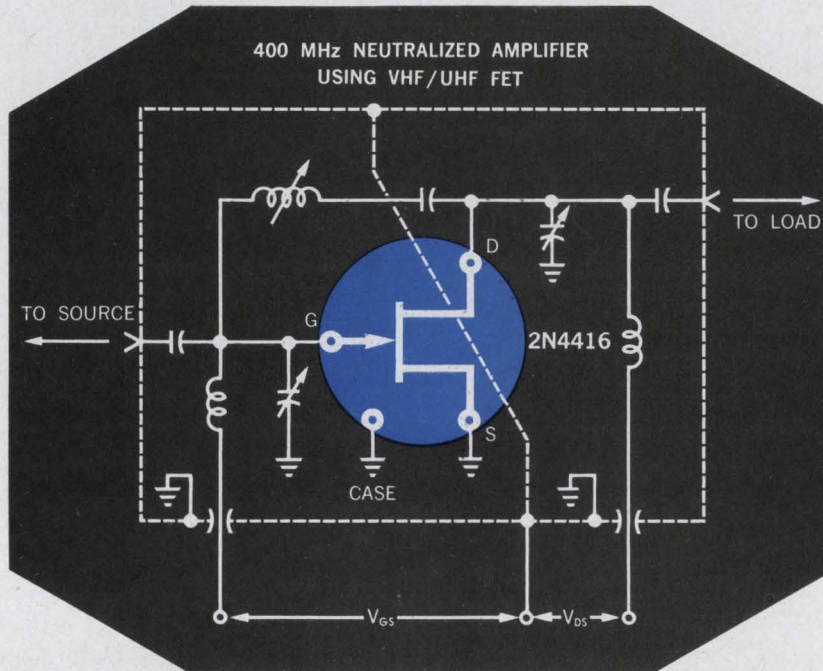

**Here's how:** Buy the Union Carbide 2N4416 universal FET in quantity, and you can select transistors over the entire frequency range covered by 80% of all field effect types. The 2N4416 is specified below as a VHF/UHF amplifier. However, from any class lot of this device you can select (1) general purpose, low noise, high gain amplifiers from D.C. to 900 MHz, or (2) ultra low noise devices for low frequency applications. This device is also available in a ribbon lead ceramic package (.138" dia.) as the low capacitance 2N4417. Use for TV tuners, FM sets, IF strips, mixers, oscillators, or even switches. Write for complete specifications.

DATA SHEET  
PULL OUT

CHARACTERISTICS Small Signal, Common Source @ 25°C	2N4416 TO-72	Frequency
Forward Transconductance RE ( $Y_{fs}$ ) (min.)	4000 $\mu$ mhos	400 MHz
Input Capacitance, $C_{iss}$ (max.)	4.0 pf	1.0 MHz
Output Capacitance, $C_{oss}$ (max.)	2.0 pf	1.0 MHz
Reverse Transfer Capacitance, $C_{rss}$ (max.)	0.8 pf	1.0 MHz
Spot Noise Figure (Neutralized), NF (max.)	4.0 dB	400 MHz
Spot Noise Figure, NF (max.) (Neutralized)	2.0 dB	100 MHz
Power Gain, $G_{ps}$ (min.) (Neutralized)	10.0 dB	400 MHz

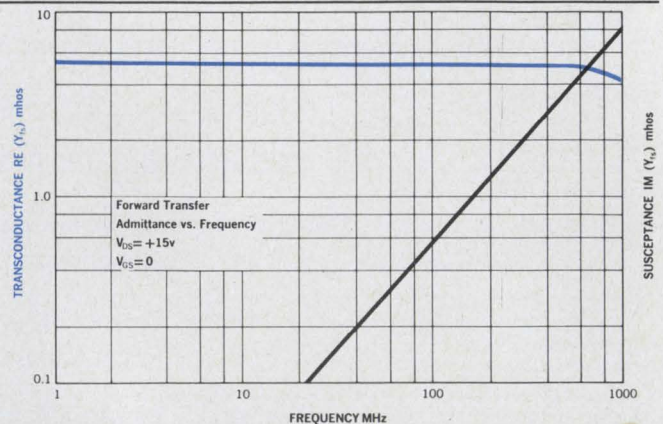

**UNION  
CARBIDE**  
ELECTRONICS

UNION CARBIDE CORPORATION 365 Middlefield Road, Mountain View, California 94040 TWX: 910-379-6942; Telephone: (415) 961-3300

ON READER-SERVICE CARD CIRCLE 37





ELECTRONICS

# 2N4416 • 2N4417

N-CHANNEL FIELD EFFECT TRANSISTORS

FOR

## VHF/UHF AMPLIFIER APPLICATIONS

Silicon planar epitaxial construction • high transconductance  
low capacitance • low noise • specified for 400 MHz operation

### MAXIMUM RATINGS

@ 25°C (UNLESS OTHERWISE NOTED)

	SYM.	2N4416 TO-72 PACKAGE	2N4417 CC-3 PACKAGE	Units
Drain to Gate Voltage	$V_{DG}$	30	30	V
Drain to Source Voltage	$V_{DS}$	30	30	V
Source to Gate Voltage	$V_{SG}$	30	30	V
Gate Current	$I_G$	10	10	mA
Total Device Dissipation at or Below Ambient Temperature	$P_D$ $T_A$	300 25	175 25	mW °C
Linear Derating Factor		1.7	1.0	mW/°C
Total Device Dissipation at or Below Case Temperature	$P_D$ $T_C$	450 125	350 25	mW °C
Linear Derating Factor		6.0	2.0	mW/°C
Storage Temperature	$T_S$	-65 to +200	-65 to +200	°C
Lead Temperature for 10 Seconds		+300	+300	°C

### ELECTRICAL CHARACTERISTICS

@ 25°C (UNLESS OTHERWISE NOTED)

	SYM.	2N4416		2N4417		Units	CONDITIONS
		min.	max.	min.	max.		
Gate Breakdown Voltage	$V_{(BR)GSS}$	-30		-30		V	$I_G = -1 \mu A, V_{DS} = 0$
Total Gate Leakage Current	$I_{GSS}$		-100		-100	pA	$V_{GS} = -20 V, V_{DS} = 0$
Total Gate Leakage Current (150°C)	$I_{GSS}$		-100		-100	nA	$V_{GS} = -20 V, V_{DS} = 0$ $T_A = +150^\circ C$
Drain Saturation Current*	$I_{DSS}$	5.0	15	5.0	15	mA	$V_{DS} = 15 V, V_{GS} = 0$
Pinchoff Voltage	$V_{GS(off)}$		-6.0		-6.0	V	$V_{DS} = 15 V, I_D = 1.0 nA$
Forward Transadmittance*	$ Y_{fs} $	4500	7500	4500	7500	$\mu mhos$	$V_{DS} = 15 V, V_{GS} = 0,$ $f = 1 kHz$
Output Admittance	$ Y_{os} $		50		50	$\mu mhos$	$V_{DS} = 15 V, V_{GS} = 0,$ $f = 1 kHz$
Small-Signal, Common-Source, Short-Circuit, Reverse Transfer Capacitance	$C_{rss}$		0.8		0.8	pF	$V_{DS} = 15 V, V_{GS} = 0,$ $f = 1 MHz$
Small-Signal, Common-Source, Short-Circuit Input Capacitance	$C_{iss}$		4.0		3.5	pF	$V_{DS} = 15 V, V_{GS} = 0,$ $f = 1 MHz$
Small-Signal, Common-Source, Short-Circuit Output Capacitance	$C_{oss}$		2.0		1.3	pF	$V_{DS} = 15 V, V_{GS} = 0,$ $f = 1 MHz$
Small-Signal, Common-Source, Short-Circuit Input Conductance	$RE(Y_{is})$		1000		1000	$\mu mhos$	$V_{DS} = 15 V, V_{GS} = 0,$ $f = 400 MHz$
Small-Signal, Common-Source, Short-Circuit Input Susceptance	$IM(Y_{is})$		10,000		10,000	$\mu mhos$	$V_{DS} = 15 V, V_{GS} = 0,$ $f = 400 MHz$
Small-Signal, Common-Source, Short-Circuit Input Conductance	$RE(Y_{is})$		100		100	$\mu mhos$	$V_{DS} = 15 V, V_{GS} = 0,$ $f = 100 MHz$
Small-Signal, Common-Source, Short-Circuit Input Susceptance	$IM(Y_{is})$		2500		2500	$\mu mhos$	$V_{DS} = 15 V, V_{GS} = 0,$ $f = 100 MHz$
Small-Signal, Common-Source, Short-Circuit Output Conductance	$RE(Y_{os})$		100		100	$\mu mhos$	$V_{DS} = 15 V, V_{GS} = 0,$ $f = 400 MHz$

\* Pulsed Measurement Required. PW  $\approx$  300  $\mu$ sec, Duty Cycle  $\leq$  1.0%.



## ELECTRICAL CHARACTERISTICS

@ 25°C (UNLESS OTHERWISE NOTED)

	SYM.	2N4416		2N4417		Units	CONDITIONS
		min.	max.	min.	max.		
Small-Signal, Common-Source, Short-Circuit Output Susceptance	IM ( $y_{os}$ )		4000		3000	$\mu\text{mhos}$	$V_{DS} = 15\text{ V}, V_{GS} = 0,$ $f = 400\text{ MHz}$
Small-Signal, Common-Source, Short-Circuit Output Conductance	RE ( $y_{os}$ )		75		75	$\mu\text{mhos}$	$V_{DS} = 15\text{ V}, V_{GS} = 0,$ $f = 100\text{ MHz}$
Small-Signal, Common-Source, Short-Circuit Output Susceptance	IM ( $y_{os}$ )		1000		800	$\mu\text{mhos}$	$V_{DS} = 15\text{ V}, V_{GS} = 0,$ $f = 100\text{ MHz}$
Small-Signal, Common-Source, Short-Circuit Forward Transconductance	RE ( $y_{fs}$ )		4000		4000	$\mu\text{mhos}$	$V_{DS} = 15\text{ V}, V_{GS} = 0,$ $f = 400\text{ MHz}$
Common-Source Power Gain	$G_{ps}$		10		10	dB	$V_{DS} = 15\text{ V}, I_D = 5\text{ mA},$ $f = 400\text{ MHz}$ (See Fig. 1)
Common-Source Power Gain	$G_{ps}$		18		18	dB	$V_{DS} = 15\text{ V}, I_D = 5\text{ mA},$ $f = 100\text{ MHz}$ (See Fig. 1)
Common-Source Spot Noise Figure	NF		4.0		4.0	dB	$V_{DS} = 15\text{ V}, I_D = 5\text{ mA},$ $f = 400\text{ MHz}$ (See Fig. 1) $R_G = 1000\text{ ohms}$
Common-Source Spot Noise Figure	NF		2.0		2.0	dB	$V_{DS} = 15\text{ V}, I_D = 5\text{ mA},$ $f = 100\text{ MHz}$ (See Fig. 1) $R_G = 1000\text{ ohms}$

## TYPICAL PERFORMANCE CURVES

@ 25°C (UNLESS OTHERWISE NOTED)

### PARAMETER INTER-RELATIONSHIP

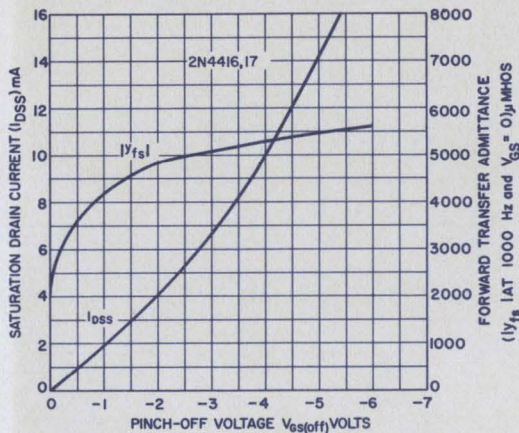

SATURATION DRAIN CURRENT AND FORWARD TRANSFER ADMITTANCE VS. PINCH-OFF VOLTAGE

FIGURE 1

### DRAIN CHARACTERISTIC

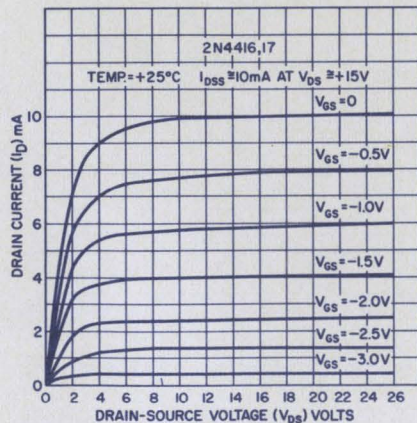

DRAIN CURRENT VS. DRAIN-SOURCE VOLTAGE

FIGURE 3

### TRANSFER CHARACTERISTIC

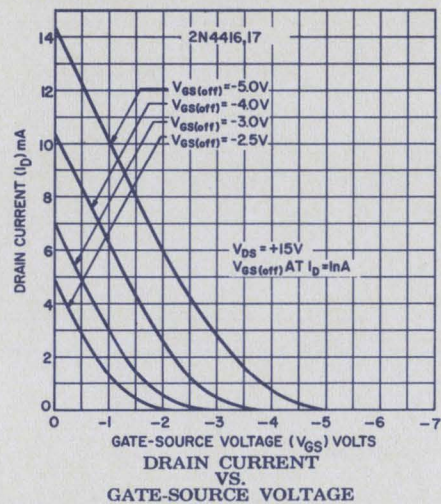
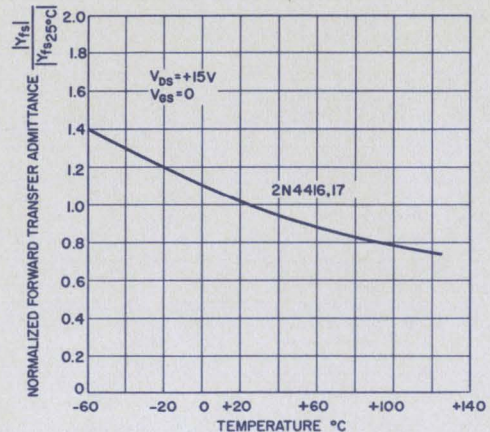

FIGURE 2

### TRANSFER CHARACTERISTIC



NORMALIZED FORWARD TRANSFER ADMITTANCE VS. TEMPERATURE

FIGURE 4



## CAPACITANCE VOLTAGE CHARACTERISTIC

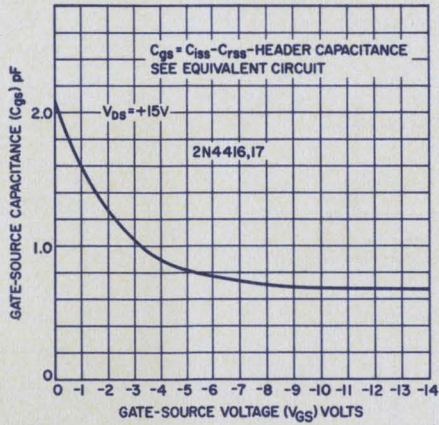

GATE-SOURCE CAPACITANCE  
VS.  
GATE-SOURCE VOLTAGE

FIGURE 11

## HIGH FREQUENCY COMMON SOURCE CHARACTERISTICS

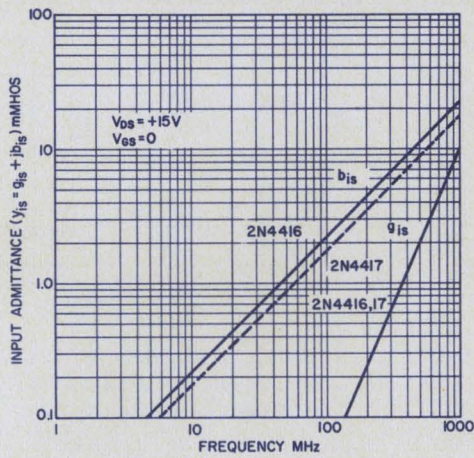

INPUT ADMITTANCE  
VS.  
FREQUENCY

FIGURE 12

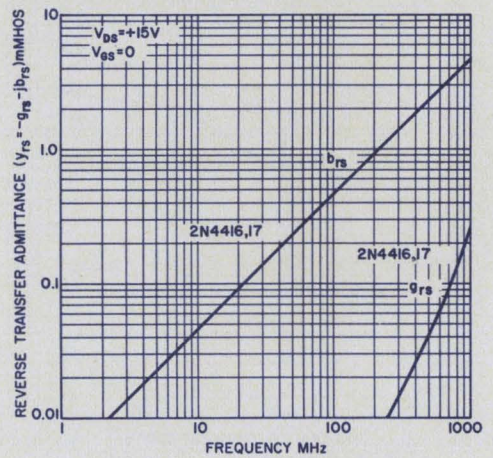

REVERSE TRANSFER ADMITTANCE  
VS.  
FREQUENCY

FIGURE 13

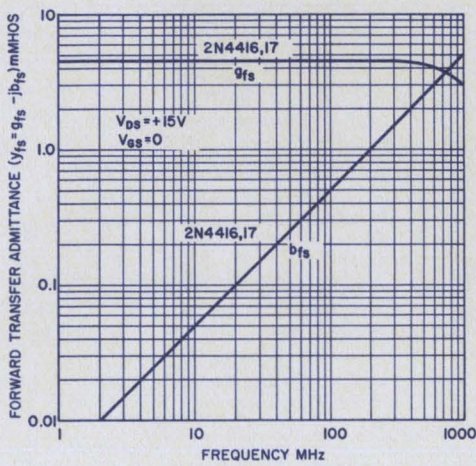

FORWARD TRANSFER ADMITTANCE  
VS.  
FREQUENCY

FIGURE 14

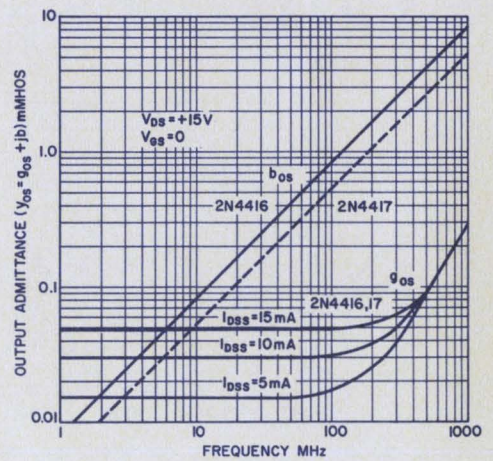

OUTPUT ADMITTANCE  
VS.  
FREQUENCY

FIGURE 15



# HIGH FREQUENCY COMMON SOURCE CHARACTERISTICS

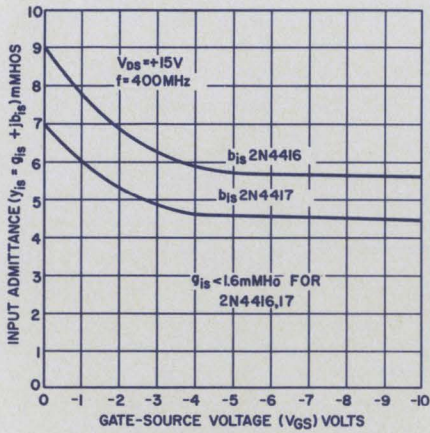

INPUT ADMITTANCE  
VS.  
GATE-SOURCE VOLTAGE

FIGURE 16

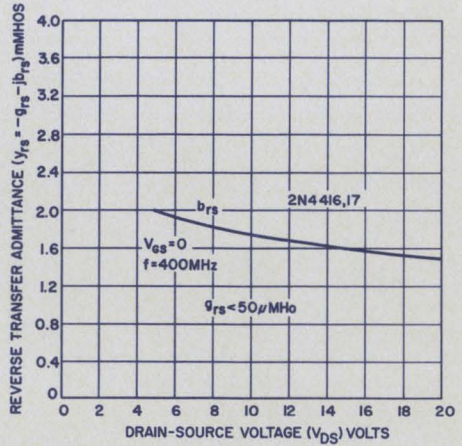

REVERSE TRANSFER ADMITTANCE  
VS.  
DRAIN-SOURCE VOLTAGE

FIGURE 17

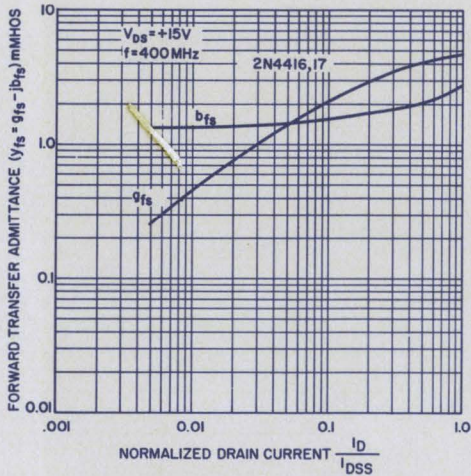

FORWARD TRANSFER ADMITTANCE  
VS.  
NORMALIZED DRAIN CURRENT

FIGURE 18

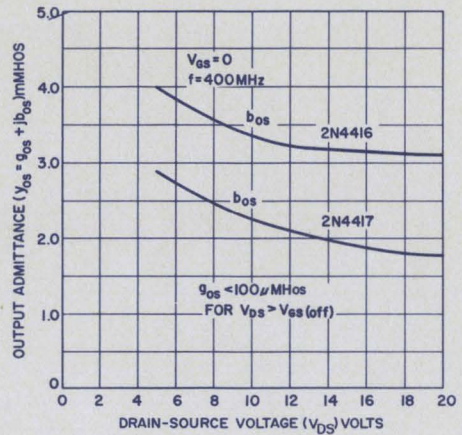

OUTPUT ADMITTANCE  
VS.  
DRAIN SOURCE VOLTAGE

FIGURE 19

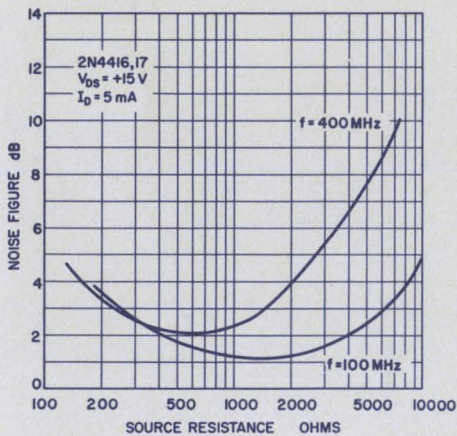

NOISE FIGURE  
VS.  
SOURCE RESISTANCE

FIGURE 20

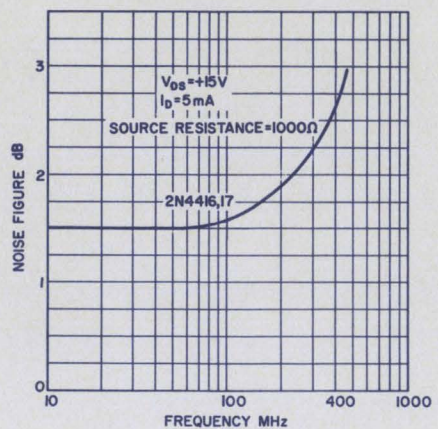

NOISE FIGURE  
VS.  
FREQUENCY

FIGURE 21



### DRAIN CHARACTERISTIC

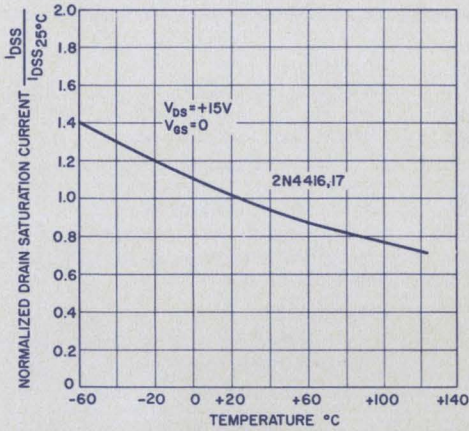

NORMALIZED DRAIN SATURATION CURRENT VS. TEMPERATURE

FIGURE 5

### LEAKAGE CHARACTERISTIC

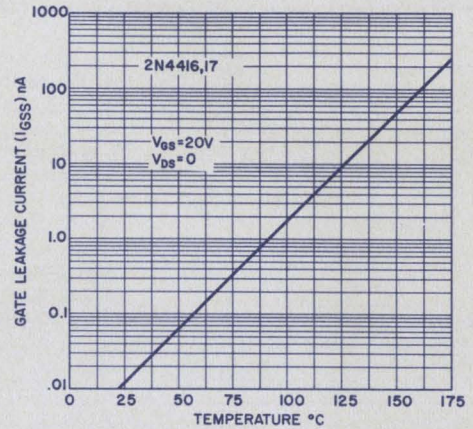

GATE LEAKAGE CURRENT VS. TEMPERATURE

FIGURE 6

### TRANSFER CHARACTERISTIC

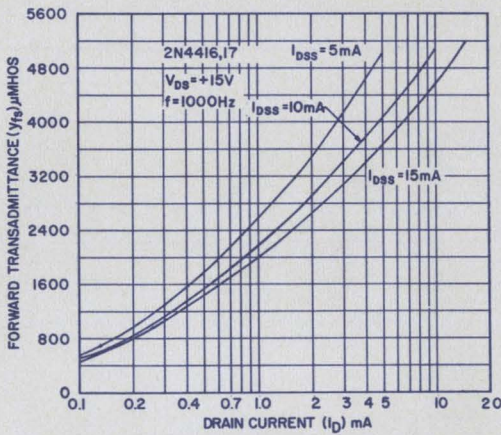

FORWARD TRANSADMITTANCE VS. DRAIN CURRENT

FIGURE 7

### OUTPUT CHARACTERISTIC

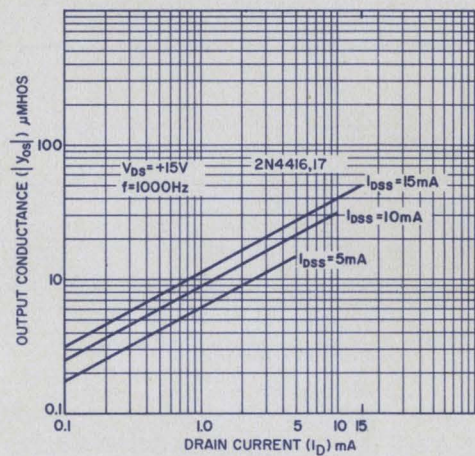

OUTPUT CONDUCTANCE VS. DRAIN CURRENT

FIGURE 8

### CAPACITANCE VOLTAGE CHARACTERISTIC

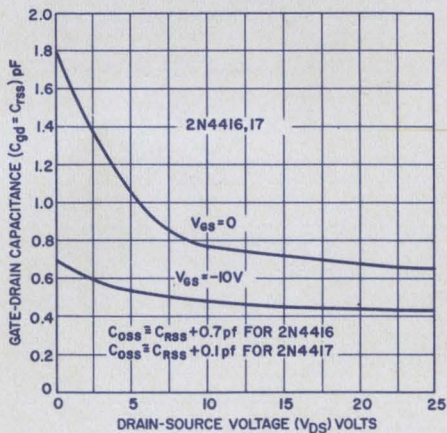

GATE-DRAIN CAPACITANCE VS. DRAIN SOURCE VOLTAGE

FIGURE 9

### CAPACITANCE VOLTAGE CHARACTERISTIC

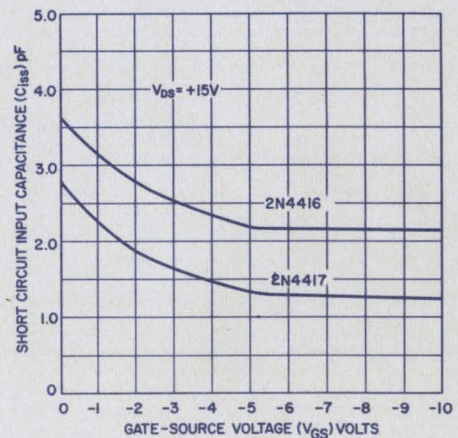

SHORT CIRCUIT INPUT CAPACITANCE VS. GATE-SOURCE VOLTAGE

FIGURE 10



## EQUIVALENT CIRCUIT

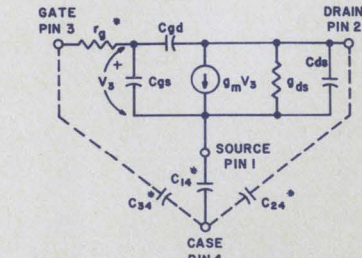

Approximate small signal equivalent circuit for the 2N4416 Field Effect Transistor.

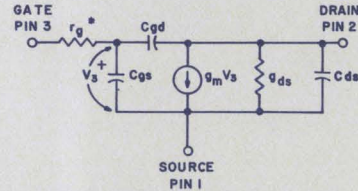

Approximate small signal equivalent circuit for the 2N4417 Field Effect Transistor.

The 2N4416 and 2N4417 transistors are identical in every respect except for their respective package configurations. Therefore capacitance values for  $C_{14}$ ,  $C_{24}$  and  $C_{34}$  should be set equal to zero, in equation 1 through 4, when computing the y parameters for the 2N4417. All of the other circuit component values are the same for both devices. Typical component values for  $C_{gs}$ ,  $C_{gd}$ ,  $g_m$ , and  $g_{ds}$  may be obtained for any set of bias conditions, from the curves.

1.  $y_{1s} \approx r_g[\omega(C_{gs} + C_{gd})]^2 + j\omega(C_{34} + C_{gs} + C_{gd})$
2.  $y_{rs} \approx -\omega^2 C_{gd}(C_{gs} + C_{gd})r_g - j\omega C_{gd}$
3.  $y_{fs} \approx g_m - \omega^2 C_{gd}(C_{gs} + C_{gd})r_g - j\omega[C_{gd} + (C_{gs} + C_{gd})r_g g_m]$
4.  $y_{os} \approx g_{ds} + (\omega C_{gd})^2 r_g + j\omega(C_{24} + C_{gd} + C_{ds})$

Small signal common source y parameter equations for the 2N4416 and 2N4417 Field Effect Transistors.

### NOTES:

1. The above equations are accurate to about 1 GHz and are good for both the 2N4416 and 2N4417 Field Effect Transistors.
2. The case is connected to the source for the common source configuration and to the gate for common gate operation.
3.  $C_{14}$ ,  $C_{24}$  and  $C_{34}$  are pin to case capacitances for the TO-72 header  $C_{14} \approx 0.6$  pF,  $C_{24} \approx 0.6$  pF,  $C_{34} \approx 0.7$  pF.
4.  $C_{ds} \approx 0.1$  pF.
5.  $r_g \approx 24$  ohms for both the 2N4416 and 2N4417 Field Effect Transistors.
6.  $g_m = |y_{fs}|$  at 1000 Hz.
7.  $g_{ds} = |y_{os}|$  at 1000 Hz.

## TEST CIRCUIT

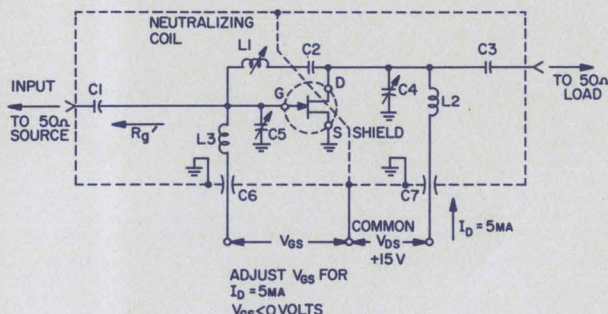

100 MHz & 400 MHz NEUTRALIZED AMPLIFIER

FIGURE 1

REF. DESIG.	VALUE	
	100 MHz	400 MHz
C1	7.0 pF	1.8 pF
C2	1000 pF	27 pF
C3	3.0 pF	1.0 pF
C4	1.0-12 pF	0.8-8 pF
C5	1.0-12 pF	0.8-8 pF
C6	0.0015 $\mu$ F	0.001 $\mu$ F
C7	0.0015 $\mu$ F	0.001 $\mu$ F
L1	3.0 $\mu$ H	0.2 $\mu$ H
L2	0.25 $\mu$ H	0.03 $\mu$ H
L3	0.14 $\mu$ H	0.022 $\mu$ H

### NOTE

1. Amplifier used to measure power gain and noise figure.
2. Transformed equivalent Source resistance ( $R_g'$ ) is 1000  $\Omega$  at 100 MHz for 100 MHz amplifier, and 1000  $\Omega$  at 400 MHz for 400 MHz amplifier.
3. When using 2N4416, pin 4 (case) should be grounded.

## MECHANICAL DATA CASE OUTLINES

2N4416: JEDEC TO-72 (TO-18 4 Lead)

2N4417: Union Carbide CC-3

All dimensions are in inches.

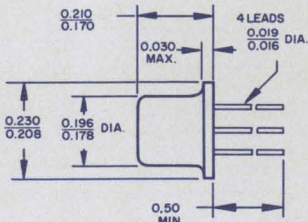

2N4416

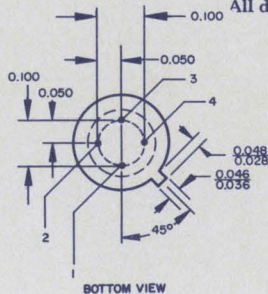

BOTTOM VIEW

### PIN CONNECTIONS

- 1—Source
- 2—Drain
- 3—Gate
- 4—Case

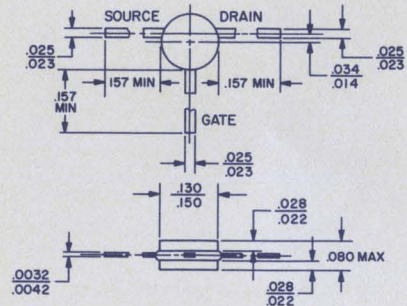

2N4417

PRINTED IN U.S.A.





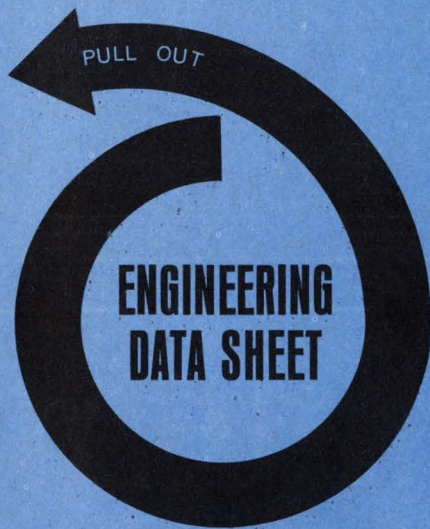

If somebody beat you to it, write to:  
**Union Carbide Electronics**  
 or call your UCE distributor  
**IN THE WEST**

- ARIZONA, Phoenix**  
Avnet Electronics • (602) 272-6821
- CALIFORNIA, Culver City**  
Avnet Electronics • (213) 870-6141  
**Los Angeles**  
K-Tronics • (213) 685-5888  
**Mountain View**  
Avnet Electronics • (415) 961-7700  
**Newport Beach**  
Western Electronic Components • (714) 540-1322  
**Palo Alto**  
Kierulff Electronics, Inc. • (415) 968-6292  
**San Diego**  
Avnet Electronics • (714) 279-1550  
**San Diego**  
Kierulff Electronics • (714) 278-2112
- COLORADO, Denver**  
Newark-Denver Electronics • (303) 757-3351
- WASHINGTON, Seattle**  
Washington Electronics • (206) 682-8981



# Letters

## MAYBE gate opens up bright new possibilities

Sir:

The invention of a high-reliability MAYBE gate offers prospects of exciting and versatile new designs.

As can be seen from the schematic (below), a conventional AND gate is used with a photoresistive load element. This element in turn is driven by a flasher arrangement, which, although nearly periodic, is in no way related to events in the system.

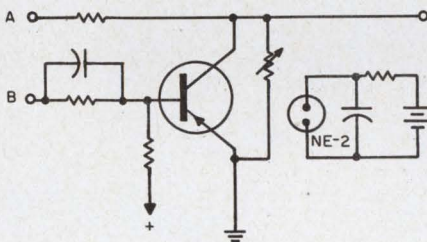

The circuit performs the following positive function. In the event that high reliability is demanded from a system that is currently producing erratic results, this small module may be added at any information junction. Should a malfunction develop anywhere in a previous logic stage, it is entirely possible for the MAYBE gate to ignore this bit of misinformation. A completely correct result would then emerge randomly from the improperly working system.

Philip Accardi

David Sarnoff Research Center  
 RCA Laboratories  
 Princeton, N. J.

## Accuracy is our policy

In "Signal generators 1.62-420 MHz" list, ED 27 (Signal Generator Reference Issue), Nov. 29, 1966, p. 26, Hewlett-Packard points out that its models 618C and 620B (listed in section SG-1) are microwave instruments that have frequency ranges of 7 to 11 GHz, not MHz as printed.

In "Try solid-state regulators," ED 26, Nov. 22, 1966, pp. 76-79, the equations for  $R_2$  and  $R_1$  in the right-hand column on p. 78 contain errors. They should read:

$$R_2 = \frac{[V_Z - (V_{EB1} + V_{EB2})]}{(I_{B2} + I_{C3})}$$

$$= 6.8 - (0.7 + 0.7) \text{ V}/1.0 \text{ mA}$$

$$= 5.4 \text{ k}\Omega,$$

and

$$R_1 = \frac{[(E_{in \text{ min}} - E_{out \text{ min}})]}{-V_{Z1}/I_1}$$

In "Laser system counts railroad freight cars," ED 28, Dec. 6, 1966, p. 36, the developer of the system is the Union Switch and Signal Div. of the Westinghouse Air Brake Co., not Westinghouse Electric.

In "Take a fresh look at filters," ED 1, Jan. 4, 1967, pp. 114-115, author Frank Noble draws attention to two equation errors.

In Fig. 1, the value of  $C_1$  should be the same as Eq. 5 on p. 114:

$$C_1 = C_p [(\omega_p/\omega_1)^2 - 1].$$

The square is missing from the figure.

In Fig. 2, the value of  $L_2$  should be the same as that shown for it in the third degenerate form of the filter circuit spelled out in the text at the top of p. 115:

$$L_2 = 1/C_p(\omega_2^2 - \omega_p^2).$$

$C_p$  is omitted from the figure.

In "Field strength meter operates 400 to 900 MHz," in the Test Equipment listing of the Products section of ED 1, Jan. 4, 1967, p. 183, Hexem's model 410 meter has a sensitivity of 1  $\mu\text{W}$ , not 1  $\mu\text{V}$  as printed.

In "IC voltage regulator is externally adjustable," the Product cover feature in ED 2, Jan 18, 1967, National Semiconductor Corp. has drawn attention to a mistake in Fig. 4 on p. 94: The connection between points Y and Z (see dotted line below) was printed in error and should be deleted.

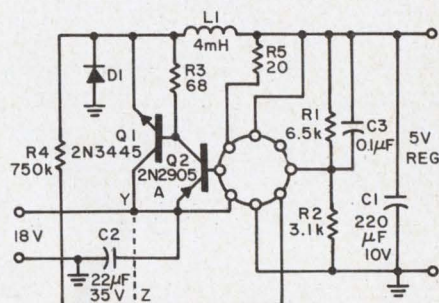



# Medical Electronics

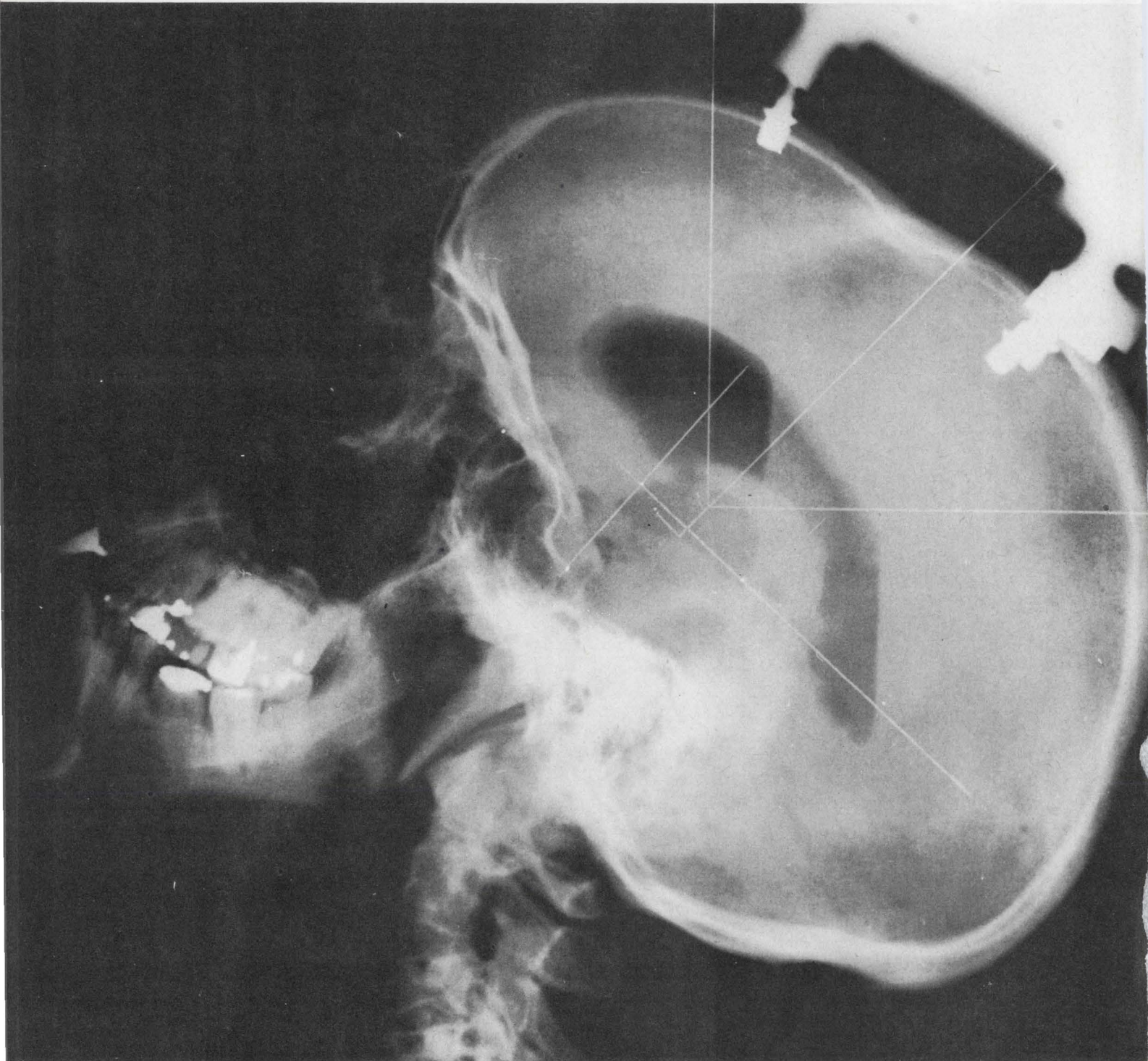

Stereotaxic device designed at National Institutes of Health pinpoints locations in the brain.



## ***Greater capability and wider applications typify this potent combination of dissimilar disciplines***

***By Frank Egan, Technical Editor***

The products of electronic technology are diffusing into every area of modern society, but nowhere is their impact greater than on medicine. Industry, research institutions and government are all contributing to the growth of this potentially booming field.

With all this activity going on, what exactly is the state of medical electronics today? What technologies are contributing to it, and how are they being applied? And what about the problems—and the future? These are the questions that this report attempts to answer. For convenience, the report is divided into three sections:

### **The designer scans the market (p. 52)**

The electronic designer has a keen interest in the technical aspects of medical electronics, but the design of medical equipment is subject to many peculiar and stringent nonengineering restrictions. The relatively limited size of the market, where and by whom the equipment is used, and safety, reliability and maintenance are all important considerations. The first section of the report ties these diverse factors together, to give a broad view over the entire field.

### **Measurement plays a vital role (p. 56)**

This section focuses on the significance of measurement in medical electronics. The prime object of medical measuring and monitoring is the human body, an exceedingly complex mechanism. The technical problems are thus quite different from those encountered in other electronic measuring systems.

### **The technologies involved range wide (p. 64)**

The technological areas that now contribute to medical electronics and examples of how they are used form the subject of section three. Lasers, ultrasonics, microelectronics, power sources, computers, systems engineering are some of the areas discussed.



# The outlook is rosy—for the initiated

*The medical electronics market is attractive and growing, but the path to success is fraught with pitfalls*

The field of medical electronics has been described as a marriage of convenience between the art of medicine and the science of electronics. As such, its success is based largely on the technical soundness of the electronic devices and equipment that have been developed. Its success, however, also depends on other factors, and in traveling around the country gathering material for this report, we have found that very often it is these other factors that are paramount. An electronic designer working in this field, in fact, must not only be a good designer, but must also understand the nature of the medical electronic market.

Who buys and uses the equipment? What do they and don't they want? How and why do they buy? If he does not know the answers to these questions, the designer may find himself headed for technical excellence—and economic obscurity. To help answer them, a panoramic review of the entire medical electronic field is given in this section. Later sections of the report deal with technical details and developments of interest.

## Up . . . up . . . up it goes

The dollar value of the U.S. medical electronics

**Table 1. Medical electronics market**  
(in millions of dollars)

Item	1954	1958	1964	1970	1975
Therapeutic equipment	40.0	55.5	69.0	94.0	135.0
Diagnostic equipment	48.6	50.4	80.5	118.5	150.5
Laboratory equipment	8.0	14.0	32.0	57.0	90.0
Data processing equipment	5.0	15.0	40.0	140.0	325.0
Patient monitoring systems	—	5.0	45.0	100.0	195.0
<b>Total</b>	<b>101.6</b>	<b>139.9</b>	<b>266.5</b>	<b>509.5</b>	<b>895.5</b>

Estimates published in 1965 by *Predicasts*, a journal of Economic Index and Surveys, Inc.

market is extremely difficult to estimate. This is in large part due to the fractured nature of the business. Some estimates include equipment such as X-ray machines and hearing aids; others exclude them. Furthermore, many items, like certain transducers and recorders, are bought for non-medical as well as medical use.

Present estimates range from just over \$200 million to slightly under \$300 million for this year. If X-ray equipment, hearing aids and similar accessories are included, they add another \$150 million to the total figure. According to a study by Arthur D. Little, Inc., this represents an increase of 20 per cent between 1956 and 1964, and a 15-per-cent growth since 1964.

Future growth is expected by some to continue at about 15 per cent per year. Others, however, like Beckman Instruments, foresee a faster growth rate, with a total market of some \$1 billion anticipated by about 1975. The results of one survey are given in Table 1.

Large as these market projections may be, they are still dwarfed when viewed in the light of the total "health bill" of the United States. As observed by Sen. Maurine B. Neuberger (D-Ore.) during recent Senate hearings pertaining to

**Table 2. Total cost of health care**

Year	GNP (billions)	Health expenditures (billions)	% GNP
1940	\$100.6	\$ 3.9	4.1
1950	284.6	12.4	4.7
1956	419.2	19.2	4.7
1958	444.5	22.8	5.2
1960	502.6	26.5	5.4
1962	554.5	31.3	5.7
1964	615.0	36.3	5.9
1966	672.0	40.2	6.0
1968	730.0	46.0	6.3
1970	790.0	51.4	6.5

Figures published by U.S. Dept. of Commerce.





**Eight coronary patients can be monitored simultaneously** with this intensive-care system installed at the Orange County General Hospital in Orange, Calif. Individual electrocardiograms and other heart parameters can be dis-

played at the nurses' central station. Designed and installed by Statham Instruments, Inc., the modular-type system allows the user to start with a basic arrangement and build as requirements and funds permit.

health, "In the United States the cost of illness, disability and death is now about ninety-three and a half billion dollars annually." Of this total, over \$40 billion represents the costs for health care services of all kinds. This is more than 6 per cent of the U.S. gross national product, as shown in Table 2. By comparison, total spending in the electronics industry is less than \$20 billion.

Medical research now accounts for some \$2 billion of the total health care outlay and is expanding at a rate of approximately 15 per cent a year. At present, though, only a small percentage of this is spent on the development of electronic instruments and devices. One reason for this, according to Dr. Robert F. Shaw of the Columbia University Electronic Research Laboratories and the San Francisco Presbyterian Medical Center, is that Government support of research in the medical instrument field has heretofore been meager by both industrial and governmental standards. Says Dr. Shaw, "Little of the almost one billion dollars applied to research support by the National Institutes of Health has been directed toward medical instrumentation. The average funding of NIH research programs is only \$35,000 and industry has in the past been excluded as a proper recipient for awards."

Because of the expected growth of medical electronics, many companies, both large and small, are entering the market, helping to boost its size. This, together with the fact that a gray area exists between medical and nonmedical devices, makes it difficult to determine how many companies are now involved in medical electronics. Estimates range from a low of about 300 companies to a high of almost 2000.

More than half the electronic instruments and devices sold to the medical market are purchased by hospitals and medical schools. Of approximately 7100 registered hospitals in the U.S., about 1300 have more than 200 beds. It is these "large" hospitals that account for almost two-thirds of all the electronic equipment used in hospitals. Research institutions and laboratories, government agencies and the country's 250,000 registered physicians purchase most of the rest.

From an equipment standpoint, medical electronics can be broken down in a variety of ways. Three major categories in any such breakdown are:

- Biomedical research equipment.
- Diagnostic instruments.
- Therapeutic devices.

Biomedical research equipment is used to study



and analyze living organisms and human cells and tissues, and to identify and measure a wide variety of chemicals. Amino acid analyzers, blood-gas analyzers, and infrared and ultraviolet spectrophotometers are all examples of this equipment.

Diagnostic instruments include electrocardiographs, electroencephalographs and a variety of ultrasonic equipment.

Therapeutic devices range from pacemakers and defibrillators to much-publicized artificial organs.

In addition to these three major categories, there are other areas of medical electronics that because of their importance are often considered separately. One of these is electrosurgery, which employs devices ranging from spark-gap generators to lasers in surgical operations. Another specialized area is aerospace medicine, in which transducer and telemetry technology are paramount. Microelectronic advances in this area will doubtless find application in other medical electronic areas.

Still a third area that warrants special consideration because of its potential significance is patient-monitoring systems. These systems continuously collect and record a variety of physiological data from hospital patients, provide convenient displays for doctors or nurses, and activate appropriate alarms whenever a patient requires special attention.

Computers represent another equipment area that can be considered separately. Their wide-ranging medical and biomedical applications run the gamut from simulation studies of bodily systems to analysis of such physiological data as electrocardiograms.

### **Government will play vital role**

The role of government, both Federal and state, in the evolution of medical electronics will be significant. Already, Federal grants, aerospace projects and U.S. Public Health Service programs have done much to promote the use of electronic instrumentation in medicine. In addition, Federal health legislation will ultimately have a profound effect. Some twenty million people are now enrolled for all-inclusive medical care under the Medicare program. In only the first two months of the program, some half billion dollars were spent.

The effect of Medicare on already overcrowded hospitals cannot help but promote the use of equipment that will ease manpower requirements and improve the efficiency of available personnel. Much of this equipment will be of an electronic nature, such as patient-monitoring systems.

Some idea of the manpower gap that might be filled at least partially by medical electronics is contained in the report of a recent study conduct-

ed by the American Hospital Association and the Public Health Service. According to the study, about 275,000 additional professional and technical personnel are needed right now if U.S. hospitals are to provide optimum patient care. This represents a 20-per-cent increase over present staffing. Undoubtedly, the shortage of trained hospital staff will become even more acute as more people take advantage of Medicare and as further government health programs are instituted.

What is considered by many as the single most important trend in health care is also a prime area for electronic instrumentation. This is mass screening. With Medicare a reality, the Government is now considering steps in the field of preventive medicine that would involve a massive effort to detect chronic ailments and impending illness. A bill called "Preventicare" has already been introduced in Congress. It calls for the establishment of regional health centers connected by data transmission links with smaller community health centers. The centers would have the capacity to give basic screening tests to 400,000 persons over the age of 50 every year. The cost of a three-year program would be \$60 million.

An excellent example of a mass-screening instrument is the PhonoCardioScan, which was developed by the Humetrics Div. of Thiokol Chemical Corp. and is now being marketed by Beckman Instruments. About the size of an attaché case, the PhonoCardioScan can detect quickly and easily a variety of heart abnormalities. An examination takes only two to three minutes, and the digital output can be recorded and sent elsewhere for medical interpretation. These two characteristics—speed and the ability to be operated by relatively unskilled medical personnel—are basic requirements of any mass-screening instrument.

### **New companies face problems**

As a result both of the growth potentials of medical electronics and of their desire to diversify, new companies are constantly entering the field. Drug companies, electronics companies, chemical companies and aerospace companies—all are being attracted into the field to some degree. Each new entrant feels—and usually rightfully so—that it has the capacity and know-how to make a useful contribution.

One might expect this expansion of suppliers to have a great impact on the policies and decisions of the old-line companies in the field. For the most part, though, this does not seem to be the case. The companies that have been serving the market for years can best be characterized by a "wait and see" attitude. Their feeling is that it takes considerably more than mere technical know-how to be successful in the field. In their eyes, a thorough acquaintance with the medical field and its mar-



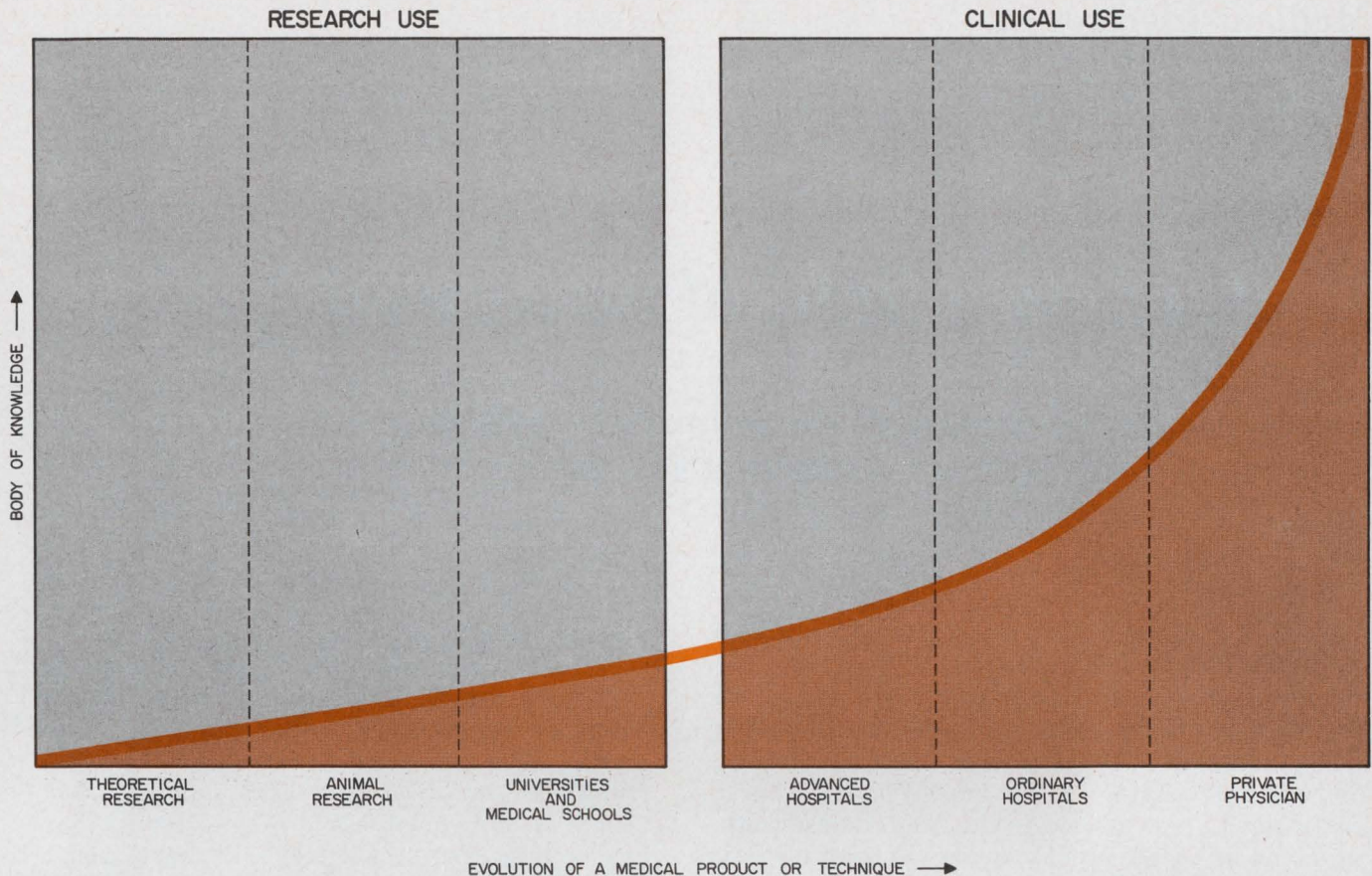

**Complete evolution of a medical product can take from two to twenty years.** Research uses come first, followed by clinical use later. The private physician, because of his necessary conservatism, is generally the last to accept and

use a new product or technique. The vertical axis of the above curve represents the whole body of knowledge that has been acquired about the product, its uses and its limitations.

keting considerations is more important than technology in many instances. And it remains to be seen whether the newer companies have or can acquire this marketing know-how.

Some companies are aware of this and have entered the market by means of acquisition or working agreements. RCA and Hoffman-La Roche, Inc., for example, have a working agreement. Hoffman-La Roche contributes experience in medical research and marketing; RCA, in electronics. Another example of this approach is the agreement between Zenith and Baxter Laboratories. The acquisition route, on the other hand, was followed by Warner-Chilcott when it acquired Research Specialties, a maker of automatic analyzers.

#### Doctor/engineer interface . . . barrier or bridge?

One of the most talked about elements of medical electronics is the relationship between doctor and engineer. Cooperation between these two vastly different disciplines is absolutely essential. Unfortunately, the degree of such cooperation varies so widely that generalizations are impossible to make.

Some doctors keep abreast of electronic devel-

opments and are quick to recognize and accept technological innovation. Foremost among these are many engaged in laboratory and clinical research. At the other end of the spectrum are the many private practitioners who are either extremely wary of new electronic gadgets or who jealously guard their professional skill against silent black boxes.

In justifiable defense of those doctors who do not appear overly enthusiastic about electronic instruments, it should be noted that a doctor's ultimate responsibility is to his patient. If a piece of equipment should fail during an operation, the proceedings cannot be halted while the equipment is fixed. (There may be time to change surgeons during an operation, but seldom equipment.) Moreover, should a patient be injured by an electronic device, whether through faulty operation or misuse, the doctor is held largely responsible.

The engineer or producer of medical electronic equipment, for his part, must do his medical homework. He must find out what is wanted by the medical profession, and not plow ahead to develop what he imagines is needed. The medical electronics graveyard is full of electronic stethoscopes and other devices that someone thought were needed. ■ ■



# It's largely a field of measurement

*Sensors represent the biggest area for improvements in today's physiological data-collection systems*

Medical electronics is to a large extent a field of measurement. Brain waves, blood flow, skin resistance and a host of other body parameters can be measured with today's instrumentation. But efficient and accurate as present instruments are, there is still great room for improvement. This is particularly true of electrodes and transducers, which make up the input elements in most medical measurement systems.

A typical block-diagram representation of the role played by electronics in medicine is shown in Fig. 1. The two main areas served by electronic equipment are diagnosis and therapy. Although surgery is shown as a therapeutic function, for some purposes it can be broken out separately.

The diagnostic equipment consists of a measurement system having one or more sensors as input devices and a recorder or other display unit as an output. In some cases a computer is included in the system to analyze the data and present them in a more usable form. The final output of the measuring system is then used by the physician or researcher to make his diagnosis.

The therapeutic equipment uses electrical or electronic elements in the treatment or rehabilitation of patients. In certain applications, such as during major surgery, the diagnostic and therapeutic elements form a closed loop. At other times, they are distinctly separate, with the diagnostic system forming an open loop.

### Signals by the score

From an engineering standpoint, Fig. 1 does not represent a very complex system—except, that is, for the fact that man and his physiological conditions are included as an integral part of the loop. The human body is an exceedingly complex organism, and to measure anything about it in a meaningful way requires knowledge of both the engi-

neering and physiological factors involved.

As an object of measurement, the human body is very much akin to the proverbial "can of worms." There are numerous bioelectric signals of interest as well as many physical phenomena that can be transduced into useful electrical signals. But to isolate an individual signal of interest so that it can be measured accurately is no small task.

Many of the usable signals interact with each other. Also, bioelectric noise signals, called "artifacts" are always present and often are of sufficient amplitude to mask the desired signal. Some of the more commonly measured body parameters are shown in Fig. 2. There are other useful parameters, such as heart rate, which are derived from one or more measured parameters.

It should be noted that the values given in Fig. 2 are only representative. Exact amplitude and frequency characteristics depend on how, when and where the measurements are made, as well as on what portion of the signal is significant for the particular measurement. The frequencies, in particular, are open to dispute, since medical people do not always agree on how much of a signal's frequency range is significant.

For example, the American Heart Association recommends that direct-writing electrocardiographs respond to an upper frequency of about 50 Hz. Others, however, suggest an upper frequency cutoff of at least 100 Hz. And in a recent report, Alan Berson, of the Veterans' Administration Research Center for Cardiovascular Data Processing, and Dr. Hubert Pipberger, of the Dept. of Medicine, Georgetown University, recommend a considerably higher cutoff frequency—under some conditions perhaps as high as 200 Hz.

The differences may appear inconsequential, until it is realized that the majority of direct-writing electrocardiographs presently in use have a high-frequency response limit well below 100



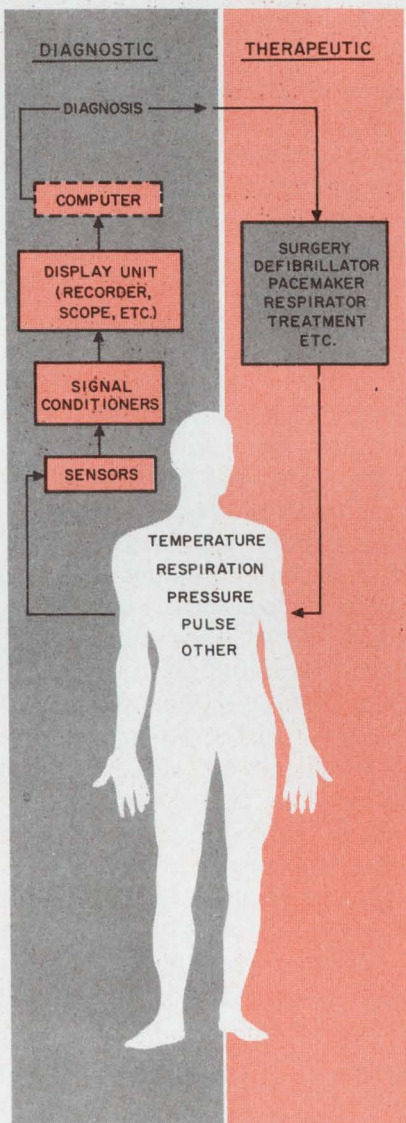

1. Measurement is the basic function of diagnostic instrumentation. Therapeutic devices can be used concurrently with diagnostic instrumentation (closed-loop) or they can be used separately (open-loop).

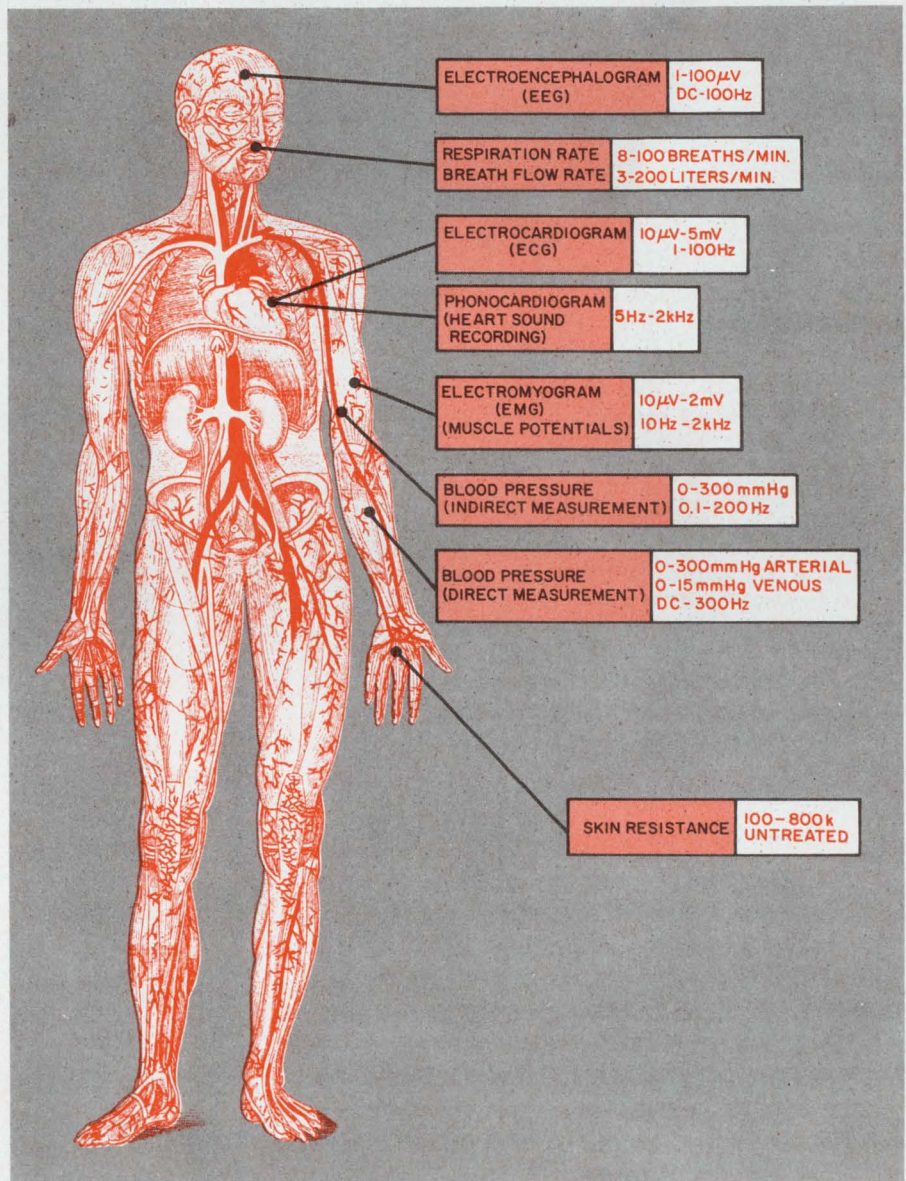

2. Many difficulties are encountered when making measurements on the body because of the small signal levels and low frequencies involved. The measurement of any particular signal is further complicated by the gross interaction between various body signals as well as by the many artifacts present.



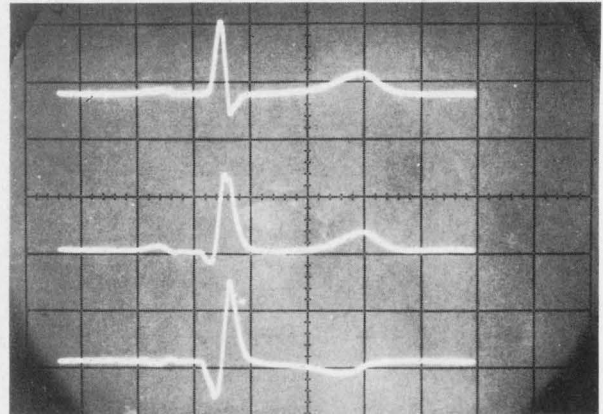
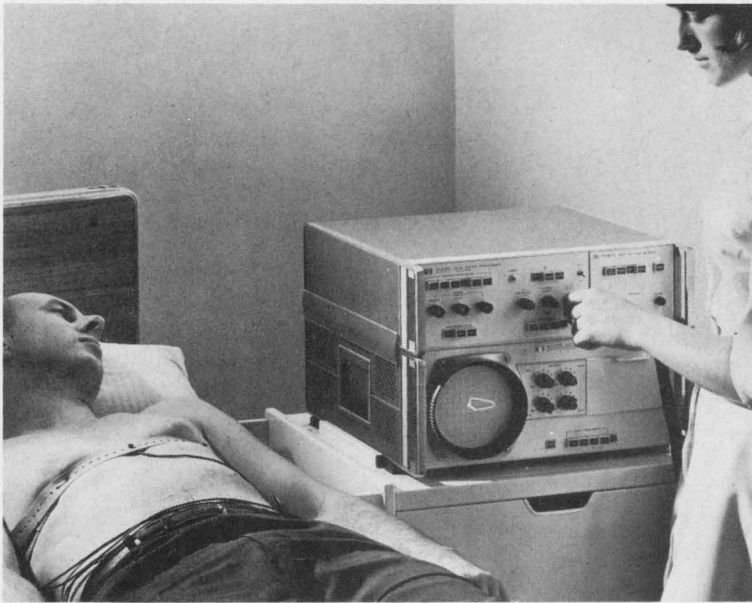

**Vector cardiograph presents 3-dimensional data** on heart activity. This Hewlett-Packard/Sanborn 1520A unit displays either vector loops of the total heart activity (shown on scope) or the individual vector components simultaneously (waveforms shown above). Sweep speeds as high as 1000 mm/s are possible with the unit.

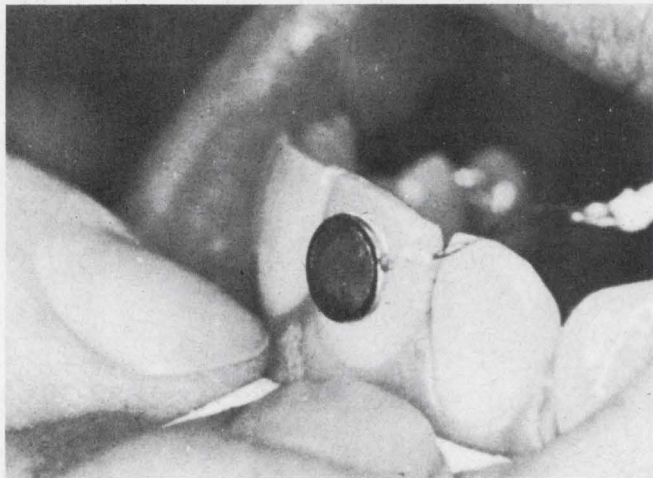

**Pressure transducer adheres to tooth** to measure the pressures that the lip exerts on the teeth. Because of its thin size (0.020 inch thick) it does not affect the natural shape and movement of the lip. Developed by Scientific Advances, Inc., the transducer uses a fully active, four-arm strain-gauge bridge. It requires an excitation voltage of 3 volts, ac or dc.

## Some commonly used sensors

### Transducers

- Variable-reluctance type
- Differential transformer
- Strain gauge
- Thermistor
- Photovoltaic cell
- Thermocouple
- Moving potentiometer
- Expansion type

### Flow probes

- Electromagnetic
- Ultrasonic

### Biopotential electrodes

Hz, and much useful medical information is quite possibly being lost as a result of this limitation. The purpose here is not to report on the shortcomings of present instrumentation, but to show that continual increases in medical knowledge result in constantly changing equipment requirements.

A further limitation on the usability of the body's signals is the fact that many of them are measured as potentials at the surface of the body. These are then used as indications of events going on deep within the body. This is sometimes a very misleading representation, because of the distortion that occurs as the signal passes through the body—which is a very oddly shaped conductor. A great deal of research, particularly in the field of electrocardiography, has been conducted in an effort to determine what happens to a signal on its way to the body surface. These studies have yielded data on the characteristics and locations of the required measurement electrodes. For example, a simple electrocardiogram, that measures heart potential horizontally across the chest, can be taken with as few as three electrodes. But a three-dimensional, or vector, cardiogram requires at least 12 electrodes to compensate for the body's odd shape and to give a true picture of heart activity. Such a vector cardiogram gives the space and time changes of heart potentials in three directions—horizontal, transverse and sagittal.

### Sensors provide interface

In any physiological measuring system a sensor of one sort or another acts as the interface between the living organism and the electronic instrumentation. No matter how sophisticated or accurate the instruments may be, the final measured value can be no more accurate than the



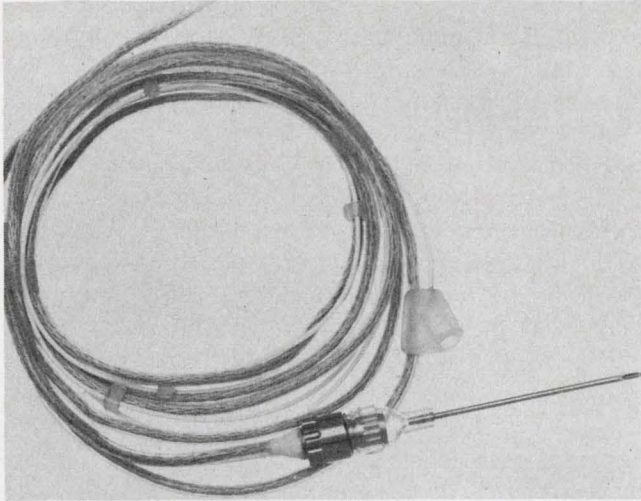

**Developed for the artificial heart program**, this transducer for the direct measurement of blood pressure weighs only 4 grams. The unbonded strain-gauge unit was designed by Statham Instruments, Inc. for prolonged internal use.

sensor. And many present-day sensors still leave a lot to be desired.

The two major types of sensors are electrodes and transducers. Electrodes convert the electrochemical biopotentials of a living organism into corresponding electrical signals. Transducers, on the other hand, are used to convert body phenomena such as heat, motion or blood flow into electrical signals. While electrode technology tends to be peculiar to the biomedical field, transducer technology has benefited greatly from work conducted in the industrial and aerospace fields. This is not to say, though, that electrodes have to be specially designed, while transducers can simply be adapted from their industrial or aerospace counterparts.

In many ways, the requirements for a medical transducer are far more stringent than for other types. If it is to be used at the surface of the body, a transducer must make good electrical contact, often during strenuous physical movement. Its materials must not irritate the skin nor interact electrically to produce false signals. Obviously the transducer must respond accurately to the desired signal, and hopefully be insensitive to unwanted signals and artifacts. It must also not require potentially hazardous energizing potentials.

If a transducer is for internal use, it must conform to even more exacting requirements. Foremost among these is that of accessibility. Its size and shape must be such that it can fit into or through the various organs and vessels of the body. Further difficulties arise from the potential danger of germs entering the body through the openings required for transducer insertion, as well as from the body's natural attempts to expel any foreign material projecting through the skin.

Nevertheless, many measurements can be made

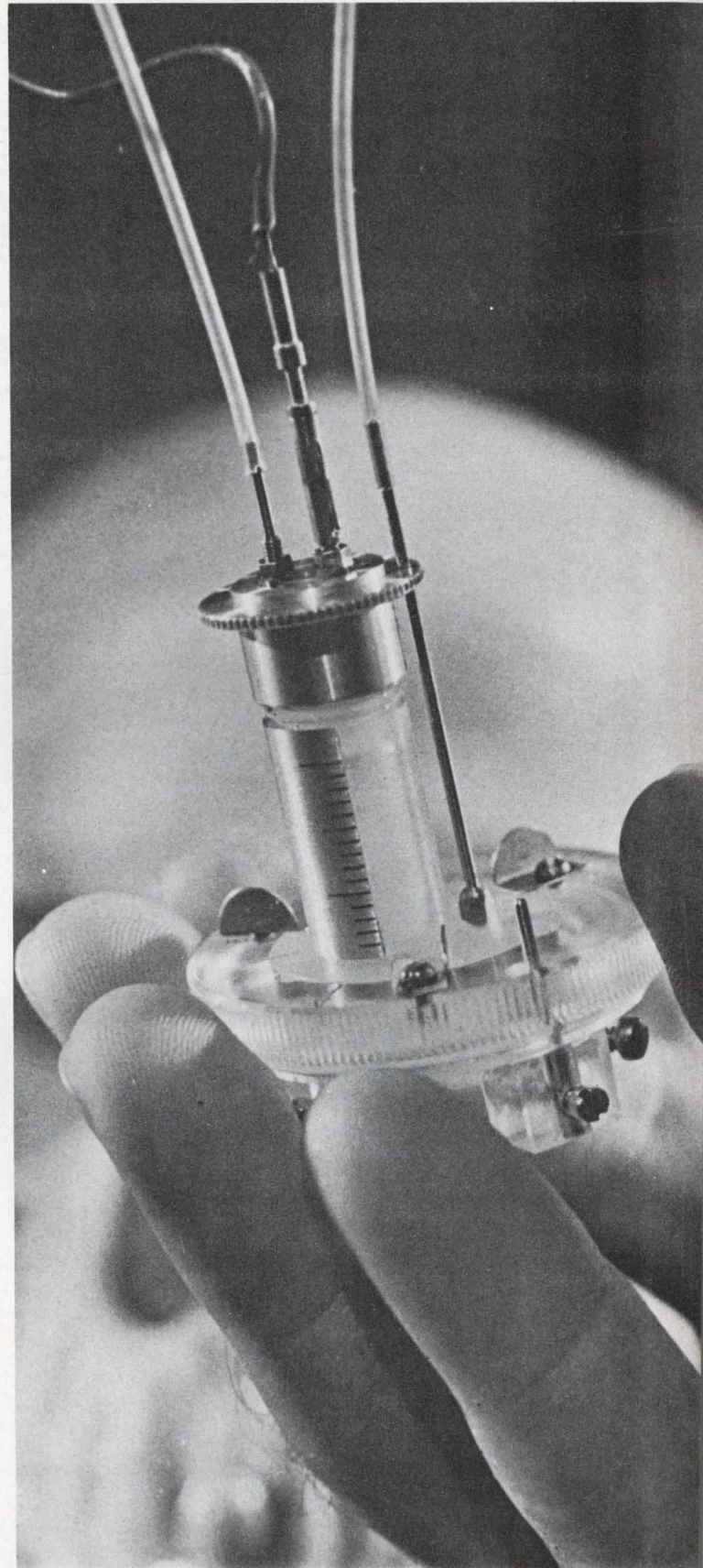

**Hydraulic microdrive** is used to implant a microelectrode into a predetermined region of the brain or spinal column. When used with an auxiliary device, it can position the electrode within one micron of the desired spot. The microdrive is used in the treatment of Parkinson's disease, and was developed by the Division of Research Services of the National Institutes of Health.



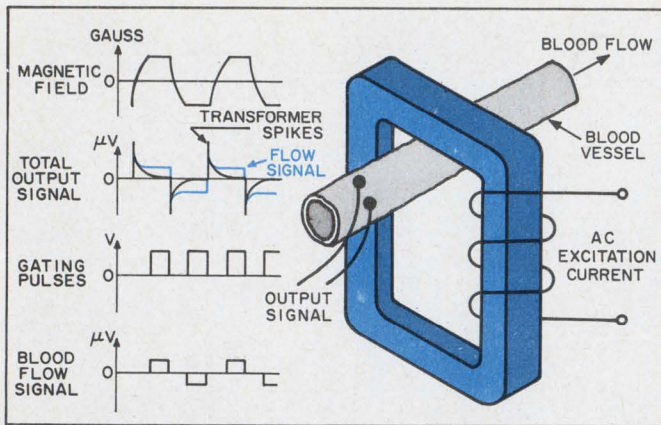

3. Blood is a moving conductor, so its flow can be measured by impressing a magnetic field across it and detecting the generated emf. A gating technique in the external circuit removes unwanted signal components generated by the transformer action.

accurately today only from inside the body. For example, although blood flow can be measured externally by techniques using X-rays, radioactive isotopes or dye solutions, a more accurate method utilizes electromagnetic measurement right inside the body at the blood vessel in question. Such a technique is possible because blood is a moving conductor. When it is made to move through a magnetic field, an emf is generated that is proportional to the strength of the field, the diameter of the blood vessel and the mean velocity of flow.

One arrangement for such a measurement is shown in Fig. 3. The electromagnet clamps onto the blood vessel and the pickup electrodes are in contact with the vessel outer wall. A basic difficulty with this technique is that the measured signal contains a transformer-induced voltage in addition to the blood-flow-induced voltage. To eliminate the unwanted transformer voltage, which is in the form of spikes during the rise and fall times of the transformer's magnetic field, gating techniques are used in the external circuitry. The end result is a square-wave pulse train whose amplitude is proportional to the blood flow.

Low-resistance metal electrodes, such as gold or platinum, have normally been used for these blood-flow measurements. Recent work, however, has shown that high-resistance electrodes made of sintered metal oxide give superior performance. They provide a distinct reduction in artifacts caused by eddy currents and noise.

Biopotential electrodes sense the minute potentials caused by electrochemical reactions within the body. These potentials are transferred by movement of positive and negative ions and make it necessary for the electrodes to operate quite differently from simple electrical connections. Instead, the electrodes become part of the biological electrochemical system; they make their connection to it through the formation or discharge of ions at their surface. Poor design or improper use of the electrodes can cause variations in contact potential that are orders of magnitude greater than the biopotentials being measured.

Biopotential electrodes are usually metal conductors placed in electrochemical contact with the living organism, where electrical signals are ionic in nature. Two basic problems stem from this combination.

First, when current is drawn, the electrodes tend to polarize. A severely polarized electrode actively impedes current flow at low frequencies, and so tends to act as a filter. This results in an altered frequency response and signal distortion. As a result, the system amplifier or preamplifier plays an important role in the measurement of biopotentials. For minimum current, its input impedance should be at least 100 times greater

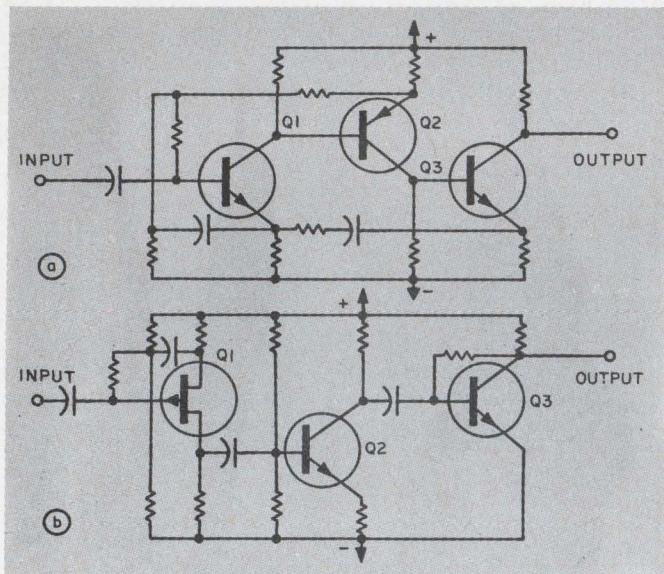

4. Two techniques for obtaining high input impedance in amplifiers and preamplifiers are bootstrapping and the use of FET input stages. In (a), an input impedance of 1 MΩ is achieved by use of a bootstrapped bias network for transistor Q1. In (b), a 10-MΩ input impedance to the amplifier is obtained by using both bootstrapping and a FET input stage.

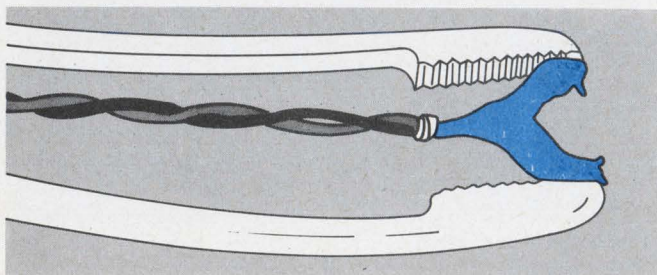

Fetal scalp electrode, shown here held by special forceps, is part of the Beckman Instruments' Fetal Monitoring System. Designed primarily for obstetrical and gynecological research, the electrode is attached to the scalp of the fetus to measure fetal EEG, heart rate, etc.



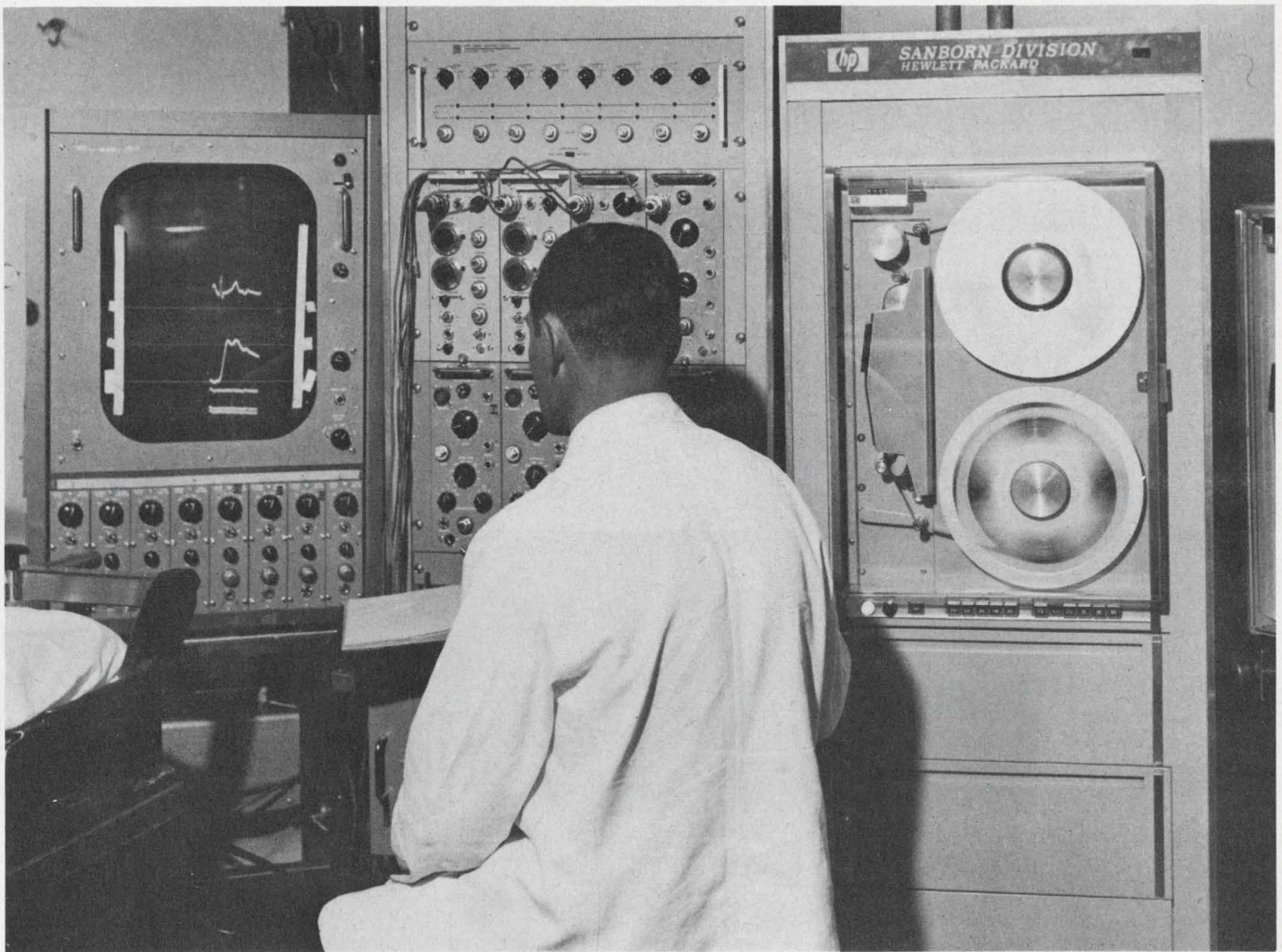

In a cardiac physiology laboratory, heart parameters are measured and recorded prior to major surgery with this Hewlett-Packard/Sanborn Div. eight-channel monitoring/recording system. After being processed by appropriate signal conditioners, the eight channels of data are displayed on the oscilloscope and simultaneously recorded

on magnetic tape. A second portable tape system is available for additional recording in the lab or at bedside. An oscillographic recorder is also part of the system. Such systems, which are used in most large hospitals, provide the heart surgeon with invaluable pre-operative and post-operative information.

than the maximum source impedance, and preferably 1000 times greater. This requires an input impedance larger than 1 megohm for most skin and tissue measurements, and even of 1000 megohms when extremely small electrodes, with their inherently high impedances, are used. A variety of techniques, including bootstrapping arrangements and the use of FET input stages, are used to achieve these impedances (Fig. 4).

The second problem is movement of the electrodes once they are in place. Such movement agitates the ion solution beneath the electrodes and can cause current transients of tens of microvolts—quite large considering that the signal being measured is in the microvolt range. To overcome this problem, ionically conducting electrode pastes are frequently used to attach the electrodes. The electrodes themselves then do not touch the skin.

When electrodes are applied to the skin, the area of contact is generally first scrubbed with a solution to remove the high-resistance outer skin

layer. Some electrodes are designed to puncture the skin, thus reaching the lower-resistance layers directly.

#### Basic instrumentation used

The elements that follow the transducers in most medical measuring systems are for the most part basic electronic components. They include signal conditioners, preamplifiers, amplifiers, oscilloscopes, oscillographic recorders, tape recorders, and sometimes even large-scale computers. Although these items are basically the same as their peers used in other fields, there are certain design differences. These differences are dictated by both the nature of what is being measured and the technical capability of the eventual user.

Since most body signals are characterized by small amplitude and low frequency (including dc), substantial amplification and good low-frequency response are important features of much medical instrumentation. Techniques involving dc am-



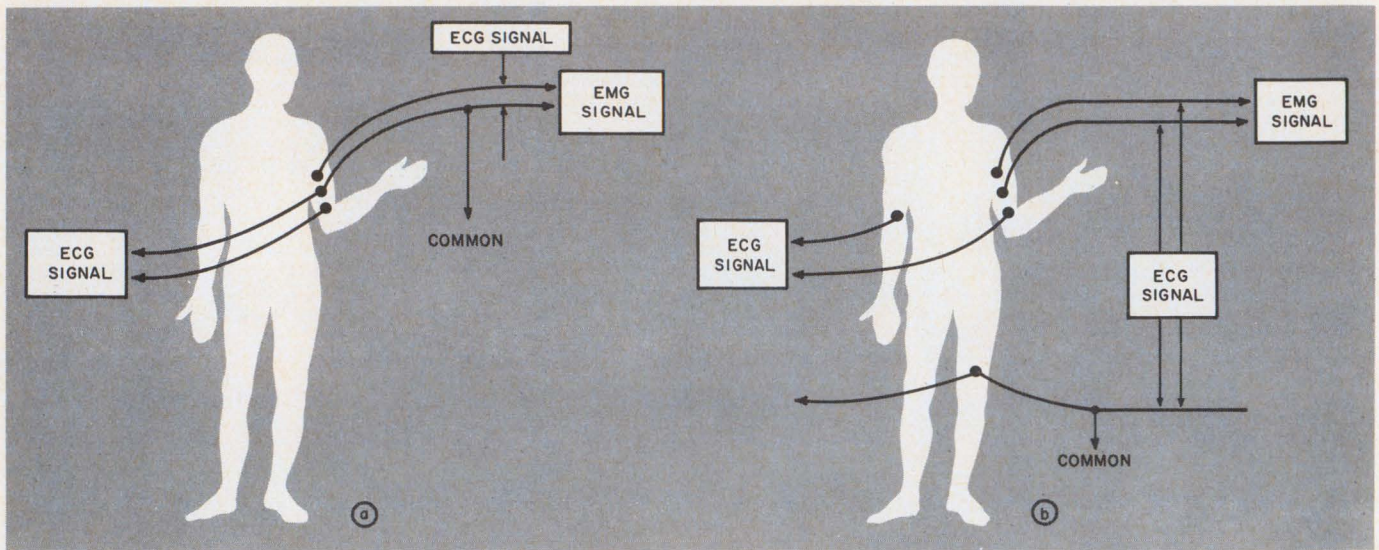

5. Single-ended measurement technique (a) would result in large common-mode errors if two signals were measured simultaneously and one was considerably larger than

the other. By using a double-ended technique (b), common-mode rejection in the smaller of the two signal channels is greatly increased.

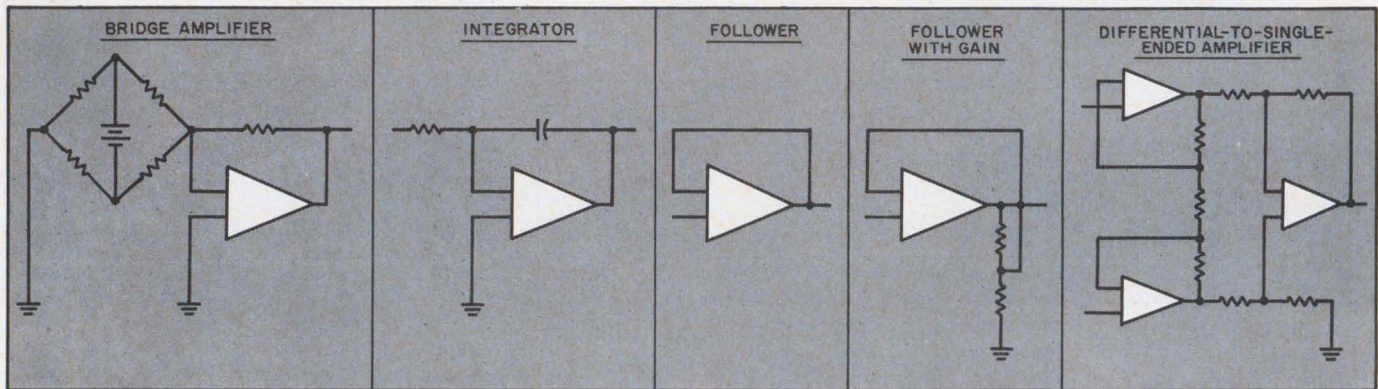

6. Operational amplifier is increasingly used in medical electronic instrumentation because of both performance

and cost considerations. These are some of the basic op amp configurations employed.

plifiers, low-frequency compensation and chopper stabilization are widely used. Good common-mode rejection is another requirement, particularly for low-level amplification of electrode and transducer signals. This is extremely important when simultaneous measurements are being made of two or more patient parameters. For example (Fig. 5a), if both an electrocardiogram and an electromyogram are being taken at the same time and a single-ended amplifier is used following the EMG transducer, the much larger electrocardiogram signal will also appear at the input to the EMG amplifier, completely masking the desired signal. But by using a double-ended balanced amplifier following the EMG transducer, common-mode rejection is enhanced (Fig. 5b).

Often the entire amplifying system is kept balanced right up to the output. This sometimes creates problems when a recording device requiring a single-ended input is used. Additional circuitry is then required to accomplish the required balanced-to-single-ended conversion.

Operational amplifiers are coming into more widespread use in medical electronic equipment. Even some of the major manufacturers are buying off-the-shelf op amps for inclusion in their equipment. The reasons for this are many. Op amps offer not only stability and good low-frequency characteristics, but also are extremely flexible and are attractively priced. Some of the op amp configurations coming into common use in medical instrumentation are shown in Fig. 6.

The operation and maintenance of medical instrumentation is often just as important as its technical capability, sometimes even more so. Workers in laboratories and research institutions who are familiar with electronic instrumentation appreciate the flexibility offered by multiple knobs, meters and switches on an instrument. Doctors, nurses and other medical technologists, however, have no such appreciation. They want an instrument that is easy to set up, operate and read. Consequently, equipment designers think carefully before adding an additional control. ■ ■



# PROGRESS REPORT

## ALSiMAG®

**SMALL  
PRECISION CERAMICS  
"AS FIRED"**

Five years ago we made guarded statements about meeting certain precision requirements with "as fired" ceramics in some configurations. Volume production of small alumina ceramics to close tolerances was the key to many electronic advances. There has been continual pressure for ever-smaller ceramics to still closer tolerances.

About once a year we have reported and illustrated our current abilities in this field. Each year progress has been made. It is based on hard won experience, employee training programs, specialized equipment and ability to control more variables.

Throughout most of this period our fast growing deliveries have not been satisfactory to us or to our customers. Now we feel that our staff of specially trained people plus our greatly enlarged production areas in both our Chattanooga and Laurens plants enable us to handle new volume requirements in agreed production time.

### DELIVERIES

We will be glad to discuss your requirements and show you the current state of the art in precision alumina, steatite, Forsterite and beryllia ceramics.

### PROGRESS IN BERYLLIA

It is often said that close tolerances on beryllia ceramics are difficult if not impossible. Small precision beryllia components are being processed regularly and in volume by American Lava. The favorable characteristics of beryllia, including its remarkable heat conduction, are thus available for a whole new range of applications.

Parts illustrated approximately actual size.

## ALUMINA

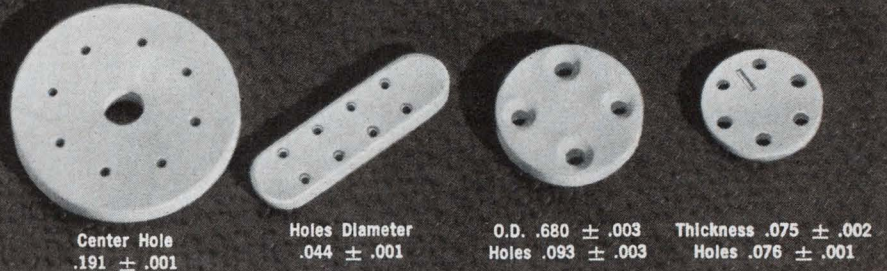

## BERYLLIA

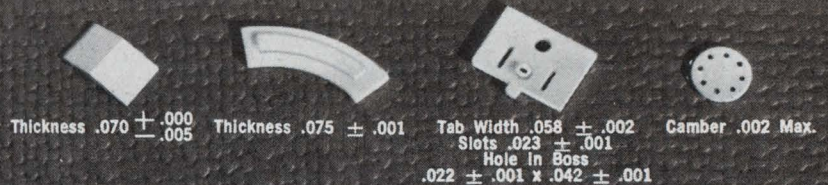
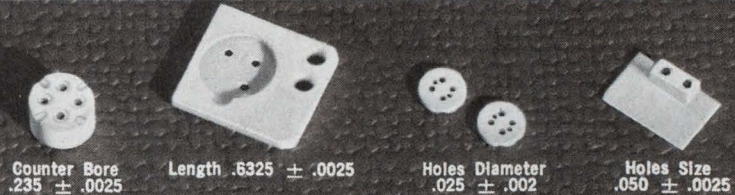

## STEATITE & FORSTERITE

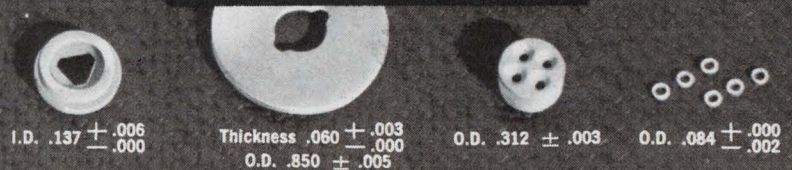

CODE IDENT. NO. 70371

PHONE 615 265-3411 • CHATTANOOGA, TENNESSEE 37405, U.S.A.

**American Lava Corporation**

A SUBSIDIARY OF **3M COMPANY**

For service, contact American Lava representatives in Offices of Minnesota Mining and Manufacturing Company in these cities (see your local telephone directory): Atlanta, Ga. • Boston: Needham Heights, Mass. • Chicago: Bedford Park, Ill. • Cleveland, Ohio • Dallas, Texas • Laurens, S. C. • Los Angeles, Calif. • Metropolitan New York: Ridgefield, N. J. • Up-State New York and Canada: Baldwinsville, N. Y. • Orange, Conn. • Philadelphia, Penn. • Roanoke, Va. • St. Louis: Lee's Summit, Mo. • South San Francisco, Cal. • Troy, Mich. • 3M International: c/o American Lava Corporation, Chattanooga, Tenn. 37405, U.S.A., 615/265-3411

65th  
YEAR  
OF  
CERAMIC  
LEADERSHIP



# Many technical disciplines are involved

*From circuit design to systems engineering, medical electronics is a potpourri of electronic technologies*

One of the most notable characteristics of medical electronics is that it draws on practically every area of electronic technology. Ultrasonics, lasers, computers, telemetry—to name just a few—are all being used. Often a variety of techniques are investigated for solutions to the same problem. But expensive as this duplication of effort may be, it is resulting in a level of health care and medical treatment that was undreamed of not too many years ago.

### Big things expected from lasers

An excellent example of the research required before any technique is accepted for medical use is offered by the laser. Over the years numerous investigations have been conducted into its possible uses. Although the results of many of these have been extremely encouraging, the laser is still primarily a research tool.

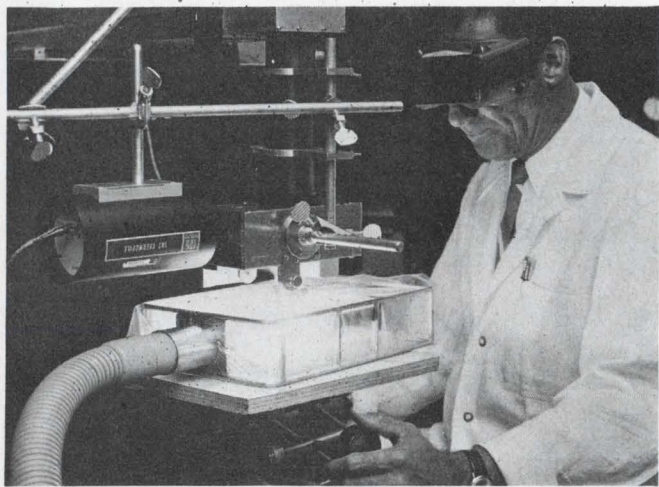

Biomedical engineer watches experimental laser shot at the NIH National Cancer Institute. The shot is part of an experimental research program to determine the effect of laser energy on the biological behavior of tumors and normal tissues. Workers are experimenting with five lasers—two are cw gaseous types and three are of the pulsed, solid-state variety. On an average day about 25 laser shots are fired.

Nevertheless, the laser's potential usefulness in medicine, surgery, dermatology and dentistry is tremendous. Its greatest promise is in the treatment of malignant tumors. Laser energy affects normal tissue only slightly and healing is usually rapid. On certain tumors it has a selective effect that causes regression or dissolution of the growth. It has been found that this effect can be induced even when only a small portion of the tumor is irradiated. Even though laser energy is nonionizing, this seems to indicate that the biological effect of laser energy is not caused solely by its heat generation. The exact etiology of this destructive effect, however, is not presently known.

Surgical applications are another likely area for lasers. Already they are in limited use to weld detached retinas in the eye and to perform bloodless surgery. Both argon and carbon dioxide lasers have been employed for this purpose, and post-

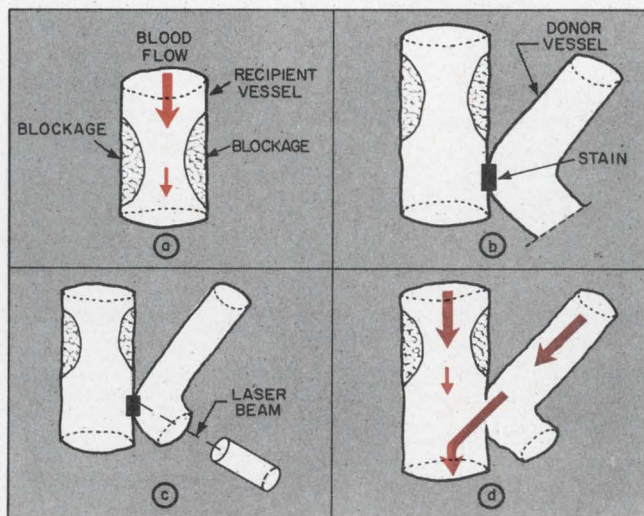

1. Lasers may be used to join blood vessels without interrupting blood flow. Blood flow in the recipient vessel (a) is retarded by injury or disease. The donor vessel is glued to the recipient vessel (b) and a stain applied to the common wall. The laser beam punctures the common wall at the spot of the stain (c), and blood flows from the donor to the recipient vessel.



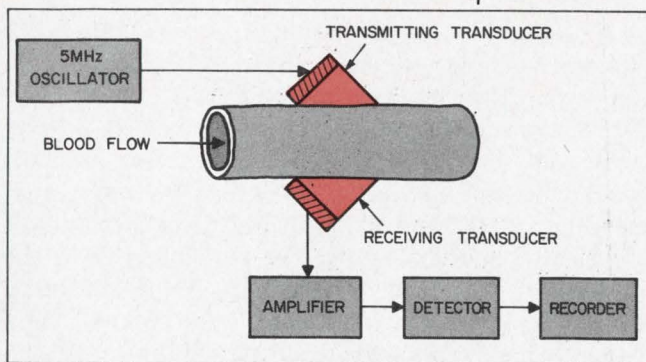

2. Frequency of Doppler shift indicates blood velocity in this ultrasonic Doppler flowmeter system. The output of the receiving transducer is an AM signal of a modulation frequency that is directly proportional to blood velocity.

operative healing has been reported very good.

Typical of the novel surgical uses to which the laser has been put is that of Drs. William Yahr and Kenneth Strully at Montefiore Hospital and Medical Center, N. Y.<sup>1</sup> They are investigating its ability to join small blood vessels together without interrupting blood flow. It is hoped that this technique will eventually serve to bring a new blood supply to the heart or brain when the vessels normally supplying such blood are damaged or diseased. Such surgery can now be accomplished only with a total interruption of the blood flow.

The technique (Fig. 1) requires a neodymium laser; each output pulse has an energy of more than 200 joules. As shown, the donor vessel is first glued to the recipient vessel at a point beyond the blockage or area of disease. This common wall is then exposed by opening the end of the donor vessel, and a copper sulfate stain is applied to the area. The laser is then aimed at the stained area, producing a hole through which blood may flow from the donor vessel to the recipient vessel. The stain is required because normal tissue is relatively transparent to the neodymium beam. But over the area of the stain almost complete absorption takes place, and this leads to the wall breakthrough.

Lasers are also being actively investigated for their application to dentistry. Their principal use so far has been for preliminary hole-drilling and crater-making in carious teeth. The main drawback at present is the lack of a small, hand-held laser applicator that is both flexible and functional, and that can beam the laser energy into the oral cavity selectively.

Various researchers are now looking into the possibility of a marriage of lasers and fiber optics. Such a combination would enable laser beams to be applied to parts of the body that were previously hard to reach. Problems to be overcome, though, include the low efficiencies of both fiber-optic materials and some lasers. Certain types of laser, like the nitrogen-carbon dioxide units, have

the necessary efficiency, but their outputs cannot be conducted by present fiber-optic materials, because their energy is at frequencies that are absorbed by practically everything.

Fiber-optic probes and needles are already in restricted use in medical applications. These include looking into body cavities as well as studying cells in muscle or similar tissue.

## Ultrasonic waves treat and measure

Ultrasonics has met with variable success in a variety of medical applications. As a therapeutic tool, it is employed in the treatment of diseases such as bursitis and arthritis. The high-frequency sound waves produced by a piezoelectric transducer are beamed into the affected part of the body to generate heat.

Ultrasonics is also used to measure blood flow and the size of internal body organs. In both cases, ultrasonic waves are beamed at the desired spot by a transmitting transducer, and reflected waves are then picked up by a receiving transducer. Either the transit time of the waves, or the phase or Doppler shift of the received waves provides the desired measurement. Both pulsed and cw ultrasonic waves have been used for these applications.

The arrangement of an ultrasonic Doppler flow-meter system is shown in Fig. 2. The lead zirconate transmitting transducer is excited by a 5-MHz oscillator and the resulting sound waves are beamed through a blood vessel wall into the bloodstream. As a result of scattering by the elements of the blood, the sound picked up by the receiving transducer consists of both direct waves from the transmitting transducer and scattered waves. This composite signal is received in the form of the direct waves amplitude-modulated by the scattered waves. The frequency of the amplitude modulation is directly proportional to the frequency of the Doppler shift, which in turn is proportional to the velocity of the blood. So by amplifying and detecting the received signal, the blood velocity is determined.

This technique has the disadvantage that it cannot determine the direction of blood flow. Workers at the USAF School of Aerospace Medicine are now investigating a method in which three ultrasonic transducers are used to measure both velocity and direction of blood flow.<sup>2</sup> Besides a transmitting transducer, two receiving transducers are needed: one for detecting Doppler shift and the other to detect the phase shift produced by the flowing blood. At present, both velocity and direction of flow can be determined by comparing recordings of the Doppler and phase shifts. Circuitry for electronic detection is under development.

(continued on p. 66)



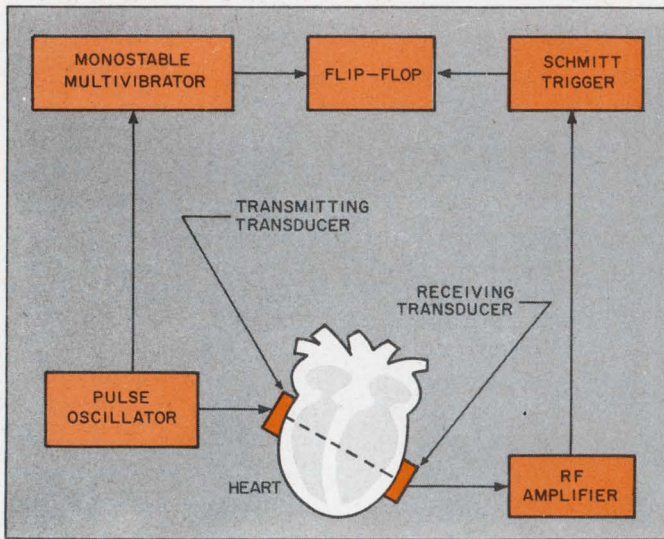

3. Variations in heart size can be measured with this ultrasonic measuring system. Organ diameter is proportional to the transit time of the ultrasonic pulse through the heart. This time is equal to the flip-flop ON time plus the fixed delay that is introduced by the monostable multivibrator.

A new and simple method for measuring the diameter of an internal organ ultrasonically is shown in Fig. 3.<sup>3</sup> The piezoelectric transducers, which are sutured to either side of the organ to be measured, operate at 5 MHz. A pulse from an avalanche-type oscillator shock-excites the transmitting crystal and at the same time actuates a monostable multivibrator. The trailing edge of the monostable in turn sets a flip-flop. After the sound burst has traversed the organ, it is picked up by the receiving transducer, amplified by a broadband RF amplifier and applied to a Schmitt trigger. The output of the Schmitt trigger then resets the flip-flop. Total transit time, which is proportional to the size of the organ, is thus equal to the flip-flop ON time plus the fixed delay inserted by the monostable. Variations in organ size appear as duty-cycle modulation, and can be recorded after filtering with a simple low-pass filter. This technique, too, was developed at the USAF School of Aerospace Medicine Brooks Air Force Base, Texas, and is now being used experimentally.

#### 4. Implantable transmitter configurations

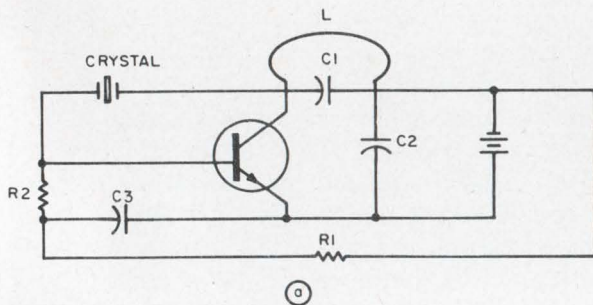

**Crystal oscillator provides good frequency stability.** This type is widely used for animal tracking and narrow-band signal transmission over a range from 100 feet to several miles. Both continuous and pulsed operation can be obtained by varying the value of resistor R1.

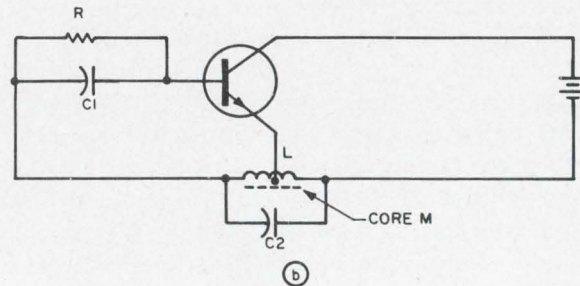

**Common-emitter Hartley oscillator unit can be pulsed or cw operated.** For measuring temperature, resistor R is replaced by a thermistor; for measuring pressure, changes in pressure move core M; and for measuring pH, suitable electrodes vary the dc operating voltage. Other variables can also be measured.

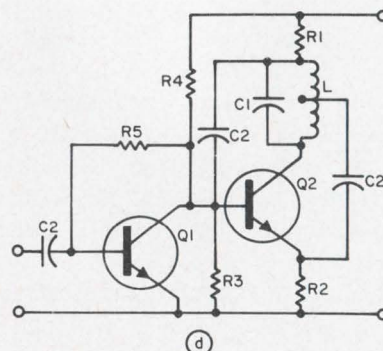
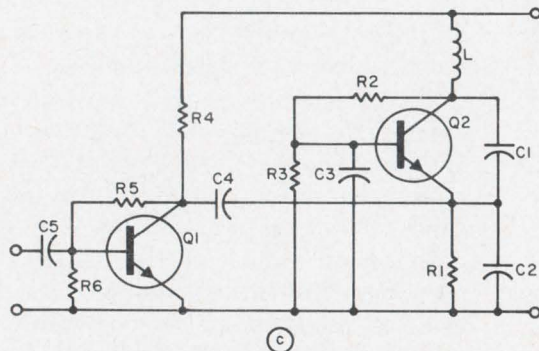

**Bandwidths of several kHz are possible** with these two configurations. One is a common-base Colpitts (c) and the other a common-base Hartley (d). Both use the voltage-sensitive capacitance between the emitter and base of transistor Q2 to frequency-modulate the carrier. These circuits are used to transmit signals such as electrocardiograms and electromyograms from a few feet up to about 100 feet.



## Microelectronics pursued actively

Microelectronics in various forms is already being exploited in some medical electronic instrumentation, although its potential is nowhere near full realization yet. Its attractiveness, however, particularly for advanced biomedical research, has stimulated intensive investigation of its possible uses.

The size and weight reductions possible with microelectronics make it possible to use an amplifier right at the site of a transducer, or even to make the amplifier an integral part of the transducer. Noise and interference effects can thus be minimized, even when the recorder or other signal display device is located at a considerable distance from the transducer. Another advantage of microcircuitry is low power requirements, which may make it possible to drive sensors and associated circuitry from biological sources of power. Such power sources, including body heat, muscle activity and chemical energy, are now the object of a great deal of research.

The widest-ranging work in the medical microelectronic area is probably that being undertaken at the Microelectronic Laboratory for Bio-Medical Sciences, Case Institute of Technology, under the direction of Professor Wen H. Ko. Possible applications for microelectronics in the fields of telemetry, biological stimulation, closed-loop control, complex decision-making systems, new transducers and novel experimental techniques have all been investigated at the Microelectronic Laboratory, many with outstanding results.<sup>4</sup>

One area, implant biotelemetry, is particularly significant. Here the technique is to transmit medical information by radio from a transmitter inside the body to a remote receiver. Receivers used in implant telemetry systems are usually standard commercial units, sometimes with minor modifications. Practically all the design effort is therefore concentrated on the transmitters, which must be designed to meet the special requirements of each application.

Most contemporary transmitting units have one or two transistor stages to perform the transducer, signal-conditioning and transmitter functions. Either FM or some form of pulse modulation is used; amplitude modulation is not, because of the errors introduced by relative motion between transmitter and receiver.

Four common types of implant transmitting units appear in Fig. 4. The circuit of Fig. 4b is the most desirable design approach, since it incorporates the transducer and signal conditioner into the oscillator.

With conventional solid-state circuitry, the complexity of implantable units is restricted by size and weight limitations. But with microelec-

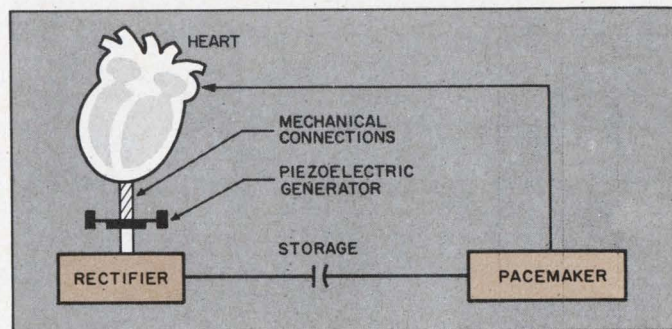

5. Implantable piezoelectric generator uses a lead zirconate titanate crystal to convert mechanical energy from the heart into electrical power to drive a pacemaker.

tronic circuits, the capability and sophistication of units is considerably increased. For example, presently under development is an implantable integrated-circuit unit that can monitor and transmit 10 body parameters on a time-division multiplexing basis. The 10-channel unit is expected to have a volume less than one cubic inch and a weight less than 30 grams. The unit is to be powered by externally generated RF energy or by a storage battery that can be charged by RF energy.

A six-channel FM/FM multiplex unit, weighing 15 grams, has already been built and successfully tested at Case.

## Power sources operated by the body

In the past, medical electronic instrumentation was powered almost exclusively by conventional electronic power supplies and batteries. But with the advent of artificial organs and other implantable devices, new power sources were required. Connecting wires brought through the body wall and batteries implanted along with the devices that they power, both have disadvantages. What is needed is a satisfactory method of converting the body's own energy into the required electrical power. A great many techniques have been investigated; some appear very promising.

A great deal of mechanical energy is available in the human body, particularly at the heart and lungs. One way of converting this into electrical power is with piezoelectric generators. A generator of this type for powering an implanted pacemaker has been developed by Carl C. Enger of Western Reserve University School of Medicine, and Miroslav Klain, of the Cleveland Clinic Foundation. As shown in Fig. 5, the generator is implanted so that it receives an input of mechanical energy from the heart beats. The ac voltage thus produced in the lead zirconate titanate element is rectified and stored in a capacitor until needed by the pacemaker. In effect, therefore, the heart powers the pacemaker, which in turn electrically



stimulates the heart. This is possible because the mechanical power delivered by the heart is many times greater than the electrical energy required for pacing.

In another type of piezoelectric generator, the crystal wafer is in the form of a cantilever beam suspended within a container. The beam is end-loaded with a weight, and vibrates when the base of the container is moved. The container therefore transmits the mechanical motion to the piezoelectric crystal while at the same time protecting it from the corrosive and short-circuit effects of body fluids.

The chemical energy of the body is also being investigated as a source of electrical power for implantable devices. In experimental work by Philippe Racine and Harold Massie, of Drexel Institute of Technology, two implantable electrodes, one made of platinum black and the other of stainless steel, have successfully powered a pacemaker. The electrode pair function as an oxygen-reduction cell, with the platinum black electrode serving as the cathode and the steel electrode as the anode. At a power drain of  $50 \mu\text{W}$  the voltage between the electrodes is almost 0.6 V, and at a drain of  $150 \mu\text{W}$  the voltage is 0.37 V. This is quite adequate for long-term pacemaker use. However, during operation the steel electrode loses weight because of oxidation. Long-term research is therefore necessary to determine the useful life of such an electrode pair.

The pacemaker operated by the electrodes is shown in Fig. 6. Energy from the electrodes is stored by capacitor  $C3$  and applied to the circuit as needed. Transistors  $Q1$  and  $Q2$  make up a pulse-forming circuit, and transistors  $Q3$  and  $Q4$  provide power amplification. Output pulses are stepped up to the desired voltage by transformer  $T1$ .

Other methods being examined to power implanted electronic devices are radioisotope batteries and RF energy radiated into the body. Most present-day batteries used with implanted pacemakers have a useful life of about two years. This useful life is normally limited by chemical deterioration of the battery and not by complete discharge. Thus, the ability of a battery to exist in the environment of the body must be improved as well as its electrical life.

The possibility of using RF energy to drive low-power implanted devices has already been proved at Case Institute. An RF power detector unit, consisting of three mutually perpendicular coils and rectifying components, was packaged in the form of a 1-cm-diameter sphere and used successfully to power implant transmitters. Power densities radiated toward the detector were below the  $10\text{-mW/cm}^2$  safe limit established by various government and industrial agencies. The circuit of

the detector is illustrated in Fig. 7.

### Computer use is flourishing

If any one aspect of modern technology had to be selected as having the greatest impact on medicine, it would undoubtedly have to be computers. Analog, digital, large and small—all types of computers are reaching and affecting every facet of medicine. Some of the areas benefiting from the use of computers are data processing, biological modeling, physiological simulation, pattern recognition and statistical analysis.

The use of computers in medical education, although a relatively new application, is expected to grow significantly. Computer simulation of patients and their symptoms offers doctors and medical technologists a matchless training opportunity. A fine example is the anesthesiological training simulator built by Aerojet-General Corp. for the University of Southern California School of Medicine. The simulator comprises an instrumented manikin (the patient), an instructor's control console and a hybrid computer. The actions of the student anesthesiologist are sensed by instruments concealed in the manikin and the anesthetic equipment. The computer interprets these actions in terms of a physiologically simulated patient, and displays them on the instructor's console.

From the console the instructor can program emergency conditions into the manikin and then monitor the student's reactions.

The computer has also given researchers a powerful tool for biological modeling. Many investigators are establishing, refining and studying computer models of the human brain, the respiratory system, the cardiovascular system, etc. From these models they gain a great understanding of the human body and how it works (Fig. 8). Analog computers, hybrids and even large-scale digital systems serve for these studies.

The use of computers for diagnostic purposes, although presently limited, is the object of much research. Already computers can analyze electrocardiogram signals and pinpoint abnormal heart conditions with noteworthy accuracy. Various clinical tests of computer analyses of ECG signals have been conducted, and according to Dr. Jacob J. Hirsch of the New York University School of Medicine, "this technique will certainly excel where large volumes of electrocardiograms tax the endurance of the human interpreter."

In one technique developed by the Advanced Systems Development Div. of IBM, preprocessing circuits search out points of interest on the ECG and convert only these into digital form for analysis by the computer. This technique reduces the data that must be handled by the computer by a factor of 10.



With the success of computer analysis of ECGs, similar techniques are being investigated for the processing and interpretation of encephalograms, plethysmograms (which show blood- and lung-volume measurements), and other waveforms of physiological functions. Unlike the ECG, though, for which a large body of data has been accumulated over the years, relatively little is known about the characteristics of some of these other waveforms. Programs, involving the collection of large numbers of them and their correlation with known diseases or conditions, will therefore have to be carried out before computer analysis techniques can be applied with confidence.

For pure manipulation of statistics the digital

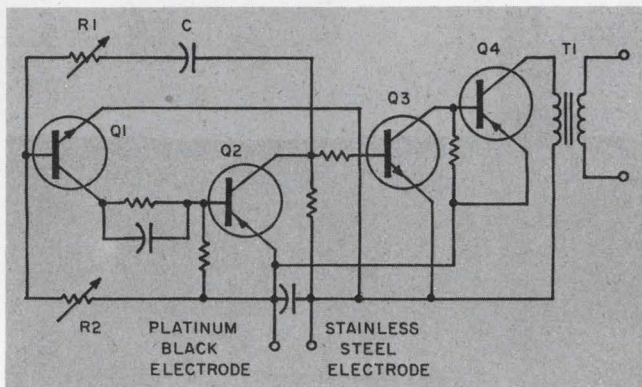

6. **Electrode-powered, implantable pacemaker delivers 3.5-V output pulses.** Pulse width is variable from 1 to 4 ms, and is set by resistor R1 and capacitor C. Resistor R2 sets the pulse frequency, which is variable from 60 to 200 pulses/min.

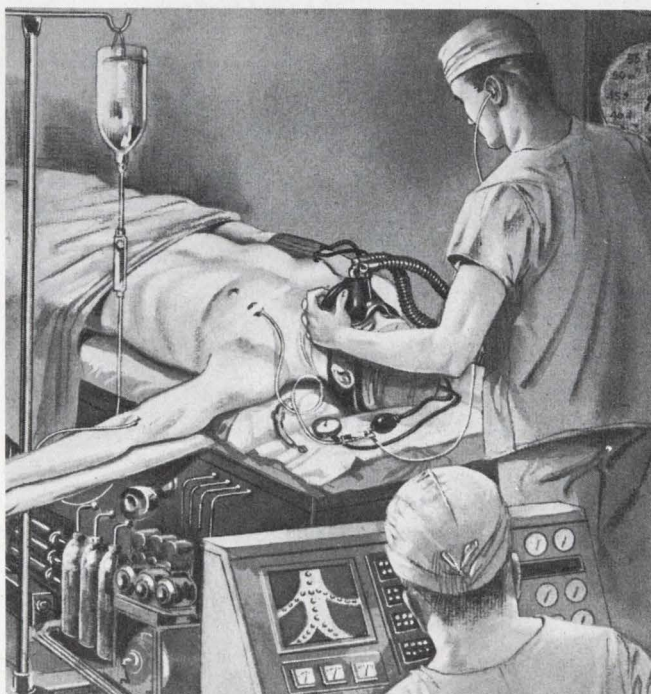

**Student anesthesiologists will be trained** with a computer-controlled simulator developed by Aerojet-General Corp. This approach provides realistic training through the use of a life-like manikin as the patient.

computer has no peer. This capability is being put to widespread use to analyze masses of data in the search for trends. In Philadelphia, a computer is at work analyzing infant mortality data sent in from hospitals across the country. From the mass of data on mother's age, baby's weight, type of anesthesia, etc., recurring patterns are sought. When one is recognized, further research is aimed at pinpointing the cause of infant deaths.

In other studies, data are collected from those suffering from cancer or heart disease, and then analyzed for significant patterns.

Because of the high cost of large computer systems, time-sharing is becoming popular among hospital and clinical-laboratory users. Such a

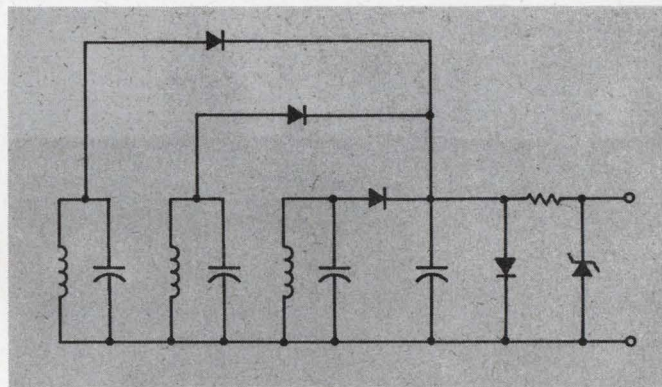

7. **RF power detector has produced a 2-mW output** in a field of less than 10 mW/cm<sup>2</sup>. Physically, the three coils are positioned to be mutually perpendicular, so that they form a sphere. This allows the detector to receive RF energy equally from any direction.

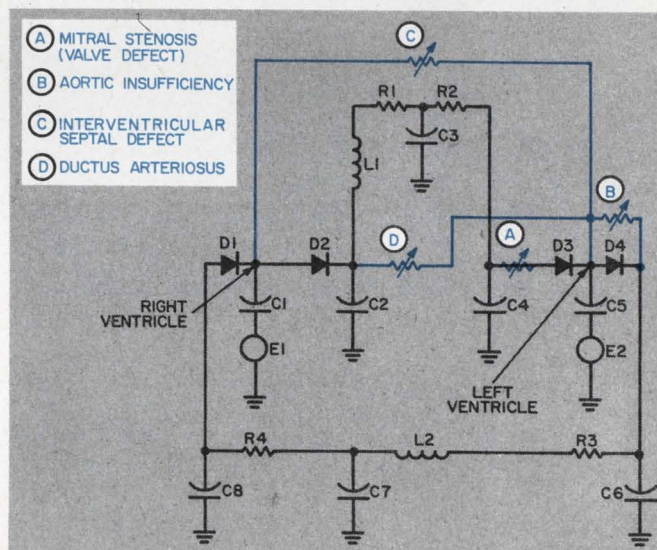

8. **Electrical analog of the cardiovascular system** (shown in black) is sufficiently accurate for use in clinical cardiology. The heart valves are represented by diodes, the vascular compliance by capacitance, the blood inertance by inductance and the peripheral resistance to blood flow by resistance. The electrical representation of four major defects that can occur in the cardiovascular system are shown in color. This model was developed at the Dept. of Bioengineering, Polytechnic Institute of Brooklyn, N. Y.



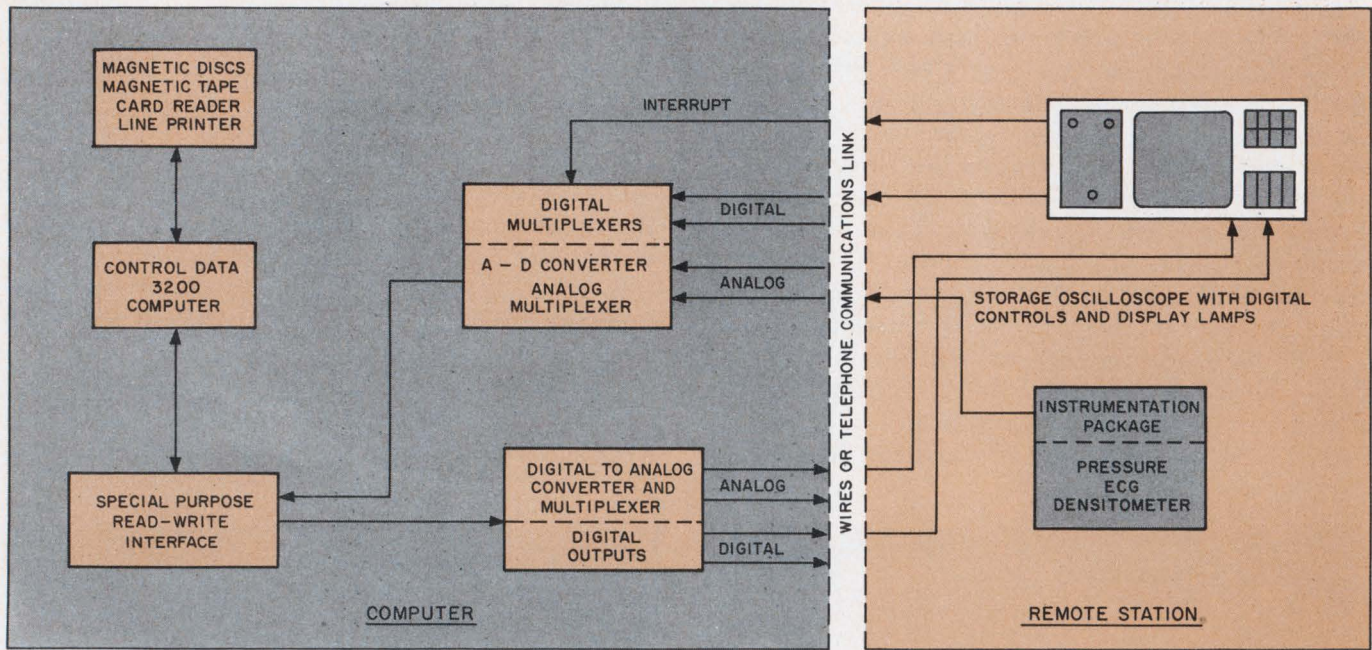

9. Three hospitals make use of time-shared computer system in Salt Lake City, Utah. Simultaneous sending and receiving of both analog and digital data are possible over

the communications link. The system was developed by workers at the Dept. of Biophysics and Bioengineering, University of Utah.

system is in use at California's Kaiser Foundation Medical Centers in San Francisco and Oakland, where the computer, an IBM 1440, is located in Oakland. A third center in Santa Clara is soon to be tied into the system, and Foundation officials hope that other centers will be established in Los Angeles, Honolulu and Portland, Ore.

Another time-shared system is centered at the Latter-day Saints' Hospital in Salt Lake City, Utah. The computer, a Control Data 3200, can be time-shared by stations within the hospital as well as by stations in two other hospitals. In the main hospital, connection to the computer is through multiple wires. Between the computer and the remote hospitals, FM multiplexing is used on a single, wide-band telephone line. Both analog and digital data can be transmitted and received simultaneously over the line. A general block diagram of the system appears in Fig. 9.

### Systems engineering being applied

Systems engineering, which has been so effective in the aerospace field, is beginning to be applied to medical electronics. To be sure, nothing so grandiose as Project Apollo has been attempted or even considered in the medical field. But some aerospace companies, such as North American Aviation, are actively investigating ways in which they can best apply their systems-engineering know-how to medicine.

Ideally these techniques would be applied early in any specific development—even, say, before a hospital is built. Little has been done on such a large scale, though, since electronic technology

has for the most part merely been grafted onto existing medical facilities and techniques.

On a smaller scale, on the other hand, systems engineering is finding its way into hospitals more and more in the form of patient-monitoring systems. Such systems have proved of great value in intensive-care units, recovery rooms and operating theaters, where they continuously monitor and display a variety of patients' physiological parameters. The requirements for these monitoring systems vary widely from hospital to hospital, so manufacturers of the equipment all use some form of modularization. This allows a hospital to select from a variety of stock items and to have its own custom system installed. A typical system for an intensive-care unit might monitor the temperature, blood pressure, pulse and respiration rate of six patients, and display the results on an oscilloscope and meters at the nurses' station. Equipment at the nurses' station might also include switching facilities to provide more elaborate display of a particular patient's condition, and alarms that indicate when parameters exceed preset high or low levels.

Continuous monitoring of coronary patients is very important from a medical standpoint. Consequently, coronary-care monitoring systems account for a large portion of the patient-monitoring systems now installed in hospitals. Parameters monitored by these systems include ECG, heart sounds, pulse rate, etc. Associated equipment such as pacemakers and defibrillators may also be tied into the system. A defibrillator (Fig. 10) applies an electrical shock, in the form of a high-energy pulse, to the heart whenever its muscles contract



incoherently (fibrillate) instead of beating rhythmically. The pulse, in effect, shocks the heart muscles back into a synchronous beat that will pump the blood through the body. Most defibrillators produce dc output pulses, although some deliver short bursts of high-frequency ac. Medical opinions differ on the relative advantages of ac versus dc, as well as on the optimum shape of the defibrillator pulse.<sup>5,6</sup>

### Systems with unattached sensors studied

Conventional physiological monitoring systems require sensors to be attached in some way to the subject and connected by wires to the measuring instruments. Telemetry systems eliminate the connecting wires, but do not remove the need for attached sensors. For applications involving rapid monitoring of large numbers of people or where it is important for persons being monitored not to be encumbered by sensors and wires, conventional systems fall short of ideal. Various techniques are therefore being investigated to overcome the

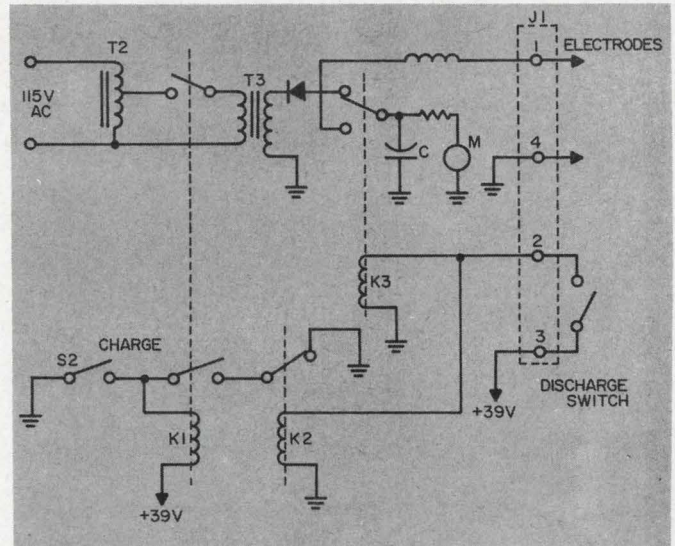

10. Defibrillator delivers a dc output pulse through discharge of capacitor C when the discharge switch is closed. Inductor L is provided to decrease the peak voltage, lengthen the pulse, and decrease the rate of change of the current—all without essentially affecting the energy content of the pulse. When the charge switch is closed, capacitor C recharges.



11. Instrumented chair can monitor physiological parameters without the need for attached sensors. Developed by the WDL Div. of Philco-Ford, the technique might also be

applied to examining tables, operating tables and automobiles for driver safety investigations. Shown here is an early model of the instrumented chair.



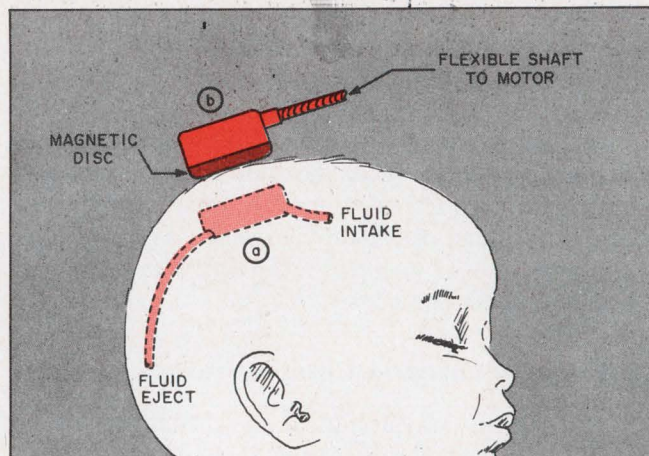
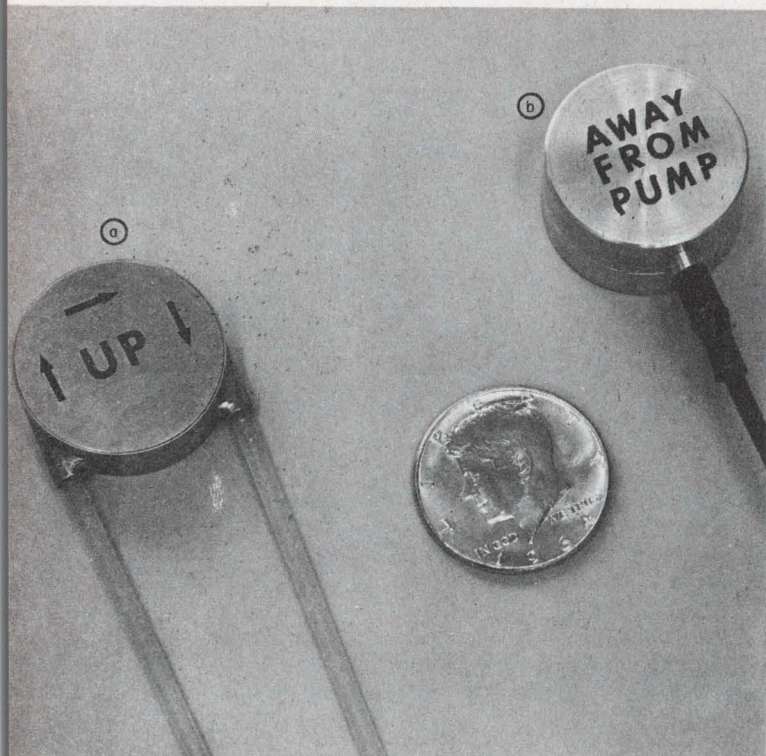

12. **Miniature implantable pump** is designed to transport excess cerebrospinal fluid (hydrocephalus) to a point in the head where it can be dissipated. The rotary pump is driven magnetically by an external unit consisting of a magnetic disk coupled by a flexible shaft to a motor. The implantable pump, which was designed by the Republic Aviation Division of Fairchild Hiller Corp., is 1.25 inches in diameter, 0.43 inch deep and 1.4 ounces in weight. Its development represents a good example of aerospace know-how and capability being applied to the medical field.

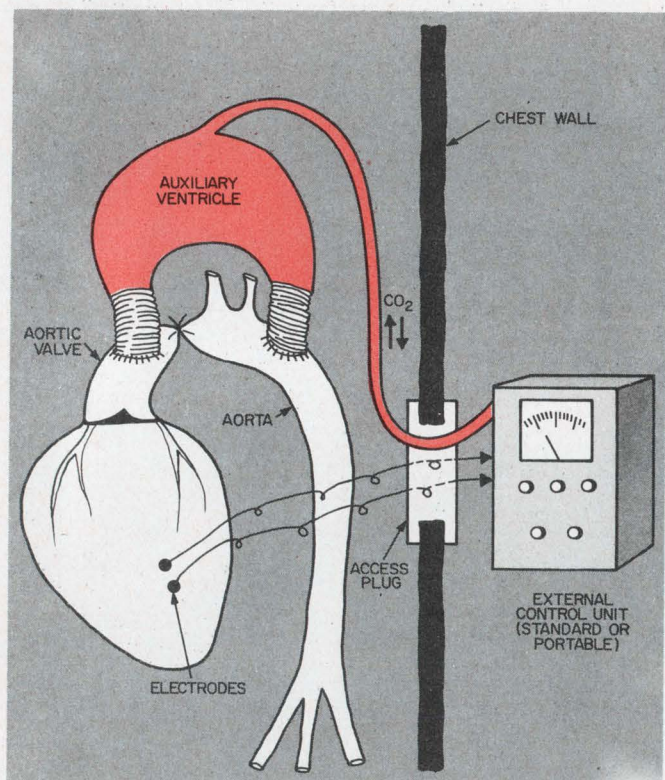

13. **Kantrowitz-Avco booster pump** is connected in parallel with the arch of the aorta. When the heart contracts, an electrical signal picked up by the electrodes causes the external control unit to send a pulse of carbon dioxide to the pump. This causes an inner bulb in the pump to contract, and expel blood forward into the general circulation and backward into the arteries feeding the heart. When the heart then relaxes, another electrical signal causes the carbon dioxide to be sucked back out of the pump. This causes the inner bulb to expand, thus completing the cycle.

drawbacks of sensors and connecting wires.

Along these lines, the WDL Division of Philco-Ford has developed an instrumented chair which can provide measurements of ECG, heart sounds, pulse waveforms and other parameters. Except for conductive armrests and a microphone in the back, the chair is of the standard "office" variety (Fig. 11). The only requirement for measurement is that the person be seated comfortably with his hands resting on the armrests. Detected signals are then applied to the measuring circuitry and recorder through connecting wires.

Philco-Ford project officials feel that the potential applications for this technique include space research, physician's office screening, and automobile driver safety measurements. Conductive plastics and metal-interwoven fabrics may lend themselves to use in this technique.

A method for remote physiological monitoring with an X-band radar system has been investigated by the Cornell Aeronautical Laboratory. This work is based on the fact that various body parameters are related to movements of the body surface. For example, certain body movements are associated with respiration, others are caused by cardiovascular activity. Cornell investigators found that by using Doppler radar techniques they could measure these movements and achieve a degree of correlation with conventionally measured parameters.

The transmitted signal had a frequency of 9375 MHz. It was produced by a 400-mW klystron. A portion of the transmitted signal was used to provide the receiver local oscillator frequency,



making the system coherent. Doppler shifts in the received "echoes" were converted in the receiver to a dc signal corresponding to range. Resolution was a very small fraction of a wavelength. A phase-lock scheme was used in the receiver to eliminate sensitivity variations due to interference nulls.

The Cornell work was of a preliminary nature, carried out only to demonstrate feasibility and identify areas of potential application.

### Other technical specialties involved

All the technological areas just described are by no means the only ones that are contributing to the advance of medical electronics. Such other disciplines as infrared and cryogenics are also being applied to medical problems with promising results. Even color television is being investigated with the aim of developing a closed-circuit system of good enough color resolution to be used in medical education. Standard color TV does not have sufficient resolution of reds and blues for use in many medical teaching areas.

Artificial organs are another area where electronics is making a vital contribution. Today's artificial organs include:

- Large external devices that temporarily take over the function of a body organ. These include artificial kidneys, heart-lung machines which take over the functions of the heart and lungs during heart surgery, and heart augmentation pumps which relieve the heart's workload temporarily by augmenting its natural pumping action.

- Implantable parts, such as artificial blood vessels or heart valves.

- Implantable devices, which, although they do not replace actual organs, perform some function that relieves a pathological condition. Typical of such devices are drains for excess brain or abdominal fluids (Fig. 12).

To be sure, most artificial organs are not exclusively electronic in nature. But the techniques used for their implantation, monitoring and control rely heavily on electronic instrumentation. One of the more widely publicized devices is the auxiliary ventricle developed by Dr. Arthur Kantrowitz of Avco Everett Research Laboratory. A byproduct of aerospace research, the device is essentially a gas-powered heart pump designed to be installed in the body and used as long as and whenever needed. In other words, when the defective heart recovers sufficiently to operate on its own, the auxiliary pumping action is stopped. The pump, though, remains in place and can be restarted at any time. The action of the Kantrowitz-Avco auxiliary ventricle is shown in Fig. 13.

The electronics involved in the ventricular system include the electrodes, which are attached to the heart, and the control equipment, which

senses the heart signals and operates the pump accordingly. Electronics also plays a big role during the open-heart surgery required to install the pump. Extensive monitoring systems are used to measure and record twenty or more patient parameters during the operation.

Mechanical devices for totally replacing the human heart are also being investigated by various groups. Unlike augmentation devices like the Avco pump, it is envisioned that these pumps will be placed in the cavity that remains after removal of a patient's worn-out heart. They will then take over the function of the heart completely. One group currently investigating such a device is located at The School of Medicine, Indiana University.

The many examples cited in the preceding pages go to show how vital and dynamic the medical electronics field is, constantly drawing, as it does, on the technical developments of many different disciplines. Researchers are forever on the lookout for new electronic techniques and equipment with medical potentials. The electronics industry, for its part, is increasingly aware of the market potential of medical electronics. Together these factors indicate a healthy environment for innovation and growth. Many areas of medical electronics which today are still largely developmental will undoubtedly find their way into widespread, practical use tomorrow. It is, then, to the design engineer's own ultimate benefit that he should make a point to keep abreast of progress. ■ ■

### References:

1. William Z. Yahr and Kenneth J. Strully, "Blood Vessel Anastomosis by Laser and Other Biomedical Applications," *J. Assoc. for the Advancement of Medical Instrumentation*, I, No. 2 (Sept./Oct., 1966), 28-31.
2. H.F. Stegall and H.L. Stone, "Phase-Shifted Ultrasound for Flow and Dimension Recording," *Proc. Annual Conference on Engineering in Medicine and Biology, 1966*, VIII, 109.
3. H.F. Stegall *et al.*, "A Simple Portable Sonomicrometer," *Ibid.*, p. 219.
4. Wen H. Ko, *Microelectronics and Bio-Instrumentation* ("1966 National Electronic Conference Seminar No. 3" [Cleveland: Case Institute of Technology]).
5. Clifford D. Ferris and Thomas W. Moore, "Factors Involved in Ventricular Defibrillation by Electronic Means," *Proc. ACEMB, 1966*, VIII, 24.
6. G.A. Rahmoeller *et al.*, "Influence to Rise Time on Effectiveness of Defibrillatory Shocks," *Proc. ACEMB, 1966*, VIII, 25.
7. F.A. Giori *et al.*, *Remote Physiological Monitoring* (Buffalo, N.Y.: Cornell Univ. Aeronautical Laboratory, Inc., Tech. Report VH-2087-E-2).

### Bibliography:

- Proceedings of the Annual Conference on Engineering in Medicine and Biology, 1966*. Available from IEEE, 345 E. 47 St., New York, N.Y. 10017, or ISA, 530 William Penn Place, Pittsburgh, Pa. 15219; price from \$10.00.
- "Medical Electronics is \$200 million market," *Chemical and Engineering News*, XLIV (Oct. 3, 1966), 28-30.
- The NIH Record*, biweekly pub. of National Institutes of Health, Bethesda, Md.
- Burns, Winston H. "The Totally Implantable Mechanical Heart: An Appraisal of Feasibility," *Annals of Surgery* (Indianapolis: Indiana Univ. School of Medicine), CLXIV, No. 3 (Sept., 1966), 445-456.



# TRW CAPACITORS ARE SMUG



...especially our new metallized polycarbonates!

TRW has now extended its leadership in film capacitors to include metallized polycarbonate types. Two features of the X463UW are outstanding. Precise processing assures low TC through temperature ranges to 125° C. Metallized construction reduces size to less than one half that of film-foil designs. Other features of the line include:

- Capacity range from .01 to 10.0 mfd
- Low dielectric absorption
- Available in tolerances to  $\pm 1\%$
- Humidity resistance per MIL-C-27287

For full information contact: TRW Capacitors, Box 1000, Ogallala, Nebraska. Phone: 308-284-3611 • TWX: 910-620-0321.

## TRW CAPACITORS

ON READER-SERVICE CARD CIRCLE 38



**Co-Publishers**

James S. Mulholland, Jr.,  
Robert E. Ahrensford

**Editorial Director**

Edward E. Grazda

**Editor**

Howard Bierman

**Managing Editor**

Robert C. Haavind

**Technical Editors**

Peter N. Budzilovich  
Joseph J. Casazza  
Maria Dekany  
Frank Egan  
Roger K. Field

**News Chief**

Ralph Dobriner

**East Coast Editor**

Neil Sclater

**West Coast Editor**

Ron Gechman

**Copy Editor**

Peter Beales

**New Products Editors**

David H. Surgan  
Daniel R. Butterly

**Washington Editor**

S. David Pursglove

**Editorial Production**

Dollie S. Viebig  
Karen L. Sherman

**Art Director**

Clifford M. Gardiner

**Art Assistant**

William Kelly

**Technical Illustrators**

Cheh Nam Low  
Douglas Luna

**Production Manager**

Thomas V. Sedita

**Asst. Production Manager**

Helen De Polo

**Production Assistants**

Bernard Wolinsky  
Robert M. Henry

**Circulation Manager**

Nancy L. Merritt

**Reader Service**

Diane Mandell

**EDITORIAL**

## Needed: A way to tame the gypsy in us

Talk to personnel recruiters and their most common complaint today is that engineers who are job hunting seem interested in only one thing: how much does the job pay? Too often, they say, applicants show little or no interest in the company and their future in it.

Why?

If we examine the records of most companies engaged in government and military work, one thing becomes clear: the engineers in such companies are expendable. That is to say, their number fluctuates, often wildly, in proportion to the contracts that the companies receive. Mass engineering layoffs are not uncommon. To assume that only "bad" engineers are caught up in such layoffs is unrealistic.

This situation is not calculated to give engineers confidence in their futures, particularly since the companies involved constitute a majority of all those in the electronics business. How can applicants listen seriously to stories about pension plans and other future benefits in such companies, if their realistic tenure is measured in terms of a few years?

Engineers swept up in this job lottery roam the country today like modern gypsies. They work a few years here, a couple there, all the time repeating: "How many kilobucks does it pay—*now*?" By the time they are 45, most companies list them (unofficially, of course) as old men of the industry, obsolete and not fit for hiring. What a waste of manpower at a time when engineering "shortages" are said to exist!

Yet, what's the solution? So far the electronics companies have not come up with anything more constructive than general statements to the effect that there is always demand for "good" engineers.

For years professional baseball players faced similar uncertainty. Their tenure with any one team was uncertain (it still is), their employable lifespan short (it still is). But today they have a stake in their "industry," no matter how many teams they play with. They have an industry-wide pension plan—a guaranteed future.

The analogy may not be as farfetched as it may seem to engineers. An industry-wide engineering pension setup wouldn't be a full solution to the problem of gypsy engineers, but it could be a meaningful start.

So far as "age obsolescence" is concerned, some companies do have educational programs to update engineers. But often these programs are lacking. It should be a function of engineering societies—or perhaps even a new, more active society—to see that refresher courses are available industry-wide.

What do you think?

PETER N. BUDZILOVICH



# GREGARIOUS!

The tighter you cram little Turbowrap™ wires together, the happier they are. Kynar and polysulfone insulation make them as tough in tight spots as much bigger wires.

Think of the opportunities that Turbowrap 312 (with Kynar) and Turbowrap 412 (with polysulfone) open up for higher-density wiring.

Made in sizes as small as 30 AWG, with walls as thin as .004" — these wires zip through automated wire-wrap operations with never a jam, skip, nick, short or break. And they perform faithfully, once in place.

Special thin-wall extruding techniques, plus the fine electricals and mechanicals of the insulation, have made it possible for Brand-Rex to produce small O.D. wires with excellent cut-through resistance.

Looking for ways to put more wire into less space? Call on our tough little extroverts, Turbowrap 312 and 412.

AMERICAN ENKA CORPORATION

BRAND-REX DIVISION

WILLIMANTIC, CONNECTICUT 06226  
PHONE 203 423-7771

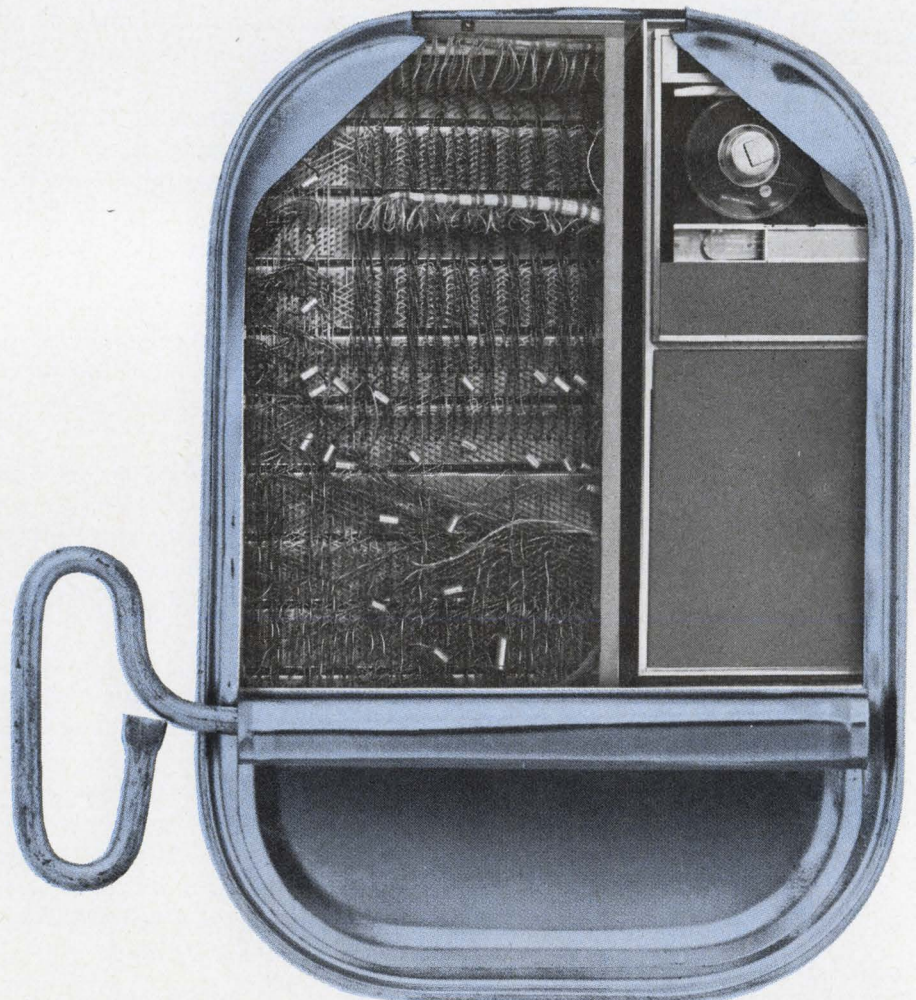



# Technology

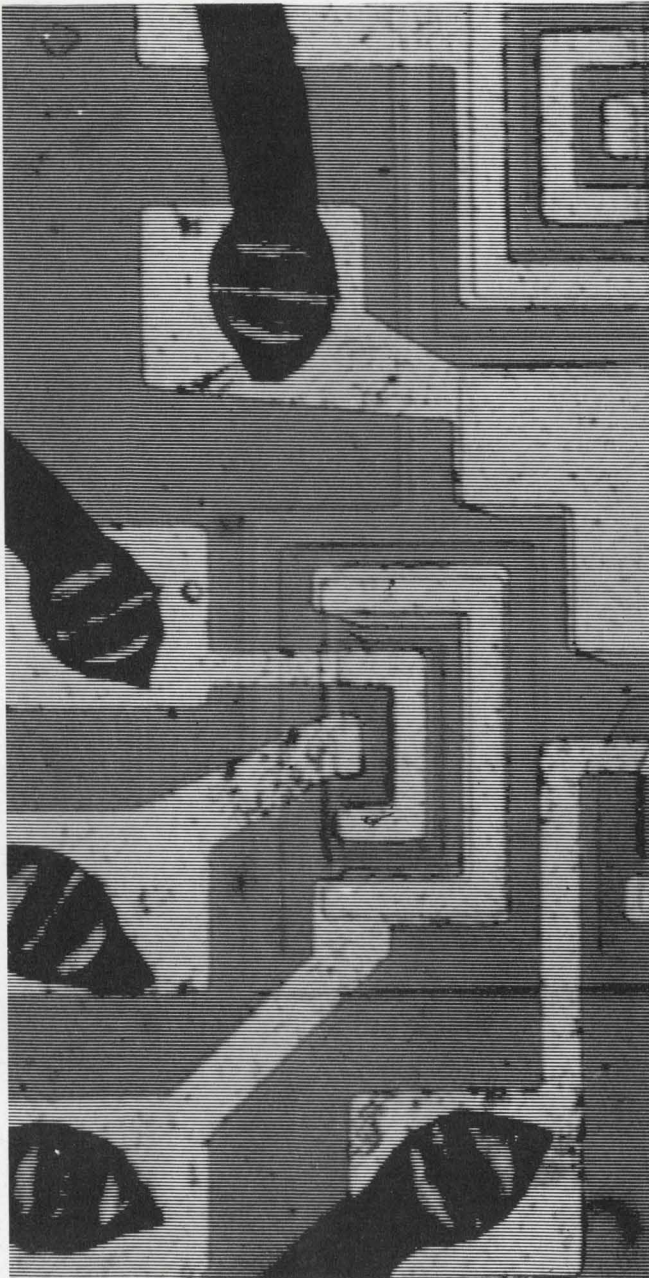

The effect of changes in monolithic-IC design is rapidly evaluated by computer. Page 78

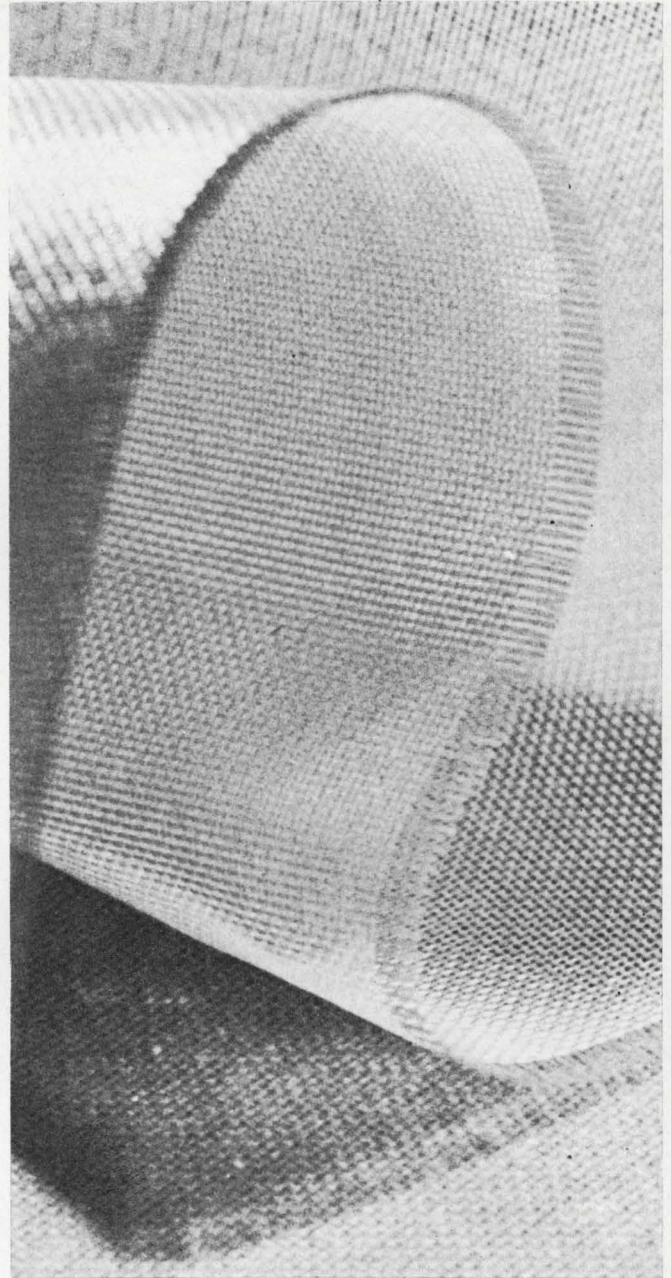

Thin laminates used in multilayer PC boards are bonded together with fiberglass. Page 84

## Also in this section:

Measure C and R of forward-biased diodes with standard test equipment. Page 92

Thermistors team with Diacs and Triacs in three motor speed control circuits. Page 98

Pinpoint profits during incentive-contract negotiations with a nomograph. Page 104



# Design a better integrated circuit

than those available off the shelf. A computer program can help you suggest circuit changes without using a breadboard.

In the analysis of monolithic integrated circuits, a computer program can help the design engineer:

- To understand the behavior of a designed circuit.
- To predict its performance as well as that of the system of which it is a part.
- To predict the effects of modifications.

Understanding circuit behavior is an absolute necessity, because laboratory testing of either discrete-component breadboards or prototype monolithic samples provides insufficient information. Discrete components lack the parasitics associated with their monolithic counterparts; terminal testing of monolithic circuits gives no indication of internal voltages and currents. Figure 1 compares discrete and monolithic transistors and resistors.

The monolithic circuit in this illustration uses p-n junction isolations. (Most commercial monolithic circuits use this isolation technique with reverse biasing.) But the parasitic capacitances resulting from these isolations can impair transient response. To predict the transient behavior of a monolithic circuit accurately, series resistance in both collectors and diffused cross-unders must be taken into account. As will be shown, these parasitics and the characteristics of active elements used in monolithic circuits can be readily determined.

A system's performance can be predicted and evaluated by analyzing the interaction of several circuits, which may be treated as one large matrix. If it is apparent that one circuit needs to be modified to improve system performance, the effects of various design alternatives can be readily predicted with such computer-aided analyses as those made with NET-1. A computer-aided approach saves both time and money, particularly when more than one design must be evaluated.

## Active elements must be modeled adequately

To obtain meaningful results from a computer

analysis of a monolithic circuit, the active elements comprising the circuit must be adequately modeled. And parasitic effects have to be included in the model. It is these requirements that have often prevented integrated-circuit users from analyzing their circuits. The parameters of the individual devices on a chip can, however, be measured on chips specifically designed for this purpose. No special equipment is needed other than the test instruments normally used for incoming inspection of transistors. A competent reliability department is capable of making the measurements routinely.

Semiconductor manufacturers can supply chips on which each individual transistor is equipped with its own set of bonding pads (see Fig. 2). The semiconductor manufacturer can prepare these chips in two ways: A special metalization pattern can be substituted for the routine production

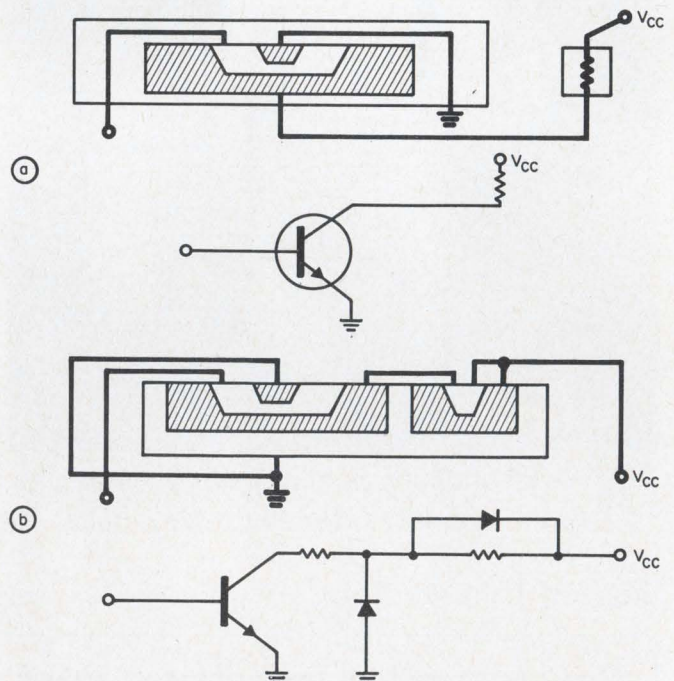

1. Do not overlook the isolation diodes associated with integrated devices; they can impair transient response. Even a resistor has a parallel associated diode. The simulated integrated version (b) contains two associated diodes that the simulation of discrete components (a) does not require.

Philip Spiegel, Senior Principal Engineer, Electronic Data Processing Div., Honeywell, Inc., Waltham, Mass.



metalization, thereby producing a whole wafer of bonded-out chips. Or, the special metalization patterns can be incorporated into the regular production mask as test patterns. Thus, every processed wafer contains hundreds of working chips and four bonded-out chips for testing purposes. These test chips are packaged in flat packs or metal (TO-5) cans to facilitate handling and electrical measurements.

Device parameters worked out with these bonded-out monolithic transistor samples satisfy the requirements of the NET-1 analysis program and can be added to the user's NET-1 library tape.

NET-1 uses an Ebers-Moll (T equivalent) model for its transistors. Though the program's user cannot tamper with the configuration of this model, he can state the values of its parameters. If this is done skillfully, integrated-circuit transistors and diodes, and all passive components can be accurately simulated.

The NET-1 transistor parameter determinations used to analyze monolithic circuits are:

- Normal and inverted betas. These are measured directly with a transistor curve tracer.
- Other dc parameters. These are obtained from  $V_{BE}$  and  $V_{CE(SAT)}$  measurements for four sets of  $I_C$  and  $I_B$ . (A FORTRAN program that performs the necessary calculations and checks the results was written in-house.)
- Intrinsic transition capacitances. These are computed from terminal capacitance measure-

ments with a correction made for package capacitance.

- Gain bandwidth. This is measured for various  $I_C$ ,  $V_{CE}$  points on a 100-MHz test set.
- Storage time. This is measured with a fast-rise pulse generator and a sampling oscilloscope.

### Approximations simplify analysis

The shunt leakage resistances are simply called 10 M $\Omega$  to ensure rapid solutions. Actual measured values for silicon epitaxial planar devices are several orders of magnitude larger, but when such values are employed in the model, NET-1 may not achieve a convergent solution.

NET-1 treats parasitic effects as they actually appear in monolithic circuits—as *diodes* with voltage-dependent capacitance. (The collector-substrate diode is shown in Fig. 1b.) Their forward I-V characteristics are not critical, as they are normally reverse-biased. Transition capacitance values are obtained during the transistor measurement program: 0.1 to 0.2 pF/mil<sup>2</sup> of collector area are typical values. Series resistance of these diode models is considerably larger than that of real, discrete diodes: it ranges from 100 to 2000 ohms.

Perfect representation of the resistor-to-isolation diode, which is distributed over the entire area of the resistor, would require the use of an infinite number of incremental diodes. But the

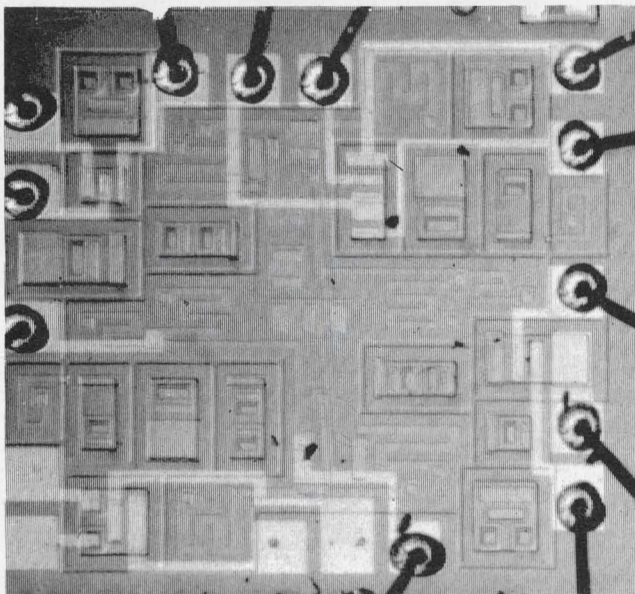

2. **Special bonding pads connect** to the individual transistors (left). These special chips, prepared by the integrated circuit manufacturer, make it easy to make parameter determinations for the NET-1 models. The special chips can be manufactured as test patterns on a wafer along with the regular production chips (right). This one has two transistors and one resistor that have been bonded out and connected to its header. Routine tests then provide information for NET-1.

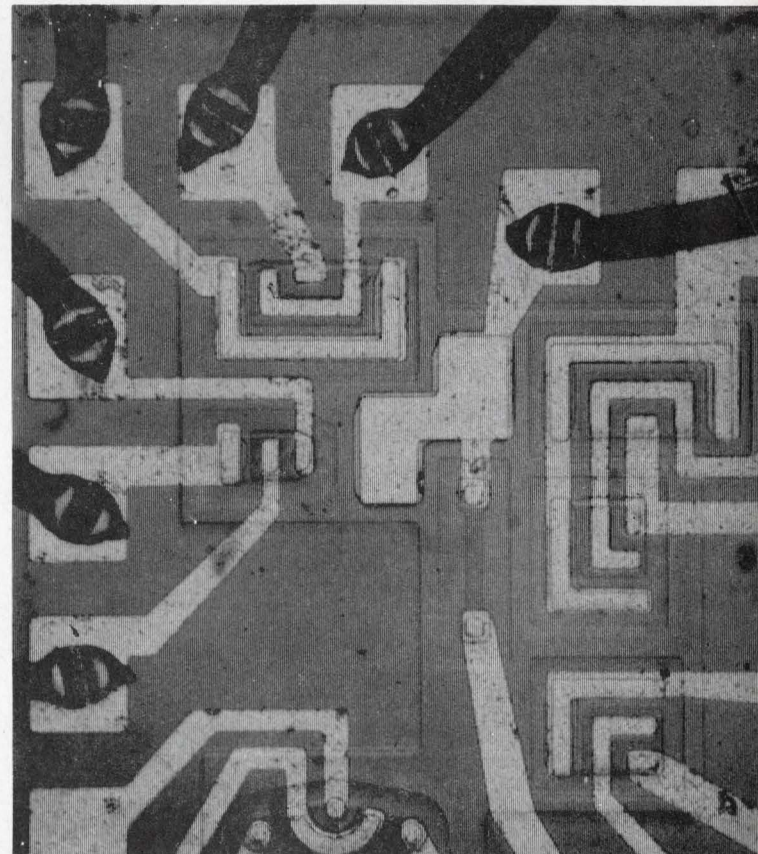



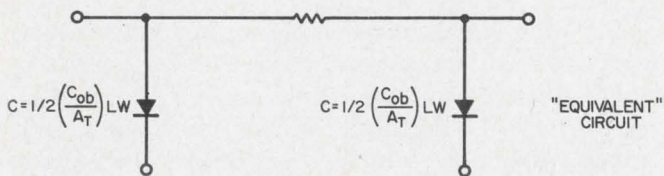
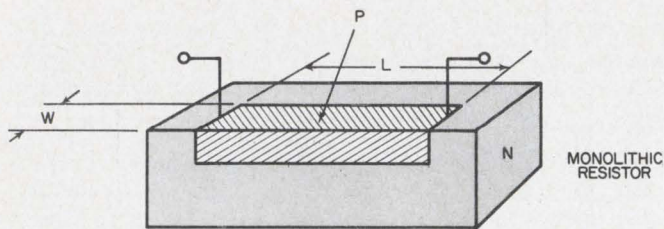

3. Derive the resistance, and equivalent capacitance of the distributed diode, directly from measurements made on the masks of the integrated circuit. The resistance  $R$  of an integrated resistor equals the nominal resistance of a diffused square (usually between 120 and 200 ohms) multiplied by its length and divided by its width. The expression for capacitance/unit area,  $C_{ob}/A_T$ , used to determine the value of the simulated capacitors that substitute for the distributed diodes, can be measured on any transistor on the chip.  $C_{ob}$  is the transistor's collector-to-base capacitance and  $A_T$  is the junction's area.

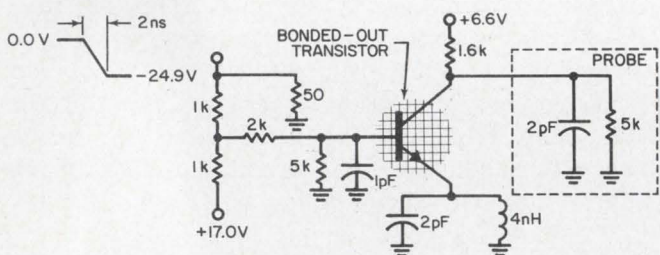

4. Sampling scope probe tests the storage time of each bonded-out transistor. This information is used to update the T-equivalent transistor models in the NET-1 library.

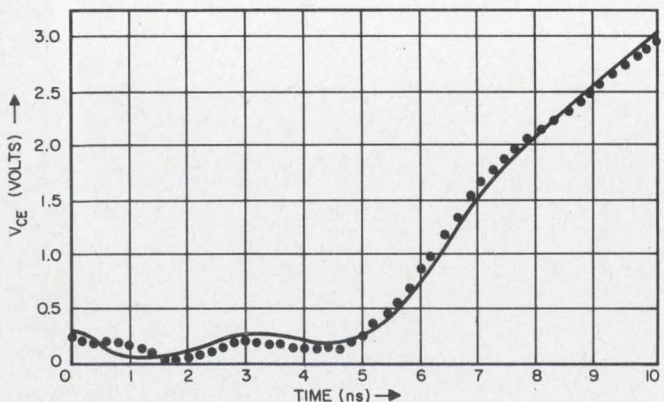

5. The NET-1 (solid) waveform barely deviates from the actual (dotted) collector voltage.

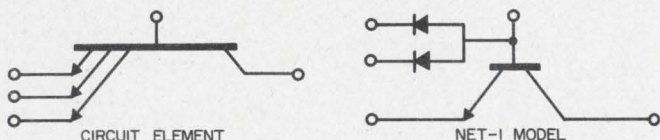

6. NET-1 cannot handle a multiemitter transistor, so simply add two diodes to a single-emitter transistor to simulate the former's properties.

## NET-1 uses Ebers-Moll models

NET-1 is a circuit analysis program that is applicable to a wide variety of circuits; it is readily available from the Los Alamos Scientific Laboratory, N. M. (see "Check design program availability," *ELECTRONIC DESIGN*, XIV, No. 23 (Oct. 11, 1966), pp. 76-80). It performs both steady-state and transient analyses, and permits up to 200 nodes. The computer input is a description of the circuit schematic where the allowable elements are  $R$ ,  $C$ ,  $L$ ,  $M$ , voltage sources, junction transistors and junction diodes. Transistors and diodes are described by Ebers-Moll models, their parameters stored on a library tape for convenience. The library tape's parameters can be replaced with alternatives as part of the input; new device parameters also may be added by the user. An optional feature enables output variables and functions of these variables to be plotted automatically. The program was developed at Los Alamos by Allan F. Malmberg. A FAP language version is available for IBM 7040/44 and 7090/94 machines; the manual for this version of NET-1 is Report LA-3119 of the Los Alamos Scientific Laboratory.

inadequacies of man and machine make it expedient to use only two (Fig. 3). When one side of the resistor is tied to either  $V_{cc}$  or ground, the diode on that side can be eliminated (see Fig. 1b).

In monolithic circuits, transistor bases and resistors are diffused simultaneously. Therefore, the resistor-isolation diode capacitance per unit area will be the same as that of a transistor's  $C_{ob}$ . Typical values are in the 0.2-to-0.4-pF/mil<sup>2</sup> range. This capacitance can thus be calculated from the area of each resistor; the areas can be calculated directly from blueprints of the mask layouts.

In the course of using NET-1, analytic and experimental results were compared. One of these checks involved a storage time test on the circuit of Fig. 4. The waveform of collector voltage observed on an oscilloscope and that plotted automatically from the NET-1 output are superimposed on the same scales in Fig. 5.

The Ebers-Moll model is evidently adequate for a saturated silicon epitaxial planar transistor; the parameter determinations made with the bonded-out chips are accurate. Actually, the assumptions of the Ebers-Moll model<sup>1</sup> are reasonably well justified by transistors fabricated in monolithic circuits. As long as there is little variation in the parameters, which are treated as constants over the transistor's operating range, a monolithic transistor's transient behavior will be predictable. It is fortunate that a transistor model with only eleven branches is sufficient. Other models with as



## NET-1 picks the right mask change

A circuit that was not meeting dc voltage specifications did very well in propagation delay. Five possible changes in the metalization mask to alleviate the problem were suggested to the integrated-circuit manufacturer, but it was not clear what adverse effect each change would have on the propagation delay.

If five different metalization masks had been made, and five sets of experimental samples processed and evaluated, the cost would have been at least \$2500, based on industry estimates.<sup>7</sup> Moreover, it would have taken a minimum of six weeks before information about the final form of this circuit would have been available.

The five proposals were analyzed by NET-1 and the one that offered the best compromise between voltage and speed was chosen. The cost was \$500 for computer time and the final decision was known in one week.

In a case such as this, where a manufacturer's product does not meet all the buyer's specifications, computer-aided circuit analysis can be economically used to propose the modifications required.

many as 38 branches<sup>2</sup> have been proposed to handle the distributed nature of high-speed transistors, but the use of such a model would seriously reduce the size of circuits that could be analyzed. NET-1, for instance, can handle only 200 branches for a transient analysis.

### Two tricks reduce simulated circuit size

Even with the program's compact device models, a monolithic circuit or subsystem will often be too large for a NET-1 transient analysis. But the size of the circuit can be reduced without much sacrifice in accuracy by means of two expedients:

- Portions of the circuit that do not affect transient response can be replaced by their Thevenin equivalents. A steady-state analysis of the original large circuit will reveal the voltages and currents needed to specify the Thevenin source and resistance.

- Parasitic diodes, especially the pair that appears at a collector (Fig. 1b), can be replaced by a single, simulated capacitor with a fixed value that is a function of the voltages across the original diode. Again, the steady-state analysis of the original circuit is a valuable source of information.

These two substitutions can substantially reduce the total number of branches and, hence, the computer storage requirements.

Some programs, like ECAP, operate with a

transistor model of as few as three or four branches. But this restricts the user: it requires him to know the operating state (cut-off, active or saturated) of the transistor. Nevertheless ECAP<sup>3</sup> is very useful because it includes automatic worst-case calculations, parameter sensitivity, and other analysis features, especially where amplitude vs frequency is desired.

Discrepancies will occur between predicted and observed performance of monolithic circuits, when the parameters obtained from samples of one wafer deviate significantly from those of another wafer. The analyst is cautioned to anticipate this and set up his analyses to obtain meaningful comparisons rather than absolute predictions. It also is extremely important to remain in close communication with the semiconductor manufacturer so that appropriate parameters can be changed in a simulated circuit to correspond to the manufacturer's changes in device geometry or processing.

### NET-1 can be adapted to most logic

Not all logic can be directly handled by NET-1, but an imaginative user can often overcome the program's limitations. High-level transistor-transistor logic<sup>4,5</sup> for instance, uses a multiemitter transistor. This presents a problem, because NET-1 provide for analysis of single-emitter transistors only. The use of additional diodes solved this problem (see Fig. 6). The diode parameters are the same as those obtained for the transistor's emitter-base diode. When these diodes are considered to be reverse-biased in the computer calculations, accurate transient analyses are obtained.

Linear, as well as digital, circuits can be analyzed with NET-1. In one case, it was used to simulate a sense amplifier, which was part of a monolithic 16-bit memory.<sup>6</sup> Parameter measurements were made on bonded-out transistors and fed to the program just as in the foregoing digital example. ■ ■

### References:

1. J. L. Moll, "Large-Signal Transient Response of Transistor Junctions," *Proc. IRE*, XLII, No. 44 (Dec., 1954), 1773-1784.
2. H. N. Ghosh, "A Distributed Model of the Junction Transistor and Its Application in the Prediction of the Emitter-Base Diode Characteristic, Base Impedance, and Pulse Response of the Device," *IEEE Trans. on Electron Devices*, Vol. ED12 (Oct., 1965), 513-531.
3. "1620 Electronic Circuit Analysis Program (ECAP)," IBM Report 1620-EE-02X.
4. G. R. Basham, J. Y. Payton and B. C. Sigal, "Integrated-Circuit Applications in LC-909 Computer," *Solid State Design/CDE*, VI, No. 7 (July, 1965), 36-42.
5. R. Van Ligten, K. Taft and T. A. Longo, "High-Level Transistor-Transistor Logic Flip-Flops," *NEREM Record 1965*, pp. 176-177.
6. T. W. Hart, "Integrated-Circuit Memory System," *NEREM Record 1966*, pp. 216-217.
7. G. Madland et al., *Integrated Circuit Engineering* (Cambridge, Mass.: Boston Technical Publishers, 1966).



# Reduce system costs with TI

TI linear integrated circuits mean fewer system components, less assembly and test time, increased manufacturing efficiency. In short — reduced system costs. Now you get improved performance and increased reliability, too, in such circuits as the Series 75 and Series 72 amplifiers described here.

## Series 75 magnetic-core sense amplifiers

Each of these new amplifiers for magnetic core memories replaces a whole circuit board of transistors and passive components. The SN7501 circuit shown in Figure 1, for example, contains 18 transistors, 25 resistors, four diodes and one capacitor in a single tiny chip of silicon. Cost is only about 80 percent of a comparable discrete-components circuit. Soldered connections are reduced by more than 90 percent — resulting in greatly improved reliability.

Performance is excellent, as shown in Figure 2. Series 75 sense amplifiers are recommended for core memory applications with cycle time as low as 0.7  $\mu$ sec.

The SN7500 is a complete monolithic sense amplifier that includes both strobe gate and pulse-shaping output circuits as shown in Figure 3. It detects low-level bipolar differential input signals, discriminates between those representing logical "1" and logical "0", and converts them to logic levels compatible with standard integrated circuit logic, including TI's Series 54 TTL.

The amplitude-discriminating sense amplifier incorporates a threshold circuit with a narrow region of uncertainty. A strobe input is provided so the threshold detector can be activated when the signal-to-noise ratio is at maximum during the system read cycle, and is inhibited during the write cycle.

The SN7501 performs a similar sense amplifier function, but also includes an externally adjustable threshold voltage and a flip-flop output. Since the flip-flop is externally set at zero, the output pulse width can be accurately controlled. The flip-flop can be used for temporary data storage.

The SN7502 sense amplifier includes an internal one-shot multivibrator, providing a negative-going output pulse when triggered by the threshold detector. The single-ended output lends itself readily to performing DOT-OR logic.

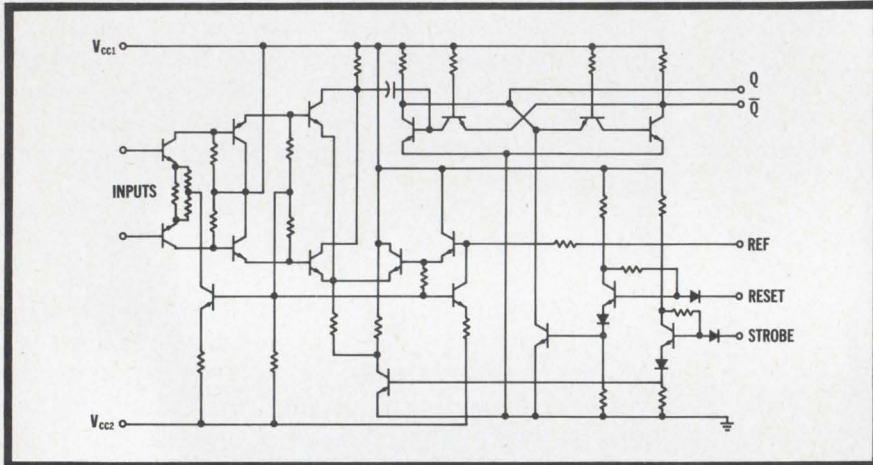

Figure 1. Circuit diagram of the SN7501 sense amplifier.

TYPICAL CHARACTERISTICS	
Input threshold voltage level	10-30 mV
"Off" output level	3.2 V
"On" output level	0.3 V
Input threshold offset	2 mV
Input impedance	3000 ohms
Propagation delay	60 nsec
Overload recovery	100 nsec
Common-mode rejection	
SN7500	2 V
SN7501	1 V
SN7502	1½ V
Temperature range	0° to + 70°C

Figure 2. Series 75 sense amplifiers.

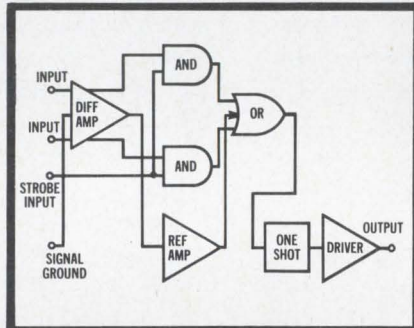

Figure 3. Functional block diagram of SN7500

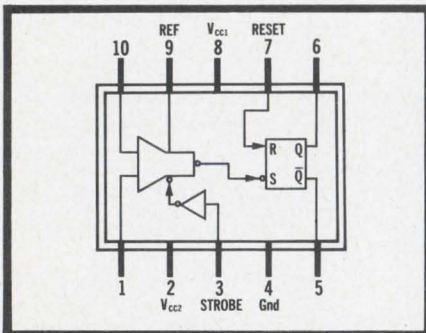

Figure 4. SN7501 incorporates flip-flop

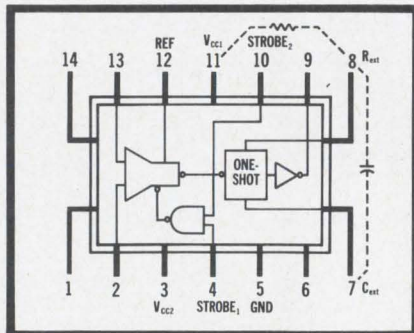

Figure 5. SN7502 includes one-shot.



# linear integrated circuits

Series 75 circuits are available in the standard TO-84 flat pack, or the transistor-type TO-100 package shown in Figure 6. The SN7500 is also available in a military version (SN5500) for operation in environments of  $-55^{\circ}$  to  $+125^{\circ}\text{C}$ . Severe temperature versions of the SN7501 and SN7502 are also available.

Circle 25 on Reader Service card for product bulletins.

## Series 72 high-performance differential/operational amplifiers

Now you can get both discrete-component performance and integrated circuit reliability in differential/operational amplifiers from Texas Instruments. Figure 7 shows that performance of SN725 and SN726 integrated circuits are comparable to discrete-component amplifiers.

The SN725 differential amplifier features an open-loop gain of 88 dB, yet it is unconditionally stable when used with two external capacitors in the frequency-response-shaping network.

The SN726 high-performance operational amplifier features a class-B output stage to give a 10 V swing with a 600-ohm load. A Darlington-connected transistor pair gives an extremely high input impedance.

In both circuits, transistor pairs are close together for improved differential-input voltage offsets and temperature-drift characteristics. Improved collector saturation resistance provides high output current and voltage capability. Both amplifiers allow  $\pm 5$  V common-mode input signals before overloading, and there is no danger of latch-up from noise or output feedback.

For less demanding applications, the SN723 differential amplifier or SN724 operational amplifier may be used at a considerable saving in cost.

TI differential and operational amplifiers are available for two temperature ranges. Series 72 is recommended for  $0^{\circ}$  to  $+70^{\circ}\text{C}$ , while Series 52 covers the full military range of  $-55^{\circ}$  to  $+125^{\circ}\text{C}$ .

Circle 26 on Reader Service card for more information on Series 72 and 52 integrated circuits.

### Choice of Packages

TI linear integrated circuits are available in either of the package types shown in Figure 6 — The time-proven TO-89 flat pack or the transistor-type TO-100 package. Both packages feature hermetic seals for high reliability in severe environments.

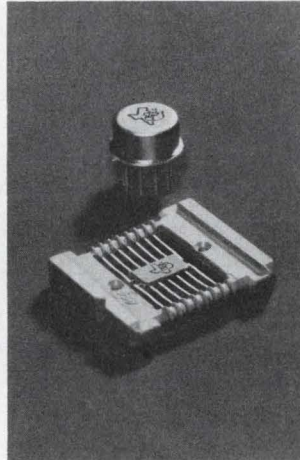

Figure 6. Package types for TI linear integrated circuits.

Characteristic	SN725	SN726
Gain, Open-loop, dB	88	60
Input-voltage Offset, mV	1	3
Temp. Coefficient		
Input-voltage Offset, $\mu\text{V}/^{\circ}\text{C}$	5	10
Input-current Offset, $\mu\text{A}$	0.3	0.03
Common-mode Rejection, dB	100	80
Output-voltage Swing, V	$\pm 8$	$\pm 5$
Output-current Peak, mA	1	10
Input Impedance, megohm	0.1	2

Figure 7. Typical Performance of integrated differential/operational amplifiers.

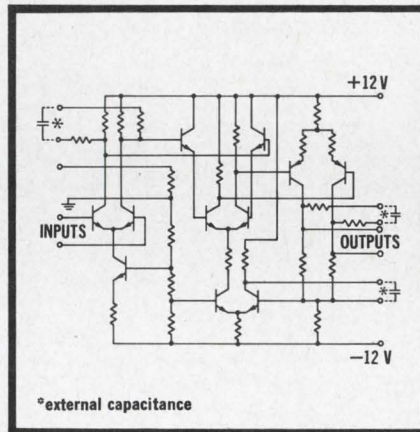

Figure 8. Circuit diagram of SN725 differential amplifier.

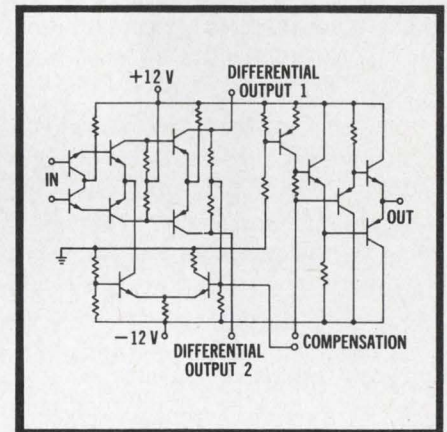

Figure 9. Circuit diagram of SN726 operational amplifier.



**TEXAS INSTRUMENTS**  
INCORPORATED  
13500 N. CENTRAL EXPRESSWAY  
P. O. BOX 5012 • DALLAS 22, TEXAS



# Explore thin-laminate properties

and limitations to find the proper combination of materials and processing steps for multilayer board design.

## Part 2 of a three-part series\*

Multilayer printed circuits are the result of combining three distinctly different raw materials, in two different physical states, into one compact package. The thin laminates used are a working balance of conductive copper foil, insulating and bonding polymer material, and supporting and stabilizing glass fabric. Various combinations of materials and processing steps are possible; the proper combination will achieve the desired design objectives at the best cost and highest production yield.

A multilayer printed-circuit board basically consists of two or more thin, copper-clad epoxy-glass laminates bearing specific circuit patterns. These laminates are bonded together with prepreg—a woven fiberglass cloth that has been impregnated with epoxy resin and partially cured (Fig. 1). The final three-dimensional package consists of copper circuits housed securely in an epoxy-glass package.

Thin laminates for multilayer boards have different characteristics from conventional 1/16-inch-thick boards, and therefore require different design specifications. Due to their thinness, they have a large surface-to-volume ratio resulting in a higher degree of water absorption and lower volume resistivity. The boards have very little rigidity (flexural modulus and flexural strength) before they are laminated together. They must be clean, bondable and capable of being heat-cycled repeatedly.

### Design criteria for copper-clad laminates

Epoxy resin is employed as the base material for such laminates because of its high bond strength with copper foil, its resistance to processing chemicals and heat, and its strength, dimensional stability and superior electrical

\*Part 1 of this series on plated-through multilayer board design ("Ten steps to multilayer board design," ED 3, Feb. 1, 1967, pp. 54-59) described the design steps from system concept to layout drawing.

**Benson Zinbarg**, Vice President, New England Laminates Co., Inc., Stamford, Conn.

properties. Woven fiberglass cloth is used as the reinforcing agent likewise because of its great strength, its thermal and chemical resistance, and its electrical properties.

Two types of copper foil can be bonded to the laminate. Both are electrolytic-grade foils: one is rolled into a foil from an electrolytically purified cake, the other is electrolytically deposited directly from copper salt solutions onto steel drums that act as both the cathode and the foil former. Most laminates for multilayer use employ the latter type of foil both because of its good bond strength to the laminate and its resistance to plating solutions. Both foils are treated in a secondary opera-

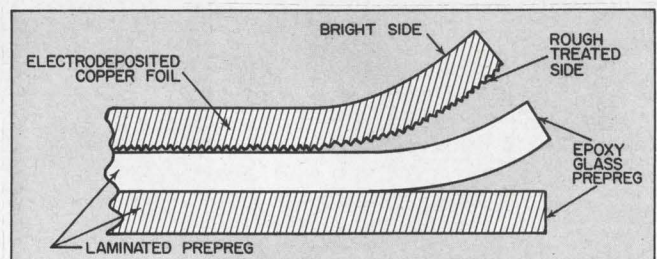

1. Copper-clad laminate assembly uses fiberglass cloth preimpregnated with epoxy resin to make up the laminate base and to bond the copper foil to the epoxy glass base.

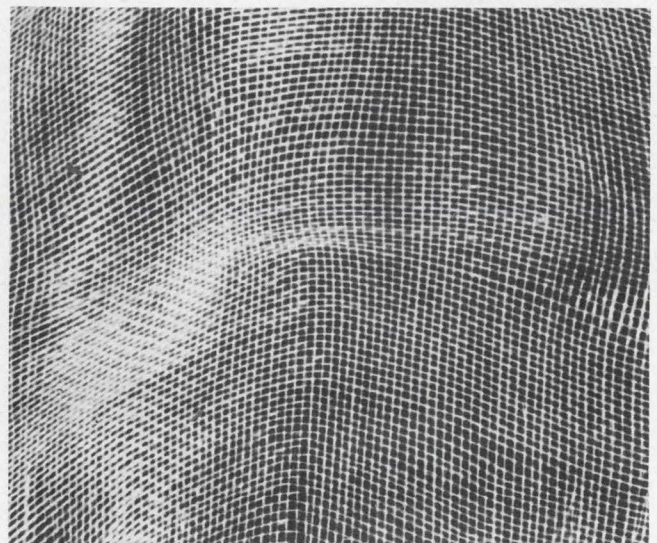

2. Nonuniform weave of the fiberglass cloth will cause irregularities in laminate thickness.



tion to improve bond strength.

Thickness and thickness tolerances for multi-layer laminates are usually designated by the base thickness plus foil thickness, rather than the overall thickness as in the case of conventional 1/16-inch-thick laminates. Table 1 shows a schedule of tolerances for both normal and tight-tolerance laminates.

The thickness of the laminate is controlled by all three materials in its construction—copper foil, glass fabric and polymer. By the same token, the tolerance on this thickness is controlled by the same three variables plus the laminator's technique and equipment.

The basic glass cloth must be woven uniformly. An example of a nonuniform weave of fiberglass cloth of one basic construction is shown in Fig. 2; such a discrepancy in the weave will affect the thickness of the laminate in its localized area. The cloth must also be impregnated very uniformly so that there are no unwanted build-ups or resin-starved areas. This resin-glass combination is laminated against copper foil; therefore, the foil employed in the manufacture of a thin, close-tolerance laminate must be very parallel. If the copper foil varies in thickness, so too will the base laminate.

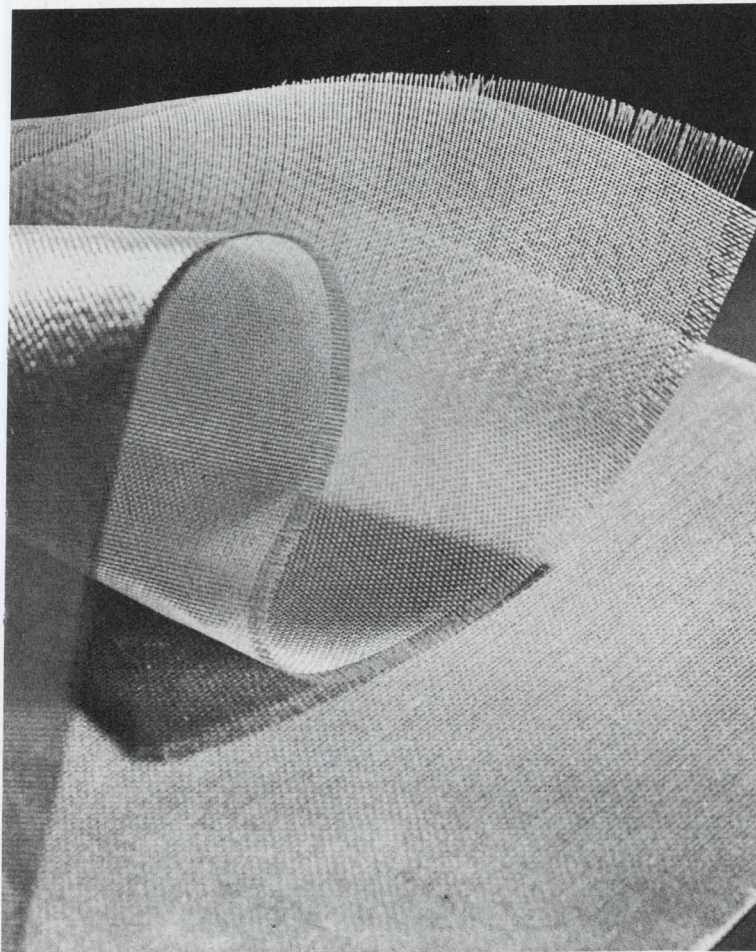

3. Unimpregnated fiberglass is soft and pliable (top) while impregnated glass cloth (bottom) is inflexible.

Obviously, the laminating press must be extremely well built and controlled to maintain near-perfect alignment. Moreover, the caul plates, against which the laminates are pressed, must be flat and parallel.

Owing to variations introduced by these factors, Class-II-tolerance laminates are usually made available in small-sheet or -panel sizes rather than full-sized twelve-square-foot sheets. Often the periphery of the Class-II sheet is thinner than the rest of it and is therefore removed. Measurements of less than one ten-thousandth of an inch are not accurate when employing deep-throated micrometers, so the quality assurance of small measurable panels is greater than that of larger sheets.

Length and width of thin laminates usually range up to 36 inches by 48 inches. Tolerances on these dimensions are plus or minus 1/16 inch; on cut panels less than 18 inches by 18 inches, the tolerances are plus or minus 1/32 inch.

#### Various factors affect dimensional stability

Dimensional stability of thin-based printed-circuit boards for use in multilayer packaging is absolutely essential. Most thin laminates will either shrink or grow during the etching operation. For most multilayer applications, this dimensional change should be kept to less than 0.0006 inch per inch; for close tolerance work where fine lines and many layers are employed, there should be as little as 0.0003-inch-per-inch change.

Dimensional stability is governed primarily by the proper use of glass fiber reinforcement and controlled impregnation of that fiber structure with a resin system that will not creep when fully cured. The epoxy resin must have a sufficiently high functionality (high degree of chemical reactivity) to ensure a highly cross-linked polymer structure.

The proper reinforcing fiberglass fabric must be selected carefully; it is of the utmost importance that it be impregnated thoroughly, and not simply be coated on the surface, with the epoxy resin. Figure 3 illustrates the effect of impregna-

Table 1. Thickness tolerances

Nominal thickness excluding copper	Thickness tolerances of copper-clad sheet after etching ( $\pm$ in.)		
	Inches	Class I	Class II
0.002 up to 0.0045		0.001	0.0005
over 0.0045 up to 0.006		0.0015	0.0010
over 0.006 up to 0.012		0.002	0.0015
over 0.012 up to 0.032		0.003	0.0025



**Table 2. Recommended bonding strength for copper field**

Copper foil weight (oz)	Copper thickness (in.)	Bond (min) (lbs/in.)
0.5	0.0007	6
1	0.0014	8
2	0.0028	10
3	0.0042	12

tion on the woven fiberglass cloth. If a full wet-out of the fibers (encapsulation at the microscopic level) is not attained in the impregnation operation, it is very difficult to achieve a uniform, stable laminate after the pressing operation. During impregnation of the glass cloth, the woven fiberglass should not be stressed or distorted; it should be processed very gently.

The epoxy resin system that is employed should be chosen for the specific end use that it will encounter. It must be properly catalyzed so that the proper degree of polymerization and cross linking will occur to bind the reinforcement into a dimensionally stable package. During the pressing stage, the resin must be brought to a complete cure, so that no further shrinkage can take place

**Table 3. Specs for surface defects\***

Largest dimension (in.)	Permissible frequency
0.010 to 0.020	10/ft <sup>2</sup> (avg)
0.021 to 0.030	6/ft <sup>2</sup> (avg)
0.031 to 0.050	1/ft <sup>2</sup> (avg)
over 0.050	1/full sheet (max)

\*Proposed by the Industrial Laminate Advisory Technical Committee of the National Electrical Manufacturers' Association.

should the resin be subjected to further curing during a subsequent operation.

Bond strength between the copper foil and base laminate is important in order that the thin lines and small pads are kept from shifting and detaching from the laminates. This property is governed primarily by the chemistry of the laminating resin. It is also controlled to a great extent by the finishing treatment given to the copper foil. This treatment is the coupling agent between the laminate and the pure copper, to which it is difficult to make a bond.

The adherent properties of the treatment fluctuate. Atmospheric conditions to which it is exposed prior to laminating will affect those properties: summer environments of high humidity and

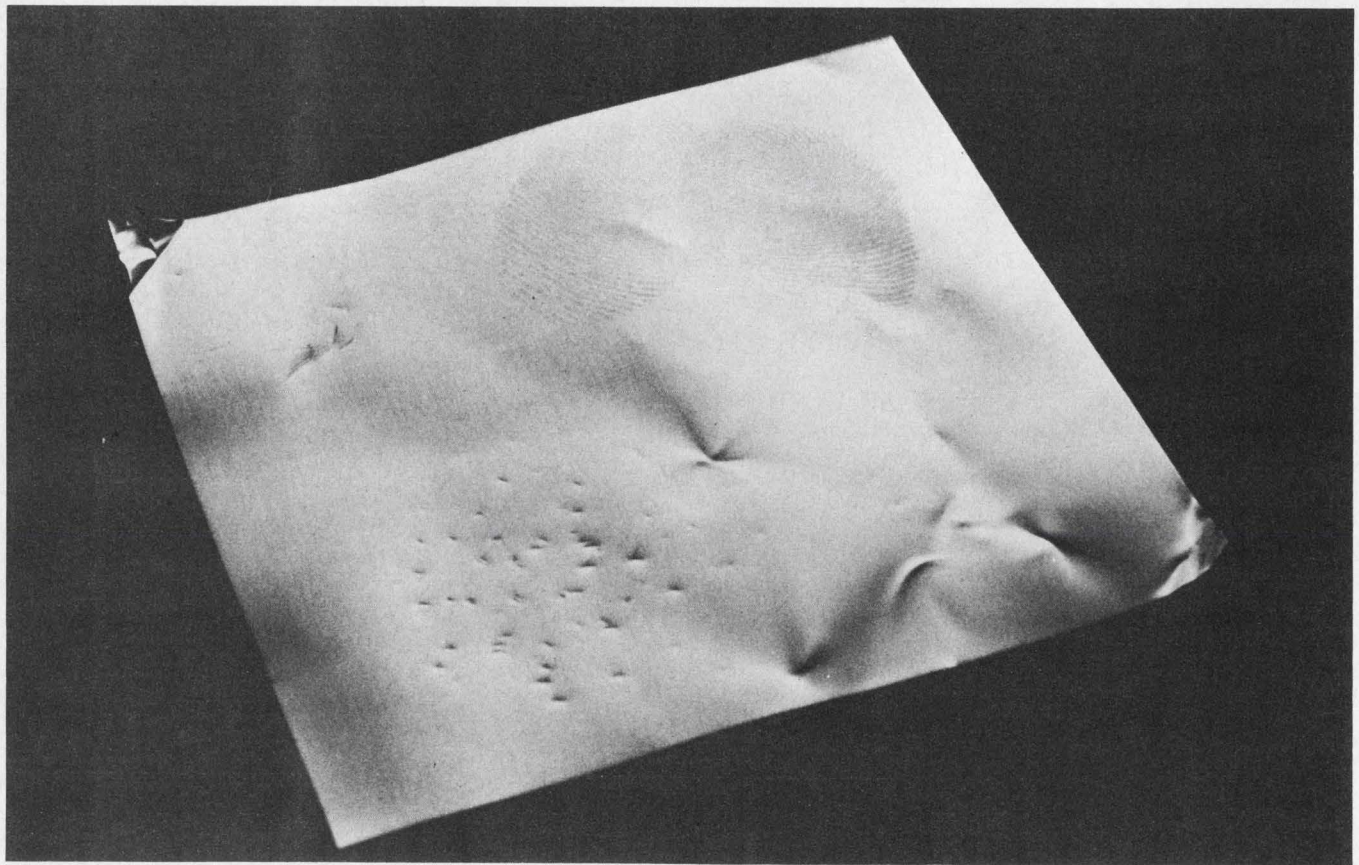

4. Dents, creases, scratches, fingerprints and mishandled corners on the copper foil are common defects stem-

ming from improper handling of the fragile thin laminate. Specs for surface defects are in Table 3.



**Table 4. Significance of foreign matter**

Largest dimension (in.)	Point value
0.001 - 0.003	1
0.004 - 0.007	2
0.008 - 0.012	3
0.013 - 0.020	5
0.021 - 0.030	10
0.031 - 0.040	15
0.041 - 0.050	25
over 0.051	51

warm temperatures generally affect them most adversely. For this reason, and because of the need to keep all materials free of contamination, the bond strength of the metal conductors fluctuates. Owing to the small thickness of multilayer laminates, bonding strength is critical; recommended values are shown in Table 2.

#### **Pits, dents, scratches and creases defined**

The surface finish on the copper should be less than 20 microinch and should have a minimal number of surface defects. These defects are usually pits, dents, scratches and creases (Fig. 4).

Pits are defined as small holes in the copper foil that decrease its thickness but that do not pene-

trate completely through it. Dents are defined as depressions in the copper foil that have been caused during the laminating process and do not significantly reduce the thickness. Creases are defects that are peculiar to thin laminates. They are gentle dents or bumps caused by handling. Slight ones are generally not a defect, but sharp creases cause rejects during the photoresist operation. Visually the slight dents and bumps are obvious and appear to be undesirable, but functionally they do not reduce the utility of the laminate. Proposed specifications on pits and dents are outlined in Table 3. This specification is very broad and many circuit people can and do work to tighter tolerances.

Since the laminates employed in multilayer packaging are very thin and often many of these laminates are combined, the optical properties of the laminate must be excellent. The laminates should be very translucent; on examination they should exhibit a minimum of foreign matter. The laminator's trademark, a requirement in heavy military-grade laminates, should not be used because it interferes with the visual examination of the finished three-dimensional printed wiring board and can also cause electrical malfunctions.

Thin laminates are particularly prone to discoloration which appears as brownish or purplish streaks and smudges after the foil has been removed by etching (Fig. 5). The stain is a transfer of the textured treatment found on the bonding side of the copper foil. This treatment is put there by the foil manufacturer to provide a good bonding surface. However, when thin laminates are manufactured, this treatment sometimes becomes embedded in the resin and leaves a permanent brown stain which can cause electrical failures at high frequencies. This defect should therefore be held down to approximately three per cent of the laminate area. At present it is difficult to obtain laminates completely free of this condition.

At times, staining is accompanied by voids or blisters in the surface of the laminate. These should be ruled out by specification because they can lead to electrical failures caused by the voids' trapping processing chemicals that are conductive.

Foreign matter—carbonized resin, lint and extraneous substances—cannot be completely eliminated with present state-of-the-art manufacturing techniques. A chart describing such particles and their relative significance in material specification is shown in Table 4.

A normal thin laminate (Class II) is allowed to have up to 50 points per square foot, and a very special multilayer package requires a premium thin laminate (Class I) with a maximum of 10 or 15 points per square foot.

A rapid check for foreign-matter contamination and voids involves passing the thin laminate

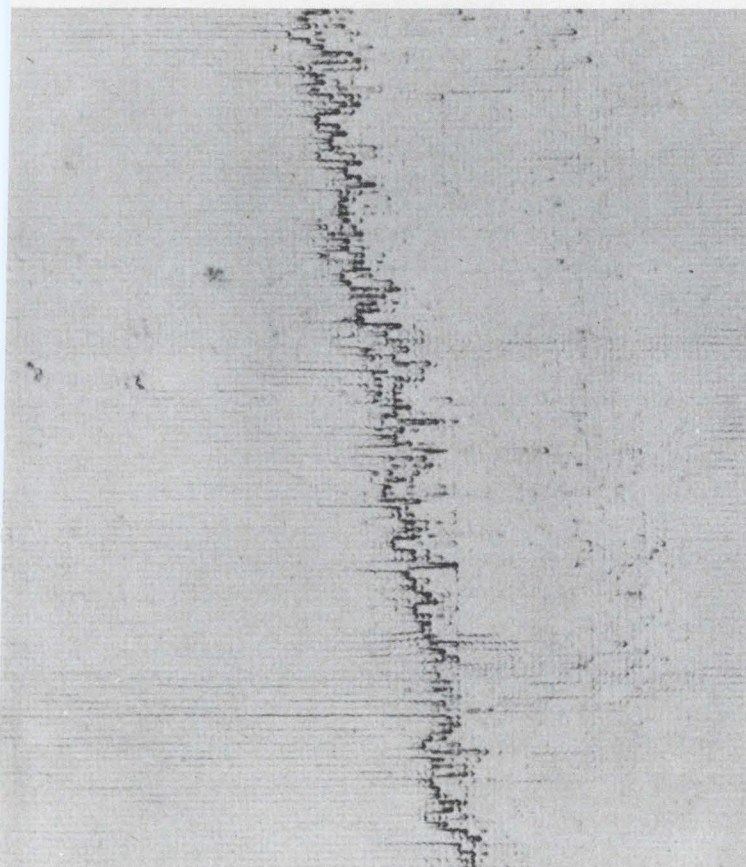

**5. Random oxide transfer stains may appear on thin laminates after the foil has been removed by etching.**



**General Technology's  
Rubidium "atomic clock"  
records over million hours  
operational time.**

**Reliability now proven;  
MTBF established at 22,000  
hours per unit.**

Records kept since 1961 on every Rubidium Frequency Standard made by GTC show the average time between random component failures to be 87,000 hours — almost 10 years!



The Model 304-B shown here is but one in a complete family of all solid-state atomic frequency standards made by GTC for use in field and laboratory. Maximum deviation is  $\pm 5$  parts per  $10^{11}$  in a year, or better. Special versions meet environmental and other requirements for tactical and missile/aircraft use.

For solutions to your stable-oscillator problems, write General Technology Corporation, subsidiary of TRACOR, Inc., 6500 Tracor Lane, Austin, Texas 78721. Phone 512-926-2800.

**Time & Frequency  
Instruments by**



TFA - 1367

ON READER-SERVICE CARD CIRCLE 40

through a dielectric strength test. A suggested specification is 750 volts per mil (vpm). When the dielectric strength perpendicular to the laminations falls below the 750-vpm level, it is an indication of the presence of a void, resin-starved area, or a conductive contaminant.

The chemical resistance of thin laminates is sometimes a problem to printed-circuit processors. Package designers should screen the materials before specifying them to avoid these production problems. Some chemicals that are employed in the manufacture of etched circuits may soften or swell the laminate. Chemical attack occurs more frequently in thin laminates than in their thicker relatives, because they present a much larger surface-to-volume ratio.

Laminate etchability in sulfuric acid should be specifically called out. At times etchability is necessary for processing plated-through holes, and at other times it is specifically not desirable. It is undesirable when the laminate is used as a resist layer to chemical milling of the composite laminate.

One of the most critical material properties for miniaturized circuitry is the dielectric constant. In most applications, it should be as low as possible, and generally it should be as uniform as possible. A thin laminate should have a dielectric constant of  $4.3 \pm 10\%$  and a dissipation factor of 0.03 maximum. Among other factors, the clarity of the signal and the reduction of crosstalk are affected by this property.

Dielectric constant is controlled by the chemistry of the raw materials employed in the laminates and the proportions used. Proper selection of these and control of their purity is of utmost importance. In epoxy-glass laminates, the resin and fiberglass have very different dielectric properties and their ratio must be kept constant to ensure uniformity and a well-balanced package. Insulation resistance and surface resistance should be a minimum of 5000 megohms at 500 volts.

At present, a number of groups are working toward standardization of the design parameters for thin laminates. The Institute of Printed Circuits has completed a specification on the prepreg material used in multilayers, but is only beginning its work on a thin-laminate specification. This work is being closely coordinated with the efforts of the Industrial Laminate Advisory Technical Committee (ILATC) of the National Electrical Manufacturers' Association (NEMA). These people in turn are coordinating with ASTM and the University of Delaware on test methods. Government agencies such as the Signal Corps, U.S. Naval Avionics Facility and Defense Electronic Supply Center are in liaison with these industrial groups and are working toward establishment of Government specifications. ■ ■



# A LOW-COST 1 AMP SPDT RELAY MIGHT DO THE JOB BETTER THAN AN EXPENSIVE ONE.

If it's the new 75-cent  
Sigma Series 65.



New Sigma Series 65 miniature relays are specifically designed for low-level DC switching applications where economy is of major importance. Available in quantity for 75 cents, these general purpose relays include extra design benefits:

**Superior Switching Performance:** The precision knife-edge hinge design of the armature provides better magnetic coupling for full utilization of coil power. This results in heavier contact forces, lower contact resistance and better electrical stability.

**Greater Mechanical Strength:** Glass-filled nylon, not ordinary phenolic, is used to support contact members assuring long-term mechanical life and stability.

**Better Thermal Stability:** Use of high-grade, low-

temperature-coefficient materials assures excellent thermal stability over a wide temperature range up to 70°C.

**We'd like to give you a new Sigma Series 65—** or any of our other standard relays. Test and compare it against the brand you may now be using. It's the best way we know to prove what we say about Sigma relay performance. Just circle our reader service number on the reader service card. We'll send you the new Sigma relay catalog and a "free relay" request form. Return the form to us and your Sigma representative will see that you get the relay you need.

**Need fast delivery? The Series 65 is available off-the-shelf from your Sigma distributor.**

SIGMA DIVISION  SIGMA INSTRUMENTS INC  
Assured Reliability With Advanced Design / Braintree, Mass. 02185

ON READER-SERVICE CARD CIRCLE 41





Model 3420B

Now that you're going to buy  
a dc voltmeter, get hp's  
extra measure of

## Performance

When you buy a dc voltmeter, you look for the least costly instrument that will give the accuracy you need for your measurements.

Only Hewlett-Packard can offer a complete line of dc voltmeters— analog, digital, and differential— each designed to give you the *exact* performance you need... the maximum performance per dollar invested!

**ANALOG hp Model 419A:**— High sensitivity null meter and wide range dc voltmeter in one compact package.

**ANALOG/DIGITAL hp Model 414A:**— Touch-and-read speed of digital autoranging eliminates range switching bother. Linear volt/ohms scale gives high resolution.

**DIGITAL hp Model 3430A:**— Provides accurate digitized measurements with error-free readability— at a low price!

**DIFFERENTIAL hp Model 3420A or 3420B:**— For precision measurements:  $\pm 0.002\%$  accuracy, 0.2 ppm resolution, 1 ppm stability.

Whatever your requirements, whatever your applications— only Hewlett-Packard can offer you a complete line of voltmeters!

hp Model 419A  
for High Sensitivity

## Performance

The hp Model 419A DC Null/Voltmeter is your best choice for high sensitivity volts/current measurements such as thermocouple voltages and other low level transducer sources, nerve potentials in biological studies, galvanic responses in chemically-generated emf's, education—or use it as a null voltmeter in dc standards and calibration work. This low cost instrument is ideal for schools, maintenance departments and accurate enough for design benches. The  $3\ \mu\text{V}$  range gives  $0.1\ \mu\text{V}$  resolution for extremely low level measurements.

And, you need not be concerned with source impedance! The variable internal nulling supply allows you to derive an essentially infinite input impedance on the  $3\ \mu\text{V}$  through 300 mV ranges. You simply buck out the input voltage, then measure the internal supply by pushing a button!

To eliminate common mode voltages—such as those found where transducers and long lead lengths are being measured—unplug the instrument from the ac source, and operate on the internal rechargeable batteries.

For leakage current measurements such as in semi-conductors, the 419A has 30 pa to 30 na full scale ranges.

The hp neon oscillator/photocon-

ductor chopper amplifier combined with high-feedback has  $<0.3\ \mu\text{V}$  noise and  $<0.5\ \mu\text{V}$  drift per day. You get readings that are dependable—and repeatable!

For high sensitivity performance, get the hp Model 419A DC Null/Voltmeter! Check the dc sensitivities in the table.

hp Model 414A  
for Touch/Read Autoranging

## Performance

It takes less than 300 msec for hp Model 414A to select and indicate the correct range and polarity! You're free of the tedious job of constantly changing ranges and of the worry of overloading the instrument. You can, whenever you need, over-ride the automatic ranging and manually select your range. When you specify the hp 414A, you get the "touch and read" convenience of autoranging!

You'll find this instrument is the most accurate analog voltmeter available! Measuring accuracy for dc voltage is  $\pm 0.5\%$  of reading,  $\pm 0.5\%$  of full scale. For resistance, accuracy is  $\pm 1\%$  of reading,  $\pm 0.5\%$  of full scale.

The  $100\ \text{M}\Omega$  input resistance (on 50 mV range and above) allows more accurate measurement with less dependence upon source impedance. For example, a  $100\ \text{k}\Omega$  source introduces only a 0.1% measurement error.

For Vdc and ohms measurements where speed, accuracy and "hands-free" operation are needed, pick the solid-state hp Model 414A Autovoltmeter. Comparative specifications are given in the table.

HEWLETT  PACKARD  
An extra measure of performance

# DEED



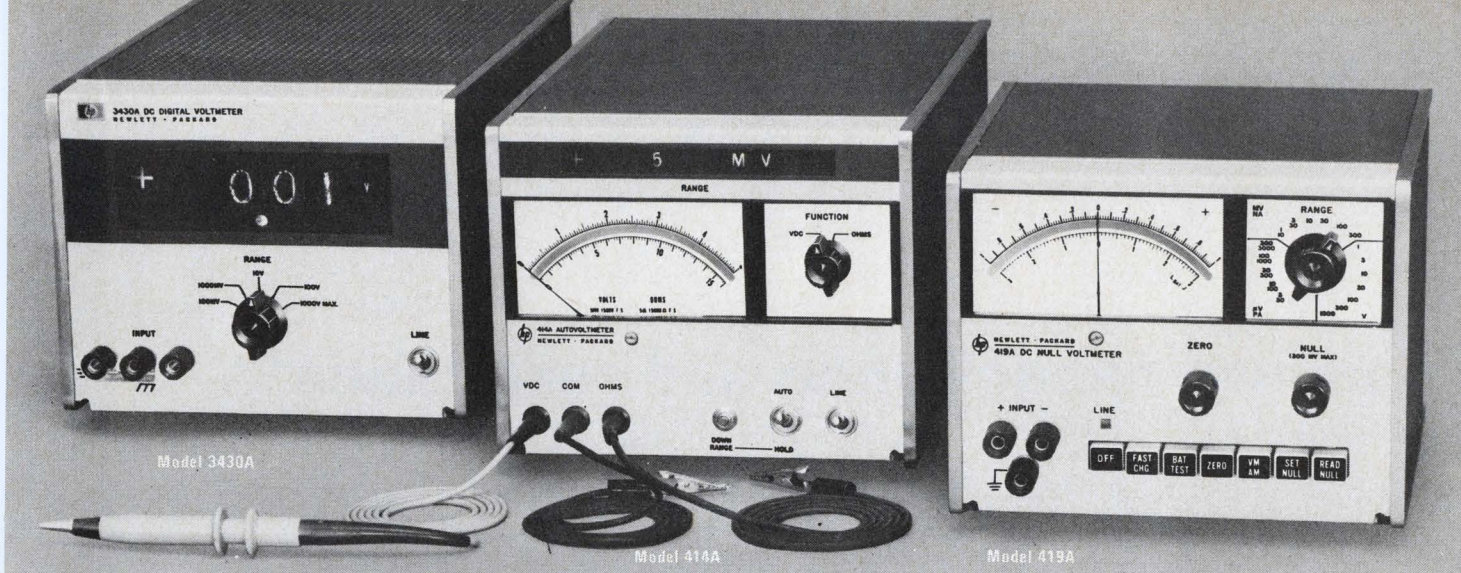

**hp Model 3430A**  
**for Easily Readable**

# Performance

Easy to read! Easy to operate—even by inexperienced personnel! Accurate enough for production testing, laboratory, repair shops, quality control, incoming inspection—and digital transducer measurements! These are the performance features you get from hp Model 3430A DC Digital Voltmeter.

The 3430A features 100  $\mu$ V resolution to give you low level dc measurements with digital accuracy ( $\pm 0.1\%$  of reading). A flashing overload indication prevents false readings when in overload. Amplifier output is accurate to within 0.1% and can be used while making measurements if load is 10k $\Omega$  or greater. Output will drive dc recorders to give you permanent records. Both accuracies hold for 90 days—save you costly calibration time.

Model 3430A has a voltage ratio option, (01). The readout display is proportional to the ratio of the input voltage (front terminals) to the reference voltage (rear terminals). A rear panel slide switch permits either normal or ratio mode operation.

Specify hp Model 3430A DC Digital Voltmeter when you need a solid-state, easily-readable instrument for continuous service under rigorous operating conditions. See the table for full specifications.

	414A	419A	3420A 3420B	3430A
DCV	5 mV— 1500 V	3 $\mu$ V— 1000 V	1 V— 1000 V	100 mV— 1000 V
Accuracy	$\pm 5\%$ Rdg., $\pm 5\%$ FS	$\pm 0.1 \mu$ V on 3 $\mu$ V range, $\pm 2\%$	$\pm 0.002\%$ Rdg., $\pm 0.0002\%$	$\pm 0.1\%$ Rdg., $\pm 1$ digit
Ohms/Current	5 $\Omega$ — 1.5 M $\Omega$	30 pA— 30 nA	—	—
Accuracy	$\pm 1\%$ Rdg., $\pm 0.5\%$ FS	$\pm 3\%$ end scale $\pm 1$ pA	—	—
Zdc	10-100 M $\Omega$	100 k $\Omega$ —100 M $\Omega$	1 M $\Omega$ —10 M $\Omega$	10 M $\Omega$
Ratiometer	—	—	0.000000001:1— 0.999999:1	0.0001:1— 1000:1
Accuracy	—	—	24 ppm	$\pm 0.15\%$ reading $\pm 1$ digit
Recorder	—	$\pm 1$ Vdc 1 mA	$\pm 1$ Vdc 1 mA	$\pm 16$ Vdc 1 mA
Output	—	—	—	—
Power	50-1000 Hz	50-1000 Hz	3420A, 50-1000 Hz 3420B, Battery/Line	50-1000 Hz
Type	Autoranging Analog	Analog	Differential	Digital (3-digit)
Price	\$650.00	\$450.00	3420A-\$1175.00 3420B-\$1300.00	\$595.00 Ratio Opt. \$80.00

**hp Model 3420A or 3420B**  
**for Precision**

# Performance

For making highly stable dc measurements and measuring precision voltage ratios, select either precision solid-state hp Model 3420A or 3420B. Use it for calibrating digital and potentiometric voltmeters; line and load regulation of dc standards measurements; calibrating precision resistance dividers; making thermistor, thermocouple or transducer measurements.

The hp Model 3420B differential voltmeter is line/battery operated so true floating dc measurements can be made by disconnecting the line cord. Readings cannot be affected by ground loops.

The hp 3420A or 3420B can be used to measure resistance and voltage ratios rapidly without using the conventional method of tedious math-

ematical computations and without an outside precision voltage source. Voltage and resistance ratios from 0.000000001:1 to 0.999999:1 can be measured in four ranges.

You won't need a highly skilled technician from a standards laboratory to make parts per million measurements when you specify the hp 3420A or 3420B! Engineers and line technicians can press the front panel pushbutton, adjust the high resolution decades and read the results!

For a resolution of 0.2 ppm and an accuracy of 0.002% of reading, get the hp 3420A or 3420B. See the table for specifications.

For data sheets giving full specifications on these dc voltmeters with the hp extra measure of performance, contact your nearest hp field engineer. Or, write to Hewlett-Packard, Palo Alto, California 94304, Tel. (415) 326-7000; Europe: 54 Route des Acacias, Geneva.





# Measure capacitance and resistance

of forward-biased diodes simply and accurately with standard laboratory test equipment.

The capacitance and dynamic resistance of forward-biased diodes are very important in designing fast gates and switching circuits. Yet there is no universally accepted method for performing these measurements and very little information exists in the literature.

A simple method for making the measurements and a straightforward test set are described below. The method enables measurements to be taken over a wide range of forward current values (3  $\mu\text{A}$  to 3 mA).

## Assumptions have to be made

In developing the measurement technique, two assumptions have been made:

- The equivalent circuit for a forward-biased diode at any one operating point consists of a resistor in parallel with a capacitor. A forward-biased diode may therefore be accurately simulated by the use of a lumped resistance and capacitance in parallel.

- A small ac signal of 50 mV imposed on a forward-biased diode will not alter the dynamic resistance and capacitance values of the diode significantly.

The basic measurement technique consists of comparing the unknown diode dynamic resistance and forward capacitance with known resistive and capacitive quantities and detecting the point at which the known and unknown are equal.

## The test circuit is simple

A block diagram showing the components of the test circuit is illustrated in Fig. 1. The setup includes the following elements:

**Test signal source**—The test signal source is a Hewlett-Packard model 214A pulse generator. The signal input provided by it is a positive rectangular pulse of 150 millivolts' amplitude.

**Bridge network**—The basic test network is

shown in Fig. 2. It comprises two parallel attenuator networks which, at balanced conditions, are identical. One network consists of a 1- $\mu\text{F}$  coupling capacitor, a series resistor ( $R_1$ ), a calibrating resistor ( $R_2$ ), and a trimming capacitor. The other network consists of an identical 1- $\mu\text{F}$  coupling capacitor, a series resistor ( $R_3$ ), a test resistor ( $R_4$ ), which establishes the dynamic resistance level for the diode, and a calibration capacitor, which can be varied to match the diode capacitance. The positive rectangular pulse is

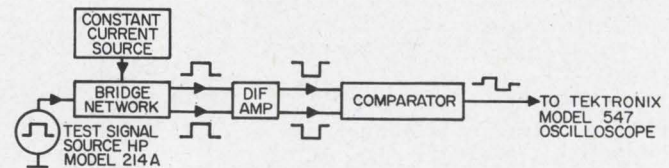

1. Diode capacitance and dynamic resistance test set can be built quickly, as this block diagram shows.

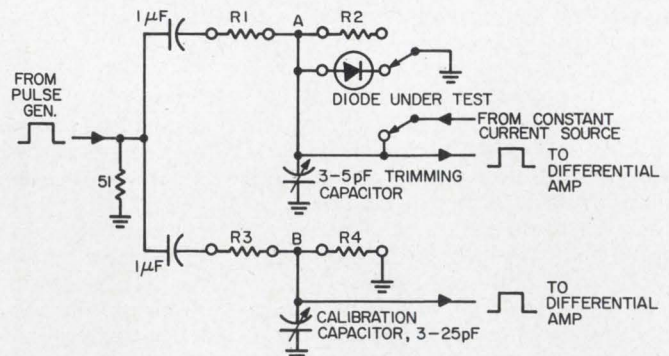

R1	R2	R3	R4
22 k $\Omega$	10 k $\Omega$	22 k $\Omega$	10 k $\Omega$
10 k $\Omega$	4.7 k $\Omega$	10 k $\Omega$	4.7 k $\Omega$
4.7 k $\Omega$	2.2 k $\Omega$	4.7 k $\Omega$	2.2 k $\Omega$
2.2 k $\Omega$	1.2 k $\Omega$	2.2 k $\Omega$	1.2 k $\Omega$
1.0 k $\Omega$	470 $\Omega$	1.0 k $\Omega$	470 $\Omega$
470 $\Omega$	270 $\Omega$	470 $\Omega$	270 $\Omega$
200 $\Omega$	100 $\Omega$	200 $\Omega$	100 $\Omega$
100 $\Omega$	47 $\Omega$	100 $\Omega$	47 $\Omega$

2. The basic test circuit is a bridge network utilizing a few standard components. Its resistors can be selected by reference to the accompanying table.

George L. Snider, Senior Engineer, Arinc Research Corp., Santa Ana, Calif.



adjusted for 50 millivolts at points *A* and *B*.

**Constant current source**—The constant current source (Fig. 3) consists of a transistor amplifier, the output current from which can be varied by means of resistor taps and a potentiometer. The current range available is from approximately 1  $\mu$ A to 10 mA. The transistor amplifier provides a high ac output impedance to the test diode and effectively isolates the constant current source from the test network.

**Differential amplifier**—The signal amplifier

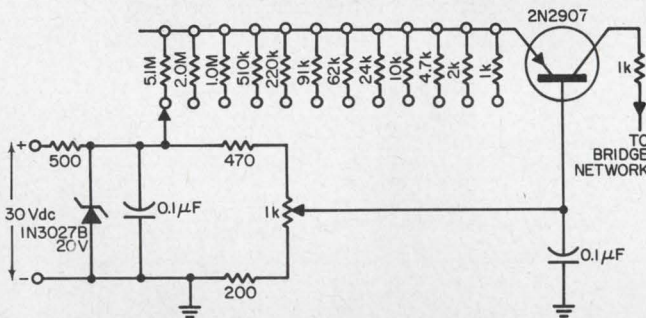

3. Constant current source provides a wide range of currents. Rough adjustment is made by selecting a proper tap; the potentiometer is used for fine setting.

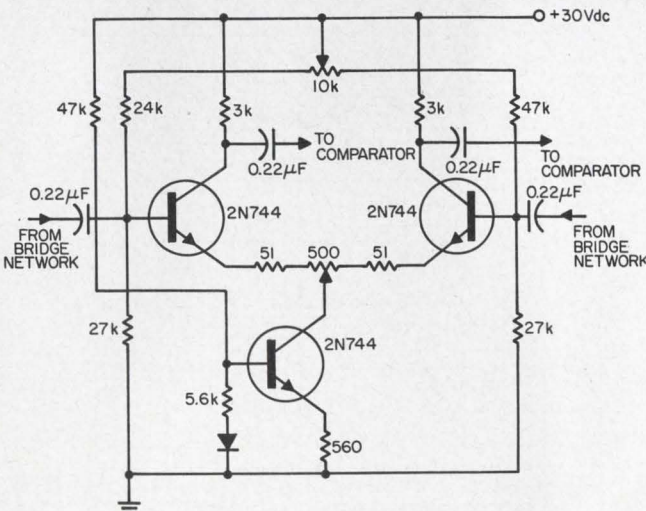

4. Inputs from the bridge network are processed by a three-transistor differential amplifier. Balancing is provided by the 500-ohm potentiometer.

(Fig. 4) is a high-frequency differential amplifier with inputs derived from the two attenuator networks. When the differential amplifier is properly balanced, the outputs will be identical, provided the inputs to the amplifier are identical. The amplifier buffers the input to the comparator with a minimum of rise-time degradation.

**Comparator**—The inputs of the comparator (Fig. 5) are derived from the differential amplifier outputs. When the test network is properly balanced, the outputs of the differential amplifier

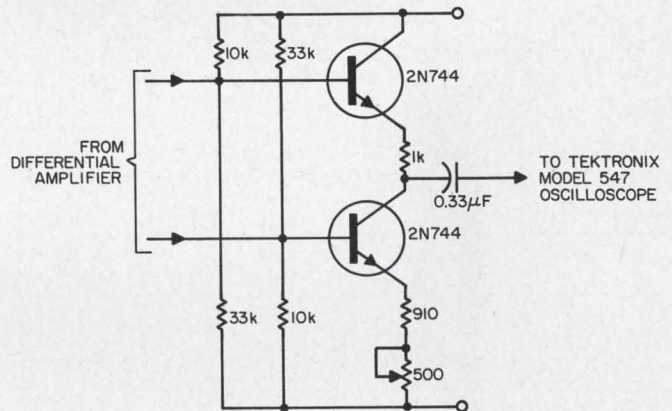

5. Differential amplifier outputs are combined into a single output and displayed on a scope. This is the last functional block in the over-all test set-up.

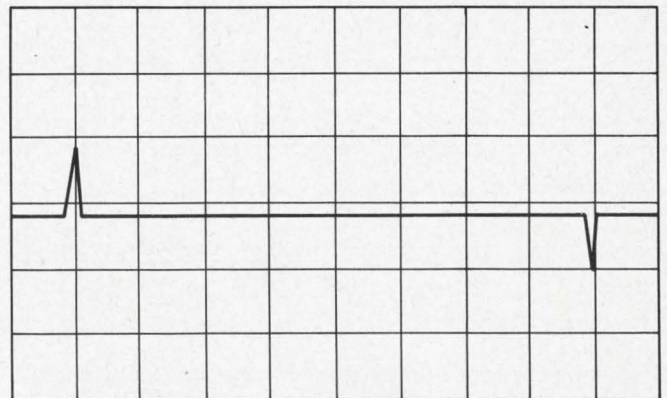

6. Resistance calibrating null should look like this. The spikes can be balanced out with the trimming capacitor for the best straight line.



will be identical, and the output of the comparator displayed on the oscilloscope will appear as a straight line.

### The test set must be calibrated

The step-by-step calibration procedure is as follows:

- The input pulse characteristics are set:
  - Repetition rate — 10 kHz
  - Amplitude — 150 mV
  - Rise time — 10 ns
  - Fall time — 10 ns
  - Pulse width — 3.5  $\mu$ s
- Resistor  $R_2$  is substituted for the diode to be tested. The remaining calibrating resistors  $R_1$ ,  $R_3$ , and  $R_4$  remain in place throughout the test.
- The calibration nulling capacitor is set to its minimum value ( $\approx 3.0$  pF), and the value balanced off by means of the 3-5-pF trimmer capacitor.
- The signal source is adjusted for an amplitude of 50 mV at resistors  $R_2$  and  $R_4$  (points A and B, respectively).
- The differential amplifier output is balanced in this manner: The 10-kilohm potentiometer is varied to "balance out" the output of the differential amplifier. The balance point is reached when the composite output is zero. The

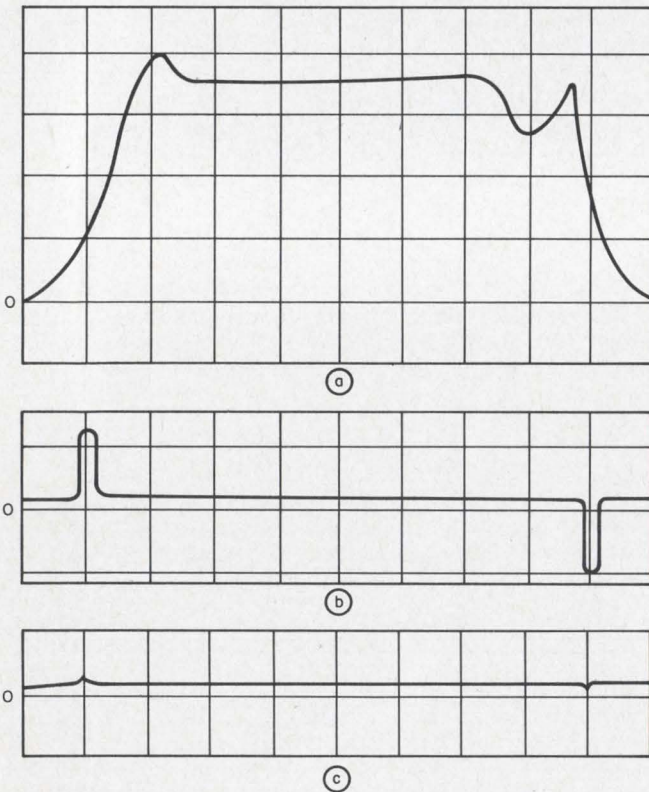

7. Placing the diode under test into the calibrated circuit produces trace (a) on the scope. Matching the dynamic resistance of the diode to  $R_3$  of Fig. 2 by varying the diode current results in trace (b). The final null (c) is achieved by adjustment of the calibrating capacitor.

scope presentation will appear as in Fig. 6. pikes seen on the scope are due to the imbalance of the capacitive values since the calibrating capacitor has some residual capacitance. This is "balanced out" by the trimming capacitor for the best straight line.

### It is simple to test a diode

Testing a diode is accomplished in four steps:

- Resistor  $R_2$  is replaced by the diode to be tested. This will cause the differential amplifier to become unbalanced because the dynamic resistance and capacitance of the forward-biased diode are different from the values of calibrating resistor  $R_3$  and the calibrating capacitor. The oscilloscope trace will generally appear as in Fig. 7a.
- The dynamic resistance of the diode is first matched to the value of calibrating resistor  $R_3$  by varying the forward current into the test diode. This is done by selecting the proper tap on the constant current source and varying the 1-k $\Omega$  potentiometer. At the point where the diode's dynamic resistance matches that of calibration resistor  $R_3$ , the oscilloscope trace will appear as in Fig. 7b.
- The capacitance values are matched by varying the calibrating capacitor until the oscilloscope

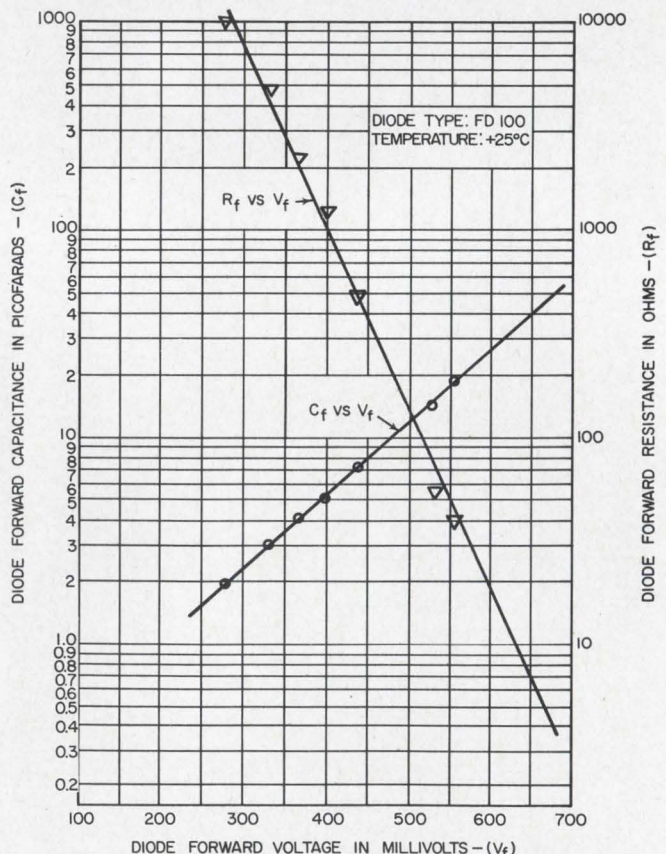

8. Diode test results are depicted above. Note that both the capacitance and dynamic resistance are exponential functions of the diode forward voltage.



trace appears as in Fig. 7c.

4. The diode parameter values can now be read as follows:
  - a. The diode dynamic resistance is equal to the value of calibrating resistor  $R_3$ .
  - b. The diode forward capacitance value is read on the dial of the calibrating capacitor.
  - c. The diode forward voltage drop is read by means of the Hewlett-Packard model 410C vacuum-tube voltmeter. This measurement is made between the test diode anode and ground. The meter is not connected while balancing the circuit.

Application of this procedure for diode testing resulted in the plot of Fig. 8, where diode forward capacitance and resistance were plotted as a function of the diode forward voltage. Note that both of these parameters are pure exponentials.

### Beware of the errors

The following sources of error are present in using the above procedure:

A. It is difficult to build the test circuit exactly symmetrical. Therefore, certain stray capacitances due to the circuit layout are not accounted for. In achieving the capacitance null, this stray capacitance may cause an estimated error as great as 1 pF. This error, while it is constant, may be significant in the measurement of low capacitance values.

B. Circuit inductance is not taken into account at all. But its only effect will be to contribute to a less than perfect null on the oscilloscope read-out by degrading the oscilloscope's resolution.

C. The test signal is not a perfect square wave, since it has switching times in the region of 10 ns. A test signal with a faster rise time would provide greater resolution.

D. The range of forward current values over which accurate measurements of capacitance and dynamic resistance can be made is limited by two factors:

- i. Diode capacitance values of less than 3.0 pF cannot be measured because of the limited range of the calibrating capacitor (3 to 25 pF). This then limits the minimum forward current to about 3 mA and the dynamic resistance to approximately 10,000 ohms. The upper range of the calibrating capacitor can easily be extended by the addition of extra capacitance in parallel.

- ii. Dynamic resistance values are limited to 39 ohms, and therefore the forward current to approximately 3 mA, owing to the insensitivity of the null to capacitance changes at this low resistance level. This being the case, the capacitance values can be altered as much as 20% without significant change in the null. The maximum capacitive values recorded are thus taken to be within  $\pm 20\%$  of the true value. ■ ■

Panel 1: Male: "Would you believe I can turn you on for \$39.50?" Female: "No!"

Panel 2: Male: "Would you believe I can control you with less than 100 microwatts?" Female: "No."

Panel 3: Male: "Would you believe my pulse rises in 100 nanoseconds?" Female: "No, sir."

Panel 4: Male: "Say, I don't believe you know me— Crydom's new SCR FIRING CIRCUIT MODULE." Female: "Yes, I mean no... make me acquainted."

### SCR FIRING CIRCUIT MODULE

*Check These Features*

- ✓ 0.5 milliamperes for control of linear region.
- ✓ Linear control of sine wave power.
- ✓ 0.5 ampere, 100 nanoseconds rise time firing pulse minimizes di/dt failures.
- ✓ 0.7 volt negative bias prevents false firing.
- ✓ 50 microwatts control power sensitivity.
- ✓ 115 or 230 volt, 47-63 Hz operation.
- ✓ Responds to d.c. polarity for closed loop applications.

*Write for complete information.*



**CRYDOM laboratories, inc.**

3115 West Warner Ave., Santa Ana, California  
Area Code 714 • 540-1390

ON READER-SERVICE CARD CIRCLE 43



# State of the monolithic art

Cut cost of IC read-only memories with Radiation 6 x 8 Diode Matrices

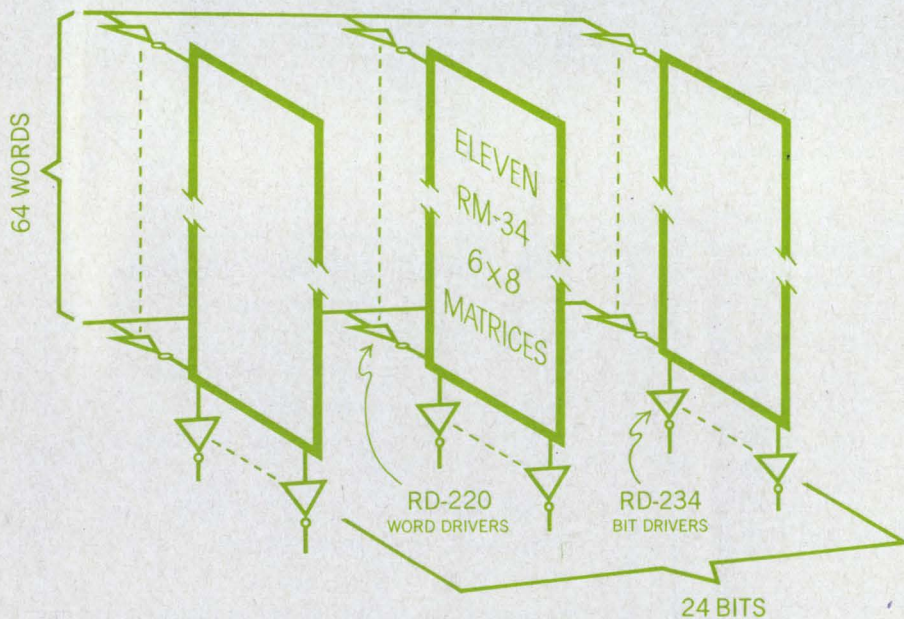
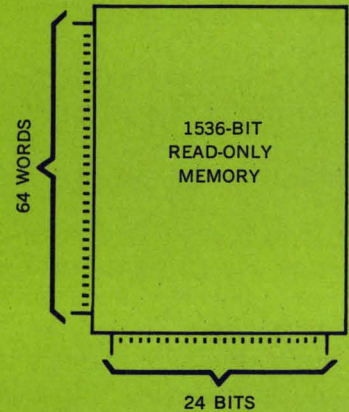

Significant advances are now possible in the design of monolithic read-only memories. This new approach, using Radiation Matrices, inverters and interface circuits produces the industry's most economical fully-monolithic integrated circuit memory. Thus, simplified design, simplified packaging, reduced cost and increased reliability of read-only memories are assured through use of Radiation's unique Monolithic Diode Matrices.

The data storage section of a 64-word memory, illustrated at left, is a good example. This subsystem requires only 33 Radiation RM-34 "custom patterned" Matrices, 33 RD-220 Hex Inverters, and four RD-234 Hex Interface Inverters.

Flexibility is achieved with Radiation's exclusive fusing technique for selection of data-storage patterns. Assembly is simplified because the subsystem can be constructed on standard printed circuit boards using T0-84 packages, or Radiation's new dual in-line packages.

VISIT US AT THE IEEE SHOW . . . BOOTH 4G32, 4G34.



# State of the design art

Radiation's popular dielectrically isolated matrices provide an unusual degree of flexibility. (1) RM-34 Matrices contain 48 active devices per chip. (2) A fusible link in series with each diode permits unlimited matrix patterns to be formed. And (3), circuits can be combined to produce an almost infinite variety of size configurations.

In addition to flexibility, Radiation 6 x 8 Matrices offer the increased reliability of monolithic construction. Size and weight requirements are slashed through reduced package count. Further, cost of matching, testing and assembly of discrete diodes is eliminated.

Production has been expanded to guarantee fast shipment of ma-

trices "customized" to your exact requirements. In fact, most orders are shipped on a 24-hour basis.

*A new low-cost RM-134 design in a ceramic dual in-line package is available in volume at a unit price of less than \$5.00—and can be supplied to any code configuration requested.*

Write for data sheets on the entire line of Radiation Monolithic Diode Matrices. *Worst-case limits* are included, as well as all information required by design engineers. We'll also be glad to supply our new manual, Monolithic Diode Matrix Technical Information and Applications. For your copy, request publication number RDM-T01/A01 from our Melbourne, Florida office.

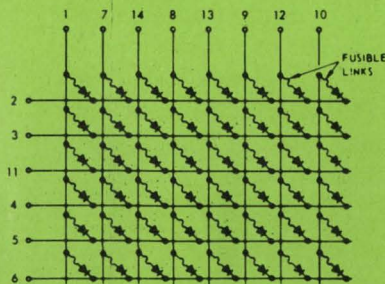

BEFORE "CUSTOMIZING"



Radiation 6 x 8 Monolithic Diode Matrices\* (typical limits)

Characteristic	Symbol	RM-30	RM-31	RM-34 RM-134†	Unit	Test conditions (T <sub>A</sub> = +25°C)
Forward drop	V <sub>F</sub>	1.0 0.7	1.3 0.75	1.0 0.7	V	I <sub>F</sub> = 20 mA I <sub>R</sub> = 1 mA
Reverse breakdown	BV <sub>R</sub>	60	60	50	V	I <sub>R</sub> = 100 μA
Reverse current	I <sub>R</sub>	7	25	70	nA	V <sub>R</sub> = 25 V
Reverse recovery	t <sub>rr</sub>	7	11	30	ns	I <sub>F</sub> = 10 mA to I <sub>R</sub> = 10 mA
Crosspoint capacitance	C <sub>cp</sub>	1.9	1.9	2.0	pF	V <sub>R</sub> = 5 V; f = 1 MHz
Coupling coefficient	I <sub>CL</sub>	20	20	20	μA	See data sheet

\*Supplied in T0-84 packages. †Supplied in ceramic dual in-line package.

All Radiation integrated circuits are dielectrically isolated.

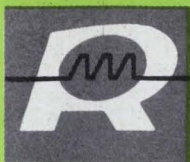

## RADIATION INCORPORATED

MICROELECTRONICS DIVISION

Sales offices: Suite 622, 650 North Sepulveda Blvd., El Segundo, Calif. (213) 772-6371—Suite 232, 600 Old Country Road, Garden City, N. Y. (516) 747-3730—Suite 201, 1725 Eye Street, N. W. Washington, D. C. (202) 337-4914—P.O. Box 37, Dept. ED-02, Melbourne, Florida (305) 723-1511, ext. 554

Use of Radiation's RA-238 Operational Amplifier greatly simplifies design of ultra-precision DC current sinks, as illustrated below. First, absolutely no external stabilization is required.

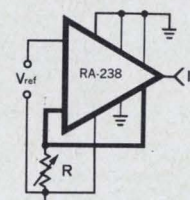

And second, in a practical system, this stable dielectrically isolated amplifier contributes typically less than 0.04% error in the total sinking current.

Hence, accuracy depends on the external voltage reference source (V<sub>ref</sub>) and the precision control resistor (R). Precise control is maintained over a 25:1 current range.

The following expression for sinking current applies:

$$I_{in} = \frac{V_{ref}}{R} \left[ 1 - \frac{1}{|A_{OL}|} \right]$$

Where A<sub>OL</sub> = open loop gain.

Further, performance data of Radiation's RA-238 in this application indicates its unusual design flexibility:

Current range = ΔI<sub>in</sub> = 0.2 to 5.0 mA  
Voltage range = ΔV<sub>in</sub> = +10 to -30 V  
Equivalent load presented: > 50 MΩ  
< 3 pF

For further information, see our ELECTRONICS ad of February 6.

Radiation's line of IC operational amplifiers opens the door for integration of systems requiring high-performance analog circuitry. These amplifiers provide the ideal 6 dB per octave high frequency roll-off required for unconditional stability in operational feedback connections *without* use of external compensation . . . even in the critical unity gain configuration.

Three types are available now in T0-84 flat packages: general-purpose, broadband, and high-gain amplifiers.

Write for data sheets. *Worst-case limits* are included, as well as all necessary design information. We'll also be glad to send you our new manual, Operational Amplifier Technical Information and Applications, ROA-T01/A01. Contact our Melbourne, Florida office for your copy.





# Switch from hot to cool with one of these three solid-state motor speed control circuits. Thermistors team up with Diacs and Triacs to do the job.

Solid-state motor speed controls can improve the performance of both heating and air-conditioning systems by reducing temperature variations and drafts, and by lowering noise level.

Three types of heating/cooling systems have been equipped with this type of control with resulting performance improvement. The systems so equipped are:

- Furnace systems.
- Fan-and-coil heat exchanger systems.
- Room air-conditioning systems.

All three use an induction motor, preferably of the permanent-split-capacitor (PSC) type, for driving the fan or blower.

Motor speed control is accomplished by controlling the ac voltage applied to the motor. Since the viscous load of the fan is an exponential function of speed, the required torque drops very rapidly as speed is decreased, providing a reasonably good match to the inherent characteristics of the induction motor operating from a variable voltage supply.

The type of bearing used in the motor is an important factor in the choice of speed control system. Most of the sleeve bearings now in use begin to lose their hydrodynamic film of oil below a certain critical speed. This loss of oil can result in a large reduction in bearing life and therefore requires the use of a control system that limits the lowest speed of the motor to a value that will maintain the oil film. Ball bearings, although more expensive, do not have this speed restriction and operate satisfactorily down to zero speed.

Speed control circuits for each of the three systems will be covered, starting with a furnace heating system.

## Thermistor sets minimum speed

In the customary furnace central heating system, the room thermostat controls the action of the burner and a second thermostat mounted in the bonnet controls the action of the blower. When

the room thermostat calls for heat, the burner is energized and bonnet temperature begins to rise. When bonnet temperature reaches a predetermined high-temperature limit, the blower is energized to circulate the heated air. When the room thermostat is satisfied and de-energizes the burner, the blower continues to run until the bonnet temperature drops below a given low-temperature limit at which point the blower is turned off. This on-off cyclic action results in room temperature variations that are beyond the control capability of the room thermostat.

A solid-state speed control (Fig. 1) for the furnace blower replaces the bonnet thermostat with a thermistor. This circuit provides continuous control of blower speed in response to bonnet temperature. It also limits the minimum speed at which the motor can run in order to protect the bearings, and to maintain a gentle circulation of air through the heating system which greatly reduces temperature gradients throughout the house. When the room thermostat energizes the

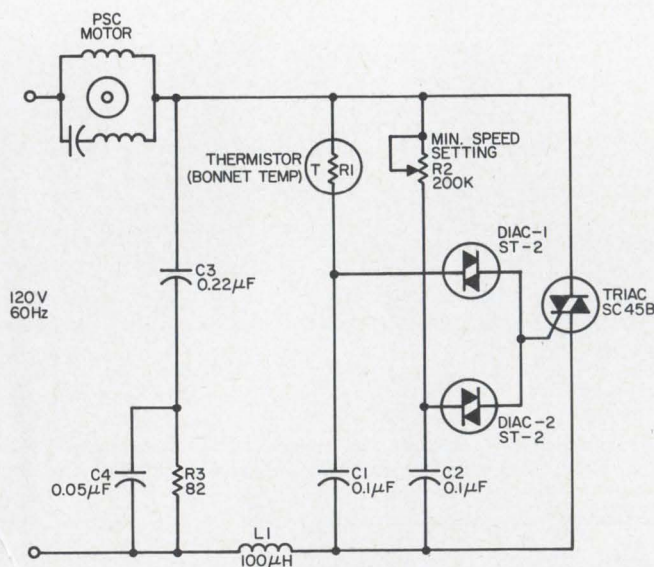

1. A thermistor replaces the thermostat normally located in the bonnet of a furnace blower. The circuit shown provides continuous control of blower motor speed. It also limits the motor's speed to the minimum value permitted for bearing protection.

E. Keith Howell, Manager, Light Industrial and Consumer Controls Applications Engineering, General Electric Company, Auburn, N. Y.



burner, the blower speed will increase gradually as bonnet temperature increases. Heat is thereby distributed to the house as soon as it is available from the burner. The thermostat then has the opportunity to turn off the burner long before the full capacity of the system is reached. This effect greatly reduces the temperature excursions that can be experienced in mild weather. Under mild heating load conditions, the blower may never need to reach full speed in order to maintain proper temperature. Similarly in severe weather, the blower may never reach minimum speed because of the high demand for heat.

The circuit of Fig. 1 uses a Triac (ac switch) which is turned on at controlled points within each half cycle of the supply frequency in order to control the voltage applied to the motor. The bonnet temperature thermistor has a resistance on the order of 100,000 ohms at 78°F. At this resistance level, the time required to charge *C1* to the breakover voltage of *Diac-1* will be long and the Diac will trigger the Triac late in each half cycle thereby producing a low motor speed. Since this speed may be too low for the particular type of motor used, a second Diac may be used with adjustable resistor *R2* set to produce the desired minimum speed. By the use of the two trigger circuits, the Diac which produces the first pulse in each half cycle has control of the Triac. At high temperatures, when the thermistor resistance is

low, *Diac-1* will produce the first triggering pulse, running the motor at higher speeds. As temperature drops, thermistor resistance increases and *Diac-1* fires later in each half cycle. Eventually, *Diac-2* wins the race and fixes the firing time of the Triac at a predetermined point, thus limiting the minimum speed which can be obtained with the motor. The low speed may also be limited by placing a fixed resistor in parallel with the thermistor instead of using the auxiliary Diac circuit. However, this greatly reduces the rate of change of speed with temperature and the motor will never reach minimum speed under normal operating conditions.

### Fan-and-coil system heats and cools

In many commercial systems, hot or cold water is pumped through heat exchanger coils in each room and a blower transfers the heat to the room air. A central unit maintains the water at the desired hot or cold temperature while a thermostat in each room turns the blower on and off to maintain desired room temperature. An automatic blower speed control for the fan and coil system is shown in Fig. 2.

In this system, the primary control is the thermistor which senses room air, replacing the room thermostat control. Unlike the furnace control system, where the thermistor must control motor

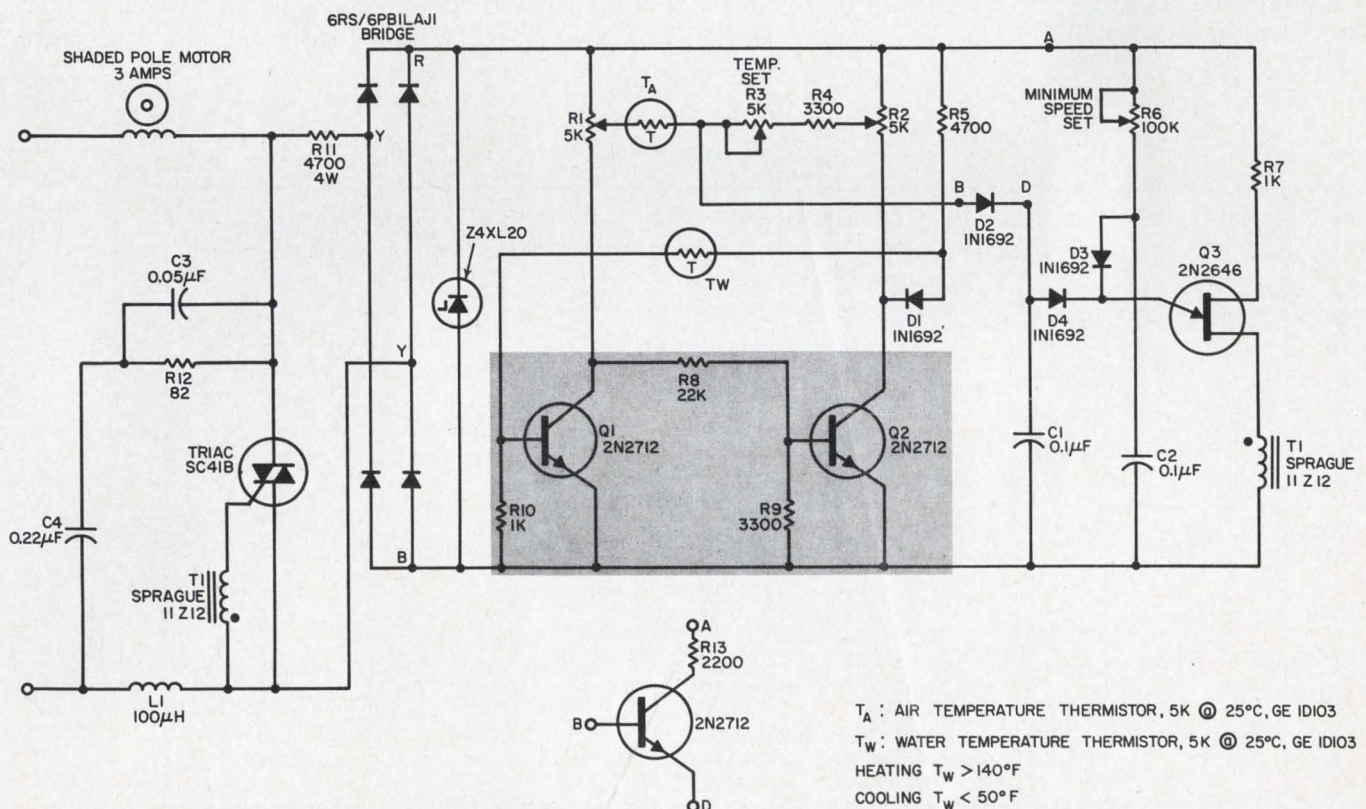

2. Fan-and-coil systems used for both heating and cooling require that the "sense" of the control be reversed for the two conditions. When heating, a room temperature

increase must decrease blower speed and vice versa. The transistor flip-flop formed by Q1 and Q2 accomplishes this "sense inversion."



speed from minimum to maximum over a temperature range from 80°F to 180°F, the thermistor in the fan-and-coil system must control blower speed from minimum to maximum over a very narrow temperature range, about 2°F. Since such a small change in temperature represents only about 5% change in thermistor resistance, a high "gain" is required in this control system. The circuit of Fig. 2 uses the ramp-and-pedestal concept to obtain the required gain.<sup>1</sup>

Since the same fan-and-coil system is used for both heating and for cooling, the "sense" of the control must be reversed for these two conditions. In the heating condition, an increase in room temperature must decrease fan speed whereas, in the cooling condition, an increase in room temperature must result in an increase in motor speed. This "sense inversion" is accomplished in the circuit of Fig. 2 by a transistor flip-flop circuit that is controlled by a second thermistor mounted on the heat exchanger to measure water temperature. This circuit is designed to switch the control sense when water temperature reaches approximately nominal room temperature. This point was selected so that the heating or cooling function cannot become regenerative if the water temperature changes slowly.

At low water temperature, in the cooling condition, the water temperature thermistor  $T_w$  is in a high-resistance condition,  $Q1$  is not conducting and  $Q2$  is conducting. An increase in room air temperature will cause the air-sensing thermistor  $T_a$  to decrease in resistance, increasing the pedes-

tal voltage applied to capacitor  $C1$ , and causing the unijunction transistor  $Q3$  to trigger earlier in the cycle and provides more power to the motor. In the heating condition,  $T_w$  is at low resistance,  $Q1$  is conducting, and an increase in air temperature reduces the pedestal voltage applied to capacitor  $C1$ , thus reducing power applied to the motor.

As in the case of the furnace blower control, this system may also require a minimum speed limit. This function is shown in Fig. 2 wherein  $R6$  and  $C2$  form an independent timing ramp that is applied to the unijunction transistor through the diode matrix  $D3$  and  $D4$ . Thus, whichever capacitor reaches the threshold voltage of the unijunction first has control of the system. Since the minimum speed limit function provides a gentle circulation of air at all times, the use of a sleeve-bearing motor may not provide accurate temperature control under very mild weather conditions. For use with a ball-bearing motor, Capacitor  $C1$  may be connected directly to the unijunction transistor emitter, then resistor  $R6$ , capacitor  $C2$ , and the diode matrix  $D3$  and  $D4$  may be eliminated.

#### Air conditioner is sensitive to line voltage change

A fan speed control for the room air conditioner is shown in Fig. 3. This control, like that used for the fan-and-coil system, is also a high-gain system since the thermistor senses room air and must control fan speed from minimum to maximum over a narrow temperature range. The minimum speed function is accomplished by a diode matrix on the pedestal voltage, rather than on the ramp

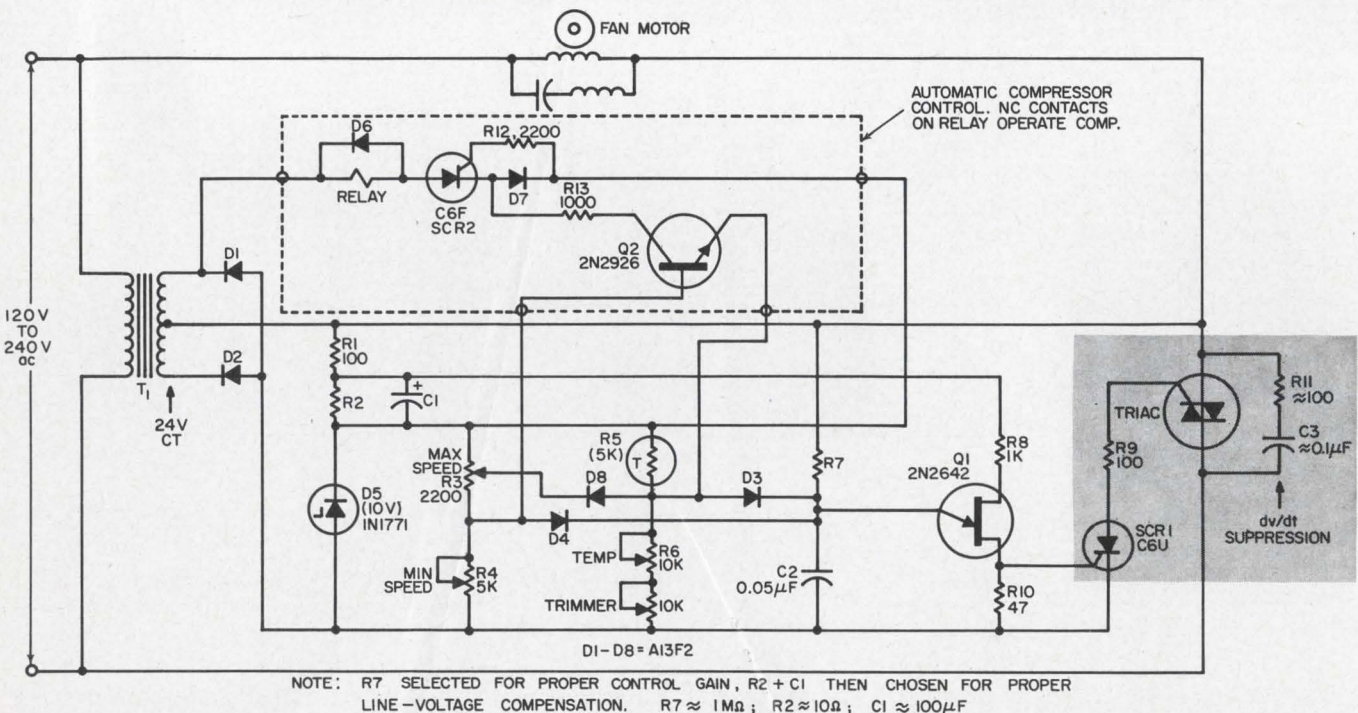

3. Maximum motor efficiency and minimum noise in air-conditioning systems are assured by the symmetrical,

full-wave control of inductive motor load using a pilot SCR driving the gate of the Triac.



as shown in the previous circuit. An optional sensing circuit, shown in the dotted line enclosure of Fig. 3, energizes a relay to turn off the compressor motor when the thermistor is calling for a speed lower than the minimum speed limit. This function is provided to avoid the mild-weather problems of temperature overshoot and freeze-up of the evaporator coils.

The circuit of Fig. 3 provides several additional functions not performed by the fan-and-coil circuit. Compensation is provided for changes in line voltage in order to maintain accurate temperature control and to hold the minimum speed at the desired level. Since speed is sensitive to applied voltage in the low speed range, this compensation for changes in line voltage can be important. To prevent overdriving the motor under high line-voltage conditions, the maximum speed may be limited by the potentiometer  $R3$  and diode  $D8$ . Compensation is provided by resistor  $R2$  and capacitor  $C1$  which must be selected according to the value of  $R7$ .<sup>1</sup> This circuit also provides symmetrical, full-wave control of the inductive motor load by the use of a pilot SCR driving the gate of the Triac. Symmetry is achieved by referencing the control circuit to the line voltage through transformer  $T1$  and by the continuous gate current after triggering provided by the SCR.<sup>2</sup> This mode of operation ensures maximum motor efficiency and minimum noise generation in the motor.

### General design considerations

There are several problems which can be successfully overcome when working with inductive loads controlled by the switching semiconductors such as the Triac.<sup>1,2,3</sup> The phase shift between load current and line voltage can result in malfunctioning of the control unless certain precautions are observed. Since the Triac can turn off only when the current goes through zero, this turn-off will occur after the beginning of the next half cycle and a finite line voltage will exist at that time. Thus, when the Triac does turn off, that line voltage will appear across the Triac rather rapidly. If this rate of change of voltage appearing across the Triac is too great, the Triac will fail to commutate and will remain in the conducting state. The corrective measure for this effect is to use a capacitor in parallel with the Triac to limit the rate at which voltage can change, and a resistor in series with the capacitor to limit the discharge current into the Triac and to damp any tendency for the circuit to oscillate. This function is accomplished in Fig. 1 by  $C3$  and  $R12$ , and in Fig. 3 by  $C3$  and  $R11$ . The phase shift between current and voltage can also result in nonsymmetrical triggering from one half cycle to the next when the control circuit begins the timing function only after the voltage appears across the Triac. The

lack of symmetry in the control produces a dc component in motor current which has a braking effect upon the motor that increases motor losses and audible noise. Fortunately, many motors will work with the types of circuits shown in Fig. 1 and 2 which derive the reference for the timing from the voltage across the Triac. The circuit of Fig. 3 fully corrects for the inductive load and will provide symmetrical operation, particularly at the very low speeds where nonsymmetry may begin to be apparent in the other circuits.

Whenever a switch closes, be it mechanical or semiconductor, the abrupt change in voltage and current will generate radio frequency interference (RFI). The inductance of the motor is not effective in suppressing the RFI generated in these switching circuits. Shunt capacitance and core losses associated with the motor windings reduce their ability to suppress RF. Adequate suppression may be obtained by the use of a critically damped filter consisting of  $L1$ ,  $C3$  and  $C4$  and a damping resistor (Figs. 1 and 2). The inductor  $L1$  is wound on a ferrite core with a wire size adequate to handle the motor current. The inductor limits the rate of rise of current through the circuit while the capacitors limit the rate of change of voltage across the Triac. The 82-ohm resistor damps this LC circuit in order to prevent oscillation of current in the capacitor, inductor, and Triac loop which would tend to turn the Triac off shortly after it had been turned on. This same RFI suppression network may be used with the circuit of Fig. 3 instead of, or in addition to, the  $dv/dt$  suppression network shown.

The use of a higher rotor resistance in the motor will result in operation at higher slip frequencies and produces a smoother speed-torque characteristic which results in improved system stability at low speeds and under certain loading conditions. At lower speeds, the reduction in normal air flow can result in increased winding temperatures in the motor unless the motor has been designed for this operation. The line voltage compensation circuit of Fig. 3 can be used to alleviate the motor problems encountered with high line voltage. A motor for use with this circuit would be designed to operate at a maximum voltage of approximately 100 volts. The circuit can then be designed to regulate motor voltage so that the design voltage is never exceeded under any condition of line voltage or demand for speed from the thermistor. This can result in a more efficient and more economical motor design. ■ ■

### References:

1. Silicon Controlled Rectifier Manual, General Electric Company Auburn, N. Y.
2. Phase Control SCR's With Transformers and Other Induction Loads Application Note 200.31, F. W. Gutzwiller & J. D. Meng, General Electric Company, Auburn, N. Y.
3. Triac Control for AC Power, Application Note 200.35, E. K. Howell, General Electric Company, Auburn, N. Y.



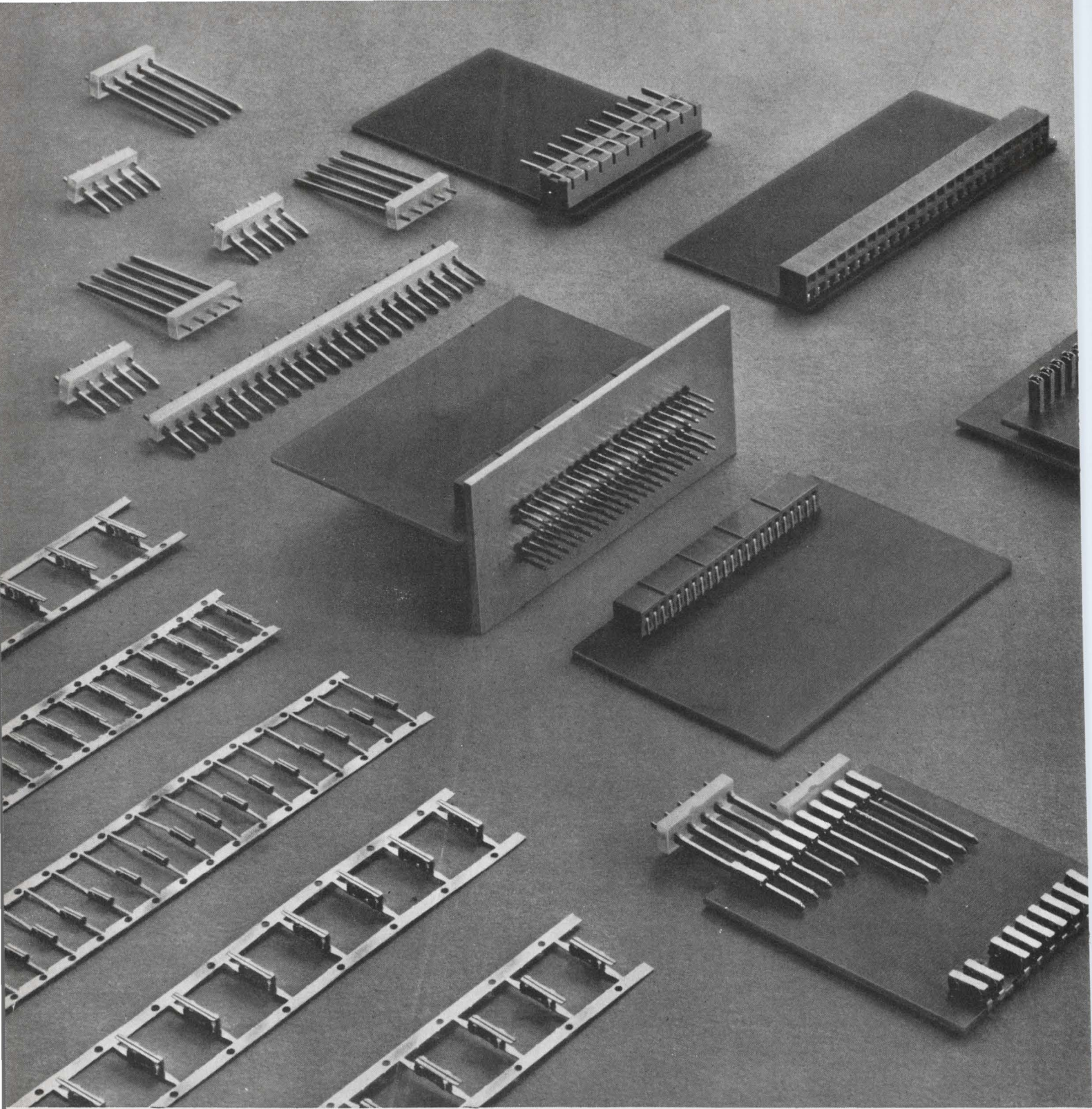

## Go modular the easy way

This entirely new approach to modularization is the AMPMODU\* Interconnection System. It permits almost unlimited design flexibility, high production speed, and economies resulting from automation and low per line cost.

Specifically designed for modular applications using printed circuit boards, it enables mounting module cards at 90° to a mother board, stacking them, or putting them end to end. The female contacts may be staked directly to a printed circuit board or enclosed in molded housings. Male contacts may be staked directly to a printed circuit board, used in nylon incremental connectors, or mounted with nylon bushings in aluminum grid plates. Two sizes of contacts are available: the standard size, which uses .031 x .062" posts for mounting on .156" centers, and the miniature size, which uses .025 x .025" posts for mounting as dense as .100". Electrical and mechanical efficiency are enhanced by the simplicity of the female contact design, which includes dual cantilever-beam springs for redundant contact action and anti-overstress devices to ensure reliability. The long life of the phosphor bronze contacts is a result of AMP's special gold plating. New modular ideas don't have to dead-end at the design stage. For information on how you might use the AMPMODU Interconnection System to modularize your product and lower your costs, write us today.



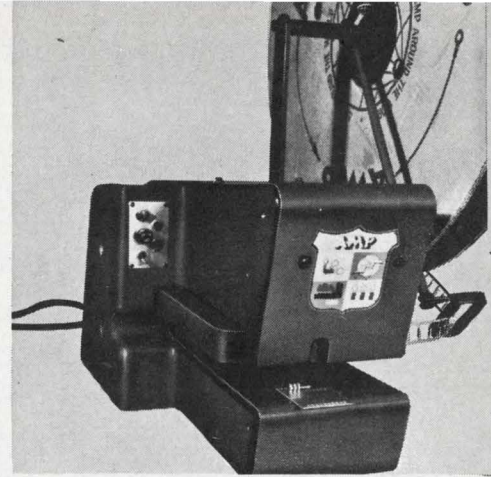
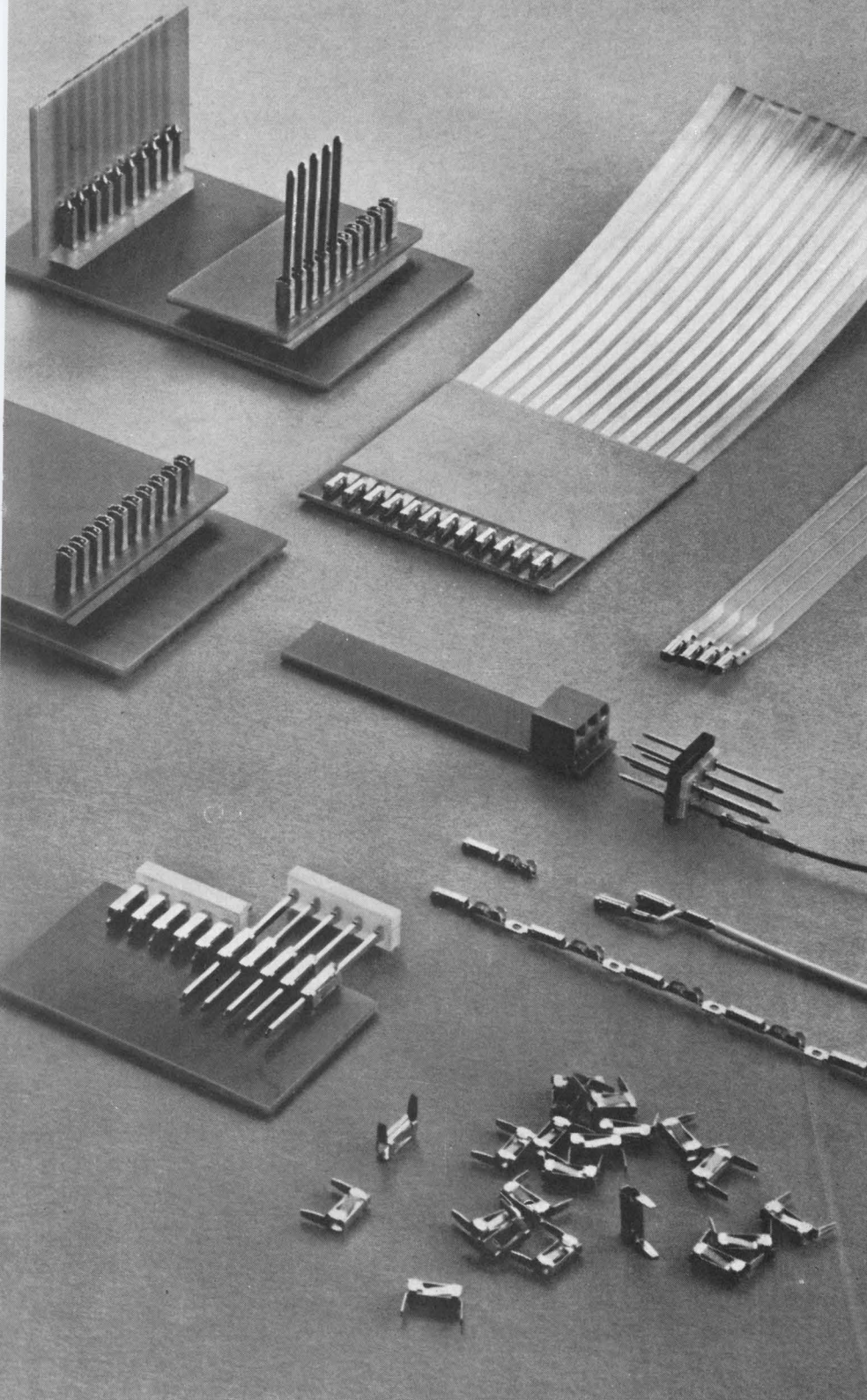

Automatic machines can stake contacts to printed circuit boards at rates of up to 1800 an hour

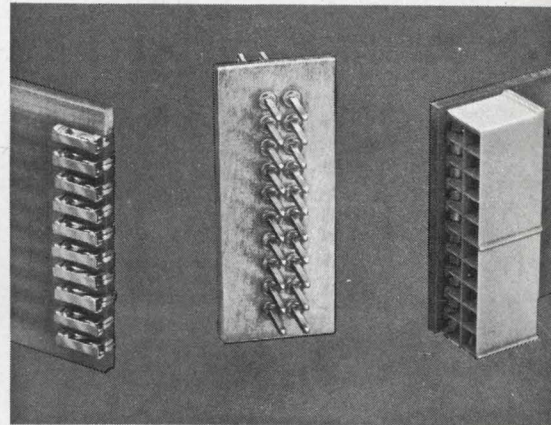

Miniature AMPMODU contacts may be mounted ten to the inch

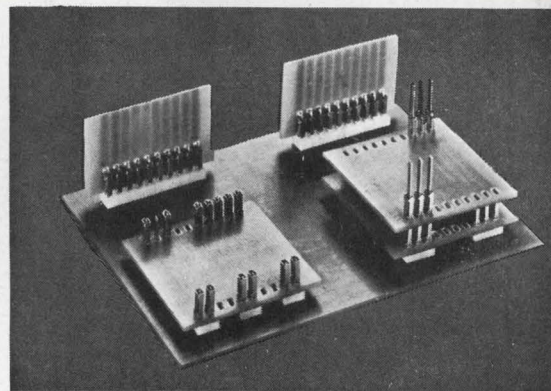

The AMPMODU female contacts may be mounted in one of three ways for modular connection versatility

ON READER-SERVICE CARD CIRCLE 45

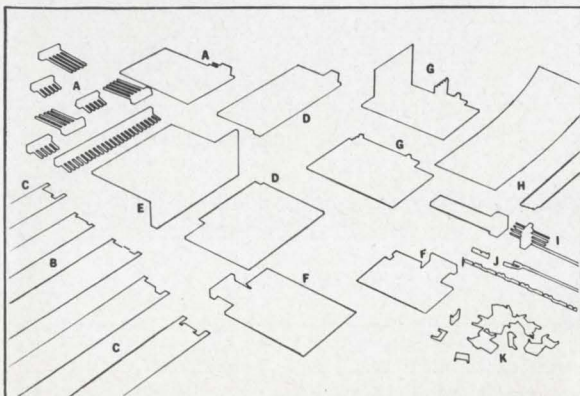

- A. AMPMODU Male Incremental Connectors
- B. Miniature AMPMODU Female Contacts in strip form
- C. Standard AMPMODU Female Contacts in strip form
- D. Miniature contacts in two-row housings
- E. Grid Plate Header
- F. Horizontally staked AMPMODU Contacts with incremental connectors
- G. Vertically staked AMPMODU Contacts
- H. Flexible tape cable AMPMODU Connectors
- I. Molded-in AMPMODU Pin Header and printed circuit board connector
- J. Miniature Crimp-Barrel AMPMODU Female Contacts
- K. Individual Standard AMPMODU Female Contacts

**AMP**  
INCORPORATED  
Harrisburg, Pennsylvania



# Pinpoint your profits during the negotiation of incentive contracts. This nomograph enables you to evaluate any contract variable quickly.

The government often offers a fixed-price-incentive-fee (FPIF) contract when there is uncertainty what development or production work will cost. Though these contracts are designed to yield a return, a careless manager may find that his company cannot execute a multimillion dollar contract at a profit.

A nomograph that indicates profit at a glance can be a very valuable tool during contract negotiations. And it is one that design engineers can use readily.

In negotiations, incentive formulas are generally proposed after the stipulations about performance of the contract, cost target, and other terms have already been discussed and evaluated. Since the incentive bonus is based on performance in relation to target cost, it is essential, if the incentive is to be meaningful, for the target cost to be realistic. If the negotiated target is too low, the seller will lose money in trying to fulfill the contract, however the incentive bonus is divided between seller and government. It is equally important to realize that every contract has a ceiling price: the maximum amount that the buyer will pay, even if the seller spends a great deal more than planned to perform on schedule.

## Nomograph pinpoints profits

The nomograph in Fig. 1 determines the value of any single parameter when the values of all the other parameters are given. The special advantage in using a nomograph of this sort is that it gives a visual assessment of the financial consequences of different completion costs.

The operation of the nomograph can best be illustrated by an example. The proposed contract in this case specifies the following:

Target profit = 12% of target cost.

Share = 25% (the portion of any savings on, or expenses above, target cost that accrue to the seller).

Ceiling price = 120% of target cost. (This is the most the government will pay for fulfillment of the contract.)

**George O. Thogersen**, Program Director, Airborne Instruments Laboratory Div., Cutler-Hammer, Inc., Deer Park, N. Y.

The nomograph can evaluate, for example, the following:

- A. Profit in the event of 10% underrun (if actual cost is 10% below target cost).
- B. Profit in the event of 15% overrun (if actual cost is 15% over target cost).

Here is the step-by-step construction (Fig. 2):

*Step 1:* Draw the horizontal 12% profit line.

*Step 2:* Draw the 120% ceiling price line.

*Step 3:* Construct a line from the intersection of these two lines to a point on the target cost axis that is higher than the profit line by a percentage equal to the ceiling price minus 100% (in this case, 20%).

*Step 4:* Draw a line from the origin (target cost = 100, profit = 0) to the point on the share arc that represents the share (in this case, 25%). Now you are ready to read the profit at any overrun or underrun. For the two examples:

- A. Profit at 10% underrun = 14.5% of target cost.
- B. Profit at 15% overrun = 5.0% of target cost.

The nomograph also shows a very important

## Learn contract terminology

<b>Target cost</b>	The negotiated cost of contract performance. It generally represents a compromise between the buyer's and the seller's estimates of cost.
<b>Overrun-underrun</b>	The difference between the cost of the completed contract and the target cost.
<b>Target profit</b>	The negotiated profit, generally expressed as a percentage of target cost.
<b>Share</b>	In the event of an underrun, the portion of the savings that may be kept by the seller. In the event of an overrun, the seller must pay out the same percentage of the extra costs.
<b>Ceiling price</b>	The maximum amount the buyer will pay for performance of the contract, expressed as a percentage of the target cost.



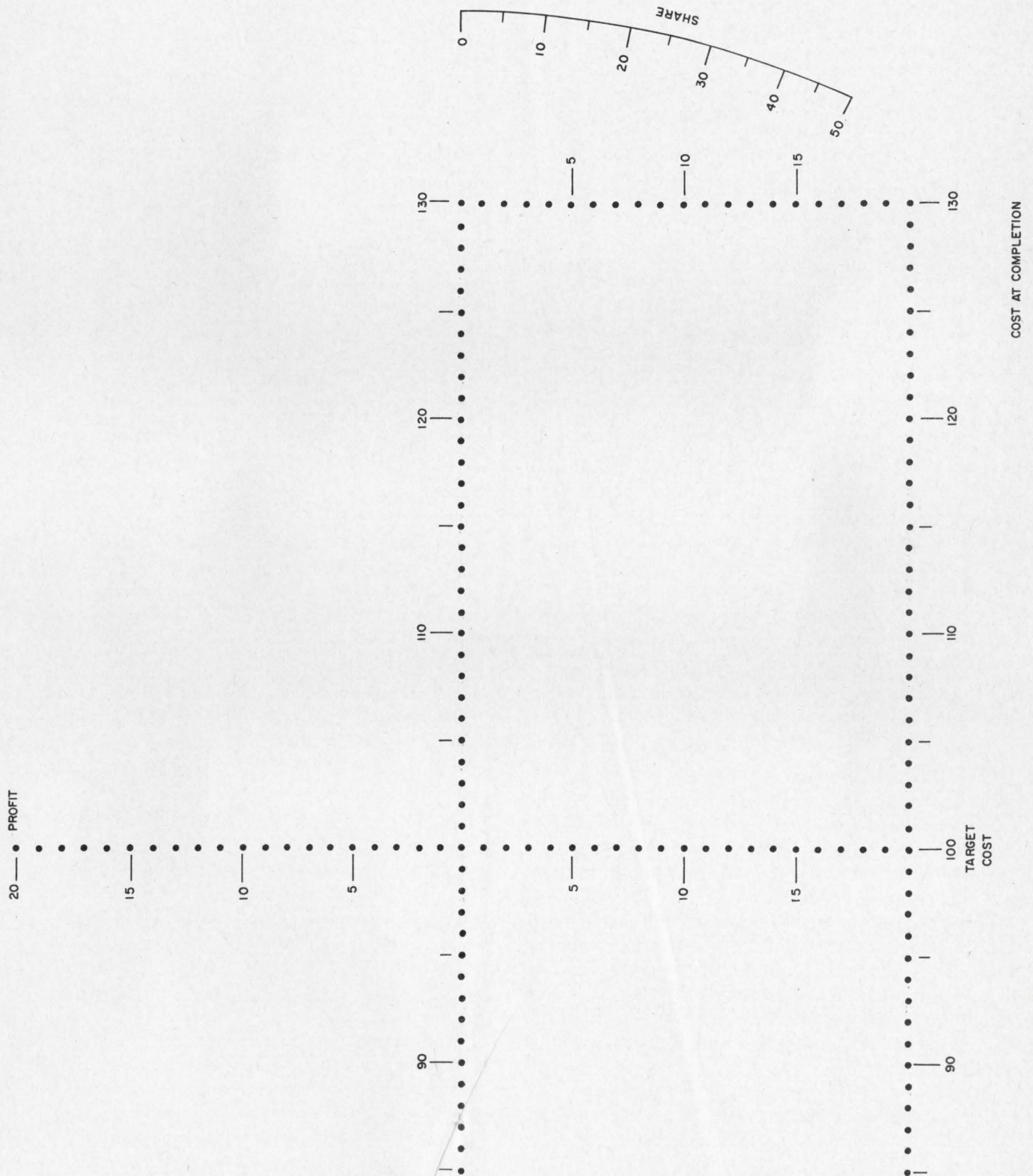

1. Use this nomograph to determine the important parameters when negotiating an incentive contract be-

tween your firm and the government. For a free vellum master, circle Reader-Service number 110.



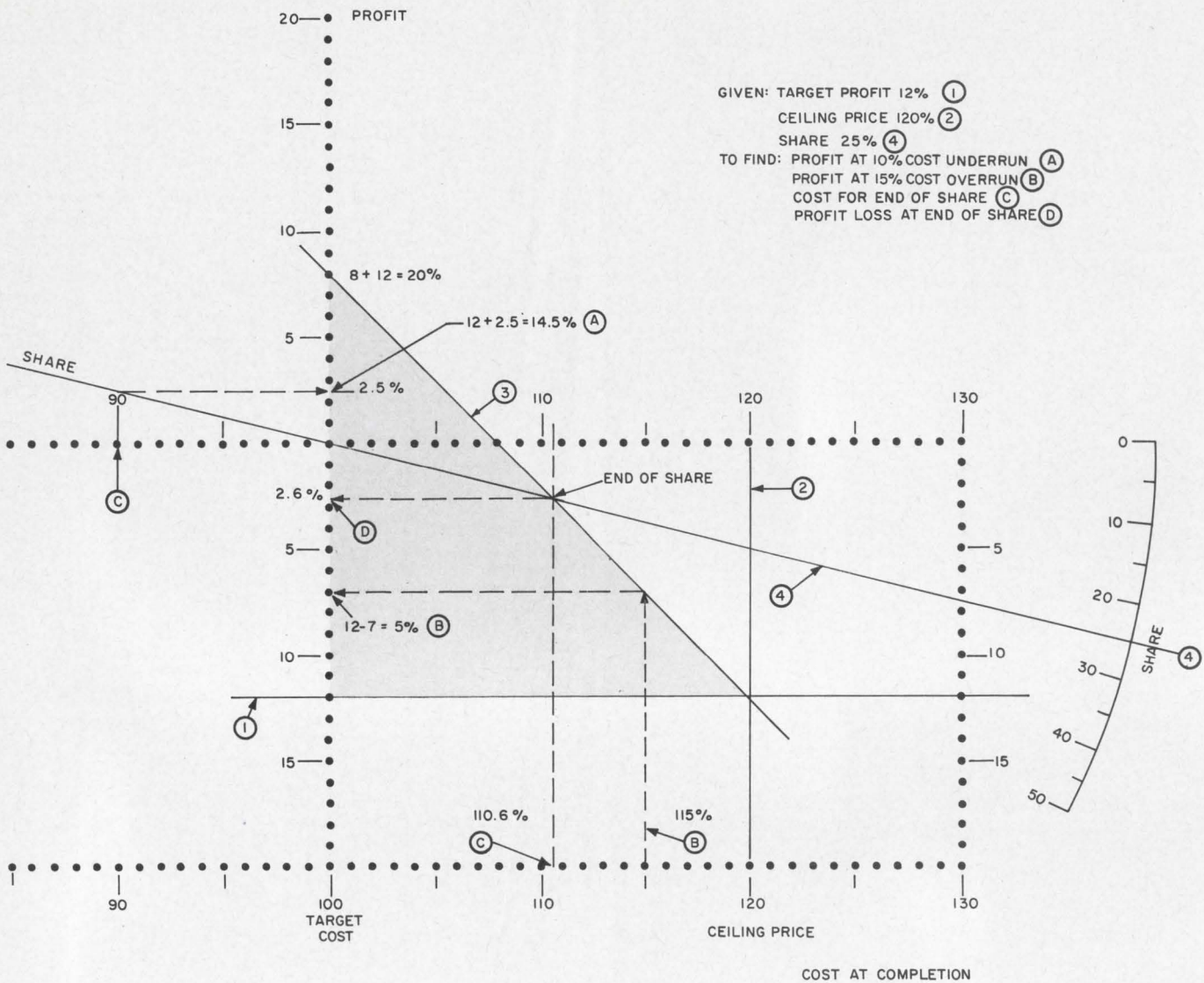

ALL NUMBERS EXPRESSED AS  
A PERCENTAGE OF TARGET COST

2. The government stops sharing excess costs when a firm's expenditure exceeds the end-of-share point (in this case, 110.6% of target cost). Profit falls gradually (along

line 4) as the cost of contract fulfillment rises. After the end-of-share point it plunges along a 135° slope until the seller loses money when cost hits the ceiling.

point—the “end of share.” When the seller exceeds this expenditure point during performance of the contract, the government ceases to pay its share of costs that are in excess of the target cost. Any further spending comes out of the seller's profits at the full rate. In the example in Fig. 2, the seller loses only 25% of the overrun cost until 110.6% of target cost is spent (C). At that point, the seller's total profit loss is 2.6% of target cost (D). Thereafter, all further expenses come entirely out of his remaining 9.4% profit. No wonder the location of this point should be of great concern to the manager!

It can also be expressed mathematically:

$$\text{End of share} = 100 + 100 (CP - P - 100) / (100 - S)$$

where:

CP = Ceiling price as percentage of target cost.

P = Target profit as a percentage of target

cost.

S = Share.

In the example, CP = 120%, P = 12%, S = 25%. Hence:

$$\begin{aligned} \text{End of share} &= 100 + 100(120 - 100 - 12) / \\ &\quad (100 - 25) \\ &= 100 + 800/75 \\ &= 110.6\% \end{aligned}$$

### Nomograph assigns value to any variable

The nomograph serves equally well to determine the value of any one of the other points of interest. For instance, given cost, share, target and profit, it will show the permissible ceiling.

Any reader who wants additional copies of this nomograph will be sent a vellum master if he simply circles number 110 on the Reader-Service card at the back of this issue. ■ ■



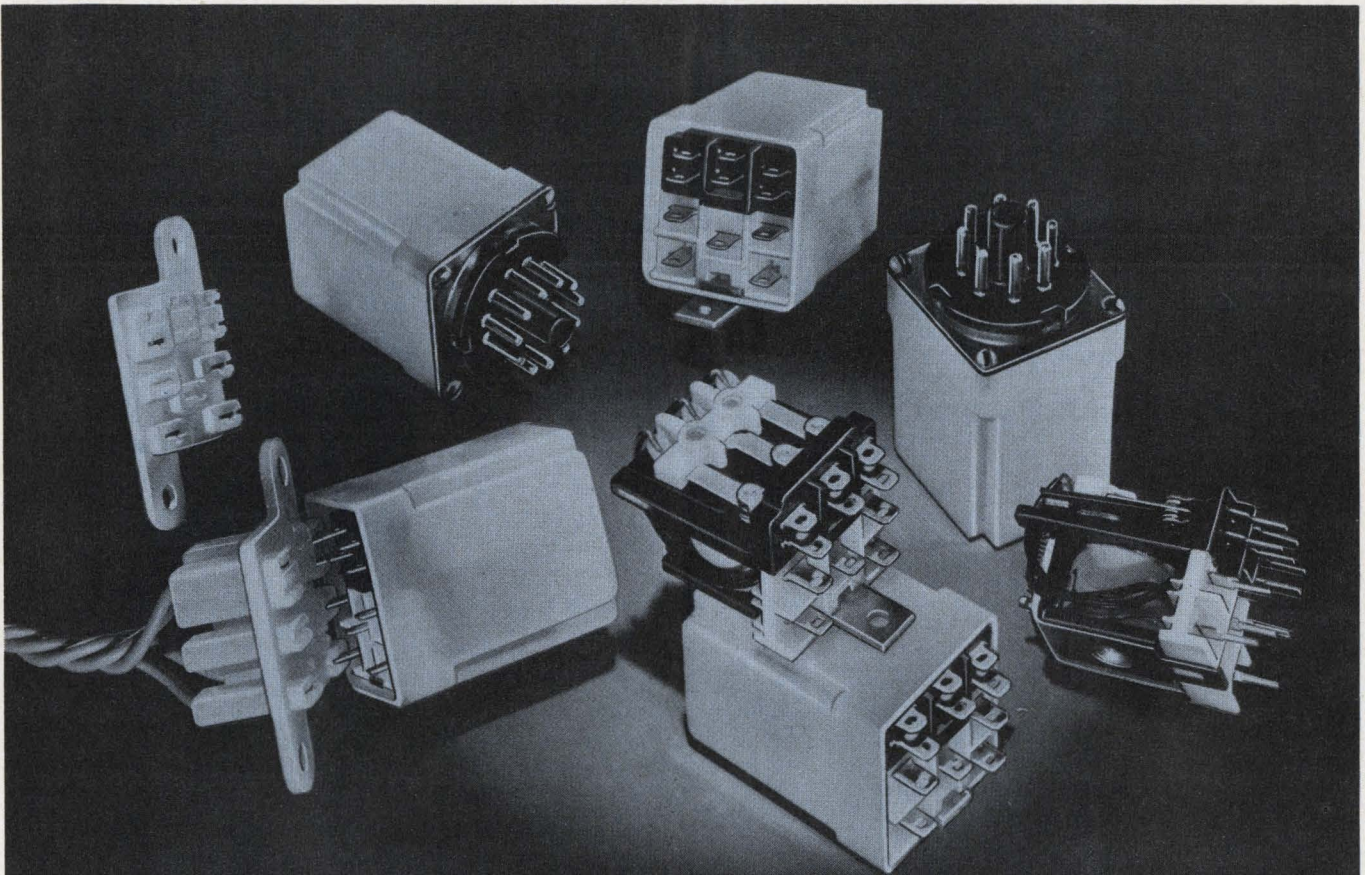

## NEW 3PDT SWITCHING RELAYS are most "versatile" and "real cost savers"!

**AC AND DC MINIATURE RELAY** users have been presented with new cost-saving opportunities with the introduction of the RBM CONTROLS line of 3 pole double-throw switching relays.

The new **Type 93** line includes both open and enclosed types, and is characterized by their rugged construction features, conservative ratings, versatility, and, above all, by several important cost-reducing features.

**FRONT WIRING**—All terminals, both coil and contacts, are out the front of the terminal block surface. This "everything out the front" construction makes it easier to wire, with resulting reductions in assembly cost.

Another cost-reducing feature is the one-screw, single-hole front mounting standard, which cuts both mounting and assembly time.



**← MOLDED PLUG**  
For 3/16" quick connect plug-in enclosed relay provides protection in handling and servicing.

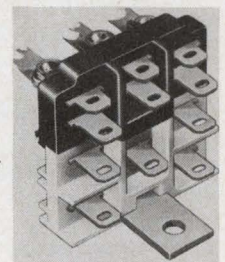

**WIRING FLEXIBILITY →**  
Both coil and contact terminals are out front for ease of wiring and low cost assembly.

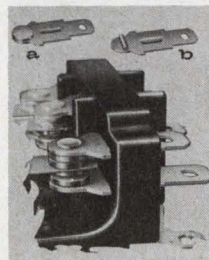

**← CONTACT FLEXIBILITY**  
Button type (a) and crossbar (b) power contacts available on same relay for multiple switching operations.

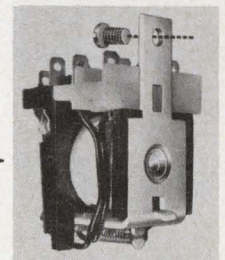

**LOW COST MOUNTING →**  
One screw, single hole standard front mounting reduces assembly time.

**UL & CSA** — Recognized under U/L Component Recognition Program and CSA with variety of contact ratings, coil voltages, and terminations.



Serving Major Markets Since 1921

# RBM CONTROLS

Division Essex Wire Corporation  
Logansport, Indiana

**RBM**  
STANDARD CONTROLS  
ARE AVAILABLE FROM YOUR  
ELECTRONIC PARTS DISTRIBUTORS



**PRODUCTION ENGINEERS  
TEST EQUIPMENT ENGINEERS**

**SOME  
PLAIN TALK  
ABOUT  
SOPHISTICATED  
COMMUNICATIONS**

At Stromberg-Carlson, we're **CAREERS** and our customers and our volume keep growing. For the first six months of 1966 our sales were running a full 24% above the corresponding period for 1965—and that was the best year in our history. You'll find a lot working for you at Stromberg-Carlson. A great salary and benefit program. A full 100% tuition refund plan. A policy of promoting strictly from within—that has moved more than 30% of our supervisors to more responsible and better paying positions just this year alone—and can do the same for you.

**Production Engineers—**

Degree in ME, EE, or IE with experience in processing electromechanical and/or electronic assemblies. Familiarity with circuitry desirable. Duties may also involve major process and product improvement. Positions available at Junior and Senior levels.

**Test Equipment Engineers—**

Degree in ME, EE with experience in electromechanical switching (relay and/or rotary) and transmission system evaluation. Most of the work is involved with electromechanical systems. Since we are entering the electronics field, we will train engineers who are experienced only in e-m systems but who desire electronics work. Work involves system evaluation, design change recommendations and determining system test requirements.

Please write, in confidence, to Mr. A. B. Kidd, Management Relations Representative.

**Stromberg-Carlson**  
A SUBSIDIARY OF GENERAL DYNAMICS CORPORATION

224 Carlson Road, Rochester, New York 14603  
An equal opportunity employer (M/F)

NASA TECH BRIEFS

**Thin-film rectifier has improved current rating**

**Problem:** Develop an improved thin-film semiconductor rectifier.

**Solution:** A cadmium selenide (CdSe)-zinc selenide (ZnSe) film is vapor-deposited onto a glass substrate, to form the required junctions between vapor-deposited gold electrodes.

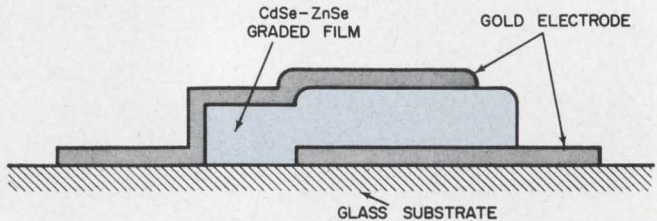

The relative proportions of CdSe and ZnSe along the thickness of the semiconductor film are varied by controlling the vapor-deposition process. In this manner, the CdSe concentration will be greater at one boundary than at the other boundary of the semi-conductor film, where junctions are formed with the vapor-deposited gold emitter and collector electrodes. The junction between the CdSe-rich portion of the semiconductor film and one gold electrode will present a relatively low energy barrier. The junction between the ZnSe-rich portion of the semiconductor film and the other gold electrode will present a relatively large energy barrier.

The magnitude of the larger energy barrier, which primarily determines the current that can be passed through the rectifier, can be varied by an applied potential to produce an asymmetrical current-voltage characteristic. The relationship between the log of the current and the square root of the voltage is linear up to a voltage determined by the ZnSe-rich boundary.

Tests on rectifier samples (0.058 cm<sup>2</sup> in area) made by this procedure yielded the following results:

Static rectification ratio at 0.4v	10 <sup>5</sup>
Forward resistance	100 ohms
Reverse breakdown potential	7 v
Forward breakdown potential	0.3 v
Leakage current at 4 v reverse bias	less than 1 microamp
Maximum forward current density	2/cm <sup>2</sup>
Shelf life (room temperature)	2000 hours

For further information, contact: Technology Utilization Officer, Manned Spacecraft Center, P. O. Box 1537, Houston, Texas, 77001, (B66-10012).



# CAREER INQUIRY – confidential

Respond to the career opportunities advertised in this issue. Fill out and send us this handy resume. **Electronic Design** will do the rest – neatly typed copies of this form will be mailed to the companies of your choice, indicated by the circled Career Inquiry Numbers at the bottom of this page.

4

<b>Name</b>		<b>Home Phone</b>	
<b>Home Address (Street)</b>		<b>City</b>	<b>State</b>
			<b>ZIP Code</b>
<b>Age</b>	<b>U.S. Citizen</b> <input type="checkbox"/> Yes <input type="checkbox"/> No	<b>Security Clearance</b>	

Prime Experience	Secondary Experience

<b>Desired Salary</b>	<b>Availability Date</b>
-----------------------	--------------------------

**Employment History – present and previous employers**

Company	City, State	Dates	Title	Specialty
		to		
		to		
		to		

**Education – indicate major if degree is not self-explanatory**

Degree	College	City, State	Dates
			to
			to

**Additional Training – non-degree, industry, military, etc.**

---



---

**Professional Societies**

---

**Published Articles**

---

**Career Inquiry Numbers:**

900	901	902	903	904	905	906	907	908	909
910	911	912	913	914	915	916	917	918	919

**ELECTRONIC DESIGN**  
850 Third Avenue  
New York, New York 10022



## COMMUNICATIONS ENGINEERS

### MICROELECTRONICS

Unusual ground-floor opportunities in microcircuit design are available at ECI for engineers who have exceptional competence in this technology. An extensive capability in microelectronics has been built and continues to develop at ECI.

A UHF digital frequency synthesizer employing integrated circuits, one of the first in the industry, is an example of technical achievements recently attained at ECI. Continuing programs deal with application of microelectronic technology to multiplex, data link, and telemetry systems and with its greater exploitation in radio communications.

Immediate professional openings involve theory and application of thermodynamics, mechanics of materials and electronic component design in the development and application of microelectronic circuitry. If you have experience and career interest in these fields, plus a BS or MS in EE or physics, you can capitalize on ECI opportunities today.



1-inch microcircuit developed at ECI for UHF digital synthesizer.

For challenging assignments in microcircuit applications programs, for opportunity in an unusual professional atmosphere, and for pleasant living on Florida's "Sun Coast," investigate ECI now.

Send your resume, in confidence, to Budd Cobb, ECI, Box 12248ED, St. Petersburg, Florida, or call him collect at (813) 347-1121. (An equal opportunity employer.)



ELECTRONIC COMMUNICATIONS, INC.  
St. Petersburg, Florida

ON CAREER-INQUIRY FORM CIRCLE 901

## Voltage supply puts out two dc voltages

**Problem:** Design an efficient circuit that will provide two different dc output voltages from an ac source without a precisely tapped transformer or dropping resistors.

**Solution:** A full-wave rectifier, connected to two passive branches, puts out the separate dc voltages through the branches.

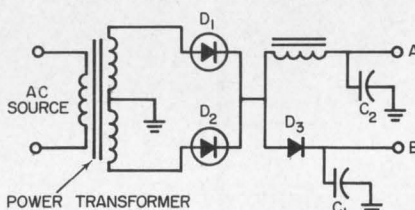

The primary winding of the power transformer is connected to the ac source, and the secondary winding is connected to the full-wave rectifier,  $D_1$  and  $D_2$ . The unfiltered output from the rectifier is fed in parallel to a conventional choke-input filter branch and a diode-capacitor branch. The diode,  $D_3$ , in the latter branch conducts on the peaks of the full-wave rectifier current and charges capacitor  $C_1$  to the peak voltage across one half of the secondary winding of the power transformer. The voltage at terminal A will be approximately 40% greater than at terminal B. The required peak inverse-voltage rating of diode  $D_3$  is only one-half the peak voltage across the full secondary winding of the transformer. The outputs have low ripple and good voltage regulation.

For maximum voltage output at terminal A, a high-conductance semiconductor diode should be used in the branch. The ratio of the output voltages may be varied by the proper choice of components.

*Inquiries concerning this invention may be directed to: Technology Utilization Officer, Lewis Research Center, 21000 Brookpark Road, Cleveland, Ohio. 44135. Refer to: B-10002.*

## Generate sine waves with sampling circuit

**Problem:** Design an electric circuit, whose output is proportional to the sine of an angle,  $\theta$ , plus or minus a fixed phase angle  $\phi$ .  $\theta$  is linearly proportional to the magnitude of the input.

**Solution:** A circuit that samples a sine wave according to the magnitude of the input signal.

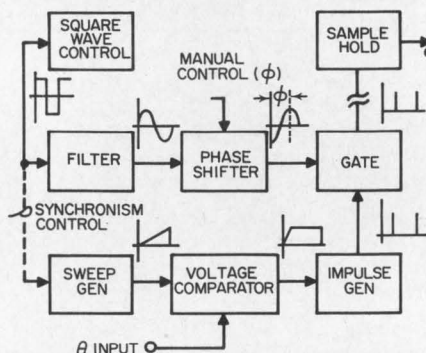

The output of the square-wave generator is filtered to recover the fundamental, which is a sine wave at the same frequency as the square wave. Simultaneously, the square wave is used to synchronize a sawtooth sweep generator. The synchronized sweep signal is one input to a voltage comparator that also receives a voltage which is linearly proportional to  $\theta$ .

When the value of  $\theta$  is equal to the magnitude of the sweep voltage, the impulse generator opens an electronic gate for a short interval. The sine wave obtained from the filter is phase shifted through a predetermined angle,  $\phi$ , and passed through the gate when the impulse generator signal is applied. Thus an impulse, whose magnitude is proportional to  $\sin(\theta + \phi)$ , is applied to the sample hold.

The synchronism control determines the frequency of sampling. The sampling rate may be as great as the fundamental frequency of the square wave. The greater the sampling rate, the more accurately the output will represent  $K \sin(\theta + \phi)$ , as  $\theta$  varies with time.

*For further inquiries, contact: Technology Utilization Officer, Manned Spacecraft Center, P. O. Box 1537, Houston, Tex. 77001. Refer to: B66-10038*



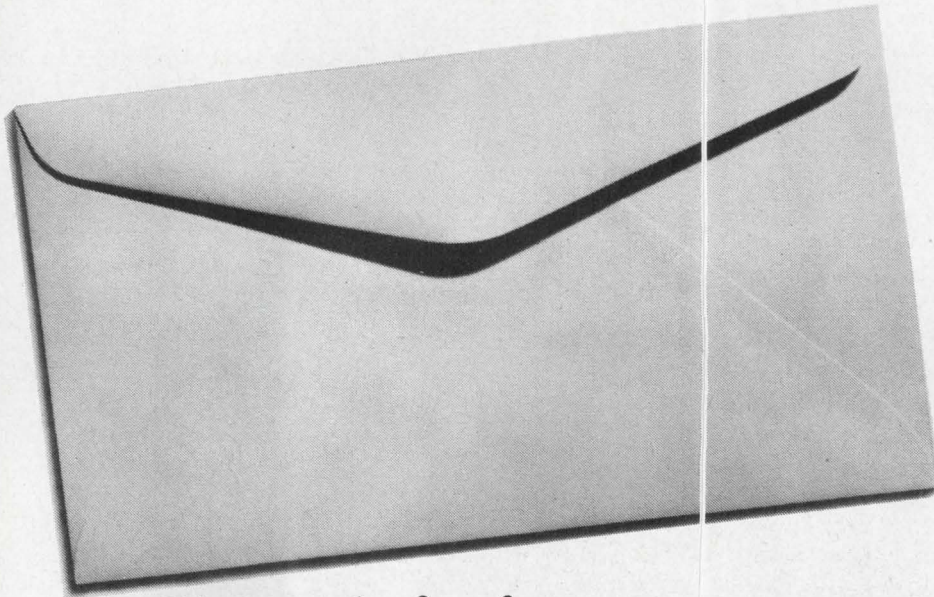

# Seal it!

Do it now. First, check what we've got to offer. Then, clip the coupon and send it. Find out what it's like to work with some of the best people in your field, with the finest equipment and facilities, only minutes from the best colleges and universities in Southern California. You'll wonder why you didn't come to Douglas sooner. Chances are we will, too.

## **DOUGLAS**

MISSILE & SPACE SYSTEMS DIVISION  
An equal opportunity employer

*Immediate openings for engineers with BSEE, MSEE and 2-7' years experience.*

### *Antenna Systems*

Responsible for design and development of spacecraft antenna system directive arrays, both fixed and steerable. Includes system analysis, component design and development, test planning and technical direction.

### *Signal Conditioning & Packaging Engineers*

Responsible for circuit design, development, and testing of signal conditioning modules for instrumentation system. System design activities include detailed examination of measurement and monitoring system interfaces to resolve problems of impedance matching and EMC. Packaging tasks will involve integration of discrete components and integrated circuits onto printed boards, design and development of housing assemblies, and interconnected wiring between PC boards.

### *Digital Systems Designers*

Perform hardware/software tradeoffs, establish self-check philosophies, digital communications criteria, and design the resulting digital systems. Includes synthesis, system test, design, and operation of advanced digital computer-based systems.

### *System Designers*

Design and develop Mission Simulation equipment resulting in most effective utilization through tradeoff of analog/digital and hardware/software implementation. Must be capable of generating preliminary system design, and implementing that design.

### *Control Electronics Development*

Establish requirements for subcontractor-designed control electronics equipment. Monitor design and development activity, participate in design reviews, and perform independent analyses to evaluate electronic and packaging design approach and selection of components. Participate in resolution of design problems and in-house development and integration using prototype and production equipment.

Mr. K.O. MacDonald, Douglas Missile & Space Systems Division  
5300 Bolsa Ave., Huntington Beach, California 92646  
I am interested in career opportunities at Douglas MSSD.

NAME \_\_\_\_\_  
 ADDRESS \_\_\_\_\_  
 CITY \_\_\_\_\_ STATE \_\_\_\_\_  
 Degree(s) : \_\_\_\_\_  
 Field(s) : \_\_\_\_\_  
 Specialty(ies) : \_\_\_\_\_  
 U. S. Citizen  Yes  No

ON CAREER-INQUIRY FORM CIRCLE 902



# Optical reader is not affected by light intensity variations

The circuit shown in Fig. 1 will produce an output voltage ( $E_o$ ) directly proportional to the contrast ratio ( $CR$ ) of the output voltage ( $E_i$ ); that is:

$$E_o = K(CR), \text{ where } K \text{ is a constant.} \quad (1)$$

Although not limited to this particular application, the circuit can be used in an optical mark sense reader. In such a case, the input signal could be the output voltage of a phototransistor which senses reflected light from a marked document (Fig. 2). As a pencil mark passes the read station, the mark absorbs some light energy. This causes a reduction in the reflected signal to the phototransistor, and so decreases its output voltage (Fig. 3).

The magnitude of  $E_o$  is determined solely by the relative amount of change, measured as the ratio of light reflected from the background to light reflected from the mark. The  $E_o$  can be coupled into a voltage comparator where a threshold has been preset for switching. Then the output from a number of these circuits sensing a number of channels on the same document could be compared with the preset threshold. Another possibility is for the outputs of such circuits to be compared to select the channel with the maximum output voltage or contrast ratio as an aid to distinguishing erasures.

In Fig. 1,  $Q1$  is an emitter-follower which presents a high input impedance to  $E_i$ . Diode  $D1$  and capacitor  $C$  form a peak detector which stores the background voltage level. When a mark is present, the capacitor discharges into the base of  $Q2$ , which acts as a current generator.

The collector current of  $Q2$  (proportional to the background voltage level) splits, driving diodes  $D2$  and  $D3$  equally. The dynamic resistance of  $D3$  is inversely proportional to the current passing through it. As the input voltage decreases because of the mark, the change is applied to the common-

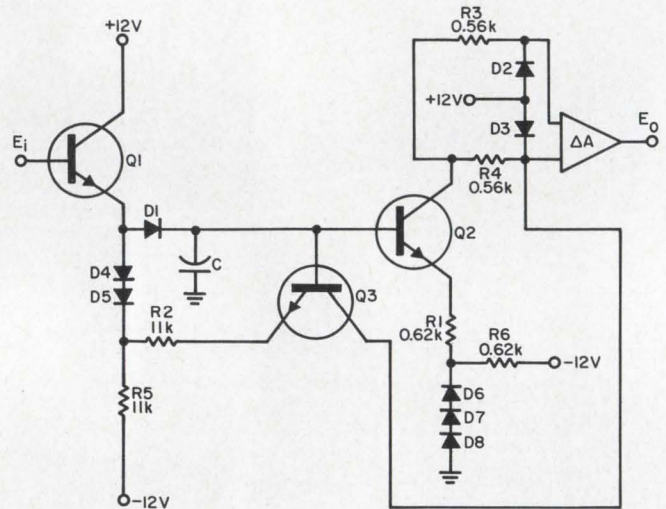

1. Contrast ratio circuit permits unambiguous optical recognition in presence of light source degradation.

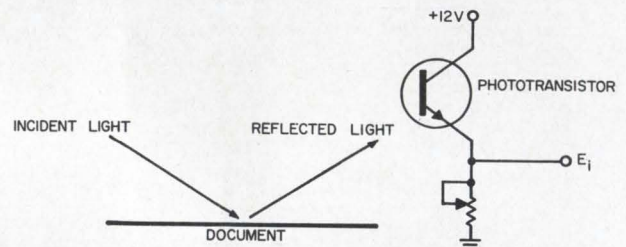

2. Input to the circuit of Fig. 1 is obtained by illuminating the document to be read and sensing the changes in the reflected light level.

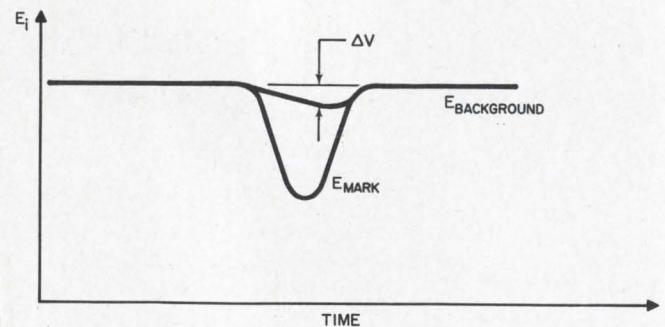

$$CR = \frac{E_{\text{BACKGROUND}} - E_{\text{MARK}}}{E_{\text{BACKGROUND}}}$$

$$0 \leq CR \leq 1$$

3. Output wavelshape of the phototransistor stage illustrates the contrast ratio sensing.

**VOTE!** Circle the Reader-Service-Card number corresponding to what you think is the best Idea-for-Design in this issue.

**SEND US YOUR IDEAS FOR DESIGN.** Submit your IFD describing a new or important circuit or design technique, the clever use of a new component, or a cost-saving design tip to our Ideas-for-Design editor. If your idea is published, you will receive \$20 and become eligible for an additional \$30 (awarded for the best-of-issue Idea) and the grand prize of \$1000 for the Idea of the Year.



REMOVE FOR YOUR FILES

# NEW 1967 *Simpson* TEST EQUIPMENT BROCHURE

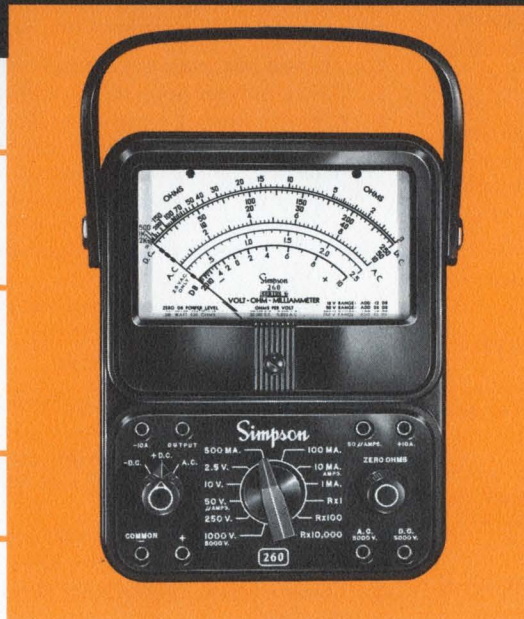
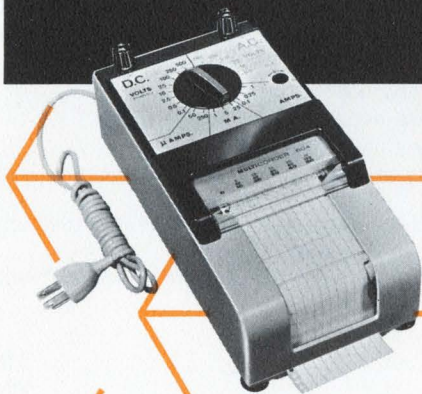

**SIMPSON ELECTRIC COMPANY**

5202 W. Kinzie Street, Chicago, Illinois 60644

Phone: (312) 379-1121

Export Dept: 400 W. Madison Street, Chicago, Illinois 60606, Cable, Simelco

IN CANADA: Bach-Simpson Ltd., London, Ontario

IN INDIA: Ruttonsha-Simpson Private Ltd., International House, Bombay-Agra Road, Vikhroli, Bombay



# Simpson 260® The World's Best Selling VOM Family of Instruments



260-5.....\$58.00



260-5M.....\$60.00



Model 261.....\$68.00



260-5P.....\$88.00



270-3.....\$70.00

## CARRYING CASES



Roll Top VOMs  
 260-5RT.....\$64.00  
 260-5MRT.....\$66.00  
 260-5PRT.....\$94.00  
 261-RT.....\$74.00  
 270-3RT.....\$76.00



Ever-Ready Vinyl  
 Carrying Case Only  
 No. 0805.....\$12.00



Utility Case  
 Cat. No. 0549  
 \$18.00



Probe Case  
 Cat. No. 0574  
 \$5.00

## WORLD FAMOUS 260®\* AC/DC Volt-Ohm-Milliammeter

**NEW IMPROVED 260®\* VOLT-OHM-MILLIAMMETER** continues as the World's largest selling VOM. Over a million instruments have been sold. Known for its reliability and ruggedness, the 260 has been continually improved to meet changing market conditions. Among the many built-in features of the 260 are:

- Movement Overload Protection.
- Self shielded Meter Movement.
- Increased linearity and stability.
- Greater repeatability.
- Input protected with an internal 1 amp fuse.
- Individual 260 instruments with special features and accuracies (Identified as 250, 255, 260-5, 5M, 261 and 270).

Complete with test leads No. 7500 and operator's manual.

260-5.....\$58.00  
 260-5M (Mirror Scale).....\$60.00

### ROLL TOP STYLES

260-5RT.....\$64.00  
 260-5MRT.....\$66.00

## NEW PROTECTED 260-5P\* AC/DC VOLT-OHM-MILLIAMMETER

This Simpson Instrument has built-in Meter and Tester protection approaching 100% which virtually makes this VOM "GOOF PROOF." The 260-5P will be of particular value in situations where the instrument may be used by inexperienced people; students, apprentices, and new employees. Technicians, too, will find the instrument ideal for exploring unfamiliar equipment, especially when lack of a schematic diagram poses the hazard of encountering unexpected high voltages when making tests.

### Combined protection not found in any other VOM.

1. Reset button pops out to indicate overload.
2. Circuits cannot be reset while overload is present.
3. Massive overloads which can cause hidden damage are not required to activate the protective circuit.
4. All ranges are protected except those not feasible in a portable instrument —1000 and 5000 volts DC and AC; 10 Amps DC.

The 260-5P has the same ranges and takes the same accessories as the Simpson 260-5 VOM.

Complete with test leads 7500 and operator's manual.

260-5P Protected (GOOF PROOF).....\$88.00  
 260-5PRT Protected Roll Top.....\$94.00

## HIGH ACCURACY 261\* and 270\*-3 AC/DC VOLT-OHM-MILLIAMMETERS

For those test VOM applications requiring higher accuracies, Simpson has combined the latest in VOM design with strict manufacturing controls to produce two popular VOM's of the 260 family, 261 and 270 Series 3.

These features include:

1. A new self-shielded annular meter movement.
2. Special calibration circuit that increases accuracy.
3. Diode overload protection. (Prevents movement burnout even on 200,000% overload.
4. Mirror scale with knife edge pointer.
5. Input protected with an internal 1 amp fuse.
6. TAUT BAND movement. (270 only)

Complete with test leads 7500 and operator's manual

Model 261.....\$68.00  
 270-3.....\$70.00

### ROLL TOP STYLES

Model 261-RT.....\$74.00  
 270-3RT.....\$76.00

\*EXCLUSIVE SIMPSON ADJUST-A-VUE HANDLE



# Designed to Meet Today's Changing Test Equipment Requirements

**New**



AC Clamp-on Adapter  
Cat. No. 0531  
... \$30.00

Model 255 ..... \$90.00

## SIMPSON'S RUGGED TAUT BAND ELECTRICAL & TEMPERATURE TESTER MODEL 255\* WITH AC AMMETER CLAMP-ON ADAPTER FACILITY

Model 255 is designed specifically for the servicemen in many fields, such as: gas appliance servicing and installation, electrical utilities, and heating service and installation. By using the AC clamp-on adapter, Cat. No. 0531, AC currents through 250 amperes can be checked without disconnecting the leads or otherwise opening the circuit. This tester includes the important VOM functions of the 260 as well as providing a temperature range of +100°F to +1050°F. A low millivolt drop is provided on the direct current ranges.

Complete with test leads with prods (Cat. No. 0115), 5 Ft. thermocouple lead (0163), and operator's manual.

Model 255 ..... \$90.00      AC Clamp-on Adapter, Cat. No. 0531 ..... \$30.00  
10,000 VAC High Voltage Probe, Cat. No. 0161 ..... \$15.00

**New**



Model 250 ..... \$63.00

## RUGGED TAUT BAND 50 MILLIVOLT DROP VOM . . . MODEL 250\*

This is Simpson's answer to transistor circuitry testing requiring a VOM with a low millivolt drop on current ranges. Model 250 contains all of the built-in features of the World's Largest Selling VOM, the 260, together with modified range coverage designed for solid state testing, plus the provision for using the add-a-tester adapters, the 260 high voltage probes and other accessories.

Complete with test leads and operator's manual.

Model 250 ..... \$63.00

### VOLT-OHM-MILLIAMMETER SPECIFICATIONS—20,000 Ω/V DC; 5,000 Ω/V AC

RANGES	250	255	260-5	260-5M	260-5P	261	270-3
DC VOLTS	0-0.050; 0-0.250; 0-2.5; 0-10; 0-50; 0-250; 0-500; 0-1000	0-0.050; 0-0.250; 0-1; 0-2.5; 0-10; 0-50; 0-250; 0-1000	0-0.25; 0-2.5; 0-10; 0-50; 0-250; 0-1000; 0-5000				
AC VOLTS	0-2.5; 0-10; 0-50; 0-250; 0-500; 0-1000	0-2.5; 0-10; 0-50; 0-250; 0-1000	0-2.5; 0-10; 0-50; 0-250; 0-1000; 0-5000				
DC MICROAMPERES	0-50 (Both 50 and 250 MV Drop)		0-50 (250 MV Drop)				
DC MILLIAMPERES	0-1; 0-10; 0-100; 0-500 (50 MV Drop)		0-1; 0-10; 0-100; 0-500				
DC AMPERES	0-10 (50 MV Drop)	NONE	0-10 (250 MV Drop)				
AC AMPERES	NONE	0-5, 0-25, 0-100, 0-250	NONE				
DB SCALE (1MW-600Ω)	-20 to +10; -8 to +22; +6 to +36; +20 to +50	NONE	-20 to +10; -8 to +22; +6 to +36; +20 to +50				
OUTPUT RANGES	NONE	NONE	0.1 mfd capacitor in series with all AC voltage ranges through 250 volts.				
RESISTANCE RANGES	R X 1 0-2000Ω (12Ω center)	R X 100 0-200KΩ (1200Ω center)	R X 10K 0-20 megΩ (120KΩ center)				
TEMPERATURE RANGE	NONE	+100° F. to +1050° F.	NONE				
ACCURACIES:							
0-50 MV; 0-250 MV; 0-2.5 to 0-1000 V DC	±2% F.S.	±2% F.S.	±2% F.S.	±1.5% F.S.	±1.25% F.S.		
0-5000 V DC	—	—	±3% F.S.	±2.5% F.S.	±2.25% F.S.		
0-50 MICROAMPERES	±1% F.S.	±1% F.S.	±1.5% F.S.	±1.0% F.S.	±.75% F.S.		
0-1 MA to 0-10 A DC	±2% F.S.	±2% F.S.	±2% F.S.	±1.5% F.S.	±1.25% F.S.		
R X 1 R X 100, R X 10,000	±2.5° of Arc ±2.0° of Arc	±2.5° of Arc ±2.0° of Arc	±2.5° of Arc ±2.0° of Arc	±2.0° of Arc ±1.5° of Arc	±1.5° of Arc ±1.0° of Arc		
0-2.5 to 0-1000 V AC	±3% F.S.	±3% F.S.	±3% F.S.	±3% F.S.	±2.0% F.S.		
0-5000	—	—	±4% F.S.	±4% F.S.	±3% F.S.		
MOVEMENT TYPE	Self Shielding Annular—Taut Band			Self Shielding Annular—Pivot and Jewel			Self Shielding Annular Taut Band
TEMPERATURE COMPENSATED	NO	NO	NO	NO	NO	NO	YES
METER MOVEMENT PROTECTION	YES	YES	YES	YES	YES	YES	YES
RESETABLE TESTER CIRCUIT PROTECTION	NO†	NO†	NO†	NO†	YES	NO†	NO†
MIRROR SCALE	NO	NO	NO	YES	NO	YES	YES
SCALE LENGTH	4.2 Inches						
DIMENSIONS	5¼" x 7" x 3½"						
NET WEIGHT	3½ lbs.						
PRICE	\$63.00	\$90.00	\$58.00	\$60.00	\$88.00	\$68.00	\$70.00

### ACCESSORIES For 250, 255, 260-5/5M/261/270

	Cat. No.	Price		Cat. No.	Price		Cat. No.	Price
10,000v DC High voltage probe...	0507	\$15.00	10,000v AC High voltage probe...	0161	\$15.00	Roll top safety case only.....	0249	\$10.00
25,000v DC High voltage probe...	0508	15.00	Banana plugs and alligator clip...	7500	2.50	Utility Carrying Case, Vinyl.....	0549	18.00
50,000v DC High voltage probe...	0509	15.00	Banana plugs and test prods.....	7538	3.00	Probe Case.....	0574	5.00
Clamp-on AC Ammeter adapter (For Model 255 only).....	0531	30.00	Leather Carrying Case.....	1818	10.00	Thermocouple lead (5 ft.) (Model 255 only).....	0163	5.00
			Ever-Redy Carrying Case.....	0805	12.00			

†1 amp fuse limits maximum current.

\*EXCLUSIVE SIMPSON ADJUST-A-VUE HANDLE



# Simpson ADD-A-TESTER ADAPTERS EXPAND SIMPSON FAMILY GROUP OF 260® VOM TEST APPLICATIONS











Before you buy any VOM consider your future test needs. Will it be a transistor tester . . . a DC VTVM . . . possibly a temperature tester . . . or maybe an AC ammeter? If so, you can use Simpson's World Famous 260, the Model 250, 255, 261 or high accuracy 270-3 VOM as the basis for these, as well as a whole "test bench" of high quality instruments. All you do is plug in

"Add-A-Tester Adapters".

As each new test need arises, you buy only an adapter; you save the cost of duplicate meters and circuitry necessary for single-purpose testers. Note: All Simpson 260 Adapters provide for normal usage without disconnecting the adapter.

Add-A-Testers cannot be used with roll top model.

ADD-A-TESTER ADAPTER DESCRIPTION	RANGES	ACCURACY										
 <b>TRANSISTOR TESTER. Model 650. \$38.00</b> Checks low and medium power transistors of the junction type. Checks Beta and ICO with an accuracy heretofore found only in laboratory type instruments. Test Lead . . . #7545 \$1.50	<b>Beta:</b> 0-10, 0-50, 0-250, (F.S.) <b>ICO:</b> 0-100 $\mu$ a	<b>Beta:</b> With 250, 255, 260 $\pm$ 5%; with 261 and 270 $\pm$ 4% <b>ICO:</b> With 260 $\pm$ 3% F.S.; with 261 and 270 $\pm$ 2% F.S.										
 <b>DC VTVM. Model 651. \$45.00</b> Ideal for general VTVM applications and transistorized circuitry. (Design and servicing) High sensitivity with laboratory type DC Coverage (10 ranges) offers higher accuracy of reading. Ground Lead . . . #0733 \$2.00	<b>Voltage:</b> 0-.5/0-1.0/0-2.5/0-5.0/0-10/0-25/0-50/0-100/0-250/0-500 <b>Input Impedance:</b> Greater than 10 meg $\Omega$ all ranges	With 250, 255, 260 $\pm$ 3% F.S.; with 261 and 270 $\pm$ 2% F.S.										
 <b>TEMP. TESTER. Model 652. \$43.00</b> Three lead hook-up. Ideal for production and engineering spot temperature measurements, servicing of heating and refrigeration devices, and for general type measurements. Normally supplied with $^{\circ}$ F scale; can be supplied with $^{\circ}$ C scale for \$1.95 additional.	-50 $^{\circ}$ F to +100 $^{\circ}$ F; +100 $^{\circ}$ F to +250 $^{\circ}$ F Three lead positions provided <b>Sensing Element:</b> Thermistor	With 250, 255, 260, 261 and 270										
 <b>AC AMMETER. Model 653. \$26.00</b> Ideal for government engineering and testing, Commercial engineering and testing, Industrial applications, general servicing, electrical installations and servicing.	0-0.25/0-1/0-2.5/0-12.5/0-25 amps <b>Frequency Range:</b> 50 to 3000 cycles	With 250, 255, 260, 261, 270 $\pm$ 3% F.S.										
 <b>AUDIO WATTMETER. Model 654. \$28.00</b> Ideal for service and installation of high fidelity and general type audio systems, telephone and intercoms and public address systems. Can also be used as a dummy load in some DC systems.	<b>Load Ranges:</b> 4, 8, 16, 600 ohms <b>Wattage:</b> Continuous 25 watts (8, 600 $\Omega$ ) 50 watts (4, 16 $\Omega$ ); Intermittent 50 watts (8, 600 $\Omega$ ), 100 Watts (4, 16 $\Omega$ )	With 250, 255, 260 $\pm$ 10%; with 261 and 270 $\pm$ 7% Direct reading scale from 17 microwatts to 100 watts.										
 <b>MICROVOLT ATTEN. Model 655. \$26.00</b> Applications: Audio circuitry (choppers, low level DC systems) design and servicing; and industrial control systems.	2.5 microvolts to 250,000 microvolts continuously variable in decade steps. <b>Frequency:</b> DC to 20 KC	With 250, 255, 260, 261, or 270 $\pm$ 1 db										
 <b>BATTERY TESTER. Model 656. \$26.00</b> Checks all radio and hearing aid batteries up to 90 volts at the manufacturer's recommended load, or any external load.	Up to 90 volts	With 250, 255, 260 $\pm$ 3% F.S.; with 261 or 270 $\pm$ 2% F.S.										
 <b>MILLIOHM METER. Model 657. \$48.00</b> Measures resistance values as low as .001 ohm. Ideal for accurate measurements of low resistance windings in meters, generators, and transformers; accurate measurement of ammeter and milliammeter shunts; and accurate measurement of contact resistance in switches and relays.	<table border="1"> <thead> <tr> <th>Range</th> <th>Max. Output Current (Ma)</th> </tr> </thead> <tbody> <tr> <td>0.1</td> <td>150</td> </tr> <tr> <td>0.25</td> <td>103</td> </tr> <tr> <td>0.5</td> <td>90</td> </tr> <tr> <td>1.0</td> <td>80</td> </tr> </tbody> </table>	Range	Max. Output Current (Ma)	0.1	150	0.25	103	0.5	90	1.0	80	With 260 $\pm$ 2% F.S.; with 261 or 270 $\pm$ 1½% F.S.
Range	Max. Output Current (Ma)											
0.1	150											
0.25	103											
0.5	90											
1.0	80											
 <b>DC AMMETER. Model 661. \$28.00</b> Multi-range, excellent accuracy of reading. Applications; automotive accessories (servicing), automotive electrical system, DC supplies, industrial (DC control systems—welding, heavy current rectifiers, etc.).	0-1/0-2.5/0-5/0-10/0-25 Amperes DC	With 250, 255, 260 $\pm$ 2% F.S.; with 261 or 270 $\pm$ 1.5% F.S.										



# SIMPSON MODEL 604 VOLT-AMP-MILLIAMP-MICROAMP MULTICORDER®

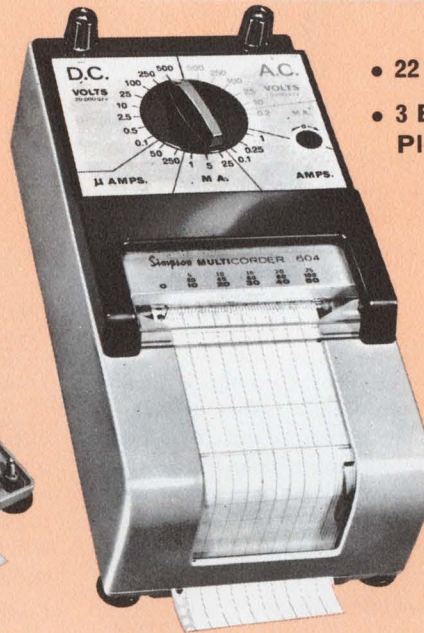
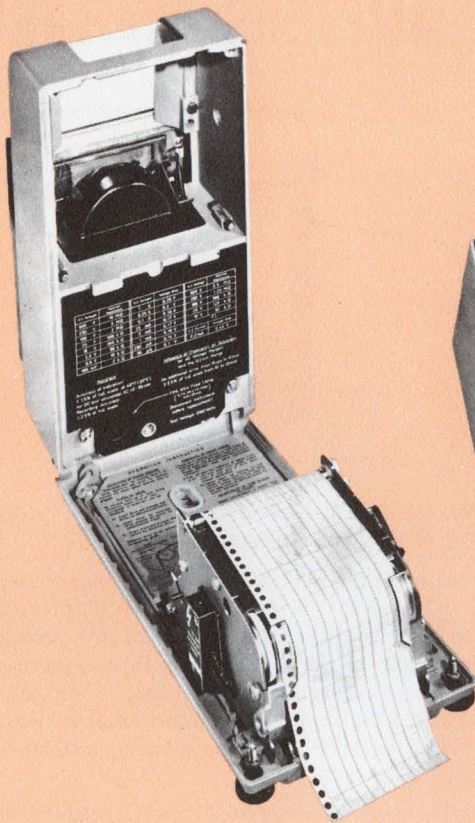

- 22 Built-in Ranges . . . AC & DC
- 3 Built-in Speeds . . . 1/3/12 in./hr.  
Plus external drive accommodation



Ever-Redy  
Vinyl  
Carrying  
Case  
Catalog No. 02611  
\$25.00 ea.

## FEATURES:

- A permanent record of both range and measured value.
- Inkless recording via fast sequential impressions on pressure sensitive strip chart paper (no pen and ink maintenance problems).
- A high torque meter movement, with a shock-proof taut band suspension moving coil system.

SIMPSON MULTICORDER Model 604 contains a unique range marking system that indicates the range being used as the value is being recorded. Compact, rugged design, easy-to-operate and accurate, the Multicorder is an indicating instrument with a wide band of ranges and functions for measurements that eliminates the need for a separate recorder for each of the functions and ranges. You get visual readout in addition to the recording action that offers three chart speeds: 1"/3"/12" per hour. This Simpson Multicorder is the only multi-function recorder available for \$200.00.

## RANGES:

D. C. Volts: 0-.1/.5/2.5/10/25/100/250/500 @ 20,000 ohms per volt.

A. C. Volts: 0-10/25/100/250/500 @ 5,000 ohms per volt.

Direct Current: 0-50/250 Mics, 1/5/25 Milliamps, .1/.25/1.0 Amps.

350 MV Drop maximum.

Alternating Current: 0-.2 Milliamps. 450 MV drop.

Complete with test leads (#7500) and two rolls of Chart Paper

Model 604 Multicorder..... \$200.00

Additional Chart Paper #02612..... ea. \$ 2.50  
(Box of 10) \$19.50

Special Gear Unit 30/60/90 in./hr.  
Cat. #0682..... \$30.00

Ever-Redy Vinyl Carrying Case Cat. #02611.. \$25.00

## SPECIFICATIONS

### ACCURACY OF INDICATION:

DC ±1.5% F.S.

AC (45 to 65 cps Sine Wave) ±1.5% F.S.

Accuracy of Recording: ±2.5% F.S.

### TEMPERATURE INFLUENCE:

DC—for 10°C change (18°F) 1 max  
(% of true value)

AC—for 10°C change (18°F) 1 max  
(Influence is positive from 20°C to 0,  
(68°F to 32) and negative from 20 to  
50°C, (68 to 122°F) (% of true value)

### FREQUENCY INFLUENCE:

Flat from 15 to 10,000 cps.  
2.5% of full scale from 10,000 to  
20,000 cps.

### Recorder:

Chart paper and chopper bar action can be driven either by the self-contained synchronous motor or by external driving means.

### Motor Drive:

Self-starting synchronous motor, 115 volts, 60 cps, contained in recorder. Grounded line cord is provided with recorder.

### Chart Speed:

1/3/12 inch/hour

Chart impressions are made every two seconds.

### Chart Paper:

Type—Pressure sensitive paper.

Width of recording—2.3 inches.

Length of paper on roll—50 feet approximately.

Divisions—50.

Size: 9¾" x 4¾" x 4". Net Weight: 5½ lbs.

NOT AVAILABLE OUTSIDE OF THE UNITED STATES OF AMERICA

SIMPSON ELECTRIC CO.



# POPULAR 7" VOLT-OHM-MILLIAMMETERS AVAILABLE FOR



Model 262-3...\$75.00

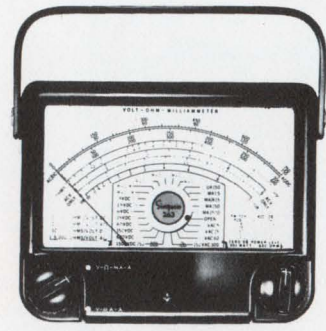

Model 263...\$88.00

## MODEL 262-3 DC/AC Volt-Ohm-Milliammeter

Model 262-3 Volt-Ohm-Milliammeter is very compact with 33 ranges on a large, easy to read 7" scale that makes accurate repetitive readings easy to attain. Meter movement furnished with diode overload protection. One control selects range and function. Self-shielded meter movement incorporates spring backed jewels which eliminates damage to the meter pivots that could result from shock and vibration—dependability and longer life are ensured.

Complete with test leads No. 0115 and operator's manual.

Model 262-3.....\$75.00

## MODEL 263—New Dual Sensitivity VOM DC/AC Volt-Ohm-Milliammeter

Dual sensitivity Volt-Ohm-Milliammeter with accuracies of  $\pm 1\frac{1}{2}\%$  DC and  $\pm 3\%$  AC F.S. Overlapping ranges offers greater accuracy expressed as a percentage of reading. Diode overload protection (Prevents movement burn-out even on 200,000% overload). External battery compartment makes battery replacement easier. Uses  $1\frac{1}{2}$  volt alkaline battery to insure greater stability on low ohms scale.

Complete with test leads No. 0115 and operator's manual....\$88.00

	MODEL 262-3 20,000 $\Omega/V$ DC 5,000 $\Omega/V$ AC			NEW MODEL 263 20,000 $\Omega/V$ DC • 10,000 $\Omega/V$ DC 10,000 $\Omega/V$ AC • 5,000 $\Omega/V$ AC		
<b>RANGES:</b>	MODEL 262-3			MODEL 263		
DC VOLTS	0-1.6/0-8/0-40/0-160/0-400/0-1600/0-4000			0-0.15/0-.75/0-3/0-7.5/0-30/0-75/0-300/0-750/0-3000 @ 20K $\Omega/V$ 0-0.3/0-1.5/0-6/0-15/0-60/0-150/0-600/0-1500/0-6000 @ 10K $\Omega/V$		
AC VOLTS	0-3/0-8/0-40/0-160/0-400/0-800			0-2.5/0-7.5/0-30/0-150/0-750 @ 10K $\Omega/V$ 0-5/0-15/0-60/0-300/0-1500 @ 5K $\Omega/V$		
DC MICROAMPERES	0-80/0-160			0-75 @ 150 MV; 0-150 @ 300 MV		
DC MILLIAMPERES	0-1.6/0-16/0-160			0-0.75/0-7.5/0-75/0-750 @ 150 MV; 0-1.5/0-15/0-150 @ 300 MV		
DC AMPERES	0-1.6/0-8			0-7.5 @ 150 MV; 0-1.5/0-15 @ 300 MV		
DB SCALE (L1MW-600)	-12 to +45.5 db in four ranges			-20 to +75.5 db in 10 ranges		
OUTPUT RANGES	0.1 mfd capacitor in series with all AC Voltage ranges through 160 Volts			0.1 mfd capacitor in series with all AC Voltage ranges through 300 Volts		
RESISTANCE RANGES	R $\times$ 1 0-500 $\Omega$	R $\times$ 10 0-5000 $\Omega$	R $\times$ 100 0-50K $\Omega$	R $\times$ 1 0-500 $\Omega$	R $\times$ 10 0-5000 $\Omega$	R $\times$ 100 0-50K $\Omega$
	R $\times$ 1K 0-500K $\Omega$	R $\times$ 10K 0-5 meg $\Omega$ (4.5 $\Omega$ center)	R $\times$ 100K 0-50 meg $\Omega$	R $\times$ 1K 0-500K $\Omega$	R $\times$ 10K 0-5 meg $\Omega$ (4.5 $\Omega$ center)	R $\times$ 100K 0-50 meg $\Omega$
<b>ACCURACIES:</b>				0-0.15 to 1500 $\pm 1\frac{1}{2}\%$ ; 0-3000 to 6000 $\pm 2\frac{1}{2}\%$		
DC VOLTS	$\pm 3\%$			$\pm 3\%$		
AC VOLTS	$\pm 4\%$			$\pm 3\%$		
DC CURRENT	$\pm 3\%$			$\pm 1\frac{1}{2}\%$		
R $\times$ 1	$\pm 3^\circ$ of Arc			$\pm 3^\circ$ of Arc		
R $\times$ 10, R $\times$ 100K	$\pm 2\frac{1}{2}^\circ$ of Arc			$\pm 2\frac{1}{2}^\circ$ of Arc		
SCALE LENGTH	6.2 inches					
DIMENSIONS	6" x 7 $\frac{1}{4}$ " x 3"					
NET WEIGHT	4 lbs.					
<b>ACCESSORIES</b> High Voltage Probes Multipliers Carrying Cases	<b>For 262-3</b>	<b>Cat. No.</b>	<b>Price</b>	<b>For 263</b>	<b>Cat. No.</b>	<b>Price</b>
	16KVDC.....	0146	\$15.00	30KV @ 10K $\Omega/V$ } .....	0158	\$15.00
	40KVDC.....	0145	15.00	15KV @ 20K $\Omega/V$ }		
	Ever-Redy Vinyl Carrying Case.....	5262	\$12.00	Ever-Redy Vinyl Carrying Case.....	5262	\$12.00
Sponge Lined Leather Case.....	1613	\$12.00	Sponge Lined Leather Case.....	1613	\$12.00	

SEE YOUR ELECTRONIC DISTRIBUTOR FOR YOUR PANEL METER



# IMMEDIATE DELIVERY FROM STOCK



Model 267...\$65.00



Model 268...\$65.00

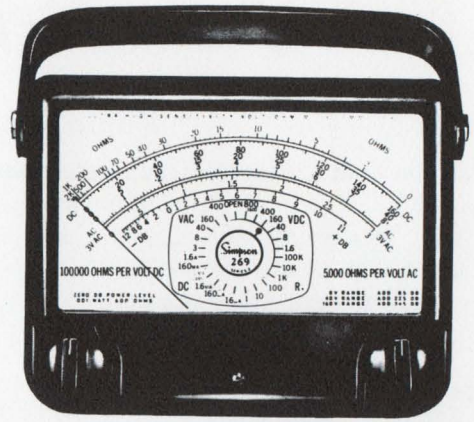

Model 269-2...\$90.00

## MODEL 267 and MODEL 268 DC/AC Volt-Ohm-Milliammeter

Companions to the World Famous 260, these instruments are ideal for TV and Radio Service work, General laboratory work, and production line testing where accurate repetitive readings are required. Simpson's 7" meter provides for expansion of all the meter scales making it easier to obtain closer repetitive readings. One major switch in the instrument selects range position and function at the same time which saves time in operation and also acts as a protection to the tester circuit. Input protected with an internal 1 amp fuse.

Complete with test leads No. 7500 and operator's manual.

Model 267...\$65.00

Model 268...\$65.00

## MODEL 269-2—New Improved 100,000 Ω/V Volt-Ohm-Microammeter

Model 269-2 incorporates Simpson's self-shielded meter movement with spring backed jewels. Damage to the meter pivots that could result from shock and vibration is eliminated. Improved Model 269-2 includes two new ranges, 400 V. AC and 800 V. DC. The ampere range coverage has been changed from a 16 ampere range to an 8 ampere range, and the Ohm Center Scale is changed to a 12 ohm center for better coverage. Accuracies are now ±2% DC and ±3% AC of full scale. External battery compartment makes battery replacement easier. Input protected with an internal 1.5 amp fuse.

Complete with test leads No. 0115, 4000V DC probe extension and operator's manual.....\$90.00

### MODEL 267

### MODEL 268

### MODEL 269-2

20,000 Ω/V DC  
5,000 Ω/V AC

100,000 Ω/V DC  
5,000 Ω/V AC

MODEL 267		MODEL 268		MODEL 269-2		
0-25/0-2.5/0-10/0-50/0-250 0-500/0-1000	0-3/0-12/0-60/0-300 0-600/0-1200	0-1.6/0-8/0-40/0-160/0-400/0-800/0-1600/0-4000				
0-2.5/0-10/0-50/0-250 0-500/0-1000	0-3/0-12/0-60/0-300 0-600/0-1200	0-3/0-8/0-40/0-160/0-400/0-800				
0-50	0-60	0-16/0-160				
0-1/0-10/0-100/0-500 0-10	0-1.2/0-12/0-120 0-12	0-1.6/0-16/0-160 0-1.6/0-8				
-20 to +10; -8 to +22 +6 to +36; +20 to +50	-12 to +11; -1 to +22 +13 to +36; +27 to +50	-12 to +45.5 db in four ranges				
0.1 mfd capacitor in series with all AC Voltage ranges through 300 Volts		0.1 mfd capacitor in series with all AC Voltage ranges through 160 Volts				
R×1 0-2000Ω	R×100 0-200KΩ (12Ω center)	R×10K 0-20 megΩ	R×1 0-200Ω	R×10 0-20KΩ	R×100 0-200KΩ	
			R×1K 0-2 megΩ	R×10K 0-20 megΩ	R×100K 0-200 megΩ	
			(12Ω center)			
			0-1.6 to 1600 ±2%; 0-4000 ±3%			
			0-3 to 800 ±3%			
			All Ranges ±2%			
			±3° of Arc			
			±2½° of Arc			
6.2 inches						
6" x 7¼" x 3"						
4 lbs.						

## MODEL 355 MIDGETESTER® AC/DC Volt-Ohmmeter 10,000 Ohms per Volt AC-DC

Model 355 Midgetester incorporates Simpson's 100 microamp, self shielded core meter movement. It has built-in ruggedness and accuracy. The core magnet movement permits the midgetester to be used any place without interference from metals or strong magnetic fields.



### VOLTAGE RANGES

DC: 3v; 12v; 60v; 300v; 1200v.  
AC: 3v; 12v; 60v; 300v; 1200v.

### RESISTANCE RANGES

0-10KΩ (120Ω center); 0-100KΩ (1200Ω center); 0-1 megΩ (12KΩ center); 0-10 megΩ (120KΩ center).

### FREQUENCY RESPONSE

Essentially flat to 10 kc.

### ACCURACY

DC: ±3%; AC: ±5%; Ohms: ±3%.

Size: 2¼" x 4½" x 1".... Net Wt.: 8 ounces  
Complete with test leads and operator's manual.....\$47.00

Cat. No.	Price
Ever-Redy Carrying Case..	6355 \$5.00
Test prods.....	8600 \$2.50

Cat. No.	Price	Cat. No.	Price	For 269-2	Cat. No.	Price
10KVDC....	0507 \$15.00	12KVDC....	0510 \$15.00	16KVDC.....	0119 \$15.00	
25KVDC....	0508 15.00	30KVDC....	0511 15.00	40KVDC.....	0157 15.00	
50KVDC....	0509 15.00					
<b>MULTIPLIERS</b>		<b>MULTIPLIERS</b>		Ever-Redy Vinyl Carrying Case.....	5262 \$12.00	
2500VDC....	8568 \$ 5.00	3000VDC....	8572 \$ 5.00	Sponge Lined Leather Case.....	1613 \$12.00	
2500VAC....	8570 5.00	3000VAC....	8574 5.00			
5000VDC....	8569 5.00	6000VDC....	8573 5.00			
5000VAC....	8571 5.00	6000VAC....	0004 5.00			



# Simpson VACUUM TUBE VOLT-OHMMETERS

MODEL 311-2	AC/DC VTVM	VOLTAGE RANGES	ACCURACY
<p>Model 311 is the most advanced vacuum tube volt-ohmmeter in its field which features: High DC input impedance (22.0 megohm). This reduces circuit loading and permits measurements in high impedance circuits. Direct readout of RMS and peak to peak values. Excellent accuracy for low DC voltage measurements in transistorized circuitry.</p> <p><b>LINE VOLTAGE</b> 105/125 v, 50/60 Hz</p> <p><b>Size:</b> 7½" x 5⅝" x 4½" . . . <b>Net Wt.:</b> 5 lbs.</p> <p><b>Model 311-2 with DC/AC ohms probe No. 7594, ground lead No. 0733 and operator's manual . . . . . \$85.00</b></p> <p><b>Dual Voltage Model, 220/110 v, 50/60 Hz . . . . . \$90.00</b></p> <p><b>High Frequency Probe . . . Cat. No. 0174 . . . . . \$15.00</b></p> <p><b>High Voltage Probe (30,000 V. Max.) . . . Cat No. 0732 . . . . . \$15.00</b></p>		<p><b>DC:</b> 0-1.5v; 5v; 15v; 50v; 150v; 500v; 1500v. (22 megΩ input impedance)</p> <p><b>AC:</b> 0-1.5v; 5v; 15v; 50v; 150v; 500v; 1500v. (RMS) (Min. 2.2 megΩ input impedance)</p> <p><b>PP:</b> 0-4v; 14v; 40v; 140v; 400v; 1400v; 4000v. (Min. 2.2 megΩ input impedance)</p> <p><b>AF:</b> 0-1.5v; 5v; 15v; 50v; 150v; 500v; 1500v. (30 Hz to 110KHz ±5%)</p> <p><b>RF:</b> 1.5v; 5v; 15v; 50v; 150v. with probe (50 Hz to 100mc, 0-150 VRMS)</p> <p><b>RESISTANCE RANGES</b> 1KΩ (10Ω center); 10KΩ (100Ω center); 100KΩ (1KΩ center); 1 megΩ (10KΩ center); 10 megΩ (100KΩ center); 100 megΩ (1 megΩ center); 1000 megΩ (10 megΩ center).</p> <p><b>FREQUENCY RESPONSE</b> ±5% to 100 KHz (with RF probe, usable to 250 MHz)</p>	<p><b>DC VOLTS:</b> ±3% of full scale.</p> <p><b>AC VOLTS:</b> ±5% of full scale.</p> <p><b>DC RESISTANCE:</b> ±3° of linear arc.</p>
MODEL 303	AC/DC VTVM	VOLTAGE RANGES	ACCURACY
<p>Model 303 is a worthy companion to the World Famous 260 volt-ohm-milliammeter. Model 303, a ruggedly built instrument with high accuracy, features low current consumption, wide voltage and resistance ranges, and a large, easy-to-read 4½ inch scale.</p> <p><b>LINE VOLTAGE</b> 105/125 v, 50/60 Hz</p> <p><b>Size:</b> 7" x 5¼" x 3¼" . . . <b>Net Wt.:</b> 4 lbs.</p> <p><b>Model 303 with DCV probe No. 0067, ACV-ohm probe No. 0068, ground lead No. 0069 and operator's manual . . . . . \$85.00</b></p> <p><b>Model 303RT (in roll top safety case) . . . . . \$91.00</b></p> <p><b>Part No. 0073 . . . R.F. Probe . . . . . \$10.00</b></p> <p><b>High Voltage Probe, 30,000 VDC . . . Cat No. 0074 . . . . . \$15.00</b></p> <p><b>Dual Voltage Model 303, 220/110 volts, 50/60 Hz . . . . . \$90.00</b></p> <p><b>Dual Voltage Model 303RT, 220/110 volts, 50/60 Hz . . . . . \$95.00</b></p>		<p><b>AC-DC:</b> 1.2v; 12v; 60v; 300v; 1200v.</p> <p><b>AF:</b> 1.2v; 12v; 60v.</p> <p><b>RF:</b> 20 volts maximum. (With RF Probe)</p> <p><b>DB:</b> -20 to +63 db in five ranges.</p> <p><b>RESISTANCE RANGES</b> 1KΩ (10Ω center); 100KΩ (1000Ω center); 1 megΩ (10KΩ center); 10 megΩ (100KΩ center); 1000 megΩ (10 megΩ center).</p> <p><b>INPUT IMPEDANCE</b> 10 megohms (all ranges) on DCV; 275K ohms shunted by 210 uuf on ACV.</p> <p><b>FREQUENCY RESPONSE</b> <b>AF:</b> Flat to 100 KHz on the three low AC ranges <b>RF:</b> 20 KHz to 100 MHz (with RF probe)</p>	<p><b>DC VOLTS:</b> ±3% of full scale.</p> <p><b>AC VOLTS:</b> ±5% of full scale.</p> <p><b>DC RESISTANCE:</b> ±3° of linear arc.</p>
MODEL 715	AC VTVM	VOLTAGE RANGES	ACCURACY
<p>High input impedance, multi-voltage ranges and wide frequency response offers a greater versatility for general purpose applications. Ideal for hi-fi and general low level audio work such as hum and ripple measurements, IF gain and vibration analyzing. Model 715 features a specially designed meter scale that provides DB markings on both the voltage range positions and the meter scale.</p> <p><b>INPUT POWER REQUIREMENTS:</b> 110 to 125 VRMS, 50/60 Hz @ 10 watts</p> <p><b>SIZE:</b> 7½" W, 5½" H, 3" D</p> <p><b>NET WEIGHT:</b> 3 lbs. 12 oz.</p> <p>Complete with operator's manual and shielded input cable . . . . . <b>\$75.00</b></p>		<p><b>Volts:</b> 0-.01/.03/.1/.3/1/3/10/30/100/300 rms</p> <p><b>Decibels:</b> Total Range -52 to +52 DBM</p> <p><b>Zero DBM:</b> 1 milliwatt in 600 ohms</p> <p><b>Scale Markings:</b> -12 to +2 DB</p> <p><b>TESTER SENSITIVITY:</b> 10 millivolts full scale on lowest range</p> <p><b>INPUT IMPEDANCE:</b> Minimum 1 meg @ 1 KHz shunted by 25 uuf</p> <p><b>INTERNAL MULTIPLIERS:</b> ±1% precision resistors</p> <p><b>FREQUENCY RESPONSE:</b> 10 Hz to 400 KHz ±1 DB</p>	<p>±5% of full scale.</p>

SCHOOLS: WRITE FOR INFORMATION ON BASIC ELECTRONICS COURSE SCHOOL PROGRAM



# SIMPSON VTVM... Model 312

Offers 40% less circuit loading than most conventional VTVMs.



AC/DC VTVM  
Model 311..... \$85.00



AC/DC VTVM  
Model 303..... \$85.00

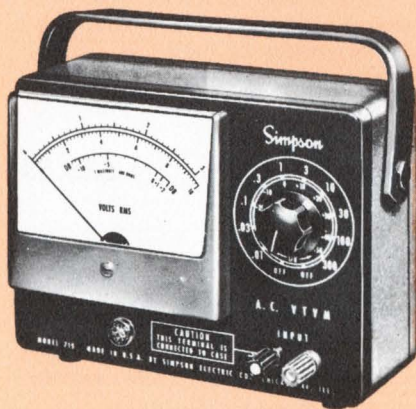

AC VTVM  
Model 715..... \$75.00

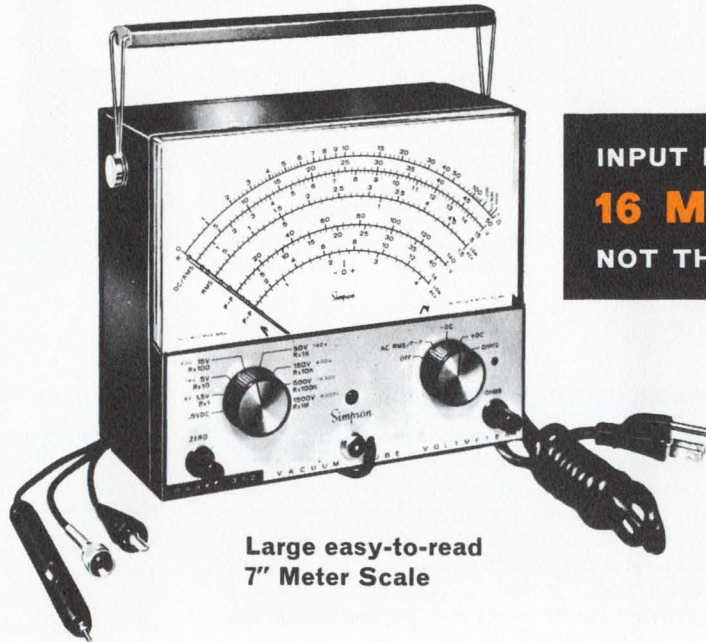

Large easy-to-read  
7" Meter Scale

INPUT RESISTANCE IS  
**16 MEGOHMS**  
NOT THE USUAL 11

This Simpson VTVM, Model 312, offers a tracking error of less than 1% and provides accuracies of  $\pm 3\%$  on all AC and DC ranges. The instrument has a specially designed circuit that protects the meter against burnout. Its  $\frac{1}{2}$  volt DC range meets today's solid state testing requirements.

Rugged, phenolic case and large easy-to-read seven inch scale.

- Model 312 with AC ohms/DC probe No. 0150 and operator's manual..... \$90.00
- R. F. Probe, Cat. No. 0152..... \$10.00
- High Voltage Probe (30,000 V. Max.), Cat. No. 0155..... \$15.00
- Carrying Case, Vinyl with Lead Storage Space, Cat. No. 0577..... \$15.00
- Sponge Lined Leather Case, Cat. No. 01565..... \$15.00

### LINE VOLTAGE

105/125V, 50/60 Hz  
Size: 7 $\frac{1}{4}$ " x 6 $\frac{3}{4}$ " x 3 $\frac{3}{4}$ ". Wt. 4 $\frac{3}{4}$  lbs.

### VOLTAGE RANGES

- DC: 0-0.5, 1.5, 5, 15, 50, 150, 500, 1500  
(16 Megohms input impedance)
- AC: (R.M.S.): 0-1.5, 5, 15, 50, 150, 500, 1500  
(1 Megohm minimum input impedance)
- AC: (Peak to Peak): 0-4, 14, 40, 140, 400, 1400, 4000

### RESISTANCE RANGES

RX1, RX10, RX100, RX1K, RX10K, RX100K, RX1M  
(10 ohm center)

### FREQUENCY RESPONSE

- $\pm 3\%$  from 15 Hz to 3 Megahertz on all AC voltage ranges through 150 volts.
- With R.F. Probe: 10KHz to 250 MHz  $\pm 1$  db. R.F. probe usable up to 40 volts rms.

### ACCURACIES

- DC:  $\pm 3\%$  of full scale
- AC:  $\pm 3\%$  of full scale
- Resistance:  $\pm 3\%$  of arc





# GENERAL PURPOSE MICRO-TESTERS\*...GET IMMEDIATE



Model 230  
Net \$40.00

Model 240  
Net \$40.00

Model 362  
Net \$35.00

Model 370  
Net \$35.00

Model 371  
Net \$35.00

Model 372  
Net \$35.00

Model 373  
Net \$35.00

Model 374  
Net \$35.00

### MODEL 230—AC/DC Volt-Ohm-Milliammeter

Simpson's Model 230 is one of the smallest AC and DC service instruments on the market, yet it contains a sufficient number of ranges to enable the experienced technician to do a complete servicing job. Specifically designed for telephone, teletype and marine use. Also excellent trouble shooter for industrial maintenance departments. The entire case, including the front panel, is molded of black phenolic for complete protection against high voltages.

1,000 Ohms per Volt DC  
400 Ohms per Volt AC

**VOLTAGE RANGES**  
DC: 10v; 50v; 250v; 1,000v.  
AC: 10v; 250v; 1,000v.

**CURRENT RANGES**  
DC: 10ma; 50ma; 250ma.  
**RESISTANCE RANGES**  
0-1,000Ω, 0-100KΩ

**ACCURACIES:** DC volts  $\pm 3\%$  F.S.; AC volts  $\pm 5\%$  F.S.; DC resistance  $\pm 3^\circ$  of linear arc from absolute value of resistance measured.  
Complete with test leads and operator's manual.....**\$40.00**

### MODEL 371—AC Voltmeter

Designed primarily for testing line voltages applied to motors, heating equipment and many other industrial applications.  
**RANGES:** 0-150, 0-300, 0-600 volts.  
**ACCURACY:**  $\pm 3\%$  of full scale. **\$35.00**

### MODEL 376—AC Voltmeter

Rectifier type, 1000 ohms per volt. Useful in circuits where a limited amount of current is present. Makes an excellent output meter when used with the proper condenser.  
**RANGES:** 0-5, 10, 25, 50, 100, 250, 500, 1000 AC volts.  
**ACCURACY:**  $\pm 5\%$  of full scale. **\$35.00**

### MODEL 377—DC Voltmeter

Resistance, 1000 ohms per volt. Useful in radio servicing and industrial applications.  
**RANGES:** 0-1, 2.5, 5, 10, 25, 50, 100, 250, 500, 1000 DC volts.  
**ACCURACY:**  $\pm 3\%$  of full scale. **\$35.00**

### MODEL 240—AC/DC Volt-Ohm-Milliammeter

Popularly called the "Hammeter", this multipurpose instrument was specially designed for general application around the laboratory, class room, ham shack and other similar applications.

With the maximum voltage ranges of 3000 volts AC or DC it was the first self contained pocket instrument built expressly to check high voltage on all the component parts of transmitters and receivers.

1,000 Ohms per Volt AC-DC  
**VOLTAGE RANGES**  
DC: 15v; 75v; 300v; 750v; 3,000v.  
AC: 15v; 150v; 750v; 3,000v.

**CURRENT RANGES**  
DC: 15ma; 150ma; 750ma.

**RESISTANCE RANGES**  
0-3,000Ω (30Ω center); 0-300KΩ (3KΩ center).

**ACCURACIES:** DC volts  $\pm 3\%$  F.S.; AC volts  $\pm 5\%$  F.S.; DC resistance  $\pm 3^\circ$  of linear arc from absolute value of resistance measured.  
Complete with test leads and operator's manual.....**\$40.00**

### MODEL 362—Low-Ohmmeter

The two ranges of the Low-Ohmmeter are essentially linear and permit highly accurate readings between 0.1 and 25 ohms. Ideal for checking motor armatures and fields; switch and relay contact resistances; shorts between generator windings and grounds; shorts in TV and radio chassis wiring; electrical equipment in industrial plants; plus many other uses.

**RANGES:** 0-5, 0-25 ohms  
**ACCURACY:**  $\pm 3\%$  of linear arc length  
Complete with calibrated test leads.....**\$35.00**

### MODEL 372—Ohmmeter

Provides a wide range of resistance measurements in a small package. .2 ohm to 500 megohms. Ideal for use in schools, on test benches or at incoming inspection facilities.  
**RANGES:** 0-500, 0-5,000, 0-50,000, 0-500,000 ohms; 0-5, 0-50 megohms.  
**CENTER SCALE:** 5, 50, 500, 5,000, 50,000, 500,000 ohms.  
**ACCURACY:**  $\pm 3^\circ$  of linear arc length.  
Complete with test leads and operator's manual.....**\$35.00**

\* SIZE: 3" x 5 1/2" x 2 1/2" . . . Net Weight 1 1/2 lbs.

Ever-Redy Carrying Case, Part No. 4299...\$10.00—for all Micro Testers except Models 391 & 392.  
Models 391 & 392 Carrying Case, Part No. 3413...\$10.00.



# DELIVERY FROM YOUR ELECTRONIC DISTRIBUTOR



Model 375  
Net \$35.00

Model 376  
Net \$35.00

Model 377  
Net \$35.00

Model 378  
Net \$35.00

Model 379  
Net \$35.00

Model 390  
Net \$60.00

Model 391  
Net \$55.00

Model 392  
Net \$60.00

## MODEL 375—DC Ammeter

Provides a complete range from a fraction of an amp to 25 amps without the necessity of using auxiliary external shunts. Ideal unit for use with unmetered power supplies generally present in radio and TV shops.

**RANGES:** 0-1, 2.5, 5, 10, 25 amperes.

**ACCURACY:**  $\pm 3\%$  of full scale.

**\$35.00**

## MODEL 370—AC Ammeter

Ideal for checking small motors, line loads and other applications where AC current measurements are required. 60 Hertz application. Self contained current transformer.

**RANGES:** 0-1, 0-2.5, 0-5, 0-10, 0-25 amperes.

**ACCURACY:**  $\pm 5\%$  of full scale.

**\$35.00**

## MODEL 373—DC Milliammeter

General purpose tester. Valuable in a number of applications such as plate and screen grid measurements on vacuum tubes. Provides for DC current measurements from .02 to 1000 ma.

**RANGES:** 0-1, 5, 10, 25, 50, 100, 250, 0-1,000 ma.

**ACCURACY:**  $\pm 3\%$  of full scale.

**\$35.00**

## MODEL 378—AC Milliammeter

Five separate ranges make it suitable for a wide variety of testing applications. Typical industrial applications are transformer tests or vacuum tube inspection. Contains a current transformer and an indicating instrument in one case.

**RANGES:** 0-5, 25, 100, 250, 1,000 ma.

**ACCURACY:**  $\pm 5\%$  of full scale.

**\$35.00**

## MODEL 379—Battery Tester

Provides accurate indications of the condition of all standard flashlight, hearing aid (mercury cells), transistor and portable radio batteries.

**RANGES:** 0-1.5, 4.5, 6.0, 7.5, 9.0, 15.0, 22.5, 30.0, 45.0, 67.5, 90.0 V

Complete with test leads and operator's manual..... **\$35.00**

## MODEL 374—DC Microammeter

Basic movement sensitivity 50 microamperes with self contained shunts for all other ranges. This tester can be used with external resistors or multipliers as a high sensitivity voltmeter at 20,000 ohms per volt. Can be shorted out of circuit by use of selector knob.

**RANGES:** 0-50, 100, 250, 500, 1000 microamperes.

**ACCURACY:**  $\pm 3\%$  of full scale.

Net..... **\$35.00**

## MODEL 390—AC Volt-Amp-Wattmeter

The most popular tester in the field for measuring AC/DC volts, AC amps. and AC watts with one meter. Ruggedly built... useful in servicing practically any appliance because of wide coverage offered with four wattage ranges.

**Volts:** 0-150, 300.

**Amps:** 0-3, 15.

**Watts:** 0-300, 600, 1,500, 3,000.

**ACCURACY:**  $\pm 3\%$  of full scale.

Complete with break-in plug, test leads and operator's manual..... **\$60.00**

Test Cord Assembly... Cat. No. 8418... **\$7.00**

## MODEL 391—AC-DC Volt-Wattmeters

Simultaneous readings of volts and watts. Has two separate 3" square meters, built-in cord and plug for connection to the line outlet . . . and separate toggle switches for range selection.

**3,000 Watts Maximum AC or DC Range**

**Volts:** 0-130, 0-260

**Watts:** 0-1,500, 0-3,000

**ACCURACY:**  $\pm 3\%$  of full scale.

Supplied with cord, plug, and operator's manual..... **\$55.00**

Leatherette Carrying Case... Part No. 3413... **\$10.00**

## MODEL 392—AC-DC Volt-Wattmeters

Simultaneous readings of volts and watts. Has two separate 3" square meters, built-in cord and plug for connection to the line outlet . . . and separate toggle switches for range selection.

**5,000 Watts Maximum AC or DC Range**

**Volts:** 0-130, 0-260

**Watts:** 0-1,000, 0-5,000

**ACCURACY:**  $\pm 3\%$  of full scale.

Supplied with cord, plug, and operator's manual..... **\$60.00**

Leatherette Carrying Case... Part No. 3413... **\$10.00**



# Simpson INDUSTRIAL • RADIO AND TV TEST EQUIPMENT

## MODEL 466

## HANDISCOPE WITH 5" SCREEN



### AC operated portable oscilloscope • Ruggedly constructed

Ideal for general purpose applications in radio and TV servicing and for industrial use. The Handiscope contains horizontal push-pull amplification for the X axis, vertical push-pull amplification for the Y axis, and an intensity modulation input for the Z axis. Horizontal deflection may be obtained from either the internal sweep circuits or from an external signal voltage.

Size: 7 $\frac{1}{8}$ " x 12 $\frac{1}{4}$ " x 16 $\frac{1}{8}$ "  
Net Weight: 19 lbs.

For use on 110 volts, 50/60 cps.

Complete with input cable  
No. 0100 and  
operator's manual **\$180.00**

Dual Voltage model  
for 220/110 volts,  
50/60 cycle..... **\$200.00**

**Frequency Response of Vertical Amplifier:** From 15 cycles/sec to 100 Kc/sec, flat within  $\pm 1$  db; 6 db down at 250 Kc/sec; usable to 1 Mc/sec.

**Maximum Vertical Deflection Sensitivity:** 30 Millivolts RMS/inch.

**Frequency Response of Horizontal Amplifier:** From 15 cycles/sec to 20 Kc, flat within  $\pm 1$  db; 6 db down at 100 Kc/sec.

**Maximum Horizontal Deflection Sensitivity:** 0.7 volt RMS/inch.  
**Z-Axis Sensitivity (Voltage Required to Extinguish Beam):** 20 volts RMS.

**Calibrating Voltage** (at 117.5 VAC power source): 1 volt P-P  $\pm 10\%$ .

**Maximum Input Voltage:** 400 volts peak.

**Input Resistance:** 0.1 Meg (at atten. x 1); 0.5 Meg (at atten. x 100).

**Input Capacitance:** 40 uuf (at atten. x 1); 35 uuf (at atten. x 100).

**Sawtooth Sweep Range:** 15 cycles/sec to 80 Kc/sec.

**Power Consumption** (at 117.5 volts AC): 50 watts  $\pm 10\%$ .

## MODEL 458

## 7" COLORSCOPE



**Line Voltage:** 105/125v,  
50/60 cycle.

Size: 11" x 16 $\frac{1}{2}$ " x 14 $\frac{1}{2}$ "

Weight: 29 lbs., Shpg. Wt. 38 lbs.

Complete with  
operator's manual..... **\$390.00**

**Accessory probes:** See Model 739  
in accessory section on back cover.

**Dual Voltage:** 220/110 volts,  
50/60 cps.

Complete with  
operator's manual..... **\$400.00**

### features:

- 7" Cathode Ray Tube.
- Wide band operation, the frequency response is flat within  $\pm 1.0$  db to 4.5 Mc. Faithfully displays COLOR BURST frequency with a sensitivity greater than 40 Mv rms per inch of vertical deflection.
- Narrow band operation, the frequency response is flat within  $\pm 2$  db from 10 cycles to 300 Kc with a sensitivity greater than 15 Mv rms per inch.
- Good square wave response provides accurate representation of sync pulses and composite wave-form pattern for trouble-shooting video, sync, and sweep circuits.
- Horizontal sweep, to 250 Kc, for expansion of high frequency wave-form detail and color burst.
- Vernier and Compensated Decimal Step Attenuator for better signal controls.
- Provision for Intensity Modulation of CRT.
- 1 volt peak to peak calibrating voltage.

## MODEL 383A

## CAPACOHMETER



**Line Voltage:** 105/125v, 60 cycles only.

Shipping Weight 12 lbs.

Complete with test leads and  
operator's manual..... **\$130.00**

Test Lead Assembly... Cat. No. 7509... **\$3.00**

### World's First IN-CIRCUIT Capacitor Leakage Tester

#### "ONE PACKAGE FLEXIBILITY"

- Measures the leakage resistance of defective paper, mica, or ceramic capacitors
- Indicates directly the capacitance of good paper, mica, or ceramic capacitors over a range of 10.0 mmf to 10.0 mf

A pulse technique detects many marginal capacitors. All measurements are made under load conditions. No adjusting of a bridge circuit and balancing controls. Borderline capacitors which cause costly "call backs" are detected immediately with the pulse test.



# Simpson TEMPERATURE MEASURING INSTRUMENTS

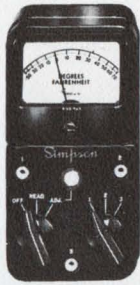

**Model 385-3L**....\$40.00  
For Three Probes

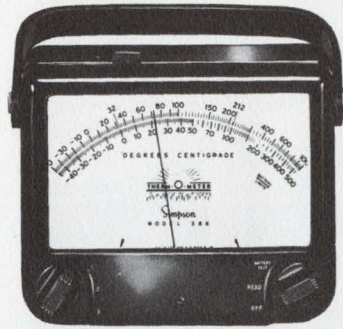

**Model 388-3L**....\$75.00  
For Three Probes

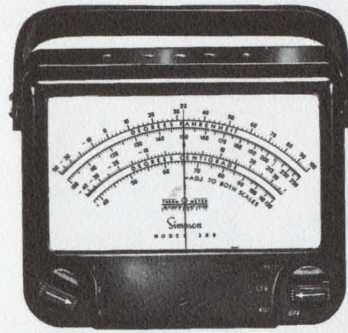

**Model 389-3L**....\$70.00  
For Three Probes



**Model 387**....\$35.00  
Appliance Tester

## MODEL 385-3L TEMPERATURE METER

Model 385-3L is ideal for those fast, accurate temperature checks from  $-50^{\circ}\text{F}$  to  $+70^{\circ}\text{F}$ . Light weight, portable, fits easily in your hand. Three lead model. Takes temperature readings in three different locations with a simple flick of the selector knob. Standard Model has Fahrenheit scale. Supplied with one No. 0010, 15 ft. thermistor lead and operator's manual.

**Size:** 3" x 5 $\frac{1}{8}$ " x 2 $\frac{1}{2}$ ". **Weight:** 1 $\frac{1}{2}$  lbs.....\$40.00

## MODEL 388-3L THERM-O-METER®

Simpson's popular wide range Therm-O-Meter tester measures the temperature of practically anything within  $-50^{\circ}\text{F}$  to  $+1000^{\circ}\text{F}$ . Standard model has combination  $^{\circ}\text{C}$  and  $^{\circ}\text{F}$  scale. Sensing Element: Thermocouple (Iron-Constantan). Supplied with internal battery and one 8' general purpose probe No. 0190 and operator's manual. Order additional probes as required.

**Size:** 7-15/16" x 6" x 2-15/16" **Weight:** 4 lbs.  
**Model 388-3L for three probes**.....\$75.00

## MODEL 389-3L DUAL RANGE THERM-O-METER®

Model 389-3L temperature tester, using three leads, makes temperature readings in three different locations at the same time; i.e., in a refrigerator, one lead could be connected to the evaporator plate, another to the wall of the food compartment and the third in the center of the food compartment. Readings are made quickly in 15 to 30 seconds depending on the medium being checked. Supplied with  $^{\circ}\text{C}$  and  $^{\circ}\text{F}$  scale.

Supplied with one general purpose thermistor lead No. 0010 and operator's manual. Order additional leads as required.

**Size:** 7-15/16" x 6" x 2-15/16". **Weight:** 4 lbs.....\$70.00

## APPLIANCE TESTER MODEL 387 MILLIVOLTMETER

Make gas unit servicing faster, more accurate. Use Simpson's Millivoltmeter. Simply place the probe across the thermocouple terminals and test for the correct value. Checks Safety Thermocouples on Gas-Fired Units.

- Furnaces
- Boilers
- Heaters
- Hot Water Heaters
- Dryers
- Refrigerators

**Size:** 3" x 5 $\frac{1}{8}$ " x 2 $\frac{1}{2}$ ". **Weight:** 1 $\frac{1}{2}$  lbs.....\$35.00

### RANGE & ACCURACY

$-50^{\circ}\text{F}$ . to  $+70^{\circ}\text{F}$ .  
 $\pm 1^{\circ}\text{F}$ . @ Center Scale  
 $\pm 2^{\circ}\text{F}$ . @ Either End

$-50^{\circ}\text{F}$ . to  $+1000^{\circ}\text{F}$ .  
 $\pm 1\frac{1}{2}$  Scale Divisions

$-50^{\circ}\text{F}$ . to  $+100^{\circ}\text{F}$ .  
 $+100^{\circ}\text{F}$ . to  $+250^{\circ}\text{F}$ .  
Within  $\pm 2^{\circ}\text{F}$ .

0-10, 0-30, 0-100,  
0-300, 0-1000 Millivolts  
 $\pm 3\%$  of Full Scale

### PROBES, LEADS AND CARRYING CASES

Description	Cat. No.	Price
Surface Temperature Probe.....	0790	\$ 7.00
Free Air Temperature Probe.....	0789	10.00
Additional Thermistor Lead.....	0010	7.00
30 Ft. Thermistor Lead.....	0216	8.00
50 Ft. Thermistor Lead.....	0415	9.00
100 Ft. Thermistor Lead.....	0416	12.00
150 Ft. Thermistor Lead.....	0417	15.00
Ever-Redy Leather Carrying Case.....	8073	10.00

General Purpose Type.....	0190	\$ 6.00
Surface Temperature Probe Type (1000° F. Max.).....	0187	10.00
Rugged Service Lead (8 ft.).....	0496	8.00
Ever-Redy Vinyl Carrying Case.....	5262	12.00

Surface Temperature Probe.....	0790	\$ 7.00
Free Air Temperature Probe.....	0789	10.00
Additional Thermistor Lead.....	0010	7.00
30 Ft. Thermistor Lead.....	0216	8.00
50 Ft. Thermistor Lead.....	0415	9.00
100 Ft. Thermistor Lead.....	0416	12.00
150 Ft. Thermistor Lead.....	0417	15.00
Ever-Redy Vinyl Carrying Case.....	5262	12.00

Test Prods and Spade Terminals.....	8379	\$ 3.00
Alligator Clips and Spade Terminals....	8376	2.50
Ever-Redy Vinyl Carrying Case.....	8073	10.00



# ACCESSORIES

## CARRYING CASES • TEST LEADS



Ever-Redy Carrying Case  
No. 0805....\$12.00

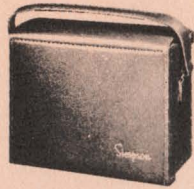

Ever-Redy Carrying Case  
No. 5262....\$12.00



Roll Top Safety Case  
\$10.00



Microtester Ever-Redy  
Carrying Case  
No. 4299....\$10.00



Leatherette Covered  
No. 3413....\$10.00

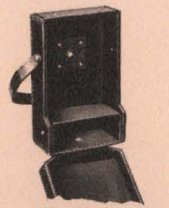

160 Handi VOM  
Carrying Case  
No. 2225....\$9.50



No. 1871 Case....\$13.00



Sponge Lined Carrying Case  
Nos. 1565, 1613

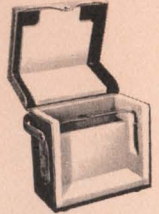

### CARRYING CASES

... Saves you time and protects your instruments.  
Instruments are always ready for instant testing.

For Testers	Cat. No.	Price
160 Handi VOM Carrying Case.....	2225	\$ 9.50
255 Utility Vinyl.....	0549	18.00
0549 Snap-on High Voltage Probe case.....	0574	5.00
250, 260, 261, 270—Leather.....	1818	10.00
250, 260, 261, 270, 303—Ever-Redy Leather...	0805	12.00
Combination 260 & adapter, leather carrying case.....	1871	13.00
250, 251, 260, 270, 303 Ever-Redy Vinyl.....	4236	14.00
262, 263, 267, 268, 269, 388-3L, 389-3L—Ever-Redy Vinyl.....	5262	12.00
312 Vinyl.....	0577	15.00
385-3L—Ever-Redy Leather.....	8073	10.00
391, 392—Leatherette-Covered.....	3413	10.00
355—Ever-Redy Leather.....	6355	5.00
All Microtesters—Ever-Redy Leather.....	4299	10.00
All Microtesters—Leatherette-Covered.....	3011	7.00
Roll Top Safety Case For 260-2, 9, 10, 880's.	6192	10.00
Roll Top Safety Case For 260-3, 261, 263, 270	0249	10.00
Roll Top Safety Case For 303.....	6379	10.00
604 Ever-Redy Carrying Case.....	02611	25.00

### NEW UTILITY CASE 250, 255, 260, 261 AND 270

Ever-Redy Carrying case (Cat. No. 0549) has extra space for accessories and/or tools. Probe case (No. 0574) can be snapped on to this case to accommodate any of the high voltage probes.



Probe Case  
Cat. No. 0574  
\$5.00

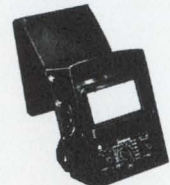

Utility Case  
Cat. No. 0549  
\$18.00

### SPONGE LINED CASES

	Cat. No.	Price
312 Leather Case.....	1565	\$15.00
262, 263, 269 Leather Case.....	1613	12.00

### LEADS

For Testers	Cat. No.	Price
Probe tip leads for 160.....	2055	\$2.75
250, 255, 260 Series 3, 4, 5, 5P, 261, 270, Banana plugs and alligator clip.....	7500	2.50
250, 260 Series 3, 4, 5, 5P, 261, 267, 268, 270, Banana plugs and test prods.....	7538	3.00
355 Test prods.....	8600	2.50
650 Test Lead.....	7545	1.50
651 Ground Lead.....	0733	2.00
466, 715 Input cable.....	0100	3.50
230/240/260-2/372 Test prods and elbow terminals.....	8381	3.00
Test prods and spade terminals— all microtesters.....	8379	3.00
230/240/260-2/372 Alligator clips and elbow terminals.....	8375	2.50
Alligator clips and spade terminals— all microtesters.....	8376	2.50
262-1, -2, 269 Combination test prods with removable alligator clips and elbow terminals.....	8463	3.00
255, 263-3, 269-2 Combination test prods with removable alligator clips and elbow terminals.....	0115	3.00
383A Test Lead Assembly.....	7509	3.00
390 Test Cord Assembly.....	8418	7.00

## NEW SIMPSON METER SAFE/GUARD FOR ALL 260's AND ANY OTHER 20,000 Ω/V VOM.

New Simpson VOM meter overload protector. Installs in minutes. Complete instructions for all 260 series— 1, 2, 3, 4. Cat. No. 12621. Complete only \$1.95 ea.



Test Prods and Spade Terminals  
For Microtesters, Cat. No. 8379

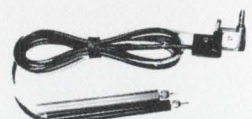

Banana Plugs and Test Prods  
For 260-3, -4, 261, 267, 268, 270,  
Cat. No. 7538



Test Prods and Elbow Terminals  
For 230, 240, 260-2, 372, Cat. No. 8381

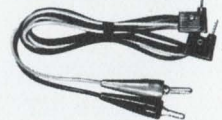

Alligator Clips and Elbow Terminals  
For 230, 240, 260-2, 372, Cat. No. 8375



Banana Plugs and Alligator Clips  
For 250, 255, 260-3, -4, -4M, -5, -5M, -5P, 261, 267, 268, 270, Cat. No. 7500

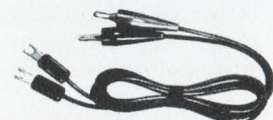

Alligator Clips and Spade Terminals  
For Microtesters, Cat. No. 8376



# ACCESSORIES

## HIGH VOLTAGE PROBES TEMPERATURE LEADS AND PROBES

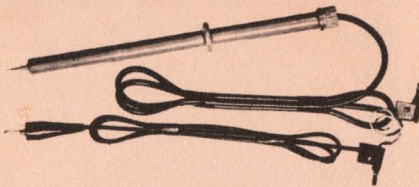

Typical High Voltage Probe  
Cat. No. 0507, 0508, 0509, 0510, 0511

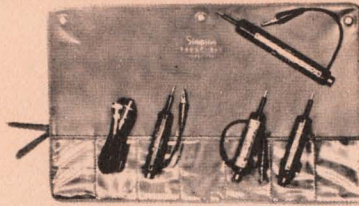

Oscilloscope Probe Kit  
Model 739....\$47.00



Clamp-On Ammeter  
Adapter for Model 255  
Cat. No. 0531....\$30.00

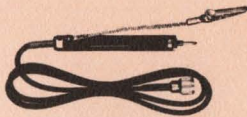

High Frequency Probe for Model 303

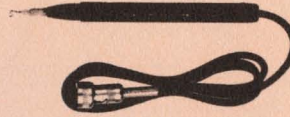

AC-DC Ohm Probe  
For Model 311, Cat. No. 0734

### OSCILLOSCOPE PROBE KIT—

#### Model 739

For use with Model 458 Oscilloscope. Includes \*low capacity probe, voltage doubler, detector, 100:1 voltage divider and dual direct-resistive. (Isolation)

Complete with 4 probes, plastic roll, and operator's manual.....\$47.00

\*For Model 458 only.

### PROBES—High Voltage Types

For	Voltage	Cat. No.	Price
221	30,000v	0009	\$15.00
260 Series 2	25,000v	0007	15.00
	50,000v	0179	15.00
250, 255, 260 Series 3, 4, 4M, 5, 5M, 5P	10,000v DC	0507	15.00
261	25,000v DC	0508	15.00
267	50,000v DC	0509	15.00
270	10,000v AC	0161	15.00
262 Series 1	16,000v	0172	15.00
	40,000v	0180	15.00
262 Series 2	16,000v	0172	15.00
	40,000v	0180	15.00
262 Series 3	16,000v	0146	15.00
	40,000v	0145	15.00
263	30KV @ 10KΩ/v 15KV @ 20KΩ/v	0158	15.00
268	12,000v DC	0510	15.00
	30,000v DC	0511	15.00
269 Series 1	16,000v	0173	15.00
	40,000v	0181	15.00

For	Cat. No.	Price
269 Series 2 16,000v	0119	\$15.00
40,000v	0157	15.00

### PROBES—Miscellaneous Types

303 DC High Volt. 30,000v..	0074	15.00
AC Probe.....	0068	4.00
DC Probe.....	0067	4.00
RF Probe.....	0073	10.00
Ground lead.....	0069	2.00
311-1 High frequency.....	0731	15.00
311-2 High frequency.....	0174	13.50
311-1 DC High Voltage (30,000v max.) multi- plies all ranges and	0732	15.00
311-2 input impedance 100X.	7594	10.00
DC/AC ohms.....	0733	2.00
Ground lead.....		
312 DC/AC ohms.....	0150	10.00
High Frequency.....	0152	10.00
DC High Voltage (30,000v max.) multiplies all ranges and input impedance 100X.....	0155	15.00

For	Cat. No.	Price
Voltage Doubler.....	0740	17.00
Low Capacitance.....	0741	17.00
100:1 Voltage Divider.....	0742	18.00
Direct-Resistive Dual Purpose.....	0743	14.00

### MULTIPLIERS

262-3 4000 V DC Multiplier.	0165	\$ 5.00
267 2500 V DC Multiplier...	8568	5.00
267 5000 V DC Multiplier...	8569	5.00
267 2500 V AC Multiplier...	8570	5.00
267 5000 V AC Multiplier...	8571	5.00
268 3000 V DC Multiplier...	8572	5.00
268 6000 V DC Multiplier...	8573	5.00
268 3000 V AC Multiplier...	8574	5.00
268 6000 V AC Multiplier...	0004	5.00

## TEMPERATURE TEST LEADS AND PROBES

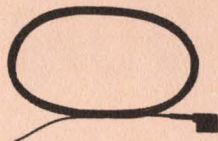

General Purpose Thermocouple Lead No. 0190

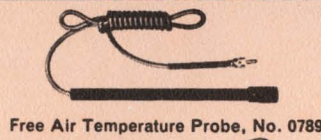

Free Air Temperature Probe, No. 0789

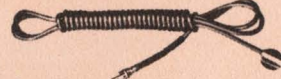

Surface Temperature Probe, No. 0790



General Purpose Thermistor Probe  
No. 0415, 0416, 0417



Ruggedized Thermocouple Lead  
For 388-3L



Surface Temperature  
Thermocouple Probe...  
Catalog No. 0187 (1000°F. Max.)

### FOR TEMPERATURE TESTERS Models 385-3L, 389-3L, 260—Adapter 652

	Cat. No.	Price
Free Air Temperature Probe.....	0789	\$10.00
15 ft. Thermistor lead.....	0010	7.00
30 ft. Thermistor lead.....	0216	8.00
50 ft. Thermistor lead.....	0415	9.00
100 ft. Thermistor lead.....	0416	12.00
150 ft. Thermistor lead.....	0417	15.00
Surface temperature probe.....	0790	7.00
<b>Models 388, 388-3L, 255</b>		
388, -3L, Rugged Service Lead (8 ft.).....	0496	8.00
388, -3L General purpose thermocouple....	0190	6.00
388, -3L Surface temperature thermocouple (1000° F. Max.).....	0187	10.00
255 only, Thermocouple Lead (5 ft.).....	0163	5.00



### New Simpson 260° VOM Classroom Demonstrator

Simpson has developed this special training aid in response to many requests from electronics instructors. It quickly shows students how to use the popular 260 VOM.

The 260 Classroom Demonstrator features a zero-adjust knob that is mechanically coupled to the meter pointer. This permits the instructor to actually set the pointer at the exact scale reference desired by turning the zero-adjust knob in a realistic manner. The 260 Demonstrator thus illustrates the use of a VOM and ties in directly with the lesson being discussed.

Lightweight and portable, the 260 Demonstrator can be hung easily in any classroom. Dimensions are 34" x 22" x 2".

ED 1 260 Classroom Demonstrator.....\$24.50



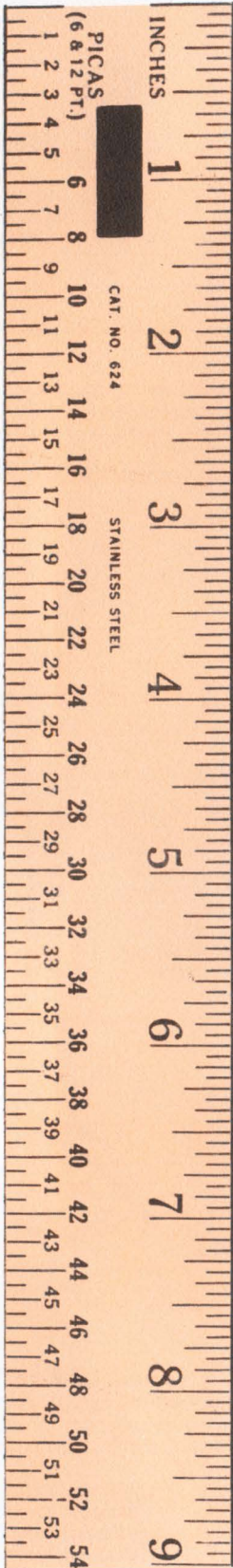

160 Volt-Ohm-Milliammeter  
Complete with alligator clip leads and operator's manual.  
..... \$50.00

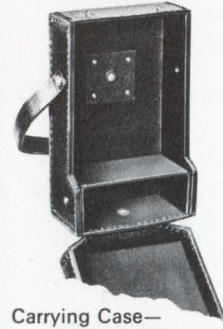

Carrying Case—  
Cat. No. 2225..... \$ 9.50  
Accessory Leads—  
Probe Tip Lead—  
Cat. No. 2055..... \$ 2.75

**NOW...a full-sized VOM  
in a palm sized "package"**

## Simpson 160 Handi-VOM<sup>®</sup>

Simpson Handi-VOM gives you the ranges, the time-saving conveniences and the sensitivity of a full-sized volt-ohm-milliammeter—yet it's only 3-5/16" wide, weighs a mere 12 ounces. Recessed range-selector switch never gets in the way . . . polarity-reversing switch saves fuss and fumble. Self-shielded taut band movement assures high repeatability and freedom from external magnetic fields. Diode overload protection prevents burn-out—permits safe operation by inexperienced employees and students. The demand is BIG, so get your order in to your electronic distributor, TODAY!

### RANGES

ACCURACY:  $\pm 3\%$  FS DC,  $\pm 4\%$  FS AC  
DC VOLTS: 0-0.25, 1.0, 2.5, 10, 50, 250, 500, 1000 @ 20,000  $\Omega/v$   
AC VOLTS: 0-2.5, 10, 50, 250, 500, 1000 @ 5000  $\Omega/v$   
DC MICROAMPERES: 0-50  
DC MILLIAMPERES: 0-1, 10, 100, 500  
DB: -20 to +10, -8 to +22, +6 to +36, +20 to +50  
"O" REFERENCE: 1 MW into 600 $\Omega$   
RESISTANCE: Rx1, Rx10, Rx 100, Rx1000, Rx10K (30  $\Omega$  center)



# Simpson

## INDICATING CONTROLLER

# NEW

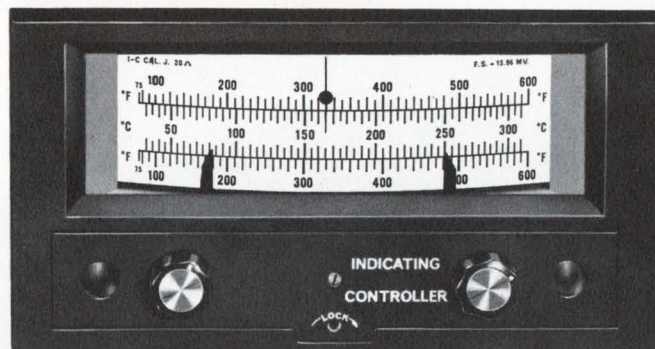

available through these **SIMPSON REPRESENTATIVES**

**CALIFORNIA**, Monrovia 91016  
Simpson Sales  
232 W. Maple Ave.  
Phone: 213/359-8132

**CALIFORNIA**, Sacramento 95821  
William J. Purdy Associates (Branch)  
4110 Stillmeadow Way  
Phone: 916/481-0971

**CALIFORNIA**, San Francisco 94103  
William J. Purdy Associates  
312 Seventh Street  
Phone: 415/863-3300

**COLORADO**, Denver 80209  
R. G. Bowen & Co., Inc.  
721 S. Broadway  
Phone: 303/722-4641

**CONNECTICUT**, Milford (Branch) 06461  
Paul R. Sturgeon Co., Inc.  
P.O. Box 170  
117 Broad Street  
Phone: 203/874-6080

**DISTRICT OF COLUMBIA**,  
Washington 20010  
Samuel K. Macdonald, Inc. (Branch)  
217 Riggs Bank Building  
3303 14th Street, N.W.  
Phone: 202/RAndolph 3-0328

**HAWAII**, Honolulu 96803  
Earl Associates  
P.O. Box 2845  
1638 Kona Street  
Phone: 808/996-953

**INDIANA**, Indianapolis, 46220  
Thomas & Sukup Inc.  
2060 E. 54th Street  
Phone: 317/251-4574

**IOWA**, Ottumwa 52501, (Branch)  
Norman W. Kathrinus & Co.  
549 Ottumwa Street  
Phone: 515/684-6110

**KANSAS**, Kansas City 66103 (Branch)  
Norman W. Kathrinus & Co.  
2336 S. Boeke Street  
Phone: 913/236-4108

**MARYLAND**, Baltimore 21214  
Samuel K. Macdonald, Inc. (Branch)  
5500 Hartford Rd., 2nd Floor  
Phones: 301/254-3380  
301/254-3381

**MASSACHUSETTS**, Chestnut Hill 02167  
Paul R. Sturgeon Co., Inc.  
1330 Boylston Street  
Phone: 617/734-7710

**MICHIGAN**, Benton Harbor 49022  
R. C. Merchant & Co., Inc.  
98 Water Street, Rm. #6  
Phone: 616/925-4211

**MICHIGAN**, Detroit 48219  
R. C. Merchant & Co., Inc.  
18411 W. McNichols Road  
Phone: 313/535-6000

**MINNESOTA**, Minneapolis 55405  
Mel Foster Company, Inc.  
228 South Cedar Lake Road  
Phone: 612/374-2612

**MISSOURI**, St. Louis 63144  
Norman W. Kathrinus & Co.  
2427 Brentwood Blvd.  
Phone: 314/962-5627

**NEW JERSEY**, Palisades Park 07650  
Simpson Instrument Sales & Service Inc.  
521 Third Street (Branch)  
Phone: 301/944-7733

**NEW YORK**, Great Neck, Long Island  
11022  
Simpson Instrument Sales & Service Inc.  
130 Cutter Mill Road  
Phones: 212/683-0674  
516/482-3103

**NEW YORK**, North Syracuse 13212  
Leonard D. Allen, Inc., WSOQ Bldg.  
Brewerton Road  
Phone: 315/458-7470

**NEW MEXICO**, Albuquerque 87110  
C. T. Carlberg & Associates  
2611 Quincy Street N.E.  
P.O. Box 3177, Sta. D.  
Phone: 505/265-1579

**OHIO**, Cincinnati 45242  
Baehr-Greenleaf & Assoc. Inc.  
9505 Montgomery Road  
Phone: 513/891-3827

**OHIO**, Cleveland 44107 (Branch)  
Baehr-Greenleaf & Assoc., Inc.  
14700 Detroit Avenue  
Phone: 216/221-9030

**OHIO**, Columbus 43221 (Branch)  
Baehr-Greenleaf & Assoc. Inc.  
P.O. Box 5722  
Upper Arlington  
Phone: 614/486-4046

**OHIO**, Xenia 45385 (Branch)  
Baehr-Greenleaf & Assoc. Inc.  
3350 Maplewood Drive  
Phone: 513/426-5485

**OREGON**, Portland 97208  
Don H. Burcham Co.  
510 N.W. 19th Avenue  
Phone: 303/722-4641

**PENNSYLVANIA**, Philadelphia 19102  
Samuel K. Macdonald, Inc.  
1531 Spruce Street  
Phone: 215/545-1205

**PENNSYLVANIA**, Pittsburgh 15237  
Samuel K. Macdonald, Inc. (Branch)  
Room 205, Kniveton Building  
7805 McKnight Road  
Phone: 412/366-2643

**UTAH**, Salt Lake City 84111  
R. G. Bowen Co., Inc. (Branch)  
31 S. Third East  
Phone: 801/364-4632

**WASHINGTON**, Seattle 98119  
Don H. Burcham Co. (Branch)  
422 First Avenue West  
Phone: 206/284-1121

**WISCONSIN**, Milwaukee 53212  
E. A. Dickinson & Associates  
3612 N. Greenbay Avenue  
Phone: 414/264-1080



# THE DEPENDABILITY YOU NEED...

The Simpson Indicating Controller regulates any process factor which can be expressed as an electrical value, and indicates the magnitude of that value constantly. It offers superior dependability, due to functional simplicity and the use of components rated beyond normal requirements. Lamp life-expectancy, for example, exceeds 60,000 hours.

Operation is contactless. Deflection of the indicating movement beyond either of two adjustable control points is sensed photoelectrically. The memory function requires only one lamp and sensor per control unit.

Manufactured by a world-famous instrument company, the Simpson Indicating Controller brings a new precision and accuracy to industrial automation. It has been proved by use in a wide range of applications. Consider its capabilities and put it to work in your plant. It will help you keep quality up and costs down.

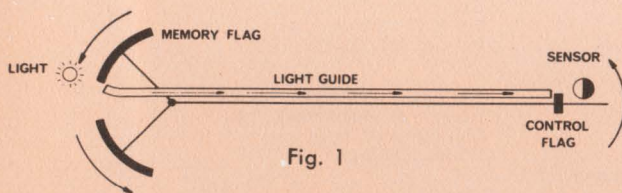
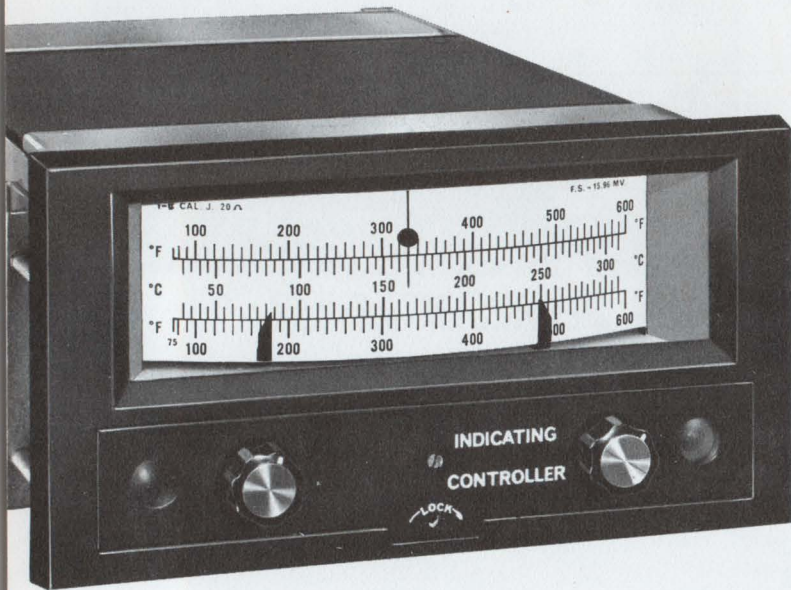

## UNIQUE MEMORY DESIGN ASSURES POSITIVE RELIABILITY

Control action is initiated by a control flag on the scale end of the pointer. Memory is provided by memory flags on the opposite end. The control flag and memory flags are arranged to counterbalance each other naturally, eliminating the heavy balance weights that degrade ballistics and repeatability.

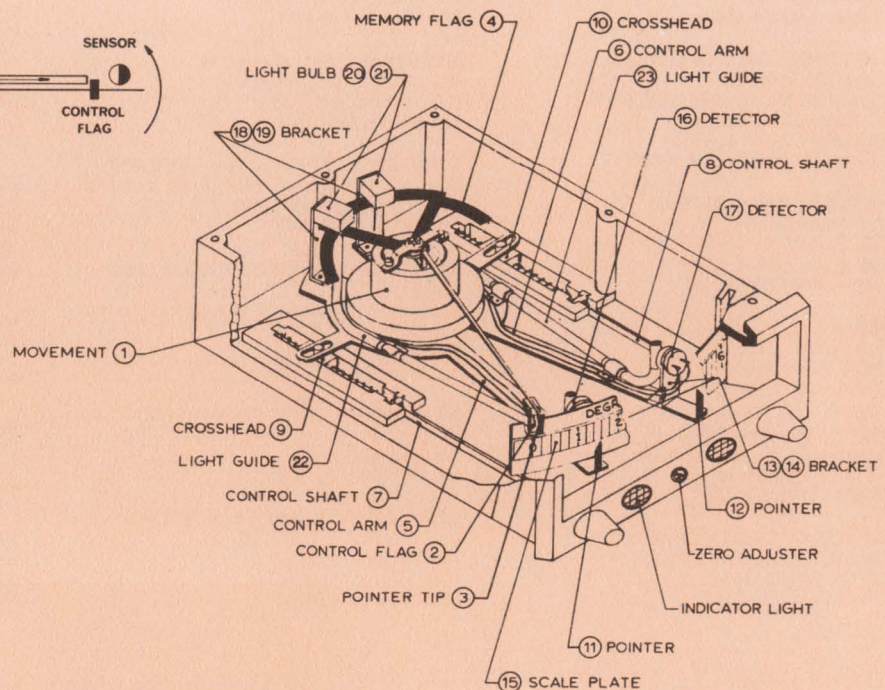



# ... the versatility today's requirements demand

## TYPICAL CONTROL POINT ARRANGEMENTS

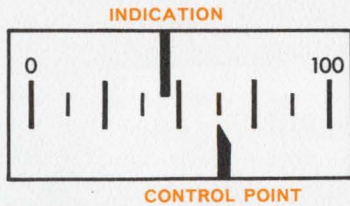

**TYPE A: SINGLE UPPER CONTROL POINT**—When the measured value rises above the pre-set control point, a control relay cuts out. When the measured value drops below the control point, the converse occurs. This arrangement can be supplied with proportioning control.

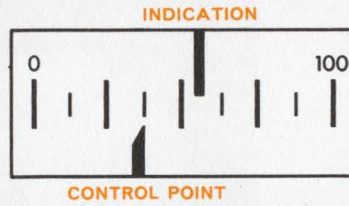

**TYPE B: SINGLE LOWER CONTROL POINT**—When the measured value falls below a pre-set control point a control relay cuts in. When the measured value rises above the control point, the converse occurs. This arrangement can also be supplied with proportioning control.

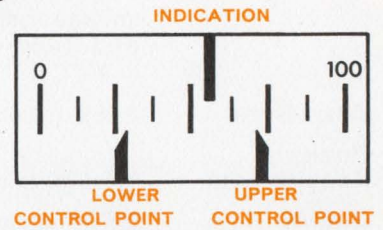

**TYPE AB-1: TWO-STEP CONTROL**—A typical application would be as a temperature controller on an electric furnace having a large element for initial warmup and a small "maintaining" element. The large element is shut off as the temperature rises above the lower control point. The small element is shut off as the temperature exceeds the upper control point. Proportioning can be supplied at the upper control point.

**TYPE AB-2: DIFFERENTIAL CONTROL**—Control action takes place when the measured value reaches the upper control point. Action is cancelled as the measured value falls below the lower control point.

**TYPE AB-3: LOW LIMIT CONTROL, HIGH LIMIT ALARM**—On-off control is at lower control point. If the measured value reaches the upper control point, alarm action and/or shutdown takes place. Proportioning is available at the lower control point.

**TYPE AB-4: LOW LIMIT ALARM, HIGH LIMIT CONTROL**—On-off control is at the upper control point. If the measured value reaches the lower control point, alarm action and/or shutdown takes place. Proportioning is available at the upper control point.

## TYPICAL RANGES

### TEMPERATURE\*\*

Degrees Fahrenheit#	Type of Thermocouple*
0-400	Copper-Constantan or Iron-Constantan
0-600	Iron-Constantan
0-1000	Iron-Constantan
0-1200	Chromel-Alumel
0-1600	Iron-Constantan or Chromel-Alumel
0-2000	Chromel-Alumel
0-2400	Chromel-Alumel
0-3000	Platinum-Platinum 13% Rhodium

#Centigrade or composite C & F scales optional.

\*Thermocouple supplied by user. Cold end compensation and open thermocouple are standard features.

\*\*A complete range of temperature controllers for use with resistance bulbs is available.

### FREQUENCY

Cycles per Second	Nominal Voltage
40-60	117
40-60	230
50-70	117
50-70	230
350-450	117
350-450	230

### DC MILLIAMPERES

Ma	Approx. Resistance, Ohms
0-1	50
0-5	50
0-10	20
0-20	10
0-50	4
0-100	2
0-200	1
0-500	0.5

### AC MILLIAMMETERS\*\* (Rectifier Type)

Ma

0-1

0-5

### AC VOLTMETERS (Rectifier Type)

V

0-50

0-100

0-150

0-300

0-500

### DC VOLTS

V

0-1

0-5

0-10

0-30

0-50

0-100

0-150

0-300

0-500

Sensitivity

All

1000 ohms

per volt

### DC MICROAMPERES

uA

0-20

0-50

0-1000

0-200

0-500

†Taut band only.

Approx. Resistance, Ohms

6600†

7000

2200

420

130

\*\*AC current indicating controllers with current transformers for higher ranges can be readily supplied.

**Note:** Other ranges and modifications such as segmental scale (200-400°, 75-150 V, etc.) can be supplied on request. Tell us about your requirement. We will give it our prompt attention.



## SPECIFICATIONS

### Calibration Accuracy

**Control**  $\pm 1\%$  standard,  $\pm 0.5\%$  on special order.

**Indication**  $\pm 0.25\%$  (Assuming line voltage held within  $\pm 10\%$  and temperature within  $\pm 20^\circ\text{C}.$ )

**Dead Band** 0.25% maximum.

**Power Requirement** 115/230 volts, 50/60 cps.

**Output** DPDT at each control point. (Rated @3 amps, 30 volts DC, or 115 volts AC, non-inductive load.)

**Movement** Self-shielding core type. Taut band or pivot and jewel.

**Control Memory** Retained over 100% of scale under all conditions.

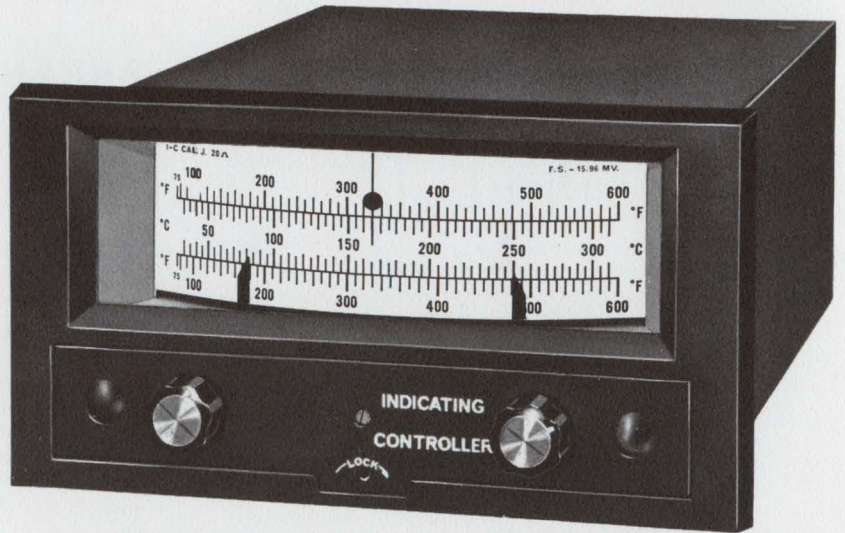

## DIMENSIONS AND MOUNTING DETAILS

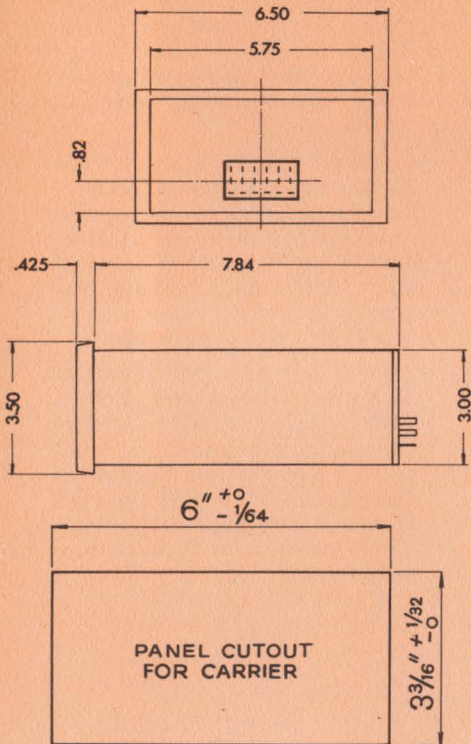

**LOCK-IN CARRIER** simplifies installing the Simpson Indicating controller on any instrument panel. Plug-in connector makes it easy to remove controller from instrument panel for calibration or adjustment.

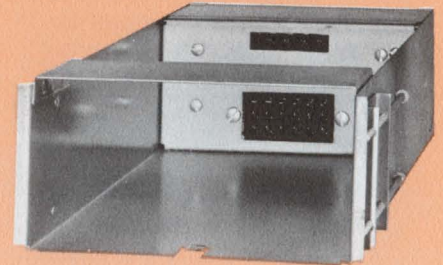

**NUMBERED TERMINALS** simplify routine testing and save time when circuitry is changed. Removable cover protects terminals.



DIVISION

**Simpson**  
INSTRUMENTS THAT STAY ACCURATE

**SIMPSON ELECTRIC COMPANY**

Representatives in Principal Cities  
... See Telephone Yellow Pages

5200 W. Kinzie Street, Chicago, Illinois 60644 • Phone: (312) 379-1121

Export Dept: 400 W. Madison Street, Chicago, Illinois 60606, Cable, Simelco

IN CANADA: Bach-Simpson Ltd., London, Ontario

IN INDIA: Ruttonsha-Simpson Private Ltd., International House, Bombay-Agra Road, Vikhroli, Bombay

WORLD'S LARGEST MANUFACTURER OF ELECTRONIC TEST EQUIPMENT



base-connected  $Q3$ . The peak collector current of  $Q3$  is then directly proportional to  $(E_{background} - E_{mark})$  and this current passes through  $D3$ .

The peak ac input to differential amplifier  $\Delta A$  is the peak collector current of  $Q3$  times the dynamic resistance of  $D3$ . The differential amplifier amplifies the millivolt ac signal across  $D2$  and  $D3$  to a higher level.

Diodes  $D4$  to  $D8$  compensate for level-shifting due to transistor base-to-emitter and diode  $D1$  voltage drops. The capacitor value was chosen to allow for a tolerable decrease ( $\Delta V$ ) in the peak detector stored voltage during the mark time. The peak output voltage of the circuit can be calculated as:

$$E_o = 2(\Delta A)(m)(R1/R2)(CR),$$

where  $\Delta A$  = differential amplifier gain, and  $m = nKT/q$  for diodes  $D2$  and  $D3$ .

N. D. Kline, IBM Systems Development Division Laboratory, Rochester, Minn.

VOTE FOR 111

## Variable preset counter uses inexpensive relays

Relay counters are used to stop automatic production equipment when consecutive rejects are detected. Most of these counter circuits have a fixed count and require relays with multiple coils and contacts.

The circuit shown here has a selector switch to vary the count or to disconnect the output relay and uses inexpensive single-coil relays with a form-C contact.

This circuit is based on the following design considerations:

- Relay drop time is greater than the relay pick time (controlled race).
- Relay polarity or phasing should be observed.
- Relay coil should be high-resistance for low power dissipation, and continuous-duty rated.
- Relay coil voltages should be  $E_s/2$ .
- Count capability, in counts per second, should be  $1000/2 T_k$  (where  $T_k$  = relay operating time in milliseconds).
- Relays required are  $count \times 2.0$ .

The operation of the circuit is as follows. Accept ( $Ka$ ) and reject ( $Kr$ ) contacts operate the counter circuit. When reject contact  $Kr$  closes, relay  $K1$  operates. The contact of  $K1$  completes the circuit to relay  $K2$ . When  $Kr$  contact opens, relay  $K2$  operates, advancing the counter. Relays  $K1$  and  $K2$  hold in series. Each time  $Kr$  contact closes and opens, the next pair of relays in the counter operates, until the counter has advanced to the last relay  $Kn$ , and all relay pairs are held in

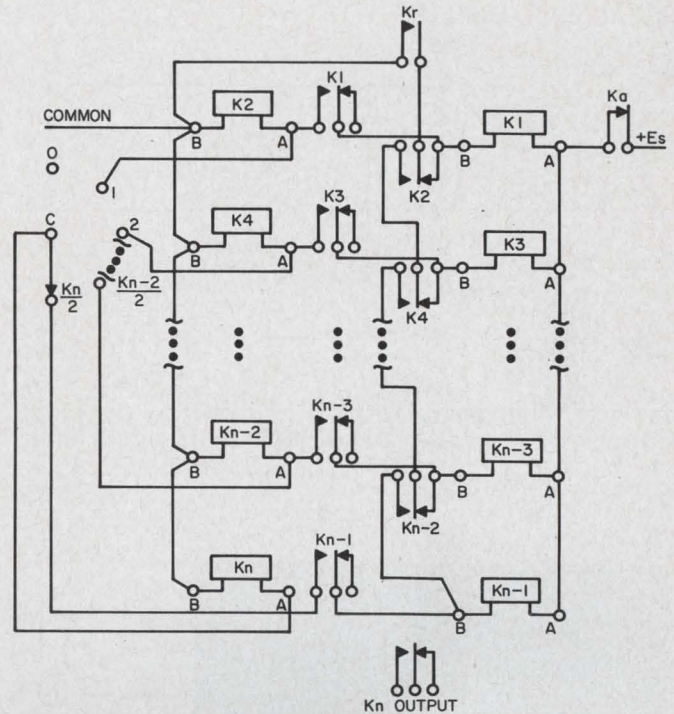

Any desired number of counts can be preset by using a proper number of relay pairs and by setting the selector switch to the corresponding tap.

series. If  $Ka$  operates before the counter advances to the output relay  $Kn$ , the circuit is restored to its initial state.

The selector switch places the output relay  $Kn$  in parallel with the advance relays (even-numbered relays), so that an output can be obtained along the count chain 1 through  $Kn$ . If the selector switch is set on zero, the output relay  $Kn$  will be disconnected, allowing the equipment to operate without stopping.

J. O. Clancy, Technical Associate Engineer, International Business Machines Corp. Components Div., Hopewell Junction, N. Y.

VOTE FOR 112

## Two transistors give sawtooth in phase with line voltage

A linear sawtooth in phase with line voltage can be produced, regardless of line frequency changes, with the simple two-transistor circuit shown in Fig. 1a. It has a wide range of applications: for example, full  $180^\circ$  phase-angle firing of SCRs.

In the circuit the output of the power transformer is rectified by  $D1$  and  $D2$  to give the usual rectified sinusoid (point  $a$ ), which charges  $C2$  through  $D3$ , providing a filtered dc power supply. It also supplies current to the base of  $Q1$  (point  $b$ ) through  $R1$ .  $Q1$  saturates during each half cycle, and is cut off very briefly as the line voltage



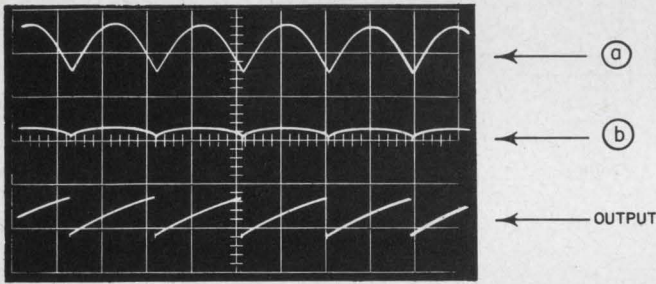
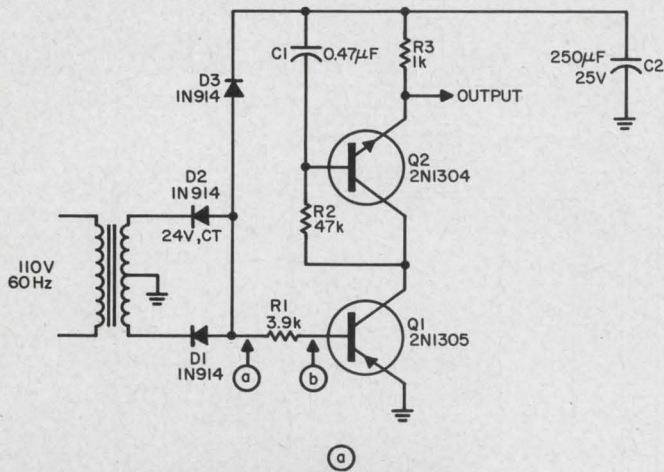

1. AC sawtooth generator (a) is automatically synchronized with the line voltage (b). Increasing the value of C1 results in better linearity but the output decreases.

crosses the zero axis.

When Q1 is ON, C1 charges through R2, giving a positive going voltage ramp at the output. When Q1 is OFF, C2 discharges rapidly through the base-emitter diode of Q2 and R3. The resulting output waveform at the emitter of Q2 can be seen in Fig. 1b. It is a low-impedance, positive-going sawtooth in perfect synchronism with the line voltage.

Keeping R2 constant and increasing C1 gives better linearity at the expense of the output level. With the values shown, output level is about 500 mV peak-to-peak.

Jean F. Delpech, Institut d'Electronique, Orsay, France.

VOTE FOR 113

## High input impedance obtained in a differential amplifier

If two terminals of a transistor can be forced to follow an input signal applied to the third terminal, high input impedance (neglecting stray capacitance) results.

This is demonstrated in the circuit diagram.

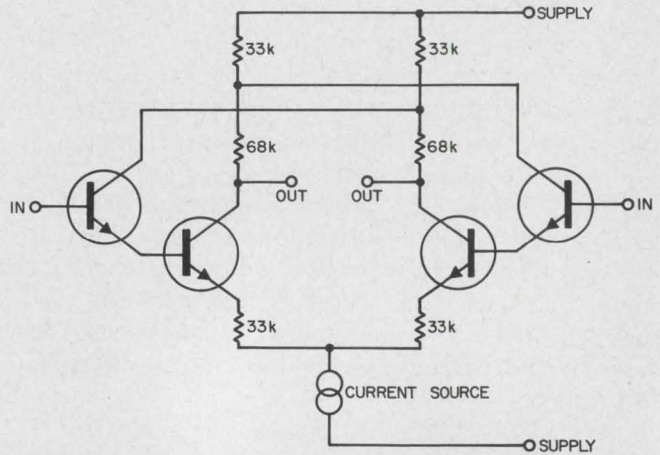

High input impedance can be realized in this cross-coupled differential amplifier. Transistors can be either pnp or npn. Any suitable current source will do.

Cross-coupling the collector eliminates reverse action.

The use of high-beta transistors (200 or higher) makes it possible to realize input impedance on the order of 100 MΩ. Either npn or pnp transistors can be used.

R. R. van den Berg, Development Engineer, NV. Peekel, The Hague, Netherlands.

VOTE FOR 114

## Shift phase with a simple, constant gain circuit

An operational amplifier used in conjunction with an RC phase-shift circuit provides a convenient means for varying the phase versus frequency characteristic while maintaining unity gain versus frequency. The circuit (see schematic) can be used as a 90° phase shifter with unity gain in a phase-sensitive demodulator or a calibrated phase shifter at frequencies from dc to above 10 kHz. A brief analysis of its operation follows.

Since a negligibly small current flows into the amplifier input terminals, the following equations apply:

$$(E_1 - e')/R_1 = (e' - E_o)/R_1, \quad (1)$$

$$E_o = A(e' - e), \quad (2)$$

$$(E_1 - e)Cs = e/R_2. \quad (3)$$

If we assume that A approaches infinity and solve for the input-output transfer function from the above equations, we obtain:

$$E_o/E_1 = -(1 - R_2 Cs)/(1 + R_2 Cs). \quad (4)$$

This is the transfer function of an all-pass shifting network whose phase varies from -180°



# UC

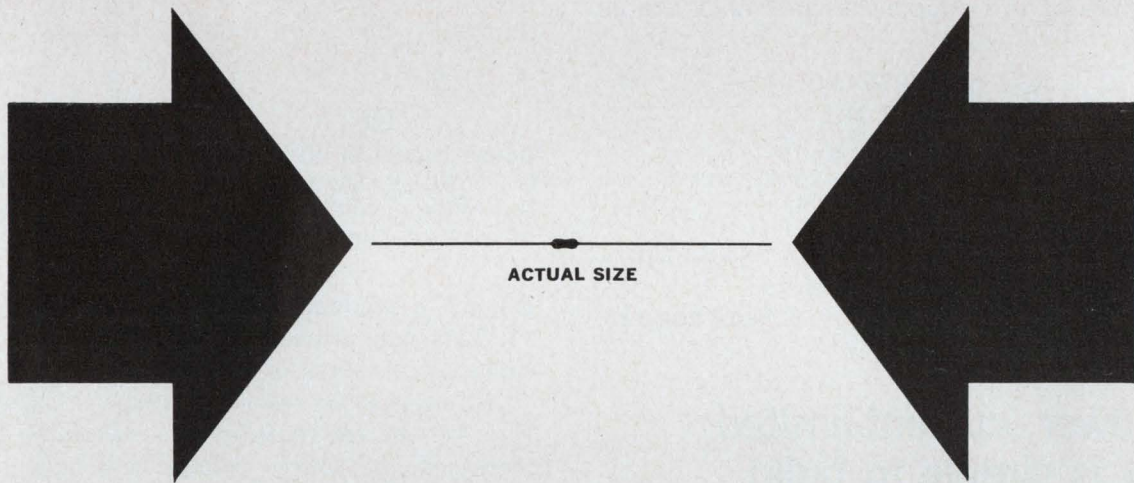

## New! Ultra-miniature metal film resistor offers precision, stability and reliability of higher-rated units

IRC, leader in metal film technology, introduces a new ultra-miniature precision metal film unit that bridges the gap between available discrete resistors and microcircuitry.

Significantly smaller than style RN-50, the UC resistor provides the precision, stability and close tolerance not available with microcircuits. It meets or exceeds all of the performance and environmental requirements of MIL-R-10509.

These tiny resistors feature gold dumet leads and the same rugged termination as all IRC premium metal films. Not a "lab item" or "special," production quantities are immediately available. Write for data, prices and evaluation sample. IRC, Inc., 401 N. Broad St., Phila., Pa. 19108.

### CAPSULE SPECIFICATIONS

BODY SIZE	.125" long x .047" dia.
POWER	1/20 watt @ 100°C
TOLERANCES	±1, 2, 5%
TEMPERATURE COEFFICIENTS	±50, 100ppm/°C
RESISTANCE	50 ohms to 10K



\* Trademark of IRC, Inc.

ON READER-SERVICE CARD CIRCLE 47



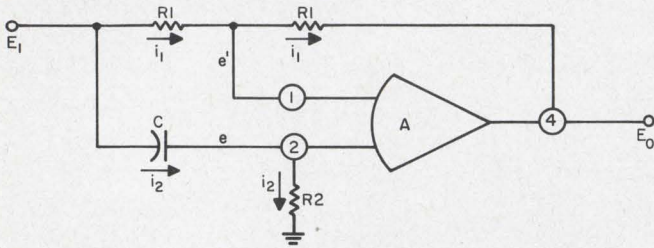

1. Constant-gain phase shifter utilizes an operational amplifier and a few external components.

to 0° as frequency varies from zero to infinity. Alternatively, the phase at any selected frequency may be varied over the -180°-to-0° range by varying  $R_2$  or  $C$ . Gain magnitude will remain at unity during this phase adjustment. If the positions of  $R_2$  and  $C$  are interchanged, the phase range is from 0° to +180°.

The values of the components in Fig. 1 are as follows:

- $R_1$ —1 k $\Omega$  to 100 k $\Omega$ ,
- $R_2$ —1 k $\Omega$  to 1 M $\Omega$ ,
- $C$ —1000 pF to 10  $\mu$ F,
- $A$ —Burr-Brown 1552,

Supply voltages— $\pm 15$  Vdc.

Gene E. Tobey, Applications Engineer, Burr-Brown Research Corp., Tucson, Ariz.

VOTE FOR 115

## Low-power, current-limited supply is simple to build

In testing integrated circuit components, it is desirable to have a power supply that is variable from 0 to about 15 volts with a current-limiting capability. Often such supplies are not immediately available.

Here is a design, while good for only about 40 mA, that does provide good regulation, low output impedance and a variable output from approximately 1 volt to 15 volts.

Transistor  $Q1$  (see Fig. 1a) is the pass transistor, and can be used in a Darlington configuration with a higher-power transistor if more current is desired. Transistors  $Q2$  and  $Q3$  form the amplifier section;  $Q2$  receives its reference from  $R1$ ,  $CR1$ , and  $CR2$ . This reference network is biased by the input source, which makes the power supply somewhat dependent on line voltage fluctuations. However, this is usually not serious for short-term measurements. If line fluctuations are objectionable, then  $R2$  can be replaced with a 10-mA constant-current source.

The circuit of Fig. 1b can be added to points A,

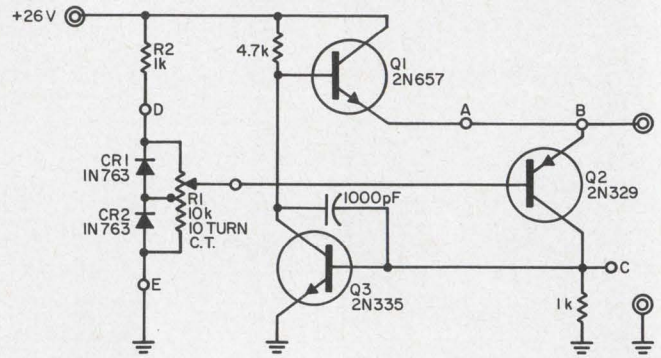

(a)

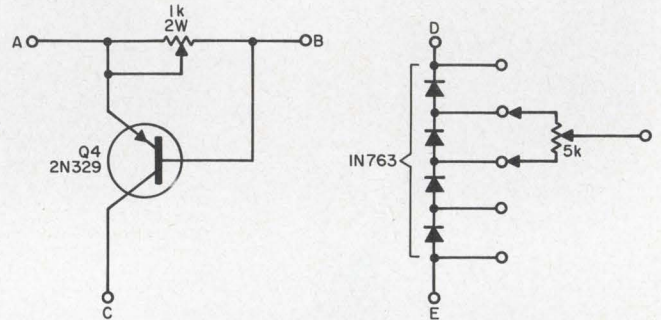

(b)

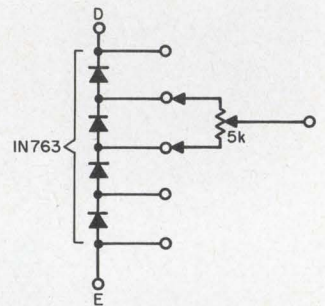

(c)

Output current of 40 mA at 1 to 15 Vdc is supplied by the circuit (a). Short-circuit protection can be realized by connecting circuit (b). Higher voltages can be obtained by using an alternative reference network (c).

$B$  and  $C$  (removing the short from  $A$  to  $B$  in Fig. 1). This will provide short-circuit protection for currents in excess of 40 mA.

An alternative reference network is shown in Fig. 1c. As the number of reference diodes is increased, the source voltage will have to be increased and the current capability decreased.

David Levers, Goodyear Aerospace Corp., Akron, Ohio.

VOTE FOR 116

## Turn on stand-by power simply and reliably

Floating magnetic drum heads must be lifted away from the drum surface before drum speed ever becomes slow enough to cause loss of air bearing action. In case of a power failure, a normally open relay applies power from a 24-volt rechargeable nickel-cadmium battery to a "head lift" motor.

Diode  $D1$  prevents the battery from discharging into the 28-volt supply when power is down. Resistor  $R1$  provides a trickle charge so that the battery remains fully charged. Diode  $D2$  allows full power to be applied to the "head lift" motor when needed.

(continued on page 118)





*There are no universal magnet wires  
or lead wires but ...*

## **BELDEN CAN HELP YOU STANDARDIZE TO REDUCE COSTS**

1. *Reduce wire inventories and procurement costs.*
2. *Reduce processing costs in potting through magnet wire and lead wire insulation compatibility.*
3. *Improve reliability through control of insulation concentricity and thickness.*
4. *Provide improved thermal, chemical, electrical and physical properties.*

For every type and size of relay or other products you manufacture using magnet wire and lead wire, you probably inventory a multitude of different wire insulations. Insulations for easy stripping, impact resistance, color consistency; for windability, economy, and solderability.

Belden can help reduce your insulation inventories and your overall production costs! For example: On relays you could standardize on Celenamel\* magnet wire and 105°C vinyl insulated lead wire...Celenamel offers uniform dimensions, solders at low tempera-

tures, is resistant to most solvents, and withstands the high temperatures of the potting operation. It has been successfully potted at 350°F. Vinyl lead wire is resistant to oils, solvents, and ozone, and is easy to strip. Colors are bright and distinct and retain their brightness after processing. It is also available in stranded tinned copper or Uni-strand\*.

For complete information on how Belden can help you standardize on magnet wire and lead wire to reduce costs, contact your Belden distributor or write P. O. Box 5070-A. \*Belden trademarks, Reg. U. S. Pat. Off. 1-1-6A

lead wire **Belden** magnet wire

**BELDEN MANUFACTURING COMPANY • P.O. Box 5070-A • Chicago, Illinois 60680**

ON READER-SERVICE CARD CIRCLE 48



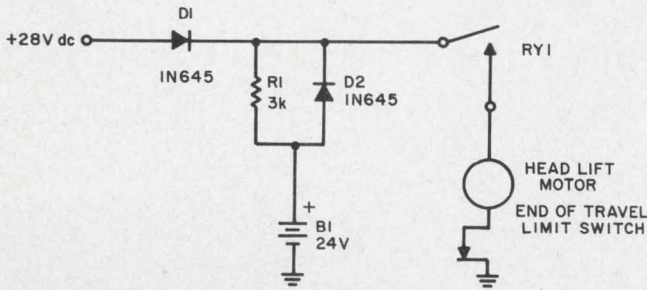

Emergency stand-by power is applied to the motor in case of power failure. The relay coil energized by the monitored power source is not shown.

Other possible applications of this circuit are in order to actuate various emergency stand-by devices.

C. H. Ristad, Sr. Associate Engineer, IBM, Systems Manufacturing Div., Endicott, N. Y.

VOTE FOR 117

## FET cascode amplifier features small current variations

The gain of both tube and semiconductor cascode amplifiers is usually controlled by varying the voltage at the bottom grid or the base. Large current variations can result and so detune the resonant circuits. The gain of a FET cascode amplifier, however, can be controlled by varying top gate voltage without appreciable change in current.

Maximum gain (see Fig. 1a) is achieved when supply voltages are equally divided between the two FETs, and remains constant as long as both FETs are held above their pinch-off voltages. A gain variation occurs whenever the top gate voltage deviates from the flat portion of the gain curve.

Figure 1b shows gain and current versus top gate voltage. Operation of the circuit should be confined to the solid portion of the gain curve, since large output admittance variations (i.e., large detuning of the output tank circuit) occur for the top gate voltages corresponding to the dashed gain curve. Stage detuning can be minimized by using +2.5-V bias supply and the dropping resistor as shown in Fig. 1a. The current variations, on the other hand, require higher bias supply voltage.

A trade-off, then, between the current variations and the stage detuning is possible by adjusting the bias supply to suit particular requirements.

While the circuit was tested by manually vary-

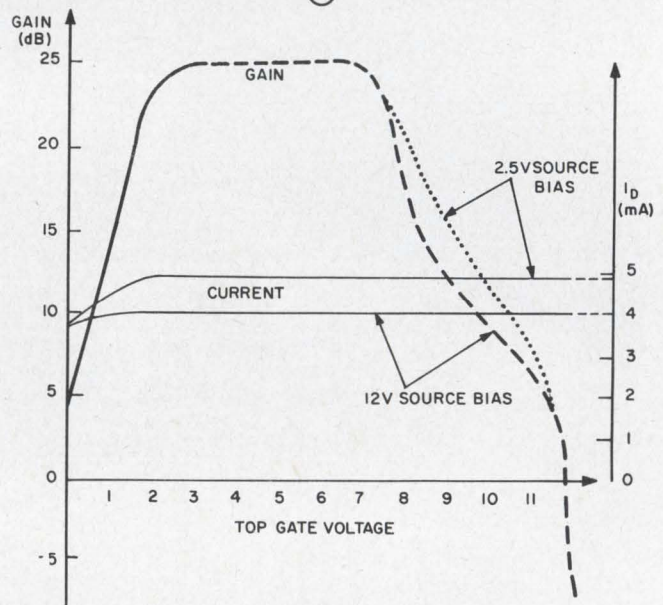
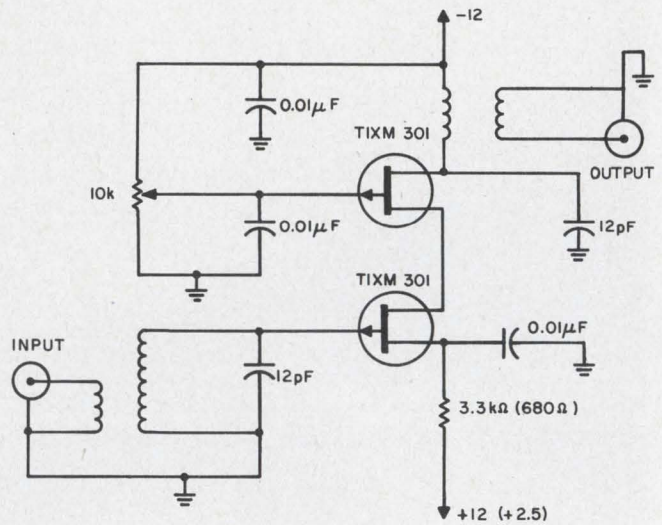

1. FET cascode amplifier (a) features constant gain and current (b). The circuit lends itself easily to agc techniques (the signal can be applied to the gate of the top FET).

ing the top gate voltage, agc techniques seem to be feasible, since the FET gate impedance is very high.

S. Sinigaglia and G. Tomassetti, Laboratorio Nazionale di Radioastronomia, Bologna, Italy.

VOTE FOR 118

## IFD Winner for Nov. 8, 1966

Fred W. Kear, Engineer, Sparton Southwest, Inc. Albuquerque, New Mexico.

His Idea, "Flexible circuit probe fits in small spaces," has been voted the \$50 Most Valuable of Issue Award.

Cast Your Vote for the Best Idea in this Issue.



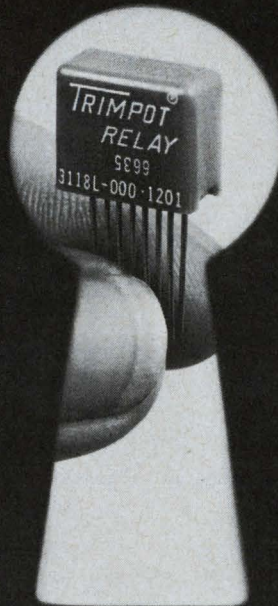

## What design doors can you open with the world's smallest industrial relay?

Our new Model 3118 TRIMPOT® DPDT Relay weighs in at 1.8 grams, yet switches a one-amp load along with the heavy-weights. Only 1/6 the size of a conventional crystal-can unit, it's the smallest industrial relay in existence. It brings high quality and performance to your applications at low cost.

Designed specifically for industrial use, the Model 3118 clearly reflects Bourns' long experience in military relays. It has the same type motor assembly and structure as the highest quality MIL unit and provides the same 100,000-cycle life. Also, it undergoes the same 5000-operation run-in as well as the rigorous final inspection for coil resistance, dielectric strength, operate and release time, pickup and dropout values, contact resistance and contact bounce. In addition, its damped return spring and balanced armature design assure excellent resistance to shock and vibration.

The 0.1" grid spaced pins let you plug the Model 3118 right into your printed circuits. Units are available immediately from the

factory with operating voltages of 6, 12 and 26.5 VDC, and in three terminal types. Write today for complete technical data.

Size:	0.26" x 0.53" x 0.43"
Pick-up sensitivity:	200 mw, max.
Contacts: DPDT; rating:	1.0 amp resistive at 28 VDC
Operating temp. range:	-55 to +85°C
Shock:	50 G, 11 ms
Vibration:	10 G, 5-3000 cps
Std. coil resistances:	60Ω to 1200Ω
Life:	100,000 cycles at rated load
Pin spacing:	0.10" grid



TRIMPOT means BOURNS—BOURNS means QUALITY  
TRIMPOT is a registered trademark of Bourns, Inc.

BOURNS, INC., TRIMPOT DIVISION, 1200 COLUMBIA AVE., RIVERSIDE, CALIF.  
PHONE 684-1700 • TWX: 714-682 9582 • CABLE: BOURNSINC.

TRIMPOT® AND PRECISION POTENTIOMETERS — RELAYS — MICROCOMPONENTS: TRANSFORMERS, INDUCTORS, RESISTORS AND CAPACITORS

ON READER-SERVICE CARD CIRCLE 49



# BIFILAR THE NEW TWIST IN RELAYS!

Of course Bifilar coil winding is no dramatic new story. But a relay with a counter EMF of 50 volts max is! We've gotten rid of all diodes and bulky shielding tricks, so the relay package is still the same small standard size.

Most importantly, our method doesn't suppress transient voltage at the expense of relay parameters, or increase temperature past recommended maximums, or affect contact resistance. Reliability's up because Bifilar isn't polarity sensitive and doesn't use additional components.

Still as tough? How about shock of 50G, 11 ms and vibration standards like 30G @ 3000 cps on a Bifilar half size crystal can. Good enough?

Then you'll be glad to know that Bifilar relays are now shipping in sub-miniature Series E, as well as husky 20-amp 3PST/NO9324 power contactors.

Call Leach Corporation, Relay Division (213) 232-8221. Mail takes a little longer. 5915 South Avalon Bl., Los Angeles, Calif. 90003. Export . . . Leach International S. A.

## LEACH

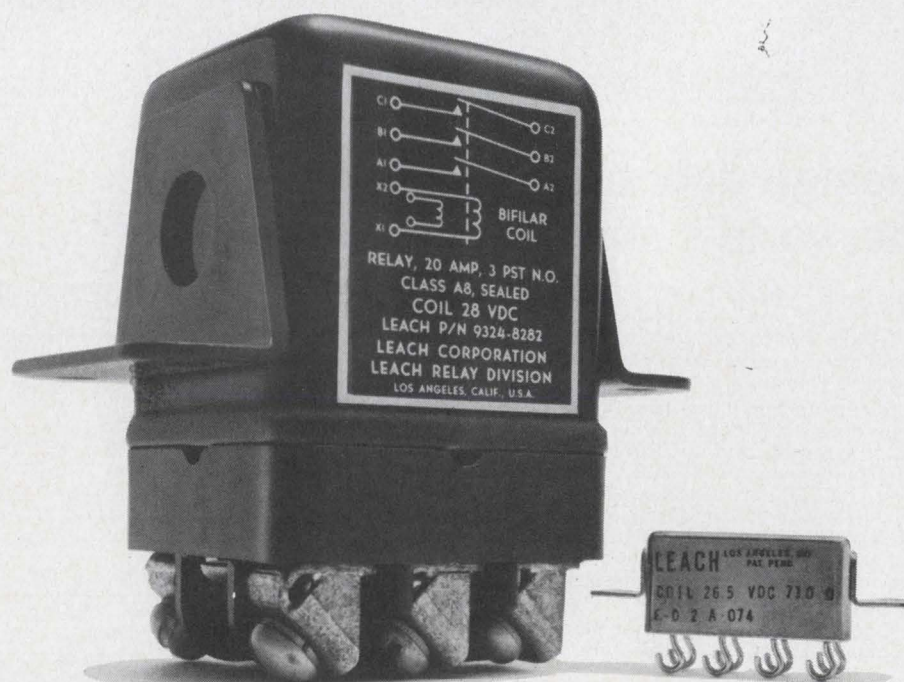



# Products

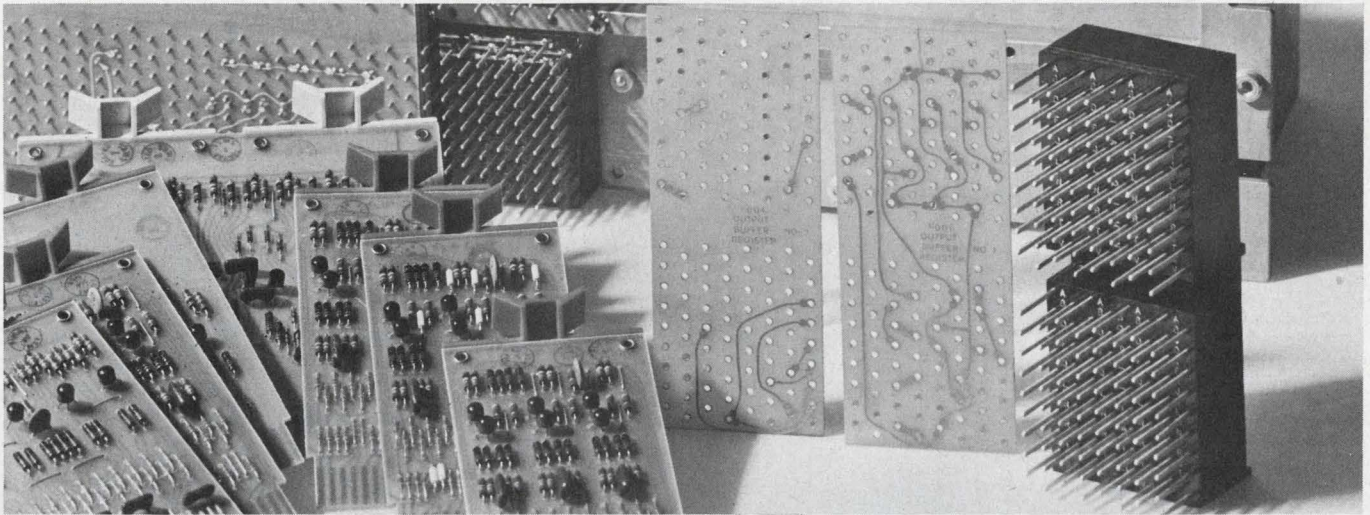

**PC boards wire PC boards.** Digital module kits are an easy-to-assemble, time-saving method

of building common or custom logic functions and computer interfaces. Page 168

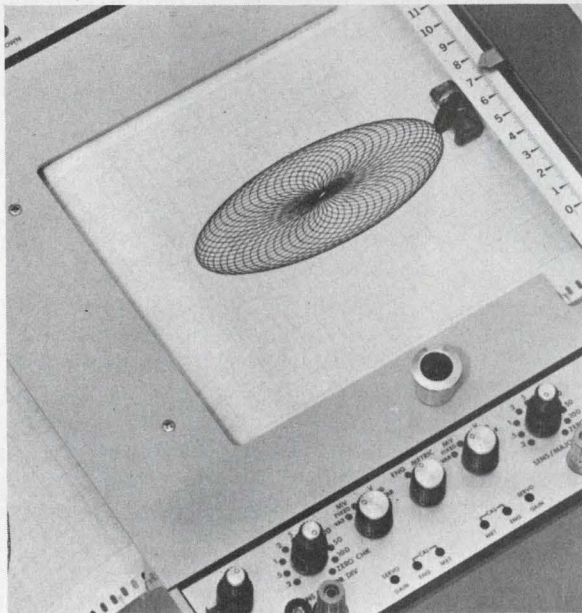

**Select English or metric scaling** with the switch on this X-Y recorder. Page 148

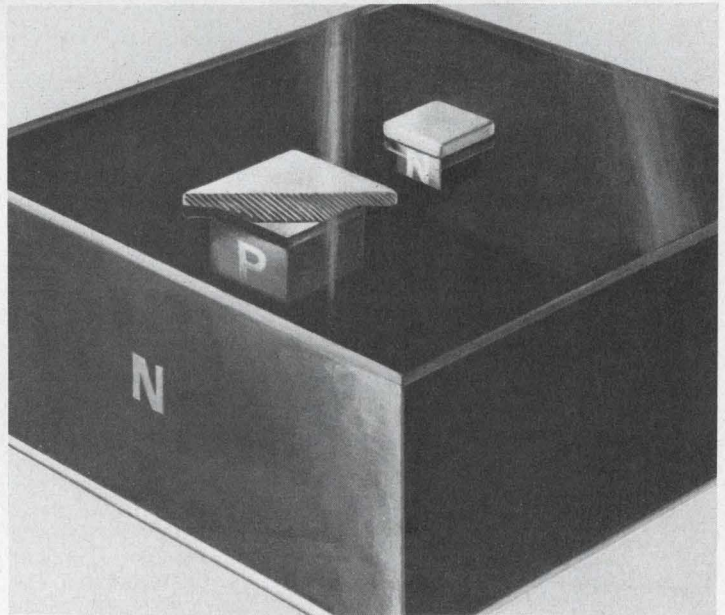

**Planar UJTs go plastic.** These low-cost unijunctions boast, nanoamp leakages. Page 122

## Also in this section:

**One-watt Zener** improves on nail-head diode design. Page 124

**Active filter design** made easy with off-the-shelf components. Page 126

**Transistor and diode families** are packaged as LIDs. Page 164

**Design Aids**, Page 172 . . . . **Application Notes**, Page 174 . . . . **New Literature**, Page 176



# Plastic planar UJTs cost less, leakages cut to nanoamps

Texas Instruments, Inc., 13500 N. Central Expwy., Dallas. Phone: (214) 235-3111. P&A: 85¢ (100 to 999); March.

Unijunction transistors with planar construction are available in plastic packages, priced at 85¢ each in quantity. The four JEDEC-registered silicon devices are said to be industry's first plastic planar UJT's. Their manufacturer, Texas

Instruments, has "application-tailored" the 2N4891 family to a variety of industrial and consumer uses:

- 2N4891 is a general-purpose unit for bistable circuits.
- 2N4892 is intended for high-frequency relaxation oscillators, voltage-sensing and frequency-dividing applications.
- 2N4893 finds use in thyristor (SCR, SCS, etc.) triggering cir-

cuits for motor control, power control or phase system timing.

- 2N4894 is for long-time-period circuits, current sensing and low-frequency control applications.

Planar processing has eliminated one major drawback to more widespread UJT use—previous alloy units typically had leakage currents in the 10- $\mu$ A range. Large timing capacitors were then needed for high-performance applications. The new units have maximum leakage of 10 nA at room temperature (average figures run about 0.1 nA). As a result of this stability, accuracy is increased by orders of magnitude in timing-circuit applications, longer time delays are possible, and small inexpensive timing capacitors may be used in the associated circuitry.

Reliability is also up: TI claims no device failures after 400,000 hours of testing.

The plastic package is the factor mainly responsible for the 85¢ price tag. The unit is the same as the TO-92, but it has a 100-mil, TO-18 pin circle lead configuration. Encapsulated in the direct plug-in, transfer-molded package, the UJTs withstand 60,000-G acceleration and claim three times the shock and vibration resistance of alloy units. Storage temperature ranges from -55 to 150°C.

Maximum ratings include an emitter-base reverse voltage of -30 V, continuous emitter current of 50 mA and peak emitter current of 1 A. Continuous device dissipation (at less than 25°C free-air) is 300 mW derating at 3 mW/°C

For those applications requiring hermetic metal can units, TI is offering TO-18 equivalents of the 2N4892, 4893 and 4894.

CIRCLE NO. 127

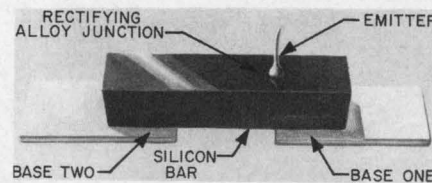
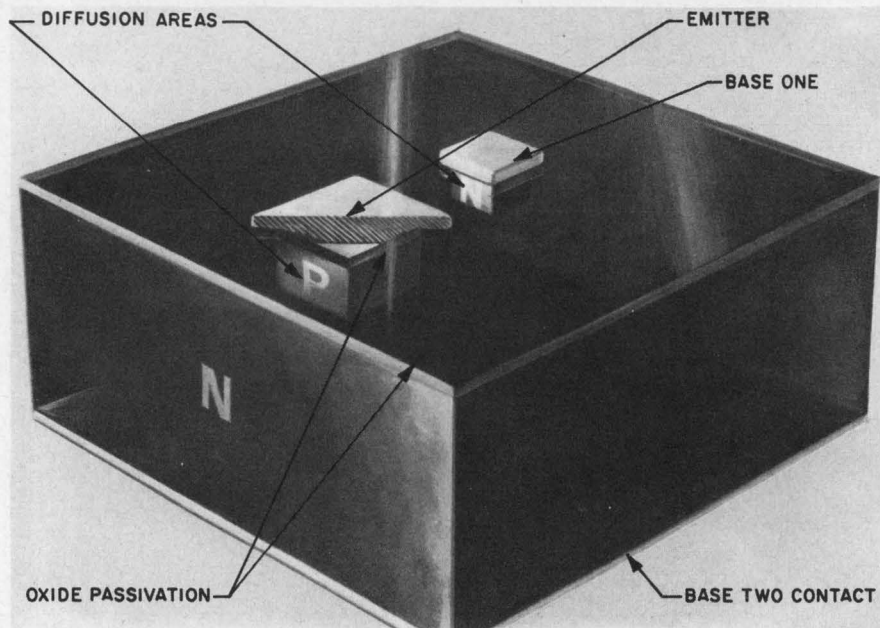

Planar unijunction construction (above) results in threefold increase in shock and vibration resistance over silicon alloy UJT's (left). Leakage currents are down in the nanoamp range so that smaller, less expensive capacitors are needed.

## Electrical characteristics (25°C)

Parameter	Test conditions	2N4891	2N4892	2N4893	2N4894
Interbase resistance ( $R_{BB}$ , k $\Omega$ )	$V_{B2B1} = 3\text{ V}, I_E = 0$	4 - 9.1	4 - 9.1	4 - 12	4 - 12
Interbase resistance TC ( $\alpha_{R_{BB}}$ , % / °C)	$V_{B2B1} = 3\text{ V}, I_E = 0$	0.1 - 0.9	0.1 - 0.9	0.1 - 0.9	0.1 - 0.9
Intrinsic standoff ratio ( $\eta$ )	$V_{B2B1} = 10\text{ V}$	0.55 - 0.82	0.51 - 0.69	0.55 - 0.82	0.74 - 0.86
Peak-point emitter current ( $I_p$ , $\mu$ A)	$V_{B2B1} = 25\text{ V}$	5	2	2	1
Valley-point emitter current ( $I_v$ , mA)	$V_{B2B1} = 20\text{ V}$	2	4	2	2
Emitter-base saturation voltage ( $V_{EB1}$ sat, V)		4	4	4	4
Emitter reverse current ( $I_{EB20}$ , nA)	$V_{EB2} = -30\text{ V}, I_{B1} = 0$	-10	-10	-10	-10
Interbase modulated current ( $I_{B2}$ , mA)	$V_{B2B1} = 10\text{ V}, I_E = 50\text{ mA}$	10	10	10	10



# Worlds of Clifton Quality

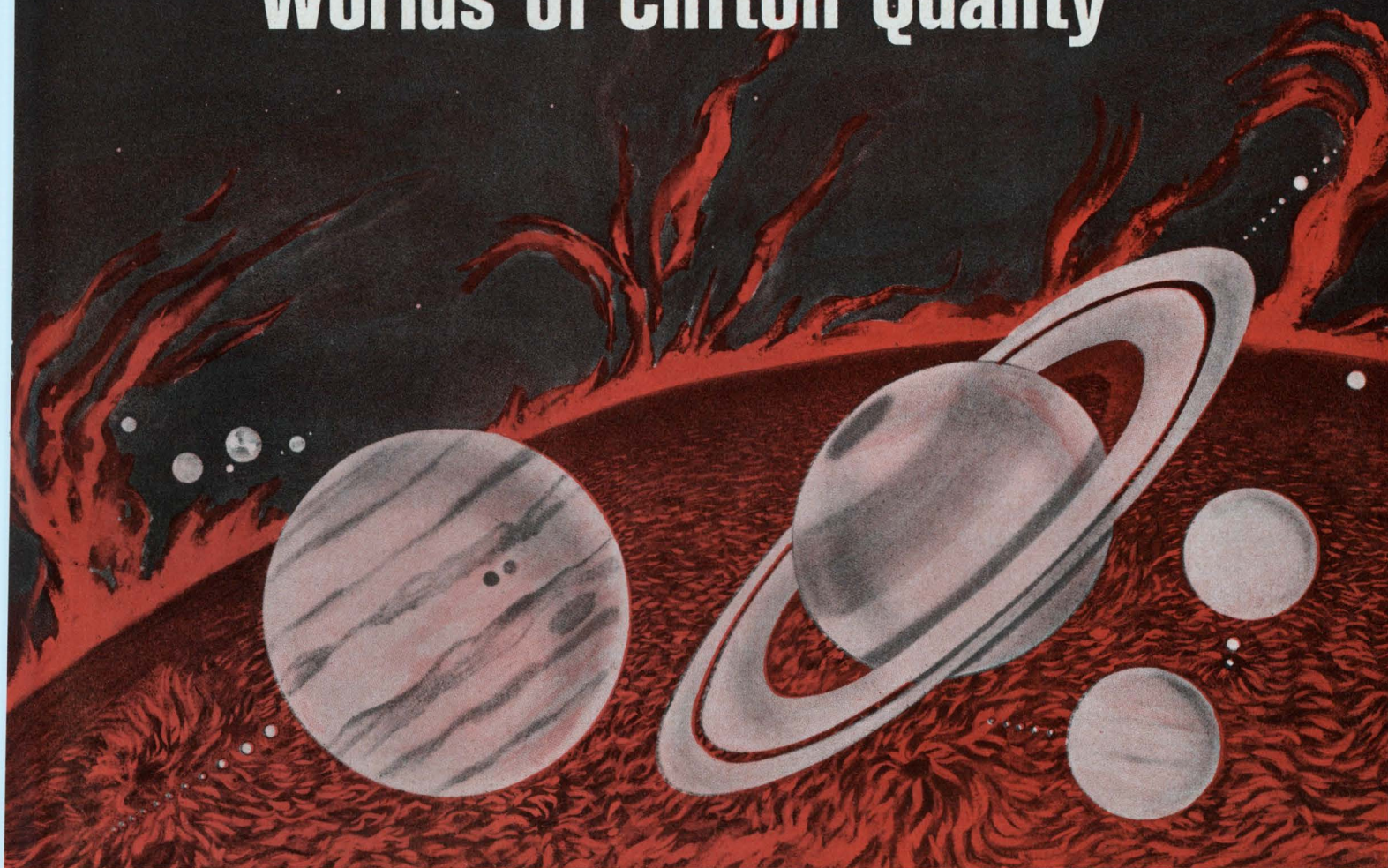

## in our **NEW**, Competitively Priced DC Motors

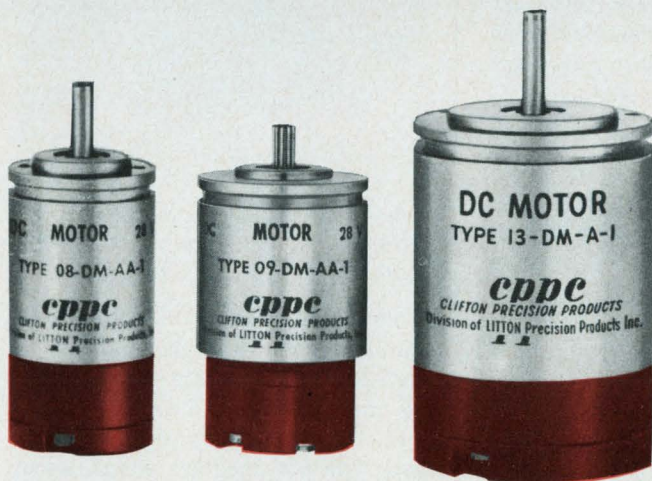

Built to exacting Clifton and MIL-E-5272 standards, these DC motors are a completely new design. They offer many advantages such as: stainless steel, corrosion resistant housings and ball bearings, and brush springs which maintain constant pressure over brush life. Brush life itself is up to 1000 hours depending upon environmental conditions and application.

These motors feature a five bar commutator. Due to the inherent design, the rotor produces a magnetic detent under zero excitation which minimizes gear train drift. Units available in both 14 and 28 volt excitation. Special voltages, shafts and housings available upon request.

Clifton Precision Products, Division of Litton Industries, Clifton Heights, Pa., Colorado Springs, Colo.

The illustration of our Solar System shows the nine planets and their 31 satellites in scale with each other and the enormous sun. The progression starts with Mercury at the left and ends with Pluto on the far right.

**cppe**

**CLIFTON**  
PRECISION PRODUCTS  
DIVISION OF LITTON INDUSTRIES

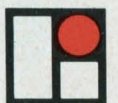

ON READER-SERVICE CARD CIRCLE 51



# DIRECT DRIVE TORQUE MOTORS IN STABILIZATION AND TRACKING SERVO SYSTEMS

The direct drive torque motor used as a servo actuator is ideally suited for many applications requiring precision rate and tracking drives. Typical of these applications are drives for tracking telescopes, radar antennas, aerial cameras, stable elements, and ultra-precise gyro test tables. The inherent features that make direct drive torque motors a logical choice for such applications are:

**high coupling stiffness:** the direct drive torque motor is attached directly to the load itself — therefore no gears, no backlash errors, no mechanical resonance problems.

**low speeds with high accuracy:** typical of precision rate drives is a table for testing rate and integrating gyros. This table has a speed range of 0.01°/sec to 1,500°/sec. Accuracy over most of this speed range is 0.1%.

**fast response:** since it produces higher torque for its size than any other electromagnetic device, and since its torque is a direct function of applied current independent of speed (a function of voltage), the torque motor's response is absolute and instantaneous at all operating speeds.

**high resolution:** the same characteristics that result in fast response from stand still to maximum operating speeds result in "locked-on" resolution. The torque motor is limited only by the sensitivity of the error sensing circuits that command it.

**high linearity:** torque increases directly with input current, independent of speed

or angular position. Electromagnetic linearity through zero excitation assures smooth operation and sensitivity to input signals.

**compact, adaptable design:** small, pancake configuration allows fitting the motor into minimum spacing around or on the end of the shaft to be driven. It also produces higher torque for its size than any other electromagnetic servo actuator.

**reliability and long life:** the basic simplicity and absolute minimum of moving parts makes a torque motor inherently reliable. Extensive design and production experience have put Inland torque motors in most major defense programs of the last decade. These include widely ranging applications under all conditions and environments from thousands of feet underwater to years of unattended operation in outer space.

Inland Motor Corporation specializes in direct drive torque motors and servo subsystems. Having originated most of the designs available today, Inland makes available a design library of over 600 torque motor models. Catalog items range from a small 0.03 lb.-ft. motor to those capable of many thousands of lb.-ft. of torque. Inland also produces rotary and solid state amplifiers, tachometer generators and other units which give Inland the unique capability to design and deliver complete direct drive servo subsystems for positioning, rate and tensioning applications. Inland's experience, production capacity and complete prototype facilities are distinct advantages to the customer.

**TORQY SAYS:**

You too, can be an expert on direct drive torque motors! Write or call today for a new condensed motor selection guide just off the press. If you're stuck on a servo drive problem—call us. We'll help solve it and you can be a hero.





**INLAND MOTOR**

CORPORATION  
RADFORD, VIRGINIA

703-NE9-3973

SUBSIDIARY OF **KOLLMORGEN**

ON READER-SERVICE CARD CIRCLE 52

## SEMICONDUCTORS

### 1-watt Zener diode has heat-sink construction

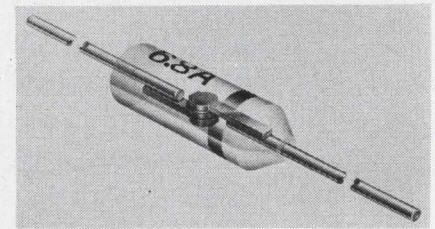

Semiconductor Div., Schauer Mfg. Corp., 4500 Alpine Ave., Cincinnati. Phone: (513) 791-3030. Price: (10% tol.) 32¢ (1000).

In these 1-watt Zener diodes the silicon wafer is aligned between two parallel, offset tantalum heat sink tabs, reducing lead tension. Gold-plated nickel leads are welded to the tantalum tabs. These leads do not extrude, and the long, bidirectional leakage path provides positive moisture protection. The body is high-pressure molded and has a banded and tapered cathode. The diodes are 0.16-in. diam by 7/16-in. long and are available in 5 tolerances from 1 to 20%, and in 21 voltages from 2.4 to 16.

CIRCLE NO. 132

### 5-V regulators in half-ounce modules

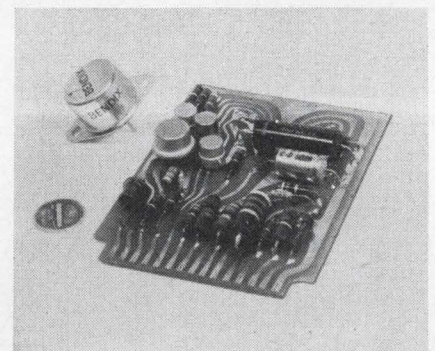

Bendix Corp., Semiconductor Div., Holmdel, N. J. Phone: (201) 747-5400. P&A: \$10.75 (1000); stock.

Two miniaturized dc voltage regulator modules are packaged in a high-dome TO-3 case. Both units are rated at 1 A and have a typical  $\pm 1\%$  regulation from min to max load. The 5-V modules weigh about 1/2 oz, with a height of 0.68-in. max. This module will fit all standard sockets and heat sinks manufactured for the TO-3 outline.

CIRCLE NO. 133

ON READER-SERVICE CARD CIRCLE 53 >



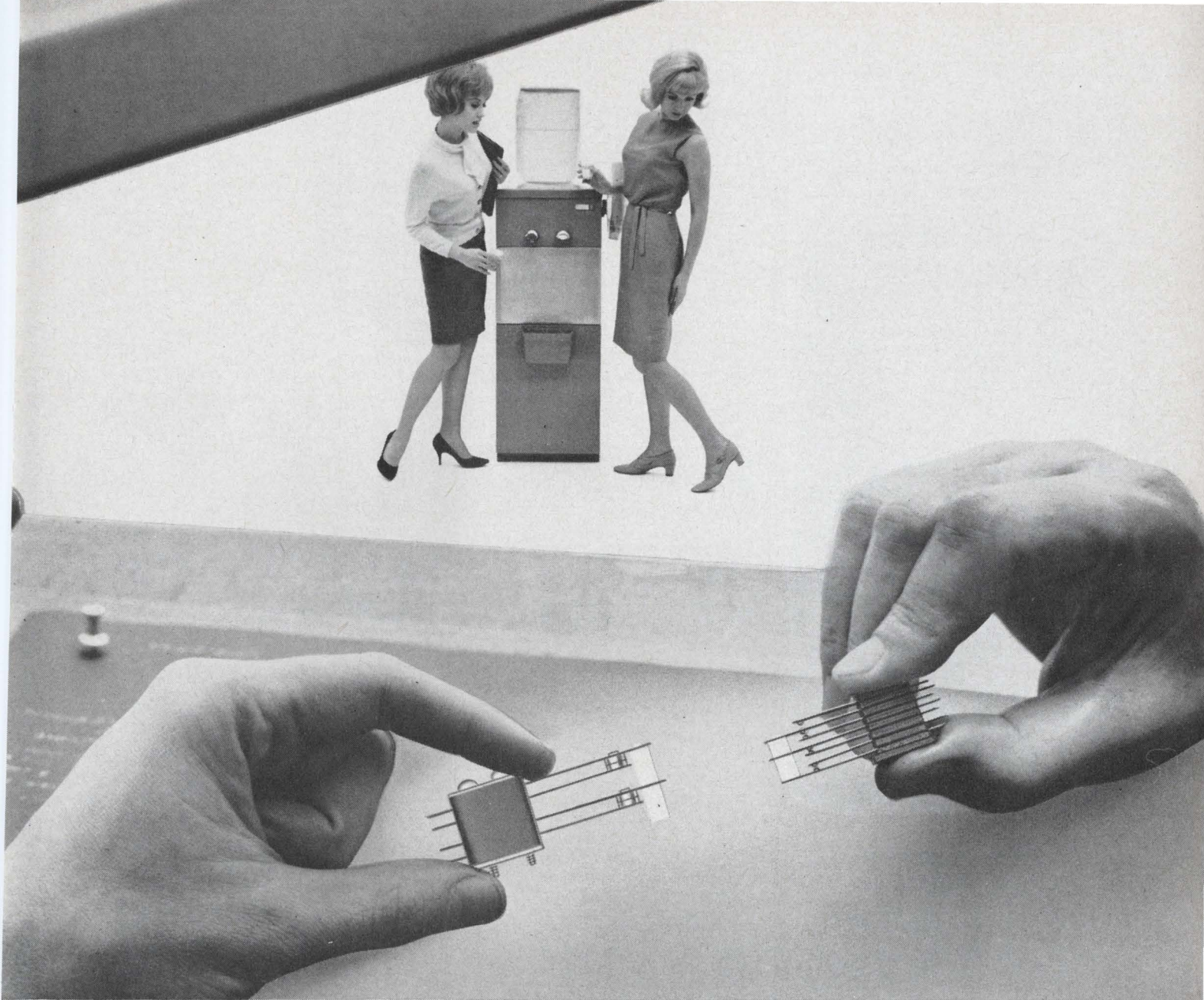

## It's time you learned the difference between MOLDED and STACKED

On the one hand, there's the molded switch. And on the other, the stack switch. Both extremely able performers. The stack switch, which is probably more familiar to most people, does the job it was designed to do—and does it well. Perhaps that's why it's always been (and still is) so popular.

Then, about a year ago, something new was added . . . the molded switch—which does everything the stack switch does, and because of its solid, one-piece design, is easier to handle. The molded switch not only saves time on your production line—cutting labor costs and speeding delivery—but it's so well put together that its alignment never wavers. No wonder the molded switch gained enthusiastic acceptance throughout

the industry as soon as it was introduced.

We recently increased our molded switch line so that we now have models available to cover most requests for this type of switch. These switches can be used anywhere conventional-type switches with  $\frac{1}{4}$ " or  $\frac{3}{8}$ " mounting are now being specified. Models range in amperage from  $1\frac{1}{2}$  to  $12\frac{1}{2}$ , and lifters from  $\frac{1}{16}$ " to  $\frac{1}{2}$ " can be supplied. A snap-on lifter is available for special applications.

We'd like you to see the difference in molded switches for yourself. Drop us a line, and we'll send you a free sample plus our new catalog, which gives a complete breakdown of all the contact combinations we currently have available.

After all, seeing is believing.

**GUARDIAN**  **ELECTRIC**

Manufacturing Company • 1550 W. Carroll Avenue, Chicago, Illinois 60607



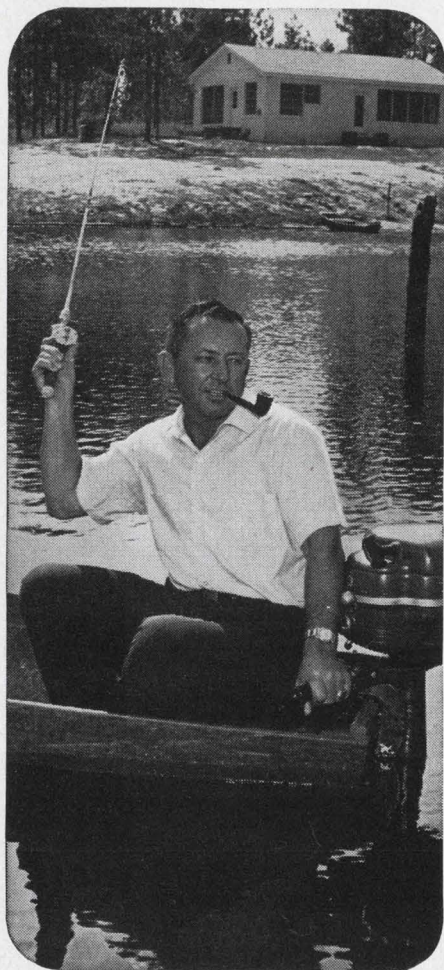

### How Lucas Ray built himself a lake with U.S. Savings Bonds

Like umpteen million other Americans, Mr. Ray loves to fish. Unfortunately, in his part of South Carolina, public lakes are scarce.

Not one to be discouraged, he cashed in a few thousand dollars' worth of Savings Bonds and built his own. He has it well-stocked with crappies, catfish, bass and other fish. And an attractive 4-room cottage sitting beside it (also built with Savings Bonds).

In case you're wondering, Mr. Ray possesses neither great wealth nor super-human powers as a saver. He accumulated the money for the lake, fish and cottage by joining the Payroll Savings Plan where he works.

Every week the company sets aside \$9 from his paycheck and puts it toward the purchase of a \$50 Bond every month. His savings build up automatically.

Americans with all kinds of savings goals buy Bonds on the Payroll Savings Plan. And while their dollars build up a nest egg for their future, they help Uncle Sam safeguard our freedom right now.

Must be lots of important things you'd like to have in your future. Why not sign up for the Payroll Savings Plan where you work and see if it isn't the easiest way in the world to save for them?

Help yourself while you help your country

**BUY U.S. SAVINGS BONDS**



This advertising is donated  
by The Advertising Council  
and this magazine.

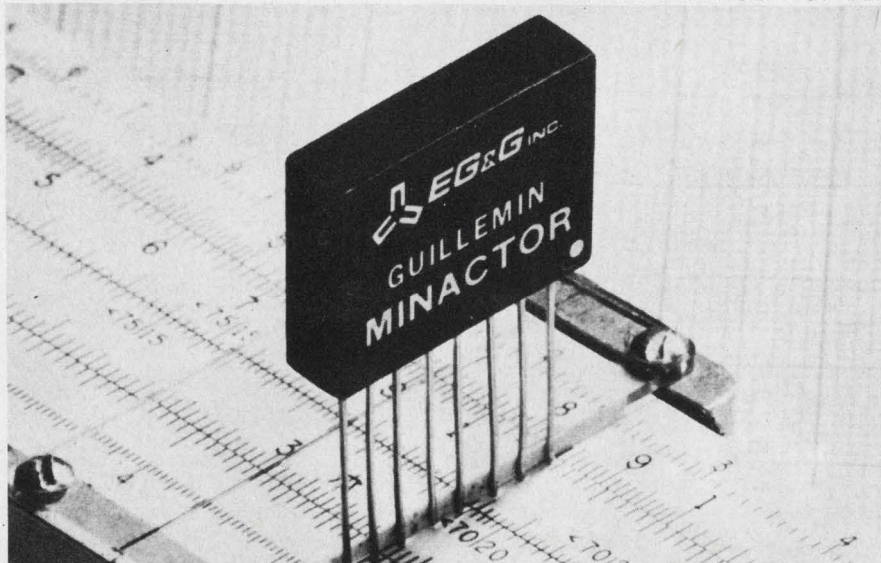

## Active filter design made easy with hybrid RC modules

EG&G, Guillemín Networks Div., 160 Brookline Ave., Boston. Phone: (617) 267-9700. P&A: under \$100; stock.

An encapsulated device, the Minactor (miniature active resonator), and a handful of external components are all you need to design your own audio-range active filter.

The device is a lumped network, fabricated by hybrid techniques. It contains a thin-film resistor substrate, an integrated-circuit amplifier, and discrete capacitors for fixed-frequency operation.

Basically the 0.6 by 0.8 by 0.2-inch module is an RC device that provides an orthogonally adjustable pair of complex conjugate poles in its voltage transfer function.

A series of ten units spanning the frequency range of 100 Hz to 18 kHz make it possible to design filters for operation at any frequency in the 70-Hz-to-25-kHz range. The device thus reduces active filter design to selecting one or more passive components in the required frequency range.

Since the device is tuned externally to obtain a desired response, the designer can employ temperature-compensating techniques to obtain constant Q and resonant frequencies at any desired stability over the required temperature range. The degree of temperature

compensation increases as the stability tolerances of the Q and resonant frequency decrease. Once the external resistance and capacitance have been selected for a given application, the temperature behavior can be determined by reference to design charts supplied with the device. Bandwidth is stabilized by an external resistance alone, and resonant frequency by an external capacitance alone.

Four design charts are supplied to aid in rapid design of a wide variety of filters:

- Normalized  $\omega_0$  and  $\alpha$  dependence on the normalized tuning components.
- Normalized  $\beta$  dependence on the parameters  $\alpha$  and  $\omega_0$  selected.
- External tuned capacitance temperature dependence required for constant resonant frequency.
- External variable resistance temperature dependence required to maintain constant Q.

With these charts the designer can select the external components to suit his purpose and avoid tedious design calculations. The units can be cascaded.

The units can be adapted for use as band-pass, low-pass, notch, and all-pass filters. In addition, low-frequency age units, oscillators, FM modulators and FM discriminators can be designed with this device.

CIRCLE NO. 128



## Hermetic receptacles have rear release

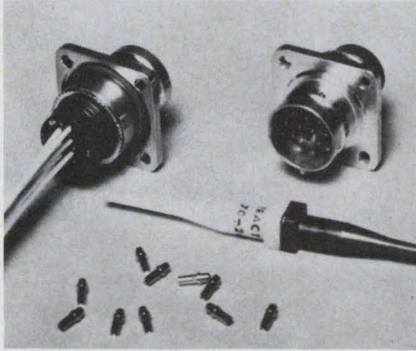

The Deutsch Co., Electronic Components Div., Municipal Airport, Banning, Calif. Phone: (714) 849-6701.

Miniature hermetic connectors increase reliability and simplify the process of connecting wires to contacts. The terminations are crimped to wire ends and connected to contacts with a simple plastic tool. The connectors mate with bayonet coupling (MIL-C-26482) plug types. Electrical and mechanical performance meet MIL-C-26482.

CIRCLE NO. 130

## Integrated crystal filter uses acoustic coupling



Piezo Technology, Inc., 2400 Diversified Way, P. O. Box 7877, Orlando, Fla. Phone: (305) 424-1574. P&A: \$35 (1 to 9).

Improved received IF and RF filtering in the VHF range is claimed with a new integrated crystal filter. The IXF filter makes use of the acoustical coupling principle. It features a 2-pole response characteristic at 112 MHz with 3-dB bandwidth of 20 kHz and stop band attenuation of 25 dB min. Midband insertion loss is less than 2 dB.

CIRCLE NO. 131

# Pain Reliever



Cinch-Graphik printed circuits are a sure cure for packaging and production headaches. They are exactly manufactured by the world's most experienced printed circuit craftsmen to insure specification compliance, uniform assembly and dependable operation...*every* time. Caution: Cinch-Graphik's formula of CARE, SKILL and EQUIPMENT is often habit forming.

**CINCH-GRAPHIK**  
DIVISION OF UNITED-CARR

200 South Turnbull Canyon Road, City of Industry (Los Angeles), Calif. 91744 • Phone (213) ED 3-1201. Offices in 22 Principal Cities throughout United States, Canada, England and Australia listed under Cinch Mfg. Co. or United-Carr Incorporated • Cinch • Cinch-Monadnock • Howard B. Jones • Ucinite • Palnut

ON READER-SERVICE CARD CIRCLE 54



# always growing with your needs

## ... Ohmite



**MOLDED VITREOUS ENAMEL**—patented innovation in coatings for wirewound resistors. Resists chipping, heat (1500°F), moisture, and provides 1000 V insulation. Consistent form and dimensions are a boon to automated assembly; also permits clip mounting for heat-sink benefits. Vitreous markings are as impervious as the coating. 1.5 to 11 watts . . . Series 99.

**MOLDED SILICONE-CERAMIC**—a blend offering the best properties of these two materials. We call it "Ohmicone." Standard TC is a low  $0 \pm 20$  ppm/°C. Molding results in a 1000 V insulation rating plus the benefits of consistent form and dimension. This resistor line includes units for close tolerance applications requiring high stability. Wirewound, 1 to 11 watts . . . Series 88.

**CONFORMAL SILICONE CERAMIC**—an optional form of Ohmite's tough, resilient "Ohmicone" coating. This type of resistor construction can also be obtained with low TC, close tolerances, and excellent stability. Most Ohmite wirewound styles can be supplied with this coating. 1 to 1000 watts depending on style . . . Series 40, 44, 45, & 47.

**PRECISION METAL FILM**—supplied *only* for the most exacting requirements of MIL-R-10509. Resistance film is non-noble metal, vacuum evaporated onto a ceramic core of exceptional surface finish. Internal connections are gold plated. Inner coating is a special resin; outer jacket, tough molded plastic.  $\frac{1}{8}$ ,  $\frac{1}{4}$ ,  $\frac{1}{2}$ , 1 watt . . . Series 66.



**OHMITE** MANUFACTURING COMPANY  
 3643 Howard St. • Skokie, Ill. 60076  
 Phone: (312) ORchard 5-2600



# resistance products



**EXPOSED WINDING CONSTRUCTION**—for very high current applications: (1) Series 28 & 23—corrugated ribbon wire on a ceramic core, partially coated with vitreous enamel, or (2) corrugated ribbon uncoated on a grooved core; (3) round or ribbon-type wire on grooved ceramic segments—Series 08 & 03. Up to 100 amps . . . Corrib® and Powr-Rib®.

**CERAMIC JACKETED**—wirewound resistors which can be mounted against almost any live or grounded surface because they are sealed inside a ceramic jacket and can withstand several thousand volts to ground. The internal coating of the resistance element is silicone-ceramic. 1 to 25 watts . . . Series 11, Tubeohm®.

**CONFORMAL VITREOUS ENAMEL**—a hard, glassy, tough coat which won't shrink or burn. It is unaffected by moisture and withstands amazing overloads. This is the most widely used family of wirewound, power-type resistors in the industry. Popular styles are illustrated. Power ratings up to 1000 watts depending on style. Series 20, 22, 25 & 27.

**New! Big Resistor Catalog 100, Tells All . . . Send For A Copy.**



ON READER-SERVICE CARD CIRCLE 55



### Glass trimmer caps with torque control

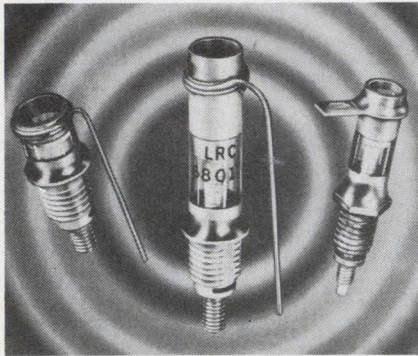

LRC Electronics, Inc., 901 South Ave., Horseheads, N. Y. Phone: (607) 739-3844. P&A: about \$2 to \$4; 3 to 4 wks.

A spring compensated torque control is featured in a series of metallized glass miniature trimmer capacitors. The new torque control permits a greater number of adjustments than previously available in low-cost glass trimmers, according to the manufacturer. There are only four parts in the entire assembly.

CIRCLE NO. 134

### Squaring module has dc-to-1-MHz range

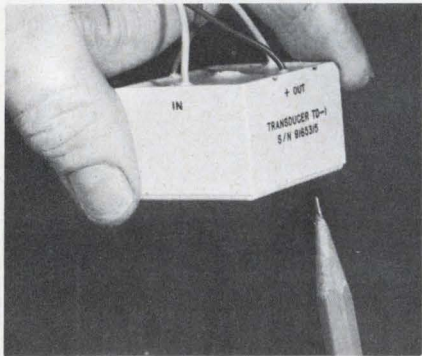

Greibach Instruments Corp., 315 North Ave., New Rochelle, N. Y. Phone: (914) 633-7900. P&A: \$200; stock.

A precision solid-state voltage-to-current analog squaring component which requires no power supply for activation will perform accurately for all input levels up to 200 mV. Operating frequency is dc to 1 MHz. The unit is made up of stable solid-state elements arranged and matched in a network. The output is  $\pm 0.1\%$  of the theoretical value.

CIRCLE NO. 135

### Economy op-amp has high drift stability

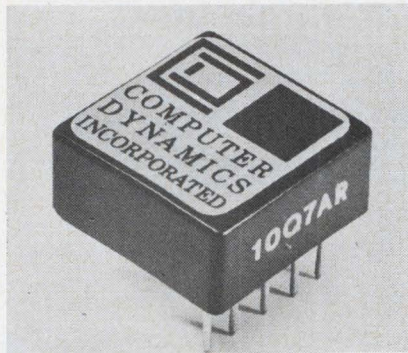

Computer Dynamics Inc., 179 Water St., Torrington, Conn. Phone: (203) 482-7621. P&A: \$13.50; stock.

This amplifier is designed for medium gain and relatively high drift stability. It is designed for relatively low-cost volume use where very low voltage and current drift are not required. Because of the matching of its transistors, this amplifier claims freedom from turn-on drifts and stabilizes rapidly.

CIRCLE NO. 136

### Optical meter relay is non-contacting

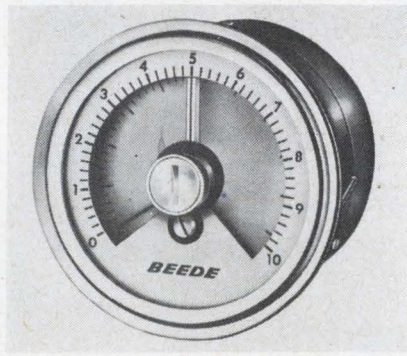

Beede Electrical Instrument Co., Inc., Penacook, N. H. Phone: (603) 753-6362. P&A: \$30; stock.

In this optical meter relay, a vane mounted on the indicating pointer interrupts a beam of light as the indicating pointer passes the set pointer. This changes the output of photoconductive cells mounted on the set pointer, triggering an electronic circuit that energizes or de-energizes an output relay. The circuit remembers the position of the indicating pointer.

CIRCLE NO. 137

### Trimmers have wide resistance range

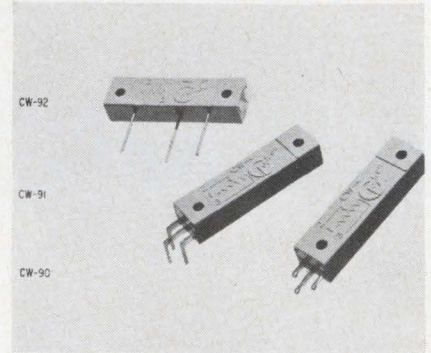

Bowmar Instrument Corp., 8000 Bluffton Rd., Ft. Wayne, Ind. Phone: (219) 747-3121.

These trimmers are manufactured in all standard resistance values from 25  $\Omega$  to 50 k $\Omega$ , with special 10- $\Omega$  units also available. Ceramic mandrels and precious metal wipers make the units applicable for precision instrument uses. Thermally stable material affords a TC of 20 ppm above 1 k $\Omega$  and a 1-W power handling capability. Derating starts at 40°C and ends at 100°C.

CIRCLE NO. 138

### Decade counter has switched time base

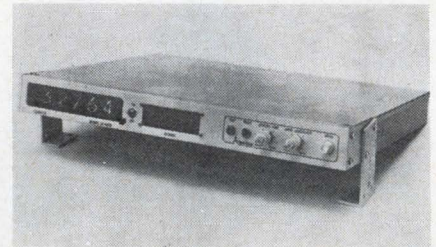

Anadex Instruments, Inc., 7833 Haskell Ave., Van Nuys, Calif. Phone: (213) 782-9527. P&A: \$945; stock to 4 wks.

A variable time base counter is designed for frequency, normalized rate and multiple frequency ratio measurements. The internal time base is generated by decade divider circuits from a 100-kHz stable crystal oscillator. Other features include five front-panel-mounted thumb switches for selecting the time base, and numerical indicator tubes for bright, in-line display.

CIRCLE NO. 139



# Enter The Hudson Bulb Sweepstakes:

## 500 Tensor Lamps given away Free!

Here's your chance to win one of those mighty mite high intensity lamps you've been meaning to get—and at the same time learn about the mighty mite bulbs that Hudson makes for almost any miniature bulb application you can think of: electronics, automotive, aircraft, indicator, instrumentation and others, including high intensity lamps. Hudson specializes in miniature bulbs so bright and reliable that purchasing agents specify our products again and again. Bulbs so tiny that Design Engineers get the space they need. Bulbs so long-lived (some exceeding 100,000 hours) that you can install them—and forget them. Send in your entry to the Hudson Bulb Sweepstakes today. It could brighten up your life in more ways than one.

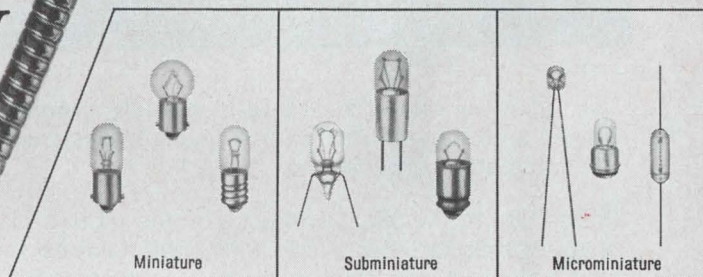
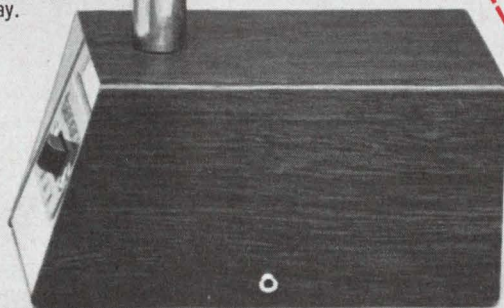

(TYPICAL BULBS IN THE HUDSON BULB LINE)

### RULES

1. As a specifier or purchasing agent, write in any one miniature bulb application your company may have, on the coupon line below.
2. Complete the coupon with your name, company and address and mail it to the Hudson Lamp Company.
3. Entries must be postmarked before midnight, April 30, 1967. Winners will be notified before May 31, 1967.
4. This Sweepstakes is void where prohibited, and closed to employees of Hudson Lamp Company, its affiliates and agencies.

Hudson Lamp Company  
550 Elm Street  
Kearny, New Jersey 07032

LAMP COMPANY  
**Hudson**

YES, enter me in your Sweepstakes. My company's miniature bulb application is:

Name \_\_\_\_\_ Title \_\_\_\_\_

Company \_\_\_\_\_

Address \_\_\_\_\_

City \_\_\_\_\_ State \_\_\_\_\_ Zip \_\_\_\_\_



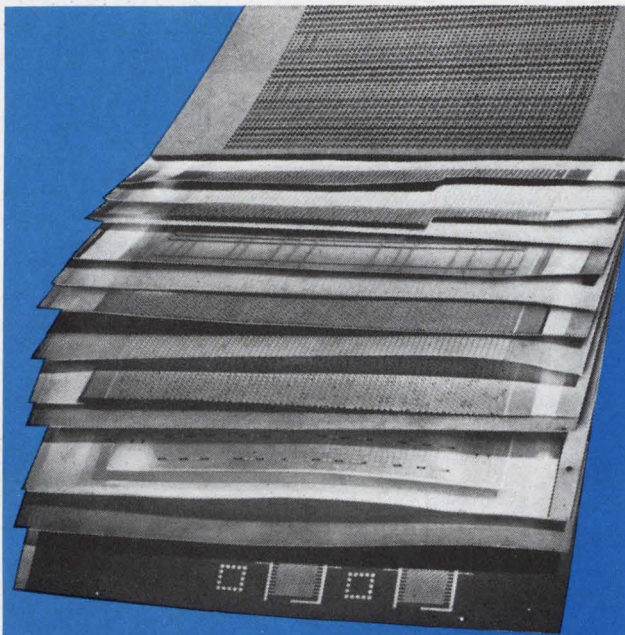

**the circuit  
is never lost  
in the shuffle  
at**



This 15-layer circuit board with multiple ground planes and signal circuits was especially designed for datamation applications.

In addition to the usual problems of line width and spacing, there are five planes with 7000 holes each which must be in perfect register . . . in a compact area just 10" x 18".

These are the kind of design parameters we thrive on at Methode's Printed Circuit Division.

With our expanded R & D and testing facilities and enlarged production facilities, we are ready to deliver single and multi-layer circuit boards for commercial or military/computer applications from the smallest ( $\frac{1}{2}$ " x  $\frac{1}{2}$ " ) to the largest, with up to 32 layers and more.

Deal us your problems . . . and rest easy.

Printed Circuit Division

**Methode Electronics, Inc.**

7447 W. Wilson Ave.

Chicago, Illinois 60656 • 312 / 867-9600

ON READER-SERVICE CARD CIRCLE 56

## COMPONENTS

### Flexible coupling protects pots

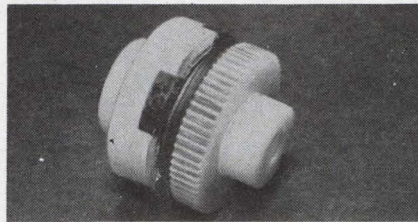

*R. Meussdorffer & Associates,  
13441 Ventura Blvd., Sherman  
Oaks, Calif. Phone: (213) 788-0771.*

Minitork is a flexible coupling made of Delrin with an adjustable torque friction surface between input and output. The slipping torque is easily adjusted from virtually zero to five in.-lbs by turning a milled wheel. It is available in bore sizes from six mm to 13/32 in. Standard stock bore is 1/4 in. Because of its light weight, low moment of inertia and wear-resistant friction surfaces, the coupling is ideal for the protection of potentiometers, switches, valves and other equipment which might be damaged through jamming or overriding the drive.

CIRCLE NO. 140

### Cooling units for easy rack-mounting

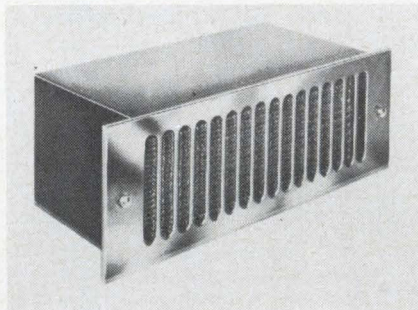

*McLean Engineering Labs., Prince-  
ton Junction, N. J. Phone: (609)  
799-0100.*

A line of packaged fans has standard notching and hardware to permit quick and easy rack installation. All units have polished stainless steel grilles and washable permanent filters easily removable without tools. Each blower has two 115-V, 50/60-Hz, life-lubricated motors, guaranteed for 20,000 hours of continuous duty life.

CIRCLE NO. 141



## Temperature controller senses 1% change

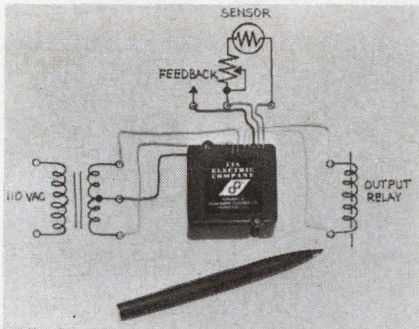

Tia Electric Co., 178 Alexander St., Princeton, N. J. Phone: (609) 921-2880. P&A: \$25 (unit); stock.

Utilizing a high gain differential amplifier, this resistance-temperature controller provides a snap-action on-off output for a sensor resistance change of only 0.1%. The output can be used to drive relays, indicators, or other electronic or mechanical control devices. The output is diode-suppressed for driving power relays with coil resistances of 250  $\Omega$  or greater, and a dc rating of 24 V.

CIRCLE NO. 142

## FET preamps feature low power-supply noise

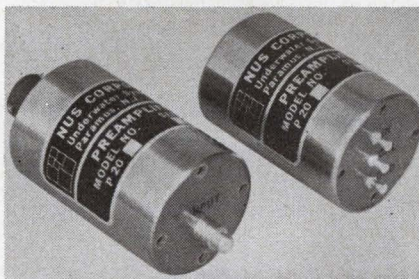

Underwater Systems Div., NUS Corp., 676 Winters Ave., Paramus, N. J. Phone: (201) 265-2400. P&A: \$145 to \$180; stock.

A series of FET preamplifiers feature a built-in power supply noise filter and isolator that reduces the effect of supply noise by more than 60 dB. All models are designed for stability when driving a capacitance load, such as a long cable. They are suited for use with high-impedance transducers including accelerometers, force gauges, hydrophones and heat and light sensing cells.

CIRCLE NO. 143

# Methode FORK CONTACTS BY THE MOUNTAIN . . .

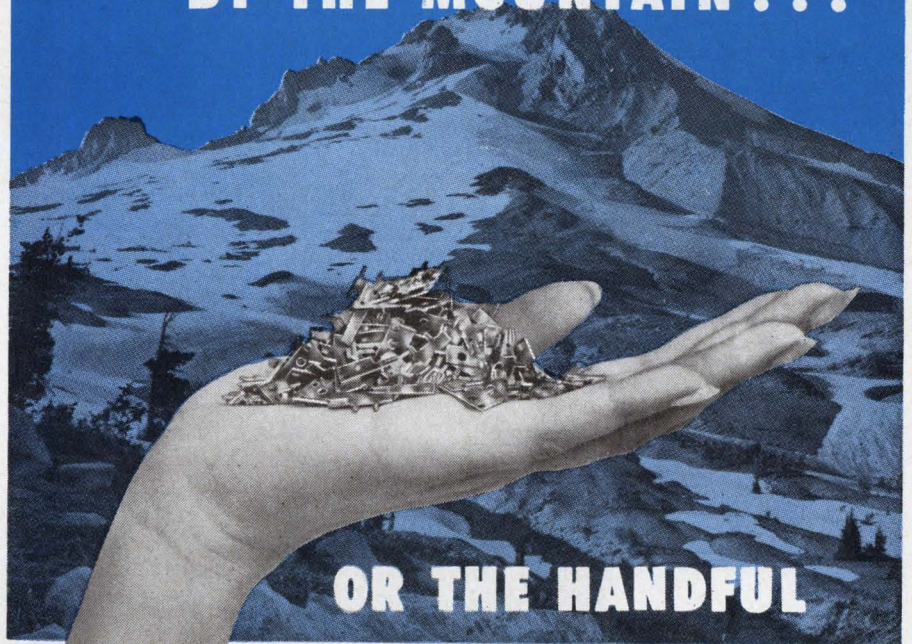

## Methode makes all styles and types

It makes no difference what your quantity or delivery requirements may be: Methode Electronics has the stock, and the production capacity to supply your needs right now!

Dependable, precise Methode fork contacts, receptacles, contact strips and disposable contact strips are available in all sizes and configurations; fully interchangeable and compatible; featuring the originally designed split leg construction which saves you money;

Connectors available with 3 to 51 contacts in all popular termination styles.

We invite your inquiry.

Connector Division  
**Methode Electronics, Inc.**  
 7447 W. Wilson Ave.  
 Chicago, Illinois 60656 • 312/867-9600

Avnet stocks Methode's full line of connectors across the country . . . order today!

Licensed under Elco patents



## Tiny metal films mate IC or PC

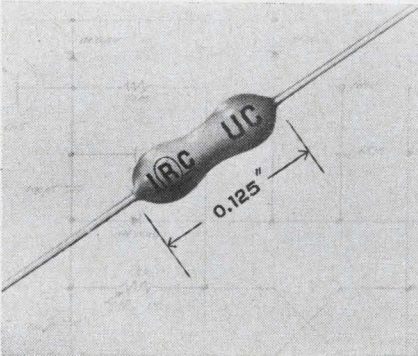

IRC, Inc., 401 N. Broad St., Philadelphia. Phone: (215) 922-8900. P&A: 67¢ (1000 lots); 8 wks.

Microminiature metal film resistors are claimed to be the smallest commercially available. The unit, 0.125 in. long with a 0.047-in. diameter, has #30 AWG (0.01-in.) gold-plated dumet leads. Resistance values range from 50  $\Omega$  to 10 k $\Omega$ , with initial tolerances of  $\pm 1$ ,  $\pm 2$  or  $\pm 5\%$ . Rated 0.05 W at 100°C, the resistors can be obtained with temperature coefficients of  $\pm 50$  or  $\pm 100$  ppm/°C.

CIRCLE NO. 144

## Miniature caps get new weld process

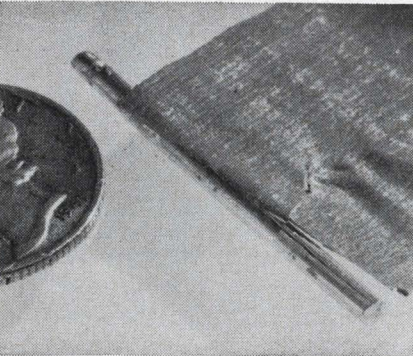

Cornell-Dubilier Electronics, 50 Paris St., Newark, N. J. Phone: (201) 624-7500.

A terminal construction for miniature aluminum capacitors, called "Cold-Weld," claims a record low contact resistance. The technique replaces the split riser method of attaching the anode foil to the riser, in which low crimp pressure can allow the electrolyte to flow into the crevice.

CIRCLE NO. 145

## Solid-state readout for wide-angle viewing

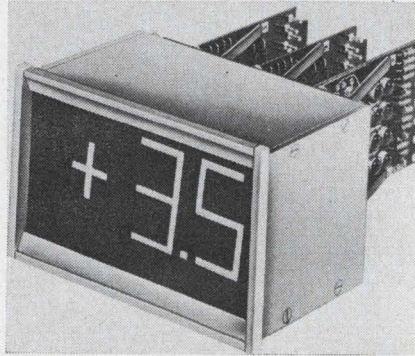

Transistor Electronics Corp., Box 6191, Minneapolis. Phone: (612) 941-1100.

Solid-state decoder/driver circuitry of the TSR series readout controls neon lamps with signals as small as 0.5 mA. Supply voltage required is  $\pm 50$  V rms, rectified, unfiltered. Displays are 0 through 9, plus, minus, and decimal point. Three models are available: with decimal input and decimal readout, BCD input and decimal readout (4- or 8-wire models) and a nondriven version to operate directly from a 10-line input.

CIRCLE NO. 146

## 12- to 24-V supply is dual plug-in

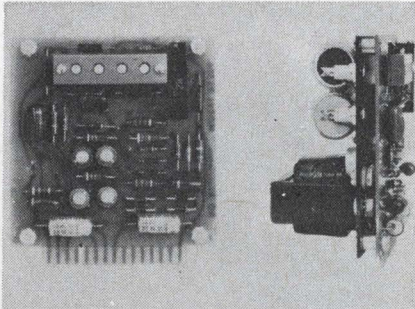

RO Associates, 917 Terminal Way, San Carlos, Calif. Phone: (415) 591-9443. P&A: \$95; stock.

A dual plug-in power supply is designed for use in analog systems, special laboratory or production test setups, and one-time test stations. It features a dual 3-wire output of  $\pm 12$  to  $\pm 24$  Vdc at 150 mA for each channel in a compact, plug-in card. Other features include current limit, short circuit protection and convection cooling.

CIRCLE NO. 147

## Deflection amplifiers for tube display systems

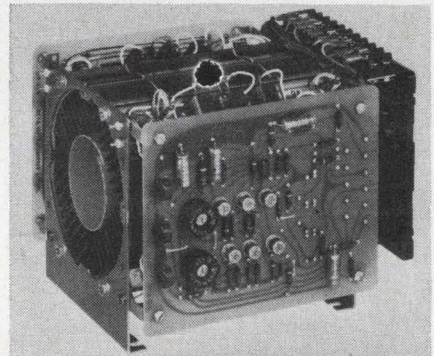

Beta Instrument Corp., 377 Elliot St., Newton Upper Falls, Mass. Phone: (617) 969-6510. P&A: \$740 to \$1555; 4 wks.

These all-silicon solid-state packages feature high deflection performance characteristics at low cost. They are dc-coupled operational difference amplifiers and are designed for application in any cathode-ray tube, or storage tube display system employing magnetic deflection. The units are capable of supplying  $\pm 2.5$ ,  $\pm 4.5$  and  $\pm 8.0$  A of deflection current to a directly coupled deflection coil. The modules have two identical channels of power amplification, one for X, and one for Y deflection.

CIRCLE NO. 148

## Axial-lead electrolytics claim 10-year life

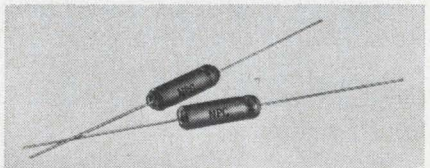

Nucleonic Products Co., Inc., 3133 E. 12th St., Los Angeles. Phone: (213) 268-3464.

When used within their specified limits, series 500 axial-lead electrolytic capacitors offer a ten-year service life. Capacitance range is from 1 to 2000  $\mu$ F with standard tolerances of  $-20\%$  and  $+50\%$  (measured at 120 Hz). Working voltage range is 3 to 150 Vdc. Can dimensions include diameters from 0.177 to 0.985 in. and lengths from 0.393 to 1.970 in.

CIRCLE NO. 149



# New Stauffer Si-O-Flex™

## RTV silicones with these electrical properties...

	Dielectric Strength (v/mil)	Dielectric Constant @			Dissipation Factor @			Volume Resistivity (ohm-cm)
		60 cps	10 <sup>3</sup> cps	10 <sup>6</sup> cps	60 cps	10 <sup>3</sup> cps	10 <sup>6</sup> cps	
Si-O-Flex SS-831	630	3.3	3.2	3.1	0.013	0.010	0.006	23°C: 6.0 x 10 <sup>14</sup> 150°C: 4.8 x 10 <sup>13</sup>
Si-O-Flex SS-832	550	4.0	3.9	3.8	0.018	0.011	0.003	23°C: 2.0 x 10 <sup>15</sup> 150°C: 1.8 x 10 <sup>14</sup>
Si-O-Flex SS-833	550	4.1	4.0	3.9	0.022	0.016	0.004	23°C: 3.0 x 10 <sup>15</sup> 150°C: 4.5 x 10 <sup>14</sup>

Have you ever seen RTV's with this *balanced property profile*?

- Low viscosity for easy handling
- Excellent electrical insulation
- Good physical properties
- 24-hour cure in any thickness
- Outstanding thermal stability
- Curing not inhibited by common materials
- Cure even at low humidity
- Short tack-free time plus long working time



STAUFFER CHEMICALS . . . at work everywhere

This *balanced property profile* makes Stauffer RTV silicone rubbers especially useful for all electrical and insulation applications . . . potting, encapsulation, embedding, sealing, and caulking. Si-O-Flex SS-831, SS-832, and SS-833 RTV's are commercially available, backed by Stauffer's knowledgeable technical service. Want more information? Just complete the coupon.

Stauffer Chemical Company, Silicone Division,  
P.O. Box 428, Adrian, Michigan 49221.

STAUFFER CHEMICAL COMPANY  
Silicone Division, Adrian, Michigan 49221 Dept. E. D.  
Please send me data on Si-O-Flex SS-831, SS-832,  
SS-833 RTV silicone rubbers. My special interest is:

Name: \_\_\_\_\_

Company: \_\_\_\_\_

Address: \_\_\_\_\_

City: \_\_\_\_\_ State: \_\_\_\_\_ Zip: \_\_\_\_\_



# VACTEC

Type O CdS Cells  
*Fastest*  
*at*  
*Low Light Levels*

The response time of any photocell slows proportionately as the light level decreases. But Vactec delivers a rapid response time even at low light levels.

At .01 ft. candles, for example, Vactec Type O material provides a rise time of 780 milliseconds with a delay time of only 90 milliseconds. And you also get the temperature stability provided only by CdS material. Even if yours is a higher light level application, isn't it reassuring to know there is a supplier whose cells are capable of such a high level of performance?

Five new materials ranging from Cadmium Sulfide to Cadmium Selenide are now available. Write for new Bulletin PCD-4 today!



VACTEC  
INC.

2423 Northline Industrial Blvd.  
Maryland Hts., Mo. 63042  
AC 314, HE 2-4200

See Vactec's listing in EBG under "Semiconductors," and in EEM, Sec. 3700.

ON READER-SERVICE CARD CIRCLE 59

## TEST SOCKET

FOR FLAT PACK INTEGRATED CIRCUITS

8075 SERIES

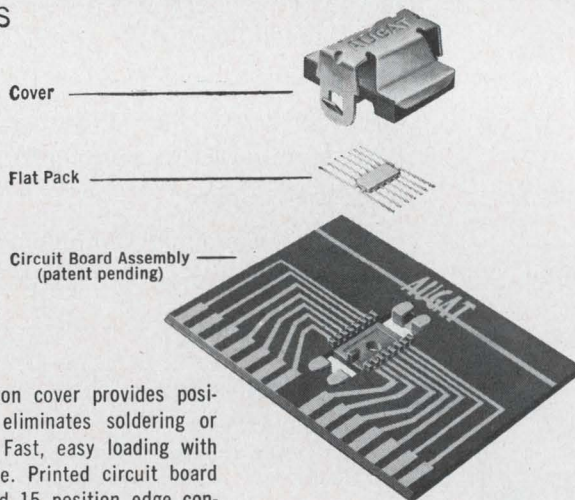

Exclusive snap-action cover provides positive contact and eliminates soldering or welding IC leads. Fast, easy loading with no IC lead damage. Printed circuit board plugs into standard 15 position edge connector. Accepts any size package up to  $\frac{1}{4} \times \frac{3}{8}$ , any number of leads up to 14.

Write for Catalog 364 on complete line of integrated circuit products for Testing Breadboarding and Packaging.

**Other applications**  
Dual-In-Line Packages  
TO-5 case size units  
T.I. Mech Pak Carrier

**AUGAT** INC. 31 PERRY AVE., ATTLEBORO, MASS. 02703

ON READER-SERVICE CARD CIRCLE 60

## COMPONENTS

### Fast circuit breaker protects transistors

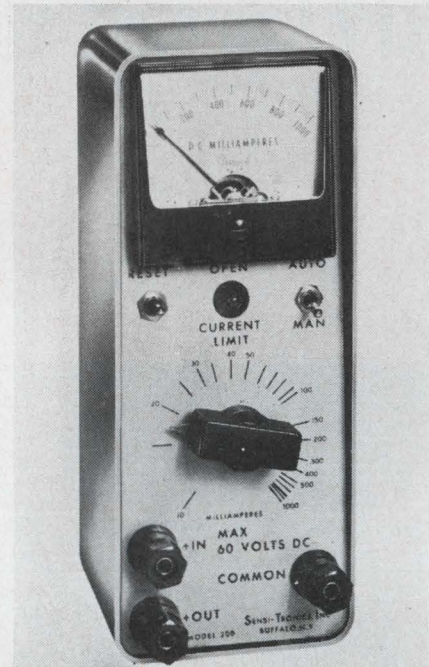

*Sensi-Tronics, Inc., 503 Franklin St., Buffalo, N. Y. Phone: (716) 885-8535.*

This electronic circuit breaker offers a high-speed (1 ms) breaker to protect high-frequency transistors or other components. A current break range from 10 to 1000 mA is provided, with a calibrated scale and knob to facilitate desired break-point setting. Reset is automatic; the breaker tries to reset and succeeds when overload is removed.

CIRCLE NO. 150

### LC phase detector in miniature can

*JFD Electronics Co., 15th Ave. at 62nd St., Brooklyn. Phone: (212) 331-1000.*

One of a new line of miniature LC circuits for phase detecting applications is packaged in a specially fabricated square can mounted on a standard 6-pin, TO-5 glass-to-metal sealed header. This unit includes a trifilar wound toroidal inductor and a ceramic variable capacitor which is adjustable from the top. The operating frequency is 60 MHz min; primary Q is 90 min; secondary Q is a min of 75.

CIRCLE NO. 151



## Ac summing amplifier fully potted

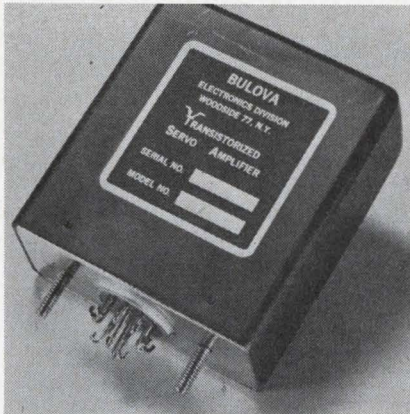

Servo Products, Bulova Electronics, 61-20 Woodside Ave., Woodside, N. Y. Phone: (212) 335-6000. P&A: \$125; 8 to 10 wks.

A fully-potted 400-Hz summing amplifier uses silicon transistors, and meets environmental requirements of MIL-E-16400 and -5400. Model 297 has a rated gain accuracy of  $1 \pm 0.05\%$  with an input and output range of 0 to 10 V rms. A 28-Vdc power supply is required with  $\pm 10\%$  regulation. The unit has four summing inputs with accuracy of  $\pm 0.05\%$  and an input impedance of 600 k $\Omega$ .

CIRCLE NO. 152

## Frequency standard is battery-operated

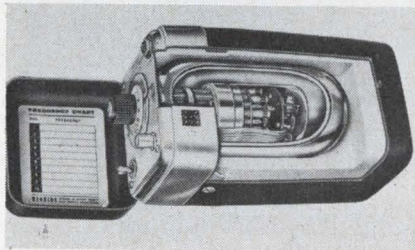

Plectron Corp., Overton, Neb. Phone: (308) 987-2416.

This portable frequency standard operates at any of 10 preselected frequencies within the range of 10 to 480 MHz. The unit weighs 2.6 lbs without the batteries. It is designed for spot or fixed frequency measurements to an accuracy exceeding FCC requirements. It is a battery-powered frequency standard for alignment of two-way radio networks.

CIRCLE NO. 153

## Miniature op-amp features low drift

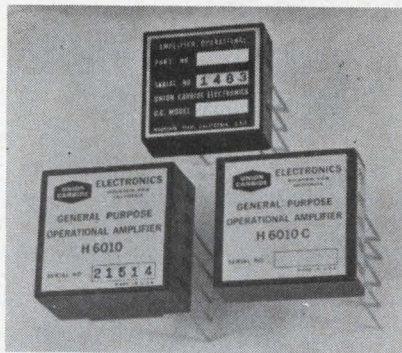

Union Carbide Electronics, 365 Middlefield Rd., Mountain View, Calif. Phone: (415) 961-3300. P&A: \$45 (1 to 4); stock.

This general-purpose op-amp develops less than 5  $\mu\text{V}/^\circ\text{C}$  and 0.5 nA/ $^\circ\text{C}$  of voltage and current drift respectively. The bandwidth is greater than 5 MHz, the common mode rejection ratio is greater than 80 dB and the input wideband noise is less than 5  $\mu\text{V}$  rms. The output is  $\pm 10$  V at  $\pm 2$  mA. Three packages are 1 by 1 by 0.4-in. and larger.

CIRCLE NO. 154

## Transducer converts pressure to frequency

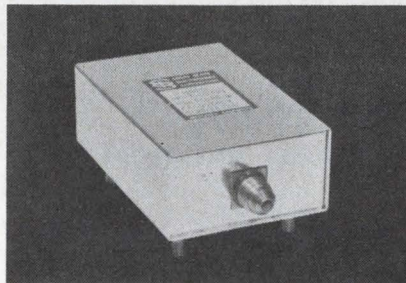

Solid State Electronics Corp., 15321 Rayen St., Sepulveda, Calif. Phone: (213) 894-2271.

A miniature pressure-to-frequency transducer provides a simplified approach to missile, space vehicle, aircraft, and industrial FM telemetering. Pressure ranges are available extending from zero-to-200 psig up to zero-to-5000 psig. Input pressures are linearly converted to a proportional output frequency. Any center frequency from 400 Hz to 12 kHz with a deviation of  $\pm 7.5\%$  can be specified.

CIRCLE NO. 155

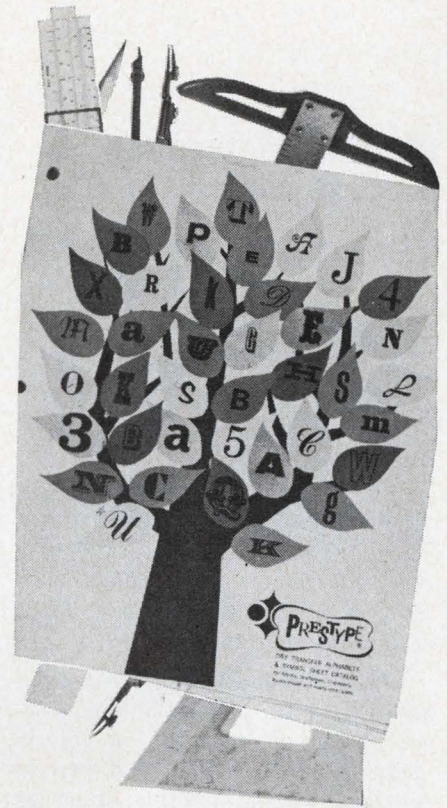

## The Complete Engineering Ensemble

The engineering wonders that people like you have accomplished have benefited all mankind. Your basic drawing board tools have also been improved to make your job easier and faster. Prestype, the leading dry transfer alphabet, symbols and borders make it easy to complete a job in quick time and with professional excellence. Our new 74 page catalog illustrates hundreds of lettering faces, borders and symbols that you use everyday.

Depend on Prestype, it's guaranteed.

## Send for it...it's FREE



PRESTYPE, INC.  
136 West 21st Street,  
New York, N.Y. 10011

NAME \_\_\_\_\_

COMPANY \_\_\_\_\_

ADDRESS \_\_\_\_\_

CITY \_\_\_\_\_

STATE \_\_\_\_\_ ZIP \_\_\_\_\_

ON READER-SERVICE CARD CIRCLE 61



## Plug-in modules for process controls

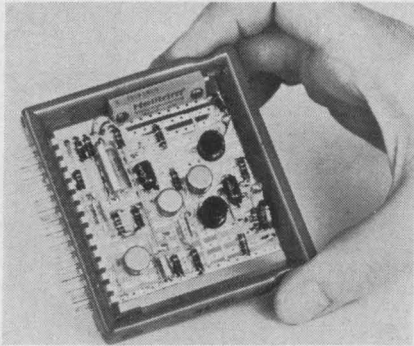

*Design Products Corp., Electronics Div., 1925 West Maple Road, Troy, Mich. Phone: (313) 647-1770.*

Eight standard circuit functions have been added to the manufacturer's line of 50 solid-state plug-in modules for industrial and process controls. Each individual function is contained in a 3 x 3-1/4-in. plug-in frame with an integral 15-pin connector. The modules are plugged into a control panel in stacks, with test probe points exposed on the front of each frame. The new modules include: null detector, pulse module, precision timer, binary-to-decimal decoder, light failure detector, ac switch with 600-V breakdown rating, photoelectric amplifier and balance detector.

CIRCLE NO. 156

## Low-noise preamps are hermetically sealed

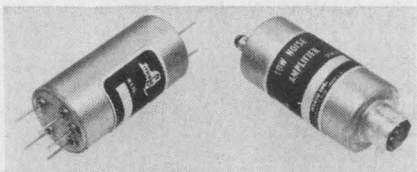

*Ithaco, Inc., 413 Taughannock Blvd., Ithaca, N. Y. Phone: (607) 272-7640.*

Designed for use with high-impedance transducers, these low-noise preamplifiers are hermetically sealed, encapsulated, and electrostatically shielded. They are available with solder pins or connector terminals at one end, or with input at one end and power and output at the other for maximum isolation. Gain accuracy is  $\pm 0.5$  dB midband, and max distortion is less than 0.5% at 1 V rms.

CIRCLE NO. 157

## IC decimal unit counts at 5-MHz rate

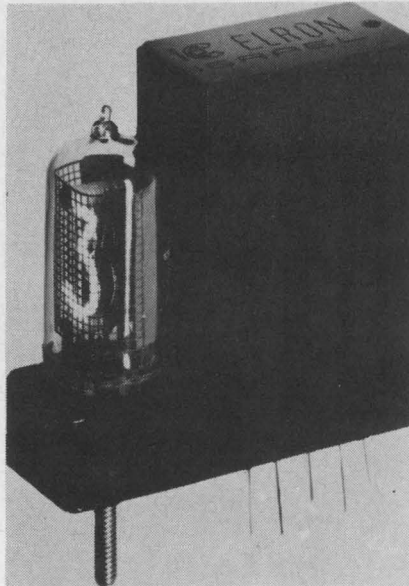

*Elron Electronic Industries Ltd., P. O. Box 5390, Haifa, Israel. Phone: 04-69333 (Israel). P&A: \$20 ea.; stock to 60 days.*

This decimal counting unit features a counting rate of 5 MHz using IC for coding and decoding, and high-voltage silicon transistors for display driving. Typical uses for the unit are in counters, scalars, timers, DVMs and other digital instruments where a numerical display is desired.

CIRCLE NO. 158

## DVM module samples and holds



*Dana Laboratories, Inc., Campus Dr. at Von Karman Ave., Irvine, Calif. Phone: (714) 833-1234.*

This DVM module can be used to measure transient signals, to reduce the uncertainty time of measurements, or to increase the scanning rate of data acquisition systems. It can also serve as an analog-to-digital converter, providing 0.01% accuracy, 500-samples-per-second speed, and remote programming.

CIRCLE NO. 159

## Heat transducer is self-contained

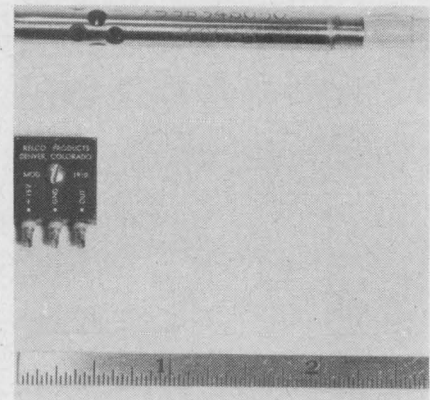

*Relco Products, Inc., 5594 Jefferson Ave., Denver, Colo. Phone: (303) 756-1143.*

A series of miniature temperature-to-voltage transducers contain both the sensing and amplifying elements so that a standard 0 to 5-Vdc output signal is supplied. This eliminates the necessity for external bridges and amplifiers. The units are of a stainless steel construction having a perforated housing for air temperature measurements.

CIRCLE NO. 160

## Solid-state timer in 5-oz package

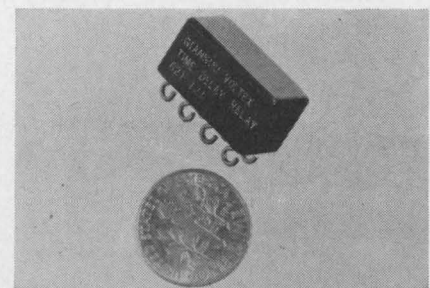

*Giannini Volter, 12140 E. Rivera Rd., Whittier, Calif. Phone: (213) 723-3371.*

Designed for aerospace applications, these timers are available with fixed time delays from 10 ms to 10 s. Standard accuracy for time delay is  $\pm 5\%$ . The normal output rating is 150 mA. The units can be used in conjunction with electromechanical timers to provide control for higher current ratings. Life expectancy is 10,000 hours minimum at rated load.

CIRCLE NO. 161



For Capacitors with **GREATER RELIABILITY . . .**

Choose  
**EL-Menco**

*The Capacitors You  
Find Wherever  
There's Electronics!*

**EL-MENCO DUR-MICA CAPACITORS**

**Only 1 Failure Per 43,000,000 Unit-Hours!**

- It has been computed that "debugged" DM30, 10,000 MMF units, when subjected to 257,000 hours of life at 85°C with 100% of the rated DC voltage applied, will yield only 1 FAILURE PER 43,000,000 UNIT-HOURS!
- DM15, DM16, DM19, DM20 . . . perfect for miniaturization and for new designs using printed wiring circuits. Also available in DM30, DM42 and DM43.
- New "hairpin" parallel leads insure easy application. Exceed all electrical requirements of military specification MIL-C-5A.

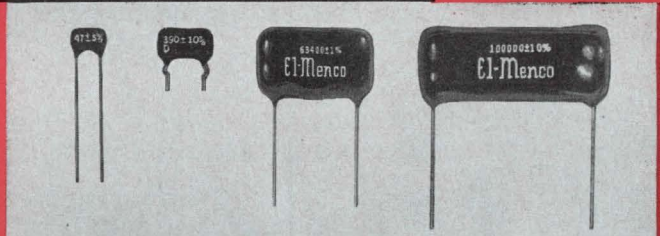

**EL-MENCO TRIMMERS & PADDERS**

**Design Versatility!**

- Available in 350 VDC and 500 VDC as well as other test voltages.
- All bases are of low-loss steatite.
- Special lugs are obtainable for printed circuitry.
- Miniature units are available.
- Solder Lugs can be bent in any position without affecting the capacity setting due to the rigid construction.
- Various types of mounting brackets are available for all trimmers.
- Units can be constructed for special applications.

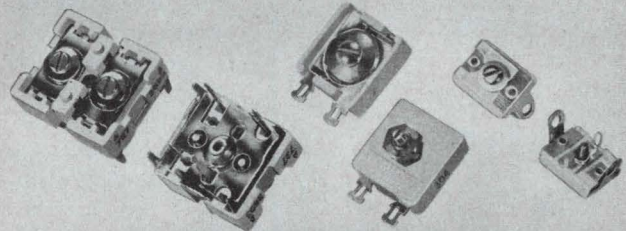

**EL-MENCO \*MYLAR-PAPER DIPPED CAPACITORS**

**Only 1 Failure in 14,336,000 Unit-Hours!**

- Life tests at 105°C with rated voltage applied have yielded only 1 FAILURE PER 1,433,600 UNIT-HOURS for 1 MFD. Since the number of unit-hours for these capacitors is inversely proportional to the capacitance, 0.1 MFD Mylar-Paper Dipped capacitors will yield only 1 FAILURE PER 14,336,000 UNIT-HOURS!
- Working volts DC: 200, 400, 600, 1000 and 1600.
- Durez phenolic resin impregnated.
- Tolerances:  $\pm 10\%$  and  $\pm 20\%$  (closer tolerances available).
- Dielectric strength: 2 or 2½ times rated voltage, depending upon working voltage.
- Exceed all electrical requirements of E.I.A. specification RS-164 and military specifications MIL-C-91A and MIL-C-25A.

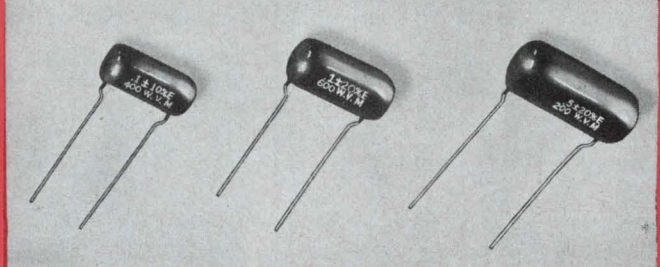

\*Registered Trademark of DuPont Co.

**EL-MENCO MOLDED MICA CAPACITORS**

**Superior Performance!**

- Unmatched for excellent stability, dielectric strength, high insulation resistance, extremely high "Q" and correspondingly low power factor.
- Units can be subjected to a short "debugging" life test at elevated voltage and temperature for removal of early life failures and for improved reliability.

*Write for Free Samples and Booklets  
on Any of The Above Capacitors*

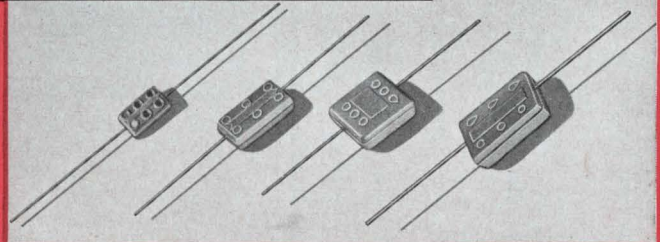

EL-MENCO OFFERS A COMPLETE LINE OF CAPACITORS . . . STANDS READY TO SERVE ALL YOUR CAPACITOR NEEDS

**THE ELECTRO MOTIVE MFG. CO., INC.**

**WILLIMANTIC, CONNECTICUT**

*Dipped Mica • Molded Mica • Silvered Mica Films • Mica Trimmers & Padders  
Mylar-Paper Dipped • Paper Dipped • Mylar Dipped • Tubular Paper*

MANUFACTURERS OF  
**EL-Menco**  
*Capacitors*

**ARCO ELECTRONICS, INC.**, Community Drive,  
Great Neck, L. I., New York  
*Exclusive Supplier to Jobbers and Distributors  
in the U. S. and Canada*

*West Coast Manufacturers Contact:*  
**COLLINS & HYDE CO.**, 1020 Corporation Way  
Palo Alto, California  
5380 Whittier Boulevard, Los Angeles, California

ON READER-SERVICE CARD CIRCLE 62



# MODEL SR-60 60 KHZ PHASE COMPARATOR RECEIVER

• Measurement Accuracies To Parts in 10<sup>10</sup> • Low Cost • Easy To Operate

The Model SR-60 is the first low cost VLF Phase Comparison Receiver designed to permit phase comparison measurements between a local oscillator and the National Bureau of Standards transmitted 60 KHz Radio Frequency receiver and can be used in any location in the United States with highly satisfactory results.

The SR-60 permits accuracy measurements to parts in 10<sup>10</sup> with relative short measurements. Phase difference is displayed on a front panel meter, an integral 2" oscilloscope or on a strip chart when more precise measurements are made over a long period of time. **MODEL SR-60 \$850.00**

Rack panel: 5 1/4" H x 19" W x 17 1/2" D

Write, wire or phone for complete catalog information.



**SPECIFIC PRODUCTS**

P. O. Box 425 / 21051 Costanzo Street / Woodland Hills, California 91364 / Phone: (Area Code 213) Diamond 0-3131

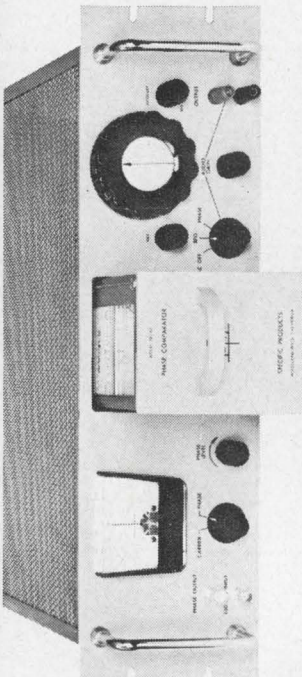

SEE OUR SPECIFICATIONS IN VSME MICROFILM CATALOG FILE

## COMPONENTS

### Magnetic push buttons eliminate arcing

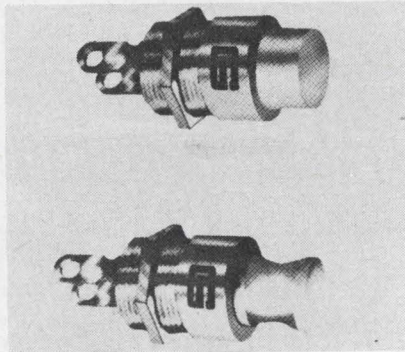

Gardiner Corp., P. O. Box 375, David City, Neb. Phone: (402) 367-3400. P&A: \$4.29 to \$8; 30 days.

Two magnetic push-button switches are designated SP-25-1 (momentary) and SP-25-2 (push-pull). Arcing is virtually eliminated by the use of high-speed switching and silver-plated contacts. Life span is predicted at 10<sup>6</sup> operations with resistive loads of 25 A at 120 Vac. Both the actuation and the positive holding pressure are completely independent of push-button pressure.

CIRCLE NO. 162

### PC reed relay has 0.5-ms switching time

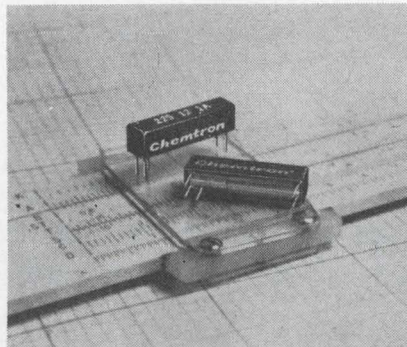

Self-Organizing Systems, Inc., P. O. Box 9918, Dallas. Phone: (214) 276-9487.

With a switching time of less than 0.5 ms, including bounce, this reed relay has direct PC mounting, eliminating the changes in reed characteristics resulting from cutting and bending of axial leads. To form an integrated assembly, the mounting pins are welded to the reeds and the relay is vacuum-encapsulated in epoxy resin.

CIRCLE NO. 163

### Precision potentiometer is direct-reading



Leeds & Northrup Co., 4901 Stenton Ave., Philadelphia, Pa. Phone: (215) 329-4900.

A direct-reading potentiometer has been designed for general laboratory use. The range switch, decades and slidewire are aligned from left to right in order of normal use. Direct reading in volts, to five (or six) digits is accomplished with three decades plus a detented slidewire having 115 main divisions. Releasing the detent permits following small, continuous changes and allows interpolation to six (or seven) digit readings.

CIRCLE NO. 164

### Video amplifiers for CRT display

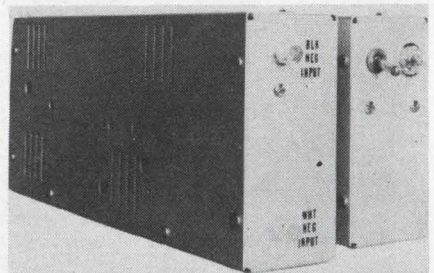

ITI Electronics, Inc., 369 Lexington Ave., Clifton, N. J. Phone: (201) 473-0900. P&A: \$400; stock to 60 days.

These two video amplifiers provide 50-V and 70-V peak-to-peak video at 20- and 14-MHz bandwidths respectively. Intended for high resolution CRT display applications, these solid-state units furnish rated output with 0.25-V peak-to-peak input. Single-ended or balanced input is provided with common mode rejection greater than 40 dB. They are designed for 60°C operation.

CIRCLE NO. 165



## Temperature detector has built-in fail-safe

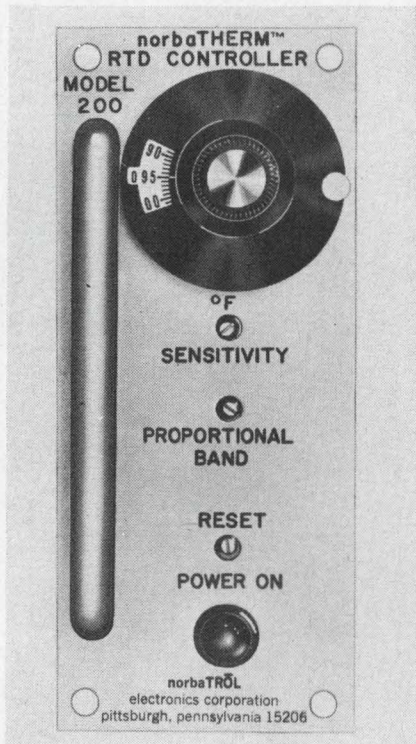

norbaTrol Electronics Corp., 356 Collins Ave., Pittsburgh.

A solid-state resistance-temperature detector-controller operates from nickel, platinum or other kinds of resistance element sensors. The use of RTD input eliminates the problems of cold-junction and lead-length compensation associated with thermocouples. Fail-safe operation in the event of sensor burn-out is inherent.

CIRCLE NO. 166

## Rotary attenuator with individual pi networks

Telonic Instruments, 60 N. First Ave., Beech Grove, Ind. Phone: (317) 787-3231. P&A: \$140; 30 to 45 days.

An attenuator spanning 100 dB in 10-dB steps employs individual attenuation pads consisting of resistive pi networks. Each pad is positioned in a precisely machined rotor assembly to maintain 50- $\Omega$  transmission line characteristics throughout the attenuator. Accuracy is 3% at 400 MHz.

CIRCLE NO. 167

## Wafer capacitors offering the ultimate in Q...

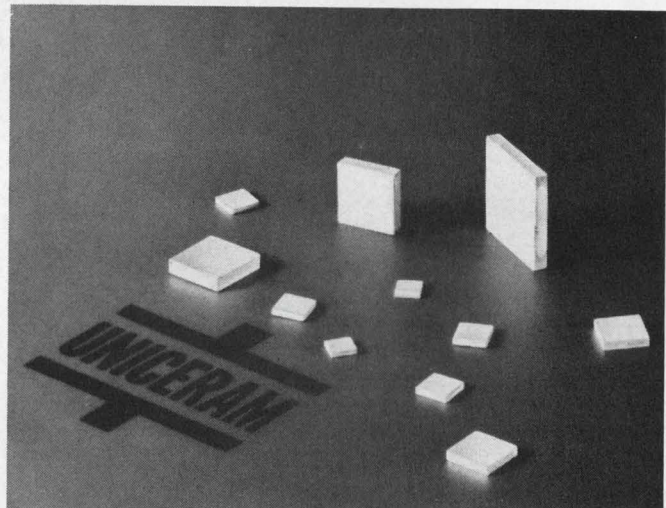

Capacitors shown enlarged 30%

## JFD Uniceram

Uniceram monolithic High Q ceramic fixed capacitors are now available as multi-layer wafers with metalized edges. Leads are eliminated—so is the associated lead inductance.

Uniceram wafers combine the ultimate in Q with exceptional stability and reliability. Offered in over 1,000 models with capacitance values from 0.5 to 3000 pf.

Uniceram wafers are ideal for high speed switching and for operation at VHF and higher frequencies where low inductance is essential. These wafers, or chips, can be used in hybrid integrated circuits, can be soldered directly to printed circuit boards or used as discrete components.

Write for Catalog UNM 65-2

**JFD** "TODAY'S COMPONENTS BUILT FOR TOMORROW'S CHALLENGES"

JFD ELECTRONICS CO. / COMPONENTS DIVISION 15th Avenue at 62nd Street Brooklyn, N. Y. 11219 / Phone 212-331-1000 • Sales Offices—Arcadia, Calif. Chi., Ill. / Balt., Md. / Saxonville, Mass. / Bklyn., N. Y. / New Hartford, N. Y. Cinn., Ohio / Phila., Pa. / Pitts., Pa. / Paris, France / Azor, Israel

ON READER-SERVICE CARD CIRCLE 64





## A-TO-D converter

10 bit parallel binary output  
10 microseconds conversion time

Model ADC-10<sub>IC</sub> is a plug-in Analog-to-Digital Converter with a 10 volt input range and contains a Clock, Reference Supply, Resistor Network and Comparison Amplifier.

Also available

## D-TO-A converter

10 bit strobed parallel binary input  
1 microsecond settling time  
(same size as A-to-D converter)

Model DAC-10<sub>IC</sub> is a Digital-to-Analog Converter and contains a Storage Register and high-speed Strobe System, Internal Reference Supply, Resistor Network and output Operational Amplifier.

Variations are available in input and output ranges, converting speeds, number of bits, and triggering modes.

Pastoriza also provides compatible Sample-and-Hold and Multiplexing Cards and Auxiliary Readout Equipment with self-contained power supplies to facilitate matching these units to OEM and system applications.

Write for A-to-D and D-to-A Converter literature.

**PASTORIZA**  
ELECTRONICS, INC.

385 Elliot St., Newton Upper Falls, Mass. 02164  
(617) 332-2131

ON READER-SERVICE CARD CIRCLE 65

## COMPONENTS

### Time delay relays are interchangeable

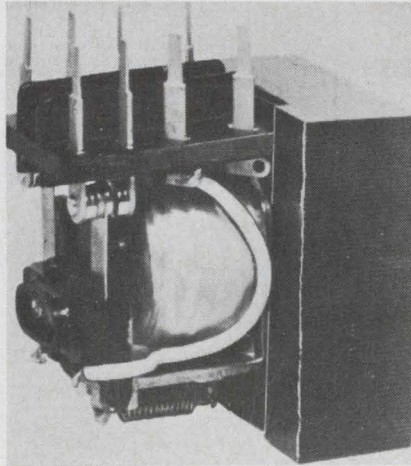

Relay Specialties, Inc., 3 Godwin Ave., Fair Lawn, N. J. Phone: (201) 791-3208. P&A: \$9.96 (1 to 9); \$7.77 (larger quantities); stock.

This series of transistor time delay relays, designed for use in industrial and commercial applications, is directly interchangeable with mechanical, pneumatic and thermal timers. Fixed time delays run from 1 to 100 seconds; higher on request. The relays operate with a time delay upon energization.

CIRCLE NO. 168

### Rotary scanner switch for data sampling

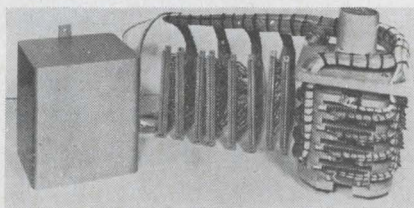

Electro-Tec Corp., P. O. Box 667, Ormond Beach, Fla. Phone: (305) 677-1771.

A rotary scanner switch has been designed for data sampling in process control and data logging operations. The multi-fingered wiping-contact switch is basically a sequential sampling device for feeding a large number of signal inputs into one channel, or conversely, feeding one signal channel to a large number of outputs. The switch consists of from one to ten 2-pole wafers with 64 ways per wafer.

CIRCLE NO. 169

### Pulse transformers for wide-band use

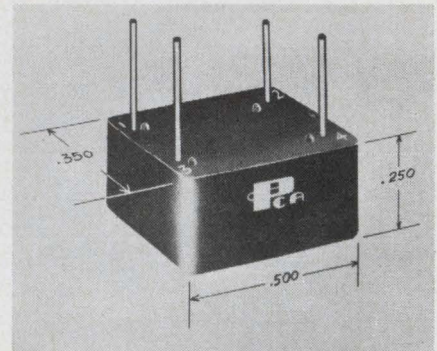

PCA Electronics, Inc., 16799 Schoenborn St., Sepulveda, Calif. Phone: (213) 892-0761. P&A: \$15; 8 wks.

Molded nanosecond pulse transformers are available in two or three windings and come in a variety of miniature epoxy cases. They feature low leakage inductance and distributed capacitance for wide operating bandwidth. The units are designed to operate in an environmental range from -55 to 125°C. Measuring only 0.25-in.<sup>2</sup> by 0.5-in. long, they meet all MIL-T-27 Grade V, Class S specifications.

CIRCLE NO. 211

### Power supply has variable voltage

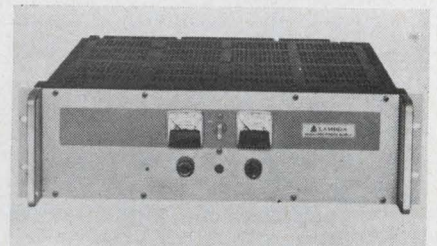

Lambda Electronics Corp., 515 Broad Hollow Rd., Melville, N. Y. Phone: (516) 694-4200. Price: \$70 (1/2-rack); \$90 (full-rack).

Suitable for rack or bench mounting, each of three power supplies has multiple current ratings for the ambient temperatures most frequently encountered in laboratory service. Voltage is continuously variable over the entire range. The models feature wide input voltage and frequency range, and adjustable, automatic current limiting.

CIRCLE NO. 212



## Transmitter cavity for 225-to-400-MHz band

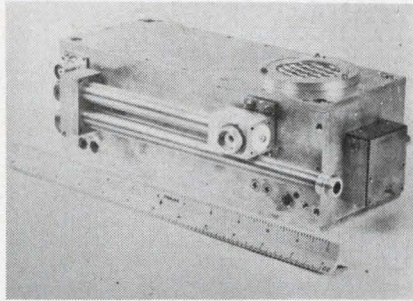

Codamite Div., Pacific Ordnance & Electronics Co., 1747KI W. Lincoln Ave., Anaheim, Calif. Phone: (714) 776-5432. P&A: \$3500; 90 days.

A uhf cavity covering the frequency range of 225 to 400 MHz is continuously tunable by a single shaft over the entire range. Using the RCA 7650 uhf tetrode, the cavity has a vswr rating of 1.5 for a continuous power output of 800 W into 50 ohms. It requires 35 W of RF drive. It is easily disassembled in the field without special tools. It is rectangular and easily mounted in customer's equipment.

CIRCLE NO. 213

## Tach gen has no brushes or bearings

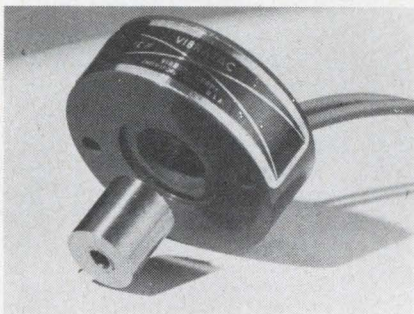

Vibrac Corp., Alpha Industrial Park, Chelmsford, Mass. Phone: (617) 256-6581. P&A: \$18.75; stock.

Brushless, bearingless tachometer generators have a cylindrical magnet, 0.484-in. diam and 0.5-in. long, fastened to the end of the shaft. The stator, which measures only 1.5-in. diameter and 9/16-in. thick, fits around the magnet but does not touch it. This new generator claims the same output voltage and reliability of units twice its size.

CIRCLE NO. 214

# SPIN YOUR DISHES WITH MECATORN®

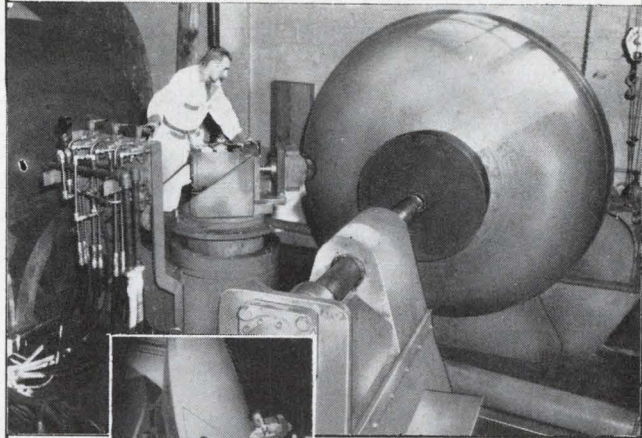

Torngren "dishes" span the nation, contributing to the efficient operation of many communication networks both military and commercial.

Our Mecatorn process can mean substantial savings in your program cost while actually increasing the overall efficiency of your system. Reflectors can be Mecatorn spun from 4" to 16 feet diameter.

Metallurgical advantages such as refined grain structure with flow line pattern matched to part configuration, elimination of porosity and occlusions in the metal, automatic self-inspection of work in progress, are all primary benefits attained through the Mecatorn spinning process.

Before you spec, check with Torngren — for parabolic reflectors of superior quality at considerable dollar savings.

Send for a free copy of our new capabilities brochure and current price list #466.

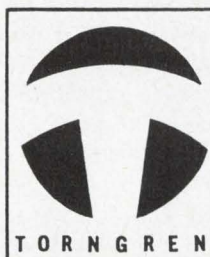

C.W.  
**TORNGREN**

COMPANY, INC.  
236 PEARL STREET  
SOMERVILLE, MASSACHUSETTS  
AREA 617/ MO 6-3250

ON READER-SERVICE CARD CIRCLE 66



## 4-pole plug-in relays for PC modules

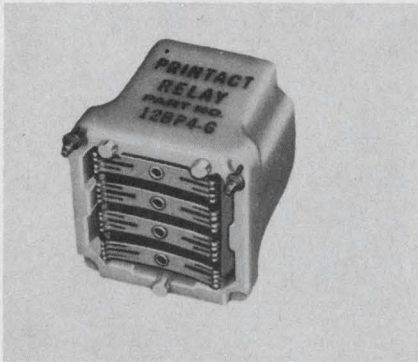

Executone, Inc., 47-37 Austell Pl., Long Island City, N. Y. Phone: (212) 392-4800.

These 4-pole plug-in PC board standard and latching magnetic relays can switch up to 4 form A (make) and 4 form B (break) in separate circuits, or up to 4 form C (transfer) contacts, or any combination of these. Contacts on the rocking armature mate with rhodium or gold-alloy over nickel-plated conductors on the PC board module which serve as fixed contacts of the relay, eliminating sockets and soldering.

CIRCLE NO. 215

## Transformer laminates made to your specs

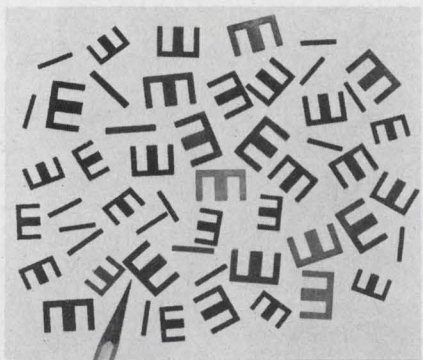

Shigoto Industries, Ltd., 350 Fifth Ave., New York. Phone: (212) 695-0200.

E and I laminates used in the construction of miniature transformers are said to offer high initial permeability because of a closely-controlled hydrogen annealing process in manufacture. They can be made in a variety of specified sizes and thicknesses.

CIRCLE NO. 216

## PC board guides are vibration-resistant

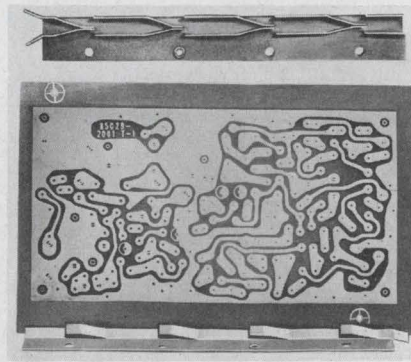

Taurus Corp., Academy Hill, Lambertville, N. J. Phone: (609) 397-2390.

These printed circuit cadmium-plated board holders are designed for applications where light weight and resistance to shock and vibration are critical requirements. The guides have a strong, positive grip that prevents lateral motion. They feature heat-treated beryllium copper spring guides (per QQC-553).

CIRCLE NO. 217

## Propeller fans for rack mounting

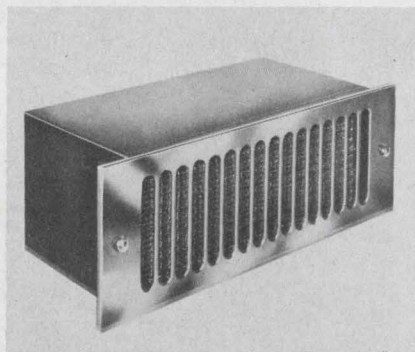

McLean Engineering Laboratories, Princeton Junction, N. J. Phone: (609) 799-0100.

This line of 19-in. rack panel packaged fans provide 250, 475, or 500 cfm. Standard notching and hardware permit quick, easy installation. All units have polished stainless steel grilles and washable permanent filters easily removable without tools. Each blower features two 115-V, 50- or 60-Hz, life-lubricated motors, guaranteed for 20,000 hours of continuous duty.

CIRCLE NO. 218

## Reed filter has high Q, long life

Electronic Components Dept., Matsushita Electric Corp. of America, Pan-Am Bldg., 200 Park Ave., N. Y. Phone: (212) 973-5710.

This reed filter consists of a tuning fork and two piezoelectric transducers. It functions on a fixed selected resonant frequency, with no moving contacts, to product a positive trouble-free operation. It features stability and long life due to its contactless structure and high Q through its mechanical vibration method.

CIRCLE NO. 219

## FM discriminator with phase-locked loop

Sonex, 20 E. Herman St., Philadelphia. Phone: (215) 843-6400.

This FM discriminator provides phase-locked-loop or pulse-averaging detector, switchable-characteristic output filter, and choice of self-contained or common power supply. The complete unit, 3-1/2 by 2-in., consists of a discriminator, a channel selector and an output filter. The channel selector, which plugs into the front of the discriminator, contains the bandpass input filter, limiter and complete circuitry for the detector and tape-speed-compensation networks.

CIRCLE NO. 220

## Amplifier-demodulator meets vibration specs

Natel Engineering Co., Inc., 7129 Gerald Ave., Van Nuys, Calif. Phone: (213) 782-4161.

A miniature, solid-state amplifier-demodulator weighs less than 6 oz and occupies only 2.5-in.<sup>3</sup> of space. It operates either as an ac-to-dc converter or as a phase-sensitive synchronous detector. The unit can operate FM subcarrier oscillators, meters, or recorders and meets shock and vibration requirements of MIL-E-5272C.

CIRCLE NO. 221

ON READER-SERVICE CARD CIRCLE 68 ➤





Flexible signal and power distribution systems for: **AEROSPACE ELECTRONICS**  
**COMMUNICATIONS**  
**DATA PROCESSING**  
**AUTOMOTIVE and**  
**APPLIANCE applications**

**MEKTRON<sup>®</sup>**  
**FLEXIBLE CIRCUITS**

including  
flat, flexible cable  
and POSITERM  
connective hardware

 **ROGERS CORPORATION**



# MEKTRON<sup>®</sup> FLEXIBLE CIRCUITRY

Now . . . the important weight- and space-saving advantages of flat, flexible wiring are available in performance-proved MEKTRON circuits.

Like Mektron **molded** circuits and laminar bus assemblies, Mektron flexible circuits are produced by automatically controlled processes; they represent the **engineered component** approach to power and signal distribution.

## Versatility

Mektron circuits can be supplied as continuously etched, straight-line cables up to 1,000 feet long . . . or in special termination patterns blended into straight conductors (see illustration at right) . . . or in almost any "printed circuit" pattern desired.

## Controlled electrical characteristics

In cable configuration, the conductors in Mektron flexible circuits are neither flattened wires nor slit foil. They are instead created by a precise

and continuous etching process. With the resultant superior control of conductor spacing and the ability to utilize paired conductors and shielding, users benefit from superior performance . . . low cross talk . . . precisely controllable electrical characteristics.

Available on request is a bulletin comparing Mektron flexible circuits with the following three basic "flat cable" specifications: MSFC 220 — June, 1963; NAS 729 — August, 1963; IPC FC 240 — December, 1965.

## Environmental termination system

Mektron flexible circuits and cables can be terminated by any standard method. In addition, Rogers offers a complete harness assembly consisting of cable and **environmentally sealed connectors**. This sealed POSITERM system of termination is especially suited for aerospace, military and other high reliability applications (see panel below).

Made for each other: MEKTRON<sup>®</sup> CABLE / environmentally sealed POSITERM termination.



1/ Rolls of copper-coated FT/duroid 8150 are etched to produce close-tolerance conductor patterns, then encapsulated with insulating film.



2/ Lengths of cable are cut to size. Cable ends are creased and bonded around a rigid plastic mandrel.



3/ A reinforced thermosetting plug is molded onto the cable. The film is then removed from contact surface portions of the conductors by a unique chemical process. Contacts are gold plated.



# Variety of insulation

Mektron flexible circuits are available with insulation material that can be selectively removed by chemical rather than mechanical means. Consequently, contact may be made at the ends or **anywhere along the flexible circuit** without weakening the conductors in any way.

Based on anticipated maximum continuous operating temperatures, designers may specify any of the following standard Rogers insulation systems, or vary them to suit specific requirements:

- CLASS A**  
FT/duroid 8150 with polyester encapsulation . . . . 125C
- CLASS B**  
FT/duroid 8150 with polyimide encapsulation . . . . 200C
- CLASS C**  
Fully encapsulated with FT/duroid 8150 . . . . . 240C

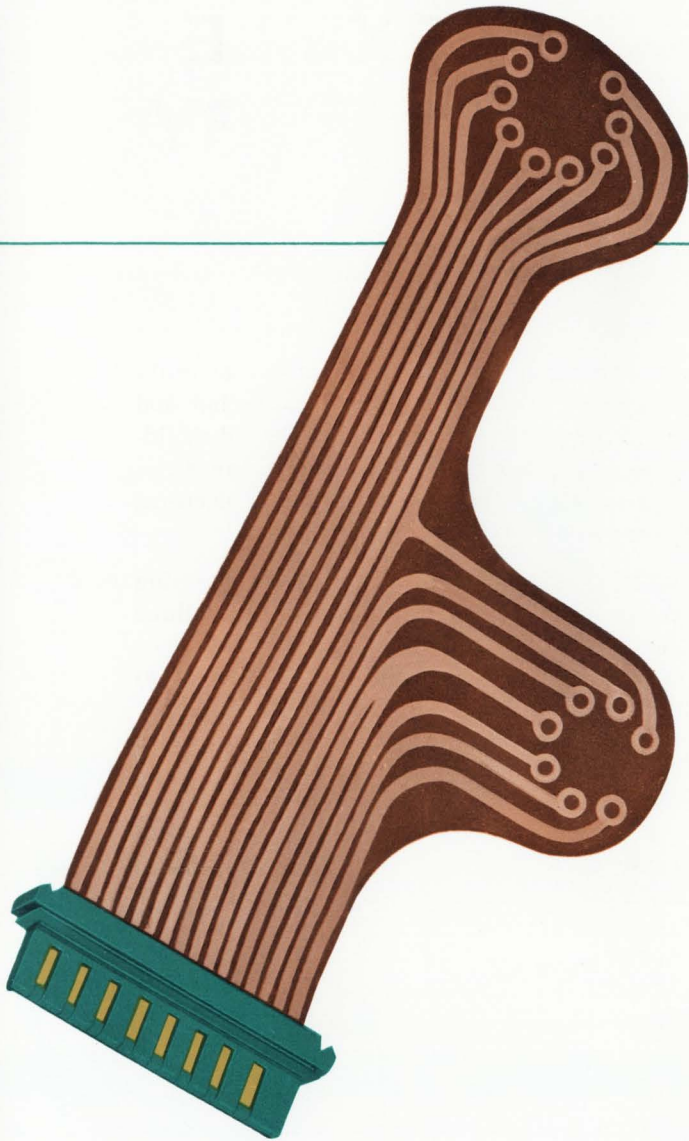

## Representative connective hardware



Plugs with alternate or opposed arrangement of conductors.



Custom plug designed to fit edgeboard connectors and printed circuit racks.



POSITERM plugs locked together to provide rack-and-panel connectors.

### CONSTRUCTION:

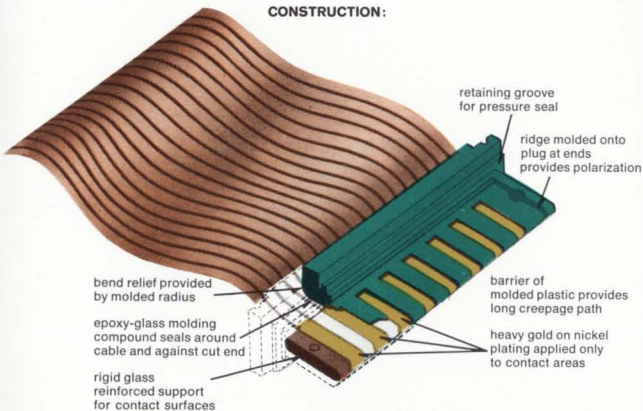



**Reliable MEKTRON®  
FLEXIBLE circuitry for  
FLAT, MULTILAYER,  
or WRAP-AROUND  
applications**

With full capability in both etching and mechanical generation of circuitry, Rogers can help you select the most effective and economical design for your flat, multilayer, or wrap-around flexible circuit. Combinations of flexible and rigid types are available. Shown here are typical examples.

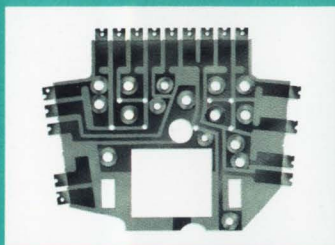

Since components like these are compatible with Mektron flexible cable, Positerm connectors, and Mektron laminar bus assemblies — Rogers is ideally equipped to provide single-source design and production service for complete power and signal distribution systems. Try us. We promise a prompt and helpful response to your inquiry.

 **ROGERS CORPORATION**

ROGERS, CONNECTICUT 06263



### Miniature switch has low operating force

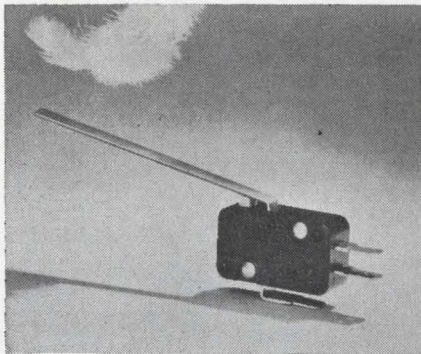

Cherry Electrical Products Corp., 1650 Old Deerfield Rd., Highland Park, Ill. Phone: (312) 432-8182. P&A: \$1.03 (1); \$0.474 (2000); stock.

Miniature switches rated at 5, 10 and 15 A have maximum operating forces of, respectively, 45, 75 and 100 grams. External actuators can be added to these switches to further reduce operating forces. With a standard 1-in. roller lever, extending 1/2 in. beyond the switch base, the required force drops to 35 grams for the 15-A unit.

CIRCLE NO. 222

### Resistance up 50% with 100°C change

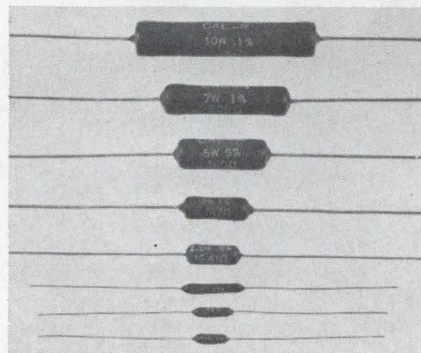

California Resistor Corp., 1631 Colorado Ave., Santa Monica, Calif. Phone: (213) 451-9761. P&A: 58¢ (25); 44¢ (500); stock.

This temperature-sensitive device is capable of more than 50% increase in resistance with an increase in temperature of only 100°C. The device will provide temperature compensation, control and measurement, liquid level control and semiconductor compensation.

CIRCLE NO. 223

### Electronic commutator for data acquisition

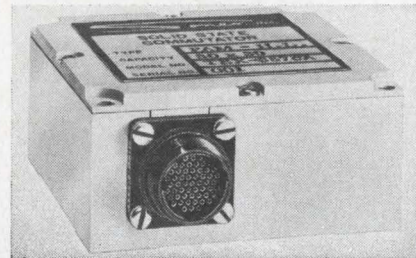

Sonex, 20 E. Herman St., Philadelphia. Phone: (215) 843-6400.

This IC electronic commutator conforms to the latest IRIG 106-66 telemetry standards. It has less than 2 W power consumption, and a volume of less than 6-in.<sup>3</sup>. Input impedance is 10 MΩ and linearity is within 0.05% of full-scale output. Channel offset and scatter is ±5 mV max.

CIRCLE NO. 224

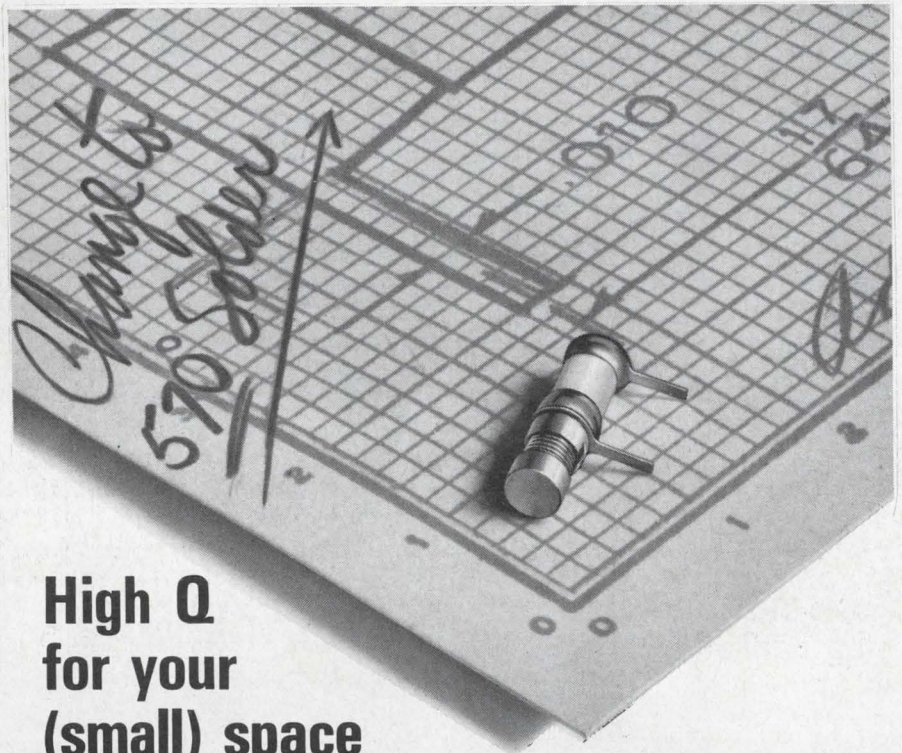

### High Q for your (small) space requirements!

The Johanson 4700 Series Variable Air Capacitors provide, in micro-miniature size, the extremely high Q important in demanding aerospace applications. In addition, the ultra-rugged construction of the 4700 Series capacitors assures highest reliability in the most critical environments.

- Available in printed circuit, turret and threaded terminal types.
- Meets Mil Specs for salt spray requirements.
- Features 570° solder, which prevents distortion and is not affected by conventional soldering temperatures.

#### SPECIFICATIONS

- Size: .140 diameter, 1/2" length
- Q @ 100 MC: > 5000
- Q @ 250 MC: > 2000
- Capacity Range: 0.35 pF to 3.5 pF
- Working Voltage: 250 VDC (Test voltage, 500 VDC)
- Insulation Resistance: > 10<sup>6</sup> Megohms
- Temp. Ranges: -55°C to 125°C
- Temp. Coefficient: 50 ± 50 ppm/°C

WRITE TODAY FOR FULL DATA.



**MANUFACTURING CORPORATION**

400 Rockaway Valley Road, Boonton, N. J. 07005 (201) 334-2676

ON READER-SERVICE CARD CIRCLE 69



### Miniature relays live to 100 million

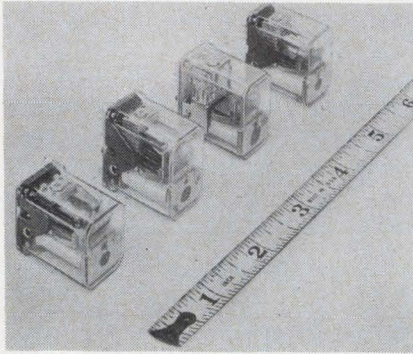

American Zettler, Inc., 697 Randolph Ave., Costa Mesa, Calif. Phone: (714) 540-4190. P&A: \$1.80; stock.

A line of miniature, general-purpose, comb-actuated relays with plug-in, solder, or printed circuit terminals have applications in computer systems, control and alarm systems, business machines and data processing equipment. Life expectancy is up to 100 million operations. The relays are less than 1-in.<sup>3</sup>.

CIRCLE NO. 225

### Push-button switch has long operating life



Gardiner Corp., P. O. Box 375, David City, Neb. Phone: (402) 367-3400. P&A: from \$4.29; 6 to 8 wks.

An all-plastic, totally enclosed, dust- and moistureproof switch features an illuminated push-button in a selection of colors, and a predicted life span of over one million operations. Both mounting and lamp replacement are simplified by permitting lamp replacement from either front or rear without special tools.

CIRCLE NO. 226

### 100 kHz to 1 GHz from 0.1-in.<sup>3</sup> transformers

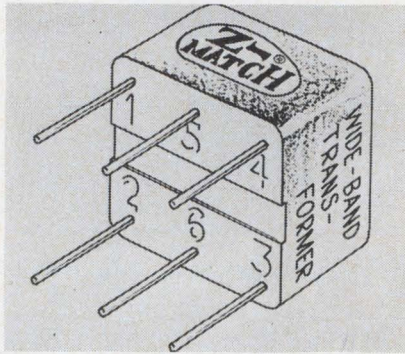

Vari-L Company, Inc., 207 Greenwich Ave., Stamford, Conn. Phone: (203) 323-2176. P&A: \$12.90 to \$20.80; stock.

Wideband transformers with impedance ratios of 1:1 and 4:1 are available in various combinations of balanced-balanced and balanced-unbalanced. Several have frequency ranges from 100 kHz to 1 GHz, and all extend well up into uhf. Max insertion loss is 0.5 dB and max vswr is 1.3. Power-handling capability (above 3 MHz) is 4 W.

CIRCLE NO. 227

### Chopperless diff-amp has high stability

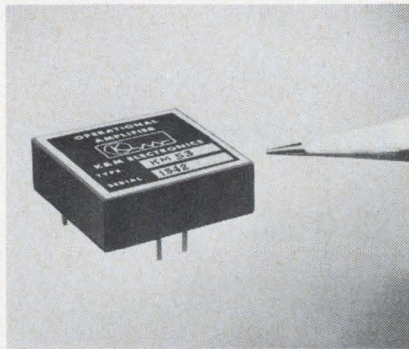

K&M Electronics Corp., 102 Hobart St., Hackensack, N. J. Phone: (201) 343-4518.

This chopperless, low-drift differential op-amp is designed specifically for low-drift applications such as strain-gage amplifiers, analog computer functions, high-gain, low-drift servo preamps, ultra-stable null detectors for galvanometers, voltage comparators, instrumentation amplifiers and automatic test equipment.

CIRCLE NO. 228

### Molded capacitors have low heat coefficients

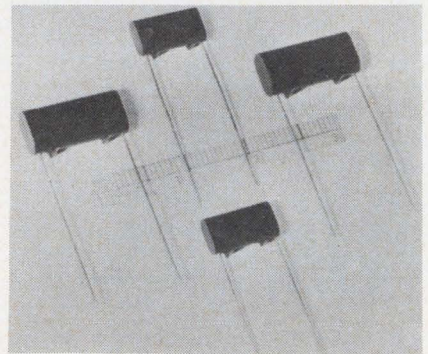

GE Capacitor Dept., Hudson Falls, N. Y. Phone: (518) 747-3341.

A new line of polycarbonate film-foil capacitors features a low temperature coefficient. Capacitance change is negligible over the temperature range of 0°C to 65°C and very nearly linear, with a typical negative coefficient of 150 ppm/°C over the range of 65°C to 125°C. It is available in seven case sizes.

CIRCLE NO. 229

### Small delay lines for PC boards

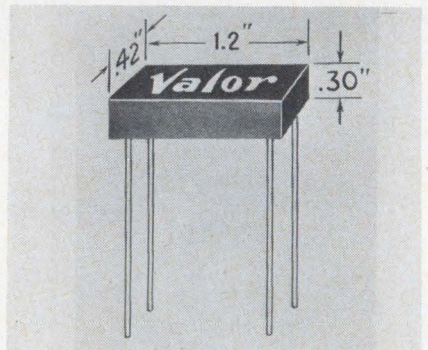

Valor Electronics, Inc., 13214 Crenshaw Blvd., Gardena, Calif. Phone: (213) 321-2280. P&A: \$12; 6 wks.

These delay lines, designed for use in radar, computers, instrumentation equipment and printed circuit boards, are typically 0.30-in. high, 0.42-in. wide and 1.2-in. long. They provide a delay time of 200 ns coupled with a rise time of 65 ns and an impedance of 1000 ohms. Leads are No. 22 pure nickel; units are packaged in molded cases of diallyl phthalate and meet all requirements of MIL-D-23859 specs.

CIRCLE NO. 230



Everything was in order (you thought). The transducer was connected to the preamp; the preamp was plugged in. The drive motors worked o.k. The signal came . . . and left . . . without a trace!

Familiar? Frankly, we had the same problem some years back. So we designed our own heat-writing system to get the quality we demanded. It performed so well that we've put it on the market. We wouldn't have done so if it didn't come up to BLH Electronics standards.

The heart of the system is the BLH THERMOTIP STYLUS with its signal-regulated automatic heat control. Set the heat control once and the system automatically adjusts to changes in signal without manual readjustment. Great for those long-wait situations where one-of-a-kind transients must be caught. Great for those multichannel applications where several different signals (each with its own variation characteristics) must be handled.

To be sure, BLH Electronics Recorders have a variety of plug-in preamplifiers. They all fit all our systems: 2, 4, 6 and 8 channels . . . portable, console or lowboy configurations.

## Ever do a slow burn over a sloppy Strip Chart Recorder Trace?

Don't do a slow burn about sloppy recording traces. Get a real "cool" oscillograph . . . the BLH High Speed Strip Chart Recorder with the BLH THERMOTIP STYLUS.

To arrange for a demonstration in your plant, or for information on this new BLH THERMOTIP STYLUS Recorder, call BLH Electronics or your nearest BLH Representative. BLH Electronics, Inc. a Subsidiary of Baldwin-Lima-Hamilton Corporation, Waltham, Mass. Plants in Waltham, Mass., Pasadena, Calif., and Darmstadt, West Germany.

**BLH ELECTRONICS, INC.**

A subsidiary of Baldwin • Lima • Hamilton Corporation



STRAIN GAGES • TEMPERATURE SENSORS • LOAD CELLS • PRESSURE CELLS •  
TORQUE PICKUPS • RECORDERS • INSTRUMENTATION • INTEGRATED SYSTEMS

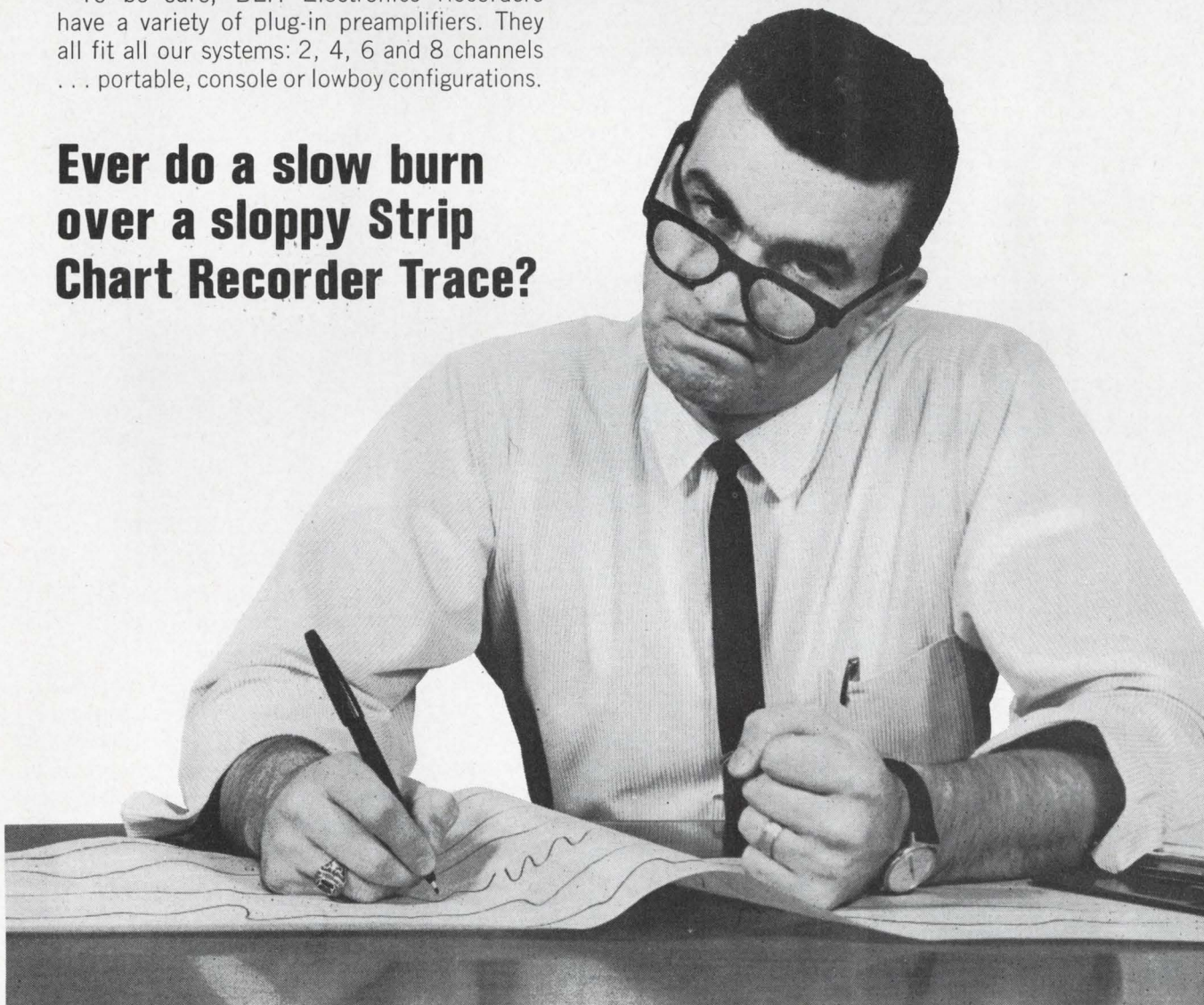

ON READER-SERVICE CARD CIRCLE 70



# AMPERITE

## Thermostatic DELAY RELAYS

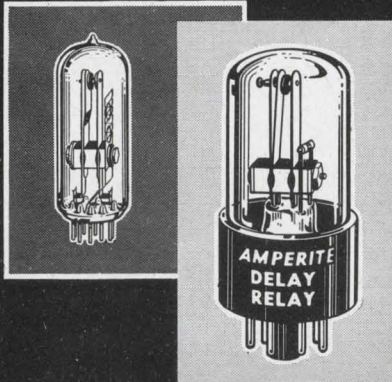

**Only a glass seal**  
offers true hermetic sealing  
... assuring maximum stability and life!

**Delays: 2 to 180 seconds** . . . Actuated by a heater, they operate on A.C., D.C., or Pulsating Current . . . Being hermetically sealed, they are not affected by altitude, moisture, or climate changes . . . SPST only—normally open or normally closed . . . Compensated for ambient temperature changes from  $-55^{\circ}$  to  $+80^{\circ}$  C. . . Heaters consume approximately 2 W. and may be operated continuously . . . The units are rugged, explosion-proof, long-lived, and—inexpensive!

TYPES: Standard Radio Octal, and 9-Pin Miniature.  
List Price, \$4.00

**PROBLEM?** Send for Bulletin No. TR-81

# AMPERITE

## BALLAST REGULATORS

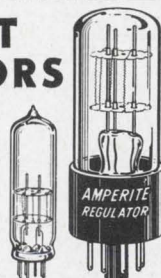
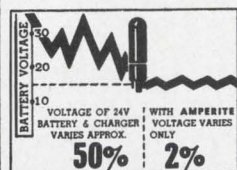

Hermetically sealed, they are not affected by changes in altitude, ambient temperature ( $-50^{\circ}$  to  $+70^{\circ}$  C.), or humidity . . . Rugged, light, compact, most inexpensive . . . List Price, \$3.00.

Write for 4-page Technical Bulletin No. AB-51

# AMPERITE

600 PALISADE AVE., UNION CITY, N.J.

Telephone: 201 UNion 4-9503

In Canada: Atlas Radio Corp., Ltd.,  
50 Wingold Ave., Toronto 10

## TEST EQUIPMENT

### X-Y recorder scales English or metric

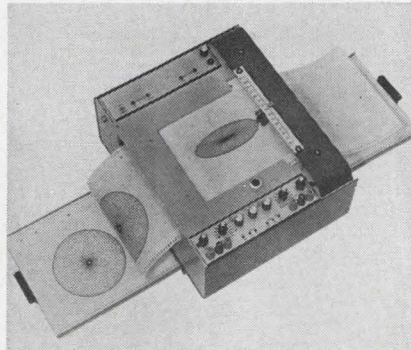

Houston Omnigraphic Corp., 4950 Terminal Ave., Bellaire, Tex. Phone: (713) 667-7403. P&A: \$2450; 30 days.

This X-Y recorder uses fan-fold paper, allowing a series of consecutive records without individual hand loading of sheets. The paper may be loaded or unloaded in mid-record and each record can be torn out as an individual sheet at the perforations. Both forward and reverse advance are inherent and can be controlled automatically by programming. English or metric scaling can be switch-selected.

CIRCLE NO. 231

### Portable oscillograph with 6 or 12 channels

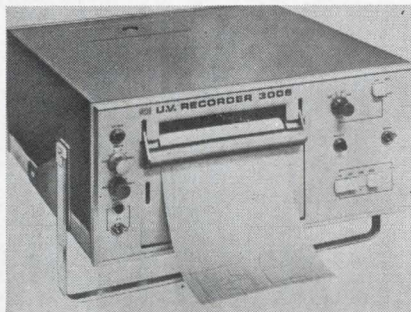

S. E. Laboratories Ltd., Astronaut House, Feltham, Middlesex, England. Phone: Feltham 1166.

This oscillograph is supplied either as a 6- or 12-channel instrument, using standard English galvanometers, writing on 6-in. wide sensitized paper. It is a portable unit, 7-in. high, weighing 42 lbs, and is suitable for table or rack mounting. Paper loading is effected by simply dropping a roll into the cassette; threading is automatic.

CIRCLE NO. 232

### Lab scope comes as kit or assembled unit

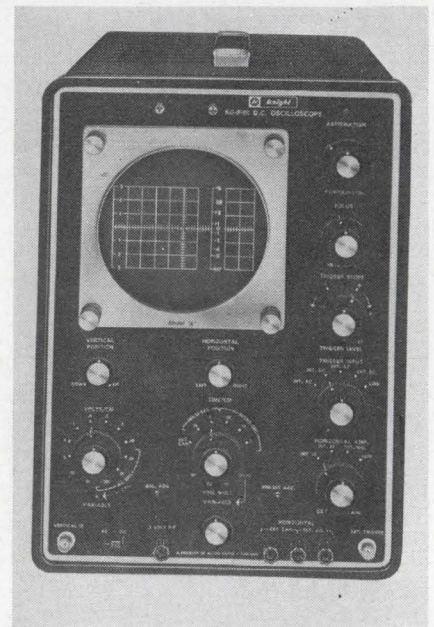

Allied Radio Corp., 100 N. Western, Chicago. Phone: (312) 421-6800. Price: \$249.95 (kit); \$349.95 (assembled).

A laboratory oscilloscope with a dc to 5-MHz triggered sweep unit features lock-in characteristics that permit viewing of stable waveform presentations at upper frequency limits, a vertical sensitivity of 5 mV/cm, an 85-ns rise time, horizontal response from dc to 800 kHz triggered sweep, and regulated high- and low-voltage supplies.

CIRCLE NO. 233

### Linear converters for frequency to dc

Solid State Electronics Corp., 15321 Rayen St., Sepulveda, Calif. Phone: (213) 894-2271.

These frequency-to-dc converters are completely solid-state units which will linearly convert frequency or repetition rate of signals to a proportional dc voltage. The output is virtually insensitive to supply voltage, temperature, input amplitude or waveforms and will function properly when driven with sine, square, triangular or pulse waveforms having an amplitude from 0.5 to 18 V p-p.

CIRCLE NO. 234

ON READER-SERVICE CARD CIRCLE 71



Dc power supplies have improved settability

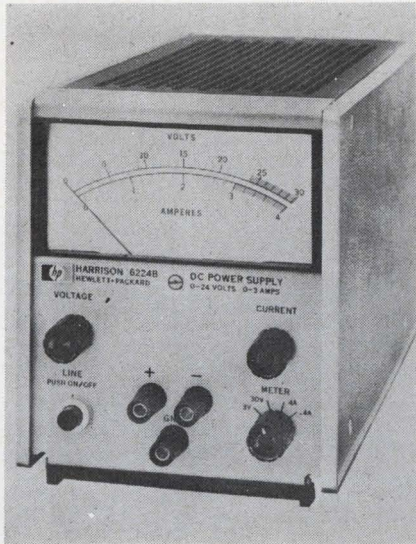

Hewlett-Packard Harrison Div., 100 Locust Ave., Berkeley Heights, N. J. Phone: (201) 464-1234. P&A: \$250; 1 to 3 wks.

For improvement over the manufacturer's general purpose dc power supplies for engineers experimenting with transistor circuit design, these three models have 10-turn voltage and current controls for better output settability. Overload-proof multiple range meters for increased bench utility, special circuitry for faster programming, and all-silicon semiconductors for greater reliability are also provided.

CIRCLE NO. 235

## Noise source for communications links

Nore Electric Co., Ltd., 461 Southchurch Rd., Southend-on-Sea, Essex, England. Phone: Southend 66814. Price: \$154.

The NV 2447 system noise source is intended primarily for automatic noise measurement systems in radar and communications links. It is suitable for airborne and naval radar applications, as it can operate from a simple, low-wattage power supply. It is designed for either pulse or continuous wave operation. Standard frequency is 9.2 to 9.45 GHz, but sources operating at other frequencies can be supplied.

CIRCLE NO. 236

# Compare the All-New PAMOTOR Model 4500 with the miniature axial fan you're now using!



### POWERFUL MOTOR

Dependable shaded-pole motor operates with low internal heat rise. Efficient inside-out design.

### COMPACT SIZE

Only 4 1/16" x 4 1/16" x 1 1/2". Weighs just 1 1/4 lbs. Interchangeable with similar, less reliable 4 1/16" fans.

### EXCLUSIVE BROACHED BEARING SYSTEM

Hand-fitted proven broached dual-sleeve bearing system assures longer, more reliable operation.

### ALL-METAL CONSTRUCTION

Precision die cast housing, hub, impellers. Corrosion resistant. Natural heat sink. Warp-free, unlike conventional plastic fans.

## 115 CFM WITH LESS THAN 37.5 dB SIL\*

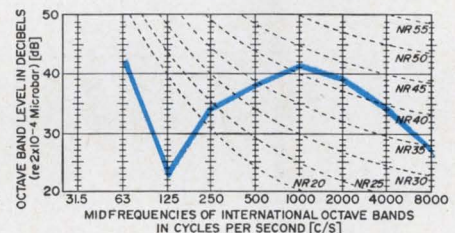
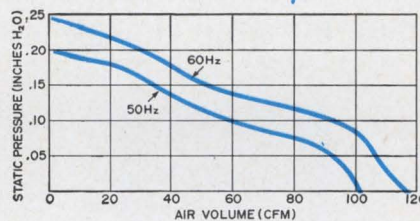

- Lubrication-free life in excess of 20,000 operational hours, continuous duty at 55° C.
- Delivers more air at a lower noise level, yet priced under similar conventional plastic fans.
- Model 4500 designed for 117 V/50-60 Hz operation, while Model 4550 operates at 230 V/50-60 Hz.
- Now available for immediate delivery through leading electronic distributors or directly from factory stock.

For complete technical data on the Model 4500 and other PAMOTOR miniature axial fans write to PAMOTOR, INC., 312 Seventh Street, San Francisco California 94103.

\*Speech Interference Level

# PAMOTOR, INC.

ON READER-SERVICE CARD CIRCLE 72



## TEST EQUIPMENT

### Preset counters operate power relays

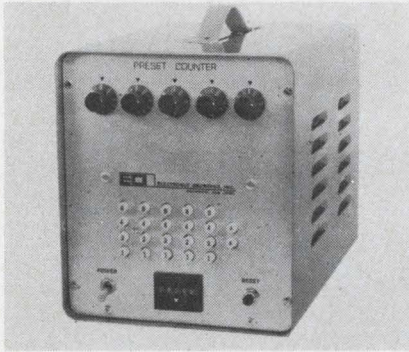

Electronic Counters, Inc., 235 Jackson St., Englewood, N. J. Phone: (201) 567-5300. P&A: \$450; stock to 4 wks.

Single and dual present counters operate up to 60,000 counts per second, and, at the end of a preset count, will operate a power relay. Relay operate time is field-adjustable. A built-in lockout circuit prevents operation if another part of the system is not functioning correctly. Readouts can be either 1-2-4-8 lamps or nixies.

CIRCLE NO. 237

### Dual-channel pulser for continuous control

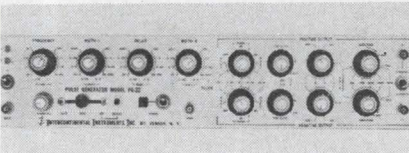

Intercontinental Instruments, Inc. 500 Nuber Ave., Mt. Vernon, N. Y. Phone: (914) 699-4400. P&A: \$1385; 30 days.

A dual-channel pulse generator permits continuous control of amplitude, width, delay, rise time, fall time and rep rate of its two independent outputs. The instrument covers 0.1 Hz to 20 MHz (double pulse mode). Model PG-32 may be operated as a voltage source having a 50- $\Omega$  impedance, or as a current source in which case the source impedance is a minimum of 500  $\Omega$ . The PG-32 may be externally driven at rep rates to 10 MHz. A pushbutton is provided to permit "one-shot" or "gated" operation, so that outputs appear only during the "gate open" period. Gate response is better than 10 ns.

CIRCLE NO. 238

### Shunt set extends DVM readings

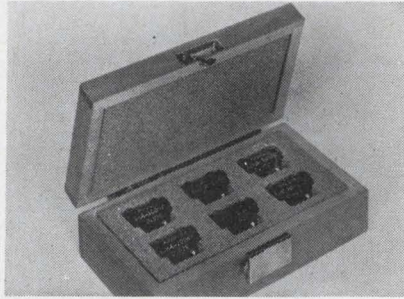

Dana Laboratories, Inc., Campus Drive at Von Karman Ave., Irvine, Calif. Phone: (714) 833-1234.

A set of 6 encapsulated precision-resistor shunts is offered for use with the manufacturer's series 5400 DVMs, each representing a full scale range of 1,000, 100, 10 or 1 mA; or 100 or 10 mA. The instrument is set to the 100-mV range. The shunt is plugged into the DVM input and the input leads are connected to the shunt assembly. The voltage drop across the shunt is measured by the DVM.

CIRCLE NO. 239

### Null potentiometer has plug-in range change

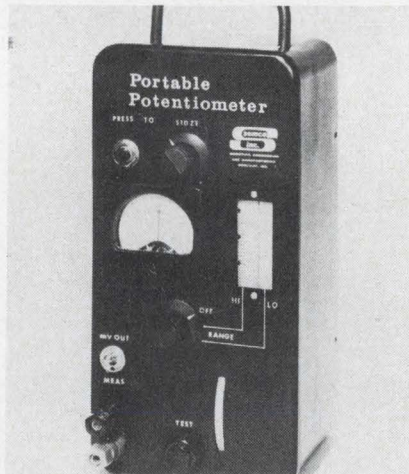

Szarko Organization, 10680 W. Pico Blvd., Los Angeles. Phone: (213) 839-4343.

A portable null potentiometer incorporating a plug-in range-change card and interchangeable stainless steel scale can be changed in the field by inexperienced personnel without need for recalibration. The unit measures 4-5/16 by 10 by 3-1/2

in., and weighs less than 4-1/2 lbs. The potentiometer can also be used as a pyrometer or a millivolt source, and can read directly in millivolts.

CIRCLE NO. 240

### Mag reaction analyzers now automated testers

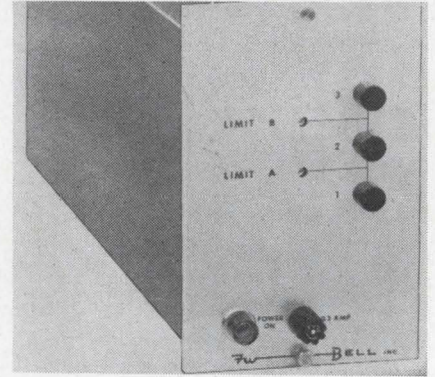

F. W. Bell, Inc., 1356 Norton Ave., Columbus, Ohio. Phone: (614) 294-4906. P&A: \$550; stock.

Automatic and process capabilities are added to the manufacturer's line of magnetic reaction analyzers with the introduction of the HU-7004 limit unit. The HU-7004 is a voltage-sensitive switching instrument acting as a triple-state gate. It will accept dc inputs from -2 to +2 V and any two points in this range can be selected as switching levels, giving readings of normal, marginal and out-of-tolerance conditions.

CIRCLE NO. 241

### X-Y oscilloscope has matched amplifiers

Data Instruments Div., 7300 Crescent Blvd., Pennsauken, N. J. Phone: (609) 662-3031. P&A: \$575; stock.

Identical vertical and horizontal amplifiers are featured in the S52 X-Y oscilloscope. The instrument has a 5-in. flat-face PDA tube with a variety of optional phosphors. Phase error is rated at less than 1% over the entire bandwidth of dc to 2 MHz. The S52 can also be used as a general-purpose scope through a control that allows the horizontal amplifier to be switched out and an internal time-base switched in.

CIRCLE NO. 242





1-pole Series  
MS24523



2-pole Series  
MS24524

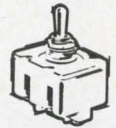

4-pole Series  
MS24525



1-pole Series  
Lever-lock  
MS24658



2-pole Series  
Lever-lock  
MS24659



4-pole Series  
Lever-lock  
MS24660



**...and  
rugged enough  
to stay  
that way**

No worry about moisture or dust entering the TL toggle switch—the only switch of its kind sealed well enough to meet the *complete* environmental sealing requirements of MIL-S-3950. Molded-in, silicone elastomer seals are used between bushing and toggle lever, between cover and case, and around the terminal inserts. Case is made of high impact arc-resistant diallyl phthalate—and assures dependable operation at temperatures from  $-85^{\circ}$  to  $+250^{\circ}$ F.

TL switches are readily adaptable for aerospace, mobile, marine, electronic and many critical industrial applications. Available in 1, 2 or 4-pole circuits; 2 and 3 position with momentary and maintained action, and special "on-on-on" circuits; standard or "pull-to-unlock" levers.

Call a Branch Office or Distributor (Yellow Pages, "Switches, Electric"). Or write for Catalog 52.

## **MICRO SWITCH**

FREEPORT, ILLINOIS 61032

**A DIVISION OF HONEYWELL**

**HONEYWELL INTERNATIONAL**—Sales and service offices in all principal cities of the world. Manufacturing in United States, United Kingdom, Canada, Netherlands, Germany, France, Japan.

ON READER-SERVICE CARD CIRCLE 73



# Requirement: How do you evaluate the RF hazard susceptibility of a weapons system?

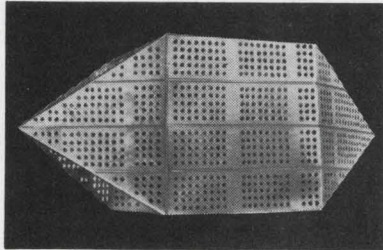

**Solution:** Amecom's RF Hazard Simulation Chamber that provides well defined electromagnetic field conditions to simulate the tactical RF environments to which a system may be exposed.

This 63,000 cubic foot chamber creates and maintains these fields at sufficiently high intensities to obtain the effective RF radiation conditions required to test a system's reflective and attenuation losses, inadvertent receiving antennas and susceptible component RF coupling.

The Problem Solvers of Amecom's Antenna Systems Department will be pleased to review all your electromagnetic radiation problems.

Call or write: Amecom Division, 1140 East-West Highway, Silver Spring, Md. 20910, Tel: (301) 588-7273.

**AMECOM** |   
DIVISION OF LITTON INDUSTRIES

ON READER-SERVICE CARD CIRCLE 74

**SAMPLE AND  
HOLDHOLDHOLDHOLDHOLDHOLDHOLD  
HOLDHOLDHOLDHOLDHOLDHOLDHOLD  
HOLDHOLDHOLDHOLDHOLDHOLDHOLD  
HOLDHOLDHOLDHOLDHOLDHOLDHOLD  
HOLDHOLDHOLDHOLDHOLDHOLDHOLD  
HOLDHOLDHOLDHOLDHOLDHOLDHOLD  
HOLDHOLDHOLDHOLDHOLDHOLDHOLD  
HOLDHOLDHOLDHOLDHOLDHOLDHOLD  
HOLDHOLDHOLDHOLDHOLDHOLDHOLD**

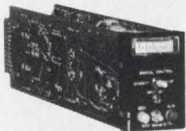

## ANALOG CONTROL SIGNALS

PD & C's new Model 102 Analog Memory Device makes continuous, trouble-free operation of process control a practical, economical reality. When a disruption of incoming data occurs, Model 102 retains the last valid signal to within 1% for over an hour, permitting service to be maintained until the input can be restored. Eliminates costly downtime and maintenance interruptions.

*Find out more today.*



**PACIFIC DATA  
& CONTROLS**

1476 Odstadt Drive • Redwood City, California 94063

ON READER-SERVICE CARD CIRCLE 75

## POWER EQUIPMENT

### Radar power supply with 0.25% regulation

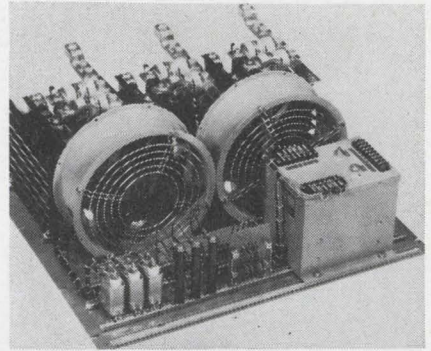

Robicon Corp., 6452 Penn Ave.,  
Pittsburgh. Phone: (412) 361-7211.

A solid-state 100-kW radar transmitter power supply with 0.25% output voltage regulation for line and load changes operates from a 480-V, 3-phase line and drives a transformer-rectifier combination. The solid-state device regulates the 180,000-Vdc, 10-kW input into the grid of a tube oscillator. Dc output is adjustable from 0 to 100% of rated value.

CIRCLE NO. 243

### Power supply module for 16 to 60 Vdc

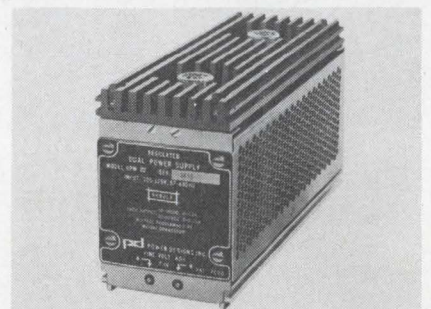

Power Designs Inc., 1700 Shames  
Dr., Westbury, N. Y. Phone: (516)  
333-5200. P&A: \$199; 3 to 4 wks.

This regulated dc power supply eliminates the need for stocking a large number of equivalent slot-range modules. It contains two independent sources of 16 to 28 Vdc at 0.5 A, and 28 to 60 Vdc at 0.25 A. The output voltages are selected by wiring of the mating connector in discrete 6-volt steps with 1% accuracy. Two 25-turn interpolation pots provide intermediate settings.

CIRCLE NO. 244



## Ac/dc supply powers digital readout tubes

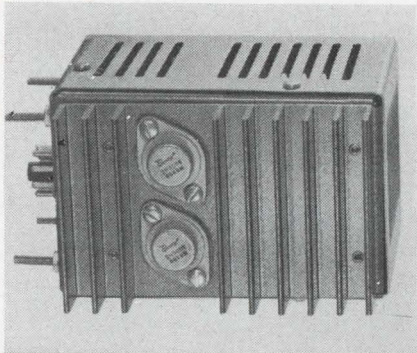

Power/Mate Corp., 163 Clay St., Hackensack, N. J. Phone: (201) 343-6294. P&A: \$80; 2 wks.

Designed to provide all dc and ac voltages for the 200 Amperex type 6977 indicator tubes, this supply provides 47 V for the anode, 4 V for the bias and 1 Vac for the filament. The compact package measures 3-1/4 x 3-7/8 x 5 in. The short-proof supply is an all-silicon design permitting operation at ambient temperatures to 71°C.

CIRCLE NO. 245

## Metal-ceramic triodes for industrial power

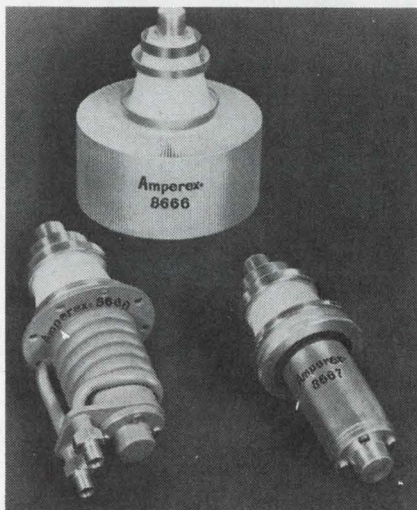

Amperex Electronic Corp., Tube Div., Hicksville, N. Y. Phone: (516) 931-6200. Availability: stock.

Two families of power triodes are available, air-or-water-cooled, with power outputs of 7.5 and 15.5 kW. Anode power independent of load factor is claimed to result from a special alloy grid, which is also said to withstand high, short-dura-

tion overloads. Mesh construction increases cathode emission and permits reduction in tube size, and increased thermal conductance from the grid to its external connections. Max frequency is 150 MHz.

CIRCLE NO. 246

## 400-Hz supply takes 50- or 60-Hz input

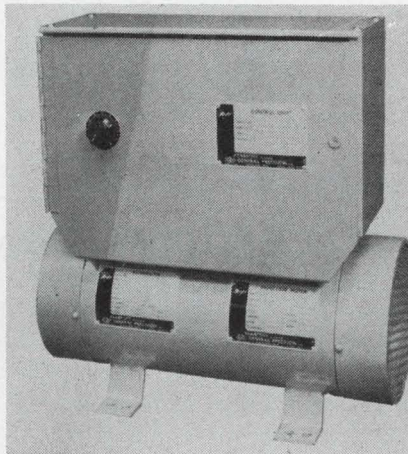

Kearfott Div., General Precision, Inc., 12690 Elmwood Avenue, N.W., Cleveland. Phone: (216) 252-4242.

Operating from either 50- or 60-Hz sources, this 400-Hz supply provides 110-V single-phase. Voltage regulation is within 2% and total harmonic distortion is below 4%. Designed primarily to power a milling machine tracer system, the supply is said to meet a variety of applications where a 400-Hz unit is needed to eliminate mounting problems and reduce maintenance.

CIRCLE NO. 247

## Broadband generator for sonic transducers

Macrosonics Corp., Carteret, N. J. Phone: (201) 541-4131. Price: \$12,-850.

This new broadband generator is designed for high power emissions within the lower end of the ultrasonic spectrum. It is used to supply power to sonic and ultrasonic transducers. It covers a continuously tunable frequency range from 10 to 100 kHz with controlled power output variable from nearly 0 to 3 kW. The output impedance is 200 Ω.

CIRCLE NO. 248

## Another Quality Product of SIGMUND COHN Corp.

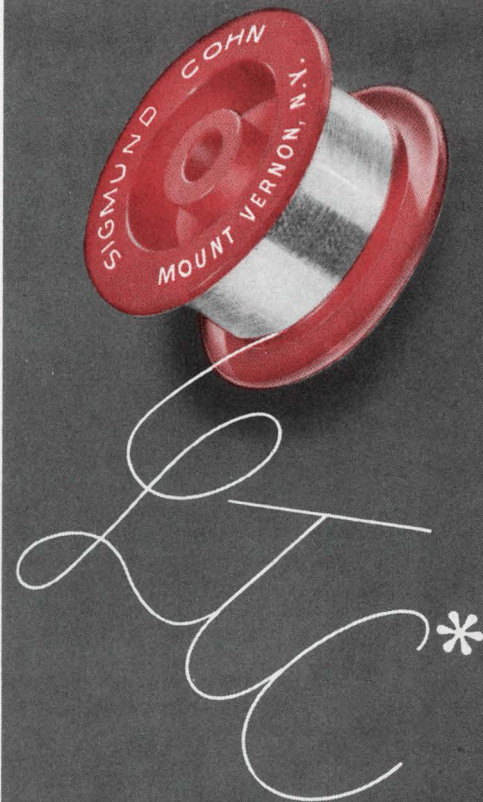

## Potentiometer Wire

with a

**\* Low Temperature Coefficient of Resistance**

U.S. Patent No. 2,840,468  
L.T.C. is a Reg. T.M.

Extremely corrosion-resistant...  
Consistently "noise-free"...

Resistivity	550Ω per cmf.
Temperature Coefficient of Resistance	20 ppm
Tensile Strength	200,000 psi (nom.)
Composition	65% GOLD; Nickel; Chromium

Write for detailed engineering brochure

## Sigmund Cohn Corp.

121 So. Columbus Avenue  
Mount Vernon, N.Y. 10553



Sigmund Cohn Corp. of California, Burbank, Cal.



### Big MTBF from small telemetry transmitter

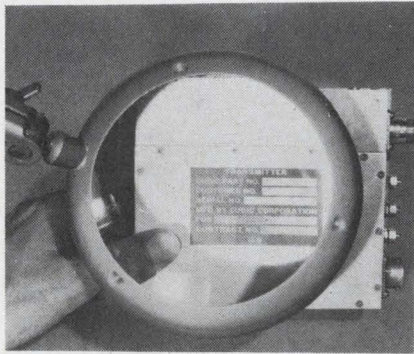

Cubic Corp., San Diego, Calif. Phone: (714) 277-6780.

L- and S-band telemetry transmitters have mean-time-between-failures of 49,000 hours. All solid-state, the S-band unit provides 4-W nominal output power and the L-band 5-W. Output is crystal-controlled for high frequency stability of  $\pm 0.0025\%$ . Both transmitters are phase-modulated with linearity within  $\pm 1\%$  full scale. Input voltage is 21 to 29.5 Vdc for both transmitters with power consumption of 1.75 A and no warm-up.

CIRCLE NO. 249

### Four-cavity klystrons have low noise figure

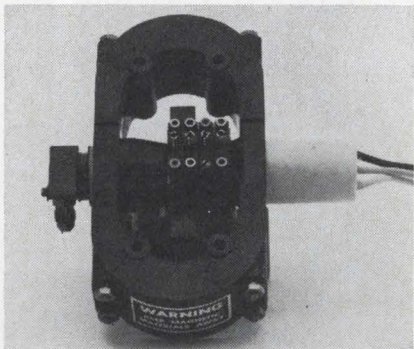

varian, 611 Hansen Way, Palo Alto, Calif. Phone: (415) 326-4000.

A new series of klystrons are rugged, low-noise, four-cavity amplifiers which deliver 300 W at a center frequency between 9.2 and 10.6 GHz. Designed for airborne Doppler radar service, these liquid-cooled tubes weigh less than 6 lbs and measure only 6.6 by 5.6 by 4.3-in. Random AM noise is at least 100 dB below carrier in a 1-kHz band.

CIRCLE NO. 250

### Transistor amplifier replaces TWT

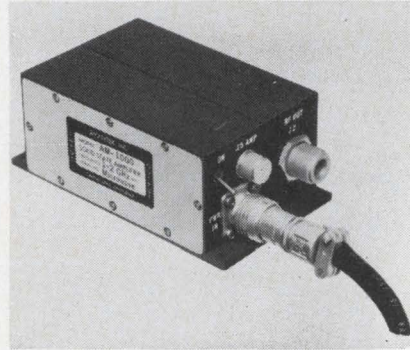

Avantek, Inc., 3001 Copper Rd., Santa Clara, Calif. Phone: (408) 739-6170. P&A: \$2500; stock to 30 days.

An integrated power supply and transistor microwave amplifier is offered for use in the L and S bands. The module allows systems designers to replace large, heavy TWTs with an all-solid-state microwave preamplifier weighing only 2 lbs. The manufacturer guarantees a 6-dB max noise figure, a frequency response of 1 to 2 GHz, and a min gain of 25 dB.

CIRCLE NO. 251

### Ku-band mixer diode is tiny and quiet

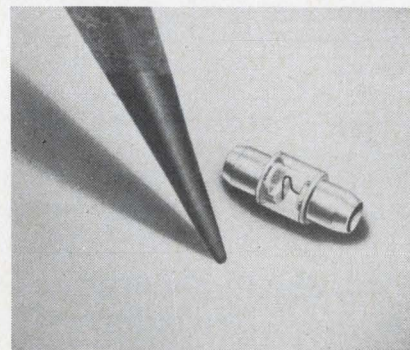

Alpha Industries, Inc., 381 Elliot St., Newton Upper Falls, Mass. Phone: (617) 969-6480.

A Ku-band mixer diode has a maximum noise figure of 7.5 dB. Type MO-2014F of the MO-2014 series is a miniature cartridge diode with electrical performance equivalent to the coax 1N78F mixer diode. Specifications include: test frequency 1.6 GHz, max vswr 1.6, IF impedance 300 to 500  $\Omega$  and burnout rating 1.0 ergs.

CIRCLE NO. 252

### Hybrid-T junction for X- and Ku-band

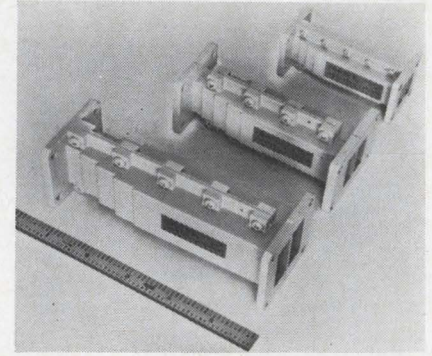

Rantec Div., Emerson Electric Co., Calabasas, Calif. Phone: (213) 347-5446. Availability: stock.

A series of X- and Ku-band tees are offered for power division and addition. The three-port hybrid-T junctions cover full waveguide bandwidth typically to within 0.05-dB unbalance. Vswr is less than 1.08 at all ports, and isolation exceeds 30 dB between the output ports. When signals are combined, unbalance is absorbed by an internal load.

CIRCLE NO. 253

### Latched ferrite switch for 300 W in S-band

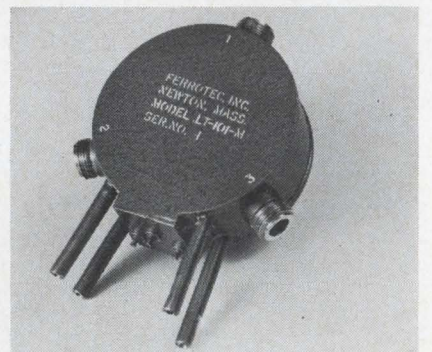

Standish Lithograph, Inc., 354 Congress St., Boston. Phone: (617) 426-6580.

This S-band ferrite circulator-switch is a latched device that does not require holding power once it has been pulsed on or off. Water cooling tubes can be provided although the device functions without cooling. Switching is spdt. The frequency range is 2.6 to 3.0 GHz, vswr is 1.2 max, and isolation is 20 dB min. Switching speed is 5 ms. Average power is 300 W.

CIRCLE NO. 254



Report from

**BELL  
LABORATORIES**

# Photodiodes with gain

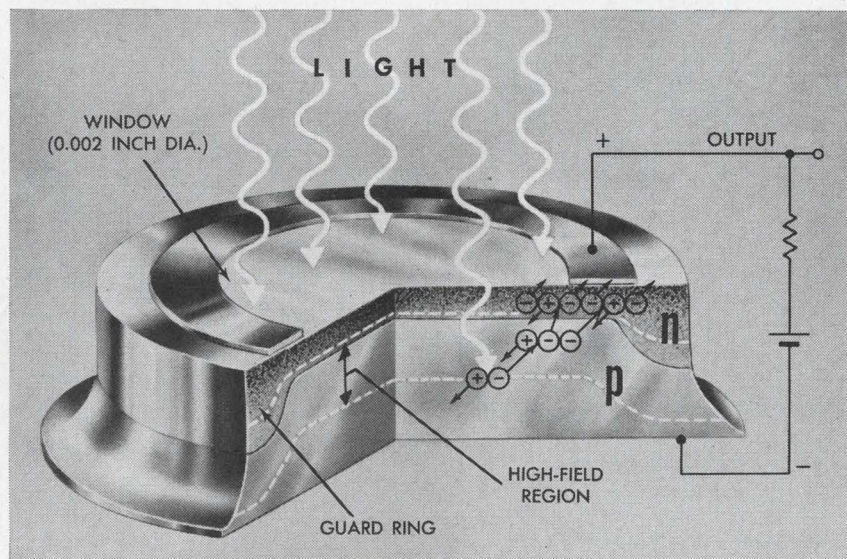

Cross-section of one form of the new photodiode. For the avalanche effect, positive voltage is applied to the n region and negative to the p (i.e., against the direction of easy current flow).

A photon, in being absorbed, creates an electron-hole pair. Electrons, formed in this way within the high-electric-field region of the junction, move toward the n-side. In so doing, they pick up energy, strike other atoms and create more pairs of electrons and holes. (A similar but opposite process occurs for the holes.) This "chain reaction"—the avalanche effect—produces relatively large currents and gives the diode its gain.

It is important that the avalanche multiplication factor be uniform over the entire window area... that no small area exhibit a particularly high multiplication factor. To achieve this, we start with homogeneous germanium and create a "guard ring" in which the density of charge-carrying impurities is relatively low. This low density results in a reduced electric field where the p-n junction meets the circumference... where breakdown currents would otherwise occur.

Because the time required for avalanche is very short, the diode responds to modulation frequencies as high as 60 GHz.

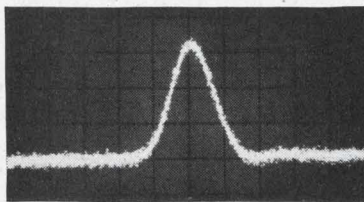

Performance of Bell Laboratories' germanium avalanche photodiode (right) compared with that of an otherwise identical non-avalanche type. Under a weak light signal (40  $\mu$ W) the output of the ordinary diode is lost in noise. High gain of the new avalanche type, however, permits the signal pulse to be clearly seen.

In a typical photodiode, a negative and a positive charge carrier—called an electron-hole pair—are created for each photon that penetrates the diode's surface. Now, Bell Laboratories scientists W. T. Lynch and H. Melchior have made experimental germanium photodiodes that have gain, developing up to 250 such electron-hole pairs per photon. And the new photodiodes respond to light of wavelengths from the visible region well into the infrared... to 1.6 microns.

The gain in these diodes stems from the "avalanche" effect (left). This requires carefully selected germanium and a special construction feature—a "guard ring"—developed here some years ago.

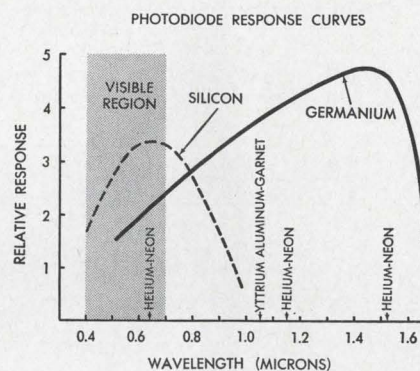

In opto-electronic systems using infrared light from helium-neon or yttrium-aluminum-garnet lasers, for instance, the response of the new diode (above right) could be used in detecting modulation signals, and its high output would permit omission of some stages of amplification. (The "avalanche effect" was discovered at Bell Laboratories; the first avalanche photodiodes were of silicon and cut off below 1 micron in the "near" infrared.)



**Bell Telephone Laboratories**  
Research and Development Unit of the Bell System



# RCL 1/2" ROTARY SWITCHES

ESTABLISHING A NEW SET OF PERFORMANCE STANDARDS!

- Up to 12 positions per deck with stops.
- As many as 6 poles per deck.
- Shorting and non-shorting poles may be grouped on one deck in any combination.
- All individual deck parts are self-contained, and are permanently molded into place.
- Wiring to switches possible "in the flat".

"OFF-THE-SHELF" SHIPMENTS FOR INDUSTRY'S BEST DELIVERY!



# RCL

Write for complete engineering information

**ELECTRONICS, INC.**

General Sales Office: One Hixon Place, Maplewood, New Jersey 07040

ON READER-SERVICE CARD CIRCLE 77

## PACKAGE INSURANCE

SKYDYNE sandwich construction  
TRANSPORTATION/OPERATING CASES

Simple insurance to make sure that your expensive equipment gets where it's going in operable condition. It's a good policy to use Skydyne sandwich cases for 100% protection of your equipment against shock... vibration... dust... water... and virtually every other environmental hazard that it might encounter.

Transit and combination cases to meet MIL-T-945, MIL-T-21200, MIL-T-4734 and MIL-T-4150 can be readily assembled to meet just about every equipment configuration from the hundreds of standard components available... and without special tooling charges.

Write for our 22 page Skydyne Design Manual for Mil. Spec. Cases.



*Skydyne, Inc*

RIVER ROAD, PORT JERVIS, N. Y.  
Telephone (914) 856-5241

ON READER-SERVICE CARD CIRCLE 78

## MICROWAVES

Fast switching diodes through 8-GHz range

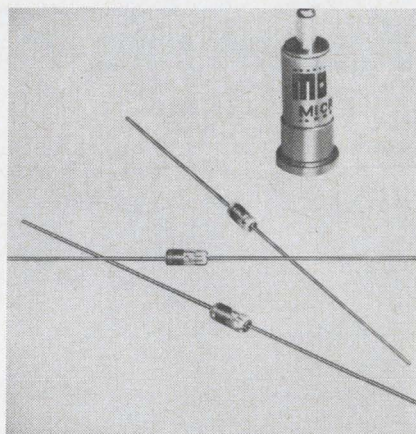

Alpha Industries, Inc., 381 Elliot St., Newton Upper Falls, Mass. Phone: (617) 969-6480.

Fast-switching microwave diodes feature extremely low capacitance coupled with good resistance values. Type MO-2800D makes possible the design of switches through the 8-GHz range with a minimum number of diodes. The results are high isolation-to-insertion-loss ratios. Specifications include forward switching time of 1 ns, total capacitance of 0.07 pF, voltage breakdown of 80 V and dynamic forward impedance of 80  $\Omega$ .

CIRCLE NO. 255

Coax terminations work from dc to 12.4 GHz

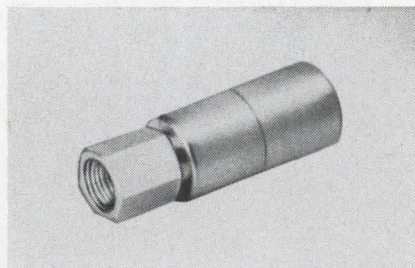

Microlab/FXR, 10 Microlab Rd., Livingston, N. J. Phone: (201) 992-7700. P&A: \$30; stock.

These miniature coax terminations, covering dc to 12.4 GHz with a vswr of 1.2 max, are only slightly more than 1-in. in length. They have a power rating of 1 W average and 1 kW peak. They are available with either male or female connectors, which mate with all popular miniature connectors.

CIRCLE NO. 256



## Crossed-field tubes deliver 1 MW peak

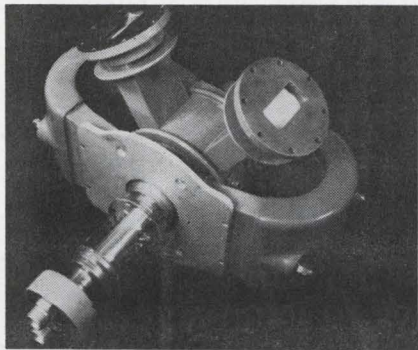

SFD Laboratories, Inc., 800 Rahway Ave., Union, N. J. Phone: (201) 687-0250.

High-gain crossed-field amplifier tubes that deliver 1 MW peak (3.5 kW average) over a 5450-to-5825-MHz band are designed for pulsed coherent and frequency-agile systems. Pulse width is 10  $\mu$ s. Duty factor is 0.0035 max. The 57-pound liquid-cooled tube is suited for use in transportable radar, instrumentation radar systems, and applications where weight and size are important.

CIRCLE NO. 257

## Microwave mixers have replaceable diodes



Sage Laboratories, Inc., 3 Huron Dr., Natick, Mass. Phone: (617) 653-0844. P&A: \$250 (dual output), \$225 (single output); stock to 30 days.

A line of miniature microwave balanced mixers has been expanded to include 8 models with replaceable diodes. The new line covers 1 to 4 GHz in two bands. In each band, dual and single IF outputs are available with 1/4-36 connectors or solderlugs.

CIRCLE NO. 258

## TWT amplifier is self-powered

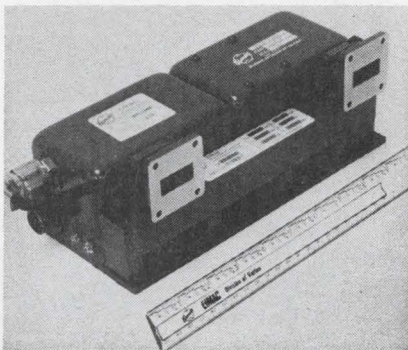

Eimac, 301 Industrial Way, San Carlos, Calif. Phone: (415) 592-1221.

A high-gain traveling-wave tube amplifier with a solid-state power supply is rated a 1 W min output in the 7.9-to-8.4-GHz frequency range. The tube and its power supply are designed for performance in excess of 50,000 hours. Designed as a driver for satellite communications terminal equipment, the package is also applicable to airborne, transportable and ground-based communications use.

CIRCLE NO. 259

## Acoustic delay line has 130-MHz bandwidth

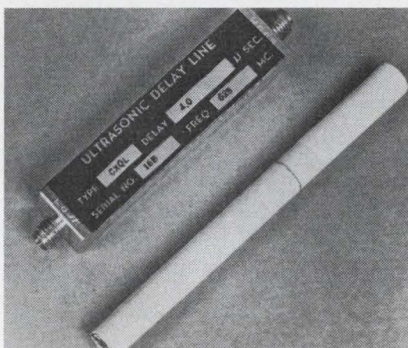

Andersen Laboratories, Inc., 1280 Blue Hills Ave., Bloomfield, Conn. Phone: (203) 242-0761.

An L-band microwave acoustic delay line is electrically matched to a 50- $\Omega$  impedance. The 2-1/4-in.-long device has a delay of 4 ms, a center frequency of 625 MHz, and a bandwidth of 130 MHz. Other parameters include insertion loss, 44 dB; spurious, 20 dB; and vswr, 1.3. The one-ounce device utilizes OSM connectors.

CIRCLE NO. 260

# digital systems

## opportunities at NCR electronics division in los angeles

### SYSTEMS FORMULATION & ANALYSIS ENGINEERS

For assignments in commercial on-line computer applications with emphasis on communications interface. Extensive experience required in hardware specifications and advanced systems, including multiprogramming and list processing. Requires B.S. in engineering, business or related field.

- SOFTWARE PROGRAMMER
- DIAGNOSTIC PROGRAMMER
- PROJECT ENGINEERS
  - Computing Systems
  - Peripheral Equipment
  - Discs & Controllers
  - Packaging
- CIRCUIT DESIGN ENGINEERS
- ELECTRICAL & MECHANICAL LIAISON ENGINEERS
- PACKAGING ENGINEERS (ALL LEVELS)
- MECHANICAL DEVELOPMENT ENGINEER
- RELIABILITY ENGINEERS
- QUALITY CONTROL ENGINEERS
- PROCESS ENGINEER—ELECTRONIC
- TEST EQUIPMENT DESIGN ENGINEERS
- MEMORY DESIGN—RESEARCH
- MECHANISMS SPECIALIST—Ph.D.
- MECHANICAL/OPTICS DESIGN ENGINEER

### ARRANGE NOW FOR INTERVIEW AT IEEE CONVENTION OR IN YOUR AREA

To arrange for a confidential interview at the March IEEE convention in New York, or in your area, please send your resume, including training, experience and salary history, to Bill Holloway, Technical Placement.

The National Cash Register Company



ELECTRONICS DIVISION  
2817 W. El Segundo Blvd., Hawthorne, Calif.  
Telephone: Area Code (213) 757-5111  
An equal-opportunity employer

ON CAREER-INQUIRY FORM, page 109, CIRCLE 903



### Down converter from S-band to vhf

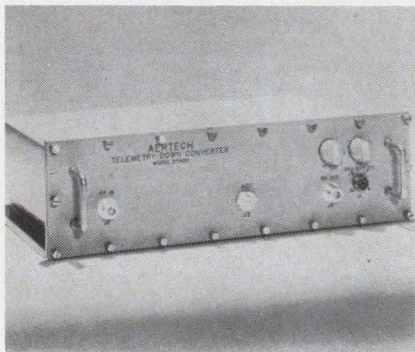

*Aerotech, 250 Polaris Ave., Mountain View, Calif. Phone: (415) 967-9492.*

This unit converts S-band telemetry signals (2.2 to 2.3 GHz) to vhf (215 to 314 MHz). The converter has an instantaneous bandwidth of 100 MHz, and an over-all noise figure of 5.5 dB. A limiter and filter are provided to protect the input tunnel diode amplifier from high power signals. A voltage-variable attenuator is incorporated to extend input RF capability to -10 dBm.

CIRCLE NO. 261

### High-energy flashtubes for laser applications

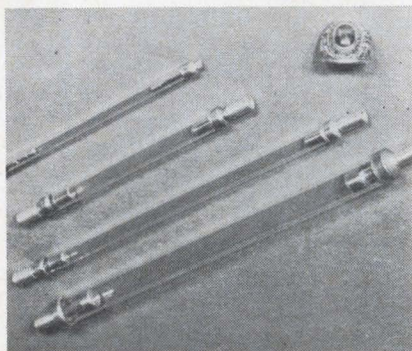

*Xenon Corp., 1 Wheeler Court, Watertown, Mass. Phone: (617) 926-2577.*

A line of flashtubes for pulsed laser applications act as high-powered switches when activated by a flash voltage. They can be triggered by a pulse from an external magnetic field, or by a series-injected high-voltage pulse. They are useful for laser stimulation, as satellite or other beacons, and in various research applications.

CIRCLE NO. 262

### T-pad attenuators for dc to 3 GHz

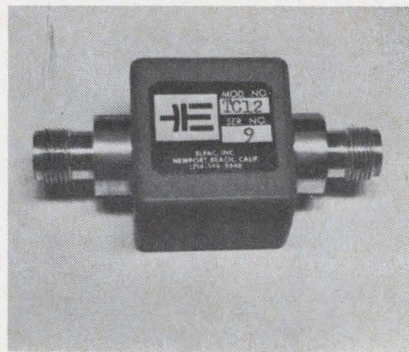

*Elpac, Inc., 3760 Campus Dr., Newport Beach, Calif. Phone: (714) 546-8640.*

A line of 14 models of stripline-encapsulated fixed attenuators, and miniature versions, are offered in T-pad construction in a package designed for extreme environmental conditions. Attenuations range from 3 to 30 dB, within  $\pm 0.2$  dB. Frequency is dc to 3 GHz. Typical vswr is 1.2. Power rating is 200 mW; impedance is 50 ohms.

CIRCLE NO. 263

### Transistor oscillator is YIG-tuned in L band



*Watkins Johnson Co., 3333 Hillview Ave., Palo Alto, Calif. Phone: (415) 326-8830.*

This compact solid-state microwave signal source is electronically tuned to cover a frequency range of 1 to 2 GHz. It is YIG-tuned for linearity over the full octave. The resonant frequency of the YIG resonator is directly proportional to the applied magnetic field. It is tuned by superposition of the field of a permanent magnet on that of an electromagnet.

CIRCLE NO. 264

### Frequency doubler for 10-to-1500-MHz range

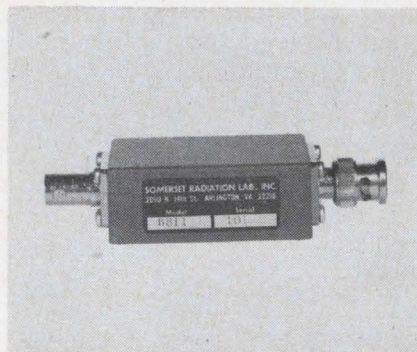

*Somerset Radiation Lab., Inc., 2060 N. 14th St., Arlington, Va. Phone: (703) 525-4255. P&A: \$88; 10 days.*

This unit is designed to double the frequency of any sweeper, signal generator or frequency synthesizer in the 10-to-1500-MHz range with typical 10-dB conversion efficiency, and frequency response flat within 1 dB. The input power handling capability is 200 mW. The doubler uses Schottky-barrier diodes in a full-wave doubler-rectifier circuit.

CIRCLE NO. 265

### Microwave amplifiers feature low noise

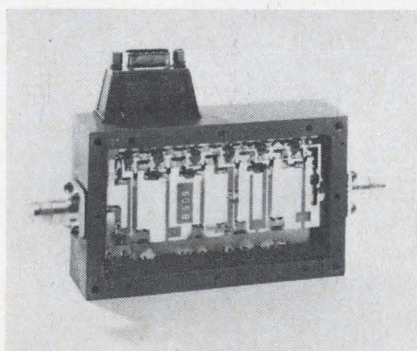

*RHG Electronics Laboratory, Inc., 94 Milbar Blvd., Farmingdale, N. Y. Phone: (516) 694-3100. P&A: \$695; 4 to 6 wks.*

A line of microwave amplifiers features noise figures to 4.5 dB and frequency coverage from 0.5 to 2.4 GHz. Microminiature silicon transistors and stripline and PC techniques aim at long life. The units are designed for use in telemetry, communications and radar systems. Gain is 20 dB min on all units.

CIRCLE NO. 266



# If you want to build your own servo amplifier, here's how.

First you start with the printed circuit board, then you buy the right silicon transistors, select your resistors, machine your supporting hardware and fittings, pick your power transformer, add your capacitors, but don't forget the diodes and chopper...and, oh yes, design and test the whole business to make sure you get the best performance from your motor.

## If you can't do the whole thing for under \$100.00, it will pay you to buy your servo amplifier from Diehl.

You can buy a new Diehl servo amplifier/package for as low as \$100.50 (in lots of 5, and for a lot less in larger quantities). This package has been designed to produce optimum performance from any 50-60 or 400 cycle servomotor with 36 volt center tapped control phase winding, requiring 55 watts or less of

control phase power. Each amplifier provides for a-c and/or d-c input, and is supplied with nominal gain of 1000, adjustable from 200-3000 for d-c input, or from 200-4000 for a-c input.

So when you're buying a servomotor why bother with the headaches of amplifier design. Diehl can supply a com-

plete amplifier-power supply-servomotor package for far less than it will cost you to do-it-yourself. And if you've already bought your motor Diehl will welcome an opportunity to provide a quote on the amplifier. Interested? For more information on Diehl's servo amplifiers or amplifier-motor packages, clip the attached coupon.

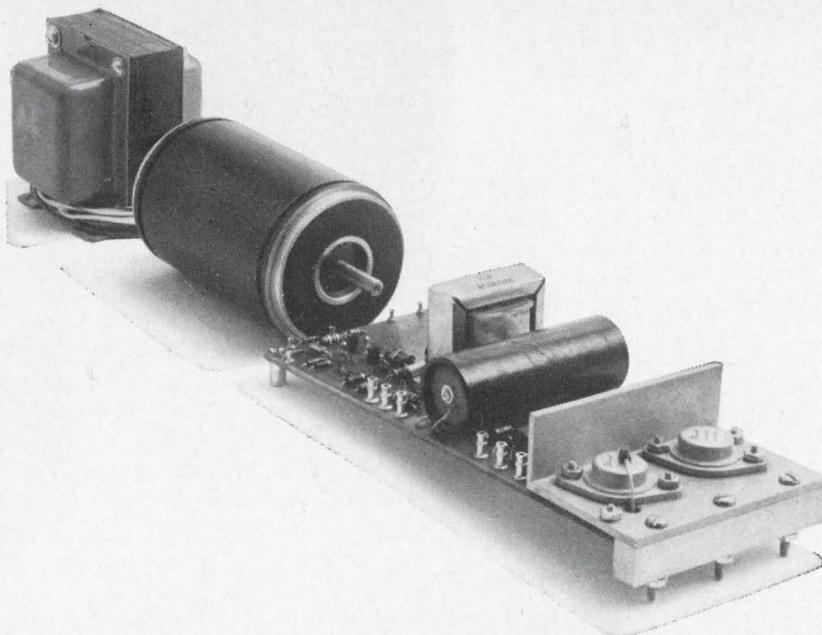

# SINGER

INDUSTRIAL CONTROLS

DIEHL DIVISION

Finderne Avenue, Somerville, N. J. 08876  
(201) 725-2200

- Please send more information on Diehl servo-amplifier packages
- Please have a salesman call

Name \_\_\_\_\_

Company \_\_\_\_\_

Address \_\_\_\_\_

City, State, Zip \_\_\_\_\_

D 123

ON READER-SERVICE CARD CIRCLE 79



# NEWEST from ARNOLD

ORDER DIRECT—  
PERFORMANCE GUARANTEED

## 100°C MICROMINIATURE DC CONVERTER

UP TO 5KV OUTPUT!

Size: Only 2 3/4" x 1 7/8" x 5/8" Thick  
Weight: 4 Oz.

Model No.	Output VDC	Output Ma.	Price Ea.
SMU-003	3	750	\$200.00
SMU-1	100	30	180.00
SMU-2.5	2.5KV	1.2	270.00
SMU-5	5.0KV	0.6	320.00

Input: 25-30VDC. Output Adjustable +5% -10%. Line Regulation: 3%. Ripple: .3% (RMS). Short Circuit, Transient and Reverse Polarity protection. AC Output Model SMV also available. Delivery from Stock. \*Ask for Bob Johnson

CIRCLE READER-SERVICE NO. 207

## 40 WATT DC-DC CONVERTER

8 MODELS—6.3V TO 5KVDC OUTPUT—ADJUSTABLE  
—senses overvoltage and current in MILLISECONDS!

Model No.	Output VDC	Output Current	Price Ea.
SHU-6.3	6.3	5.0 Amps	\$195.00
SHU-300	300	133 Ma.	200.00
SHU-1000	1000	40 Ma.	230.00
SHU-5000	5000	8 Ma.	390.00

SIZE: 3 1/2 x 3 1/2 x 1 5/8" Thick—Weight: 26 Oz. Input: 28 ±2.0 VDC or 115V 50-500 Hz (PHU) Load Regulation: 1%-4% Typical Ripple: 0.2% (of E<sub>out</sub>) Max. Delivery from Stock—Special Voltages -2 Weeks ARO. \*Ask for Alan Schramm

CIRCLE READER-SERVICE NO. 208

## MODEL PHU

Size: 1 5/8" x 3 1/2" x 3 5/8". Designed to meet vibration and shock of MIL-E-5272C.

Weight: 27 oz.

Model No.	Output VDC	Output Current	Price Each
PHU-2WW	2	8 Amps	\$265.00
PHU-3WW	3	8 Amps	265.00
PHU-4.5WW	4.5	8 Amps	265.00
PHU-6WW	6	6.5 Amps	265.00

Input: 108-130 VAC @ 50-500 Hz. Output: adjustable +5 to -40%. Line Regulation: ±.015% per volt. Load Regulation: less than 2.5%. Ripple: less than 1.5%. Operating Temp. Range: -55°C to +71°C. Delivery from stock. Ask for Art Heath.

CIRCLE READER-SERVICE NO. 209

## MINIATURIZED HIGH VOLTAGE

CONVERTER— .44KV/Cubic Inch

PRICES REDUCED SEPT. '66

Eight models: from 6KVDC at 5MA to 20KVDC at 1.5MA. For CRT, TWT, Klystron. Size: 3 1/2" x 4 3/4" x 2 3/4". Weight: 59 oz.

Model	Output Volts DC	Output Current	Price Ea.
SFU-6	6K	5 Ma.	\$295.00
SFU-10	10K	3 Ma.	415.00
SFU-16	16K	1.8 Ma.	595.00
SFU-20	20K	1.5 Ma.	695.00

Bulletin SFU \*Ask for Alan Schramm

CIRCLE READER-SERVICE NO. 210

ARNOLD MAGNETICS

## ARNOLD MAGNETICS CORP.

6050 W. Jefferson Blvd., Los Angeles, Calif. 90016  
Telephone: 837-5313; 870-6284. (213)  
TWX: 213-836-0430

## MICROWAVES

### Waveguide terminations for S- to Ku-band

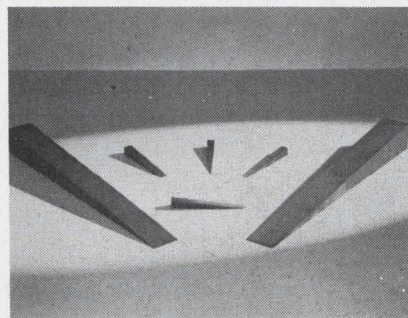

Emerson & Cuming, Inc., Canton, Mass. Phone: (617) 828-3300. P&A: \$15 to \$75; stock.

Low-power waveguide terminating elements for frequencies from S-band to Ku-band, are made in the shape of bottom-wall wedges, from lossy dielectric absorbing material. One side of the wedge is mounted in contact with the bottom (broad) wall of the waveguide to provide a rugged structure that will withstand more abuse than the pyramidal termination. In addition, this construction permits greatly improved heat dissipation by virtue of the wedge-waveguide contact.

CIRCLE NO. 267

### Coax switch transfers 15 kW at 100 MHz

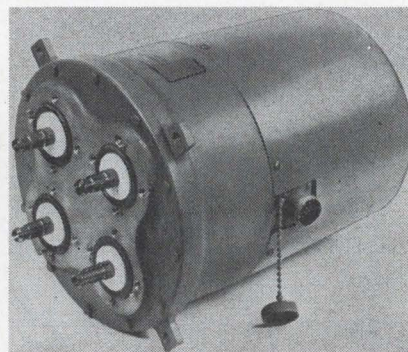

Andrew Corp., P. O. Box 807, Chicago, Ill. Phone: (312) 349-3300.

This 1-5/8-in. transfer switch maintains a vswr of less than 1.05 up to 2.9 GHz, and has an average power handling capability of 15 kW at 100 MHz. Mounted in any position, the motor-driven switch can be cycled manually in case of ac power failure. It provides two independent interlock circuits.

CIRCLE NO. 268

### Voltage tunable BWO for swept-signal source

Watkins Johnson Co., 3333 Hillview Ave., Stanford Industrial Pk., Palo Alto, Calif. Phone: (415) 326-8830.

A single-helix voltage-tunable oscillator utilizing a permanent magnet focusing system is suited for use as a swept-signal source in highly stable signal generators. Other applications include local oscillators in ECM receivers, master oscillators in frequency diversity transmitters, and in electronic test sets. Power output can be modulated with the grid or anode circuit.

CIRCLE NO. 269

### Coax couplers cover octave bands

Microlab/FXR, 10 Microlab Rd., Livingston, N. J. Phone: (201) 992-7700. P&A: \$130 to \$140; stock.

A line of miniaturized high-directivity coax couplers each cover octave bandwidths. The couplers measure as small as 3 x 1-1/2 x 1/2-in. All are supplied with MFM female connectors which mate with all popular miniature connectors. Designated the CB Series, 20- and 30-dB couplers are available with a directivity of 23 dB in the 2-to-4-GHz range and 20 dB in the 4-to-8-GHz range.

CIRCLE NO. 270

### Frequency multiplier is all solid-state

Microwave Development Labs., Inc., 57 Crescent Rd., Needham Heights, Mass. Phone: (617) 449-0700.

A X200 frequency multiplier consists of transistor amplifiers and diode multipliers cascaded to give X5, X5, X2 and X4. An input signal of 28.25 MHz and 3 mW results in a 5650-MHz, 30-mW output. All spurious signals are reduced 30 dB min. Dc input power of 3 W is required. The unit measures 2.5 x 4 x 9.2 in. plus connectors.

CIRCLE NO. 271



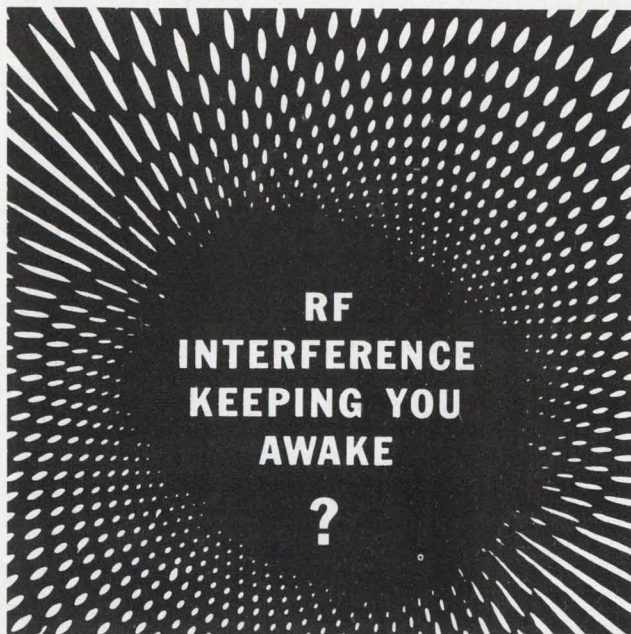

RF  
INTERFERENCE  
KEEPING YOU  
AWAKE  
?

Rest easy with reliable Littelfuse RF Interference shielded fuse posts. Wide range of military and commercial applications. Write or phone for information.



# LITTELFUSE

DES PLAINES, ILLINOIS

ON READER-SERVICE CARD CIRCLE 80

## NEW 1967 catalog

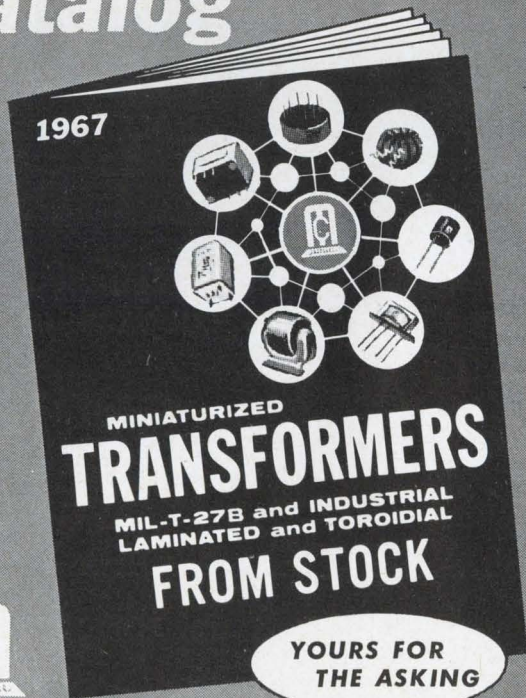

### MICROTRAN

145 E. Mineola Ave., Valley Stream, N. Y. 11582

ON READER-SERVICE CARD CIRCLE 81

ELECTRONIC DESIGN 4, February 15, 1967



## Charge Amplifier TRIPLETS!

### HIGH PERFORMANCE . . .

DCS Model GCA-1 Charge Amplifier with VCO and Galvo outputs . . . Built-in calibration.



### WITH EXTRA FUNCTIONS...

DCS Model GCA-2 Charge Amplifier with servo control output and front panel meter.



### FOR MULTI-FUNCTION PIEZOELECTRIC TRANSDUCER SIGNAL CONDITIONING . . .

DCS Model GOC-5 Charge Amplifier/VCO combination. Compact for portable and field use.



### AND... They're omniplugable



with DCS VCO's, Millivolt Oscillators, Low Level Amplifiers, Line Amplifiers, Discriminators, Crystal Oscillators, Translators, signal conditioning, calibrators, and magnetic tape recording equipment.

INTERESTED? Call our office nearest you for information and data bulletins on DCS Charge Amplifiers.

Or write directly to:

Department T-2, Data-Control Systems, Inc.  
East Liberty Street, Danbury, Connecticut 06813

Telephone: 203-743-9241 TWX 744-1999



**DATA-CONTROL SYSTEMS INC.**  
*Instrumentation for Research*

Sales Offices  
Silver Spring, Md., Huntsville, Winter Park, Long Beach, Santa Clara,  
Albuquerque  
Copenhagen London Rome Paris Munich Amsterdam

ON READER-SERVICE CARD CIRCLE 82



# 800 DELIVERED WATTS

of 0.01% regulated  
DC power from this  
compact Deltron module

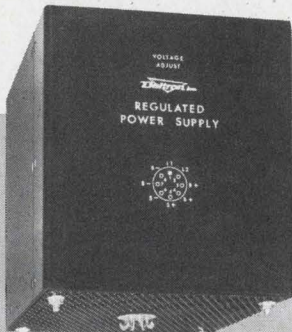

261 models... 1.5 to 264 volts  
... up to 44 amps

DELTRON Series "A" Silicon Power Modules offer you the maximum amount of extremely reliable power...per unit volume... available in the industry.

- ▶ Priced lower than any comparable units.
- ▶ 100% silicon, fully repairable modules—for dependable operation up to 71°C.
- ▶ Convection cooled... require no external heat sinks, no forced air, no special chassis mount.
- ▶ Modules used in military applications.
- ▶ Ripple—less than 500 microvolts.
- ▶ Completely protected for all overload and short circuit conditions with automatic recovery after fault is cleared.
- ▶ Accessories include: Crowbar over-voltage protectors... over/under voltage relays... and do-it-yourself rack adapter system for creating custom supplies in minutes.

REQUEST TECHNICAL BULLETIN

see our complete catalog  
in eem... Section 4000

D 103

## Deltron

WISSAHICKON AVE., NORTH WALES, PA. 19454  
PHONE: (215) 699-9261 • TWX: (510) 661-8061

ON READER-SERVICE CARD CIRCLE 83  
162

## MATERIALS

### Air-dielectric coax meets CATV needs

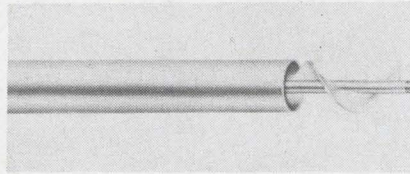

Phelps Dodge Copper Products Corp., 300 Park Ave., New York. Phone: (212) 751-3200.

Air-dielectric coaxial cable features a solid polyethylene helix which completely covers the solid-copper center conductor. By offering lower attenuation, guaranteed 32-dB return loss and the necessity of employing fewer amplifiers, Spirafil II meets CATV needs for an air-dielectric coax competitive with the cost of foam cable systems. Basic construction consists of a seamless aluminum outer conductor, continuous polyethylene dielectric and solid-copper inner conductor. The coax is available plain or jacketed in 0.412-, 0.5- and 0.75-in. diameters, 75- $\Omega$  impedance in 1000-foot reels.

CIRCLE NO. 272

### Solderless lug for shield grounding

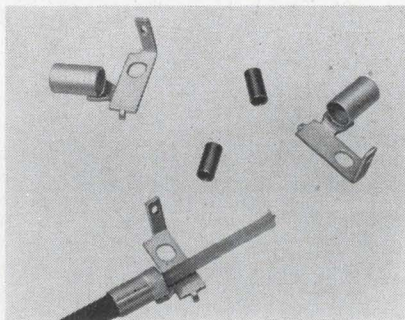

Thomas & Betts Co., 36 Butler St., Elizabeth, N. J. Phone: (201) 354-4321.

This connector can be bolted directly to the structure and eliminates the need for a separate grounding wire. Installation procedure requires the use of a hard inner sleeve that is slipped over the insulation of the wire and under the braid of the shielded or coaxial cable. The outer sleeve is then positioned over the inner and crimped.

CIRCLE NO. 273

### Conductive elastomer is flexible sensor

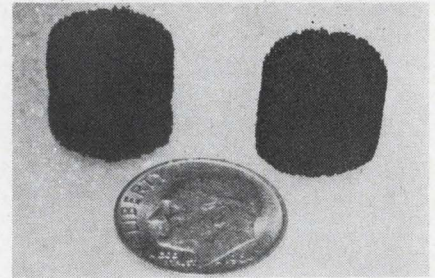

Scientific Advances, Inc., 1400 Holly Ave., Columbus, Ohio. Phone: (614) 294-5436.

A conductive elastomer, Conductor, which changes resistance when deformed or compressed, finds use as a strain-sensing material in pressure transducers. The advantage over other conducting rubbers, according to the licensee, is that it eliminates fatigue of the elastomer substrate. The material can be produced to any resistance range, as low as 10  $\Omega$  and as high as 50 k $\Omega$ . In addition to its use as a strain gauge in pressure, weight and deflection transducers, the elements can be used as a low-modulus, high-elongation strain gauge, or substituted for potentiometer elements.

CIRCLE NO. 274

### Photoresists stripped nondestructively

Allied Chemical Corp., Industrial Chemicals Div., P. O. Box 353, Morristown, N. J. Phone: (201) 538-8000.

Two new solutions remove photosensitive resist films from printed circuit boards and metals used in transistor and integrated circuit manufacture. The B&A stripping solutions are mixtures of high-purity organic solvents and activating ingredients. The non-flammable liquids remove resist films without damaging. CB-1 is formulated to strip Kodak Photo Resist (KPR) and other resists of this family used on printed circuit boards. A-20 was developed to strip Kodak Metal Etch Resist (KMER) and Kodak Thin Film Resist (KTFR) from silicon, silicon oxide, aluminum and other metals used to make transistors and ICs.

CIRCLE NO. 275



**Flexible copper laminate  
puts out the fire**

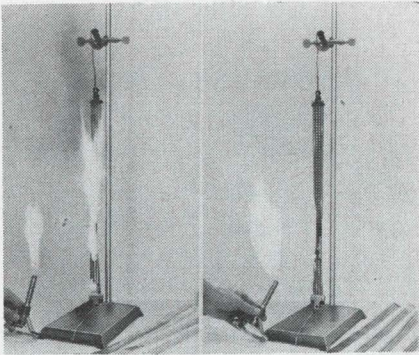

G. T. Schjeldahl Co., Northfield, Minn. Phone: (507) 645-5633.

Copper-foil polyester laminate for flexible circuitry will not support flame. For complete encapsulation, self-extinguishing circuits manufactured from the base laminate are overlaid with a matching film. Schjel-Clad L-5575 readily extinguishes flame if the source of the flame is removed. To provide the self-extinguishing feature for applications such as cable wrap, the dielectric film is used in the form of a heat-sealable tape. Dielectric strength is 7,000 V/mil and tensile strength 22,200 psi. Typical bond strength for 90° peel at room temperature is 6 in.-lbs. The material will withstand 15,000 flexes without delaminating.

CIRCLE NO. 276

**Conductive Ag coatings  
have high service temp.**

Electro-Science Laboratories, Inc., 1133-35 Arch St., Philadelphia. Phone: (215) 563-1360. Price: \$25 (2-oz. kit with thinner).

Resin-silver conductive coatings feature substantially higher service temperatures than most conductive organics. Continuous service temperatures are in the 300 to 350°C range. They may either be soldered directly, or used to replace soldered conductors in applications where solder would melt. Both the A-25 and I-30 pastes have volume resistivity of 0.001 Ω-cm., conductivity of 0.05 Ω/square (for a 2-mil film), and shelf life of 3 to 6 months under refrigeration. They adhere to ceramics, metals and high-temperature thermosetting plastics.

CIRCLE NO. 277

**NEW! ONLY FROM INDUSTRO**

**HIGH  
VOLTAGE  
SILICON TRANSISTORS**

**PNP**  
200-500V

**NPN**  
200-1000V



TO-5  
15 WATTS

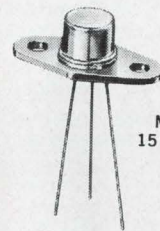

MD-14  
15 WATTS

Design Your Complementary Circuits with INDUSTRO High Voltage Transistors

PNP		NPN	
$V_{CEO}$ @ $I_C = 10mA$	200-500V	$V_{CEO}$ @ $I_C = 25mA$	200-600V
$V_{CER}$ @ $I_C = 200\mu A$	200-500V	$V_{CER}$ @ $I_C = 200\mu A$	200-1000V
$H_{FE}$ @ $V_{CE} = 10V$ $I_C = 20mA$	30 min.	$H_{FE}$ @ $V_{CE} = 4V$ to 475V: $I_C = 50mA$ from 500V: $I_C = 25mA$	30 min.
GBW @ $V_{CE} = 20V$ $I_C = 10mA$	30 MHz	GBW @ $V_{CE} = 10V$ $I_C = 50mA$	60 MHz

Write today for complete specifications.

watch...

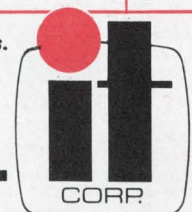

**INDUSTRO TRANSISTOR CORPORATION**

35-10 36th AVENUE/LONG ISLAND CITY, NEW YORK 11106/(212) EX 2-8000  
ON READER-SERVICE CARD CIRCLE 84



# LOW COST, HIGH PERFORMANCE



## ERA MAGITRAN® POWER SUPPLIES

- All-Silicon Design
- Low Cost for all Systems Applications
- Automatic Short Circuit Protection
- Automatic Overload Protection
- Series or Parallel Operation
- Remote Sensing
- Ungrounded Outputs
- Convection Cooled
- Functional Design-Easily Serviceable
- Minimum Size and Weight
- Front and Rear Terminals
- Relay Rack or Bench Mounting

### General Specifications

Input Voltage Range: 105-125 VAC  
 Input Frequency Range: 50-400 cps  
 Regulation Line:  $\pm 0.01\%$  or 5 mv  
 Regulation Load: 0.05% or 8 mv  
 Ripple: Less than 1 mv, RMS  
 Transient Response: Less than 50  $\mu$ sec  
 Operating Temperature:  $-20^{\circ}\text{C}$  to  $+65^{\circ}\text{C}$   
 Temperature Coefficient: 0.01%/°C or 3 mv  
 Reverse Voltage Protection Cooling:  
 Convection  
 Metering: Separate Current and Voltage Meters

### Standard Models

Model	Voltage	Current	Price
SL36-2M	0-36 VDC	0-2 amps	\$235.
SL36-2/2M	0-36 VDC Dual	0-2 amps Dual	465.
SL36-4M	0-36 VDC	0-4 amps	290.
SL36-8M	0-36 VDC	0-8 amps	355.
SL36-12M	0-36 VDC	0-12 amps	455.
SL36-25M	0-36 VDC	0-25 amps	650.

Write Today for Catalog #133a



## ELECTRONIC RESEARCH ASSOCIATES, INC.

Dept. ED-2, 67 Sand Park Road  
 Cedar Grove, N. J. 07009 • (201) 239-3000  
 Subsidiaries: ERA Electric Co. • ERA Acoustics Corp.  
 ERA Dynamics Corp. • ERA Pacific, Inc.

ON READER-SERVICE CARD CIRCLE 85

## MICROELECTRONICS

### Semiconductor families packaged in LIDs

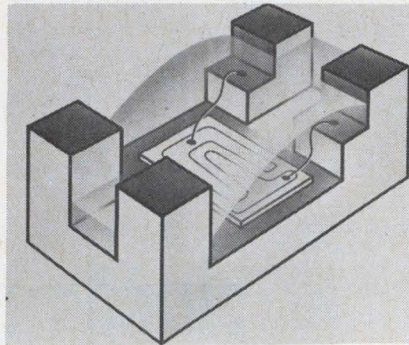

Amperex Electronic Corp., Slatersville, R. I. Phone: (401) 762-9000.

Six new families of LIDs (leadless, inverted devices) transistors and diodes in a microelectronic package permit mechanized production of hybrid integrated circuits. Four of the transistors are silicon planar npns and pnps and two are dual diodes. Applications include RF, IF, audio and low-noise amplifiers, op-amps, D-to-A converters and high-voltage and current decoders.

CIRCLE NO. 278

### Fast-removal sockets for dual-in-line ICs

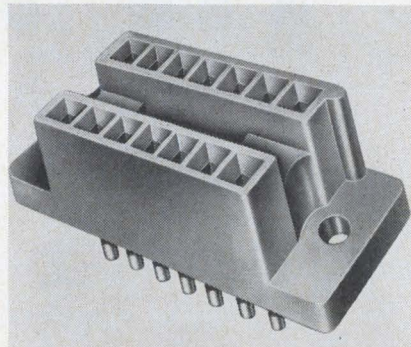

Barnes Development Co., Lansdowne, Pa. Phone: (215) 622-1525. P&A: \$0.41 to \$1.50; stock to 2 wks.

A series of sockets for aging, production, breadboarding and life or sampling tests of dual-in-line IC packages accommodate all dual-in-line plugs in common use, with 14 or 16 leads in 0.1-in. centers. Round, rectangular and octagonal leads trimmed as short as 0.1-in. are accepted. Large chamfered entrances permit fast, easy insertion.

CIRCLE NO. 279

### IC decoder cards for data processing

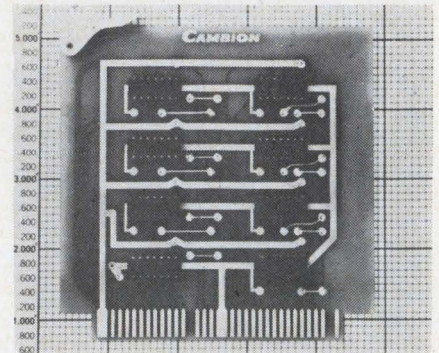

Cambridge Thermionic Corp., 445 Concord Avenue, Cambridge, Mass. Phone: (617) 876-2800.

These general purpose cards are offered in a choice of BCD to decimal, 2421 to decimal, 5421 to decimal, excess 3 to decimal, binary to octal and binary to hexadecimal decoding circuits. They are useful as interface logic between equipments and display logic in data processing systems or computers. Binary coded decimal to decimal decoders provide conversion from a 4-bit binary code to a 10-bit decimal equivalent. A single (DEA 2019) and dual decoder (DEA 2024) are available.

CIRCLE NO. 280

### Shift registers are 16- and 20-bit

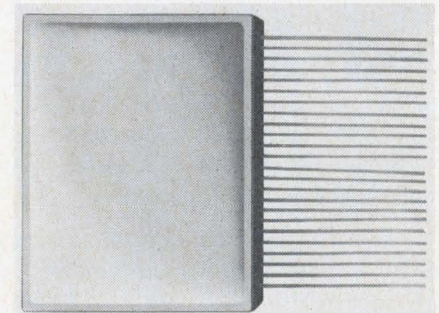

Amelco Semiconductor, 1300 Terra Bella Ave., Mountain View, Calif. Phone: (415) 968-9241. P&A: \$250 and \$275 (10 to 99); 30 days.

Two shift registers are assembled with TTL logic elements to provide serial or parallel input and output, 1-MHz clock rate and low power dissipation (190 mW for the 2-bit register). Amelco claims 275 monolithic circuits per cubic inch. Dimensions are 1 by 0.75 by 0.08 in.

CIRCLE NO. 281



**FOR THE GUARANTEED ANSWER  
TO YOUR AIR MOVEMENT NEEDS  
ASK FOR THESE BULLETINS**

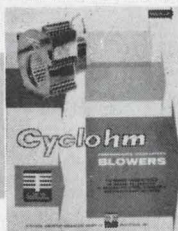

In the Howard CYCLOHM Fans and Blowers they describe, you get this unique combination of values:

**MORE AIR AT LESS COST**

For proof, see the performance data and price schedules in the Bulletins.

**GUARANTEED PERFORMANCE**

All CYCLOHM air movement units are Powered by the Howard Unit Bearing Motor, guaranteed for 5 years to require no maintenance or re-lubrication.

**IMMEDIATE DELIVERY**

of standard models. For availabilities contact Standard Motor Product Sales, 23 Broadway, Des Plaines, Ill. 60616 (TWX 91C 233-1658).

3 Good Reasons for Requesting Bulletins 8-01 and 9-03 describing Fans and Blowers with Air To Spare.



**HOWARD INDUSTRIES**  
MSL INDUSTRIES, INC./MOTOR GROUP  
1760 STATE STREET  
RACINE, WIS. 53404

ON READER-SERVICE CARD CIRCLE 86

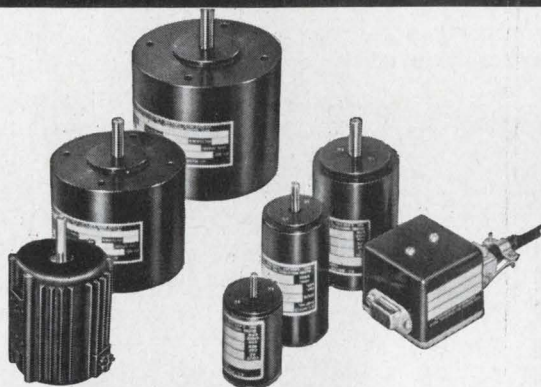

**217 BRUSHLESS D.C. MOTORS**

217 variations of 6 basic frame sizes—Globe offers you all the advantages of a brushless d.c. motor (no brush dust, no brush replacements, no arcing, extremely long life) in 217 standard, proven motors! No matter what your requirement in a brushless d.c. motor up to .1 HP, look to Globe. Our compact transistor inverter is mounted separately from the motor in its own enclosure. Separate mounting follows best engineering practice, by isolating the transistors from motor heat. Virtually any performance you require may be furnished. Be sure to ask Globe when you need one motor or 10,000 motors with brushless d.c. design.

Request Bulletin BR-3. Globe Industries, Inc.,  
2275 Stanley Ave., Dayton, Ohio 45404  
Tel. 513-222-3741

**GLOBE**

ON READER-SERVICE CARD CIRCLE 87

ELECTRONIC DESIGN 4, February 15, 1967

# You can't see "Q"

...but it's there—  
at an exceptionally  
high level—in every  
Johnson capacitor

Regardless of size, machined plate technique provides excellent "Q" (greater than 1500 at 1 MHz) and outstanding mechanical and electrical stability (plus  $45 \pm 15$  PPM /°C.). Rotors and stators are machined from solid brass and have exceptionally uniform delta C and voltage characteristics—breakdown ratings available to 1,100 VDC.

E. F. Johnson Type U sub-miniature capacitors are available from stock in a wide selection of single section units with PC, panel, or two-hole mounting; in butterfly and differential PC models, and combined with an inductor in the U-LC tuner with either PC or panel mounting. Miniature Type V and W capacitors are single section types, available in either panel or PC mounting. Specials to your specifications are available in production quantities.

Write today for complete information on these and other Johnson quality electronic components.

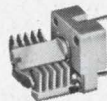

**Type U**  
to 24.5 pf, 0.2 sq. in.

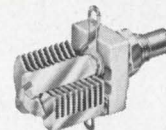

**Type V**  
to 34 pf, 0.3 sq. in.

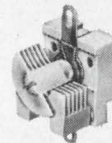

**Type W**  
to 54 pf, 0.6 sq. in.



**E. F. JOHNSON COMPANY**

3316 Tenth Ave. S.W., Waseca, Minn. 56093

Providing nearly a half-century of communications leadership

ON READER-SERVICE CARD CIRCLE 88





Please send me the latest Acopian catalog that lists

**62,000  
DIFFERENT  
POWER  
SUPPLIES**

available for shipment in 3 days.

Name \_\_\_\_\_

Title \_\_\_\_\_

Company \_\_\_\_\_

Address \_\_\_\_\_

City \_\_\_\_\_

State \_\_\_\_\_

ZIP \_\_\_\_\_

ACOPIAN CORP.  
EASTON, PENNSYLVANIA  
TEL: (215) 258-5441



ON READER-SERVICE CARD CIRCLE 89

## MICROELECTRONICS

### IC test sockets eliminate bent leads

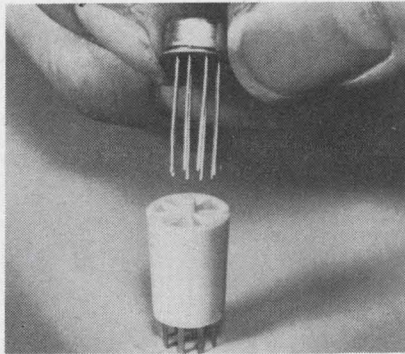

*Textool Products Inc., 1410 Pioneer Dr., Irving, Tex. Phone: (214) 473-9296.*

Miniature multilead TO-5 IC test sockets are available with six, eight, 10 or 12 contact arrangements. The small size (0.375 in. diameter by 0.562 in. high) allows high-density placement for multi-socket installations. Since socket entry holes are on the same pin circle as the device to be tested, the possibility of bent or distorted leads is eliminated. Socket body material is polysulfone and contact material is tempered beryllium copper gold-plated. Minimum lead length is 0.4 in. and standard terminations may be dipped or hand soldered.

CIRCLE NO. 282

### Dual in-line cards available DTL or TTL

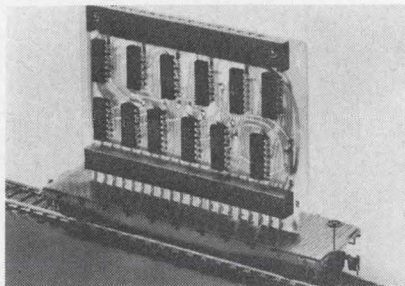

*Monitor Systems, Inc., Ft. Washington, Pa. Phone: (215) 646-8100.*

Dual in-line diode transistor logic (DTL) and transistor-transistor logic (TTL) IC circuit cards are available. Features include top-mounted test points and gold-coated spring-pin connectors. The product lines will enable the designer to make his decision between DTL and TTL on the basis of factors parti-

ent only to circuit design. Where high speed and lower cost are important, TTL will be the choice. Where noise is an important factor, DTL will be preferred.

CIRCLE NO. 283

### 85-MHz flip-flop has high input states

*Motorola Semiconductor Products, Inc., P. O. Box 955, Phoenix. Phone: (602) 273-6900. P&A: \$3.50 (1000-4999); stock.*

A J-K flip-flop consisting of a charge-controlled, current-mode circuit is guaranteed to flip at a frequency of at least 70 MHz, and typically 85 MHz. It is one of a family featuring a nominal propagation delay of only 5 ns and is designed for an ac fan-out up to 15. The inputs are labeled  $\bar{J}$  and  $\bar{K}$ .

CIRCLE NO. 284

### Versatile IC packs in TO-5 cases

*RCA, Electronic Components & Devices, Harrison, N. J. Phone: (201) 485-3900. Price: \$1.50 (1000).*

Two IC packages are offered in TO-5 cases. One has four matched npn transistors on a single silicon chip, two which have no interconnections, and two with an emitter-to-base interconnection. A second module has four diodes in a "quad" configuration and two isolated diodes, on a single silicon chip.

CIRCLE NO. 285

### High-speed logic in molded packages

*Alpha MicroElectronics Co., Inc., 10501 Rhode Island Ave., Beltsville, Md. Phone: (301) 474-1222. P&A: \$85; stock.*

A family of high-speed logic elements is offered in molded plastic packages for operation up to 100 MHz. Positive logic is used such that logical "1" is 6 V and logical "0" is 0. Rise time, propagation delay, and fall time are each 5 ns or less, due to internal buffering with high-speed transistors and thin-film passive components.

CIRCLE NO. 286



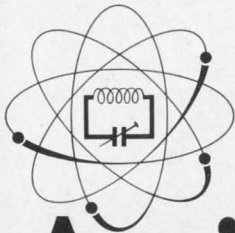

# April in Paris is electronic.

## Let Air France turn you on.

- April 5-10** International Exhibition of Electronic Components.  
**April 10-15** International Conference on Electronics and Space.  
**April 14-21** MESUCORA (Measurement and Automation).

We'll see you in the air and at the shows. We're happy to be the official carrier once again, and look forward to jetting you to Paris. At the shows, our Welcome Service will be on hand to give you any assistance you may need. For free brochures, mail the coupon to Air France, Overseas Trade Show Department, Box 707, New York, N. Y. 10011.

*Festival in the sky* stereo, and movies by In-Flight Motion Pictures, available at nominal cost.

Name \_\_\_\_\_  
 Company \_\_\_\_\_  
 Address \_\_\_\_\_  
 City \_\_\_\_\_ State \_\_\_\_\_ Zip \_\_\_\_\_  
 ED-4

*à Votre Service*  
**AIR FRANCE**  
 THE WORLD'S LARGEST AIRLINE

ON READER-SERVICE CARD CIRCLE 90  
 ELECTRONIC DESIGN 4, February 15, 1967

## Here's What Heath Means By Value . . .

**A Professional Transistor Tester Offering Complete DC Analysis Factory Assembled and Tested For \$84.95 (kit form . . . \$54.88)**

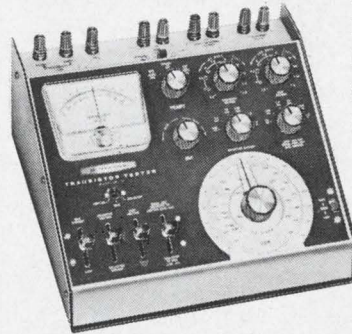

*Provides Full Laboratory Facilities In One Compact Unit.*

**Heathkit IM-30 Analysis Includes . . .** base current, collector current, collector voltage, collector-to-emitter leakage (I<sub>ceo</sub>), collector-to-base leakage (I<sub>cbo</sub>), and diode forward and reverse current. Separate voltage and current range switches for both gain and leakage settings allow tests under a wide variety of conditions. DC Beta (0-150, 150-300) and DC Alpha are read directly on the calibrated Gain Scale. Requires 7 "D" cells for internal power — provisions included for external power. The IM-30 is truly an exceptional value in transistor testing facilities. 10 lbs. Kit IM-30, \$54.88. Wired IMW-30, \$84.95.

**A 10 Hz to 100 kHz Sine-Wave Audio Generator, Switch Selected, With Metered Output Factory Assembled and Tested For \$64.95 (kit form . . . \$41.95)**



*Provides Virtually Perfect Sine-Wave Waveforms From 20 To 20,000 Hz . . . (less than 0.1% distortion).*

**Invaluable For Instrument Calibration And Precise Circuit Analysis . . .** an excellent instrument for production testing, since all signal characteristics are accurately resettable. The entire frequency range of 10 Hz to 100 kHz is switch selected . . . with switch positions for two significant figures plus multiplier. Signal amplitude is adjusted with a 10 db per step output attenuator and range vernier (0 to 0.003, 0.01, 0.03, 0.1, 0.3, & 1 volts RMS to 600 ohms and 0 to 3, & 10 volts RMS to high Z) . . . and output signal level is read on the panel meter in db and R.M.S. volts. Both amplitude and frequency calibration are accurate to 5%. Here is an instrument chosen by many electronics manufacturers and engineering facilities requiring a precision sine-wave audio generator. 9 lbs. Kit IG-72, \$41.95. Wired IGW-72, \$64.95.



**FREE! World's Largest Electronic Kit Catalog**

Includes these and over 250 other items for the service technician, engineer, ham, teacher, and hobbyist.

**HEATH COMPANY, Dept. 520-26**  
 Benton Harbor, Mich. 49022  
 In Canada, Daystrom Ltd.



Please send my FREE Heathkit Catalog.

Enclosed is \$ \_\_\_\_\_, plus postage.

Please send model(s) \_\_\_\_\_

Name \_\_\_\_\_

Address \_\_\_\_\_

City \_\_\_\_\_ State \_\_\_\_\_ Zip \_\_\_\_\_

Prices & Specifications subject to change without notice. TE-156

ON READER-SERVICE CARD CIRCLE 91



# 1200 CFM FAN

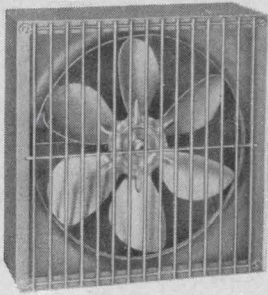

## McLEAN REVERSIBLE REVERSIBLE

Three Mil-Spec models in this series offer air deliveries of 275, 725 and 1200 CFM. Use them for cooling and ventilating electronic cabinets, military and electronic field vehicles, and mobile power generating systems. Mount them in any position, vertical, horizontal, backwards, forwards, for either push or pull airflow. Mechanical changes or field modifications are unnecessary! They're compact, quiet, easy to install, low cost, and rugged.

Complete engineering details on this and other McLean cooling equipment available in our new 1967 Catalog.

**McLEAN ENGINEERING  
LABORATORIES**

Princeton Junction, N. J. 08550  
Phone 609-799-0100  
TELEX 083-4345

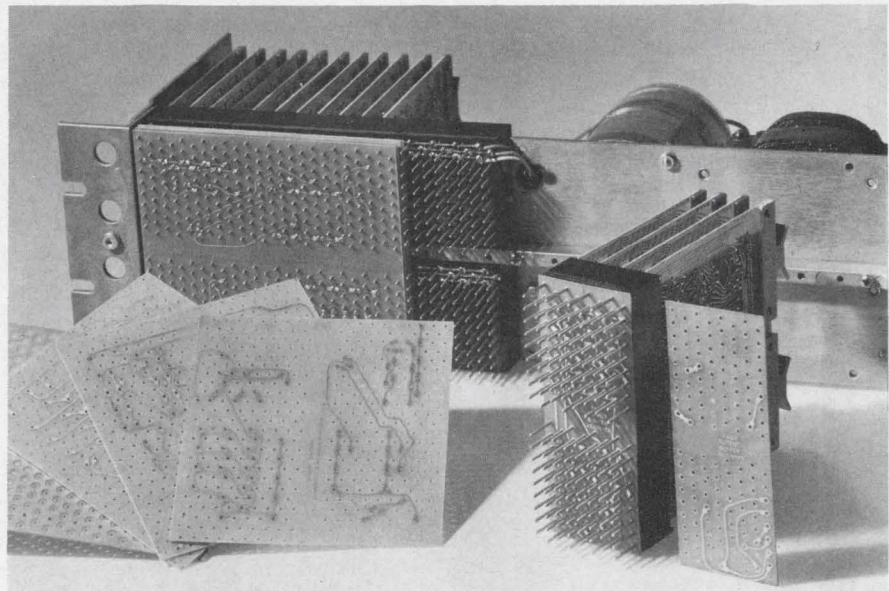

## PC boards interwire PC boards, cut costs across the board

*Digital Equipment Corp., 146 Main St., Maynard, Mass. Phone: (617) 897-8822. P&A: from \$60 (Octaid), from \$400 (Panelaid); stock.*

Full advantage is taken of printed wiring techniques in a system in which PC modules are interconnected by PC wiring boards.

Standard digital modules are plugged into a connector block-mounted on a rack panel. Behind the panel, connector pins at the rear of the block accept printed wiring boards that interconnect the module in accordance with the particular system requirement.

The PC modules, rack panel, connector block and interconnecting boards are furnished in kit form. Interconnecting boards are available for a standard system or to accommodate the customer's own design.

A rear view of the panel is shown above with connector mounted and pins protruding. The PC interconnecting boards are placed over the pins, etched side out, and the pins are soldered to the PC pads. As many as four boards may be applied one over the other.

In this technique, the advantages of printed wiring are not confined to the separate plug-ins, but apply throughout the over-all system wiring. Thus the cost of production wiring, and testing for wiring error or breakage, are eliminated. In

addition, the uniformity required in critical wiring is assured.

The kits included the "Octaid" series containing up to eight standard modules, the "Panelaid" series, containing up to sixty-four modules, and the specially designed PC back-panel wiring boards. In addition, input-output buffer kits are available to interface between assembled units.

Assembly of the kits is easy and rapid. The mounting panel is placed as shown above with its connecting pins at the left, and the power supply mounting space at the right. The interconnecting PC boards are then placed over the pins and soldered wherever the pins contact conductive paths. As many as four boards may be used. They are etched on one side only, so that no separators are required.

The system offers the designer a wide range of possibilities. From a large series, he may select the elements of his system. He may then furnish the interconnecting data to the manufacturer, who will supply the boards to specification.

The series of modules covers a wide range of popular logic functions, such as up-and-down counting, decoding, digital-to-analog and analog-to-digital conversion, and computer interfaces.

CIRCLE NO. 287



# Do You Use A SPINNER?

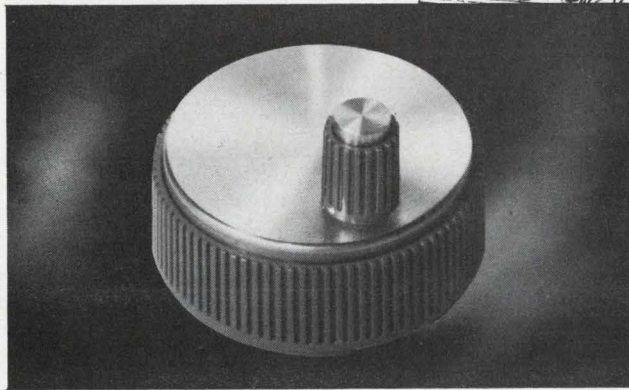

If not, we can fill your needs with other **BUCKEYE *Matching* Instrument Knobs**

- Complete stock maintained to provide samples and prompt delivery.
    - Available in three stock series in choice of **designs** and **types**.
    - Molded of high-impact styrene — with aluminum bushing and two set screws.
    - Wide range of specials and modifications.
    - Six basic sizes in four stock colors.
- Write for catalog and prices



the **BUCKEYE** stamping co.  
555 MARION RD., COLUMBUS, O. 43207  
"QUALITY PRODUCTS SINCE 1902"  
ON READER-SERVICE CARD CIRCLE 93

## LUGS • CLIPS • TERMINALS

hundreds  
of  
types!

### LOCKWASHER TERMINALS

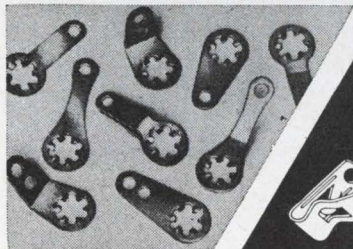

**THE TERMINAL  
THAT'S A  
LOCKWASHER . . .**  
for permanent  
connections that  
stay permanent  
100 types  
and sizes—  
all metals  
Immediate  
delivery  
from  
stock



STANDARD  
ELECTRICAL PARTS

delivered **FAST!**

Lugs • Clips • Terminals  
Wire Forms From Stock

Send for your copy of the new  
Zierick catalog No. 24 TODAY!

**ZIERICK MANUFACTURING CORP.**

96 Beechwood Ave., New Rochelle, N. Y. • (914) New Rochelle 6-8520

ON READER-SERVICE CARD CIRCLE 94  
ELECTRONIC DESIGN 4, February 15, 1967

## Crystals or tuning-forks?

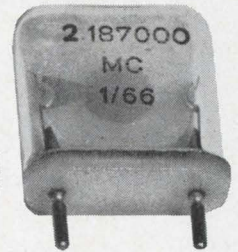
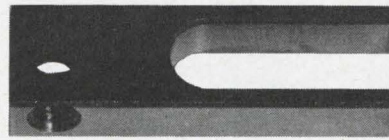

**Assuming equal accuracies,  
which would be best for your  
oscillator application?**

**What kind of accuracy is  
readily available? What  
other specifications  
must be considered?**

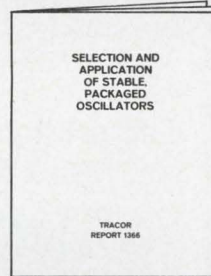

**This free  
technical report  
from TRACOR  
may help you.**

"Selection and Application of Stable, Packaged Oscillators" outlines just what needs to be evaluated in comparing crystal versus tuning-fork oscillators. Section I describes the salient parameters of both kinds of standard oscillators in the 0.5% to 0.0001% accuracy range.

Section II offers specific guidelines for choosing an oscillator for a particular application. The report is free.

Contact: TRACOR, Inc.  
6500 Tracor Lane Austin, Texas 78721.  
Phone (512) 926-2800.

**Component  
Products by TRACOR**

REPRESENTATIVES IN PRINCIPLE CITIES

TFA 967

ON READER-SERVICE CARD CIRCLE 95



# YTTRIUM AND RARE EARTHS

High purity  
oxides, metals,  
salts

from the world's  
largest  
ion-exchange  
facility

## APPLICATIONS:

- Phosphors
- Electronic Ceramics
- High Temperature Refractories
- Ceramic Control Materials
- Metallurgy
- Coloring Agents
- Permanent Magnets
- Lasers
- Catalysts
- Glass, Lenses
- Metal Halide Lamps

Like technical data on any of the above oxides or metals? Write, wire or call us about your specific interest.

**MICHIGAN  
CHEMICAL  
CORPORATION**



RARE EARTH SALES  
2 North Riverside Plaza  
Chicago, Illinois 60606

Copyright 1967 by Michigan Chemical Corporation RE-67-1

ON READER-SERVICE CARD CIRCLE 96

## SYSTEMS

### Computer measures complex quantities



*Dranetz Engineering Laboratories, Inc., 1233 North Ave., Plainfield, N. J. Phone: (201) 755-7080.*

A vector component computer provides a direct computation of the in-phase and quadrature components of a sine-wave voltage. It is available with a variety of plug-ins and accessories for measurement of complex impedance and admittance of electroacoustical transducers under low and high power, and of real and imaginary input power.

CIRCLE NO. 288

### Sequential programmer for rapid setup

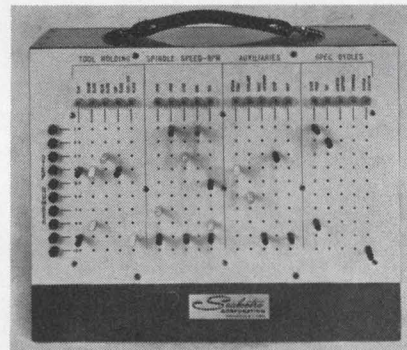

*Sealectro Corp., 225 Hoyt St., Mararoneck, N. Y. Phone: (914) 698-5600.*

A multi-purpose control system combines a programming board with sequential scanning circuits. The new device claims fewer moving parts than current fully dynamic sequential programmers. It comprises a stationary programming section that permits reprogramming during the control cycle. Applications include process control, batching functions, machine tool controls and traffic control systems.

CIRCLE NO. 289

### Hybrid multiplier system has up to 8 channels

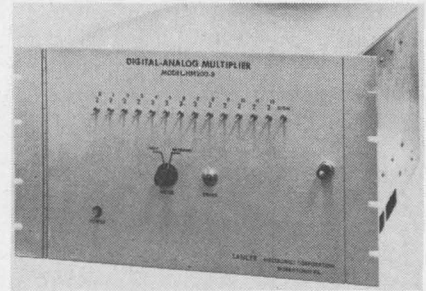

*Lancer Electronics Corp., P. O. Box 142, Norristown, Pa. Phone: (215) 275-3344.*

A hybrid multiplier system has up to eight multiplier channels. Model HM200 performs high speed multiplication or division between  $\pm 100$ -V analog and 14-bit digital variables. Operational error is less than 0.01% full scale. The unit operates directly upon an analog input up to  $\pm 150$  V without preliminary scaling. System output capability per channel is  $\pm 100$  V at  $\pm 35$  mA with full-power bandwidth beyond 50 kHz.

CIRCLE NO. 290

### Solid-state multiplexer samples 100 channels

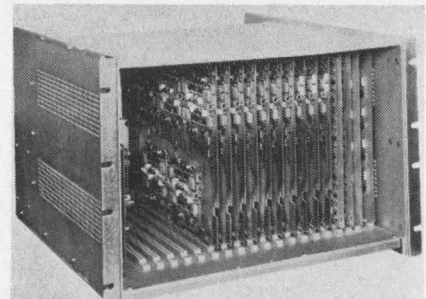

*Astrodata, Inc., 240 E. Palais Rd., Anaheim, Calif. Phone: (714) 772-1000.*

This differential multiplexer is capable of sampling up to 100 channels. The composite signal is relayed through its differential amplifier to data acquisition equipment, an on-line computer or other peripheral monitoring devices. The multiplexer offers random access through computer control or an external sequencer. Channels are addressed by "tens" and "units" logic levels.

CIRCLE NO. 291



# the 4<sup>th</sup> FLOOR IS TOPS!

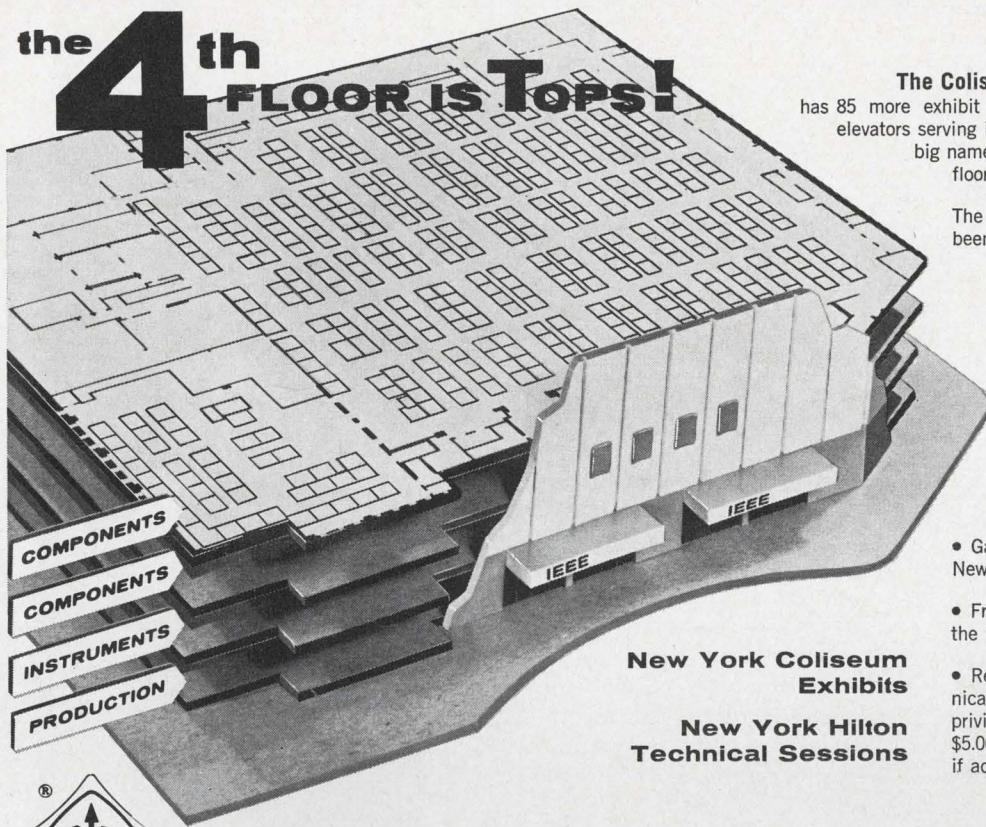

**New York Coliseum Exhibits**  
**New York Hilton Technical Sessions**

The Coliseum's newly constructed fourth floor has 85 more exhibit spaces and new escalators and express elevators serving it. Many engineers will go there first to see big name components firms who are exhibiting. This floor will really buzz!

The increased space finally gives firms who have been on the waiting list an opportunity to exhibit. It also helps to relieve crowding on the other floors. Any way you look at it, the fourth floor is tops and the IEEE EXHIBITION this year will be bigger and better than ever.

- 74 Technical Sessions at the New York Hilton
- FOUR COMPLETE FLOORS OF EXHIBITS (over 700 firms) at the New York Coliseum
- Gala Annual Banquet—Wednesday 7:15 p.m. New York Hilton Grand Ballroom—\$15.00
- Free shuttle busses every few minutes between the Hilton and the Coliseum
- Registration—Good for all four days—Technical sessions and exhibits, with in and out privileges. IEEE Members \$2.00 Non-members \$5.00 Ladies \$1.00 High School Students \$2.00 if accompanied by an adult.



**IEEE** '67 International CONVENTION / EXHIBITION

**Monday thru Thursday**  
**March 20 - 23**

ON READER-SERVICE CARD CIRCLE 97

give...so more will live  
**HEART FUND**

## MEASURE & CONTROL LIGHT PRECISELY IN PHOTOPROCESSING!!



IL600/610 Flash Integration System



**Precision International**  
 Light instruments measure

and control light across the radiant spectrum. They are invaluable in research and photoprocessing, testing and quality control of semiconductors, printed circuitry and integrated circuitry for electronic components. They can measure light intensities and total energies emitted from flashes, pulses or steady state sources of short duration. Units are compact, portable. For complete details, write:



**international light inc.**

12 UNICORN STREET, NEWBURYPORT, MASSACHUSETTS 01950 / TEL. 617 466-5923

ON READER-SERVICE CARD CIRCLE 98



# Design Aids

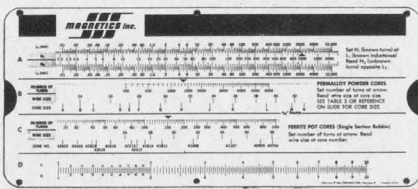

## Magnetic core calculator

An 8-scale slide rule simplifies core selection and calculation. The moly-permalloy powder core and ferrite pot core calculator is a rapid means to the solution of the equations relating flux to voltage, current to magnetizing force, wire to space factor, inductance to turns, and capacitance and inductance to frequency and dc resistance. With a given inductance requirement at a specified frequency and voltage, the designer has to select a core meeting the requirements which gives the highest available Q. The rule is accompanied by an instruction manual giving formulas, tables, operating instructions and typical problems. Magnetics, Inc.

CIRCLE NO. 292

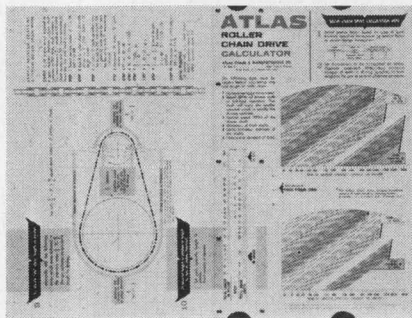

## Roller chain calculator

A fold-out slide-chart aids in the calculation of roller chain drive requirements. In ten quick steps, size and length of roller chain are determined given such factors as hp, rpm, shaft diameter and load duration. Atlas Chain & Mfg. Co.

CIRCLE NO. 293

## Conversion factors

A handy pocket-sized manual tabulates factors used in converting most physical units. The 20-page, pocket-sized brochure contains over 1200 factors. Testing Machines, Inc.

CIRCLE NO. 294

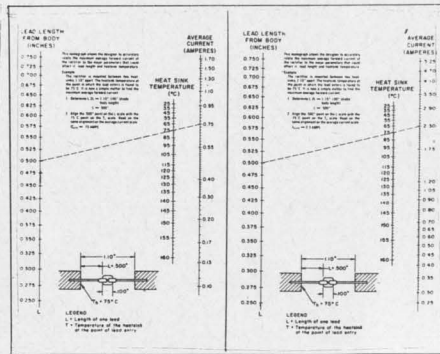

## Rectifier rating nomograms

A pair of nomograms aid in determining maximum allowable forward current for microminiature rectifiers. One is designed for silver and the other for nickel leads. The nomograms relate lead length from the body, heat sink temperature and average current. Hoffman Semiconductor.

CIRCLE NO. 295



## 'Do Not Disturb' sign

Been bothered by nocturnal marauders around your test setup? Post one of these signs on your rig. The bright red signs bear the legend "Equipment Under Test—Do Not Disturb." A blank space is left for the user to identify himself and his equipment. Power/Mate Corp.

CIRCLE NO. 296

## Stripline coupler design chart

This chart gives coupling in dB in 1-dB steps for the stripline dielectric thicknesses of 1/8 and 1/16-in. The chart is valid for stripline materials of 2.32 dielectric constant and assumes 1-oz copper-clad for 1/16-in. boards and 2-oz copper-clad for 1/8-in. boards. The chart is presented in 2 forms: Given a value of coupling in dB, S/B can be determined for W/B ratios of 0.6, 0.8 or 1, or, for standard boards, S can be determined directly for 50-Ω lines and a given value of coupling. Electronic Standards Corp. of America.

CIRCLE NO. 297

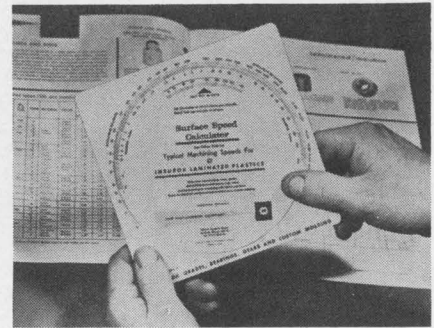

## Surface speed calculator

A handy surface speed calculator for determining speed settings for machining high-pressure laminated plastics and other materials is offered. The circular slide chart relates diameter and rpm to surface feet per minute. On the reverse side, machining data and technical tips are included. INSUROK Div., Richardson Co.

CIRCLE NO. 298

## Mass standards wall chart

A single wall chart, "Adjustment Tolerance Schedule for Mass Standards," gives a quick visual comparison between established mass classes. The chart illustrates only larger masses whose adjustment tolerances exceed 1 milligram. The two general types of standards are shown by two sets of slopes on a graph. Classes S, M, S1 and P have adjustment tolerances which are the same percentage of the nominal mass for all values. Adjustment tolerance of classes A, B and C changes with the nominal mass. TransMetrics, Inc.

CIRCLE NO. 299

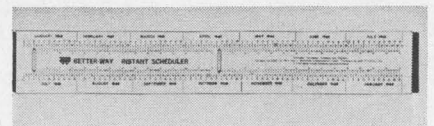

## Scheduling slide rule

A unique slide rule instantly computes work days by eliminating Saturdays, Sundays and holidays. Production schedules, inventories and manpower needs can be calculated in seconds without counting on a calendar. The slide rule is based on a 2-year calendar.

Available for \$5.25 from Betterway, Inc., 6225 W. 63 St., Chicago.



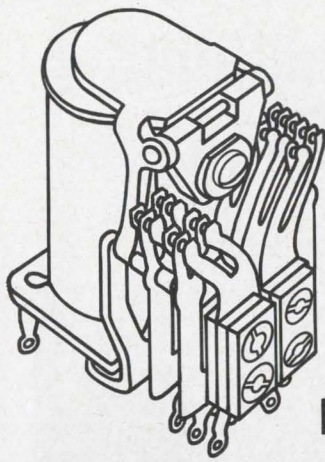

ERM

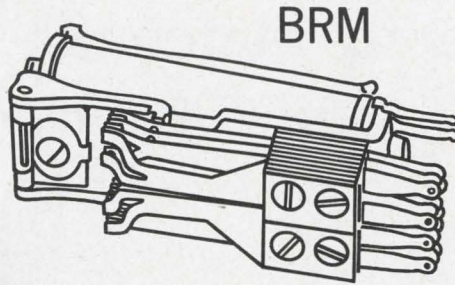

BRM

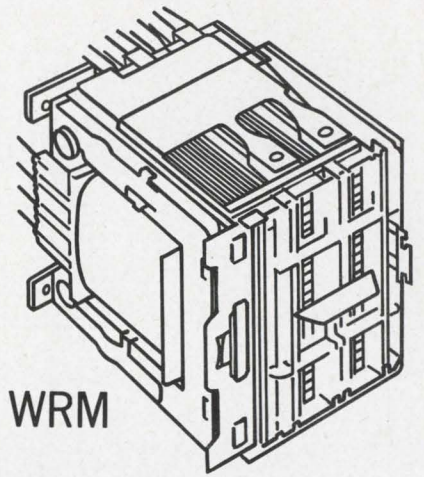

WRM

# AE magnetic latching relays save power, space, friction wear

(Also money.)

You save power because, after the initial "lock up" pulse, the relay works without continuous coil energizing. You save space because a magnetic latching relay is small and compact. And you save wear and tear, since there are no "friction parts" that need readjustment.

These things can add up to *dollar* savings.

AE makes more magnetic latching relays than anybody. You can get magnetic latching on our Class E, Class B and Class W relays. This means you can select almost any number of latching form C contacts—from one all the way up to fifty-one—and get them all on one relay!

An AE magnetic latching relay works in any position (it's unaffected by gravity). It takes light shock and vibration—won't un-

latch. And it has a perfect memory. You don't need expensive safeguards to enable the relay to remember whether it was turned "on" or "off." Even if there's been a power or circuit failure.

A magnetic latching relay is tamperproof, too. It can't be inadvertently "locked up" manually.

Where can you use these advantages? Get some helpful, detailed design information. Ask for Circular 1081. Just write to the Director, Relay Control Equipment Sales, Automatic Electric, Northlake, Illinois 60164.

**AUTOMATIC ELECTRIC**  
SUBSIDIARY OF  
**GENERAL TELEPHONE & ELECTRONICS GTE**

ON READER-SERVICE CARD CIRCLE 99



# An X-Y Scope With Perfectly Matched Price

**\$575**

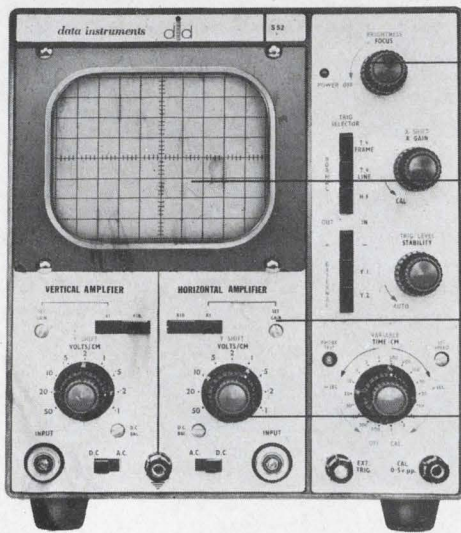

○ Low Cost

○ Solid State Reliability

○ 10cm x 10cm Viewing Area

○ Matched, Calibrated Attenuators

○ 1° Phase Error at 2MHz

Are your amplifiers out of phase with your budget? Here's a scope that's matched in every way—Data Instruments S52. Two identical, eight stage, high gain amplifiers permit measurements and comparisons all the way to 2MHz with a phase error of only 1°. The calibrated input attenuators are also matched to assure accuracy. And the sophisticated 5 inch PDA tube operates at 2.4kv and provides a 10cm x 10cm display area. The S52 can also be used as a conventional single beam scope. A front panel control allows the Horizontal Amplifier to be switched out and the Time Base to be switched in. The Time Base is a miller type giving excellent linearity and starting time, and features automatic synchronization to 3MHz. Extensive use of solid state circuitry gives the instrument a high degree of reliability and is backed up with a full year warranty. Field and Factory Service are also provided by Data Instruments. The specifications:

X-Y AMPLIFIERS					
BANDWIDTH	SENSITIVITY/CM	ATTENUATORS	RISETIME	IMPEDANCE	
DC-3MHz DC-300kHz	100mv-50v 10mv-5v	9 position Matched	0.1μs	1MΩ + 3pf	
TIME BASE		CRT		PHYSICAL	
SPEED/CM	ACCURACY	DIA.	PHOSPHOR	VOLTS	DIM. & WEIGHT
1μs-0.5 sec. (18 cal. ranges)	± 5%	5" PDA	P31 P7 optional	2.5kv	8½" x 9¼" x 15" 24 lbs.

Few other instruments have amplifiers so completely matched over such a broad bandwidth. Still, we're not perfect. We do have that 1° phase error in performance. But not in price. At \$575 the price is perfect. And it's unmatched.

**Data Instruments Division • 7300 Crescent Blvd. • Pennsauken, N.J. 08110**

ON READER-SERVICE CARD CIRCLE 100

## Application Notes

### Precision lubricants

This data sheet gives tables and explanatory material on 39 different kinds of delicate mechanism, indicating the proper lubricant for each. Included are nonspreading, dolphin head, synthetic and other instrument oils, as well as instrument greases, and specialties such as barrier films to stop oil creep. William F. Nye, Inc.

CIRCLE NO. 311

### Stripline techniques

A 2-page data sheet tells how to obtain equal power division with 90° phase difference between outputs, and equal power division with an odd number of ports in stripline techniques. Diagrams are included. EMC Technology, Inc.

CIRCLE NO. 312

### Semiconductor flashers

A 7-page brochure gives schematics and explanatory text on semiconductor circuits for contactless flashers, ring counters and chasers. They are useful for flashing incandescent lights for a variety of safety devices. General Electric.

CIRCLE NO. 313

### PC board design

For the engineer-designer who may be unfamiliar with the techniques of PC board design, this brochure has 8 pages of techniques and applications, from drawings to the final problems of soldering and marking. Lockheed Electronics Co.

CIRCLE NO. 314

### Programed testing

A 4-page brochure describes applications of the manufacturer's two digitally programed test instruments to the testing of transistors, with a view to both validity of test results and protection of the test sample from destruction or damage during test. Teradyne.

CIRCLE NO. 315



### Insertion-loss test set

Block diagrams and text describe applications of a dual-channel insertion-loss test set to the precise calibration of attenuators and the measurement of insertion losses in switches, cable assemblies and similar devices. Included are tables comparing the characteristics of competitive units that can be used in conjunction with the test set. Weinschel Engineering.

CIRCLE NO. 316

### Voltage-sensing relays

Two models of a miniature voltage-sensing relay with  $\pm 5\%$  repeatability, environmental, and  $\pm 1\%$ , static, are described in two 4-page data sheets, with specs and diagrams. Applications include monitoring of ac and dc. Bourns, Inc.

CIRCLE NO. 317

### Magneto-resistive terminology

MIL-STD 1305-1 (AS), developed by the National Bureau of Standards in cooperation with industry at the request of the Department of the Navy, Air Systems Command, is designed to standardize new magneto-resistive terminology. The standard contains devices, definitions, letter symbols, color codes and circuit symbols, together with a tutorial appendix NBS.

CIRCLE NO. 318

### Filament wound structures

"Design Considerations and General Properties of Filament Wound Structures" acquaints the reader with the basic characteristics of filament winding and gives guidelines for determining the feasibility of filament winding for new applications. The product, filament wound reinforced plastic, offers a combination of outstanding properties in application areas such as mechanical, electrical and chemical.

Available on company letterhead from NEMA, 155 E. 44th St., New York.

# HOW SMALL CAN A MICROWAVE COUPLER GET?

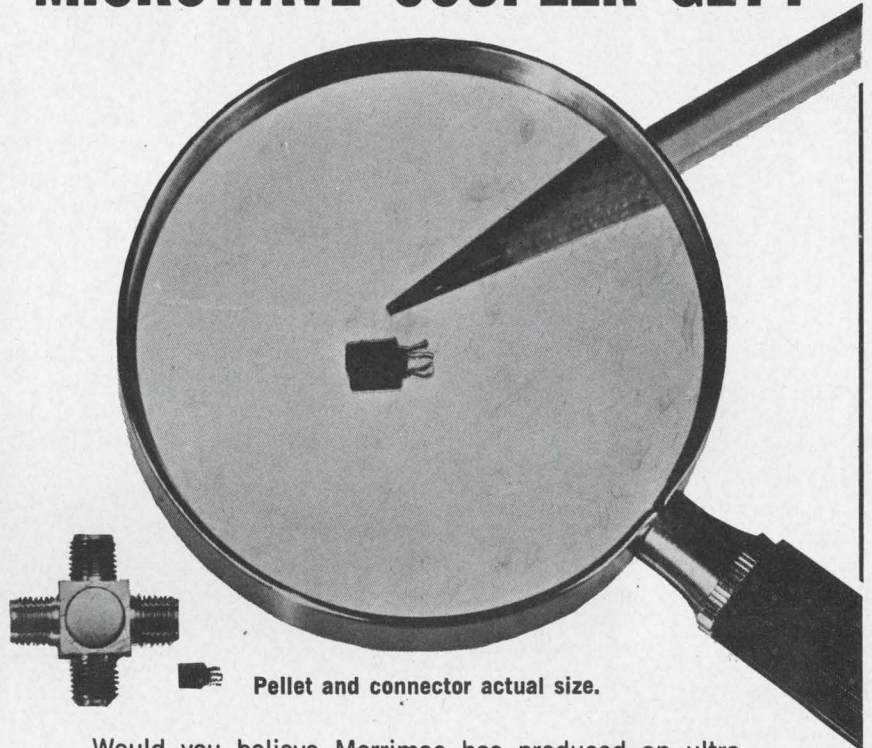

Pellet and connector actual size.

Would you believe Merrimac has produced an ultra-miniature microwave quadrature hybrid coupler  $\frac{1}{8}$  inch in diameter and  $\frac{3}{16}$  inch long? Size reduction was made possible by using a novel lumped element synthesis (U. S. Patents applied for). The Model QHU-2 is intended primarily for use with printed circuit boards and is highly suitable for aircraft and space applications. The pellet can be provided in a miniature connector housing, designated Model QHM-2. The new hybrid coupler, with or without connector, is presently available in the 2.1-to-2.3 GHz frequency range. Merrimac also can provide, on request, couplers at frequencies within 1-to-4 GHz. Inquiries on special requirements are invited.

**Applications include image rejection mixers, phase comparators, phase shifters, attenuators, single sideband modulators, solid state power amplifiers, discriminator networks and power dividers.**

Models QHU-2 and QHM-2 exhibit more than 23 db isolation with VSWR of 1.2:1; impedance 50 ohms. Other specifications include: Bandwidth 10%, phase quadrature  $90^\circ \pm 3^\circ$ ; output equality  $\pm 0.3$  db; insertion loss typically less than 0.3 db; and power 5 watts average.

For further information, write or phone:



**MERRIMAC RESEARCH AND DEVELOPMENT, INC.**  
41 FAIRFIELD PLACE, WEST CALDWELL, N. J. 07007 • 201-228-3890

ON READER-SERVICE CARD CIRCLE 101



# New Literature

A monograph of significance in the history and development of Air-movers, reprinted from:

## MEMOIRS OF THE Royal Society;

Being a New Abridgement of the  
Philosophical Transactions.

Giving an Account of the Undertakings, Studies, and Labours of the LEARNED and INGENIOUS in many considerable Parts of the WORLD; from the first Institution of that ILLUSTRIOUS SOCIETY in the Year 1662, to the Year of our LORD 1753 inclusive.

The whole carefully abridg'd from the Originals, and the Order of Time regularly observ'd, with a Translation of the LATIN TRACTS, and the Theoretical Parts apply'd to Practical Uses; also an Explanation of the Terms of ART as they occur in the Course of the Work. Being a Work of general Use to the Publick, and worthy the Perusal of all MATHEMATICIANS, ARTIFICERS, TRADESMEN, &c. for their Improvement in various Branches of Business.

By MR. DADDAM.

VOL. X.

Illustrated with a great Variety of COPPER PLATES.

LONDON:

Printed by G. SMITH, in Strand, near Chancery-lane, and Sold by T. COOPER, at the Globe in Peter-street near St. Dunstons Church in Old Street.

MDCCLIII.

by IMC Magnetic Corp., Eastern Division

## Memoirs of the Royal Society

Two hundred and fifty years ago, engineers were just as concerned with cooling equipment as today. This 8-page reprint of the Royal Society's memoirs on "Air-Movers" bears witness to this. All "mathematicians, artificers and tradesmen" of today should find the reprint a welcome philosophical pause. IMC Magnetic Corp.

CIRCLE NO. 319

## Hybrid computers

A family of totally integrated, general purpose, hybrid computers is described in a 16-page technical bulletin. Featured is a discussion of how a hybrid computer has been used to solve a complex chemical processing problem. Beckman Instruments.

CIRCLE NO. 320

## Supply catalog

A 12-page short form catalog describes the manufacturer's complete line of power supplies. Principal electrical and mechanical specs are given for 195 models of the Sorensen line. Also listed are frequency changers and line regulators. Raytheon Co., Sorensen Operation.

CIRCLE NO. 321

## Dictionary of acronyms

Acronyms and other cryptic designations have permeated the language of technology. Some of these terms have a logical basis and some do not. Some are borrowed words, some nicknames, others are alphanumeric and still others are combinations of these forms. Here's a concise dictionary of over 5000 acronyms and Space Age project names to help the design engineer. The 80-page book covers the military, electronics and space fields. General Dynamics.

CIRCLE NO. 322

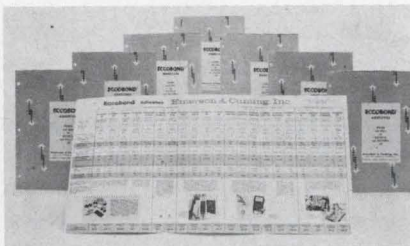

## Adhesives wall chart

Suitable for notebook or wall mounting, a 2-color wall chart provides a quick means of selecting the proper adhesive for the job. Products with similar properties—such as liquids, solids, pastes, or those electrically conductive are grouped together. For each product, mix consistency and pot life are shown, together with cured properties, such as lap shear strength, service temperature, thermal conductivity and dielectric properties. The chart includes photographs illustrating uses, as well as references to other Emerson & Cuming technical bulletins for more detailed information. Emerson & Cuming, Inc.

CIRCLE NO. 323

## Test equipment

A 12-page catalog provides specifications, technical information and photographs of test and measurement equipment. A section of the catalog is devoted entirely to communications test units. Specs are included for six units. Wiltron.

CIRCLE NO. 324

the  
**Demodulator**

*Pulse Code Modulation*

The constant search for better communications at lower cost has led the telephone industry to a radically different method of transmitting speech information. This method, using binary digital pulses rather than conventional analog signals, provides high quality transmission and has proven to be very economical in short-haul carrier systems.

LENKURT ELECTRIC... specialists in VOICE, VIDEO & DATA transmission

## Communication techniques

You can have a free subscription, if you qualify, to this monthly periodical, which will keep you up to date on the most important communications principles and techniques. It is distributed free to engineers, technicians and managers employed by companies or government agencies who use and operate communications systems. If you circle the Reader Service Number, you will receive a qualification form from the publisher. Lenkurt Electric.

CIRCLE NO. 325

## Shells and headers

A booklet of 119 pages presents data and dimensioned drawings of diallyl phthalate shells, headers and molded cases for semiconductors and microminiature circuitry. The Milton Ross Co.

CIRCLE NO. 326

## Data amplifiers

A 2-page data sheet is available, describing data amplifiers that feature a front-panel switch allowing the operator to select the output passband that best fits his application. Specs and descriptive material are included. Dana Laboratories, Inc.

CIRCLE NO. 327



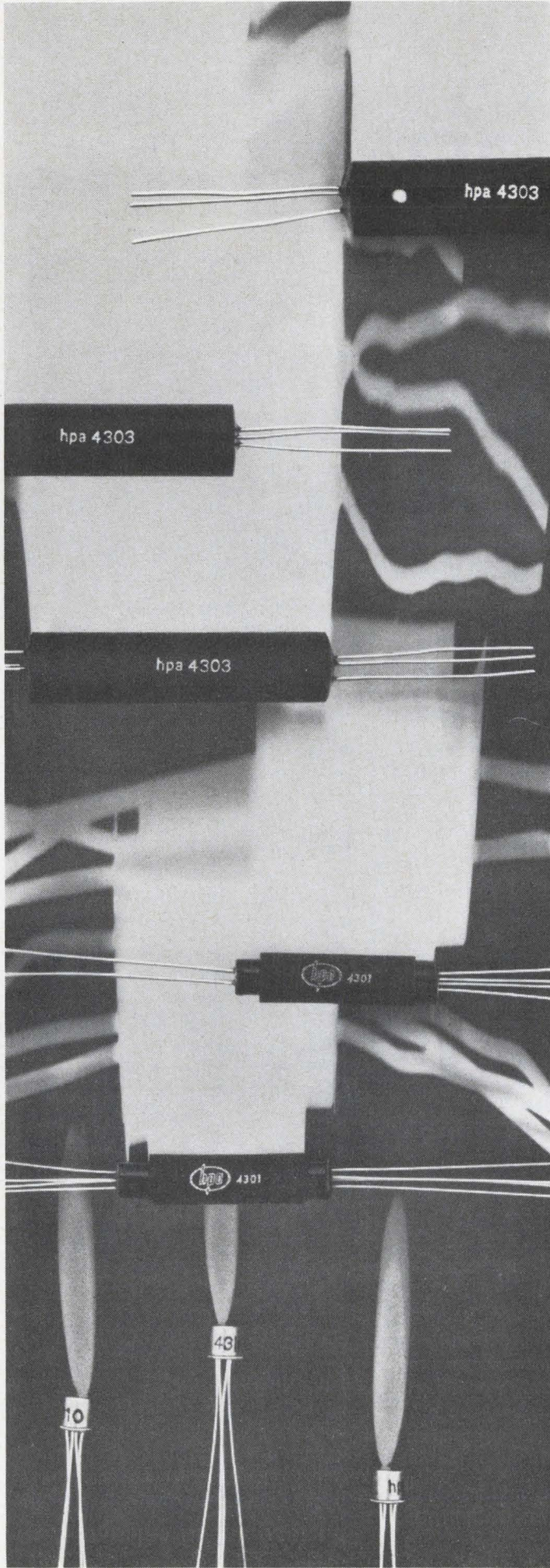

## NEW EASE IN CIRCUIT DESIGN WITH PHOTON-COUPLED ISOLATORS...

Isolation  $>10^{11}\Omega$ , 0.01 pF, 200 to 50,000 V

Low leakage, high speed

Proven reliability

Value priced

... from HPA

HPA photon-coupled isolators offer the design engineer new flexibility, simplicity and performance characteristics in working with DC interface voltages.

Coupling between a gallium arsenide infrared source and a silicon PIN photodetector eliminates the problems presented by physical connections. Separate headers and shields on input and output sections for high circuit isolation. Low voltage isolator packaged on a TO-18 header with four leads.

Ideal for use as RF signal couplers, video pulse transformers, switches and ground loop breakers.

Call your local Hewlett-Packard field engineer for complete data, including pricing and application information. HP Associates, 620 Page Mill Road, Palo Alto, California 94304.

### Typical transfer characteristics at 20°C

	4301	4303	4309	4310	Units
DC current transfer $I_2/I_1$	.0004	.0004	.0004	.002	
Cut-off frequency of current transfer	5	5	5	3.5	MHz
Coupling capacitance	.01	.01	.01	2	pF
Isolation voltage	10,000	20,000	50,000	200	Volts
Price:					
1-9	\$90.00	\$100.00	\$130.00	\$40.00	
10-99	\$76.50	\$ 85.00	\$100.00	\$34.00	

HEWLETT  
PACKARD



HP  
ASSOCIATES

2606

ON READER-SERVICE CARD CIRCLE 102



# MASKS

for

integrated circuitry

thin film devices

semiconductors

## PHOTOMASKS

NEW Perma-Chrome (metal film on glass).

High resolution photo emulsion.

## EVAPORATION MASKS

Electroformed nickel.

Etched molybdenum and stainless steel.

Bi-metal (electroformed nickel and copper).

Prompt quotations and deliveries.

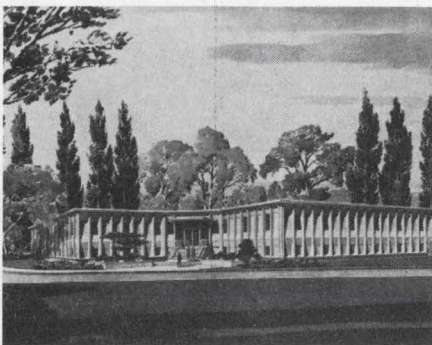

Our new headquarters at  
ONE U.S. Highway 206, Somerville, N.J.



**TOWNE  
LABORATORIES, INC.**

SOMERVILLE, N.J. 08876 tel. 201-722-9500

## NEW LITERATURE



### Silicon transistors and ICs

More than 500 types of silicon transistors and integrated circuits are described in an 18-page catalog. Among the more than 400 silicon transistors are new epoxy-molded types, JAN-approved types, npn and pnp small-signal units, differential amplifiers, pnp avalanche transistors, radiation-resistant devices, medium power switches and integrated choppers. The catalog includes outline drawings of 18 different package configurations, and also lists and describes flip-flops, registers, gates, buffers, adders, counter adders and inverters in a line of RTL ICs. Milliwatt RTL circuits, including flip-flops, expanders, adders, buffers and gates are also described. Seven cermet hybrid integrated circuits, including microchoppers, operational amplifiers, and audio, video and hearing aid amplifiers are listed. National Semiconductor Corp.

CIRCLE NO. 328

### Wiring system

A 7-page brochure describes and illustrates multiconductor transmission-line wiring systems designed for controlled impedance values, crosstalk, velocity of propagation and capacitance. Also shown are single and multilayered systems as well as systems shielded on one or two sides with various shielding materials such as foil, wire mesh or special dielectrics. aci Div. of Kent Corp.

CIRCLE NO. 329

### "Understanding the Atom"

Three more booklets in AEC's "Understanding the Atom" series are available.

"Atomic Power Safety" begins with a general discussion of atomic power and its practical uses. It describes the researches devoted to radioactive hazards and how to circumvent them.

CIRCLE NO. 330

"Power Reactors in Small Packages" discusses the problems of developing small, and even portable, nuclear power plants, and the ultimate goal of energy depots for refueling of nuclear-powered vehicles.

CIRCLE NO. 331

"Research Reactors" takes us through the various kinds of reactors used to provide sources of radiation for research into basic and applied physics, chemistry and biology, and the effects of radiation on materials. AEC.

CIRCLE NO. 332

### Beryllium copper shielding

The shielding effectiveness of beryllium copper finger strips is evaluated in a 5-page test report. The report presents attenuation figures for beryllium copper RF gaskets in a magnetic field of 200 kHz, a near electric field of 400 MHz and in the presence of a plane wave of 10 GHz. It also details complete test procedures and instruments used, test fixtures and actual test steps. Instrument Specialties Co.

CIRCLE NO. 333

### Gold alloys

A new bulletin describes over 70 different gold alloys, their percentage compositions and melting points in both °C and °F. In addition, it also provides information on gold base alloys such as gold-tin, gold-germanium, gold-antimony and gold-silicon which are particularly suited for soldering because of their excellent wettability, good thermal conductivity, high strength, resistance to etchants and low melting points. Semi-Alloys, Inc.

CIRCLE NO. 334



## 200-page relay selector

Relays are featured in the 200-page 1967 edition of "Relaymaster" together with a special switch section. Fully illustrated, the publication provides comprehensive engineering and buying information describing products manufactured by the 23 foremost firms in the relay and switch component industry. Each of the two sections in the book is preceded by introductory pages covering terms and definitions, testing, selection and availability chart. Kierulff Electronics, Inc.

CIRCLE NO. 335

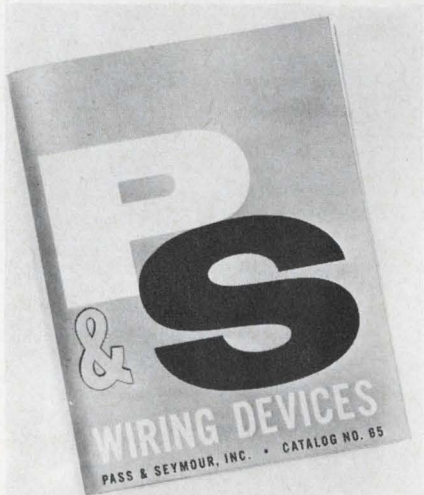

## 164-page wiring catalog

A pocket-sized catalog of wiring devices is offered. Among the devices included are switches, outlets, grounding, wallplates, fluorescents and lampholders. The 164-page catalog is fully illustrated. Pass & Seymour, Inc.

CIRCLE NO. 336

## RFI and EMI filters

A 6-page illustrated folder gives complete descriptions and specifications of a filter line. The catalog covers: multi-circuit ground support filters for 1-phase and 3-phase power systems; high and low current feed-through capacitors; tubular feed-through filters, radio interference filters, and shielded-room filters. Also treated are power line filters, in 10-kHz to 10-MHz models, designed to military and Underwriters Laboratories requirements. Elpac Components.

CIRCLE NO. 337

## THE NEW BIRTCHEER MODEL 800 IC TEST SET ...unlimited test capability with modular design

Advanced features and modular construction make the Model 800 whichever you want it to be: lab tester—incoming inspection station—production tester. Features include  Integral DC power supplies with the option of digital programming  Pushbutton test sequencing  Choice of 10x20 or 10x40 crossbar matrix, with provision for up to five external inputs  Provision for external DVM or oscilloscope display  Decade load resistors and capacitors  Optional integral pulse generator  Readout accuracy of 1% of full scale  Test adapters for all types of IC packages. Price from approximately \$1500. Write for catalogue and prices.

## THE BIRTCHEER CORPORATION/INSTRUMENT DIVISION

1200 MONTEREY PASS ROAD / MONTEREY PARK, CALIFORNIA 91754 / TELEPHONE (213) 264-6610

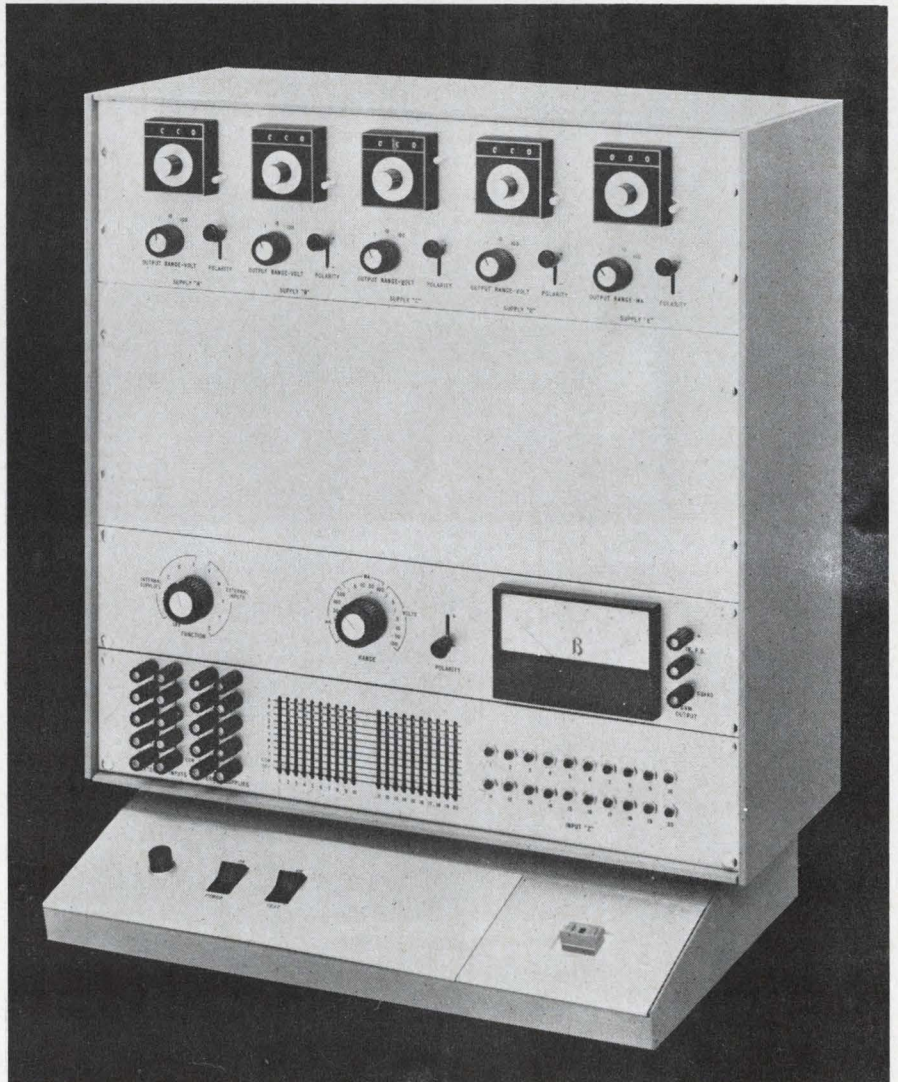

ON READER-SERVICE CARD CIRCLE 104



# Design Data from Manufacturers

Advertisements of booklets, brochures, catalogs and data sheets. To order use Reader-Service Card.

(Advertisement)

## Laminated and Molded Bus Bars For Power Distribution

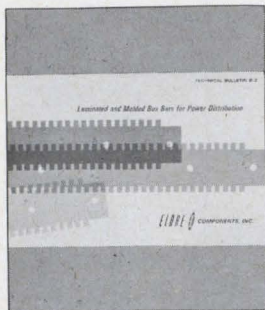

A 16 page Technical Bulletin is now available, describing a new concept in power distribution. Basic mechanical and electrical design principles, along with descriptive pictures and diagrams, are included in this bulletin. These compact buses can replace bulky cable harnesses and repetitive wiring for computer or modular application. This method of construction satisfies the demanding requirements of low inductance and resistance of high speed, solid state systems, while controlling electrical noises.

### Eldre Components, Inc.

1239 University Avenue  
Rochester, New York 14607

# 171

## Engineers' Relay Handbook

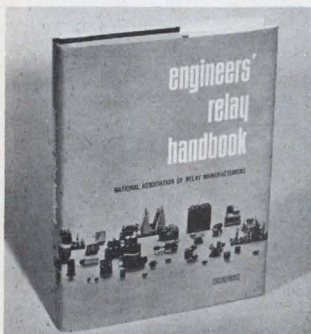

A definitive work that is fast becoming a standard reference text for the relay user. Prepared and edited by the National Association of Relay Manufacturers, this book is a complete guide to the principles, properties, performance characteristics, application requirements, specifications, and testing of relays. Systems and product engineers will find the *Handbook* an indispensable help in determining the correct types of relays for their applications. For further information about this unique sourcebook, write Dept. ED

### Hayden Book Co., Inc.

116 W. 14th Street  
New York, N. Y. 10011

# 172

## Biddle Precision Test Instruments

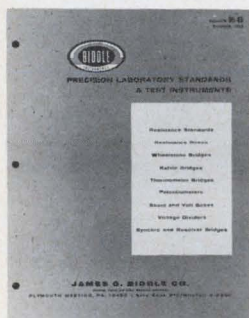

This new condensed catalog covers the full line of Biddle Precision Laboratory Standards and Test Instruments, and is designed to bring you up to date on new and improved models. Described are: Resistance Standards, Resistance Boxes, Wheatstone Bridges, Kelvin Bridges, Temperature Bridges, Potentiometers, Shunt and Volt Boxes, Voltage Dividers, and Ratio Sets. Also reference is made to a selection of Kipp Instruments; Galvanometers, Microammeters, etc. A checklist is included for requesting more detailed bulletins on instruments of your choice.

James G. Biddle  
Plymouth Meeting, Pa. 19462

# 173

## NEW LITERATURE

### Computer memory

A six-page brochure, with color photos and diagrams deals with coincident current core memory, magnetic film and ferrite core systems and core-wiring techniques. Fabri-tek, Inc. CIRCLE NO. 338

### Reprints Available

The following reprints are available free and in limited quantities. To obtain single copies, circle the number of the article you want on the Reader-Service Card.

*It's what's up front that counts*  
(No. 339)

*Keeping a CRT's spot in focus*  
(No. 340)

*Need a circuit design program?*  
(No. 341)

*Need a pedestal-free gate?* (No. 342)

### Accuracy Policy

It is the policy of ELECTRONIC DESIGN:

To make reasonable efforts to insure accuracy of editorial matter.

To publish promptly corrections brought to our attention.

To reserve the right to refuse any advertisement deemed misleading or fraudulent.

All editorial correspondence should be sent to:

Howard Bierman, Editor  
ELECTRONIC DESIGN  
850 Third Avenue  
New York, N. Y. 10022

### Subscription Policy

ELECTRONIC DESIGN is circulated free of charge to qualified design engineers in the U.S., Western European Continent and Britain. To establish your qualifications, send ELECTRONIC DESIGN the following information on your company's letterhead: Your name, engineering title, description of your design duties and a list of your company's major products. The letter must be signed by you personally.

Subscription rates for nonqualified subscribers—\$25 a year in the U.S., \$35 in all other countries. Single copy, \$1.50.

### Change of Address

A subscriber's change of address requires a restatement of his qualifications. To expedite the change, and to avoid missing any issues, send along a label from a back copy.

### Microfilm Copies

Microfilm copies of all 1961, 1962, 1963, 1964, 1965 and 1966 issues of ELECTRONIC DESIGN are available through University Microfilms, Inc., 300 N. Zeeb Rd., Ann Arbor, Mich. 48106



# Electronic Design

## Advertising Representatives

**New York 10022**  
 Robert W. Gascoigne  
 Thomas P. Barth  
 Samuel M. Deitch  
 Richard W. Nielson  
 850 Third Avenue  
 (212) PLaza 1-5530  
 TWX: 867-7866

**Philadelphia**  
 Fred L. Mowlds, Jr.  
 P. O. Box 206  
 Merion Station, Pa. 19066  
 (215) MO 4-1073

**Boston**  
 Richard Parker  
 7 Redstone Lane  
 Marblehead, Mass. 01945  
 (617) 742-0252

**Chicago 60611**  
 Thomas P. Kavoras  
 Berry Conner, Jr.  
 720 N. Michigan  
 (312) 337-0588

**Cleveland**  
 Robert W. Patrick  
 8410 Treetower Drive  
 Chagrin Falls, Ohio 44107  
 (216) 247-7670

**Los Angeles 90303**  
 Stanley I. Ehrenclou  
 Terrence D. Buckley  
 W. James Bischof  
 2930 W. Imperial Highway  
 Inglewood, Calif.  
 (213) 757-0183

**San Francisco**  
 Ashley P. Hartman  
 175 South San Antonio Rd.  
 Ste. 243  
 Los Altos, Calif. 94022  
 (415) 941-3084

**Southwestern 75206**  
 Tommy L. Wilson  
 6200 North Central Express-  
 way  
 Dallas, Tex.  
 (214) EMerson 1-2311

**London W. 1**  
 Brayton C. Nichols  
 44 Conduit Street

**Verviers, Belgium**  
 Andre Jamar  
 1, Rue Mallar, 1  
 (087) 253.85

**Tokyo**  
 Yoshihiro Takemura  
 International Planning  
 Service, Inc.  
 Room 231 Tokyu-Mita Bldg.  
 1, Shiba-Mita Koun-cho  
 Minato-ku, Tokyo

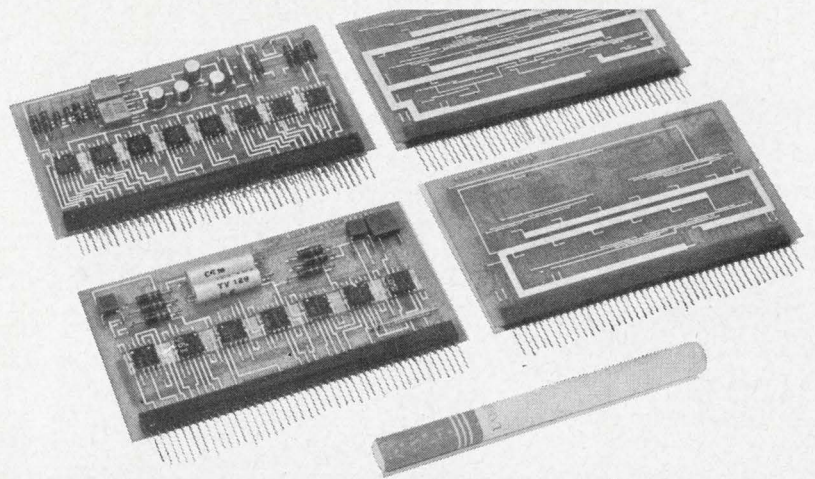

**an Industry/Military/NASA  
 QUALIFIED SOURCE**

Advanced Instrumentation  
 Outer Space to  
 Undersea Applications



**For Engineering:** Concept. Analysis. De-  
 sign (Circuitry, Interwiring, Structures,  
 Heat Transfer, System Integration).

**For Manufacturing:** Volume Production.  
 Prototype, Experimental Fabrication. Test.

**Contact:** William J. Lavery, Manager, Programs/  
 Marketing Division, The Sippican Corporation,  
 Marion, Mass. 02738, Telephone 617 748-1160.

**sippican**

ON READER-SERVICE CARD CIRCLE 105

### ACTIVE FILTERS

**TUBE:** Plug-in feedback amplifier-network combinations for single-tuned or higher order band pass responses as illustrated. Center frequencies down to 0.005 cycle. Q's to 75. Widely used where LC filter sections are impractical. High pass, low pass and narrow notch response characteristics available.

**TRANSISTOR:** Integral transistorized amplifier-network units for single-tuned band pass responses. No external components required. Units will cascade for higher order responses. Center frequencies down to 0.01 cycle. Q's to 40. High pass, low pass and narrow notch response characteristics available.

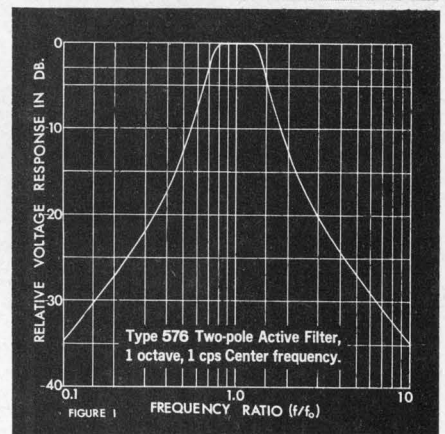

### PASSIVE FILTERS

**LC FILTERS:** Stable toroidal LC's—low, high, band pass and reject over wide impedance ranges in the audio frequency spectrum.

**RC TWIN-T NETWORKS:** Null frequencies 0.005 cycle to 50 kc in wide range of impedance levels. Useful for low pass filtering, harmonic rejection, feedback circuits.

- STANDARD FILTERS AND NETWORKS HERMETICALLY SEALED
- SPECIAL ENCAPSULATIONS AVAILABLE
- PLUG-IN OR STUDS FOR MOUNTING (OR BOTH)
- EARLY DELIVERIES—MODERATE PRICES
- PROMPT ENGINEERING ON INDIVIDUAL PROBLEMS

Write for technical bulletins describing filters in the audio spectrum and below, active and passive; Network Notes containing filter selection and application suggestions. Much performance information not yet published available on request. Ask about low-frequency spectrum analyzers.

**White**

**INSTRUMENT LABORATORIES  
 Incorporated**

Phone Area 512 — GL 3-6621  
 Box 9006 Austin, Texas 78756

ON READER-SERVICE CARD CIRCLE 106



# Advertisers' Index

Advertiser	Page	Advertiser	Page	Advertiser	Page
AMP, Incorporated	102, 103	Gudebrod Bros. Silk Co., Inc.	6	RBM Controls Division	107
Acopian Corp.	166	Guardian Electric Manufacturing Company	125	RCA Electronic Components and Devices	Cover IV
Air France	167			RCL Electronics, Inc.	156
Allen-Bradley Co.	8, 9	H P Associates	177	Radiation, Incorporated	96, 97
Aluminum Company of America	38, 39	Hayden Book Company, Inc.	180	Rogers Corporation	144 A-B-C-D
Amecon Division of Litton Industries	152	Heath Company	167	Rowan Controller Co., The	25
American Lava Corporation	63	Hewlett-Packard, Dymec Division	31		
Amperite	148	Hewlett-Packard	Cover II, 23, 90, 91	Sigma Division, Sigma Instruments, Inc.	89
Analog Devices, Inc.	4, 5	Honeywell, Computer Control Division	28	Simpson Electric Company	112 A-T
Arnold Magnetics Corp.	160	Howard Industries, Inc.	167	Singer Company, The, Diehl Division	159
Augat, Inc.	136	Hudson Lamp Company	131	Sippican Corporation, The	181
Automatic Electric, A Subsidiary of General Telephone & Electronics	173			Skydyne, Inc.	156
		IEEE	171	Specific Products	140
BLH Electronics, Inc.	147	IRC, Inc.	115	Sprague Electric Company	10, 20
Belden Manufacturing Company	117	Industro Transistor Corporation	163	Stauffer Chemical Company	135
Bell Telephone Laboratories	155	Inland Motor Corporation	124	Sylvania, Subsidiary of General Telephone & Electronics	32 A-H
Bendix Corporation, The, Semiconductor Division	44, 45	International Light, Inc.	171	Sylvania Electric Products, Inc. Electronic Components Group	43
Biddle, James G.	180			Systron-Donner Corporation	12
Bircher Corporation, The	179	JFD Electronics Co./Components Division	141		
Bourns, Inc.	119	James Electronics, Inc.	184	TRW Capacitors	74
Brand Rex, Division of American Enka Corporation	76	Johanson Manufacturing Corp.	145	Tektronix, Inc., Oscilloscopes	40
Buckeye Stamping Co., The	169	Johnson Company, E. F.	165	Texas Instruments Incorporated, Semiconductors-Components Division	82, 83
				Torngren Co., Inc., C. W.	143
Cinch-Graphik, Division of United-Carr Incorporated	127	LFE Electronics, Division of Laboratory of Electronics, Inc.	33	Towne Laboratories Inc.	178
Clifton Precision Products, Division of Litton Industries	123	Leach Corporation	120	Tracor, Inc.	88, 169
Cohn Corp., Sigmund	153	Littelfuse	161		
Cohu Electronics, Inc.	47			Union Carbide Corporation	48, 48 A-F, 49
Computer Test Corporation	27	McCoy Electronics Company	41		
Crydom Laboratories, Inc.	95	McLean Engineering Laboratories	168	Vactec Inc.	136
		Merrimac Research and Development, Inc.	175	Varian Associates, Bomac Division	16
Dale Electronics, Inc.	Cover III	Methode Electronics, Inc.	132, 133	Vishay Resistor Products	42
Data Control Systems, Inc.	161	Michigan Chemical Corporation	170		
Data Instruments Division	174	MicroSwitch, A Division of Honeywell	151	Wems, Inc.	46
Datapulse Division, Datapulse, Incorporated	2	Microtran Company, Inc.	161	Westinghouse Molecular Electronics Division	15
Deltron, Inc.	162	Motorola Semiconductor Products, Inc.	7	White Instruments Laboratories, Inc.	181
Eldre Components, Inc.	180	National Semiconductor Corporation	18, 19	Zierick Manufacturing Corp.	169
Electro-Motive Mfg. Co., Inc., The	139				
Electronic Design	183	Ohmite Manufacturing Company	128, 129		
Electronic Research Associates, Inc.	164			Career Advertising	
		Pacific Data & Controls	152	Douglas Missile & Space Systems Division	111
Fairchild Instrumentation, A Division of Fairchild Camera and Instrument Corporation	34, 35, 37	Pamotor, Inc.	149	Electronic Communications, Inc.	110
		Pastoriza Electronics, Inc.	142	National Cash Register Company, The	157
General Radio Company	1	Prestype, Inc.	137	Stromberg-Carlson	108
Globe Industries, Inc.	165				



# KILOVAC

HIGH VACUUM ELECTRONICS, INC.

## WANTED TO KNOW WHICH PUBLICATIONS ARE READ BY ENGINEERS INTERESTED IN VACUUM RELAYS

PUBLICATION	Rank		% Read	
	Always Read	Always & Sometimes Read (Combined)	Always	Always & Sometimes (Combined)
ELECTRONIC DESIGN	1		44.9	87.8
ELECTRONIC INDUSTRIES	3	4	31.3	65.3
ELECTRONICS	8	5	23.8	64.6
ELECTRICAL DESIGN NEWS	7	3	27.2	68.7
IEEE SPECTRUM	4 (tie)	8	29.9	53.1
ELECTRONIC EQUIPMENT ENGINEERING	4 (tie)	6	29.9	57.1
ELECTRO-TECHNOLOGY	6	7	29.3	55.8
ELECTRO-MECHANICAL DESIGN	10	10	14.3	36.1
ELECTRONIC PRODUCTS	2	2	32.0	81.4
ELECTRONIC NEWS	9	9	19.7	49.6

## ONCE AGAIN, **Electronic Design** RANKS FIRST IN READERSHIP!

Here is the case of another electronic manufacturer who wanted to find out which publications are *really* read by his own customers and prospects. KILOVAC (High Vacuum Electronics, Inc.) mailed a readership questionnaire to every fifth name on its customer list. The results are shown above—*Electronic Design* ranks first in "Always Read!"

Again, and again, and again, when manufacturers survey their own customers, *Electronic Design* turns up on top of the readership list. What better way to take the guesswork out of media selection? In study after study, one publication stands out clearly above the others. When you buy *Electronic Design*, you buy *Readership!*

### READERSHIP STUDY BOX SCORE

STUDY NUMBER	NUMBER OF STUDIES TO DATE	NUMBER WON BY ELECTRONIC DESIGN
53	53	49

**Electronic Design** BEST-READ ELECTRONIC MAGAZINE



a HAYDEN publication 850 Third Avenue, New York, N.Y. 10022 (212) PL 1-5530





CHOPPERS • RELAYS • TRANSFORMERS • SWITCHES

# JAMES

SOLVES THE PROBLEM OF SWITCHING LOW-LEVEL SIGNALS

## Micro-Scan RELAY

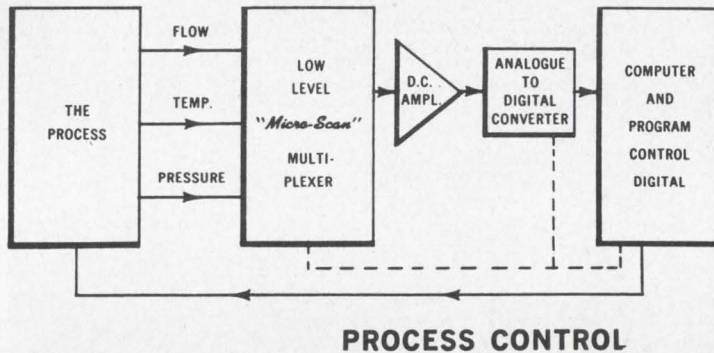
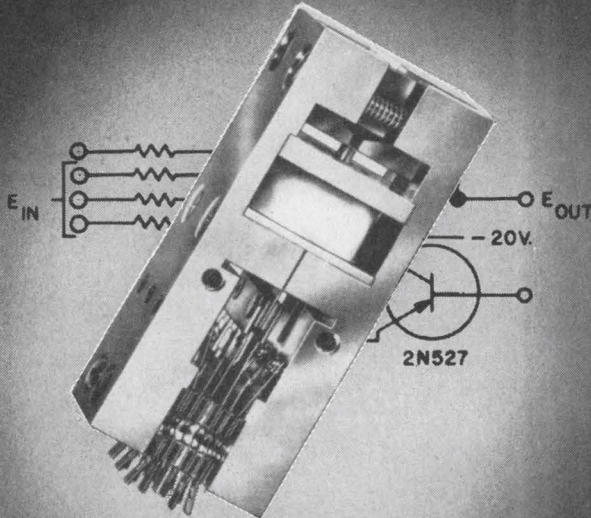

### LOW THERMAL CIRCUITS

Less than .5 microvolt offset for remote transducer switching.

### HIGH SHIELDING

Magnetic and electrostatic isolation of switching circuit—up to 150 db.

### HIGH OPERATING SPEEDS

As low as 650 microseconds pull-in and 750 microseconds dropout.

James Micro-Scan Relays are the specialized solution for multiplexing, direct digital control, and data sampling of measurements. Use it as a calibration or sampling switch in scanning devices; or as an integrator switch in analog acquisition equipment. The first choice where high operating speed, shielding, repeatability, and reliability are critical.

Write for full technical details.

# JAMES<sup>®</sup> ELECTRONICS INC.

4042 North Rockwell  
Phone 312-463-6500

• TWX — 312-222-0745

Chicago, Illinois 60618  
• FAX — JML

ON READER-SERVICE CARD CIRCLE 107

## Designer's Datebook

FEBRUARY						
S	M	T	W	T	F	S
			1	2	3	4
5	6	7	8	9	10	11
12	13	14	15	16	17	18
19	20	21	22	23	24	25
26	27	28				

MARCH						
S	M	T	W	T	F	S
			1	2	3	4
5	6	7	8	9	10	11
12	13	14	15	16	17	18
19	20	21	22	23	24	25
26	27	28	29	30	31	

For further information on meetings, use Reader Service card.

### Feb. 15-17

**International Solid-State Circuits Conference** (Philadelphia) Sponsors: IEEE, University of Penn.; Lewis Winner, 152 W. 42 St., New York, N. Y. 10036

CIRCLE NO. 343

### Feb. 20-24

**Winter Institute on Advanced Control** (Gainesville, Fla.) Sponsor: National Science Foundation, Univ. of Florida; Prof. O. I. Elgerd, EE Dept., Univ. of Fla., Gainesville, Fla. 32601

CIRCLE NO. 344

### Feb. 24-25

**Electric Automobile Seminar** (San Jose, Calif.) Sponsor: Santa Clara Valley Engineers Council; Hugh C. Ross, 11915 Shadybrook, Saratoga, Calif. 95070

CIRCLE NO. 345

### Mar. 1-3

**Numerical Control Society's Meeting and Conference** (Detroit) Sponsor: NCS; Mary DeVries, Numerical Control Society, 44 Nassau St., Princeton, N. J. 08540

CIRCLE NO. 346

### Mar. 20-23

**IEEE International Convention** (New York City) Sponsor: IEEE; The IEEE, 345 E. 47 St., New York, N. Y. 10017

CIRCLE NO. 347

### Mar. 22-24

**International Symposium on Modern Optics** (New York City) Sponsor: Polytechnic Institute of Brooklyn, AFOSR, NOR; Symposium Committee, Polytechnic Institute of Brooklyn, 333 Jay St., Brooklyn, N. Y. 11201

CIRCLE NO. 348

### Mar. 29-31

**Symposium on Microwave Power** (Stanford, Calif.) Sponsor: IMPI; Dr. Donald Dunn, IMPI, P. O. Box 2335, Stanford, Calif. 94305

CIRCLE NO. 349



# New Dale industrial wirewounds...**priced right!**









*Dale expands with new silicone coated resistors to replace & outperform vitreous enamel*



- **Expanded Industrial Line** provides direct replacements for the full range of vitreous enamel styles and sizes. You pay no more—less in many cases
- **Proven Reliability:** Over 1,800,000 unit test hours prove maximum HL failure rate to be .05% per 1,000 hours (full power, 25°C; failure defined as 3% Δ R, 60% confidence level)
- **Superior Stability:** Multi-layer silicone coating provides lower T.C. (±30 ppm). Standard tolerance ±5%. Precision tolerances available.

Write for Complete Resistor Catalog A

## BUY NEW MODELS...NEW SIZES...FROM THIS COMPLETE INDUSTRIAL WIREWOUND LINE!

TYPE	APPLICATION	APPLICABLE MIL SPEC AND TYPES	WATTAGE RATING	RESISTANCE RANGE	CORE SIZES	TOLERANCE
<b>CW</b> Axial Lead 	Axial leads. For applications requiring high performance at low cost	MIL-R-26 RW-57, 58, 59	1.25-13 watts	.1 ohm to 273K ohms	Body Dia. .093 to .375" Body Length .406 to 1.781" Leads 1.5 to 2"	±5% (10% below 1 ohm)
<b>HL</b> Tubular 	Silicone-coated general purpose wirewound resistor. A direct replacement in both cost and performance for vitreous enamel types.	MIL-R-26 RW-29, 30, 31, 32, 33, 35, 36, 37, 38, 47	5-225 watts	.1 ohm to 1.3 Megohms	O.D. ¼ to 1½" Length 1-10½"	±5% (10% below 1 ohm)
<b>NHL</b> Non-Inductive 	High frequency circuits and applications requiring low inductive effect and minimum distributed capacity	None	5-225 watts	1 ohm to 90K ohms	O.D. ¼ to 1½" Length 1-10½"	±5%
<b>HL</b> Flat 	High power-to-size ratio. Self-stacking hardware for vertical or horizontal mounting.	MIL-R-26 RW-20 thru RW-24	24-95 watts	.1 ohm to 150K ohms	Length 1¼ to 6"	±5% (10% below 1 ohm)
<b>HLM</b> Miniature Flat 	For limited space, high power-to-size requirements particularly in high vibration areas.	None	10-20 watts	.1 ohm to 51K ohms	Length ¾ to 2-1/16"	±5% (10% below 1 ohm)
<b>HLA</b> Adjustable 	For resistance or voltage adjustment	MIL-R-19365C RX-29, 32, 33, 35, 36, 37, 38, 47	12-225 watts	1 ohm to 100K ohms	O.D. 5/16 to 1½" Length 1½ to 10½"	±5%
<b>HLT</b> Tapped 	For voltage divider networks	MIL-R-26	11-225 watts	.1 ohm to 1.1 Megohms	O.D. 5/16 to 1½" Length 1½ to 10½"	±10% each section (±10% total)
<b>HLW</b> Tubular 	General application where terminal wires are required for direct electrical connection	None	5-20 watts	.1 ohm to 80K ohms	O.D. ¼ to 7/16" Length 1 to 2"	±5% (10% below 1 ohm)



**DALE ELECTRONICS, INC.**  
1328 28th Ave., Columbus, Nebraska 68601





Based on these industry favorites

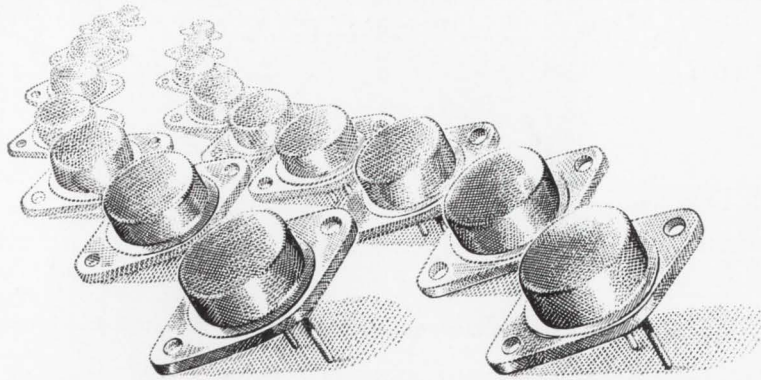

2N3442

2N3773

# RCA now introduces two new Hometaxial-Base power transistors

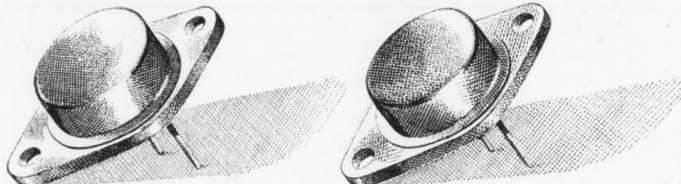

2N4347

2N4348

at attractive low prices

	2N4347	2N3442	2N4348	2N3773	Units
$I_C$ (max)	5	10	10	16	A
$P_T$ @ $T_C = 25^\circ\text{C}$	100	117	120	150	W
$h_{FE}$	20-70 @ $I_C = 2\text{A}$	20-70 @ $I_C = 3\text{A}$	15-60 @ $I_C = 5\text{A}$	15-60 @ $I_C = 8\text{A}$	
$V_{CEV}$ (sus)	140	160	140	160	V
$\Theta_{j-c}$	1.75	1.5	1.46	1.17	$^\circ\text{C/W}$
Price	\$1.80*	\$2.75*	\$2.75*	\$4.75*	

\*In quantities of 1,000 and up

Available in production quantities, RCA's latest additions to its Hometaxial-Base family offer top-of-the-line performance at economy prices. Featuring high-power characteristics plus freedom from second breakdown, the new units are even less expensive in quantity than their popular prototypes.

RCA-2N4347 and 2N4348 are general-purpose silicon transistors ideal for power-switching circuits, series and shunt-regulator driver and output stages, dc-to-dc converters, inverters, and solenoid (hammer)/relay driver service.

For additional information and delivery on these and other RCA Hometaxial-Base transistors, see your RCA Representative. For technical data on specific types, write: RCA Commercial Engineering, Section IG2-3 Harrison, N.J. 07029.

CHECK YOUR RCA DISTRIBUTOR FOR HIS PRICE AND DELIVERY

RCA Electronic Components and Devices



The Most Trusted Name in Electronics

ON READER-SERVICE CARD CIRCLE 206