

By the Publishers of
**MECHANIX
ILLUSTRATED**

Ham Station Control Center
Special Transistor Projects

ELECTRONICS ILLUSTRATED®

JUNE • 35¢

**FREE
HI-FI TEST RECORD**

in this issue!

SEE PAGE 65



Radio Television Electronics

NRI training is for beginners. No previous experience or advance education needed.

Home

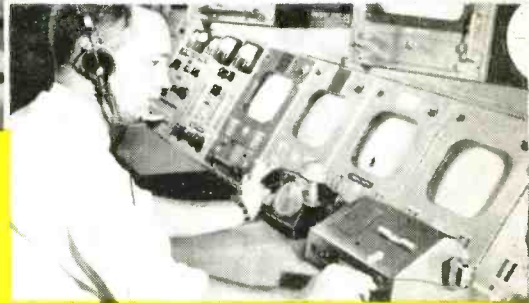
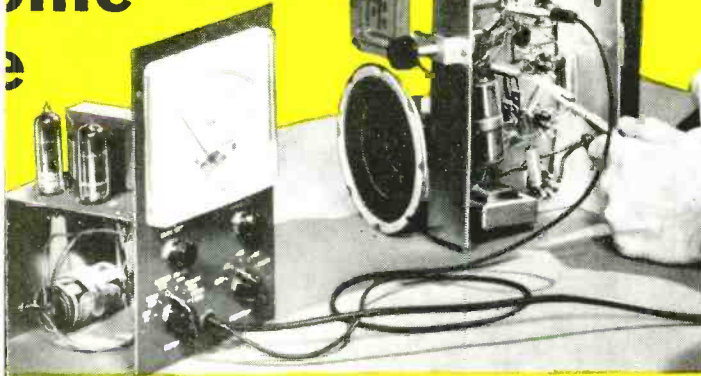

Why This Fast Growing Field Offers You High Pay, Success, Bright Future



J. E. SMITH
Founder

This is the age of Electronics. Job counselors are recommending careers in Electronics because they know the pay is high, jobs interesting, advancement opportunities great. If you are dissatisfied with your present job and pay, you will want to investigate the big, exciting, fast growing Electronic industry. It offers good income, prestige and a bright future in Industrial or Military Electronics, Radio Television Communications, Radio Television Servicing.

Act now to assure a better future. Remember the difference between those who *want* to succeed and those who *do* succeed is that one group *does something* about it. Take the first step toward a better future now. Mail the postage-free card. Find out how you can train at home for a career in Electronics.

Need for Men Who Know Electronics Increasing

Start Soon Earning Extra Money in Spare Time

You don't have to go away to school and you don't need a high school Diploma. You keep your present job until you are ready for a better one. From coast to coast NRI graduates now fill good positions, earn high pay. Starting soon after you enroll. NRI provides instructions you need to add to your income doing servicing work in spare time. You start quickly to fix radio or television sets or other electronic equipment for friends, neighbors, small businesses in your neighborhood. Mail postage-free card now.

You Get Special Training Kits No Extra Charge Makes Learning Easier, Faster

NRI is America's oldest, largest home study Radio Television Electronics School. The special equipment NRI training includes makes learning at home easier and faster. Kits bring to life principles you read about in illustrated lesson texts. You recognize electronic circuits, capacitors, diodes, other components. You make experiments and tests that make learning a pleasure. Act now to be a part of the age of Electronics. New 64-page catalog tells the fascinating story of Electronics. Tells what NRI graduates are doing and earning, gives facts about NRI training in Industrial and Military Electronics, Radio Television Servicing and Radio Television Communications. Monthly payments available. Cut it and mail the postage-free card today.

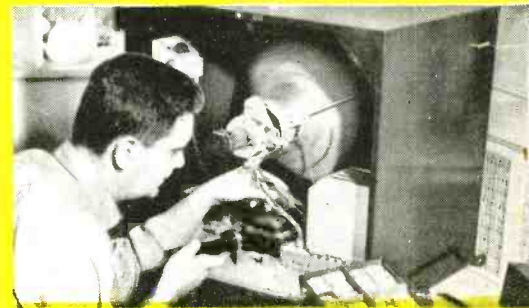

NRI Trained These Men

"I am Senior Electronics Instructor for Sikorsky Aircraft, teaching Auto-pilot systems. The Basic Electronics I learned thru NRI helped me qualify." J. SENIA, Stratford, Conn.



"Thanks to NRI, I am in a top position with FAA. We install 12S, Vor Tacan, Vortac and other major Navaid Electronics." J. K. DUCKWORTH, Ft. Worth, Texas.

"Now with GE Advanced Electronics Center, Cornell University. Thanks to NRI I now have a job which I enjoy and which also pays well." T. BILAK, Cayuga, N. Y.



YOU be the judge of *knight-kit*® value

A PRODUCT OF ALLIED RADIO



FREE examination privilege

More and more people are finding out how easy it is to build exciting Knight-Kits, how satisfying they are to own, and how much they save.

If you haven't yet enjoyed the experience and fun of building and owning a Knight-Kit, we invite you to take advantage of our free examination offer. Order any Knight-Kit. Examine it on arrival. Inspect the

quality of the components, the circuitry, the easy-assembly manual. We're so confident you'll want the kit, we can make this offer: If you're not COMPLETELY SATISFIED, just return the kit for full refund.

Order a Knight-Kit now. Know the thrill of the most satisfying build-your-own experience in electronics.



Y-731 Deluxe FM-AM Stereo HI-FI Tuner (Multiplex add-in) \$87.50
only \$5 down



Y-774 Deluxe 40-Watt Stereo Amplifier (with Center Channel) \$79.50
only \$5 down



Y-773 Super-Value 20-Watt Stereo HI-FI Amplifier...\$44.50
only \$2 down



Y-787 FM-AM HI-FI Tuner (with Multiplex jack) \$49.95
only \$2 down



Y-713 Best-selling Citizens Band Transceiver. Tunable 22-channel super-regen receiver...\$39.95

only \$2 down



Y-258 4-Band "Span Master" Receiver (with cabinet) \$25.95

only \$2 down



R-100 Amateur Communications Receiver (HI-gain, with built-in Q-Multiplier)...\$104.50

only \$5 down



Y-708 1000 Ohm/Volt Pocket Volt-Ohm-Milliammeter \$9.95



Y-737 "Ranger" Clock-Radio with "sleep" switch...\$24.95

only \$2 down



Y-771 5-Transistor Superhet Portable Radio (less battery) \$25.95

only \$2 down



Y-125 General-purpose VTVM (11 meg. input res.) \$25.75

only \$2 down



Y-143 Model "600" Tube Checker (checks over 700 types)...\$32.95

only \$2 down

easiest to build...
satisfying to own...
money-saving

ONLY \$2 DOWN

on orders up to \$50;
\$5 down on orders up to \$200...

see scores of other *knight-kits*

HI-FI KITS

Stereo Preamplifier
60-W Stereo Amplifier
Monaural Amplifiers
HI-FI Tuners
Speaker Systems
and others

HOBBYIST KITS

"Space-Spanner" Radio
"Ranger" Radios
Transistor Radios
2-Way Intercom
Electronic Lab Kits
and many others

INSTRUMENT KITS

Lab AC VTVM
VOM's
5" Scopes
Tube Checkers
Signal Tracer
Audio Generator
Sweep Generator
plus many others

AMATEUR KITS

50-Watt Transmitter
Self-Powered VFO
100 kc Crystal Calibrator
Code Practice Oscillator
Grid Dip Oscillator

there's a money-saving *knight-kit* for every need... see them all in the

ALLIED CATALOG

Describes the complete KNIGHT-KIT line in detail. Order the kit of your choice—judge quality and value for yourself under our Free examination privilege!

FREE

send for it!



ALLIED RADIO

ALLIED RADIO, Dept. 26-F
100 N. Western Ave., Chicago 80, Ill.

Send FREE Catalog featuring Knight-Kits.

Name _____

Address _____

City _____ Zone _____ State _____

ELECTRONICS ILLUSTRATED

June, 1960

Vol. 3, No. 6

A Fawcett Publication

CHARLES TEPFER Editor
Larry Klein Technical Editor
Edward Nonas Feature Editor
David Kipnes Assistant Editor
Murray Cooper Art Editor
Lou Rubsamen Art Associate
Elaine Sapoff Editorial Assistant

CONTENTS

EI SPECIAL

How to Test Your Hi-Fi	59
<i>Plus Hi-Fi Test Record</i>	65

FEATURES

Music From Nowhere — The Theremin	25
The Great QSL Quarrel	28
Cosmic Clearing House	34
Tiniest Radiation Monitor	52
Fosdic III and the '60 Census	58
TV Tape Takes to the Road	68
Spotlight on 6 Meters	70
FM Auto Radio	77
Transistorized Lung	77
Electronics Tells the Chemist	78
Torture Test	82
Don't Fry that Ham	84

BUILD-IT PROJECTS

Ham Station Control Center	30
Build-it Course— Citizen Band Power Supply	44
Transistorized VU Meter	49
Electronic Oven Thermometer	53
Signal Pencil	74
Handy Foot Switch	80
A Wide Range Watt Meter	86
Try These	89
Ham 2-Meter Converter Kit	90
Milt Kiver on Transistor Testing — I	38
Hi-Fi Doctor and Clinic	42
Electronic Brain	56

Cover Photo by Daniel R. Rubin

Ralph Daigh Editorial Director
James Boynton Advertising Director
Al Allord Art Director
Ralph Mattison Associate Art Director
George H. Carl Production Director

Larry Eisinger Editor-in-Chief
Phyllis Bendremer Production Editor
Benita Mills Assistant Production Editor
John F. Webster Advertising Manager

ELECTRONICS ILLUSTRATED is published monthly by Fawcett Publications, Inc., Fawcett Place, Greenwich, Conn. W. H. Fawcett, Jr., President; Gordon Fawcett, Secretary and Treasurer; Roger Fawcett, General Manager; Roscoe K. Fawcett, Circulation Director; Donald P. Hanson, Assistant General Manager.

EDITORIAL AND ADVERTISING OFFICES: 67 West 44th Street, New York 36, N. Y.
ADDRESS ALL MAIL: Subscriptions, change of address, Form 3579 to Subscription Dept., Fawcett Bldg., Greenwich, Conn.; and all editorial and advertising to Fawcett Publications, Inc., 67 W. 44th St., New York 36, N. Y.

Second-class postage paid at Greenwich, Conn., and at additional mailing offices.
Subscription price \$4.00 per year in the U. S. and possessions and Canada. All other countries \$6.00 per year. Foreign subscriptions and sales should be remitted by International Money Order in U. S. funds payable at Greenwich, Conn.

Printed in U.S.A. Copyright 1960 by Fawcett Publications, Inc.
Permission hereby granted to quote from this issue of this magazine on radio or television provided a total of not more than 1,000 words is quoted and credit is given to the title of the magazine and issue, as well as the statement, copyright 1960, by Fawcett Publications, Inc.

Member of: Audit Bureau of Circulations  Magazine Publishers Association, Inc. 



**A HIGHLY
RESPECTED TRADE—
START SOON TO
EARN EXTRA MONEY
IN SPARE TIME**

Learn at Home IN YOUR SPARE TIME to Fix Electrical Appliances

To build a better future, get into a field where there's much important work and the security that comes from knowing a good trade. Servicing electrical appliances offers that OPPORTUNITY. Every wired home has many electrical appliances and millions and millions of new appliances are sold every year. Owners pay well to keep them in repair. That's making a fast-growing need for trained men.

Add To Your Income Starting Soon Need For Service Technicians Increasing

Make extra money in your spare time. Start soon to fix electric toasters, fans, clocks, vacuum cleaners, and other electric appliances for your neighbors and friends. Work in your basement, garage or spare room. It's easy to increase your earning power—to pay for your training many times over—to have extra money to buy things you need.

Learn and Earn with Multi-Use Tester Built with Parts We Send

This course includes the parts to build a portable, sturdy Appliance Tester that helps you locate electrical defects quickly and easily. You use it to learn and do actual electrical appliance repair jobs. If you want better pay learn this good trade. No need to give up your present

job. You can train at home in your spare time for only \$3.00 down and \$6.00 a month. A small price to pay for increased earnings, a more secure future. Paste coupon below on a postal or mail in envelope for free book and sample lesson. Address **National Radio Institute, Dept. KFO, Washington 16, D. C.**

**MAILING THIS
COUPON MAY START
YOU TO SUCCESS**

**LESSON AND BOOK
FREE**



NATIONAL RADIO INSTITUTE, Dept. KFO, Washington 16, D. C.

Please send me Electric Appliance Training lesson and book free. (No salesman will call.)

Name Age

Address

City Zone State

ACCREDITED MEMBER NATIONAL HOME STUDY COUNCIL

A Message From the Editor



Some of the projects that will appear in the next issue of EI.

By now you've already seen our exclusive hi-fi test record on page 65 and perhaps even played it on your record player. We want your comments or questions relative to the use of this record or to the results you got on your hi-fi when using it. Write to us, that is what EI's Hi-Fi Clinic is for.

Incidentally, those of you who are interested in *electronic* music should read the article about the Theremin, starting on page 25 in this issue. Frankly, we are publishing this to arouse your interest and curiosity because we are now preparing a full-scale construction article on a Theremin for a future issue. We have been playing (?) it here in our office—sounds like a spook's convention!

It has been brought to my attention that many of our readers may not be aware of the intensive work that goes into our monthly kit reports. We are not a consumer-testing agency, but we use the same rigorous test methods they do. Every kit assembler is an authority on the type of equipment he assembles or works with a consultant who is. When the instructions furnished with the kit are easy to follow and instructive, when all the parts fit together well and the layout is so designed that the assembly is not tricky, when the finished product operates according to the manufacturer's published claims, and when the price for the kit represents a genuine saving over commercially assembled items with similar specifications, then we rate the kit as a "Good Buy." You realize, of course, that there are many new kits marketed every month; no magazine could hope to keep up with all of them. Therefore, we must select for our reports those kits which we think would be of greatest interest to you and which we feel warrant your attention. There are many kits of products which I am sure you would be interested in, however, we haven't reported on them because after careful investigation we don't think these will be worth your while to assemble. Either the instruction manual is inadequate, or the parts are inferior, or the assembled product tests out poorly. From time to time, however, we will report on such a kit, if in so doing

These men are getting practical training in...

ELECTRICITY ELECTRONICS



On Real:

**A.C. and D.C. Motors
Generators
Switchboards
Controllers
Modern Appliances
Automatic Electronic
Control Units**

(Shown at left—Instructor explaining operation and testing of a large Motor Generator in our A.C. Department.)

TELEVISION RADIO ELECTRONICS

On Real:

**Television Receivers
Black & White and Color
AM-FM and Auto Radios
Transistors—Printed
Circuits—Test Equipment**

(Right — Instructor helping students check the wiring and trace circuits of television receivers.)

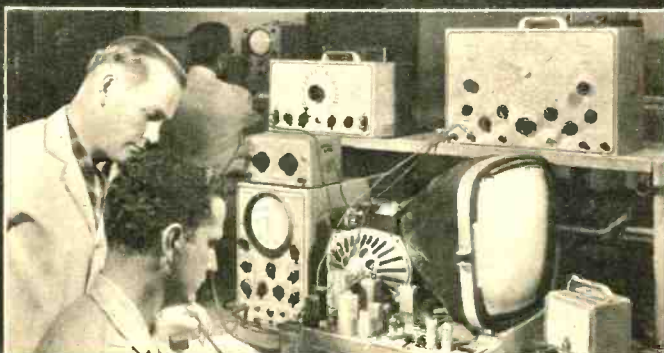

Train in the NEW SHOP-LABS of COYNE

Largest, Oldest, Best Equipped School of its Kind in the U.S.

Prepare for your future now in today's top opportunity field. Don't be satisfied with a "No Future" job. Train the Coyne way for a better job in a field that offers a world of opportunities in the years ahead.

You train in **Chicago**—the Electrical and Electronic Center of the World—on real equipment. Professional and experienced instructors show you how, then you do practical jobs yourself. No previous experience or advanced education is needed.

FINANCE PLAN: Enroll now, pay most of tuition after graduation. Part-time employment help for students.

Mail coupon or write to address below for free book—"Guide to Careers". Whether you prefer Electricity, Television-Radio or Combined Electronics Training, which includes both fields, this book describes all training and gives facts to Vets and Non-Vets.



**Mail Coupon or Write
for FREE Book**

Book comes by mail. No obligation and no salesman will call.

Mail coupon below in an Envelope or paste on a Postal Card or write Address given and Free book. "Guide to Careers", with information will be sent to you by return mail.

COYNE ELECTRICAL SCHOOL
Dept. AO-8C, New Coyne Building
1501 W. Congress Pkwy., Chicago 7, Illinois

Send BIG FREE book and details of all the training you offer. However, I am especially interested in:

Electricity Television Both Fields

Name _____

Address _____

City _____ State _____

(I understand no Salesman will call)

B. W. Cook, Jr., Pres. COYNE Founded 1899
ELECTRICAL SCHOOL

CHARTERED AS AN EDUCATIONAL INSTITUTION NOT FOR PROFIT
1501 W. CONGRESS PARKWAY, CHICAGO 7 Dept. AO-8C
ELECTRICITY ★ RADIO ★ TELEVISION ★ REFRIGERATION ★ ELECTRONICS

COMPLETE SERVICE TRAINING

... written so you can understand it!

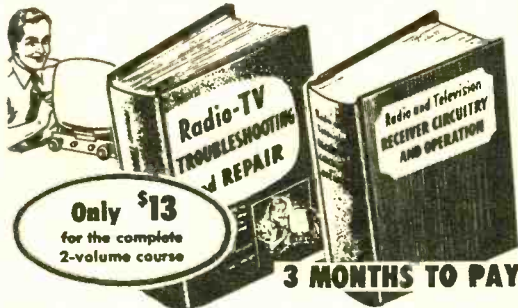

Fix any TV or Radio Ever Made

EASIER - BETTER - FASTER!

No complicated theory or mathematics! These famous Ghirardi books get right down to brass tacks in showing you how to handle all types of AM, FM, and TV service work by approved professional methods. Almost 1500 pages and over 800 clear illustrations show how to handle every phase of troubleshooting and servicing. Each book is co-authored by A. A. Ghirardi whose manuals have helped train more servicemen than any other books or courses of their kind!

1—Radio and Television Receiver TROUBLESHOOTING AND REPAIR

A complete guide to profitable professional methods. For the beginner, it is a comprehensive training course. For the experienced serviceman, it is a quick way to "brush up" on specific jobs, to develop improved techniques or to find fast answers to puzzling service problems. Includes invaluable "step-by-step" troubleshooting charts that show what to look for and where. 820 pages, 417 illustrations, price \$7.50 separately.

2—Radio and Television Receiver CIRCUITRY AND OPERATION

This 669-page volume is the ideal guide for servicemen who realize it pays to know what really makes modern radio-TV receivers "tick" and why. Gives a complete understanding of basic circuits and circuit variations; how to recognize them at a glance; how to eliminate guesswork and useless testing in servicing them. 417 illus. Price separately \$6.75.

Special low price . . . you save \$1.25

If broken into lessons and sent to you as a "course," you'd regard these two great books as a bargain at \$75 or more!

Under this new offer, you buy both books for only \$13.00 . . . you save \$1.25—and have the privilege of paying in easy installments while you use them! No lessons to wait for. You learn fast—and right!

STUDY 10 DAYS FREE!

Dept. PR-50, RINEHART & CO., Inc.
232 Madison Ave., New York 16, N. Y.

Send books below for 10-day FREE EXAMINATION. In 10 days I will either remit price indicated (plus postage) or return books postpaid and owe you nothing.

Radio & TV Receiver TROUBLESHOOTING & REPAIR (Price \$7.50 separately)

Radio & TV CIRCUITRY & OPERATION (Price \$6.75)

Check here for MONEY-SAVING COMBINATION OFFER . . . Save \$1.25. Send both of above big books at special price of only \$13.00 for the two. (Regular price \$14.25 you save \$1.25.) Payable at rate of \$4 plus postage after 10 days if you decide to keep books and \$3 a month for 3 months until the total of \$13.00 has been paid.

SAVE! Send cash and we pay postage. Same 10-day return privilege with money promptly refunded.

Name _____

Address _____

City, Zone, State _____

Outside U.S.A.—\$8.00 for TROUBLESHOOTING & REPAIR; \$7.25 for CIRCUITRY & OPERATION; \$14.00 for both. Cash only, but money refunded if you return books in 10 days.

we can save many of our readers from a definitely unprofitable purchase. Ordinarily, however, most of the kits that we report on are good buys. We don't think there is much sense in telling you about the others. If you're interested in a specific kit let us know; we are making up our schedule for future reports now.

In past surveys of our readership we have come up with the stimulating fact that there is no typical *EI* reader: some are engineers, some are doctors, lawyers, students, some technicians, etc., etc. Oftimes some of our readers know more about a particular item or subject we describe than the author himself. Since this is so, and since we are constantly looking for new talent and new build-it-yourself projects, what makes more sense than to ask you, our readers, to become contributors. If you have any build-it-yourself project ideas and can develop them into articles for us, write to our technical editor. He'll tell you all about our style, requirements and payment (it is excellent).

Summertime is picture-taking time and there has been a quiet revolution occurring in photography. The new automatic cameras make picture taking easier than ever, and, of course, electronics is the magic genie behind it all. If you want to know how the new automatic still and movie cameras work, and if you are interested in building three original projects to make for better picture taking and picture making, be sure to read the special 16-page bonus section on photography in our July issue. Remember our 1-transistor FM receiver and 1-transistor AM receiver projects? If you do, you know what to expect from our 2-tube AM-FM stereo receiver coming in our July issue. Interested in building an electronics library at cut-rate prices? Read all about how you can do it in our next issue. Looking forward to seeing you then.

Charles Tupper

In Spare Time at Home—Prepare for a Better Job—or
Your Own Business in One of the Many Branches of

ELECTRONICS

You build and keep this valuable Vacuum Tube VOLT METER



You build and keep this 5-inch COLOR OSCILLOSCOPE — almost a "must" for TV servicing.

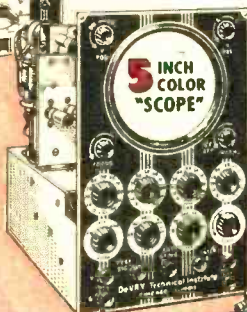

RADIO - TELEVISION - RADAR

If you are seeking a better job or a business of your own, the appealing field of Television-Radio-Electronics offers **REAL PROMISE!**

In this fast-growing field, trained Electronic technicians find many good-paying, interesting jobs in manufacturing, installing, operating, servicing. Equally important is the fact that these are **GOOD JOBS**—offering the kind of a future that an untrained man often dreams about.

No previous technical experience or advanced education needed. Prepare for this profitable field in your spare time at home, or in our modern Chicago or Toronto Laboratories. Nothing else like it! Send for **FREE** details.

EARN WHILE YOU LEARN

After you get part of DeVry Tech's training with equipment at home, you may then in your spare time, begin to earn real money servicing Radio and Television sets.



HOME MOVIES . . .

. . . make important points crystal clear. Speeds your learning. It's almost like having an instructor at your side!

MILITARY SERVICE

If you are subject to military service, the information we have should prove very helpful. Mail coupon to-day.

COLOR TV

DeVry Tech's program also includes training in Color Television

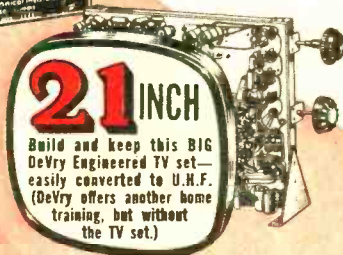

21 INCH

Build and keep this BIG DeVry Engineered TV set—easily converted to U.H.F. (DeVry offers another home training, but without the TV set.)

Your GUIDE

to Profitable Job Opportunities

TV-Radio Broadcast Technician
Color Television Specialist
Radar Operator • Laboratory Technician
Airline Radio Man • Computer Specialist
Quality Control Manager
Your Own Sales & Service Shop
. . . **PLUS MANY OTHERS**

YOU GET THE SAME EMPLOYMENT SERVICE

that has helped thousands of our graduates toward fine careers in Electronics.



Send for **FREE BOOKLET TODAY!**

Accredited Member of National Home Study Council

"One of North America's
Foremost Electronics
Training Centers"



DeVRY TECHNICAL INSTITUTE

CHICAGO 41, ILLINOIS



You work over
300
Learn-By-Doing
projects

Build over 300 practical projects from many shipments of Radio-Electronic parts. You build and operate TV-Radio circuits . . . wireless microphone . . . and many other major projects—all designed to provide outstanding practical experience at home.

ACT NOW! Get information-packed publication **FREE!** Mail coupon today.

DeVRY TECHNICAL INSTITUTE

4141 Belmont Ave., Chicago 41, Ill., Dept. E1-6-Q
Please give me your **FREE** booklet, "Electronics in Spore Travel," and tell me how I may prepare to enter one or more branches of Electronics.

Name _____ Age _____

Street _____ Apt. _____

City _____ Zone _____ State _____

2044 Canadian residents address DeVry Tech. of Canada, Ltd.
626 Roselawn Ave., Toronto 12, Ontario

Electronics in the news

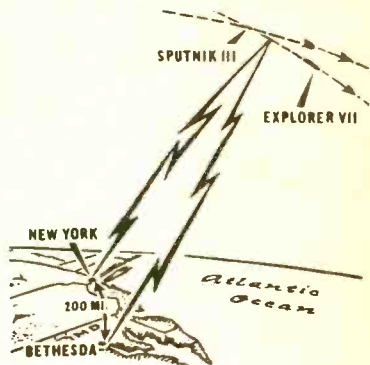

Two young amateur radio enthusiasts have accomplished a feat that to date scientists have been unable to match. They made a CW contact between New York and Bethesda, Maryland, a distance of 200 miles by bouncing their signals off the Earth satellites. Their moment of success came on their 35th try early February 6th when both Sputnik III and Explorer VII were in low orbit and passing at almost the same instant over the Atlantic Coast (See diagram above). Perry Klein 17 is shown with his ham gear; Rophael Soifer, a freshman of MIT, is the other half of this combination.



The eighth annual Edison Radio Amateur Award was presented to Walter Ermer, Sr., 51, for his outstanding public service in organizing and directing a 300-man emergency radio communications corps in Cleveland, Ohio. Their work during the Cuyohaga River flood in '59 is being reminisced by Ermer and a member of his corps. The two boys were among those rescued. Mr. Ermer is shown below accepting his trophy from L. Berkley Davis, a vice-president at GE, the sponsors of the award.



BIG REWARDS

for the most-wanted men in Radio-TV-Electronics



General Electronics Technician

Radio-TV Engineer

Radio-TV Service Manager

Industrial Electronics Technician

Electrical Engineering Technician

Electrical Draftsman

That's right! There are big rewards for the most-wanted men in Radio-TV-Electronics.

You can be one of these men. With the right training you can qualify for a big-pay job in a vital industry. You can start yourself on an exciting, rewarding career in a field that offers unlimited opportunities.

But you must be thoroughly trained. You must know more than wires and tubes. You must *think* in electronic terms.

There's no short-cut to success in Radio-TV-Electronics. But there is a simple, sure way... the I.C.S. way.

I.C.S. is the world's oldest and largest technical training school. Sixty-seven years of experience in training 6½ million students have made the I.C.S. system a success-proven method

of home study. Today, there are more trained men from I.C.S. in supervisory and management jobs than from any other school.

Up-to-the-minute I.C.S. Courses make electronic fundamentals clear, easy-to-follow. *Personalized* guidance helps you through each step.

You study at home — in your spare time — at your own pace. Everything you learn is practical, usable. Courses are prepared by experts who know what *you* need to know to go places.

Join the ranks of the most-wanted men in Radio-TV-Electronics. Your first step is to send for your free I.C.S. Career Kit. You have nothing to lose. You can gain an exciting career in the fastest-growing industry of all time.

HOW WILL YOUR I.C.S. SUCCESS STORY SOUND ?

"I took my diploma from your school in Radio Operating in 1947. In 3 years I became chief engineer of WKOK in Sunbury, Pa. Then I came to California as Audio Engineer for ABC in Hollywood. I still hold this position. I will always be grateful for your help in getting me in the type of profession that has so much to look forward to."

William R. Dreese

"I had been in the radio-repair business for 30 years, when I enrolled in the I.C.S. Television Servicing Course.

"Now I am able to approach a television job in a systematic manner, while others are still operating on the hit-or-miss level."

Kelsey G. Cobb

"Up to the time I enrolled, my interest in electronics was purely a hobby, but before completing my course I was able to do a considerable amount of radio work. Now I have a good part-time business."

George A. Chase

Send the coupon below for your free I.C.S. Career Kit!

- 1 "How to Succeed," 36-page guide to advancement.
- 2 Opportunity handbook for the field of your choice.
- 3 Sample lesson (Math) to demonstrate I.C.S. method.

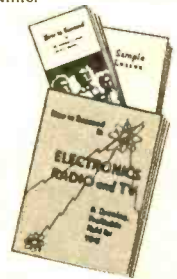

For Real Job Security — Get an I.C.S. Diploma!

I.C.S., Scranton 15, Penna.

Accredited Member,
National Home Study Council

INTERNATIONAL CORRESPONDENCE SCHOOLS



BOX 02574E, SCRANTON 15, PENNA.

(Partial list of courses)

Without cost or obligation, send me "How to Succeed" and the opportunity booklet about the field BEFORE which I have marked X (plus sample lesson):

RADIO TELEVISION ELECTRONICS

- General Electronics Tech.
- Industrial Electronics
- Practical Radio-TV Eng'g
- Practical Telephony
- Radio-TV Servicing

BUSINESS

- Cost Accounting
- Managing a Small Business
- Purchasing Agent

DRAFTING

- Electrical Drafting

HIGH SCHOOL

- High School Diploma
- Good English
- High School Mathematics

ELECTRICAL

- Electrical Engineering
- Elec. Engr. Technician
- Elec. Light and Power
- Practical Electrician
- Professional Engineer (Elec.)

LEADERSHIP

- Industrial Foremanship
- Industrial Supervision
- Personnel-Labor Relations
- Supervision

Name _____ Age _____ Home Address _____

City _____ Zone _____ State _____ Working Hours _____ A.M. to _____ P.M. _____

Occupation _____ Canadian residents send coupon to International Correspondence Schools, Canadian, Ltd., Montreal, Canada. . . . Special tuition rates to members of the U. S. Armed Forces.



Any way you look at it!...

EMC leads in Quality Electronic Test Equipment, at Lowest Prices!

NEW! EMC Model 301 Speedi Tube Tester

Precision crafted for checking tubes in seconds. Only 2 settings to make. Checks for shorts, leakages, and quality. Over 375 tubes now listed, including 0Z4 tube. New listings available. Uses line voltage regulation. Saves precious time and quickly pays for itself. Also available with 7½" meter.

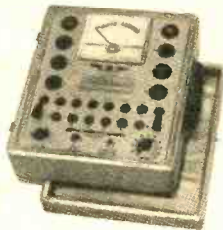

Model 301P, illustrated with 4½" plastic front meter, in oak carrying case, \$47.50; in Kit Form, \$33.20. Model 301C, Sloping Counter Case, \$46.50; Kit, \$32.60. Model PTA, Picture Tube Adaptor (to check and rejuvenate picture tubes) \$4.50



NEW! EMC Model 108 Handi Tester

The only appliance and auto battery tester in its price class to use a D'Arsonval, instead of an iron vane type meter. You get exclusive advantages of maximum accuracy, maximum scale length, and minimum battery replacement cost . . . at no extra cost. Complete with test leads and instruction manual. Wired, \$15.95; in Kit Form, \$12.95.

NEW! EMC Model 905-6A Battery Eliminator, Charger, and Vibrator Checker

A MUST for auto radio service. Features continuously variable voltage output — in either 6 or 12 volt operation. Checks all 6 or 12 volt vibrators. Model 905-6A (Comb.) Wired, \$67.90; Kit, \$44.90. Model 905, Battery Eliminator and Charger (only) Wired, \$37.50; Kit, \$28.90. Model 906, Vibrator Checker (only) Wired, \$31.80; in Kit Form, \$17.05.



NEW! Model BEA, Battery Eliminator Adaptor (for Transistor Radio Checking) Wired, \$9.70

Yes, tell me more, send me—FREE—a detailed catalog of the complete EMC line. EL-6

NAME _____

STREET _____

CITY _____ STATE _____

EMC

Electronic Measurements Corp.
625 B'way • New York 12, N. Y.

EX. DEPT. PAN-MAR CORP., 1270 B'WAY, NEW YORK, N. Y.

...News



Leon M. Bablouzian, a technician at Arthur D. Little, Inc., has invented a device to enable blind people to bowl. The apparatus, consisting of a small box is mounted near the ball rack. The top of the box has small holes representing the position of the pins with pegs projecting through each of the holes when the pins are standing. As pins are knocked down, the corresponding peg is withdrawn. To enable the bowler to position himself, a flat rubber strip with position indicators is placed at the foul line.



In addition to processing information and deciding payment for services rendered, computers now talk to each other via regular toll telephone calls. IBM recently introduced the two 7701 Teleprocessing data machines. To get computed information from one place to another quickly, the operator places the data-filled tape reel on the 7701 and then dials the telephone number of the receiving location. Learning that data is to be sent, the receiving location operator verifies that the receiving terminal is prepared to record the transmitted data. As the operation begins, data passes at the speed of 150 characters a second from the 7701, through a modulating subset provided by the telephone company, through the communication circuits, to a demodulating subset at the other end and into the receiving 7701. The information may also be sent via telegraph.

NOW!
at a price
you can afford!

MAKE MORE MONEY in TELEVISION RADIO-ELECTRONICS

**BETTER...MORE COMPLETE...LOWER COST...
WITH NATIONAL SCHOOLS SHOP-METHOD
HOME TRAINING!**

BETTER... Training that is proved and tested in Resident School shops and laboratories, by a School that is the **OLDEST** and **LARGEST** of its kind in the world.

MORE COMPLETE... You learn **ALL PHASES** of *Television-Radio-Electronics*.

LOWER COST... Other schools make several courses out of the material in our **ONE MASTER COURSE**... and you pay more for less training than you get in our course at **ONE LOW TUITION!**



These
two **FREE** books will
show you how!

You get all information by mail... You make your own decision... at home! **NO SALESMAN WILL CALL**

TOP PAY... UNLIMITED OPPORTUNITIES LIFETIME SECURITY CAN BE YOURS!

You are needed in the Television, Radio, and Electronics industry! Trained technicians are in growing demand at excellent pay—in **ALL PHASES**, including Servicing, Manufacturing, Broadcasting and Communications, Automation, Radar, Government Missile Projects.

NATIONAL SCHOOLS SHOP-METHOD HOME TRAINING, with newly added lessons and equipment, trains you in your spare time at home, for these unlimited opportunities, including many technical jobs leading to supervisory positions.

YOU LEARN BY BUILDING EQUIPMENT WITH KITS AND PARTS WE SEND YOU. Your National Schools course includes thorough *Practical* training—**YOU LEARN BY DOING!** We send you complete standard equipment of professional quality for building various experimental and test units. You advance step by step, perform more than 100 experiments, and you build a complete TV set from the ground up, that is yours to keep! A big, new TV picture tube is included at no extra charge.

EARN AS YOU LEARN. We'll show you how to earn extra money right from the start. Many of our students pay for their course—and more—while studying. So can you!

RESIDENT TRAINING AT LOS ANGELES

If you wish to take your training in our Resident School at Los Angeles, the world's TV capital, start **NOW** in our big, modern Shops, Labs and Radio-TV Studios. Here you work with latest Electronic equipment—professionally installed—finest, most complete facilities offered by any school. Expert, friendly instructors. Personal attention. Graduate Employment Service. Help in finding home near school... and part time job while you learn. Check box in coupon for full information.

LESSONS AND INSTRUCTION MATERIAL ARE **UP-TO-DATE, PRACTICAL, INTERESTING.** Every National Schools Shop-Method lesson is made easy to understand by numerous illustrations and diagrams. All instruction material has been developed and tested in our own Resident School Shops, Laboratories and Studios.

SEND FOR INFORMATION TODAY... it can mean the difference between **SUCCESS** and failure for you! Send for your **FREE BOOK "Your Future in Television-Radio-Electronics"** and **FREE Sample Lesson.** Do it **TODAY**, while you are thinking about your future. It doesn't cost you anything to investigate!

**GET THE BENEFITS OF OUR OVER
50 YEARS EXPERIENCE**

Approved for
GI Training



NATIONAL TECHNICAL SCHOOLS
Los Angeles 37, Calif.

YOU GET...

- 19 Big Kits—**YOURS TO KEEP!**
- Friendly Instruction and Guidance
- Job Placement Service
- Unlimited Consultation
- Diploma—Recognized by Industry
- **EVERYTHING YOU NEED FOR SUCCESS!**

**SHOP-METHOD HOME TRAINING
COVERS ALL PHASES OF INDUSTRY**

1. Television, including Color TV
2. Radio AM & FM
3. Electronics for Guided Missiles
4. Sound Recording and Hi-Fidelity
5. FCC License
6. Automation and Computers
7. Radar & Micro-Waves
8. Broadcasting and Communications

NATIONAL TECHNICAL SCHOOLS
WORLD-WIDE TRAINING SINCE 1905

MAIL NOW TO

NATIONAL TECHNICAL SCHOOLS, Dept. R4Y-50
4000 S FIGUEROA ST. LOS ANGELES 37, CALIF.
Rush free TV-Radio "Opportunity" Book and sample lesson. No salesman will call.

NAME _____ AGE _____

ADDRESS _____

CITY _____ ZONE _____ STATE _____

Check if interested **ONLY** in Resident School training at Los Angeles
VETERANS Give date of Discharge _____

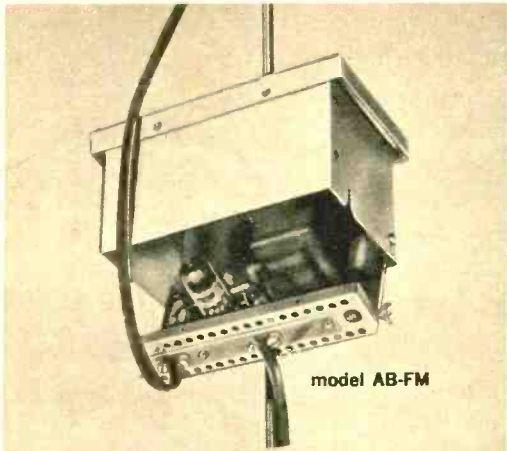

model AB-FM

key to top FM
performance in fringe
and weak signal areas

BLONDER-TONGUE FM ANTENNA BOOSTER

more than 16 db gain over the FM band (88-108mc)

53⁹⁵ list

No matter how sensitive the equipment, the finest FM installation sounds even better when signal power is boosted sharply to bring in all stations crisp and clear. The product that performs this function and does it easily, and at low cost is the Blonder-Tongue AB-FM mast-mounted antenna booster.

The AB-FM features:

new 6ER5 frame-grid tube provides lowest noise figure for brilliant reception • remote control via power supply at or near receiver • amplifier may be located up to 600 feet from remote control unit at receiver • internal multiplex circuit—same transmission line carries AC power 'up' and signal 'down' • easy mast mounting close to the antenna boosts signal before line loss can develop • swing-down chassis for easy service and maintenance • no-strip terminals for speedy, secure installation.

for top TV performance in fringe areas,
VHF Antenna Booster Model AB-2, 53.95 list



Dept. EI-6
BLONDER-TONGUE LABS., INC.
9 Alling Street, Newark 2, N. J.

In Canada: Telequipment Mfg. Co. Ltd., London, Ont.
Export: Morhan Export Corp., New York 13

hi-fi components • UHF converters • master TV
• industrial TV cameras • FM-AM radios

...News



Yardney Electric Corp. has manufactured a silver-cadmium portable TV battery capable of more than 2,000 hours of operation. The 8-cell power pack, is rated at 5 ampere hours. Complete information available from Yardney, 40-50 Leonard Street, New York, New York.



For TV watchers who do not like to leave their comfortable seats, Admiral Corporation has developed a new transistorized remote control amplifier. It incorporates seven transistors and one power diode, no tubes, or batteries. The advantage of this unit is that it doesn't have to be activated nor shut off at the TV set itself as did previous models. The Super Son-R transmits an ultrasonic signal from the small two-button hand remote control unit which activates the TV set, changes channels, adjusts the volume and shuts the set off. Perfect for bedside TV's.

BUILD 16 RADIO CIRCUITS AT HOME

with the New Deluxe PROGRESSIVE RADIO "EDU-KIT"®

only \$22.95

Reg. U.S. Pat. Off.



A Practical Home Radio Course

Now Includes

- ★ 12 RECEIVERS
- ★ TRANSMITTER
- ★ SIGNAL TRACER
- ★ SIGNAL INJECTOR
- ★ CODE OSCILLATOR
- ★ No Knowledge of Radio Necessary
- ★ No Additional Parts or Tools Needed
- ★ EXCELLENT BACKGROUND FOR TV
- ★ School Inquiries Invited
- ★ Sold in 79 Countries

YOU DON'T HAVE TO SPEND HUNDREDS OF DOLLARS FOR A RADIO COURSE

The "Edu-Kit" offers you an outstanding PRACTICAL HOME RADIO COURSE at a rock-bottom price. Our Kit is designed to train Radio & Electronics Technicians, making use of the most modern methods of home training. You will learn radio theory, construction practice and servicing. THIS IS A COMPLETE RADIO COURSE IN EVERY DETAIL.

You will learn how to build radios, using regular schematics; how to wire and solder in a professional manner, how to service radios. You will work with the standard type of punched metal chassis as well as the latest development of Printed Circuit chassis.

You will learn the basic principles of radio. You will construct, study and work with RF and AF amplifiers and oscillators, detectors, rectifiers, test equipment. You will learn and practice radio theory, construction practice and servicing. You will learn and practice trouble-shooting, using the Progressive Signal Tracer, Progressive Signal Injector, Progressive Dynamic Radio & Electronics Tester and the accompanying instructional material. You will receive training for the Novice, Technician and General Classes of F.C.C. Radio Amateur License. You will build 16 Receiver, Transmitter, Code Oscillator, Signal Tracer and Signal Injector circuits, and learn how to operate them. You will receive an excellent background for Television, Hi-Fi and Electronics.

Absolutely no previous knowledge of radio or science is required. The "Edu-Kit" is the product of many years of teaching and engineering experience. The "Edu-Kit" will provide you with a basic education in Electronics and Radio, worth many times the complete price of \$22.95. The Signal Tracer alone is worth more than the price of the entire Kit.

THE KIT FOR EVERYONE

You do not need the slightest background in radio or science. Whether you are interested in Radio & Electronics because you want an interesting hobby, a well paying business or a job with a future, you will find the "Edu-Kit" a worth-while investment. Many thousands of individuals of all

ages and backgrounds have successfully used the "Edu-Kit" in more than 79 countries of the world. The "Edu-Kit" has been carefully designed, step by step, so that you cannot make a mistake. The "Edu-Kit" allows you to teach yourself at your own rate. No instructor is necessary.

PROGRESSIVE TEACHING METHOD

The Progressive Radio "Edu-Kit" is the foremost educational radio kit in the world, and is universally accepted as the standard in the field of electronics training. The "Edu-Kit" uses the modern educational principle of "Learn by Doing." Therefore you construct, learn schematics, study theory, practice trouble-shooting—all in a closely integrated program designed to provide an easily-learned, thorough and interesting background in radio. You begin by examining the various radio parts of the "Edu-Kit." You then learn the function, theory and wiring of these parts. Then you build a simple radio. With this first set you will enjoy listening to regular broadcast stations, learn theory, practice testing and trouble-shooting. Then you build a more advanced radio, learn more advanced theory and techniques. Gradually, in a progressive manner, and at your own rate, you will find yourself constructing more advanced multi-tube radio circuits, and doing work like a professional Radio Technician.

Included in the "Edu-Kit" course are sixteen Receiver, Transmitter, Code Oscillator, Signal Tracer, and Signal Injector circuits. These are not unprofessional "breadboard" experiments, but genuine radio circuits, constructed by means of professional wiring and soldering on metal chassis, plus the new method of radio construction known as "Printed Circuitry." These circuits operate on your regular AC or DC house current.

THE "EDU-KIT" IS COMPLETE

You will receive all parts and instructions necessary to build 16 different radio and electronics circuits, each guaranteed to operate. Our Kit contains tubes, tube sockets, variable, mica, ceramic and paper dielectric condensers, resistors, tie strips, coils, hardware, tubing, punched metal chassis, Instruction Manuals, hook-up wire, solder, etc.

In addition, you receive Printed Circuit materials, including Printed Circuit chassis, special tube sockets, hardware and instructions. You also receive a useful set of tools, a professional electric soldering iron, and a self-powered Dynamic Radio & Electronics Tester. The "Edu-Kit" also includes Code instructions and the Progressive Code Oscillator, in addition to F.C.C.-type Questions and Answers for Radio Amateur License training. You will also receive lessons for servicing with the Progressive Signal Tracer and the Progressive Signal Injector, a High Fidelity Guide and a Quiz Book. You receive Membership in Radio-TV Club, Free Consultation Service, Certificate of Merit and Discount Privileges. You receive all parts, tools, instructions, etc. Everything is yours to keep.

PRINTED CIRCUITRY

At no increase in price, the "Edu-Kit" now includes Printed Circuitry. You build a Printed Circuit Signal Injector, a unique servicing instrument that can detect many Radio and TV troubles. This revolutionary new technique of radio construction is now becoming popular in commercial radio and TV sets.

A Printed Circuit is a special insulated chassis which has been deposited with conducting material which takes the place of wiring. The various parts are merely plugged in and soldered to terminals.

Printed Circuitry is the basis of modern Automation Electronics. A knowledge of this subject is a necessity today for anyone interested in Electronics.

UNCONDITIONAL MONEY-BACK GUARANTEE

ORDER DIRECT FROM AD—RECEIVE FREE BONUS RESISTOR AND CONDENSER KITS WORTH \$7

- Send "Edu-Kit" Postpaid. I enclose full payment of \$22.95.
- Send "Edu-Kit" C.O.D. I will pay \$22.95 plus postage.
- Rush me FREE descriptive literature concerning "Edu-Kit."

Name

Address

PROGRESSIVE "EDU-KITS" INC.

1186 Broadway, Dept. 524AE, Hewlett, N. Y.

FREE EXTRAS

- SET OF TOOLS
- SOLDERING IRON
- ELECTRONICS TESTER
- PLIERS-CUTTERS • ALIGNMENT TOOL
- WRENCH SET
- VALUABLE DISCOUNT CARD
- CERTIFICATE OF MERIT
- TESTER INSTRUCTION MANUAL
- HIGH FIDELITY GUIDE • QUIZZES
- TELEVISION BOOK • RADIO TROUBLE-SHOOTING BOOK
- MEMBERSHIP IN RADIO-TV CLUB: CONSULTATION SERVICE • FCC AMATEUR LICENSE TRAINING
- PRINTED CIRCUITRY

SERVICING LESSONS

You will learn trouble-shooting and servicing in a progressive manner. You will practice repairs on the sets that you construct. You will learn symptoms and causes of troubles in home, portable and car radios. You will learn how to use the professional Signal Tracer, the unique Signal Injector and the Dynamic Radio & Electronics Tester. While you are learning in this practical way, you will be able to do many a repair job for your friends and neighbors, and charge fees which will far exceed the price of the "Edu-Kit." Our Consultation Service will help you with any technical problems you may have.

J. Stataitis, of 25 Poplar Pl., Waterbury, Conn., writes: "I have repaired several sets for my friends, and made money. The "Edu-Kit" paid for itself, I was ready to spend \$240 for a Course, but I found your ad and sent for your Kit."

FROM OUR MAIL BAG

Ben Valerio, P. O. Box 21, Magna, Utah: "The Edu-Kits are wonderful. Here I am sending you the questions and also the answers for them. I have been in Radio for the last seven years, but like to work with Radio Kits, and like to build Radio Testing Equipment. I enjoyed every minute I worked with the different kits; the Signal Tracer works fine. Also like to let you know that I feel proud of becoming a member of your Radio-TV Club."

Robert L. Shuff, 1534 Monroe Ave., Huntington, W. Va.: "Thought I would drop you a few lines to say that I received my Edu-Kit, and was really amazed that such a bargain can be had at such a low price. I have already started repairing radios and phonographs. My friends were really surprised to see me get into the swing of it so quickly. The Troubleshooting Tester that comes with the Kit is really swell, and finds the trouble, if there is any to be found."



A device which will allow America's first orbiting astronaut to determine his position over the Earth at any time is

being designed by Minneapolis-Honeywell. It consists of a small globe-like replica of the Earth which revolves slowly to duplicate the position of the Earth under the orbiting capsule. Mechanically powered, the Earth Path Indicator will be the prime source of position information for the astronaut should he lose contact with the ground stations.



Eric Engineering Company has unveiled a new dual channel amplifier priced at \$103.70 (East), \$99.95 (West). The "Dual Twenty" is an ultra-linear amp-preamp with 20 watts per channel incorporating the usual stereo controls and inputs. The nearly identical "Dual Ten" lists for \$79.95.

Another of Eric's new products is the Auto FM tuner. Model FM 100 operates on any car with a 12-volt battery through the regular car radio and speaker. It is installed under the dash. Priced at \$79.95 from Eric, 1823 Colorado Avenue, Santa Monica, California.



the fastest growing name in
SOLDERING IRONS

ALL SOLDER-CHIEF IRONS FEATURE:

- Unconditional Guarantee • Extra-Fast Heating Elements • Rugged Construction
- Replaceable Tips • U.L. Approved Cords and Plugs • 110-120 Volts AC or DC Operation

STANDARD LINE OF LOW COST IRONS



PENCIL SOLDERING IRON

MODEL A 500
30 wattsList \$2.20
This quality iron is unexcelled in its versatility and usefulness. There is no other iron sold that is more ideal for Transistor and Printed Circuit work, than this power-packed Pencil Iron. And the entire weight of the iron including cord and plug is only 4 ounces. We recommend this iron for all delicate and precision work.



MODEL A 100
30 wattsList \$1.24
MODEL A 200
60 wattsList \$1.56
MODEL A 300
80 wattsList \$1.76
Features Pre-Tinned, Long-Life Tips. Inexpensive Irons with expensive appearance and high quality performance. These irons will outlast and out-perform any other brand selling in this price range. Newly designed barrel concentrates the full heat at the Tip. The excellent balance of the iron makes it a delight to work with. More convenient and less tiring than any gun iron for continuous use.



HEAVY DUTY PRODUCTION SOLDERING IRONS

MODEL A 600
100 wattsList \$5.00
MODEL A 700
150 wattsList \$6.20
MODEL A 800
200 wattsList \$7.60
MODEL A 900
300 wattsList \$9.40
Ideal for Continuous duty, 24 hour operation. On-Off switch on handle for convenience of user. Long-life nickel-plated tips. Lightweight, shatterproof handles. Fast-Heating Precision-Wound Elements. Excellent for heavy Factory work.



Available at your local Radio, Hardware, Automotive, Dept., and Variety stores. Write to us for name and address of nearest dealer.

L.I. ELECTRO-LABS, INC. 1186 Broadway, Dept. 501 AR, Hewlett, N. Y.

F.C.C. COMMERCIAL OPERATOR LICENSE

Training... for Jobs in Electronics

F.C.C. LICENSE—THE KEY TO BETTER JOBS

An F.C.C. *commercial* (not amateur) license is your ticket to higher pay and more interesting employment. This license is Federal Government evidence of your qualifications in electronics. Employers are eager to hire *licensed* technicians.

WHICH LICENSE FOR WHICH JOB?

The **THIRD CLASS** radiotelephone license is of value primarily in that it qualifies you to take the second class examination. The scope of operation covered by a third class license is extremely limited.

The **SECOND CLASS** radiotelephone license qualifies you to install, maintain and operate every type of radiotelephone equipment except commercial broadcast station equipment.

The **FIRST CLASS** radiotelephone license qualifies you to install, maintain and operate every type of radiotelephone equipment (except amateur) including all radio and television stations in the United States, its territories and possessions. This is the highest class of radiotelephone license available.

GRANTHAM TRAINING PREPARES YOU

The Grantham Communications Electronics Course prepares you for a **FIRST CLASS** F.C.C. license, and it does this by **TEACHING** you electronics. Each point is covered simply and in detail, with emphasis on making the subject easy to understand. The organization of the subject matter is such that you progress, step-by-step, to your specific objective—a first class F.C.C. license.

CORRESPONDENCE OR RESIDENCE CLASSES

Grantham training is available by correspondence or in resident classes. Either way, you are trained quickly and well. Write, or mail the coupon below, to any division of Grantham School of Electronics. Our free booklet will be sent to you immediately.

HERE'S PROOF...

that Grantham students prepare for F.C.C. examinations in a minimum of time. Here is a list of a few of our recent graduates, the class of license they got, and how long it took them:

Name	Address	License	Weeks
Richard M. Wilhoit	2104 Santa Paula, Las Vegas, Nev.	1st	12
Larry R. Perrine	7 Normandy Place, Champaign, Ill.	1st	15
Marion Woolsey	3246 Warwick, Kansas City, Mo.	1st	12
Harold W. Johnson	5070 Hermosa Ave., Los Angeles, Calif.	1st	15
Ralph Frederick Beisner	2126 Grand, Joplin, Mo.	1st	12
N. B. Mills, II	110 So. Race St., Statesville, N. C.	1st	12
Dean A. Darling	403 S. Chase Ave., Columbus 4, Ohio	1st	12
Gerald L. Chopp	518 Audubon Road, Kohler, Wis.	1st	12

FOUR COMPLETE SCHOOLS: To better serve our many students throughout the entire country, Grantham School of Electronics maintains four complete Divisions—located in Hollywood, Calif., Seattle, Wash., Kansas City, Mo., and Washington, D.C. All Divisions of Grantham School of Electronics offer the same rapid courses in F.C.C. license preparation, either by home study or in resident classes.

Get your First Class Commercial F.C.C. License in 12 weeks by training at

Grantham School OF ELECTRONICS

HOLLYWOOD
CALIF.

1505 N. Western Ave.
Hollywood 27, Calif.
(Phone: HO 7-7727)

SEATTLE
WASH.

408 Marion Street
Seattle 4, Wash.
(Phone: MA 2-7227)

KANSAS CITY
MO.

3123 Gillham Road
Kansas City 9, Mo.
(Phone: JE 1-6320)

WASHINGTON
D. C.

821-19th Street, N.W.
Washington 6, D. C.
(Phone: ST 3-3614)

for **FREE** Booklet **CLIP COUPON** and mail
in envelope or paste on postal card.



To: **GRANTHAM SCHOOL OF ELECTRONICS**

1505 N. Western Hollywood • 408 Marion Seattle • 3123 Gillham Rd. Kansas City • 821-19th, NW Washington

Please send me your free booklet telling how I can get my commercial F.C.C. license quickly. I understand there is no obligation and no salesman will call.

Name _____ Age _____

Address _____

City _____ State _____

I am interested in: Home Study, Resident Classes 08-G

MAIL COUPON NOW

PASS A GENIUS!

HOW TO

All of us can't be geniuses. But any ordinarily talented mortal can be a success—and that's more than some geniuses are.

All that's needed is training—the kind of specialized job training that sets you apart from the great mass of unskilled workers.

In good times and bad times, in every technical and business field, the trained man is worth a dozen untrained ones, no matter how gifted.

The International Correspondence Schools can't make you into a genius. For more than 70 years, however, I.C.S. has been helping its students to become trained, successful leaders—and it can do the same for you.

Mark your special job interest on the coupon below. I.C.S. will send FREE a valuable Career Kit with 3 famous booklets that helped thousands find real success.

INTERNATIONAL CORRESPONDENCE SCHOOLS



Box 32574E, Scranton 15, Penna.

(Partial list of courses)

Without cost or obligation, send me "HOW to SUCCEED" and the opportunity booklet about the field BEFORE which I have marked X (plus sample lesson):

- | | |
|--|---|
| <input type="checkbox"/> Architecture | <input type="checkbox"/> Electrical |
| <input type="checkbox"/> Art | <input type="checkbox"/> High School |
| <input type="checkbox"/> Automotive | <input type="checkbox"/> Mechanical |
| <input type="checkbox"/> Business | <input type="checkbox"/> Plumbing-Heating-Air Cond. |
| <input type="checkbox"/> Civil Engineering | <input type="checkbox"/> Radio-TV-Electronics |
| <input type="checkbox"/> Drafting | <input type="checkbox"/> Salesmanship |

Name _____

Home Address _____

City _____ State _____

...News



The RE-400, a new dual speed tape recorder has been announced by Lafayette. A single knob controls all operations (stop, play, etc.) and an indicator light shows optimum volume control setting. Outputs for another speaker, recording from microphone or phonograph are provided. Playing speeds are 7½ and 3¾ ips. Priced at \$54.50 complete with crystal microphone from Lafayette, 165-08 Liberty Avenue, Jamaica 33, New York.



The Pony, a rechargeable battery and plug-in charger for transistor radios has been made available by B & K Manufacturing Co. It can replace the 9-volt battery used in most transistor radios. Price for both battery and charger is \$4.95 from B & K, 1801 W. Belle Plaine Avenue, Chicago 13, Illinois.

World's only TRANSISTORIZED POCKET F-M RADIO KIT.



An F-M radio tuner for your car, home, and any portable radio. The tuner can be used as a pocket set with the special matched earpiece, and used in planes as it tunes the aircraft band. Your choice of the following bands (one choice only):

No. 1 Band from channel 5 T-V and the 88 to 108 Meg. band regular F-M. No. 2 Band from 88 to 145 Meg.; this includes aircraft transmissions and the F-M. No. 3 Band from channel 2, 3, 4, 5 TV-sound transmissions. No. 4 Band from 30 to 60 Meg.; this is police cars, to mobile phone transmissions.

Transistorized pocket F-M kit with special matched earpiece **\$29.95 P. P.**

EKERADIO

650 North Fair Oaks, Pasadena, California

Here's The Offer No Other Radio-TV School DARES MAKE!

LEARN AT HOME in Spare Time!

YOU DO MANY PRACTICAL JOBS with the kits we send you. That's right, you PRACTICE what we TEACH! You build a Signal Generator, AC-DC Power Pack, and AC-DC Superheterodyne Radio Receiver and top quality 21 inch TV Set. EARN AS YOU LEARN with the famous RTS 30 Day Income Plan. Full instructions provided. NO HIGH SCHOOL DIPLOMA NECESSARY. This is a COMPLETE course which starts with basic subjects and gradually advances to Radio-TV. . . . ALL FOR A PRICE YOU CAN AFFORD!



*THE ONLY VERTICAL MULTI-CHASSIS 21" TV KIT OFFERED BY ANY RADIO-TV SCHOOL

YOU BUILD THESE AND OTHER UNITS!

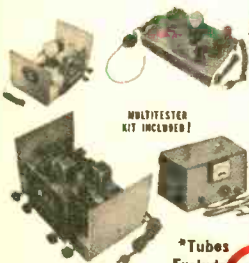

MULTIFESTER KIT INCLUDED!

*Tubes Excluded

COMPLETE COLOR TV INSTRUCTION INCLUDED!

Each student is entitled to unlimited consultation service. All questions are answered promptly and completely by highly specialized instructors.

RTS' Membership in The Association of Home Study Schools is your assurance of Reliability, Integrity and Quality of Training.



RADIO-TELEVISION TRAINING SCHOOL
5100 S. VERMONT AVENUE
LOS ANGELES 37, CALIFORNIA

L 101B

Est. 1922



Rush Coupon for FREE FACTS!

RTS Will Train You at a Price You Can Afford and When You Are a Qualified Graduate Will Help You Open a Service Shop of Your Own and Supply You With Every Bit of Equipment You Need to Get Started - Plus an Inventory of Parts and Necessary Supplies.

ALL FINANCED WITHOUT INTEREST OR CARRYING CHARGES!!

You Also Receive . . . Advertising Help and Material, Shop Plans, Business Systems, Letterheads, Calling Cards and Much More!

Here's What Two of Many Business Plan Shop Owners Have to Say!

This business takes in between \$1500 and \$2000 a month. I've had to hire help to keep up with it.

CULLEN W. IRBY
Corpus Christi, Texas

The school lives up to its promises 100%. RTS does not lose interest in its students once they graduate.

HAROLD R. STANLAKE
Perry, Michigan

DON'T LOSE OUT — FIND OUT!

RADIO TELEVISION TRAINING SCHOOL, Dept. E1-660
5100 S. Vermont Ave., Los Angeles 37, Calif.
Rush me full information by return mail. (Please Print)

NAME _____ AGE _____
STREET _____
CITY _____ ZONE _____ STATE _____

NO SALESMAN WILL CALL ON YOU!

free
NEW



GIANT Electronics Catalog

plus
every new issue
for one full year!

Own America's most complete electronics buying guide—Radio Shack's giant 312-page catalog filled with over 100,000 items! Stereo, hi-fi, ham radio, LP records, tapes, optical goods and scores more—all at famous money-saving Radio Shack prices. 15-day no-risk home trial on any item! Mail the coupon now for your catalog free and postpaid to you, PLUS every new issue for full year FREE! Satisfaction guaranteed.



8-Transistor Portable \$29.95

Outperforms all portables under \$100! It's a radio, a speaker, a P.A. amplifier. 6½ x 3-9/16 x 1¾". Battery included.

RADIO SHACK CORP.

MAIL COUPON NOW

Radio Shack Corp., 730 Commonwealth Ave.
Boston 17, Mass. Dept. 60F8

Send FREE Electronics Catalog—Also every new issue for 12 months, a full year's subscription Free.

Name _____

Address _____

Postoffice _____

or City _____

Zone _____ State _____

ONE CENT SALE

**BUY ONE AT OUR REGULAR LOW PRICE AND
GET THE SECOND FOR ONLY 1¢ MORE**

CITIZENS BAND TRANSMITTER (27 MC) 5 watt chassis, complete with crystal, \$14.99 each, two for \$15.00.

CITIZENS BAND RECEIVER chassis tunable through all 22 channels. Complete with audio amplifier. \$9.99 each, two for \$10.00.

AMATEUR BAND TRANSCEIVER (144-148 MC) chassis with dual VHF triodes for walkie-talkie radiophone. \$9.99 each, two for \$10.00.

TRANSCEIVER TRANSFORMER: Mike to grid input and plate to low impedance headphone output. Good for telephone handsets. \$1.99 pair, two for \$2.00.

TELEPHONE HANSET with push-to-talk switch. \$5.99 each, two for \$6.00.

SIGNAL BOOSTER chassis for 27 MC. High gain (20DB) double tuned RF pentode amplifier. Improves performance of any Citizen Band receiver. Complete with tube \$11.99 each—2 for \$12.00.

COILED CORD 4 conductor 11" telephone cord. Extends to over 4 ft. .99 each, two for \$1.00.

KIT OF PARTS for AM-FM VHF radio receiver. Tunable from 80-200 mc. which includes U. S. satellite frequencies. \$6.99 each, two for \$7.00.

TRANSISTOR AUDIO AMPLIFIER gives 50X voltage gain on low level signals. Operates on 1½ volts. \$3.99 each, two for \$4.00.

CONVERTER (crystal controlled) for 27 MC Citizens Band. Adapts any standard broadcast radio to 27 MC band. Tunes all 22 channels. Complete with tubes and crystal. \$14.99 each, 2 for \$15.00.

ALL MERCHANDISE GUARANTEED

Limited Quantity—No Literature or Catalog

Remit in full, include sufficient postage. No C.O.D.'s.

VANGUARD ELECTRONIC LABS. Box 12-EL-6
Hollis 23, N. Y.

...News

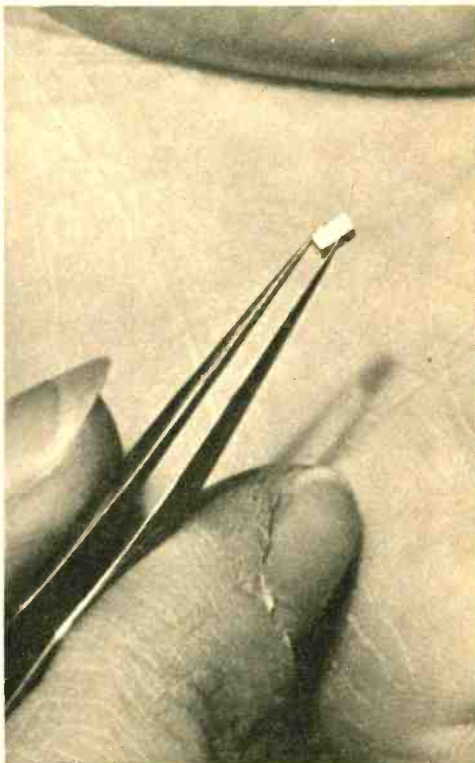

General Electric research scientists have successfully made tunnel diodes which work at frequencies above 4000 megacycles. Key to the improved performance is the use of gallium arsenide, a little known and rarely used semiconductor material, as the basic element in the device's construction. Frequencies well above 10,000 megacycles are possible with tunnel diodes made of gallium arsenide.

Now computers not only do a job, but figure out how much they should be paid for their services. Heretofore, the computers were paid on an hourly basis, but at the RCA Electronic Systems Center on Wall Street in New York City, the stipend will be determined by the amount of work involved which is decided by the computer itself. RCA said the computer method would permit a saving of up to 50 per cent of present accounting costs.

ANOTHER WAY RCA
SERVES EDUCATION
THROUGH
ELECTRONICS

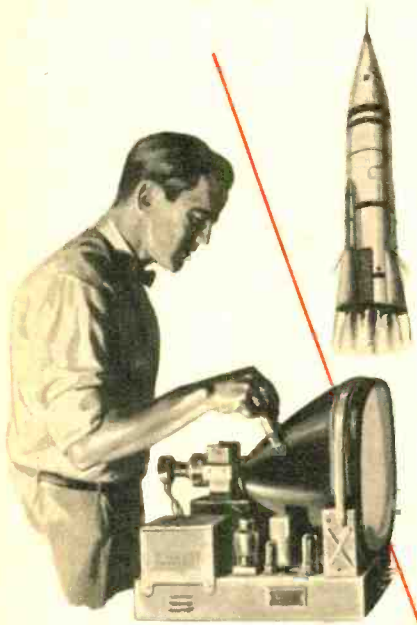

6 REASONS WHY RCA TRAINING IN ELECTRONICS

can be the smartest investment
you'll make in your *entire lifetime!*

1. You get the finest training-at-home under the supervision of the RCA INSTITUTES, experts in technical training for over 50 years. The very name "RCA" means dependability, integrity, and scientific advance.

2. You get comprehensive training in your choice of four complete, up-to-date Courses . . . from basic electronics theory to Color TV and Automation.

3. You get Theory, Experiment, and Service Practice starting with the very first lesson . . . a complete training package throughout the course. No special technical background is required.

4. You get prime quality equipment as a regular part of your Course . . . equipment that you keep and use on the job. You never have to take apart one piece to build another.

5. You get each study group on a pay-as-you-go basis. Should you wish to interrupt your training at any time, you will not owe RCA Institutes a penny more, unless and until you decide to resume the Course.

6. You get top recognition — worldwide. Graduates of RCA Institutes now work for leaders in the electronics field; many have their own businesses. This record is true tribute to the high quality of RCA Institutes training.

Send for this
64-page Home
Study Catalog
FREE!



RESIDENT SCHOOL Courses in New York City and Los Angeles offer comprehensive training in Television and Electronics. Day and Evening classes start four times each year. Detailed information on request.

RCA INSTITUTES, Inc. Home Study School Dept. EI-60

A Service of Radio Corporation of America
350 West Fourth Street, New York 14, N. Y.

Please rush me your FREE illustrated 64-page book "Your Career in Electronics," describing your home training programs. No obligation. No salesman will call.

Name Age
please print

Address

City Zone State

Korean Vets! Enter discharge date

CANADIANS — Take advantage of these same RCA courses at no additional cost. No postage, no customs, no delay. Send coupon to: RCA Victor Company, Ltd., 5001 Cote de Liesse Rd., Montreal 9, Quebec
To save time, paste coupon on postcard.

IT'S FUN TO BE AN ARMCHAIR ADVENTURER



With a NATIONAL NC-60 SPECIAL "A" Shortwave Radio Receiver you can cross the six continents in the comfort of your favorite chair, visit foreign lands, eavesdrop on aircraft, ships at sea and radio hams. Enjoy standard broadcast too, with this powerful new radio receiver. Suggested price only \$59.95. Write for literature and name of nearest dealer.

JOIN THE NATIONAL ASSOCIATION OF ARMCHAIR ADVENTURERS

SEND 50c for membership certificate and exciting new book on Shortwave Listening. Tells when, where, how to listen, provides log for listing countries you hear. SEND 50c to:

National RADIO CO., INC.
MELROSE 76, MASS. 
A wholly owned subsidiary of National Company, Inc.
Export: AD AURIEMA, INC. 85 Broad St., New York, N. Y., U.S.A.
In Canada: CANADIAN MARCONI CO., Toronto 17

DIAGNYZER

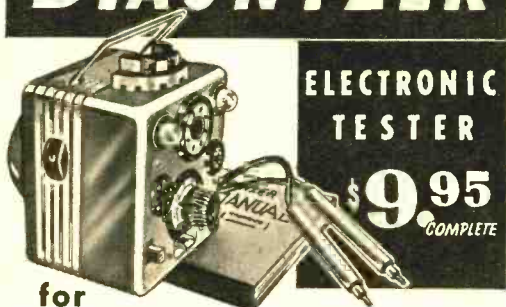

**ELECTRONIC
TESTER**

\$9.95
COMPLETE

for DO-IT-YOURSELF SERVICING

INDISPENSABLE—FOR TV, RADIO, HI-FI—
Appliances, Autos, Electrical Tools. Used in Home, Shop and Farm,
Checks Radio and TV Tubes, Components, Voltages and Circuits, etc.

INEXPENSIVE TO OWN, EASY TO USE
Anyone can do servicing with this wonderful instrument, pays for itself
the first time you use it. Best value for money, nothing else like it.

**COMPLETE TRAINING COURSE AND SERVICE MANUAL
INCLUDED FREE WITH EACH INSTRUMENT**

- Send "Diagnyzer" postpaid. I enclose full payment of \$9.95
- Send "Diagnyzer" C.O.D. I will pay \$9.95 plus postage.
- Rush me FREE descriptive literature concerning "Diagnyzer."

Name

Address

APPARATUS DEVELOPMENT CO.
Dept. E1-6, Wethersfield, Conn.

...News



This new compact battery-operated tube tester is quite versatile. Only 3 3/4" x 6", the unit will test most tube types and circuits for continuity. In addition it will check out high voltage circuits, fuses and pilot lamps. Priced at \$6.95 from Empire Merchandising Co., 170 Marbledale Road, Tuckahoe, New York. The tester is manufactured by Darod Electronics, Inc., Mt. Vernon, N. Y.

The whispers in the wind can now be heard with the help of microphones no larger than a letter of type on this page. Prof. Erik L. Moloo-Christensen of M.I.T. and his associates are assembling apparatus that will enable them to add known sounds at known temperatures and pressures to the air. The researchers hope to find out what becomes of the added sounds. They want to learn how jets and rockets carry and scatter their noise. In addition to the new tiny microphones, wires so fine they are difficult to see with the naked eye will be incorporated into the apparatus.



Accredited by the National Home Study Council

good training
doesn't cost . . .
it pays!

How To Get an



FCC License (Commercial)

Get Your FCC License
Quickly

We Guarantee to train you **until you receive** **Your FCC License**

Get all 3 FREE

We guarantee
to train you until you receive
Your FCC License

—or your money back

The master Course in Electronics will provide you with the mental tools of the electronics technician and prepare you for a First Class FCC License (Commercial) with a radar endorsement. When you successfully complete the Master Course, if you fail to pass the FCC examination, you will receive a full refund of all tuition payments.

GET THIS HANDY POCKET
ELECTRONICS DATA GUIDE

Free . .

Puts all the commonly used conversion factors, formulas, tables, and color codes at your fingertips. Yours absolutely free if you mail the coupon in 30 days. No further obligation!

TO GET THIS FREE
GIFT, MAIL COUPON Within 30 Days!

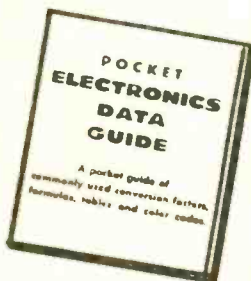

Cleveland Institute of Electronics

4900 Euclid Ave., Desk EI-21

Cleveland 3, Ohio



Cleveland Institute of Electronics

4900 Euclid Ave., Desk EI-21, Cleveland 3, Ohio

Please send Free Booklets prepared to help me get ahead in Electronics and a free copy of your "Pocket Electronics Data Guide." I have had training or experience in Electronics as indicated below:

- | | |
|---|---|
| <input type="checkbox"/> Military | <input type="checkbox"/> Broadcasting |
| <input type="checkbox"/> Radio-TV Servicing | <input type="checkbox"/> Home Experimenting |
| <input type="checkbox"/> Manufacturing | <input type="checkbox"/> Telephone Company |
| <input type="checkbox"/> Amateur Radio | <input type="checkbox"/> Other _____ |

In what kind of work
are you now engaged?

In what branch of
Electronics are you
interested?

Name _____ Age _____

Address _____

City _____ Zone _____ State _____

EI-21



The wind can power this auto if the sun doesn't. The sail-like panel mounted atop this 1912 Baker electric is composed of 10,000 silicon solar cells which catch the sunlight and through the conversion system, power the auto. Although charging the 72-volt battery may take over 10 hours, the car's 3 hp motor is capable of running at a speed of 20 mph for almost 50 miles. Needless to say, improvements will be made. The conversion system was designed by Dr.

Charles A. Escoffery of M.I.T. and the actual car was created by International Rectifier Corporation, a manufacturer of silicon cells. Mass production for a consumer market is expected.

Computer automated checkout systems for supermarkets are now in design stages. First, the Keedoozle, involves the customer inserting a special key into a case slot below the desired item and the tape in the key is punched. At the checkout stand the tape is inserted into the reader which activates a chute in the warehouse bringing the merchandise to the front. The Auto-Serve system works by having the customer take a punched card at the merchandise display and present the cards at the checkout stand where they are run through a reader and the merchandise is handled as above. In addition to speed, an automated system must allow the customer to see the cost of the items being rung up and issue an itemized receipt

Build the Best CITIZENS BAND TRANSCEIVER ...



- 760 (117 VAC) less bracket: Kit \$59.95, Wired \$89.95
- 761 (117 VAC & 6 VDC): Kit \$69.95, Wired \$99.95
- 762 (117 VAC & 12 VDC): Kit \$69.95, Wired \$99.95

Highly reliable; exemplary electronic, mechanical, industrial design. Powerful 5-watt (as defined by FCC) crystal-controlled transmitter & extremely sensitive, selective Superhet receiver with RF stage & noise limiter. Built-in speaker, detachable ceramic mike. Pre-set & sealed crystal oscillator circuit elements. To change channels, just change crystals — no adjustments needed. Built-in variable "pi" network matches most popular antennas. Portable whip, rear bumper & roof antennas available. No exams or special skills needed — any citizen 18 years or older may obtain station license by submitting FCC form, supplied free by EICO.

Build the Best 6-TRANSISTOR RADIO RA-6

Kit \$29.95 Wired \$49.95
includes FET, less 9V battery

High sensitivity & selectivity. New plug-in type transistors. Big-set volume & tone: 4" x 6" speaker; push-pull audio. Built-in Ferrite rod antenna. Pre-aligned RF & IF transformers. Planetary vernier tuning. Earphone jack for private listening. Attractive tan leatherette case, retractable handle. Compact: 8½" w, 4½" h, 2½" d. Only 3 lbs.



90-WATT CW TRANSMITTER* #720

Kit \$79.95 Wired \$119.95

*U.S. Pat No. D-184,776
"Top quality" — ELECTRONIC KITS GUIDE. Ideal for veteran or novice. 90W CW, 65W external plate modulation. 80 through 10 meters.



HIGH-LEVEL UNIVERSAL MODULATOR-DRIVER #730

Kit \$49.95 Wired \$79.95

Cover E-5 \$4.50
Delivers 50W undistorted audio. Modulates transmitters having RF inputs up to 100W. Unique over-modulation indicator.



Build the Best Ham Gear

New Code Practice Oscillator #706

Kit \$8.95 Wired \$12.95

Rugged battery-operated transistor oscillator circuit, built-in speaker. Front panel has flashing light, phone jack, pitch control (500-2000 cps), external key terminals, "Temporary" key. Panel switch selects Tone, Light, or both Tone & Light. 6½" h, 3¾" w, 2¾" d.



GRID DIP METER #710

Kit \$29.95 Wired \$49.95

Includes complete set of coils for full band coverage. Continuous coverage 400 kc to 250 mc. 500 ua meter.



Compare — judge for yourself — at your neighborhood EICO dealer. For FREE catalog on over 70 models of easy-to-build professional test instruments, hi-fi and ham gear, fill out coupon on Page 24.



Add 5% in the West. © 1960

3300 N. Blvd., L. I. C. I. N. Y.

IMPORTANT: For the man who wants to make big money in Radio-Television!

ONLY SPRAYBERRY TRAINING IN RADIO and TELEVISION

**OFFERS YOU ALL OF THESE VITAL NEW ADVANTAGES
TO HELP YOU EARN MORE MONEY FROM THE START!**

NEW BUSINESS BUILDERS

... through these practical proven plans and ideas we help you make plenty of extra money in spare time while training.

NEW TRAINING EQUIPMENT

... the famous Sprayberry Training kits have been newly engineered by our staff to offer you the latest in Radio-TV Service Techniques!

NEW TRANSISTOR COURSE

... literally millions of new transistor radios are being used. We show you how to make money fixing them!

NEW HIGH FIDELITY

... there's big money to be made installing and servicing Hi-Fi units. Your Sprayberry training now offers you this valuable and profitable preparation!

TRAIN AT HOME—SPARE TIME

WITH THESE **25 BIG COMPLETE KITS OF PARTS & EQUIPMENT**



You learn Radio-TV Servicing the best way... the practical way... testing and assembling these modern kits of equipment.

The new Sprayberry Training Television Receiver, built and tested in 5 sections.



Now offered... this fine modern oscilloscope.



You build this powerful two-band super-heterodyne radio receiver.

You build the new Sprayberry tester—a complete 18-range Volt-Ohm-Milliammeter test meter.



FREE These two big new books are yours free! Find out what Radio-Television offers you... and let us show you how easily you can learn, even without previous experience of any kind. Rush COUPON today!

The field of Radio-Television Servicing is such a fast moving industry that the best jobs and biggest incomes always go first to the man with the most modern, complete and up-to-date training. Thanks to constant revision and improvement... Sprayberry Training helps you earn more from the start... and keeps you earning more in the months and years ahead!

Make no mistake! All radio-television training is not alike. The basic purpose behind Sprayberry Training is to prepare you as rapidly and as surely as possible... to make top money servicing Radio and Television sets and equipment. This is where the big money has been for years... and will continue to be in the years ahead.

It's important for you to know that for over 30 years... Sprayberry Training has been preparing ambitious men for success in this interesting and profitable kind of work. Our school has helped hundreds to qualify for the best jobs... or to get started in profitable businesses of their own. Today our student rolls are the largest in our school's history... because the need and demand for Radio-Television Service Technicians has never been more urgent.

Just \$6.00 Starts You

To encourage more men to enter Radio-Television at once... to help fill the great need for trained men... we're making it easier than ever before to start training. Just \$6.00 enrolls you. This liberal offer is naturally limited. Get the facts now

and consider enrollment while these favorable terms are available to you.

KEEP YOUR JOB

... while learning

Under the Sprayberry Plan you train entirely at home in spare time. You combine the most modern lesson training with fascinating and invaluable practical work with 25 big kits of parts and equipment that we supply. You get the equivalent of years of shop practice... and you can train as fast or as slowly as you wish. We help you make excellent spare time money while learning... and everything you receive—lessons, books, manuals, equipment—all yours to keep!

This is the Radio-Television industry's most modern and up-to-the-minute training. Sprayberry is the one school that gives you personalized attention and takes a real interest in your progress. Remember... just \$6 starts you! Mail the coupon today. Let the facts speak for themselves. Let us send you our new catalog and sample lesson... and prove the kind of opportunity that Sprayberry training can open up for you.



MAIL COUPON—No Salesman Will Call

SPRAYBERRY ACADEMY OF RADIO-TELEVISION
DEPT. 120-L, 1512 W. JARVIS AVE., CHICAGO 26, ILL.
Please rush all information on your ALL-NEW Radio-Television Training Plan. I understand this does not obligate me and that no salesman will call upon me. Include New Catalog and Sample Lesson FREE.

NAME.....AGE.....
ADDRESS.....
CITY.....ZONE.....STATE.....

SPRAYBERRY ACADEMY OF RADIO-TELEVISION

Dept. 120-L, 1512 West Jarvis Ave., Chicago 26, Ill.

the experts say
YOUR BEST BUY
 is **EICO**...

EICO, 3300 N. Blvd., L.I.C. 1, N.Y. EI-6

Show me HOW TO SAVE 50% on 70 models of top-quality: HI-FI TEST INSTRUMENTS
 "HAM" GEAR. Send FREE Stereo Hi-Fi Guide. Send FREE Short Course for Novice License. Send FREE Catalog & name of neighborhood EICO dealer.

ADD 5% IN THE WEST

Name
 Address
 City Zone State

...in
STEREO and MONO HI-FI



STEREO Dual Amplifier-Preamplifier HF81
 Kit \$69.95.
 Wired \$109.95.
 "Excellent" — SATURDAY REVIEW; HI-FI MUSIC AT HOME.



NEW! STEREO Automatic Changer/Player 1007 (7 mil diamond, 3 mil sapphire dual styli)
 \$59.75 incl. F.E.T.



FM Tuner HFT90 Kit \$39.95*.
 Wired \$65.95*.
 Cover \$3.95.
 "One of the best buys" AUDIOCRAFT.

*Less Cover, F.E.T. incl.

AM Tuner HFT94 Kit \$39.95. Wired \$65.95, incl. Cover & F.E.T.
FM/AM Tuner HFT92 Kit \$59.95. Wired \$94.95. Includes Cover & F.E.T.



STEREO Dual Preamplifier HF85
 Kit \$39.95.
 Wired \$64.95.
 "Extreme flexibility" — HI-FI REVIEW a bargain"



Mono Power Amplifiers (60, 50, 35, 30, 22, 14-Watt; use 2 for Stereo) from Kit \$23.50. Wired \$41.50.



2-Way Bookshelf Speaker System HFS1 complete with factory-built cabinet: \$39.95.

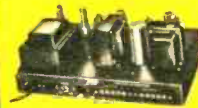

STEREO Dual Power Amplifiers: New 100W HF89
 Kit \$99.50
 Wired \$139.50
 70W HF87: Kit \$74.95. Wired \$114.95.
 28W HF86: Kit \$43.95. Wired \$74.95.



Mono Integrated Amplifiers: (50, 30, 20, 12-Watt; use 2 for Stereo) from Kit \$34.95. Wired \$57.95.



NEW! COMPLETE STEREO DUAL AMPLIFIER AF-4
 Kit \$38.95
 Wired \$64.95

TRUE Hi-Fi quality to drive hi efficiency speakers to concert volume.

...and in
TEST INSTRUMENTS



New Power & Bias Supply for Transistorized Eqp. #1020*
 Kit \$19.95
 Wired \$27.95
 * Patent Pending



Miniaturized Multi-Signal Tracer #145A
 Kit \$19.95
 Wired \$28.95.



Vacuum Tube Voltmeter #221
 Kit \$25.95.
 Wired \$39.95.



Peak-to-Peak VTVM #232 & Uni-Probe (pat. pend.)
 Kit \$29.95.
 Wired \$49.95.



New TUBE & CRT FIL. Tester #612
 Kit \$3.95.
 Wired \$5.95.
 Fast-checks radio/TV tubes, pilot lamps, etc.



1000 Ohms/Volt V-O-M #536
 Kit \$12.90.
 Wired \$14.90.



5" Push-Pull Scope #425
 Kit \$44.95
 Wired \$79.95.



DC-5 MC 5" Scope #460
 Kit \$79.95
 Wired \$129.50.

Tube Tester #625
 Kit \$34.95.
 Wired \$49.95.



RF Signal Generator #324
 Kit \$26.95.
 Wired \$39.95.



Series/Parallel R-C Combination Box #1140
 Kit \$13.95. Wired \$19.95
 1350 Combinations!



6V & 12V Battery Eliminator & Charger #1050
 Kit \$29.95. Wired \$38.95.
 Extra-filtered for transistor equip. #1060
 Kit \$38.95. Wired \$47.95



R-C Bridge & R-C-L Comparator #950B
 Kit \$19.95.
 Wired \$29.95.

IN STOCK! Compare, take them home — right "off the shelf" — from 2000 neighborhood dealers. Over 2 MILLION EICO instruments in use throughout the world.

© 1960 ELECTRONIC INSTRUMENT CO., INC., 33-00 N. BLVD., L.I.C. 1, N.Y.

◀ See Page 22 for the BEST BUYS in CITIZENS TRANSCEIVERS, "HAM" GEAR and TRANSISTOR RADIOS.

electronic's strangest music maker

Music From Nowhere

By James Joseph

**The theremin—is it "electronics gone haywire?"
Picking music from air isn't as easy as it looks.**

MAYBE you were among the hundreds of TV skeptics who, doubting their own eyes, recently flooded a network's switchboard with angry complaints about what appeared to be a man coaxing music out of thin air.

Plain on your screen loomed an apparent fraud: a keyless, stringless instrument from which, hands hocus-pocusing before its two antennas, a mustachioed "musician" was urging strange and haunting melodies. Seemingly, he was pick-

Left hand over volume antenna and right hand near pitch rod, Dick Hoffman tames electronic maverick.

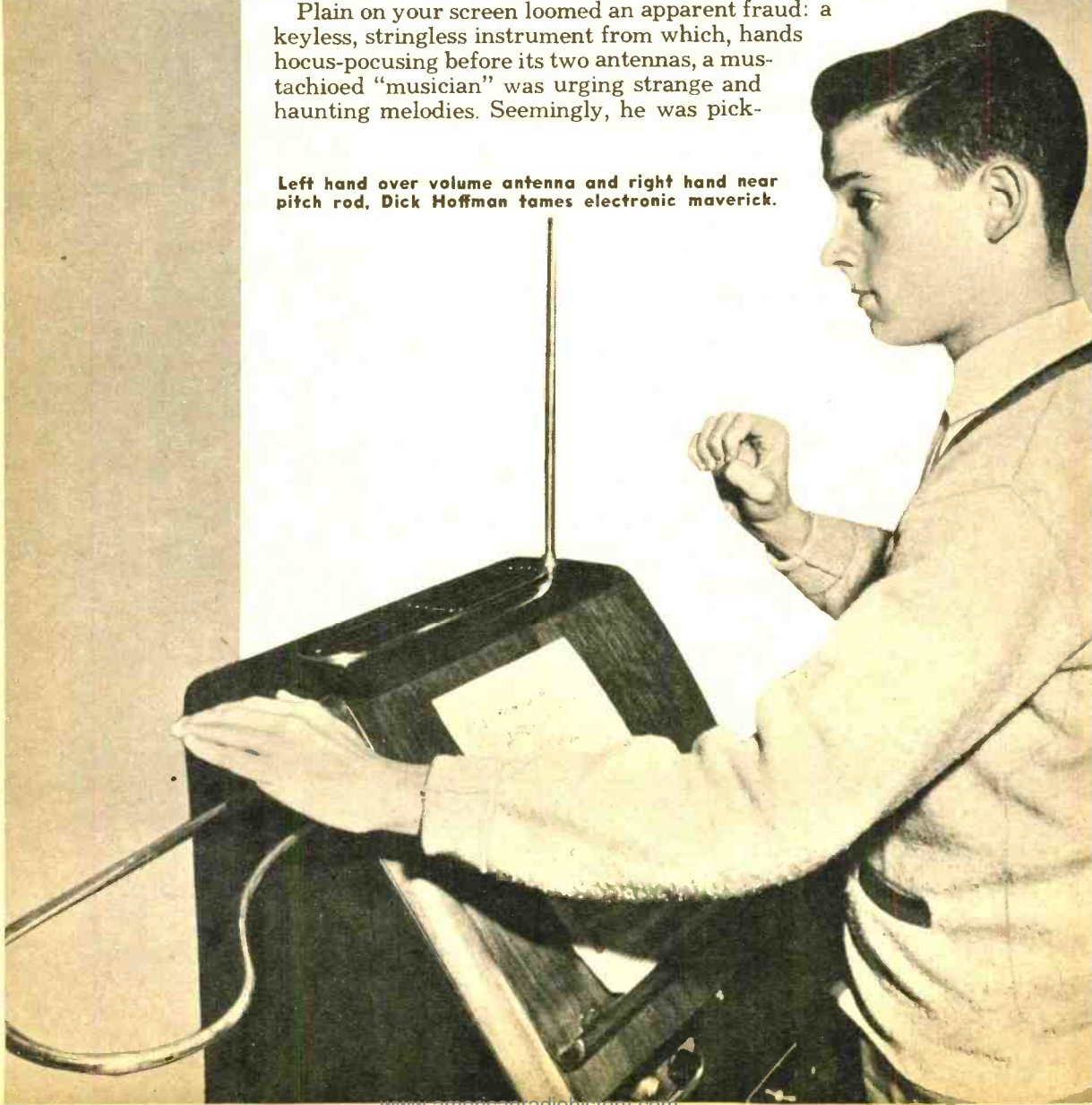



Coaxing eerie music from electrostatic fields is Dr. Sam Hoffman. He has put theremin on many movie soundtracks. Each hand move, 1/16" nearer antenna, encounters new note.

ing notes—and whole sonatas—from nowhere.

His right hand teased—but never touched—the instrument's vertical antenna. Simultaneously, his left wavered above a looped, horizontal antenna.

No hoax was either the musician, Dr. Sam Hoffman, nor his eerie-voiced music maker—a theremin.

The theremin (pronounced "thur'-a-min") is one of the world's strangest electronic instruments. And Dr. Hoffman, a mild-mannered Beverly Hills, Calif., foot doctor, is not only its musical master, but undoubtedly the world's foremost theremin virtuoso.

Together they've teamed to goose-pimple the soundtracks of more than thirty movies, including "Spellbound" and "Lost Weekend," both Oscar winners. Hypnotizing nothing more than a couple of chrome-plated antennas, Dr. Hoffman has put the theremin's electronic voice between the covers of half a dozen record albums—one aptly titled, "Music Out of the Moon." Recently, after years behind the cameras, he stepped before them to prove to skeptical viewers that the theremin is fact, not fantasy.

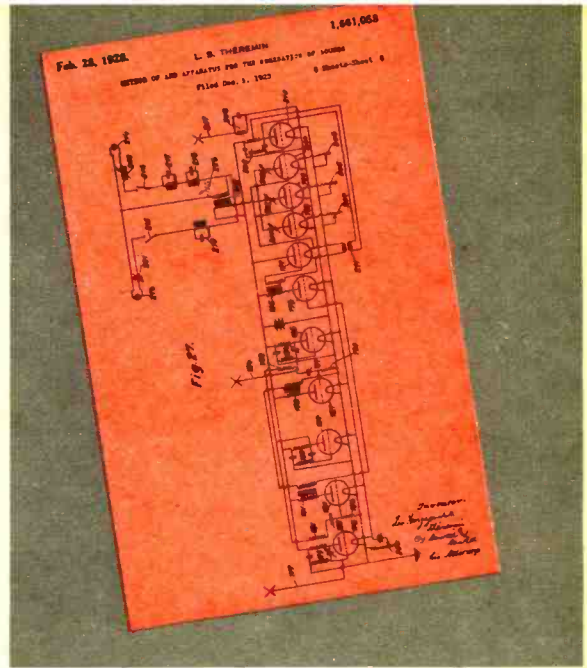

This gadget was really invented by a Russian, Leo Theremin. Despite simplicity of theory, design and construction, U.S. patent (1928) carries a full six pages of schematic diagrams.

Strange as is its music, stranger yet is the theremin itself. Some have called it "a radio gone haywire." Others contend that it is really not a musical instrument at all, simply an oscillatory circuit bib-and-tuckered in a mahogany console.

Though hailed as "the newest of instruments," it was concocted 35 years ago by Russian-born electronic engineer Leo Theremin. Manufacturing rights were sold to RCA.

Just as paradoxical is the fact that while a beginner in electronics can easily build a theremin (so simple and low cost is its circuitry), few have ever learned to tame its electronic temperament. Perhaps not a hundred people have succeeded in turning the theremin's squeals into anything approaching music.

Shrugs one electronic engineer: "Queer duck, the theremin. Most guys who build one can't play it. And most who can play it don't know beans about electronics . . . or, in fact, how the darn thing works."

"It works, but don't ask me how," concedes the theremin's master, Dr. Hoffman.

[Continued on page 98]

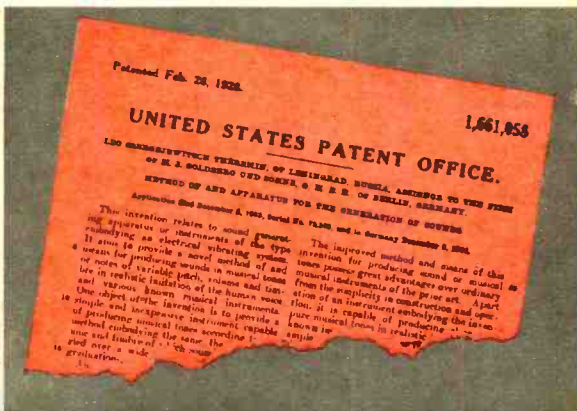

Range of the theremin, both in pitch and volume, may be preset by musician with these controls. Theremin has a maximum range of four octaves which may be narrowed to two.

Quoting patent: "... method and means of this invention for producing musical tones possesses great advantages over ordinary instruments." Yet Theremin couldn't play theremin!



Six tubes, plus power supply (not shown), comprise the original RCA model. Note the variable pitch oscillator coil and pitch antenna (vertical), at left side of cabinet.

s w l's and hams, stop that feudin'

The Great QSL Quarrel

By Carole F. Hoover, K9AMD

WHY would any ham in his right mind purposely throw a QSL card into the wastebasket? Well, thousands of shortwave listeners wonder the same thing. Others, who know why, grit their teeth in anger when they think of what's happening to the cards they send. Hams and SWLs have been feudin' for years, and it's high time a truce was declared.

"Why should I furnish postage and one of my expensive cards to some guy who uses a postcard and a worn-out ball-point pen?" grumbles a typical ham as he shreds an SWL card into his circular file.

A good part of the fun of hamming is confirming radio contact by mail, and many amateurs spend hours designing their own cards, dressing them up with a photograph of the rig and operator, an original drawing, or some other clever idea which takes time and dollars. Swapping an artistic, custom-made QSL card for a dull, limp postcard is hardly a fair trade, although some folks seem to think so. In plain language, an SWL card should be a worthwhile addition to any "hamshack."

Next, let's tackle that ball-point pen business. No matter how attractive a card may be on one side, it's a big let-down to discover that the writing on the back is harder to [Continued on page 94]

If SWL's follow the checklist in this article, chances are their QSL cards won't suffer the same fate as those below. Coming home from work, Gus, K9EBA, (left) disposes of one incomplete SWL report at the mailbox. At right, another K9 and his canine sort the mail and QSL cards with the aid of a circular file.





Shortwave listening is a popular hobby all over the world and many hams enjoy collecting SWL cards—providing they are attractive, accurate and complete.

Walter Greenwood, Coffeen, III., has been an avid SWL for years. Through his interest, son Brent is K9RHL. Here they check DX guide, reply coupons in hand.



June, 1960

Ham Station Control Center

By Howard S. Pyle

Convenient home-built device puts all ham shack switching in one compact table-top instrument.

CHANCES are that if you have a ham rig—modest or magnificent—you've also got plenty of odds-and-ends of station equipment in addition to your basic receiver and transmitter. There's the clock, the Conelrad monitor, audio noise limiter, keying monitor, external VFO, and what-have-you. Now wouldn't it be nice if all this gear could be plugged into one "little magic box" to provide fingertip control for *all* your gear?

That's what we have here—a versatile ham station control unit that can serve as the heart of any ham shack. Moreover it may be unplugged for quick, trouble-free station set-up wherever you may go on your vacation—or Field Day. Very light and completely portable (5" x 5" x 7"), all station equipment plugs into it. Switches and fuses for each item are built right in, along with an electric clock and timer, an audio noise clipper, transistorized keying monitor, speaker, plus a few other "gimmicks." Antenna provision is very flexible. You can use a whip or random length antenna while traveling, as well as any conventional home sky-wire or beam.

Power Circuits

There are no 'trick' circuits and both mechanical and electrical

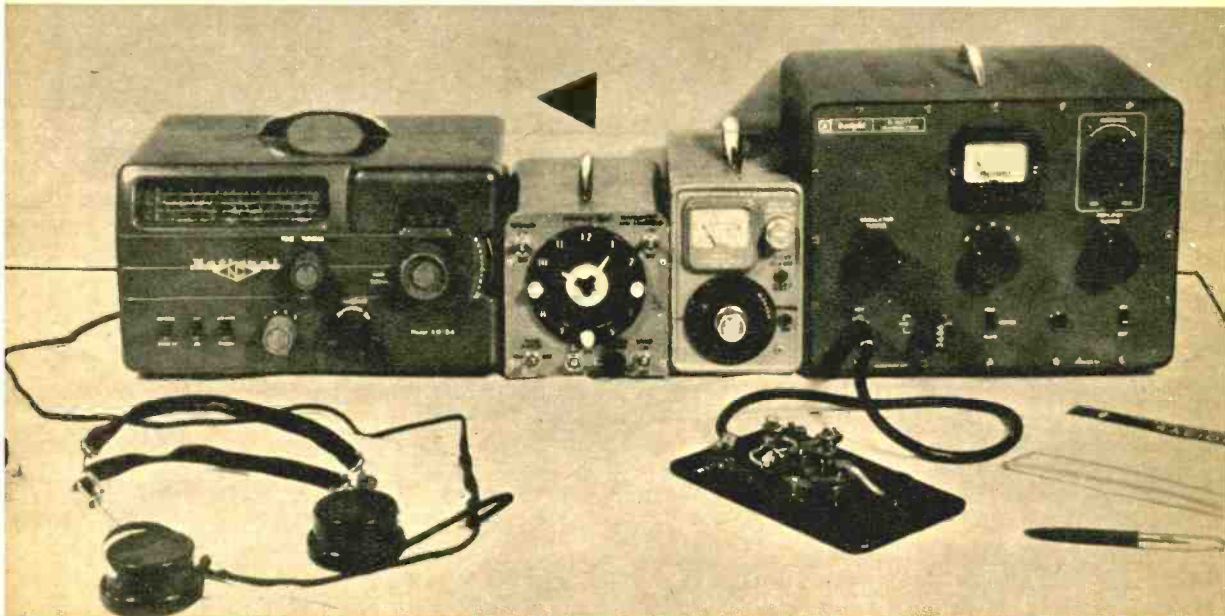

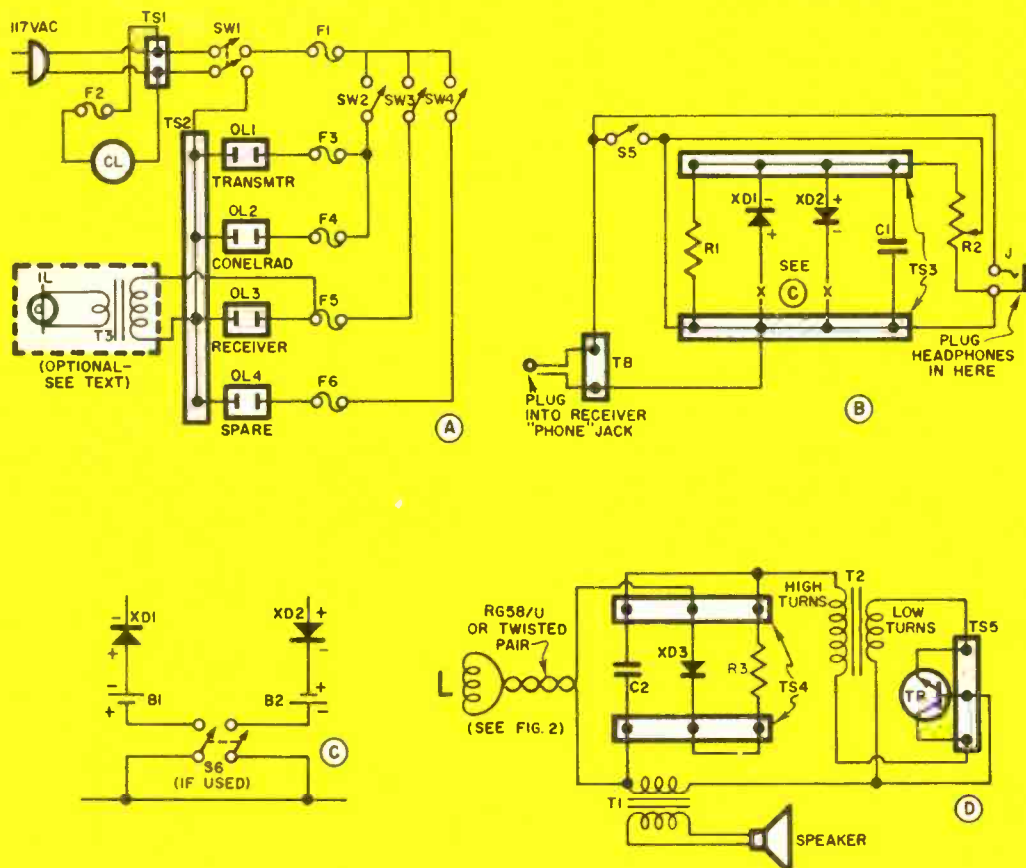
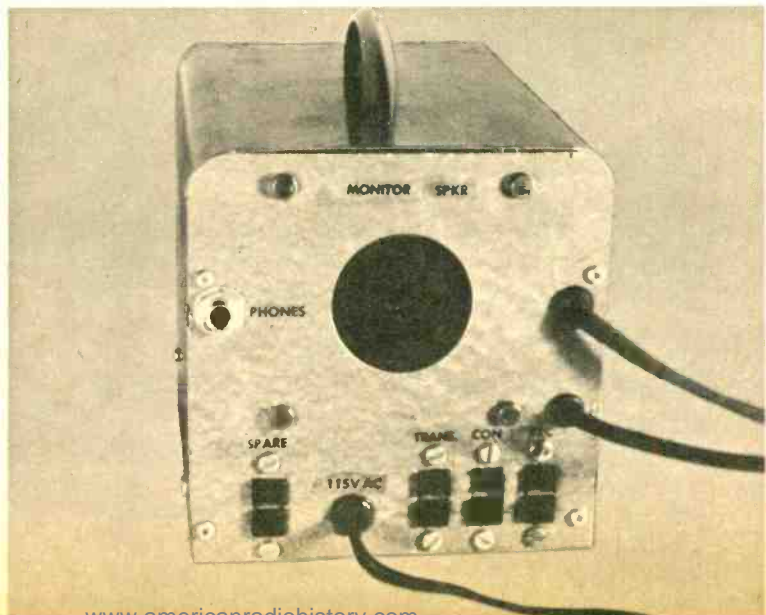
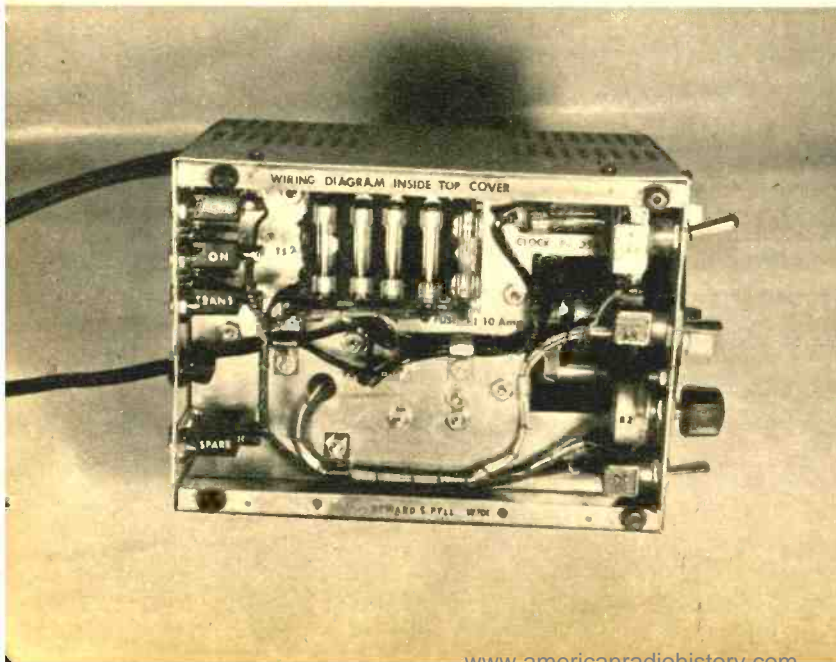
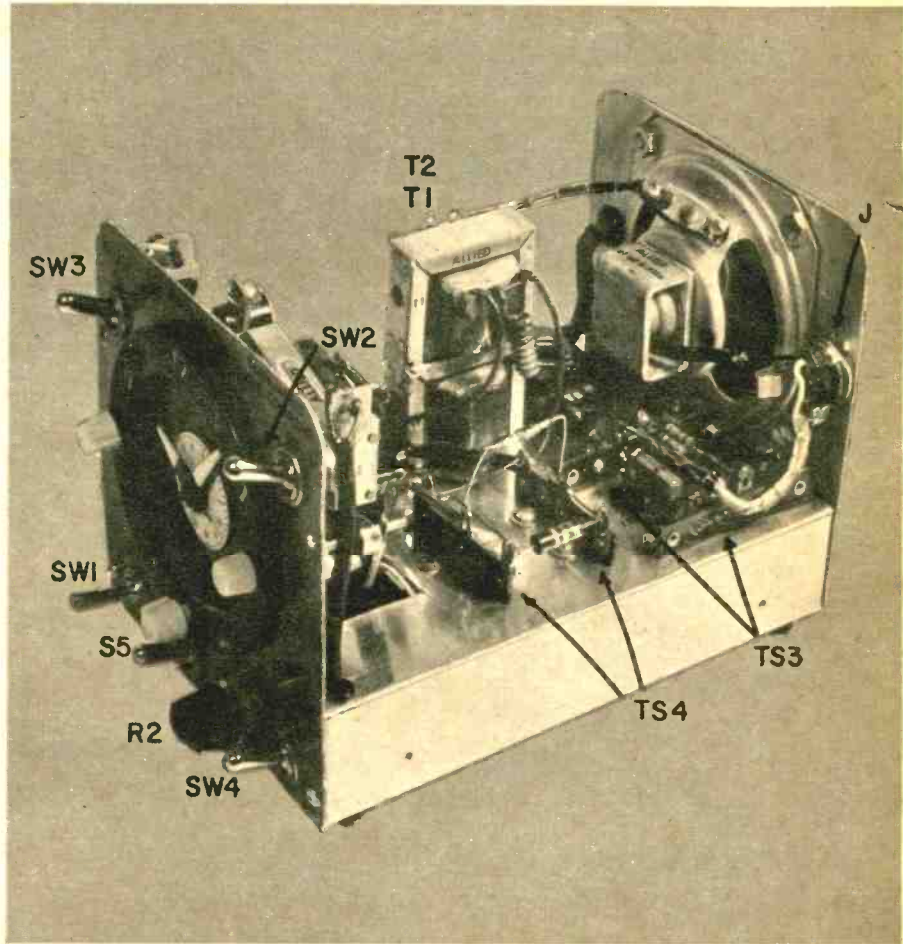

Fig. 1. Schematics A, B, C and D break down the unit into its component circuits for simplicity. Details on the above are described in the text.

Rear view of control unit. All cords, plugs, cables, etc., are connected to the rear panel concealed from a frontal view of the equipment. This also keeps the cables out of the operator's way.



Control unit with cover removed. Note that T1 and T2 are stacked to save space. Refer to the parts list on the opposite page for identification of all components.



Underside view of chassis. Wires have been laced for permanence and neatness. Each circuit has an individual fuse held in its place by a clip-holder. Cutout for clock mechanism on chassis is seen in photo.

design are flexible. You can add more AC outlets to accommodate a self-powered VFO such as the Knight-Kit V-44, an external modulator or a spare outlet as is shown for a desk lamp.

The AC cord enters the cabinet through a grommited hole and terminates on a two point tie-strip, TS1. (Schematic A.) From here the electric clock (CL) on the face of the unit takes off through a .25 ampere fuse, F2. Also from TS1, a pair of wires goes to SW1, a DPST toggle switch. See the trick? SW1 becomes the "main switch" and turns on or off all equipment connected to the control unit *except* the clock. When you're through with the rig after an evening of contacts, throw SW1 'off' and hit the sack; you haven't forgotten a thing!

Individual switches are provided nevertheless, for the transmitter and receiver. Sometimes you may merely want to listen; turn on the receiver outlet (OL3) with SW3 and the transmitter off with SW2. Note that the transmitter and Conelrad monitor are switched on and off simultaneously with SW2. As long as your transmitter is on, your Conelrad must be also, to comply with FCC requirements. For receiving only, you don't need Conelrad.

The indicator light circuit represented by IL and filament transformer T3 is optional since most transmitters, receivers and Conelrad units are so equipped. Note that each piece of equipment is separately fused in the control unit. The cabinet includes a matching chassis and has a bottom cover plate which may be left off for convenient access to the [Continued on page 113]

PARTS LIST

F1 thru F6—clip-type fuse holders and fuses (see text)
 SW1, SW6—DPST toggle switches
 SW2, SW3, SW4, SW5—SPST toggle switches
 IL—6.3-volt pilot light assembly (optional)
 OL1 thru OL4—chassis mounting AC sockets (Olson X-803)
 T3—filament transformer 6.3 volt @ 1 amp or less (optional)
 TS1—2-point tie strip
 TS2—4-point tie strip
 TS3—two 4-point tie strips
 TS4—two 3-point tie strips
 TS5—3-point tie strip
 R1—15000 ohm, 1/2 watt resistor
 R2—10000 ohm potentiometer
 R3—470 ohm, 1/2 watt resistor
 PL—phone plug
 XD1 and XD2—1N34A crystal diodes
 XD3—1N56A crystal diode
 C1—.0025 mfd, 600-volt mica capacitor
 C2—.001 mfd, 600-volt mica capacitor
 L—monitor pick-up loop (see text)
 T2—Audio transformer (Allied Radio 62G062)
 T1—Universal output transformer (Allied Radio 62G023)
 TR—2N35 transistor
 TB—terminal board
 J—phone jack
 CL—clock
 Loudspeaker—3" or 4" PM type

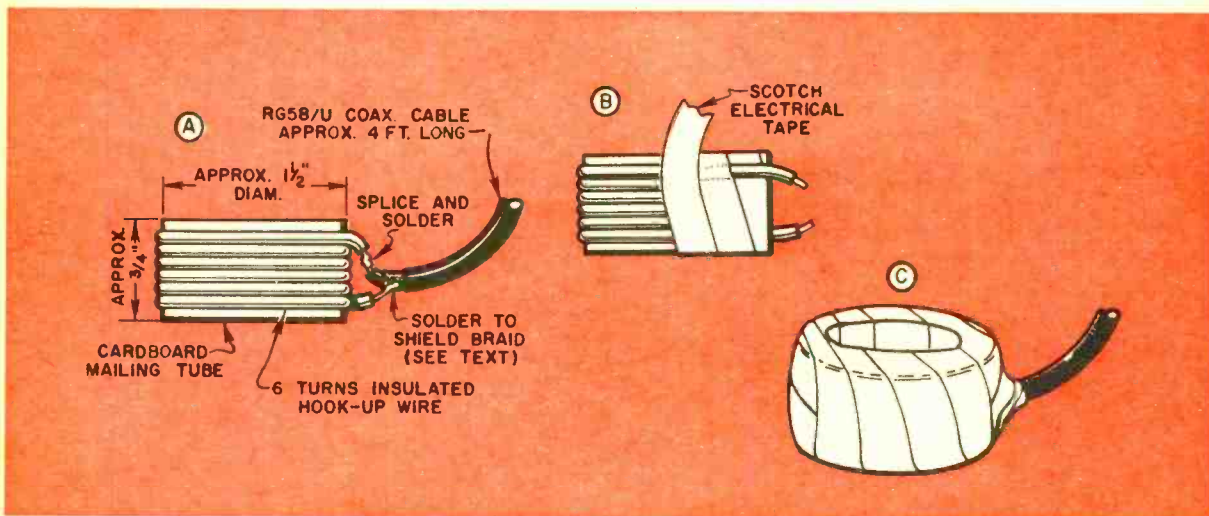

Figure 2. A step-by-step procedure for constructing the RF pick-up coil is shown in the drawing above. Black electrical tape holds wire to coil form.

electronics "talks" to the universe through Cosmic Clearing House

By Lloyd Mallan

Life on other planets? How can we communicate?
These are questions for Cornell's new space center.

THERE are about ten-billion suns in our "local" universe, the Milky Way. Will man be able to communicate with countless planets that are probably revolving about them? Is our knowledge of radio adequate? The planet Venus—apart from the moon, our closest celestial neighbor—may very well be teeming with life. Can powerful radar pulses penetrate through its cloudy atmosphere to verify or deny this?



Below is working model of fabulous 1000-foot wide radar, designed by Cornell U. for construction in Puerto Rico (see artist's conception, left). It will explore cloud-covered Jupiter, more than 400-million miles away. Model was built by G. M. Zeitlin, shown holding driven element which is suspended above dish.

Photos by Dan Schreher



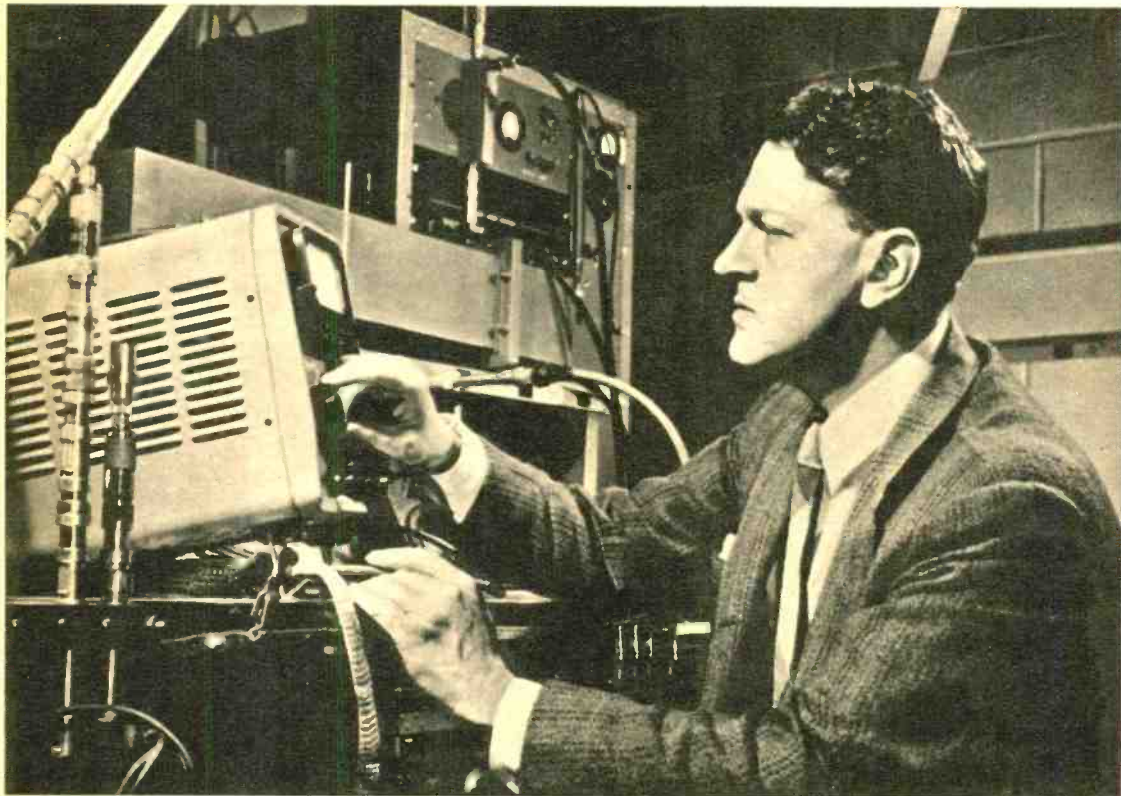

Prof. Thomas Gold, director of the space center, is a world famous theoretician, yet keeps his hand in electronics. Here he works with microwave counter.

Radio astronomy is not new at Cornell. The University has long operated field station at airport near campus. New equipment for center will greatly advance knowledge of space.

Researchers below operate 18-foot radio-telescope at field station. In background is a fixed unit 28-feet in diameter. This field station will be obsolete by end of next year.





New tools are always being sought to help man learn more about universe. Antenna design is vital project of new center. Here Profs. W. Gordon and W. McGuire study new dish.

Man's questions are many. Are new universes continuously being created somewhere in the depths of intergalactic space, or did one gigantic explosion spread the stuff that made the atoms, the stars and the dust? How did the earth itself originate? How did intelligent life evolve on its surface? Those recently discovered high-energy radiation belts that surround the earth—are they a cause of human illness?

The answers to such important questions may very well be answered by a new coordinated effort of scientists at Cornell University. Outstanding experts in electronics, nuclear physics and astrophysics will coordinate with top authorities in radio, electrical and aeronautical engineering. They will also work closely with the scientists of the National Aeronautics and Space Administration (NASA) as well as with those of the Defense Department's Advanced Research Projects Agency.

The new effort is dedicated to pure scientific research, finding the keys to unlock the mysteries of the *total* universe. The Cornell Center for Radio-physics and Space Research is being headed by Professor Thomas Gold, an Austrian-born astrophysicist who has startled the scientific world with his

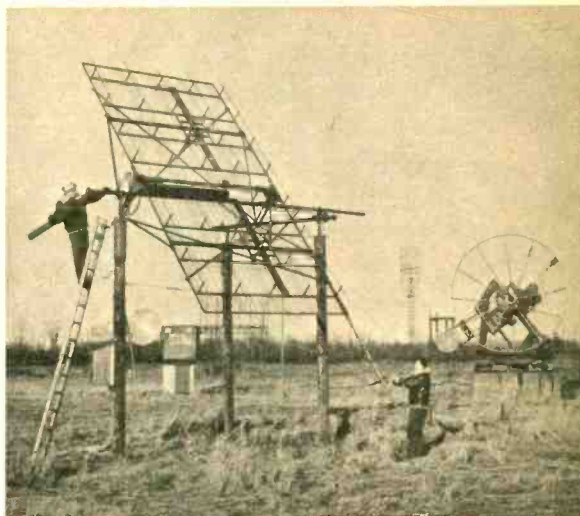

Many variations of antennas have been tried for radio astronomy work. Wavelength sensitivity varies from one to another, depending upon what area of the sky they are to cover.

bold theories. He is one of those rare birds of science—a combination engineer and theoretician—a practical dreamer.

Soft-spoken but intense, Professor Gold's theories are derived from an incredible store of knowledge. In 1953 he said that sunspot "explosions" start solar magnetic fields suddenly expanding into space, pushing electrically charged gases ahead of them. In effect, they are magnetic shock-waves and when they finally strike the earth's magnetic field, violent fluctuations occur, causing auroras and disrupting communication. This theory was proposed five years before the IGY. Six years later, in May 1959, scientists at AVCO proved the correctness of his theory by simulating the same effects in their laboratory.

Professor Gold is even more famous among astrophysicists for another theory that he developed in collaboration with Herman Bondi and Fred Hoyle at Cambridge U. in England. This is the assumption of a "steady-state" universe. Gold says that the universe is eternally adding new material to itself from some secret source. As the universe's matter accelerates away from its

[Continued on page 104]

One of several major new units for probing the universe at the Cornell Center will be this 28-foot antenna for transmitting signals to any area of sky.

Prof. Stanley Byron, researcher in the aeronautical labs at Cornell, is studying equilibrium ionization behind strong shock waves, adding to ionization data.

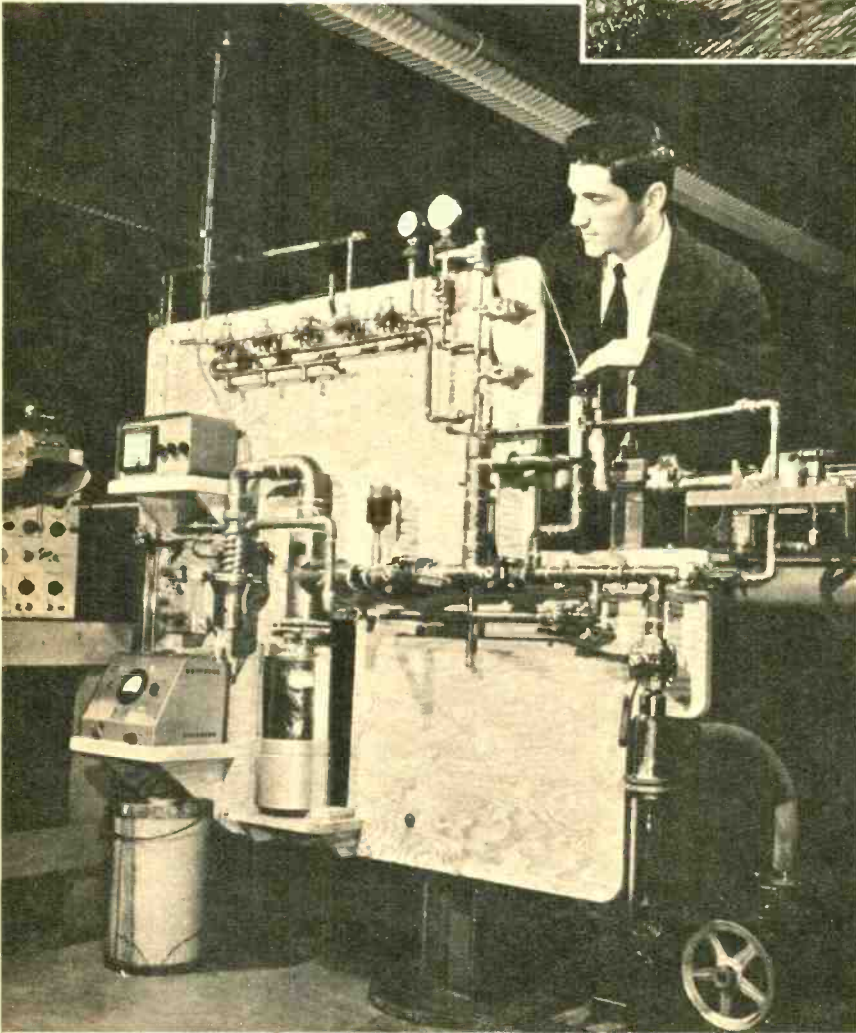
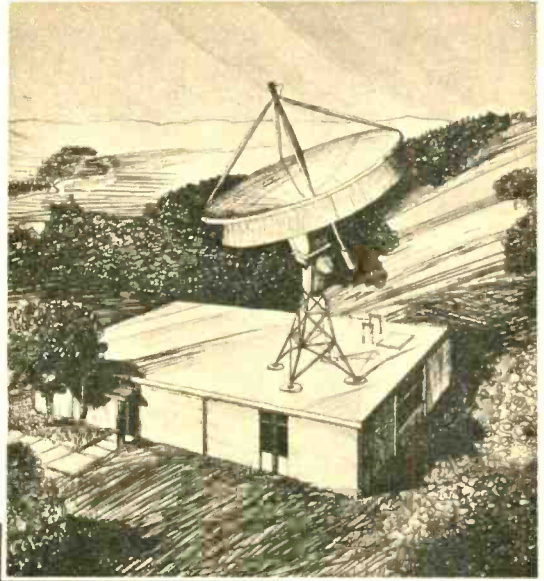



RCA
2N373

A high-frequency transistor with a fourth lead connected internally to the casing. This "shield" lead is generally grounded in circuit.

EMITTER
BASE
SHIELD
COLLECTOR

Milt Kiver on

Transistor Testing - 1

This first article in the new series discusses transistor types—theory—and important parameters.

THE rising importance of transistors and their increasing appearance in home receivers makes it imperative that the technician have some sort of quick and reliable testing method. Such testing devices are particularly important now while transistors are still quite new, and not only still subject to failure but have wide variations in characteristics within the same type number.

While tubes and transistors serve a similar purpose, that of amplifying signals, their mode of operation is completely different. Tubes are basically voltage amplifying devices; that is, they amplify or increase the *voltage* of a signal rather than its *current*. It is true that power tubes deliver considerable amounts of current, but they do this from an input voltage, not an input current.

Transistors, on the other hand, are current or power amplifying devices; that is, they utilize the power or current of an input signal as the factor that controls the current that passes through the transistor. This current, in turn, when passed through an output load resistor, will make available a greater amount of power than was present at the input. Hence, when a transistor is checked, the most important characteristic to be measured is the current gain. This may either be "alpha" or "beta" current gain. Both quantities represent different ways of looking at what is essentially the same thing—the current flow through the transistor and how well it can be controlled. Alpha represents the ratio of collector current to emitter current and has a value less than 1. Beta is the ratio of the change in collector current to a change in base current and beta is considerably higher than 1. Both quantities are related however, and knowing one will enable the tech-

nician to calculate the other quantity.

There is still another significant difference between tubes and transistors. In tubes, electrons flow from cathode to plate. This means that the plate is always positive with respect to the cathode while the grid is almost always negative with respect to the cathode. If the plate is made negative with respect to the cathode, current flow ceases.

Not so with transistors. Here the collector may be negative or positive with respect to the emitter, depending on the transistor type; i.e., PNP or NPN. (These letters stand for the *doping* accorded the various transistor sections during manufacture.) In a PNP transistor, the operating voltages of the base and collector are *negative* with respect to the emitter. For an NPN transistor, just the opposite voltage conditions must be established—in that the base and collector are both positive with respect to the emitter.

In checking transistors, it is very important that the type, either NPN or PNP, be known. Transistor testers will contain either separate sockets for each transistor type or one socket and a polarity reversing switch of the voltages fed to the elements of the transistor. If an NPN transistor is mistakenly tested as a PNP transistor (or vice versa), the meter will indicate that the unit is in-

ternally shorted—and the transistor may be damaged. This situation, which is peculiar to transistors, has absolutely no counterpart in vacuum tube testing.

When the statement is made that transistors are “rugged,” the reference is to a physical, *not* electrical, property. For although physically rugged, transistors are extremely fragile devices electrically and if not carefully and properly checked, can be easily destroyed.

There is one characteristic for which both tubes and transistors are tested—that is leakage. As our tube-testing discussions have indicated, leakage testing in a vacuum tube will frequently uncover defects which have a marked effect on circuit operation. In a transistor, leakage is even *more* important, for a transistor which has more than the normal amount of leakage will frequently have much lower gain. Hence, nearly *every* transistor checker currently available has some leakage checking provision, which is not true with tube testers.

Transistor Varieties

Before we examine transistor testing procedure, it's necessary to become familiar with the many different transistor shapes and electrode arrangements. Fortunately, a degree of standardiza-

Fig. 1. At left is a physical representation of a transistor showing its basic semiconductor material composition. Standard symbols are at right.

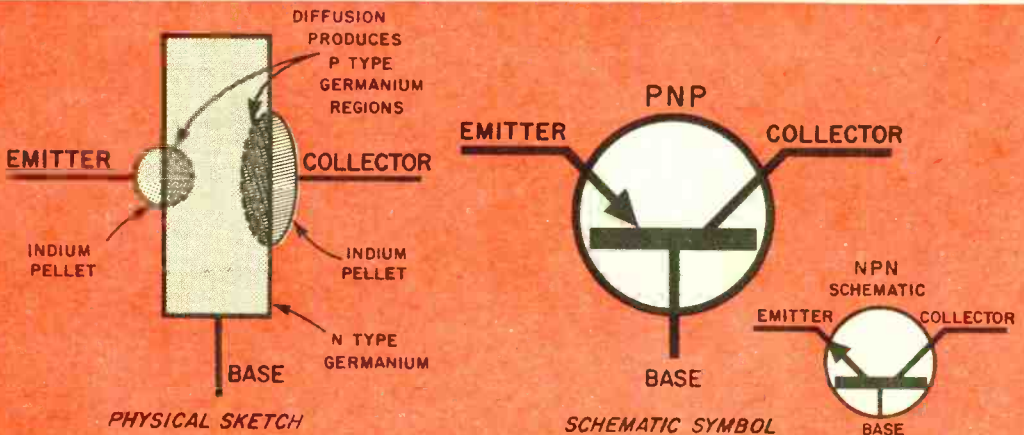

tion of transistor housings is being established. Not too long ago, however, when the transistor housing was at the discretion of the manufacturer, a wide variety of shapes were developed; a good many of which are still in use. It is desirable to be familiar with their terminal arrangements should they be encountered.

Recently, in high-frequency transistors, another lead has been added to the usual collector, base, emitter arrangement. (See photo of RCA 2N373 at the head of this article). The new lead, the one closest to the collector, is connected internally to the metallic transistor housing. If this lead is present and employed in the circuit, it is generally grounded. Sometimes these transistors will be found in a circuit with the lead clipped off; which means there is no need for the ground.

In addition, there are a wide variety of other lead arrangements and the more important of these are shown in

Figs. 2 and 3. Some transistors use a colored marker near collector or a locating tab positioned generally nearest the emitter lead. If one of these transistors has four leads, the locating tab is positioned between the emitter on the right and a ground lead on the left. (The same arrangement of four leads and a locating tab has also been employed with transistors possessing two bases. These are called tetrodes and at the present time, few are being manufactured.)

All the transistors in Fig. 2 are small, low power units. When we come to power transistors (Fig. 3) we find an equally wide variety of lead types and positions. For example, on some of the power units there is a stud that comes out at the center of the housing base and is connected internally to the collector. A green sleeving might be placed over the base lead while a white, yellow, or brown sleeving identifies the emitter. A power transistor with flexible leads

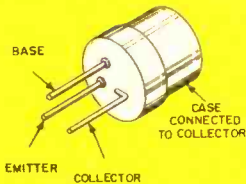
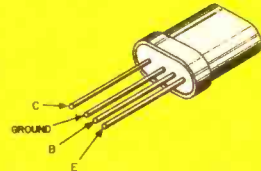
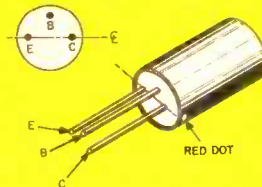
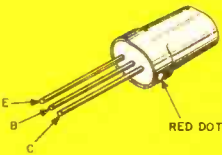
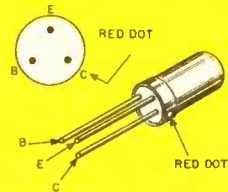
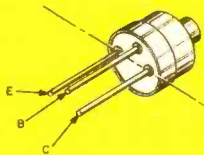
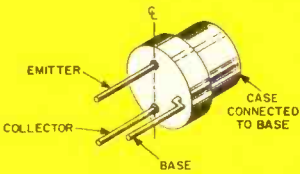

Fig. 2. Introduced only a few years ago, transistors have found many applications. The various shapes and lead configurations shown above are due to a lack of standardization.

(rather than solid connectors) frequently has a yellow emitter, black base, and red collector wire. Sometimes the collector may have a red dot with the base and emitter positioned away from it.

The foregoing illustrations represent most of the transistor housings likely to be encountered. Undoubtedly a few units will be met which do not fall into the categories indicated. In that case, it may be necessary to refer to the manufacturer's literature. If not available, check the unit using the transistor. Because of the large number of imported transistor radios now flooding the country, it may be necessary to check with the importer for a source of replacement transistors for the foreign types in these sets. With a schematic and the equipment, there should be little difficulty in identifying each of the various elements.

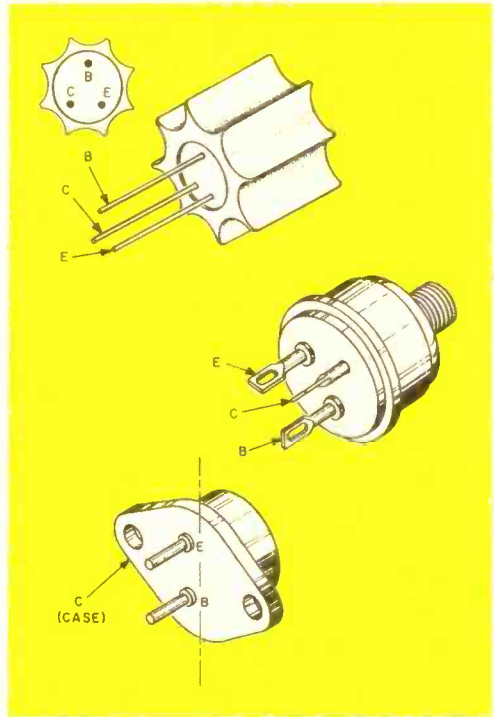

Fig. 3. Additional power transistor housings and types which are likely to be encountered in home or industrial equipment. These are the generally larger power types for heavy use.

Courtesy Precision Apparatus Co.

Exploding Wire

WHAT happens when you switch several thousand amperes into a 1 mil wire about 1/4-inch long in a time period no longer than a few millimicroseconds? Simple: it explodes—with vaporization energy many times normal, temperatures above 100,000 degrees centigrade and pressures in the megabar

range. This is powerful stuff. An Army sponsored study by Electro-Optical Systems, Inc., Pasadena, Calif., claims that exploding wire impulses could provide a space vehicle with 2 to 10 times the thrust now obtainable by chemical means. The technique, developed as a result of detonator research, may also be used for space communications via light, as well as terrestrial searchlight operations. A .002 to .02 mfd capacitor is charged to 10,000 to 20,000 volts and suddenly discharged into the wire. Current is switched by a hydrogen thyratron and triggered air spark gap.

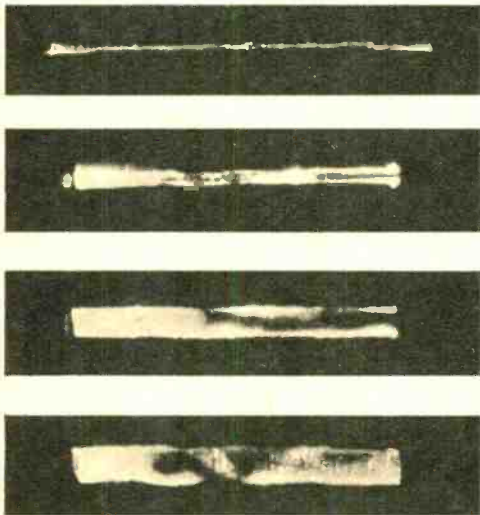

Here, in series of ultra-high-speed photos, aluminum wire explodes after switching of current.

EI'S *Hi-Fi Doctor* . . .

The Evolution of Audio—Part I

Those old timers who can remember back to the days when hi-fi was a pursuit reserved for broadcast station engineers and Bell Telephone lab workers may recognize what I like to call "The Mythology of Hi-Fi."

Most of these issues are long since dead, and by most forgotten, but it is interesting to peek into the not-too-distant audio past to see what insights it can provide into today's sound squabbles.

One of the biggest past hassles was the *Triode vs. Pentode* controversy. Triodes, claimed some, "sound sweeter" and conversely of course, pentodes grated on their delicate golden ears. The build-it-yourself magazines of the day ran a number of all-triode amplifier projects and the 2A3 output tube which was on the verge of being consigned to the junk heap received a new lease on life. The Collins and Brook Companies produced all-triode amplifiers—massive jobs, almost too heavy for the average audiophile to lift—with a total output of a big 10 watts. No feedback, no tricks, just a straight-forward all-triode power amplifier.

Which brings us directly to the question of what, if any, advantage did push-pull triode output configurations have over the beam-power pentode equivalents? Aside from what the amplifier's distortion vs. power output curves show—the major advantage of the triode seems to be in the fact that it has a much better damping relationship with the speaker (which does *not* show up in an amplifier test). Proper damping holds the speaker in tight control and subdues resonant peaks. The unfed-back pentode, on the other hand, tends to let the speaker go its merry way uninhibited by a low shunting load or to say it a different way—a high damping factor.

Things change somewhat after the

product of Mr. Williamson burst upon the scene. Although seldom billed as such, the Williamson power amplifier is an all-triode job. In fact, in the original circuit separate triodes were used instead of the dual triode 6SN7 so popular in the Yankee version. What made the Williamson so good was the particular attention paid to the construction of the output transformer. In the original articles by Williamson, which appeared in *Wireless World*, there were complete specifications for rolling your own transformer. Another factor which separated the Williamson from the rest of the herd was the 20 db feedback loop (which the improved transformer made possible) from the transformer secondary to the input triode cathode. Numerous versions of the Williamson appeared with push-pull 6L6s, 807s, 5881s, all triode connected.

Right about this time, a most significant advance in the audio art appeared—which forevermore ended the triode vs. pentode argument. That was the Ultra-Linear output transformer configuration. Output tubes so connected to this transformer have almost the linearity and damping factor of a triode and almost the power output of a pentode.

A good demonstration of this could be made with the old UTC Williamson amplifier. In its original version this job used one of the fine UTC LS-series output transformers and 6L6s or KT66s as triodes. Its output was a clean 10-12 watts. After the invention of the Ultra-Linear, the UTC engineers discovered that there were taps on the primary of their output transformer which, when connected to the output tube screen grids, would convert their fine 10-watt Williamson to an even better 20-watt Williamson.

We will continue our informal history next month. —

and Clinic

Tape Azimuth

When I play back tapes made on my next-door neighbor's machine they sound very dull. They sound fine on his machine. I have a few pre-recorded tapes and they sound okay to me on my machine. What is this?

E. Schreiber
Phila., Penn.

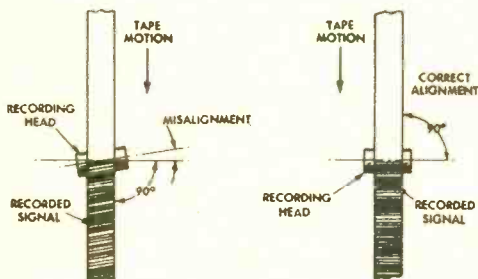
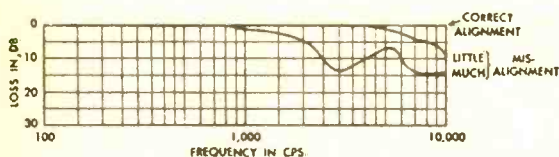

This sounds like a matter of azimuth adjustment. If the angle of the head (or heads) in each machine is not the same, high-frequency loss will be the result when tapes are swapped. I'd say your machine was alright in this respect since the pre-recorded tapes sound good. Play one of these on the other machine. If it sounds dull, the azimuth (head angle) must be adjusted on your neighbor's machine. *Don't* make this adjustment yourself; special equipment is needed.

Record Hiss

When I play records I hear a hissing and shrillness that is not present on the tuner. What could this be?

Charles Reme
Chicago, Ill.

Hi-Fi questions are all answered by mail. If of general interest they will appear in this column.

The first thing I would do is check your cartridge by replacing it with a borrowed one. Your cartridge may have a resonant peak at its high-frequency end. If this doesn't help, have your serviceman check the treble equalization in your preamplifier with an audio signal generator. At high frequencies there should be a definite drop in output when compared to the output at mid-frequencies. This drop in volume is known as "roll-off" and is part of the technique used to reduce hiss and scratch on records. Absence of this equalization would definitely make records sound shrill.

A less likely source of your problem may be the setting of your tweeter or level control. If your tweeter is set for too high an output to compensate for an inadequate treble response from your tuner, the net result will be a treble boost in your system which makes your tuner sound normal, but your phono sound shrill.

FM Coupling

I was told to couple my FM antenna to my TV antenna. Not only is there no improvement, I'd say my FM reception is even worse. The TV signal is very good. Why is this?

E. Rogers

New Haven, Conn.

This isn't very surprising at all. Barring a defective coupler your trouble is simple. Some TV antennas are very broad, covering the lower TV bands from 2-6, thru the FM band which is in the middle, and 7-13. Other antennas simply use two elements, one for the low band, and the other for the high. In between, just where the FM band is, they have a very great dip in the response, and in some cases—yours apparently—have no signal pickup at all. The cure is simple, either get a separate FM outside antenna, or go back to your previous indoor FM antenna. ☹

EI Build-it Course-10

Completing the CB series, here are 6 and 12-volt DC and 117-volt AC power supplies for the rig.

THE Citizens Band rig described in this series will be ready for operation once a power supply is built and various interconnections are made. These items, plus some "loose ends" are detailed in this wind-up article. At this point, the builder should decide on the type of operation desired and build the appropriate power supply: 6- or 12-volt DC for mobile operation, or the 117-volt AC supply for home use.

No matter which supply is chosen, the physical dimensions remain the same. It's possible to interchange the supplies for use of the rig at home, in a car or boat.

One of the problems encountered in vibrator power supplies is a form of interference known as "hash." The waveform output of a vibrator is rich in harmonics; energy which reaches up into the 27 mc band and is heard as an annoying buzz in the speaker. Various measures were incorporated into the design of the sup-

Top view of power supply module, below left as it is wired for 6 or 12 volt DC operation. Vibrator socket is pointed out in the underside view at right.

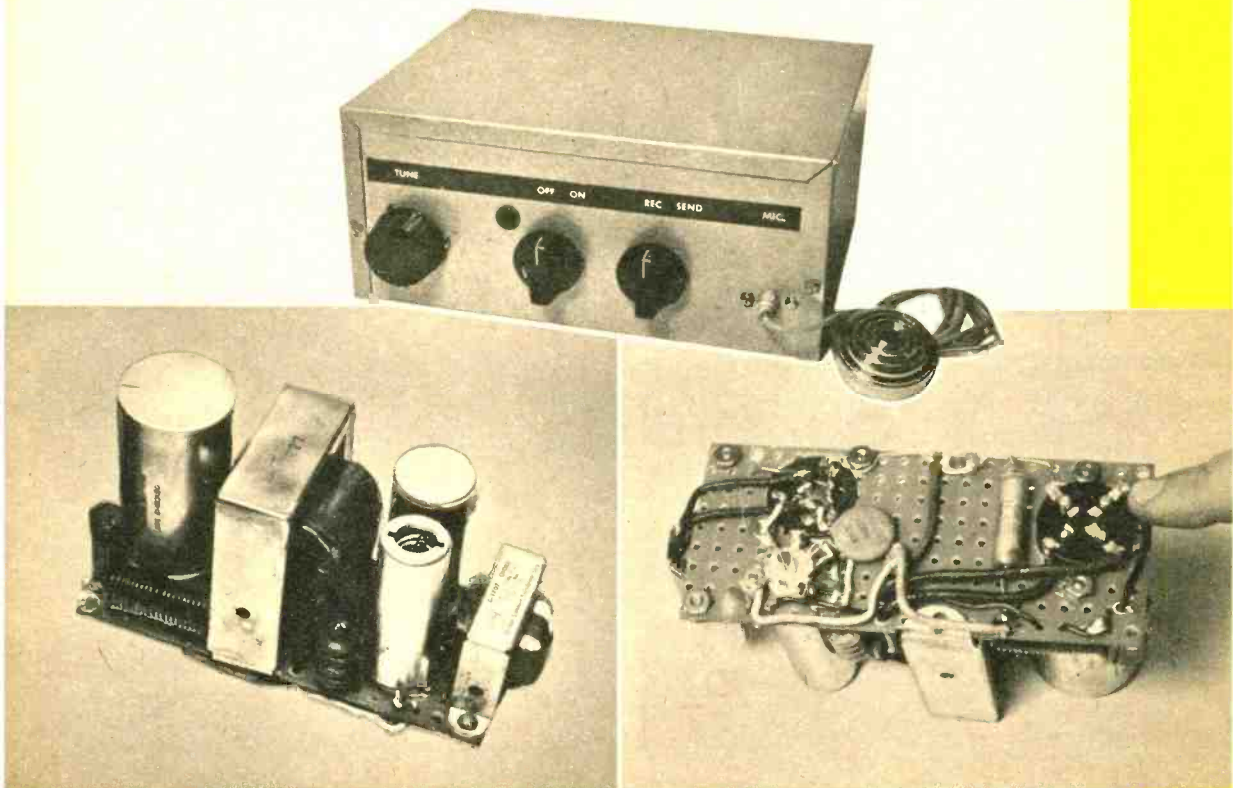

Schematic circuit for 117 volt AC operation. Hash choke L6 and capacitors C25, C26 are not needed.

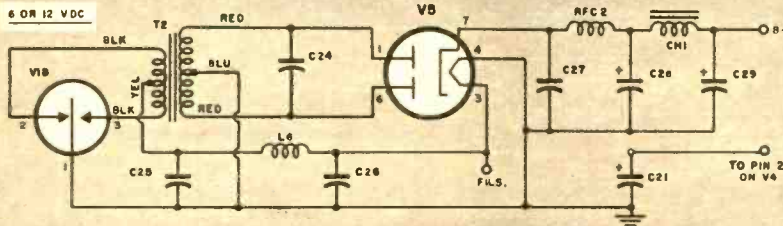
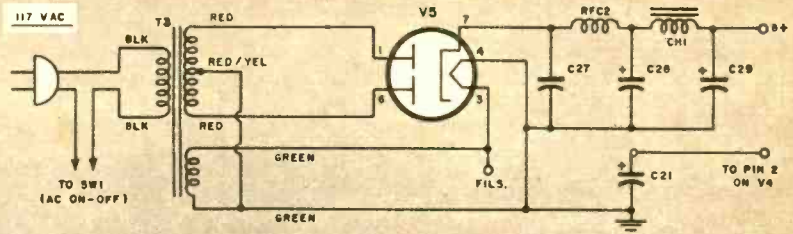

Schematic for DC operation. Vibrator and transformer T2 differ for 6 or 12 volt use.

plies described here to minimize this—but results are somewhat unpredictable. To reduce hash, keep the power lead (6 or 12 volts DC, as the case may be) as short as possible. A good ground is important, too. The best way to find a suitable grounding point is to connect a wire to the case of the rig and touch various metallic points under or near the dashboard. Find the one producing the quietest response in the speaker and connect the wire to it. More on installation later.

The pictorial wiring guide basically shows the wiring of the 6-volt vibrator supply; for 12 volts, there are several minor changes. Note that there is a different parts list number for both the 12-volt vibrator and its transformer. The other change is that the filament of the 6X4 rectifier tube is wired *in series* with another tube. Since this filament rewiring affects other tubes, too, be sure to consult the drawing devoted to 12-volt filament wiring—see p. 109.

Building the rig for 117 volts AC operation requires some alterations. Filament wiring remains the same as for the 6-volt DC unit. The major modification is the replacement of the vibrator and its transformer with a 117-volt power transformer. Wire one of the primary leads (black) of the power transformer

to the unused pair of contacts on SW1. Once the power supply has been wired and mounted, the other modules (converter, RF oscillator-amp., modulator) are interconnected according to the wiring guide. The lead wiring is the same for the 6- or 12-volt supplies. For the 117-volt AC unit, omit the lead

PARTS LIST

For 6 volts DC

V1B—6-volt vibrator, 4-prong
T2—6-volt vibrator transformer
V5—6X4 tube
C24—.006 mfd, 2000 volt disc buffer capacitor
C25—.22 mfd, 200 volt or higher capacitor
C26—.05 mfd, 400 volt capacitor
C27—.01 mfd, 600 volt capacitor
C21, C28, C29—Triple-section electrolytic capacitor
20-20 mfd @ 450 volts (C29, C28) 20 mfd @ 25 volts (C21) (Mallory FP 345.8)
RFC2—RF choke 2.5 millihenry, @ 100 ma
CH1—Filter choke, 7 henries @ 50 ma (Stancor C-1707)

L6—Hash choke, constructed of 20 turns #16 solid enameled wire, air-wound with 3/8" diameter SW1, SW2—4P3T rotary switch (Lafayette SW-30) (Some sections not used)

For 12 volt DC, substitute following

V1B—12-volt vibrator, 4-prong
T2—12-volt vibrator transformer
Note: Replace V4 (6AQ5) in Modulator with 12AQ5 and wire filaments as shown in diagram

For 117-Volt AC

T3—Power transformer, 117-volt pri. 230-0-230 volts sec. @ 50 ma, 6.3-volt sec. @ 2.5 amp. (Stancor PC-841B or equiv.)

Misc.—7-pin miniature tube socket with shield, 4-pin tube socket, perforated Vectorbord 2 7/16"x5/2", shielded phono cable, four 3/8" metal spacers, four 1" 6-32 machine screws and nuts, auto-radio type antenna jack (chassis-mount) and plug, hookup wire

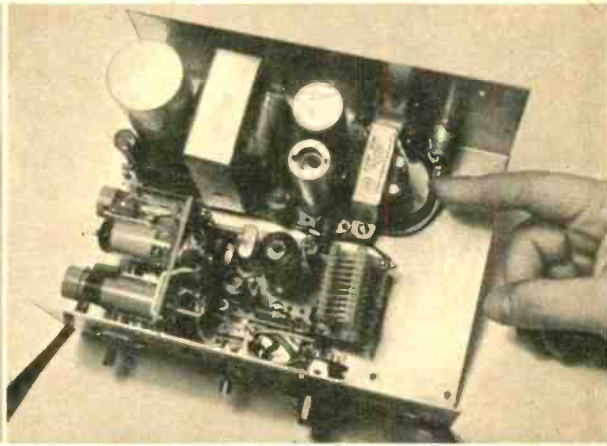
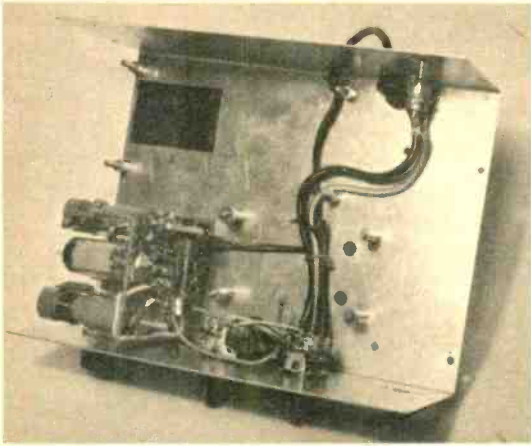

On upper left corner of chassis, strips of tape prevent vibrator socket from shorting to case.

Power supply is shown mounted in chassis. All modules except modulator are also visible.

Wiring guide below shows all modules properly interconnected in chassis.

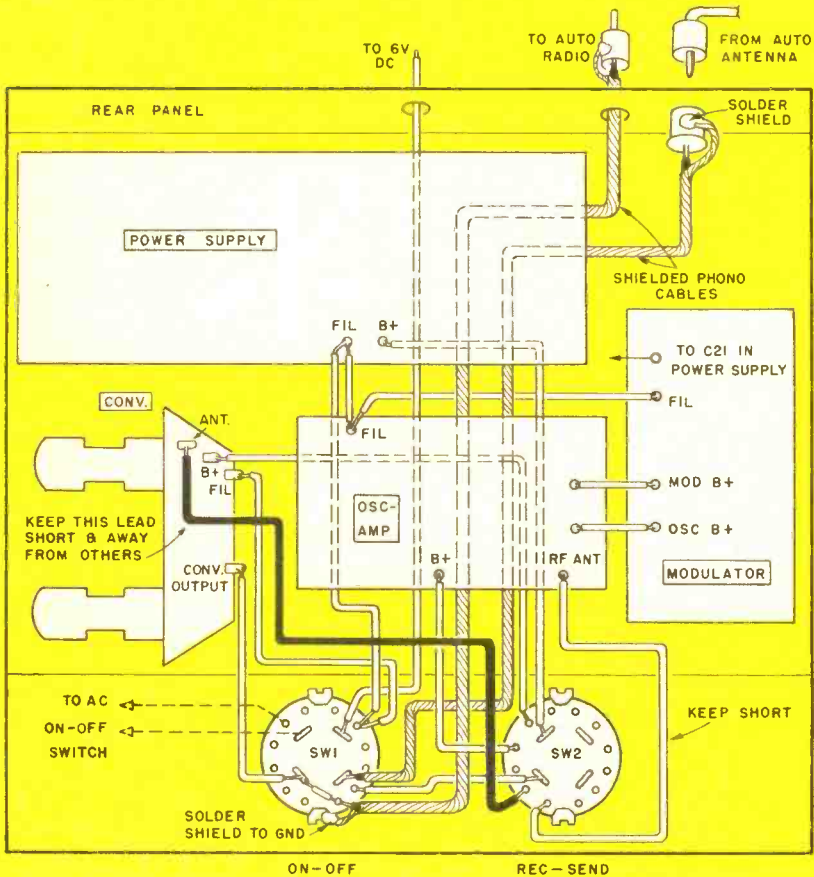

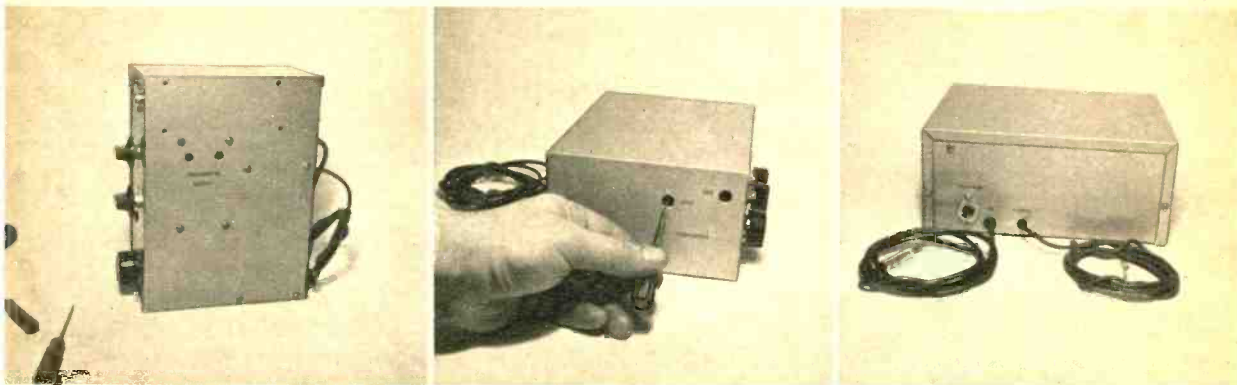

Bottom, side and rear views of completed unit shows position of holes to be drilled. Rear of unit contains auto antenna plug, and input and output cables.

marked "to 6 V DC" at the top of the pictorial. Instead, substitute an AC line cord and run it through the same hole for connection to the primary of the power transformer.

Putting the rig into operation requires an alignment procedure that should be done with the aid of a voltmeter of at least 20,000 ohms-per-volt sensitivity and an RF output indicator such as the "A Citizens Band Power Indicator" in the June 1959 issue of *EI*.

With the mobile job, pull the antenna plug from the auto radio and insert it into the jack marked *antenna* on the rear of the CB rig. The plug on the CB unit marked "to auto radio" should be inserted in the auto radio's antenna jack. Connect the power lead to the source of 6 or 12 volts located on one of the "hot" leads behind the dashboard. Fasten the ground lead and turn the rig on and switch to the receive position.

For 117 volts AC operation, a length of wire approximately 8 feet long is plugged into the CB antenna jack. The cable to the broadcast receiver (marked "to auto radio") should be terminated in a three-turn loop of wire about the same size as the loop on the back of the broadcast receiver and taped flat against it.

Converter Tune-Up

Turn on the radio and tune it to an empty spot on the dial in the vicinity of 1400 to 1500 kc. Insert a thin screwdriver into the access hole for coil L3

and tune its slug until a hiss is heard in the radio's speaker. (L3 is the oscillator coil and serves to adjust the converter's output to the BC receiver). Antenna coil L2 is now tuned until signals in the Citizens Band are heard. Converter alignment is best done with a signal generator, but a nearby CB transmitter will also supply calibrating signals. If a known frequency is received, L2 and L3 may be adjusted alternately so the tuning dial will be at maximum counterclockwise while the lowest Citizens Band frequency is received.

Transmitter Alignment

The first step in aligning the transmitter section is to trim the crystal oscillator for reliable output. Place the negative lead of a voltmeter on pin 2 of V2A, the positive to case ground. Switch to *Send* and tune L4 slug until the meter reading suddenly jumps to several times its initial value; from a volt or two, to about 5-7 volts negative. Switch back and forth between *Send* and *Receive* to make sure that the crystal oscillates each time. If not, touch up L4 until it does. C15 and C16 are in the output section and are tuned for maximum indication on the RF output indicator. You'll find some interaction between C15 and C16, so tune them alternately several times.

The modulator needs no adjustments—simply plug the microphone in.

Once the rig has been installed it will
 [Continued on page 109]

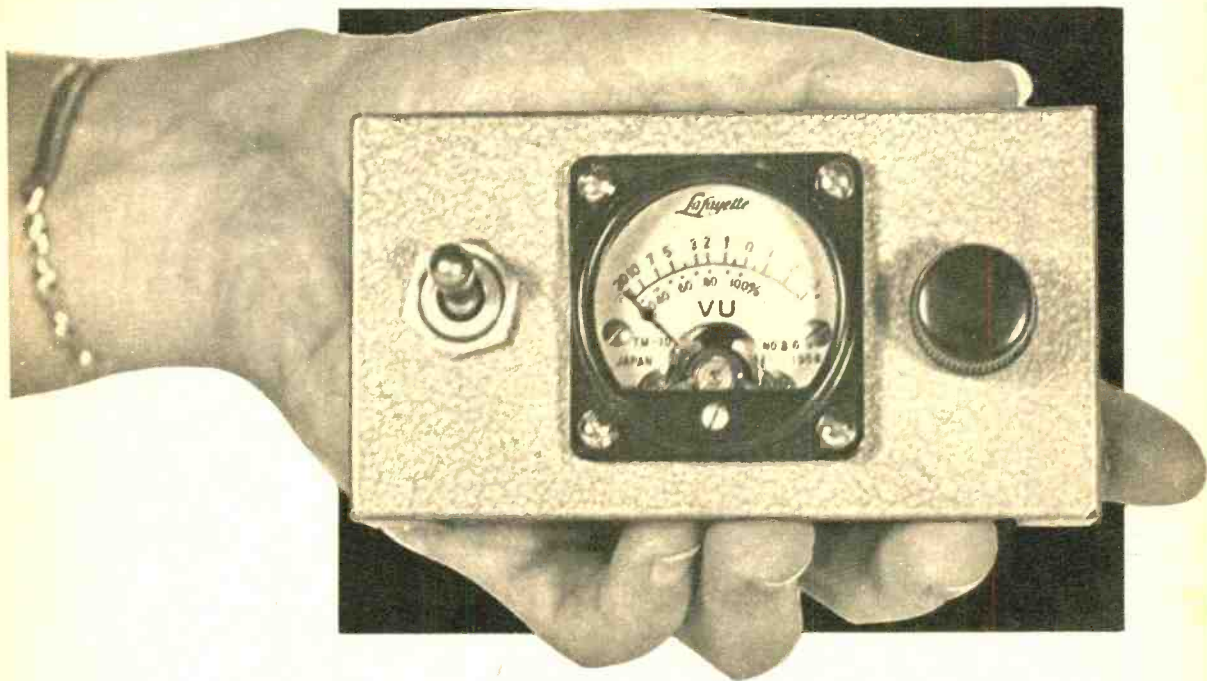

professionalize your recordings with a **Transistorized VU Meter**

By Harry Kolbe

UNHAPPY with the sound quality of the tapes you've been turning out on your home tape recorder? Your distortion and noise problems may be due to an incorrect recording level. If the level is too high, overload distortion results or, if the level is set too low (in an effort to avoid distortion) hum and noise

THE VU METER

Designed especially for reading the intensity (level, volume, loudness) of program material, the VU meter is actually a special type of AC voltmeter. Speech and music, composed of complex audio signals have asymmetrical waveforms and a constantly varying frequency, intensity and duration. VU meters, unlike conventional AC meters, are designed so that their dynamic characteristics (meter needle damping, speed of response, amount of overswing, etc.) enable them to follow accurately the complex audio signal.

The characteristics of the VU meter have been standardized so that under the same conditions it will always read the same on any given program material. For this reason, VU meter readings can be correlated closely with distortion due to overload of the recording head and/or amplifier. In short, the point of first audible distortion will always occur at the same VU reading regardless of the type of program material. The magic eye, neon lamps and conventional meters will indicate overload but not by how much, and the reading corresponding to distortion will not be the same for different material.

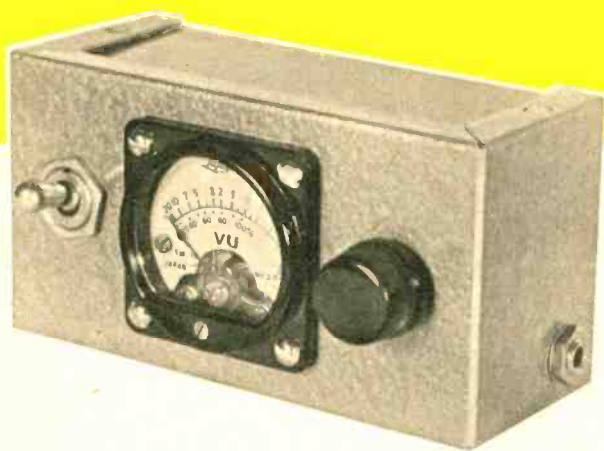
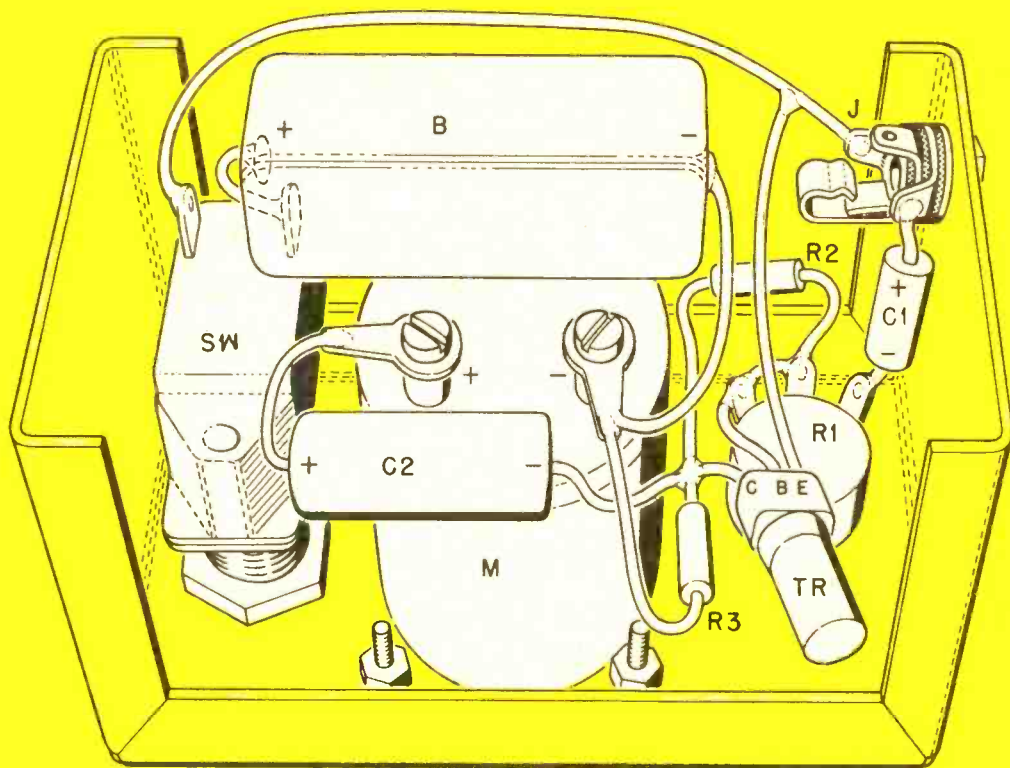

Many of the components shown in the wiring guide above are miniaturized to fit easily into the compact case. A separate subchassis is not needed.

creeps in and you get a poor signal-to-noise ratio. The margin of safety between these two extremes is relatively small, which means that an accurate recording level indicator is a *must* for top quality recordings.

The level indicator employed by the professional is the VU meter. Chances

are that your home-tape recorder does *not* have a VU meter but rather a magic-eye, neon lamps or a conventional meter. These less desirable indicators are capable of a fair degree of accuracy when the recordist has acquired sufficient experience to compensate for their limitations, but in the last analysis, the VU

meter is the best recording level indicator—simply because it is designed specifically for this purpose. Unfortunately, the combination of high cost and relatively low sensitivity of the VU meter makes its use with the home tape recorder rare indeed.

The transistor VU meter described here eliminates the problem of both cost and sensitivity. Construction cost is less than ten dollars and provision is made for adjusting the sensitivity of the meter to meet the requirements of your particular recorder. Battery drain is low enough so that, for all practical purposes, battery life is equal to shelf life. Since the VU meter is a low impedance device of low sensitivity (it has an internal resistance of 7500 ohms and a full-scale sensitivity of 1.23 volts), an amplifier of some sort must be inserted between the recorder and the meter.

The amplifier used is straightforward, using a 2N109 transistor in a common-emitter connection. The collector load resistor, R3, is 3900 ohms, which provides the correct source impedance for proper operation of the VU meter. A 22½-volt battery is needed to provide sufficient collector voltage to respond to the voltage peaks which occur in speech and music. Sensitivity is controlled by

the 500,000 ohm series input pot. (R1).

The meter and amplifier are completely contained in a 4"x2½"x1½" Minibox. Construction and layout are clearly indicated and no further explanation should be necessary.

The transistor VU meter can be connected almost anywhere in the audio system. However, it is best to connect it to a high signal level point within the amplifier. If possible, connect it to the grid of the last stage. In this case R1 must be set to its high resistance end. This makes for a very high meter input impedance with negligible loading effects. Avoid connecting the meter to points where a high DC voltage exists, such as the plate of an amplifier stage. If you can get adequate signal only at a point where a high DC voltage appears, remember that the input capaci-

[Continued on page 108]

PARTS LIST

- R1—500,000 ohms miniature potentiometer
- R2—1 megohm resistor, ½ watt
- R3—3,900 ohm resistor, ½ watt
- C1—2 mfd 25 volt miniature electrolytic capacitor
- C2—1 mfd 200 volt metalized paper capacitor
- TR—2N109 transistor
- M—miniature VU meter (Lafayette TM-10)
- SW—SPST toggle switch
- B—22½ volt battery (Burgess Y-15 or equiv.)
- J—miniature phone jack
- Case—(Minibox CU-2102-A)

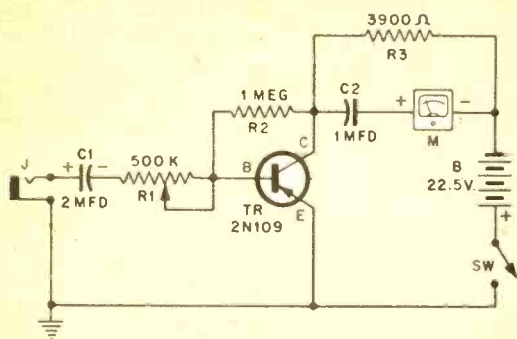

R3 provides the recommended source impedance for proper damping of the VU meter.

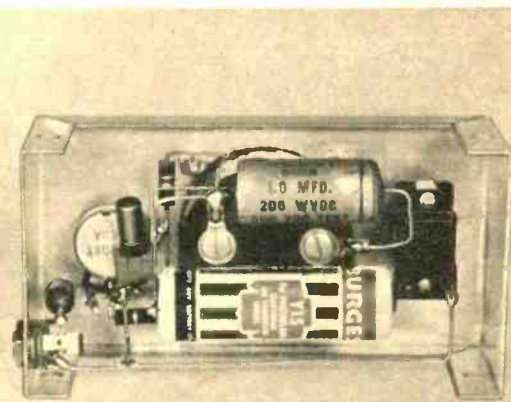

Neatness of wiring is evident from this view. Transistor socket is suspended by wiring.



The radiation detector, battery and amplifier all are enclosed in this single small package that has been fabbed an "Alpha cigar" by Hughes.

for space, industry and medicine

Tiniest Radiation Monitor

IT fits into the tip of a hypodermic needle, operates on low voltage (no big power pack), and is 1000 times faster than previous radiation detectors—that's Hughes Aircraft's new solid state ionization chamber. It's actually a slice of "doped" silicon which emits a measurable pulse when struck by a charged nuclear particle. It may be used for space exploration (precise measurements of cosmic rays), for instant information on ground-level radioactivity, for reactor power control, radiation cancer treatment control, and for various industrial processes.

Here is tiny heart of sensitive but rugged instrument—a very thin slice of doped silicon.

Palm-sized radiation detector will be low-cost, handy for use in industrial radiation surveys.



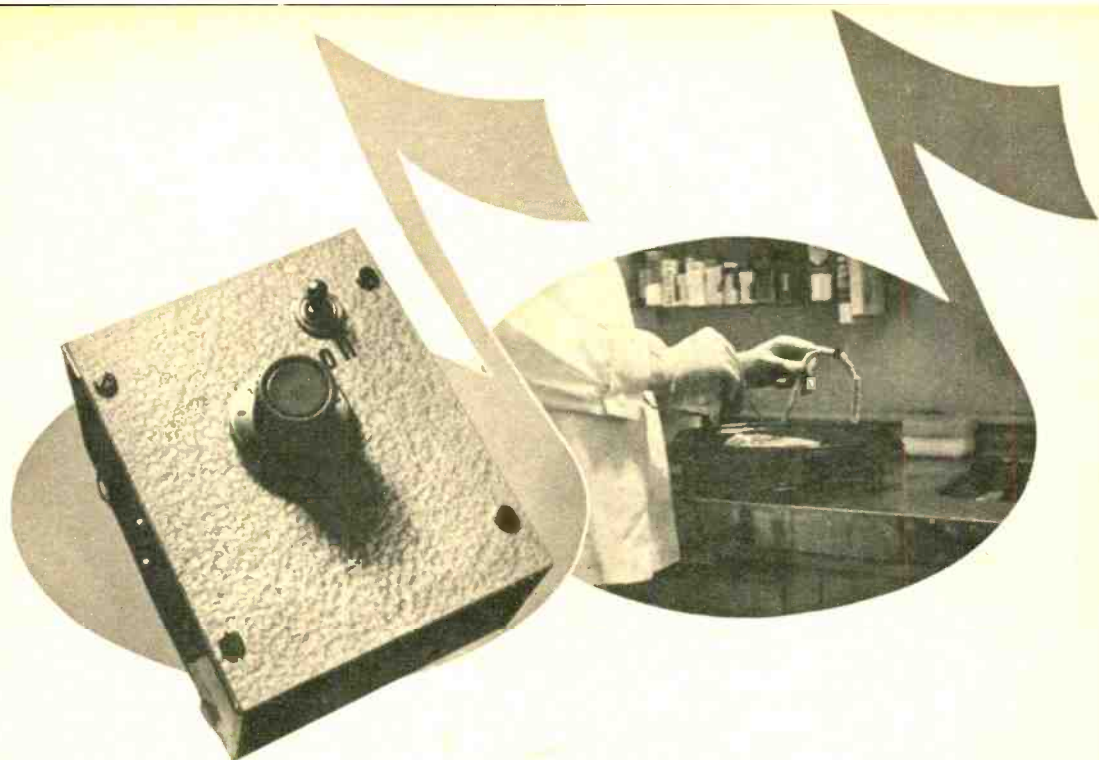

Electronic Oven Thermometer

By Steve Hahn

Meat "meter" will play "Smoke Gets In Your Eyes" when the roast is cooked to your own specifications.

MEN! You can insure yourself against coming home to a burnt-to-a-crisp dinner by building for your wife, mother or girlfriend this simple but super-accurate electronic meat thermometer. Let her wander from the kitchen, take a nap, read or watch TV. When the preset temperature has been reached for succulent ham or rare roast beef, she will be subtly reminded to high-tail it back to the kitchen by a tinkling music-box rendition of "Smoke Gets In Your Eyes." (An alternate appropriate tune also available is "How Dry I Am.") The cable that connects the probe to the rest of the circuit may stretch 50 feet, and the entire device can be constructed for under \$10—a bargain.

The entire unit is built into a 3" x 4" x 5" utility cabinet with removable top and bottom. It is desirable to utilize a metal chassis since it will act as a sounding board for the music-box mechanism. Leave off the bottom plate of the utility cabinet and mount rubber feet in the bottom-plate mounting holes, thus raising the entire cabinet $\frac{1}{2}$ " or so off the table top. This allows the sound to escape from the inside of the box.

The circuit is simplicity itself and no difficulties should be

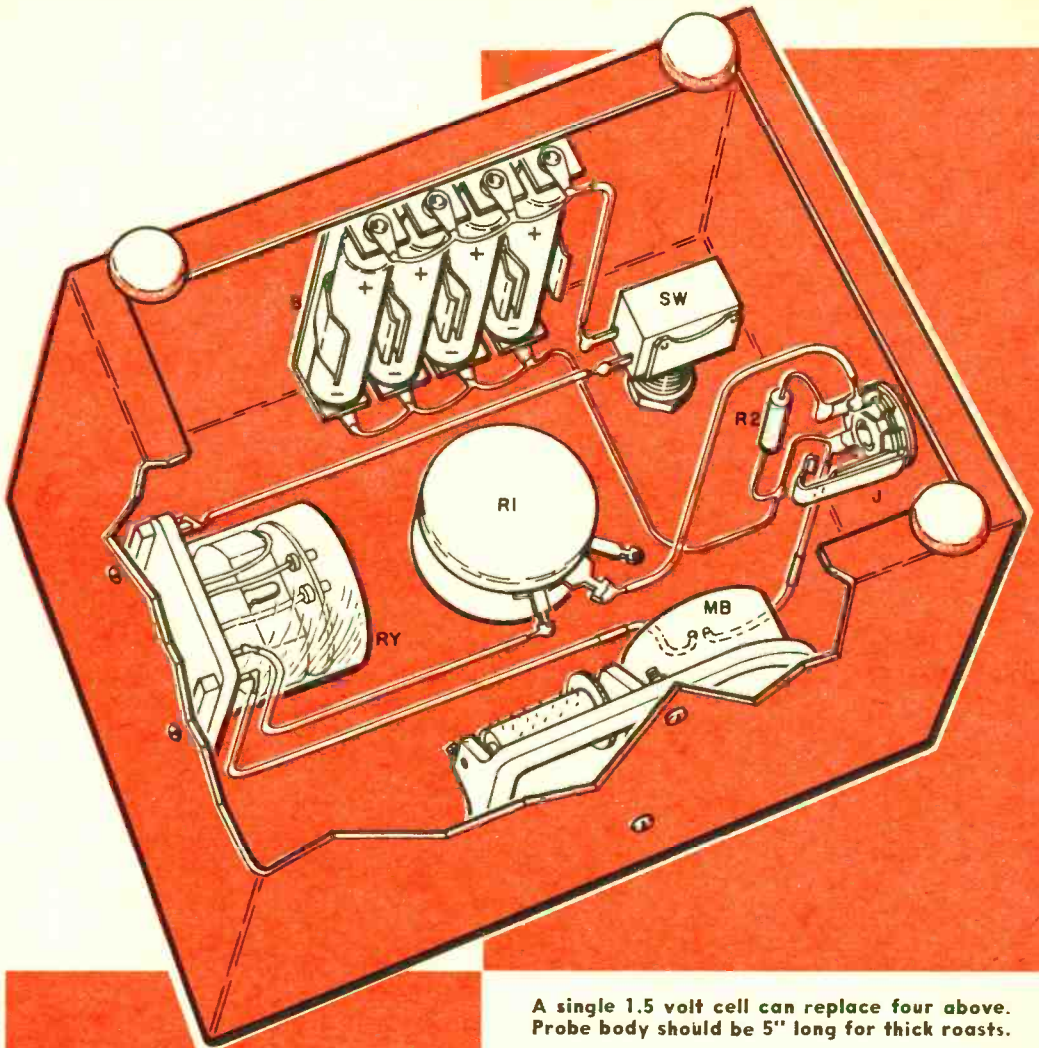

A single 1.5 volt cell can replace four above. Probe body should be 5" long for thick roasts.

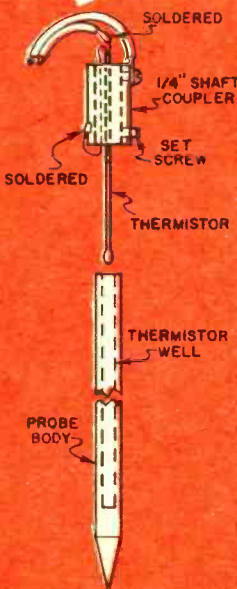

encountered in wiring. The temperature sensing probe input jack (J) is of the closed-circuit variety. This jack is wired in such a manner that when the temperature probe is removed, a resistor of approximately the same resistance as the probe thermistor at about 150°F is inserted into the circuit. This allows the user to check the thermometer prior to use merely by turning the temperature control to a minimum setting at which point the music box mechanism should begin to play. Any 1.5-volt battery powers the circuit and it is not necessary to use four batteries in parallel (as we did) unless extremely frequent usage is indicated.

The relay is a sensitive meter type

relay. In some instances, the relay failed to release once it had closed, even though the current was removed. This later turned out to be a blessing in disguise since it simply meant that the music box kept on playing until the box was tapped lightly.

The Probe

The most critical component of the meat thermometer is the probe itself. The heart of the probe is a glass-encapsulated bead-thermistor useable up to 300°C. This thermistor has an internal resistance of about 1500 ohms at 50°C. which drops down to about 100 ohms at 100°C. The probe housing is made from a 1/4" round piece of brass, aluminum or stainless steel tubing, up to 5" in length (depending upon the thickness of roasts normally cooked). One end of this probe is flattened and sharpened to a point with a grinder. The thermistor, which comes with glass insulating sleeving, is inserted into the probe and should rest about 1/2" away from the sharpened end of the probe. Assemble and wire the probe as per the diagram.

Probably the most difficult step in the whole procedure is the problem of get-

ting a wire which is able to withstand typical oven temperatures—which may go as high as 500°F. For those who want the very best, the Birnback Company makes thin wall Teflon tubing (cat. No. T500) which remains stable over this temperature range. About three or four feet of No. 20 or No. 22 stranded bare wire is soldered to one lead of the thermistor, protruding through the shaft extension bushing. Ordinary radio solder wire which melts at around 600°F. should hold up. The Teflon tubing is then slipped over the entire length. The grounded leg uses #20 or 22 stranded wire soldered or clamped under the set screw of the shaft extension bushing and then wound around the Teflon protected cable. Operation of the thermometer is not [Continued on page 99]

PARTS LIST

R1—1000-ohm wirewound linear taper potentiometer
 R2—300-ohm resistor, 1/2 watt
 SW—SPST toggle switch
 RY—relay (Lafayette F 482)
 J—phone jack, normally closed
 B—1.5 volt battery
 MB—1.5 volt music box movement, Lafayette MS-761, "Smoke Gets in Your Eyes," or Olson X-76B, "How Dry I Am"
 Thermistor—Glennite Type 32P82
 Case—3"x4"x5" (Bud CU-728B or equiv.)

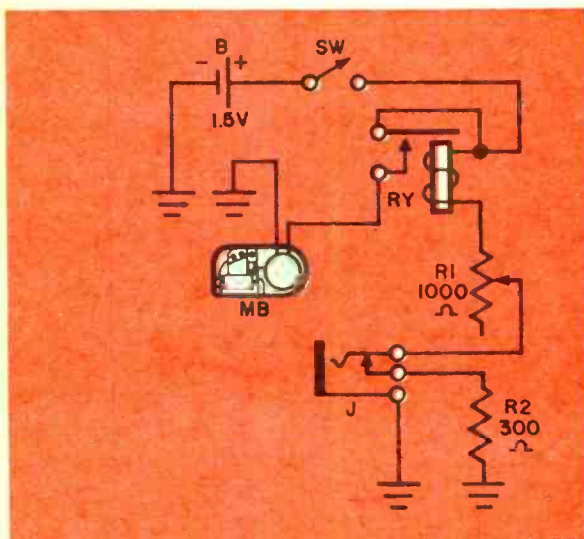

Normally-closed jack J, places R2 in circuit, permitting user to check unit prior to use.

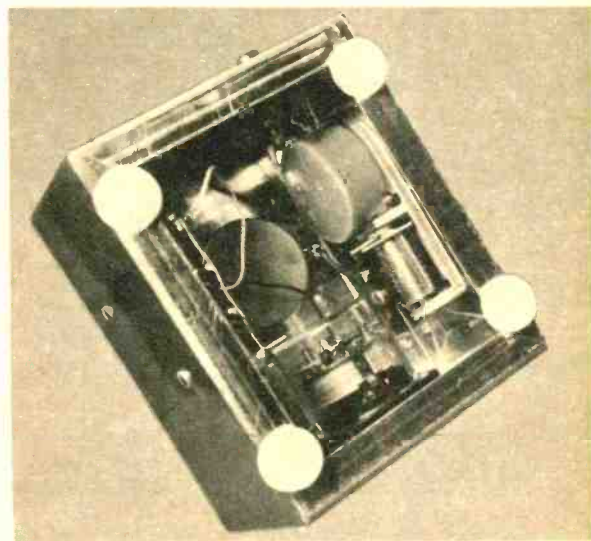

Four rubber or plastic feet (in white) serve to raise cabinet, for greater music volume.

Electronic Brain

Have you any questions on electronics? Send it in and the Electronic Brain will provide the answer.

Armstrong Oscillator

Can you explain why the circuit shown oscillates?

Richard Pomp, Newark, N. J.

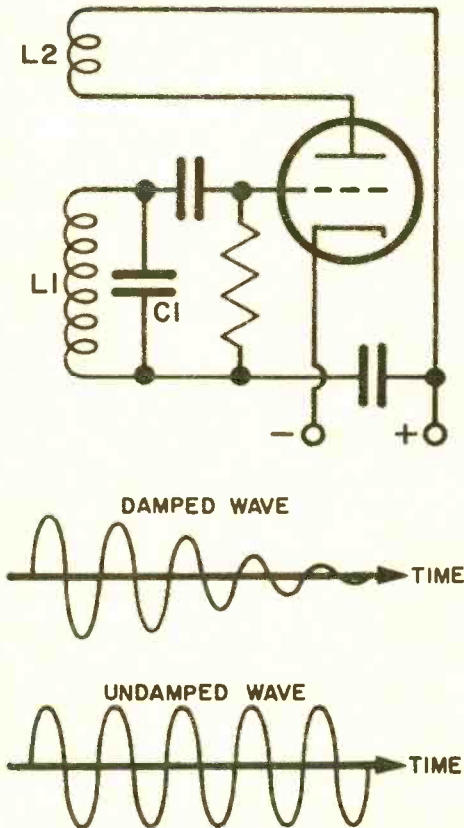

The basis of any oscillator of this type is the resonant circuit formed by L1 and C1. The oscillator you have drawn is the Armstrong series-feed type.

If C1 can receive a charge from some source in the circuit, it will discharge through L1 in an oscillatory manner, producing a sine wave that quickly damps out due to the resistance present in the coil and connecting wires. This is true of any capacitor-coil combination

whether it is connected in a tube circuit or not.

The tube and the rest of the associated components should be viewed merely as "helpers." The oscillatory energy passing back and forth from L1 to C1 causes the voltage on the grid of the tube to vary at the same frequency. This then produces a variation in plate current flowing through L2; due to the inductive coupling between L2 and L1, a part of the plate circuit energy is fed back into L1 so that the *resistance losses* are compensated for and the original damped wave is changed to an undamped oscillatory voltage. This is comparable to the mechanical analogy of the pendulum in a grandfather clock: the pendulum tends to swing back and forth whether it is connected to the clock mechanism or not; all that the spring and escapement does is feed small amounts of energy to the pendulum to make up for the friction and air resistance losses it suffers as it swings.

In both the vacuum tube oscillator and the pendulum, the bits of feedback energy must be properly timed so that the natural frequency of oscillation undergoes no interference. Timing in the oscillator is effected by phasing L2 properly with respect to L1; in the pendulum, the escapement mechanism dictates the right instant at which the spring adds some of its energy to the pendulum.

Tachometer

Is it possible to build an electronic tachometer to check the RPM of small electric motors?

Leo Michaels, Wheeling, West Va.

An electronic tachometer was described in the July issue of *Electronics Illustrated* on page 81. This tachometer can be used to measure the RPM of any rotating device. This meter is available in kit form from Heath.

Electrostatic Voltmeter

I have been told that the right way to measure the voltage across a Geiger counter tube is by means of an electrostatic voltmeter. What is this instrument and how does it work? Can an ordinary test voltmeter be used to measure from 900 to 1,000 volts on a Geiger tube?

Fred E. Follis, Nashville, Tennessee

A good vacuum tube voltmeter can be used to measure voltages across Geiger tubes provided that the input resistance is 25 megohms or higher. The need for this high input resistance arises from the fact that the power supply ordinarily used to energize a counter tube is not designed to supply more than a few microamperes of current. If the meter needs current to deflect its needle, this would reduce the voltage—often seriously—so that the reading

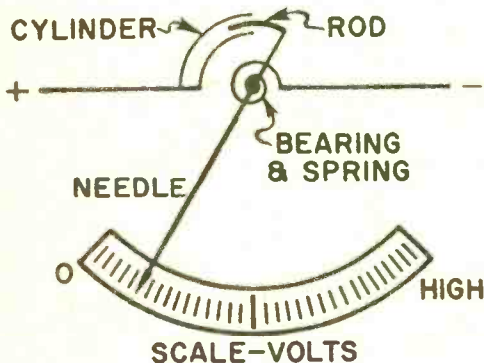

would be unreliable. This would be true, for example, if you attempted to measure this voltage with an ordinary voltmeter or multimeter.

An electrostatic voltmeter is a simple device in which the attraction of unlike charges is made to produce a deflection of a needle. As the deflection is proportional to the square of the voltage, its scale must obviously be non-linear; it is crowded at the low voltage end and spread out at the high voltage end. The instrument must have a very well-balanced, frictionless bearing since the attractive forces are quite small, even for the higher voltages. Unless one has machinist's facilities, it would hardly pay to attempt to build an electrostatic volt-

meter for the use you mention. Essentially, the instrument is intended for precise laboratory work rather than test purposes.

The diagram shows the essential parts of a popular type of electrostatic voltmeter. The return spring holds the needle on zero when there is no applied voltage. When connected to a source of potential, the curved cylinder attracts the rod so that it moves further to the left, causing the needle to move across the scale. The instrument must be calibrated with accurately known sources of voltage.

AC/DC Receiver

One side of the loop antenna on my AC/DC radio accidentally came in contact with an external ground. When this happened, something in the radio was damaged. Can you tell me what it might be?

James Moody, Dayton, Ohio

In most cases, experiences like yours can be explained when we remember that many AC/DC radios are still poorly designed. One end of a loop antenna should be at signal ground potential; when the manufacturer is careless, he allows this common ground point to be the same as the B— of the receiver. In an AC/DC set, the B— point is often connected to one lead of the AC line cord and hence the AC line.

If the radio's AC plug happens to be placed in the receptacle so that this particular lead joins the ground system of the house, nothing can happen. But there is a 50-50 chance that the plug is reversed from this position, placing the B— point (hence the whole loop) at the potential of the "hot" side of the AC line. Now should the loop touch a radiator or pipe, the current that flows through it will be determined only by the resistance of the loop wires connected right across the 117-volt outlet. This resistance is small, hence the current flowing may be several amperes—more than enough to melt one of the loop wires or one of its solder joints. It would appear that you have an open or high resistance circuit somewhere in the loop and its associated wires. ⚡

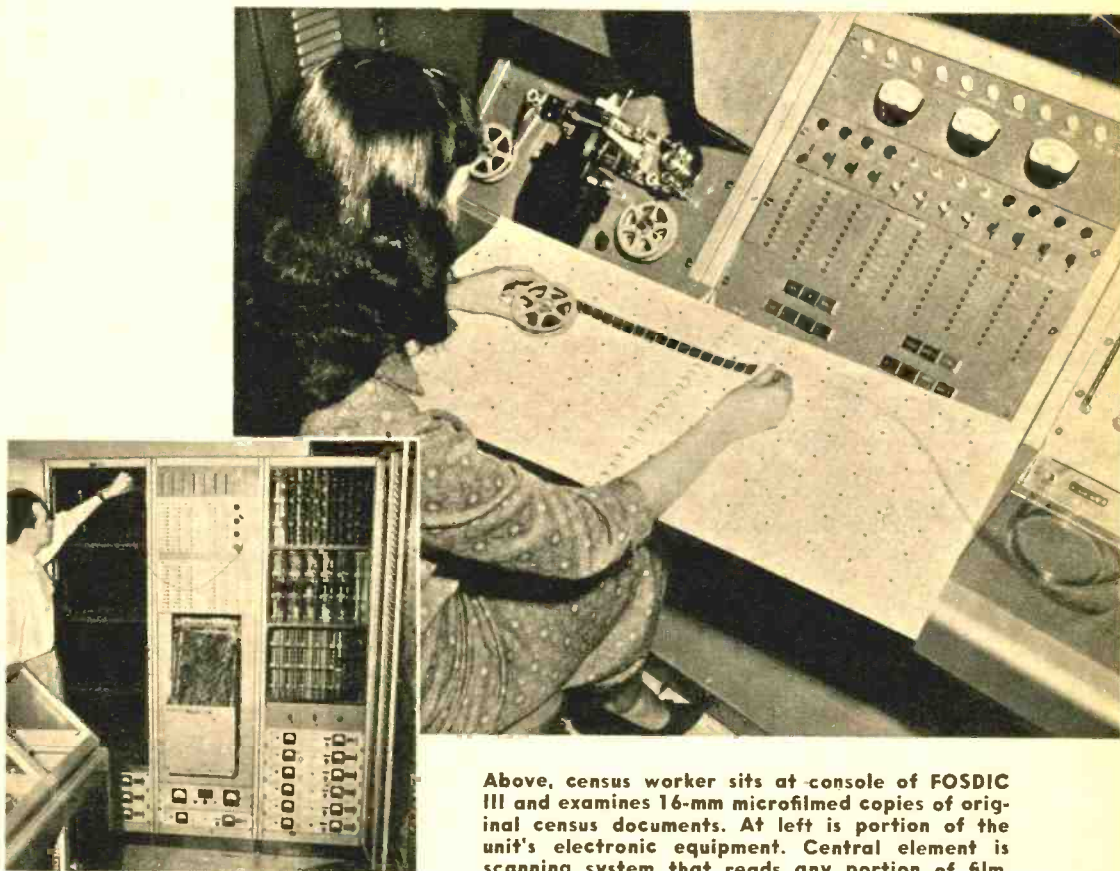

Above, census worker sits at console of FOSDIC III and examines 16-mm microfilmed copies of original census documents. At left is portion of the unit's electronic equipment. Central element is scanning system that reads any portion of film.

fosdic III and the **'60 Census**

Electronics lends a much needed helping hand to the census takers for this big once-in-10-years event.

IF you haven't already, you'll soon be filling in the decennial census form, 1960 version, designed to include every U. S. family. Nearly 160,000 persons will be employed by the Bureau of the Census to collect and process this data. The National Bureau of Standards has made their job easier by developing FOSDIC III (Film Optical Sensing Device for Input to Computers), an electronic workhorse that rapidly reads (detects) pen or pencilled marks in multiple choice answer areas that have been microfilmed. The information conveyed by these marks, scanned by an electron beam and photocell, is automatically coded into computer characters and then recorded onto magnetic tape. Thus FOSDIC III takes human information, identifies it, and converts it into computer language with electronic speed. 

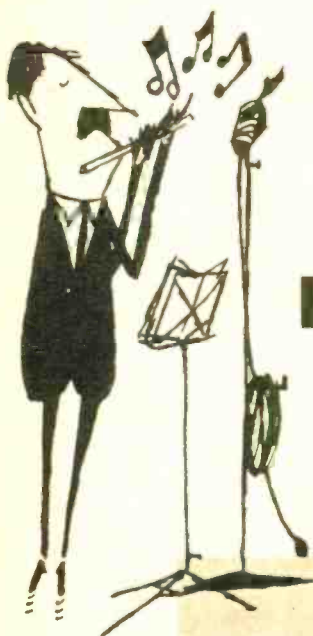

HI-FI

How to Test Your

THE EAR AS A TEST INSTRUMENT

THE most versatile and sensitive of all hi-fi test instruments is the human ear. This is convenient because when meter, generator and scope remain at home, our ears are along, ready for instant appraisal of a friend's hi-fi components or for sizing up some new item at the store.

If properly used, ears are the best yardstick to measure the merits of any sound system. That's why experienced hi-fi designers, after all measurements are made, put away their instruments and let the ear be the ultimate judge.

Such critical "evaluative" listening is neither simple nor can it be casual. If the ear is to serve as a gauge, it must—like all test instruments—be calibrated to a standard. This standard, of course, is the actual sound of "live" music.

Compared to other primary lab standards—which sometimes cost thousands of dollars—this one is cheap to come by. A two-dollar seat for a good symphony concert and careful listening are all you need to "calibrate" your ears.

But "calibrating your ears" against the standard of actual orchestral sound is only part of the job. The real trick is to make them *hold* calibration. In other words, you must accurately *remember* the sound of "live" music to make it serve as a basis of comparison later when you listen to your hi-fi system.

Fortunately, it is possible to train our tonal memory for hi-fi testing. The main thing in such training is to know just what to listen for. Here we

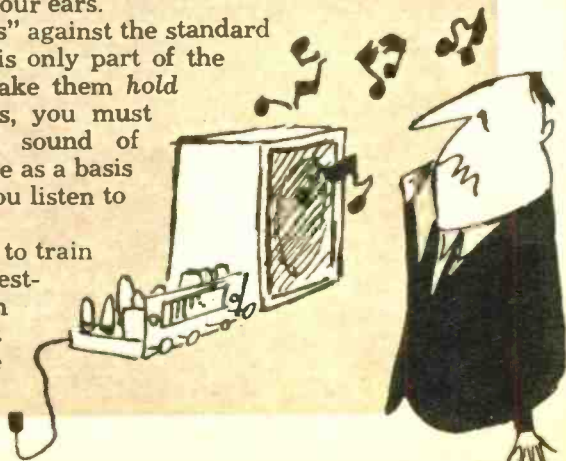

shall try to isolate and define these tell-tale factors in tone. When you get them firmly in mind, they are as clear in their indication of hi-fi quality as the meter of a tube tester: your trained ear can immediately flash you the signals—"good," "no good," or "so-so."

Good aural test material includes strings, percussion, brass, organ, male speech, etc. Each reveals specific performance factors in a hi-fi system. We have incorporated a number of these musical "telltales" in the *EI* Test Record; but they must be supplemented by frequent and careful listening to *live* music to achieve a permanent "built-in" standard of quality comparison.

Strings and Full Orchestra



Listen for silky sheen in the violins; solid weight in cellos and contrabass and clear separation of individual instruments throughout the entire frequency and dynamic range.

The massed strings of a first-rate symphony orchestra should have a clear, smooth brilliance without a trace of fuzz or stridency. Is there a rough, grating "edge" in the violin sound? That's a tell-tale sign of non-linear frequency response. It may mean that there is a peak (usually between 5,000 and 10,000 cps) in your pickup or tweeter. It seems that engineers find it far more difficult to obtain linearity in electro-mechanical devices than in the purely electronic ones.

Try a different cartridge and tweeter, and make sure you are using the manufacturer's recommended crossover frequency for your speaker system. If you have only a single "full-range" speaker, try adding a good tweeter which uses a 1000-cycle or lower crossover network.

Full orchestra is the payoff. All the factors we need to consider combine into the making of orchestral sound. For instance, the benefit of good transient response is not confined to percussion alone. The tonguing of the woodwinds, the cellist's bow digging hard into the string—all these come into sharper focus in a sound system with good transients. The whole texture of even the heaviest orchestral passage stays amazingly "transparent" when you have a good amplifier and loudspeaker.

Brass

Listen for metallic blare and brassy "edge." There should be no harshness, buzz or breakup.

The bold tone of a loud trumpet is one of the best checks for upper midrange frequency response. It should come through with a tingling metallic edge. You recall the brassy blare of a bugle call and the almost bell-like ring of a marching band; listen for it. If instead you hear a dull, spongy sound, chances are that one of the components in your system restricts the range. Check your pickup and your tweeter.

But don't mistake harshness for brilliance. For all its sparkle, the trumpet should stay sweet. A tinny, grating sound betrays the presence of distortion perhaps in the amplifier or in a peaky tweeter. But your first suspects should be a worn stylus or an unyielding, low-compliance pickup. Your tone arm may be stiff in the joints. If you hear a rattle or buzz, it's a good idea to check the stylus pressure of your arm—it may be too *light*.

Percussion

When the drummer's stick crashes against the tight skin of the drum, there is an almost explosive moment of hard collision, a sharp, articulated impact. It lasts only a split second and is gone; but for your hi-fi system this kind of "hit-and-run" sound is the "moment of truth." Crash-and-bang sounds viewed on an oscilloscope have steep wavefronts, rising like peaks above the ripples of the rest of the music. This abrupt change in the amplitude of the signal is called a "transient" because it is gone as quickly as it came. It is the moment of brief encounter between drum and drumstick, xylophone and mallet, harp and plucking finger, etc.

Tracking such transients is a task that really puts your hi-fi system on its mettle. What with capacitive and inductive time constants in nearly all its circuits, your amplifier has a certain amount of electronic inertia. When the transient comes along, a sluggish amplifier just can't jump fast enough to keep pace with the rapid signal change. Result: the transient waveform gets bent out of shape and loses its sharp contours. What does this mean to the ear? Simply this: instead of a sharp, exciting "click" you're more likely to hear a "clunk."

So far in our discussion of transients we have concerned ourselves only with the "arrival" of such sounds—their steep initial wavefront. Yet the departure of these percussive sounds, the moment of their stopping, is equally important to their faithful reproduction through the loudspeaker. Here again the attentive ear renders "data" in many ways more informative than instrument readings obtained in anechoic chambers.

One of the common troubles of inferior amplifiers is that they literally don't know when to stop. The transient sound (let us again visualize the impact of stick against drum skin) provides so much power that, like a bell that has been struck, the amplifier may continue ringing long after the initial pulse is gone. An amplifier needs lots of "self-control" to check such spurious oscillation. Technically such self-control is usually achieved by good design and careful attention to circuit details. The knowing ear, remembering the sound of "live" music, can readily spot such "runaway" amplifiers by the blur trailing the drumbeats.

Yet the chief culprit that robs percussion of its keen edge is more likely lurking in the loudspeaker. After the sudden swing of the speaker cone that mirrors the motion of the struck drum skin, some speakers keep jiggling after the original sound is silenced. In doing so, they not only tend to falsify the percussive stroke itself, but blur whatever follows it. This so-called "hangover" (no relation to the familiar "morning after") may last for only a fraction of a second. But this is long enough to wipe out the sharp contrast between the percussive portion of a sound and the sustained note following it.

Good damping, therefore, is one of the prime requirements of a quality loudspeaker. It is attained in two ways: 1) By a magnet powerful enough to "inhibit" the speaker cone so that its motion remains strictly proportional to the signal wave-

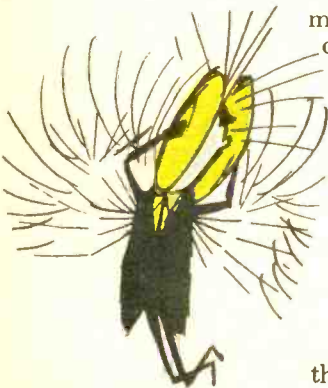

form—in other words, the cone gets no chance to do any uncontrolled jiggling of its own. 2) By an enclosure or baffle so matched to the speaker as to provide adequate “loading” of the cone. This means that at the critical bass frequencies, the acoustical conditions are such that air masses keep the speaker from running away with itself.

One final caution: In judging the transient response of a hi-fi system on the basis of percussion music, you must make allowance for the acoustics of the recording hall. Don't mistake natural reverberation in the hall for “hangover” in the playback system. Natural reverberation lends body to the percussive sound by adding a normal echo. “Hangover” adds only unrelated random vibration that strikes the ear as a fuzzy smear of sound.

Organ

A large pipe organ with its gigantic 16-foot and in some cases even 32-foot pipes provides unique tonal test material for loud-speaker bass response.

The lowest pedal notes of a large pipe organ reach to the very bottom of the audible range, producing those majestic tones in the 30 cps region that are the massive foundation of the entire tonal structure of organ music. This is the ultimate touchstone for your woofer and its housing.

To sound such deep tones with all their original beauty and power, the woofer must vibrate at the low fundamental frequency. Inferior speakers often “break up” on such low notes, producing merely the harmonics of the bass without the real fundamental frequency. Usually the octave above the true bass becomes prominent. This type of distortion is therefore called “doubling.” Some manufacturers of inferior loudspeakers deliberately exploit this effect because the false octave plays tricks on the ear and makes the bass seem louder and more impressive to the listener who doesn't know the real thing. What really counts, musically speaking, is whether your woofer responds cleanly to those soft, low notes that lend a feeling of richness and solidity to the entire musical texture. Listen to the “feel” of such low pedal notes on the pipe organ. If they come through clean you get a sort of velvet impression—soft, but with a sense of great power. Even though a really low note may seem barely audible, the whole room seems filled with it.

If the organ passage played on the *EI* Test Record lacks solid-bottomed bass, it's a fairly safe bet that either your amplifier or your speaker are skimpy on lows. If you know that your speaker is capable of reaching down to 50 cps or lower without loss of volume and you still don't get that heavy, massive bass feeling—better check the power response of your amplifier. If the manufacturer's specs say your amplifier is in the 12-watt class—it may deliver those 12 watts all right in the midrange region, but get short of breath lower down where the heavier bass amplitudes demand plenty of electronic “muscle.” That's why higher wattage amplifiers (20 watts and up) with their ample reserve power are good insurance that you're really getting all that rich, solid bass that forms the foundation of orchestral sound—providing, of course, that your speaker delivers what your amplifier puts out.

Male Speech



Listen for normal voice quality—lack of beer-barrel bass. Smooth, not overly sibilant “esses.”

The male speaking voice readily shows up cases of “boom boxiness,” a widely prevalent evil among loudspeakers mismatched to their enclosures.

Bass reflex baffles are particularly prone to this difficulty. The acoustic mismatch results in a resonant hump in the 70 to 100 cps range which may sound “mellow” to indiscriminating listeners—but actually blurs everything to a dull boom.

Tune in any good radio station (preferably FM) and listen to the announcer. Does he sound as if he were talking inside a beer barrel? Well, either the announcer is barrel-chested or you have a boomy speaker enclosure—and we’ll give you odds on the latter. As a remedy for your phonograph’s “chest cold” try lining (or adding more) the inside of the speaker baffle with Fiberglas or some similar sound-absorbent padding. Try tacking a layer of burlap over the port opening.

In some obstinate cases it may be necessary to change the area of the bass port opening so that the reflex enclosure is properly “tuned” to the loudspeaker’s cone resonance. It’s a simple enough cure and very worth while, because the “chest cold” boom of your loudspeaker will give a splitting headache from “listener fatigue” if you play music for any length of time. The effect is somewhat like monoxide exhaust gas; you don’t notice it at first, but the strain builds up fast.

Summing Up

So far, we have made no reference to stereo. Not that we want to slight this vital innovation; but all we really need to explain about it is that everything we said “goes double” for stereo.

You have put your sound system to the test. You have charted its merits and its shortcomings in terms of musical performance. Now—listen to the *music*, rather than the *sound*. For the purpose of high fidelity is to *clear away* obstacles between you and the music, not create new ones.



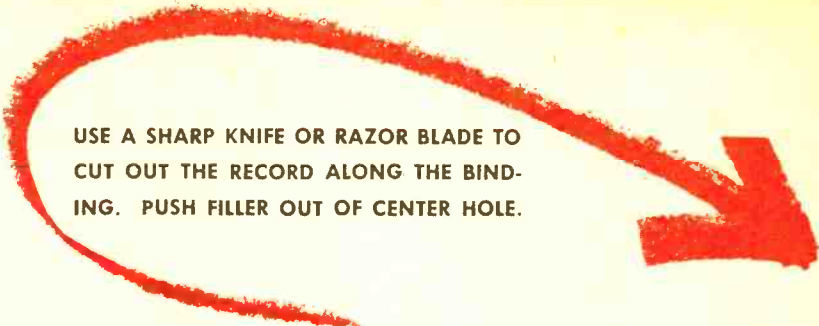

USE A SHARP KNIFE OR RAZOR BLADE TO CUT OUT THE RECORD ALONG THE BINDING. PUSH FILLER OUT OF CENTER HOLE.

The EI Test Record contains musical selections and frequency tones which you can use to check out the fidelity of your music reproducing system. For details on how this works refer to the preceding article, "How To Test Your Hi-Fi."

HOW TO USE THIS RECORD:

If you have a record changer set it for manual operation and place the tone arm on the first groove. If your turntable has a ridged rubber or plastic mat, first place a standard record on the turntable and then place the EI Test Record on it and tape down the corners. Adjust the volume of your system so that the 1000-cycle reference tone is at normal listening level in your home; set the tone controls to the "flat" position; the equalization control (if present) should be set to RIAA.

What to Listen For, Band-by-band:

1. 1000 cycles—Listen for wow (a slow rise and fall in pitch) indicating variation in turntable speed.
2. 12,000 cycles—Can you hear it? This tests the upper frequency limit of your ears, tweeter (or full range speaker), and phono cartridge.
3. 100 to 40 cycle sweep—Does your speaker system suddenly boom out at one point in this sweep? If so, you have found its resonant peak. Also listen for rattles in the speaker cabinet.

The musical tests. Unlike the preceding three bands, the musical tests are comparative. Each of the selections is played twice. The first time each selection has been recorded with the highest fidelity. It is then immediately repeated, but now the sound has been degraded so that it resembles what you hear from a poor phonograph. If you cannot tell the difference between the "good" and "poor" then your system makes all recordings sound poor. If you can hear the difference on certain bands and not on others refer to the article "How To Test Your Hi-Fi" for further information.

4. Clarity Test—(selection from Mozart's *Symphony No. 40* on Westminster record XWN 18527). Listen for clear and full string (violin, viola) section, smooth treble.
5. Transient Test—Listen for clearly defined triangle, bells, woodblocks, snare, bass and kettle drums. Each sound should begin and end sharply without blur or fuzzy fadeout.
6. Brilliance Test—(selection from Kodaly's *Hary Janos Suite* on Westminster record WLAB 7034). Listen for shiny brass, brilliant blare of trumpet.
7. Bass Test—(selection from J. S. Bach's *Passacaglia in C Minor* on Westminster record XWN 18260). Listen for the low pedal note at the end. The first time you should hear that final low C in its soft but full sonority; the second time around it is missing due to bass cutoff.

and now... an independent tone arm
that measures up to

SHURE STANDARDS

...for use with any quality cartridge

...monophonic or stereo



new safety for records

Surface wear is held to absolute minimum through flawless tracking made possible by an ingenious and unprecedented combination of adjustments. Optimum static and dynamic balance, precise height, correct cartridge "overhang," and incredibly accurate stylus force are quickly achieved and easily maintained without guesswork.

new sound from records

Modern high-compliance, light tracking cartridges (Shure M3D compliance is 4.0×10^{-6} cm/dyne; 3 gm. tracking) require arm balance of a high order in *all* planes to deliver ALL the sound, undistorted. The Shure arm pivots on drag-free precision bearings. Precision adjustments assure optimum suspension and permanent balance, regardless of cartridge characteristics.

new simplicity in installation and operation

Installs completely from top side of motorboard. Special cable and plug assembly eliminates hum problem, speeds up and simplifies installation. Eliminates soldering. All you do is plug in one end of cable to tone arm, the other end to amplifier. Lock-on heads are instantly interchangeable. Direct-reading stylus force gauge with instant disconnect, and "micrometer" counterweight assembly permit visual static balance checks.

TONE ARM M232, for 12" records.....	\$29.95 net
M232-7 (with M7D cartridge installed).....	\$53.95 net

Literature available / SHURE BROTHERS, INC., 222 HARTREY AVENUE, EVANSTON, ILLINOIS

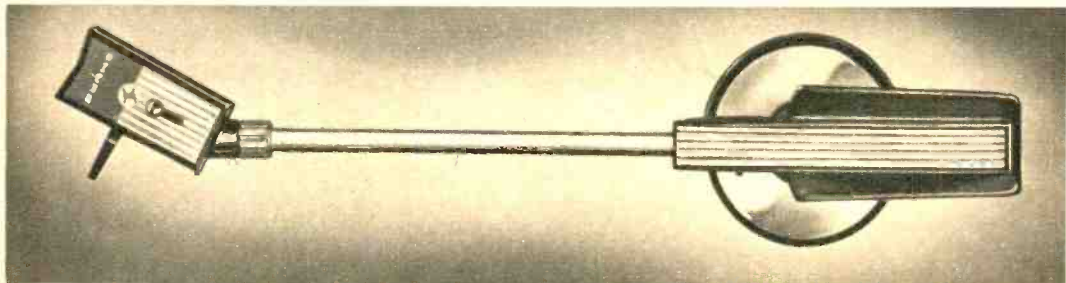

TV Tape Takes to Road

Have you noticed "live" location pictures on your TV screen lately? It's probably mobile videotape.

WHEN Soviet Premier Nikita S. Khrushchev visited a farm and meat packing plant at Coon Rapids, Iowa, CBS-TV newsmen knew they had a scoop. No, they weren't the only ones there. The other two networks also had plans to use videotape coverage of the event on their newscasts, since tape requires no processing time and yields "live" fidelity pictures. But only the CBS-contracted Giantview mobile videotape unit was able to follow Mr. K. as he ambled around farm and packing plant.

The Giantview unit can capture broadcast quality pictures on videotape at almost any location. What does this mean to the TV producer and director? Cut costs, for one thing. What does it mean to you, the viewer? Good, authentic backgrounds that studio-anchored cameras cannot get. A director can shoot westerns, commercials, sports events, etc., at remote locations, check the results on the spot, and reshoot those scenes which do not satisfy him without having to wait for a film run.

On board the truck are an Ampex videotape recorder with cue and erase channels, editing facilities, four TV cameras which are electronically switched and mixed, audio recording facilities with six microphone channels, lighting equipment, monitors, cables, a complete servicing shop and radio-telephone.

A hospital documentary is recorded and played back on the spot inside six-ton truck that houses complete gear for recording, editing and repairing.

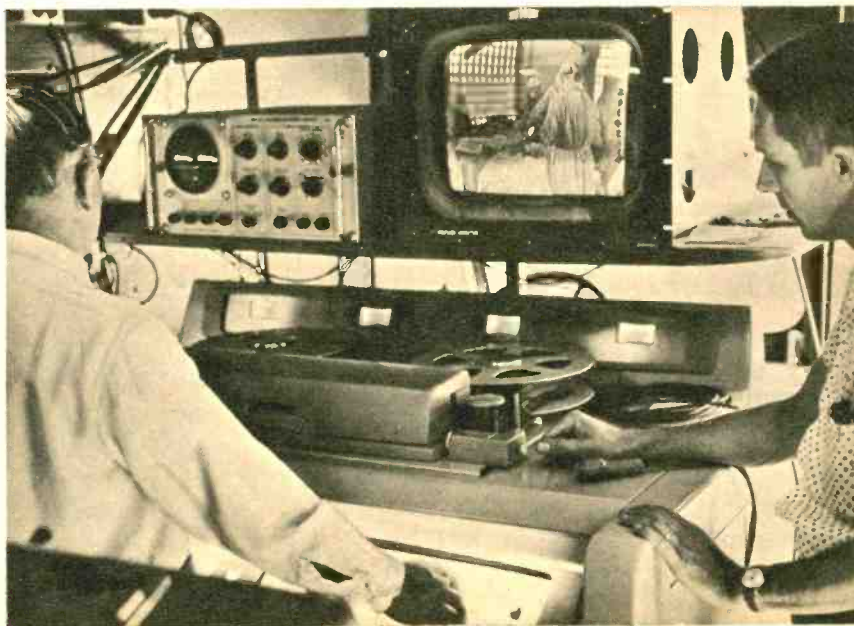



Cameramen on non-skid roof of truck and on ground level aim lenses at performers on location for TV commercial.

Cameras, plugged into truck, move right in on demonstration of machine tools that are to be auctioned via television.



Man, upper right, has a "long lens" on camera while others in recording crew get ready for Mr. K's Iowa farm visit.



June, 1960

spotlight on:

6-Meters

By C. M. Stanbury II

Reliable short-range communications, mobile operations and even some exciting DX—that's VHF on 50-54 mc band.

PRIOR to World War II, all of VHF (30-300 mc) was experimental territory. Efficient equipment for this frequency range was in the developmental stage and no reliable long range communication was available. Wide band television and FM broadcasting were not yet commercial. After the war, when they were ready for the public, VHF mushroomed into a first rate and popular means of communication.

The first VHF amateur band (after VHF was divided into bands), was five meters—roughly where TV Channel 2 now meets Channel 3. Later it was dropped down to 54 mc, just below Channel 2. While pioneering VHF, hams made two important discoveries. First they found that dependable short range QRM-free communications were easy to establish. This offered many

At left is highly directional multi-element beam for six meters (TACO model 10A6M). At right, 1960 Edison Award Winner, Walter Ermer, Sr., picks up mike of ham-equipped sports car to discuss traffic patrol problem with other public spirited hams assisting Cleveland police during parade. Note horizontally polarized mobile six meter antenna. CD, RACES use six meters.





Primarily for General and Technician Class licensees, Heathkit "Seneca" transmitter tunes up on all the VHF ham frequencies, covering both six and two meter bands. It has built-in VFO, four crystal positions and delivers 120 watts input for phone work.

advantages for amateur radio communications. Secondly, VHF DX was not only possible, but in some respects even more exciting than its shortwave counterpart.

Under normal conditions (and we use the term loosely), six meter transmission (50-54 mc) is limited to space wave reception and, to a certain extent, by the line of sight principle. Of course, the higher your antenna, the broader your horizon. Signals can be received beyond line of sight range with the help of a slight bending effect always present in the lower atmosphere. Diffraction also may add distance. Such "normal" beyond-the-horizon propagation improves as the frequency drops.

A well-known example of this is TV Channel 2, often received at far greater distances than channels at higher frequencies.

There are two major sources of DX in VHF. Tropospheric inversion (ducting) can produce distances up to 500 miles or better. Upward extension of ionospheric effects can do the same. From a DX standpoint, the latter is a key factor on six meters, so we'll look at it in detail this month, and do the same with the troposphere next month.

With a high sunspot count, the F2 layer will become ionized to the point where it will reflect frequencies above 30 mc. This usually occurs during fall or early winter, and only at certain

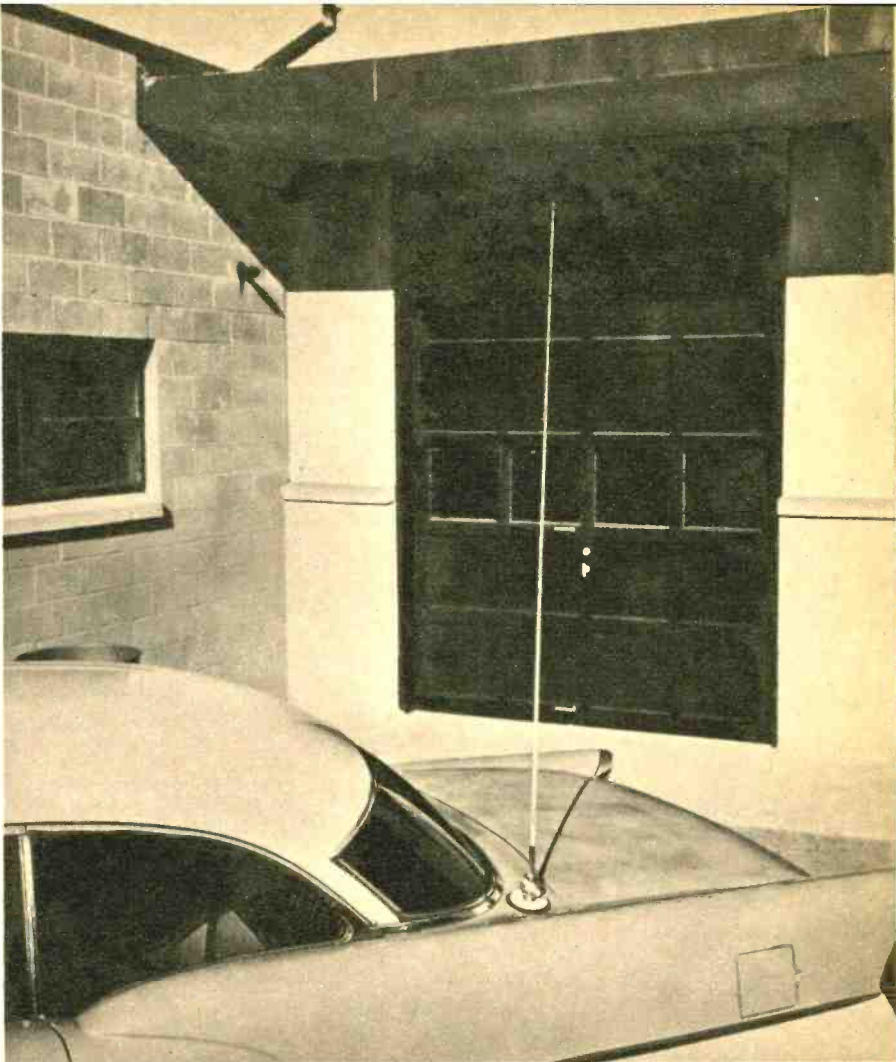

The non-directional, vertically polarized whip antenna is popular for mobile ham operations on six meters. Length of a six meter whip is about 54 inches. This Shakespeare Wonderod (model 10-1) is attached to car by a simple ball mount.

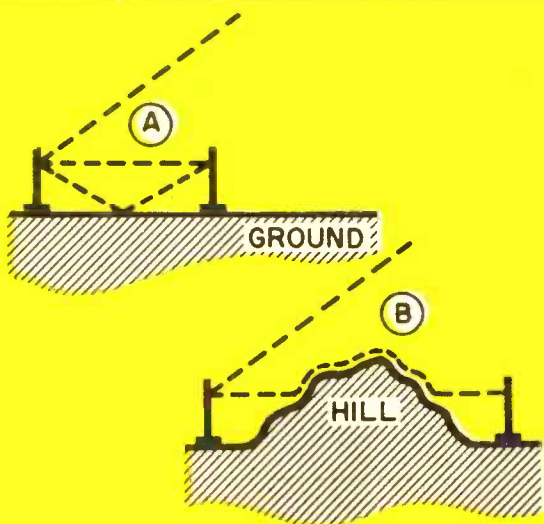

A) Six meter communication occurs via direct space wave and reflected ground wave. Latter is out of phase and reduces signal strength, thus antenna with maximum radiation parallel to ground is best. High angle radiation probably will not be returned to earth. B) Diffraction can bend VHF frequencies around curvature of earth only for short distances.

hours of the day. Transmissions are generally limited to one, or at best two hops. Far more common is Sporadic-E layer reflection. This has the same maximum hop distance as the normal E layer (approximately 1200 miles), and because its formation is quite erratic, the Sporadic-E does not usually support more than two hops. However, the past couple of summers it has made six meter world-wide communications possible on a scale never before thought feasible. The exact nature and cause of the Sporadic-E are unknown, but VHF-wise it appears most often during the summer months (as does tropospheric DX) and when the sunspot count is high. Six meter DX is like roulette, long dry spells—then suddenly a lucky streak.

Operating on the Band

When we began this series back in January, we referred to 80 meters as a short-range band. The term was used comparatively: 200 miles contrasted with the continent-spanning common to other shortwave frequencies. Now six meters is a short-range band (normally) and by short here we mean 75 to 100 miles, depending upon terrain, antenna height and power. Obviously

this figure should be scaled down for mobile operations. However, six meters has the greatest working range (reliable working range) of any VHF or UHF band. It is the lowest in frequency and therefore most subject to diffraction and normal tropospheric bending (as distinguished from a duct).

For mobile work this band is a compromise between ten meters and two meters. There is a possibility of real DX, and the shorter wavelength increases the number of practical antennas. Anything from a highly directional beam to a simple vertical half-wave could conceivably be mounted atop your car (the latter is the most common). A beam is best for DX, but the vertical radiates in all directions and is best for utility mobile use.

Portable and mobile stations, in addition to providing companionship for traveling hams, are of vital importance to civil defense. And by civil defense we don't necessarily mean a national emergency, but rather the local disasters—floods, twisters, etc.

The ham civil defense organization is RACES (Radio Amateur Civil Emergency Service). It is a joint undertaking of government CD agencies and the am-

[Continued on page 107]

For VHF communications such as those on six meters, polarization of the antenna is as important as type of antenna used. Vertical or horizontal? Neither has been proven "better" than the other, but there are certain practical factors which determine the amateur's choice. First, what are the other local hams using? If you want to communicate with them you had better have the same polarization. In figure below, note that signal from mobile vertically polarized antenna on car at left is readily received by other vertical antennas, while horizontally polarized antenna only gets a small portion of the signal. For DX, use a beam vertically because signals can be beamed in a single direction for a power gain.

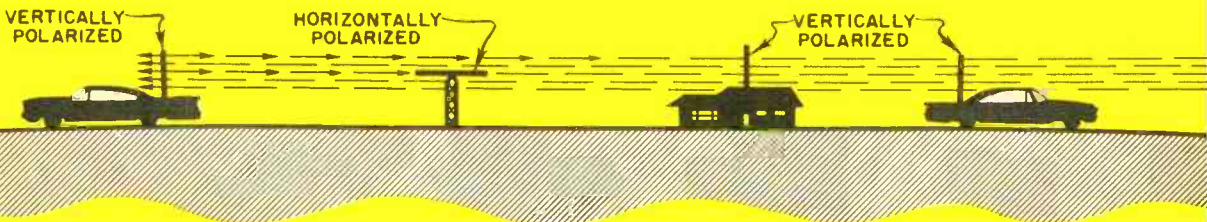



A Signal Pencil

By R. L. Winklepleck

Pocket signal injector—handy for radio & TV audio.

THERE have been many plans published of small oscillators specifically designed for use in signal-injection trouble-shooting. Some have been very good and they've been well accepted and widely used. Many have been quite compact and this is important—especially if this handy signal generator is to see maximum use.

The "signal pencil" was designed to take advantage of the many small components now readily available. It has the shape and approximate size of a cigar for shirt pocket portability and to make it easy to use in the crowded "innards" of today's electronic equipment. It produces a powerful audio signal loaded with harmonics which covers the audio, IF frequencies and the RF broadcast band.

The Circuit

A simple two-stage, direct-coupled, complementary-symmetry transistor amplifier, with a feedback capacitor coupling the output back to input functions as an audio frequency multivibrator. The output signal, a modified square wave, appears across load

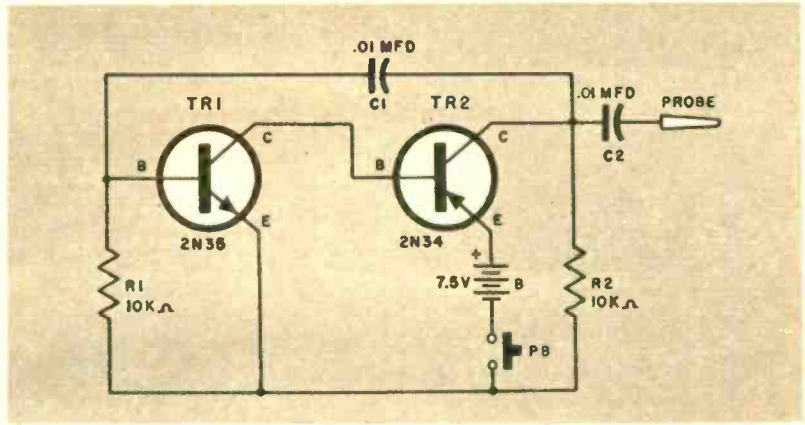

Two transistor amplifier using capacitive feedback to make multivibrator.

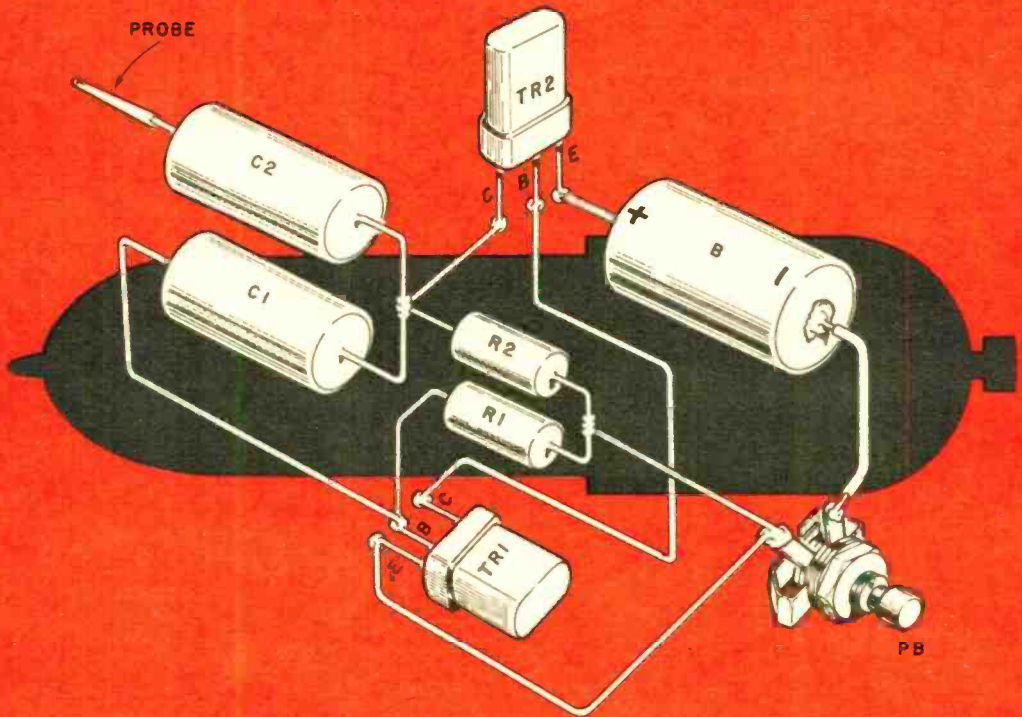

All the miniature components must be wired as shown above with all leads short. This requires the use of a low wattage soldering iron and heat sinks.

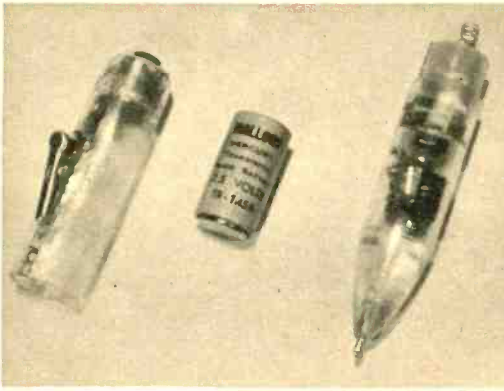

The two major sections of the author's signal pencil are at left. The mercury battery is the largest single component. In photo below the pencil is shown in use with a table radio.

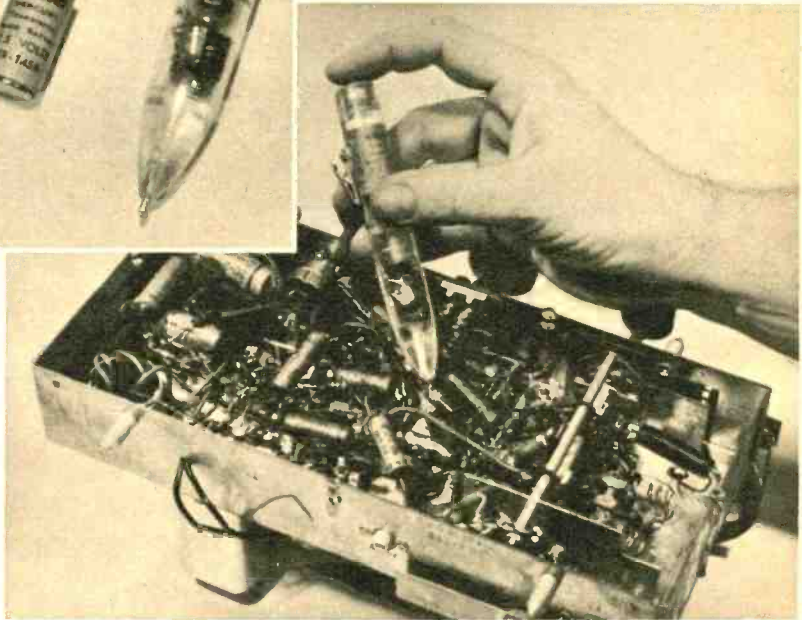

resistor R2 and is coupled through C2 to the pencil's output tip.

Since current consumption of the unit is only three milliamperes, the small mercury battery should last for many months under hard usage. The battery, small though it is, actually is the largest component.

Construction Details

Your version of the pencil can be as complicated as you desire. The author's model was constructed of $\frac{3}{4}$ " polystyrene tubing with $\frac{5}{8}$ " inside diameter. A $\frac{1}{2}$ " plug of $\frac{5}{8}$ inch polystyrene rod is drilled out to accept the pushbutton switch which is fastened in place with poly cement. However, since the layout is not at all critical, you can assemble the components in any sort of metal or plastic container you wish. If desired, a ground lead can be wired to the portion of the circuit connected to the emitter of TR1. Or if a metal Mini-Box is used, TR1's emitter circuit can be connected directly to the cabinet (as a chassis ground) and the ground lead

connected under a chassis screw.

Servicing With The Signal Pencil

The pencil is used to supply a test signal, usually to a dead or weak receiver or amplifier, to pin-point the faulty section. The standard approach, is to insert an audio signal across the speaker leads and then work, "backwards" from stage to stage, through the audio amplifiers, the detector, the IF amplifiers and possibly clear out to the antenna until the weak or dead stage is encountered. If all is well the signal as heard in the speaker should increase in volume as more stages of [Continued on page 99]

PARTS LIST

R1, R2—10,000 ohm resistor, $\frac{1}{2}$ watt
 C1, C2—.01 mfd capacitor 200 volts (Aerovox miniature Type P83Z)
 TR1—transistor 2N35
 TR2—transistor 2N34
 PB—pushbutton switch (Switchcraft No. 903 or equiv.)
 B—mercury battery, $7\frac{1}{2}$ volts (Mallory TR-145R or equiv.)
 Misc.—Case or $\frac{3}{4}$ " polystyrene tubing, $\frac{5}{8}$ " polystyrene rod, alligator clip

New FM Auto Radio

OUR recent survey "FM Radios for Your Car" (December 1959) contained several reports from leading auto radio makers which stated flatly they had no plans for marketing an FM auto radio. Motorola was one of them. In spite of their former stand—or perhaps because of our article—Motorola is now mass producing the FM-900, a mobile radio that tunes 88-108 mc. This

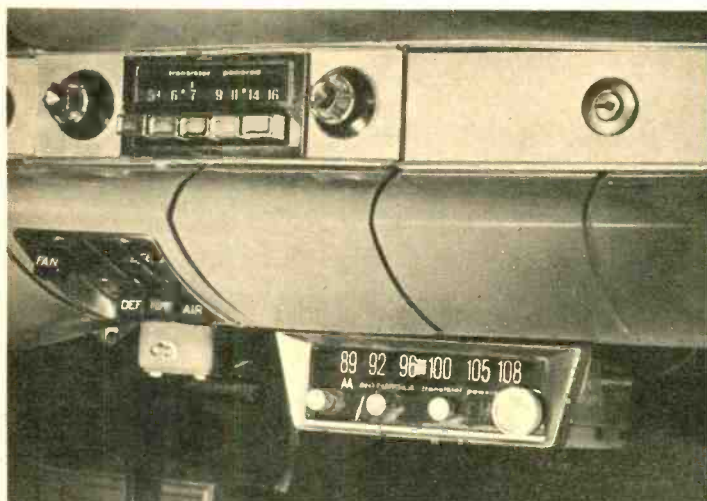

under-the-dash-installation unit can operate independently of the car's AM set. Three transistors power the hybrid circuit, which contains seven additional tubes. FM-900 shares the AM set's antenna and can be used with any 12-volt, negatively grounded ignition system. No need to sell the FM set when you sell your car. It may be moved from auto to auto, or auto to boat. Other features are AGC, AFC and \$125 price.

Transistorized Lung

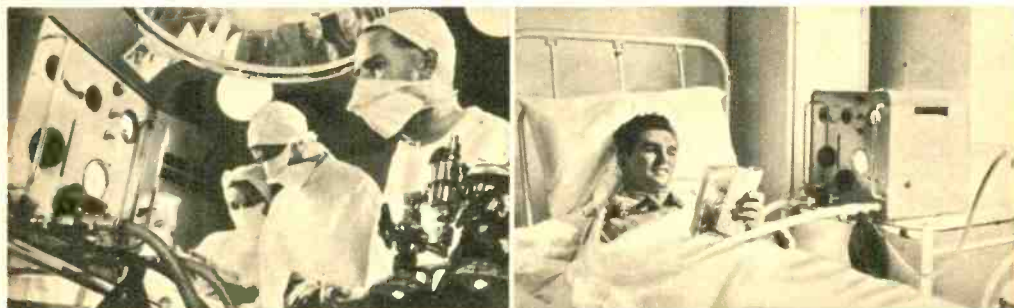

In the operating room the ventilator controls anaesthesia and patient's breathing rate. At bedside of patients with respiratory illnesses, it sets pace for air entering and leaving lungs. Distributed by Pye Ltd., unit has only two lightweight tubes that touch patient, permitting freedom of movement.

CUMBERSOME, uncomfortable iron lungs may be a thing of the past. The British invention of the transistorized, battery-powered Barnet "ventilator," weighing only 56 pounds, can do just about everything an iron lung can do, and then some. Automatic respiration, administration of anaesthesia and resuscitation are but a few of its uses, while portability adds to its versatility. Batteries last 20 hours, are recharged from house current.

unusual compounds find uses because

Electronics Tells The Chemist

By Shirley Motter Linde

THERE are about 750,000 known organic chemical compounds. Less than one percent of these have any known medical or industrial use!

The other 99 percent are a huge potential of untapped applications. They represent hundreds of thousands of chemicals sitting idle on laboratory shelves when they might possibly be useful in curing cancer, fighting viruses, killing insects, giving more gas mileage, making rocket fuels for space vehicles, producing new synthetics, etc.

With present methods, it's a long, time-consuming, laborious process ferreting out practical uses for new compounds. Let's say a company comes up with a new chemical as a by-product. They may spend millions of dollars in research trying the compound in one application, [Continued on page 100]

With computer in background and stack of facts on chemicals with known uses waiting to be coded, scientists check model of hydrocarbon molecule.

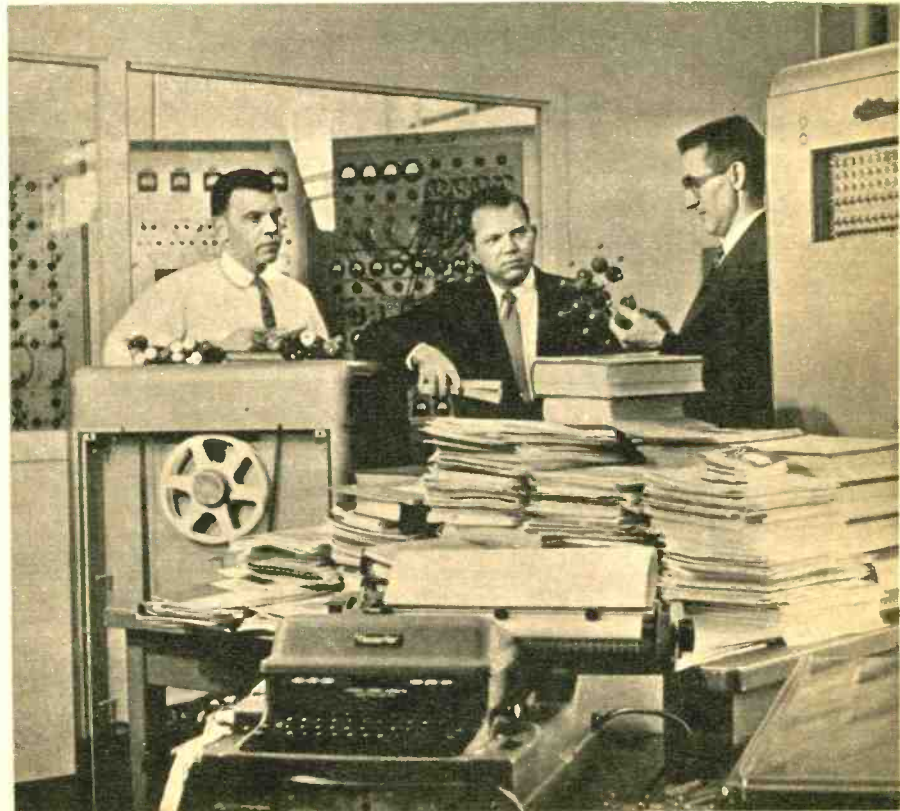



Chemists, engineers and computer experts join forces at Midwest Research Institute to expand computer memory in field of chemistry.



Data on punch cards held by R. A. Carpenter, right, has to be translated and prepared on magnetic tape for big Vanguard computer.

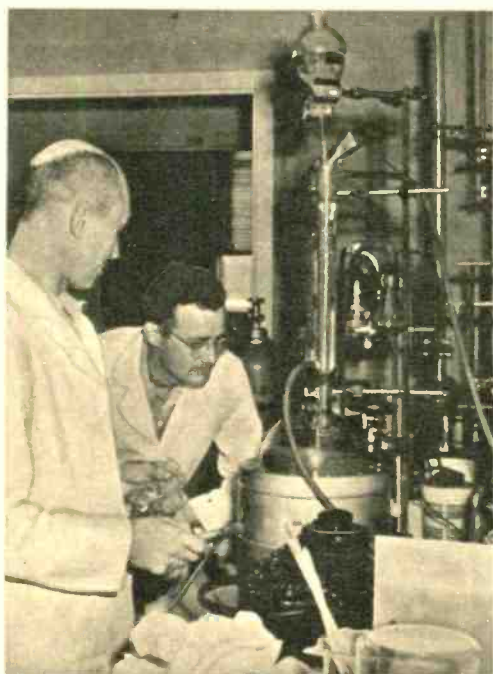

Having classified a new compound, the chemist is often at a loss to find a use for it. Comparisons of the compound's structure with those of other known-use chemicals, such as is being done in photos above, is often a tedious, hit-and-miss project. The computer is expected to find industrial and medical uses for now idle compounds.



Heavy-duty foot switch (available as an SPST or SPDT) serves in the workshop or darkroom.

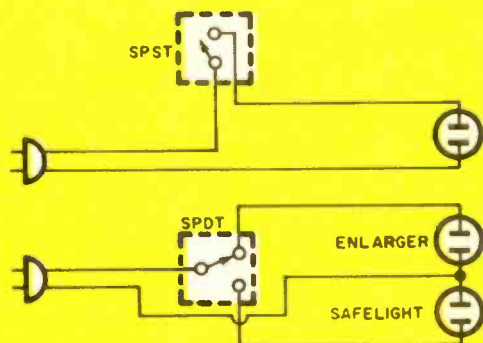

A Handy Foot Switch

By David Gordon

ARE you handicapped by the lack of a third hand? Then use your head—and build a foot switch! Probably one of the handiest accessories for the darkroom and workshop, the foot switch hasn't achieved the popularity it deserves both because of high cost and lack of flexibility. But a relatively new push-button wall switch manufactured by Honeywell under the name Tap-Lite is both inexpensive and available in single and double-throw types suitable for all manner of souped-up switching.

Since the Honeywell switch was designed as a wall switch for the home only, a little experimentation was necessary to adopt it for use as a foot switch.

The base plate is cut from a 5"x7" piece of scrap $\frac{3}{4}$ " plywood or pine. A hole must be cut through its center large enough to allow the mounting flanges of the switch to be screwed down flush with the surface of the plate. The plastic "flush plate" provides a neat cover for the switch's "works" and is simply pressed on over

the switch button as per the instructions accompanying the unit.

If you intend to give the switch hard usage—such as on the floor of a woodworking shop—it might be worthwhile to construct a more durable switch cover. A small piece of ¼" plywood cut out properly will serve nicely. It may be necessary to shim up the plywood top plate with washers to insure proper switch action.

Two more scraps of plywood serve as the feet of the switch and allow sufficient space for the wiring. The SPST switch (Honeywell #25WS1) serves for normal on-off use in machine shops, etc., but for the photographer and his darkroom, a Honeywell SPDT switch (#25WS2) will provide enlarger on - lights off action. Both the Honeywell switches listed have a rating of up to 15 amps—adequate for all of your switching needs. —

Built-in gauge on rear of switch determines length of connecting wire to be stripped.

A pre-assembly view showing front plate, switch with wire attached and base plate.

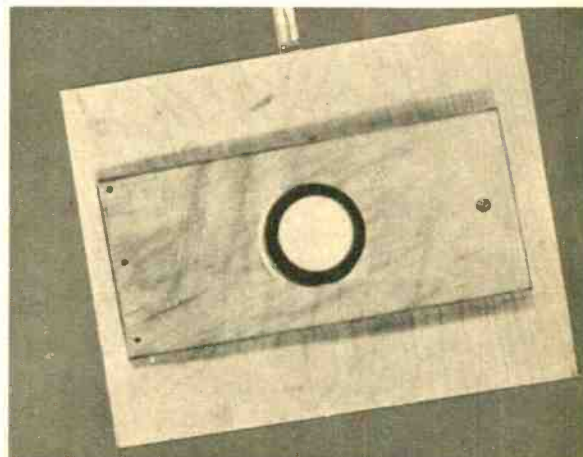
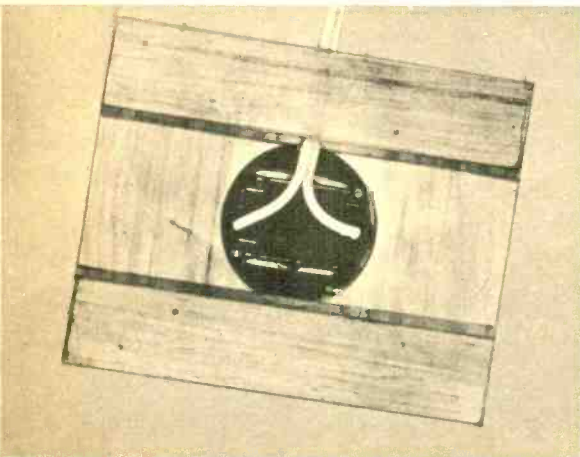
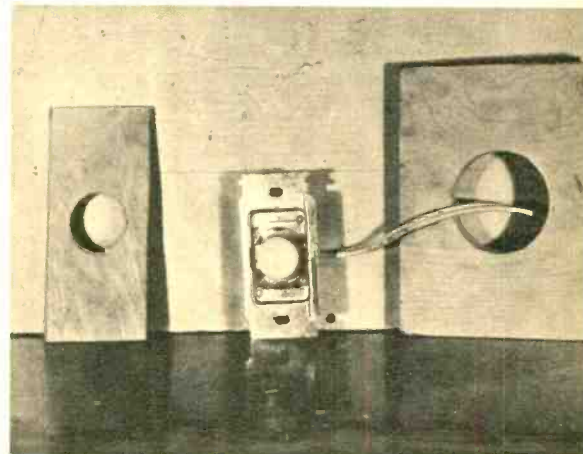
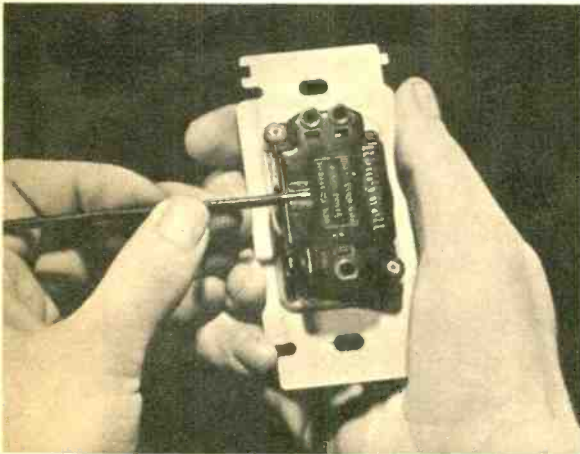

Rear view of the assembled switch showing the bottom strips which holds the wire in place.

The completed foot switch. Shim up top piece for proper push-button action if necessary.

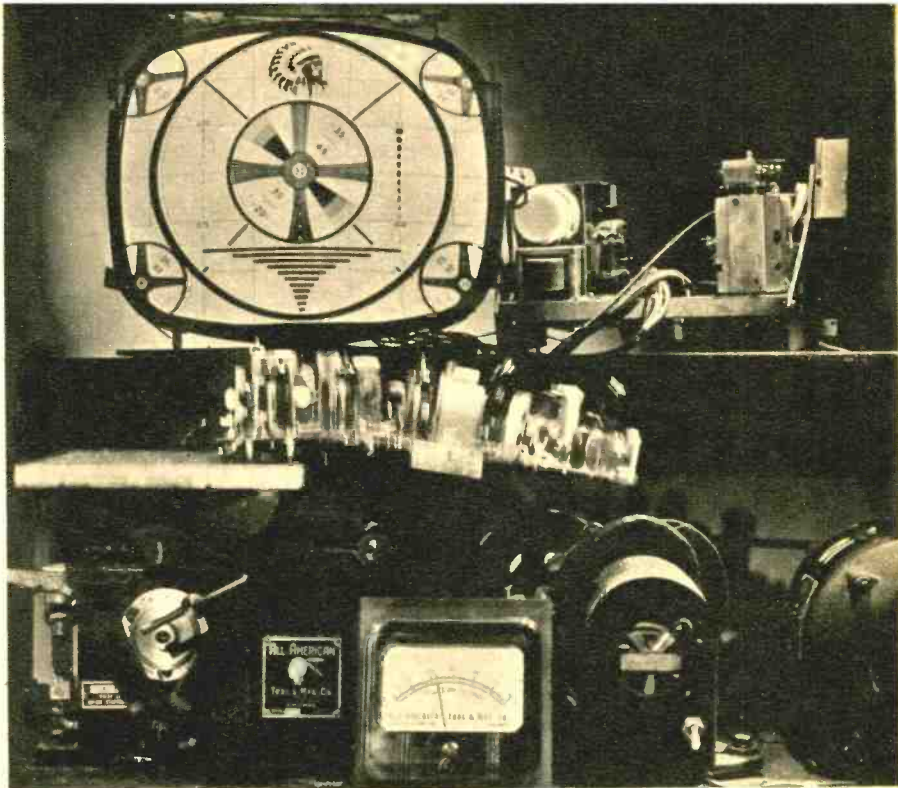

Groaning printed circuit of Sylvania TV set, with tubes and components in place, is made to vibrate up to four inches out of position 22 times per sec.

Torture Test!

It's murder! Sardonic schemes check consumer products to see if they can take rugged treatment.

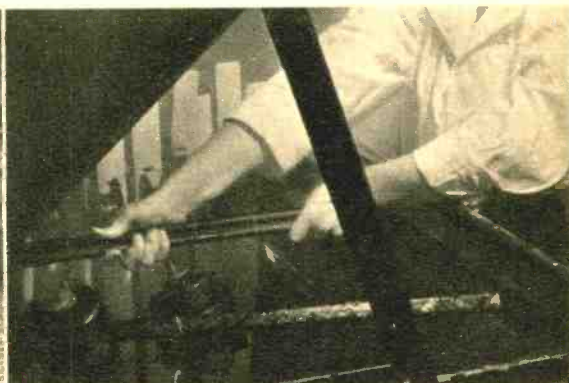

At left, simulated rainstorm pounds down on boxes of electronic components. This environmental test center at Frankford Arsenal, Philadelphia, also can subject components to searing sunshine. At U.S. Testing Corp. labs, right, electric motors are placed in tank where they will be soaked with salt spray.

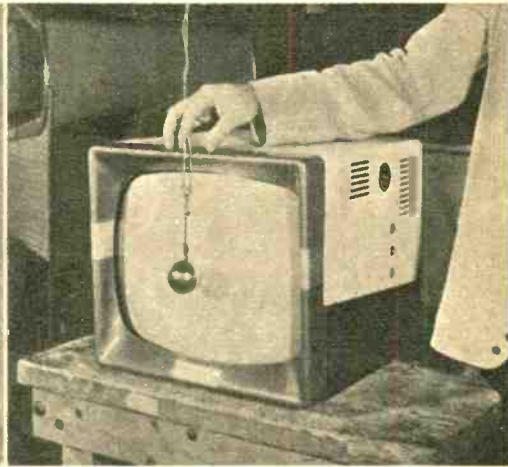

Shure mobile radio microphone suffers indignity of being dragged along concrete road behind speeding auto. It survived 35,000 separate impacts.

Above right, Underwriters' Laboratory technician checks to be sure steel ball will hit center of TV set's screen when ball is swung from high point.



Quality control engineer shovels wet snow over Electro-Voice's "Musicaster" outdoor speaker to see if new silicone-treated cone can take it. The Buchanan, Michigan, snowfall rose over two feet.

Don't Fry That Ham!

By Carole F. Hoover, K9AMD

Never trust outdoor power lines. Get to know 'em from a distance and be dead sure, not sure dead!

THE familiar nets of electric light and power wires that criss-cross city and country miles alike may look as harmless as Granny's clothesline, but they certainly have lots more personality. The shocking truth is that practically every red-blooded ham who shimmies up a tree, pole, or ladder to string his own antenna probably rubs elbows with enough electricity in those same little wires to lay him low. Of course, as long as he minds his amps and volts, there's no harm done. The time taken to study a few power poles with its electrical distribution system will not be wasted.

The first lesson in learning to identify voltages tells us that electricity is carried from pole to pole in many ways. Anywhere from two to eight wires may run between supporting pins on wooden crossarms; a single wire sometimes rides a steel pin and insulator at the center-top of a pole with no crossarms at all; or maybe two to four wires run on distribution racks on the sides of other poles without crossarms. The high-power lines carrying lethal, "primary" voltages of 2300, 7200, [Continued on page 110]

So anxious to rig new beam, ham doesn't notice element swing onto pole circuit carrying 13,000-V, enough to add him to "Silent Key" list.

When you don't let power company trim tree branches entire tree may become booby trap for amateur. Insulation wears, tree conducts.





Obviously this OM is trying to string a long wire antenna, but he probably won't feel much like working his rig after he gets a jolt from the house power lead-in wires. There are about 240 volts between his left jaw and his right hip.

Top (l to r): 34,000-v two skirts; 16,000-v top groove; 7200-v top groove; 2300-v side groove. Bottom: 117-v spool used with secondary; same with support; glass telephone insulator.

Size of insulators identify voltages: Three on top carry 34,500-v conductors. Below them are 7200-v lines. Bare wires extending to right are 110/220-v secondary wires running into home.

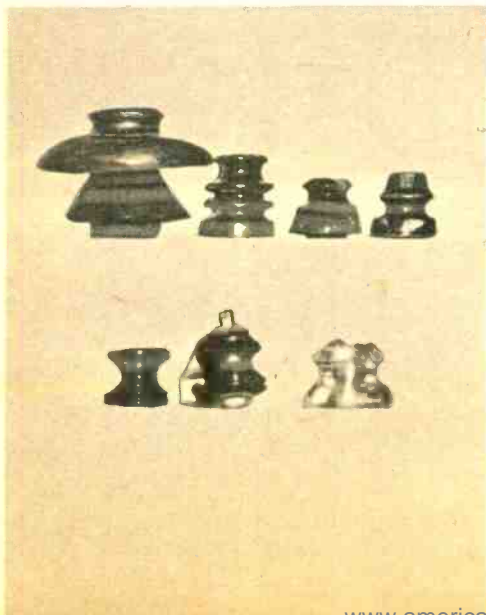

A Wide-Range Watt Meter

For appliance testing and troubleshooting

By Branch Jurgen

HAVE you ever plugged an appliance into an already heavily taxed outlet, hoping that the power lines were just carrying electricity and not beginning to heat up the walls? If the lights didn't dim, you probably felt pretty safe.

Here's a little device that can be built for about five dollars and will answer all your power questions. In addition, it is a useful test bench service tool in detecting shorted circuits and other equipment faults which are reflected in excessive power demands from the AC line.

The device utilizes an under \$2.00 intercom transformer with

All components are mounted directly on the Bakelite front panel of the cabinet as shown in pictorial diagram below.

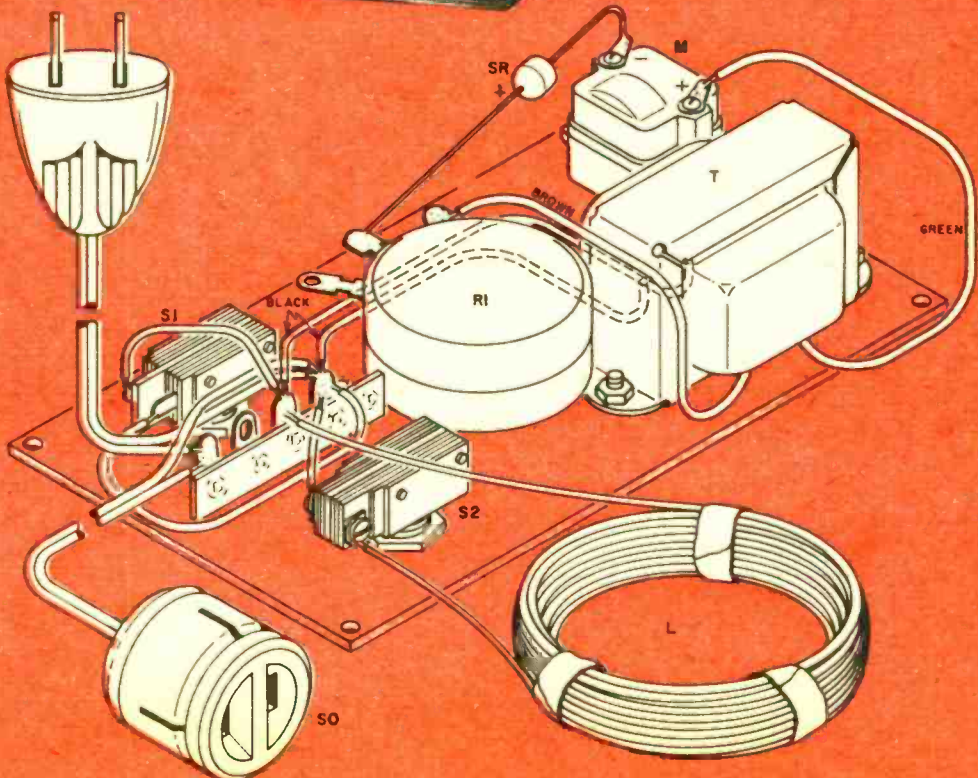

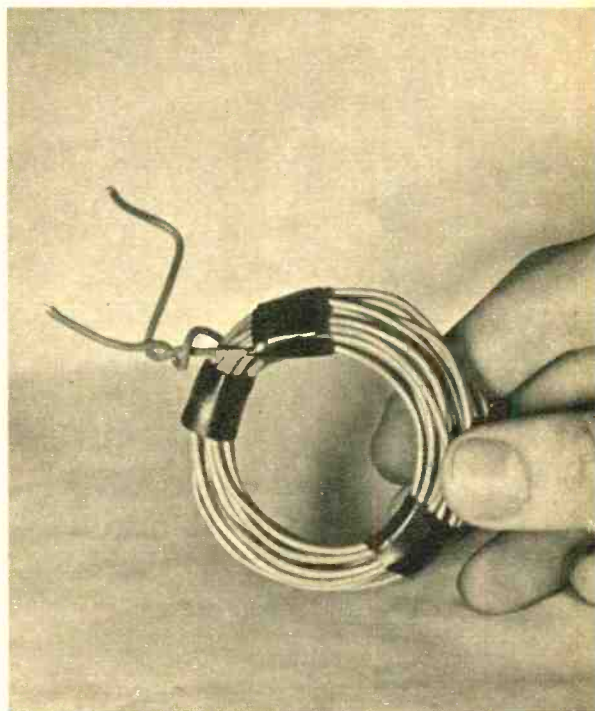
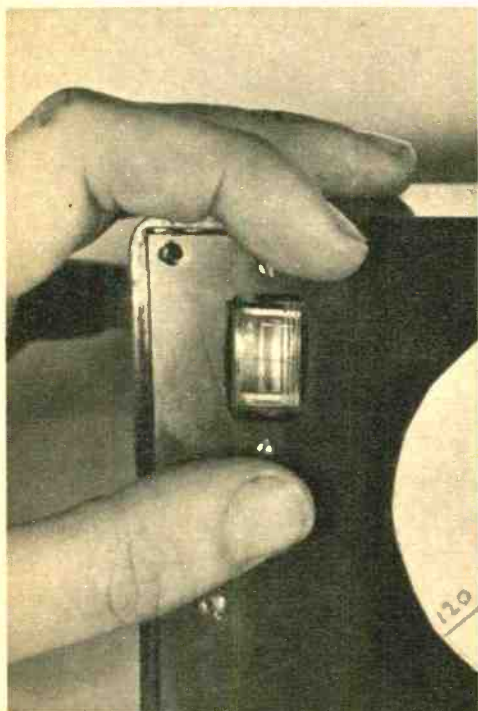

A miniature AM tuning meter provides accurate reading of wattage when properly calibrated. An inked-in scratch marks its "null" point. Simple coil serves as high-current, low-resistance input shunt resistor.

a 4-ohm primary and a 25,000 ohm secondary, providing very high turns ratio. When the 4-ohm side of this transformer is connected *in series* with the appliance whose power rating is being measured, a very small voltage drop determined by the current drawn appears across the transformer's winding. This voltage drop is so low that the appliance receives, for all intents and purposes, the full line voltage. Since the transformer primary is in series with the load, the current through it is the same as the current through the load. Although the primary voltage drop remains quite small with loads up to 1500 watts, it is much larger at the transformer secondary. It is now possible to rectify and read it on a DC meter. The amplitude of the secondary voltage is directly proportional to the primary voltage drop and this drop is, in turn, directly proportional to the current flowing through the primary. Thus, by calibrating the meter in the secondary, we can accurately determine the amount of power consumed by the load without introducing excessive losses in the primary circuit.

Construction

The entire unit can be built into a commercial Bakelite cabinet. The meter is an inexpensive miniature AM tuning meter. The 110 volt "in" and "out" leads are brought out at the short side of the cabinet through two $\frac{3}{8}$ " holes. Rubber grommets are not necessary since the Bakelite will not abrade the cable.

The primary circuit of T1 contains two switches; both of which

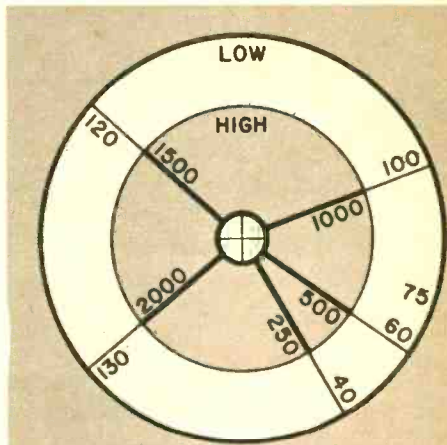
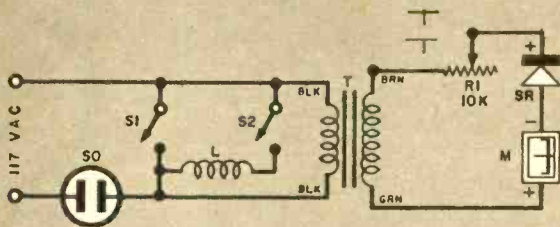

Rectification of voltage developed in the transformer secondary enables the potentiometer R1 to calibrate the meter according to the varying loads. Circular scale above is rough guide for use in the calibration procedure.

should be screw-lug rather than solder lug types. The first is a simple bypass switch (S1) which shorts out the transformer primary thus removing the wattmeter from the circuit when in the "shorted" position. The second switch (S2) is a High-Low range switch. When the switch is in the High-range position, a shunt (L) is inserted in parallel with the transformer primary. This is necessary since the transformer cannot carry more than about 2 amperes. The shunt consists of about 20 turns, 2" diameter, solid No. 20 insulated hookup wire. The exact number of turns and wire size is not too critical and is best determined through experimentation when the scale is calibrated.

Calibration

Since the meter used in this device has an arbitrary numerical scale, a calibration technique must be employed. To do this, a center line is scratched across the meter's plastic case using a sharp pointed tool. Some red ink is then carefully rubbed into the scratch to make the center line easily visible. To calibrate this unit, various size lamp bulbs (40 watts, 75 watts, 100 watts and 150 watts) are inserted as the load with range switch (S2) in the "low" position. Potentiometer (R1) is then adjusted until the meter needle falls directly under the center line. This point is

noted and marked on the potentiometer scale. At least five or six calibration points are found in this manner and then the intermediate points can be interpolated. The low wattage scale will run from about 30 to 150 watts.

In calibrating the high wattage scale, S2 is thrown to the high position so that the shunt is in parallel with T's primary. Incandescent lamp bulbs can again be used. For example, to obtain a 300 watt load, two 150 watt bulbs are inserted in parallel. In calibrating at very high wattage levels, 500 watts to about 1,500 watts (the limit of the meter), the parallel bulb system may become cumbersome. To calibrate the unit in these high ranges, a 1,000 watt heating element, which is available in any hardware store, becomes very handy.

In using this wattmeter, the load is plugged into SO while the meter itself is plugged into [Continued on page 106]

PARTS LIST

R1—10,000 ohm, 4-watt wirewound potentiometer
 SR—low-voltage selenium rectifier or general-purpose diode (10 ma)
 M—AM tuning meter (Lafayette type TM-12)
 T—transformer, primary: 4 ohm, secondary: 25,000 ohm (Stancor A-4744 or equiv.)
 S1, S2—SPST toggle switch, (12A-125v)
 L—2" diameter coil, 20 turns of No. 20 solid hookup wire (see text)
 Misc.—Bakelite case and panel 2 1/4" x 3 3/4" x 2" (Lafayette MS 216, MS 217), male plug, AC receptacle, 2" pointer knob

Try These

Crystal Storage Holder

If you keep your crystals indifferently jumbled in a cigar box or scattered among components in a drawer, you know the exasperation that arises when a needed crystal cannot be readily found. A few minutes of your time is all that is necessary to build the unit shown. The holder may be Formica, Plexiglas, or hardwood. Its dimensions are dictated by the number of crystals to be stored. Space the rows so that the crystals may be easily removed. For FT-243 type crystals, use a No. 39 drill and $\frac{1}{2}$ " spacing between holes for pins. Smaller, overtone type crystals, require a No. 55 drill. The completed unit may be hung on the wall with the addition of two screw eyes.

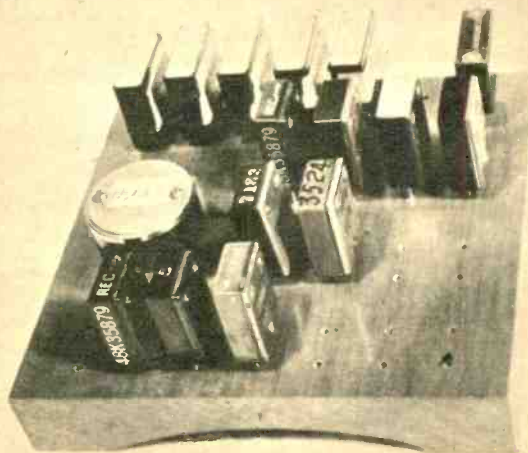

Insulating Outdoor Connections

If you are faced with the problem of having to run AC extension cords across the damp floor of a cellar or a wet lawn, here is a handy hint that may save you from a shock or a blown fuse. Simply wrap the receptacle and plug in a piece of lightweight transparent plastic sheeting, such as serves as wrapping for vegetables, shirts, etc. Twist the plastic tightly around the connectors and wrap securely with tape at both ends. You now have a shock-free, waterproof connection that is not likely to pull loose at a critical moment.

Color-Code Your Reamer

To indicate accurately when you have enlarged a hole enough with a reamer, color-code your reamer with bands of different colored paint. Use red paint for $\frac{1}{4}$ ", black for $\frac{3}{8}$ ", etc. Although in time, the paint on the outside edges of the reamer will wear off, the paint in the flutes will remain.



El assembles a

Ham Converter Kit

Two-Meter phone band is opened up by easy to build kit. Useful to Novice and General Class hams.

WITH the appearance of the Heath XC-2, the Novice can venture into a region where even General Class hams often fear to tread—the VHF band where coils can resemble hairpins, and capacitors are formed by parallel wires. The small army of ham designers at the Heath Co. have proved their salt once again by packaging a kit of advanced design that can be built by a beginner. Thus, the Novice is not tied to pounding a code key—he can rag chew with the rest on the peaceful 2-meter phone band.

The converter unit receives frequencies in the 144-148 mc range and converts them down into frequencies that can be handled by the conventional ham receiver. The 2-meter band appears in a slot between 22 and 26 mc on the dial and is tuned with the receiver's normal tuning controls. This 4-megacycle slot may be shifted easily into any location between 22 and 35 mc by



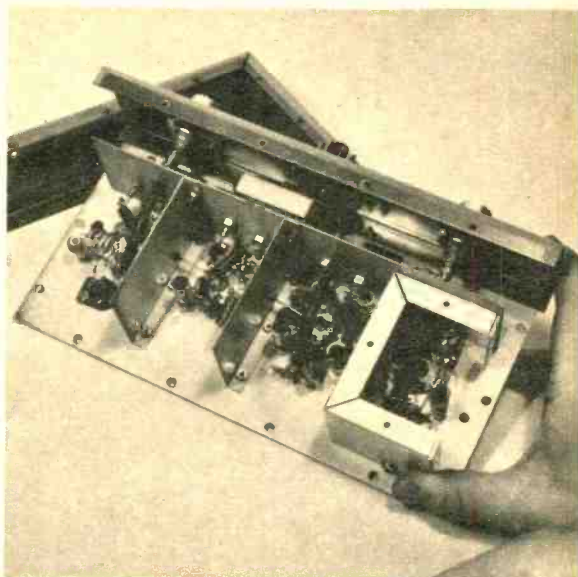
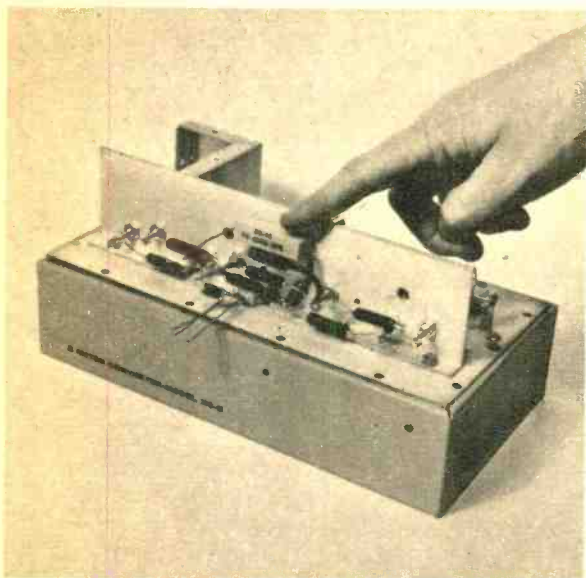

Dropping resistor lowers B-plus voltage supplied by receiver to converter. Power required is 150 volts DC and 6.3 volts AC. Elaborate shield plates separate stages to prevent circuit interaction. Oscillator section at right will be totally enclosed.

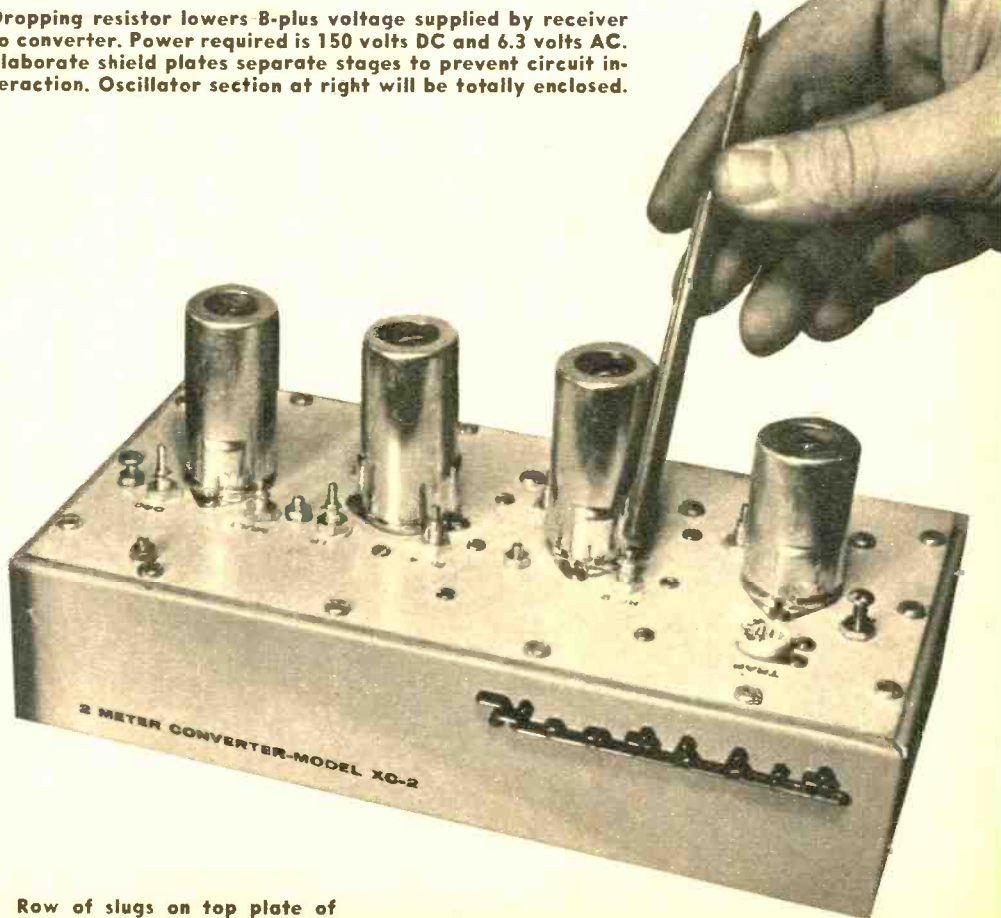

Row of slugs on top plate of converter are for alignment.

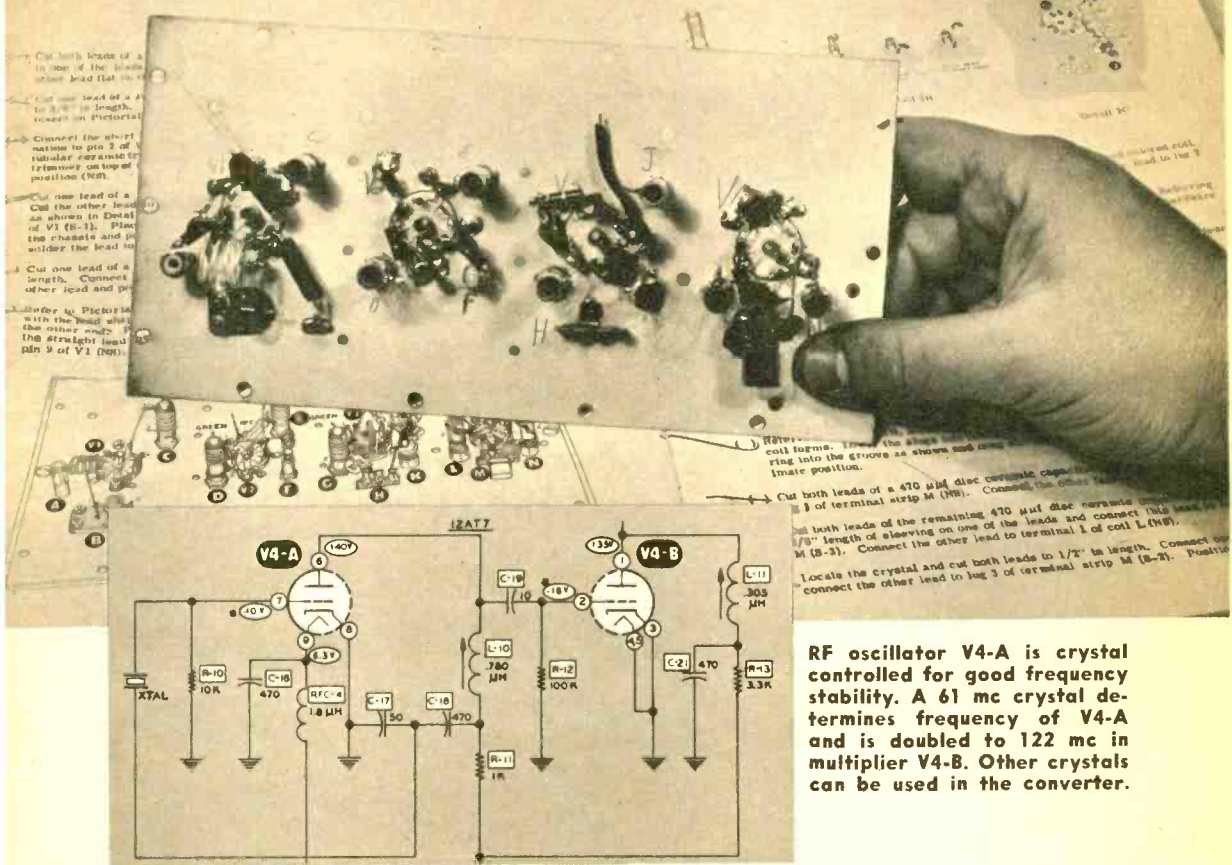

proper choice of converter crystal. The only other consideration is power, which is "stolen" from the ham receiver. If your receiver is an AC-DC type, an external power supply must be used.

Construction of the converter involves almost as much "plumbing" as electronics. Since VHF circuits are notorious for interaction and instability, Heath has used a remarkable number of silver-plated shield panels, special feed-through capacitors and sheet metal screws. This builder realized, after completing the kit, that no hookup wire was used—which points up the key to successful VHF gear—*short leads!* It is in this area that the builder must follow the manual absolutely or end up with whistles, birdies and a converter that generates several stations of its own.

The constructor who makes an error in assembling this kit has a problem

for a cross-sectional view of it looks like a 7-layer cake. It has to—measure up to the stringent demands of these nimble frequencies. Make sure you double check each step. Construction time runs about 12 hours depending upon the care exercised by the builder.

The XC-2 requires careful alignment for peak performance. Realizing that the Novice might not own a scope and sweep generator, the construction manual details three alternate alignment methods. The simplest uses a transmitter as the signal source. This is a safe assumption since the converter is of little interest without a companion transmitter.

The first air checks with the completed converter pulled in several 2-meter stations from two call areas. At a price of \$36.95, the Heath XC-2 represents a Good Buy for the Novice, or General Class ham.

Why be satisfied with less when:

this College-level program of home study in Electronic Engineering Technology

—can help you achieve new levels of income and success



Mail This Coupon Today

CAPITOL RADIO ENGINEERING INSTITUTE
ECPD Accredited Technical Institute Curricula • Founded 1927
Dept. 1706-G, 3224 16th St., N.W., Washington 10, D. C.

Please send me your course outline and FREE 44-Page Book "Insurance for Your Future in the New World of Electronics" . . . describing opportunities and CREI home study courses in Advanced Electronic Engineering Technology.

Check field of greatest interest

- Radar, Servo and Computer Engineering Technology
- Electronic Engineering Technology
- Communications Engineering Technology
- Television Engineering Technology
- Aeronautical Electronic Engineering Technology
- Automation and Industrial Electronics Engineering Technology

Name _____ Age _____

Street _____

City _____ Zone _____ State _____

Check: Home Study Residence School Korean Veteran

CREI OFFERS COLLEGE-LEVEL OPPORTUNITY to the man who wisely realizes that the recognition and rewards in electronics are now going to other men—especially the man with modern advanced education.

WITHIN TWO TO FOUR YEARS, depending on the courses selected and amount of stick-to-itiveness brought to bear, you can complete this program in electronics, which is comparable in technological content to advanced residence courses. You study during hours chosen by you. You have plenty of time to do your best.

THIS ADVANCED PROGRAM IS THE CULMINATION of 33 years of working closely with leading companies and Government agencies in the critical field of electronics, where demand for engineering and technical personnel far exceeds the supply. The courses are presented in easy-to-understand form, and our experienced instructors guide your progress step by step.

YOU QUALIFY FOR CREI if you have a high school diploma or equivalent, and if you have had basic electronic training and practical experience in electronics.

PLEASE WRITE US NOW FOR DETAILED, ILLUSTRATED, 44-PAGE CATALOGUE, which gives complete information on home study program and registration procedure. CREI also offers a Residence School Program, where graduates earn AAS degree. Day and evening classes start at regular intervals. Electronics experience is not required for admittance to the Residence School.

CREI PROFESSIONAL STANDING

U.S. Office of Education lists CREI as "an institution of higher education."

CREI was a co-founder of the National Council of Technical Schools.

CREI was among the first three technical institutes whose curricula were accredited by the Engineers' Council for Professional Development.

More than 20,500 students are enrolled in CREI Home Study and Resident Programs.

America's leading electronics, communications, missiles and space exploration companies and Government agencies recognize CREI. Many of these organizations actually pay the tuition for their employees studying with CREI.



To obtain fast, immediate service and to avoid delay, it is necessary that the following information be filled in:

Employed by _____

Type of Present Work _____

Education: _____

Years of High School _____

Other _____

Electronics Experience _____

The Great QSL Quarrel

Continued from page 29

read than a doctor's prescription. If you can't type, print; if you can't print, write neatly; and whether you write or print, don't use a pencil or half-shot ball-point.

There's got to be beef in a bun to make a tasty hamburger, and similarly, perfect penmanship on a glorious card isn't worth a hoot if the message is missing. Since a shortwave listener can't pick up a microphone and join in the rag-chew, the signal report and comments he puts on his card must be accurate and detailed. Who wouldn't toss away a card that says merely, "I heard you calling CQ on 20 meters on February 22?" That just isn't enough information.

A complete shortwave report should start with the ham's call letters and the date, time, and his exact transmitting frequency. An accurate readability and signal strength report should follow, as well as description of the receiver and antenna set-up used in listening. The calls of other stations involved in the contact should be included. Some amateurs will feel that the card is still in sad shape if a sentence or two from the rag-chew itself isn't quoted. This is the real fun of QSL'ing. If the ham describes his hometown, introduced his mother-in-law, or predicted the outcome of the World Series, mention it on your card. There's no law saying an SWL card has to be as stiff and statistical as an income tax report, so add some humor and watch the results.

"If somebody wants my QSL, let him study and save to get his own radio license and rig just like I did," say a small number of hams.

Although few hams understand why, many people prefer listening to talking, and they wouldn't take a microphone, key, or call letters even on a silver platter. On the other hand, the SWL population is full of folks already in the process of getting their own licenses and still others whose interest in amateur radio grows with each contact heard and QSL card received.

The world's best authorities on swapping cards are the DX or foreign hams who receive QSLs from every amateur contacted as well as bushels of SWL cards from all the continents. One such station collects about 100 cards each week from shortwave listeners alone.

"The incomplete cards go in the fire," he admits, and nobody can blame him.

Enclosing postage for return cards is a

practice much appreciated by all amateurs and almost sure to draw an answer. Foreign stations are particularly grateful but, unfortunately, International Reply Coupons aren't always the answer. The value of an IRC in another country may be much less than what an SWL pays for it. For example, a coupon costing 15 cents in a U. S. post office is exchanged in Haiti for only two cents. This means that a 10 cent air mail stamp there would require five IRC's purchased here at 15 cents each. Al-



though IRC's are always welcome, many foreign stations simply can't afford air mail answers.

Of course, a certain number of everybody's cards fall prey to playful children, chewing lap-dogs, spring housecleaners, and pack-rats. But, generally speaking, the shortwave listener who mails an attractive card that is both neat and complete will have it welcomed by the ham. And adding a clever comment and return postage may put a ham's card in the mailbox instead of an SWL card in the wastebasket.

BONUS
PHOTOGRAPHY SECTION
IN
JULY EI

**"GET...STEREO'S
FINEST VALUE!"**

**integrated
STEREO-AMPLIFIER**

**MODEL
214**
Made in
U.S.A. not
an import!



**BELOW
WHOLESALE
COST!...**
with money back
GUARANTEE!
.....
No better Amplifier
at twice the cost!

monaural amplifier (56 watts peak). In addition it can be used as a 28 watt monaural amplifier with complete stereo preamplifier so arranged that one preamplifier is used to drive the internal 28 watt monaural amplifier while the other preamplifier is used to drive any existing monaural amplifier. Model 214 uses ganged treble and bass controls. It has a balance control, contour control switch, rumble filter switch and speaker selector switch for local and remote speaker systems. It uses a 2 color, deep etched, gold anodized aluminum panel.

SPECIFICATIONS . . .

OUTPUT: 14 watts less than 1% harmonic distortion, 2% IM 60/6000 c.p.s.) **PEAK POWER OUTPUT:** 28 watts per channel, 56 watts combined. **OUTPUT IMPEDANCE:** 8, 6, and 32 ohms per channel, 4, 8, and 16 ohms when strapped. **FREQUENCY RESPONSE:** ± 0.5 DB 15-30,000 c.p.s. at 1 watt; output ± 1 DB 45-20,000 c.p.s. at full output. **DAMPING FACTOR:** 5. **HUM:** MINIMUM VOLUME: 80 DB below 14W. **TUNER, AUX. & PHONO (hi-level):** 70 DB below 14W (0.5V input reference) **PHONO (RIAA POSITION):** 60 DB below 14W (6 mv input reference); (1 mv input reference). **TAPE INPUT:** 55 DB below 14W (1 mv input reference). **CROSS TALK:** Better than 50 DB. **BASS CONTROL RANGE:** ± 12 DB at 50 c.p.s. **TREBLE CONTROL RANGE:** ± 12 DB at 10,000 c.p.s. **RUMBLE FILTER:** 12 DB per octave below 50 c.p.s. **INPUT LEVELS:** Aux., Tuner and Phono (hi-level) 300 millivolts, 2 megohms, flat response. Phono (Mag): 3 mv at 1 KC. Tape: 1 mv at 250 c.p.s. **TAPE OUTPUT LEVEL:** 1 volt from each channel. **PREAMPLIFIER OUTPUT LEVEL:** 0.5 volt, modified by all controls (one channel only). **RECORD EQUALIZATION:** RIAA. **TAPE EQUALIZATION:** NARTB. **TUBE COMPONENT 1-GZ34, 4-EL84, 2-ECC82/12AU7, 3-ECC83/12AX7.** (10 in all.) **DIMENSIONS:** 4½" x 15½" x 9½" deep (excluding knobs). **POWER CONSUMPTION:** 125 watts. **SHIPPING WEIGHT:** 18 lbs.

MODEL 214 STEREO-AMPLIFIER . . .

Model 214 combines the features of three instruments in one. It is able to select, control and amplify any source of stereo such as discs, tape, or tuners and send it through two self contained 14W amplifiers to a pair of speakers. It consists of a complete stereo preamplifier and two separate 14 watt power amplifiers (28 watts peak for each amplifier). It can be used as a 28 watt



TESTMASTER, INC. 192 Mercer Street Dept. New York 12, N.Y. EI-660

Send me C.O.D. a Model 214 or 214 Stereo Kit as checked. It is understood that I may return the amplifier for a full cash refund within 10 days after I receive it if I am not fully satisfied. Kits must be in original unassembled condition.

- MODEL 214 (Wired) \$69.50
- MODEL 214 (Kit) \$48.90

I enclose full cost to save transportation and C.O.D. charges . . . it is understood that I have the same return privilege

Name.....
Address.....
City..... Zone..... State.....

All prices net, F.O.B., N. Y. C.

EXAMINE ANY OF THESE TESTERS BEFORE YOU BUY!!

Yes, we offer to ship at our risk one or more of the testers described on these pages.

Superior's New Model 70 UTILITY TESTER®

FOR REPAIRING ALL ELECTRICAL APPLIANCES and AUTOMOBILE CIRCUITS



- As an electrical trouble shooter the Model 70:**
- Will test Toasters, Irons, Broilers, Heating Pads, Clocks, Fans, Vacuum Cleaners, Refrigerators, Lamps, Fluorescents, Switches, Thermostats, etc.
 - Measures A.C. and D.C. Voltages, A.C. and D.C. Current, Resistances, Leakages, etc.
 - Will measure current consumption while the appliance under test is in operation.
 - Incorporates a sensitive direct-reading resistance range which will measure all resistances commonly used in electrical appliances, motors, etc.
 - Leakage detecting circuit will indicate continuity from zero ohms to 5 megohms (5,000,000 ohms).

- As an Automotive Tester the Model 70 will test:**
- Both 6 Volt and 12 Volt Storage Batteries • Generators • Starters • Distributors • Ignition Coils • Regulators • Relays • Circuit Breakers • Cigarette Lighters • Stop Lights • Condensers • Directional Signal Systems • All Lamps and Bulbs • Fuses • Heating Systems • Horns • Also will locate poor grounds, breaks in wiring, poor connections, etc.

Model 70—UTILITY TESTER
Total Price...\$15.85—
 Terms: \$3.85 after 10 day trial, then \$4.00 monthly for 3 months, if satisfactory. Otherwise return, no explanation necessary.



INCLUDED FREE This 64-page book—practically a condensed course in electricity. Learn by doing.

Just read the following partial list of contents: What is electricity? • Simplified version of Ohms Law • What is wattage? • Simplified wattage charts • How to measure voltage, current, resistance and leakage • How to test all electrical appliances and motors using a simplified trouble-shooting technique. • How to trace trouble in the electrical circuits and parts in automobiles and trucks.

Model 70 comes complete with 64 page book and test leads

\$15.85
 Only

Superior's New Model 82A A truly do-it-yourself type

TUBE TESTER

TEST ANY TUBE IN 10 SECONDS FLAT!



Model 82A—Tube Tester
Total Price...\$36.50
 Terms: \$6.50 after 10 day trial, then \$6.00 monthly for 5 months if satisfactory. Otherwise return, no explanation necessary.

- 1 Turn the filament selector switch to position specified.
- 2 Insert it into a numbered socket as designated on our chart (over 600 types included).
- 3 Press down the quality button—

THAT'S ALL! Read emission quality direct on bad-good meter scale.

FEATURES:

- Tests over 600 tube types. • Tests OZ4 and other gas-filled tubes. • Employs new 4" meter with sealed air-damping chamber resulting in accurate vibrationless readings. • Use of 22 sockets permits testing all popular tube types and prevents possible obsolescence. • Dual Scale meter permits testing of low current tubes. • 7 and 9 pin straighteners mounted on panel. • All sections of multi-element tubes tested simultaneously. • Ultra-sensitive leakage test circuit will indicate leakage up to 5 microhms.

Production of this Model was delayed a full year pending careful study by Superior's engineering staff of this new method of testing tubes. Don't let the low price mislead you! We claim Model 82A will outperform similar looking units which sell for much more—and as proof, we offer to ship it on our examine before you buy policy.

Model 82A comes housed in handsome, portable Saddle-Stitched Texon case (Picture Tube Adapter available for \$5.50 additional)

\$36.50
 Only

DID YOU EVER?

- Order merchandise by mail, including deposit or payment in full, then wait and write . . . wait and write?
- Purchase anything on time and sign a lengthy complex contract written in small difficult-to-read type?
- Purchase an item by mail or in a retail store then experience frustrating delay and red tape when you applied for a refund?

Obviously prompt shipment and attention to orders is an essential requirement in our business . . . We ship at our risk!

NO

CONTRACT TO SIGN CO-MAKERS EMPLOYER NOTIFICATION

The simple order authorization included in this offer is *all* you sign. We ask only that you promise to pay for or return the goods we ship in good faith.

EXAMINE ANY ITEM YOU SELECT IN THE PRIVACY OF YOUR OWN HOME

Then if completely satisfied pay on the interest-free terms plainly specified. When we say interest-free we mean not one penny added for "interest" for "finance" for "credit-checking" or for "carrying charges." The net price of each tester is plainly marked in our ads—that is all you pay except for parcel post or other transportation charges we may prepay.

Superior's New Model 76

ALL PURPOSE BRIDGE

IT'S A CONDENSER BRIDGE

IT'S A SIGNAL TRACER

IT'S A RESISTANCE BRIDGE

IT'S A TV ANTENNA TESTER



Model 76 ALL PURPOSE BRIDGE

Total Price \$26.95
Terms: \$6.95 after 10 day trial, then \$5.00 per month for 4 months if satisfactory. Otherwise return, no explanation necessary.

✓ CAPACITY BRIDGE SECTION

4 Ranges: .00001 Microfarad to .005 Microfarad; .001 Microfarad to .5 Microfarad; .1 Microfarad to 50 Microfarads; 20 Microfarads to 1000 Microfarads. Will also measure the power factor of all condensers from .1 to 1000 Microfarads.

✓ RESISTANCE BRIDGE SECTION

2 Ranges: 100 ohms to 50,000 ohms; 10,000 ohms to 5 megohms.

✓ SIGNAL TRACER SECTION

With the use of the R.F. and A.F. Probes included with the Model 76, you can

make stage gain measurements, locate signal loss in R.F. and Audio stages, locate distortion and hum, etc.

✓ TV ANTENNA TESTER SECTION

Loss of sync., snow and instability are only a few of the faults which may be due to a break in the antenna, so why not check the TV antenna first? Locates a break in any TV antenna and measures the location of the break in feet from the set terminals.

Complete with R.F. and A.F. probes and test leads

\$26.95
NET

Superior's
New
Model 77

VACUUM TUBE VOLTMETER

WITH NEW 6" FULL-VIEW METER

Compare it to any peak-to-peak V. T. V. M. made by any other manufacturer at any price!

- Extra large meter scale enables us to print all calibrations in large easy-to-read type.
- Employs a 12AU7 as D. C. amplifier and two 9006's as peak-to-peak voltage rectifiers to assure maximum stability. • Meter is virtually burn-out proof. The sensitive 400

AS A DC VOLTMETER: The Model 77 is indispensable in Hi-Fi Amplifier servicing and a must for Black and White and color TV Receiver servicing where circuit loading cannot be tolerated.

AS AN ELECTRONIC OHMMETER: Because of its wide range of measurement leaky capacitors show up glaringly. Because of its sensitivity and low loading, Intermittents are easily found, isolated and repaired.

AS AN AC VOLTMETER: Measures RMS values if sine wave, and peak-to-peak value if complex wave. Pedestal voltages that determine the "black" level in TV receivers are easily read.

micro-ampere meter is isolated from the measuring circuit by a balanced push-pull amplifier. • Uses selected 1% zero temperature coefficient resistors as multipliers. This assures unchanging accurate readings on all ranges.

SPECIFICATIONS

- DC VOLTS—0 to 3/15/75/150/300/750/1,500 volts at 11 megohms input resistance.
- AC VOLTS (RMS)—0 to 3/15/75/150/300/750/1,500 volts. • AC VOLTS (Peak to Peak)—0 to 8/40/200/400/800/2,000 volts.
- ELECTRONIC OHMMETER—0 to 1,000 ohms/10,000 ohms/100,000 ohms/1 megohm/10 megohms/100 megohms/1,000 megohms. • DECIBELS: -10 db to +18 db, +10 db to +38 db, +30 db to +58 db. All based on 0 db = .006 watts (6 mw) into a 500 ohm line (1.73v).
- ZERO CENTER METER—Por discriminator alignment with full scale range of 0 to 1.5/7.5/37.5/75/150/375/750 volts at 11 megohms input resistance.

Comes complete with operating instructions, probe leads, and streamlined carrying case. Operates on 110-120 volt 60 cycle. Only

\$42.50
NET



Model 77—VACUUM TUBE VOLT-

METER. Total Price . . . \$42.50
Terms: \$12.50 after 10 day trial, then \$6.00 monthly for 5 months if satisfactory. Otherwise return, no explanation necessary.

Try any of the instruments on this or the facing page for 10 days before you buy. If completely satisfied then send down payment and pay balance as indicated on coupon. **No Interest or Finance Charges Added!** If not completely satisfied return unit to us, no explanation necessary.

MOSS ELECTRONIC, INC.
Dept. D-751, 3849 Tenth Ave., New York 34, N. Y.

Please send me the units checked on approval. If completely satisfied I will pay on the terms specified with no interest or finance charges added. Otherwise, I will return after a 10 day trial positively cancelling all further obligation.

Name
Address
City Zone State

All prices net, F.O.B. N. Y. C.

- Model 77 Total Price \$42.50
\$12.50 within 10 days. Balance \$6.00
monthly for 5 months.
- Model 76 Total Price \$26.95
\$6.95 within 10 days. Balance \$5.00
monthly for 4 months.
- Model 70 Total Price \$15.85
\$3.85 within 10 days. Balance \$4.00
monthly for 3 months.
- Model 82A Total Price \$36.50
\$6.50 within 10 days. Balance \$6.00
monthly for 5 months.
- Include Model 82A Picture Tube
Adapter at \$5.50

Export Division: Roche International Corp., 13 East 40th St., New York 16, N. Y.

Music From Nowhere

Continued from page 27

Not even its inventor, Leo Theremin, ever learned to make his brainchild behave. Neither have some of the ablest of musicians—which explains why RCA put together only a few hundred of the instruments (back in 1929-30), and never produced another.

The scores of theremins lying forgotten in attics are currently worth their weight in gold—anywhere from \$500 to \$1000.

"Why they should be worth anything at all," said one engineer, "beats me. A half dozen tubes and as many coils and you can build your own theremin for maybe \$50.

(NOTE: Electronics Illustrated will feature complete plans for a theremin in an early issue. Cost: Under \$20! Watch for it.)

A theremin involves nothing more complex than three radio-frequency oscillators. Two of them beat at an audible frequency. Add hand capacity—as does Dr. Hoffman with his *right hand* as he gestures before the vertical *pitch* antenna—and you lower or raise the frequency of one of the RF oscillators, thus the *pitch* of the beat frequency, which is amplified.

Amplification, or volume, is controlled by a third oscillator. Like the others, its frequency is changed by hand capacity. The player's *left hand* wavers above the looped, horizontal *volume* antenna. The volume oscillator's rectified output biases an output amplifier tube.

Actually, many oscillating circuits have been devised which give similar musical, or dissident, results. Essential to them all, however, are oscillating circuits controlled by hand capacity. The closer a musician's right hand to the *pitch* antenna, the *higher* the pitch. Some theremins range through four full octaves and can strike notes above a soprano's high-C.

The farther the left hand from the *volume* antenna, the louder the theremin's eerie output.

Most theremins, for example, lapse silent unless a hand interrupts their electrostatic fields. Reason: the two pitch oscillators, one set at fixed frequency, the other motivated by hand capacity, are adjusted to produce a zero beat (no audible sound) unless disturbed. Also assuring "silence" is the fact that, undisturbed, the volume control oscillator biases the "gain control" tube to cut-off.

A musician can limit the theremin's tonal range simply by turning a knob on

the console panel. This in turn sets the fixed pitch oscillator for the lowest note the performer wishes to play.

"In effect," explains Dr. Hoffman, "turning that knob either spaces the notes farther apart or brings them closer together."

When, for example, the theremin is set for its full four octave range, the movement of the musician's right hand toward the pitch antenna "finds" a new note every $\frac{1}{16}$ of an inch in the electrostatic field. With its tonal output limited, say to two octaves, the theremin's notes are spaced about $\frac{1}{8}$ inch apart.

In the process of "picking" notes from a theremin's field, the musician's hands must constantly vibrate to extract from raw notes a subtle vibrato quality which produces what some call "music bewitched." In its higher registers, the theremin speaks as shrilly as a violin. In its lowest it cries like a cello.

You'd think that your entire hand would cause musical havoc with a new note every $\frac{1}{16}$ of an inch. It doesn't. "Capacity" exists only between the antenna and the tip of your fingers. If, however, you make the musically fatal mistake of contacting the antenna—either the volume antenna with your left hand or the pitch control with your right—silence reigns. Why? Electronically speaking, you've grounded the oscillators.

"Critical though hand capacity is," concedes Dr. Hoffman, "there's nothing critical in the antennas themselves." Antennas, about 24 inches in length, are sized for the stature and convenience of the musician. Nor is it significant that one is vertical, the other horizontal and looped. Their structure merely adds dramatic effect. Set at right angles to one another, the chance of conflict between their electrostatic fields is reduced.

Aside from the oscillatory circuits, of course, theremins also must have a power supply, power amplifiers and a loud-speaker. Most theremin speakers are usually 12-inch jobs. Hi-fi, of course, wasn't in the commercial lexicon when RCA built what few theremins it did back in 1929.

"Hi-fidelity speakers might improve tonal quality," concedes Dr. Hoffman, "though I'm no authority on such things. My own instrument's 12-inch speaker chills movie and TV audiences without a boost from higher fidelity. And as a musician, I'm satisfied with its quality."

So, apparently, are Hollywood moguls who have hired Dr. Hoffman to harry the soundtracks of their greatest spine-tinglers with the invisible "keyboard" of electronics' strangest music maker.

Electronic Oven Thermometer

Continued from page 55

affected if the bare grounded wire touches the oven. In use, the two wires are brought out through a crack in the oven door and the remaining control cable can of course consist of any low-resistance conductor such as ordinary lamp cord.

Ordinary asbestos wrapped appliance cable, like the kind used for heavy household irons, may be substituted for the Teflon. Of course, the cable's cloth cover must be removed with a razor.

Calibration

Before putting this device in use, it must be calibrated against a fairly accurate standard. It may come as a surprise to know that although oven temperatures often go as high as 450°-550°F, the temperature inside the meat rarely exceeds 200°F. Consequently, the actual probe itself must be calibrated in this lower temperature range. The best way to do this is to borrow a good standard meat thermometer, or any other accurate thermometer marked in degrees to 212°F. A kettle of cold water is placed on the fire and both the thermistor probe and the standard are inserted into the cold water. The electronic meat thermometer is turned on and the dial is set to the lowest point (in other words, the least resistance in the circuit).

At a certain temperature, the thermometer's relay will energize and you will hear the strains of the music box movement. The temperature at which this occurs should be read off on the standard and marked accordingly on the electronic thermometer dial. (Allowing for some

variation in circuit values, this usually occurs at around 140°F. or, as the cooks would have it—very rare beef temperature.) The dial on the thermometer is then turned until the meter relay drops out. Remember, you may have to tap the box if the relay sticks. This process is repeated until the water boils. Actually, you will find that this thermometer will measure higher than 212°F. However, we would not recommend roasting anything to that temperature!

A Signal Pencil

Continued from page 76

plification are added before the speaker.

An audio frequency is required in the audio stages, a modulated IF frequency next and a modulated RF signal at the broadcast frequencies at the front end. The "signal pencil," with its basic audio and its powerful harmonics, supplies all these needed signals. It's only necessary to touch the pencil point to the output and input of each stage and press the button. In the front sections of a receiver or the input of an amplifier the signal will be heard loudly.

For testing the final output stage and speaker when the signal is too weak to be useable, a short test lead may be added from the pencil's ground clip to chassis ground of the unit under test.

Actually, you can achieve three levels of output; the greatest with a ground lead from the clip, the least with only the pencil tip touching the circuit and an intermediate level if the hand holding the pencil touches the clip and the other hand touches the radio or amplifier chassis.

TIMETABLE FOR ROASTING

Kind of Roast	Oven Temperature	Internal Temperature	Approx. Min. per lb.
Beef Ribs (Standing)	300°F.		
Rare		140°F.	18-20
Medium		160°F.	22-25
Well-done		170°F.	27-30
Beef Ribs (Rolled)	300°F.		
Pork (Fresh)	350°F.		Add 10 min. per lb. to above
Loin, 3-4 pounds		185°F.	35
Shoulder		185°F.	30-35
Ham		185°F.	30-35
Butt		185°F.	50-55
Pork (Cured)			
Ham (14 to 18 lbs.)	300°F.	160°F.	15-20
Ham (10 to 14 lbs.)		160°F.	18-20
Half Ham		160°F.	22-25
Tender Ham		160°F.	22-25
Lamb	300°F.	180°F.	30-35
Veal	300°F.	170°F.	25-30
Turkey or Heavy Poultry	325°F.	180°F. Center of Stuffing 190°F. Center of Thigh Muscle	

Electronics Tells the Chemist

Continued from page 79

then another trying to find a use. After years of hit or miss research, they *might* be successful.

Or the company may catalog the fundamental characteristics of the compound and pass the information on to other industries in hopes of receiving suggestions on how the substance might be developed.

Or, if the compound looks like it might work as, say, an insecticide, the company might ask an insecticide expert to compare its properties with known bug killers and decide whether it's feasible.

All this set scientists at the Midwest Research Institute, Kansas City, Mo., to wondering whether a program might be developed to determine, with the aid of electronic computer techniques, the structural and physical properties which correlate the uses of chemical compounds.



Institute chemist Richard A. Carpenter said, "The mental processes of the expert led us to think of employing rapid electronic equipment to simulate his decisions. Since the expert bases his decisions on the comparison of the new compound with the properties and structures of materials previously found promising, this information could be coded and processed into a memory device. The results would be a sort of 'super chemist' armed with millions of facts, correlations and significant patterns from past experience and research. This 'super chemist' would be equipped with a never-failing memory able to make many comparisons simultaneously without bias and at a high rate of speed."

Like the expert, the computer could calculate, compare, correlate, and come up—in minutes—with possible uses for the new compound.

For example, says Carpenter, the computer can be used to pick out likely chemicals to treat cancer. So far, he points out,

cancer research has been a matter of blindly trying everything that comes along in hopes of a cure. Over 20,000 compounds have been tried already. The computer, on the other hand, can analyze the common characteristics of the more promising substances and pin-point similar but different substances offering the most promise for further experimentation.

Much preliminary work was necessary even before the computer could be called into play. The research team wrote to 1,000 companies for catalogs and data sheets on their compounds. The material poured in. Hundreds of thousands of facts on boiling points, densities, formulas, and uses had to be coded and punched onto computer input cards. A system had to be devised for transcribing that data onto a magnetic tape. This process is still under way.

Monthly trips are made to Washington, D. C., to make use of the huge Vanguard computation center. Only about five minutes a month are allowed the researchers, however, because the computer priority is allotted to satellite problems. But those five minutes are the equivalent of 25 years of desk computing time. It takes researchers three weeks to get enough information together to take up the five minutes on the computer.

After two years of painstaking work, the research team has assembled and coded facts about almost all the 3,000 compounds with known uses. These facts will serve as the computer's memory. Within a few months the entire memory system will be complete. Then the electronic computer, with its high-speed classifying system, will start on practical problems.

What will be the impact of this electronic brain on chemistry? Says Carpenter: "It will certainly stimulate research, reveal better chemicals for many old and new uses, cut development costs by making research more efficient and productive, generate new knowledge by revealing normally obscured correlations, and most significantly, it will substitute a methodology for the current confusion." 

BONUS

PHOTOGRAPHY SECTION

IN

JULY EI



symbol of
RAD-TEL
FIRST QUALITY

RAD
 TEL

GUARANTEED

INSIST ON RAD-TEL FOR EVERY
 TELEVISION AND RADIO TUBE NEED

GUARANTEED ONE FULL YEAR! **70% OFF on BRAND NEW TUBES**

You Can Rely On Rad-Tel's Speedy One Day Service!

Not Used — Not Pulled Out Of Old Sets • Each Tube Individually and Attractively Boxed!

Qty.	Type	Price	Qty.	Type	Price	Qty.	Type	Price	Qty.	Type	Price	Qty.	Type	Price	Qty.	Type	Price
—	0Z4M	.79	—	4BC5	.56	—	6A05	.50	—	6CG8	.77	—	8AW8	.93	—	12BH7	.73
—	1AX2	.62	—	4BC8	.96	—	6AR5	.55	—	6CM7	.66	—	8BQ5	.60	—	12BK5	.70
—	1B3GT	.79	—	4BE6	.54	—	6AS5	.60	—	6CN7	.65	—	8CG7	.62	—	12BL6	.56
—	1DN5	.55	—	4BN6	.75	—	6AT6	.43	—	6CR6	.51	—	8CM7	.68	—	12BQ6	1.06
—	1G3	.73	—	4BQ7	.96	—	6AT8	.79	—	6CS6	.57	—	8CN7	.97	—	12BY7	.74
—	1J3	.73	—	4BS8	.98	—	6AU4	.82	—	6CU5	.58	—	8CX8	.93	—	12BZ7	.75
—	1K3	.73	—	4BU8	.71	—	6AU6	.50	—	6CU6	1.08	—	8EB8	.94	—	12C5	.56
—	1L6	1.05	—	4BZ6	.58	—	6AU7	.61	—	6CY5	.70	—	100A7	.71	—	12CA5	.59
—	1LA6	.69	—	4BZ7	.96	—	6A08	.87	—	6CY7	.71	—	11CY7	.75	—	12CN5	.56
—	1LC6	.79	—	4CB6	.59	—	6AV6	.40	—	6DA4	.68	—	12A4	.60	—	12CR6	.54
—	1LN5	.59	—	4CS6	.61	—	6AW8	.89	—	6DB5	.69	—	12AB5	.55	—	12CU5	.58
—	1R5	.62	—	4DE6	.62	—	6AX4	.65	—	6DE6	.58	—	12AC6	.49	—	12CUG	1.06
—	1S5	.51	—	4DK6	.60	—	6AX7	.64	—	6DG6	.59	—	12AD6	.57	—	12CX6	.54
—	1T4	.58	—	4DT6	.55	—	6BA6	.49	—	6DQ6	1.10	—	12AE6	.43	—	12DB5	.69
—	1U4	.57	—	5AM8	.79	—	6BC5	.54	—	6DT5	.76	—	12AF3	.73	—	12DE8	.75
—	1U5	.50	—	5AN8	.86	—	6BC7	.94	—	6DT6	.53	—	12AF6	.49	—	12DL8	.85
—	1X2B	.82	—	5AQ5	.52	—	6BC8	.97	—	6EU8	.79	—	12AJ6	.46	—	12DM7	.67
—	2AF4	.96	—	5AT8	.80	—	6BD6	.51	—	6EA8	.79	—	12AL5	.45	—	12DQ6	1.04
—	2BN4	.60	—	5BK7A	.82	—	6BE6	.55	—	6EB8	.94	—	12AL8	.95	—	12DS7	.79
—	2CY5	.71	—	5BQ7	.97	—	6BF6	.44	—	6HG6T	.58	—	12A05	.52	—	12E26	.56
—	3AL5	.42	—	5BR8	.79	—	6BG6	1.66	—	6J5GT	.51	—	12AT6	.43	—	12EL6	.50
—	3AUG	.51	—	5CG8	.76	—	6BH6	.65	—	6J6	.67	—	12AT7	.76	—	12EG6	.54
—	3AV6	.41	—	5CL8	.76	—	6BH8	.87	—	6K6	.79	—	12AUG	.50	—	12EK6	.56
—	3BA6	.51	—	5EA8	.80	—	6BJ6	.62	—	6S4	.48	—	12AUG	.60	—	12EZ6	.53
—	3BC5	.54	—	5EU8	.80	—	6BK5	.80	—	6SA7GT	.76	—	12AV5	.97	—	12F5	.66
—	3BE6	.52	—	5J6	.68	—	6BK7	.85	—	6SK7GT	.74	—	12AV6	.41	—	12F8	.66
—	3BN4	.63	—	5T8	.81	—	6BL7	1.00	—	6SL7	.80	—	12AV7	.75	—	12FM6	.45
—	3BN6	.76	—	5U4	.60	—	6BN4	.57	—	6SN7	.65	—	12AX4	.67	—	12K5	.65
—	3BU8	.78	—	5U8	.81	—	6BN6	.74	—	6SQ7	.73	—	12AX7	.63	—	12SA7M	.86
—	3BY6	.55	—	5V6	.56	—	6BQ5	.65	—	6T4	.99	—	12AZ7	.86	—	12SK7GT	.74
—	3BZ6	.55	—	5X8	.78	—	6BQ6GT	1.05	—	6T8	.80	—	12B4	.63	—	12SN7	.67
—	3CB6	.54	—	5Y3	.46	—	6BQ7	.95	—	6U8	.78	—	12BA6	.50	—	12SQ7M	.73
—	3CF6	.60	—	6AB4	.46	—	6BR8	.78	—	6V6GT	.54	—	12BD6	.50	—	12U7	.62
—	3CS6	.52	—	6AC7	.96	—	6BS8	.90	—	6W4	.57	—	12BE6	.53	—	12V6GT	.53
—	3CY5	.71	—	6AF3	.73	—	6BU8	.70	—	6W6	.69	—	12BF6	.44	—	12W6	.69
—	3DE6	.62	—	6AF4	.97	—	6BY6	.54	—	6X4	.39	—			—		
—	3DK6	.60	—	6AG5	.65	—	6BZ6	.54	—	6X5GT	.53	—			—		
—	3DT6	.50	—	6AH6	.99	—	6BZ7	.97	—	6X8	.77	—			—		
—	3Q5	.80	—	6AK5	.95	—	6C4	.43	—	7AU7	.61	—			—		
—	3S4	.61	—	6AL5	.47	—	6CB6	.54	—	7B8	.68	—			—		
—	3V4	.58	—	6AM8	.78	—	6CD6	1.42	—	7B6	.69	—			—		
—	4AUG	.54	—	6AN4	.95	—	6CF6	.64	—	7Y4	.69	—			—		
—	4BA6	.51	—	6AN8	.85	—	6CG7	.60	—	8AU8	.83	—			—		

Use This As Your Order Form. Please Print Plainly

Name

Address

City

SEND FOR FREE TROUBLE SHOOTER GUIDE AND NEW TUBE & PARTS CATALOG.

RAD-TEL TUBE CO.

55 Chambers St.
 Newark 5, N. J.

EI-660

TERMS: 25% deposit must accompany all orders — balance C. O. D. Not Affiliated With
 \$1 HANDLING CHARGE FOR ORDERS UNDER \$5. Subject to prior sale. Any Other Mail
 Please add postage. No C. O. D.'s outside continental U. S. A. Order Tube Co.

FROM HEATH . . . MORE NEW HOBBY KITS!



AD-10 \$33.95

STEREO RECORD PLAYER KIT (AD-10)

Made by famous Garrard of England to superb specifications. "Plug-in" cartridge feature. Rubber matted heavy turntable is shock-mounted, and idler wheels retract when turned off to prevent flat spots. Powered by a line-filtered, four-pole induction motor at 16, 33 1/3, 45 and 78 rpm. Supplied with Sonotone STA4-SD ceramic stereo turnover cartridge with .7 mil diamond and 3 mil sapphire styli. Assembles in minutes; mechanism and vinyl covered mounting base pre-assembled, arm pre-wired. With 12" record on table, requires approximately 15" W. x 13" D. x 6" H. Color styled in cocoa brown and beige. 10 lbs.

Mechanism Only: Less cartridge, base and cables. Model AD-30, 8 lbs. \$22.95



AA-50 \$79.95

HI-FI RATED 25/25 WATT STEREO AMPLIFIER-PREAMPLIFIER KIT (AA-50)

A complete 25/25 watt stereo power and control center (50 watts mono) . . . 5 switch-selected inputs for each channel . . . new mixed center speaker output . . . stereo reverse and balance controls . . . special channel separation control . . . separate tone controls for each channel with ganged volume controls . . . all of these deluxe features in a single, compact and handsomely styled unit! Five inputs for each 25 watt channel are provided: stereo channel for magnetic phono cartridge (RIAA equalized); tape head input; three high level auxiliary inputs for tuners, TV, etc. There is also an input for monophonic magnetic phono cartridge, so switched that monophonic records can be played through either or both amplifiers. The automatically mixed center speaker output lets you fill in the "hole-in-the-middle" found in some stereo recordings, or add extra monophonic speakers in other locations. Nearly all of the components are mounted on two circuit boards, simplifying assembly and minimizing possibility of wiring errors. Handsome cabinet features new "visor" effect, with vinyl-clad steel cover in black leather-like texture with gold design. 30 lbs.



AA-20
\$34.95



AA-30 \$45.95

ECONOMY PREAMPLIFIER KIT (AA-20)

Although these two new Heathkit models are designed as companion pieces, either one can be used with your present stereo system. The preamplifier (AA-20) features 4 inputs in each stereo channel (RIAA "mag" phono, "xtal" phono, and two auxiliary inputs). A six-position function selector switch gives you instant selection of "Amplifier A" or "Amplifier B" for single channel monophonic; "Monophonic A" or "Monophonic B" for dual channel monophonic using both amplifiers and either preamplifier; "Stereo" and "Stereo Reverse". Self-powered. (AA-20) 8 lbs.

HI-FI RATED 14/14 WATT BASIC STEREO AMPLIFIER KIT (AA-30)

Two 14-watt high fidelity amplifiers, one for each stereo channel, are packaged in the single, compact, handsomely styled amplifier (AA-30). Suitable for use with any stereo preamplifier or with a pair of monophonic preamplifiers, it features individual channel gain controls, speaker phase reversal switch and convenient pilot light. Output accommodates 4, 8 and 16 ohm speakers. Handsome satin black expanded-metal cover, gold colored chassis. (AA-30) 21 lbs.



ORDERING INSTRUCTIONS

Fill out the order blank below, giving us your name and address in the space provided at right. Include charges for parcel post according to weights shown. Express orders are shipped delivery charges collect. All prices F.O.B. Benton Harbor, Mich. A 20% deposit is required on all C.O.D. orders. Prices subject to change without notice. Dealers and export prices slightly higher.

QUAN.	ITEM	MODEL NO.	PRICE

Ship via Parcel Post Express C.O.D. Best Way

FREE CATALOG

Describes over 150 different and exciting kits in HI-FI, Test, Ham Radio, Marine and Hobby fields. Send for yours today!



HEATH COMPANY Benton Harbor 39, Mich.
Please send my free copy of your complete catalog.

NAME _____

ADDRESS _____

CITY _____

ZONE _____

STATE _____

*first of a series designed to
teach the fundamentals
of electronics . . .*



EK-1
\$19.95



EDUCATIONAL KIT (EK-1)

Youngsters and oldsters alike will find this kit a priceless introduction into the wonderful world of electronics. Now, at less than the cost of several standard textbooks on the subject, Heath offers a complete basic electricity course, resulting in a finished test instrument of a thousand and one uses. The EK-1 is a combination kit and text-workbook designed to teach the principles of voltage, current, and resistance—the basic “yardsticks” of electronics to students of junior high level. Adults also will find the project beneficial as a beginning or refresher course in electronics. When finished with the project the student will have learned the theory and construction of direct current series and parallel circuits, voltmeter, ammeter and ohmmeter circuits and the application of ohms law to these circuits. The completed meter will then be used to verify ohms law and the maximum power transfer theorem, one of the most important theorems in electronics. The finished kit, a practical volt-ohm-milliammeter, may be used to make measurements of voltage, current and resistance in a wide variety of applications.

Procedures for checking home appliances and automobile circuits are included with the kit. The EK-1 will serve as a prerequisite to following Heathkit Educational Kits. Get started NOW in this new and exciting series. 4 lbs.

XR-2P
\$29.95
(6 lbs.)



XR-2L
\$34.95
(7 lbs.)

6-TRANSISTOR PORTABLE RADIO KIT (XR-2 series)

Dependable portable entertainment wherever you are—wherever you go! Choose the gleaming, two-tone molded plastic model or the handsome simulated leather-and-plastic combination—both feature a gracefully curved grille in smart beige plastic. The XR-2P complements the handsome grille with a mocha colored case of high-impact plastic, while the XR-2L encases the grille in sun tan color Sur-o-Lon simulated leather. Vernier tuning control gives you smooth, precise station selection. Six Texas Instrument transistors are used for quality performance and long life; a large 4" x 6" PM speaker provides “big set” richness of tone. Ready to play after simple assembly—transformers prealigned. Six flashlight batteries used for power (500-1000 hrs.) (batteries not included).

HW-19 (10 meter)

HW-29 (6 meter)

\$39.95



10 & 6 METER TRANSCEIVER KITS

Complete ham facilities at low cost! Ideal for beginning and veteran hams for “local” net operations. Transmitter and receiver are combined in one easy-to-use instrument. Features neat, modern styling, press-to-talk transmit/receive switch, built-in AC power supply, variable gain control and built-in amplifier metering jack. Operates mobile using vibrator power supply. Microphone and two power cables included. Styled in mocha and beige. Less crystal. 10 lbs.

Vibrator Power Supplies: VP-1-6 (6v.), VP-1-12 (12v.). 4 lbs. kit; \$8.95 ea., Wired; \$12.95 ea.

ORDER DIRECT BY MAIL OR SEE YOUR HEATHKIT DEALER*

*The convenience of Local Heathkit Sales and Service costs but a few dollars more.

Cosmic Clearing House

Continued from page 37

center, it approaches the speed of light—at which point it becomes electromagnetic energy, thus returning to the “universal” fountain of energy from which new universes are born. One of the big aims of the Cornell space center is to check the correctness of this concept.

Intergalactic space appears to be a vast mass of electrostatic charges, magnetic fields and electromagnetic radiations. The recent discovery of anti-matter indicates that an “anti-universe” must also exist somewhere—a universe in which all the atomic particles are electrically charged exactly opposite to those of our own universe. Such a situation would set up a field-force between the two universes, just as the two plates of a capacitor are charged oppositely, setting up an electrostatic tension between them. Such a universal tension could act as a conductor of energy through apparently “empty” space—again, as a capacitor transports radio-frequency, cycling it into more direct impulses.

The propagation of electromagnetic waves through space might occur in a similar way. Radio waves, like light, are electromagnetic energy. So the special way by which we see things, as well as our ability to communicate by radio, may be possible in space because space itself is an electrical conductor. This is an intriguing idea, for if it's true, man may be able to communicate through the “void” instantaneously—without being hampered by the “slowness” of the speed of light.

For example, to send a radio signal one way to the nearest star would take about four years. Another four years would lapse before the answering signal could be received on earth. Other complications are interference from natural radio sources (radio-emitting stars and galaxies) and the position of the star toward which we are beaming our signals. If the star is located in front of a strong natural radio source, cosmic radio interference will over-ride the answering signals, if any. There would be no way of knowing whether our signals were reaching intelligent beings alive on a planet orbiting about that star.

Two physicists, Drs. G. Cocconi and P. Morrison, have collaborated recently on a method to make use of radio to determine whether intelligent life exists elsewhere in the universe. A main point of their proposal is the calculation of the most favor-

able positions in the Milky Way toward which to beam radio signals. This would be a region where cosmic “static” is at a minimum.

Dr. Morrison is an advisor to the new Cornell Center. He and his colleague have stated that near some star like our sun there probably are civilizations with scientific interests and technical possibilities much greater than those available to us. To these intelligent beings our own sun must appear as a likely site for the evolution of a new society. It is probable that for a long time they will have been expecting the development of science near our sun. We shall assume that long ago they established a channel of communication that would one day become known to us, and that they look forward patiently to the answering signals from us that would make known to them the fact that a new society has entered the community of intelligence. In other words, they are waiting for word from us.

The word “radiophysics” in the Cornell Center's name is significant. It refers to the field of science where research into all the aspects of physics—from the formation of the earth to the evolution of the total universe—is carried out primarily by using radio as the tool of investigation. This covers everything from antenna design to microwave amplification, and from solid-state physics to magneto-hydrodynamics. This last mentioned imposing subject is one of the newest of the physical sciences and concerns itself with the investigation of the fluid relationships between magnetic fields and electrically charged gases.

Professor Gold will soon have available (by 1961), a thousand-foot-diameter radar antenna driven by a transmitter of 2.5 megawatts peak power. This instrument will permit penetration of the dense gases, thousands of miles thick, in the atmosphere of Jupiter. It will reach the very core of that planet—the giant of our solar system. Jupiter's average distance from Earth is about 500-million miles.

The radar system of the Cornell Center, to be located in Puerto Rico, will be capable of transmitting such strong signals that reflected echo will have 10,000 times the power of those received from Venus during the Air Force's recent radar probe of that planet from their Cambridge Research Center.

According to Professor Gold, “At the present time, we have just barely been able to detect Venus. This power (of the Cornell radar) would make possible the actual penetration of the Venusian surface. It will

be possible to 'see' the variations of that surface—and to plot them."

But even more than this, Professor Gold continues: "It is not unreasonable to claim that we will be able to discover the general order of magnitude of vegetation on Venus by using a number of different radar wavelengths. The clusters or concentrations of vegetation could be determined by the way the radar 'paints' different slopes and levels on the scope."

The extreme value of such pure scientific research to the practical future of landing an expeditionary space crew on Venus is self-evident. Yet of equal importance will be the radio-communications know-how that will certainly be acquired through the Venusian experiments with radar. The characteristics of microwave radio propagation between the earth and Venus should suggest new designs for efficient two-way communications over millions of miles of interplanetary space.

Determining exact distances between the earth, the planets and the sun will be another project of the Cornell Center. By combining radar with optics, precise distances can be determined. At 400 mc, the giant radar system of the center will be

able to resolve the sun's surface to 1/6 of a degree, far greater accuracy than has ever before been achieved. Much new information about the sun will pay off in a closer understanding of the earth's upper atmosphere, a deeper understanding of how radio waves are affected by the ionosphere, how storms are created, and how weather systems are formed.

One technique proposed by Professor Gold to analyze the sun is the use of microwave back-scatter from the ionized layers of the solar atmosphere. Simply, a radio wave, depending on its energy and angle, strikes the electrons and charged atomic nuclei of the electrified hot gases of the sun, causing them to release particles of electromagnetic energy in various directions. The original radio energy is absorbed, but the energy released will be of the same frequency. If the angle of the absorbed radio wave is just right, then some of the released radio energy will be scattered backwards toward the source of the transmitted energy—hence the phrase, "back-scatter."

The foregoing are only a few of many important projects planned by the Cornell Center. The key men at the Center read

THIS IS the logical choice for stereo and mono reproduction

SINGLE PLAY TURNTABLE — for unrestricted manual or fully automatic operation.

AUTOMATIC RECORD CHANGER — simply change spindles — nothing else to do.

TRACKS AND TRIPS AT AS LOW AS 1½ GRAMS — lets you use the most sensitive professional turntable cartridges with high compliance stylus, ensuring long life for all records.

FOOLPROOF RECORD INDEXING — the roller feeler guides in the tonearm measure each record individually. Can't miss.

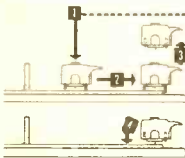

1. When START button is pressed, tone arm moves toward center. 2. With wheels down, arm glides lightly over top unused surface until outer wheel locates exact outer edge. 3. Arm rises and wheels retract. 4. Arm gently descends to play.

ELEVATOR ACTION CHANGER SPINDLE — lifts entire stack off the bottom record to let it descend gently to turntable. No possible damage to record edges or center holes.

POWERFUL RUMBLE-FREE MOTOR — so powerful, in fact, that heavy turntable reaches full RPM in less than ¼ turn from dead start!

LAMINATED AND CONCENTRICALLY GIRDED TURNTABLE — can't warp, can't wobble. Rotates on heavy duty ballbearing.

CHOICE OF REPEAT — now you can repeat same record indefinitely, or just once with self-cancelling repeat button.

THE DUAL 1006 combination turntable/changer



Tested and acclaimed by technical and consumer reporting organizations, the United Audio Dual-1006 is decidedly your \$6995 best value at only

united Audio

WIGO • PRODUCTS OF DISTINCTION • DUAL
12 West 18th St., N. Y. 11, N. Y.

CONSTANT SPEED CHANGE-CYCLE — independent auxiliary transmission is used only for cycling. Thus change action is fast at all speeds.

ONE-PIECE PROFESSIONAL TONEARM — avoids distortion of cartridge output and multiple resonances common to two-piece arms.

PERFECT TRACKING — double set of ball-bearings in each axis provides perfect arm motion — lateral and vertical — so vital for stereo tracking.

AUTOMATIC GEAR DISENGAGEMENT — idler and all individual speed gears disengage after every play . . . and motor shuts off. Nothing to remember, no worry about flat spot thump.

BUILT-IN STYLUS FORCE GAUGE (A) direct reading for instant check. Fingertip accessibility for wide-range of adjustment.

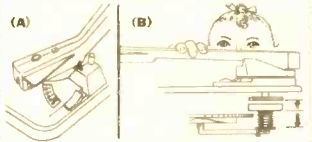

JAMPROOF TONEARM SLIP-CLUTCH (B) completely disengages tonearm during play, allowing it to track freely, with no drag, no variation in tracking force ever.

INTERRUPT PLAY AT ANY TIME — and start again at any place on record, even during changer operation.

LOCK-IN CARTRIDGE HOLDER — takes all standard-size cartridges; lets you interchange cartridges instantly, effortlessly.

MULTI-PURPOSE STEREO / MONO SWITCH — adapts stereo cartridges for mono output; very handy too for balancing stereo speakers.

like a Who's Who in Radiophysics. Their job will be to correlate practical observations with the best inferences of theory—a two-way correlation between actual information and ideas. In this sense, the new Cornell space center is a unique cosmic clearing house.

NAVIGATION IN SPACE—What happens when an astronaut reaches the point where he can no longer rely on navigational aid from Earth, yet is still too far from his destination to use radar? The Franklin Institute has come up with a solution: Our spaceman will have to use star radiations as his compass and speedometer. This method of navigation will be based on the Doppler effect—the change in frequency of electromagnetic phenomena due to relative motion between two objects. Radiations from the sun, or a star, received at the space vehicle will vary in frequency with the velocity of the vehicle. If the astronaut can detect and measure this change, he will be able to chart his speed and course. The task now is to develop gear compact enough to be carried aboard a space ship, yet sensitive enough to detect the very low signal level of the stars. Packing a giant radio-telescope aboard a Flash Gordon-type rocket ship is, of course, out of the question.

BONUS

PHOTOGRAPHY SECTION

IN

JULY EI

A Wide Range Watt Meter

Continued from page 88

the power line. With S2 set for the high range, R1 is rotated until a center reading on the meter is achieved. Wattage can be read directly off the scale. This little unit will tell you more things than the manufacturer's specifications may indicate.

For example, a television set may be rated at 300 watts but will draw considerably more in the first second or two due to the fact that the tube filaments must be brought to the proper operating temperature from a dead cold start. In addition, the wattmeter can be a useful service tool. For example, if the filter capacitor or a tube on a high fidelity amplifier is shorted, the wattmeter will continue to show a wattage reading considerably higher than the rating specified by the manufacturer. In addition, the meter reading will drop considerably when the defective tube is removed and will obviously not return to the high wattage level when a new tube is inserted.

Though this meter can handle loads up to about 1500 watts (about 14 amps in a 110 volt line), it is not advisable to leave it constantly connected in the circuit. Thus, the transformer primary should be shorted out with the "in-out" switch whenever the unit is not being used to take a reading. On very high wattage loads (in excess of 1,000 watts), the meter will give a slight reading even when S1 is shorting out the transformer primary. This is due to the fact that the switch acts as a very low resistance shunt which nevertheless allows some current to flow through the transformer primary and thereby developing a small voltage in the transformer secondary, proving that even the best switches have some internal resistance.



Continued from page 73

ateur radio fraternity. Officially recognized by the FCC, specific portions of each band have been assigned to RACES. During an actual emergency, hams engaged in civil defense operation under the control of RACES would be given exclusive use of these channels. While space has been provided in all bands below 300 mc, the VHF allocation is most commonly used in an actual emergency. Drills are conducted on the lower frequencies as well since these would become important during a wide spread emergency such as a nuclear attack.

The Technician Class

For the first time in this series we encounter a new kind of amateur. He is half-way between the Novice and General Class ham. He must be able to send and receive code at a rate of five w.p.m. which is the Novice standard, but unlike the Novice, his know-how must equal that of the General Class amateur. The Technician's license is renewable year after year.

The technician may not operate on any frequency below 30 mc. But where he is allowed to operate (including the entire six meter band), he has full amateur privileges—in other words, the full kilowatt if desired and any type of modulation permitted on the particular frequency.

Not intended as a stepping stone from the non-renewable Novice license to the General Class ticket, it is nevertheless one way the ham having the "13 w.p.m. blues" can stay on the air. With this intermediate stage, all shortwave privileges are lost, at least until the ham passes that code test. Until such time his only chance for international DX would be right here on six meters.

The Technician Class originally was created for those persons interested primarily in the technical side of radio rather than in rag chewing, traffic handling and DX just for the sake of DX. It was created specifically for those persons wishing to study VHF and UHF propagation. On six meters the foremost target is, needless to say, the Sporadic-E layer. Last month we told you that summer heat and meteor showers were two possible causes of this baffling propagation phenomenon. Other factors might include sunspots and the ionospheric disturbances (magnetic storms) which accompany them. In any case, the Sporadic-E layer is just one challenge of VHF.

ONLY GIVES YOU SUCH CHOICE

... a complete range of the finest quality speakers and accessories ... with exclusive built-in features of versatility and flexibility ... to let you custom-build stereo and monophonic speaker systems to your requirements of budget, space and listening preferences.

TWELVE WIDE-RANGE SPEAKERS

... from a modest 8" 2-way to deluxe 15" 3-way models. One example from the new Series 200 line, **MODEL 312 12" 3-WAY SPEAKER** features special cloth surround and exceptionally rigid cone for rich, true bass down to 28 cps. Exclusive Difusicone mid-range and the fabulous Sphericon Super Tweet-



NEW!

er (see below) provide 120° dispersion in all directions. Built-in network and adjustable brilliance control. User net: \$73.00.

SEVEN WOOFERS

... in 8", 12" and 15" models, in both high efficiency designs for conventional systems and high compliance designs for bookshelf systems. Most feature University's exclusive dual voice coil for one-woofer stereo applications. For example: **MODEL C-8HC 8" HIGH COMPLIANCE WOOFER** has many new refinements: special low resonance cone with treated



NEW!

cloth surround, extra deep dual voice coil and heavy die-cast basket all combine to produce its remarkable range of 20-3000 cps (in suitable enclosure). Any good 10 watt amplifier suffices. User net: \$39.95.

SEVEN MID-RANGE SPEAKERS

... in both cone and wide-angle horn models for use in 3-speaker systems. For example: **MODEL T-30 DRIVER/H-600 MID-RANGE HORN** combines famous patented "reciprocating-flare" principle with hemispherical deflection for unusually uni-



form dispersion (125° x 55°). Response extends to 15,000 cps. User net: \$49.00

SIX TWEETERS

... in both wide-angle horn and direct radiator models with compression drivers. For example: **MODEL T202 SPHERICON SUPER TWEETER** offers the most phenomenal high frequency response ever achieved—from 3000 cps to 40,000 cps (±2 db to 22,000 cps)—with amazing clarity, transparency and sweetness. Matches perfectly to any system



NEW!

—especially high compliance—without sacrificing bass efficiency. Built-in network and adjustable brilliance control. User net: \$24.95.

Desk E-3, University Loudspeakers, Inc., 80 So. Kensico Ave., White Plains, N. Y.

Please send me complete information on University high fidelity speakers, speaker systems and accessories.

NAME _____

STREET _____

CITY _____ STATE _____

University Loudspeakers, Inc., a subsidiary of Ling-Altec Electronics, Inc.



BALLANTINE BOOK'S NEW

ROCKET MANUAL FOR AMATEURS

ONLY **\$1.00**
Postage and Handling Included



By **Captain B. R. Brinley**

Noted rocket education authority with foreword by Willy Ley

368 pages, over 80 illustrations

The most understandable and information-packed book available on Rocket Science Fundamentals. In simple terms explains rocket design, fuels, instrumentation, pre-flight tests, launching, tracking, safety procedure, and club organization. Includes step-by-step data and drawings for building and operating successful amateur rockets. Essential for rocket students; ideal for teachers, advisors, public officials, libraries.

CLOTHBOUND EDITION \$6.00

Learn How To Apply Electronics To Rocket Testing, Tracking and Instrumentation

SPACE PRODUCTS CORPORATION
Rocket Science Products Supply House
38 East 57th Street, New York 22, N.Y.
Enclosed in \$_____ Please rush
 Copies of the paperback edition at \$1.00 each.
 Copies of the clothbound edition at \$6.00 each.
Put me on your mailing list for free info.

NAME _____
ADDRESS _____
CITY _____ ZONE _____ STATE _____
Outside U.S. and Canada paperback \$1.25; clothbound \$6.50

ORDER FORM



take your HEADQUARTERS with you **Regency**

MODEL CB-27 CITIZENS BAND TRANSCEIVER AT ONLY \$124.95

No operator's examination required for license.

USES: SERVICEMEN, HUNTERS, FISHERMEN, FARMERS, DOCTORS, FREIGHT DISPATCHERS, TRUCK FLEETS, CONSTRUCTION COMPANIES, OIL COMPANIES, BOATS, TAXI OPERATORS, ETC

The **REGENCY** Model CB-27 is a small (4 1/2" x 6 1/2" x 8 3/4") Citizens Band Transceiver incorporating features found only in expensive communication equipment.

TRANSMITTER provides choice of two channels for interference-free transmission. Unit comes equipped with crystal for one channel operation. Hand-held microphone with push-to-talk button is included.

The **RECEIVER** is tunable across the band for maximum flexibility. Features: Double conversion, super-heterodyne design, adjustable squelch, noise limiter, illuminated slide rule dial, AVC, and crystal controlled first oscillator.

Available in two Models—Model CB-27 for use on 115V 60 cy AC, and Model CBM-27 for 12V DC. \$124.95

Regency Division, I.D.E.A., Inc.

7900 Pendleton Pike, Indianapolis 26, Indiana

Transistorized VU Meter

Continued from page 51

tor (C1) of the meter is rated at only 25V. and an extra capacitor (.5 mfd or higher) with a rating of at least 400 volts will have to be put in series with the 25-volt input capacitor.

Calibration

Extremely accurate calibration of the VU meter for a specific recorder and tape requires specialized equipment. However a good calibration, adequate for most recording applications, can be made as follows: Using a phonograph as a program source, make a series of recordings of the same passage of music—each at an increasingly higher recording level. Continue until you reach the point which just begins to produce audible playback distortion. At this level, while still recording, adjust the sensitivity of the VU meter to read 0 VU. This will be easy if you record a music passage which is relatively slow and contains a few sudden changes in intensity. With the meter thus set, record the passage again and decrease the recording level until the meter reading averages -6. Leaving the level setting as is, re-record the passage and increase the VU meter sensitivity until it reads 0 VU. If you are careful always to record and make level and sensitivity adjustments on the same passage of music, you should wind up with a meter calibration which indicates a 0 VU reading when the recording level is 6 db (-6 VU) below the point of audible distortion. Now, when recording, keep the average recording level at 0 VU. The 6 db margin will prevent overloading on peaks or sudden changes of intensity in the program material.

Try out this little transistor meter. If you use it correctly, you will be amazed at the better sound of your recordings.

BONUS

PHOTOGRAPHY SECTION

IN

JULY EI

Citizens Band Power Supply

Continued from page 48

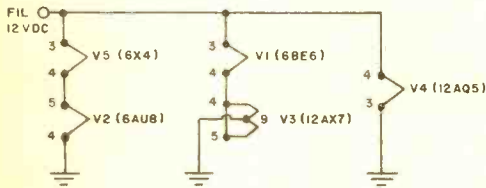

Filament wiring for 12 volt supply, see text.

be noted that reception on the broadcast set (auto or home) is unaffected. When the CB unit is switched to its *off* position, the antenna is automatically feeding the radio once again. However, it's a good idea to touch up the auto BC set's antenna trimmer for best response. Find the antenna trimmer hole (usually adjacent to the antenna jack). A small paper label with tuning instructions is usually fastened next to the trimmer hole. If missing, simply set the radio to a weak BC station up at around 1300 kc and tune for maximum volume (use a small screwdriver).

This completes this series on the CB rig. The unit described in these pages performs in a manner comparable to commercial sets. Final tests were conducted under adverse conditions; (in the city while driving between tall buildings) and reliable communication with the home station was achieved over a radius of 1½ miles. Far greater range is possible in open country—where intelligible communication has been achieved over six to eight miles.

**BONUS PHOTOGRAPHY SECTION
IN JULY EI**

CUT HOLES IN 1-1/2 MINUTES

(OR LESS)

with Greenlee
Chassis Punches



Many sizes . . . quickly make smooth, accurate holes in metal, hard rubber, or plastics . . . for sockets, plugs, controls, meters, panel lights, etc. Easy to use, simply turn with a wrench. Write today for free literature.



GREENLEE TOOL CO.
1783 Columbia Avenue, Rockford, Ill.



HELP

yourself to better service from your postal service by including postal zone numbers on all correspondence.

Don't forget to include your own postal zone number in your own return address.

Postal zoning helps your post office give you better service.



New! LAFAYETTE HE-15 Citizens Band 11 Meter SUPERHET TRANSCEIVER



Made in U.S.A.

Completely Wired

NOT A KIT

64⁵⁰

only 2.00 down

Not Superregenerative but SUPERHET

- 5 Crystal Controlled Transmitting Positions • Complete with Channel 9 Transmitting Crystal • Anyone Over 18 can operate
- Planetary Vernier Tuning • High Output Crystal Microphone

HE-15 Factory Wired and Tested (less antenna) Net 64.50

HE-17 Whip Antenna Net 6.95

HE-16 Power Supply For 12 Volts Net 11.95

HE-18 Power Supply For 6 Volts Net 11.95

FOR DESCRIPTIVE BROCHURE — WRITE TO ► LAFAYETTE RADIO DEP'T. EI 165-08 LIBERTY AVE. JAMAICA 33, N. Y.

EASIEST TO BUILD LAYER BUILT COLOR GUIDE

Grommes

DE LUXE HI-FIDELITY KITS



101GTK
FM TUNER

Finest tuner kit offered! "Standard Coll" tuning unit is pre-wired, pre-aligned and can be tuned-in as soon as completed, without professional adjustments. Better reception than tuners costing 2 or 3 times as much. Latest circuits, matched crystal diode detector, Foster Seeley Discriminator, AFC, Electronic Tuning Eye. Quiet, drift-free. Simply and successfully assembled by anyone with screwdriver, pliers and soldering iron. Step-by-step instructions. Model 101GTK, only. **\$59.50**



20 WATT STEREO AMP.

De Luxe stereo at half the cost! Two 10 watt channels with 2 pre-amps. 40 watts peak. Fre. Res. ± 0.5 DB. 20-20,000 CPS. Complete controls. 201JK **\$59.50**



10 WATT AMPLIFIER

With built-in pre-amp. 20 watts peak. Fre. Res. ± 1 DB. 20-20,000 CPS. 4 Inputs. Output: 4, 8, 16 ohms. Automatic Loudness Control. LJ6K **\$24.95**

Many other kits available—
At dealers or sent prepaid with check or M.O.

FREE!

GROMMES Div. of Precision Electronics, Inc.
9101-S King Ave., Franklin Park, Ill.
Please rush details on Grommes Kit Line.

Name _____
Address _____
City _____ State _____



**NEW
.22
6-SHOT
REVOLVER
\$12.95**

Fires both .22 short & long ammo. This sensational NEW 6-shot Rosco Vest Pocket .22 revolver is a tremendous value at 3 times its price. Made in W. Germany, it is a tight, well-made, exceedingly accurate handgun. Fires easy-to-get Win., Rem., Western & Peters .22 Long & Short ammo. Features side gate loading, trigger adjustment, screw-in ejector rod. Has STEEL RIFLED BARREL with blade front sights. Easy and fun to shoot. Terrific for target shooting, varmint hunting or as a home defense weapon. Only \$12.95. Leather holster \$2.25. 100 rds. of .22 long ammo only \$1.30. Shipped F.O.B. Los Angeles express charges collect. Send cash, check or M.O. COD's require \$7.50 deposit. Satisfaction guaranteed. Purchasers must be 18 years old. Res. of I.A. & vicinity, please purchase at our store.



**GENUINE
TRANSISTOR
RADIO
WITH SPEAKER
\$9.95**

ppd

WITH SPEAKER! No wires or ear plugs to fool with. This purse-size plays loud & clear ANYWHERE—even in buses & streetcars. Ideal gift. Includes battery & carrying case. Only \$9.95 postpaid. Send cash, check or M.O. SATISFACTION GUARANTEED.

SEAPORT TRADERS, INC., Dept. EL-6, 1221 S. Grand Ave., Los Angeles 15, Calif.

Don't Fry That Ham

Continued from page 85

or 34,500 volts are usually strung at the very top of a pole, while farther down, wires on racks or spools at lower potentials of 115 to 440 volts are more neighborly, but still not to be trusted.

A more reliable clue to finding the voltage of a wire or conductor than checking its location on the pole is noting the size of the insulator that supports the "live wire." A brown or white-glazed porcelain insulator about the size of a bowling ball with large grooves on the sides and top is a sure sign of high voltage. This model usually has one or two covering "skirts" to protect it from water seepage during rainy weather. A fist-size insulator handles 2300 to 7200 volts while a larger one designed for 16,500 volts compares in size to a big beer mug. Many high-voltage circuits still use green glass insulators which are considered harmless in telephone lines but are quite capable of handling much higher voltages elsewhere.

Even a city-slicker knows that a rattlesnake won't hurt anybody unless he's fooled with, and the same is true of a power line high on a pole. All would be well if hams didn't have the risky habit of getting long wires, ladders, and metal beam elements tangled in everything from the chimney on the roof to the bird house in the backyard.

"But all wires are insulated, aren't they?" you may argue.

Sure, wires are wrapped up, but that covering protects the conductor against corrosion from bad weather, and not a ham who gets his pinkies on it or an antenna against it.

"The vital function of any tree includes holding up a long wire first and a bird-nest second," contends the typical amateur, and the same fellow will gasp in horror when he hears that his friendly old oak can turn into a booby trap overnight. Should a power line droop through its branches and rub against a limb, the cambium layer and green sap will do what comes naturally and conduct electricity better than a trimmed Christmas tree. Any doubting Thomases in the crowd will recall that lightning often dives for the nearest tree in a spring storm.

"Don't try to tell me that 115 volts on an ordinary streetlight circuit is dangerous," scoffs the amateur who hasn't seen the right light.

If only a few volts can be deadly, certainly 115 is to be respected; besides that grim fact, there's a joker in this deck, too. While many lighting systems carry 115 volts similar to wiring in h m s, larger systems must have a "constant current" transformer to boost the voltage as each additional light is added. A town of a few thousand people might be supplied by a single series circuit with one wire meandering miles and miles carrying more than 5000 vicious volts. This series system sabotages the game of guessing voltages by the size of the insulators. The streetlight circuit where voltage to ground is lower than line voltage usually employs common 2300 volt side-groove insulators.

Although many power companies have adopted definite standards in their distribution systems, there are flies in every ointment. After a windstorm or severe icing, high and low voltage conductors are sometimes wound up with telephone lines like licorice sticks and every wire becomes dangerous. Joint construction placing power lines and communication circuits on the same poles is a common practice almost everywhere, and even in fair weather a falling limb may pull a primary line onto a normally harmless neighbor.

In short, the safest and best rule for all hams is to observe in handling electric power lines is "Not To." Call the company lineman who has had years of experience in identifying voltages and pointing out dangers. And what about the wire that crosses your lot or swings over the roof? Well, consider it dangerous until proven innocent. Even after checking its position on the power pole and noting the size of the insulator, too, don't march under it with a tall steel mast, nudge it with a beam element, or trust the tree it touches. You can never be quite sure what voltages are sizzling along up there. The variety of ham we're talking about isn't for frying.

BONUS
PHOTOGRAPHY SECTION
 IN
JULY EI

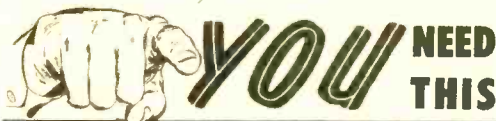

FREE GIANT 1960 B-A CATALOG

- 204 KING-SIZED PAGES**
- EVERYTHING IN RADIO TV AND ELECTRONICS**
- 100'S OF NEW ITEMS LISTED HERE FOR 1st TIME**
- 21 PAGES OF BARGAINS NOT IN ANY OTHER CATALOG**

BURSTEIN-APPLEBEE CO.

Dept. EI, 1012 McGee St., Kansas City 6, Mo.

Send Free 1960 B-A Catalog No. 601.

Name _____

Address _____

City _____ State _____

SEND FOR IT TODAY



*** FREE**

Fill in coupon for a FREE One Year Subscription to OLSON RADIO'S Fantastic Bargain Packed Catalog — Unheard of LOW, LOW, WHOLESALE PRICES on Brand Name Speakers, Changers, Tubes, Tools, Hi-Fi's, Stereo Amps, Tuners, and other Bargains.

NAME _____

ADDRESS _____

CITY _____ ZONE _____ STATE _____

If you have a friend interested in electronics send his name and address for a FREE subscription also.

OLSON RADIO CORPORATION

408 Forge Street Akron 8, Ohio

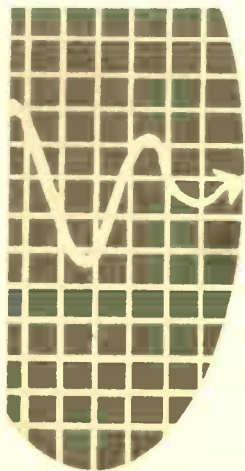

ELECTRONICS ILLUSTRATED

Classified Ads

Your advertisement can reach this mail-buying audience for only 35¢ per word . . . payable in advance (Check or M.O. please) . . . minimum 10 words. Closing dates are the 20th of 3rd preceding month i.e. copy for the September issue must be in our office by June 20th. Mail to ELECTRONICS ILLUSTRATED, 67 West 44th St., New York 36, N. Y. Word count: Zone number free. Figure one word: Name of state (New Jersey), name of city (New York); sets of characters as in key (14-D); also abbreviations as 35MM, 8x10, D.C., A.C.

SAVE MONEY • ORDER BY MAIL

• • • FOR SALE

MONEY SAVING Prices on tubes. TV Radio, Transmitting and Industrial Types. New, 1st quality, guaranteed. Top name brands only. Government surplus and commercial test, lab and communications equipment in stock. Sell us your excess tubes and equipment. Unused, clean tubes of all types wanted. Send specific details in first letter. Write for "Green Sheet" catalog 25¢. Barry Electronics Corp., 512 Broadway, (Dept. EI.), WA 5-7000, New York 12, N. Y.

GOVERNMENT SURPLUS—Anyone can buy electronic equipment direct from U. S. Government. Weekly letter tells When, Where and What is being offered. 3 months (13 issues) \$7.00. Government Surplus Sales, P. O. Box 6602EI, Washington 9, D. C.

GOVERNMENT SELLS: Surplus Electronics; Test Equipment; Oscilloscopes; Transceivers; Jeeps; Boats; Aircrafts; Misc.—Send for U. S. Depot Directory & Procedure \$1.00. "Government Surplus Sales," Box 425-EL, Nanuet, N. Y.

AUTOMATIC DOOR Operators new famous make. Only \$59.95. Buy Direct. Save! Free literature. Demco, Sebring 9, Ohio.

78 R.P.M. RECORDINGS. Many types. Free lists. Collections bought, P.O.B. 155(EL), Verona, N. J.

• • • EMPLOYMENT OPPORTUNITIES

PRINTING - ADVERTISING SALESMEN. Excellent moneymaking sideline selling Decalcomania Name Plates. Advertising Specialties. Sign letters, Automobile initials. Free Samples. "Ralco"—EI, Box L, Boston 19, Mass.

• • • PRINTING, MULTIGRAPHING, MIMEOGRAPHING

100 PERSONALIZED ENVELOPES, 150 Sheets \$2.98. Armstrong, 52724 Frances Road, South Bend 17, Indiana.

• • • BUSINESS OPPORTUNITIES

GROW MUSHROOMS. Cellar, shed and outdoors. Spare, full time, year round. We pay \$4.50 lb. dried. We have 29,000 customers. Free Book. Mushrooms, Dept. 315, 2954 Admiral Way, Seattle, Wash.

VENDING MACHINES—No selling. Operate a route of coin machines and earn high profits. 32-page catalog free! Parkway Machine Corp., Dept. 33, 715 Ensor St., Baltimore 2, Md.

• • • HI-FI

UNUSUAL VALUES. Hi-fi components, tapes, tape recorders, catalogue; package quotations. Budget Hi-Fi, 83-06c Vietor Ave., Elmhurst, N. Y.

COMPONENTS, RECORDERS. Free Wholesale Catalogue. Carston, 125-G East 88, NYC 28.

• • • RADIO & TV

DIAGRAMS for repairing radios, amplifiers, \$1.00; television \$2.00. Give make, model. Diagram Service, Box 672-EL, Hartford 1, Conn.

STEREO IN your car, book covers F-M, convertors, etc., \$2.00. Free folder of pocket F-M kits, etc. Ekeradio, 650 N. Fair Oaks, Pasadena, California.

TRANSISTOR RADIOS Repaired. Prompt estimate given. George Denton, California, Maryland.

HAM-SWAP—NEED a new piece of gear? Need to trade or sell the old? Then you need Ham-Swap! Published twice monthly—national circulation. \$1 ad free with \$1 year's subscription. Ham-Swap, Inc., 35 East Wacker, Chicago 1, Illinois.

15 DISTANCE ONE-TUBE Plans—25¢, with Transistor experiments, catalog. Laboratories, 1131-K Valota, Redwood City, California.

• • • TAPE RECORDERS

LEARN WHILE Asleep with your recorder, phonograph or amazing new "Electronic Educator" endless tape recorder. Details free. Sleep-Learning Research Association, Box 24-EI, Olympia, Washington.

TAPE RECORDERS, Hi-Fi components, Sleep Learning Equipment, tapes. Unusual values. Free catalog. Dressner 69-02 Z 174 St., Flushing 65, N. Y.

• • • PERSONAL

LOANS BY Mail. \$50 To \$600 For Any Purpose. Employed men and women eligible. Confidential. 2 years to repay. Write for free loan application. American Loan Plan, City National Bldg., Dept. EI-5150, Omaha 2, Nebraska.

• • • DETECTIVES

DETECTIVES—WORK Home—Travel. Experience unnecessary. Detective Particulars free. Writa, Wagner, 8-125 West 86th, New York 24.

• • • MUSIC

SONGPOEMS AND Lyrics Wanted! Mail to: Tin Pan Alley, Inc., 1650 Broadway, New York 19, N. Y.

Ham Station Control Center

Continued from page 33

fuses. There is no possibility of RF radiation from below the chassis. Remember to replace the original fuse in each piece of gear with a larger size (by 2 or 3 amps) and put the proper size fuse for the specific piece of equipment in the control unit.

Audio Noise Limiter

Sure, an audio noise limiter will knock your audio level down, but if you have a half-way modern receiver you've got more audio than you need anyway. Try the simple limiter shown in schematic B. At those rare times when you want every bit of audio your receiver will produce, simply flip S5 on the control unit and the noise limiter is out of the circuit. Some authorities recommend a 1.5-volt cell in series with each of the crystal diodes. Both ways have been explored and we fail to see enough difference to warrant remembering to throw an extra switch. However, suit yourself. Schematics B and C show proper polarities of batteries and diodes.

The RF pick-up coil of this transistorized

keying monitor (see schematic D) may be dropped inside your transmitter cabinet adjacent to your tank or antenna coil—wherever you get the best pickup. When using a whip antenna, you can drop the "doughnut" over the whip. Single wire antenna lead-ins can be fed through the 'hole in the doughnut' before connection to the transmitter. This little monitor will give you fair volume. If you want more, simply add another transistor and a small battery in a conventional transistor amplifying circuit. If the monitor doesn't oscillate readily on the first try, reverse either the primary or secondary connections to T2; not both. See Figure 2 for detailed drawing of pickup coil.

The clock used here has a timer that can be set to sound off an alarm as well as turn on your transmitter and receiver 10 or 15 minutes before that schedule which you would probably otherwise forget.

There you have it. There is lots of room for initiative. Using a larger cabinet would enable you to incorporate the Conelrad unit. Other changes will no doubt suggest themselves to you, but for all around convenience and operating pleasure, we suggest sticking to the basic design. v

MICRO

ELECTRON TUBE

INTRODUCES FOR THE FIRST TIME
ANYWHERE A SELECT STOCK OF USED
TUBES AT A FABULOUS LOW PRICE

37¢

ea.

FOR any TUBE LISTED

\$35 PER HUNDRED ASSTD

Jan Sargent Tubes!

ALL TUBES SENT POSTAGE PAID

Please send 25¢ handling for orders under \$5. Send 25¢ deposit on COD orders. Send approximate postage on Canadian and foreign orders.

MICRO

ELECTRON TUBE CO.

Dept. EI-6, P. O. Box 55 Park 5ta., Paterson 3, N. J.

• Each and every tube is tested in our own laboratory for mutual conductance and life test.

• We guarantee FREE replacement for one year of any tube purchased from us which fails to function efficiently under any or all operating conditions. Prompt refunds are made on any defective merchandise.

• The advertised tubes are not necessarily new, but may be electrically perfect factory seconds or used tubes—each is clearly so marked.

6A2	6X6	6BN6	6SF5	724	19BG6C
02A	6Y3GT	6BJ6	6SJ7	12AB	19J6
1A7CT	6Y3GT	6BK5	6SK7	12A05	19T8
1B3CT	6AB	6BK7	6SL7GT	12AT6	24A
1W4G	6AG	6BL7GT	6SN7GT	12AT7	25A
1N6GT	6AC7	6BN6	6SQ7	12AU6	25AV5
1L4	6AF4	6BQ6CT	6S7	12AV7	25BQ6
1L6	6AG5	6BQ7	6S7	12AV8	25DN6
1N5GT	6AG7	6BY5G	6S7	12AV9	25L6GT
1Q5GT	6AG7	6BZ6	6T4	12AX7	25W4GT
1F5	6AH4GT	6BZ7	6U6	12AX4GT	25Z5
1T4	6AK6	6C4	6U6	12AX7	25Z6
1U4	6AK5	6C5	6V6	12A27	28
1U5	6AL5	6C6	6W4GT	12B4	28
1V2	6AL7	6C6	6W6GT	12B6	35A5
1K2	6AN6	6C6C	6X4	12B6G	35C5
2A3	6AN6	6C6C	6X6	12B7	35L6GT
2A4	6A8	6C7	6X6	12B7	35W4
3B5	6A8	6C7	6X6	12B7	35Y4
3BN6	6AQ7GT	6CL6	6Y6	12B7	35Z5GT
3BZ6	6AR6	6CM6	7A4/XXL	12C45	39/44
3C5B	6AS6	6CM7	7A5	12E5	42
3C7B	6AT6	6CN7	7A6	12F6	45
3C5G	6AT6	6CS6	7A7	12G7	50B5
3L4	6AU6GT	6CU6	7B4	12H7	50C5
3Q4	6AV6GT	6DE5	7B4	12J7	50L6GT
3S4	6AV6	6E6	7B5	12K7	50R6
3V4	6AV6	6F8	7B6	12L6	50S6
4BQ7A	6AV5GT	6H6	7B7	12M7	50T6
4BZ7	6AV6	6J4	7B8	12N7	50U6
5A5B	6AW6	6J5	7C4	12P7	50V6
5AT6	6AX4GT	6J7	7C5	12Q7	50W6
5AV6	6AX5GT	6K6GT	7C6	12R7	50X6
5AW6	6B	6K7	7C7	12S7	50Y6
5B17	6B4	6K7	7E6	12T7	50Z6
5J6	6B5	6K8	7E7	12U6GT	58
5T6	6B6	6L7	7E7	12V6GT	58
5U4C	6B6	6N7	7F7	12W6GT	78
5U8	6B6	6Q7	7H7	12X7	78
5V40	6B6	6S4	7H7	12Y7	78
5V6GT	6B6	6S4GT	7Q7	12Z7	78
		6S47	7Q7	12Z7	78
		6S47	7X7/XXFM	14B6	80
		6S47	7Y4	14C7	80
				14D7	80
				14E7	80
				14F7	80
				14G7	80
				14H7	80
				14I7	80
				14J7	80
				14K7	80
				14L7	80
				14M7	80
				14N7	80
				14O7	80
				14P7	80
				14Q7	80
				14R7	80
				14S7	80
				14T7	80
				14U7	80
				14V7	80
				14W7	80
				14X7	80
				14Y7	80
				14Z7	80

WRITE DEPT. EI-6 FOR OUR FREE COMPLETE LIST OF TUBES & SPECIAL PURPOSE TUBES

ALL TUBES INDIVIDUALLY UNCONDITIONALLY GUARANTEED ONE YEAR SEND FOR FREE COMPLETE TUBE LIST & ORDER BLANK INQUIRY PUTS YOU ON MAIL-LIST

TELTRON SMASHES PRICES ON TUBES for '60!

GIFT OFFER
ONE 6BG6G tube will be shipped FREE with any \$10.00 or more order accompanying this ad.

\$7.50 list value. Includes 3 6SN7 tubes & 25 assorted resistors & condensers with each order of \$25.00 or more of receiving tubes and special purpose tubes only.

FREE

FREE EICO TUBE



TESTER

By popular demand we are repeating this fabulous FREE GIVE-AWAY. You get this EICO tube tester or kit w/ 625K A50. LUTELY FREE when you purchase \$199.00 worth of receiving tubes from TELTRON within 60 days.

Tube tester may be purchased outright for \$34.95 PREPAID. Send for FREE list of other EICO test equipment & Hi Fi components that we distribute.

MOST PARTIAL LIST OFTEN USED TUBES

024	.45	6BA8	.49	9U8	.79
1B3GT	.43	6BC5	.38	10DE7	.49
1R5	.51	6BE8	.49	12A85	.44
1S2	.43	6BF5	.46	12AF6	.44
1T4	.51	6BG6	1.18	12AT6	.44
1U4	.51	6BG6G	1.18	12AU7	.43
1U5	.43	6BJ6	.51	12B6	.42
1X2	.62	6BK5	.51	12AU7	.43
2AF4	1.02	6BK5	.51	12AV6	.58
2BN4	.53	6BK7	.78	12AV7	.73
3AU6	.43	6B17GT	.78	12AXGT	.60
3BC5	.58	6BN4	.44	12AZ7	.61
3BN6	.45	6BN6	.83	12AZ7	.61
3BZ6	.45	6BQ6CT	.83	12B4	.52
3CG6	.51	6BQ7A	.85	12B6	.46
3DT6	.48	6BZ6	.75	12B6	.46
3V4	.69	6BZ7	.45	12B7	.61
48C8	.75	6C2	.95	12B6	.63
48Q7	.51	6C86	.41	12BY7	.63
4CB6	.59	6CG6G	1.63	12CR6	.65
5AM8	.64	6CF6	.45	12CUB	.43
5AT8	.54	6CG7	.45	12D05	.63
5AV8	.68	6CN8	.44	12D08	.59
5BK7	.68	6CM7	.44	12K5	.63
5X8	.61	6CS6	.45	12K7	.44
5T8	.59	6CU6	.45	12SK7	.45
5U4G	.45	8DE6	.95	12SN7GT	.45
5U4GA	.49	6D08GT	.50	12SQ7	.56
5U4GB	.49	6D6	.89	12L6GT	.43
5U8	.45	6H6	.66	12L6G	.43
5V4G	.55	6J5	.49	12W6GT	.68
5Y3GT	.30	6K6GT	.61	19A4	.68
6AB4	.43	6S4	.39	198G6	.60
6AC7	1.02	6SA7	.45	25BQ6GT	1.48
6AD4	.52	6GC7	.54	25CDEG	1.19
6AC5	.43	6SK7	.45	25CU6	.43
6AH6	.43	6SN7GT	.60	25V4GT	.41
6AL5	.59	6SQ7	.38	3585	.36
6AM8	.48			3585	.48

NEW AND HARD TO GET TYPES PROMPT DELIVERY

1DN5	.60
1G3GT/1B3	.70
2C5	.50
3AF4	1.02
4DE6	.55
4T5	.57
5CQ8	.59
6B8	.64
6BQ5	.74
6CQ8	.59
6CX8	.64
6D55	.69
8AW8	.73
8CX8	.50
11C7	.74
12EK6	.59
17AXGT	.50
17D4.50 50EH5	.59

APPROX. COST ANY TYPE. EXCESS REFUNDED.

Obsolete, seldom used tubes. Immed. delivery.

1A6	.93	7B4	.44
1CSGT	.57	7B5	.41
1C7	.59	7B8	.47
1F5	.39	7C5	.44
1H4G	.39	7F8	.77
1LA6	.66	7H7	.51
1L6	.69	7H7	.52
1LM4	.66	7V7	.82
1LN5	.66	7Y4	.35
3LF4	.66	7Z4	.40
8T4	.59	12A8GT	.40
6A7	.59	12K7GT	.40
8A8	.40	12Q7GT	.48
8AB7/	.56	12SR7	.57
1853	.60	14A7	.43
6AQ7GT	.60	14B6	.36
6AS7G	1.50	14Q7	.52
6D6	.59	27	.45
6F5GT	.44	35A5	.48
6P6	.42	35Y4	.35
6S7	.89	37	.59
6SB7Y	.50	39/44	.39
6SR7	.43	45	.55
6U5	.54	50A5	.48
6UT6	.40	50X6	.53
7A4/	.56	56	.48
XXL	.47	71A	.65
7A6	.47	75	.44
7B6	.46	77	.55
7A7	.42	80	.40

Semiconductors for immediate delivery.

IN34	.49
IN38	.95
IN60	.34
IN68	1.00
IN82A	1.00
IN253	4.25
IN256	19.95
IN255	19.95
IN460A	4.60
IN1096	9.00
2N63	3.75
2N130A	3.75
2N329A	40.00
2N484	1.75
2N622	30.00
2N633	1.35

Special-purpose, transmitting and Industrial Tubes for immediate delivery.

0A2	.70	807	1.00
2A4G	.75	811A	3.25
2D21	.65	813	9.25
2E26	2.50	833A	40.00
2X2	.75	866A	1.00
SR4GY1.00	2050	.85	
GJ4	1.00	5875	12.25
12A6	.60	5879	1.10
FG27	8.50	6146	3.85
HY69	1.75	6161	34.50

NEW PRICE SCHEDULE OF TELEVISION PICTURE TUBES

PICTURE GUARANTEED FOR ONE (1) YEAR					
8DP4	* 17EP4	\$13.25	21AVP4	\$19.25	
10ABP4	* 17CP4	17.25	21AWP4	18.75	
10BP4	\$ 7.95	17GP4	17.95	21EP4	17.25
12LP4	10.75	17HP4	16.49	21FP4	19.25
14BP4	11.75	17JP4	16.49	21MP4	21.25
14CP4	11.95	17KP4	17.45	21WP4	17.25
14QP4	13.25	17QP4	13.25	21XP4	18.75
14RP4	14.25	17TP4	16.49	21YP4	18.75
16AP4	16.45	17VP4	16.49	21ZP4	17.25
16BP4	12.45	19AP4	16.25	24ADP4	*
16CP4	11.99	20CP4	15.75	24AP4	*
16EP4	15.99	20DP5	15.75	24CP4	27.25
16GP4	15.99	20HP4	17.75	24DP4	28.75
16MP4	12.45	21AP4	21.95	24PP4	*
16KP4	11.95	21ALP4	18.75	24TP4	*
16LP4	11.95	21AMP4	18.75	24VP4	*
16RP4	11.95	21AP4	21.25	24YP4	*
16TP4	11.95	21ATP4	19.25	24EP4	*
17ATP4	16.75	21AUP4	19.25	27RP4	*
17AVP4	15.75				

* Price upon request.
ALUMINIZED ON ANY TUBE, \$4.00 EXTRA
All picture tubes require a deposit on your dud. Please add an additional \$5.00 on tube sizes to 17". Add \$7.00 on sizes 19", 20", 21" and 17". Your cash deposit will be refunded immediately upon receipt of your dud prepaid. Picture tubes are shipped promptly from our warehouse (the US continent and Canada only) F.O.B. Harrison, New Jersey.

HEAVY DUTY SOLDER GUN

KIT, 133 w gun. Dual spotlight illum. work when gun on. INCL: wire soldering brush & aid to make tight twists, reopen old joints, lge. pig. solder. Prep'd., \$4.99. 3 for \$14.29.

FIBER FUSE CLIPS—15c ea.

12 for \$1.65 PREPAID

RCA CHEATER CORDS

39c ea. 3 for \$1.95 PREPAID

Complete Outdoor ALL CHANNEL CONICAL ANT.

local/fringe arc. as. 8 elem. ant. with crossbar. 5' seamless mast (alum.), chimney mt. or 7" wall brkt. (state need) 8 standoffs, 50' 300 ohm wire. 3 —\$7.49. Imm. dl. FOB Harrison, N.J.

SWITCH-TYPE

Indoor Antenna Shipped postage paid. New 6 position switch for use on UHF, VHF and color sets. Attractively packaged \$2.99. lots of 6 \$2.49.

PARALLEL PICTURE TUBE BRIGHTENER 9C

Series type.....\$1.39

AUTO VIBRATORS

6 Volt 4 Prong Universal.....\$1.59
12 Volt 3 Prong Standard.....\$1.79
12 Volt 4 Prong Standard.....\$1.99

NEW LIBERAL TERMS: NO MINIMUM ORDER. FREE POSTAGE ON ALL TUBE & PARTS ORDERS OVER \$5.00 IN U.S.A., APDs & TERRITORIES. 25% DEPOSIT REQUIRED ON CDS. PLEASE SEND APPROXIMATE POSTAGE ON CANADIAN AND FOREIGN SHIPMENTS. EXCESS WILL BE REFUNDED. All picture tubes and outdoor antennas shipped FOB Harrison, New Jersey.

TELTRON ELECTRIC CO.

428 Harrison Ave. Harrison, N. J. Phone HUmboldt 4-9848

Dept. E1-6

NEW ^{LOW COST} TRANSISTOR RADIO! WITH BUILT-IN LOUD-SPEAKER & BUILT-IN ANTENNA!



\$ 95 COMPLETE SET

The Secrets of Earth-Orbiting Satellites Built Into TRANSISTOR RADIO SET!

Incredible but true! Now you can have a powerful new precision-engineered tiny cigarette pack-size Transistor Radio with built-in Loud Speaker and built-in Antenna for only \$8.95 plus \$1.00 pkg. & hdlg. or **\$9.95 in all!** Similar sets sell for up to \$60.00 but our factory produces thousands of sets monthly and we pass on the savings to you! COMET is complete—nothing more to buy—no ground needed! Order Today! Supply really limited.

AMAZING NEW CONCEPT!

History is being made in the scientific world today. The U. S. Government recently achieved a major breakthrough in satellite communications. The first satellite communication link was established between the earth and a satellite. This is the first time that a satellite has been used for communications. The first satellite system was built by the U.S. Army and is being used for military purposes. It is a very important step in the development of satellite communications. The first satellite system was built by the U.S. Army and is being used for military purposes. It is a very important step in the development of satellite communications. The first satellite system was built by the U.S. Army and is being used for military purposes. It is a very important step in the development of satellite communications.

SUPER POWERFUL WITH BUILT-IN LOUD SPEAKER!

Breathtaking! A wonderful world of sound from COMET, the new tiny, marvelous Transistor Radio weighing about 9 ounces, and yet not much larger than a lady's compact. Complete with built-in loud speaker and antenna—ready to use—nothing else to buy—wide range of stations, including broadcasts for Civil Defense and other emergencies. Now, EVERYONE can enjoy COMET'S tremendous ability to receive stations at good distances with surging power clear and wonderful reception. It's the first De Luxe, powerful, tiny low cost Transistor Radio with a built-in loud speaker and built-in antenna.

SO LITTLE BUT SO MIGHTY!



Think of a lady's compact, or a package of cigarettes. Then think of the miracle of today's scientific achievements of a transistor radio set weighing approximately 9 ounces, and not much bigger than a lady's compact or a package of cigarettes that can bring you through a loud speaker built into the radio set the world's greatest music news and drama from stations miles and miles away.

10 TIMES MORE POWERFUL!



COMET'S amazing power plant, with its reflex circuit, pulls in wonderful radio signals. These signals are strong because our signal attracting power plant is like that used in radar and sonar equipment. It's the type used in Television, too! Then we strengthen the signal by using transistors as used in finest radios for military use. Our transistors never wear out. No tubes to break or replace.

TRY FREE FOR 10 DAYS!

Use COMET for 10 days. If, at the end of that time, you are not overjoyed with COMET, return the set in good condition and we will immediately refund your purchase price. However, our supply is limited, due to the fact that we import these sets from thousands of miles away, and because they are selling at a terrific pace. You take no chances. Send only **\$9.95 TODAY!**

MONEY-BACK GUARANTEE

L & M CO., Dept. EL-7, Box 881, St. Louis, Mo.

FIRST TRANSISTOR SET WITH BUILT-IN SPEAKER at LOW PRICE!

It's easy to make a good quality transistor set with a built-in loud speaker and a built-in antenna for \$8.95 in all, but it took a lot of time and money to get it with all these features to just **\$9.95 in all!** You must see and listen to this wonderful set to realize how great it is.

THE INSIDE STORY

COMET uses the same high quality circuit board in the most expensive transistor set built into COMET's tiny high power little antenna plus a 9 1/2 inch permanent dynamic type loud speaker. We gave you the best components for the best money!

THE OUTSIDE STORY

Each COMET set is carefully packaged. It's ready to use from the factory. A simple quick twist of the dial brings out the power. You'll get 100% of the sound that brings complete range of stations.

PLAYS SO LOUD!

COMET brings in so many stations so loud, so clear, you'll have to reduce the volume! Not to be compared with some sets with "private audiences," to watch the sound is so private the only way to hear it is to take COMET with you to parties, ball games, baseball games, horse races, and other places where you can't get in. COMET slips into your pocket to be ready to use when you want it. Order today! Complete set is only \$8.95 plus \$1.00 for pkg. & hdlg. or only **\$9.95 in all!**

MONEY-BACK GUARANTEE COUPON!

L & M COMPANY
415 North 8th Street, Dept. EL-7
St. Louis 1, Missouri

Please send me COMET RADIO complete with built-in loud speaker, built-in antenna, battery and package. I will pay Postage \$2.00 plus C.O.D. if you wish. You save expensive C.O.D. charges if you order money with order.

NAME _____
ADDRESS _____
CITY _____ STATE _____

It's up to you! The Army's new "Choose-it-Yourself" System lets you pick valuable training before you enlist. Here's how it works: **1. Choose** before enlistment. Choose your training from fields like Auto Mechanics, Missiles, Aircraft Maintenance, Meteorology, Surveying—and many more. **2. Qualify** before enlistment. Take aptitude and physical exams to qualify for the training you've chosen. **3. Know** before enlistment. If you qualify, you know you'll get the training you want. Your choice is written into your future Army record—guaranteed before you enlist. **Choose, qualify, know—this week!** Ask your Army recruiter to show you his complete list of available training fields.

Want training in Auto Mechanics? Construction? Electronics?

choose-it-yourself
before enlistment



Auto Mechanic and Instructor

CHOOSE IT

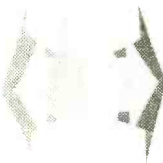

YOURSELF VOCATIONAL TRAINING SYSTEM

US ARMY