

RX-V863

AV Receiver

Ampli-tuner audio-vidéo

OWNER'S MANUAL
MODE D'EMPLOI
BEDIENUNGSANLEITUNG
BRUKSANVISNING
GEBRUIKSAANWIJZING
ИНСТРУКЦИЯ ПО ЭКСПЛУАТАЦИИ

Caution: Read this before operating your unit.

- 1 To assure the finest performance, please read this manual carefully. Keep it in a safe place for future reference.
- 2 Install this sound system in a well ventilated, cool, dry, clean place – away from direct sunlight, heat sources, vibration, dust, moisture, and/or cold. Allow ventilation space of at least 30 cm on the top, 20 cm on the left and right, and 20 cm on the back of this unit.
- 3 Locate this unit away from other electrical appliances, motors, or transformers to avoid humming sounds.
- 4 Do not expose this unit to sudden temperature changes from cold to hot, and do not locate this unit in an environment with high humidity (i.e. a room with a humidifier) to prevent condensation inside this unit, which may cause an electrical shock, fire, damage to this unit, and/or personal injury.
- 5 Avoid installing this unit where foreign objects may fall onto this unit and/or this unit may be exposed to liquid dripping or splashing. On the top of this unit, do not place:
 - other components, as they may cause damage and/or discoloration on the surface of this unit.
 - burning objects (i.e. candles), as they may cause fire, damage to this unit, and/or personal injury.
 - containers with liquid in them, as they may fall and liquid may cause electrical shock to the user and/or damage to this unit.
- 6 Do not cover this unit with a newspaper, tablecloth, curtain, etc. in order not to obstruct heat radiation. If the temperature inside this unit rises, it may cause fire, damage to this unit, and/or personal injury.
- 7 Do not plug in this unit to a wall outlet until all connections are complete.
- 8 Do not operate this unit upside-down. It may overheat, possibly causing damage.
- 9 Do not use force on switches, knobs and/or cords.
- 10 When disconnecting the power cable from the wall outlet, grasp the plug; do not pull the cable.
- 11 Do not clean this unit with chemical solvents; this might damage the finish. Use a clean, dry cloth.
- 12 Only voltage specified on this unit must be used. Using this unit with a higher voltage than specified is dangerous and may cause fire, damage to this unit, and/or personal injury. Yamaha will not be held responsible for any damage resulting from use of this unit with a voltage other than specified.
- 13 To prevent damage by lightning, keep the power cord and outdoor antennas disconnected from a wall outlet or the unit during a lightning storm.
- 14 Do not attempt to modify or fix this unit. Contact qualified Yamaha service personnel when any service is needed. The cabinet should never be opened for any reasons.
- 15 When not planning to use this unit for long periods of time (i.e. vacation), disconnect the AC power plug from the wall outlet.
- 16 Install this unit near the AC outlet and where the AC power plug can be reached easily.
- 17 Be sure to read the “Troubleshooting” section on common operating errors before concluding that this unit is faulty.
- 18 Before moving this unit, press **⓪SYSTEM OFF** to set this unit to the standby mode, and then disconnect the AC power plug from the AC wall outlet.
- 19 **VOLTAGE SELECTOR** (Asia and General models only)
The **VOLTAGE SELECTOR** on the rear panel of this unit must be set for your local main voltage **BEFORE** plugging into the AC wall outlet. Voltages are:
 - Asia model 220/230–240 V AC, 50/60 Hz
 - General model 110/120/220/230–240 V AC, 50/60 Hz
- 20 The batteries shall not be exposed to excessive heat such as sunshine, fire or like.
- 21 Excessive sound pressure from earphones and headphones can cause hearing loss.

WARNING

TO REDUCE THE RISK OF FIRE OR ELECTRIC SHOCK, DO NOT EXPOSE THIS UNIT TO RAIN OR MOISTURE.

As long as this unit is connected to the AC wall outlet, it is not disconnected from the AC power source even if you turn off this unit by **⓪SYSTEM OFF**. In this state, this unit is designed to consume a very small quantity of power.

■ For U.K. customers

If the socket outlets in the home are not suitable for the plug supplied with this appliance, it should be cut off and an appropriate 3 pin plug fitted. For details, refer to the instructions described below.

Note

The plug severed from the mains lead must be destroyed, as a plug with bared flexible cord is hazardous if engaged in a live socket outlet.

■ Special Instructions for U.K. Model

IMPORTANT

THE WIRES IN MAINS LEAD ARE COLOURED IN ACCORDANCE WITH THE FOLLOWING CODE:

Blue: NEUTRAL

Brown: LIVE

As the colours of the wires in the mains lead of this apparatus may not correspond with the coloured markings identifying the terminals in your plug, proceed as follows:

The wire which is coloured BLUE must be connected to the terminal which is marked with the letter N or coloured BLACK. The wire which is coloured BROWN must be connected to the terminal which is marked with the letter L or coloured RED.

Making sure that neither core is connected to the earth terminal of the three pin plug.



This symbol mark is according to the EU directive 2002/96/EC.

This symbol mark means that electrical and electronic equipment, at their end-of-life, should be disposed of separately from your household waste.

Please act according to your local rules and do not dispose of your old products with your normal household waste.

Contents

INTRODUCTION

Features	2
Supplied accessories	2
Notice	3
Getting started	4
Quick start guide	5

PREPARATION

Connections	10
Optimizing the speaker setting for your listening room (YPAO)	32
Using AUTO SETUP	32

BASIC OPERATION

Selecting the SCENE templates.....	37
Selecting the desired SCENE template to the SCENE buttons.....	37
Creating your original SCENE templates.....	40
Using the remote control for the SCENE feature	41
Playback	42
Basic procedure	42
Selecting the MULTI CH INPUT component.....	43
Selecting the front speaker set	43
Selecting audio input jacks (AUDIO SELECT).....	44
Displaying the current status of this unit on a video monitor.....	44
Using your headphones.....	45
Muting the audio output.....	45
Playing video sources in the background of an audio source.....	45
Displaying the input source information	46
Using the sleep timer	47
Sound field programs	48
Selecting sound field programs	48
Sound field program descriptions	48
Enjoying unprocessed input sources (Straight decoding mode)	51
Using audio features	52
Adjusting the speaker level.....	52
Enjoying pure hi-fi sound	52
Adjusting the tonal quality.....	52
FM/AM tuning	53
Overview.....	53
Basic tuning operations.....	53
Using station preset feature	54
Radio Data System tuning (Europe and Russia models only).....	57
Selecting the Radio Data System program type (PTY SEEK mode).....	57
Using the enhanced other networks (EON) data service	58
Displaying the Radio Data System information	59
Using iPod™	60
Controlling iPod™.....	60
Using Bluetooth™ components	62
Pairing the Bluetooth™ adapter and your Bluetooth™ component	62
Playback of the Bluetooth™ component	62
Recording	63

ADVANCED OPERATION

Advanced sound configurations.....	64
Changing sound field parameter settings.....	64
Selecting decoders	70
Customizing this unit (MANUAL SETUP).....	72
Using SET MENU	76
1 BASIC MENU	77
2 VOLUME MENU	81
3 SOUND MENU.....	82
4 INPUT MENU.....	85
5 OPTION MENU.....	88
Remote control features.....	92
Controlling this unit, a TV, or other components	92
Setting remote control codes	94
Programming codes from other remote controls	96
Changing source names in the display window.....	97
Macro programming features	98
Clearing configurations	101
Using multi-zone configuration.....	104
Connecting Zone 2.....	104
Controlling Zone 2.....	105
Advanced setup.....	107
Using the advanced setup	107

ADDITIONAL INFORMATION

Troubleshooting.....	111
Resetting the system.....	119
Glossary.....	120
Sound field program information.....	123
Specifications	124
Index.....	126

APPENDIX

(at the end of this manual)

Front panel.....	i
Remote control	ii
List of remote control codes	iii

“**A**SPEAKERS” or “**6**DVD” (example) indicates the name of the parts on the front panel or the remote control. Refer to the attached sheet or the pages at the end of this manual for the information about each position of the parts.

INTRODUCTION

PREPARATION

BASIC
OPERATION

ADVANCED
OPERATION

ADDITIONAL
INFORMATION

APPENDIX

English

Features

Built-in 7-channel power amplifier

- ◆ Minimum RMS output power (20 Hz to 20 kHz, 0.06% THD, 8 Ω)
Front: 105 W + 105 W
Center: 105 W
Surround: 105 W + 105 W
Surround back: 105 W + 105 W

SCENE function

- ◆ Preset SCENE templates for various situations
- ◆ SCENE templates for customizing capability
- ◆ Controlling Yamaha SCENE control signal support component (some models only) working with the SCENE function

Sound field programs

- ◆ Proprietary Yamaha technology for the creation of sound fields
- ◆ Compressed Music Enhancer mode
- ◆ Virtual CINEMA DSP
- ◆ SILENT CINEMA

Digital audio decoders

- ◆ Dolby TrueHD, Dolby Digital Plus decoder
- ◆ DTS-HD Master Audio, DTS-HD High Resolution Audio decoder
- ◆ Dolby Digital/Dolby Digital EX decoder
- ◆ DTS/DTS-ES Matrix 6.1, Discrete 6.1, DTS 96/24 decoder
- ◆ Dolby Pro Logic/Dolby Pro Logic II/Dolby Pro Logic IIX decoder

Radio tuners

- ◆ FM/AM tuning capability
- ◆ Radio Data System capability (Europe and Russia models only)

HDMI™ (High-Definition Multimedia Interface)

- ◆ HDMI interface for standard, enhanced or high-definition video as well as multi-channel digital audio based on HDMI version 1.3a (HDMI is licensed by HDMI Licensing LLC.)
 - Automatic audio and video synchronization (lip sync) information capability
 - Deep Color video signal (30/36 bit) transmission capability
 - “x.v.Color” video signal transmission capability
 - High refresh rate and high resolution video signals capability
 - High definition digital audio format signals capability
- ◆ HDCP (High-bandwidth Digital Content Protection System) licensed by Digital Content Protection, LLC.
- ◆ Analog video to HDMI digital video up-conversion (composite video ↔ S-video ↔ component video → HDMI digital video) capability for monitor out
- ◆ Analog video up-scaling from 480i (NTSC)/576i (PAL) or 480p/576p to 720p, 1080i or 1080p

DOCK terminal

- ◆ DOCK terminal to connect a Yamaha iPod universal dock (such as YDS-10, sold separately) or Bluetooth adapter (such as YBA-10, sold separately)

Other features

- ◆ YPAO (Yamaha Parametric Room Acoustic Optimizer) for automatic speaker setup
- ◆ 192-kHz/24-bit D/A converter
- ◆ OSD (on-screen display) menus that allow you to optimize this unit to suit your individual audiovisual system
- ◆ 5.1 or 7.1-channel additional input jacks for discrete multi-channel input
- ◆ Component video input/output capability includes (3 COMPONENT VIDEO INs and 1 MONITOR OUT)
- ◆ Digital video signal conversion (composite video ↔ S-video ↔ component video) capability for monitor out
- ◆ Pure Direct mode for pure hi-fi sound for all sources
- ◆ Adaptive dynamic range controlling capability
- ◆ Adaptive DSP effect level controlling capability
- ◆ iPod controlling capability
- ◆ Remote control with preset remote control codes, learning, and macro capability
- ◆ Zone 2 custom installation facility
- ◆ Bi-amplification connection capability
- ◆ Sleep timer





Supplied accessories

Check that you received all of the following parts.

- Remote control
- Batteries (4) (AAA, R03, UM-4)
- Optimizer microphone
- AM loop antenna
- Indoor FM antenna

Notice

About this manual

-  indicates a tip for your operation.
- Some operations can be performed by using either the buttons on the front panel or the ones on the remote control. In case the button names differ between the front panel and the remote control, the button name on the remote control is given in parentheses.
- This manual is printed prior to production. Design and specifications are subject to change in part as a result of improvements, etc. In case of differences between the manual and product, the product has priority.
- “SPEAKERS” or “DVD” (example) indicates the name of the parts on the front panel or the remote control. Refer to the attached sheet or the pages at the end of this manual for the information about each position of the parts.
- The symbol “” with page number(s) indicates the corresponding reference page(s).



Manufactured under license from Dolby Laboratories. “Dolby”, “Pro Logic”, and the double-D symbol are trademarks of Dolby Laboratories.



Manufactured under license under U.S. Patent No's: 5,451,942;5,956,674;5,974,380;5,978,762;6,226,616;6,487,535 & other U.S. and worldwide patents issued & pending. DTS is a registered trademark and the DTS logos, Symbol, DTS-HD and DTS-HD Master Audio are trademark of DTS, Inc. © 1996-2007 DTS, Inc. All Rights Reserved.

iPod™

“iPod” is a trademark of Apple Inc., registered in the U.S. and other countries.

Bluetooth™

Bluetooth is a registered trademark of the Bluetooth SIG and is used by Yamaha in accordance with a license agreement.

HDMI

“HDMI”, the “HDMI” logo and “High-Definition Multimedia Interface” are trademarks or registered trademarks of HDMI Licensing LLC.

x.v.Color™

“x.v.Color” is a trademark of Sony Corporation.

SILENT™ CINEMA

“SILENT CINEMA” is a trademark of Yamaha Corporation.

Getting started

■ Installing batteries in the remote control

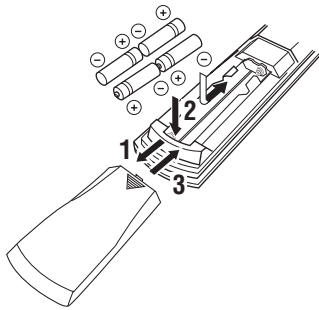

- 1 Press the ▼ part and slide the battery compartment cover off.**
- 2 Insert the four supplied batteries (AAA, R03, UM-4) according to the polarity markings (+ and -) on the inside of the battery compartment.**
- 3 Slide the cover back until it snaps into place.**

Notes

- Change all of the batteries if you notice the following conditions:
 - the operation range of the remote control decreases.
 - the transmit indicator (②) does not flash or its light becomes dim.
- Do not use an old battery together with a new one.
- Do not use different types of batteries (such as alkaline and manganese batteries) together. Read the packaging carefully as these different types of batteries may have the same shape and color.
- If the batteries have leaked, dispose of them immediately. Avoid touching the leaked material or letting it come into contact with clothing, etc. Clean the battery compartment thoroughly before installing new batteries.
- Do not throw away batteries with general house waste; dispose of them correctly in accordance with your local regulations.
- If the remote control is without batteries for more than 2 minutes, or if exhausted batteries remain in the remote control, the contents of the memory may be cleared. When the memory is cleared, insert new batteries, set up the remote control code and program any acquired functions that may have been cleared.

■ VOLTAGE SELECTOR (Asia and General models only)

Caution

The VOLTAGE SELECTOR on the rear panel of this unit must be set for your local voltage BEFORE plugging the power cable into the AC wall outlet. Improper setting of the VOLTAGE SELECTOR may cause damage to this unit and create a potential fire hazard.

Rotate the VOLTAGE SELECTOR clockwise or counterclockwise to the correct position using a straight slot screwdriver.

Voltages are as follows:

Asia model 220/230–240 V AC, 50/60 Hz

General model

..... 110/120/220/230–240 V AC, 50/60 Hz

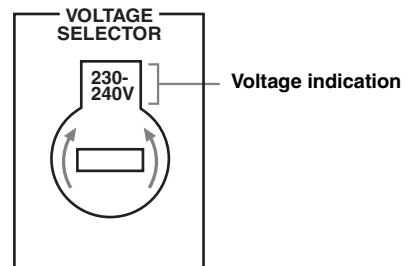

Quick start guide

The following steps describe the easiest way to enjoy DVD movie playback in your home theater. See pages 11 to 15 for details of the speaker placement.

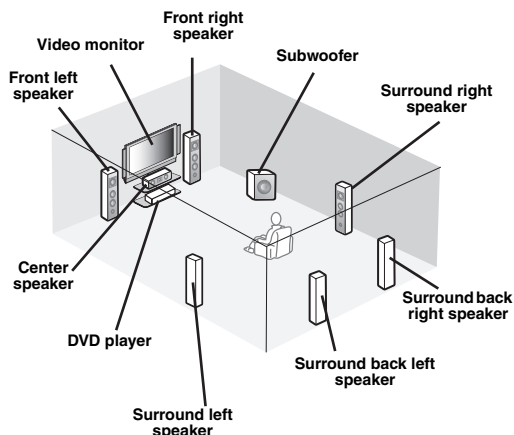

Step 1: Set up your speakers

P. 6

Step 2: Connect your DVD player and other components

P. 7

Step 3: Press SCENE 1 button

P. 8

Enjoy DVD playback!

Preparation: Check the items

Prepare the following items.

- Speakers**
 - Front speakers** x 2
 - Center speaker** x 1
 - Surround speakers** x 4Select magnetically shielded speakers. The minimum required speakers are two front speakers. The priority of the requirement of other speakers is as follows:
 1. Two surround speakers
 2. Center speaker
 3. One (or two) surround back speaker(s)
- Active subwoofer** x 1
Select an active subwoofer equipped with an RCA input jack.
- Speaker cables** x 7
- Subwoofer cable** x 1
Select a monaural RCA cable.
- DVD player** x 1
Select DVD player equipped with coaxial digital audio output jack and composite video output jack.
- Video monitor** x 1
Select a TV monitor, video monitor or projector equipped with a composite video input jack.
- Video cable** x 2
Select an RCA composite video cable.
- Digital coaxial audio cable** x 1



You can also connect two subwoofers to this unit. In this case, prepare two active subwoofers and subwoofer cables.

Step 1: Set up your speakers

Place your speakers in the room and connect them to this unit.

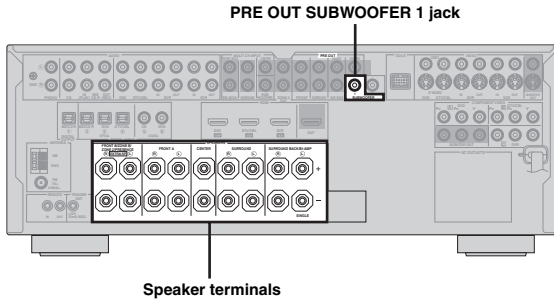

1 Place your speakers and subwoofer in the room.

2 Connect speaker cables to each speaker.

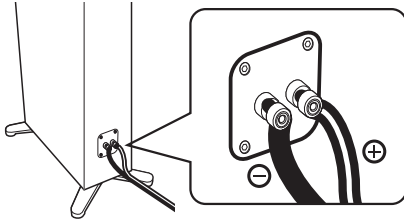

Be sure to connect the “+” (red) and “-” (black) properly. Cables are colored or shaped differently, perhaps with a stripe, groove or ridge. Connect the striped (grooved, etc.) cable to the “+” (red) terminals of this unit and your speaker. Connect the plain cable to the “-” (black) terminals.

3 Connect each speaker cable to the corresponding speaker terminal of this unit.

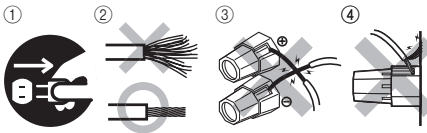

- ① Make sure that this unit and the subwoofer are unplugged from the AC wall outlets.
- ② Twist the exposed wires of the speaker cables together to prevent short circuits.
- ③ Do not let the bare speaker wires touch each other.
- ④ Do not let the bare speaker wires touch any metal part of this unit.

Be sure to connect the left channel (L), right channel (R), “+” (red) and “-” (black) properly.

Front speakers and center speaker

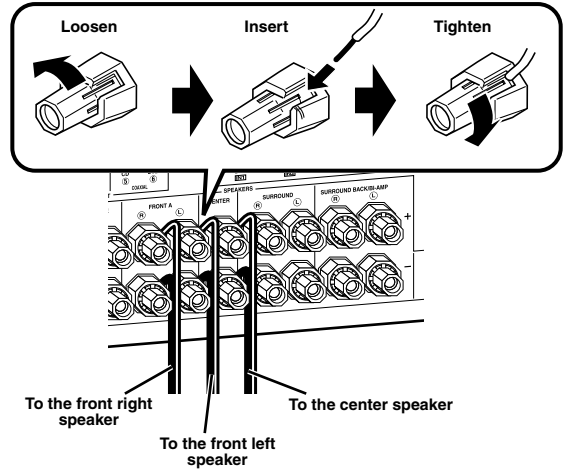

Surround and surround back speakers

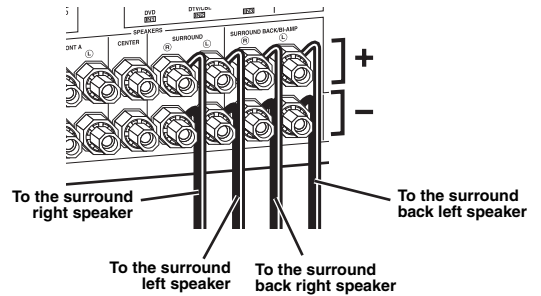

4 Connect the subwoofer cable to the SUBWOOFER PRE OUT 1 jack of this unit and the input jack of the subwoofer.

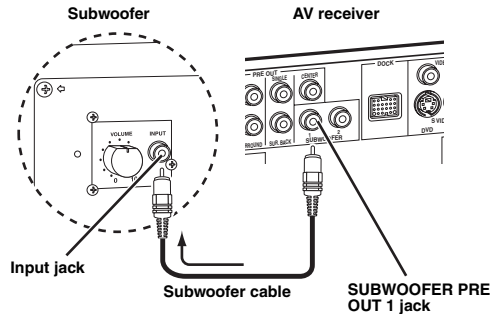

You can also connect another subwoofer to the SUBWOOFER PRE OUT 2 jack.

Step 2: Connect your DVD player and other components

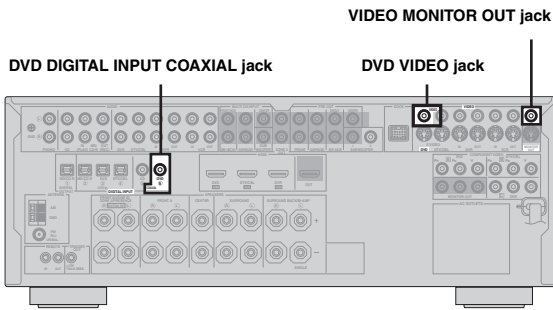

Make sure that this unit and the DVD player are unplugged from the AC wall outlets.

- 1 Connect the digital coaxial audio cable to the digital coaxial audio output jack of your DVD player and the DVD DIGITAL INPUT COAXIAL jack of this unit.

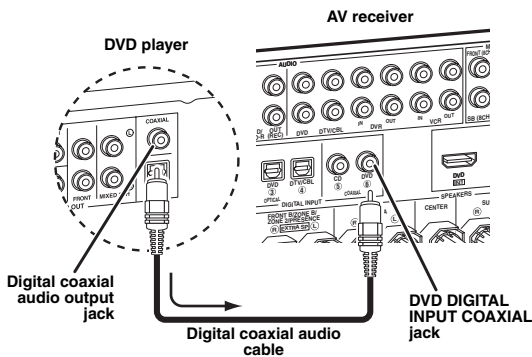

- 2 Connect the video cable to the composite video output jack of your DVD player and DVD VIDEO jack of this unit.

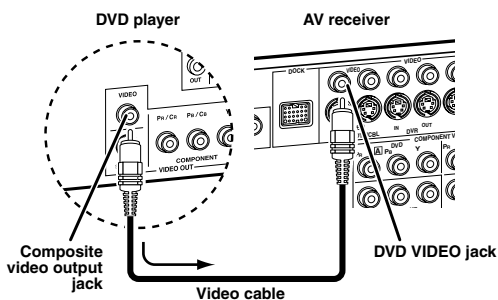

- When you connect a component that has only a SCART jack, use an appropriate converter. The connection between a converter and this unit depends on signals that are available on the converter. For details, refer to the instructions of your converter.
- This unit cannot transmit RGB signals.

- 3 Connect the video cable to the VIDEO MONITOR OUT jack of this unit and the video input jack of your video monitor.

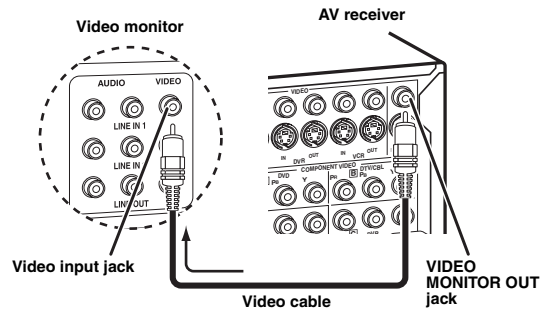

- 4 Connect the power plug of this unit and other components into the AC wall outlet.



This unit is equipped with AC OUTLET(S) for the power supply of the other components (except Korea model). See page 28 for details.

■ For further connections

- Using the other kind of speaker combinations P. 11
- Connecting a video monitor via various ways of the connection P. 20
- Connecting a DVD player via various ways of the connection P. 21
- Connecting a DVD recorder or a digital video recorder P. 22
- Connecting a set-top box P. 22
- Connecting a CD player, an MD recorder or a turntable P. 23
- Connecting an external amplifier P. 24
- Connecting a DVD player via analog multi-channel audio connection P. 25
- Connecting a Yamaha iPod universal dock or Bluetooth adapter P. 25
- Using the REMOTE IN/OUT jacks P. 26
- Using the VIDEO AUX jacks on the front panel P. 26
- Connecting a FM/AM antenna P. 27

Step 3: Press SCENE 1 button

Check the type of the connected speakers.

If the speakers are 6 ohm speakers, set "SP IMP." to "6Ω MIN" before using this unit (see page 28). 4 ohm speakers can be also used as the front speakers (see page 107).

1 Turn on the video monitor and then set the input source selector of the video monitor to this unit.

2 Press  SCENE 1 button.

This unit is turned on. "DVD Movie Viewing" appears in the front panel display, and this unit automatically optimize own status for the DVD playback.

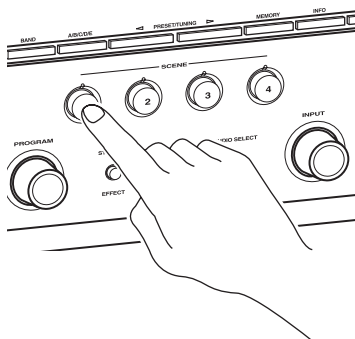

The indicator on the selected SCENE button lights up while this unit is in the SCENE mode.

3 Rotate  VOLUME to adjust the volume.

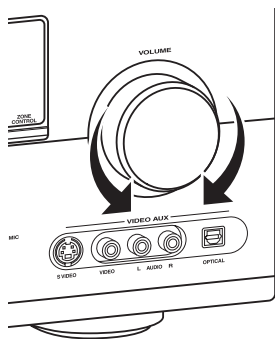

Note

When you change the input source or sound field program, the SCENE mode is deactivated.

About SCENE function

Just by pressing one SCENE button, you can turn on this unit and recall your favorite input source and sound field program according to the SCENE template that has been assigned to the SCENE button. The SCENE templates are built combinations of input sources and sound field programs.



If you connect a Yamaha product that has capability of the SCENE control signals, this unit can automatically activate the component and start playback. Refer to the instruction manual of the DVD player for further information.

The default assigned SCENE templates

Default SCENE button	The name of the SCENE template and its description
SCENE 1	DVD Movie Viewing – input source: DVD – sound field program: Sci-Fi For when you want to enjoy a movie from the connected DVD player.
SCENE 2	Music Disc Listening – input source: DVD – sound field program: 2ch Stereo For when you want to listen to a music disc from the connected DVD player.
SCENE 3	TV Viewing *1 – input source: DTV/CBL – sound field program: Straight For when you want to watch a TV program.
SCENE 4	Radio Listening *2, *3, *4 – input source: TUNER – sound field program: 7ch Enhancer For when you want to listen to a music program from the FM radio station.

Notes

*1 You must connect a cable TV or a satellite tuner to this unit in advance. See page 22 for details.

*2 You need to connect the supplied FM and AM antennas to this unit in advance. See page 27 for details.

*3 You must tune into the desired radio station in advance. See pages 53 to 56 for tuning information.

*4 To achieve the best possible reception, orient the connected AM loop antenna, or adjust the position of the end of the indoor FM antenna.



You can change the assigned SCENE template for the SCENE buttons. See page 37 for details.

■ After using this unit...

Press **Ⓚ MAIN ZONE ON/OFF** to set this unit to the standby mode.

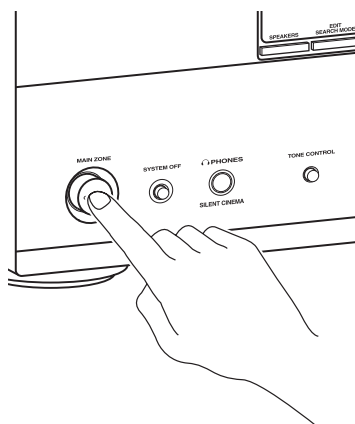

This unit is set to the standby mode and consumes a small amount of power in order to receive infrared signals from the remote control. To turn on this unit from the standby mode, press the desired **Ⓢ SCENE** buttons (or **Ⓞ SCENE**) or **Ⓚ MAIN ZONE ON/OFF** (or **Ⓟ POWER**). See page 29 for details.

What do you want to do with this unit?

■ Customizing the SCENE templates

- Using various SCENE templates ☞ P. 37
- Creating your original SCENE templates ☞ P. 40

■ Using various input sources

- Basic controls of this unit ☞ P. 42
- Enjoying FM/AM radio programs ☞ P. 53
- Using your iPod with this unit ☞ P. 60
- Using the Bluetooth components ☞ P. 62

■ Using various sound features

- Using various sound field programs ☞ P. 48
- Using the pure direct mode for high fidelity sound ☞ P. 52
- Customizing the sound field programs ☞ P. 64

■ Adjusting the parameters of this unit

- Automatically optimizing the speaker parameters for your listening room (AUTO SETUP) ☞ P. 32
- Manually adjusting various parameters of this unit ☞ P. 72
- Setting the remote control ☞ P. 92
- Adjusting the advanced parameters ☞ P. 107

■ Additional feature

- Automatically turning off this unit ☞ P. 47

Connections

Rear panel

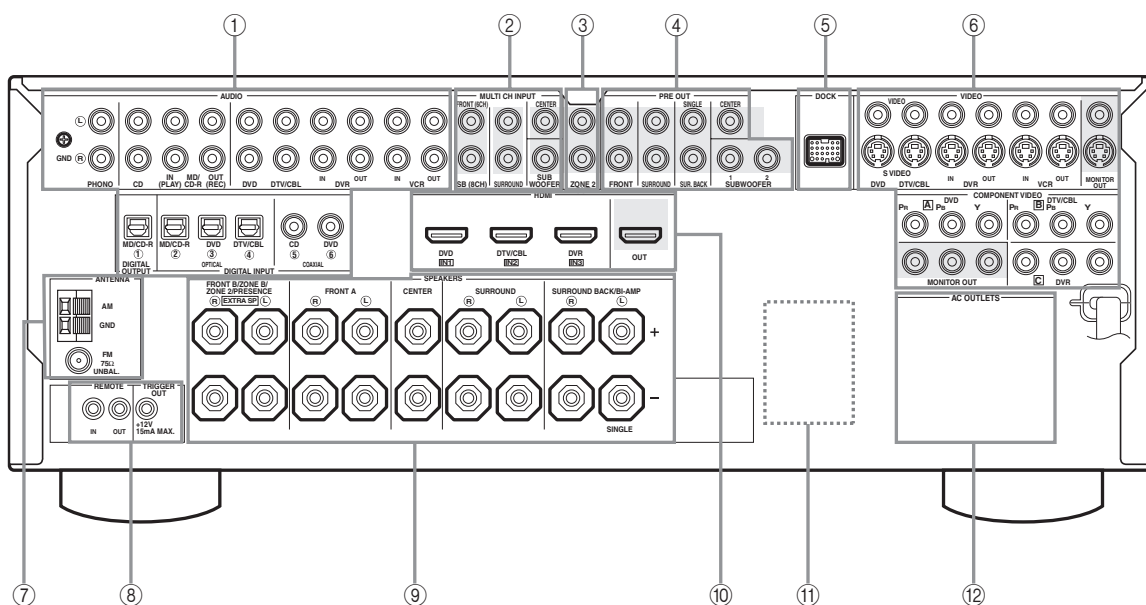

	Name	Page
①	AUDIO jacks	21
	DIGITAL INPUT/OUTPUT jacks	17-23
②	MULTI CH INPUT jacks	25
③	ZONE 2 OUT jacks	104
④	PRE OUT jacks	24
⑤	DOCK terminal	25
⑥	Video component jacks (VIDEO and S VIDEO)	17-22
	COMPONENT VIDEO jacks	17-22
⑦	ANTENNA terminals	27
⑧	REMOTE IN/OUT jacks	26
⑨	Speaker terminals	11-16
⑩	HDMI jacks	18
⑪	VOLTAGE SELECTOR (Asia and General models only)	4
⑫	AC OUTLET(S)	28

⑧ TRIGGER OUT jack

This is control expansion jack for custom installation.

Placing speakers

The speaker layout below shows the speaker setting we recommend. You can use it to enjoy the CINEMA DSP and multi-channel audio sources.

■ 7.1-channel speaker layout

7.1-channel speaker layout is highly recommended for playback the sound of high definition audio formats (Dolby TrueHD, DTS-HD Master Audio, etc.) as well as the conventional audio sources with sound field programs. See page 14 for connection information.

 We recommend that you also add the presence speakers for the effect sounds of the CINEMA DSP sound field program. See page 13 for details.

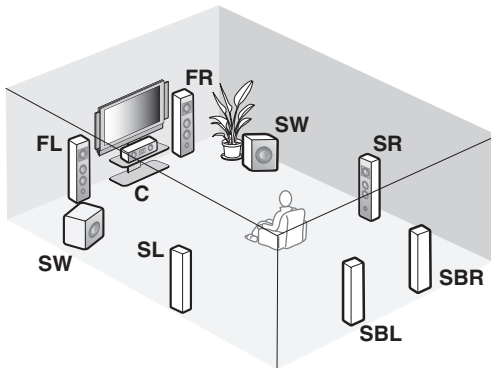

Speaker indications

FL/FR: Front left/right

C: Center

SL/SR: Surround left/right

SBL/SBR: Surround back left/right

SW: Subwoofer

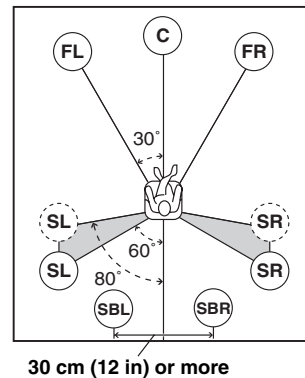

Front left and right speakers

The front speakers are used for the main source sound plus effect sounds. Place these speakers at an equal distance from the ideal listening position. The distance of each speaker from each side of the video monitor should be the same.

Center speaker

The center speaker is for the center channel sounds (dialog, vocals, etc.). If for some reason it is not practical to use a center speaker, you can do without it. Best results, however, are obtained with the full system.

Surround left and right speakers

The surround speakers are used for effect and surround sounds.

Surround back left and right speakers

The surround back speakers supplement the surround speakers and provide more realistic front-to-back transitions.

Subwoofer(s)

The use of a subwoofer with a built-in amplifier, such as the Yamaha Active Servo Processing Subwoofer System, is effective not only for reinforcing bass frequencies from any or all channels, but also for reproducing the high fidelity sound of the LFE (low-frequency effect) channel included in Dolby Digital and DTS sources. You can connect one or two subwoofer(s) to this unit. When you use two subwoofers, you can enjoy deeper bass sound. The position of the subwoofer is not so critical, because low bass sounds are not highly directional. But it is better to place the subwoofer near the front speakers. Turn it slightly toward the center of the room to reduce wall reflections.

 When you use two subwoofers, select the same type of the subwoofer as another and set these subwoofers as same sound characteristics. Place each subwoofer at the same distance from the listening position. The signal output at the SUBWOOFER PRE OUT 2 jack is the same as the one output at the SUBWOOFER PRE OUT 1 jack.

■ 6.1-channel speaker layout

See page 14 for connection information.



We recommend that you also add the presence speakers for the effect sounds of the CINEMA DSP sound field program. See page 13 for details.

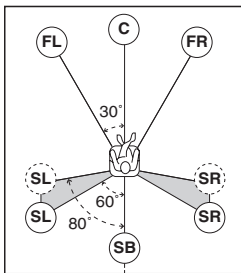
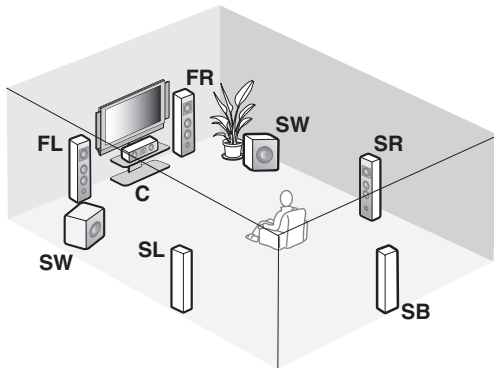

Speaker indications

FL/FR: Front left/right
C: Center
SL/SR: Surround left/right
SB: Surround back
SW: Subwoofer

Front left and right speakers Center speaker Surround left and right speakers Subwoofer(s)

The functions and settings of each speaker are the same as those for the 7.1-channel speaker layout (see page 11).

Surround back speaker

Connect a single surround speakers to the SURROUND BACK SINGLE speaker terminal and place the single surround back speaker behind the listening position. The surround back left and right channel signals are mixed down and output at the single surround back speaker when you set "SUR.B L/R SP" to "SMLx1" or "LRGx1" (see page 78).

■ 5.1-channel speaker layout

See page 14 for connection information.



We recommend that you also add the presence speakers for the effect sounds of the CINEMA DSP sound field program. See page 13 for details.

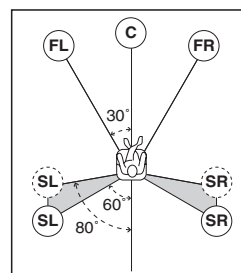
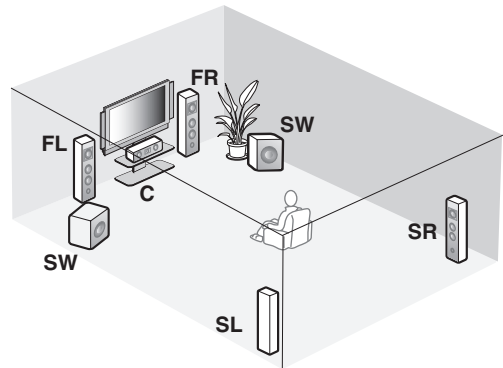

Speaker indications

FL/FR: Front left/right
C: Center
SL/SR: Surround left/right
SW: Subwoofer

Front left and right speakers Center speaker Subwoofer(s)

The functions and settings of each speaker are the same as those for the 7.1-channel speaker layout (see page 11).

Surround left and right speakers

Connect the surround speakers to the SURROUND speaker terminals even if you place the surround speakers behind the listening position. For the smooth and unbroken sound field behind the listening position, place the surround left and right speakers farther back compared with the placement in the 7.1-channel speaker layout. The surround back channel signals are directed to the surround left and right speakers when "SUR.B L/R SP" is set to "NONE" (see page 78).

For other speaker combinations

You can enjoy multi-channel sources with sound field programs by using a speaker combination other than the 7.1/6.1/5.1-channel speaker combinations.

Use the automatic setup feature (see page 32) or set the "SPEAKER SET" parameters in "MANUAL SETUP" (see page 77) to output the surround sounds at the connected speakers.

■ Using presence speakers

The presence speakers supplement the sound from the front and surround back speakers with extra ambient effects produced by the sound field programs (see page 48). You can adjust the vertical position of dialogues with using the presence speakers (see page 65).

To use the presence speakers, connect the speakers to the EXTRA SP terminal (see page 14) and set “EXTRA SP ASSIGN” to “PRESENCE” (see pages 33 and 77).

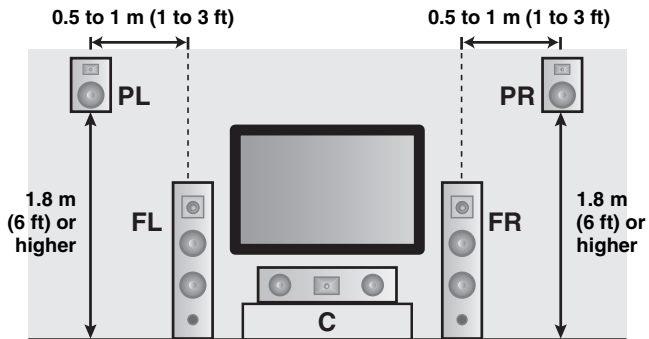

Speaker indications

- FL:** Front left
- FR:** Front right
- C:** Center
- PL:** Front presence left
- PR:** Front presence right

Connecting speakers

Be sure to connect the left channel (L), right channel (R), “+” (red) and “-” (black) properly. If the connections are faulty, this unit cannot reproduce the input sources accurately.

Caution

- Before connecting the speakers, make sure that the AC power plug is disconnected from the AC wall outlet.
- Do not let the bare speaker wires touch each other or let them touch any metal part of this unit. This could damage this unit and/or the speakers. If the speaker wires are short-circuited, “CHECK SP WIRES” appears in the front panel display when you turn on this unit.
- Use the magnetically shielded speakers. If this type of speaker still creates interference with the monitor, place the speakers away from the monitor.
- If you are to use 6 ohm speakers, be sure to set “SP IMP.” to “6Ω MIN” before using this unit (see page 28). 4 ohm speakers can be also used as the front speakers. For details about the speaker impedance setting, see page 107.

Note

A speaker cord is actually a pair of insulated cables running side by side. Cables are colored or shaped differently, perhaps with a stripe, groove or ridge. Connect the striped (grooved, etc.) cable to the “+” (red) terminals of this unit and your speaker. Connect the plain cable to the “-” (black) terminals.

■ For the 7.1-channel speaker setting

EXTRA SP terminals

Connect the alternative front speaker system (FRONT B), front speaker systems in another room (ZONE B), presence speakers, or Zone 2 speakers. To select the function of the speakers connected to the EXTRA SP terminals, set the “EXTRA SP ASSIGN” parameter in “SOUND MENU” (see page 77).



You can also select the function of the speakers connected to the EXTRA SP terminals in “AUTO SETUP” (see page 33).

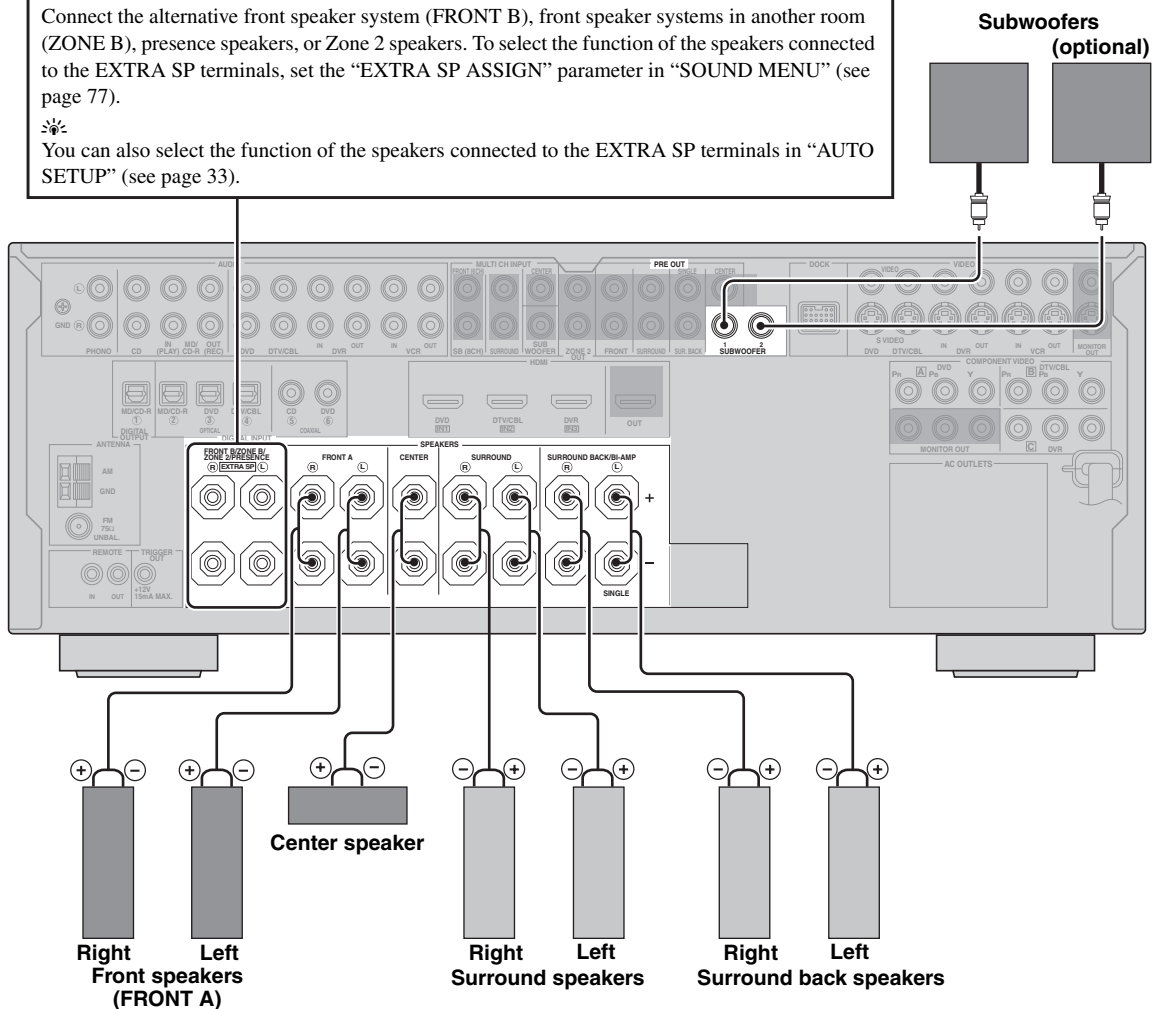

■ For the 6.1-channel speaker setting

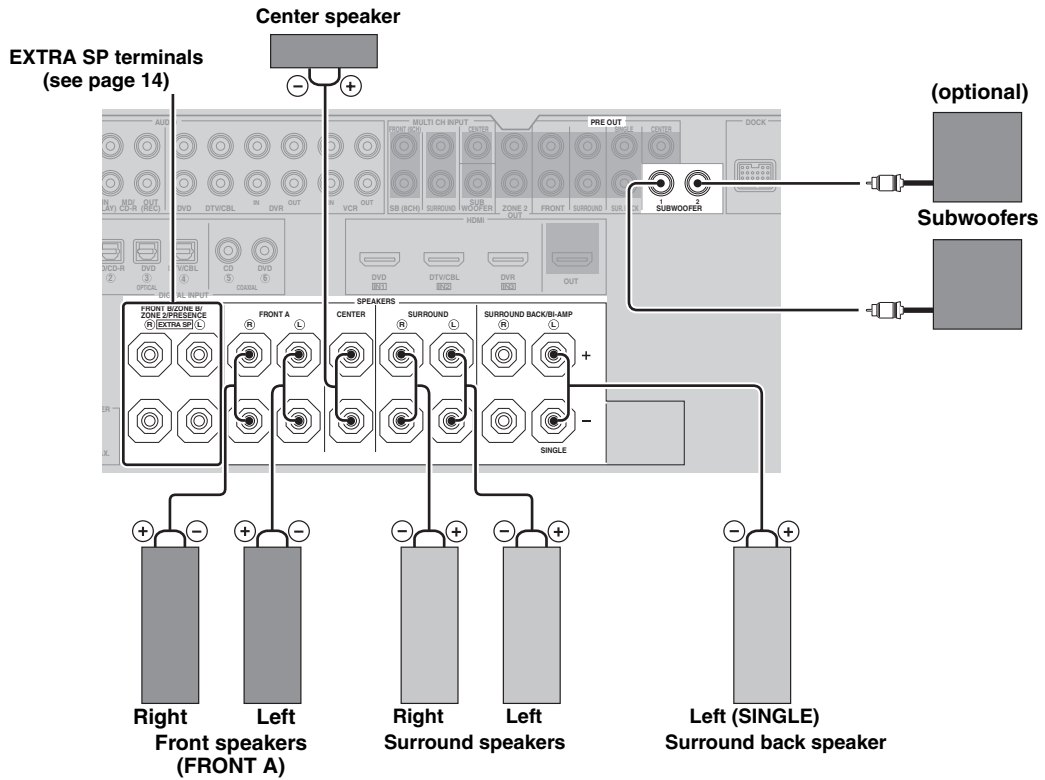

■ For the 5.1-channel speaker setting

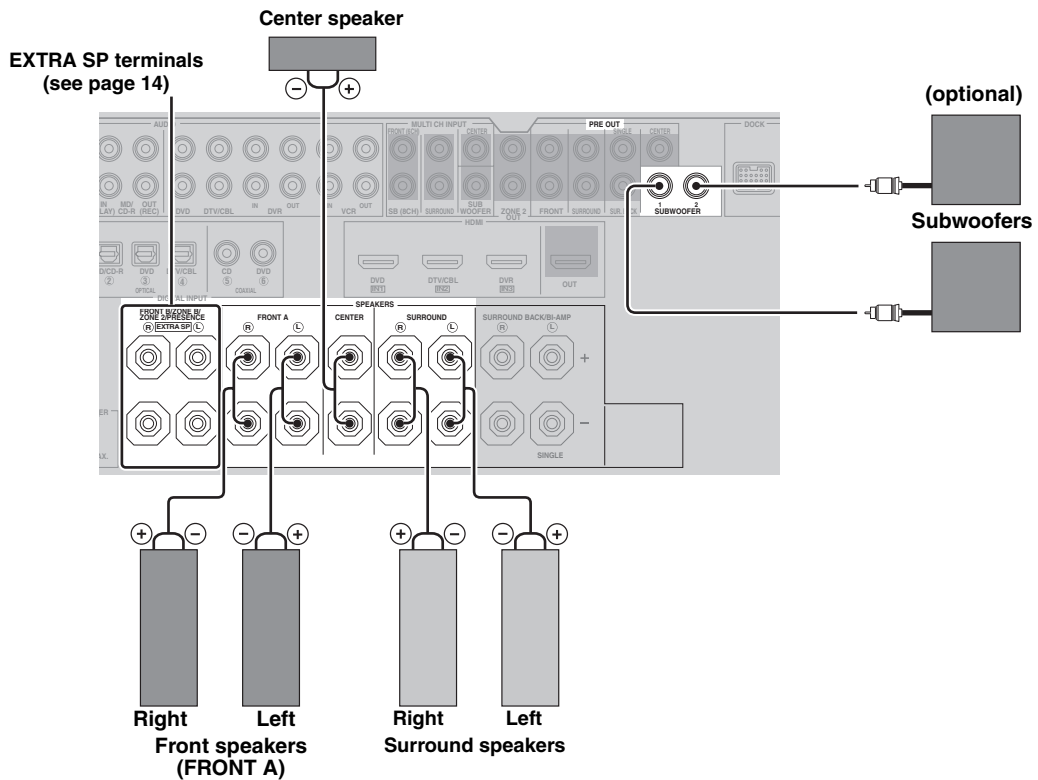

■ Connecting the speaker cable

- 1 Remove approximately 10 mm (0.4 in) of insulation from the end of each speaker cable and then twist the exposed wires of the cable together to prevent short circuits.

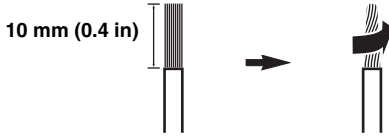

- 2 Loosen the knob.

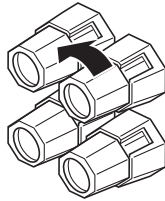

Red: positive (+)
Black: negative (-)

- 3 Insert one bare wire into the hole on the side of each terminal.

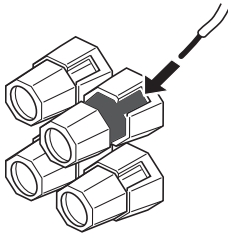

- 4 Tighten the knob to secure the wire.

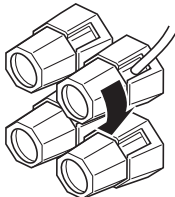

■ Using bi-amplification connections

Caution

Remove the shorting bars or bridges of your speakers to separate the LPF (low pass filter) and HPF (high pass filter) crossovers.

This unit allows you to make bi-amplification connections to one speaker system. Check if your speakers support bi-amplification.

To make the bi-amplification connections, use the FRONT and SURROUND BACK/BI-AMP terminals as shown below. To activate the bi-amplification connections, set “BI-AMP” to “ON” in “ADVANCED SETUP” (see page 110).

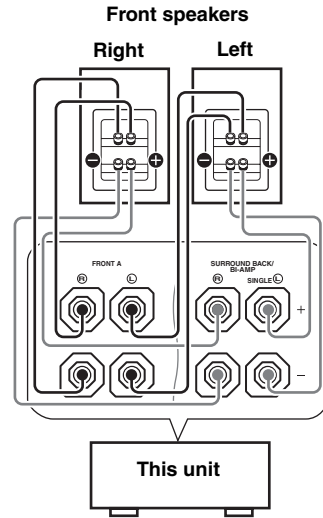

Note

When you make the conventional connection, make sure that the shorting bars are put into the terminals appropriately. Refer to the instruction manuals of the speakers for details.

Information on jacks and cable plugs

Connect one of the type of the audio jack(s) and/or video jack(s) that your input components are equipped with.

Audio jacks and cable plugs

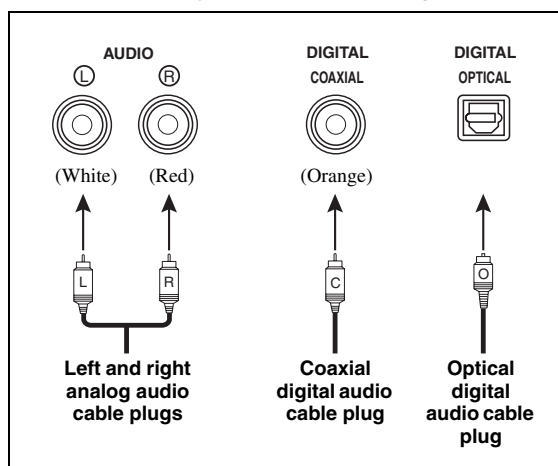

■ Audio jacks

This unit has three types of audio jacks. Connection depends on the availability of audio jacks on your other components.

AUDIO jacks

For conventional analog audio signals transmitted via left and right analog audio cables. Connect red plugs to the right jacks and white plugs to the left jacks.

DIGITAL COAXIAL jacks

For digital audio signals transmitted via coaxial digital audio cables.

DIGITAL OPTICAL jacks

For digital audio signals transmitted via optical digital audio cables.

Note

You can use the digital jacks to input PCM, Dolby Digital and DTS bitstreams. When you connect components to both the COAXIAL and OPTICAL jacks, priority is given to the signals input at the COAXIAL jack. Optical input jacks are compatible with digital signals with up to 96 kHz of sampling frequency.

Video jacks and cable plugs

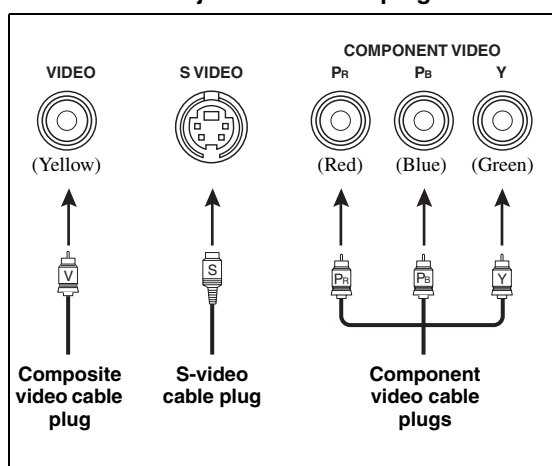

■ Video jacks

This unit has three types of video jacks. Connection depends on the availability of input jacks on your video monitor.

VIDEO jacks

For conventional composite video signals transmitted via composite video cables.

S VIDEO jacks

For S-video signals, separated into the luminance (Y) and chrominance (C) video signals transmitted on separate wires of S-video cables.

COMPONENT VIDEO jacks

For component video signals, separated into the luminance (Y) and chrominance (P_B, P_R) video signals transmitted on separate wires of component video cables.



This unit is equipped with the video conversion function. See pages 19 and 88 for details.

Information on HDMI™

■ HDMI signal compatibility

Audio signals

Audio signal types	Audio signal formats	Compatible media
2ch Linear PCM	2ch, 32-192 kHz, 16/20/24 bit	CD, DVD-Video, DVD-Audio, etc.
Multi-ch Linear PCM	8ch, 32-192 kHz, 16/20/24 bit	DVD-Audio, Blu-ray Disc, HD DVD, etc.
DSD	2/5.1ch, 2.8224 MHz, 1 bit	SA-CD, etc.
Bitstream	Dolby Digital, DTS	DVD-Video, etc.
Bitstream (High definition audio)	Dolby TrueHD, Dolby Digital Plus, DTS-HD Master Audio, DTS-HD High Resolution Audio, DTS Express	Blu-ray Disc, HD DVD, etc.



- If the input source component can decode the bitstream audio signals of audio commentaries, you can play back the audio sources with the audio commentaries mixed down by using the following connections:
 - multi-channel analog audio input (see page 25)
 - DIGITAL INPUT OPTICAL (or COAXIAL)
- Refer to the supplied instruction manuals of the input source component, and set the component appropriately.

Notes

- When CPPM copy-protected DVD-Audio is played back, video and audio signals may not be output depending on the type of the DVD player.
- This unit is not compatible with HDCP-incompatible HDMI or DVI components.
- To decode audio bitstream signals on this unit, set the input source component appropriately so that the component outputs the bitstream audio signals directly (does not decode the bitstream signals on the component). Refer to the supplied instruction manuals for details.
- This unit is not compatible with the audio commentary features (for example, the special audio contents downloaded via Internet) of Blu-ray Disc or HD DVD. This unit does not play back the audio commentaries of the Blu-ray Disc or HD DVD contents.

Video signals

This unit is compatible with the video signals of the following resolutions:

Video signal format

- 480i/60 Hz
- 576i/50 Hz
- 480p/60 Hz
- 576p/50 Hz
- 720p/60 Hz, 50 Hz
- 1080i/60 Hz, 50 Hz
- 1080p/60 Hz, 50 Hz, 24 Hz

Default input assignment of HDMI input jacks

HDMI input jack	Assigned input source
IN1	DVD
IN2	DTV/CBL
IN3	DVR

■ HDMI jack and cable plug

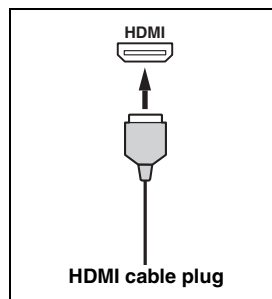

- We recommend that you use an HDMI cable shorter than 5 meters (16 feet) with the HDMI logo printed on it.
- Use a conversion cable (HDMI jack ↔ DVI-D jack) to connect this unit to other DVI components.

Notes

- Do not disconnect or connect the cable or turn off the power of the HDMI components connected to the HDMI OUT jack of this unit while data is being transferred. Doing so may disrupt playback or cause noise.
- If you turn off the power of the video monitor connected to the HDMI OUT jack via a DVI connection, this unit may fail to establish the connection to the component.
- The analog video signals input at the composite video, S-video and component video jacks can be digitally up-converted to be output at the HDMI OUT jack. Set “VIDEO CONV.” to “ON” in “MANUAL SETUP” (see page 88) to activate this feature.

Audio and video signal flow

Audio signal flow

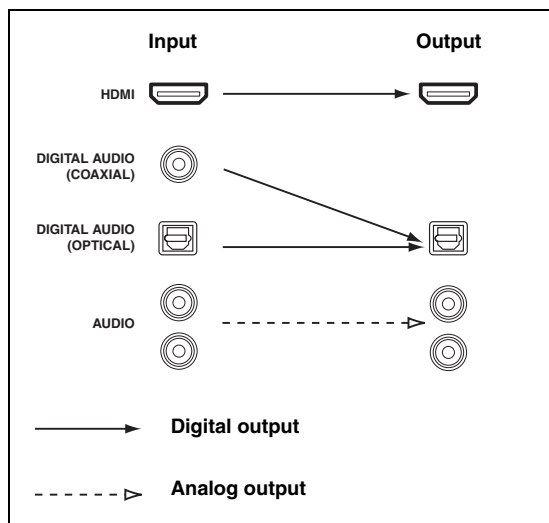

Notes

- 2-channel as well as multi-channel PCM, Dolby Digital and DTS signals input at one of the HDMI IN jacks can be output at the HDMI OUT jack only when "S.AUDIO" is set to "OTHER" (see page 91).
- Audio signals input at the HDMI IN jacks are not output at the AUDIO output and DIGITAL OUTPUT jacks.

Video signal flow

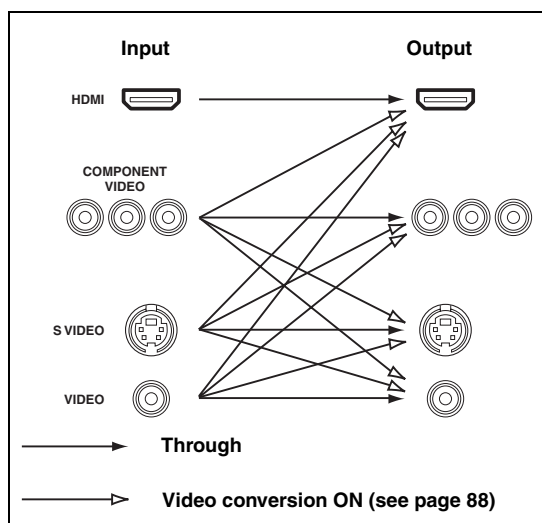

Notes

- When the video signals are input at the HDMI, COMPONENT VIDEO, S VIDEO, and VIDEO jacks, the priority order of the input signals is as follows:
 1. HDMI
 2. COMPONENT VIDEO
 3. S VIDEO
 4. VIDEO
- Digital video signals input at one of the HDMI IN jacks cannot be output from analog video output jacks.
- The analog component video signals with 480i (NTSC)/576i (PAL) of resolution are converted to the S-video or composite video signals and output at the S VIDEO MONITOR OUT and VIDEO MONITOR OUT jacks.
- The analog component video signals with 1080p of resolution are only output at the COMPONENT VIDEO MONITOR OUT jacks.
- Use the "HDMI RES." parameter in "VIDEO SET" to deinterlace and convert the resolution of the analog video signals output at the HDMI OUT jack (see page 89).

Connecting a TV monitor or projector

Connect your TV (or projector) to the HDMI OUT jack, the COMPONENT VIDEO MONITOR OUT jacks, the S VIDEO MONITOR OUT jack or the VIDEO MONITOR OUT jack of this unit.



Make sure that this unit and other components are unplugged from the AC wall outlets.



- You can choose to play back HDMI audio signals on this unit or on another HDMI component connected to the HDMI OUT jack of this unit. Use the “S.AUDIO” parameter in “OPTION MENU” to select the component to play back HDMI audio signals (see page 91).

- When you use the internal tuner of the TV as the input source, connect the digital or analog audio output jacks of the TV and digital or analog audio input jacks of this unit. Refer to “Connecting a set-top box” on page 22 for connecting information.

Notes

- If a video monitor is connected to this unit via a DVI connection, you may not take full advantage of the HDMI features.
- Some video monitors connected to this unit via a DVI connection fail to recognize the HDMI audio/video signals being input if they are in the standby mode. In this case, the HDMI indicator flashes irregularly.
- If the connected video monitor is compatible with the automatic audio and video synchronization feature (automatic lip sync feature), this unit adjusts the audio and video timing automatically (see page 84). Connect the video monitor to the HDMI OUT jack of this unit to use the feature.

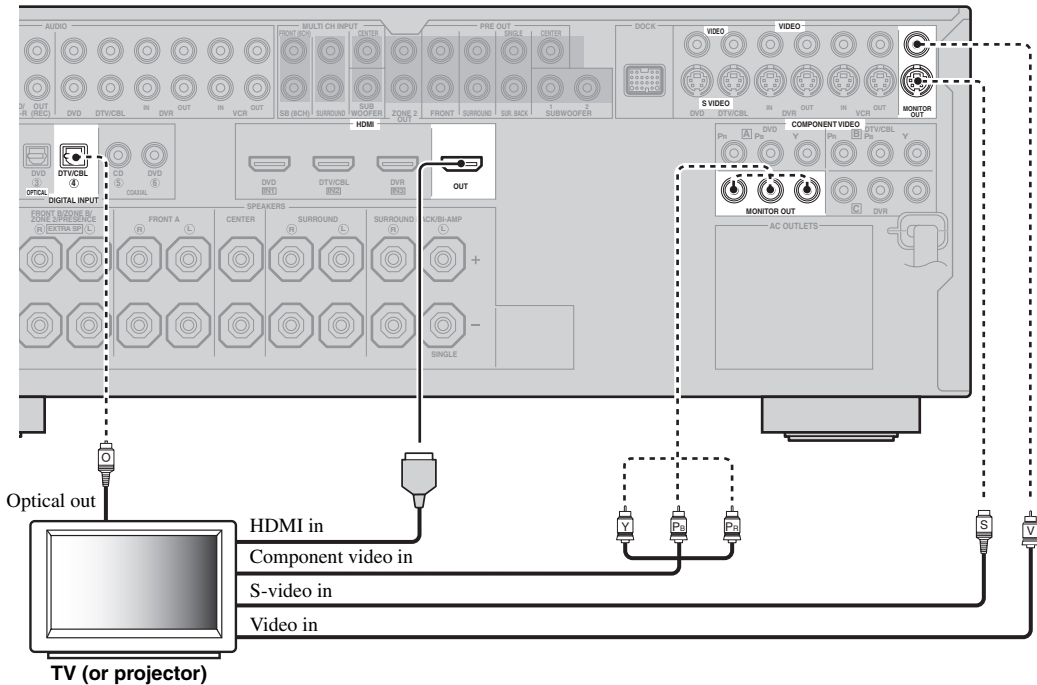

———— indicates recommended connections
 - - - - - indicates alternative connections
 (One for the video connection, and one for the audio connection)

Connecting other components



Make sure that this unit and other components are unplugged from the AC wall outlets.

Notes

- When “VIDEO CONV.” is set to “OFF” (see page 88), be sure to make the same type of video connections as those made for your TV (see page 20). For example, if you connected your TV to the VIDEO MONITOR OUT jack of this unit, connect your other components to the VIDEO jacks.

■ Connecting a DVD player

- When “VIDEO CONV.” is set to “ON” (see page 88), the converted video signals are output only at the MONITOR OUT jacks. To record a source, make the same type of video connections between each component.
- To make a digital connection to a component other than the default component assigned to each DIGITAL INPUT or DIGITAL OUTPUT jack, select the corresponding setting for “OPTICAL OUT”, “OPTICAL IN”, or “COAXIAL IN” in “I/O ASSIGNMENT” (see page 85).
- If you connect your DVD player to both the DIGITAL INPUT (OPTICAL) and the DIGITAL INPUT (COAXIAL) jacks, priority is given to the signals input at the DIGITAL INPUT (COAXIAL) jack.

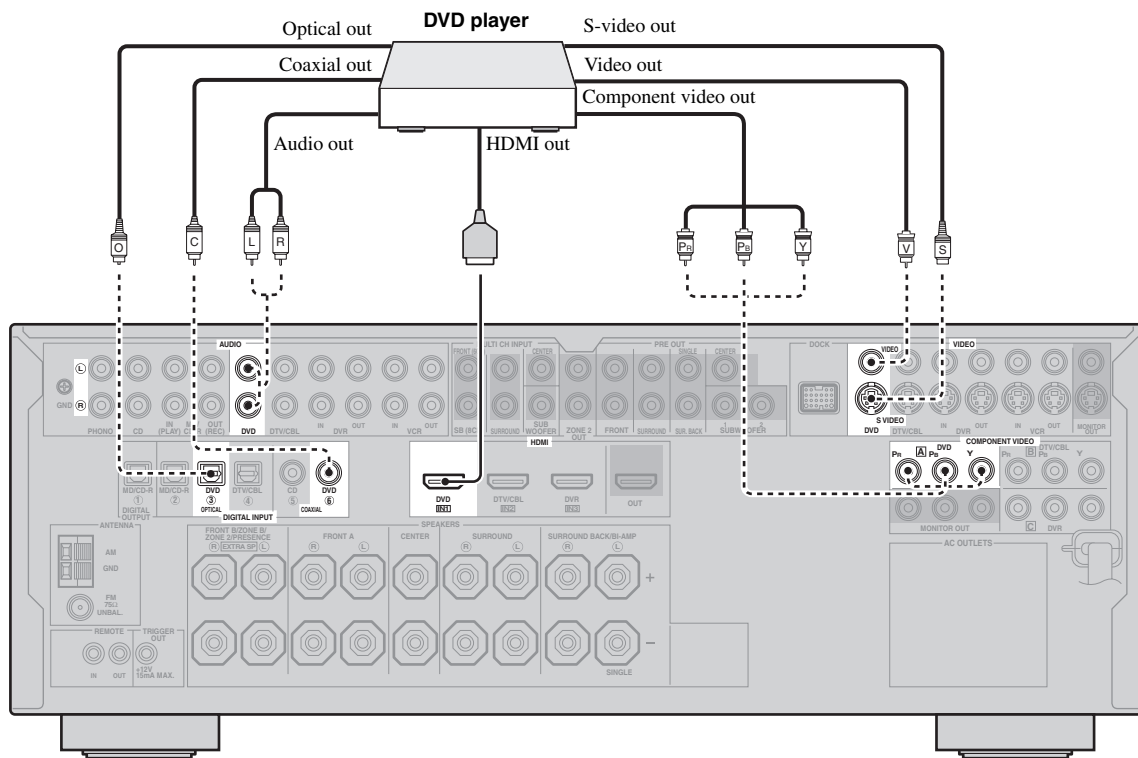

————— indicates recommended connections
 - - - - - indicates alternative connections
 (One for the video connection, and one for the audio connection)

■ Connecting a DVD recorder, PVR or VCR

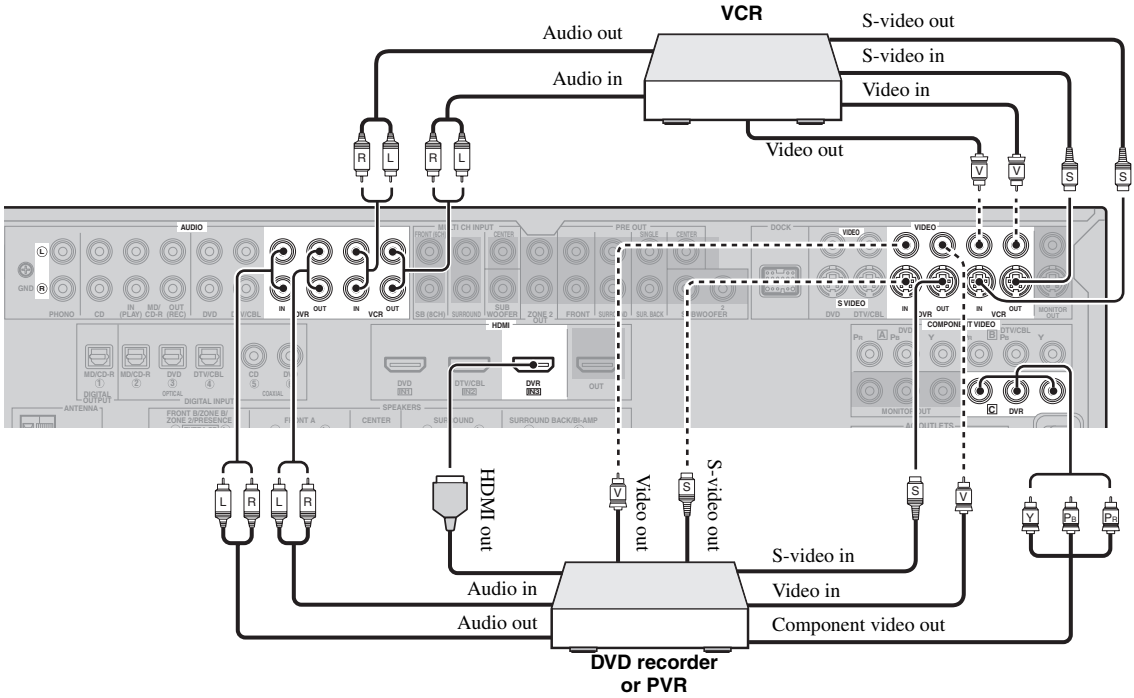

■ Connecting a set-top box

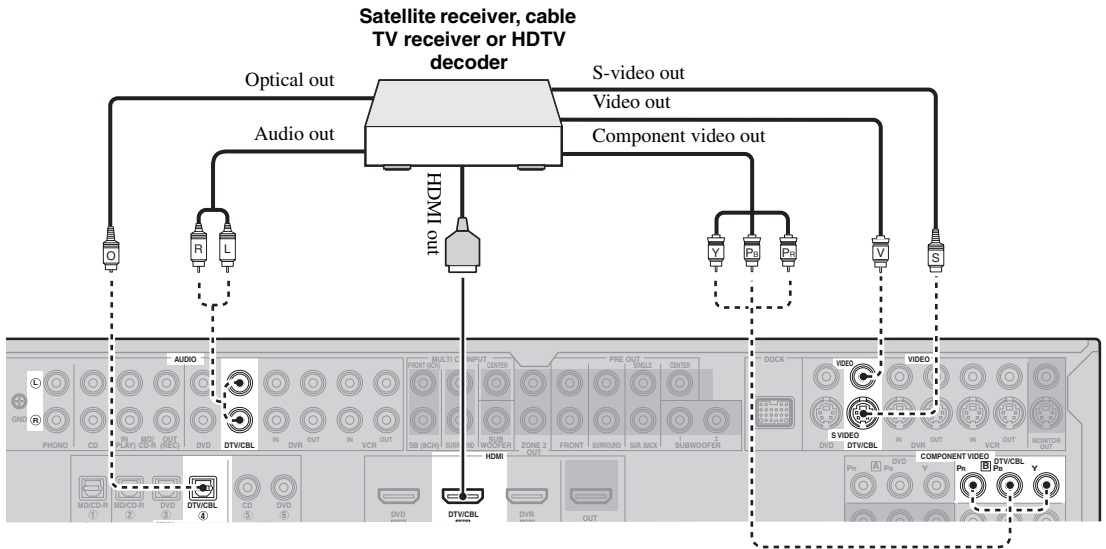

— indicates recommended connections
 - - - indicates alternative connections
 (One for the video connection, and one for the audio connection)

■ Connecting audio components

Notes

- To make a digital connection to a component other than the default component assigned to each the DIGITAL INPUT jack or the DIGITAL OUTPUT jack, select the corresponding setting for “OPTICAL OUT”, “OPTICAL IN”, or “COAXIAL IN” in “I/O ASSIGNMENT” (see page 85).
- Connect your turntable to the GND terminal of this unit to reduce noise in the signal. However, you may hear less noise without the connection to the GND terminal for some turntables.
- The PHONO jacks are only compatible with a turntable with an MM or a high-output MC cartridge. To connect a turntable with a low-output MC cartridge to the PHONO jacks, use an in-line boosting transformer or an MC-head amplifier.
- When you connect both the DIGITAL INPUT (OPTICAL) jack and the DIGITAL INPUT (COAXIAL) jack to an audio component, the priority is given to the DIGITAL INPUT (COAXIAL) jack.

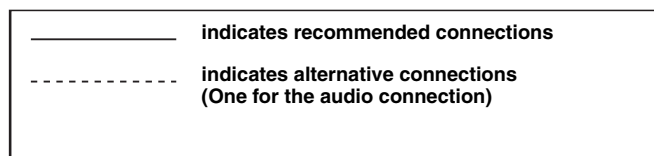
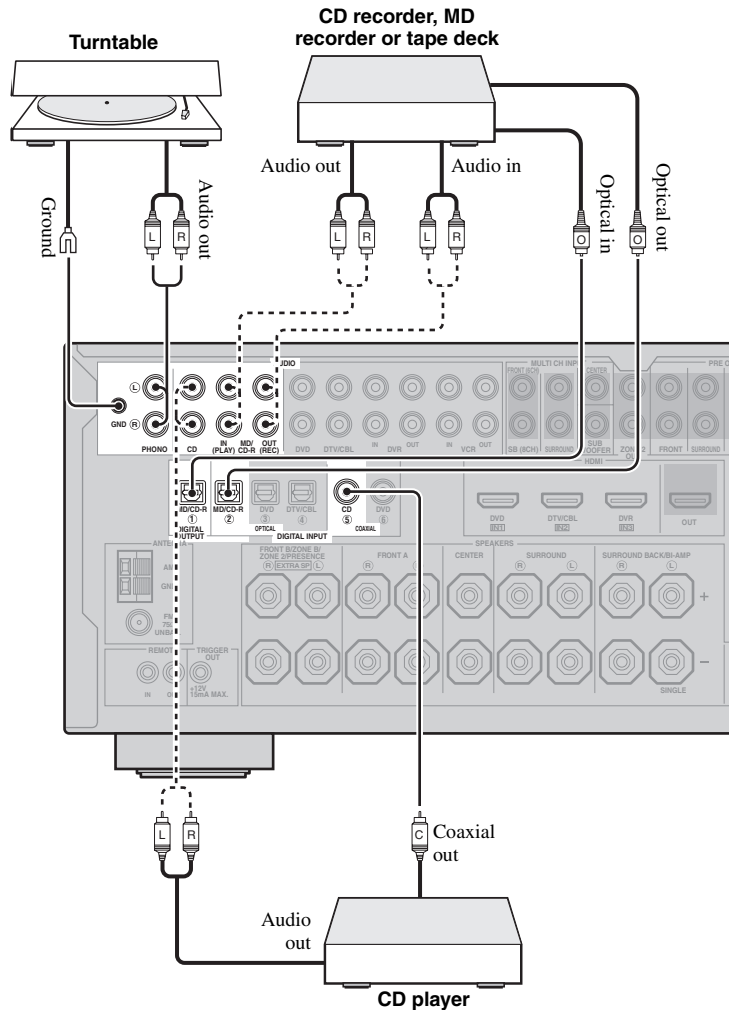

■ Connecting an external amplifier

This unit has more than enough power for any home use. However, if you want to add more power to the speaker output or if you want to use another amplifier, connect an external amplifier to the PRE OUT jacks. Each PRE OUT jack outputs the same channel signals as the corresponding SPEAKERS terminals.

Notes

- When you make connections to the PRE OUT jacks, do not make connections to the SPEAKERS terminals.
- The signals output at the FRONT PRE OUT jacks are affected by the TONE CONTROL settings (see page 52).
- Adjust the volume level of the subwoofer with the control on the subwoofer (see page 52).
- Some signals may not be output at the SUBWOOFER PRE OUT jacks depending on the settings for “SPEAKER SET” (see page 77).

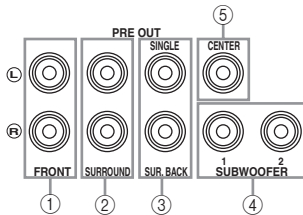

① FRONT PRE OUT jacks

Front channel output jacks.

② SURROUND PRE OUT jacks

Surround channel output jacks.

③ SUR.BACK PRE OUT jacks

Surround back channel output jacks. When you only connect one external amplifier for the surround back channel, connect it to the SINGLE jack.

Notes

- When “BI-AMP” is set to “ON”, this unit outputs the front channel audio signals at the SUR.BACK PRE OUT jacks.
- The audio signals output at the SUR.BACK PRE OUT jacks differ depending on the “EXTRA SP ASSIGN” setting (see pages 33 and 77).

④ SUBWOOFER PRE OUT jacks

Connect one or two subwoofers with a built-in amplifier.

Note

The signal output at the SUBWOOFER PRE OUT 2 jack is the same as the one output at the SUBWOOFER PRE OUT 1 jack.

⑤ CENTER PRE OUT jack

Center channel output jack.

■ Connecting a multi-format player or an external decoder

This unit is equipped with 6 additional input jacks (left and right FRONT, CENTER, left and right SURROUND and SUBWOOFER) for discrete multi-channel input from a multi-format player, external decoder, sound processor or pre-amplifier.

If you set "INPUT CH" to "8CH" in "MULTI CH" (see page 87), you can use the input jacks assigned as "FRONT" in "MULTI CH" (see page 87) together with the MULTI CH INPUT jacks to input 8-channel signals.

Connect the output jacks on your multi-format player or external decoder to the MULTI CH INPUT jacks. Be sure to match the left and right outputs to the left and right input jacks for the front and surround channels.

Notes

- When you select the component connected to the MULTI CH INPUT jacks as the input source (see page 43), this unit automatically turns off the digital sound field processor, and you cannot select sound field programs.
- This unit does not redirect signals input at the MULTI CH INPUT jacks to accommodate for missing speakers. We recommend that you connect at least a 5.1-channel speaker system before using this feature.

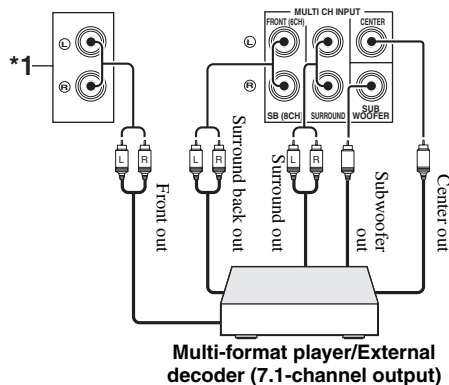
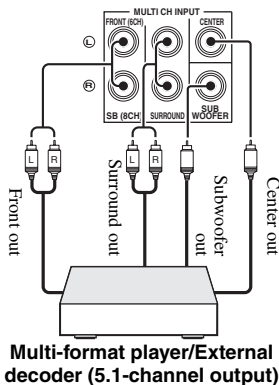

*1 The analog audio input jacks assigned as "FRONT" in "MULTI CH" (see page 87).

■ Connecting a Yamaha iPod universal dock or Bluetooth adapter

This unit is equipped with the DOCK terminal on the rear panel that allows you to connect a Yamaha iPod universal dock (such as YDS-10, sold separately) or Bluetooth adapter (such as YBA-10 sold separately). Connect a Yamaha iPod universal dock or Bluetooth adapter to the DOCK terminal on the rear panel of this unit using its dedicated cable.



Refer to "Using iPod™" on page 60 for playback of your iPod and "Using Bluetooth™ components" on page 62 for playback of your Bluetooth components.

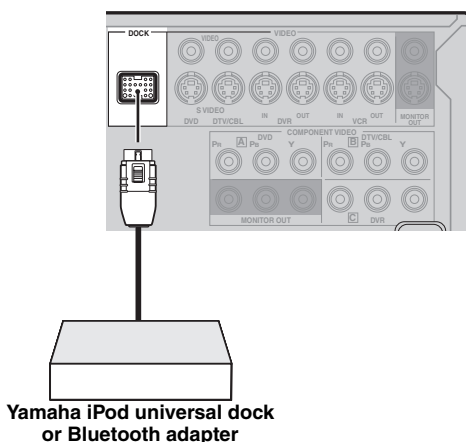

■ Using REMOTE IN/OUT jacks

When the components are the Yamaha products and have the capability of the transmission of the remote control signals, connect the REMOTE IN jack and REMOTE OUT jack to the remote control input and output jack with the monaural analog mini cable as follows.

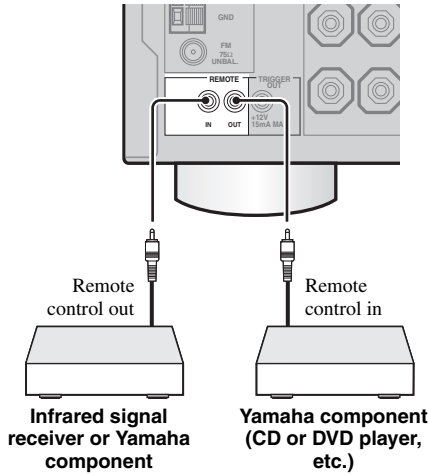

- If the components have the capability of the SCENE control signals, this unit can automatically activate the corresponding components and start the playback when you use one of the SCENE buttons. Refer to the owner's manuals for details about the capability of the SCENE control signals of the components.
- If the component connected to the REMOTE OUT jack is not the Yamaha product, set "SCENE IR" in the advanced setup menu to "OFF" (see page 110).

Using the VIDEO AUX jacks on the front panel

Use the VIDEO AUX jacks on the front panel to connect a game console or a video camera to this unit.

Caution
Be sure to turn down the volume of this unit and other components before making connections.

Notes

- The audio signals input at the DOCK terminal on the rear panel take priority over the ones input at the VIDEO AUX jacks.
- To reproduce the source signals input at these jacks, select "V-AUX" as the input source.

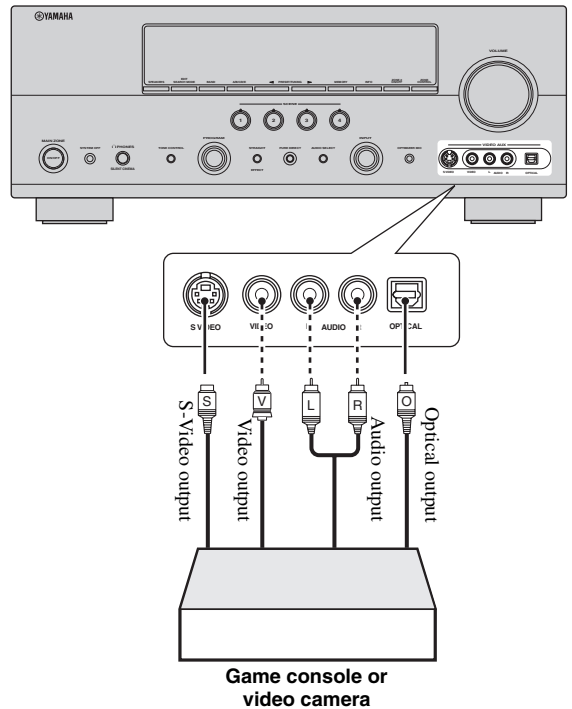

————— indicates recommended connections

----- indicates alternative connections
(One for the video connection, and one for the audio connection)

Connecting the FM and AM antennas

Both FM and AM indoor antennas are supplied with this unit. Connect each antenna correctly to the designated terminals. In general, these antennas should provide sufficient signal strength.

Notes

- The AM loop antenna should be placed away from this unit.
- A properly installed outdoor antenna provides clearer reception than an indoor one. If you experience poor reception quality, install an outdoor antenna. Consult the nearest authorized Yamaha dealer or service center about outdoor antennas.
- The AM loop antenna should always be connected, even if an outdoor AM antenna is connected to this unit.

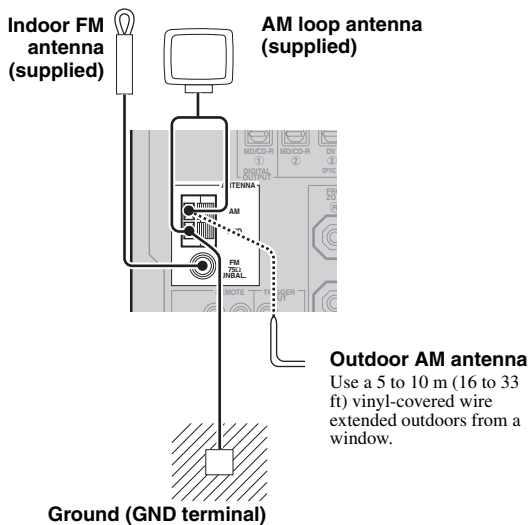

For maximum safety and minimum interference, connect the antenna GND terminal to a good earth ground. A good earth ground is a metal stake driven into moist earth.

Connecting the wire of the AM loop antenna

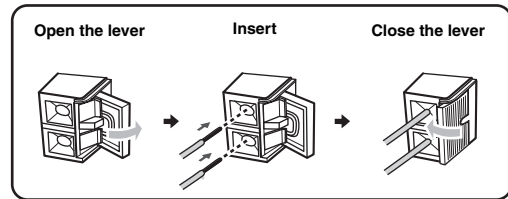

The wire of the AM loop antenna does not have any polarity and you can connect either end of the wire to AM or GND terminal.

Assembling the supplied AM loop antenna

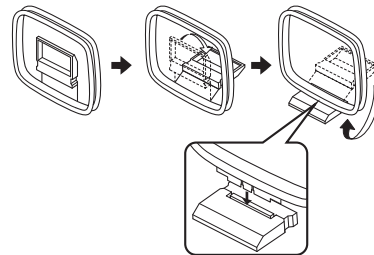

Connecting the power cable

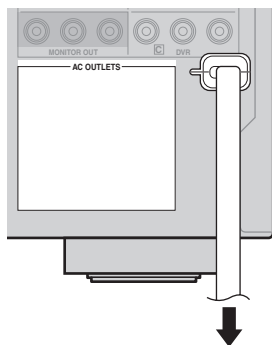

To the AC wall outlet

■ AC OUTLET(S) (SWITCHED)

Australia model	1 outlet
Korea model	None
Other models	2 outlets

Use these outlet(s) to supply power to any connected components. Connect the power cable of your other components to these outlet(s). Power to these outlet(s) is supplied when the main zone or Zone 2 is turned on. However, power to these outlet(s) is cut off when the main zone and Zone 2 are turned off or when **SYSTEM OFF** on the front panel is pressed. For information on the maximum power or the total power consumption of the components that can be connected to these outlet(s), see “Specifications” on page 124.

Note

The power to AC OUTLET(S) of this unit is not cut off while this unit is charging connected iPod even when this unit is in the standby mode. When this unit completes charging or the iPod is disconnected, the power is cut off automatically when this unit is in the standby mode.

Memory back-up

The memory back-up circuit prevents the stored data from being lost even if this unit is in the standby mode. However, the stored data will be lost in case the power cable is disconnected from the AC wall outlet or if the power supply is cut off for more than one week.

Setting the speaker impedance

Caution

If you are to use 6 ohm speakers, set “SP IMP.” to “6Ω MIN” as follows BEFORE using this unit. 4 ohm speakers can be also used as the front speakers.

- 1 Press **SYSTEM OFF** on the front panel to turn off this unit.
See page 29 for details.
- 2 Press and hold **TONE CONTROL** and then press **MAIN ZONE ON/OFF** to turn on this unit.
This unit turns on, and the advanced setup menu appears in the front panel display.



- 3 Rotate the **PROGRAM** selector to select “SP IMP.”.
“SP IMP.” and the current speaker impedance setting (“8Ω MIN”) appear in the front panel display.
- 4 Press **TONE CONTROL** repeatedly to select “6Ω MIN”.
- 5 Press **SYSTEM OFF** to save the new setting and turn off this unit.

Note

The setting you made is reflected next time you turn on this unit.

Turning this unit on and off

■ Turning on this unit

Press **Ⓚ MAIN ZONE ON/OFF** (or **Ⓛ POWER**) to turn on this unit.

The main zone is turned on.



- When you turn on this unit, there will be delay for a few seconds before this unit can reproduce sound.
- You can also turn on the main zone by pressing **Ⓢ SCENE** (or **④ SCENE**) buttons.

■ Set the main zone to the standby mode

Press **Ⓚ MAIN ZONE ON/OFF** (or **Ⓛ STANDBY**) to set the main zone to the standby mode.

In the standby mode, this unit consumes a small amount of power in order to receive infrared signals from the remote control.



Press **Ⓛ SYSTEM OFF** to set the main zone and Zone 2 (see page 105) to the standby mode simultaneously.

Front panel display

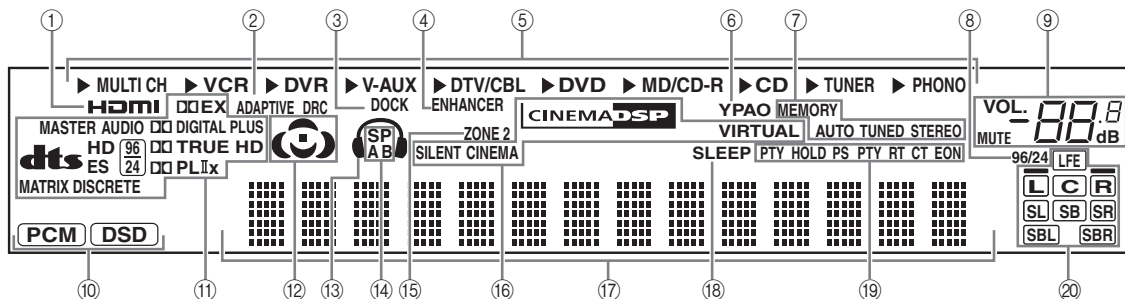

① HDMI indicator

Lights up when the signal of the selected input source is input at the HDMI IN jacks (see page 18).

② ADAPTIVE DRC indicator

Lights up when the adaptive dynamic range control feature is turned on (see page 81).

③ DOCK indicator

- Lights up when you station your iPod in a Yamaha iPod universal dock (such as YDS-10, sold separately) connected to the DOCK terminal of this unit (see page 25) and V-AUX is selected as the input source. The DOCK indicator also lights up when this unit is charging the battery of the stationed iPod in the standby mode.
- Flashes while the connected Yamaha Bluetooth adapter (such as YBA-10, sold separately) and the Bluetooth component is in the pairing or the Bluetooth adapter is searching the Bluetooth component (see page 62).
- Light up while the Yamaha Bluetooth adapter is connected to the Bluetooth component (see page 62).

④ ENHANCER indicator

Lights up when the Compressed Music Enhancer mode is selected (see page 50).

⑤ Input source indicators

The corresponding cursor lights up to show the currently selected input source.

⑥ YPAO indicator

Lights up when you run “AUTO SETUP” and when the speaker settings set in “AUTO SETUP” are used without any modifications (see page 32).

⑦ Tuner indicators

Lights up when this unit is in the FM or AM tuning mode (see pages 53 to 56).

⑧ 96/24 indicator

Lights up when a DTS 96/24 signal is input to this unit.

⑨ MUTE indicator and VOLUME level indicator

- The MUTE indicator flashes while the MUTE function is on (see page 45).
- Indicates the current volume level.

⑩ Input signal indicators

Lights up when this unit is reproducing PCM (Pulse Code Modulation) or DSD (Direct Stream Digital) digital audio signals.

⑪ Decoder indicators

The respective indicator lights up when any of the decoders of this unit function.

⑫ Sound field indicators

Light up to indicate the active sound fields (see page 48).

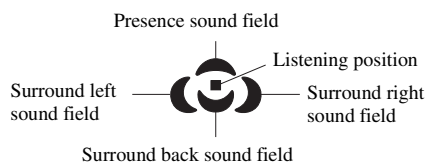

⑬ Headphone indicator

Lights up when headphones are connected (see page 45).

⑭ SP A B indicators

Light up according to the set of front speakers activated (see page 43).

SP A: The FRONT A speakers are activated.

SP B: The FRONT B speakers are activated.

SP A B: The FRONT A and FRONT B speakers are activated.

⑮ ZONE2 indicator

Lights up when Zone 2 is turned on (see page 105).

⑯ DSP indicators

The respective indicator lights up when any of the sound field programs are selected (see page 48).

CINEMA DSP indicator

Lights up when you select a CINEMA DSP sound field program (see page 48).

VIRTUAL indicator

Lights up when the Virtual CINEMA DSP mode is active (see page 51).

SILENT CINEMA indicator

Lights up when headphones are connected and a sound field program is selected (see page 51).

⑰ Multi-information display

Shows the name of the current sound field program and other information when adjusting or changing settings.

⑱ SLEEP indicator

Lights up while the sleep timer is on (see page 47).

⑲ Radio Data System indicators (Europe and Russia models only)**PTY HOLD**

Lights up while this unit is in the PTY SEEK mode (see page 57).

PS, PTY, RT and CT

Light up according to the available Radio Data System information (see page 59).

EON

Lights up when the EON data service is available (see page 58).

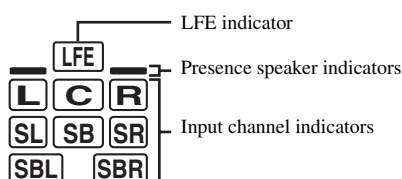
⑳ Input channel and speaker indicators**Input channel indicators**

- Indicate the channel components of the current digital input signal.
- Light up or flash according to the settings of the speakers when this unit is in the automatic setup procedure (see page 32) or in the “BASIC MENU” in “MANUAL SETUP” (see page 79).

Presence speaker indicators

Light up or flash according to the setting of “EXTRA SP ASSIGN” when this unit is in the automatic setup procedure (see page 32) or in the “BASIC MENU” in “MANUAL SETUP” (see page 77).



You can make settings for the presence and surround back speakers automatically by running “AUTO SETUP” (see page 32) or manually by adjusting settings for “SUR.B L/R SP” (see page 78) in “SPEAKER SET”.

Using the remote control

The remote control transmits a directional infrared ray. Be sure to aim the remote control directly at the remote control sensor on this unit during operation.

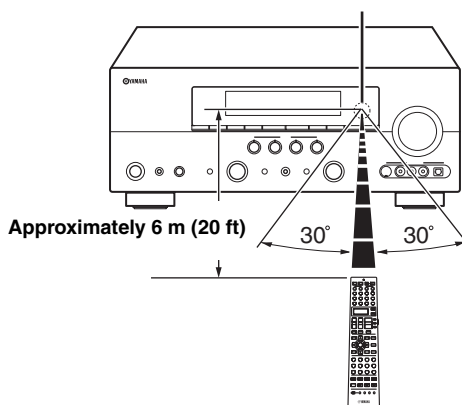
Remote control sensor**Infrared window (①)**

Outputs infrared control signals. Aim this window at the component you want to operate.

Transmit indicator (②)

Flashes while the remote control is sending infrared signals.

Display window (⑥)

Shows the name of the selected input source that you can control.

Operation mode selector (⑯)

The function of some buttons depends on the operation mode selector position.

AMP

Operates the amplifier function of this unit.

SOURCE

Operates the component selected with an input selector button (see page 93).

TV

Operates the TV assigned to either DTV/CBL or PHONO (see page 92).

Notes

- Do not spill water or other liquids on the remote control.
- Do not drop the remote control.
- Do not leave or store the remote control in the following types of conditions:
 - places of high humidity, such as near a bath
 - places of high temperatures, such as near a heater or stove
 - places of extremely low temperatures
 - dusty places
- To set the remote control codes for other components, see page 94.

Optimizing the speaker setting for your listening room (YPAO)

This unit employs the YPAO (Yamaha Parametric Room Acoustic Optimizer) technology which lets you avoid troublesome listening-based speaker setup and achieves highly accurate sound adjustments automatically. The supplied optimizer microphone collects and this unit analyzes the sound your speakers produce in your actual listening environment.

Using AUTO SETUP

Notes

- Be advised that it is normal for loud test tones to be output during the “AUTO SETUP” procedure.
- To achieve the best results, make sure the room is as quiet as possible while the “AUTO SETUP” procedure is in progress. If there is too much ambient noise, the results may not be satisfactory.



- Initial settings are indicated in bold.
- You can run “AUTO SETUP” using the system menu that appears in the OSD or in the front panel display. This manual uses the OSD illustrations to explain the “AUTO SETUP” procedure.
- Before performing operations, set the operation mode selector on the remote control to **AMP**.
- This unit uses the speakers connected to the FRONT A speaker terminals as the front speakers for the adjustment.

1 Make sure of the following check points.

Note

Before starting the automatic setup, check the following check points.

- Speakers are connected appropriately.
- Headphones are disconnected from this unit.
- This unit and the video monitor are turned on.
- This unit is selected as the video input source of the video monitor.
- The connected subwoofer is turned on and the volume level is set to about half way (or slightly less).
- The crossover frequency controls of the connected subwoofer is set to the maximum.

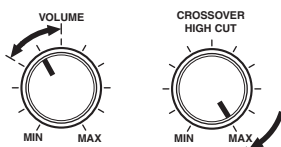

Controls of a subwoofer (example)

- The room is sufficiently quiet.



If you connect two subwoofers to this unit, the volume level of each subwoofer is set to slightly less.

2 Connect the supplied optimizer microphone to the OPTIMIZER MIC jack on the front panel.

“MIC ON View OSD menu” appears in the front panel display.

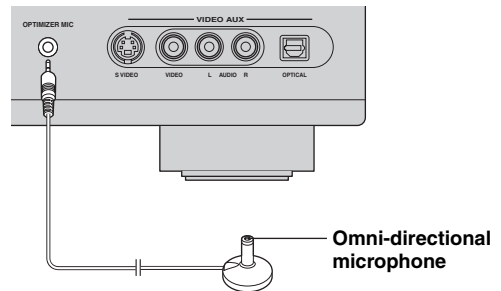

The following menu screen appears on the video monitor.

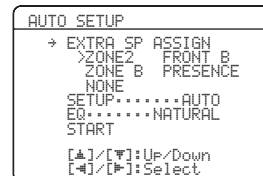

3 Place the optimizer microphone at your normal listening position on a flat level surface with the omni-directional microphone heading upward.

Optimizer microphone

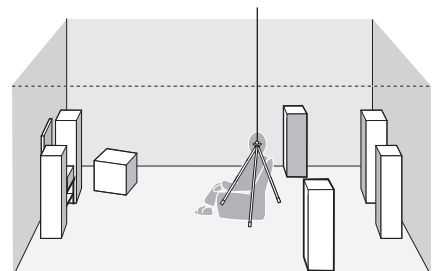

It is recommended that you use a tripod (etc.) to affix the optimizer microphone at the same height as your ears would be when you are seated in your listening position. You can use the attached screw of a tripod (etc.) to fix the optimizer microphone to the tripod (etc.).

4 Press **Ⓞ** < / > to select the desired setting for “EXTRA SP ASSIGN” and then press **Ⓞ** ∇.

Extra speaker assignment

EXTRA SP ASSIGN

Selects the function of the speakers connected to the EXTRA SP terminals.

Choices: **FRONT B**, ZONE2, ZONE B, PRESENCE, NONE

- **When you use the alternative front speaker system (see page 43)**
Select “FRONT B”.
- **When you use the Zone 2 speakers (see page 105)**
Select “ZONE2” to set the function of the speakers to the Zone 2 speakers. This unit drives the Zone 2 speakers by using the internal amplifier.
- **When you want to use another front speaker system in Zone B**
Select “ZONE B”.
- **When you use the presence speakers (see page 13)**
Select “PRESENCE” to set the function of the speakers to the presence speakers.
- **When you do not use the EXTRA SP terminals**
Select “NONE” to deactivate the EXTRA SP terminals.

Note

If you select “ON” in “BI-AMP” (see page 110), you cannot select “PRESENCE” or “ZONE2” in “EXTRA SP ASSIGN”.

5 Press **Ⓞ** < / > to select “SETUP” and then press **Ⓞ** ∇.

Choices: **AUTO**, RELOAD, UNDO, DEFAULT

- Select “AUTO” to automatically run the entire “AUTO SETUP” procedure.
- Select “RELOAD” to reload the last “AUTO SETUP” settings and override the previous settings.
- Select “UNDO” to undo the last “AUTO SETUP” settings and restore the previous settings.
- Select “DEFAULT” to reset the “AUTO SETUP” parameters to the initial factory settings.

Notes

- “RELOAD” or “UNDO” is available only when you have previously run “AUTO SETUP” and confirmed the results.
- “RELOAD” or “UNDO” is not available when you change the setting of “BI-AMP” in the advanced setup (see page 110) or “EXTRA SP ASSIGN” in “BASIC MENU” (see page 77).

6 Press **Ⓞ** < / > to select the desired setting of “EQ”.

Parametric equalizer type EQ

Parametric equalizer adjusts the level of the specified frequency bands. This unit automatically selects the crucial frequency bands for the listening room and adjusts the level of the selected frequency bands to create a cohesive sound field in the room. You can select the type of the parametric equalizer adjustment from the following choices.

Choices: **NATURAL**, FLAT, FRONT

- Select “NATURAL” to average out the frequency response of all speakers with higher frequencies being all speakers to achieve more natural sound. Recommended if the FLAT setting sounds a little harsh.
- Select “FLAT” to average the frequency response of all speakers. Recommended if all of your speakers are of similar quality.
- Select “FRONT” to adjust the frequency response of each speaker in accordance with the sound of your front speakers. Recommended if your front speakers are of much higher quality than your other speakers.

7 Press \odot ∇ to select “START” and then press \odot **ENTER to start the setup procedure.**

The following message appears in the OSD. When this unit starts the automatic setup procedure, loud test tones are output at the speakers. For more accurate measurements, keep quiet and move to the wall where speakers are not around. We recommend that you leave the listening room during the automatic setup procedure.

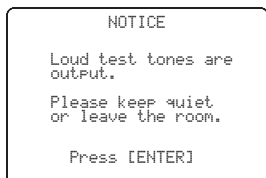

Once you perform the next operation, this unit starts the automatic setup procedure.

8 Press \odot **ENTER to start the automatic setup procedure.**

The following screen appears in the OSD and setup procedure starts in 10 seconds.

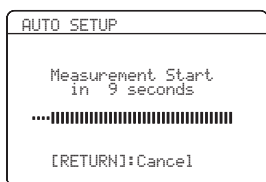

Loud test tones are output from each speaker during the auto setup procedure. Once all items are set, the “RESULT” display appears in the OSD.

Notes

- During the automatic setup procedure, do not perform any operation on this unit.
- We recommend that you get out of the room while this unit is in the auto setup procedure. It takes approximately 3 minutes for this unit to complete the auto setup procedure.



Press \odot Δ to cancel the automatic setup procedure.

9 Make sure that the following screen appears and then press \odot **ENTER to display the result screen.**

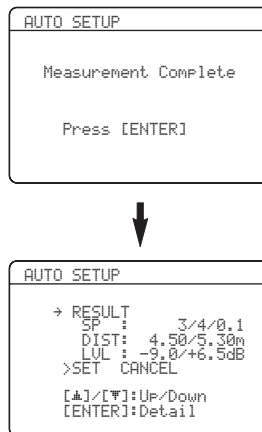

The results displayed under “RESULT” are as follows:

Number of speakers SP

Displays the number of speakers connected to this unit in the following order: Front/Back/Subwoofer

Speaker distance DIST

Displays the speaker distance from the listening position in the following order: Closest speaker distance/Farthest speaker distance

Speaker level LVL

Displays the speaker output level in the following order: Lowest speaker output level/Highest speaker output level

Notes

- The signal output at the SUBWOOFER PRE OUT 2 jack is the same as the one output at the SUBWOOFER PRE OUT 1 jack. Therefore, even if you connect two subwoofers, the number of the connected subwoofer is indicated as “0.1”.
- If “E-10:INTERNAL ERROR” appears during the testing procedure, restart from step 4.
- If you selected other than “AUTO” in step 5, no test tones are output.
- If an error occurs during the “AUTO SETUP” procedure, the setup procedure is canceled and an error screen appears. For details, see “If an error screen appears” on page 36.
- When this unit detects potential problems during the “AUTO SETUP” procedure, “WARNING” and the number of warning messages appears in the above of “RESULT” (see page 36).
- Depending on the listening environment, “SWFR PHASE:REV” appears during the automatic procedure and “SUBWOOFER PHASE” in “SOUND MENU” (see page 79) is automatically set to “REVERSE”.

10 Press **Ⓢ** **ENTER** to display the setup results in detail.

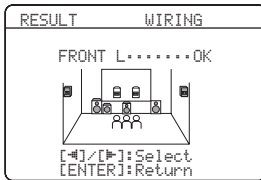
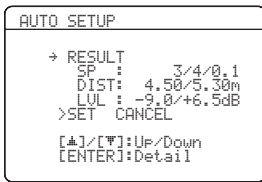

11 Press **Ⓢ** **</>** repeatedly to toggle between the setup result displays.

Press **Ⓢ** **△/▽** to toggle between the parameters in a results.

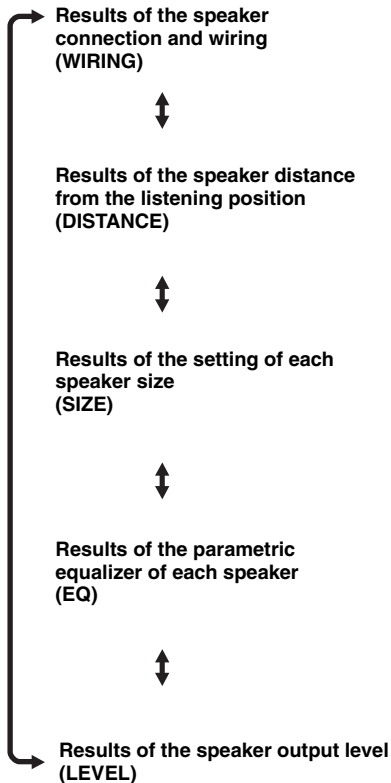

If you are not satisfied with the results or want to manually adjust each parameter, use “MANUAL SETUP” (see page 72).

Notes

- The distances displayed in the “DISTANCE” results may be longer than the actual distance depending on the characteristics of your subwoofer.
- In the “EQ” results, different values may be set for the same frequency to provide finer adjustments.

12 Press **Ⓢ** **ENTER** to return to the top result display.

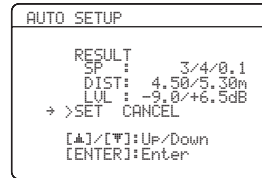

13 Make sure the pointer is pointing at “SET” and “CANCEL” and then press **Ⓢ** **</>** to select “SET” or “CANCEL”.

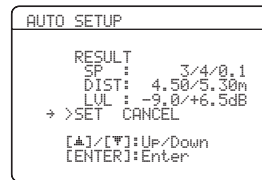

Choices: **SET**, **CANCEL**

- Select “SET” to confirm the “AUTO SETUP” results.
- Select “CANCEL” to cancel the “AUTO SETUP” results.

14 Press **Ⓢ** **ENTER** to confirm your selection.

The following screen appears. Disconnect the optimizer microphone from this unit to exit from “SET MENU”. The optimizer microphone is sensitive to heat. Keep it away from direct sunlight and do not place it on top of this unit.



If you change speakers, speaker positions, or the layout of your listening environment, run “AUTO SETUP” again to recalibrate your system.

■ If an error screen appears

Press **⓪** / **△** / **▽** / **◀** / **▶** to select “RETRY” or “EXIT” and then press **⓪** **ENTER**.

The following display is an example when “E-9:USER CANCEL” appears in the OSD.

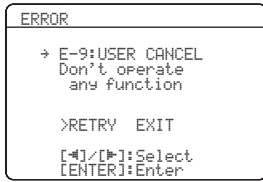

Choices: **RETRY**, **EXIT**

- Select “RETRY” to retry the “AUTO SETUP” procedure.
- Select “EXIT” to exit from the “AUTO SETUP” procedure.



If “E-5:NOISY” appears, “PROCEED” also appears in the choices. When you select “PROCEED”, this unit continues the measurements and settings, but the settings may not be optimal.

■ If “WARNING” appears

When this unit detects potential problems during the “AUTO SETUP” procedure, “WARNING” appears in the top result display. Check the warning messages to correct your speaker settings.

Note

Warnings differ from errors in that warnings do not cancel the “AUTO SETUP” procedure.

1 Make sure the pointer is pointing at “WARNING” and then press **⓪** **ENTER** to display the detailed information about the warning.

The number on the right of “WARNING” indicates the number of warning messages.

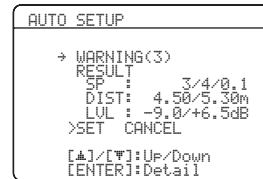

2 Press **⓪** / **◀** / **▶** repeatedly to toggle between the warning displays.

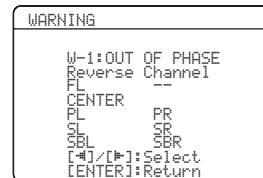

- For details about each warning message, see the “AUTO SETUP” section in “Troubleshooting” on page 117.
- When the corresponding warning message is not applicable to a speaker, “—” is displayed instead.
- If “SWFR: TOO LOUD” or “SWFR: TOO LOW” appears in the “W-3: LEVEL ERROR” display, adjust the volume level of the subwoofer(s).

3 Press **⓪** **ENTER** to return to the top result display.

Selecting the SCENE templates

This unit is equipped with 17 preset SCENE templates for various situations of using this unit. As the initial factory setting, the following SCENE templates are assigned to each SCENE button (see page 8):

SCENE 1: DVD Movie Viewing

SCENE 2: Music Disc Listening

SCENE 3: TV Viewing

SCENE 4: Radio Listening

If you want to use other SCENE templates, you can select the desired SCENE templates from the SCENE template library and assign the templates to the selected SCENE buttons on the front panel and the remote control.

Select the desired SCENE template

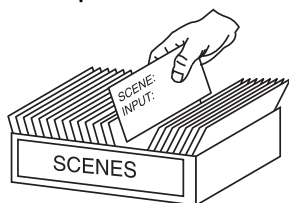

SCENE template library (Image)



Assign the SCENE template to the SCENE button

- 2 Rotate the **ⓇINPUT** selector (or set the operation mode selector to **ⓈAMP** and then press **Ⓣ◀/▶**) to select the desired template.



- 3 Press the **ⓈSCENE** (or **ⓉSCENE**) button again to confirm the selection.

The selected SCENE template is assigned to the SCENE button.



Front panel

or



Remote control

Note

Once the desired SCENE templates are assigned to the corresponding SCENE buttons, you need to set the input source of the SCENE template on the remote control. See page 41 for details.

Selecting the desired SCENE template to the SCENE buttons

- 1 Press and hold the **ⓈSCENE** (or **ⓉSCENE**) button for 3 seconds.

The indicator on the selected SCENE button on the front panel starts to flash, and the name of the currently assigned SCENE template appears in the front panel display.

3 seconds



Front panel

or

3 seconds



Remote control



Flashes

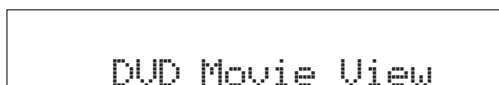

■ Which SCENE template would you like to select?

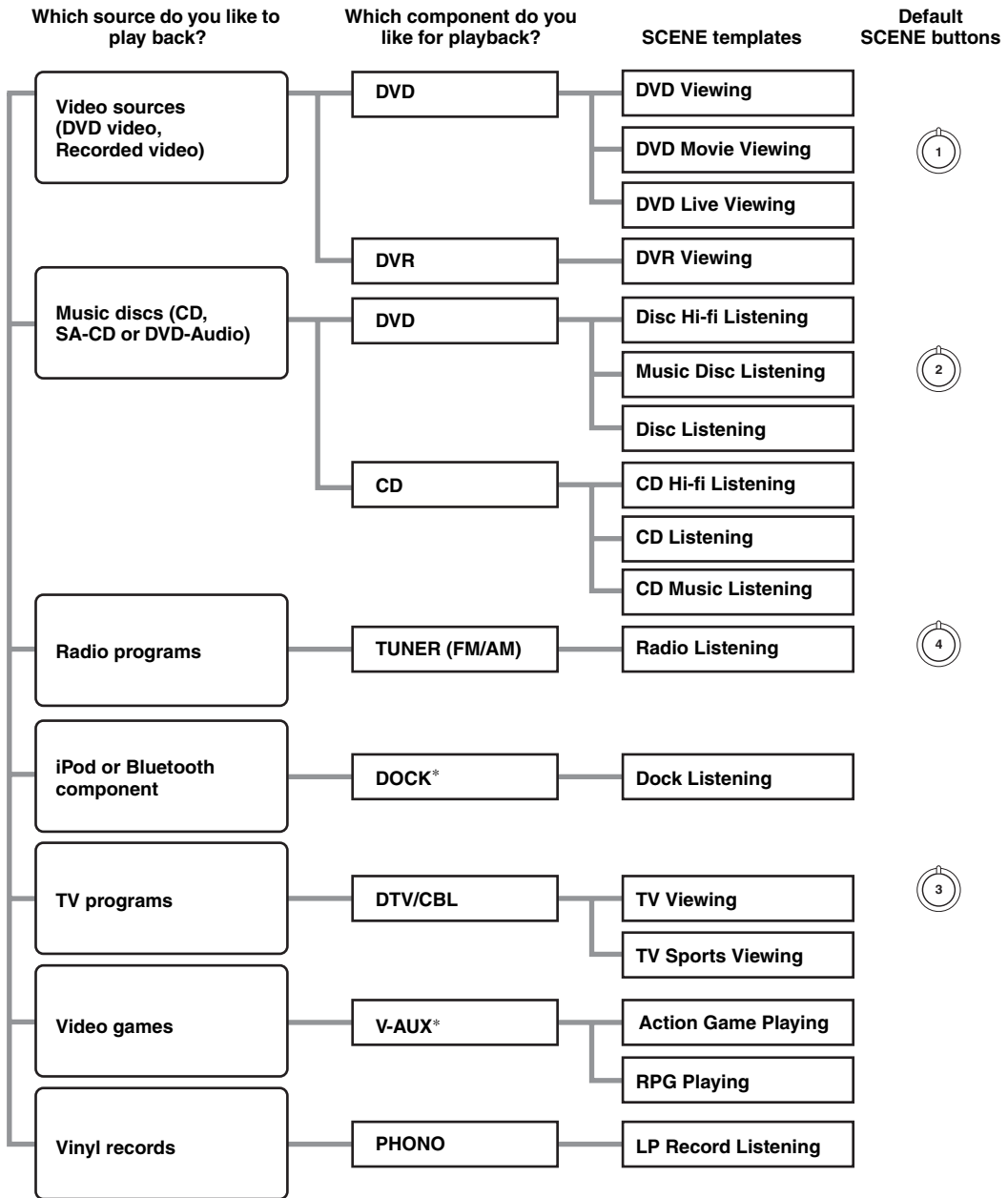

Note





* When iPod is connected to the Yamaha iPod universal dock or a Bluetooth component is connected to the Bluetooth adapter, this unit plays back the audio sources input at the DOCK terminal.



You can create your original SCENE templates by editing the preset SCENE templates. See page 40 for details.

■ Preset SCENE templates descriptions

The illustrations of the SCENE button in the following table indicate the assigned SCENE buttons in the default setting.

SCENE template	Input source	Playback mode	Features
DVD Viewing	DVD*	Straight	Select this SCENE template when you play back general contents on the DVD player.
DVD Movie Viewing 	DVD*	MOVIE Sci-Fi	Select this SCENE template when you play back movies on your DVD player.
DVD Live Viewing	DVD*	ENTERTAINMENT Music Video	Select this SCENE template when you enjoy the music live video on your DVD player.
DVR Viewing	DVR	MOVIE Drama	Select this SCENE template when you play back movies on your digital video recorder.
Disc Hi-fi Listening	DVD*	Pure Direct	Select this SCENE template when you enjoy the high fidelity sound of the music discs on your DVD player.
Music Disc Listening 	DVD*	STEREO 2ch Stereo	Select this SCENE template when you play back music discs on your DVD player.
Disc Listening	DVD*	STEREO 7ch Stereo	Select this SCENE template when you play back music sources on your DVD player as the background music.
CD Hi-fi Listening	CD*	Pure Direct	Select this SCENE template when you enjoy the high fidelity sound of the music discs on your CD player.
CD Listening	CD*	STEREO 7ch Stereo	Select this SCENE template when you play back music discs on your CD player.
CD Music Listening	CD*	STEREO 2ch Stereo	Select this SCENE template when you play back music source on your CD player as the background music.
Radio Listening 	TUNER	MUSIC ENHANCER 7ch Enhancer	Select this SCENE template when you enjoy FM or AM radio programs.
Dock Listening	V-AUX	MUSIC ENHANCER 7ch Enhancer	Select this SCENE template when you play back music on your iPod stationed in a Yamaha iPod universal dock or Bluetooth component that is connected to the Bluetooth adapter.
TV Viewing 	DTV/CBL	Straight	Select this SCENE template when you enjoy general programs on your TV.
TV Sports Viewing	DTV/CBL	ENTERTAINMENT Sports	Select this SCENE template when you enjoy sports programs on your TV.
Action Game Playing	V-AUX	ENTERTAINMENT Action Game	Select this SCENE template when you play action games such as car racing and FPS games.
RPG Playing	V-AUX	ENTERTAINMENT Roleplaying Game	Select this SCENE template when you play role-playing games.
LP Record Listening	PHONO	Pure Direct	Select this SCENE template when you play back vinyl records on your turntable.

* When the connected DVD player or CD player has the capability of the SCENE control signals and is connected to the REMOTE OUT jack of this unit, this unit operates the DVD player or CD player worked with the SCENE features.

Creating your original SCENE templates

You can create your original SCENE templates for each SCENE button. You can refer to the preset 17 SCENE templates to create the original SCENE templates.

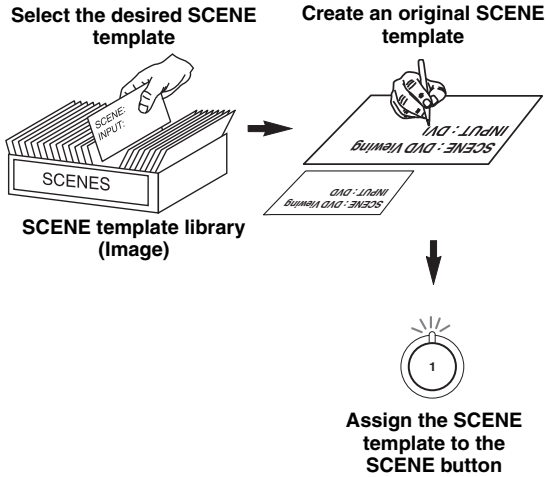

1 Turn on the video monitor connected to this unit.

2 Press and hold the desired ④SCENE button for 3 seconds.

The SCENE template customizing screen appears on the video monitor.

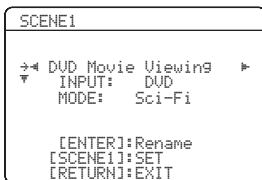

Note

When the SCENE template you want to customize is not assigned to any of the ④SCENE buttons, press ⑨◀/▶ repeatedly to recall the desired SCENE template on the menu screen.

3 Press ⑨△/▽ to select the desired parameter of the SCENE template and then ⑨◀/▶ to select the desired value of the selected parameter.

You can adjust the following parameters for a SCENE template:

- **INPUT:** The input source component.
- **MODE:** The active sound field programs, “Straight” or “Pure Direct” mode.

4 Press the ④SCENE button again to confirm the edit.



An asterisk mark (*) appears by the name of the original SCENE template.

Notes

- Once the desired SCENE templates are assigned to the corresponding ④SCENE buttons, you need to set the input source of the SCENE template on the remote control. See page 41 for details.
- You can create a customized SCENE template for each SCENE button, and if you create another customized SCENE template, this unit overwrites the old customized SCENE template with the new one.
- The newly created template is only available for the assigned SCENE button.

■ Rename the SCENE templates

Select the name of the SCENE template at step 3 of “Creating your original SCENE templates” and then press ⑨ENTER.

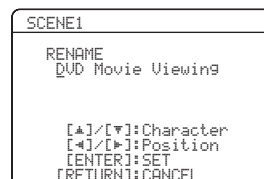

- Press ⑨△/▽ to select the desired character.
- Press ⑨◀/▶ to place an “_” (underscore) under the space or the desired character.
- Press ⑩RETURN to cancel the new name.
- Press ⑨ENTER to confirm the new name.

Using the remote control for the SCENE feature

■ Controlling the input source components in the SCENE mode

You can operate both this unit and the input source component by using the remote control. You must set the appropriate remote control code for each input source in advance (see page 94).

Before performing the following operations, set the operation mode selector on the remote control to **ⓈSOURCE**.

- 1** Press the desired **④ SCENE** button on the remote control.
- 2** Press the desired buttons in the * area below to control the input source component of the selected SCENE template.

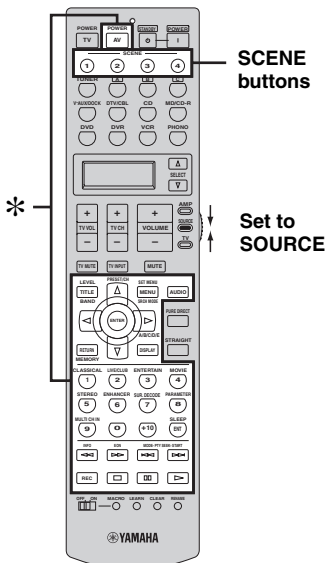

Note

* These buttons control the input source component. See page 93 for details of the function of each button.

■ Setting the input source of the customized SCENE template on the remote control

If you customize the input source of the selected SCENE template, you must set the input source of the SCENE template on the remote control to operate the input source component correctly.

- 1** Press and hold the **④ SCENE** button and the desired input selector button (**⑤**).
The transmit indicator (**②**) flashes twice.
- 2** Keep holding down the buttons pressed in step 2 until “OK” appears in the display window (**⑥**) on the remote control.

Note

If the setting of the input source is not successful, “NG” appears in the display window (**⑥**). In this case, repeat the setting procedure.

Playback

Caution

Extreme caution should be exercised when you play back CDs encoded in DTS. If you play back a CD encoded in DTS on a DTS-incompatible CD player, you will only hear some unwanted noise that may damage your speakers. Check whether your CD player supports CDs encoded in DTS. Also, check the sound output level of your CD player before you play back a CD encoded in DTS.



To play DTS-encoded CDs when using a digital audio connection, set "DECODER MODE" in "INPUT MENU" to "DTS" before the playback (see page 86).

Before performing the following operations, set the operation mode selector on the remote control to **AMP**.

Basic procedure

1 Turn on the video monitor connected to this unit.



See page 46 to display the input source information on the video monitor.

2 Rotate the **INPUT** selector (or press one of the input selector buttons (5)) to select the desired input source.

The name of the currently selected input source appears in the front panel display for a few seconds.

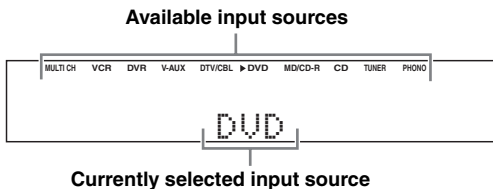

The corresponding input selector button on the remote control for the currently selected input source lights up for approximately 5 seconds after you press any buttons on the remote control, showing which source component is currently being operated.

3 Start playback on the selected source component or select a broadcast station.

- Refer to the operating instructions for the source component.
- See page 53 for details about FM/AM tuning instructions.
- See page 60 for details about iPod operations.
- See page 62 for details about Bluetooth operations.

4 Rotate **VOLUME** (or press **VOLUME +/-**) to adjust the volume to the desired output level.



- See page 52 to adjust the level of each speaker.
- This does not affect the AUDIO OUT (REC) level.
- You can set the initial volume level and maximum volume level (see page 81).

5 Rotate the **PROGRAM** selector (or press one of the sound field program selector buttons (28) repeatedly) to select the desired sound field program.

The name of the selected sound field program appears in the front panel display. See page 48 for details about sound field programs.



Note

Sound field programs cannot be selected when the component connected to the MULTI CH INPUT jacks is selected as the input source (see page 43).



- Choose a sound field program based on your listening preference, not merely on the name of the program.
- When you select an input source, this unit automatically selects the last sound field program used with the corresponding input source.
- To display information about the currently selected sound field program in the OSD, see page 64 for details.

Before performing the following operations, set the operation mode selector on the remote control to **AMP**.

Selecting the MULTI CH INPUT component

Use this feature to select the component connected to the MULTI CH INPUT jacks (see page 25) as the input source.

Rotate the **INPUT** selector to select “MULTI CH” (or press **MULTI CH IN**).

“MULTI CH” appears in the front panel display.



Use “MULTI CH” menu in “INPUT MENU” to set the parameters for MULTI CH INPUT (see page 87).

Note

Sound field programs cannot be selected when the component connected to the MULTI CH INPUT jacks is selected as the input source.

Selecting the front speaker set

Use this feature to turn the front speaker system (FRONT A and/or FRONT B) on or off.

Press **SPEAKERS** on the front panel repeatedly to turn on or off the set of front speakers connected to the FRONT A and/or EXTRA SP speaker terminals.

The active front speaker set changes as follows.

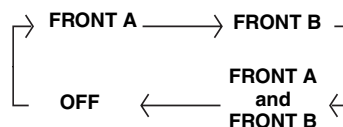

Notes

- FRONT A and B or FRONT B setting is not available when “EXTRA SP ASSIGN” is set to “PRESENCE”, “ZONE 2” or “NONE” (see page 77).
- Turn off the volume level of this unit when you switch the front speaker setting.

Using the Zone B feature

When you set “EXTRA SP ASSIGN” to “ZONE B” (see page 77), you can use the speakers connected to the EXTRA SP speaker terminals in another room (Zone B).

Press **SPEAKERS** on the front panel repeatedly to turn on or off the Zone B speakers.

When you activate the Zone B speakers, all the speakers in the main room are muted.

Note

If you select the sound field program and activate the Zone B speakers, Virtual CINEMA DSP activates automatically (see page 51).

Before performing the following operations, set the operation mode selector on the remote control to **AMP**.

Selecting audio input jacks (AUDIO SELECT)

This unit comes with a variety of input jacks. Use this feature (audio input jack select) to switch between input jacks when more than one input jack is assigned to the same input source.

- We recommend that you set the audio input jack select to “AUTO” in most cases.
- You can adjust the default audio input jack select of this unit by using “AUDIO SELECT” in “OPTION MENU” (see page 90).

Press **AUDIO SELECT** (or **AUDIO**) repeatedly to select the desired audio input jack select setting.

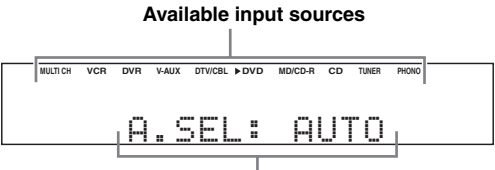

Currently selected audio input jack select setting

AUDIO SELECT	Function
AUTO	Automatically selects input signals in the following order: (1) HDMI (2) Digital signals (3) Analog signals
HDMI	Selects only HDMI signals. When HDMI signals are not input, no sound is output.
COAX/OPT	Automatically selects input signals in the following order: (1) Digital signals input at the COAXIAL jack (2) Digital signals input at the OPTICAL jack When no signals are input, no sound is output.
ANALOG	Selects only analog signals. If no analog signals are input, no sound is output.

Note

This feature is not available when no digital input jacks (OPTICAL, COAXIAL and HDMI) are assigned. In addition, HDMI is not available as an audio input jack select setting when the HDMI IN jacks are not used. Use “I/O ASSIGNMENT” in “INPUT MENU” to reassign the respective input jack (see page 85).

Displaying the current status of this unit on a video monitor

You can display the operating information of this unit on a video monitor.

- 1 Turn on the video monitor connected to this unit.
- 2 Press **DISPLAY** on the remote control. The current status screen appears in the OSD.

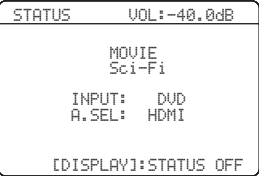

- You can select the amount of time that the current status is displayed in the OSD by using the “OSD-AMP” parameter in “OPTION MENU” (see page 88).
- To turn off the status screen, press **DISPLAY** again.

Note

The OSD signal is not output at the DVR and VCR VIDEO OUT jacks and will not be recorded.

Using your headphones

Connect a pair of headphones with a stereo analog audio cable plug to the PHONES jack on the front panel.

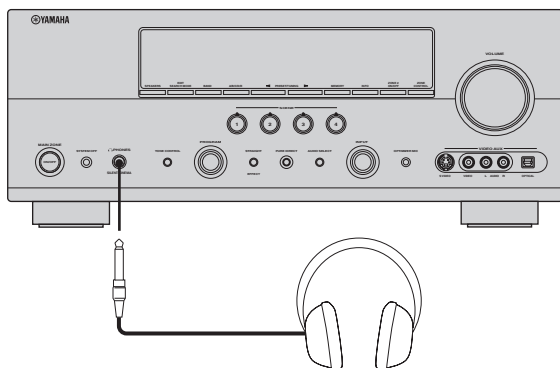

When you select a sound field program, SILENT CINEMA mode activates automatically (see page 51).

Notes

- When you connect headphones, no signals are output at the speaker terminals.
- All Dolby Digital and DTS audio signals are mixed down to the left and right headphone channels.

Muting the audio output

Press **MUTE** on the remote control to mute the audio output.

Press **MUTE** again to resume the audio output.



- You can also rotate **VOLUME** (or press **VOLUME +/-**) to resume the audio output.
- You can adjust the muting level by using the “MUTE TYPE” parameter in “VOLUME MENU” (see page 81).
- The MUTE indicator flashes in the front panel display when the audio output is muted and disappears from the front panel display when the audio output is resumed.

Before performing the following operations, set the operation mode selector on the remote control to **AMP**.

Playing video sources in the background of an audio source

You can combine a video image from a video source with sound from an audio source. For example, you can enjoy listening to classical music while viewing beautiful scenery from the video source on the video monitor.

Press the input selector buttons (5) on the remote control to select a video source and then an audio source.

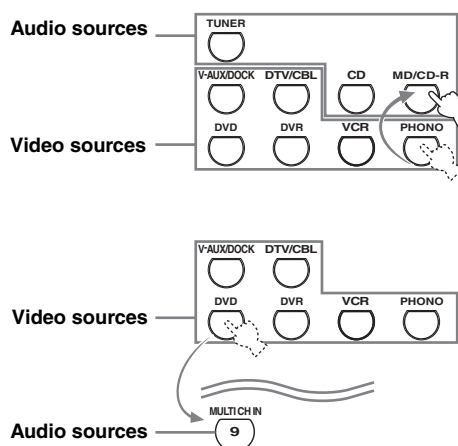

- You can also select “MULTI CH” as the audio source (see page 43). Set the operation mode selector to **AMP** and then press **MULTI CH IN**.
- Set the “BGV” parameter in the “MULTI CH” menu to the desired setting to select the default background video input source of the MULTI CH INPUT sources (see page 87).

Displaying the input source information

You can display the audio and video information of the current input signal.

- 1 Set the operation mode selector to **AMP** and then press **SET MENU** on the remote control.

The top “SET MENU” display appears in the OSD.



- 2 Press **DOWN** repeatedly to select “SIGNAL INFO” and then press **ENTER**.

The audio information about the input source appears in the OSD.

- 3 Press **LEFT/RIGHT** to toggle between the audio and video information displays.

- 4 Press **SET MENU** on the remote control again to exit from “SET MENU”.

Audio information

Information	Descriptions
FORMAT	Signal format. When this unit cannot detect a digital signal, it automatically switches to analog input.
SAMPLING	The number of samples per second taken from a continuous signal to make a discrete signal.
CHANNEL	The number of source channels in the input signal (front/surround/LFE). For example, a multi-channel soundtrack with 3 front channels, 2 surround channels and LFE, is displayed as “3/2/0.1”.
BITRATE	The number of bits passing a given point per second.
FLAG	Flag data encoded in DTS, Dolby Digital, or PCM signals that cue this unit to automatically switch decoders (“Surround EX”, etc.).

Note

“---” appears when this unit cannot display the corresponding information.

Video information

Information	Descriptions
HDMI SIGNAL	Type of the source video signals and the video signals output at the HDMI OUT jack of this unit.
HDMI RES.	Resolution of the input signal (analog or HDMI) and the output signal (HDMI). When input video signals are composite video or S-video signals, the input video signals are indicated as “Composite” or “S-Video”.
ANALOG RES.	Resolution of the analog video signals output at the COMPONENT VIDEO MONITOR OUT jacks of this unit.
HDMI ERROR (HDMI MESSAGE)	Error message for HDMI sources or connected HDMI devices.

Note

“---” appears when this unit cannot display the corresponding information.

HDMI error and message

Message	Cause
DEVICE OVER	The number of the connected HDMI components is over the limit.
HDCP ERROR	HDCP authentication failed.
Out of Res.	Out of resolution. The connected monitor is not compatible with the resolution of the input video signal.

Using the sleep timer

Use this feature to automatically set the main zone to the standby mode after a certain amount of time. The sleep timer is useful when you are going to sleep while this unit is playing or recording a source. The sleep timer also automatically turns off any external components connected to the AC OUTLET(S) (see page 28).

Note

Even if this unit is in the standby mode, this unit does not cut off the power to AC OUTLET(S) while charging connected iPod (see page 28).

Set the operation mode selector to **AMP and then press **SLEEP** repeatedly to set the amount of time.**

Each time you press **SLEEP**, the front panel display changes as shown below.

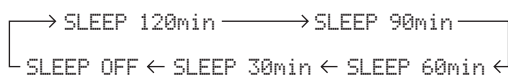

The SLEEP indicator flashes while you are switching the amount of time for the sleep timer. Once the sleep timer is set, the SLEEP indicator lights up in the front panel display, and the display returns to the selected sound field program.

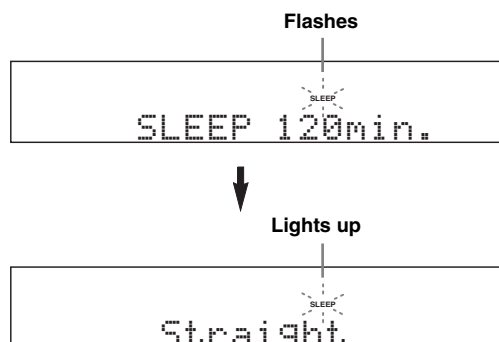

Canceling the sleep timer

Press **SLEEP** on the remote control repeatedly until “SLEEP OFF” appears in the front panel display.

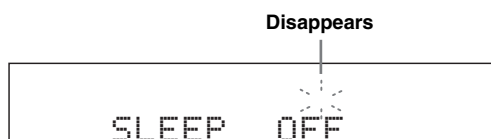

The SLEEP indicator turns off, and “SLEEP OFF” disappears from the front panel display after a few seconds.



The sleep timer setting can also be canceled by pressing **STANDBY** (or **MAIN ZONE ON/OFF**) to set the main zone to the standby mode.

Sound field programs

This unit is equipped with a variety of precise digital decoders that allow you to enjoy multi-channel playback from almost any stereo or multi-channel sound source. This unit is also equipped with a Yamaha digital sound field processing (DSP) chip containing several sound field programs which you can use to enhance your playback experience.

Selecting sound field programs

Rotate the **PROGRAM** selector (or set the operation mode selector to **AMP** and then press one of the sound field program selector buttons repeatedly).

The name of the selected sound field program appears in the front panel display and in the OSD.

Notes

- When you select an input source, this unit automatically selects the last sound field program used with the corresponding input source.
- Sound field programs cannot be selected when the component connected to the MULTI CH INPUT jacks is selected as the input source (see page 43).
- When you play back the Dolby TrueHD, Dolby Digital Plus, DTS-HD Master Audio, or DTS-HD High Resolution Audio sources, this unit does not activate any sound field program.
- When the sampling frequency of the input sources are higher than 96 kHz, this unit does not apply any sound field programs.

Sound field program descriptions



Select a sound field program based on your listening preference, not merely on the name of the program, etc.

■ For audio music sources



For audio music sources, we also recommend that you use the Pure Direct mode (see page 52).

Notes

- The available sound field parameters differ depending on the settings of the speakers.
- "DIALG.LIFT" is available only when "EXTRA SP ASSIGN" in "SPEAKER SET" is set to "PRESENCE" (see page 77).

CLASSICAL

Program	Descriptions
Hall in Munich	This sound field simulates a concert hall with approximately 2500 seats in Munich, using stylish wood for the interior finishing as normal standards for European concert halls. Fine, beautiful reverberations spread richly, creating a calming atmosphere. The listener's virtual seat is at the center left of the arena.
Hall in Vienna	This is an approximately 1700-seated, middle-sized concert hall with a shoebox shape that is traditional in Vienna. Pillars and ornate carvings create extremely complex reflections from all around the audience, producing a very full, rich sound.
Chamber	This program creates a relatively wide space with a high ceiling like an audience hall in a palace. It offers pleasant reverberations that are suitable for courtly music and chamber music.

LIVE/CLUB

Program	Descriptions
Cellar Club	This program simulates a live house with a low ceiling and homey atmosphere. A realistic, live sound field features powerful sound as if the listener is in a row in front of a small stage.
The Roxy Theatre	This is the sound field of a rock music live house in Los Angeles, with approximately 460 seats. The listener's virtual seat is at the center left of the hall.
The Bottom Line	This is the sound field at stage front in The Bottom Line, that was a famous New York jazz club once. The floor can seat 300 people to the left and right in a sound field offering real and vibrant sound.

■ For various sources

Notes

- The available sound field parameters and the created sound fields differ depending on the input sources and the settings of this unit.
- "DIALG.LIFT" is available only when "EXTRA SP ASSIGN" in "SPEAKER SET" is set to "PRESENCE" (see page 77).

ENTERTAINMENT

Program	Descriptions
Sports	This program allows the listeners to enjoy stereo sport broadcasts and studio variety programs with enriched live feeling. In sports broadcasts, the voices of the commentator and sportscaster are positioned clearly at the center while the atmosphere of the stadium expands in an optimum space to offer the listeners with a feeling of presence in the stadium.
Action Game	This sound field has been suitable for action games such as car racing and FPS games. It uses the reflection data that limits the effects range per channel in order to offer a powerful playing environment with a being-there feeling by enhancing various effects tones while maintaining a clear sense of directions.
Roleplaying Game	This sound field has been suitable for role-playing and adventure games. It combines the sound field effects for movies and the sound field designs for "Action Game" to represent the depth and 3D feeling of the field during play, while offering movie-like surround effects in the movie scenes in the game.
Music Video	This sound field offers an image of a concert hall for live performance of pop, rock and jazz music. The listener can indulge oneself in a hot live space thanks to the presence sound field that emphasizes the vividness of vocals and solo play and the beat of rhythm instruments, and to the surround sound field that reproduces the space of a big live hall.

■ For movie sources



You can select the desired decoder used with following sound field program (except "Mono Movie"). See page 69 for details.

Notes

- The available sound field parameters and the created sound fields differ depending on the input sources and the settings of this unit.
- "DIALG.LIFT" is available only when "EXTRA SP ASSIGN" in "SPEAKER SET" is set to "PRESENCE" (see page 77).

MOVIE

Program	Descriptions
Standard	This program creates a sound field emphasizing the surrounding feeling without disturbing the original acoustic positioning of multi-channel audio such as Dolby Digital and DTS. It has been designed with the concept of "an ideal movie theater", in which the audience is surrounded by beautiful reverberations from the left, right and rear.
Spectacle	This program represents the spectacular feeling of large-scale movie productions. It reproduces a broad theater sound field matching the cinemascope and wider-screen movies with an excellent dynamic range from very small to extremely large sound.
Sci-Fi	This program clearly reproduces the finely elaborated sound design of the latest science fiction and special effects-featuring movies. You can enjoy a variety of cinematographically created virtual spaces reproduced with clear separation between dialog, sound effects and background music.

Program	Descriptions
Adventure	This program is ideal for precisely reproducing the sound design of action and adventure movies. The sound field restrains reverberations but puts emphasis on reproducing a powerful space expanded widely to the left and right. The reproduced depth is also restrained relatively to ensure the separation between audio channels and the clarity of the sound.
Drama	This sound field features stable reverberations that match a wide range of movie genres from serious dramas to musicals and comedies. The reverberations are modest but offer an optimum 3D feeling, reproducing effects tones and background music softly but cubically around clear words and center positioning in a way that does not fatigue the listener even after long hours of viewing.
Mono Movie	This program is provided for reproducing monaural video sources such as a classic movie in an atmosphere of a good old movie theater. The program produces the optimum expansion and reverberation to the original audio to create a comfortable space with a certain sound depth.

Note

The available parameters differ depending on the input sources and the settings of this unit.

STEREO

Program	Descriptions
2ch Stereo	Use this program to mix down multi-channel sources to 2 channels.
7ch Stereo	Use this program to output sound from all speakers. When you play back multi-channel sources, this unit downmixes the source to 2 channels, and then outputs the sound from all speakers. This program creates a larger sound field and is ideal for background music at parties, etc.

■ The Compressed Music Enhancer**MUSIC ENHANCER**

Program	Descriptions
Straight Enhancer	Use this program to enhance the sound nearest to the original depth and width of the 2-channel or multi-channel compression artifacts.
7ch Enhancer	Use this program to play back compression artifacts in 7-channel stereo.

■ Surround decode mode**SUR. DECODE**

Program	Descriptions
Sur. Decoder	Select this program to playback sources with selected decoders. You can playback 2-channel sources on multi-channels. See page 70 for details.

■ Using sound field programs without surround speakers (Virtual CINEMA DSP)

Virtual CINEMA DSP allows you to enjoy the CINEMA DSP programs without surround speakers. It creates virtual speakers to reproduce the natural sound field. When you set “SUR. L/R SP” to “NONE” (see page 78), Virtual CINEMA DSP activates automatically whenever you select a sound field program (see page 48).

Note

Virtual CINEMA DSP will not activate even when “SUR. L/R SP” is set to “NONE” (see page 78) in the following cases:

- when the component connected to the MULTI CH INPUT jacks is selected as the input source (see page 43).
- when headphones are connected to the PHONES jack.
- when this unit is in the “7ch Stereo” mode.

■ Enjoying multi-channel sources and sound field programs with headphones (SILENT CINEMA)

SILENT CINEMA allows you to enjoy multi-channel music or movie sound, including Dolby Digital and DTS sources, through ordinary headphones. SILENT CINEMA activates automatically whenever you connect headphones to the PHONES jack while listening to sound field programs (see page 48). When activated, the SILENT CINEMA indicator lights up in the front panel display.

Notes

- SILENT CINEMA does not activate when the component connected to the MULTI CH INPUT jacks is selected as the input source (see page 43).
- SILENT CINEMA is not effective when the “Pure Direct” (see page 52) or “2ch Stereo” mode (see page 50) is selected, or when this unit is in the “Straight” mode (see page 51).

Before performing the following operation, set the operation mode selector on the remote control to **AMP**.

Enjoying unprocessed input sources (Straight decoding mode)

When this unit is in the “Straight” mode, 2-channel stereo sources are output from only the front left and right speakers. Multi-channel sources are decoded straight into the appropriate channels without any additional effect processing.

Press **STRAIGHT** (or **STRAIGHT**) to select “Straight”.

■ Deactivating the “Straight” mode

Press **STRAIGHT** (or **STRAIGHT**) so that “Straight” disappears from the front panel display.

The sound effect is turned back on.

Using audio features

Before performing the following operations, set the operation mode selector on the remote control to **AMP**.

Adjusting the speaker level

You can adjust the output level of each speaker while listening to a music source. This is also possible when playing sources input at the MULTI CH INPUT jacks.

Note

This operation will override the level adjustments made in “AUTO SETUP” (see page 32) and “SP LEVEL” (see page 79).

- 1 Press **LEVEL** on the remote control and then **▲ / ▼** repeatedly to select the speaker you want to adjust.

Display	Adjusted speaker
FRONT L	Front left speaker
FRONT R	Front right speaker
CENTER	Center speaker
SUR. L	Surround left speaker
SUR. R	Surround right speaker
SBL	Surround back left speaker
SBR	Surround back right speaker
SWFR	Subwoofer
PRNS L	Presence left speaker
PRNS R	Presence right speaker



- The available speaker channels differ depending on the setting of the speakers.
- When the video monitor is turned on, the “LEVEL” adjustment menu appears in the video monitor.

- 2 Press **◀ / ▶** to adjust the speaker output level.

- Press **▶** to increase the value.
- Press **◀** to decrease the value.

Control range: -10.0 dB to +10.0 dB

- 3 Press **LEVEL** to turn off the speaker level adjustment display.

Enjoying pure hi-fi sound

Use the Pure Direct mode to enjoy the pure high fidelity sound of the selected source. When the Pure Direct mode is activated, this unit plays back the selected source with the least circuitry.

- Press **PURE DIRECT** (or **PURE DIRECT**) to turn the Pure Direct mode on or off.

The **PURE DIRECT** button on the front panel lights up while this unit is in the Pure Direct mode. The front panel display automatically dims.

Notes

- The following operations are not possible when this unit is in the Pure Direct mode:
 - switching the sound field program
 - displaying the OSD
 - adjusting the “SET MENU” parameters (except for level settings)
 - operating video functions (video conversion, etc.)
- The Pure Direct mode is automatically canceled whenever this unit is turned off.



The front panel display turns on momentarily when an operation is performed.

Adjusting the tonal quality

Use this feature to adjust the balance of bass and treble for the front left and right speaker channels.



Speaker and headphone adjustments are stored independently.

- 1 Press **TONE CONTROL** on the front panel repeatedly to select the high-frequency response (TREBLE) or the low-frequency response (BASS).

- 2 Rotate the **PROGRAM** selector to adjust the high-frequency response (TREBLE) or the low-frequency response (BASS).

Control range: -6 dB to +6 dB

Notes

- If you increase or decrease the high-frequency or the low-frequency sound to an extreme level, the tonal quality of the surround speakers may not match.
- TONE CONTROL is not effective when PURE DIRECT is selected, or when MULTI CH INPUT is selected as the input source.

FM/AM tuning

Overview

You can use two tuning modes to tune into the desired FM/AM station:

Frequency tuning mode (AUTO TUNING/MANUAL TUNING)

You can search or specify the frequency of the desired FM/AM station automatically or manually (see “Basic tuning operations” on this page).

Preset tuning mode (PRESET TUNING)

You can preset the desired FM/AM station in advance, and then recall the station by specifying the preset group and number (see “Using station preset feature” on page 54).

Note

Orient the connected FM and AM antennas for the best reception.

Basic tuning operations

Before performing the following operations, set the operation mode selector on the remote control to **SOURCE** and then press **TUNER**.

1 Rotate the **INPUT** selector (or press **TUNER**) to select “TUNER” as the input source.

2 Press **BAND** (or **BAND**) to select the reception band.
“FM” or “AM” appears in the front panel display.

3 Press **SEARCH MODE** (or **SRCH MODE**) to select the desired tuning mode.

Automatic tuning mode (AUTO TUNING)

Use this feature when the signal from the station you want to select is strong.

When this unit is in the automatic tuning mode, “AUTO TUNING” appears in the front panel display for a moment. The AUTO indicator appears in the front panel display.

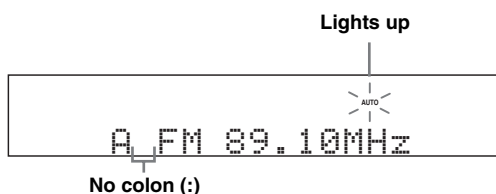

Manual tuning mode (MANUAL TUNING)

Use this feature if the signal from the station you want to select is weak and you cannot tune by using the automatic tuning. When this unit is in the manual tuning mode, “MANUAL TUNING” appears in the front panel display for a moment.

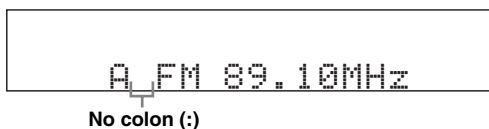

Manually tuning into an FM station automatically switches the tuner to monaural reception to increase the signal quality.

Preset tuning mode (PRESET TUNING)

Use this feature to recall the preset stations. When this unit is in the preset tuning mode, “PRESET TUNING” appears in the front panel display for a moment. Frequency tuning is not possible. See page 54 for details.

4 Press **PRESET/TUNING** \triangleleft / \triangleright (or **PRESET/CH** \triangle / ∇) repeatedly to tune into the desired station.

- Press **PRESET/TUNING** \triangleright (or **PRESET/CH** \triangle) to tune into a higher frequency.
- Press **PRESET/TUNING** \triangleleft (or **PRESET/CH** ∇) to tune into a lower frequency.



- When this unit is tuned into a station, the TUNED indicator lights up.
- Hold down the button to continue searching when this unit is in the manual tuning mode.
- Press **ⓂINFO** (or **ⓂINFO**) repeatedly to toggle the frequency information and sound field program information in the front panel.

Before performing the following operations, set the operation mode selector on the remote control to **ⓂSOURCE** and then press **ⓂTUNER**.

■ Direct frequency tuning

Use this feature tune into the desired station directly by entering the frequency.

- 1 Press **ⓂBAND** on the remote control repeatedly to select the desired reception band.**
“FM” or “AM” appears in the front panel display.
- 2 Press **ⓂSEARCH MODE** (or **ⓂSRCH MODE**) repeatedly to select “AUTO TUNING” or “MANUAL TUNING”.**

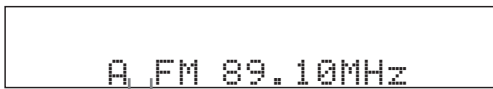

No colon (:)



If a colon (:) appears in the front panel display, manual tuning is not possible. Press **ⓂSEARCH MODE** (or **ⓂSRCH MODE**) to turn the colon (:) off.

- 3 Enter the frequency of the desired station by pressing the numeric buttons (Ⓜ).**

Example: To tune into 103.75 MHz



If the entered frequency is out of the range of the FM/AM tuning, “WRONG STATION!” appears in the front panel display and then this unit automatically tunes into the last selected station.

Using station preset feature

Use this feature to store up to 40 stations FM/AM stations (A1 to E8: 8 preset station numbers in each of the 5 preset station groups). Preset the desired stations to this unit by using the automatic or manual preset tuning features in advance (see “Automatic station preset” and “Manual station preset” on page 55).

Before performing the following operations, set the operation mode selector on the remote control to **ⓂSOURCE** and then press **ⓂTUNER**.

- 1 Press **ⓂSEARCH MODE** (or **ⓂSRCH MODE**) repeatedly to select “PRESET TUNING”.**
- 2 Press **ⓂPRESET/TUNING** \triangle/\triangleright (or **ⓂPRESET/CH** \triangle/\triangledown) to select the desired preset station number (A1 to E8).**
The preset station group and number appear in the front panel display along with the station band and frequency.



Preset group and preset station number



You can select the preset station group (A to E) by pressing **ⓂA/B/C/D/E** (or **ⓂA/B/C/D/E** \triangle/\triangleright) repeatedly.

Automatic station preset

You can use the automatic preset tuning feature to store up to 40 FM stations with strong signals (A1 to E8: 8 preset station numbers in each of the 5 preset station groups) in order.

1 Rotate the **INPUT selector (or press **TUNER**) to select “TUNER” as the input source.**

2 Press **BAND (or **BAND**) to select “FM” as the reception band.**
“FM” appears in the front panel display.

3 Press and hold **MEMORY (or **MEMORY**) for more than 3 seconds.**

The preset station number as well as the MEMORY and AUTO indicators flashes. After approximately 5 seconds, automatic presetting starts from the current frequency and proceeds toward higher frequencies.

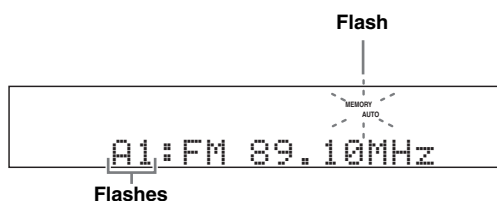

When automatic preset tuning is completed, the MEMORY indicator disappears.



- You can specify the preset number from which this unit stores FM stations. Press **A/B/C/D/E** (or **A/B/C/D/E** **</>**) and then **PRESET/TUNING** **</>** (or **PRESET/CH** **Δ / ∇**) repeatedly after you perform step 3 to select the preset station number under which the first station will be stored.
- To cancel the automatic station preset, press **MEMORY** (or **MEMORY**) again.

Notes

- Any stored station data existing under a preset station number is cleared when you store a new station under the same preset station number.
- If the number of received stations does not reach 40 (E8), automatic preset tuning automatically stops after searching for all the available stations and copy the stored stations to the rest preset station numbers.
- Only FM stations with sufficient signal strength are stored automatically by automatic preset tuning. If the station you want to store is weak in signal strength or an AM radio station, tune into it manually and store it as described in “Manual station preset” below.
- (Europe and Russia models only)
Only Radio Data System broadcasting station are stored automatically by automatic preset tuning.

Manual station preset

Use this feature to store the FM or AM stations with weak signals manually.

1 Tune into a station.

See page 53 for tuning instructions.

2 Press **MEMORY (or **MEMORY**).**

The MEMORY indicator flashes in the front panel display for approximately 30 seconds.

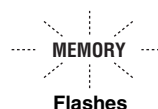

To cancel the preset memory mode, press **MEMORY** (or **MEMORY**) again.

3 Press **PRESET/TUNING **</>** (or **PRESET/CH** **Δ / ∇**) repeatedly to select a preset station group and number (A1 to E8) while the MEMORY indicator is flashing.**

- Press **E** **>** (or **9** **Δ**) to select a higher preset station group and number.
- Press **E** **<** (or **9** **∇**) to select a lower preset station group and number.

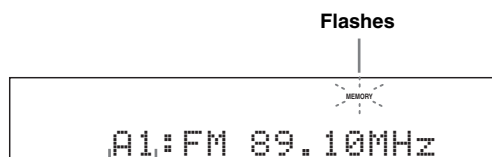

The displayed station has been stored as A1.



You can select the preset station group (A to E) by pressing **A/B/C/D/E** (or **A/B/C/D/E** **</>**) repeatedly.

4 Press **MEMORY (or **MEMORY**) while the MEMORY indicator is flashing.**

The station band and frequency appear in the front panel display with the preset station group and number you have selected. The MEMORY indicator disappears from the front panel display.

Notes

- Any stored station data existing under a preset station number is cleared when you store a new station under the same preset station number.
- The reception mode (stereo or monaural) is stored along with the station frequency.

■ Exchanging preset stations

You can exchange the assignments of two preset stations with each other. The example below describes the procedure to exchange preset station “E1” with “A5”.

Before performing the following operations, set the operation mode selector on the remote control to **ⓂSOURCE** and then press **ⓂTUNER**.

1 Select preset station “E1” using **ⓂA/B/C/D/E** and **ⓂPRESET/TUNING** $\triangleleft/\triangleright$.

See “Using station preset feature” on page 54.

2 Press and hold **ⓂEDIT** for more than 3 seconds.

“E1” and the MEMORY indicator flash in the front panel display.

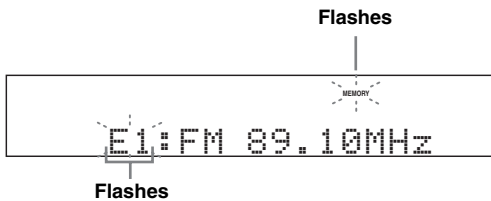

3 Select preset station “A5” using **ⓂA/B/C/D/E** and **ⓂPRESET/TUNING** $\triangleleft/\triangleright$.

“A5” and the MEMORY indicator flash in the front panel display.

See “Using station preset feature” on page 54.

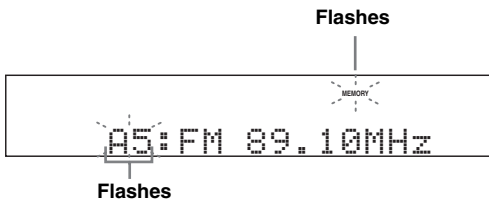

4 Press **ⓂEDIT** again.

“EXCHANGE E1-A5” appears in the front panel display and the assignments of the two preset stations are exchanged.

Radio Data System tuning (Europe and Russia models only)

Radio Data System is a data transmission system used by FM stations in many countries. This unit can receive various Radio Data System data such as PS (program service), PTY (program type), RT (radio text), CT (clock time), and EON (enhanced other networks) when receiving Radio Data System broadcasting stations.

Selecting the Radio Data System program type (PTY SEEK mode)

Use this feature to select the desired radio program by program type from the all preset Radio Data System broadcasting stations.

Before performing the following operations, set the operation mode selector on the remote control to **SOURCE** and then press **TUNER**.

1 Press BAND repeatedly to select “FM” as the reception band.

2 Press PTY SEEK MODE on the remote control to set this unit to the PTY SEEK mode.

The name of the program type or “NEWS” flashes in the front panel display.



Flashes



To cancel the PTY SEEK mode, press **PTY SEEK MODE** on the remote control again.

3 Press PRESET/CH Δ / ∇ on the remote control to select the desired program type.

The name of the selected program type appears in the front panel display.



Lights up

Program type	Descriptions
NEWS	News
AFFAIRS	Current affairs
INFO	General information
SPORT	Sports
EDUCATE	Education
DRAMA	Drama
CULTURE	Culture
SCIENCE	Science
VARIED	Light entertainment
POP M	Popular music
ROCK M	Rock music
M.O.R. M	Middle-of-the-road music (easy-listening)
LIGHT M	Light classics
CLASSICS	Serious classics
OTHER M	Other music

4 Press **PTY SEEK START** on the remote control to start searching for all the available Radio Data System preset stations.

The name of the selected program type flashes and the PTY HOLD indicator lights up in the front panel display.

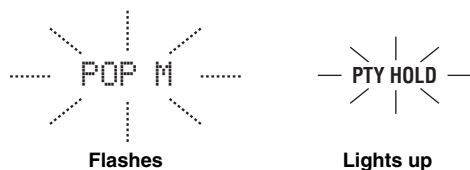

To stop searching for stations, press **PTY SEEK START** on the remote control again.

Notes

- This unit stops searching for stations when a station broadcasting the selected program type is found.
- If the station found is not the one you desire, press **PTY SEEK START** again to resume searching for another station broadcasting the same program type.

Using the enhanced other networks (EON) data service

Use this feature to receive the EON (enhanced other networks) data service of the Radio Data System station network. Once you select one of the 4 Radio Data System program types (NEWS, AFFAIRS, INFO, or SPORT), this unit automatically searches for all the available preset stations that are scheduled to broadcast the EON data service of the selected program type for a certain duration of time. When the scheduled EON data service starts, this unit automatically switches to the local station broadcasting the EON data service and then switches back to the national station once the EON data service ends.

Notes

- You can use this feature only when the EON data service is available.
- The EON indicator lights up in the front panel display only when the EON data service is being received from a Radio Data System station.

1 Tune into the desired Radio Data System broadcasting station.

2 Make sure the EON indicator is lit in the front panel display.

If the EON indicator is not lit in the front panel display, select another Radio Data System program so that the EON indicator lights up.



3 Press **EON** on the remote control repeatedly to select one of the 4 Radio Data System program types (NEWS, AFFAIRS, INFO or SPORT).

The name of the selected program type appears in the front panel display.

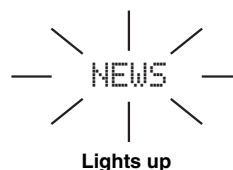

To cancel the EON feature, press **EON** on the remote control repeatedly until the name of the program type disappears and "EON OFF" appears in the front panel display.

Displaying the Radio Data System information

Use this feature to display the 4 types of the Radio Data System information: PS (program service), PTY (program type), RT (radio text) and CT (clock time). The corresponding indicators light up in the front panel display (see page 31).

Notes

- You can select one of the Radio Data System display modes only when the corresponding Radio Data System indicator lights up in the front panel display. It may take a while for this unit to receive all of the Radio Data System data from the station.
- You can select only the available Radio Data System display modes being offered by the station.
- If the signals being received are not strong enough, this unit may not be able to utilize the Radio Data System data. In particular, the RT mode requires a large amount of data and may not be available even when the other Radio Data System display modes are available.
- In case of poor reception conditions, press **ⓂSRCH MODE** on the remote control repeatedly to select "MANUAL TUNING" (see page 53).
- If the signal strength is weakened by external interference while this unit is receiving the Radio Data System data, the reception may be cut off unexpectedly and "...WAIT" appears in the front panel display.
- When the RT mode is selected, this unit can display the program information by a maximum of 64 alphanumeric characters, including the umlaut symbol. Unavailable characters are displayed with the "_" (underscore).
- If the reception is cut off when the CT mode is selected, "CT WAIT" appears in the front panel display.

Before performing the following operations, set the operation mode selector on the remote control to **ⓂSOURCE** and then press **ⓅTUNER**.

1 Tune into the desired Radio Data System broadcasting station.

- We recommend using the automatic preset tuning to tune into the Radio Data System broadcasting stations (see page 55).
- You can also use PTY SEEK mode to tune into the desired Radio Data System broadcasting station from the preset ones (see page 57).

2 Press **ⓂINFO** (or **ⓂINFO**) repeatedly to select the desired Radio Data System display mode.

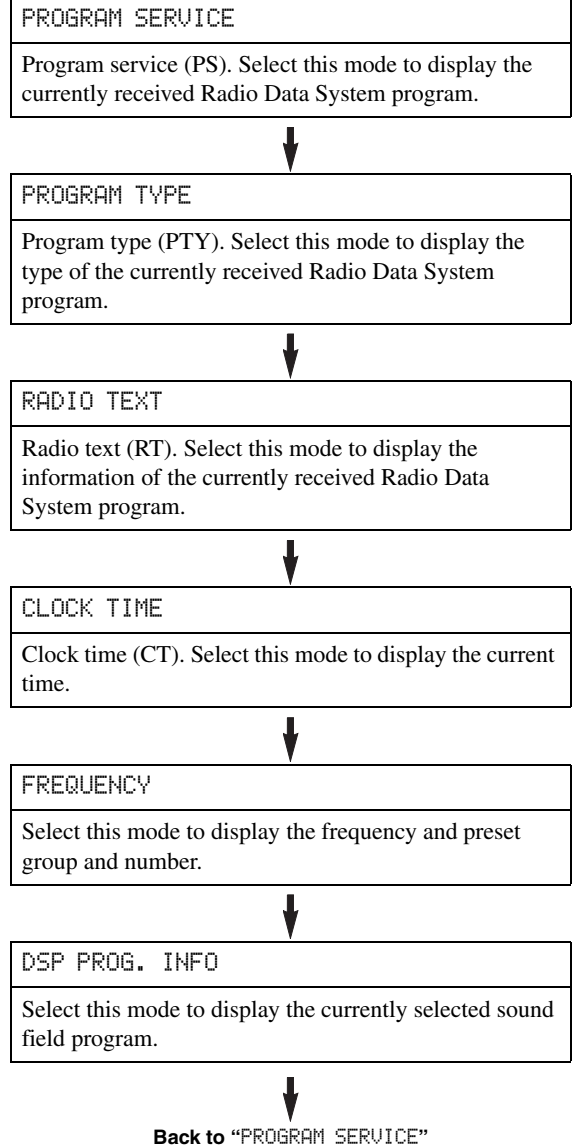

Using iPod™

Once you have stationed your iPod in a Yamaha iPod universal dock (such as YDS-10, sold separately) connected to the DOCK terminal of this unit (see page 25), you can enjoy playback of your iPod using the supplied remote control. You can also use the Compressed Music Enhancer mode of this unit to improve the sound quality of the compression artifacts (such as the MP3 format) stored on your iPod (see page 50).

Notes

- Only iPod (Click and Wheel), iPod nano, and iPod mini are supported.
- Some features may not be compatible depending on the model or the software version of your iPod.



- For a complete list of status messages that appear in the front panel display and in the OSD, see the “iPod” section in “Troubleshooting” on page 116.
- Once the connection between your iPod and this unit is complete, “iPod connected” appears in the front panel display and the DOCK indicator lights up in the front panel display.
- Only the analog audio and video signals of your iPod are input at the DOCK terminal, and the analog audio signals can be output at the analog AUDIO OUT (REC) jacks for recording.
- Your iPod battery is automatically charged when your iPod is stationed in a Yamaha iPod universal dock connected to the DOCK terminal of this unit as long as this unit is turned on. You can also select whether this unit charges the battery of the stationed iPod or not when this unit is in the standby mode by selecting the “STANDBY CHARGE” parameter in “INPUT MENU” (see page 86). The DOCK indicator turns on while this unit charges the battery of the connected iPod when this unit is in the standby mode.

Controlling iPod™

You can control your iPod when “V-AUX” is selected as the input source. The operations of your iPod can be done with the aid of the OSD of this unit (menu browse mode) or without it (simple remote mode).

■ Remote control operation

Before performing the following operations, set the operation mode selector on the remote control to **⑮SOURCE** and then press **⑤V-AUX/DOCK**.

Button	Function
⑨ ENTER	Subsequent menu
△	Menu up
▽	Menu down
◀	Previous menu
▶	Subsequent menu
⑫ ◀◀	Search backward (Press and hold)
▶▶	Search forward (Press and hold)
▶▶▶	Skip forward
◀◀◀	Skip backward
□	Stop
⏸	Pause (Menu browse mode) Play/Pause (Simple remote mode)
▶	Play (Menu browse mode) Play/Pause (Simple remote mode)
⑮ MENU	Previous menu
⑳ DISPLAY	Display

■ Controlling iPod in the simple remote mode

You can perform the basic operations of your iPod (play, stop, skip, etc.) using the supplied remote control without the aid of the OSD of this unit.



- You can view the photos or video clips stored on your iPod (some models only).
- Operations can be also done with the controls on your iPod.

■ Controlling iPod in the menu browse mode

You can perform the advanced operations of your iPod using the supplied remote control with the aid of the OSD of this unit. You can browse the songs stored on your iPod in the OSD. Further, you can change or adjust settings for your iPod to suit your personal preferences.



- The name of the song being played also appears in the front panel display according to the “FL SCROLL” parameter in “OPTION MENU” (see page 88).
- You can select the amount of time the iPod menu and play information is displayed in the OSD by using the “OSD-SOURCE” in “OPTION MENU” (see page 88).

Notes

- Operations cannot be done with the controls on your iPod.
- There are some characters that cannot be displayed in the front panel display or in the OSD of this unit. Those characters are replaced with underscores “_”.
- The “Settings” parameters can be changed or adjusted only in the OSD. Press **ⓂENTER** or **ⓂΔ / ▽** repeatedly on the remote control to toggle between the “Settings” parameter settings.
- You cannot browse the photos or video clips stored on your iPod in the OSD. Use the simple remote mode to enjoy watching the photos or video clips stored on your iPod.

1 Set the operation mode selector to **ⓂSOURCE** and then press **ⓂDISPLAY** on the remote control.

The following display appears in the OSD.



2 Press **ⓂΔ / ▽ / ◀ / ▶** to navigate the iPod menu and then press **ⓂENTER** to begin playback of the selected song.

Choices: Playlists (playlists), Artists (artists), Albums (albums), Songs (songs), Genres (genres), Composers (composers), Settings (settings)

- Playlists > Songs
- Artists > Albums > Songs
- Albums > Songs
- Songs
- Genres > Artists > Albums > Songs
- Composers > Albums > Songs
- Settings > Shuffle, Repeat

Shuffle Shuffle

Use this feature to set this unit to play songs or albums in random order.

Choices: Off, Songs, Albums

- Select “Off” to deactivate this feature.
- Select “Songs” to set this unit to play songs in random order.
- Select “Albums” to set this unit to play albums in random order.



When “Shuffle” is set to a setting other than “Off”, “” appears in the top right corner while songs or albums are being shuffled.

Repeat Repeat

Use this feature to set this unit to repeat one song or a sequence of songs.

Choices: Off, One, All

- Select “Off” to deactivate this feature.
- Select “One” to set this unit to repeat one song.
- Select “All” to set this unit to repeat a sequence of songs.



When “Repeat” is set to a setting other than “Off”, “” or “” appears in the top right corner while one song or a sequence of songs are being repeated.

■ The function of the play information display

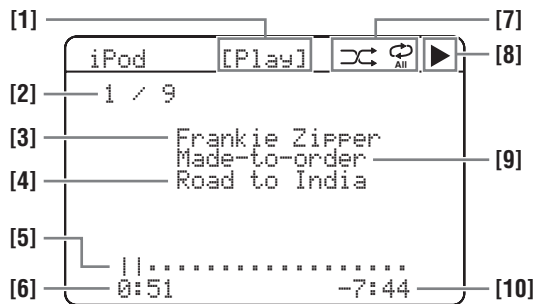

- [1] Playback status
- [2] Track number/total tracks
- [3] Artist name
- [4] Song title
- [5] Progress bar
- [6] Elapsed time
- [7] Shuffle and repeat icons
- [8] **▶** (playback), **||** (pausing), **▶▶** (search forward) and **◀◀** (search backward)
- [9] Name of the album
- [10] Remaining time

Using Bluetooth™ components

You can connect a Yamaha Bluetooth adapter (such as YBA-10, sold separately) to the DOCK terminal of this unit and enjoy the music contents stored in your Bluetooth component (such as a portable music player) without wiring between this unit and the Bluetooth component. You need to perform “pairing” the connected Bluetooth adapter and your Bluetooth component in advance.

Pairing the Bluetooth™ adapter and your Bluetooth™ component

Pairing must be performed when using a Bluetooth component with the Bluetooth adapter connected to this unit for the first time or if the pairing data has been deleted. “Pairing” refers to the operation of registering a Bluetooth component for Bluetooth communications.



- You only need the pairing operation for the first time that you use the Bluetooth component with the Bluetooth adapter.
- Pairing requires operations on this unit and on the other component with which Bluetooth communications are to be established. If necessary, refer to the other component’s operating instructions.

There are two pairing methods: pairing by using “START PAIRING” in “SET MENU” and quick pairing.

■ Pairing by using “SET MENU”

Use this feature to perform pairing with the video monitor. Select “START PAIRING” in “INPUT MENU”. See page 87 for details.

■ Quick pairing

To ensure security, a time limit of 8 minutes is set for the pairing operation. You are recommended to read and fully understand all the instructions before starting.

1 Rotate the **Ⓐ** INPUT selector (or set the operation mode selector to **Ⓔ** SOURCE and then press **Ⓔ** V-AUX/DOCK) to select “V-AUX” as the input source.

2 Turn on the Bluetooth component you want to pair with.

3 Press and hold **Ⓒ** BAND (or **Ⓓ** BAND) for 3 seconds to start pairing.

Once the Bluetooth adapter starts pairing, “Searching...” appears for a moment. While the Bluetooth adapter is in the pairing mode, DOCK indicator flashes in the front panel display.



To cancel the pairing, press **Ⓒ** BAND (or **Ⓓ** BAND) again.

Note

If the Bluetooth adapter is not connected to the DOCK terminal of this unit, “No BT adapter” appears in the front panel display.

4 Check that the Bluetooth component detects the Bluetooth adapter.

If the Bluetooth component detects the Bluetooth adapter, “YBA-10 YAMAHA” (example) appears in the Bluetooth device list.

5 Select the Bluetooth adapter in the Bluetooth device list and then enter the pass key “0000” on the Bluetooth component.

When the pairing procedure is successful, “Completed” appears in the front panel display.

Note

The Yamaha Bluetooth adapter can be paired with up to eight Bluetooth components. When pairing is conducted successfully with a ninth component and the pairing data is registered, the pairing data for the least recently used other component is cleared.

Playback of the Bluetooth™ component

1 Rotate the **Ⓐ** INPUT selector (or set the operation mode selector to **Ⓔ** SOURCE and then press **Ⓔ** V-AUX/DOCK) to select “V-AUX” as the input source.

2 Start playback of your Bluetooth component.

When the connected Bluetooth adapter detects the Bluetooth component, “BT connected” and the DOCK indicator appears in the front panel display.



- When you press **Ⓒ** ENTER on the remote control, the connected Bluetooth adapter searches and connect to the last connected Bluetooth component. If the Bluetooth adapter cannot find the Bluetooth component, “Not found” appears in the front panel display.
- To disconnect the Bluetooth adapter from the Bluetooth component, press **Ⓔ** RETURN.

Recording

Recording adjustments and other operations are performed from the recording components. Refer to the operating instructions for those components.

Caution

The DTS signal is a digital bitstream. Attempting to digitally record the DTS bitstream will result in noise being recorded. Therefore, if you want to use this unit to record sources encoded in DTS, the following considerations and adjustments need to be made. To play DTS-encoded DVDs and CDs (when using a digital audio connection) on your DTS-compatible player, follow its operating instructions to make a setting so that the analog signal will be output from the player.

Notes

- When this unit is set to the standby mode, you cannot record between other components connected to this unit.
- TONE CONTROL (see page 52) and VOLUME settings, the speaker level (see page 52) and the sound field programs (see page 48) do not affect recorded material.
- The source connected to the MULTI CH INPUT jacks of this unit cannot be recorded.
- Digital signals input at the DIGITAL INPUT jacks are not output at the analog AUDIO OUT (REC) jacks for recording. Likewise, analog signals input at the AUDIO IN jacks are not output at the DIGITAL OUTPUT jack. Therefore, if your source component is connected to provide only digital or analog signals, you can only record digital or analog signals.
- A given input source is not output on the same AUDIO OUT (REC) channel.
- S-video and composite video signals pass independently through the video circuits of this unit. Therefore, when recording or dubbing video signals input from a video source component that provides only an S-video or a composite video signal, you can only record an S-video or a composite video signal on your VCR.
- The analog audio signals input at the DOCK terminal can be output at the analog AUDIO OUT (REC) jacks for recording.
- Check the copyright laws in your country to record from CDs, radio, etc. Recording of copyrighted material may infringe copyright laws.



Do a test recording before you start an actual recording.

If you play back a video source that uses scrambled or encoded signals to prevent it from being dubbed, the picture itself may be disturbed due to those signals.

- 1 Turn on all the connected components.**
- 2 Rotate the **Ⓡ** INPUT selector (or press one of the input selector buttons (**Ⓢ**)) to select the source component you want to record from.**
- 3 Start playback on the selected source component or select a broadcast station.**
- 4 Start recording on the recording component.**

Advanced sound configurations

Changing sound field parameter settings

You can enjoy good quality sound with the initial factory settings. Although you do not have to change the initial factory settings, you can change some of the parameters to better suit the input source or your listening room.

Note

You cannot change the sound field parameter values when "MEMORY GUARD" in "OPTION MENU" is set to "ON" (see page 90). If you want to change the sound field parameter values, set "MEMORY GUARD" to "OFF".

1 Turn on the video monitor connected to this unit.

2 Set the operation mode selector to **AMP and then press **PARAMETER** on the remote control.**

The following screen is shown in the OSD.

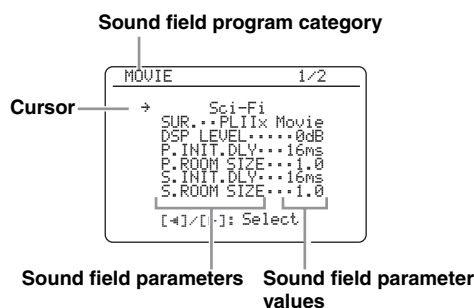

3 Press one of the sound field program selector buttons (25**) repeatedly to select the desired sound field program you want to adjust.**

4 Press **9△ / ▽ to select the desired sound field parameter and then **9**◀ / ▶ to change the selected sound field parameter value.**

- Press **9**▶ to increase the value.
- Press **9**◀ to decrease the value.



- For details about the function and control range of each sound field parameter, see page 66.
- When you set a sound field parameter to a value other than the initial factory settings, an asterisk mark (*) appears by the sound field parameter name in the OSD.
- Repeat steps 3 and 4 as necessary to change other sound field program parameter settings.
- The available sound field parameters for some of the sound field programs may be displayed on more than one page in the OSD. In this case, press **9**△ / ▽ to scroll through pages.
- If you press and hold **9**◀ / ▶ to change the sound field parameter value, the initial factory settings are shown momentarily in the front panel display.
- To initialize the parameters of the selected sound field program, press **9**▽ repeatedly to select "INITIALIZE" and then press **9**▶. Once the confirmation screen appears in the OSD, press **9**▶ to confirm or **9**◀ to cancel the initialization.

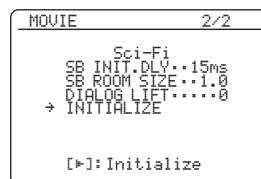

5 Press **25PARAMETER to turn off the sound field parameter screen.**

■ Basic configuration of sound field programs

Each sound field program has some parameters defining the characteristics of the program. To customize the selected sound field program, adjust “DSP LEVEL” and/or “DIALG.LIFT” first, and then try other parameters.



To change sound field parameter settings, see page 64 for details.

Adjusting the effect sound level of the sound field programs (DSP LEVEL)

Sound field programs add effect sounds (DSP effect sounds) to the original source sound to create sound field in the listening room. Use the “DSP LEVEL” parameter to adjust the level of the effect sounds.

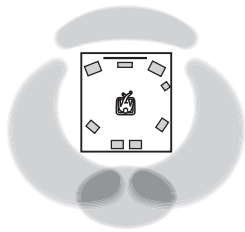

The DSP effect sound level is low.

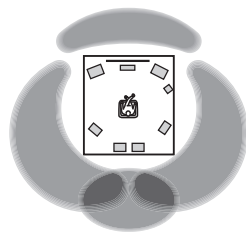

The DSP effect sound level is high.

Adjust “DSP LEVEL” in the following cases:

Increase the value of “DSP LEVEL”

- The effect sound of the selected sound field program is too weak.
- You cannot recognize any difference between the sound field programs.

Decrease the value of “DSP LEVEL”

- The sound is vague.
- You feel that the additional sound effect is excessive.

Control range: -6 dB to +3 dB

Adjusting the vertical dialogue position (DIALG.LIFT)

Use this feature to adjust the vertical position of the dialogues in movies. The ideal position of the dialogues is at the center of the video monitor screen.

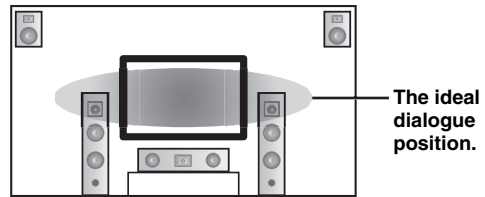

If the dialogues are heard at the lower position of the video monitor screen, increase the value of “DIALG.LIFT”.

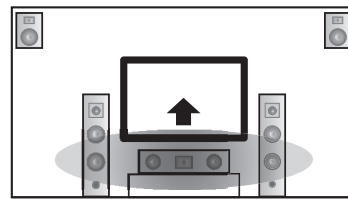

Move up to the ideal dialogue position.

Choices: 0, 1, 2, 3, 4, 5

“0” (initial setting) is the lowest position, and “5” is the highest position.

Notes

- “DIALG.LIFT” is only available only “EXTRA SP ASSIGN” is set to “PRESENCE” (see page 72).
- You cannot move the dialogue position down from the initial dialogue position.

■ Sound field parameters for the advanced configurations

Use the following sound field parameters to customize sound field programs in detail.



To change sound field parameter settings, see page 64 for details.

Sound field parameter	Features
INIT.DLY P.INIT.DLY S.INIT.DLY SB INI.DLY	<p>Initial delay. Presence, surround, and surround back sound field initial delay. Changes the apparent distance from the source sound by adjusting the delay between the direct sound and the first reflection heard by the listener. The smaller the value, the closer the sound source seems to the reflection face.</p> <p> When you adjust the initial delay parameters, we also recommend that you adjust the corresponding room size parameters likewise. This adjustment is especially effective for the CINEMA DSP programs.</p>
<p>Control range: 1 to 99 ms (INIT.DLY and P.INIT.DLY) 1 to 49 ms (S.INIT.DLY and SB INI.DLY)</p>	

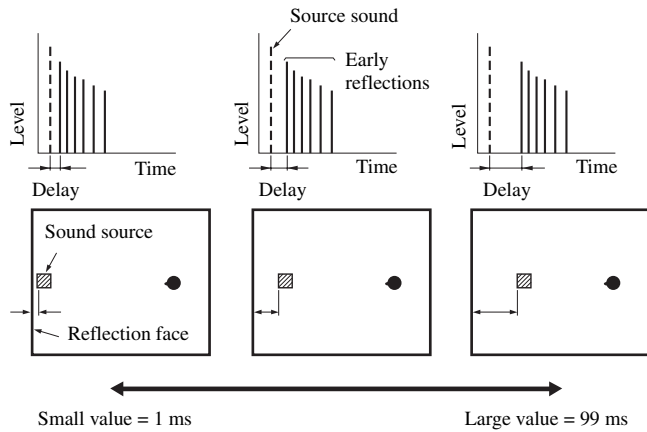

Sound field parameter	Features
-----------------------	----------

ROOM SIZE
 P.ROOM SIZE
 S.ROOM SIZE
 SB ROOM SIZE

Room size. Presence, surround, and surround back room size. Adjusts the apparent size of the surround sound field. The larger the value, the larger the surround sound field becomes. As the sound is repeatedly reflected around a room, the larger the hall is, the longer the time between the original reflected sound and the subsequent reflections. By controlling the time between the reflected sounds, you can change the apparent size of the virtual venue. Changing this parameter from one to two doubles the apparent length of the room.



When you adjust the room size parameters, we also recommend that you adjust the corresponding initial delay parameters likewise. This adjustment is especially effective for the CINEMA DSP programs.

Control range: 0.1 to 2.0

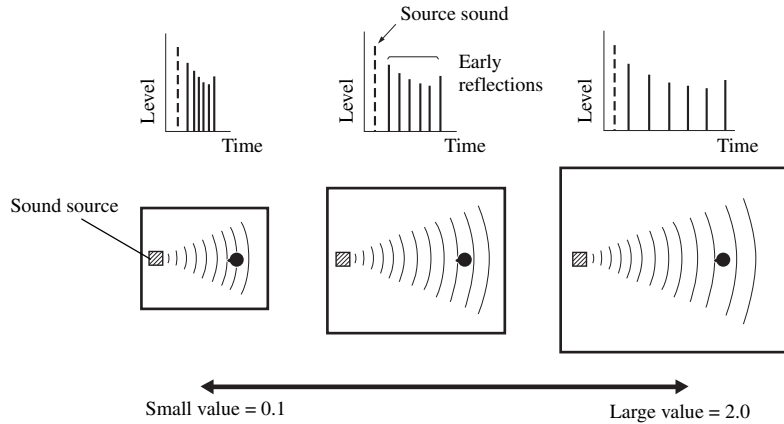

LIVENESS
 S.LIVENESS
 SB LIVENESS

Liveness. Surround and surround back sound field liveness. Adjusts the reflectivity of the virtual walls in the hall by changing the rate at which the early reflections decay. The early reflections of a sound source decay much faster in a room with acoustically absorbent wall surfaces than in one which has highly reflective surfaces. A room with acoustically absorbent surfaces is referred to as “dead”, while a room with highly reflective surfaces is referred to as “live”. This parameter lets you adjust the early reflection decay rate and thus the “liveness” of the room.

Control range: 0 to 10

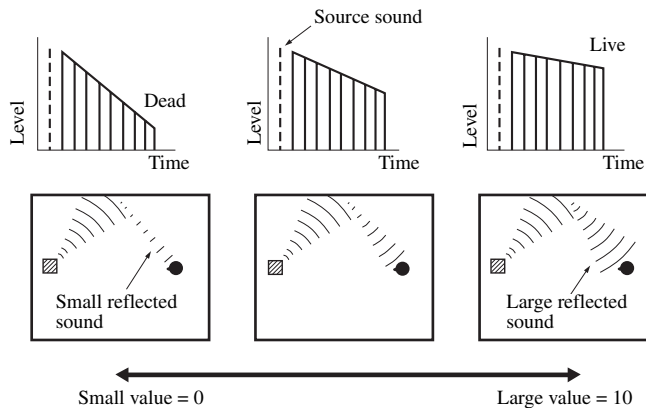

Sound field parameter	Features
-----------------------	----------

REV.TIME

Reverberation time. Adjusts the amount of time taken for the dense, subsequent reverberation sound to decay by 60 dB at 1 kHz. This changes the apparent size of the acoustic environment over an extremely wide range. Set a longer reverberation time for “dead” sources and listening room environments, and a shorter time for “live” sources and listening room environments.

Control range: 1.0 to 5.0 s

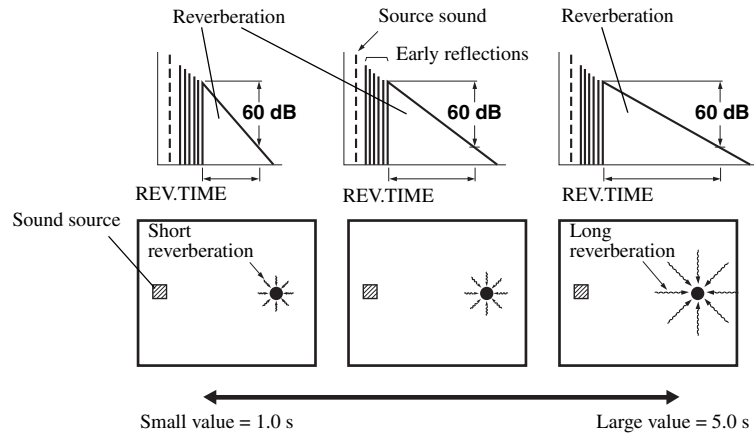

REV.DELAY

Reverberation delay. Adjusts the time difference between the beginning of the direct sound and the beginning of the reverberation sound. The larger the value, the later the reverberation sound begins. A later reverberation sound makes you feel as if you are in a larger acoustic environment.

Control range: 0 to 250 ms

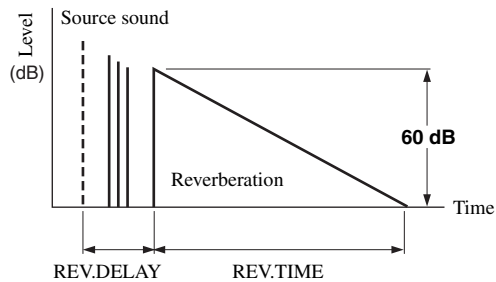

REV.LEVEL

Reverberation level. Adjusts the volume of the reverberation sound. The larger the value, the stronger the reverberation becomes.

Control range: 0 to 100%

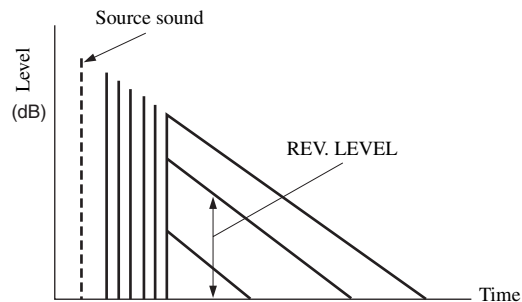

Sound field parameter	Features
DIRECT ("2ch Stereo" only)	<p>2-channel stereo direct. Bypasses the decoders and the DSP processors of this unit for pure hi-fi stereo sound when playing 2-channel analog sources.</p> <hr/> <p>Choices: AUTO, OFF</p> <hr/> <p></p> <ul style="list-style-type: none"> • Select "AUTO" to bypass the decoders, the DSP processors and the tone control circuitry only when "BASS" and "TREBLE" are set to 0 dB (see page 52). • Select "OFF" not to bypass the decoders, the DSP processors and the tone control circuitry when "BASS" and "TREBLE" are set to 0 dB. • When multi-channel signals (Dolby Digital and DTS) are input, they are downmixed to 2 channels and output from the front left and right speakers. • The low-frequency signals of the front left and right channels are redirected to the subwoofer in the following cases: <ul style="list-style-type: none"> – "LFE/BASS OUT" is set to "BOTH" (see page 77). – "FRONT SP" is set to "SMALL" (see page 78) and "LFE/BASS OUT" is set to "SWFR" (see page 77).
CT LEVEL SL LEVEL SR LEVEL SB LEVEL PL LEVEL PR LEVEL ("7ch Stereo" only)	<p>7-channel stereo center, surround left, surround right, surround back, presence left and presence right levels. Adjusts the volume level of each channel in the 7-channel stereo mode. The available parameters differ depending on the setting of the speakers.</p> <hr/> <p>Control range: 0 to 100%</p>
EFFECT LEVEL ("Straight Enhancer" and "7ch Enhancer" only)	<p>Straight and 7-channel Compressed Music Enhancer effect level. The high-frequency signals of some sources may be emphasized too much. In this case, set the effect level to "LOW".</p> <hr/> <p>Choices: HIGH, LOW</p> <hr/> <ul style="list-style-type: none"> • Select "HIGH" for a high effect level. • Select "LOW" for a low effect level.

■ Selecting decoders used with sound field programs (SUR.)

Use this feature to select the desired decoder used with MOVIE sound field programs (except "Mono Movie"). See page 49 for details about MOVIE sound field program.

Available decoders

Decoder	Functions
PLIIx Movie PLII Movie	Dolby Pro Logic IIx (or Dolby Pro Logic II) processing for movie sources. The Pro Logic IIx decoder is not available when "SUR.B L/R SP" is set to "NONE" (see page 78).
Neo:6 Cinema	DTS processing for movie sources.

Selecting decoders

■ Selecting decoders for 2-channel sources (surround decode mode)

Use this feature to play back sources with selected decoders. You can play back 2-channel sources on multi-channels.

Set the operation mode selector to **AMP and then press **SUR. DECODE** repeatedly on the remote control to select the desired surround decoder.**

You can select from the following modes depending on the type of source you are playing and your personal preference.

■ Decoder descriptions (SUR.)

Decoder	Descriptions
Pro Logic	Dolby Pro Logic processing for any sources.
PLIIx Movie PLII Movie	Dolby Pro Logic Ix (or Dolby Pro Logic II) processing for movie sources. The Pro Logic Ix decoder is not available when "SUR.B L/R SP" is set to "NONE" (see page 78).
PLIIx Music PLII Music	Dolby Pro Logic Ix (or Dolby Pro Logic II) processing for music sources. The Pro Logic Ix decoder is not available when "SUR.B L/R SP" is set to "NONE" (see page 78).
PLIIx Game PLII Game	Dolby Pro Logic Ix (or Dolby Pro Logic II) processing for game sources. The Pro Logic Ix decoder is not available when "SUR.B L/R SP" is set to "NONE" (see page 78).
Neo:6 Cinema	DTS processing for movie sources.
Neo:6 Music	DTS processing for music sources.



When you select the surround decode mode for Dolby Digital, DTS or DTS 96/24 sources, this unit automatically selects "SURROUND DECODE Dolby Digital", "SURROUND DECODE DTS" or "SURROUND DECODE DTS 96/24" program.



You can change the decoder parameter settings (see page 71). Set the operation mode to **AMP** and then press **PARAMETER** to display the decoder parameters in the OSD. Press **▲/▼** repeatedly to select the desired decoder parameter and then press **◀/▶** repeatedly to change the value of the selected parameter.

Decoder parameter descriptions

Decoder parameter	Features
PANORAMA ("PLIIX Music" and "PLII Music" only)	<p>Pro Logic IIX Music and Pro Logic II Music panorama. Sends stereo signals to the surround speakers as well as the front speakers for a wraparound effect.</p> <hr/> <p>Choices: OFF, ON</p>
DIMENSION ("PLIIX Music" and "PLII Music" only)	<p>Pro Logic IIX Music and Pro Logic II Music dimension. Adjusts the sound field either towards the front or towards the rear.</p> <hr/> <p>Control range: -3 (towards the rear) to +3 (towards the front)</p> <hr/> <p>Initial setting: STD (standard)</p>
CENTER WIDTH ("PLIIX Music" and "PLII Music" only)	<p>Pro Logic IIX Music and Pro Logic II Music center width. Moves the center channel output completely towards the center speaker or towards the front left and right speakers. A larger value moves the center channel output towards the front left and right speakers.</p> <hr/> <p>Control range: 0 (center channel sound is output only from the center speaker) to 7 (center channel sound is output only from the front left and right speakers)</p> <hr/> <p>Initial setting: 3</p>
C. IMAGE ("Neo:6 Music" only)	<p>DTS Neo:6 Music center image. Adjusts the front left and right channel output relative to the center channel to make the center channel more or less dominant as necessary.</p> <hr/> <p>Control range: 0.0 (center channel sound is output only from the front left and right speakers) to 1.0 (center channel sound output only from the center speaker)</p> <hr/> <p>Initial setting: 0.3</p>

Customizing this unit (MANUAL SETUP)

You can use the following parameters in “SET MENU” to adjust a variety of system settings and customize the way this unit operates. Change the initial settings (indicated in bold under each parameter) to reflect the needs of your listening environment.

■ Auto setup AUTO SETUP

Use this feature to automatically adjust speaker and system parameters (see page 32).

■ Manual setup MANUAL SETUP

Use this feature to manually adjust speaker and system parameters.

Basic menu 1 BASIC MENU

Menu	Parameter	Functions	Page
A) SPEAKER SET	EXTRA SP ASSIGN	Selects the function of the speakers connected to the EXTRA SP speaker terminal.	77
	LFE/BASS OUT	Selects the speakers that output the LFE (low-frequency effect) and the low-frequency signals.	77
	FRONT SP	Selects the size of the front speakers.	78
	CENTER SP	Selects the size of the center speaker.	78
	SUR. L/R SP	Selects the size and number of the surround speakers.	78
	SUR. B L/R SP	Selects the size and number of the surround back speakers.	78
	CROSS OVER	Selects the crossover frequency of all the speakers set to “SML” (or “SMALL”) in “SPEAKER SET” (see page 78).	79
	SUBWOOFER PHASE	Switches the phase of your subwoofer if bass sounds are lacking or unclear.	79
B) SP LEVEL	FR. L/FR. R/CNTR/ SUR. L/SUR. R/ SBL/SBR/SWFR/ PR. L/PR. R	Adjust the balance the speaker levels between the front left or surround left speakers and each speaker selected in “SPEAKER SET” (see page 77).	79
C) SP DISTANCE	UNIT	Selects the unit to adjust the speaker distance.	80
	FRONT L/FRONT R/ CENTER/SUR. L/ SUR. R/SBL/SBR/ SWFR/PRNS L/ PRNS R	Adjust the distance of each speaker and the delay applied to the respective channel.	80
D) TEST TONE	—	Turns the test tone output on or off for the “SPEAKER SET”, “SP LEVEL”, and “SP DISTANCE” settings.	80

Volume menu 2 VOLUME MENU

Parameter	Functions	Page
ADAPTIVE DRC	Selects whether this unit automatically adjusts the dynamic range in conjunction with the volume level or not.	81
ADAPTIVE DSP LEVEL	Selects whether this unit adjusts the DSP effect level automatically in conjunction with the volume level or not.	81
MUTE TYPE	Adjusts how much the mute function reduces the output volume (see page 45).	81
MAX VOL.	Sets the maximum volume level of the main zone.	81
INIT. VOL.	Sets the volume level of the main zone when the power of this unit is turned on.	81

Sound menu 3 SOUND MENU

Menu	Parameter	Functions	Page
A)EQUALIZER	EQ TYPE SELECT	Selects the type of equalizer.	82
	GEQ	Adjusts the tonal quality of the speakers when you set "EQ TYPE SELECT" to "GEQ".	82
	TEST	Selects whether this unit outputs the test tone while making adjustments of "GEQ" or not.	82
B)LFE LEVEL	SPEAKER	Adjusts the speaker LFE level.	83
	HEADPHONE	Adjusts the headphone LFE level.	83
C)DYNAMIC RANGE	SPEAKER	Adjusts the amount of the dynamic range compression of the speakers.	83
	HEADPHONE	Adjusts the amount of the dynamic range compression of the headphones.	83
D)LIPSYNC	HDMI AUTO	Selects whether this unit activates the automatic audio and video synchronization function (automatic lip sync) or not.	84
	AUTO	Makes fine adjustments of the audio delay when the automatic audio and video synchronization function is active.	84
	MANUAL	Adjustment the audio delay manually when the connected video monitor is not compatible with the automatic audio and video synchronization function or "HDMI AUTO" is set to "OFF".	84
E)EXTD SUR.	—	Use this feature to enjoy 6.1/7.1-channel playback for multi-channel sources using the Dolby Pro Logic IIx, Dolby Digital EX, or DTS-ES decoders by using the connected surround back speakers.	84

Input menu 4 INPUT MENU

Note

Some parameters described below may not be available for all input sources and some parameters are only available for specific input sources.

Parameter	Functions	Page
I/O ASSIGNMENT	Assigns the input/output jacks according to the component to be used if the initial settings of this unit do not correspond to your needs.	85
INPUT RENAME	Changes the name of the input source that appears in the OSD and in the front panel display.	86
VOL. TRIM	Adjusts the level of the signal input at each jack.	86
DECODER MODE	Switches the decoder activation mode. You can designate the reassigned digital input jacks for DTS signals.	86
STANDBY CHARGE	Selects whether this unit charges the battery of the stationed iPod or not when this unit is in the standby mode (see page 29).	86
START PAIRING	Pair the connected Yamaha Bluetooth adapter (such as YBA-10, sold separately) with a Bluetooth component (see page 62).	87
BGV	Selects the video source played back in the background of the sources input at the MULTI CH INPUT jacks.	87
INPUT CH	Selects the number of channels input from an external decoder.	87
FRONT	Selects the analog jacks at which the front channel signals from an external decoder are input when you set "INPUT CH" to "8CH".	87

Option menu 5 OPTION MENU

Menu	Parameter	Functions	Page
A>DISPLAY SET	DIMMER	Adjusts the brightness of the front panel display.	88
	OSD SHIFT	Adjusts the vertical position of the OSD.	88
	OSD-SOURCE	Sets the amount of time to display the iPod menu in the video monitor after you perform a certain operation.	88
	OSD-AMP	Sets the amount of time to display the status information screen after you perform a certain operation.	88
	FL SCROLL	Selects the mode to display the information of the iPod in the front panel display.	88
B>VIDEO SET	VIDEO CONV.	Selects whether to convert the video signals input at the VIDEO, S VIDEO, and COMPONENT VIDEO jacks.	88
	HDMI RES.	Selects whether this unit activates the HDMI up-conversion of the analog video signals input at the VIDEO, S VIDEO, and COMPONENT VIDEO jacks so that the up-scaled video signals are output at the HDMI OUT jack.	89
	HDMI ASPECT	Adjusts the aspect ratio for analog video signals output at the HDMI OUT jack.	89
C>MEMORY GUARD	—	Prevents accidental changes to sound field program parameter values and other system settings.	90

Menu	Parameter	Functions	Page
D)INIT. CONFIG	AUDIO SELECT	Designates the default audio input jack select setting for the input sources connected to the DIGITAL INPUT jacks when you turn on the power of this unit.	90
	DECODER MODE	Designates the default decoder mode for the input sources connected to the DIGITAL INPUT jacks when you turn on the power of this unit.	90
	EXTD SUR.	Designates the extended decoder mode for the input sources connected to the DIGITAL INPUT jacks when you turn on the power of this unit.	90
E)HDMI SET	S.AUDIO	Selects whether to play back HDMI audio signals on this unit or on another HDMI component connected to the HDMI OUT jack.	91
F)ZONE2 SET	MAX VOL.	Adjusts the maximum volume level in Zone 2.	91
	INIT. VOL.	Sets the volume level of Zone 2 when you turn on the power of this unit.	91

■ Signal information SIGNAL INFO

Use this feature to check audio and video signal information (see page 46).

Using SET MENU

Use the remote control to access and adjust each parameter.



- You can change the “SET MENU” parameters while this unit is reproducing sound.
- If you press **ⓂPARAMETER** during the “SET MENU” operation, the “SET MENU” operation is canceled.
- Press **ⓂRETURN** to return to the previous menu level.

1 Set the operation mode selector to **ⓂAMP and then press **ⓂSET MENU** to enter “SET MENU”.**

The top “SET MENU” display appears in the OSD.

2 Press **ⓂΔ / ▽ to select “MANUAL SETUP”.**

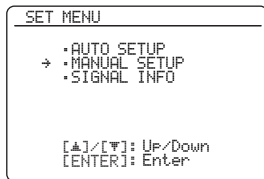

3 Press **ⓂENTER to enter “MANUAL SETUP”.**

The “MANUAL SETUP” display appears in the OSD.

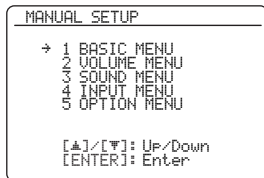

4 Press **ⓂΔ / ▽ repeatedly and then press **ⓂENTER** to select and enter the desired menu.**

The following displays are examples where “SOUND MENU” is selected.

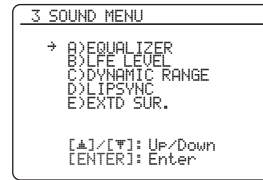

5 Press **ⓂΔ / ▽ repeatedly and then press **ⓂENTER** to select and enter the desired submenu.**

The following display is an example where “LFE LEVEL” is selected.

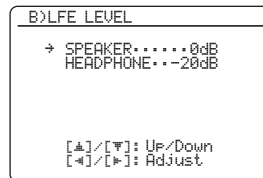

6 Press **ⓂΔ / ▽ to select the desired parameter and then **Ⓜ◀ / ▶** to change the parameter settings.**

- Press **Ⓜ▶** to increase the value.
- Press **Ⓜ◀** to decrease the value.

7 Press **ⓂSET MENU to exit from “SET MENU”.**

1 BASIC MENU

Use this feature to manually adjust the basic speaker settings. Most of the “BASIC MENU” parameters are set automatically when you run the automatic setup.



☀️ Set “TEST TONE” to “ON” to output the test tone for the “SPEAKER SET”, “SP LEVEL” and “SP DISTANCE”.

■ Speaker settings A)SPEAKER SET

☀️ To select the desired parameter, press Ⓞ/▽ repeatedly.

Extra speaker assignment EXTRA SP ASSIGN

Selects the function of the speakers connected to the EXTRA SP terminals.



Choice	Descriptions
ZONE2	Select this setting when you use the Zone 2 speakers (see page 105).
FRONT B	Select this setting when you use another front speaker system in the main zone (see page 43).
ZONE B	Select this setting when you use another front speaker system in another room (see page 43).
PRESENCE	Select this setting when you use the presence speakers (see page 13).
NONE	Select this setting when you do not use the EXTRA SP terminals.

Notes

- This parameter shares the value with the “EXTRA SP ASSIGN” parameter in “AUTO SETUP” (see page 33).
- If you select “ON” in “BI-AMP” (see page 110), you cannot select “PRESENCE” or “ZONE2” in “EXTRA SP ASSIGN”.
- After changing the “EXTRA SP ASSIGN” setting, carry out “AUTO SETUP” again (see page 32).

LFE/bass out LFE/BASS OUT

Use this feature to select the speakers that output the LFE (low-frequency effect) and the low-frequency signals.

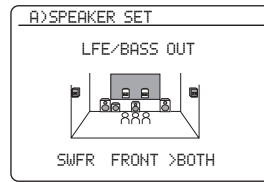

LFE signals output

Choice	Subwoofer(s) and speakers		
	Subwoofer(s)	Front speakers	Other speakers
BOTH	Output	No output	No output
SWFR	Output	No output	No output
FRONT	No output	Output	No output

Low-frequency signals output

Choice	Subwoofer(s) and speakers		
	Subwoofer(s)	Front speakers	Other speakers
BOTH	*1	*2	*3
SWFR	*4	*3	*3
FRONT	No output	*1	*3

- *1 Output(s) the low-frequency signals of the front channels and other speakers set to “SMALL”.
- *2 Always output the low-frequency signals of the front channels.
- *3 Output the low-frequency signals if the speakers are set to “LARGE”.
- *4 Outputs the low-frequency signals of the speakers set to “SMALL” or “NONE”.

Measure for the speaker size

- The woofer section of a speaker is
- 16 cm (6.5 in) or larger: large
 - smaller than 16 cm (6.5 in): small

Front speakers FRONT SP

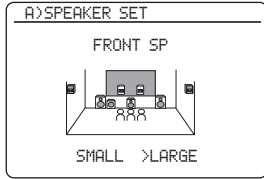

Choice	Descriptions
LARGE	Select this setting when the front speakers are large.
SMALL	Select this setting when the front speakers are small.

Note

When "LFE/BASS OUT" is set to "FRONT", you can select only "LARGE" in "FRONT SP". If the value of "FRONT SP" is set to other than "LARGE" in advance, this unit change the value to "LARGE" automatically.

Center speaker CENTER SP

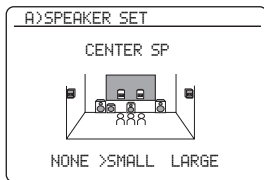

When the center speaker is large:

Select "LARGE" (large).

When the center speaker is small:

Select "SMALL" (small).

When you do not use the center speaker:

Select "NONE" (none). The center channel signals are directed to the front left and right speakers.

Choice	Descriptions
LARGE	Select this setting when the center speaker is large.
SMALL	Select this setting when the center speaker is small.
NONE	Select this setting when you do not use the center speaker. The center channel signals are directed to the front left and right speakers.

Surround left/right speakers SUR. L/R SP

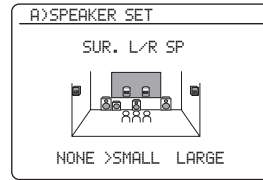

Choice	Descriptions
LARGE	Select this setting when the surround speakers are large.
SMALL	Select this setting when the surround speakers are small.
NONE	Select this setting when you do not use the surround speakers. This unit is set to the Virtual CINEMA DSP mode (see page 51), and "SUR.B L/R SP" is automatically set to "NONE".

Surround back left/right speakers

SUR.B L/R SP

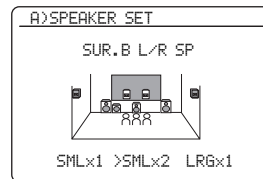

Choice	Descriptions
LRGx1	Select this setting when the single surround back speaker is large.
LRGx2	Select this setting when the surround back left and right speakers are Large.
SMLx1	Select this setting when the single surround back speaker is small.
SMLx2	Select this setting when the surround back left and right speakers are small.
NONE	Select this setting when you do not use the surround back speakers. The surround back channel signals are directed to the surround left and right speakers.

Note

If the Dolby TrueHD audio signals are input and "SUR.B L/R SP" is set to "NONE", the left and right surround back channels are not directed to the surround left and right speakers.

Bass cross over CROSS OVER

Use this feature to select the crossover frequency of all the speakers set to “SML” (or “SMALL”) in “SPEAKER SET” (see page 77). All frequencies below the selected frequency will be sent to the subwoofer(s) or front speakers depending on the setting of “LFE/BASS OUT” in “SPEAKER SET” (see page 77).

Choices: 40Hz, 60Hz, **80Hz**, 90Hz, 100Hz, 110Hz, 120Hz, 160Hz, 200Hz

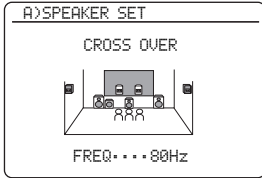

If your subwoofer can adjust the output volume and the crossover frequency, set the volume to about half way (or slightly less) and set the crossover frequency to the maximum.

Subwoofer phase SUBWOOFER PHASE

Use this feature to switch the phase of your subwoofer if bass sounds are lacking or unclear.

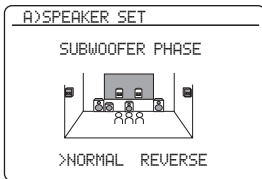

Choice	Functions
NORMAL (normal)	Does not change the phase of your subwoofer.
REVERSE (reverse)	Sets the phase of your subwoofer to reverse.

■ **Speaker level** B>SP LEVEL

Use this feature to manually balance the speaker levels between the front left or surround left speakers and each speaker selected in “SPEAKER SET” (see page 77).

Control range: -10.0 dB to +10.0 dB

Control step: 0.5 dB

Initial setting:

FR.L/FR.R/SWFR/PR.L/PR.R: 0 dB

CNTR/SUR.L/SUR.R/SBL/SBR: -1.0 dB

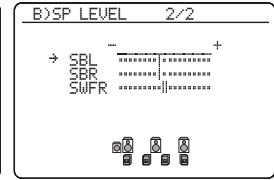
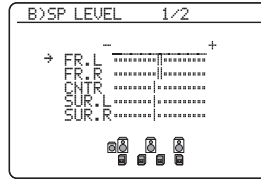

SP LEVEL	Adjusted speaker
FR.L	Front left speaker
FR.R	Front right speaker
CNTR	Center speaker
SUR.L	Surround left speaker
SUR.R	Surround right speaker
SBL	Surround back left speaker
SBR	Surround back right speaker
SWFR	Subwoofer
PR.L	Presence left speaker
PR.R	Presence right speaker



- If your subwoofer can adjust the output volume and the crossover frequency, set the volume to about half way (or slightly less) and set the crossover frequency to the maximum.
- Set “TEST TONE” to “ON” to output the test tone for the “SPEAKER LEVEL” setting (see page 80).

Notes

- The available speaker channels differ depending on the setting of the speakers.
- Instead of “SBL” and “SBR”, “SB” is displayed if “SUR. B L/R SP” is set to either “SMLx1” or “LRGx1” (see page 78).

■ Speaker distance C)SP DISTANCE

Use this feature to manually adjust the distance of each speaker and the delay applied to the respective channel. Ideally, each speaker should be the same distance from the main listening position. However, this is not possible in most home situations. Thus, a certain amount of delay must be applied to the sound from each speaker so that all sounds will arrive at the listening position at the same time.

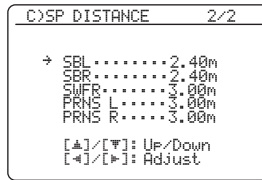
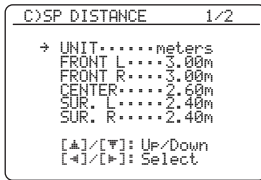

Unit for the speaker distance adjustment UNIT

Initial setting:

[U.S.A. and Canada models]: feet (ft)

[Other models]: meters (m)

Choice	Functions
meters (m)	Adjusts speaker distances in meters.
feet (ft)	Adjusts speaker distances in feet.

Speaker distances

Control range: 0.30 to 24.00 m (1.0 to 80.0 ft)

Control step: 0.10 m (0.5 ft)

Initial setting:

FRONT L/FRONT R/SWFR/PRNS L/

PRNS R: 3.00 m (10.0 ft)

CENTER: 2.60 m (8.5 ft)

SUR. L/SUR. R/SBL/SBR: 2.40 m (8.0 ft)

SP DISTANCE	Adjusted speaker
FRONT L	Front left speaker
FRONT R	Front right speaker
CENTER	Center speaker
SUR. L	Surround left speaker
SUR. R	Surround right speaker
SBL	Surround back left speaker
SBR	Surround back right speaker
SWFR	Subwoofer
PRNS L	Presence left speaker
PRNS R	Presence right speaker

Notes

- The available speaker channels differ depending on the setting of the speakers.
- Instead of “SBL” and “SBR”, “SUR.B” is displayed if “SUR.B L/R SP” is set to either “SMLx1” or “LRGx1” (see page 78).

■ Test tone D)TEST TONE

Turns the test tone output on or off for the “SPEAKER SET”, “SP LEVEL”, and “SP DISTANCE” settings.

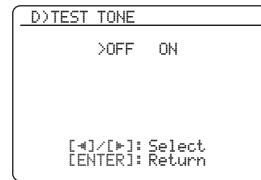

Choice	Functions
OFF	This unit does not output the test tone for the “SPEAKER SET”, “SP LEVEL”, and “SP DISTANCE” settings.
ON	This unit outputs the test tone for the “SPEAKER SET”, “SP LEVEL”, and “SP DISTANCE” settings.



If you use a handheld sound pressure level meter, hold at arm's length and point upwards so that the meter is in the listening position. With the meter set to the 70 dB scale and to C SLOW, calibrate each speaker to 75 dB.

Note

This function is automatically turned off if you exit from “BASIC MENU”.

2 VOLUME MENU

Use this menu to manually adjust the various volume settings.

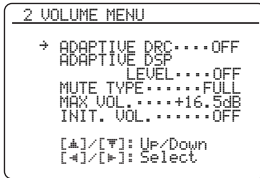

Adaptive dynamic range control

ADAPTIVE DRC

Use this feature to adjust the dynamic range in conjunction with the volume level. This feature is useful when you are listening at lower volumes or at night. When “ADAPTIVE DRC” is set to “AUTO”, this unit controls the dynamic range as follows:

- If the VOLUME setting is low: the dynamic range is narrow
- If the VOLUME setting is high: the dynamic range is wide

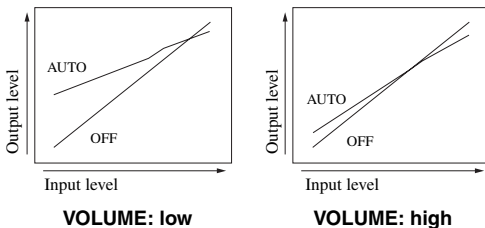

Choice	Functions
AUTO	Adjusts the dynamic range automatically.
OFF	Does not adjust the dynamic range automatically.



- You can also adjust the dynamic range of the bitstream signal sources by using “DYNAMIC RANGE” in “SOUND MENU” (see page 83).
- This function is also useful for listening with your headphones.

Note

The adaptive dynamic range control feature does not function when this unit is in the Pure Direct mode (see page 52).

Adaptive DSP level ADAPTIVE DSP LEVEL

Use this feature to make fine adjustments of the DSP effect level (see page 65) automatically in conjunction with the volume level.

Choice	Functions
AUTO	Adjusts the DSP effect level in conjunction with the volume level.
OFF	Does not adjust the DSP effect level automatically.

Note

Even if you set “ADAPTIVE DSP LEVEL” to “AUTO”, this unit does not change but the fine-tunes the specified value of “DSP LEVEL” (see page 65).

Muting type MUTE TYPE

Use this feature to adjust how much the mute function reduces the output volume (see page 45).

Choice	Functions
FULL	Mutes all the audio output.
-20dB	Reduces the current volume by 20 dB.

Maximum volume MAX VOL.

Use this feature to set the maximum volume level in the main zone. This feature is useful to avoid the unexpected loud sound by mistake. For example, the original volume range is -80.0 dB to +16.5 dB. However, when “MAX VOL.” is set to -5.0 dB, the volume range becomes -80.0 dB to -5.0 dB.

Control range: -30.0 dB to +15.0 dB, **+16.5 dB**

Control step: 5.0 dB

Notes

- When this unit is in the auto setup procedure, the volume level is automatically set to 0 dB regardless of the current “MAX VOL.” setting.
- The “MAX VOL.” setting takes priority over the initial volume setting. For example, if “INI.VOL.” is set to -20.0 dB and “MAX VOL.” is set to -30.0 dB, the volume level is automatically set to -30.0 dB when you turn on the power of this unit next time.
- Use “MAX VOL.” in “ZONE SET” to set the initial volume level in Zone 2.

Initial volume INIT. VOL.

Use this feature to set the volume level of the main zone when the power of this unit is turned on.

Choices: **OFF**, MUTE, -80.0 dB to +16.5 dB

Control step: 0.5 dB

Note

The “MAX VOL.” setting takes priority over the initial volume setting.

3 SOUND MENU

Use this feature to adjust the audio parameters.

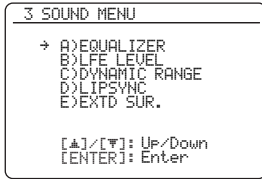

■ Equalizer A)EQUALIZER

Use this feature to select the parametric equalizer or the graphic equalizer.

Equalizer type select EQ TYPE SELECT

Use this feature to select the type of equalizer.

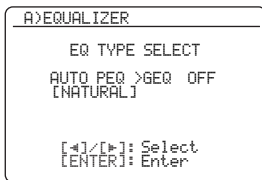

Choice	Functions
AUTO PEQ	Uses the parametric equalizer adjusted in "AUTO SETUP" (see page 33).
GEQ	Adjusts the built-in 7-frequency band graphic equalizer so that the tonal quality of the speakers matches. Press Ⓢ ENTER to display the graphic equalizer screen.
OFF	Deactivates the equalizing feature.



Currently applied parametric equalizer type (see page 33) appears under "AUTO PEQ".

Note

You can select "AUTO PEQ" only when you carry out "AUTO SETUP" in advance (see page 32). In this case, "AUTO PEQ" is automatically selected as the default setting.

Graphic equalizer GEQ

Use this feature to match the tonal quality of the center, surround L/R and surround back L/R, and surround back speakers with that of the front L/R speakers. You can adjust 7 frequency bands (63 Hz, 160 Hz, 400 Hz, 1 kHz, 2.5 kHz, 6.3 kHz, 16 kHz).

Control range: -6.0 dB to +6.0 dB

Control step: 0.5 dB

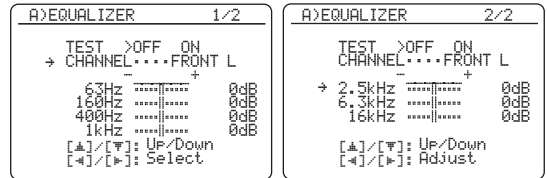

Press **Ⓢ**▲/▼ to select a frequency band and **Ⓢ**◀/▶ to adjust the selected frequency band.

Note

The "GEQ" parameter can be adjusted only when "GEQ" is selected in "EQ TYPE SELECT".

Test tone TEST

Use this feature to make adjustments of "GEQ" while listening to a test tone. To select "TEST", press **Ⓢ**▲/▼ repeatedly in the graphic equalizer screen.

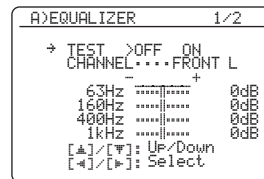

Choice	Functions
OFF	Does not output test tones and output the currently selected source component.
ON	Outputs test tones from the selected speakers.

■ **Low-frequency effect level**

B>LFE LEVEL

Use this feature to adjust the output level of the LFE (low-frequency effect) channel according to the capacity of your subwoofer or headphones. The LFE channel carries low-frequency special effects which are only added to certain scenes. This setting is effective when the input signal contains the LFE channel.

Control range: -20 to 0 dB

Control step: 1 dB

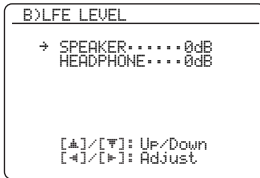

Speakers SPEAKER

Adjusts the speaker LFE level.

Headphones HEADPHONE

Adjusts the headphone LFE level.

Note

Depending on the settings of “LFE/BASS OUT” (see page 77), some signals may not be output at the SUBWOOFER PRE OUT jack.

■ **Dynamic range** C>DYNAMIC RANGE

Use this feature to select the amount of dynamic range compression to be applied to your speakers or headphones. This setting is effective only when this unit is decoding bitstream signals.

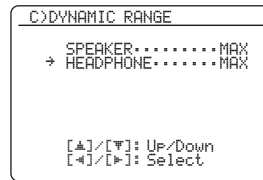

Speakers SPEAKER

Adjusts the dynamic range compression for the speakers.

Headphones HEADPHONE

Adjusts the dynamic range compression for the headphones.

Choice	Functions
MIN/AUTO	<ul style="list-style-type: none"> • MIN: Adjusts the dynamic range to narrow when this unit is decoding bitstream signals (except Dolby TrueHD). • AUTO: Adjusts the dynamic range according to the instruction of the input source signals when this unit is decoding Dolby TrueHD signals.
STD	Adjusts the dynamic range to medium. When this unit is decoding Dolby TrueHD signals, the dynamic range control is always active regardless of the instruction of the input source signals.
MAX	Preserves the greatest amount of dynamic range.

■ **Audio and video synchronization (lip sync)** D>LIPSYNC

Use this feature to adjust the audio and video synchronization.

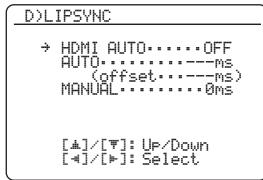

HDMI automatic lip sync mode HDMI AUTO

If the connected video monitor is connected to the HDMI OUT jack of this unit and compatible with the automatic audio and video synchronization function (automatic lip sync), this unit adjusts the audio and video synchronization automatically. Use this feature to activate or deactivate the automatic lip sync.

Choices: ON, **OFF**

If the connected video monitor is compatible with the automatic lip sync:

Select “ON”. Use “AUTO” to make fine adjustments of the audio and video synchronization.

If the video monitor is not compatible with the automatic lip sync or you do not want to use the automatic lip sync:

Select “OFF”. Use “MANUAL” to adjust the audio and video synchronization.

Auto delay AUTO

Use this feature to make fine adjustments of the audio and video synchronization when you set “HDMI AUTO” to “ON”.

Control range: **0** to 240 ms

Control step: 1 ms



“offset” indicates the difference between the value of the audio delay that this unit sets automatically and the value of the audio delay that you set in “AUTO”. This unit stores the value of “offset” and applies the value to other automatic lip sync compatible video monitors.

Manual delay MANUAL

Use this feature to adjust the delay of the sound output manually to synchronize audio with video images when you set “HDMI AUTO” to “OFF”.

Control range: **0** to 240 ms

Control step: 1 ms

■ **Extended surround** E>EXTD SUR.

Use this feature to enjoy 6.1/7.1-channel playback for multi-channel sources using the Dolby Pro Logic IIx, Dolby Digital EX, or DTS-ES decoders by using the connected surround back speakers.

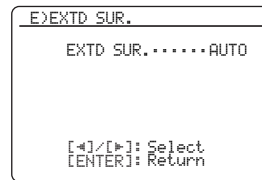

Choice	Functions
AUTO	Activates the optimum decoder to play back signals in 6.1/7.1 channels when this unit recognizes a signal flag being input.
PLIIxMovie	Plays back Dolby Digital or DTS signals in 7.1 channels using the Pro Logic IIx movie decoder.
PLIIxMusic	Plays back Dolby Digital or DTS signals in 6.1/7.1 channels using the Pro Logic IIx music decoder.
EX/ES	Plays back Dolby Digital or DTS signals in 6.1/7.1 channels using the Dolby Digital EX or DTS-ES decoder.
OFF	Does not use any decoders to create 6.1/7.1 channels.

4 INPUT MENU

Use this menu to adjust the parameters of each input source.

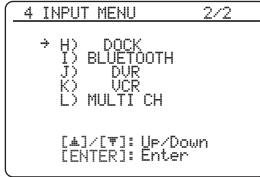
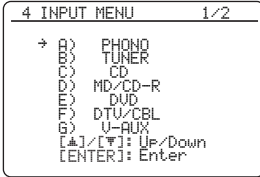

Input source	Parameter
B)TUNER	INPUT RENAME VOL. TRIM
L)MULTI CH	INPUT RENAME VOL. TRIM BGV INPUT CH FRONT
A)PHONO	I/O ASSIGNMENT
C)CD	INPUT RENAME
D)MD/CD-R	VOL. TRIM
E)DVD	DECODER MODE
F)DTV/CBL	
G)V-AUX	
J)DVR	
K)VCR	
H)DOCK	INPUT RENAME VOL. TRIM STANDBY CHARGE
I)BLUETOOTH	INPUT RENAME VOL. TRIM START PAIRING

Note

Some parameters described above may not be available for all input sources and some parameters are only available for specific input sources.

Input/output assignment

I/O ASSIGNMENT

Use this feature to assign the input/output jacks according to the component to be used if the initial settings of this unit do not correspond to your needs. Change the parameter to reassign the respective jacks and effectively connect more components.

Once the input/output jacks are reassigned, you can select the corresponding component by using the **Ⓡ**INPUT selector on the front panel (or the input selector buttons **(5)** on the remote control).

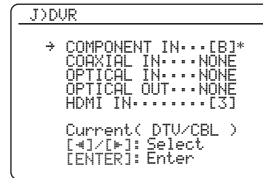

- “NONE” appears in the OSD when any input source is not assigned to the input/output jack.
- Set “OPTICAL OUT” to “(1)” for the digital recording component that you connect to the DIGITAL OUTPUT jack.
- You cannot select a specific item more than once for the same type of jack.
- An asterisk (*) appears to the right of the input/output jack names that have been changed from their previous settings.
- The currently assigned input source for the selected input/output jack appears in the OSD (“Current(DTV/CBL)” in the display example above).

Input rename INPUT RENAME

Use this feature to change the name of the input source that appears in the OSD and in the front panel display.

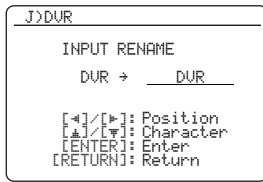

1 Press **Ⓞ** </> to place the “_” (underscore) under the space or the character you want to edit.

2 Press **Ⓞ** ▲ / ▼ to select the character you want to use and then press **Ⓞ** </> to move to the next space.

Notes

- You can use up to 9 characters for each input.
- Press **Ⓞ** ▼ to change the character in the following order, or press **Ⓞ** ▲ to go in the reverse order:
 A to Z, 0 to 9, a to z, symbols (#, *, -, +, etc.), space.

3 Repeat steps 1 through 2 to rename each input source.

4 Press **Ⓞ** ENTER to complete.

Volume trim VOL. TRIM

Use this feature to adjust the level of the signal input at each jack. This feature is useful if you want to balance the level of each input source to avoid sudden changes in volume when switching between input sources.

Control range: -6.0 dB to +6.0 dB

Control step: 0.5 dB

Initial setting: 0.0 dB

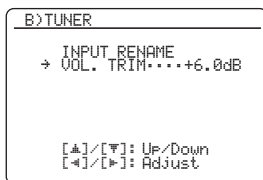

This parameter also affects the signals output at the audio ZONE OUT jacks.

Decoder mode DECODER MODE

Use this feature to switch the decoder activation mode. When you select “DTS” and digital audio signals are input, this unit always activates the DTS decoder and only plays back the DTS digital audio signals.

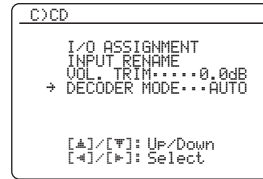

Choice	Functions
AUTO	Automatically detects digital audio signal input types and selects the appropriate decoder.
DTS	Activates the DTS decoder and plays back only DTS digital audio signals when digital audio signals are input.

Note

“DECODER MODE” is only available when the digital audio input jacks (HDMI, OPTICAL, and/or COAXIAL) are assigned to the selected input source.

Charge on standby STANDBY CHARGE

Use this feature to select whether this unit charges the battery of the stationed iPod or not when this unit is in the standby mode.

Choice	Functions
AUTO	Charges the battery of the stationed iPod when this unit is turned on and in the standby mode.
OFF	Charges the battery of the stationed iPod only when this unit is turned on.

Start pairing START PAIRING

Use this feature to start pairing the connected Yamaha Bluetooth adapter (such as YBA-10, sold separately) with your Bluetooth component. For details about the pairing, refer to “Pairing the Bluetooth™ adapter and your Bluetooth™ component” on page 62.

To ensure security, a time limit of 8 minutes is set for the pairing operation. You are recommended to read and fully understand all the instructions before starting.

1 Press **Ⓜ**ENTER to start pairing.

The connected Bluetooth adapter starts searching Bluetooth components. “Searching...” appears in the video monitor.

2 Check that the Bluetooth component detects the Bluetooth adapter.

If the Bluetooth component the Bluetooth adapter, “YBA-10 YAMAHA” (example) appears in the Bluetooth device list.

3 Select the Bluetooth adapter in the Bluetooth device list and then enter the pass key “0000” on the Bluetooth component.

Once this unit completes the pairing successfully, “Pairing completed” appears.



To cancel the pairing, press **Ⓜ**RETURN to exit from “START PAIRING”.

4 Press **Ⓜ**RETURN to exit from “START PAIRING”.

Notes

- If the connected Bluetooth adapter cannot find any Bluetooth components, “Not found” appears.
- If a Bluetooth adapter is not connected to this unit, “No Bluetooth Adapter” appears.

Multi-channel input BGV BGV

Use this feature to select the video source played in the background of the sources input at the MULTI CH INPUT jacks.

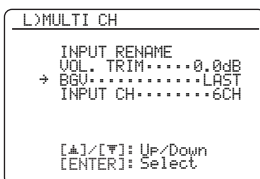

Choice	Functions
LAST	Automatically selects the last selected video source as the background video source.
DVD, DTV/ CBL, DVR, VCR, V-AUX	Selects the corresponding input source as the background video source.
OFF	Does not play the video source in the background.

Input channels INPUT CH

Use this setting to select the number of channels input from an external decoder (see page 25).

Choices: **6CH**, **8CH**

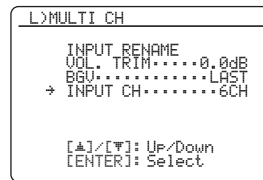

If the connected component outputs discrete 6-channel audio signals.

Select “6CH”.

If the connected component outputs discrete 8-channel audio signals.

Select “8CH”. Also set “FRONT” (see below) to the analog audio jacks at which the front left and right channel signals output from the connected component are input.

Front left and right channels input jack FRONT

If you selected “8CH” in “INPUT CH”, you can select the analog audio jacks at which the front left and right channel signals output from the connected external decoder is input.

Choices: CD, MD/CD-R, **DVD**, DTV/CBL, DVR, VCR, V-AUX

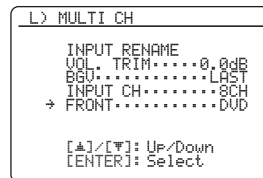

Note

“FRONT” parameter appears only when you set “INPUT CH” to “8CH”.

5 OPTION MENU

Use this menu to adjust the optional system parameters.

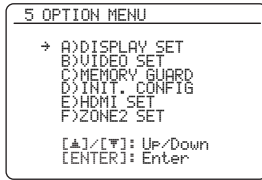

■ Display settings A)DISPLAY SET

Note

Use “VIDEO” of “INIT” in “ADVANCED SETUP” to set “OSD SHIFT” to the factory presets (see page 110).

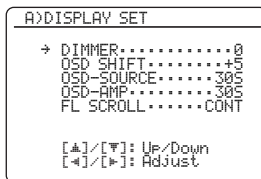

Dimmer DIMMER

Use this feature to adjust the brightness of the front panel display.

Control range: -4 to 0

Control step: 1

- Press **Ⓔ**◀ to make the front panel display dimmer.
- Press **Ⓔ**▶ to make the front panel display brighter.

OSD shift OSD SHIFT

Use this feature to adjust the vertical position of the OSD.

Control range: -5 (downward) to +5 (upward)

Control step: 1

Initial setting: 0

- Press **Ⓔ**◀ to lower the position of the OSD.
- Press **Ⓔ**▶ to raise the position of the OSD.

Source feature OSD display time OSD-SOURCE

Use this feature to set the amount of time to display the iPod menu in the OSD after you perform a certain operation.

Choice	Functions
ON	Displays the OSD unceasingly during an operation.
10S	Turns off the OSD 10 seconds after you perform a certain operation.
30S	Turns off the OSD 30 seconds after you perform a certain operation.

Amplifier function OSD display time OSD-AMP

Use this feature to set the amount of time to display the status information screen after you perform a certain operation.

Choice	Functions
ON	Displays the OSD unceasingly during an operation.
10S	Turns off the OSD 10 seconds after you perform a certain operation.
30S	Turns off the OSD 30 seconds after you perform a certain operation.

Front panel display scroll FL_SCROLL

Use this feature to set the mode to display the iPod menu (such as song title or channel name) in the front panel display.

Choice	Functions
CONT	Continuous mode. Select this to display the operation status in the front panel display in a continuous manner.
ONCE	Scroll-once mode. Select this to display the operation status in the front panel display by the first 14 alphanumeric characters after scrolling all characters once.

■ Video settings B)VIDEO SET

Note

Use “VIDEO” of “INIT” in “ADVANCED SETUP” to set the parameters in “VIDEO SET” to the factory presets (see page 110).

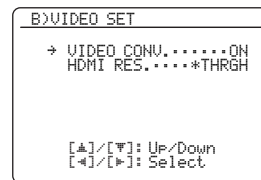

Video conversion VIDEO CONV.

Use this feature to set whether to convert the video signals input at the VIDEO, S VIDEO, and COMPONENT VIDEO jacks.

Choice	Functions
ON	Converts composite, S-video, and component video signals interchangeably and up-converts composite, S-video, and component video signals to HDMI video signals.
OFF	Does not convert any signals.

Notes

- This unit does not convert 480 line video signals and 576 line video signals interchangeably.
- The analog component video signals with 480i (NTSC)/576i (PAL) of resolution are converted into the S-video or composite video signals and output at the S VIDEO MONITOR OUT and VIDEO MONITOR OUT jacks.
- The converted video signals are only output at the MONITOR OUT jacks. When recording a video source, you must make the same type of video connections between each component.
- When composite video or S-video signals from a VCR are converted into component video signals, the picture quality may suffer depending on your VCR.
- Unconventional signals input at the composite video or S-video jacks cannot be converted or may be output abnormally. In such cases, set "VIDEO CONV." to "OFF".

HDMI resolution HDMI RES.

Use this feature to activate or deactivate the HDMI up-scaling of the analog video signals input at the VIDEO, S VIDEO and COMPONENT VIDEO jacks so that the up-scaled video signals are output at the HDMI OUT jack.

This unit up-scales the video signals as follows:

- 480i (NTSC)/576i (PAL) → 480p/576p, 1080i, 720p, or 1080p
- 480p/576p → 1080i, 720p, or 1080p



Choice	Functions
THROUGH	Does not up-scale any analog video signals.
576p (or 480p), 1080i, 720p, 1080p	Up-scales analog video signals to 480p or 576p, 1080i, 720p, or 1080p of resolution.

Notes

- This unit does not up-scale the analog component video signals with 720p or 1080i of resolution.
- The "HDMI RES." parameter appears only when you set "VIDEO CONV." to "ON".
- If you connect your video monitor via HDMI connection, this unit automatically detects the available video signal resolution of the video monitor, and an asterisk (*) appears on the left of the available video signal resolution(s).
- If this unit cannot detect the available video signal resolution(s) of the connected video monitor, set "MON. CHK" (see page 110) to "SKIP" and then set "HDMI RES." again.
- This unit does not convert between 480 line video signals and 576 line video signals.

HDMI aspect ratio HDMI ASPECT

Use this feature to select the adjustment of aspect ratio for analog video signals output at the HDMI OUT jack.

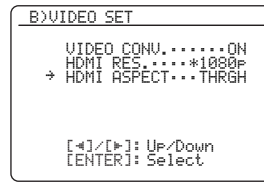

Choice	Functions
THRGH	Does not make any adjustments to the aspect ratio for the HDMI video signal sources.
16:9	Displays video images with the aspect ratio of 4:3 on your video monitor with the aspect ratio of 16:9. Black stripes appear on the right and left sides as a result.
SMART	Fits video images with the aspect ratio of 4:3 to your video monitor with the aspect ratio of 16:9.

Notes

- When "HDMI RES." is set to "THROUGH", you cannot make any adjustments to "HDMI ASPECT".
- If the aspect ratio of the input video source is other than 4:3, this unit automatically ignores the setting of "HDMI ASPECT".
- When "HDMI ASPECT" is set to "SMART", the video images of the edge of the video monitor are rather stretched.
- When the video signals are input at HDMI IN jacks or the signals are input with 720p, 1080i or 1080p of resolution, the setting of "HDMI ASPECT" does not affect the video signals output at the HDMI OUT jack.

■ Memory guard C>MEMORY GUARD

Use this feature to prevent accidental changes to sound field program parameter and other system settings.

```
C>MEMORY GUARD
      >OFF  ON
      [←]/[→]: Select
      [ENTER]: Return
```

Choice	Functions
OFF	Turns off the “MEMORY GUARD” feature.
ON	Protects: <ul style="list-style-type: none"> – sound field program parameters – “AUTO SETUP” items – all speaker levels – “MANUAL SETUP” items

Notes

- You can change the following parameters even if “MEMORY GUARD” is set to “ON”:
 - “EXTD SUR.” in “SOUND MENU” (see page 84)
 - “DECODER MODE” in “INPUT MENU” (see page 86)
 - “MEMORY GUARD”
- When “MEMORY GUARD” is set to “ON”, “” appears at the top right of the “SET MENU” screen.
- You can change the settings of “SUR.” in the sound field program parameter screen (see page 69) even if “MEMORY GUARD” is set to “ON”.

■ Initial configuration D>INIT. CONFIG

Use this feature to select the settings of the audio input jack select, active decoders and extended surround when you turn on this unit.

```
D>INIT. CONFIG
→ AUDIO SELECT..AUTO
  DECODER MODE..AUTO
  EXTD SUR.....AUTO

[←]/[→]: Select
[ENTER]: Return
```

Audio select AUDIO SELECT

Use this feature to designate the default audio input jack select setting (see page 44) for the input sources connected to the DIGITAL INPUT jacks when you turn on the power of this unit.

Choice	Functions
AUTO	Automatically detects the type of input signals and selects the appropriate audio input jack select setting.
LAST	Automatically selects the last input jack select setting used for the connected input source.

Decoder mode DECODER MODE

Use this feature to designate the default decoder mode (see page 86) for the input sources connected to the DIGITAL INPUT jacks when you turn on the power of this unit.

Choice	Functions
AUTO	Automatically detects the type of input signals and select the appropriate decoder mode setting.
LAST	Automatically selects the last decoder mode setting used for the connected input source.

Extended surround EXTD SUR.

Use this feature to designate the extended decoder mode (see page 84) for the input sources connected to the DIGITAL INPUT jacks when you turn on the power of this unit.

Choice	Functions
AUTO	Automatically detects the digital audio input signals and activates the appropriate decoder.
LAST	Automatically selects the last decoder mode set for “EXTD SUR.” in “SOUND MENU”.

■ HDMI set E>HDMI SET

Use this feature to select the component to play back HDMI audio signals.

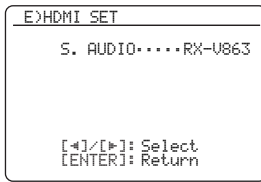

Support audio S.AUDIO

Use this feature to select whether to play back HDMI audio signals on this unit or on another HDMI component connected to the HDMI OUT jack on the rear panel of this unit.

Choice	Functions
RX-V863	Plays back HDMI audio signals on this unit. The HDMI audio signals input at the HDMI input jacks of this unit are not output to the HDMI component connected to the HDMI OUT jack on the rear panel of this unit.
OTHER	Plays back HDMI audio signals on another HDMI component connected to the HDMI OUT jack.

Notes

- This unit transmits audio and video signals input at the HDMI input jacks to the HDMI out jack only when this unit is turned on even if “S.AUDIO” is set to “OTHER”.
- Available audio/video signals depend on the specification of the connected video monitor. Refer to the instruction manual of each connected component.

■ Zone 2 settings F>ZONE2 SET

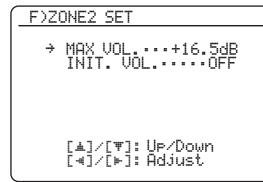

Zone 2 Maximum volume MAX VOL.

Use this feature to set the maximum volume level in the Zone 2.

Control range: -30.0 dB to +15.0 dB, **+16.5 dB**

Control step: 5.0 dB

Notes

- The “MAX VOL.” setting takes priority over the “INI.VOL.” setting. For example, when “INI.VOL.” is set to -20.0 dB and then “MAX VOL.” is set to -30.0 dB, the volume level is automatically set to -30.0 dB when you turn on the power of this unit next time.
- The “MAX VOL.” setting does not affect the output level at the “ZONE 2 OUT” jacks.

Zone 2 Initial volume INI.VOL.

Use this feature to set the volume level of Zone 2 when the power of this unit is turned on.

Choices: **OFF**, MUTE, -80.0 dB to +16.5 dB

Control step: 0.5 dB

Notes

- The “MAX VOL.” setting takes priority over the “INI.VOL.” setting.
- When you select “FRONT B”, “PRNS”, “Zone B”, or “NONE” in “EXTRA SP ASSIGN” (see page 77), “Zone 2 SP Not Assigned” appears in the OSD and the “ZONE2 SET” parameter is not available.
- The “INI.VOL.” setting does not affect the output level at the “ZONE 2 OUT” jacks.

Remote control features

In addition to controlling this unit, the remote control can also operate other audiovisual components made by Yamaha and other manufacturers. To control your TV or other components, you must set up the appropriate remote control code for each input source (see page 94).

Controlling this unit, a TV, or other components

■ Controlling this unit

Set the operation mode selector to **⑩AMP** to control this unit.

■ Controlling a TV

Set the operation mode selector to **⑩TV** to control your TV. To control your TV, you must set the appropriate remote control code for **⑤DTV/CBL** or **⑤PHONO** (see page 94). When you set the remote control codes for both **⑤DTV/CBL** and **⑤PHONO**, priority is given to the one set for **⑤DTV/CBL**.

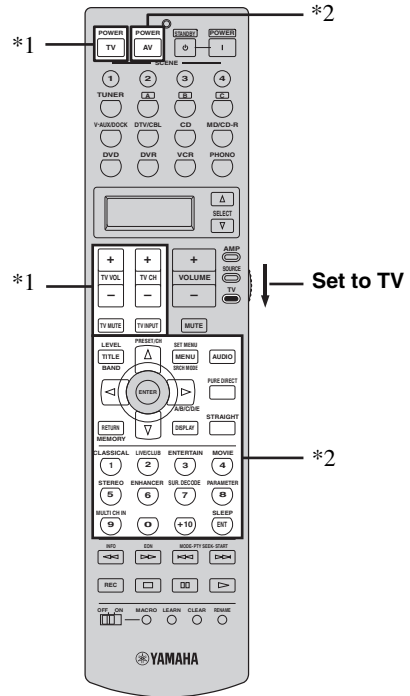
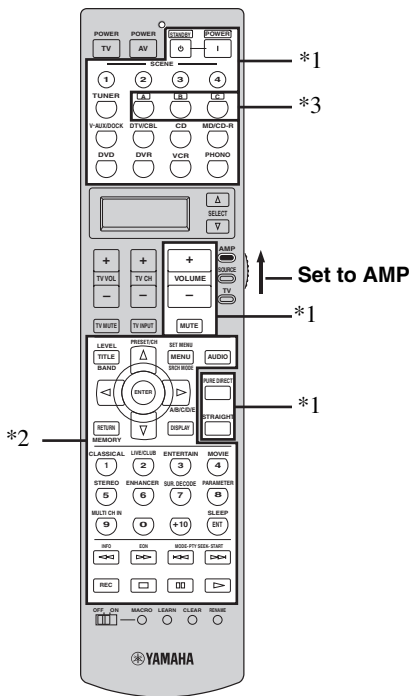

Notes

- *1 These buttons always control this unit regardless of the operation mode selector position.
- *2 These buttons control this unit only when the component operation mode selector is set to **⑩AMP**.
- *3 **⑤A, B, or C**, is the optional component control area button. You can control the desired component without changing the input source of this unit.

Notes

- *1 These buttons always control your TV regardless of the operation mode selector position.

Remote control	Digital TV/Cable TV
TV POWER	Turns on or off the power.
TV VOL +/-	Increases or decreases the volume level.
TV CH +/-	Changes the channel number.
TV MUTE	Mutes the audio output.
TV INPUT	Changes the input source.

- *2 These buttons control your TV only when the operation mode selector is set to **⑩TV**. For details, see the "TV" column on page 93.

■ Controlling other components

Set the operation mode selector to **⑩ SOURCE** to control other components selected with the input selector buttons (⑤). You must set the appropriate remote control code for each input source in advance (see page 94). The following table shows the function of each control button used to control other components assigned to each input selector button (⑤). Be advised that some buttons may not correctly operate the selected component.



The remote control has 12 modes (control areas) to control components so that the remote control can operate up to 12 different components.

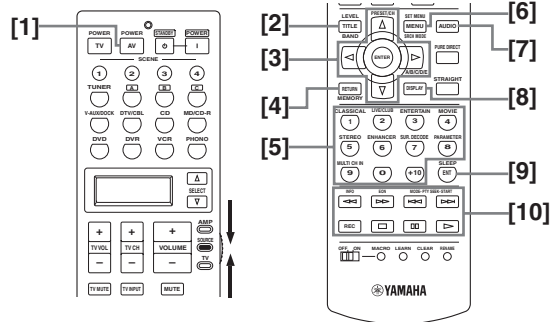

	DVD player/ DVD recorder	VCR	Cable TV/ Satellite tuner	TV	LD player	CD player	MD recorder/ CD recorder	Tape deck	Tuner
[1] AV POWER	Power *1	Power *1	Power *1	VCR power *2	Power *1	Power *1	Power *1	Power *1	Power *1
[2] TITLE	Title	Title	Title	Title					Band
[3] ENTER	Menu enter		Menu select	Menu select					
PRESET/CH Δ	Menu up		Menu up	Menu up					Preset up (1 to 8)
PRESET/CH ∇	Menu down		Menu down	Menu down					Preset down (1 to 8)
A/B/C/D/E ◀	Menu left		Menu left	Menu left					Preset down (A to E)
A/B/C/D/E ▶	Menu right		Menu right	Menu right				Direction A/B	Preset up (A to E)
[4] RETURN	Return	Return	Return	Return					Memory
[5] 1-9, 0, +10	Numeric buttons	Numeric buttons	Numeric buttons	Numeric buttons	Numeric buttons	Numeric buttons	Numeric buttons		Preset stations (1 to 8) / Numeric buttons
[6] MENU	Menu		Menu	Menu					Sound mode
[7] AUDIO	Audio				Audio				
[8] DISPLAY	Display		Display	Display	Display	Display	Display		
[9] ENT		Enter	Enter/recall	Enter					Enter
[10] ◀◀	Search backward	Search backward	DVR search backward *2	DVR search backward *2	Search backward	Search backward	Search backward	Search backward	Information
▶▶	Search forward	Search forward	DVR search forward *2	DVR search forward *2	Search forward	Search forward	Search forward	Search forward	EON
◀◀	Skip backward		DVR skip backward *2	DVR skip backward *2	Chapter/Skip backward	Skip backward	Skip backward	Direction back	Program type seek mode
▶▶	Skip forward		DVR skip forward *2	DVR skip forward *2	Chapter/Skip forward	Skip forward	Skip forward	Direction forward	Program type seek mode
REC	Disc skip (player) Rec (recorder)	Rec	DVR rec *2	DVR rec *2		Disc skip	Rec	Rec	
□	Stop	Stop	DVR stop *2	DVR stop *2	Stop	Stop	Stop	Stop	
▢	Pause	Pause	DVR pause *2	DVR pause *2	Pause	Pause	Pause	Pause	
▷	Play	Play	DVR play *2	DVR play *2	Play	Play	Play	Play	

Notes

*1 This button is operational only when the original remote control supplied with the component has a POWER button.

*2 These buttons operate your VCR or DVR when you set the appropriate remote control code for DVR (see page 94).

■ Selecting a component to be controlled

You can select a component to be controlled independently of the input source selected with the input selector buttons.

Press **⑥ SELECT** Δ / ∇ repeatedly to select the desired component.

The name of the component to be controlled appears in the display window (⑥) on the remote control.



■ Controlling optional components (Option mode)

“OPTN” is an optional component control area that can be programmed with remote control functions independently from any input source. This area is useful for programming commands that are to be used only as a part of a macro function or for components that do not have a valid remote control code.

To select the option mode, press **⑥ SELECT** Δ / ∇ repeatedly until “OPTN” appears in the display window (⑥) on the remote control.



Note

You cannot set a remote control code for the optional area. See page 96 to program buttons operated within this component control area.

Setting remote control codes

You can control other components by setting the appropriate remote control codes. Codes can be set up for each control area. For a complete list of available remote control codes, refer to “List of remote control codes” at the end of this manual.

The following table shows the default component (Library: component category) and the remote control code for each control area.

Remote control code default settings

Control area	Component category	Manufacturer	Default code
TUNER	TUNER	Yamaha	2602
A	TAPE	Yamaha	2700
B	LD	Yamaha	2200
C	TUNER	Yamaha	2607
V-AUX/DOCK	TUNER	Yamaha	2606
DTV/CBL	TV	-	-
CD	CD	Yamaha	2300
MD/CD-R	CD-R	Yamaha	2400
DVD	DVD	Yamaha	2100
DVR	DVR	Yamaha	2807
VCR	VCR	-	-
PHONO	TV	-	-

Note

You may not be able to operate your Yamaha component even if a Yamaha remote control code is preset as listed above. In this case, try setting another Yamaha remote control code.

- 1 Set the operation mode selector to **⑩ SOURCE** and then press an input selector button (⑤) to select the control area you want to set up.

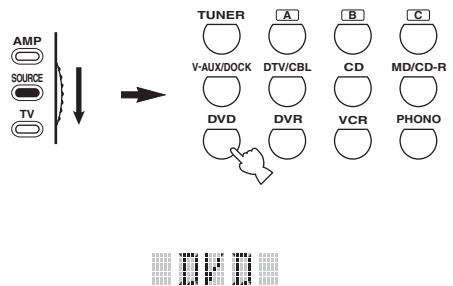

2 Press and hold **LEARN** for about 3 seconds using a ballpoint pen or similar object.

The library name (e.g. L;DVD) and the name of the selected control area (e.g. DVD) appear alternately in the display window (6) on the remote control.



- You can set a remote control code of a different type of component to an control area. Press **ENTER** repeatedly to change the library (component category).
Library choices: L;DVD, L;DVR, L;LD, L;CD, L;CDR, L;MD, L;TAP (tape), L;TUN (tuner), L;AMP, L;TV, L;CAB (cable), L;SAT (satellite), L;VCR
- If you want to setup for another control area, press the input selector button, or press **SELECT** Δ / ∇ repeatedly to select the control area.

Notes

- Be sure to press and hold **LEARN** for at least 3 seconds, otherwise the learning process will start.
- If you do not complete each of the following steps within 30 seconds, the setting mode will be automatically canceled. In this case, start over from step 2.

3 Press **ENTER**.

The four-digit code set for the selected component appears in the display window (6).

Note

“0000” appears in the display window (6) if no code has been set.

4 Press the numeric buttons (11) to enter the four-digit remote control code for the component you want to use.

For a complete list of available remote control codes, refer to “List of remote control codes” at the end of this manual.

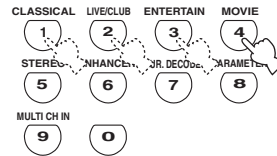

5 Press **ENTER** to set the number.

“OK” appears in the display window (6) on the remote control if setting was successful.

“NG” appears in the display window (6) on the remote control if the setting was unsuccessful. In this case, start over from step 3.



If you continuously want to set up another code for another component, press the input selector button (6), or **SELECT** Δ / ∇ repeatedly to select the component, then repeat steps 2 through 5.

6 Press **LEARN** again to exit from the setup mode.



7 Press **ENTER** or **AV POWER** to confirm whether you can control your component using the remote control.

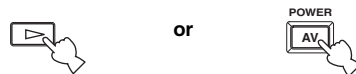

If operation is not possible and the manufacturer of your component has more than one code, try each of them until you find the correct one.

Notes

- “ERROR” appears in the display window (6) on the remote control if you press a button not indicated in the respective step, or when you press more than one button simultaneously.
- The supplied remote control does not contain all possible codes for commercially available audio and video components (including Yamaha components). If operation is not possible with any of the remote control codes, program the new remote control function using the learn feature (see “Programming codes from other remote controls” on page 96) or use the remote control supplied with the component.
- Functions programmed using the learn feature take priority over remote control code functions.

Programming codes from other remote controls

You can program remote control codes from other remote controls. Use the learn feature if you want to program functions not included in the basic operations covered by the remote control codes, or an appropriate remote control code is not available. You can program the function of other remote control to the buttons in the highlighted areas in the following illustration. The buttons can be programmed independently for each control area.

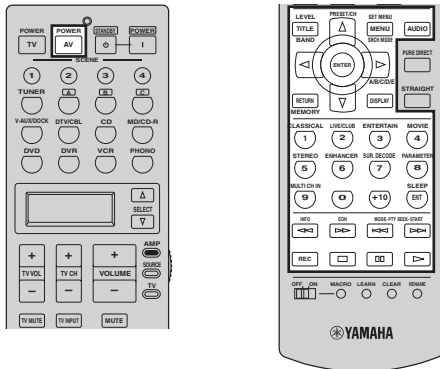

Note

The remote control transmits infrared rays. If the other remote control also uses infrared rays, this remote control can learn most of its functions. However, you may not be able to program some special signals or extremely long transmissions. Refer to the operating instructions for the other remote control.

- 1 Set the operation mode selector to **⑬SOURCE** and then press an input selector button **⑮** to select a control area.

Note

Make sure that the operation mode selector is set to **⑬SOURCE**. When you set the operation mode selector to **⑬AMP** and program a remote control codes from other remote controls, the programmed key cannot operate the amplifier function of this unit.

- 2 Place this remote control about 5 to 10 cm (2 to 4 in) apart from the other remote control on a flat surface so that their infrared transmitters are aimed at each other.

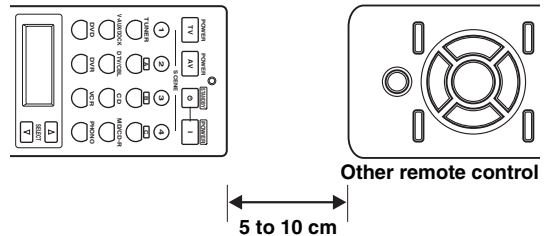

- 3 Press **⑬LEARN** using a ballpoint pen or similar object.

“LEARN” and the name of the selected control area (e.g. “DVD”) appear alternately in the display window **⑮** on the remote control.

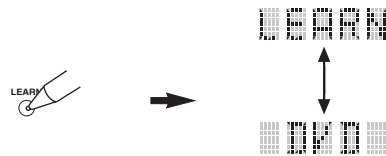

Notes

- Do not press and hold **⑬LEARN**. If you hold it down for more than 3 seconds, the remote enters the remote control code setting mode.
- If you do not complete each of the following steps within 30 seconds, the learning mode will be automatically canceled. In this case, start over from step 3.

- 4 Press the button for which you want to program the new function.

“LEARN” appears in the display window **⑮** on the remote control.



5 Press and hold the button you want to program on the other remote control until “OK” appears in the display window (ⓐ) on the remote control.

“NG” appears in the display window (ⓐ) on the remote control if learning was unsuccessful. In this case, start over from step 4.

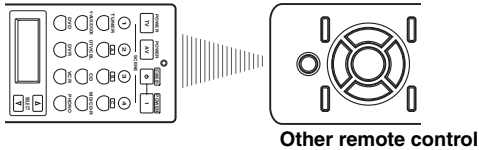

- If you want to program another function, repeat steps 4 and 5.
- If you continuously want to program another function for another component, press ⓐ **SELECT** Δ / ∇ to select the component, and then repeat steps 4 and 5.

6 Press ⓑ **LEARN** again to exit the learning mode.



Notes

- “ERROR” appears in the display window (ⓐ) on the remote control if you press a button not indicated in the respective step, or when you press more than one button simultaneously.
- This remote control can learn approximately 200 functions. However, depending on the signals learned, “FULL” may appear in the display before you program 200 functions. In this case, clear unnecessary programmed functions to make room for further learning.
- Learning may not be possible in the following cases:
 - when the batteries in the remote control for this unit or other components are weak.
 - when the distance between the two remote controls is too great or too small.
 - when the remote control infrared windows are not facing each other at the appropriate angle.
 - when the remote control is exposed to direct sunlight.
 - when the function to be programmed is continuous or uncommon.

Changing source names in the display window

You can change the name of the input source that appears in the display window (ⓐ) on the remote control if you want to use a different name than the factory preset. This feature is useful when you have set an control area to control a different component.

1 Set the operation mode selector to ⓑ **AMP** or ⓑ **SOURCE** and then press an input selector button (ⓐ) to select the control area you want to rename.

The name of the selected control area appears in the display window (ⓐ).

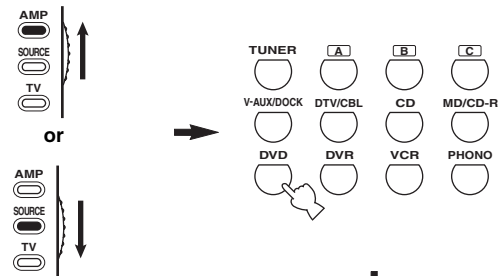

2 Press ⓑ **RENAME** using a ballpoint pen or similar object.



Note

If you do not complete each of the following steps within 30 seconds, the renaming mode will be automatically canceled. In this case, start over from step 2.

3 Press Ⓢ Δ / ∇ to select and enter a character.

Pressing Ⓢ ∇ changes the character as follows:

A to Z, 1 to 9, 0, + (plus), - (hyphen), ; (semicolon), / (slash), and space.

Pressing Ⓢ Δ changes the characters in reverse order.

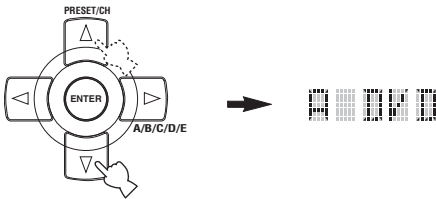

4 Press Ⓢ \triangleright to move the cursor to the next position.

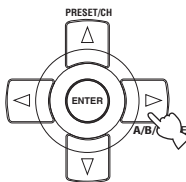

Press Ⓢ \triangleleft to move the cursor to the previous position.

5 Press Ⓢ ENTER to set the new name.

“OK” appears in the display window (Ⓢ) on the remote control if renaming was successful.

“NG” appears in the display window (Ⓢ) on the remote control if renaming was unsuccessful. In this case, start over from step 3.



If you continuously want to rename another control area, press the input selector button (Ⓢ), or press Ⓢ SELECT Δ / ∇ repeatedly to select the component, then repeat steps 3 through 5.

6 Press Ⓢ RENAME again to exit the renaming mode.



Note

“ERROR” appears in the display window (Ⓢ) on the remote control if you press a button not indicated in the respective step, or when you press more than one button simultaneously.

Macro programming features

The macro programming feature makes it possible to perform a series of operations with the press of a single button. For example, when you want to play a CD, normally you would turn on the components, select the CD input, and press the play button to start playback. The macro programming feature lets you perform all of these operations simply by pressing the CD macro button. The buttons listed as macro buttons below are factory set with macro programs. You can also program your own macros (see page 100).

MACRO operations

Macro buttons

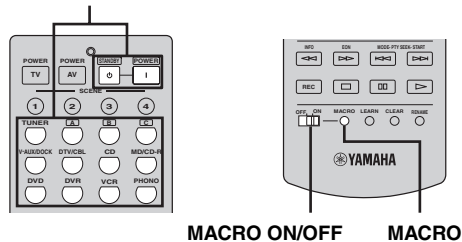

1 Set the Ⓢ MACRO ON/OFF selector to ON.

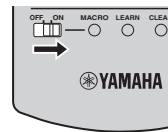

2 Press the desired macro button.

3 Set the Ⓢ MACRO ON/OFF selector to OFF when you finish to using the macro programming operation.

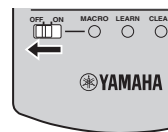

Notes

- While the remote control is running a macro program, it does not accept any other operation until it has completed running the program (the transmission indicator stops flashing).
- Continue to aim the remote control at the component the macro is operating until the macro operation is complete.

■ Default macro functions

Pressing macro button	To automatically transmit these signals in order		
	First	Second	Third
		—	—
	(*1)	(*2)	—
	(*1)	(*3)	—
			—
			—
			—
			—
			—
			(CD area) (*4)
			(MD/CD-R area) (*4)
			(DVD area) (*4)
			(DVR area) (*4)
			(VCR area) (*4)
			—

*1 You can turn on some components (including Yamaha components) connected to this unit by connecting them to the AC OUTLETS on the rear panel of this unit. Power control may not be synchronized with this unit depending on the component. For details, refer to the operating instructions for the connected component.

*2 When the remote control code for your TV is set up for either **⑤DTV/CBL** or **⑥PHONO** (see page 94), you can turn on the power of your TV without selecting an input source. The remote control code set up for **⑤DTV/CBL** takes priority over the one for **⑥PHONO**.

*3 When **⑤TUNER** is selected as the input source, this unit plays the last station received before the unit was set in the standby mode.

*4 Playback can be started for any Yamaha remote control-compatible CD player, CD recorder, DVD player, or DVD recorder. When using macros to operate other components, you will need to program the play button on the control area of that component (see page 96) or set a remote control code (see page 94).

■ Programming macro operations

You can program your own macro and use the macro programming feature to transmit several remote control commands in sequence at the press of a button. Be sure to set up remote control codes or perform learning operations before programming the macro.

Notes

- The default macro is not cleared when a new macro is programmed for a button. The default macro can be used again when the programmed macro is cleared.
- It is not possible to add a new signal (macro step) to the default macro. Programming a macro changes all macro contents.
- We do not recommend programming continuous operations such as volume control in a macro.

1 Set the operation mode selector to ⑩AMP or ⑩SOURCE and then press ⑩MACRO using a ballpoint pen or similar object.

“MCR ?” appears in the display window (⑥) on the remote control.

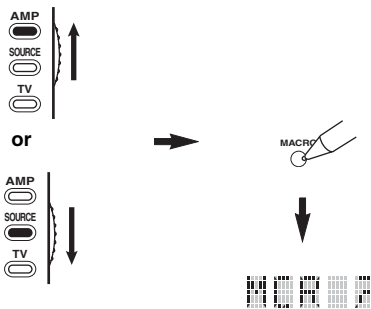

Note

If you do not complete each of the following steps within 30 seconds, the macro programming mode will be automatically canceled. In this case, start over from step 1.

2 Press the macro button you want to use to operate the macro.

The macro button name (e.g. “M;DVD”) and the selected component name (e.g. “DVD”) appear alternately in the display window (⑥) on the remote control.

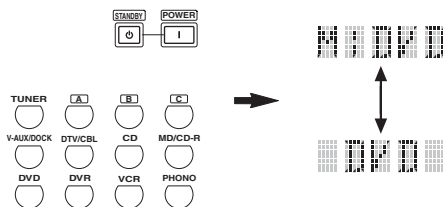

Note

“AGAIN” appears in the display window (⑥) if you press a button other than a macro button.

3 Press the buttons for the functions you want to include in the macro operation in sequence.

You can set up to 10 steps (10 functions). After you have set 10 steps, “FULL” appears and the remote control automatically exits the macro mode. The following example is for programming the following procedure:

Step 1 (“MCR 1”): Press POWER.

Step 2 (“MCR 2”): Press DVD.

Step 3 (“MCR 3”): Press AUDIO.

MCR 1: POWER

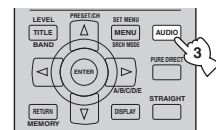
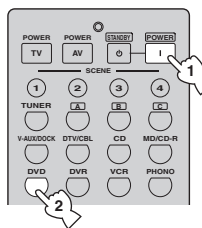

MCR 3: AUDIO

MCR 2: DVD



Indicates the number of macro steps entered



Flashes alternately so you can set the next step



Note

To change the selected control area, press ⑩SELECT Δ / ∇ . Pressing the input selector buttons will program a macro step, whereas ⑩SELECT Δ / ∇ only changes the selected control area.

4 Press ⑩MACRO again using a ballpoint pen or similar object when the operation sequence you want to program is complete.

Note

“ERROR” appears in the display window (⑥) if you press more than one button simultaneously.

Clearing configurations

You can clear all changes made in each function set, such as learned functions, macros, renamed control area names and setup remote control ID.

■ Clearing function sets

1 Set the operation mode selector to **AMP** or **SOURCE** and then press **CLEAR** by using a ballpoint pen or similar object.

“CLEAR” appears in the display window (⑥).

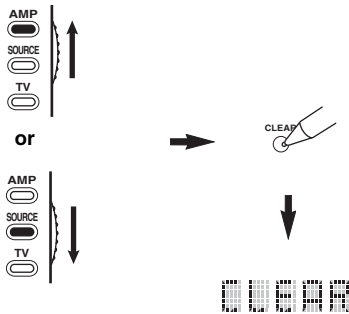

Note

If you do not complete each of the following steps within 30 seconds, the clearing mode will be automatically canceled. In this case, start over from step 1.

2 Press **△ / ▽** to select the clear mode.

L;CD (etc.) (L; Name of an control area)	Clears all learned functions in the respective control area. The name of a component is shown after a semicolon (;). Press an input selector button to select the control area.
L;AMP	Clears all learned functions for controlling the amplifier functions of this unit.
L;ALL	Clears all learned functions.
M;ALL	Clears all programmed macros.
RNAME	Clears all renamed source names.
FCTRY	Clears all remote functions and returns the remote to the factory settings.

3 Press and hold **CLEAR** again for about 3 seconds.

“WAIT” appears in the display window (⑥). If clearing was successful, “C;OK” appears in the display window (⑥) on the remote control.



Once you have cleared a learned function for a button, the button reverts to the factory setting (or to the manufacturer setting, if you have set remote control codes).

Notes

- “L;ALL” and “FCTRY” may take about 30 seconds to complete.
- “C;NG” appears in the display window (⑥) if clearing was unsuccessful. In this case start over from step 2.
- “ERROR” appears in the display window (⑥) if you press a button not indicated in the respective step, or if you press more than one button simultaneously.

■ Clearing a learned function

You can clear the function learned for a certain button in each control area.

- 1 Set the operation mode selector to **AMP** or **SOURCE** and then press an input selector button to select the control area containing the function you want to clear.

The selected component name appears in the display window.

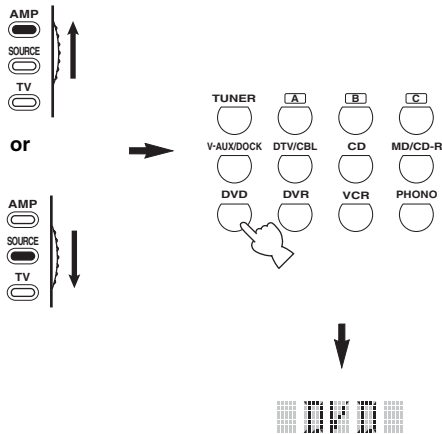

- 2 Press **LEARN** using a ballpoint pen or similar object.

“LEARN” and the selected component name (e.g. “DVD”) appear alternately in the display window.

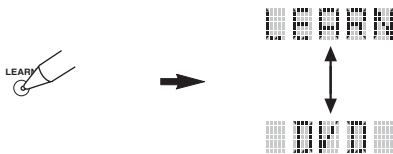

Notes

- Do not press and hold **LEARN**. If you hold it down for more than 3 seconds, the remote control enters the remote control code setting mode.
- If you do not complete each of the following steps within 30 seconds, the learning mode will be automatically canceled. In this case, start over from step 2.

- 3 Press and hold **CLEAR** using a ballpoint pen or similar object and then press the button you want to clear for about 3 seconds.

“C;OK” appears in the display window if clearing was successful. Once “C;OK” appears in the display window on the remote control, release the ballpoint pen or similar object used to press **CLEAR** to exit the clearing mode. The remote control returns to the learning mode.



- If you continuously want to clear another function, repeat step 3.
- If you continuously want to clear another function for another component, press **SELECT** Δ / ∇ to select the control area, then repeat step 3.
- Once you clear a learned function, the button reverts to the factory setting (or to the manufacturer setting if you have set remote control codes).

- 4 Press **LEARN** again to exit.

Notes

- “C;NG” appears in the display window on the remote control if clearing was unsuccessful. In this case, start over from step 2.
- “ERROR” appears in the display window on the remote control if you press more than one button simultaneously.

■ Clearing a macro function

You can clear the function programmed for a certain macro button.

- 1 Set the operation mode selector to **AMP** or **SOURCE** and then press **MACRO** using a ballpoint pen or similar object.

“MCR ?” appears in the display window (6) on the remote control.

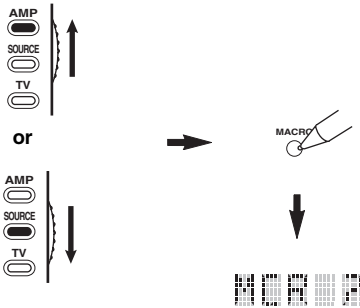

Note

If you do not complete each of the following steps within 30 seconds, the macro programming mode will be automatically canceled. In this case, start over from step 1.

- 2 Press and hold **CLEAR** using a ballpoint pen or similar object, then press the macro button you want to clear for about 3 seconds. “C;OK” appears in the display window (6) on the remote control if clearing was successful.

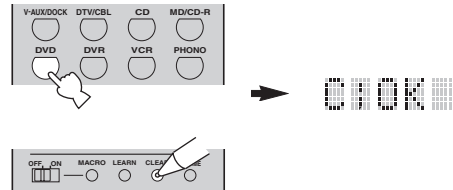

- If you continuously want to clear another function, repeat step 2.
- Once you clear a programmed function, the button reverts to the factory setting (or to the manufacturer setting if you have set remote control codes).

- 3 Press **MACRO** again to exit the macro programming mode.

Notes

- “C;NG” appears in the display window (6) on the remote control if clearing was unsuccessful. In this case, start over from step 2.
- “ERROR” appears in the display window (6) on the remote control if you press more than one button simultaneously.

Using multi-zone configuration

This unit allows you to configure a multi-zone audio system. The Zone 2 feature allows you to set this unit to reproduce separate input sources in the main zone and the second zone (Zone 2). You can control this unit from the second zone using the supplied remote control.

Only analog signals are sent to the second zone. Any source you want to listen to in the second zone must be connected to the analog AUDIO IN jacks of this unit.

Connecting Zone 2

You need the following additional equipment to use the multi-zone functions of this unit:

- An infrared signal receiver in the second zone.
- An infrared signal emitter in the main zone. This emitter transmits the infrared signals from the remote control via the infrared signal receiver in the second zone to a CD player or a DVD player, etc. in the main zone.
- An amplifier and speakers in the second zone.



- Since there are many possible ways to connect and use this unit in a multi-zone configuration, we recommend that you consult with your nearest authorized Yamaha dealer or service center about the Zone 2 connections that best meet your requirements.
- Some Yamaha models are able to connect directly to the REMOTE jacks of this unit. If you own these products, you may not need to use an infrared signal emitter. Up to 6 Yamaha components can be connected as shown below.

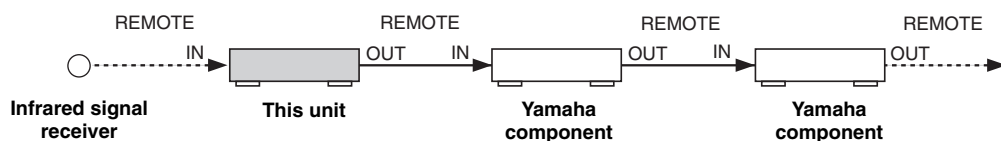

■ Using the external amplifier

Connect the amplifier/receiver in the second zone and other components to this unit as follows.

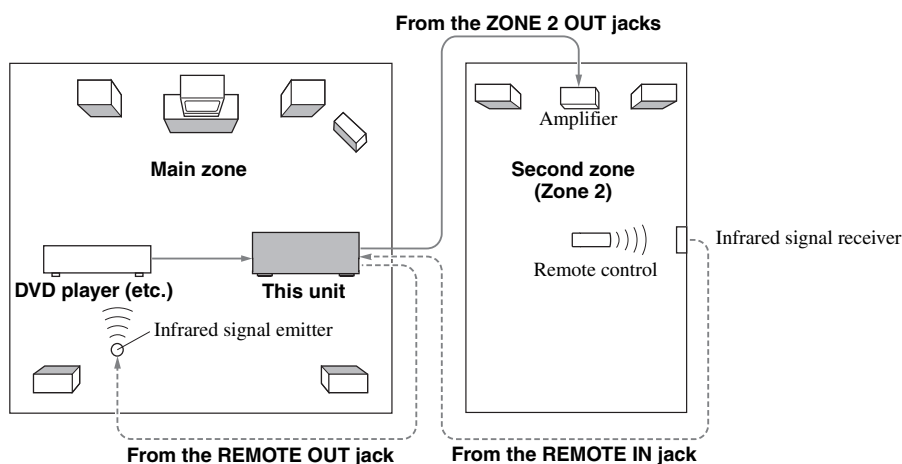

Note

To avoid unexpected noise, DO NOT USE the Zone 2 feature with CDs encoded in DTS.

■ Using the internal amplifier of this unit

Important safety notice

The EXTRA SP speaker terminals of this Receiver should not be connected to a Passive Loudspeaker Selector Box or more than one loudspeaker per channel.

Connection to a Passive Loudspeaker Selector Box or multiple speakers per channel could create an abnormally low impedance load resulting in amplifier damage. See this owner's manual for correct usage.

Compliance with minimum speaker impedance information for all channels must be maintained at all times. This information is found on the back panel of your Receiver.

Connect the speakers in the second zone to the EXTRA SP speaker terminals and then set the "EXTRA SP ASSIGN" to "ZONE2" (see page 77).

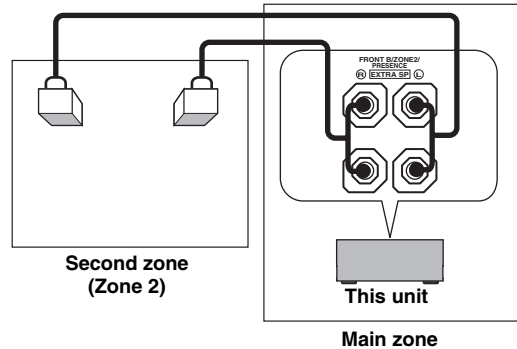

- You can use the speakers connected EXTRA SP speaker terminals as the front speaker system of another zone. Set "EXTRA SP ASSIGN" to "ZONE B" (see page 77).
- When you use the internal amplifiers for the Zone 2 speakers, you can adjust the volume level and set the initial volume level and maximum volume level of the Zone 2 speakers (see page 91).

Controlling Zone 2

You can select and control Zone 2 by using the control buttons on the front panel or on the remote control. The available operations are as follows:

- Selecting the input source of Zone 2.
- Tuning into FM or AM when "TUNER" is selected as the input source of Zone 2 (see page 53).
- Enjoying music stored on your iPod stationed in a Yamaha iPod universal dock (such as YDS-10 sold separately) connected to the DOCK terminal of this unit when "V-AUX" is selected as the input source (see page 60).

Note

You must complete each step while the ZONE2 indicator is flashing in the front panel display. Otherwise, the Zone 2 mode is automatically canceled and this unit returns to the normal operation mode. In this case, repeat the Zone 2 selection procedure.

■ Controlling Zone 2 with the front panel

Turning on Zone 2

Press **Ⓜ** ZONE 2 ON/OFF to turn on Zone 2.

Activating the Zone 2 operation mode

Press **Ⓜ** ZONE CONTROL to control Zone 2.

The ZONE2 indicator flashes in the front panel display for approximately 10 seconds.

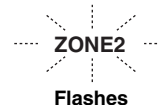

Operate the following operations after activating the Zone 2 operation mode.

Operating Zone 2

Rotate the **ⓇINPUT selector to select the desired input source while the ZONE2 indicator is flashing in the front panel display.**

- Select “TUNER” as the input source to use the TUNER features in Zone 2. For details about the TUNER operations, see “FM/AM tuning” on page 53.
- Select “V-AUX” as the input source to use iPod features or Bluetooth features in Zone 2. For details about the iPod operations, see “Using iPod™” on page 60 or “Using Bluetooth™ components” on page 62.

Set Zone 2 to the standby mode

Press **ⓂZONE 2 ON/OFF to set Zone 2 to the standby mode.**



Press **Ⓜ**SYSTEM OFF to set the main zone and Zone 2 to the standby mode simultaneously.

■ Controlling Zone 2 with the remote control

Activating the Zone 2 operation mode

Set the operation mode selector to **ⓈAMP and then press **Ⓟ**SELECT **Δ** repeatedly to select the Zone 2 operation mode.**

“ZONE 2” is displayed in the display window **Ⓟ** on the remote control.

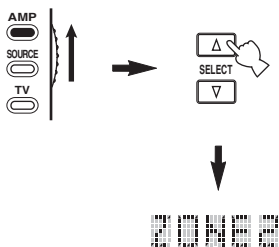

To deactivate the Zone 2 operation mode, press **Ⓟ**SELECT **Δ** / **∇** repeatedly to select other than “ZONE 2”.

Turning on or off Zone 2 using the remote control

- Ⓟ**POWER and **Ⓛ**STANDBY on the remote control work differently depending on the selected zone that appears in the display window **Ⓟ** on the remote control.
- When the main zone, Zone 2 mode is selected, you can turn on the main zone or Zone 2 or set them to the standby mode individually.
 - When the all mode is selected, pressing **Ⓟ**POWER turns on the main zone and Zone 2 simultaneously and pressing **Ⓛ**STANDBY sets them to the standby mode simultaneously.

Control mode	Display window Ⓟ	POWER and STANDBY
Main zone mode	Name of the selected input area	Turns on the main zone only or sets it to the standby mode.
Zone 2 mode	“ZONE 2” or “2;name of the selected input area”	Turns on Zone 2 or sets it to the standby mode.
All mode	“ALL”	Ⓟ POWER: turns on the main zone and Zone 2. Ⓛ STANDBY: sets the main zone and Zone 2 to the standby mode.

Notes

- When the remote control is in the main zone mode, “MAIN” appears for a few seconds when **Ⓟ**POWER or **Ⓛ**STANDBY is pressed.
- “ALL” appears in the display window **Ⓟ** on the remote control only when **Ⓟ**SELECT **∇** is pressed.

Selecting the input source of Zone 2

Press one of the input selector buttons **Ⓟ to select the input source of the selected zone.**

If the remote control is used to select the input source, “2; name of the selected input area” is displayed in the display window **Ⓟ** on the remote control when Zone 2 is selected respectively.

Note

The selected input source is shared across all zones.

Advanced setup

This unit has additional menus that are displayed in the front panel display. The advanced setup menu offers additional operations to adjust and customize the way this unit operates. Change the initial settings (indicated in bold under each parameter) to reflect the needs of your listening environment.

Notes

- The settings you make are reflected next time you press **ⓀMAIN ZONE ON/OFF** to turn on this unit (see page 29).
- Only **ⓀMAIN ZONE ON/OFF**, **ⓁSYSTEM OFF**, **ⓂTONE CONTROL** and the **ⓃPROGRAM** selector are effective while you are using the advanced setup menu.
- No other operations can be made while you are using the advanced setup menu.
- The advanced setup menu is only available in the front panel display.

Using the advanced setup

1 Press ⓁSYSTEM OFF on the front panel to set this unit to the standby mode.

2 Press and hold ⓂTONE CONTROL and then press ⓀMAIN ZONE ON/OFF to turn on this unit.

This unit turns on, and the advanced setup menu appears in the front panel display.



3 Rotate the ⓃPROGRAM selector to select the parameter you want to adjust.

The name of the selected parameter appears in the front panel display.

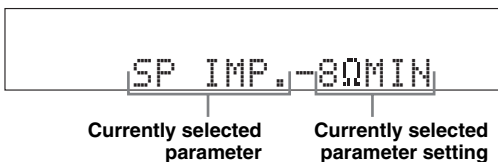

4 Press ⓂTONE CONTROL repeatedly to change the selected parameter setting.

5 Press ⓁSYSTEM OFF to save the new setting and set this unit to the standby mode.



The settings you made are reflected next time you turn on this unit.

■ Speaker impedance SP IMP.

Use this feature to set the speaker impedance of this unit so that it matches that of your speakers.

Choices: **8ΩMIN**, 6ΩMIN

- Select “8ΩMIN” to set the speaker impedance to 8 Ω.
- Select “6ΩMIN” to set the speaker impedance to 6 Ω.

SP IMP.	Speaker	Impedance level
8ΩMIN	Front	If you use one set (A or B), the impedance of each speaker must be 8 Ω or higher. If you use two sets (A and B), the impedance of each speaker must be 16 Ω or higher.*
	Center	The impedance of each speaker must be 8 Ω or higher.
	Surround	
	Surround back	
6ΩMIN	Front	If you use one set (A or B), the impedance of each speaker must be 4 Ω or higher. If you use two sets (A and B), the impedance of each speaker must be 8 Ω or higher.
	Center	The impedance of each speaker must be 6 Ω or higher.
	Surround	
	Surround back	

* The Canada model cannot use two separate speaker systems (A and B) simultaneously when “SP IMP.” is set to “8ΩMIN”.

See page 107 for the operation of the advanced setup.

Remote control AMP ID REMOTE AMP

Use this feature to set the AMP ID of this unit for remote control recognition. This feature is useful when you operate this unit and the other Yamaha receivers/amplifiers in the same room separately.

Choices: **ID1**, **ID2**

- Select “ID1” when the remote control AMP ID code is set to “2201”.
- Select “ID2” when the remote control AMP ID code is set to “2202”.

Setting remote control AMP ID codes

You need to set the remote control AMP ID code for the remote control.

1 Set the operation mode selector to **AMP or **SOURCE**.**

2 Press and hold **LEARN for about 3 seconds using a ballpoint pen or similar object and then press **ENTER** repeatedly until “L;AMP” appears in the display window **ENTER** on the remote control.**

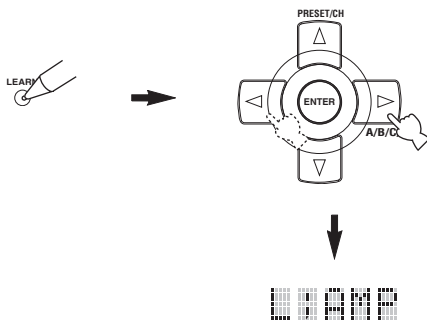

Notes

- Be sure to press and hold **LEARN** for at least 3 seconds, otherwise the learning process will start.
- If you do not complete each of the following steps within 30 seconds, the setting mode will be automatically canceled. In this case, start over from step 1.

3 Press **ENTER.**

The four-digit code set for the selected input area appears in the display window **ENTER** on the remote control.

4 Press the numeric buttons **1-4 to enter the four-digit remote control code for the input area you want to use.**

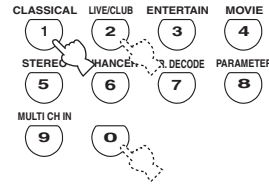

Remote control AMP ID codes

Select one of the following codes to set the remote control AMP ID code for the input area you want to use.

AMP ID code (remote control setting)	Function	Remote control AMP ID
2201 (initial setting)	To operate this unit using the default code.	ID1 (initial setting)
2202	To operate this unit using an alternative code.	ID2

5 Press **ENTER to set the number.**

“OK” appears in the display window **ENTER** if setting was successful.
 “NG” appears in the display window **ENTER** if the setting was unsuccessful. In this case, start over from step 1.

6 Press **LEARN again to exit from the setup mode.**



See page 107 for the operation of the advanced setup.

Remote control TUNER ID REMOTE TU

Use this feature to set the TUNER ID of this unit for remote control recognition.

Choices: ID1, ID2

- Select "ID1" when the remote control TUNER ID code is set to "2602".
- Select "ID2" when the remote control TUNER ID code is set to "2610".

Setting remote control TUNER ID codes

You need to set the remote control TUNER ID library code for the remote control.

- 1 Set the operation mode selector to **AMP** or **SOURCE** and then press **TUNER** on the remote control to select the tuner to change the remote control ID.

- 2 Press and hold **LEARN** for about 3 seconds using a ballpoint pen or similar object and the **◀/▶** repeatedly until "L;TUN" and "TUNER" appear in the display window (6) on the remote control.

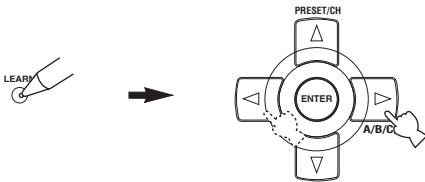

Notes

- Be sure to press and hold **LEARN** for at least 3 seconds, otherwise the learning process will start.
- If you do not complete each of the following steps within 30 seconds, the setting mode will be automatically canceled. In this case, start over from step 1.

- 3 Press **ENTER**.

The four-digit code set for the selected input area appears in the display window (6) on the remote control.

- 4 Press the numeric buttons (11) to enter the four-digit remote control code for the input area you want to use.

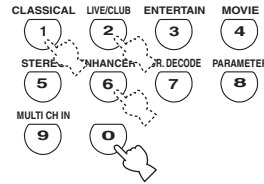

Remote control tuner ID codes

Select one of the following codes to set the remote control tuner ID code for the input area you want to use.

Tuner ID code (remote control setting)	Function	Remote control tuner ID
2602 (initial setting)	To operate this unit using the default code.	ID1 (initial setting)
2610	To operate this unit using an alternative code.	ID2

- 5 Press **ENTER** to set the number.

"OK" appears in the display window (6) if setting was successful.

"NG" appears in the display window (6) if the setting was unsuccessful. In this case, start over from step 1.

- 6 Press **LEARN** again to exit from the setup mode.



See page 107 for the operation of the advanced setup.

■ Bi-amplifier setting BI-AMP

Use this feature to activate or deactivate the bi-amplifier function (see page 16).

Choices: ON, OFF

- Select "ON" if you want to activate the bi-amplifier function. "SUR.B L/R SP" is set to "NONE" automatically, and this unit outputs the front channel audio signals at the SURROUND BACK/BI-AMP speaker terminals.
- Select "OFF" if you want to deactivate the bi-amplifier function.

Note

When "BI-AMP" is set to "ON", you can only select "FRONT B", "ZONE B", or "NONE" in "EXTRA SP ASSIGN" (see page 77).

■ SCENE IR code setting SCENE IR

Use this feature to output the remote control signals at the REMOTE OUT jack automatically when this unit is in the SCENE mode.

Choices: ON, OFF

- Select "ON" when the component connected to the REMOTE OUT jack is the Yamaha component and has the capability of the SCENE control signals. This unit automatically sends the remote control signals to the component.
- Select "OFF" when the component connected to the REMOTE OUT jack is not the Yamaha component and does not have the capability of the SCENE control signals.

Note

If noises are output when you operate the SCENE function, set "SCENE IR" to "OFF".

■ Monitor check MON. CHK

Use this feature to activate or deactivate the monitor check function of this unit. When this parameter is set to "YES", this unit receives the information of the available video signal resolutions from the video monitor connected via HDMI and you can only select the resolutions supported by the video monitor in "HDMI RES." (see page 89). When "MON. CHK" is set to "SKIP", you can select any resolution in "HDMI RES.".

Choices: YES, SKIP

■ Tuner frequency step TU (Asia and General models only)

Use this feature to set the tuner frequency step according to the frequency spacing in your area.

Choices: AM10/FM100, AM9/FM50

- Select "AM10/FM100" for North, Central and South America.
- Select "AM9/FM50" for all other areas.

■ Parameter initialization INIT

Use this feature to reset the parameters of this unit to the initial factory settings. You can select the category of parameters to be initialized.

Choices: DSP PARAM, VIDEO, ALL, CANCEL

- Select "DSP PARAM" to initialize all the parameters of the sound field programs (see page 64).
- Select "VIDEO" to initialize the parameters in "VIDEO SET" (see page 88) and "OSD SHIFT" in "DISPLAY SET" (see page 88).
- Select "ALL" to initialize all the parameters of this unit.
- Select "CANCEL" to cancel the initialization procedure.

Note

Use "INITIALIZE" in the sound field program menu to initialize the parameters of the desired program (see page 64).

Troubleshooting

Refer to the table below when this unit does not function properly. If the problem you are experiencing is not listed below or if the instruction below does not help, turn off this unit, disconnect the power cable, and contact the nearest authorized Yamaha dealer or service center.

■ General

Problem	Cause	Remedy	See page
This unit fails to turn on or enters the standby mode soon after the power is turned on.	The power cable is not connected or the plug is not completely inserted.	Connect the power cable firmly.	—
	The speaker impedance setting is incorrect.	Set the speaker impedance to match your speakers.	28
	The protection circuitry has been activated.	Make sure that all speaker wire connections on this unit and on all speakers are secure and that the wires for each connection do not touch anything other than their respective connections.	14
	This unit has been exposed to a strong external electric shock (such as lightning or strong static electricity).	Set this unit to the standby mode, disconnect the power cable, plug it back in after 30 seconds and then use this unit normally.	—
No sound.	Incorrect input or output cable connections.	Connect the cables properly. If the problem persists, the cables may be defective.	20-26
	The optimizer microphone is connected.	Disconnect the optimizer microphone.	35
	Audio input jack select is set to "HDMI", "COAX/OPT" or "ANALOG".	Set Audio input jack select to "AUTO".	44
	Audio input jack select is set to "ANALOG" while playing a source encoded in Dolby Digital or DTS.	Set Audio input jack select to "AUTO" or "COAX/OPT".	44
	No appropriate input source has been selected.	Select an appropriate input source with the INPUT selector on the front panel (or the input selector buttons on the remote control).	42, 43
	Speaker connections are not secure.	Secure the connections.	14
	The front speakers to be used have not been selected properly.	Select the front speakers by pressing (A) SPEAKERS on the front panel repeatedly.	43
	The volume is turned down.	Turn up the volume.	—
	The sound is muted.	Press (M) MUTE or (V) VOLUME +/- on the remote control to resume audio output and then adjust the volume.	45
	Signals this unit cannot reproduce are being input from a source component, such as a CD-ROM.	Play a source whose signals can be reproduced by this unit.	—
	The HDMI components connected to this unit do not support the HDCP copy protection standards.	Connect HDMI components that support the HDCP copy protection standards.	18
	"S.AUDIO" is set to "OTHER" and "HDMI" audio signals are not being played back on this unit.	Set "S.AUDIO" to "RX-V863" in "MANUAL SETUP".	91
No picture.	The output and input for the picture are connected to different types of video jacks.	Set "VIDEO CONV." to "ON" or connect your source components in the same way as you connect your video monitor to this unit.	88
	Non-standard video signals are input.		
The sound suddenly goes off.	The protection circuitry has been activated because of a short circuit, etc.	Check that the speaker impedance setting is correct. Check that the speaker wires are not touching each other and then turn this unit back on.	28, 107 —
	The sleep timer has turned this unit off.	Turn this unit on, and play the source again.	—
	The sound is muted.	Press (M) MUTE or (V) VOLUME +/- on the remote control to resume audio output.	45
Sound is heard from the speaker on one side only.	Incorrect cable connections.	Connect the cables properly. If the problem persists, the cables may be defective.	14
	Incorrect settings in "SP LEVEL".	Adjust the "SP LEVEL" settings.	79

Problem	Cause	Remedy	See page
Only the center speaker outputs substantial sound.	When playing a monaural source with a sound field program, the source signal is directed to the center channel, and the front and surround speakers output effect sounds.		
No sound is heard from the center speaker.	“CENTER SP” in “SET MENU” is set to “NONE”.	Set “CENTER SP” to “SMALL” or “LARGE”.	78
	One of the sound field programs (except for “7ch Stereo”) has been selected.	Try another sound field program.	48
No sound is heard from the presence speakers.	The sound field programs are turned off.	Press Ⓢ STRAIGHT to turn them on.	51
	You are using a source or program combination that does not output sound from all channels.	Try another sound field program.	42
	“EXTRA SP ASSIGN” is set to a setting other than “PRESENCE”.	Set “EXTRA SP ASSIGN” to “PRESENCE”.	77
No sound is heard from the surround speakers.	“SUR. L/R SP” in “SET MENU” is set to “NONE”.	Set “SUR. L/R SP” to “SML” or “LRG”.	78
	This unit is in the “Straight” mode and a monaural source is being played back.	Press Ⓢ STRAIGHT on the front panel so that “Straight” disappears from the front panel display.	51
No sound is heard from the surround back speakers.	“SUR. L/R SP” in “SET MENU” is set to “NONE” and “SUR.B L/R SP” is automatically set to “NONE”.	Set “SUR. L/R SP” and “SUR.B L/R SP” to a setting other than “NONE”.	78
	“SUR.B L/R SP” in “SET MENU” is set to “NONE”.	Set “SUR.B L/R SP” to a setting other than “NONE”.	78
Zone 2 speaker settings are not available in “SET MENU”.	“EXTRA SP ASSIGN” is set to a setting other than “ZONE2”.	Set “EXTRA SP ASSIGN” to “ZONE2”.	77
FRONT B speakers cannot be activated.	“EXTRA SP ASSIGN” is set to a setting other than “FRONT B”.	Set “EXTRA SP ASSIGN” to “FRONT B”.	77
No sound from the center, surround or surround back speakers when the FRONT B speakers are activated.	“EXTRA SP ASSIGN” is set to “ZONE B”.	Set “EXTRA SP ASSIGN” to “FRONT B”.	77
Presence speaker settings are not available in “SET MENU”.	“EXTRA SP ASSIGN” is set to a setting other than “PRESENCE”.	Set “EXTRA SP ASSIGN” to “PRESENCE”.	77
No sound is heard from the subwoofer.	“LFE/BASS OUT” in “SET MENU” is set to “FRONT” when a Dolby Digital or DTS signal is being played.	Set “LFE/BASS OUT” to “SWFR” or “BOTH”.	77
	“LFE/BASS OUT” in “SET MENU” is set to “SWFR” or “FRONT” when a 2-channel source is being played.	Set “LFE/BASS OUT” to “BOTH”.	77
	The source does not contain low-frequency signals.		
Dolby Digital or DTS sources cannot be played. (Dolby Digital or DTS indicator in the front panel display does not light up.)	The connected component is not set to output Dolby Digital or DTS digital signals.	Make an appropriate setting following the operating instructions for your component.	—
	Audio input jack select is set to “ANALOG”.	Set Audio input jack select to “AUTO”.	44
A humming sound is heard.	Incorrect cable connections.	Connect the audio cables firmly. If the problem persists, the cables may be defective.	—
	No connection from the turntable to the GND terminal.	Connect the grounding cable of your turntable to the GND terminal of this unit.	23
The volume level is low while a record is being played.	The record is being played on a turntable with an MC cartridge.	Connect your turntable to this unit through an MC-head amplifier.	23

Problem	Cause	Remedy	See page
The volume level cannot be increased, or the sound is distorted.	The component connected to the AUDIO OUT (REC) jacks of this unit is turned off.	Turn on the power of the component.	—
The sound effects cannot be recorded.	It is not possible to record the sound effects with a recording component.		
A source cannot be recorded by a digital recording component connected to the DIGITAL OUTPUT jack.	The source component is not connected to the DIGITAL INPUT jacks of this unit. Some components cannot record Dolby Digital or DTS sources.	Connect the source component to the DIGITAL INPUT jacks.	21, 23
A source cannot be recorded by an analog component connected to the AUDIO OUT (REC) jacks.	The source component is not connected to the analog AUDIO IN jacks of this unit.	Connect the source component to the analog AUDIO IN jacks.	23
The sound field parameters and some other settings of this unit cannot be changed.	“MEMORY GUARD” in “SET MENU” is set to “ON”.	Set “MEMORY GUARD” to “OFF”.	90
This unit does not operate properly.	The internal microcomputer has been frozen by an external electric shock (such as lightning or excessive static electricity) or by a power supply with low voltage.	Disconnect the power cable from the AC wall outlet and then plug it in again after about 30 seconds.	—
No sound is heard from the connected HDMI component.	The HDMI component does not accept the multi-channel audio signals.	Convert the multi-channel audio signals to the 2-channel audio signals at the source component such as a DVD player.	—
“CHECK SP WIRES” appears in the front panel display.	Speaker cables are short-circuited.	Make sure all speaker cables are connected correctly.	14
There is noise interference from digital or radio frequency equipment.	This unit is too close to the digital or high-frequency equipment.	Move this unit further away from such equipment.	—
The picture is disturbed.	The video source uses scrambled or encoded signals to prevent dubbing.		
This unit suddenly enters the standby mode.	The internal temperature is too high and the overheat protection circuitry has been activated.	Wait about 1 hour for this unit to cool down and then turn it back on.	—

■ HDMI

Problem	Cause	Remedy	See page
No picture or sound.	The number of the connected HDMI components is over the limit.	Reduce the number of the connected HDMI components.	—
	HDCP authentication failed.	Check that the connected HDMI components support the HDCP copy protection standards.	—

■ Tuner (FM/AM)

	Problem	Cause	Remedy	See page
FM	FM stereo reception is noisy.	The characteristics of FM stereo broadcasts may cause this problem when the transmitter is too far away or the antenna input is poor.	Check the antenna connections.	27
			Try using a high-quality directional FM antenna.	—
			Use the manual tuning method.	53
	There is distortion, and clear reception cannot be obtained even with a good FM antenna.	There is multi-path interference.	Adjust the antenna position to eliminate multi-path interference.	—
	The desired station cannot be tuned into with the automatic tuning method.	The signal is too weak.	Use a high-quality directional FM antenna.	—
			Use the manual tuning method.	53
	Previously preset stations can no longer be tuned into.	This unit has been disconnected for a long period.	Preset the stations again.	54
AM	The desired station cannot be tuned into with the automatic tuning method.	The signal is weak or the antenna connections are loose.	Tighten the AM loop antenna connections and orient the antenna for the best reception.	—
			Use the manual tuning method.	53
	There are continuous crackling and hissing noises.	Noise can result from lightning, fluorescent lamps, motors, thermostats and other electrical equipment.	Use an outdoor antenna and a ground wire. This will help somewhat, but it is difficult to eliminate all noise.	—
	There are buzzing and whining noises.	A TV set is being used nearby.	Move this unit away from the TV set.	—

■ Remote control

Problem	Cause	Remedy	See page
The remote control does not work or function properly.	Wrong distance or angle.	The remote control will function within a maximum range of 6 m and no more than 30 degrees off-axis from the front panel.	31
	Direct sunlight or lighting (from an inverter type of fluorescent lamp, etc.) is striking the remote control sensor of this unit.	Reposition this unit.	—
	The batteries are weak.	Replace all batteries.	4
	The operation mode selector is set incorrectly.	Set the operation mode selector correctly. When operating this unit, set it to the ⓂAMP position. When operating the component selected by the input selector button, set it to the ⓂSOURCE position. When operating the TV set in the ⓂDTV/CBL or ⓂPHONO area, set it to the ⓂTV position.	—
	The remote control code was not correctly set.	Set the remote control code correctly using “List of remote control codes” at the end of this manual.	94
		Try setting another code of the same manufacturer using “List of remote control codes” at the end of this manual.	94
The library code of the remote control and the remote control ID of this unit do not match.	Match the remote control ID of this unit with the corresponding remote control library code.	108, 109	
Even if the remote control code is correctly set, there are some models that do not respond to the remote control.	Program the necessary functions independently into the programmable buttons using the Learn feature.	96	
The remote control does not learn new functions.	The batteries of this remote control and/or the other remote control are too weak.	Replace the batteries.	4
	The distance between the two remote controls is too much or too little.	Place the remote controls at the proper distance.	96
	The signal coding or modulation of the other remote control is not compatible with this remote control.	Learning is not possible.	—
	Memory capacity is full.	Delete other unnecessary functions to make room for the new functions.	102

■ iPod

Note

In case of a transmission error without a status message appearing in the front panel and in the OSD, check the connection to your iPod (see page 25).

Status message	Cause	Remedy	See page
Loading...	This unit is in the middle of recognizing the connection with your iPod. This unit is in the middle of acquiring song lists from your iPod.		
Connect error	There is a problem with the signal path from your iPod to this unit.	Turn off this unit and reconnect the Yamaha iPod universal dock to the DOCK terminal of this unit. Try resetting your iPod.	25 —
Unknown iPod	The iPod being used is not supported by this unit.	Only iPod (Click and Wheel), iPod nano, and iPod mini are supported.	—
iPod connected	Your iPod is properly stationed in a Yamaha iPod universal dock (such as YDS-10, sold separately) connected to the DOCK terminal of this unit, and the connection between your iPod and this unit is complete.		
Disconnected	Your iPod was removed from a Yamaha iPod universal dock (such as YDS-10 sold separately) connected to the DOCK terminal of this unit.	Station your iPod back in a Yamaha iPod universal dock (such as YDS-10 sold separately) connected to the DOCK terminal of this unit.	25
Unable to play	This unit cannot play back the songs currently stored on your iPod.	Check that the songs currently stored on your iPod are playable. Store some other playable music files on your iPod.	— —

■ Bluetooth

Status message	Cause	Remedy	See page
Searching...	The Bluetooth adapter and the Bluetooth component is in the middle of the pairing. The Bluetooth adapter and the Bluetooth component is in the middle of establishing the connection.		
Completed	The pairing is completed.		
Canceled	The pairing is canceled.		
BT connected	The connection between the Yamaha Bluetooth adapter (such as YBA-10, sold separately) and the Bluetooth component is established.		
Disconnected	The Bluetooth component is disconnected from the Yamaha Bluetooth adapter (such as YBA-10, sold separately).		
No BT adapter	The Bluetooth adapter is not connected to the DOCK terminal.	Connect the Yamaha Bluetooth adapter (such as YBA-10, sold separately) to the DOCK terminal.	25
Not found	Yamaha Bluetooth adapter (such as YBA-10, sold separately) could not find any Bluetooth components.		
Not Available	Another Bluetooth connection has already been established.	Terminate the existing connection.	62

■ AUTO SETUP

Before AUTO SETUP

Error message	Cause	Remedy	See page
Connect MIC!	Optimizer microphone is not connected.	Connect the supplied optimizer microphone to the OPTIMIZER MIC jack on the front panel.	32
Unplug HP!	Headphones are connected.	Unplug the headphones.	—
Memory Guard!	The parameters of this unit are protected.	Set "MEMORY GUARD" to "OFF".	90

During AUTO SETUP

Error message	Cause	Remedy	See page
E-1:NO FRONT SP	Front L/R channel signals are not detected.	Check the front L/R speaker connections.	14
E-2:NO SUR SP	A surround channel signal is not detected.	Check the surround speaker connections.	14
E-3:NO PRNS SP	A presence channel signal is not detected.	Check the presence speaker connections.	14
E-4:SBR->SBL	Only a right surround back channel signal is detected.	Connect the surround back speaker to the LEFT SURROUND BACK SPEAKERS terminal if you only have one surround back speaker.	14
E-5:NOISY	Background noise is too loud.	Try running "AUTO SETUP" in a quiet environment. Turn off noisy electric equipment like air conditioners or move them away from the optimizer microphone.	— —
E-6:CHECK SUR.	Surround back speakers are connected, though surround L/R speakers are not.	Connect surround speakers when you use surround back speakers.	14
E-7:NO MIC	The optimizer microphone was unplugged during the "AUTO SETUP" procedure.	Connect the supplied optimizer microphone to the OPTIMIZER MIC jack on the front panel.	32
E-8:NO SIGNAL	The optimizer microphone does not detect test tones.	Check the microphone setting. Check the speaker connections and placement.	32 14
E-9:USER CANCEL	The "AUTO SETUP" procedure was cancelled due to user activity.	Run "AUTO SETUP" again.	32
E-10:INTERNAL ERROR	An internal error occurred.	Run "AUTO SETUP" again.	32

After AUTO SETUP

Warning message	Cause	Remedy	See page
W-1:OUT OF PHASE	Speaker polarity is not correct. This message may appear depending on the speakers even when the speakers are connected correctly.	Check the speaker connections for proper polarity (+ or -).	14
W-2:OVER 24m (80ft)	The distance between the speaker and the listening position is over 24 m (80 ft).	Bring the speaker closer to the listening position.	—
W-3:LEVEL ERROR	The difference of volume level among speakers is excessive.	Readjust the speaker installation so that all speakers are set in locations with similar conditions.	—
		Check the speaker connections.	14
		Use speakers of similar quality.	—
		When “SWFR: TOO LOUD” or “SWFR: TOO LOW” appears in the result screen, the output volume of the subwoofer.	32
W-4:CHECK PRNS	“EXTRA SP ASSIGN” is set to “PRESENCE”, though the presence channel signals are not detected.	Check the presence speaker connections.	14
		Set “EXTRA SP ASSIGN” to a setting other than “PRESENCE”.	33

Notes

- If the “ERROR” or “WARNING” screens appears, check the cause of the problem, then run “AUTO SETUP” again.
- If a warning message “W-1”, “W-2”, or “W-3” appears, corrections are made, but they may not be optimal.
- If an error message “E-10” occurs repeatedly, contact a qualified Yamaha service center.

Resetting the system

Use this feature to reset all the parameters of this unit to the initial factory settings.

Notes

- This procedure completely resets all the parameters of this unit including the “SET MENU” parameters.
- The initial factory settings are activated next time you turn on this unit.



To cancel the initialization procedure at any time without making any changes, press **ⓁSYSTEM OFF** on the front panel.

1 Press **ⓁSYSTEM OFF** on the front panel to set this unit to the standby mode.

2 Press and hold **ⓂTONE CONTROL** and then press **ⓀMAIN ZONE ON/OFF** to turn on this unit.

This unit turns on, and the advanced setup menu appears in the front panel display.



3 Rotate the **ⓃPROGRAM** selector to select “INIT”.

4 Press **ⓂTONE CONTROL** repeatedly to select “ALL”.



Select “CANCEL” to cancel the initialization procedure without making any changes.

5 Press **ⓁSYSTEM OFF** to confirm your selection and set this unit to the standby mode.

■ Audio and video synchronization (lip sync)

Lip sync, an abbreviation for lip synchronization, is a technical term that involves both a problem and a capability of maintaining audio and video signals synchronized during post-production and transmission. Whereas the audio and video latency requires complex end-user adjustments, HDMI version 1.3 incorporates an automatic audio and video syncing capability that allows devices to perform this synchronization automatically and accurately without user interaction.

■ Bi-amplification connection

A bi-amplification connection uses two amplifiers for a speaker. One amplifier is connected to the woofer section of a loudspeaker while the other is connected to the combined mid and tweeter section. With this arrangement each amplifier operates over a restricted frequency range. This restricted range presents each amplifier with a much simpler job and each amplifier is less likely to influence the sound in some way. The internal crossover of the speaker consists of a LPF (low pass filter) and a HPF (high pass filter). As its name implies, the LPF passes frequencies below a cutoff and rejects frequencies above the cutoff frequency. Likewise, the HPF passes frequencies above its cutoff.

■ Component video signal

With the component video signal system, the video signal is separated into the Y signal for the luminance and the Pb and Pr signals for the chrominance. Color can be reproduced more faithfully with this system because each of these signals is independent. The component signal is also called the “color difference signal” because the luminance signal is subtracted from the color signal. A monitor with component input jacks is required in order to output component signals.

■ Composite video signal

With the composite video signal system, the video signal is composed of three basic elements of a video picture: color, brightness and synchronization data. A composite video jack on a video component transmits these three elements combined.

■ Deep Color

Deep Color refers to the use of various color depths in displays, up from the 24-bit depths in previous versions of the HDMI specification. This extra bit depth allows HDTVs and other displays go from millions of colors to billions of colors and eliminate on-screen color banding for smooth tonal transitions and subtle gradations between colors. The increased contrast ratio can represent many times more shades of gray between black and white. Also Deep Color increases the number of available colors within the boundaries defined by the RGB or YCbCr color space.

■ Dolby Digital

Dolby Digital is a digital surround sound system that gives you completely independent multi-channel audio. With 3 front channels (front L/R and center), and 2 surround stereo channels, Dolby Digital provides 5 full-range audio channels. With an additional channel especially for bass effects, called LFE (Low Frequency Effect), the system has a total of 5.1-channels (LFE is counted as 0.1 channel). By using 2-channel stereo for the surround speakers, more accurate moving sound effects and surround sound environment are possible than with Dolby Surround. The wide dynamic range from maximum to minimum volume reproduced by the 5 full-range channels and the precise sound orientation generated using digital sound processing provide listeners with unprecedented excitement and realism. With this unit, any sound environment from monaural up to a 5.1-channel configuration can be freely selected for your enjoyment.

■ Dolby Digital EX

Dolby Digital EX creates 6 full-bandwidth output channels from 5.1-channel sources. This is done using a matrix decoder that derives 3 surround channels from the 2 in the original recording. For the best results, Dolby Digital EX should be used with movie sound tracks recorded with Dolby Digital Surround EX. With this additional channel, you can experience more dynamic and realistic moving sound especially with scenes with “fly-over” and “fly-around” effects.

■ Dolby Digital Plus

Dolby Digital Plus is an advanced audio technology developed for high-definition programming and media including HD broadcasts, HD DVD, and Blu-ray Disc. Selected as a mandatory audio standard for HD DVD and as an optional audio standard for Blu-ray Disc, this technology delivers multichannel sound with discrete channel output. Supporting bitrates up to 6.0 Mbps, Dolby Digital Plus can carry up to 7.1 discreet audio channels simultaneously. Supported by HDMI version 1.3 and designed for the optical disc players and AV receivers/amplifiers of the future, Dolby Digital Plus also remains fully compatible with the existing multichannel audio systems that incorporate Dolby Digital.

■ Dolby Pro Logic II

Dolby Pro Logic II is an improved technique used to decode vast numbers of existing Dolby Surround sources. This new technology enables a discrete 5-channel playback with 2 front left and right channels, 1 center channel, and 2 surround left and right channels instead of only 1 surround channel for conventional Pro Logic technology. There are three modes available: “Music mode” for music sources, “Movie mode” for movie sources and “Game mode” for game sources.

■ Dolby Pro Logic IIx

Dolby Pro Logic IIx is a new technology enabling discrete multi-channel playback from 2-channel or multi-channel sources. There are three modes available: “Music mode” for music sources, “Movie mode” for movie sources (for 2-channel sources only) and “Game mode” for game sources.

■ Dolby Surround

Dolby Surround uses a 4-channel analog recording system to reproduce realistic and dynamic sound effects: 2 front left and right channels (stereo), a center channel for dialog (monaural), and a surround channel for special sound effects (monaural). The surround channel reproduces sound within a narrow frequency range. Dolby Surround is widely used with nearly all video tapes and laser discs, and in many TV and cable broadcasts as well. The Dolby Pro Logic decoder built into this unit employs a digital signal processing system that automatically stabilizes the volume on each channel to enhance moving sound effects and directionality.

■ Dolby TrueHD

Dolby TrueHD is an advanced lossless audio technology developed for high-definition disc-based media including HD DVD and Blu-ray Disc. Selected as a mandatory audio standard for HD DVD and as an optional audio standard for Blu-ray Disc, this technology delivers sound that is bit-for-bit identical to the studio master, offering a high-definition home theater experience. Supporting bitrates up to 18.0 Mbps, Dolby TrueHD can carry up to 8 discrete channels of 24-bit/96 kHz audio simultaneously. Supported by HDMI version 1.3 and designed for the optical disc players and AV receivers/amplifiers of the future, Dolby TrueHD also remains fully compatible with the existing multichannel audio systems and retains the metadata capability of Dolby Digital, allowing dialog normalization and dynamic range control.

■ DSD

Direct Stream Digital (DSD) technology stores audio signals on digital storage media, such as Super Audio CDs. Using DSD, signals are stored as single bit values at a high-frequency sampling rate of 2.8224 MHz, while noise shaping and oversampling are used to reduce distortion, a common occurrence with very high quantization of audio signals. Due to the high sampling rate, better audio quality can be achieved than that offered by the PCM format used for normal audio CDs.

■ DTS 96/24

DTS 96/24 offers an unprecedented level of audio quality for multi-channel sound on DVD video, and is fully backward-compatible with all DTS decoders. “96” refers to a 96 kHz sampling rate compared to the typical 48 kHz sampling rate. “24” refers to 24-bit word length. DTS 96/24 offers sound quality transparent to the original 96/24 master, and 96/24 5.1-channel sound with full-quality full-motion video for music programs and motion picture soundtracks on DVD video.

■ DTS Digital Surround

DTS digital surround was developed to replace the analog soundtracks of movies with a 6.1-channel digital sound track, and is now rapidly gaining popularity in movie theaters around the world. DTS, Inc. has developed a home theater system so that you can enjoy the depth of sound and natural spatial representation of DTS digital surround in your home. This system produces practically distortion-free 6.1-channel sound (technically, front left and right, center, surround left and right, and LFE 0.1 (subwoofer) channels for a total of 5.1 channels). This unit incorporates a DTS-ES decoder that enables 6.1-channel reproduction by adding the surround back channel to the existing 5.1-channel format.

■ DTS Express

DTS Express is an advanced audio technology for the optional feature on Blu-ray Disc or HD DVD, which offers high-quality, low bit rate audio optimized for network streaming, and Internet applications. DTS Express is used for the Secondary Audio feature of Blu-ray Disc or the Sub Audio feature of HD DVD. These features deliver audio commentaries (for example, the additional commentaries made by the director of a film) on demand by the users via the Internet, etc. DTS Express signals are mixed down with the main audio stream on the player component, and the component sends the mixed audio stream to the AV receivers/amplifiers via digital coaxial, digital optical, or analog connections.

■ DTS-HD High Resolution Audio

DTS-HD High Resolution Audio is an high resolution audio technology developed for high-definition disc-based media including HD DVD and Blu-ray Disc. Selected as an optional audio standard for both HD DVD and Blu-ray Disc, this technology delivers sound that is virtually indistinguishable from the original, offering a high-definition home theater experience. Supporting bitrates up to 3.0 Mbps for HD DVD and 6.0 Mbps for Blu-ray Disc, DTS-HD High Resolution Audio can carry up to 7.1 discrete channels of 24-bit/96 kHz audio simultaneously. Supported by HDMI version 1.3 and designed for the optical disc players and AV receivers/amplifiers of the future, DTS-HD High Resolution Audio also remains fully compatible with the existing multichannel audio systems that incorporate DTS Digital Surround.

■ DTS-HD Master Audio

DTS-HD Master Audio is an advanced lossless audio technology developed for high-definition disc-based media including HD DVD and Blu-ray Disc. Selected as a mandatory audio standard for both HD DVD and Blu-ray Disc, this technology delivers sound that is bit-for-bit identical to the studio master, offering a high-definition home theater experience. Supporting bitrates up to 18.0 Mbps for HD DVD and up to 24.5 Mbps for Blu-ray Disc, DTS-HD Master Audio can carry up to 7.1 discrete channels of 24-bit/96 kHz audio simultaneously. Supported by HDMI version 1.3 and designed for the optical disc players and AV receivers/amplifiers of the future, DTS-HD Master Audio also remains fully compatible with the existing multichannel audio systems that incorporate DTS Digital Surround.

■ HDMI

HDMI (High-Definition Multimedia Interface) is the first industry-supported, uncompressed, all-digital audio/video interface. Providing an interface between any source (such as a set-top box or AV receiver) and an audio/video monitor (such as a digital television), HDMI supports standard, enhanced or high-definition video as well as multi-channel digital audio using a single cable. HDMI transmits all ATSC HDTV standards and supports 8-channel digital audio, with bandwidth to spare to accommodate future enhancements and requirements. When used in combination with HDCP (High-bandwidth Digital Content Protection), HDMI provides a secure audio/video interface that meets the security requirements of content providers and system operators. For further information on HDMI, visit the HDMI website at “<http://www.hdmi.org/>”.

■ LFE 0.1 channel

This channel reproduces low-frequency signals. The frequency range of this channel is from 20 Hz to 120 Hz. This channel is counted as 0.1 because it only enforces a low-frequency range compared to the full-range reproduced by the other 5/6 channels in Dolby Digital or DTS 5.1/6.1-channel systems.

■ Neo:6

Neo:6 decodes the conventional 2-channel sources for 6-channel playback by the specific decoder. It enables playback with the full-range channels with higher separation just like digital discrete signal playback. There are two modes available: "Music mode" for music sources and "Cinema mode" for movie sources.

■ PCM (Linear PCM)

Linear PCM is a signal format under which an analog audio signal is digitized, recorded and transmitted without using any compression. This is used as a method of recording CDs and DVD audio. The PCM system uses a technique for sampling the size of the analog signal per very small unit of time. Standing for "Pulse Code Modulation", the analog signal is encoded as pulses and then modulated for recording.

■ Sampling frequency and number of quantized bits

When digitizing an analog audio signal, the number of times the signal is sampled per second is called the sampling frequency, while the degree of fineness when converting the sound level into a numeric value is called the number of quantized bits. The range of rates that can be played back is determined based on the sampling rate, while the dynamic range representing the sound level difference is determined by the number of quantized bits. In principle, the higher the sampling frequency, the wider the range of frequencies that can be played back, and the higher the number of quantized bits, the more finely the sound level can be reproduced.

■ S-video signal

With the S-video signal system, the video signal normally transmitted using a pin cable is separated and transmitted as the Y signal for the luminance and the C signal for the chrominance through the S-video cable. Using the S VIDEO jack eliminates video signal transmission loss and allows recording and playback of even more beautiful images.

■ "x.v.Color"

A color space standard supported by HDMI version 1.3. It is a more extensive color space than sRGB, and allows the expression of colors that could not be expressed before. While remaining compatible with the color gamut of sRGB standards, "x.v.Color" expands the color space and can thus produce more vivid, natural images. It is particularly effective for still pictures and computer graphics.

Sound field program information

■ Elements of a sound field

What really creates the rich, full tones of a live instrument are the multiple reflections from the walls of the room. In addition to making the sound live, these reflections enable us to tell where the player is situated as well as the size and shape of the room in which we are sitting.

There are two distinct types of sound reflections that combine to make up the sound field in addition to the direct sound coming straight to our ears from the player's instrument.

Early reflections

Reflected sounds reach our ears extremely rapidly (50 ms to 100 ms after the direct sound), after reflecting from one surface only (for example, from a wall or the ceiling).

Early reflections actually add clarity to the direct sound.

Reverberations

These are caused by reflections from more than one surface (for example, from the walls, and the ceiling) so numerous that they merge together to form a continuous sonic afterglow. They are non-directional and lessen the clarity of the direct sound.

Direct sound, early reflections and subsequent reverberations taken together help us to determine the subjective size and shape of the room, and it is this information that the digital sound field processor reproduces in order to create sound fields.

If you could create the appropriate early reflections and subsequent reverberations in your listening room, you would be able to create your own listening environment. The acoustics in your room could be changed to those of a concert hall, a dance floor, or a room with virtually any size at all. This ability to create sound fields at will is exactly what Yamaha has done with the digital sound field processor.

■ CINEMA DSP

Since the Dolby Surround and DTS systems were originally designed for use in movie theaters, their effect is best felt in a theater having many speakers designed for acoustic effects. Since home conditions, such as room size, wall material, number of speakers, and so on, can differ so widely, it is inevitable that there are differences in the sound heard. Based on a wealth of actually measured data, Yamaha CINEMA DSP uses Yamaha original sound field technology to combine Dolby Pro Logic, Dolby Digital and DTS systems to provide the audiovisual experience of a movie theater in the listening room of your own home.

■ SILENT CINEMA

Yamaha has developed a natural, realistic sound effect DSP algorithm for headphones. Parameters for headphones have been set for each sound field so that accurate representations of all the sound field programs can be enjoyed on headphones.

■ Virtual CINEMA DSP

Yamaha has developed a Virtual CINEMA DSP algorithm that allows you to enjoy DSP sound field surround effects even without any surround speakers by using virtual surround speakers. It is even possible to enjoy Virtual CINEMA DSP using a minimal two-speaker system that does not include a center speaker.

■ Compressed Music Enhancer

The Compressed Music Enhancer feature of this unit enhances your listening experience by regenerating the missing harmonics in a compression artifact. As a result, flattened complexity due to the loss of high-frequency fidelity as well as lack of bass due to the loss of low-frequency bass is compensated, providing improved performance of the overall sound system.

Specifications

AUDIO SECTION

- Minimum RMS Output Power for Front, Center, Surround, Surround back
20 Hz to 20 kHz, 0.06% THD, 8 Ω 105 W
- Dynamic Power (IHF)
Front L/R, 8/6/4/2 Ω 140/175/205/250 W
- Maximum Useful Output Power (JEITA)
[Asia, General, China and Korea models]
1 kHz, 10% THD, 8 Ω 145 W
- Maximum Output Power [Europe, Russia and Asia models]
Speaker impedance setting: 8 Ω, 1 kHz, 0.7% THD, 4 Ω 155 W
- Dynamic Headroom [U.S.A. and Canada models]
8 Ω 1.25 dB
- IEC Output Power [Europe, Russia and Asia models]
Front L/R, 1 kHz, 0.06% THD, 8 Ω 115 W
- Damping Factor (IHF)
Front L/R, SPEAKERS A, 20 Hz to 20 kHz, 8 Ω 120 or more
- Input Sensitivity/Input Impedance
PHONO (MM) 3.5 mV/47 kΩ
CD, etc. 200 mV/47 kΩ
MULTI CH INPUT 200 mV/47 kΩ
- Maximum Input Voltage
PHONO (MM)
1 kHz, 0.1% THD 60 mV or more
CD, etc.
Effect On, 1 kHz, 0.5% THD 2.3 V or more
- Rated Output Voltage/Output Impedance
OUT (REC) 200 mV/1.2 kΩ
PRE OUT 1.0 V/1.2 kΩ
SUBWOOFER (2ch Stereo, FRONT SP: SMALL)
..... 1.0 V/1.2 kΩ
ZONE 2 OUT 200 mV/1.2 kΩ
- Headphone Jack Rated Output/Impedance
CD, etc. (1 kHz, 50 mV, 8 Ω) 150 mV/100 Ω
- Frequency Response
CD to Front L/R, 10 Hz to 100 kHz +0/-3 dB
- RIAA Equalization Deviation
PHONO (MM) 0 ± 0.5 dB
- Total Harmonic Distortion
PHONO (MM) to OUT (REC)
20 Hz to 20 kHz, 1 V 0.02% or less
CD, etc. to Front L/R
2ch Stereo, 20 Hz to 20 kHz, 50 W, 8 Ω 0.06% or less
- Signal to Noise Ratio (IHF-A Network)
PHONO (MM, 5 mV) to OUT (REC)
[Australia, Europe, Russia, Korea and Asia models]
..... 81 dB or more
[Other models] 86 dB or more
CD, etc. (Effect Off, 250 mV) to Front L/R
..... 100 dB or more
- Residual Noise (IHF-A Network)
Front L/R 150 μV or less
- Channel Separation (1 kHz/10 kHz)
PHONO (shortened) to Front L/R 60 dB/55 dB or more
CD, etc. (5.1 kΩ shortened) to Front L/R
..... 60 dB/45 dB or more

- Volume Control MUTE/-80 dB to 16.5 dB
- Tone Control (Front L/R)
BASS Boost/Cut ±10 dB/50 Hz
BASS Turnover Frequency 350 Hz
TREBLE Boost/Cut ±10 dB/20 kHz
TREBLE Turnover Frequency 3.5 kHz
- Filter Characteristics (fc=40/60/80/90/100/110/120/160/200 Hz)
H.P.F.
(FRONT SP, CENTER SP, SUR. L/R SP, SUR.B L/R SP:
SMALL/SML) 12 dB/oct.
L.P.F. (Subwoofer) 24 dB/oct.

VIDEO SECTION

- Video Format (Gray Back)
[U.S.A., Canada, General and Korea models] NTSC
[Europe, Russia, Australia, Asia and China models]
..... PAL
- Video Format (Video Conversion) NTSC/PAL
- Signal Level
Composite 1 Vp-p/75 Ω
S-video 1 Vp-p/75 Ω (Y), 0.286 Vp-p/75 Ω (C)
Component 1 Vp-p/75 Ω (Y), 0.7 Vp-p/75 Ω (Pb/Pk)
- Maximum Input Level (Video Conversion Off)
..... 1.5 Vp-p or more
- Signal to Noise Ratio
..... 50 dB or more
- Frequency Response (MONITOR OUT)
Component (Video Conversion Off)
..... 5 Hz to 100 MHz, -3 dB

FM SECTION

- Tuning Range
[U.S.A. and Canada models] 87.5 to 107.9 MHz
[Asia and General models] 87.5/87.50 to 108.0/108.00 MHz
[Other models] 87.50 to 108.00 MHz
- 50 dB Quieting Sensitivity (IHF)
1 kHz, 100% MOD., Mono 2.8 μV (20.2 dBf)
- Signal to Noise Ratio (IHF)
Mono/Stereo 73 dB/70 dB
- Harmonic Distortion (1 kHz)
Mono/Stereo 0.5%
- Antenna Input (unbalanced) 75 Ω

AM SECTION

- Tuning Range
[U.S.A. and Canada models] 530 to 1710 kHz
[Asia and General models] 530/531 to 1710/1611 kHz
[Other models] 531 to 1611 kHz

GENERAL

- Power Supply
 - [U.S.A. and Canada models] AC 120 V, 60 Hz
 - [General model]
 - AC 110/120/220/230–240 V, 50/60 Hz
 - [Asia model]
 - AC 220/230–240 V, 50/60 Hz
 - [China model] AC 220 V, 50 Hz
 - [Korea model] AC 220 V, 60 Hz
 - [Australia model] AC 240 V, 50 Hz
 - [Europe and Russia models] AC 230 V, 50 Hz
- Power Consumption
 - [U.S.A. and Canada models] 400 W/500 VA
 - [Other models] 440 W
- Standby Power Consumption
 - [U.S.A. and Canada models] 0.8 W or less
 - [Other models] 0.1 W or less
- Maximum Power Consumption [General model only]
 - 6ch, 10% THD 850 W
- AC Outlets
 - [U.S.A., Canada, and China models]
 - 2 (Total 100 W maximum)
 - [Asia, General, Europe and Russia models]
 - 2 (Total 50 W maximum)
 - [Australia model] 1 (100 W maximum)
- Dimensions (W x H x D) 435 x 171 x 393 mm
(17-1/8 x 6-3/4 x 15-1/2 in)
- Weight 11.9 kg (26 lbs 4 oz)

* Specifications are subject to change without notice.

Index

■ Numerics

1 BASIC MENU, Manual setup	72
2 VOLUME MENU, Manual setup	73
2ch STEREO, Sound field program	50
3 SOUND MENU, Manual setup	73
4 INPUT MENU, Manual setup	74
5 OPTION MENU, Manual setup	74
7ch Enhancer, Sound field program	50
7ch STEREO, Sound field program	50
96/24 indicator	30

■ A

A)DISPLAY SET, Option menu	88
A)EQUALIZER, Sound menu	82
A)SPEAKER SET, Basic menu	77
AC OUTLET(S) (SWITCHED)	28
Action Game, Sound field program	49
ADAPTIVE DRC indicator	30
ADAPTIVE DRC, Volume menu	81
ADAPTIVE DSP LEVEL, Volume menu	81
Adaptive DSP level, Volume menu	81
Adaptive dynamic range control, Volume menu	81
Advanced setup	107
Advanced sound configurations	64
Adventure, Sound field program	50
AFFAIRS, Radio Data System program type	57
AM antenna connection	27
AM tuning	53
Amplifier function OSD display time, Display settings	88
ANALOG RES., Video information	46
Audio and video synchronization, Sound menu	84
Audio cable plugs	17
Audio components connection	23
Audio information	46
Audio input jacks selection	44
AUDIO jacks	17
Audio jacks	17
AUDIO SELECT	44
AUDIO SELECT, Initial configuration	90
Audio select, Initial configuration	90
Audio signal flow	19
AUTO DELAY, Lip sync	84
Auto delay, Lip sync	84
AUTO SETUP	32, 72
Auto setup	72
AUTO SETUP, Troubleshooting	117

AUTO TUNING, FM/AM tuning	53
Automatic tuning mode, FM/AM tuning	53
Available decoders with Sound field programs	69

■ B

B)LFER LEVEL, Sound menu	83
B)SP LEVEL, Basic menu	79
BASIC MENU, Manual setup	77
Basic menu, Manual setup	72
Bass cross over, Speaker settings	79
BGV, Input menu	87
BI-AMP, Advanced setup	110
Bi-Amplifier, Advanced setup	110
BITRATE, Audio information	46
Bluetooth adapter connection	25
Bluetooth component playback	62
Bluetooth component use	62
Bluetooth, Troubleshooting	116
BT connected, Bluetooth status message	116

■ C

C)DYNAMIC RANGE, Sound menu	83
C)MEMORY GUARD, Option menu	90
C)SP DISTANCE, Basic menu	80
Cable plugs	17
Canceled, Bluetooth status message	116
CD player connection	23
CD recorder connection	23
Cellar Club, Sound field program	49
CENTER PRE OUT jack connection	24
CENTER SP, Speaker settings	78
Center speaker level, Sound field parameter	69
Center speaker, Speaker settings	78
CENTER WIDTH, Decoder parameter	71
Chamber, Sound field program	48
CHANNEL, Audio information	46
Charge on standby, Input menu	86
CHECK PRNS, Automatic setup warning message	118
CHECK SP WIRES	14
CHECK SUR., Automatic setup error message	117
CINEMA DSP indicator	30
CLASSICAL, Sound field category	48
CLASSICS, Radio Data System program type	57
Clear settings, Remote control	101
CLEAR, Remote control	101

CLOCK TIME, Radio Data System information	59
Clock time, Radio Data System information	59
Completed, Bluetooth status message	116
COMPONENT VIDEO jacks	17
Compressed Music Enhancer	50
Connect error, iPod status message	116
Connect MIC!, Automatic setup error message	117
Connection, AM antenna connection	27
Connection, audio components	23
Connection, Bluetooth adapter	25
Connection, CD player	23
Connection, CD recorder	23
Connection, CENTER PRE OUT jack	24
Connection, DVD player	21
Connection, DVD recorder	22
Connection, External amplifier	24
Connection, external decoder	25
Connection, FM antenna	27
Connection, FRONT PRE OUT jacks	24
Connection, iPod universal dock	25
Connection, MD recorder	23
Connection, Multi-format player	25
Connection, Power cable	28
Connection, projector	20
Connection, PVR	22
Connection, set-top boxes	22
Connection, speaker cable	16
Connection, SUBWOOFER PRE OUT jack	24
Connection, SUR.BACK PRE OUT jacks	24
Connection, SURROUND PRE OUT jacks	24
Connection, Tape deck	23
Connection, Turntable	23
Connection, TV monitor	20
Connection, VCR	22
CROSS OVER, Speaker settings	79
CT indicator	31
CT LEVEL, Sound field parameter	69
CT, Radio Data System information	59
CULTURE, Radio Data System program type	57
Current status display	44

■ D

D)INIT. CONFIG, Option menu	90
D)LIPSYNC, Sound menu	84
D)TEST TONE, Basic menu	80
Decoder descriptions	70

- Decoder indicators 30
 DECODER MODE,
 Initial configuration 90
 Decoder mode,
 Initial configuration 90
 DECODER MODE, Input menu 86
 Decoder mode, Input menu 86
 Decoder selection 70
 DEVICE OVER,
 HDMI error message 46
 DIALOG.LIFT,
 Sound field parameter 65
 Dialogue lift,
 Sound field parameter 65
 DIGITAL COAXIAL jacks 17
 DIGITAL OPTICAL jacks 17
 DIMENSION, Decoder parameter 71
 DIMMER, Display settings 88
 Dimmer, Display settings 88
 Direct frequency tuning,
 FM/AM tuning 54
 DIRECT, Sound field parameter 69
 Disconnected,
 Bluetooth status message 116
 Disconnected,
 iPod status message 116
 Display settings, Option menu 88
 DIST, Auto setup result 34
 DOCK indicator 30
 DRAMA, Radio Data System
 program type 57
 Drama, Sound field program 50
 DSP effect level,
 Sound field parameter 65
 DSP indicators 30
 DSP LEVEL,
 Sound field parameter 65
 DSP PROG. INFO, Radio Data System
 information 59
 DVD player connection 21
 DVD recorder connection 22
 Dynamic range, Sound menu 83
- **E**
- E)EXTD SUR., Sound menu 84
 E)HDMI SET, Option menu 91
 E-1:NO FRONT SP, Automatic setup
 error message 117
 E-10:INTERNAL ERROR, Automatic
 setup error message 117
 E-2:NO SUR SP, Automatic setup error
 message 117
 E-3:NO PRNS SP, Automatic setup error
 message 117
 E-4:SBR->SBL, Automatic setup error
 message 117
 E-5:NOISY, Automatic setup error
 message 117
 E-6:CHECK SUR., Automatic setup error
 message 117
 E-7:NO MIC, Automatic setup error
 message 117
 E-8:NO SIGNAL, Automatic setup error
 message 117
- E-9:USER CANCEL, Automatic setup
 error message 117
 EDUCATE, Radio Data System program
 type 57
 EFFECT LEVEL,
 Sound field parameter 69
 Enhanced other networks data service,
 Radio Data System tuning 58
 ENHANCER indicator 30
 ENTERTAINMENT, Sound field
 category 49
 EON data service, Radio Data System
 tuning 58
 EON indicator 31
 EQ TYPE SELECT, Equalizer 82
 EQ, Auto setup parameter 33
 Equalizer type select, Equalizer 82
 Equalizer, Sound menu 82
 EXTD SUR., Initial configuration 90
 Extended surround,
 Initial configuration 90
 Extended surround, Sound menu 84
 External amplifier connection 24
 External decoder connection 25
 EXTRA SP ASSIGN,
 Auto setup parameter 33
 EXTRA SP ASSIGN,
 Speaker settings 77
 Extra speaker assignment,
 Auto setup parameter 33
 Extra speaker assignment,
 Speaker settings 77
- **F**
- F)ZONE2 SET, Option menu 91
 FL SCROLL, Display settings 88
 FLAG, Audio information 46
 FM antenna 27
 FM antenna connection 27
 FM tuning 53
 FORMAT, Audio information 46
 FREQUENCY, Radio Data System
 information 59
 Frequency, Radio Data System
 information 59
 Front panel display 30
 Front panel display scroll,
 Display settings 88
 FRONT PRE OUT jack
 connection 24
 FRONT SP, Speaker settings 78
 Front speaker set selection 43
 Front speakers, Speaker settings 78
 FRONT, Input menu 87
- **G**
- GEQ, Equalizer 82
 Graphic equalizer, Equalizer 82
- **H**
- Hall in Munich,
 Sound field program 48
 Hall in Vienna,
 Sound field program 48
- HDCP ERROR,
 HDMI Error message 46
 HDMI 18
 HDMI aspect ratio 89
 HDMI ASPECT,
 Video settings 89
 HDMI AUTO, Lip sync 84
 HDMI auto, Lip sync 84
 HDMI error and message 46
 HDMI ERROR,
 Video information 46
 HDMI indicator 30
 HDMI RES., Video information 46
 HDMI RES., Video settings 89
 HDMI resolution,
 Video settings 89
 HDMI set, Option menu 91
 HDMI SIGNAL,
 Video information 46
 HDMI, troubleshooting 113
 HEADPHONE, Dynamic range 83
 HEADPHONE,
 Low frequency effect level 83
 Headphones 45
 Headphones indicator 30
 Headphones, Dynamic range 83
 Headphones,
 Low frequency effect level 83
- **I**
- I/O ASSIGNMENT, Input menu 85
 INFO, Radio Data System
 program type 57
 Infrared window 31
 INI.VOL., Zone 2 settings 91
 INIT, Advanced setup 110
 INIT.DLY, Sound field parameter 66
 INI.VOL., Volume menu 81
 Initial configuration,
 Option menu 90
 Initial delay,
 Sound field parameter 66
 Initial volume, Volume menu 81
 INPUT CH, Input menu 87
 Input channel and speaker
 indicators 31
 Input channel indicators 31
 INPUT MENU, Manual setup 85
 Input menu, Manual setup 74
 INPUT RENAME, Input menu 86
 Input rename, Input menu 86
 Input signal indicators 30
 Input source indicators 30
 Input source information display 46
 Input/output assignment,
 Input menu 85
 INTERNAL ERROR, Automatic setup
 error message 117
 iPod connected,
 iPod status message 116
 iPod universal dock connection 25
 iPod use 60
 iPod, Trouble shooting 116

■ J

Jacks 17

■ L

LEARN, Remote control, Learning,
Remote control settings 96
LEVEL ERROR, Automatic setup
warning message 118
LFE/BASS OUT,
Speaker settings 77
LFE/Bass out, Speaker settings 77
LIGHT M, Radio Data System
program type 57
Lip Sync, Sound menu 84
LIVE/CLUB,
Sound field category 49
LIVENESS,
Sound field parameter 67
Liveness, Sound field parameter 67
Loading, iPod status message 116
Low-frequency effect level,
Sound menu 83
LVL, Auto setup result 34

■ M

M.O.R. M, Radio Data System program
type 57
Macro programming, Remote control
settings 98
MANUAL DELAY, Lip sync 84
Manual delay, Lip sync 84
MANUAL SETUP 72
Manual setup 72
Manual tuning mode,
FM/AM tuning 53
MANUAL TUNING,
FM/AM tuning 53
MAX VOL., Volume menu 81
MAX VOL., Zone 2 settings 91
Maximum volume 81
Maximum volume,
Volume menu 81
MCR ?, Remote control 100
MD recorder connection 23
Memory Guard!, Automatic setup
error message 117
Memory guard, Option menu 90
MON.CHK, Advanced setup 110
Monitor check, Advanced setup 110
Mono Movie,
Sound field program 50
MOVIE, Sound field category 49
MULTI CH INPUT
component selection 43
MULTI CH INPUT jacks 25
Multi-channel input BGV,
Input menu 87
Multi-channel input channels,
Input menu 87
Multi-channel input front left and right
channel input jack,
Input menu 87
Multi-channel source playback with
headphones 51

Multi-format player connection 25
Multi-information display 31
MULTI-ZONE Configuration 104
MUSIC ENHANCER,
Sound field category 50
Music Video,
Sound field program 49
MUTE 45
MUTE indicator 30
MUTE TYPE, Volume menu 81
Muting 45
Muting type, Volume menu 81

■ N

Neo:6 Cinema, Decoder type 69, 70
Neo:6 Music, Decoder type 70
NEWS, Radio Data System
program type 57
No BT Adapter, Bluetooth
status message 116
NO FRONT SP, Automatic setup
error message 117
NO MIC, Automatic setup
error message 117
NO PRNS SP, Automatic setup error
message 117
NO SIGNAL, Automatic setup error
message 117
NO SUR SP, Automatic setup error
message 117
NOISY, Automatic setup
error message 117
Number of speakers,
Auto setup result 34

■ O

Operation mode selector 31
OPTIMIZER MIC jack 32
Optimizing the speaker setting
for your listening room 32
OPTION MENU, Manual setup 88
Option menu, Manual setup 74
OPTN, Remote control 94
OSD SHIFT, Display settings 88
OSD shift, Display settings 88
OSD-AMP, Display settings 88
OSD-SOURCE, Display settings 88
OTHER M, Radio Data System
program type 57
OUT OF PHASE, Automatic setup
warning message 118
Out of Res., HDMI message 46
OVER 24m (80ft), Automatic setup
warning message 118

■ P

P.INIT.DLY,
Sound field parameter 66
P.ROOM SIZE,
Sound field parameter 67
Pairing, Bluetooth operation 62
PANORAMA, Decoder parameter 71
Parameter initialization,
Advanced setup 110

Parametric equalizer type, Auto setup
parameter 33
PHONES jack 45
PL LEVEL,
Sound field parameter 69
Playing video sources
in the background 45
PLII Game, Decoder type 70
PLII Movie, Decoder type 69, 70
PLII Music, Decoder type 70
PLIIX Game, Decoder type 70
PLIIX Movie, Decoder type 69, 70
PLIIX Music, Decoder type 70
POP M, Radio Data System
program type 57
Power cable connection 28
PR LEVEL, Sound field parameter 69
Presence left speaker level, Sound field
parameter 69
Presence right speaker level,
Sound field parameter 69
Presence sound field initial delay,
Sound field parameter 66
Presence sound field room size,
Sound field parameter 67
Presence speaker indicators 31
Presence speaker using 13
Preset SCENE templates 39
PRESET TUNING 53
Preset tuning mode,
FM/AM tuning 53
Pro Logic, Decoder type 70
PROGRAM SERVICE, Radio Data
System information 59
Program service, Radio Data System
information 59
PROGRAM TYPE, Radio Data System
information 59
Program type, Radio Data System
information 59
Projector connection 20
PS indicator 31
PS, Radio Data System
information 59
PTY HOLD indicator 31
PTY indicator 31
PTY SEEK mode, Radio Data System
tuning 57
PTY, Radio Data System
information 59
Pure Direct 52
Pure hi-fi sound 52
PVR connection 22

■ R

Radio Data System indicators 31
Radio Data System tuning 57
RADIO TEXT, Radio Data System
information 59
Radio text, Radio Data System
information 59
Rear panel 10
REMOTE AMP,
Advanced setup 108

- Remote control AMP ID,
 - Advanced setup 108
 - Remote control code setting 94
 - Remote control TUNER ID,
 - Advanced setup 109
 - Remote control,
 - Trouble shooting 115
 - REMOTE IN/OUT jacks 26
 - REMOTE TU, Advanced setup 109
 - Rename, SCENE template 40
 - Repeat 61
 - Repeat, iPod playback 61
 - Resetting the system 119
 - REV.DELAY,
 - Sound field parameter 68
 - REV.LEVEL,
 - Sound field parameter 68
 - REV.TIME,
 - Sound field parameter 68
 - Reverberation delay, Sound field parameter 68
 - Reverberation level, Sound field parameter 68
 - Reverberation time,
 - Sound field parameter 68
 - ROCK M, Radio Data System
 - program type 57
 - Roleplaying Game,
 - Sound field program 49
 - ROOM SIZE,
 - Sound field parameter 67
 - Room size,
 - Sound field parameter 67
 - RT indicator 31
 - RT, Radio Data System
 - information 59
- S**
- S VIDEO jacks 17
 - S.Audio, HDMI set 91
 - S.INIT.DLY,
 - Sound field parameter 66
 - S.LIVENESS,
 - Sound field parameter 67
 - S.ROOM SIZE,
 - Sound field parameter 67
 - SAMPLING,
 - Audio information 46
 - SB INI.DLY,
 - Sound field parameter 66
 - SB LEVEL,
 - Sound field parameter 69
 - SB LIVENESS,
 - Sound field parameter 67
 - SB ROOM SIZE,
 - Sound field parameter 67
 - SBR->SBL, Automatic setup
 - error message 117
 - SCENE 1 8
 - SCENE 2 8
 - SCENE 3 8
 - SCENE 4 8
 - SCENE IR code setting,
 - Advanced setup 110
 - SCENE IR, Advanced setup 110
 - SCENE template rename 40
 - SCIENCE, Radio Data System
 - program type 57
 - Sci-Fi, Sound field program 49
 - Selection, Audio input jacks 44
 - Selection, Front speaker set 43
 - Selection, MULTI CH INPUT
 - component 43
 - Selection, Radio Data System program
 - type 57
 - Selection, SCENE template 37
 - SET MENU usage 76
 - Set-top box connection 22
 - Shuffle, iPod playback 61
 - SIGNAL INFO 46
 - Signal information 75
 - SILENT CINEMA 51
 - SILENT CINEMA indicator 31
 - SL LEVEL,
 - Sound field parameter 69
 - SLEEP indicator 31
 - Sleep timer 47
 - Sound field indicators 30
 - Sound field parameter changing 64
 - Sound field program, Radio Data System
 - information 59
 - Sound field programs 48
 - Sound field programs
 - with headphones 51
 - Sound field programs
 - without surround speakers 51
 - SOUND MENU, Manual setup 82
 - Sound menu, Manual setup 73
 - Source feature OSD display time,
 - Display settings 88
 - source name setting, Remote control
 - settings 97
 - SP A B indicators 30
 - SP IMP., Advanced setup 107
 - SP, Auto setup result 34
 - Speaker cable connection 16
 - Speaker distance,
 - Auto setup result 34
 - Speaker distance, Basic menu 80
 - Speaker distances 80
 - Speaker impedance setting 28
 - Speaker impedance,
 - Advanced setup 107
 - Speaker level adjustment 52
 - Speaker level, Auto setup result 34
 - Speaker level, Basic menu 79
 - Speaker settings, Basic menu 77
 - SPEAKER, Dynamic range 83
 - SPEAKER,
 - Low frequency effect level 83
 - Speakers, Dynamic range 83
 - Speakers,
 - Low frequency effect level 83
 - Specifications 124
 - Spectacle, Sound field program 49
 - SPORT, Radio Data System
 - program type 57
 - Sports, Sound field program 49
 - SR LEVEL,
 - Sound field parameter 69
 - Standard, Sound field program 49
 - STANDBY CHARGE,
 - Input menu 86
 - Standby mode, Main zone 29
 - Standby mode, Zone 2 106
 - START PAIRING, Input menu 87
 - Start pairing, Input menu 87
 - STEREO, Sound field category 50
 - Straight 51
 - Straight Enhancer,
 - Sound field program 50
 - Straight mode 51
 - SUBWOOFER PHASE,
 - Speaker settings 79
 - Subwoofer phase,
 - Speaker settings 79
 - SUBWOOFER PRE OUT jack
 - connection 24
 - Supplied accessories 2
 - Support audio, HDMI set 91
 - SUR. L/R SP, Speaker settings 78
 - SUR.B L/R SP, Speaker settings 78
 - SUR.BACK PRE OUT jack
 - connection 24
 - Surround back left/right speakers,
 - Speaker settings 78
 - Surround back sound field initial delay,
 - Sound field parameter 66
 - Surround back sound field liveness,
 - Sound field parameter 67
 - Surround back sound field room size,
 - Sound field parameter 67
 - Surround back speaker level,
 - Sound field parameter 69
 - Surround decode mode 70
 - Surround left speaker level,
 - Sound field parameter 69
 - Surround left/right speakers,
 - Speaker settings 78
 - SURROUND PRE OUT jack
 - connection 24
 - Surround right speaker level,
 - Sound field parameter 69
 - Surround sound field initial delay,
 - Sound field parameter 66
 - Surround sound field liveness,
 - Sound field parameter 67
 - Surround sound field room size,
 - Sound field parameter 67
 - SYSTEM OFF 29
- T**
- Tape deck connection 23
 - Test tone, Basic menu 80
 - Test tone, Equalizer 82
 - TEST, Equalizer 82
 - The Bottom Line,
 - Sound field program 49
 - The Roxy Theatre,
 - Sound field program 49
 - Tonal quality adjustment 52
 - Transmit indicator 31

Troubleshooting	111	Zone 2 Initial volume, Zone 2 settings	91
TU, Advanced setup	110	Zone 2 Maximum volume, Zone 2 settings	91
Tuner frequency step, Advanced setup	110	Zone 2 settings, Option menu	91
Tuner indicators	30	Zone B	43
Tuner, Trouble shooting	114	ZONE2 indicator	30
Turning off	29		
Turning on	29		
Turntable connection	23		
TV controlling by remote control	92		
TV monitor connection	20		
■ U			
Unable to play, iPod status message	116		
UNIT, Speaker distance	80		
Unit, Speaker distance	80		
Unknown iPod, iPod status message	116		
Unplug HP!, Automatic setup error message	117		
Unprocessed input sources	51		
USER CANCEL, Automatic setup error message	117		
■ V			
VARIED, Radio Data System program type	57		
VCR connection	22		
VIDEO AUX jacks	26		
VIDEO CONV., Video settings	88		
Video conversion, Video settings	88		
Video information	46		
VIDEO jacks	17		
Video jacks	17		
VIDEO SET, Option menu	88		
Video settings, Option menu	88		
Video signal flow	19		
Video sources in the background	45		
Virtual CINEMA DSP	51		
VIRTUAL indicator	31		
VOL. TRIM, Input menu	86		
VOLTAGE SELECTOR	4		
VOLUME level indicator	30		
VOLUME MENU, Manual setup	81		
Volume menu, Manual setup	73		
Volume Trim, Input menu	86		
■ W			
W-1:OUT OF PHASE, Automatic setup warning message	118		
W-2:OVER 24m (80ft), Automatic setup warning message	118		
W-3:LEVEL ERROR, Automatic setup warning message	118		
W-4:CHECK PRNS, Automatic setup warning message	118		
■ Y			
YPAO indicator	30		
■ Z			
Zone 2	104		

“**A**SPEAKERS” or “**D**DVD” (example) indicates the name of the parts on the front panel or the remote control. Refer to the attached sheet or the pages at the end of this manual for the information about each position of the parts.

Limited Guarantee for European Economic Area (EEA) and Switzerland

Thank you for having chosen a Yamaha product. In the unlikely event that your Yamaha product needs guarantee service, please contact the dealer from whom it was purchased. If you experience any difficulty, please contact Yamaha representative office in your country. You can find full details on our website (<http://www.yamaha-hifi.com/> or <http://www.yamaha-uk.com/> for U.K. resident).

The product is guaranteed to be free from defects in workmanship or materials for a period of two years from the date of the original purchase. Yamaha undertakes, subject to the conditions listed below, to have the faulty product or any part(s) repaired, or replaced at Yamaha's discretion, without any charge for parts or labour. Yamaha reserves the right to replace a product with that of a similar kind and/or value and condition, where a model has been discontinued or is considered uneconomic to repair.

Conditions

1. The original invoice or sales receipt (showing date of purchase, product code and dealer's name) MUST accompany the defective product, along with a statement detailing the fault. In the absence of this clear proof of purchase, Yamaha reserves the right to refuse to provide free of charge service and the product may be returned at the customer's expense.
2. The product MUST have been purchased from an AUTHORISED Yamaha dealer within the European Economic Area (EEA) or Switzerland.
3. The product must not have been the subject of any modifications or alterations, unless authorised in writing by Yamaha.
4. The following are excluded from this guarantee:
 - a. Periodic maintenance and repair or replacement of parts due to normal wear and tear.
 - b. Damage resulting from:
 - (1) Repairs performed by the customer himself or by an unauthorised third party.
 - (2) Inadequate packaging or mishandling, when the product is in transit from the customer. Please note that it is the customer's responsibility to ensure the product is adequately packaged when returning the product for repair.
 - (3) Misuse, including but not limited to (a) failure to use the product for its normal purpose or in accordance with Yamaha's instructions on the proper use, maintenance and storage, and (b) installation or use of the product in a manner inconsistent with the technical or safety standards in force in the country where it is used.
 - (4) Accidents, lightning, water, fire, improper ventilation, battery leakage or any cause beyond Yamaha's control.
 - (5) Defects of the system into which this product is incorporated and/or incompatibility with third party products.
 - (6) Use of a product imported into the EEA and/or Switzerland, not by Yamaha, where that product does not conform to the technical or safety standards of the country of use and/or to the standard specification of a product sold by Yamaha in the EEA and/or Switzerland.
 - (7) Non AV (Audio Visual) related products.
(Products subject to "Yamaha AV Guarantee Statement" are defined in our website at <http://www.yamaha-hifi.com/> or <http://www.yamaha-uk.com/> for U.K. resident.)
5. Where the guarantee differs between the country of purchase and the country of use of the product, the guarantee of the country of use shall apply.
6. Yamaha may not be held responsible for any losses or damages, whether direct, consequential or otherwise, save for the repair or replacement of the product.
7. Please backup any custom settings or data, as Yamaha may not be held responsible for any alteration or loss to such settings or data.
8. This guarantee does not affect the consumer's statutory rights under applicable national laws in force or the consumer's rights against the dealer arising from their sales/purchase contract.

■ Front panel/Face avant/Frontblende/Frontpanelen/Voorpaneel/
Фронтальная панель

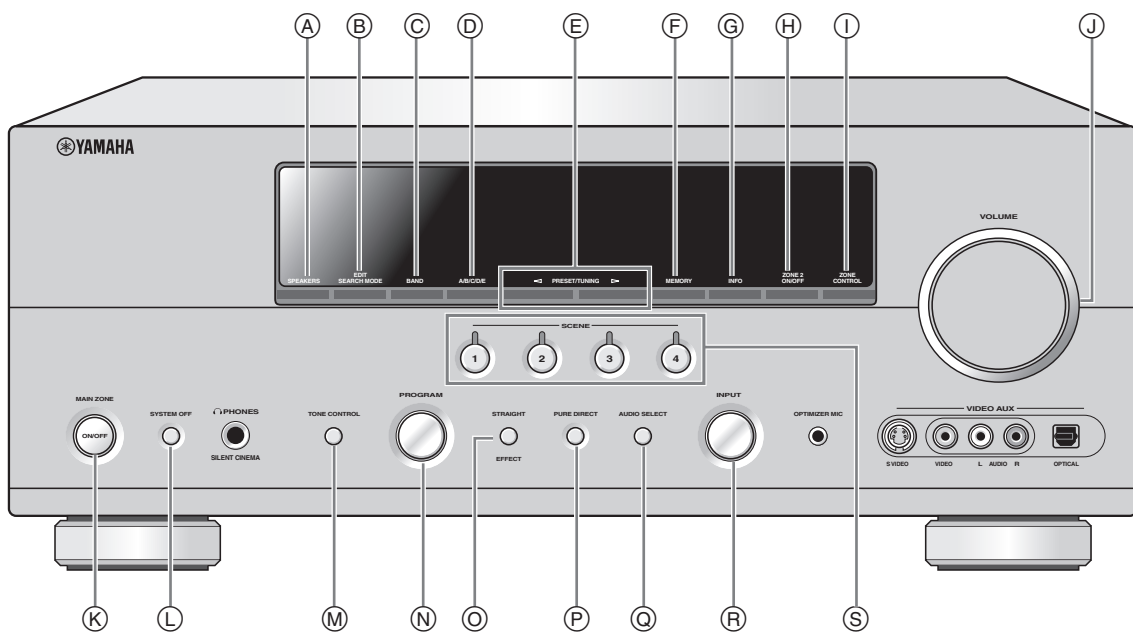

■ Remote control/Boîtier de télécommande/Fernbedienung/Fjärrkontrollen/
Afstandsbediening/Пульт ДУ

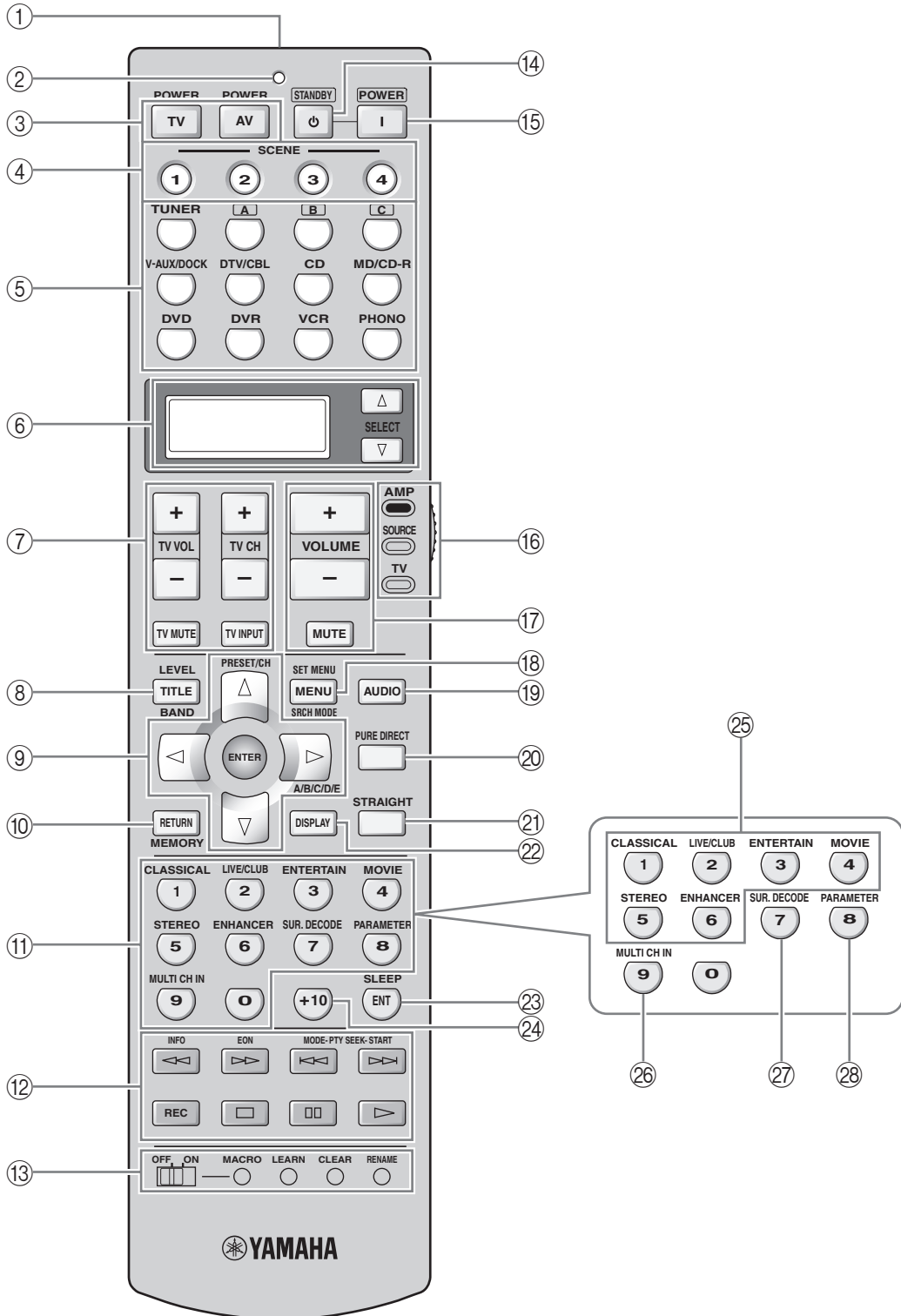

**List of remote control codes
Liste des codes de commande
Liste der Fernbedienungscodes
Lista över fjärrstyrningskoder
Lijst met afstandsbedieningscodes
Список кодов дистанционного управления**

CABLE

ABC 0030, 0035
AMERICAST 0926
BELL SOUTH 0926
BIRMINGHAM CABLE COMMUNICATIONS 0303
BRITISH TELECOM 0030
CABLE & WIRELESS 1095
DAERYUNG 0035, 0504, 0904, 1904
DIRECTOR 0503
FILMNET 0470
GENERAL INSTRUMENT 0030, 0303, 0503, 0837,
GOLDSTAR 0171
HAMLIN 0036, 0300
JERROLD 0030, 0303, 0503,
0837
LG 0171
MNET 0470
MEMOREX 0027
MOTOROLA 0303, 0503, 0837,
1133
NTL 1095
NOOS 0844
ONO 1095
PVP STEREO VISUAL MATRIX 0030
PACE 0264, 1087, 1095
PANASONIC 0027, 0035, 0134
PARAGON 0027
PHILIPS 0332, 0344
PIONEER 0171, 0560, 0904,
1904
PULSAR 0027
QUASAR 0027
REGAL 0300, 0306
RUNCO 0027
SAGEM 0844
SAMSUNG 0027, 0171
SCIENTIFIC ATLANTA 0035, 0504, 0904,
1904
SONY 1033
STARCOM 0030
SUPERCABLE 0303
TS 0030
TELE+1 0470
TELEWEST 1095
TORX 0030
TOSHIBA 0027
TRANS PX 0303
UNITED CABLE 0030
ZENITH 0027, 0552, 0926

CD PLAYER

AIWA 0184
ARCAM 0184
AUDIO RESEARCH 0184
AUDIO TON 0184
AUDIOLAB 0184
AUDIOMECA 0184
CAIRN 0184
CALIFORNIA AUDIO LABS 0056
CARVER 0184, 0206
CYRUS 0184
DKK 0027
DMX ELECTRONICS 0184
DENON 0900
DYNAMIC BASS 0206
EMERSON 0332
FISHER 0206
GENEXXA 0059, 0332
GOODMANS 0332
GRUNDIG 0184
HARMAN/KARDON 0184, 0200
HITACHI 0059
JVC 0099
KENWOOD 0055, 0064
KRELL 0184
LXI 0332
LINN 0184
MCS 0056
MAGNAVOX 0184, 0332
MARANTZ 0056, 0184
MATSUI 0184
MEMOREX 0332
MERIDIAN 0184
MICROMEGA 0184
MIRO 0027
MISSION 0184
MYRYAD 0184
NAD 0027
NSM 0184
NAIM 0184
OPTIMUS 0027, 0059, 0064,
0206, 0332
PANASONIC 0056
PHILIPS 0184
PIONEER 0059, 0332
POLK AUDIO 0184
PROTON 0184
QED 0184
QUAD 0184
QUASAR 0056
RCA 0059, 0206, 0332
REALISTIC 0206
REVOX 0184
ROTEL 0184
SAE 0184
SANSUI 0184, 0332
SANYO 0206
SCOTT 0332

SEARS 0332
SHARP 0064
SIMAUDIO 0184
SONIC FRONTIERS 0184
SONY 0027
SYMPHONIC 0332
TAG MCLAREN 0184
TANDY 0059
TECHNICS 0056
THORENS 0184
THULE 0184
UNIVERSUM 0184
VICTOR 0099
WARDS 0184
YAMAHA 2300, 2301

KOSS 0678
LG 0768
LIMIT 0795
MAGNAVOX 0530, 0702
MARANTZ 0566
MEMOREX 0858
MICO 0750
MICROSOFT 0549
MINTEK 0744
MITSUBISHI 0548
MUSTEK 0757
NESA 0744
ONKYO 0530
ORITRON 0678
PALSONIC 0699
PANASONIC 0517, 0659, 1389
PHILIPS 0530, 0566, 0673,
0881
PIONEER 0552, 0598, 0658,
0659
POLK AUDIO 0566
PROSCAN 0549
QWESTAR 0678
RCA 0549, 0598, 0744
ROTEL 0650
SM ELECTRONIC 0757

CD RECORDER

KENWOOD 0653
MARANTZ 0653
PHILIPS 0653
YAMAHA 2400

DVD PLAYER

ACOUSTIC SOLUTIONS 0757
ALBA 0744
AMSTRAD 0740
APEX DIGITAL 0699, 0744, 0782,
0821, 0823, 0857,
1127
BLAUPINKT 0744
BLUE PARADE 0598
BUSH 0740
CENTREX 0699
CLATRONIC 0815
CYBERHOME 0741
DVD2000 0548
DAEWOO 0811, 0797
DANSAI 0797
DECCA 0797
DENON 0517
DIAMOND 0795
DIGITREX 0699
EMERSON 0618
ENTERPRISE 0618
FISHER 0697
GE 0549, 0744
GO VIDEO 0742
GOLDSTAR 0768
GRADIENTE 0678
GREENHILL 0744
GRUNDIG 0566
HITACHI 0600, 0691
HITEKER 0699
JVC 0585, 0650
KLH 0744
KENWOOD 0517, 0561
SAMSUNG 0600
SANYO 0697
SHARP 0657
SHERWOOD 0797
SHINSONIC 0560
SLIM ART 0811
SONY 0560, 0891
SYLVANIA 0702
TATUNG 0797
TEAC 0598, 0744
TECHNICS 0517
THETA DIGITAL 0598
THOMSON 0549
TOSHIBA 0530
URBAN CONCEPTS 0530
XBOX 0549
YAMAHA 0517, 0566, 0572,
2100
ZENITH 0530, 0618, 0768
ZEUS 0811

Blu-ray Disc player

PANASONIC 2800, 2801, 2802
SAMSUNG 2816

DVD RECORDER

PANASONIC 2800
YAMAHA 2807

HD DVD PLAYER

TOSHIBA 2103

LD PLAYER

CARVER	0091
DENON	0086
MARANTZ	0091
MITSUBISHI	0086
NAD	0086
NAGSMI	0086
OPTIMUS	0086
PHILIPS	0091
PIONEER	0086
SALORA	0091
SONY	0228
TELEFUNKEN	0086
YAMAHA	2200

MD RECORDER

KENWOOD	0708
ONKYO	0895
SHARP	0888
SONY	0517
YAMAHA	2500, 2501, 2502

RECEIVER (TUNER)

ADC	0558
AIWA	0185, 1116, 1415, 1432, 1668
ALCO	1417
ANAM	1636
APEX DIGITAL	
	1284
AUDIOLAB	1216
AUDIOTRONIC	
	1216
AUDIOVOX	1417
BOSE	1256
CAMBRIDGE SOUNDWORKS	
	1397
CAPETRONIC	
	0558
CARVER	1116, 1216
CENTREX	1284
DENON	1387
FERGUSON	0558
FINE ARTS	1216
GRUNDIG	1216
HARMAN/KARDON	
	0137, 1331
INTEGRA	0162, 1325
JBL	0137, 1333
JVC	0101, 0558, 1401, 1522
KLH	1417, 1439
KENWOOD	1054, 1340
MCS	0066
MAGNAVOX	0558, 1116, 1216, 1296,
MARANTZ	0066, 1116, 1216, 1316
MICROMEGA	1216
MUSICMAGIC	
	1116
MYRYAD	1216
NAD	0347
NORCENT	1416
ONKYO	0162, 0869, 1325
OPTIMUS	0558, 1050
PANASONIC	0066, 1315, 1545, 1790

PHILIPS	1116, 1216, 1293, 1295, 1296, 1310, 1316
PIONEER	0041, 0558, 1050, 1411
POLK AUDIO	1316
PROSCAN	1281
QUASAR	0066
RCA	0558, 1050, 1281, 1417, 1636,
SABA	0558
SANSUI	1116
SCHNEIDER	0558
SONY	0185, 1085, 1185, 1685, 1785
STEREOPHONICS	
	1050
SUNFIRE	1340
TEAC	1417
TECHNICS	0066, 1335, 1336, 1545
TELEFUNKEN	
	0558
THOMSON	1281
THORENS	1216
UHER	0558
VENTURER	1417
VICTOR	0101
WARDS	0041, 0185
YAMAHA	0203, 1203, 1358, 2601, 2608, 2609, 2611
(TUNER ID1)	2602
(TUNER ID2)	2610
(iPod)	2606

SATELLITE TUNER

@SAT	1327
ABSAT	0150
ALBA	0482
ALPHASTAR	0799
AMSTRAD	0874
ASTON	0169, 1156
ASTRO	0200
ATSAT	1327
AVALON	0423
BLAUPUNKT	0200
BRITISH SKY BROADCASTING	
	0874, 1202
CANAL DIGITAL	
	0880
CANAL SATELLITE	
	0880
CANAL+	0880
CHAPARRAL	0243
CITYCOM	1203
CONNEXIONS	
	0423
CROSSDIGITAL	
	1136
CYRUS	0227
D-BOX	0750, 1154
DMT	1102
DNT	0227, 0423
DAERYUNG	0423
DAEWOO	1323
DIGENIUS	0326
DIRECTV	0274, 0419, 0593, 0666, 0751, 0776, 0846, 1103, 1136, 1169, 1776, 1883
DISH NETWORK SYSTEM	
	0802, 1032
DISHPRO	0802, 1032

DISTRATEL	0111
DREAM MULTIMEDIA	
	1264
ECHOSTAR	0194, 0423, 0637, 0802, 0880, 0898, 1032, 1113
ENGEL	1044
EXPRESSVU	0802
FTE	0890
FINLUX	0482
FRACARRO	0898
FUBA	0423
GE	0593
GOI	0802
GALAXIS	0890, 1138
GENERAL INSTRUMENT	
	0896
GOLD BOX	0880
GRUNDIG	0200, 0874
HTS	0802
HIRSCHMANN	
	0200, 0423
HITACHI	0482, 0846
HUGHES NETWORK SYSTEM	
	0776, 1169, 1776
HUMAX	0890, 1203
INVIDEO	0898
JVC	0802
KATHREIN	0150, 0200, 0227, 0276, 0685, 1248
KREISELMEYER	
	0200
LABGEAR	1323
LOGIX	1044
LORENZEN	0326
MAGNAVOX	0749, 0751
MANHATTAN	
	0482, 1044, 1110
MARANTZ	0227
MEDIASAT	0880
MEMOREX	0751
METRONIC	0111
MITSUBISHI	0776
MOTOROLA	0896
MYRYAD	0227
NEXT LEVEL	0896
NOKIA	0482, 0750, 0778, 1154, 1250, 1750
OCTALTV	1032
ORBITECH	1127
PACE	0482, 0874, 1202, 1350
PANASONIC	0274, 0728, 0874, 1347
PANDA	0482
PAYSAT	0751
PHILIPS	0160, 0227, 0482, 0749, 0751, 0776, 0880, 1103, 1169, 1776
PIONEER	0880
PROMAX	0482
PROSCAN	0419, 0593
RCA	0170, 0419, 0593, 0882
RFT	0227
RADIO SHACK	
	0896
RADIOLA	0227
RADIX	0423
SKY	0874, 0883, 1202
SM ELECTRONIC	
	1227
SABRE	0482
SAGEM	0847, 1141, 1280

SAMSUNG	1044, 1136, 1303, 1319
SAT CONTROL	
	1327
SATSTATION	1110
SCHWAIGER	1138
SEEMANN	0423
SIEMENS	0200
SONY	0666, 0874, 1666
STAR CHOICE	
	0896
STRONG	1327
TPS	0847, 1280
TANTEC	0482
TECHNISAT	1126, 1127
TELESTAR	1127
THOMSON	0482, 0880, 1073, 1318
TOPFIELD	1233
TOSHIBA	0776, 0817, 1776
ULTIMATETV	
	0419, 0666
UNIDEN	0749, 0751
UNIVERSUM	0200
VENTANA	0227
WISI	0200, 0423, 0482
XSAT	0150
ZEHNDER	1102
ZENITH	0883, 1883

TAPE DECK

AIWA	0056
CARVER	0056
GRUNDIG	0056
HARMAN/KARDON	
	0056
MAGNAVOX	0056
MARANTZ	0056
MYRYAD	0056
OPTIMUS	0054
PHILIPS	0056
PIONEER	0054
POLK AUDIO	0056
RCA	0054
REVOX	0056
SANSUI	0056
SONY	0270
THORENS	0056
WARDS	0054
YAMAHA	2700, 2701

TV

AGB	0543
AOC	0036, 0057, 0087, 0119, 0120, 0135, 0205, 0207, 0478
ASA	0131
AWA	0036
ACURA	0036
ADDISON	0119, 0135, 0680
ADMIRAL	0120, 0190, 0490
ADVENT	0788
AIKO	0119
AKAI	0036, 0057, 0235, 0388, 0543, 0729, 0839
AKURA	0291
ALBA	0036, 0064, 0398, 0695
AMERICA ACTION	0207
AMPRO	0778

AMSTRAD	0036, 0064, 0198, 0398, 0439, 0460, 0543	DIGATRON	0064	HITACHI	0036, 0057, 0119, 0132, 0136, 0172, 0190, 0205, 0252, 0383, 0508, 0575, 0605, 1172, 1283	MEMOREX	0036, 0177, 0181, 0205, 0277, 0490, 1064
ANAM	0036, 0207, 0277	DUMONT	0044			METZ	0474
ANAM NATIONAL	0277, 0677	DWIN	0747, 0801			MICROMAXX	0835
ANITECH	0036	ECE	0064	HUA TUN	0036		
APEX DIGITAL		ELBE	0286	HUANYU	0401	MICROSTAR	0835
	0775, 0792, 0794	ELECTROBAND	0027	HYPSON	0064, 0291	MIDLAND	0044, 0074, 0078
AUDIOSONIC	0064, 0136	ELIN	0064, 0575	ICE	0291, 0398	MINERVA	0514
BANG & OLUFSEN	0592	ELITE	0347	ITS	0398	MINOKA	0439
BASIC	0036	ELTA	0036	ITT	0190, 0388, 0575	MITSUBISHI	0057, 0120, 0135, 0177, 0181, 0205, 0207, 0263, 0277, 0539, 0863, 1277
BAUR	0064, 0388, 0539	EMERSON	0181, 0205, 0207, 0263, 0388, 0490, 0650	IMPERIAL	0274, 0397, 0445	MIVAR	0318, 0319, 0543, 0636
BAYSONIC	0207	ENVISION	0057, 0840	INDIANA	0064	MOTOROLA	0120
BEAUMARK	0205	EPSON	0860	INFINITY	0081	MULTITECH	0036, 0207
BEKO	0397, 0513, 0741, 0742	ERRES	0064	INGELEN	0190	MYRYAD	0583
BELL & HOWELL	0181	ETHER	0036, 0057	INNO HIT	0543	NAD	0183, 0205, 0388, 0893
BEON	0064	ETRON	0036	INNOVA	0064	NEC	0036, 0057, 0078, 0181, 0183, 0197, 0205, 0482, 0524, 1731
BLAUPUNKT	0222	EUROPHON	0543	INTEQ	0044	NEI	0064
BLUE SKY	0695, 1064	FERGUSON	0064, 0100, 0136, 0265, 0314, 0362, 0587	INTERFUNK	0064, 0190, 0274, 0388, 0539	NTC	0119
BONDSTEC	0274			INTERVISION		NECKERMANN	0064, 0583
BRADFORD	0207	FIDELITY	0388	JBL	0064, 0291, 0404 0081	NETSAT	0064
BRANDT	0136, 0362	FINLANDIA	0235, 0373	JCB	0027	NEWAVE	0036, 0119, 0120, 0205
BROKSONIC	0263, 0490	FINLUX	0064, 0131, 0132, 0373, 0543	JVC	0080, 0398, 0490, 0680, 0710	NIKKAI	0064, 0291
BUSH	0036, 0064, 0398, 0401, 0695, 1064	FIRSTAR	0036, 0263	JEAN	0036, 0078, 0119, 0183, 0263	NIKKO	0057, 0119, 0205
CCE	0064	FIRSTLINE	0036, 0274, 0695	JENSEN	0788	NOKIA	0388, 0500, 0507, 0575, 0658
CGE	0274	FISHER	0131, 0181, 0235, 0397	KEC	0207	NORCENT	0775, 0851
CTC	0274	FLINT	0482	KTV	0057, 0207	NORDMENDE	0136, 0314, 0587
CXC	0207	FORMENTI	0064, 0347	KAISUI	0036	OCEANIC	0190, 0388
CANDLE	0057	FORTRESS	0120	KAPSCH	0190	ONWA	0207, 0460
CARNIVALE	0057	FRONTECH	0190, 0274, 0291	KARCHER	0637	OPTIMUS	0181, 0193, 0277, 0677
CARVER	0081, 0197	FUJITSU	0710, 0836	KATHREIN	0583	OPTONICA	0120
CASCADE	0036	FUNAI	0207, 0198, 0291	KENDO	0064	ORION	0064, 0263, 0347, 0490, 0543
CATHAY	0064	FUTURETECH		KENWOOD	0057	OSAKI	0291, 0439
CELEBRITY	0027		0207	KNEISSEL	0286, 0462	OTTO VERSAND	0064, 0347, 0539, 0583
CELERA	0792	GE	0057, 0074, 0078, 0119, 0205, 0207, 0478, 0587, 1174, 1374, 1481	KOLIN	0080, 0135, 0207	PALLADIUM	0397, 0445
CENTURION	0064	GEC	0064, 0543	KORPEL	0064	PANAMA	0291
CHANGHONG	0792	GATEWAY	1782, 1783	KOYODA	0036	PANASONIC	0064, 0078, 0081, 0190, 0277, 0677, 1437
CHING TAI	0036, 0119	GELOSO	0036	L&S ELECTRONIC	0835	PATHE CINEMA	0265, 0347
CHUN YUN	0027, 0036, 0119, 0207	GENEXXA	0190	LG	0057, 0064, 0087, 0135, 0205, 0741	PAUSA	0036
CHUNG HSIN	0080, 0135, 0207	GIBRALTER	0044, 0057	LXI	0074, 0081, 0181, 0183, 0205	PENNEY	0057, 0074, 0078, 0087, 0183, 0205, 1374
CIMLINE	0036	GOLDSTAR	0057, 0064, 0136, 0181, 0205, 0404	LEYCO	0064, 0291	PERDIO	0347
CINERAL	0119, 0478	GOODMANS	0064, 0398, 0401, 0661	LIESENK & TTER	0064	PHILCO	0057, 0064, 0081, 0172, 0205, 0207, 0274, 0490, 1688
CITIZEN	0057, 0087, 0119	GOREMJE	0397	LOEWE	0539	PHILIPS	0027, 0057, 0064, 0078, 0081, 0119, 0135, 0205, 0401, 0583, 0717, 1481
CLARION	0207	GRADIENTE	0080, 0197	LUXOR	0383, 0388	PHONOLA	0064
CLARIVOX	0064	GRAETZ	0190, 0388	M ELECTRONIC		PILOT	0057
CLATRONIC	0274, 0397	GRANDIN	0637		0036, 0064, 0131, 0132, 0136, 0190, 0314, 0373, 0401, 0507	PIONEER	0136, 0190, 0193, 0314, 0706, 0787, 0893
CONDOR	0347, 0397	GRUNDIG	0064, 0222, 0514, 0583, 0614	MAGNADYNE		PORTLAND	0119
CONRAC	0835	GRUNPY	0207		0274, 0543		
CONTEC	0036, 0207	HCM	0036, 0439	MAGNAFON	0543		
CRAIG	0207	HALLMARK	0205	MAGNAVOX	0057, 0081, 1281, 1481		
CROSLEY	0081	HANKOOK	0057, 0205, 0207	MANESTH	0291, 0347		
CROWN	0036, 0064, 0207, 0397, 0445	HANSEATIC	0064, 0347, 0388, 0455, 0583	MARANTZ	0057, 0064, 0081, 0583		
CURTIS MATHES		HANTAREX	0543	MARK	0064		
	057, 0074, 0081, 0087, 0120, 0172, 0181, 0193, 0478, 0729, 1174, 1374	HARMAN/KARDON	0081	MATSUI	0036, 0064, 0235, 0398, 0514, 0543		
DAEWOO	0036, 0057, 0064, 0119, 0135, 0181, 0197, 0205, 0207, 0401, 0478, 0650, 0661, 1688	HARVARD	0207	MATSUSHITA			
DANSAI	0064	HVERMY	0120		0277, 0677		
DAYTON	0036	HELLO KITTY		MEDIATOR	0064		
DE GRAAF	0235, 0575		0478	MEDION	0695, 0835, 1064		
DECCA	0064, 0543	HINARI	0036, 0064	MEGATRON	0172, 0205		
DENON	0172	HISAWA	0482				

PRANDONI-PRINCE	0543	SHENG CHIA	0036, 0120, 0263	UNIVERSUM	0064, 0131, 0132, 0291, 0373, 0397, 0519	CITIZEN	0064, 0305, 1305
PRIMA	0788	SIAREM	0543	VECTOR RESEARCH	0057	COLT	0099
PRISM	0078	SIEMENS	0064, 0222	VESTEL	0064	COMBITECH	0379
PROFEX	0036, 0388	SINUDYNE	0543	VICTOR	0080, 0277, 0677, 0680	CRAIG	0064, 0074, 0099, 0267
PROSCAN	0074	SKANTIC	0383	VIDEOSAT	0274	CROWN	0099, 0305
PROTECH	0036, 0064, 0274, 0291, 0445, 0695	SKYGIANT	0207	VIDIKRON	0081	CURTIS MATHES	0062, 0068, 0087, 1062
PROTON	0036, 0057, 0205	SKYWORTH	0064	VIDTECH	0205	CYBERNEX	0267
PULSAR	0044	SOLAVOX	0190	VIEWSONIC	1782	CYRUS	0108
QUASAR	0078, 0277, 0677	SONITRON	0235	VISION	0347	DAEWOO	0072, 0131, 0305, 0669, 1305
QUELLE	0064, 0131, 0388, 0539	SONOKO	0036, 0064	VOXSON	0190	DANSAI	0099
R-LINE	0064	SONOLOR	0190, 0235	WALTHAM	0383	DE GRAAF	0069
RCA	0027, 0057, 0074, 0117, 0119, 0205, 0706, 1074, 1174, 1274, 1374, 1474, 1481, 1574	SONTEC	0064	WARDS	0057, 0081, 0205, 0893	DECCA	0027, 0108
RFT	0455	SONY	0027, 0677, 0861, 1127, 1532, 1678	WATSON	0064, 0347	DENON	0069
RADIOSHACK	0057, 0074, 0181, 0205, 0207	SOUNDESIGN	0205, 0207	WAYCON	0183	DUAL	0068
RADIOLA	0064	SOUNDWAVE	0064, 0445	WHITE WESTINGHOUSE	0064, 0347, 0490, 0650	DUMONT	0027, 0108, 0131
RADIOMARELLI	0543	SOWA	0078, 0087, 0119, 0183, 0205	YAMAHA	0057, 0172, 0677, 0796, 0860, 2900 (projector), 2901 (projector), 2904 (projector)	DYNATECH	0027
REALISTIC	0057, 0181, 0205, 0207	SQUAREVIEW	0198	YAPSHE	0277	ESC	0027, 0305
REDIFFUSION	0388	STANDARD	0036	YOKO	0064, 0291	ELCATECH	0099
REOC	0741	STARLITE	0207	ZENITH	0044, 0119, 0205, 0490	ELECTROHOME	0064
REVOX	0064	STERN	0190, 0286			ELECTROPHONIC	0064
REX	0190, 0286, 0291	SUPREME	0027			EMEREX	0059
ROADSTAR	0036, 0291, 0445	SYLVANIA	0057, 0081, 0198			EMERSON	0027, 0062, 0064, 0070, 0072, 0211, 0267, 0305, 1305, 1506
RUNCO	0044, 0057, 0524, 0630	SYMPHONIC	0198, 0207			FERGUSON	0068, 0347
SBR	0064	SYNCO	0027, 0087, 0119, 0120, 0205, 0478			FIDELITY	0027
SEG	0291, 0695	SYSLINE	0064			FINLANDIA	0108, 0131
SEI	0543	T + A	0474			FINLUX	0027, 0069, 0108, 0131
SKY	0064	TCM	0835			FIRSTLINE	0064, 0070, 0072, 0099
SSS	0207	TMK	0205			FISHER	0074, 0131
SABA	0136, 0190, 0314, 0362	TNCI	0044			FUJI	0060, 0062
SACCS	0265	TVS	0490			FUJITSU	0027, 0072
SAGEM	0637	TACICO	0036, 0119, 0205			FUNAI	0027
SAISHO	0036, 0291, 0543	TAI YI	0036			GE	0062, 0087, 0267, 0834, 1062, 1087
SALORA	0190, 0380, 0388, 0575	TANDY	0120, 0190			GEC	0108
SAMBERS	0543	TASHIKO	0119, 0677			GARRARD	0027
SAMPO	0036, 0057, 0119, 0120, 0181, 0198, 0205, 0677, 1782	TATUNG	0036, 0064, 0078, 0081, 0087, 0181, 0183, 0543			GENERAL	0072
SAMSUNG	0036, 0057, 0064, 0087, 0117, 0119, 0181, 0205, 0291, 0397, 0583, 0614, 0645, 0729, 0793, 0839, 0841	TEAC	0036, 0064, 0291, 0439, 0445, 0482, 0695, 1064			GO VIDEO	0459
SANSEI	0478	TEC	0274			GOLDHAND	0099
SANSUI	0490	TECHNEMA	0347			GOLDSTAR	0064, 0252, 0507, 1264
SANYO	0131, 0181, 0207, 0235, 0366, 0826	TECHNICS	0078, 0277, 0677			GOODMANS	0027, 0064, 0099, 0305
SCHAUB LORENZ	0388	TECHWOOD	0078			GRADIENTE	0027
SCHNEIDER	0064, 0274, 0398, 0695	TECO	0036, 0078, 0119, 0120, 0205, 0291, 0680			GRAETZ	0068, 0131, 0267
SCOTCH	0205	TEKNIKA	0081, 0087, 0119, 0177, 0207			GRANADA	0108, 0131
SCOTT	0205, 0207, 0263	TELEFUNKEN	0136, 0289, 0362, 0652, 0729			GRANDIN	0027, 0064, 0099
SEARS	0074, 0081, 0181, 0183, 0198, 0205	TELEMEISTER	0347			GRUNDIG	0099, 0108, 0253, 0374
SELECO	0190, 0286	TELETECH	0036			HCM	0099
SEMIVOX	0207	TENSAI	0347			HI-Q	0074
SEMP	0183	TERA	0057			HANSEATIC	0064
SHARP	0057, 0120, 0677	THOMSON	0136, 0314, 0587, 0652, 1474			HARLEY DAVIDSON	0027
SHEN YING	0036, 0119	THORN	0064, 0131, 0388, 0539			HARMAN/KARDON	0108
		TOSHIBA	0087, 0181, 0183, 0535, 0645, 0677, 0859, 1283, 1383, 1683, 1731			HARWOOD	0099
		TRIUMPH	0543			HINARI	0099, 0267, 0379
		TUNTEX	0036, 0057, 0119			HITACHI	0027, 0064, 0068, 0069, 0267
		UHER	0347				
				VCR			
				ASA	0064, 0108		
				ADMIRAL	0075		
				ADVENTURA	0027		
				AIKO	0305		
				AIWA	0027, 0064, 0334, 0375, 0379		
				AKAI	0068, 0342		
				AKIBA	0099		
				ALBA	0099, 0305, 0342, 0379		
				AMERICA ACTION	0305		
				AMERICAN HIGH	0062		
				AMSTRAD	0027		
				ANAM	0064, 0253, 0267, 0305, 0507		
				ANAM NATIONAL	0253, 1589		
				ANITECH	0099		
				ASHA	0267		
				ASUKA	0064		
				AUDIOVOX	0064, 0305		
				BAIRD	0027, 0068, 0131		
				BASIC LINE	0099, 0305		
				BEAUMARK	0267		
				BELL & HOWELL	0131		
				BLAUPUNKT	0253		
				BRANDT	0347		
				BRANDT ELECTRONIC	0068		
				BROKSONIC	0211, 0375, 1506		
				BUSH	0099, 0305, 0379		
				CCE	0099, 0305		
				CGE	0027		
				CALIX	0064		
				CANON	0062		
				CARVER	0108		
				CIMLINE	0099		
				CINERAL	0305		



© 2008 YAMAHA CORPORATION All rights reserved.

YAMAHA ELECTRONICS CORPORATION, USA 6660 ORANGETHORPE AVE., BUENA PARK, CALIF. 90620, U.S.A.
YAMAHA CANADA MUSIC LTD. 135 MILNER AVE., SCARBOROUGH, ONTARIO M1S 3R1, CANADA
YAMAHA ELECTRONIK EUROPA G.m.b.H. SIEMENSSTR. 22-34, 25462 RELINGEN BEI HAMBURG, GERMANY
YAMAHA ELECTRONIQUE FRANCE S.A. RUE AMBROISE CROIZAT BP70 CROISSY-BEAUBOURG 77312 MARNE-LA-VALLEE CEDEX02. FRANCE
YAMAHA ELECTRONICS (UK) LTD. YAMAHA HOUSE, 200 RICKMANSWORTH ROAD WATFORD, HERTS WD18 7GQ, ENGLAND
YAMAHA SCANDINAVIA A.B. J A WETTERGRENS GATA 1, BOX 30053, 400 43 VÄSTRA FRÖLUNDA, SWEDEN
YAMAHA MUSIC AUSTRALIA PTY. LTD. LEVEL 1, 99 QUEENSBRIDGE STREET, SOUTHBANK, VIC 3006, AUSTRALIA

YAMAHA CORPORATION
Printed in Malaysia ◀ WN24780

The circled numbers and alphabets correspond to those in the Owner's Manual.

Les nombres et lettres dans un cercle correspondent à ceux du mode d'emploi.

Die umkreisten Zahlen und Buchstaben entsprechen denen in der Bedienungsanleitung.

Inringade nummer och bokstäver motsvarar de som anges i bruksanvisningen.

I manuali e le lettere dell'alfabeto corrispondono a quelli nel Manuale di istruzioni.

Los números y las letras en el interior de círculos se corresponden con aquellos del manual de instrucciones.

De omcirkelde cijfers en letters corresponderen met die in de Gebruiksaanwijzing.

Цифры и буквы в кружках относятся к цифрам и буквам в Инструкции по эксплуатации.

원 번호 및 원 알파벳은 사용 설명서 안의 표기와 일치합니다.

■ Front panel/Face avant/Frontblende/Frontpanelen/Pannello anteriore/Panel delantero/Voorpaneel/ Фронтальная панель/ 전면 패널

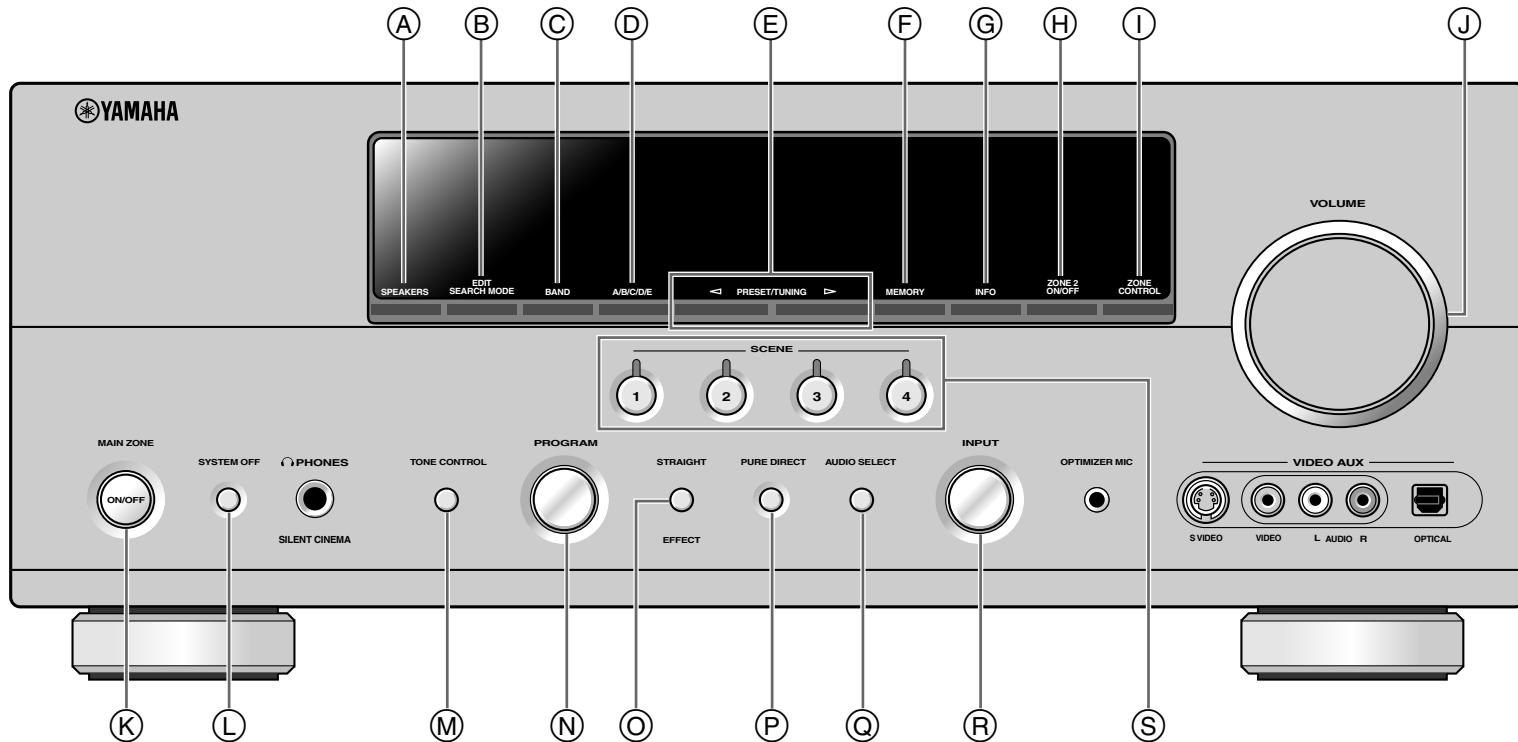

■ Remote control/Boîtier de télécommande/Fernbedienung/Fjärrkontrollen/
Telecomando/Mando a distancia/Afstandsbediening/Пульт ДУ/ 리모콘

