

JOSAM CARRIERS & DRAINS

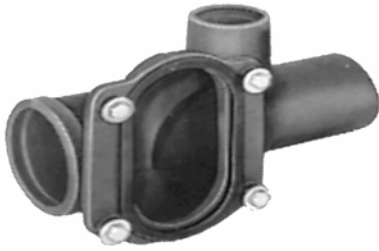

HORIZONTAL CLOSET CARRIERS



10674 LH BODY ONLY
10684 RH BODY ONLY
12674 LH COMPLETE
12684 RH COMPLETE



10694 BACK TO BACK BODY
12694 BACK TO BACK COMPLETE

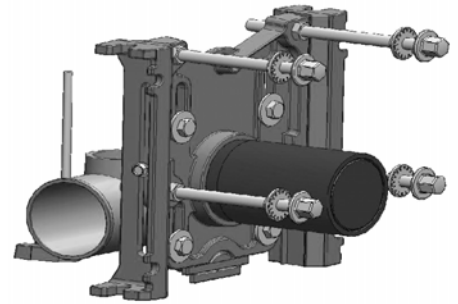

(FURNISHED STANDARD WITH 7" NIPPLE)
12000-PF STANDARD TRIM
12000-35PF HANDICAP TRIM
-10 WITH 12" NIPPLE

VERTICAL CLOSET CARRIERS



10704 BODY ONLY LH VENT
10714 BODY ONLY RH VENT
12704 COMPLETE CARRIER
12714 COMPLETE CARRIER
-LH4 LH 4" NH BRANCH
-RH4 RH 4" NH BRANCH
-D4 DOUBLE 4" NH BRANCH
-35 HANDICAP HEIGHT



10724 BODY ONLY REV/VENT
12724 COMPLETE CARRIER
OS4 OPPOSITE VENT 4" BRANCH
D4 DOUBLE 4" NH BRANCH
-35 HANDICAP HEIGHT

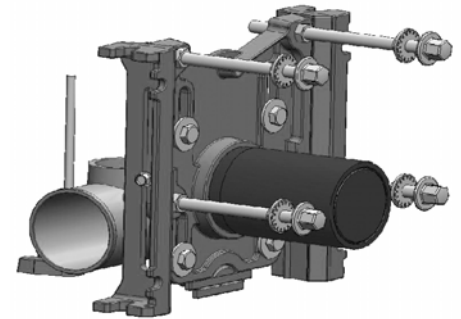

(FURNISHED STANDARD WITH 7" NIPPLE)
12000-PF STANDARD TRIM
12000-35PF HANDICAP TRIM
-10 WITH 12" NIPPLE
07095A 7" NIPPLE ONLY
07095E 12" NIPPLE ONLY
575985T CAP NUT SET

CLOSE ROUGH CARRIERS

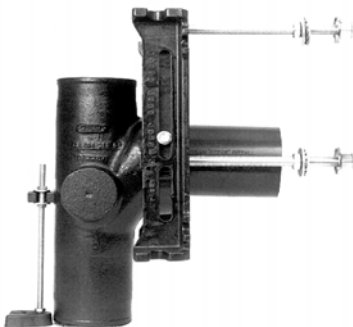

14464 SINGLE CARRIER
 4" VENT
FOR SIPHON JET CLOSETS ONLY









14484 BACK TO BACK
 4" VENT
FOR SIPHON JET CLOSETS ONLY

RESIDENTIAL CARRIER



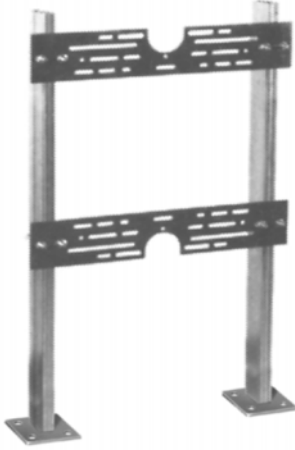







16123 SINGLE FOR PVC PIPE
 WITH PVC ADAPTER
FOR SIPHON JET CLOSETS ONLY

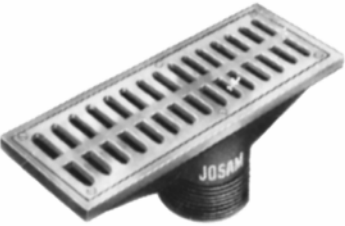
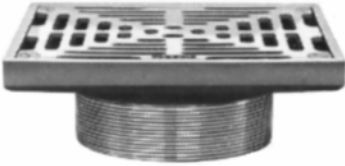

CONCEALED ARM LAV CARRIER	BACK TO BACK CONCEALED ARM	PLATE TYPE CARRIER
 <p> 17100-202P LAV CARRIER 17100-67P HANDICAP LAV 566290T ARM ONLY 20X18 (EA) 566310T ARM ONLY ADA (EA) 566340T 6-1/2" ARM SLEEVE 566350T 10-1/2" SLEEVE ADA 566262 LOCKING DEVICE (2) 566263 LEVELING DEVICE (4) </p>	 <p> 17100-BB 20X18 BACK TO BACK LAVATORY CARRIER </p>	 <p> 17550 LAV CARRIER 17550-UR URINAL CARRIER 17550-WC WATER COOLER CARRIER </p>
	<p>BI-LEVEL COOLER CARRIER</p>  <p> 17550-WCBL BI-LEVEL WATER COOLER CARRIER </p>	<p>ADA BI-LEVEL CARRIER W/BEARING PL</p>  <p> 17560-WCBL BI-LEVEL ADA WATER COOLER CARRIER WITH BEARING PLATE </p>
 <p> 17560 CARRIER WITH BEARING PLATE 17560-UR URINAL CARRIER WITH BEARING PLATE ADA 17560-WC WATER COOLER CARRIER WITH BEARING PLATE ADA </p>		 <p> 17730 FLOOR MOUNT ADJUSTABLE COUPLING CARRIER FOR WALL HUNG SURGEONS SCRUB SINKS </p>

21500 SERIES ROOF DRAIN	21500-16 OVERFLOW	21500-AE ADJUSTABLE
STANDARD ROOF DRAIN CAST IRON BODY WITH 15" POLY DOME	OVERFLOW ROOF DRAIN C.I. BODY WITH 15" POLY DOME	STANDARD ROOF DRAIN CAST IRON BODY WITH 15" POLY DOME
		
21502 2" WITH POLY DOME 21503 3" WITH POLY DOME 21504 4" WITH POLY DOME 21506 6" WITH POLY DOME 21508 8" WITH POLY DOME 21509 10" WITH POLY DOME -Z NO-HUB -Y PUSH ON (2, 3, 4" ONLY) -1 DECK CLAMP ASSM -2 DRAIN RECEIVER -17 2" HIGH CLAMP COLLAR -22 CAST IRON DOME -26 ALUMINUM DOME	21502-16 2" WITH POLY DOME 21503-16 3" WITH POLY DOME 21504-16 4" WITH POLY DOME 21506-16 6" WITH POLY DOME -Z NO-HUB -Y PUSH ON (2, 3, 4" ONLY) -1 DECK CLAMP ASSM -2 DRAIN RECEIVER -17 2" HIGH CLAMP COLLAR -22 CAST IRON DOME -26 ALUMINUM DOME	21502-AE 2" WITH POLY DOME 21503-AE 3" WITH POLY DOME 21504-AE 4" WITH POLY DOME 21506-AE 6" WITH POLY DOME 21508-AE 8" WITH POLY DOME 21509-AE 10" WITH POLY DOME -Z NO-HUB -Y PUSH ON (2, 3, 4" ONLY) -1 DECK CLAMP ASSM -2 DRAIN RECEIVER -17 2" HIGH CLAMP COLLAR -22 CAST IRON DOME -26 ALUMINUM DOME
21500-AE-16 ADJUSTABLE	22010 CAST IRON ROOF DRAIN	22080 CAST IRON ROOF DRAIN
OVERFLOW ROOF DRAIN CAST IRON BODY WITH 15" POLY DOME	WITH 12" CI BEEHIVE DOME	WITH 9" CI HIGH DOME
		
21502-AE-16 2" 21503-AE-16 3" 21504-AE-16 4" 21506-AE-16 6" 21508-AE-16 8" 21509-AE-16 10" -Z NO-HUB -Y PUSH ON (2, 3, 4" ONLY) -1 DECK CLAMP ASSM -2 DRAIN RECEIVER -17 2" HIGH CLAMP COLLAR -22 CAST IRON DOME -26 ALUMINUM DOME	22012 2" W/ CI BEEHIVE 22013 3" W/ CI BEEHIVE 22014 4" W/ CI BEEHIVE 22016 6" W/ CI BEEHIVE -Z NO-HUB -1 DECK CLAMP ASSM -2 DRAIN RECEIVER -17 2" HIGH CLAMP COLLAR	22012 2" W/ SMALL CI HIGH DOME 22013 3" W/ SMALL CI HIGH DOME 22014 4" W/ SMALL CI HIGH DOME -Z NO-HUB -Y PUSH ON -1 DECK CLAMP ASSM
22200 COMBINATION DRAIN AND OVERFLOW W/ CAST IRON DOMES		
		
22202-Z 2" NO HUB COMBINATION DRAIN AND OVERFLOW COMBINED WITH SUMP RECEIVER 22203-Z 3" NO HUB COMBINATION DRAIN AND OVERFLOW COMBINED WITH SUMP RECEIVER 22204-Z 4" NO HUB COMBINATION DRAIN AND OVERFLOW COMBINED WITH SUMP RECEIVER		
EASTER & SONS	X261	COPYRIGHT 2008

23500 SERIES PROMENADE TOP	23500-AE SERIES ADJUSTABLE	23510 SERIES PARKING GARAGE
<p>CAST IRON ROOF DRAIN WITH 14" SQUARE PROMENADE TOP</p>  <p>23502 2" 23503 3" 23504 4" 23506 6" 23508 8" 23509 10"</p> <p>-Z NO-HUB -Y PUSH ON (2, 3, 4" ONLY) -1 DECK CLAMP ASSM -2 DRAIN RECEIVER -50 NIKALOY LAMINATE TOP -51 SATIN BRONZE LAMINATE TOP</p>	<p>CAST IRON ROOF DRAIN WITH 14" SQUARE PROMENADE TOP</p>  <p>23502 2" 23503 3" 23504 4" 23506 6" 23508 8" 23509 10"</p> <p>-Z NO-HUB -Y PUSH ON (2, 3, 4" ONLY) -1 DECK CLAMP ASSM -2 DRAIN RECEIVER -50 NIKALOY LAMINATE TOP -51 SATIN BRONZE LAMINATE TOP</p>	<p>CAST IRON DRAIN W/ EXTRA HEAVY DUTY 15" PARKING GRATE</p>  <p>23512 2" 23513 3" 23514 4" 23516 6" 23518 8"</p> <p>-Z NO-HUB -Y PUSH ON (2, 3, 4" ONLY) -1 DECK CLAMP ASSM -2 DRAIN RECEIVER -VP VANDAL PROOF</p>
<p>24500 SERIES ALL BRONZE SILL TYPE DRAIN WITH 4" DOME</p>  <p>24502 2" ALL BRONZE 24503 3" ALL BRONZE 24504 4" ALL BRONZE -45 45 DEGREE OUTLET -90 90 DEGREE OUTLET -T THREADED OUTLET -TSO THREADED SIDE OUTLET</p>	<p>25010 SERIES DOWNSPOUT SATIN BRONZE WITH WALL FLANGE</p>  <p>25012 2" DOWNSPOUT 25013 3" DOWNSPOUT 25014 4" DOWNSPOUT 25016 6" DOWNSPOUT 25018 8" DOWNSPOUT 25019 10" DOWNSPOUT 25010-12 12" DOWNSPOUT -T STANDARD THREADED -Z NO-HUB 12" AVAILABLE IN NO HUB ONLY</p>	<p>25540 SERIES INDIRECT WASTE FLOW-SEPTOR DRAIN WITH SOLID WATER DAM & INTERNAL BRONZE DOME</p>  <p>25542 2" INDIRECT DRAIN 25543 3" INDIRECT DRAIN 25544 4" INDIRECT DRAIN 25546 6" INDIRECT DRAIN -T THREADED OUTLET -Y PUSH ON (2, 3, 4" ONLY) -Z NO-HUB -20 GALVANIZED CAST IRON</p>
<p>26700 SERIES VP VENT CAPS CAST IRON VANDAL PROOF VENTED HOOD CAP</p> 	<p>PIPE SIZE</p> <p>26700-1-1/2 1-1/2" PIPE SIZE 26700-2 2" PIPE SIZE 26700-2-1/2 2-1/2" PIPE SIZE 26700-3 3" PIPE SIZE 26700-4 4" PIPE SIZE 26700-6 6" PIPE SIZE</p>	

<p>30000 SERIES CI FLOOR DRAIN BODY W/CLAMPING COLLAR AND PLUGGED PRIMER TAP</p>  <p>30002 2" DRAIN BODY 30003 3" DRAIN BODY 30004 4" DRAIN BODY -X INSIDE CAULK -Y PUSH ON -Z NO HUB -50 PRIMER TAP(NC) -92 GALVANIZED BODY</p>	<p>SERIES "A" ROUND STRAINER SATIN NIKALOY FINISH</p>  <p>5A 5" ROUND NIKALOY 6A 6" ROUND NIKALOY 7A 7" ROUND NIKALOY 8A 8" ROUND NIKALOY 9A 9" ROUND NIKALOY 10A 10" ROUND NIKALOY -J BACKWATER VALVE SS STAINLESS STEEL -VP VANDAL PROOF -80 PERFORATED STAINLESS STEEL BASKET</p>	<p>SERIES "E" TRACTOR STRAINER HD NIKALOY TRAFFIC GRATE</p>  <p>6E 6" HD NIKALOY STRAINER 7E 7" HD NIKALOY STRAINER 9E 9" HD NIKALOY STRAINER -VP VANDAL PROOF -80 PERFORATED STAINLESS STEEL BASKET</p>
<p>SERIES "E1" EXTENDED RIM NIKALOY STRAINER ASSEMBLY</p>  <p>6E1 6" NIKALOY STRAINER 7E1 7" NIKALOY STRAINER 9E1 9" NIKALOY STRAINER -VP VANDAL PROOF -80 PERFORATED STAINLESS STEEL BASKET</p>	<p>SERIES "E2" FUNNEL STRAINER WITH F4 4" ROUND NIKALOY FUNNEL</p>  <p>7E2 7" FUNNEL STRAINER -VP VANDAL PROOF -80 PERFORATED STAINLESS STEEL BASKET</p>	<p>SERIES "E3" FUNNEL STRAINER WITH F9 9" OVAL NIKALOY FUNNEL</p>  <p>7E3 7" FUNNEL STRAINER -VP VANDAL PROOF -80 PERFORATED STAINLESS STEEL BASKET</p>
<p>SERIES "F" NIKALOY FUNNELS</p>  <p>F4 4" RD NIKALOY FUNNEL F6 6" RD NIKALOY FUNNEL</p>	<p>SERIES "G" ROUND STRAINER WITH SOLID HINGED COVER</p>  <p>5G 5" ROUND NIKALOY 6G 6" ROUND NIKALOY 7G 7" ROUND NIKALOY 8G 8" ROUND NIKALOY -VP VANDAL PROOF -80 PERFORATED STAINLESS STEEL BASKET</p>	<p>SERIES "H" ROUND STRAINER WITH HINGED GRATE</p>  <p>5H 5" ROUND NIKALOY 6H 6" ROUND NIKALOY 7H 7" ROUND NIKALOY 8H 8" ROUND NIKALOY -VP VANDAL PROOF -80 PERFORATED STAINLESS STEEL BASKET</p>
 <p>F8 1" TALL OVAL FUNNEL F9 3-3/4" TALL OVAL FUNNEL</p>	<p>MANY OTHER DRAINS ARE AVAILABLE, CONTACT YOUR SALESMAN OR CALL EASTER AND SONS SALES OFFICE. IF YOU DON'T SEE THE ONE YOU NEED, PLEASE CALL.</p>	
<p>EASTER & SONS</p>	<p>X263</p>	<p>COPYRIGHT 2008</p>

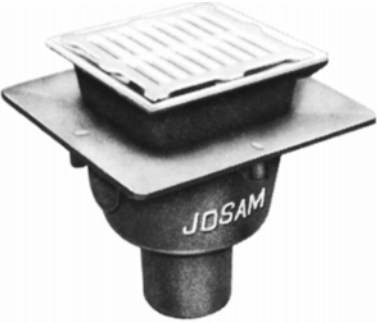
SERIES "R" RECTANGULAR	SERIES "S" SQUARE STRAINER	SERIES "W" STRAINER EXTENSION
<p data-bbox="132 219 509 248">NIKALOY STRAINER ASSEMBLY</p>  <p data-bbox="153 504 485 719"> 5R 5" X 9" 6R 5" X 13" 7R 5" X 16-3/4" 8R 5" X 21" -VP VANDAL PROOF -80 PERFORATED STAINLESS STEEL BASKET </p>	<p data-bbox="596 219 946 248">SQUARE NIKALOY STRAINER</p>  <p data-bbox="600 472 932 719"> 5S 5" X 5" SQUARE 6S 6" X 6" SQUARE 8S 8" X 8" SQUARE 9S 9" X 9" SQUARE SS STAINLESS STEEL -VP VANDAL PROOF -80 PERFORATED STAINLESS STEEL BASKET </p>	 <p data-bbox="1042 472 1444 533"> 2W 2" STRAINER EXTENSION 49850 FLUSHING RIM DRAIN </p>  <p data-bbox="1059 696 1410 719">CALL FOR SPECS AND PRICE</p>
<p data-bbox="132 723 509 784">SERIES 32100 CI FLOOR DRAIN WITH 9" TOP ASSEMBLY</p>  <p data-bbox="132 1106 509 1384"> 32102 32103 32104 -X INSIDE CAULK -Y PUSH ON -Z NO HUB -50 PRIMER TAP -81 SLOTTED CI BUCKET -92 GALVANIZED BODY </p>	<p data-bbox="587 723 962 784">SERIES 32100-AE ADJUSTABLE WITH 9" TOP ASSEMBLY</p>  <p data-bbox="600 1106 962 1384"> 32102-AE 2" 32103-AE 3" 32104-AE 4" -X INSIDE CAULK -Y PUSH ON -Z NO HUB -50 PRIMER TAP -81 SLOTTED CI BUCKET -92 GALVANIZED BODY </p>	<p data-bbox="1042 723 1433 784">SERIES 32100-TG TRAFFIC DUTY WITH 9" TRAFFIC DUTY TOP</p>  <p data-bbox="1042 1106 1433 1384"> 32102-TG 2" 32103-TG 3" 32104-TG 4" -X INSIDE CAULK -Y PUSH ON -Z NO HUB -50 PRIMER TAP -81 SLOTTED CI BUCKET -92 GALVANIZED BODY </p>
<p data-bbox="132 1384 509 1444">SERIES 32200 CI FLOOR DRAIN WITH 12" SUPER-FLO TOP</p>  <p data-bbox="201 1738 424 1888"> 32202 2" 32203 3" 32204 4" 32206 6" 32208 8" </p> <p data-bbox="256 1899 834 1921">OPTIONS FOR 32200 SERIES 12" FLOOR DRAINS</p> <p data-bbox="153 1928 424 2011"> -X INSIDE CAULK -Y PUSH ON -Z NO HUB </p>	<p data-bbox="587 1384 962 1444">SERIES 32200-SD SPECIAL HD WITH 12" SUPER-FLO TOP</p>  <p data-bbox="624 1738 863 1888"> 32202-SD 2" 32203-SD 3" 32204-SD 4" 32206-SD 6" 32208-SD 8" </p> <p data-bbox="600 1928 946 2011"> -50 PRIMER TAP -81 SLOTTED CI BUCKET -92 GALVANIZED BODY </p>	<p data-bbox="1042 1384 1433 1480">SERIES 39600 PLANTER DRAIN WITH STAINLESS STEEL MESH COVERED DOME</p>  <p data-bbox="1023 1805 1369 2011"> 39602 2" PLANTER DRAIN 39603 3" PLANTER DRAIN 39604 4" PLANTER DRAIN 39606 6" PLANTER DRAIN -X INSIDE CAULK -Z NO HUB -92 GALVANIZED BODY </p>

SERIES 49300 CI FLOOR SINK WITH PORCELAIN GRATE 8" X 8" 6-1/4" DEEP	SERIES 49300-NB CI FLOOR SINK WITH NICKEL BRONZE RIM & GRATE 8" X 8" 6-1/4" DEEP	SERIES 49320A CI FLOOR SINK WITH PORCELAIN GRATE 12" X 12" 6-1/4" DEEP
 <p>49302 2" WITH FULL GRATE 49303 3" WITH FULL GRATE 49304 4" WITH FULL GRATE -X INSIDE CAULK -Z NO HUB -LF LESS FLANGE -LG LESS GRATE -3 HALF GRATE -4 3/4 GRATE -31 ALUM SEDIMENT BUCKET -35 SS MESH BUCKET LINER -55 TRAP PRIMER TAP -C CLAMP DEVICE</p>	 <p>49302-NB 2" WITH FULL GRATE 49303-NB 3" WITH FULL GRATE 49304-NB 4" WITH FULL GRATE -X INSIDE CAULK -Z NO HUB -LF LESS FLANGE -LG LESS GRATE -3 HALF GRATE -4 3/4 GRATE -31 ALUM SEDIMENT BUCKET -35 SS MESH BUCKET LINER -55 TRAP PRIMER TAP -C CLAMP DEVICE</p>	 <p>49322A 2" WITH FULL GRATE 49323A 3" WITH FULL GRATE 49324A 4" WITH FULL GRATE -X INSIDE CAULK -Z NO HUB -LF LESS FLANGE -LG LESS GRATE -3 HALF GRATE -4 3/4 GRATE -31 ALUM SEDIMENT BUCKET -35 SS MESH BUCKET LINER -55 TRAP PRIMER TAP -C CLAMP DEVICE</p>
SERIES 49320A-NB FLOOR SINK WITH NICKEL BRONZE RIM & GRATE 12" X 12" 6-1/4" DEEP	SERIES 49340A CI FLOOR SINK WITH PORCELAIN GRATE 12" X 12" 8-3/8" DEEP	SERIES 49340A-NB FLOOR SINK WITH NICKEL BRONZE RIM & GRATE 12" X 12" 8-3/8" DEEP
 <p>49322A-NB 2" WITH FULL GRATE 49323A-NB 3" WITH FULL GRATE 49324A-NB 4" WITH FULL GRATE -X INSIDE CAULK -Z NO HUB -LF LESS FLANGE -LG LESS GRATE -3 HALF GRATE -4 3/4 GRATE -31 ALUM SEDIMENT BUCKET -35 SS MESH BUCKET LINER -55 TRAP PRIMER TAP -C CLAMP DEVICE</p>	 <p>49342A 2" WITH FULL GRATE 49343A 3" WITH FULL GRATE 49344A 4" WITH FULL GRATE -X INSIDE CAULK -Z NO HUB -LF LESS FLANGE -LG LESS GRATE -3 HALF GRATE -4 3/4 GRATE -31 ALUM SEDIMENT BUCKET -35 SS MESH BUCKET LINER -55 TRAP PRIMER TAP -C CLAMP DEVICE</p>	 <p>49342A-NB 2" WITH FULL GRATE 49343A-NB 3" WITH FULL GRATE 49344A-NB 4" WITH FULL GRATE -X INSIDE CAULK -Z NO HUB -LF LESS FLANGE -LG LESS GRATE -3 HALF GRATE -4 3/4 GRATE -31 ALUM SEDIMENT BUCKET -35 SS MESH BUCKET LINER -55 TRAP PRIMER TAP -C CLAMP DEVICE</p>
<p>EASTER & SONS X265 COPYRIGHT 2008</p>		

CLEANOUT ASSEMBLIES

SERIES 55000 CAST IRON TOP



- 55002** 2" HD CLEANOUT
- 55003** 3" HD CLEANOUT
- 55004** 4" HD CLEANOUT
- 55006** 6" HD CLEANOUT
- Y PUSH ON (2, 3, 4 ONLY)
- Z NO HUB
- 1-SD HD NIKALOY TOP
- 14 CARPET CO MARKER

SERIES 55000-1 NIKALOY TOP



- 55002-1** 2"
- 55003-1** 3"
- 55004-1** 4"
- 55006-1** 6"
- Y PUSH ON (2, 3, 4 ONLY)
- Z NO HUB
- 1-12 RECESSED FOR TILE
- 14 CARPET CO MARKER
- SS STAINLESS STEEL TOP
- VP VANDAL PROOF

SERIES 55000-1-SQ SQUARE NIKALOY TOP

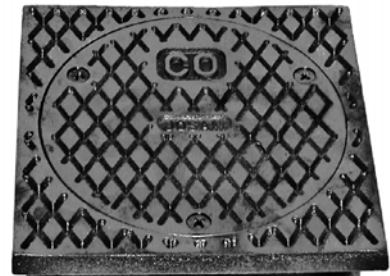

- 55002-1-SQ** 2"
- 55003-1-SQ** 3"
- 55004-1-SQ** 4"
- 55006-1-SQ** 6"
- Y PUSH ON (2, 3, 4 ONLY)
- Z NO HUB
- 14 CARPET CO MARKER
- SS-SQ STAINLESS STEEL TOP
- VP VANDAL PROOF

SERIES 58360 ADJUSTABLE C/O



- 58362** 2" CLEANOUT
- 58363** 3" CLEANOUT
- 58364** 4" CLEANOUT
- 58366** 6" CLEANOUT
- Y PUSH ON (2, 3, 4 ONLY)
- Z NO HUB

SERIES 58680 ACCESS COVER WITH ANCHOR FLANGES AND HEAVY DUTY SCORIATED SECURED COVER





- 58680** COVER ASSEMBLY
- 5 DUCTILE IRON COVER
- VP VANDAL PROOF
- CO2 2" NH CLEANOUT
- CO3 3" NH CLEANOUT
- CO4 4" NH CLEANOUT
- CO6 6" NH CLEANOUT







60100H MANUAL CLEANING ON-FLOOR TYPE GREASE INTERCEPTOR EPOXY COATED

MODEL	FLOW RATE	GREASE CAP.	PIPE SIZE
	GPM	LBS.	
60102H	7	14	2
60103H	10	20	2
60104H	15	30	2
60105H	20	40	3
60106H	25	50	3
60107H	35	70	3
60108H	50	100	3

- SA SEMI-AUTOMATIC
- 61 FLANGE AND CLAMP DEVICE
- EXT EXTENSION, 6" STANDARD (SPECIFY EXT HEIGHT)
- RT RECESSED TYPE
- ET ENCLOSED TYPE
- HD HEAVY-DUTY COVER

SERIES 67100A BALL-FLOAT	SERIES 67400 NO-HUB	SERIES 67500 HUB& SPIGOT
BACKWATER VALVE	SWING CHECK BACKWATER VLV	SWING CHECK BACKWATER VLV
		
67102A 2" NO-HUB 67103A 3" NO-HUB 67104A 4" NO-HUB 67106A 6" NO-HUB	67402 2" NO-HUB 67403 3" NO-HUB 67404 4" NO-HUB 67406 6" NO-HUB	67502 2" HUB & SPIGOT 67503 3" HUB & SPIGOT 67504 4" HUB & SPIGOT 67506 6" HUB & SPIGOT 67508 8" HUB & SPIGOT

JOSAM WALL HYDRANTS

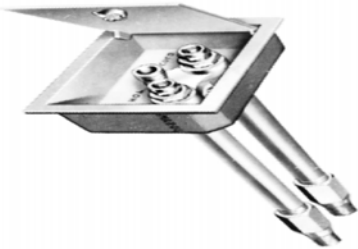
SERIES 71000 NIKALOY	SERIES 71020 NIKALOY	SERIES 71050 NIKALOY
BOX WALL HYDRANT	MILD CLIMATE BOX HYDRANT	WALL HYDRANT
		
71000-4 4" WALL 71000-6 6" WALL 71000-8 8" WALL 71000-10 10" WALL 71000-12 12" WALL	71020 3/4" FEMALE X 1" MALE FOR 4" WALL	71050-3 2-3/4" WALL 71050-4 4" WALL 71050-6 6" WALL 71050-8 8" WALL 71050-10 10" WALL 71050-12 12" WALL
SERIES 71070 MILD CLIMATE	SERIES 71600 BOX YARD	SERIES 71650 HOT & COLD
WALL HYDRANT FOR 4" WALL	HYDRANT	BOX WALL HYDRANT
		
71070 MILD CLIMATE FOR 4" WALL	71600-2 2 FOOT BURY BOX YARD HYDRANT	71650 6-8" WALL HOT & COLD BOX WALL HYDRANT

SERIES 88250 TRAP PRIMER VALVE



- 88250** 1/2" TRAP PRIMER VALVE
- 10** CHROME PLATED
- 90** 1/2" FEMALE COPPER CONNECTION
- 91** 1/2" FEMALE IPS UNION CONNECTION

BLUCHER JOSAM



STAINLESS STEEL DRAINS AND TRENCH FOR INDUSTRIAL, INSTITUTIONAL, AND FOOD SERVICE CALL FOR SPECIAL QUOTES

SHOWER PAN LINER

40 MIL PAN LINER



- 4SPM** 48" WIDE 6" RULED SHOWER PAN MATERIAL
- 5SPM** 60" WIDE 6" RULED SHOWER PAN MATERIAL
- 6SPM** 72" WIDE 6" RULED SHOWER PAN MATERIAL

**CUT TO LENGTH OR SOLD IN ROLLS
FOR ROLLS CHANGE SUFFIX TO (L)**

SPC SHOWER PAN CORNERS

SUPPLY BOXES

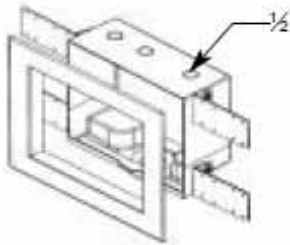
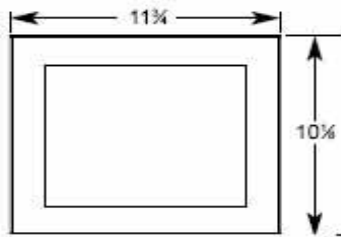

38934 PLASTIC WASHING MACHINE BOX WITH VALVES

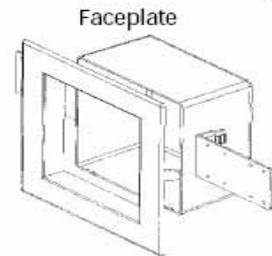
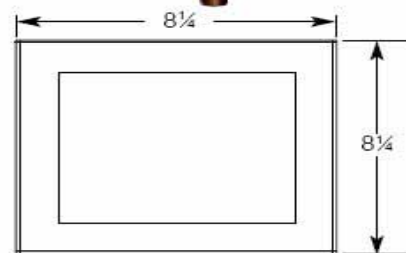

38681 PLASTIC ICEMAKER BOX WITH VALVE



B200 GALVANIZED WASHING MACHINE WITH VALVES



BIM875 GALVANIZED ICE MAKER BOX WITH VALVE

LEAD CLOSET BENDS



LEAD CLOSET BENDS

- 88-34BB** 3X4X12X15 BRASS
- 88-34PB** 3X4X12X15 PVC
- 88-44PB** 4X4X12X15 PVC
- 88-44BB** 4X4X12X15 BRASS

CLOSET BEND ARE CLOSED END

INGOT & LEAD WOOL



- 88-5LB** INGOT LEAD
5# BLOCKS
- 88-5LW** LEAD WOOL
5# BOX

LEAD & POLY ROOF FLASHINGS 2-1/2LB & 4LB



2-1/2# LEAD	4# LEAD	POLY	
88-152	88-154	88-150PF	1-1/2"
88-202	88-204	88-200PF	2"
88-302	88-304	88-300PF	3"
88-402	88-404	88-400PF	4"
88-502	N/A	N/A	5"
88-602	N/A	N/A	6"

LEAD EXTENSIONS AND STUBS



EXTENSION

- 88-46LE** 4X6 LEAD EXTENSION
- 88-34PS** 3X4X12 PVC STUB
- 88-34BS** 3X4X12 BRASS STUB
- 88-44PS** 4X12 PVC STUB
- 88-44PSX** 4X12 XH PVC STUB
- 88-44BS** 4X12 BRASS STUB

CLOSED END LEAD STUBS



**MASTER FLASH®
ROOF FLASHINGS**

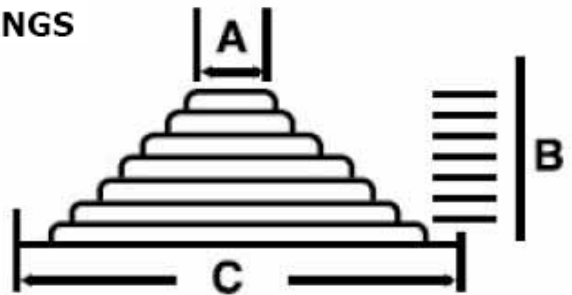

✓	Product No.	Description	Top Opening (A)	Cut to fit base size (B)	Base Dimension (C)	PACK	CARTON WEIGHT
	14050	1/4" - 2" Master Flash Roof Flashing	Closed	1/4 - 2	4-1/2	6	1 lb.
	14051	1-1/4" - 3" Master Flash Roof Flashing	7/8	1-1/4 - 3	6	6	2 lbs.
	14052	1/4" - 4" Master Flash Roof Flashing	Closed	1/4 - 4	8"	6	4 lbs.
	14053	3" - 6" Master Flash Roof Flashing	2-1/2	3 - 6	10	6	5 lbs.
	14054	4" - 7" Master Flash Roof Flashing	3-1/2	4 - 7	11	2	3 lbs.
	14055	5" - 9" Master Flash Roof Flashing	4	5 - 9	12	2	4 lbs.
	14056	6" - 11" Master Flash Roof Flashing	5	6 - 11	14	2	6 lbs.
	14057	7" - 13" Master Flash Roof Flashing	6	7 - 13	17	2	7 lbs.
	14059	10" - 18" Master Flash Roof Flashing	8-1/2	10 - 18	25	5	23 lbs.