

electronics®

FLAT-PLANE ANTENNA

Crossed dipole structure, below,

has complete polarization diversity, p 48

PREDICTING FLIGHT PATHS

*New air traffic
control concept, p 27*

SPACECRAFT RECEIVER

*Unit controlled Mercury
capsule, p 32*

RAT'S NEST CALORIMETER

*Measures laser
energy output, p 36*

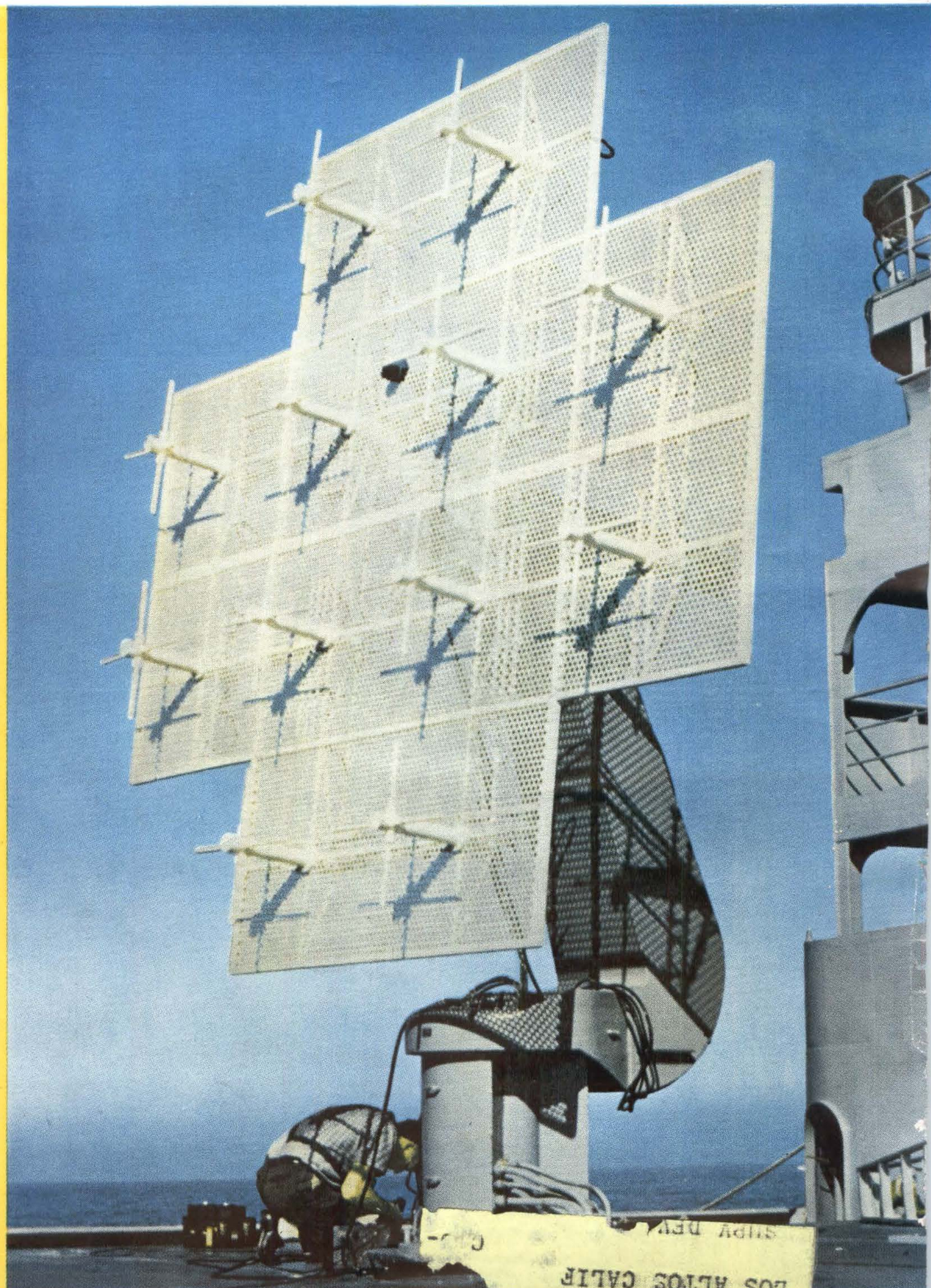

SHIP DEPT
LOS ALTOS CALIF
1960 GOVINGTON RD
SAN ANTONIO TEXAS

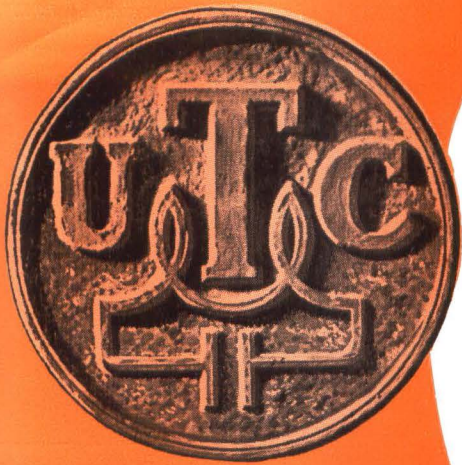

SPECIAL FILTERS

TO YOUR REQUIREMENTS

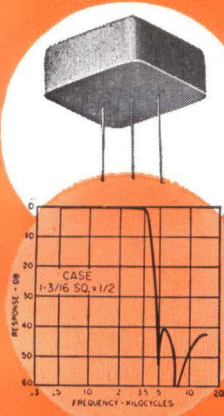

Miniaturized 3.5 KC low pass filter. 10K ohms to 10K ohms. Within 1 db up to 3500 cycles. Greater than 40 db beyond 4800 cycles.

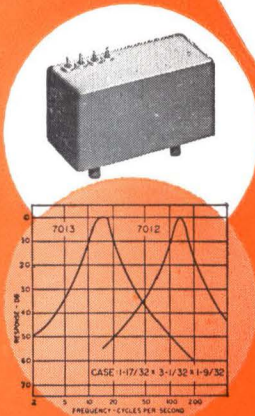

Fifteen cycle and 135 cycle filters for Tacan. 600 ohms to high impedance. Extreme stability -55°C. to $+100^{\circ}\text{C.}$

Almost thirty years of experience in the design and production of special filters have resulted in UTC being a first source for difficult units. Present designs incorporate a wide variety of core structures, winding methods, and capacitors to provide maximum performance, stability, and reliability. The units illustrated show a few of the thousands of specials produced by UTC, to customers' requirements, and only slightly indicate the possibilities in present special filter design. Range of frequencies on special units is from .1 cycles to 400 MC.

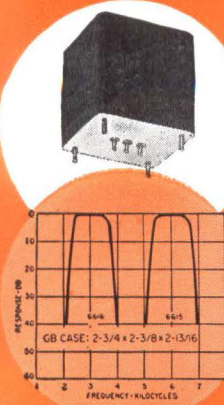

Three KC and 6 KC flat top band pass filters. 400 ohms to 20K ohms. MIL-T-27A; each filter 1.7 lbs.

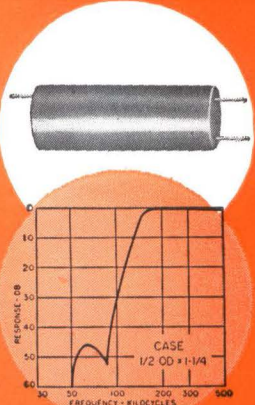

High frequency Mini-filters, .33 oz. MIL-T-27A Grade 5. 150 KC High Pass 3 db to 150 KC, down 45 db below 85 KC. 7500 ohms.

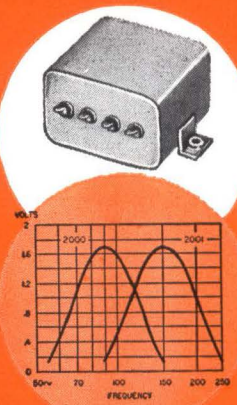

Curves of our miniaturized 90 and 150 cycle filters for glide path systems. $1\frac{1}{4}''$ x $1\frac{1}{4}''$ x $1\frac{1}{8}''$.

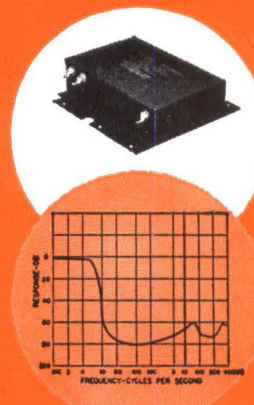

Power line filter from sources of 50 to 400 cycles . . . attenuation from 14 KC to 400 MC . . . 29 cubic inches.

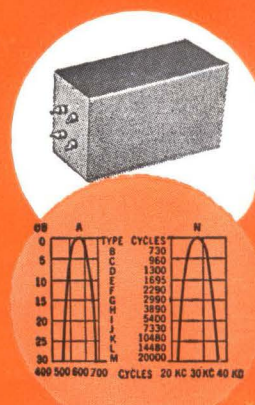

Multi-channel telemetering band pass filters for 400 cycle to 40 KC. Miniaturized units for many applications.

Plus
over 1,000
STOCK ITEMS
with UTC
High Reliability
from your local
distributor



→ write for catalog

UNITED TRANSFORMER CORP.

150 VARICK STREET, NEW YORK 13, N. Y.

PACIFIC MFG. DIVISION: 3630 EASTHAM DRIVE, CULVER CITY, CALIF.
EXPORT DIVISION: 13 EAST 40th STREET, NEW YORK 16, N. Y. CABLES: "ARLAB"

CIRCLE 900 ON READER SERVICE CARD

electronics

A McGraw-Hill Publication 75 Cents



W. W. MacDONALD, Editor

J. M. CARROLL, Managing Editor
 SENIOR EDITORS: Samuel Weber, George W. Sideris. SENIOR ASSOCIATE EDITORS: Michael F. Wolff, John F. Mason. ASSOCIATE EDITORS: Michael F. Tomaino, Sylvester P. Carter, William P. O'Brien, Sy Vogel, Leslie Solomon, George J. Flynn, Laurence D. Shergalis, George V. Novotny, Leon H. Dulberger. ASSISTANT EDITORS: Nilo Lindgren, Stanley Froud, Stephen B. Gray, Roy J. Bruun, Barry A. Briskman. REGIONAL EDITORS: Harold C. Hood (Pacific Coast, Los Angeles), Thomas Maguire (New England, Boston), Cletus M. Wiley (Midwest, Chicago). ART DIRECTOR: Howard R. Berry. ASSISTANT ART DIRECTOR: John C. Wright, Jr. EDITORIAL ASSISTANTS: Lorraine Rossi, Virginia T. Bastian, Lynn Emery, Ann Mella, Lorraine Werner, Alice M. O'Brien. FOREIGN NEWS BUREAU: Director, John Wilhelm; Alyne Elias, Betsy Wilson. LONDON—John Shinn, Derek Barlow, Nicholas Landan. BONN—Bruce Bendow, Richard Mikton, Silke McQueen. BRUSSELS—Peter Forbath. PARIS—Robert Farrell, Arthur Erikson. MILAN—Marc A. Messina. MEXICO CITY—Wesley Perry, Jr. RIO DE JANEIRO—Leslie Warren. MOSCOW—Stewart Ramsey. TOKYO—Richard Haloran, Charles Cohen, John Yamaguchi.

W. W. GAREY, Publisher

DIPOLE FLAT PLANE ANTENNA for vhf telemetry tracking and acquisition is mounted aboard a U.S. Navy range ship. *The Rantec Corp. antenna uses crossed dipoles to achieve complete polarization diversity and is only two feet deep. See p 48*

COVER

SUPERSONIC AIRLINER Challenges Aircraft Equipment Designers. Navigation gear must be upgraded and the plane's high speed may make automatic weather-avoidance equipment necessary. *Equipment designed for supersonic military planes may not be applicable; reliability requirements differ*

14

SATELLITE STATION Rushed in Japan. Postal Ministry is hoping to complete the station in time for tv and radio transmission by satellite of the 1964 Olympics. *U.S. will be asked to put Relay and Syncom into suitable orbital paths*

15

RS-70 DEBATE Coming Up Again. Congress is expected to lock horns with the administration on the need for the new manned bomber. *Industry has a big stake in the outcome of this dispute*

18

NEW FROM BRITAIN: Tunable Detectors, Faster Microwave Switching. Here's a quick wrapup of new component ideas revealed at the Physics show in London. *R&D efforts are centering on low-noise ir and microwave detectors*

22

NEW AIR TRAFFIC SYSTEM Predicts Flight Paths. Like the two hunters, one of whom wanted to find out where the bear came from while the other wanted to know where he was going, prediction is the key to collision avoidance. *This system uses a predicted-path system of computer-aided control to help the radar-approach controller keep planes separated.*

By S. D. Moxley and J. A. Inderhees, Avco 27

MERCURY SPACECRAFT COMMAND RECEIVER: First Design Details. Here is how the Mercury space capsules that carried America's astronauts on their globe-girdling flights got ground signals to actuate escape and retrorockets, set the clock and calibrate instruments. *It is a 20-channel double-conversion superhet with both local oscillators crystal controlled.*

By R. Elliott, Motorola 32

MEASURING LASER OUTPUT ENERGY With the Rat's Nest Calorimeter. We were intrigued by this title. It turns out the rat's nest is a jumble of 1,000 feet of fine enameled wire. *It makes up a bolometer whose change in resistance is proportional to energy absorbed.*

By R. M. Baker, Westinghouse Electric 36

Published weekly, with Electronics Buyers' Guide as part of the subscription, by McGraw-Hill Publishing Company, Inc. Founder: James H. McGraw (1860-1948).

Title ® registered U.S. Patent Office; © copyright 1963 by McGraw-Hill Publishing Co., Inc. All rights reserved, including the right to reproduce the contents of this publication, in whole or in part.

Executive, editorial, circulation and advertising offices: McGraw-Hill Building, 330 West 42nd Street, New York 36, N. Y. Telephone Longacre 4-3000. Teletype TWX N.Y. 212-640-4646. Cable McGrawhill, N. Y. PRINTED IN ALBANY, N. Y.; second class postage paid at Albany, N. Y.

OFFICERS OF THE PUBLICATIONS DIVISION: Shelton Fisher, President; Vice Presidents: Joseph H. Allen, Operations; John R. Callahan, Editorial; Ervin E. DeGraff, Circulation; Donald C. McGraw, Jr., Advertising Sales; Angelo R. Venezian, Marketing.

OFFICERS OF THE CORPORATION: Donald C. McGraw, President; Hugh J. Kelly, Harry L. Waddell, Executive Vice Presidents; L. Keith Goodrich, Executive Vice President and Treasurer; John J. Cooke, Vice President and Secretary.

Subscriptions are solicited only from those actively engaged in the field of the publication. Position and company connection must be indicated on orders. Subscription rates: United States and Possessions, \$6.00 one year, \$9.00 two years, \$12.00 three years. Canada: \$10.00 one year. All other countries \$20.00 one year. Single copies, United States and Possessions and Canada 75¢. Single copies all other countries \$1.50.

THE PUBLISHER, UPON WRITTEN REQUEST FROM ANY SUBSCRIBER TO OUR NEW YORK OFFICE AGREES TO REFUND THAT PART OF THE SUBSCRIPTION PRICE APPLYING TO COPIES NOT YET MAILED.

Subscribers: Please address change of address notices, subscription orders or complaints to Fulfillment Manager, Electronics, at above address. Change of address notices should provide old as well as new address, including postal zone number if any. If possible, attach address label from recent issue. Allow one month for change to become effective.

Postmaster: Please send Form 3579 to Fulfillment Manager, Electronics, 330 West 42nd Street, New York 36, New York.



Audited Paid Circulation

CONTENTS continued

COAX-CABLE DELAY MEASUREMENTS With Subnanosecond Precision. Pulse delay in interconnecting cable is an important factor in nuclear-detection work. Here, a pulse is sent down the line and its reflection retriggers the pulse generator to produce sustained oscillations. *Of course, prf is then proportional to cable delay.* By E. F. Laine, Lawrence Radiation Lab 39

NOVEL FEEDBACK LOOP Stabilizes Audio Oscillator. This circuit combines oscillator and amplifier in a single stage. *The circuit incorporates extensive negative feedback to minimize effects of unstable transistor characteristics and make the oscillator independent of load.* By R. G. Fulks, General Radio 42

REFERENCE SHEET: Rapid Evaluation of Complex Receiving Systems. Cascaded systems of preamplifiers, multicouplers and receivers can be evaluated as to noise figure and sensitivity by these convenient nomographs. *Second unit performance can be expressed also as equivalent noise temperature.* By H. H. Reed, Collins Radio 44

DEPARTMENTS

Crosstalk. *Crystal Ball* 3
Comment. *Klystron Magnets, Reliability* 4
Electronics Newsletter. *Orbiting Dipole Belt Project on Again?* 7
Washington This Week. *Military Contracts to Require Value Engineering* 10
Meetings Ahead. *Data Acquisition and Processing in Medicine* 25
Research and Development. *New Telemetry Antenna Adds Flexibility* 48
Components and Materials. *Interconnections Pose Design Problems* 54
Production Techniques. *Machine Simplifies Bonding Process* 60
New Products. *Checking Pulse Coincidence at 100-Mc Rate* 64
Literature of the Week 68
People and Plants. *Polarad Completes Decentralization* 72
Index to Advertisers 80

CROSSTALK

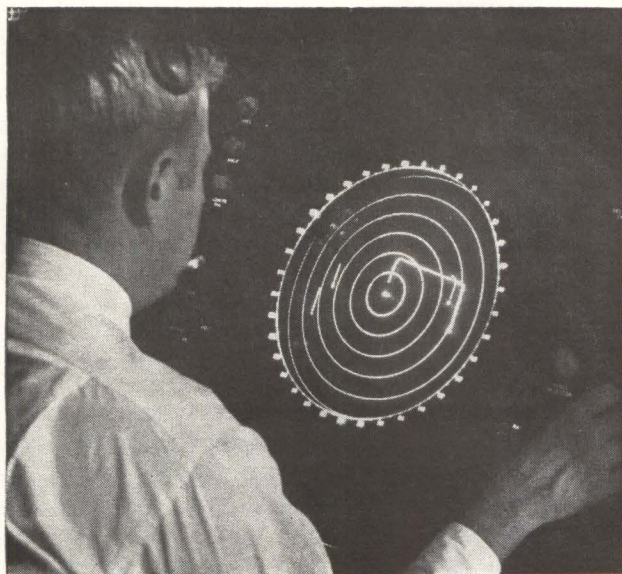

CRYSTAL BALL. Our lead feature article this week (p 27) is an exclusive report on a new traffic control system that is the electronic equivalent of a crystal ball. It shows the controller where planes circling the airport will be in the next several minutes. By looking at this radar view of the future, he can detect when planes are on convergent flight paths and avert a possible disaster.

We were eager to publish this article, not only because it is technically an interesting system, but because it also points up the human element that must be taken into account in the design of air traffic control equipment.

As we have noted in these pages previously, air traffic controllers are busy men—dangerously too busy at times, think some people concerned about airplane safety. A traffic controller now may have to keep a dozen or more planes stacked out of each other's way while bringing them into a landing and fitting new arrivals into the landing pattern. The new system can eliminate much of the mental strain.

Such equipment—equipment that can present air traffic data in a form the human brain can cope with—is a core requirement in the massive program to keep air safety in step with the increase in air travel. As was noted in the opening paragraph of our recent three-part series on

the air traffic control program, there will be more than 130,000 planes flying over the U. S. in a dozen years (*ELECTRONICS*, p 37, Dec. 7, p 46, Dec. 14, 1962, and p 42, Jan 4, 1963). With a substantial part of that huge fleet in the air at one time, and with supersonic airliners entering the mix (see p 14 this week), keeping the traffic sorted out for the controllers will require some first-rate human engineering.

Coming In Our February 8th Issue

CLEARING THE AIR. If astronomers could clear all the atmosphere away from the earth's surface they would be happy—it's one of the burdens of their life. They can't see through it as well as they would like to. Apart from clouds, which completely obscure their view, many additional affects, including variable refraction due to changing air density, set a limit to observation from ground-based observatories.

The solution is to lift the observatory above the atmosphere. The task is not simple, but it can be done. In 1957, Professor M. Schwarzschild, of Princeton University, took near-perfect photographs from an automated telescope hoisted up by a balloon. Now another balloon attempt, scheduled for next week, is under way. A larger telescope is being used and an elaborate electronics control package is being carried aloft with it.

The basic requirement is that the 3-ton telescope must remain on target to within 0.02 second of arc for up to an hour while dangling from a balloon 15 miles high. Details of the electronic system that permit this achievement are described by E. R. Schlesinger, of Perkin-Elmer, in a five page feature next week.

In another article next week we provide a circular sliderule for engineers concerned with receiver and amplifier noise calculation. It can be cut from the pages and pasted onto cardboard stiffeners. The sliderule and its reference sheet come from R. Larosa, T. Cafarella and C. E. Dean, of Hazeltine.

Additional feature articles next week include:

- A phase-locking technique for demodulators
- A backward-diode clamp that reduces tunnel diode delay time
- Use of automated techniques in transistor manufacture
- Design methods for high efficiency servos.



JERROLD'S® versatile

900A SWEEP GENERATOR covers the range of three regular instruments!

The most economical wide-band Sweep Generator in the electronics industry... covers all your needs from 1/2 mc to 1200 mc, for IF's, radar, video, telemetering, communications!

Two ranges—0.5 mc to 400 mc and 275 mc to 1200 mc. Supplies sweep signal with center from 500 kc to 1000 mc and with sweep widths as broad as 400 mc and as narrow as 100 kc. RF output, carefully monitored by matched crystal diodes feeding two-stage, push-pull AGC amplifier, is flat within ± 0.5 db at full sweep width up to 800 mc and ± 1.5 db from 800 mc to 1200 mc. When using sweep widths as narrow as 20 mc, flatness at any center frequency is approximately ± 0.15 db. **\$1260.00**

Now... full production assures fast delivery.

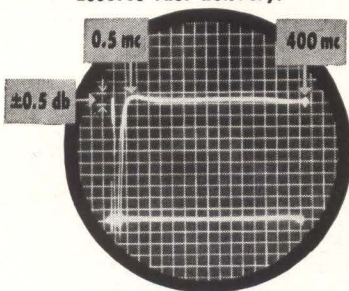

• HIGH OUTPUT!

.25 volt RMS on VHF, .5 volt RMS on UHF!

• WIDE SWEEP WIDTHS!

VHF—100 kc to 400 mc

UHF—100 kc to 40% or more of C.F.

• FLAT OUTPUT!

Flat to ± 0.5 db on widest sweep width!

Write for on-the-spot demonstration.

JERROLD

ELECTRONICS CORPORATION

A subsidiary of The Jerrold Corporation
Philadelphia 32, Pa.

COMMENT

Klystron Magnets

Regarding the p 3 item of 21 Dec., 1962 on klystrons:

All the pre-WW II klystrons I ever saw, and the 723 A/B, etc., of WW II, didn't use a magnet. When *did* the magnet get wrapped around the klystron—or are we talking about different devices?

FRANK C. ALEXANDER, JR.
Swarthmore, Pennsylvania

That Crosstalk item concerned the following week's article, *New Design Concept Reduces Klystron Weight* (p 36, Dec. 28, 1962).

The devices to which reader Alexander refers, were early reflex klystrons that were small, simple, and required no focusing of the beam for operation. High-power, high-frequency klystrons have a multiplicity of resonant cavities, and their long length requires a means of focusing the beam to keep it from spreading out as it travels through the tube.

The 723 A/B was a low-power device suitable as a local oscillator in a receiver, or as a signal generator source.

Reliability

Congratulations on your fine article on reliability (p 53, Nov. 30, 1962). I think the editorial entitled "How Much Reliability?" (p 3) was very much to the point.

I think one of the major problems today in reliability for military products is the chaotic bidding situation. The situation is chaotic, not so much because of the high reliability requirements sometimes imposed, but because these requirements bear little relationship to the mission of the equipment that is to be produced.

Specification writers have learned to use the word MTBF and use it with wild abandon even for equipments where it is meaningless. An additional factor producing chaos is the fact that most reliability specifications are more concerned with producing documents than they are with producing good hardware. One MIL group even

measures reliability growth by the documents received!

As full implementation of some of this documentation can be extremely costly, and is only justifiable on a few programs such as the Minuteman program, bidders have a tendency to use golden words to describe their actions while adjusting their actual tasks to the equipment at hand.

This adjustment is vital and necessary, but it would be far better if the contracting agencies did this themselves. Apparently some government contracting agencies are beginning to realize the desirability of this, and are actually putting limitations upon some aspects of reliability programs to prevent potential bidders from spending too much effort in reliability tasks that do nothing for the hardware.

One of the areas of greatest abuse, of course, is in the field of crystal-ball gazing, sometimes called reliability prediction. This effort, if not monitored, can easily get out of hand, and monies will be expended that could have been spent much more wisely in design engineering.

GORDON H. BECKHART
Chairman

Reliability Training Conference
IRE-ASQC

Atomic Frequency Standards

Concerning my article, Atomic Frequency Standards (p 31, Nov. 23, 1962):

In Fig. 1 (p 31), the correct ET Cs frequency is 9192631770 cps. Add title to upper left part: Various Seconds Expressed by Number of Cs³³³ (4,0 — 3,0) Cycles in Zero Magnetic Field.

Page 32, under Rb⁸⁷ Gas-Cell Standard, the second sentence should read: ". . . straight-line flight from wall to wall . . ."

Page 33: Delete all references in the table.

Page 35: second paragraph under Applications should read: "All atomic standards are *fairly* insensitive . . ." Under Conclusions, delete reference 10 after laboratory applications.

F. H. REDER

U. S. Army Electronics Research
and Development Laboratory
Fort Monmouth, New Jersey

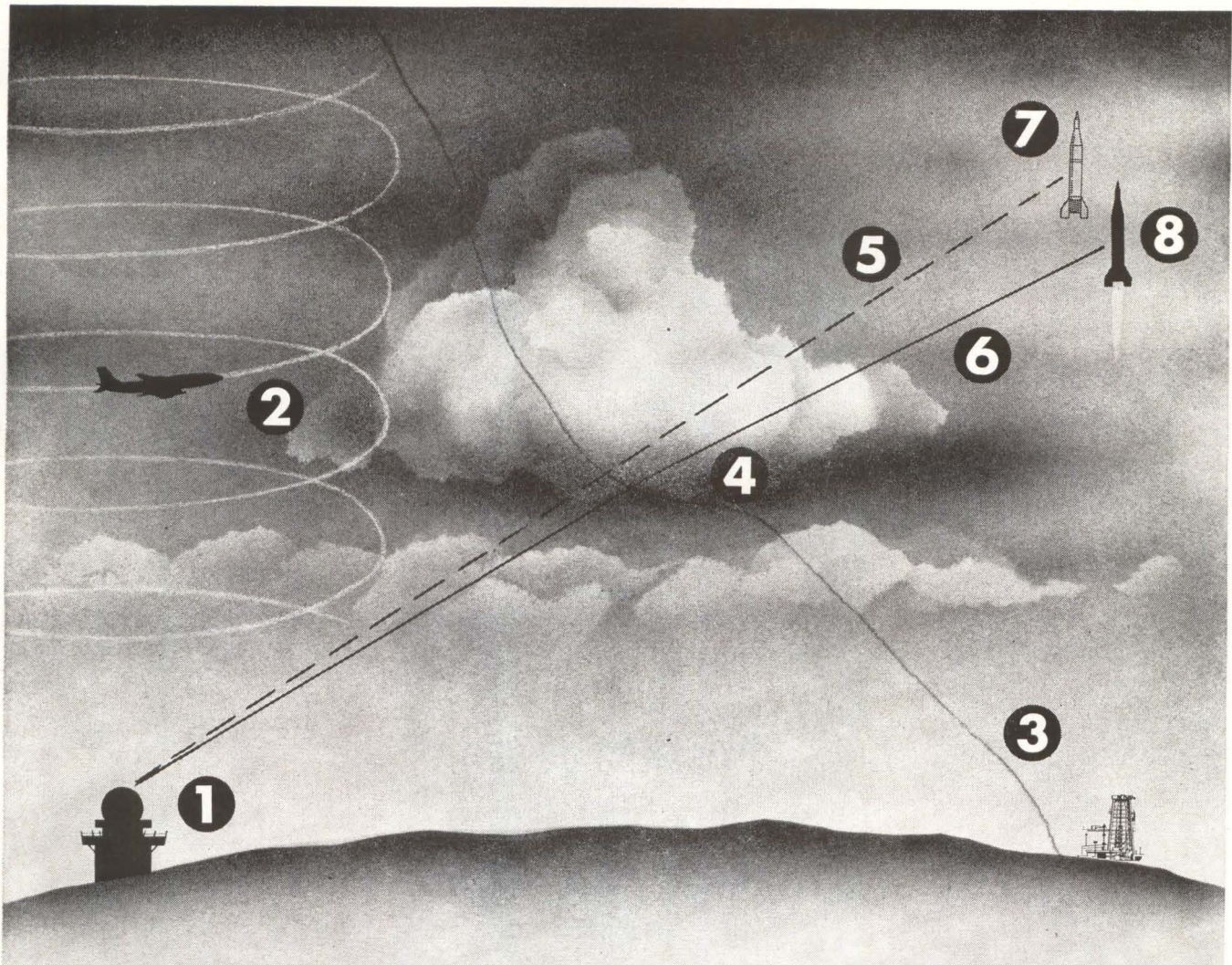

CRC microwave refractometer increases accuracy of radar tracking systems

...this is how: ① tracking station ② airborne microwave refractometer taking refractive index measurements ③ profile of the refractive index of the atmosphere ④ atmospheric duct resulting from a marked change in refractive index ⑤ apparent radar beam ⑥ actual radar beam, bent by variations in propagation velocity above, below and through the atmospheric duct ⑦ apparent missile position ⑧ actual missile position, determined by correcting, with refractometer readings, errors caused by the variations in propagation velocity.

The Colorado Research absolute microwave refractometer, accurate to $\pm 1N$ unit, is the only instrument able to provide the precision measurements required for this type of application.

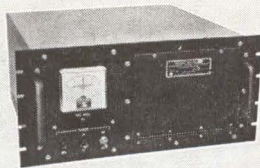

But accuracy is only part of the story. The CRC instrument is completely transistorized. It has been designed to operate unattended except for periodic verification of the basic instrument calibration. Signal output characteristics are suitable for direct computer and recorder input. Reliability and long-term stability ($\pm 1N$ unit for a 30-day period) have been demonstrated by many thousands of hours of operation in both ground-based and airborne installations.

For complete specifications and application details, address Manager of Marketing, Colorado Research Company, Broomfield, Colorado.



COLORADO RESEARCH Company

BROOMFIELD, COLORADO

The Electronics Division of Bell & Gossett Company

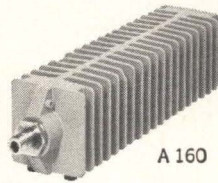

"made-to-measure precision"

How to twist the power in a 50Ω line around your finger (and live!)

Wrap your fingers around the selector knob on a Sierra 164 Bi-Directional Power Monitor, and you're ready to measure power flowing either way in the line. Twist the knob, and you see reflected; twist again, and you're reading incident. The knob, in your gentle fingertip grasp, takes the sweat and swearing out of switching. To us, that's really living.

A 164 has other qualities that help add sparkle to life afield, or in the lab. With just 9 easy-to-calibrate plug-in elements, it covers one of the widest dynamic ranges around: 1 to 1,000 watts and 2 to 1,000 MC. At $7\frac{1}{2}$ lbs., the case with handy carrying strap practically floats off the end of your arm. And when you mate it to a Sierra Series 160 Coaxial Load, you've got a termination wattmeter that's the living end.

The 164 Power Monitor costs \$110, complete with Type N connector and a sunny smile from your Sierra sales representative. The smile is optional. So are matching Type UHF, C, LC, HN, BNC, or TNC connectors. Even before you buy, you're entitled to a bulletin that gives full information in a spirit of sobriety. Write us for it, or contact your nearest Sierra representative.

SIERRA ELECTRONIC DIV.

OF

PHILCO

A SUBSIDIARY OF *Ford Motor Company*

Sierra Electronic Division / 3885 Bohannon Drive / Menlo Park 1, California

Orbiting Dipole Belt Project on Again?

SECRET AIR FORCE experiment in which six small dipoles were placed in orbit is apparently part of an effort to get the West Ford orbital-scatter communications project rolling again, but without stirring up the criticism that was aroused by the unsuccessful attempt in 1961 (p 9, Oct. 27, 1961; p 9, Jan. 26, 1962, and p 7, March 16, 1962).

If the test shows that the orbiting dipoles would have predictably short lifetimes, it would allay objections from astronomers who fear the dipoles will interfere with their observations. The test appears to be an effort to test on a small, harmless scale the lifetime of a new material.

The experiment, sometime in 1962, was revealed last week at the Institute of Aerospace Sciences meeting in New York by W. E. Morrow, of MIT. Later, in Cambridge, a Lincoln Laboratory spokesman, said the Pentagon had authorized only the following statement:

"Six experimental tin alloy dipoles approximately 15.7 inches long with total weight of 1 gram were released from an Air Force satellite in an effort to gain further data on the effects of drag, solar pressure and electrical charges on orbiting objects. The lighter the objects, the more pronounced the effects, thus making them easier to observe and measure. Details of the launch of these dipoles are classified."

It is known that Lincoln Lab has been experimenting with white tin alloy dipoles. Hopefully, these would be transformed within a predictable time into gray tin powder and be pushed into the atmosphere by solar radiation pressure.

Offer \$175 Million in Lunar Bug Subcontracts

NEW YORK—Grumman plans to subcontract about half of its estimated \$350-million contract for the lunar excursion module (LEM) that will

be used in the Apollo program.

Among subsystems to be subcontracted, the company said at a briefing last week for prospective subcontractors, are navigation and guidance, stabilization and control, communications, crew displays and electrical power. Subcontractors will be required to use as much existing Apollo knowhow and hardware as practical, Grumman said.

Laser Shutter Gives High-Speed Pulses

PASADENA—Laser strobe light has been developed by a CalTech team. Intended for high-speed photography, the technique might be applied to laser radar because it provides a very high peak pulse and a highly collimated beam. The device is reported capable of exposure times of 1 nanosecond and frame rates up to 500,000 a second. Beam intensity is equivalent to 200,000 100-watt bulbs.

A Kerr cell shutters the ruby crystal so it emits uniform pulses rather than random ones, and intensifies the beam by building up

wave amplitude and cutting duration. The cell, developed by Hughes, is between one end of the laser and the partially reflecting mirror and interrupts the beam, preventing the overflow of photons from escaping through the mirror. The laser stores energy while the shutter is closed. At pulse rates above 100,000 a second, pulse amplitude and time variation level off.

The strobe was developed to film the microscopic cavitation bubbles that damage ship propellers and pumps. The investigations are supported by the Office of Naval Research.

Early Warning Satellite Will Not Be Operational

MIDAS SATELLITE system will not be deployed operationally due to a recent decision by Secretary of Defense Robert McNamara (p 7, Jan. 18). The first tracking station to be scrapped is at Ottumwa, Iowa (see p 10). Latest word from Air Force is still that R&D will continue.

Midas (Missile Defense Alarm System) is an infrared-equipped

Military Services Plunge Into SSB

ARMY SIGNAL CORPS and Air Force communications equipment is rapidly being converted to single sideband. SAC, TAC, and the airways communications stations of the Air Force Communications Service are now retrofitted to ssb. All new aircraft requiring h-f communications equipment are being production-line equipped with ssb.

Simplified digital circuits tune the new equipment from the pilot's seat, eliminating the need for an airborne radio operator, reports Air Force.

Army Signal Corps has been replacing its outmoded a-m systems with extended range, h-f ssb in its global networks which are now almost exclusively ssb. The Army recently standardized on the AN/GRC-106, a fully militarized vehicular ssb unit.

Military sources report that ssb improves efficiency by providing greater output than conventional a-m transmitters with comparable input powers. Doubling a-m channel use, reduced size and weight, and more reliable operation under marginal propagation conditions are also cited

satellite designed to pick up rocket exhausts as soon as it gets above the atmosphere—about one minute after launch. Its objective was to detect enemy missile launching before the missiles moved over the horizon sufficiently to be picked up by the Bmews radar net, and to detect missiles launched the long way around to bypass the Arctic radar fence.

Lockheed is prime contractor for the satellite system which consists of a modified Atlas with an Agena as the second stage and satellite vehicle. Lockheed and Philco are associate contractors for the satellite tracking net.

Infrared Detectors May Predict Volcano Eruption

WASHINGTON — Geological Survey scientists equipped with multiple-sensing infrared and optical equipment are beginning an airborne probe of Kilauea volcano, Hawaii.

The heat map turned up in the long-wave infrared is expected to show key differences in subsurface radiation between the volcanic and surrounding quiet areas. If the expected delineations show up, efforts may be made to correlate infrared radiation with the level of volcanic activity. The experiment may lead to a volcano eruption warning system.

EIA Sees 1963 Sales Hitting \$15 Billion

EIA PREDICTS sales of \$15 billion for the electronics industry this year. By the end of 1970 annual sales should reach \$20 billion. Leading growth segment in 1963 is expected to be industrial electronics, with sales rising to \$2.7 billion from the 1962 total of \$2.4 billion, EIA says. Total government expenditures for electronics in 1963 are estimated at \$9 billion, a 16-percent rise over 1962.

Gregorian Feed May Extend Arecibo's Range

BOSTON—Gregorian feed may be added to the 1,000-foot Arecibo Radio Observatory dish in Puerto Rico

(p 20, Jan. 27, 1961). The ARPA-funded facility is to be completed this summer. Already built for the spherical antenna is a narrow-band phased line source feed centering on 430 Mc. (p 46, July 7, 1961).

A modified Gregorian feed developed by Sheppard Holt, of AFCRL, consists of a dish-shaped auxiliary reflector facing the large primary reflector and an associated feed-horn. Auxiliary reflector and feed-horn move as a unit to scan for higher frequencies.

Its broadband features would extend from about 430 Mc out beyond 1,400 Mc, encompassing the hydrogen-line region (21 cm).

Blind-Landing System Specs Due This Summer

SPECS FOR a new bad-weather landing system should be written by this summer, according to the FAA. The system would be scheduled for delivery in 1966.

A big part of the system will probably consist of an improved version of the present-day instrument landing system, a spokesman said. Other existing systems are being studied but no one of these will be adopted, although components may be drawn from several, he said. One system considered is the British-developed BLEU (p 46, Dec. 14, 1962), but FAA thinks it delegates too many functions to the automatic pilot.

USSR A-Tests Increased Space Radiation, Too

LARGE INCREASES of radiation in the gap between the two Van Allen belts were detected by Telstar after the Russian nuclear blasts of October 22 and 28, it was disclosed by W. L. Brown, of Bell Telephone Laboratories, at the American Institute of Physics meeting last week.

The slot between the inner and outer Van Allen belts is normally free of radiation. The increased radiation died away in several days. Brown told ELECTRONICS that the Russian blasts may have contributed to Telstar's November failure. The failure in the circuits, due to surface radiation effects, has since been removed (p 30, Jan. 11).

In Brief . . .

AUSTRALIA has developed an anti-submarine missile-torpedo, the Ikara, that Britain and U. S. are reportedly interested in. The device is presently undergoing tests at Woomera, Australia. U. S. has contributed \$4 million toward Ikara's development.

TOKYO reports that GE and Tokyo Shibaura have jointly organized Toshiba Electronic Systems Co. to manufacture and sell GE-type electronic equipment. The two companies are also reported near agreement on a technical know-how tieup on computers.

ARMY AWARDED Raytheon \$11.2 contract to build high-power illuminators for Hawk missile system.

BOEING RECEIVED three AF contracts totaling \$105 million for work on Minuteman.

AIR FORCE is establishing an EDP Equipment Office at Hanscom Field, Mass., to decide on future selection of computers for user commands.

NASA is negotiating contracts of about \$500,000 each with Boeing and Lockheed for study of NASA-developed concepts for the supersonic transport plane (see p 14).

GENERAL PURPOSE digital computers for process control systems will be supplied to Minneapolis-Honeywell by Scientific Data Systems.

LORAL PLANS to acquire A & M Instrument in a stock swap.

MCDONNELL AIRCRAFT expects to receive contracts totaling \$1 billion in the next few months. Included would be work on Navy and AF Phantoms and NASA Gemini spacecraft.

NAVY'S BULLPUP missile is being equipped with a beam-rider guidance system. A computer in the aircraft, instead of the pilot, will direct Bullpup to its target.

GOODYEAR AIRCRAFT says it has built a transportable tracking antenna capable of pinpointing a 28-inch diameter satellite 22,300 miles away. Unit was developed for Defense Satellite Communications Program and the Syncom system.

our stock answer is

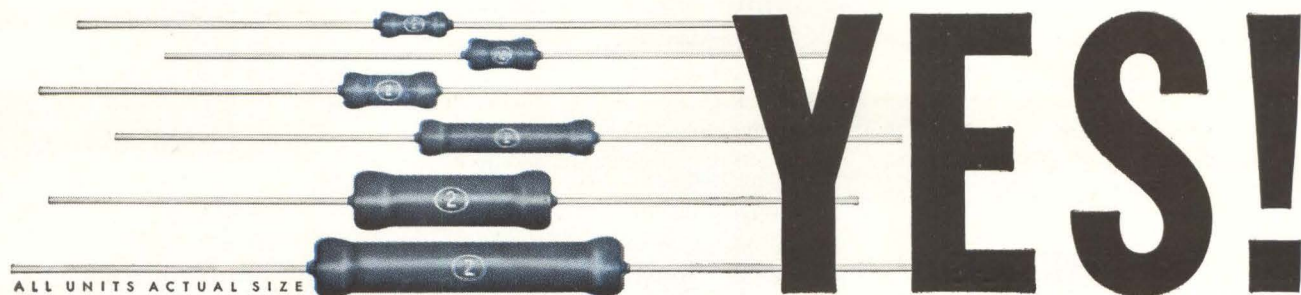

ALL UNITS ACTUAL SIZE

ALL AXIAL LEAD BLUE JACKET RESISTORS

*in 1, 2, 3, 5, 7 and 10-watt power ratings are carried in
factory stock for immediate delivery. Place your order now with your
nearest Sprague District Office or Sales Representative.*

Key Sprague Industrial Distributors carry most popular ratings in local stocks.

S P R A G U E S A L E S O F F I C E S

Ariz.	Phoenix, Sprague Electric Co., 3550 N. Central Ave., 279-5435	Mo.	St. Louis, Sprague Electric Co., 3910 Lindell Blvd., JE 5-7239
Cal.	Los Angeles, Sprague Electric Co., 12870 Panama St., UP 0-7531 or EX 8-2791	N. J.	Camden, Sprague Electric Co., 545 Cooper St., W0 6-1776
	San Francisco, W. J. Purdy of Calif., 312 7th St., UN 3-3300	N. M.	Albuquerque, Bowen & Carlberg Co., 2228A San Mateo Blvd., N.E., AM 5-1579
Colo.	Denver, R. G. Bowen Co., Inc., 721 S. Broadway, RA 2-4641	N. Y.	New York, Sprague Electric Co., 50 E. 41st St., OR 9-1195
D.C.	Washington, Sprague Electric Co., 2321 Wisconsin Ave., N.W., 338-7911		Great Neck, William Rutt, Inc., 123 Middle Neck Rd., HU 2-8160
Fla.	Clearwater, Sprague Electric Co., 1152 Cleveland St., 446-3119	N. C.	Winston-Salem, Sprague Electric Co., 928 Burke St., 722-5151
Ill.	Chicago, Sprague Electric Co., 5942 W. Montrose Ave., MU 5-6400	Ohio	Chagrin Falls, Sprague Electric Co., 24 N. Main St., CH 7-6488
Mass.	North Adams, Sprague Electric Co., Marshall St., 664-4411		Dayton, Sprague Electric Co., 224 Leo St., BA 3-9187
	Newton, Sprague Electric Co., 313 Washington St., W0 9-7640	Tex.	Dallas, Sprague Electric Co., 3603 Lemmon Ave., La 1-9971
Mich.	Detroit, ABM Sales Co., 10116 Puritan Ave., UN 2-1300	Utah	Salt Lake City, R. G. Bowen Co., Inc., 463 E. 3rd St., S., EM 3-4528
Minn.	Minneapolis, H. M. Richardson & Co., Inc., 9 E. 22nd St., FE 6-4078	Wash.	Seattle, Sprague Electric Co., 4601 Aurora Ave., ME 2-7761

*For application engineering assistance write:
Marketing Dept., Resistor Division, Sprague Electric Co., Nashua, New Hampshire.*

SPRAGUE COMPONENTS

RESISTORS	INTERFERENCE FILTERS	HIGH TEMPERATURE MAGNET WIRE
CAPACITORS	PULSE TRANSFORMERS	CERAMIC-BASE PRINTED NETWORKS
MAGNETIC COMPONENTS	PIEZOELECTRIC CERAMICS	PACKAGED COMPONENT ASSEMBLIES
TRANSISTORS	PULSE-FORMING NETWORKS	FUNCTIONAL DIGITAL CIRCUITS
MICRO CIRCUITS	TOROIDAL INDUCTORS	ELECTRIC WAVE FILTERS



'Sprague' and '®' are registered trademarks of the Sprague Electric Co.

WASHINGTON THIS WEEK

MILITARY CONTRACTS TO REQUIRE VALUE ENGINEERING

VALUE ENGINEERING provisions will be required in a majority of military procurement contracts from now on. Under value engineering (VE) procedures, a contractor assigns a special engineering staff to work full-time scrutinizing weapon specifications, performance requirements, production techniques, and other cost factors. The purpose is to produce a cheaper weapon or component without impairing the function.

A new Defense Department procurement regulation calls for VE clauses in all contracts "of sufficient size and duration to offer a reasonable likelihood for cost reduction." It spells out three types of contract provisions: (1) an incentive clause under which contractors share in cost reduction resulting from voluntary VE, (2) a "program clause" obligating a formal VE program; and (3) a combination of both, obligating a formal VE program and providing incentives.

MIDAS SYSTEM'S FUTURE HAZY

RUMORS PERSIST that the Defense Department is considering cancellation of the Air Force's Midas project to develop a satellite infrared missile warning system. The project, costing some \$400 million so far, has encountered serious development bugs and is badly behind operational schedules. The Pentagon's top echelons are pessimistic about Midas' prospects.

The latest gossip on Midas' demise stems from an Air Force disclosure that it no longer needs the Naval Air Station at Ottumwa, Iowa. Plans were to use the facility as a ground station for the Midas system. Officially, Air Force knocks down the cancellation talk, says R&D work is continuing on Midas. Lockheed is prime contractor.

AIR FORCE'S GEMINI PLANS ARE STYMIED

AIR FORCE PLANS to get a Gemini space program of its own—unofficially called Blue Gemini—has hit snags. The Pentagon cut a \$100-million request for the program out of the fiscal 1964 budget. Now Air Force is upset by creation of an Air Force-NASA planning board to coordinate defense and civilian space needs in the Gemini program.

Air Force badly wanted its own fleet of Gemini spacecraft for flights independent of NASA, using two-man capsules with more in-space maneuverability than NASA needs. With unmanned Gemini flights to start late this year and manned flights early next year, Air Force spokesmen wonder how they will get any technical changes in the capsule to meet their military needs. But Air Force still hopes to get its own Gemini program at a later date.

ALL BLIND- FLYING PLANES TO USE DME

NEW REGULATIONS by the Federal Aviation Agency will push demand up sharply for distance measuring equipment (DME) to be installed on airplanes. Most commercial airline jets already are equipped with DME. Now, all other civil aircraft—commercial and private, piston and jet—that fly under instrument flight rules (IFR) above 24,000 feet will have to have DME after June 30. The requirement will be extended to all commercial aircraft operating IFR, regardless of altitude, beginning with turboprop planes January 1, 1964, and pressurized piston-engine planes July 1, 1964.



amplify signals
as low as
 5×10^{-14} ampere



new CK587
does it with
1/2 less filament power
40% less volume

Newest addition to Raytheon's line of subminiature electrometer tubes is the CK587. The CK587 is small in size (.230" x .290" x 1"), requires the lowest input power of any electrometer tube available (.00625 watts), and stands up under rugged service with reduced filament resonance effects by virtue of its shorter structure. Compared with the CK5886 under similar gain conditions, the CK587 requires 1/2 less filament power and is over 40% smaller in volume.

Typical Operating Conditions	CK 5886 (Pentode)	CK 5889 (Pentode)	CK 587 (Pentode)
Filament Voltage	1.25 volts	1.25 volts	0.625 volts
Filament Current	10 ma	7.5 ma	10 ma
Plate Voltage	8.5 volts	12 volts	12 volts
Screen Grid Voltage	4.5 volts	4.5 volts	4.5 volts
Control Grid Voltage	-2 volts	-2 volts	-1.6 volts
Nominal Control Grid Current	1×10^{-14} amp.	1×10^{-15} amp.	3×10^{-15} amp.

A maximum control grid current of 1×10^{-13} ampere and input resistance of 10^{15} ohms make the CK587 a logical choice for low-noise amplification of minute outputs from ion chambers, photomultipliers, proportional counters, biological transducer probes and sensors. Complete technical characteristics and application data for Raytheon electrometer tubes, CK5889, CK5886, and CK587 are available from: Raytheon Company, Industrial Components Division, 55 Chapel Street, Newton 58, Massachusetts.

For small order and prototype requirements see your local franchised Raytheon Distributor.



CIRCLE 11 ON READER SERVICE CARD



1.2 MC Frequency Counter

Model 13-20A Frequency Counter is a precision direct reading instrument of wide versatility capable of measuring frequency, time interval, period, time and frequency rates and frequency drift. It features secondary standard output frequencies, self-check and six place display.

Specifications:

- Frequency Measurement.....
10 cps to 1.2 mc
- Input Impedance.....
1 megohm 30 mmf shunt
- Input Sensitivity... 0.1 v rms min.
- Period Measurement.....
0 to 100 kc (sine waves)
- Time Interval.....
1 μ sec. to 100,000 sec.
- Total Events..... 1 to 999,999
- Standard Frequency.....
10 cps, 1 kc, 100 kc, 1 mc
- Display.....
seconds, milliseconds or
microseconds with automatic
decimal point placement
- Stability.....
(standard) ± 2 parts in 10^6
per week
(high) ± 5 parts in 10^8
per week
- Price.....
Standard.....\$1165.
High.....\$1420.
Nixie readout..\$ 210.
(additional)

NORTHEASTERN
ENGINEERING INCORPORATED
DEPT. 3-A, MANCHESTER, NEW HAMPSHIRE
AFFILIATE OF ATLANTIC RESEARCH CORP.
Employment Opportunities Open At All Levels

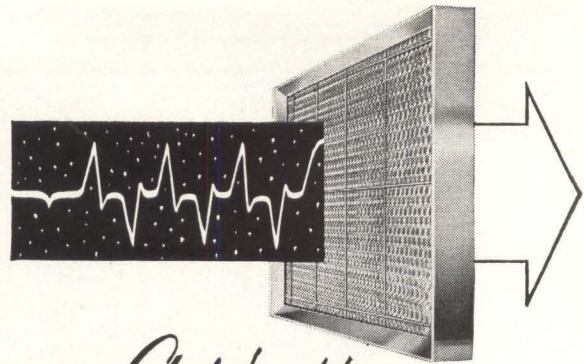

Get both RF SHIELDING and THOROUGH AIR CLEANING

Now... any electronic package can be equipped with an air window that provides both RF shielding and air cleaning. Available in practically any size... all aluminum... washable and permanent. E Z Klean Air Filters permit maximum air flow and minimum restriction. Ventilating air is scrubbed clean... and attenuation in excess of 50 db at 10,000 mc/s and in excess of 40 db at 1000, 10 and 1 mc/s is attained. Write for information.

RP / **E Z KLEEN**[®]
AIR FILTERS

RESEARCH PRODUCTS Corporation Dept. 241-B, Madison 1, Wis.
CIRCLE 200 ON READER SERVICE CARD

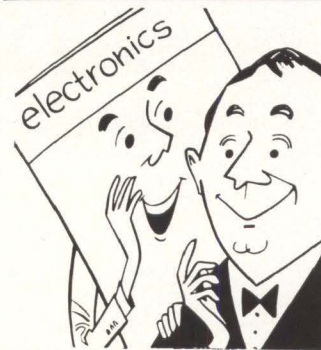

electronics
IS EDITED
TO KEEP YOU
FULLY INFORMED
— a "well-rounded"
engineer

What's your *present* job in electronics? Do you work on computers? (**electronics** ran 158 articles on computers between July, 1961 and June, 1962!) Are you in semiconductors? (For the same period, **electronics** had 99 articles, not including transistors, solid-state physics, diodes, crystals, etc.) Are you in military electronics? (**electronics** had 179 articles, not including those on aircraft, missiles, radar, etc.)

In all, **electronics'** 28-man editorial staff provided more than 3,000 editorial pages to keep you abreast of all the technical developments in the industry. No matter where you work today or in which job function(s), **electronics** will keep you fully informed. Subscribe today via the Reader Service Card in this issue. Only 7½ cents a copy at the 3 year rate.

electronics

electronics

In **SERIES REGULATOR** Circuits
Transistors Must Handle **POWER . . .**

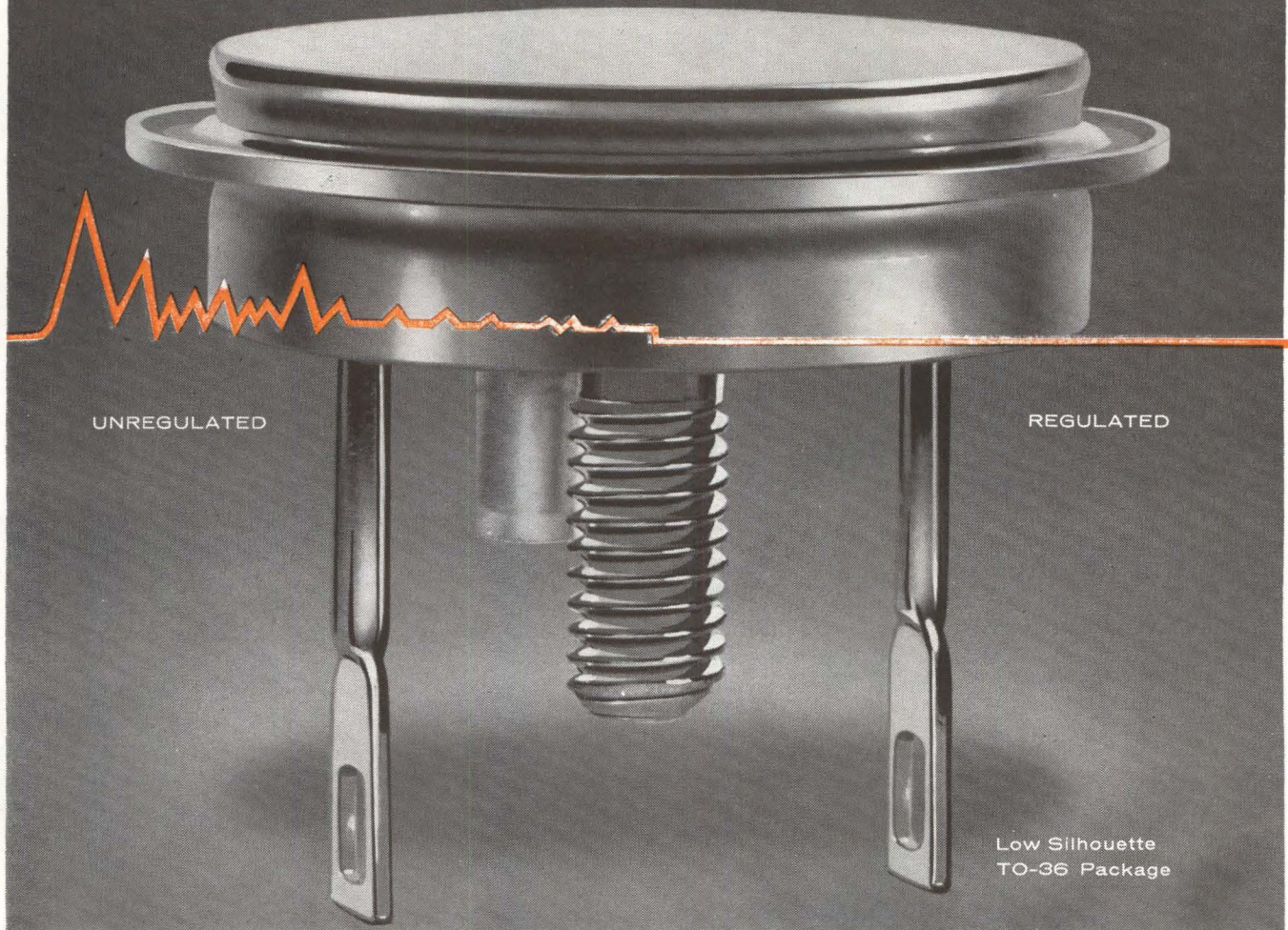

**MOTOROLA 170-WATT POWER TRANSISTORS
ARE BUILT TO TAKE IT!**

The most important measurement of a power transistor in a series regulator circuit is its ability to absorb power. Motorola's TO-36 germanium power transistors, with 110°C maximum junction temperature and thermal resistance of only .5°C per watt, are rated for 170 watts at 25°C case temperature . . . the greatest power capability of any germanium power transistors today! (The power handling factor of a transistor can be calculated by dividing the difference between its maximum junction temperature, and 25°C, by its thermal resistance rating.)

In high-current applications higher power capability can actually reduce the number of parallel units required for a given set of power conditions. Use of fewer transistors, in turn, eliminates the need for the extra resistors, capacitors, etc. normally used to adapt each device to the circuit and reduces the total heat sink area required.

The result? Simplified, more rugged series regulator designs . . . and excellent cost savings!

MOTOROLA TO-36 POWER TRANSISTORS*			
hFE (min) @ I _c (amps)		Type Number	
20	5	2N2075 thru	2N2078
35		2N2079 "	2N2082
50		2N2152 "	2N2154
80		2N2156 "	2N2158
25	15	2N2152 thru	2N2154
30		MP500 "	MP502
40		2N2156 "	2N2158
50		MP504 "	MP506
15	25	2N2152 thru	2N2158
12	50	MP500 thru	MP506

*All types have T_J(max)=110°C, θ_{Jc}=0.5°C/W(max)

Units are available from your local Motorola distributor or your nearest Motorola District Office . . . many types with "Meg-A-Life" reliability data. For complete technical information on any of these devices contact the Technical Information Department, Motorola Semiconductor Products Inc., 5005 East McDowell Road, Phoenix 8, Arizona.



MOTOROLA
Semiconductor Products Inc.

A SUBSIDIARY OF MOTOROLA INC.

5005 EAST McDOWELL ROAD • PHOENIX 8, ARIZONA

E-122-006

Supersonic Airliner Challenges Flight

Navigation gear must be upgraded, weather avoidance system needed

ANN ARBOR, MICH.—Supersonic transport planes proposed for airline use in the 1970's will require electronic navigation, operating and ground control equipment far more advanced than that used now by the airlines.

Some of the needs may be supplied through refinements of present-day equipment. But the mach-3 airliner's operating characteristics will also demand fresh approaches and instrumentation—not to meet new problems, but old ones intensified.

This summarizes the varying viewpoints expressed last month at the Supersonic Transport Seminar, sponsored by the Institute of Navigation

and the Institute of Science and Technology at the University of Michigan. Some 160 persons from a dozen nations attended.

NAVIGATION NEEDS—One problem is the requirement for precise measurement of the vertical plane—now unattainable. Onboard equipment is needed for this, it was said, for three-dimensional navigation, especially in terminal zones, and to determine “climb-out corridors” with the greatest accuracy. Fuel consumption rates could approach or exceed 400,000 pounds per hour “on a reasonably efficient climb path” to cruise altitude.

Present navigation systems present problems. For example, vortac could give rise to serious angular vor errors—as much as 1,000 feet in altitude if the system lies 90 degrees to the aircraft's track. At cruise altitudes, present vortac network stations would cause co-chan-

nel interference with the present system.

Conversion to a high-altitude vortac was suggested as a possible answer. Further research and development on vertical-slot antennas to narrow “over the station” cones for higher altitudes would be needed.

Other navigation equipment envisioned included doppler-inertial guidance, day-night astro trackers, automatic position reporting.

WEATHER GEAR—Meteorological conditions aloft may require onboard equipment for measuring, reporting and analysis, as an integral part of operational instrumentation. At the supersonic transport cruise altitude of 55,000 to 75,000 feet, polar night westerly winds stream at 150 to 200 knots, and sharp temperature variations over small distances result in turbulence and fuel consumption problems.

Moreover, it was reported that meteorological focusing of sonic boom can cause ground level overpressures 10 times those formerly anticipated—up to a damaging 4 pounds a square foot, a condition calling for avoidance by meteorological detection and navigation.

OTHER SYSTEMS — The discussions also indicated a need for airborne digital data processors and cockpit readouts of controlling input parameters to detect and isolate defective subsystems. One chore of onboard processors would be determining reserve fuel allowances.

Robert J. Shank, FAA deputy administrator for development and conference keynoter, listed as capabilities “we ought to have right now” as well as for the supersonic airliner: all-weather blind-landing capability (*ELECTRONICS*, p 12, Jan. 25), flight planning and traffic control requiring no holding operation, and long-range navigation with fewer fixed references and few required tunings.

Self-check circuits, written communication in the cockpit, forward-scatter, single-sideband and satellite communications were among other

Machine Helps Aphasics Speak



VICTIM of aphasia, language impairment due to brain injury, works teaching device developed at University of Michigan while two researchers look on. Machine helps patient regain normal speech by asking him tape-recorded questions about pictures it presents

Equipment Designers

needs reported at the meeting. The latter was reported to look particularly promising if economic problems can be solved.

RELIABILITY—Suggestions that existing equipment on military aircraft, such as the B-58, might serve the plane's needs were met with the reply that military and civilian reliability needs are different.

Size and weight penalties are acceptable with civilian aircraft for added long-term reliability, but military aircraft, demanding high

short-term capability for single-mission reliability, can make sacrifices for weight savings. For the supersonic transport electronics equipment manufacturers were urged to aim for an average of 3,000 to 4,000 hours between equipment failures.

Shank also stressed reliability: The greatest cost uncertainty would be maintenance—now estimated about 30 percent of the total (while fuel costs would be 50 percent). These maintenance costs should be brought down, he said.

Japan Rushes Satellite Station

Wants U. S. satellites to transmit radio, tv from 1964 Olympics

TOKYO—The Postal Ministry is pressing for completion of its satellite communications station in time for satellite radio and tv transmissions of the 1964 Olympics to be held in Japan.

One of the major facilities, a 98.5-foot parabolic reflector—reportedly the largest in the Orient—has been completed. The Postal Ministry's Radio Research Laboratories is building the station.

Funds for construction of the transmitter, receiver and automatic tracking equipment are slated for the April, 1963, and 1964 budgets.

Japan plans to use the station for communication with U.S. Relay and Syncom communications satellites. Postal officials hope to persuade NASA to adopt orbital paths that will permit Japan to use the satellites, and to persuade other countries to build ground stations in time for the 1964 Olympics. Postal officials plan to attend the NASA-sponsored meeting of cooperating nations in Rio de Janeiro this month and next.

Nippon Electric is prime contractor for the station. Uraga

Heavy Industries built the reflector.

Antenna servo system will be completed this summer. All operations will be controlled remotely from a console. Antenna operation will include manual control, aided tracking, automatic tracking, program tracking, scan and brake.

Automatic tracking is by amplitude sensing using simultaneous lobing. The 136-Mc tracking receiver will be a phase-lock type.

Electronics in the station will include automatic tracking and receiving system, program tracking system, angular encoding system, data handling system and data recording system.

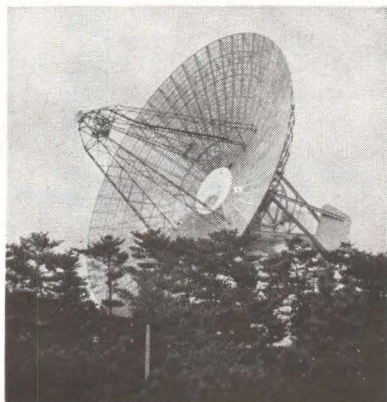

PARABOLIC REFLECTOR for satellite station peers over top of pine trees 50 miles northeast of Tokyo

WHAT ARE YOUR DELIVERY REQUIREMENTS?



STANDARD
TAPE TRANSPORTS
4 WEEKS

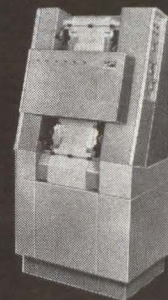

STANDARD
PRINTERS
12 WEEKS



NEW PRINTER DIVISION

Broad acceptance of our product line coupled with the fact that so many Potter "specials" are now industry standards has resulted in such dramatic growth that we have increased our plant and production capacity by more than 65%. This new production capability can directly benefit you through faster delivery.

For example, we can deliver our standard transports in 4 weeks, and standard printers in 12 weeks from receipt of order.

If you require fast delivery — with no sacrifice in performance or reliability, write us today.



POTTER INSTRUMENT CO., INC.

TAPE TRANSPORT DIVISION
151 Sunnyside Boulevard • Plainview, New York

PRINTER DIVISION
East Bethpage Road • Plainview, New York

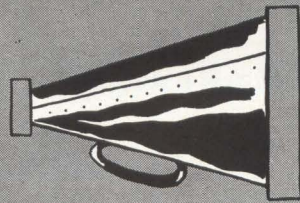

ANNOUNCING FOR 1963

a tremendous
electronics BUYERS' GUIDE Issue

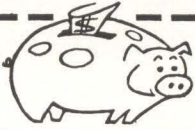

NEW LOW CATALOG RATES ALLOW SUFFICIENT SPACE FOR YOU TO PROVIDE COMPLETE BUYING INFORMATION ON YOUR ENTIRE PRODUCT LINE



Take complete advantage of marketing's
MAGIC COMBINATION

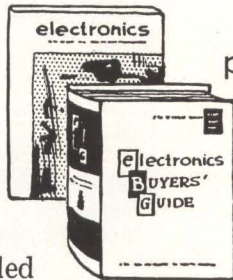

electronics every Friday – to create preference for your products...

The 1963 **BUYERS' GUIDE** to make product preference pay off in buying action

For 22 years of sales-minded

this combination has worked magic for thousands of companies. It will work for you in 1963 more effectively and economically than ever before. Your **electronics** representative has full information on how this can be accomplished. Look at these new eBG catalog rates:

CATALOG ADVERTISING RATES PER PAGE:

Without "EARLY BIRD" Discounts

Space Used	Rates	Space Used	Rates
1 page	\$900	12-15 pages	\$545 per page
2-3 pages	740 per page	16-19 pages	495 per page
4-5 pages	670 per page	20-23 pages	465 per page
6-7 pages	630 per page	24 or more	440 per page
8-11 pages	590 per page		

FOR THE SAME PRICE AS 1962, FROM 33% TO 60% MORE SPACE!

Rates with "EARLY BIRD" Discounts

1 page	\$837.00	12-15 pages	\$506.85
2-3 pages	688.20	16-19 pages	460.15
4-5 pages	623.10	20-23 pages	433.45
6-7 pages	585.90	24 or more	409.20
8-11 pages	548.70		

"EARLY BIRD" Closing Dates (For Discounts)

Reservations for space Feb. 15th / Copy to set April 16th / Complete plates April 25th

ACT NOW!



A MESSAGE of GREAT IMPORTANCE to every ELECTRONIC ENGINEER

Effective Immediately

Electronic Research Associates, Inc. presents a new line of Premium Silicon 71°C TRANSPAC[®] DC Power Modules at prices competitive with germanium types.

- Meets High Temperature Requirements
- Rugged All-Silicon Design
- Low Cost . . . Made Possible by New ERA Engineering Developments
- Miniaturized . . . Replaces Bulky, Expensive Equipment
- Modular Versatility . . . May Be Used Singly, or Combined in Series or Parallel Circuits
- Complete Line . . . Over 30 Models to Choose From
- Full Rating Operation up to 71°C Without External Heat Sinking or Air Blow
- Fast Warm-Up and Stabilization Time
- Less than 5 MV Long Term Stability
- Input Range 50-400 cps
- Conservative, Precision Specifications
- Remote Sensing
- Remote Voltage Control
- Automatic Short Circuit and Transient Protected

● All Components Accessible for Repair and Replacement

Specifications

Input: 105-125 VAC 50-400 cps

Output Voltage Ranges (nom): 6, 12, 18, 24, 28, 32 VDC

Output Current Ranges: 500 MA, 1 amp, 2 amp, 4 amp, 8 amp

Ripple: Less than 800 Microvolts RMS

Line Regulation: Less than $\pm 0.01\%$ or 5 millivolts for full input change

Load Regulation: Less than 0.05% or 8 millivolts for 0-100% load change

Transient Response: Less than 50 Microseconds for step line or load change

Maximum operating temperature: 71°C, free air, full ratings

Maximum Permissible Temperature Rise: 110°C (stud temperature)

Temperature Coefficient: Less than 0.01% per degree C or 3 MV

Long Term Stability: Within 5 millivolts for 8 hours, after 20 minute warmup (line, load, temperature constant)

Interconnection: Series or parallel operation permissible

Voltage Adjustment: External screw driver voltage control

Remote Voltage Control: Provision for external control of output voltage

Remote Sensing: Remote sensing facilities available

Short Circuit Protection: Automatic short-circuit protection with automatic recovery

Output Connection: Ungrounded outputs, either positive or negative terminals may be grounded.

Physical: Modular construction, all components fully accessible

Heat Sinking: Internal, Convection cooled. Provision for remote location of internal heat sinks

Price Range: \$115. to \$395. Off-the-Shelf Delivery on Most Units.



FOR LITERATURE AND DETAILED INFORMATION, WRITE:

ELECTRONIC RESEARCH ASSOCIATES, INC.

67 Factory Place • Cedar Grove, New Jersey • CEnter 9-3000

Stage Is Set Again for RS-70

By JOHN F. MASON
Senior Associate Editor

Industry has a big stake in the outcome of the controversy

HOT DEBATE is expected in Congress over the apparent slow kill of the RS-70 program.

Although the Administration has not halted development of the mach-3 reconnaissance-strike aircraft outright, it shows no signs of planning to carry it beyond the three-plane experiment fixed by President Kennedy two years ago.

The budget submitted to Congress last month contains no new money for the project.

At the core of the controversy is the administration's apparent decision that a new manned bomber will not be a military necessity five years from now, when the RS-70 was to be ready. Air Force—with support by a number of powerful congressmen—disagrees and feels that both manned bombers and ICBM's are essential.

Another focus of the debate is whether the aircraft's electronic subsystems—and particularly the side-looking radar and display system—could be developed in time to make the plane useful. Defense Department chiefs say they can't, but proponents of the plane believe the systems are feasible.

The answer to these questions may be revealed soon—or at least narrowed down—when studies made by both DOD and Air Force groups are made known. Congress' Armed Services and Appropriations Committees are scheduled to get the results of the studies when the RS-70 issue comes up.

The reevaluation of the RS-70 program was initiated last March by Defense Secretary McNamara after Senator Carl Vinson threatened action to force DOD to spend the extra money appropriated by

Congress for RS-70. A test of whether Congress could do this was avoided by the compromise.

FUNDS FOR RS-70—The President put a ceiling of \$1,300 million on the RS-70 project. This year, DOD released \$81 million out of the fiscal 1963 appropriation, leaving only \$28 million in the \$1,300-million kitty (see table on p 20). Presumably, the \$28 million would be spent in 1965.

However, if DOD approves recently-submitted Air Force plans for sensor development work, an extra \$50 million for that would be added to the program. This would raise the ceiling to \$1,350 million and give a dozen or so electronics firms with advanced radar capabilities a chance to bid on the contract.

MILITARY MISSION—The RS-70's mission would be to (1) observe and report the enemy's condition during and after an initial strike; (2) detect and destroy targets missed by the ICBM's; (3) seek out and destroy unique targets; and (4) provide the precision, discrimination and flexibility inherent in a manned weapon.

BOMB-NAV SUBSYSTEM — The only electronic contract now alive is the bomb-nav system for the B-70, the RS-70's forerunner. It is scheduled for testing in the third of three prototype aircraft on order from North American Aviation, prime contractor. This test plane is to be built by July, 1964.

IBM began work on the bomb-nav system in 1955 and it became directly associated with the B-70 in 1958. IBM is responsible for system integration, computer, consoles and display. General Precision provides doppler equipment, GE the side-looking radar for navigation, and Goodyear Aircraft the high-resolution capability needed to detect targets with radar flying at 70,000 feet altitude at 2,000 mph.

Although the bomb-nav system included an air-to-ground missile capability, emphasis was on gravity

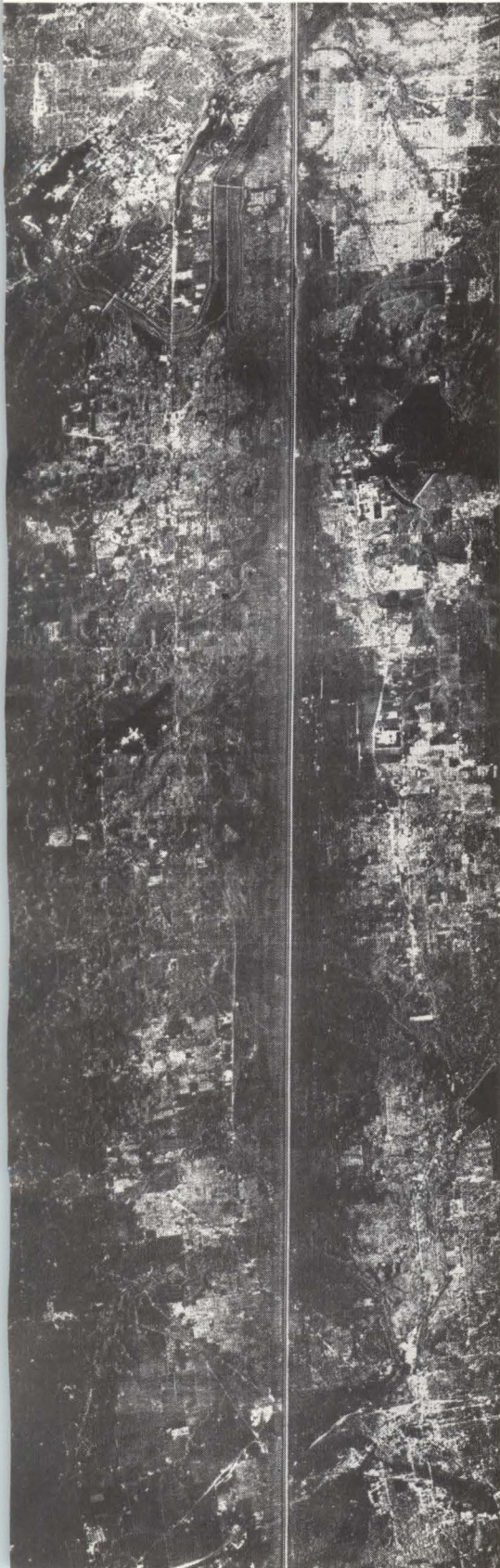

SIDE-LOOKING radar view of the Fort Worth area, taken from an RB-47, almost looks like an optical photograph

Debate

bombs. The switch from the bomber (B-70) concept to the reconnaissance-strike (RS-70) means that if the project is continued, this system will have to be brought up to date.

CANCELLED CONTRACTS—Motorola twice got a subcontract from NAA for a communications subsystem to handle intelligence flow to and from the aircraft, including reception of ground-based navigation signals. Twice the contract was cancelled.

Advanced techniques were to be used to provide voice-to-digital conversion, equipment miniaturization, high reliability and human-engineered displays. One of the design problems is getting components to withstand the heat inside the plane.

Westinghouse Electric was twice awarded a subcontract for an electronic defensive subsystem and it was twice cancelled. The air-to-ground missile was never contracted to industry, although Air Force did in-house work with non-funded cooperation from industry.

WILL THE RADAR WORK?—Whether industry can build side-looking radar to spot targets from the RS-70 flying at 2,000 mph at 70,000 feet has been as hotly debated as the need for the plane itself (*ELECTRONICS*, p 3, Jan. 11).

Defense Secretary McNamara

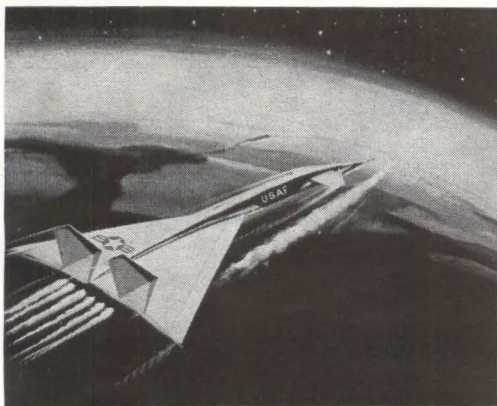

FLYING AT 2,000 mph at an altitude of 70,000 feet, the RS-70 would assess damage done by ICBM's to enemy and seek targets. The first RS-70 will fly this spring on airframe tests

UHF

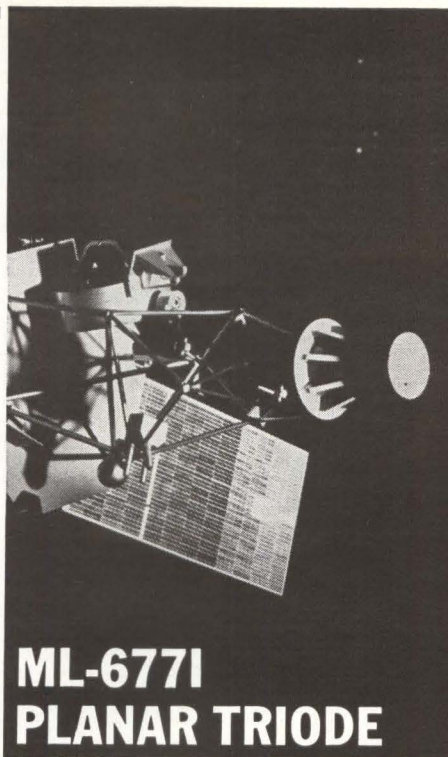

ML-6771 PLANAR TRIODE

The **only** electron tubes aboard the **MARINER II** in rf circuits are the Machlett ML-6771 planar triodes, adapted specifically for this application

Space communications from the Mariner II Venus experiment were successfully maintained by the two 3-watt transmitters and $\frac{1}{4}$ watt driver, each powered by a Machlett special ML-6771 planar triode.

High reliability* is the reason that Jet Propulsion Laboratory, designer of the rf cavities, has chosen Machlett planar triodes.

*High reliability means, here, excellent cathode emission stability; and uniform long-life, performance achieved through the highest Quality Control standards.

Send for
UHF Planar Triode Brochure



An Affiliate of Raytheon Company

THE MACHLETT LABORATORIES, INC.
SPRINGDALE, CONNECTICUT

Wide Selection of Silicon Chopper Transistors Now Available in Production Quantities

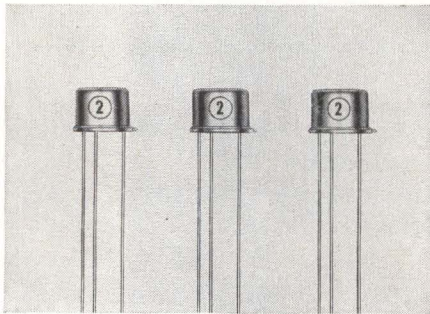

High speed Silicon Precision Alloy Transistors specifically designed for use as low-level choppers and developed by the Sprague Electric Company are now available in a broad range of types and performance characteristics.

Sprague Silicon Chopper Transistor specifications have been tailored to meet specific circuit requirements. Superior in performance to ordinary alloy devices, they offer low offset voltage, low dynamic resistance, low output capacitance, low I_{CBO} , and high frequency response. The wide selection of types includes a variety of matched pairs.

2N2162 2N2165	Guaranteed 30 volt rating. Typical f_T of 20 Mc and low offset voltage make these transistors ideal where high voltage is required
2N2163 2N2166	Have 15 volt rating and same high frequency performance and low offset voltage as 2N2162
2N2164 2N2167	Highest frequency P-N-P Silicon Choppers available as standard types
2N2185	Extremely low leakage current of 1 nano-ampere at 10 volts. Has 30 volt rating
2N2274	Similar to 2N2185 but has lower inverted dynamic saturation resistance
2N2276	Low-cost version of 2N2274
2N2278	Very low offset voltage of 1.75 mV at $I_B = 1$ mA
2N2187	Matched pair of 2N2185 with $\Delta V_{OFF} = 50 \mu V$ max. from +25 C to +85 C
2N2275	Matched pair of 2N2274 with $\Delta V_{OFF} = 100 \mu V$ max. from +25 C to +65 C
2N2277	Matched pair of 2N2276 with $\Delta V_{OFF} = 100 \mu V$ max. from +25 C to +65 C
2N2279	Matched pair of 2N2278 with $\Delta V_{OFF} = 50 \mu V$ max. from +25 C to +85 C

These transistors are inherently stable. Every Sprague Chopper undergoes a rigid production conditioning of 40 temperature cycles from -55 C to $+140$ C, a 200 hour bake at $+140$ C, and a two hour 125 mW operational burn-in!

For application engineering assistance without obligation, write Product Marketing Section, Transistor Division, Sprague Electric Company, Concord, New Hampshire. For complete technical data write Technical Literature Service, Sprague Electric Company, 35 Marshall Street, North Adams, Massachusetts.

45-469

APPROPRIATIONS FOR B-70/RS-70 PROGRAM SINCE 1959

	Eisenhower Administration		Kennedy Administration				
	1959 ^a	1960	1961	1962	1963	1964	1965
	(Millions of Dollars)						
President recommended . . .	215	342	75	220	171	81	28 ^c
Congress approved	227	342	265	400	363	?	?
What DOD released	225	155	265	220	171+50 ^b	?	?

a) Approximately \$155 million was released during 1955-58. b) Two years ago, Kennedy set a \$1.3 billion ceiling on the program. An extra \$50 million may be released for sensor development this year; this would raise the ceiling to \$1.35 billion. c) Remainder of ceiling figure noted in (b)

testified to Congress last year that "some of the key elements may well lie beyond what can be done on the basis of present scientific knowledge." He said he couldn't assure that radar capable of seeing and displaying 750 million square feet of ground area per second could be made operational by 1970. He said that theoretically the screen would have to be 15 feet square.

Brockway McMillan, assistant secretary of the Air Force, however, pointed out that the operators would have up to 1½ minutes to look at the picture before the target

got out of reach. He testified that an adequate system could be developed in two years.

Gen. B. A. Schriever, commander of Air Force Systems Command, recalled that side-looking radar was proposed for reconnaissance-strike missions as far back as 1950 to 1954 and that the technical feasibility of the equipment was not even questioned. Other Air Force spokesmen also said that the system was feasible, that air crews could operate such a system and that high-quality pictures are being taken with side-looking radar.

64-Megabit Drum Storage

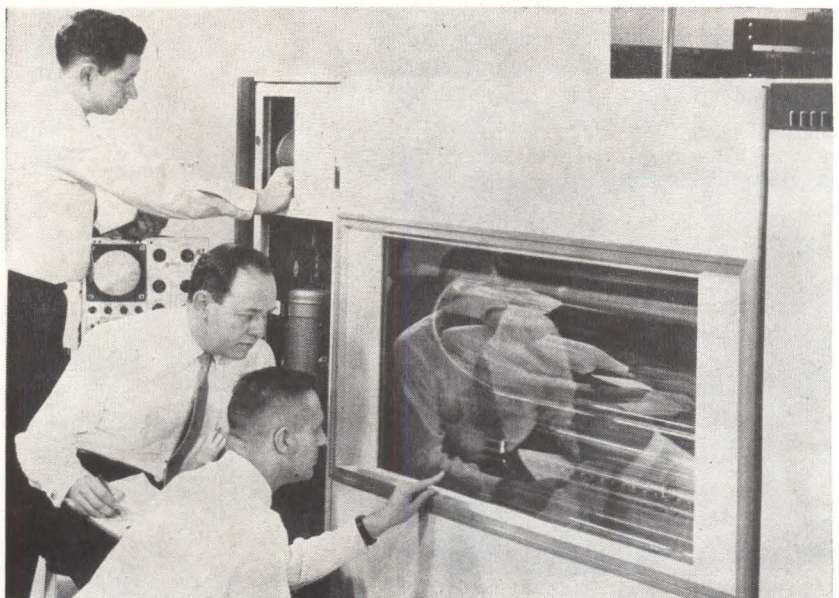

MASS STORAGE system announced by Univac can store 64.9 million characters of information and deliver them in 92 μ sec. It has two drums rotating at 870 rpm and searched by 54 flying heads. Theoretically, 96 of these units can be used with a Univac 490 computer

NEW

Soniline Magnetostrictive Delay Lines

4 TO 20,000 MICROSECONDS

STANDARD SONILINE MODELS

3C Soniline Model	S-33A	S-33A-1	S-44A	S-66A	S-66B	S-77B	S-88A	S-88B	S-99A	S-99B	S-99C	S-99D
Delay Range (μ sec)	4-14	4-14	Max. 1000	Max. 1500	Max. 2000	Max. 2200	Max. 3500	Max. 6500	Max. 4500	Max. 9000	Max. 15,000	Max. 20,000
Case Size L x W x H (Inches)	5 x 1 x 7/16	5 x 1 x 7/16	3 1/4 x 3 1/16 x 7/16	4 1/4 x 4 7/8 x 7/16	4 1/4 x 4 7/8 x 3/4	4 1/2 x 5 1/2 x 3/4	6 x 7 x 7/16	6 x 7 x 3/4	9 1/2 x 10 1/2 x 7/16	9 1/2 x 10 1/2 x 3/4	9 1/2 x 10 1/2 x 1	9 1/2 x 10 1/2 x 1 1/2
Maximum Storage Capacity RZ (Binary Bits)	28	28	1000	1500	2000	2200	3500	5000	4500	9000	10,000	10,000
Bit Rate RZ (Megacycles)	0-2	0-2	0-1	0-1	0-1	0-1	0-1	0-0.8	0-1	0-1	0-0.7	0-0.5
INPUT												
V-in. (Volts)	15	15	15	15	15	15	15	15	15	15	25	25
I-in. (MA)	50	50	50	50	50	50	50	50	50	50	80	80
Z-in. (Ω)	300	300	300	300	300	300	300	300	300	300	300	300
L-in. (μ H)	15	15	30	30	30	30	30	30	30	30	60	60
Pulse Width (μ sec)	0.20	0.20	0.4	0.4	0.4	0.4	0.4	0.4	0.4	0.4	0.8	0.8
Rise & Fall Time (μ sec)	0.05	0.05	0.1	0.1	0.1	0.1	0.1	0.1	0.1	0.1	0.2	0.2
OUTPUT												
V-out (MV)	70	20	20	20	10	10	10	10	10	5	5	2
Z-out (Ω)	1500	1500	1500	1500	1500	1500	4000	4000	4000	4000	4000	4000
L-out (μ H)	80	80	150	150	150	150	150	150	150	150	300	300
(RZ) Pulse Width (μ sec)	0.5 \pm 0.05	0.5 \pm 0.05	1.0 \pm 0.1	1.0 \pm 0.1	1.0 \pm 0.1	1.0 \pm 0.1	1.0 \pm 0.15	1.25 \pm 0.15	1.0 \pm 0.15	1.0 \pm 0.2	2.0 \pm 0.2	2.0 \pm 0.2
Signal to Spurious Noise (Static)	10:1	10:1	10:1	10:1	10:1	10:1	10:1	10:1	10:1	10:1	8:1	6:1
Signal to Spurious Noise (Dynamic)	5:1	5:1	5:1	5:1	5:1	5:1	4:1	4:1	5:1	4:1	4:1	3:1
MECHANICAL												
Volume (Cu. In.)	2.2	2.2	5.5	9.4	15.6	18.6	18.4	31.5	43.5	75	100	150
Weight (lbs.)	0.2	0.2	0.4	0.6	1.0	1.2	1.1	1.25	2.7	3.0	3.1	3.4
Mounts*	TS	TS	TBI	TBI	TBI	TBI	TBI	TBI	EMTI	EMTI	EMTI	EMTI
ENVIRONMENTAL												
Opt. Temp. Range ($^{\circ}$ C)	0-80	0-80	0-55	0-55	0-55	0-55	0-55	0-55	0-55	+10 to +40	+10 to +40	+10 to +40
Max. Delay Change Due to Temperature (μ sec)	\pm 0.04	\pm 0.005	\pm 0.1	\pm 0.1	\pm 0.1	\pm 0.1	\pm 0.1	\pm 0.15	\pm 0.1	\pm 0.1	\pm 0.2	\pm 0.3
(Non-operating) Shock	50 g, 11 ms	50 g, 11 ms	50 g, 11 ms	50 g, 11 ms	50 g, 11 ms	50 g, 11 ms	50 g, 11 ms	50 g, 11 ms	50 g, 11 ms	Normal Handling	Normal Handling	Normal Handling
(Non-operating) Vibration	20 g, 5-2000 cps	20 g, 5-2000 cps	20 g, 5-2000 cps	20 g, 5-2000 cps	20 g, 5-2000 cps	20 g, 5-2000 cps	20 g, 5-2000 cps	20 g, 5-2000 cps	20 g, 5-2000 cps	20 g, 5-2000 cps	Normal Handling	Normal Handling

* TBI — Threaded Blind Inserts

* TS — Threaded Studs

* EMTI — Edge Mounted Threaded Inserts

Delivery on standard models in 3 to 4 weeks

ON REQUEST — LIBRARY OF INFORMATION ON DELAY LINES

HOW TO USE — An extensive collection of technical notes describes a variety of typical digital applications for magnetostrictive delay lines including storage, sequential buffering, cross-and auto-correlation, signal compression and expansion, and video signal analysis **HOW TO SPECIFY** — 20-Page technical booklet discusses specification of magnetostrictive delay lines for digital applications. Details include: capabilities and limitations, principles of operation, modulation techniques, test patterns and effects of temperature **HOW TO ORDER** — 3C Catalog MDL-1 details complete line of standard Soniline models. Order form included.



COMPUTER CONTROL COMPANY, INC.

OLD CONNECTICUT PATH, FRAMINGHAM, MASS. • 2251 BARRY AVENUE, LOS ANGELES 64, CALIF.

NEW FROM BRITAIN: Tunable Detectors, Faster Microwave Switching

By DEREK BARLOW, McGraw-Hill World News

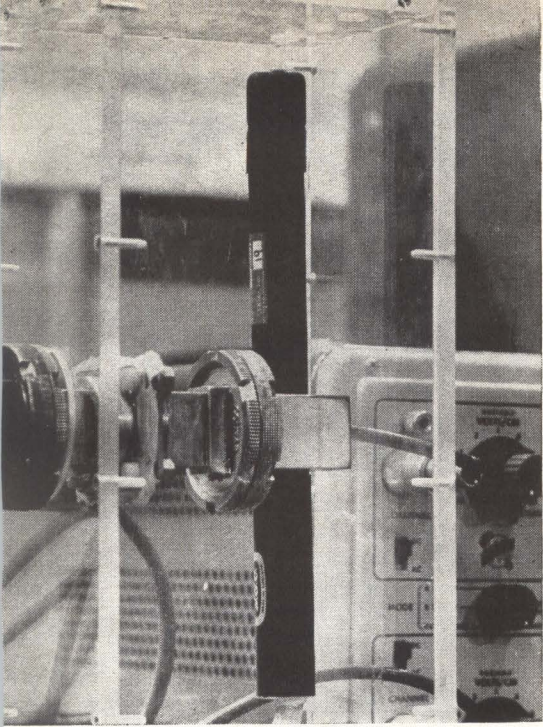

OPHITRON is a wideband microwave generator only $\frac{3}{4}$ inch in diameter, developed by GEC

R&D efforts center on low-noise ir and microwave detectors

British General Electric Company. These experimental tubes are advances on GEC's earlier 660-Mc quadripole which achieved 20-db power gain with less than 2 db noise figure. In the tunable version, external circuits such as lecher bars or coaxial systems, adjust the pumping frequency. Frequency range achieved with a 100 deg K equivalent noise temperature is 400 to 2,300 Mc for the coaxial version; range of the lecher-line system is less, 400-1,250 Mc.

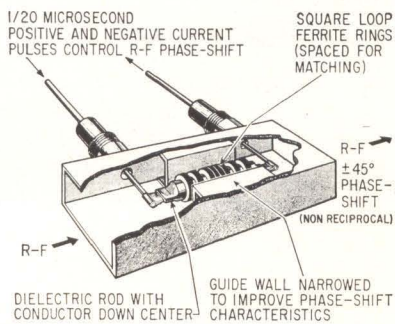
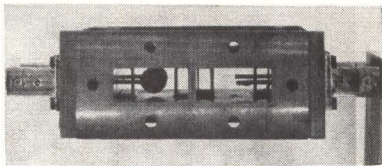

PULSED FERRITE rings provide fast switching in microwave component developed by Admiralty

LONDON—Main emphasis of last month's Institute of Physics and Physical Society exhibition was on new microwave and millimetric systems and components.

Lower noise levels and wideband tunable devices were the major advances on display. Exhibits included tunable quadripole amplifiers, low noise parametric microwave amplifiers, wideband electrostatically focused backward-wave oscillators, pulsed microwave phase-shifters giving 50-nanosecond switch times and tunable submillimeter detectors.

AMPLIFIERS—An exciting new development was an experimental tunable quadripole amplifier by the

A low-noise parametric amplifier by Mullard Ltd. operates at 3 Gc and has a noise factor of 3 db at a 30-Mc bandwidth. Pump frequency is 8 Gc from a 35-mw source. Altering the pump frequency and level gives a tuning range of 500 Mc without altering the signal or idling circuits.

A new compact wideband microwave generator, the Ophitron, has been developed by General Electric. It adds electrostatic beam focusing to a backward-wave oscillator. Only 9 in. long and $\frac{3}{4}$ in. in diameter, the generator operates over a frequency range of 8.5 to 12.5 Gc. A single stamped periodic structure and two flat focusing plates form the propagating path for the r-f wave and also set up the periodic electrostatic field to focus the beam. Power output is greater than 10 milliwatts.

MICROWAVE SWITCHING—A new technique developed by the British Admiralty's Surface Weap-



RESEARCH is emphasized at London show

ons Establishment achieves fast microwave switching by using pulsed ferrite rings mounted on a dielectric rod in the center of a waveguide. Switching time is 50 nanoseconds, insertion loss 0.3 db while peak power handling capacity to date is 40 Kw. The pulses that switch the direction of the remanent magnetic field pass through the central conductor and magnetize the rings circumferentially. To the left of the waveguide center line, the magnetic field is downwards while to the right the field is upwards. These regions each contain components of r-f magnetic field that are circularly polarized in opposite senses. With the power flow in one direction, the direction of r-f polarization has the same sense on both sides with respect to the steady remanent field. Reversing the magnetic field or the direction of power flow will alter the polarization with respect to this field and provide the controllable nonreciprocal phase shift.

WIDEBAND SWITCH—An approach by Mullard provides wideband switching at 2.5 to 7.5 Gc in a wideband modulator without tuning. It switches power up to one watt in less than 0.5 microsecond. The circuit uses a pair of variable resistance *pin* diodes and a 3-db directional coupler. Incident power from the stage is transmitted through the coupler only when a pair of similar terminating diodes is biased to either a high or low resistance. However, if the diodes are biased such that their resistance equals the output impedance of the coupler, the incident power is absorbed in the load formed by the diodes. The device will match the source and load in all operating conditions.

TUNABLE IR DETECTOR — A tunable detector developed by the Royal Radar Establishment operates at 0.06 millimeter. The detector, an extension of earlier work (*ELECTRONICS*, p 44, Feb. 16, 1962), comprises a high purity indium antimonide element containing 5×10^{18} excess donors per cc. It is positioned inside a niobium-zirconium solenoid producing 30 kilogauss. The complete detector is mounted in

Fast, foolproof production testing and sorting of 2 and 3 terminal devices

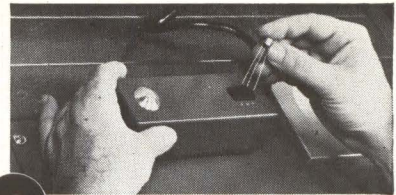
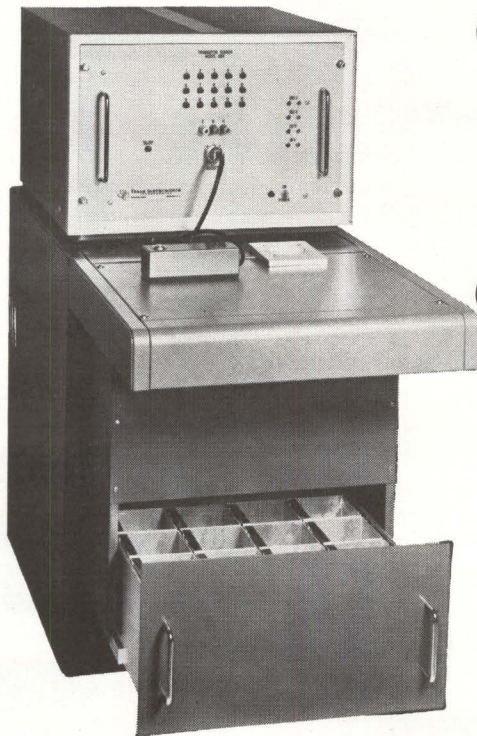

1 Insert Device

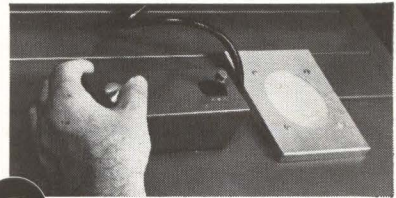

2 Press Button

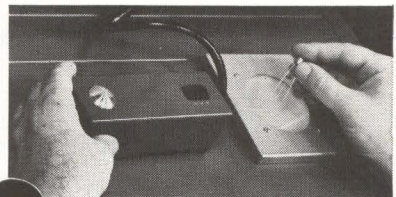

3 Drop in Chute

15 tests in less than
a second

Automatic sorting to
16 categories

No operator decision

Texas Instruments Model 654 Transistor and Diode Tester with 16-Bin Automatic Sorter provides production-speed testing and accurate automatic grouping of two- and three-terminal devices.

Operation requires only three simple manual steps, completely eliminating operator decision. Sorting logic determined by printed plug-in circuit boards in the tester automatically routes the component to the proper bin. At the conclusion of the test, the operator merely drops the device into the entry chute. Sorting logic is held during the testing of the next device.

The Model 654 combines speed and accuracy with flexibility of circuit board programming. The Automatic Sorter and other accessory equipment insure continued maximum effectiveness of the basic instrument.

Write for complete information.

INDUSTRIAL PRODUCTS GROUP
STRIP CHART RECORDERS
TEST EQUIPMENT
DATA SYSTEMS
TRANSDUCERS



TEXAS INSTRUMENTS
INCORPORATED
3609 BUFFALO SPEEDWAY
P. O. BOX 66027 HOUSTON 6, TEXAS

550

ELECTRONIC DRAWER PULL-OUT CABLES...

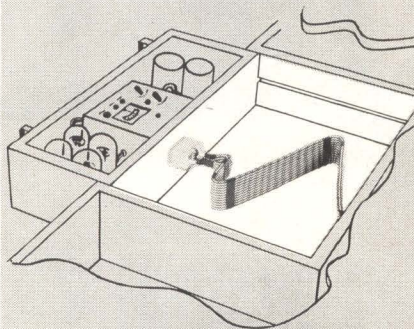

SPECTRA-FLEX CABLES®

Spectra-Flex Cables are efficiently neat, flexible, compact and easily handled. Comes in all sizes from #10 to #30 AWG. Made to your specifications, any wire with a vinyl jacket.

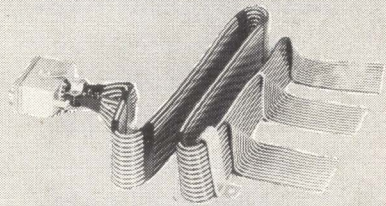

Write for information regarding extensible, retractable harness.



P.O. BOX 415, Tel.: 714 537-4530
TWX 714 530-0313
GARDEN GROVE, CALIF.

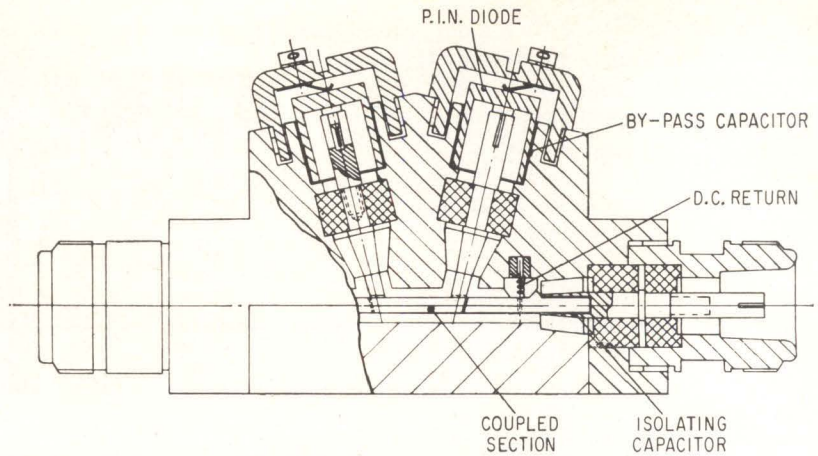

EXPERIMENTAL microwave modulator from Mullard for 3 to 7 Gc has peak isolation of 30 db at 5 Gc

a simple cryostat containing liquid helium at 4.2 deg K.

Radiation from a mercury lamp is reflected from a grating so that several orders of interference are focused onto the detector. As the magnetic field is increased, the detector will sweep through the wavelength range 2.0—0.6 millimeters to observe successive orders from the grating. Operating at 4.2 deg K the detector has a bandwidth of about 10 percent of the frequency observed and a responsivity of the order 50 volts per watt. However, by reducing the temperature to 1.5 deg K, the detector bandwidth is halved and the responsivity is increased by a factor of four. The response time of the detector is approximately 10^{-6} second.

MEMORIES — New techniques with possible computer applications include nonerasable stores, and thin-film test equipment.

Of considerable interest to logic designers is a 'read only' store (Fig. 4) under development by Plessey Ltd. The stored information comprises punched holes on thin metal foil cards inserted between drive and sense conductors printed and etched on copper-bonded Mylar. Drive and sense conductors are arranged orthogonally forming a matrix and are normally screened from each other by the metal foil card. At the bit locations, the hole in the card provides coupling between the conductors and generates an output signal during the drive pulse. Cycle time is less than 1 microsecond and the access time is less than 500 nanoseconds. Each card contains 16 words of 50

bits; maximum system capacity is 512 words.

LASER MODULATOR — Laser research centered around new modulation methods. At Mullard Ltd, ultrasonic waves propagated in a fused quartz bar are proposed as a laser modulation system using the periodic changes occurring in the bar's refractive index. In its experimental form ultrasound is propagated in a compressional mode down the bar as c-w pulses of 75 nanoseconds duration. These pulses with a 62.5 Mc carrier frequency are generated by an X-cut quartz crystal transducer bonded to the bar. Parallel light illuminates the bar normal to the propagation direction of the ultrasound. The light is focused on a stop a few feet away. The ultrasound variations diffract light passing through the bar. The diffracted light is detected by a multiplier phototube mounted coincident with a slit in the stop. Increasing the number of detectors will pick off additional information in the laser beam by examining the diffraction conditions at different points along the bar due to the pulse input pattern.

A single-stage image converter developed by Mullard Ltd provides an electron optical equivalent of a zoom lens. It gives a variable 6:1 image magnification range through adjustment of two electrode potentials in the tube. At the highest magnification, 0.8 times, the brightness gain of the image from photocathode to screen is 100. For lower magnification this increases to a maximum of 3,600, but resolution suffers.

MEETINGS AHEAD

INSTITUTE OF ELECTRICAL & ELECTRONICS ENGINEERS WINTER GENERAL MEETING & EXPOSITION, IEEE; Statler and New Yorker Hotels, New York City, Jan. 27-Feb. 1.

MILITARY ELECTRONICS WINTER CONVENTION, IRE-PGMIL; Ambassador Hotel, Los Angeles, Calif. Jan. 30-Feb. 1.

ELECTRONIC MARKETING CONFERENCE, Electronic Sales—Marketing Association; Americana Hotel, New York City. Feb. 11-13.

QUANTUM ELECTRONICS INTERNATIONAL SYMPOSIUM, IRE, SFER, ONR; Unesco Building and Parc de Exposition, Paris, France, Feb. 11-15.

INFORMATION STORAGE AND RETRIEVAL SYMPOSIUM, American University; International Inn., Washington, D. C., Feb. 11-15.

ELECTRICAL & ELECTRONIC EQUIPMENT EXHIBIT, ERA, FRC; Denver Hilton Hotel, Denver, Colo., Feb. 18-19.

SOLID STATE CIRCUITS INTERNATIONAL CONFERENCE, IRE-PGCT, AIEE, University of Pennsylvania; Sheraton Hotel and U. of P., Philadelphia, Pa., Feb. 20-22.

PACIFIC COMPUTER CONFERENCE, AIEE; California Institute of Technology, Pasadena, Calif., March 15-16.

BIONICS SYMPOSIUM, United States Air Force; Biltmore Hotel, Dayton, Ohio, March 18-21.

IEEE INTERNATIONAL CONVENTION, Institute of Electrical and Electronics Engineers; Coliseum and Waldorf-Astoria Hotel, New York, N. Y., March 25-28.

ENGINEERING ASPECTS OF MAGNETO-HYDRODYNAMICS SYMPOSIUM, IRE-PGNS, AIEE, IAS, University of California; UCLA, Beverly, Calif., April 10-11.

OHIO VALLEY INSTRUMENT-AUTOMATION SYMPOSIUM, ISA, et al; Cincinnati Gardens, Cincinnati, Ohio, April 16-17.

CLEVELAND ELECTRONICS CONFERENCE, IRE, AIEE, Case Institute, Western Reserve University, ISA; Hotel Sheraton Cleveland, April 16-18.

INTERNATIONAL NON-LINEAR MAGNETICS CONFERENCE, IRE-PGEC, PGIE, AIEE; Shorham Hotel, Washington, D. C., April 17-19.

ADVANCE REPORT

DATA ACQUISITION & PROCESSING IN MEDICINE & BIOLOGY CONFERENCE, University of Rochester, Rochester Chapter of IRE-PGME, et al; Whipple Auditorium, University of Rochester Medical Center, Rochester, N. Y., July 15-17. April 30 is deadline for submitting abstracts to: Kurt Enlein, 42 East Avenue, Rochester 4, N. Y. Conference emphasis is on computing aspects—*analog or digital.*

GAS DYNAMICS SYMPOSIUM, Northwestern University; N. U., Evanston, Illinois, Aug. 14-16. Feb. 4 is deadline for submitting abstracts in triplicate to: Gas Dynamics Symposium, Gas Dynamics Laboratory, Northwestern University, Technological Institute, Evanston, Ill. Topics include: *electromagnetic wave interactions, radiation measurements, energy conversion devices, magnetohydrodynamic flows.*

HOW WE SHRUNK TEFLON*

Why Gudebrod's Common Sense Approach to Lacing Problems Pays Dividends for Customers!

Some years ago motor manufacturers had a problem! They required a high temperature lacing tape that would not deteriorate during the baking process of motor manufacture and would be practical in its application.

Teflon offered the most practical solution to the problem since it provides a temperature range from -100°F to 500°F . We took teflon and flat braided it—we originated the process—but what about shrinkage? When teflon is baked it shrinks . . . it would cut thru fine motor wires!

To meet this problem, we developed an exclusive pre-shrunk process for teflon. This patented process pre-shrinks teflon so that the maximum shrinkage is less than 3% after 16 hours at 425°F . We call this lacing tape Pre-Shrunk TEMP-LACE. Motor manufacturers use it in great quantities.

Pre-shrinking teflon is but one of the many processes we have developed to meet the needs of customers. Whatever your lacing needs—nylon, glass, dacron†, fungus proofing, color coding—Gudebrod's common sense approach to the problem will pay dividends for you because

1. Gudebrod lacing tape increases production!
2. Gudebrod lacing tape reduces labor costs!
3. Gudebrod lacing tape means minimal maintenance after installation!
4. Gudebrod is quality—our standards for lacing tape are more exacting than those required for compliance with MIL-T!

Write today for our Technical Products Data Book which explains the many advantages of Gudebrod lacing tape for both civilian and military use.

*Du Pont registered trademark for its TFE-fluorocarbon fiber.

†Du Pont trade name for its polyester fiber.



GUDEBROD BROS. SILK CO., INC.

FOUNDED IN 1870

Electronics Division

12 SOUTH 12th STREET, PHILADELPHIA 7, PENNA.

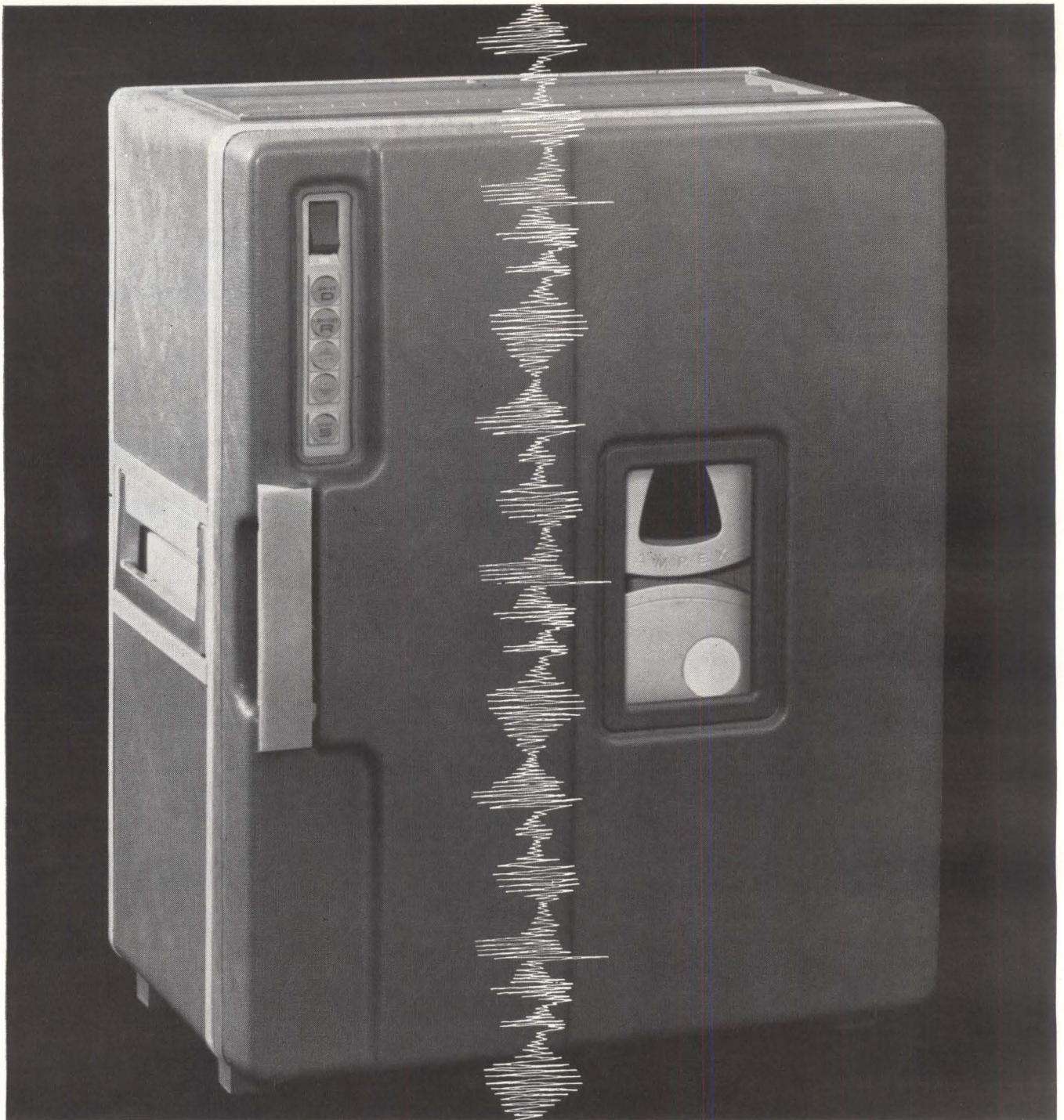

Who'd have thought a 14-track 300 KC recorder could fit into a case this small?

AMPEX

Here is the portable recorder you've been waiting for: the new Ampex FR-1300. It offers all the performance, all the reliability of much larger rack-mounted instrumentation recorders. Yet it fits into a portable case only 24 inches tall. In fact, it's so compact and lightweight that you'll find yourself treating it like any standard piece of laboratory or test equipment; moving it from job to job or lab to lab. And just look at all you get: 14 tracks, Direct and FM recording, six electrically selected speeds,



recording capability from 300 cps to 300 KC at 60 ips—and all solid-state electronics throughout, all packaged in one portable case. The FR-1300 also features a built-in capstan servo system to guarantee accurate tape speeds, without the need for an accessory motor drive amplifier. For more details write the only company providing recorders, tape and memory devices for every application: Ampex Corporation, 934 Charter Street, Redwood City, California. Worldwide sales, service.

AMPEX

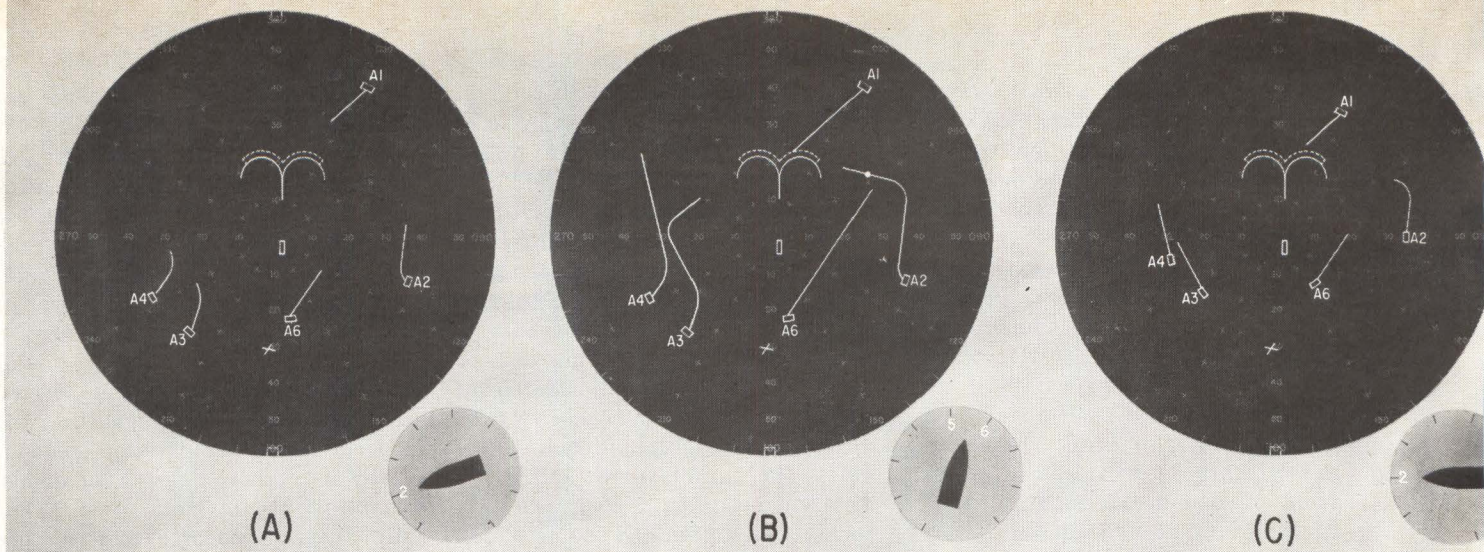

FLIGHT PATH projections of airplanes are predicted for two minutes (A) and 5.5 minutes (B); (C) shows a later prediction for two minutes—FIG. 1

New

electronics

February 1, 1963

AIR-TRAFFIC SYSTEM

Predicts Flight Paths

This system uses an analog computer to predict flight paths of airplanes coming in for a landing. The computer generates projected flight paths of up to 15 planes on ppi and landing-schedule displays

By S. D. MOXLEY and J. A. INDERHEES Avco Corp., Electronics and Ordnance Div., Cincinnati, Ohio

THE PURPOSE of air traffic control is to prevent collisions.

Thus, the radar-approach controller has to keep aircraft separated at all times. When using a conventional tool, a surveillance radar display, he can see only the present separation of aircraft, and then only in plan view. He must estimate their closure rates in plan, while remembering the altitudes to which he has cleared at least those aircraft under his control. Since his criterion is separation, the traffic rate that can be accepted at his air-

port is determined by the separation safety factors he uses and his skill at predicting pilot response and overtake speeds. The predicted-path system of computer-aided control should help the radar-approach controller overcome these problems.

PREDICTION METHOD—While enroute prediction can be based on straight-line projections, terminal area flight paths are randomly curved as well as straight, and thus unpredictable by direct computation. The path-prediction system

uses a high-speed adaptive analog computer to predict flight paths by sequentially "flying" the future path of each aircraft at a rapid rate. To reach a prediction of the aircraft's future path while accounting for all the factors that will affect it, the computer rapidly re-integrates forward on a methodical trial-and-error basis similar to iteration in a digital computer. New path predictions are established on the basis of several dozen iterations a second. The path is then sequentially replotted, as are those of all

other aircraft, at a rate rapid enough to produce a nonflickering display on any resolved-sweep ppi indicator. Ordinarily, the next two minutes of each aircraft's predicted path is illuminated on the ppi screen (Fig. 1A); however, the controller may, at the turn of a dial, probe farther into the future, as shown in Fig. 1B. Here the forward end of each path projection represents the expected position of each aircraft in 5½ minutes. The arriving aircraft A2 will pass safely in front of enroute aircraft A6, notwithstanding possible altitude separation. As flights progress, path segments move forward with time (1C.), continually up-dating each aircraft's prediction.

Shape of each aircraft's predicted-path may be based on the most direct approach to the airport, or may reflect intended "path-stretching" to efficiently space the aircraft between other arrivals. The controller establishes arrival order and minimum separations with the schedule display shown in Fig. 2, thereby determining the resulting approach path. The diagonal lines on a time versus distance scale, represent each aircraft's scheduled occupancy on the common final approach path. The upper end of each diagonal indicates the time and distance out on the common path at which the aircraft will turn onto final approach. The lower end of each diagonal is readable on the lower scale as the time of touchdown for that aircraft. The diagonals slowly slide from right to left as flights progress, displaying at any time the anticipated separation between aircraft on the common approach path. At the time of touchdown, each diagonal has completely disappeared from the display.

The controller's separation job is to space approach paths so that schedule diagonals never cross, since such a crossing would put two aircraft at the same place at the same time on final approach.

SYSTEM—Implementation of the projected-path equipment for a radar-approach-control center is illustrated in Fig. 3. Predicted-paths for the controlled aircraft are displayed on the ppi as a function of arrival spacing set up on the schedule display. The operator uses a control panel to insert such data as

aircraft type and initial altitude on which computer predictions are based. The operator initiates a new track by manipulating a joystick to acquire a radar target displayed on the ppi. At the initiation of each new path prediction, a printer types out a chronology of future headings and altitudes defining the path.

Complexity of the terminal area prediction problem is illustrated by the plan, altitude and velocity profiles of a two-fix approach (Fig. 4A). The path involves at least 4 different headings, 3 clearance altitudes, 4 velocities and the acceleration between them. Although analytical prediction becomes prohibitive in the face of such complexity, the high-speed analog path-tracer easily integrates through such involved projections, iteratively, adjusting its control logic unit all boundary conditions are met. The resulting predicted-path then intelligently matches what the pilot can easily do.

The fast-time adaptive computer consists of the flight simulator, flight control logic and adaptive control. The flight-path simulator extrapolates the path forward, under control of the flight control logic. Adaptive control of the flight control logic enables the simulator to initially iterate toward the correct solution.

The flight simulator simulates aircraft performance by tracing predicted flights in the three space axes at a highly accelerated time base. A path-tracing time scale of

2 microseconds computer time per second of real time results in 3,600 microseconds computer time to draw a 30-minute flight. An additional 1,000 microseconds are required at the beginning of each simulated flight for reset of integrators and for the transferral of data for the next simulated flight.

The simulator, then, is capable of generating 225 flights per second. The system is so arranged that the simulator is commutated sequentially through 15 different channels, enabling it to plot 15 different flights, each repeated 15 times per second. The commutation sequence is illustrated in Fig. 4B. The high recurrence rate on each channel permits display of the resulting paths on a ppi scope without objectionable flicker, and permits iterative solution of each path.

To circulate the simulator through 15 different flight paths, initial conditions for each flight are commutated into the simulator (Fig. 5). For example, initial altitude *A*, is independently set on each of 15 different potentiometers to define 15 separate flight paths. A reference voltage is electronically commutated sequentially to each channel's input potentiometer. Since only one *A*, potentiometer at a time is excited with reference voltage, the adder amplifier output at any time is the initial cruise altitude for that flight path being integrated. The same reference voltage is simultaneously commutated to other initial condition inputs for that

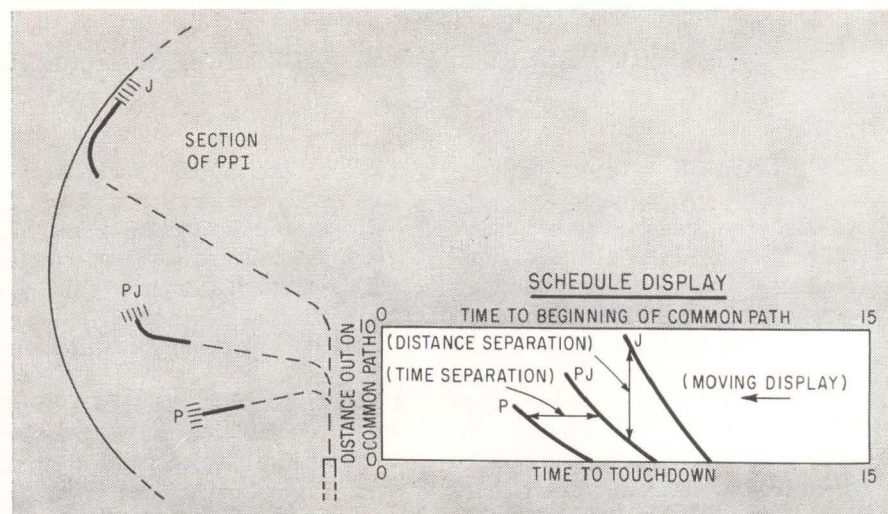

SEPARATIONS between prop (P), prop-jet (PJ) and jet (J) planes are established by controller after he sees path predictions on schedule display (right). To left is the corresponding display on the ppi—Fig. 2

channel. This switching technique permits the use of a single commutator for the system.

Since all flights terminate at a common runway in a common final approach direction, extrapolation of the flight path is simpler from the runway out to the aircraft. By integrating the flight in the reverse direction, the path integrator and heading resolver can be reset to the same starting voltage for all flights, greatly simplifying the circuits.

COMPUTER DETAILS—The fast-time computer is shown in Fig. 6. The altitude simulator generates the altitude profile from cruise altitude (A_c) to final approach level-off (A_f). Simulation inputs A_c and A_f are obtained from control-panel adjustments that are operated by the controller; simulation input \dot{A} (rate of descent) is preset by the controller. The simulation starts, in reverse sequence, at final approach altitude. On command from the flight control logic section, the aircraft's programmed rate of descent \dot{A} is integrated back up to initial altitude. When integrated altitude A becomes equal to cruise altitude A_c , the integration of \dot{A} is stopped and A_c is held for the balance of the reverse-direction flight simulation. A bright spot is generated on the ppi trace at the point where \dot{A} integration is stopped to mark the point at which the air traffic controller should command the pilot to begin descent.

Simultaneously during altitude-

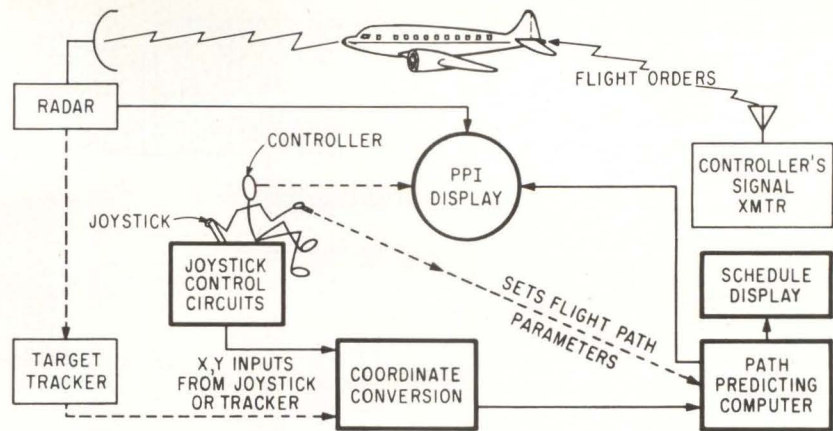

PATH-PREDICTION SETUP indicated by heavy lines, and how it fits into the overall system of semiautomatic air traffic control—Fig. 3

HOW IT FITS IN

Figure 3 shows how the path prediction system (heavy outlines) fits into the overall setup. The path-predicting computer projects flight paths into the future on both the ppi display and the schedule display, which shows projections of airplane landings in distance and time away from touchdown and the common flight path. To get a projected path of a new aircraft, the controller manipulates the joystick, "steering" a new path prediction so that it touches the aircraft blip on the ppi. (He doesn't need the joystick when an automatic target tracker is available.) Computer prediction circuits then estimate the future path of the plane, showing it on both displays.

voltage integration (Fig. 6), a take-off of altitude voltage is modified to produce an air density function V_T/V (true air speed/indicated air speed). This function V_T/V is multiplied by operator-set controls V_c and V_f (indicated cruise velocity and final indicated velocity) to pro-

duce initial aircraft air-mass velocity and final air mass velocity.

The heading resolver simulates heading ϕ and heading-change capability $\dot{\phi}$ of the aircraft. Upon command from the flight control logic unit, the resolver rotates at a simulated aircraft-turning rate of

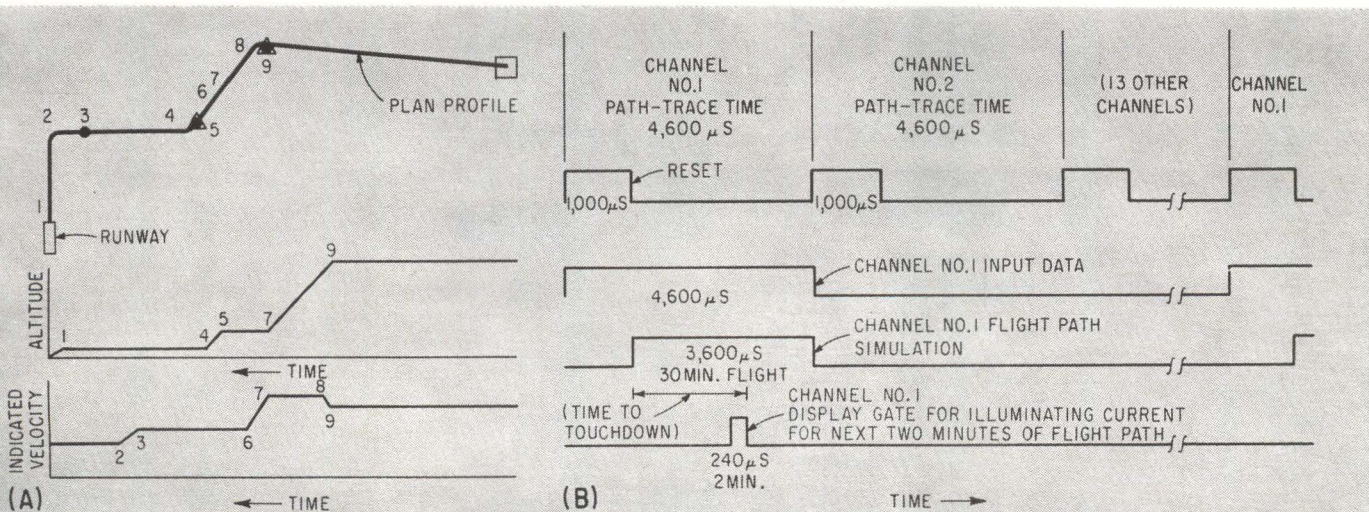

FLIGHT PATH profiles are shown in (A) for plane flying in the terminal area. Commutated data from different flight paths (B) goes to computer—Fig. 4

1.5 degrees per second or 3.0 degrees per second. The x and y ratios of aircraft air mass velocity are thereby generated: $\sin \phi'$ and $\cos \phi'$. The turning rates are operator controlled; these rates differ for jet and prop-type aircraft.

The multiplier unit performs two simultaneous multiplications,

$$V_x = V_T \sin \phi'$$

$$V_y = V_T \cos \phi'$$

and

where V_T is the instantaneous aircraft air mass velocity and ϕ' is the instantaneous aircraft heading. The outputs V_x and V_y are then the x and y components of aircraft air-mass velocity.

Wind velocity W_n and heading θ_{wn} (from north) are set up for discrete altitude layers. Using the altitude analog as an input, the wind function generator switches at appropriate times to insert the correct wind into the path integrator. The output of the wind simulator is then:

$$W_E = W_n \sin \theta_w$$

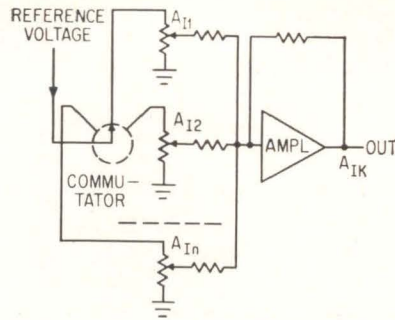

COMMUTATION of input data—
Fig. 5

and

$$W_N = W_n \cos \theta_w$$

where W_E and W_N are the east and north components of the wind. These components are converted to runway coordinates W_x and W_y . The path integrator(s) integrates wind and aircraft velocity to trace the aircraft's ground path

$$x = \int_0^t (W_x + V_x) dt$$

and
$$y = \int_0^t (W_y + V_y) dt$$

Since all computation is done in runway coordinates, the output of the integrators must be multiplied by the sine and cosine function of runway heading to obtain the simulated path in earth coordinates. Primed angles show direction with respect to the runway.

COMMUTATION — The function of the flight control logic is to provide discrete commands to the flight simulator. Since flight paths are simulated in the reverse direction, these commands are generated at specific times from touchdown.

Figure 7A shows a typical flight-path trajectory generated by the system. There are sixteen points (including t_0) identified along the trajectory.

To control various parts of the flight-path integration, the flight control logic generates control gates

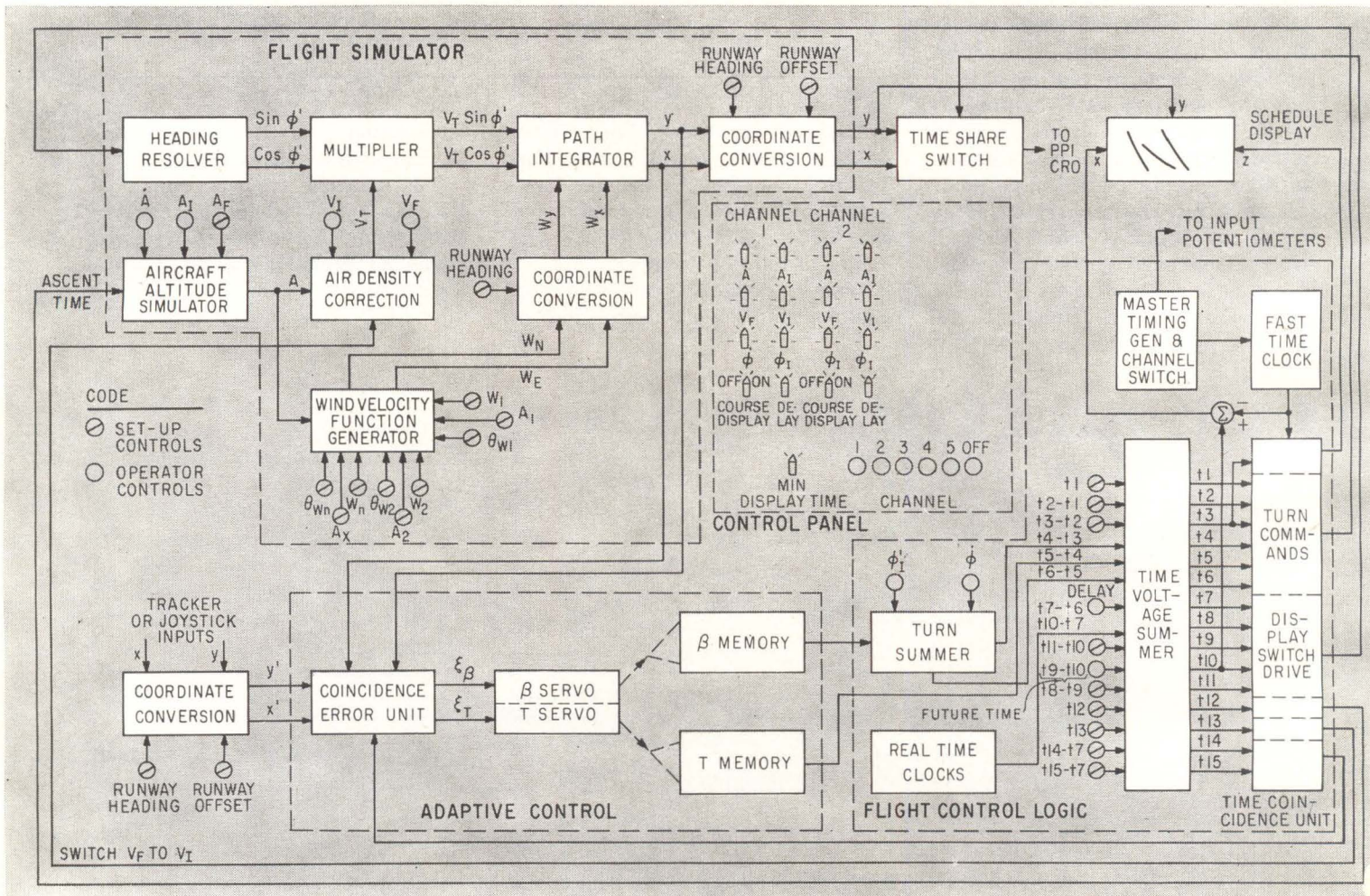

ANALOG COMPUTER comprises flight-simulation, control, and switching-logic section—Fig. 6

for appropriate portions of the system at the correct times.

Times t_0 through t_{15} are simulated by analog voltages that are set or adjusted by the controller; these voltages are unchanged during any one flight-path extrapolation. Note that subscripts 1 through 15 do not, in general, correspond to consecutive points in flight time. Time intervals t_0 , t_1-t_0 , t_2-t_1 , and t_3-t_2 are set initially and remain the same for all aircraft. Time interval t_4-t_3 , the time of the β turn, is generated in the turn summer by dividing β by the rate of turn. Time interval t_5-t_4 is a path length (T) that comes from the T servo. Time interval t_6-t_5 is the time of the γ turn and is computed by the turn summer

$$t_6 - t_5 = [(\alpha + \beta) - \phi'_1] / \dot{\phi}$$

where ϕ'_1 is the initial heading and $\dot{\phi}$ is the rate of turn, both controls being adjusted by the controller.

Time interval t_7-t_6 is the delay

time adjusted by the controller plus a small minimum delay (t_i) to provide a nonzero time on initial heading. Time interval $t_{10}-t_7$ is the elapsed time since the aircraft has been scheduled. This voltage is generated by a real-time integrator released when the specific channel is taken out of its plot mode. Time interval t_9-t_{10} is the display time on the ppi, an operator control, and is the same for all trajectories. Intervals t_8-t_9 and $t_{11}-t_{10}$ are time intervals that allow time for the ppi beam to slew to the trajectory and return to radar sweeps.

Intervals $t_{12}-t_6$ and $t_{13}-t_6$ are manually set intervals that generate the ascent and acceleration times respectively. Time intervals $t_{11}-t_7$ and $t_{15}-t_7$ are manually set intervals to generate a sample time at the end of the course.

The time voltage summer also performs the sequential summation

$$\begin{aligned} t_0 &= t_0 \\ t_1 &= t_0 + (t_1 - t_0) \\ t_2 &= t_1 + (t_2 - t_1) \\ &\dots \\ t_{15} &= t_{14} + (t_{15} - t_{14}) \end{aligned}$$

Thus, the output of the time voltage summer comprises separate lines of t_1, t_2 to t_{15} . The inputs to the time coincidence unit are t_1, t_2 to t_{15} and the fast time clock voltage. The fast time clock input is a ramp voltage starting at a voltage less than t_0 . The time coincidence unit consists of sixteen comparators, each comparing the fast time clock ramp voltage to its assigned t_n . When coincidence occurs, the comparator changes states, thereby generating or cancelling a control gate to the simulator or the ppi or the schedule display.

The schedule display is a distance-time plot on a crt of the final approach. This plot is made simultaneously with the generation of the predicted path, the vertical deflection being produced by the y output of the flight simulator. The time location of the schedule display trace is determined by voltage t_{10} , which is constant during a plot. The horizontal deflection is produced by t_{10} minus the high-speed-clock's ramp, which thus provides a time

base starting from the current present time from touchdown. The z axis of the crt is gated on from t_0 to t_3 .

ADAPTIVE CONTROL — In establishing a new flight path at the beginning of an aircraft's approach, the complexity of the projection prohibits analytical solution for the course. Instead, the simulator arbitrarily starts extrapolating a flight path that initially does not end up at the aircraft while adaptive control of the β and T servos iterates it to coincide with the aircraft (Fig. 7B). The flight path is constrained to begin on the aircraft's initial heading and end on final heading at the runway. Adaptive adjustments of β and T , resulting from repetitive trial and error extrapolations, shift the flight path until it coincides with the aircraft's radar target.

During the gate interval $t_{14}-t_{15}$ (Fig. 7A) which is centered around t_7 (the end of the trajectory), x and y components of the trajectory are sampled from the flight simulator. These sampled voltages (x_1, y_1) are compared to the x and y position of the aircraft as inserted either from the controller's joystick or an electronic target tracker. The difference or error signals are resolved along the polar coordinates β and T (Fig. 7B). These error signals drive the β and T servos. Repetition of the flight path 15 times a second permits these sampled data servos a bandwidth of 2 cps and a solution time of about 2 seconds.

The flight path thus established is the aircraft's shortest possible approach to the runway within restraints such as initial heading and altitude, velocity and rate of descent. Should the resulting predicted arrival time conflict with other aircraft, the controller can delay the aircraft's arrival by lengthening the initial portion of the flight path (t_7-t_0 , Fig. 7A). By delay or alteration of the aircraft's initial heading, the controller can reshape the flight to avoid conflict with other traffic.

This article was made possible by research performed on Air Force Contract Number AF19(604)-7481, under cognizance of the 482L SPO, Technical Support Div., Fort Dawes, Massachusetts.

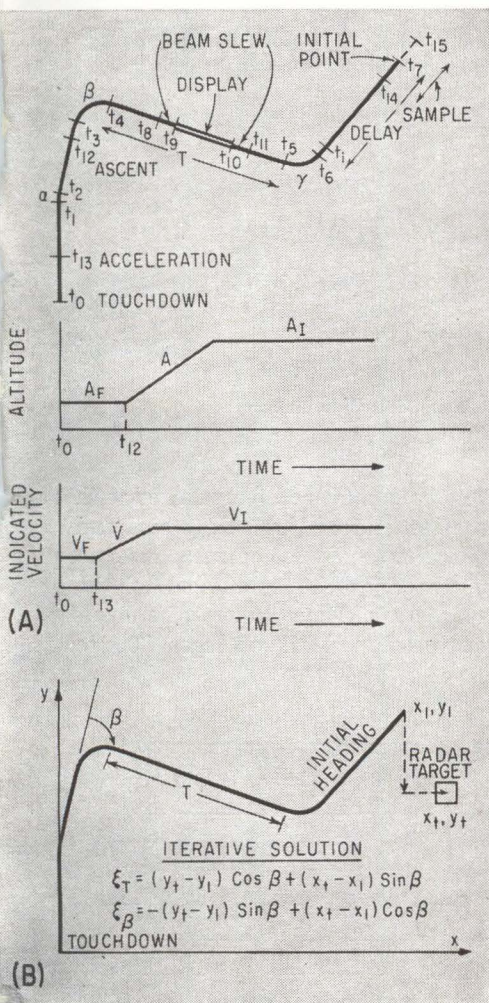

TYPICAL FLIGHT course (A) generated by system iterates its simulations until it generates final course—Fig. 7

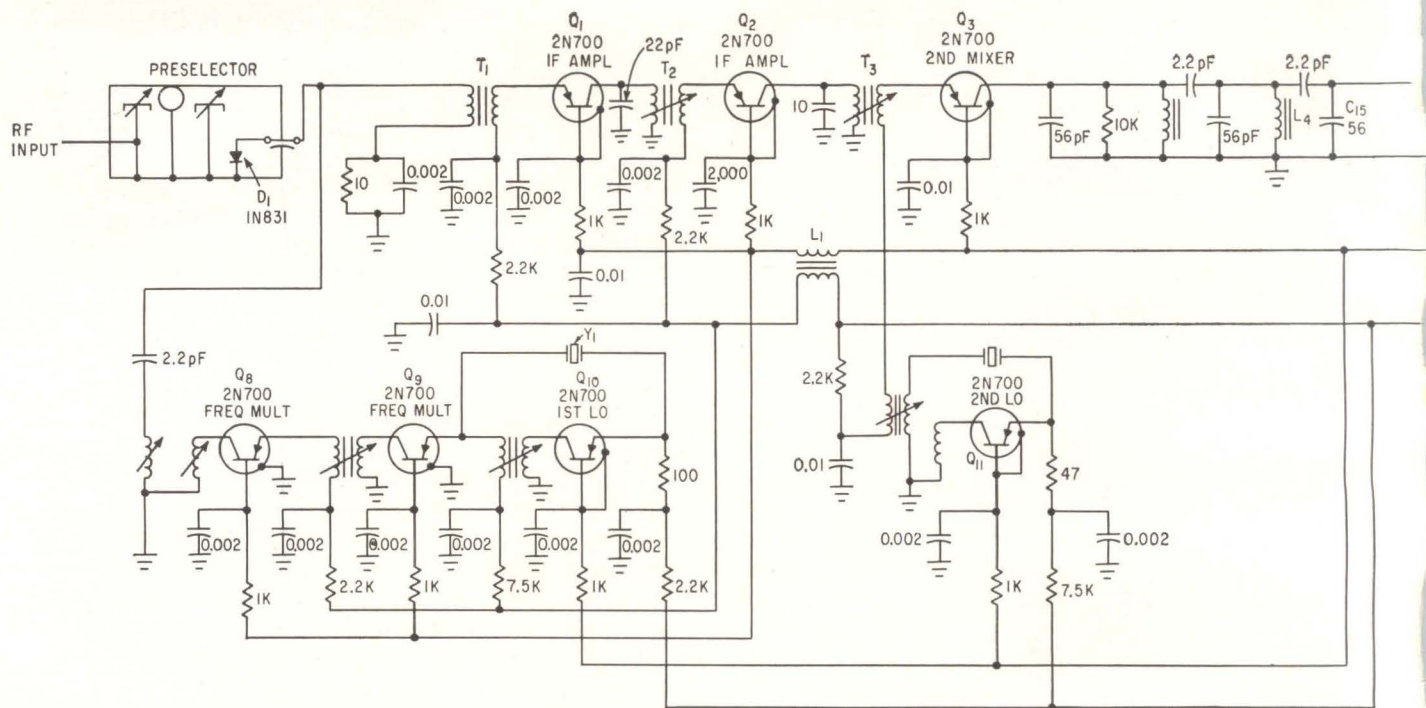

FIRST DETAILS on Mercury

Twenty channel, double-conversion superheterodyne supplies signals that actuate the escape rocket and retrorockets, make spacecraft clock changes, and perform instrument calibration as well as other normal and emergency control signals transmitted from the ground station

By RAYMOND ELLIOTT, Senior Engineer, Military Electronics Division, Motorola Inc., Scottsdale, Arizona

THE PROJECT MERCURY command receiver is a double-conversion f-m superheterodyne providing 20-channel operation and initiates the escape rocket sequence should trouble develop in the launch ve-

hicle, actuates retrorocket firing, makes spacecraft clock changes and is used for instrument calibration.

Twenty on-off channels and an emergency voice channel with a range of 1,000 miles are desired.

The command receiver shares with the h-f and uhf voice systems and telemetry, a biconical antenna mounted at the small end of the spacecraft. Emergency voice channel bandwidth is at least 300 to

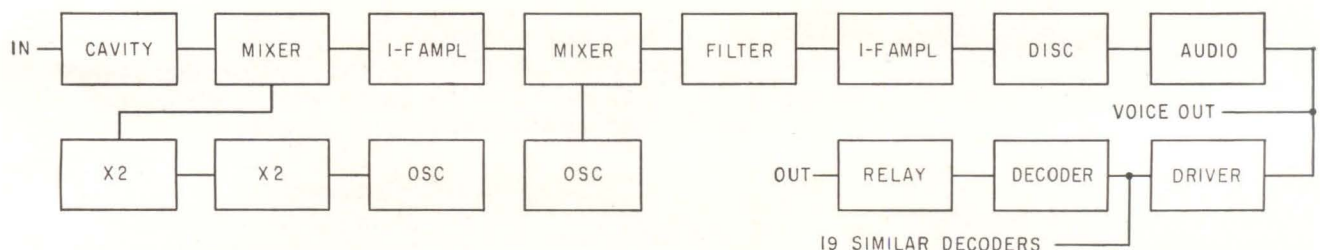

COMMAND receiver is a double-conversion f-m superheterodyne with both local oscillators crystal controlled. The audio amplifier drives 20 similar decoders and also is an emergency voice channel—Fig. 1

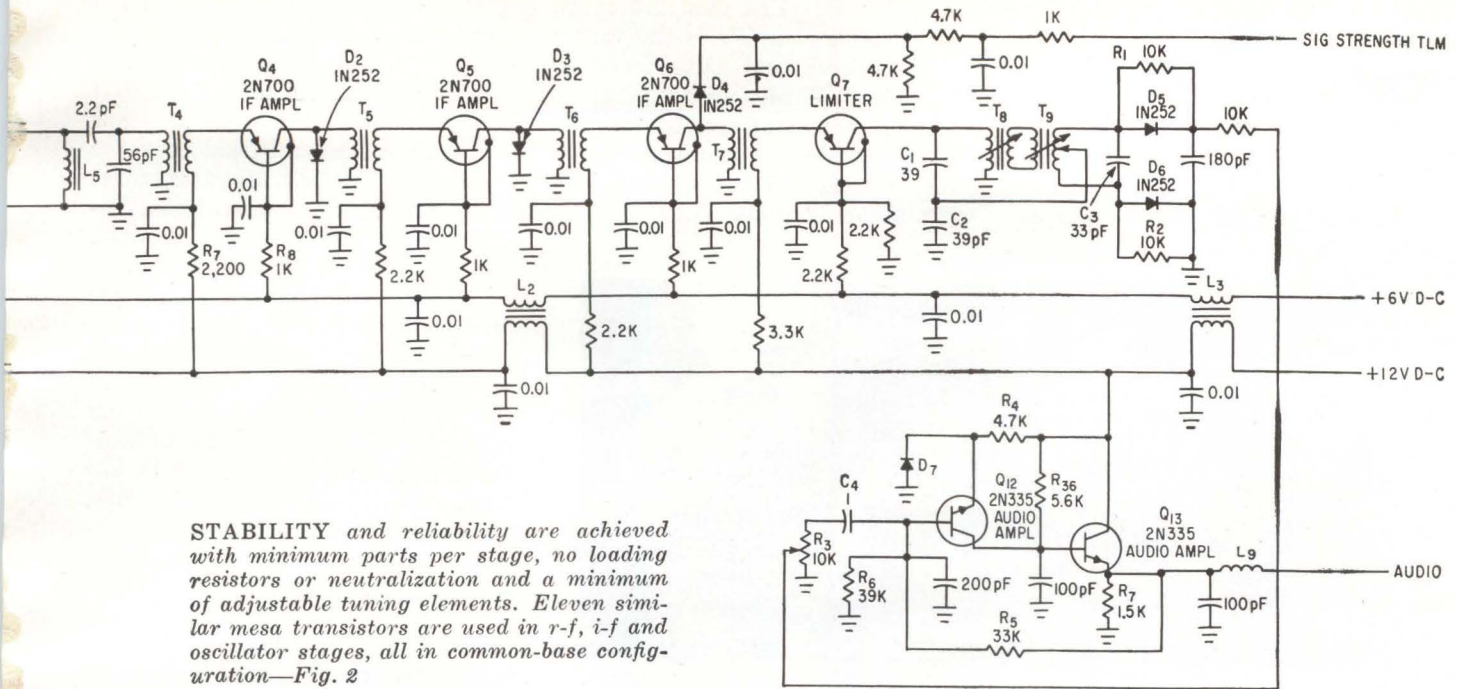

Spacecraft Command Receiver

3,500 cps. The maximum standby power is 1.5 w for the receiver and 1.1 w for each activated decoder channel.

Because weight and volume requirements were stringent, the AN/DRW-13 crystal-controlled, double-conversion f-m superheterodyne was the design basis. Increasing available channels from the original 10 to the desired 20 required some modifications. Overall operation is shown in Fig. 1.

DESIGN FEATURES — Common-base configuration is used throughout the receiver to yield the most stable r-f, i-f and oscillator circuits with minimum components. Stability against regeneration is assured by designing a mismatch of several db in each stage. To further improve stability and reproducibility, transistor parameters were carefully specified and tested.

Eleven mesa transistors, chosen because of high-frequency response, low junction capacitance, isolated collector, grounded case and small package, are used in the i-f, r-f and

two local oscillator stages.

Because of the low capacitance and base resistance of the 2N700 transistor and the mismatch losses designed in each stage, the common-base configuration is stable at the i-f frequencies. This stability was achieved with a minimum of parts per stage, no neutralization

or loading resistors, and tuning capacitors in the first i-f stages only.

To achieve a high degree of limiting and good f-m characteristics, the limiter stage is biased for optimum limiting. To prevent strong signal, low-frequency oscillation, diode limiters are used in each 10.7-Mc i-f amplifier stage. The diode in

AUTHOR Raymond Elliott and final version of receiver



the last i-f amplifier is both a limiter on strong signals and a signal-strength detector for alignment and telemetry.

The audio amplifier and decoder stages are compensated for temperature variations. All decoders are constructed on identical printed

chart boards. The only difference between the channels is the values of inductance and capacitance in the filters. Thus, any combination of channels may be used in the various receiver configurations.

A modified Foster-Seeley discriminator is used. Only one re-

sistor and capacitor are used for the diode load and summing circuits. The reference signal is coupled and developed across the split primary tuning capacitor, thus eliminating an additional choke or resistor. This circuit uses three parts less than the conventional discriminator and there is no sacrifice in reliability of performance.

Modular construction is used for simplicity in construction, testing, assembly and disassembly. All modules are potted before assembly into the receiver. By mounting these encapsulated modules in compression, supporting structures are minimized. This encapsulation and compression process has proved reliable under all environmental conditions.

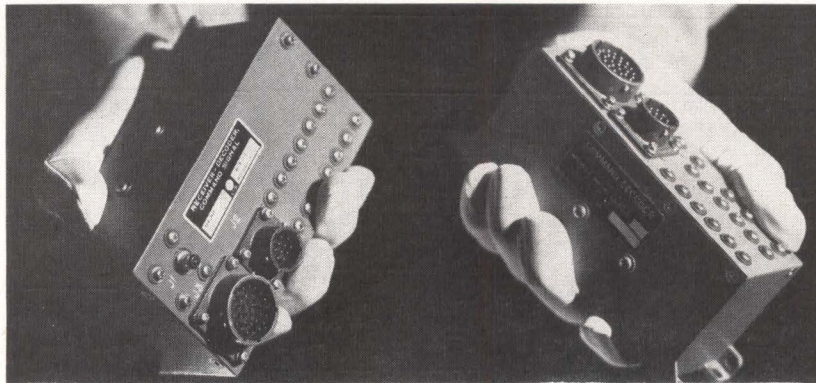

FINAL command receiver (left) and decoder (right) used in Project Mercury spacecraft

RELIABILITY PLUS

NASA's Project Mercury spacecraft are probably the most safety-engineered vehicles in history. A man's life and a lot of prestige are at stake. As things can go wrong in a hurry, and there is a limit to how much an astronaut can do, electronic controls play a very important role. The command receiver described in this article picks up and responds to normal and emergency control signals transmitted by ground stations. If trouble occurs during launch, it fires the escape rocket. During flight, it makes corrections to the spacecraft clock, calibrates instruments, activates retrofire and provides an emergency voice channel

RECEIVER R-F ASSEMBLY—Input r-f is applied to the dual-cavity preselector, see Fig. 2. One tuning capacitor in each cavity provides preset tuning for maximum image rejection and reduction of spurious responses.

The incoming signal is mixed in D_1 with a signal from the first local oscillator. The difference frequency is applied to the emitter of Q_1 through pretuned matching transformer T_1 .

The signal is amplified and coupled through tuned matching transformer T_2 to the emitter of Q_2 where it is again amplified. Both Q_1 and Q_2 are common base, class-A amplifiers with a combined gain of approximately 30 db.

The i-f signal is coupled through tuned matching transformer T_3 to the emitter of second mixer Q_3 . The second local oscillator and the first i-f signals are mixed in Q_3 and the second i-f difference frequency is selected in the four-section LC output band-pass filter.

Filter output is coupled by T_4 to the first stage of a four-stage second i-f amplifier. The four stages are essentially class-A, common-base amplifiers with a combined gain of approximately 80 db. Coupling transformers T_4 through T_7 are tuned with corresponding transistor collector and circuit capacitances to obtain desired frequency. Silicon diodes D_2 through D_4 , connected between the collectors and ground, prevent high signal level transistor saturation. A signal strength telemetering output is also

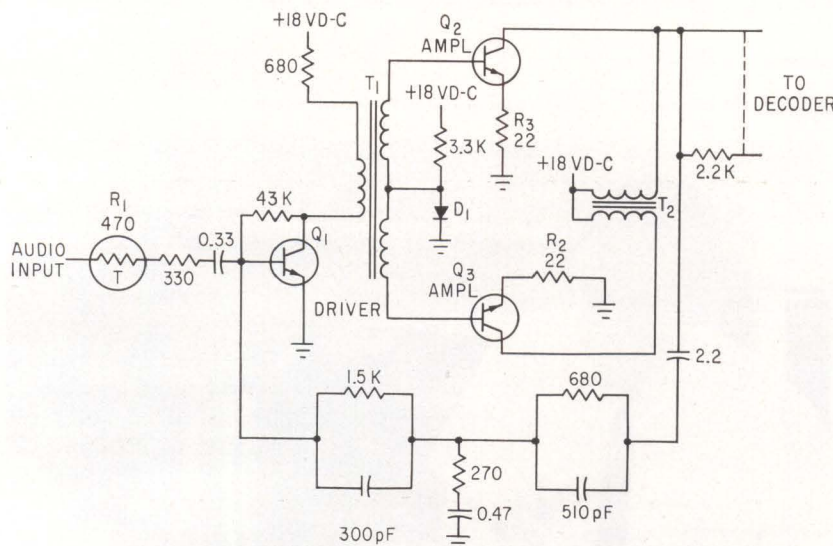

DECODER DRIVE unit accepts audio signals from receiver, amplifies them and drives 20 parallel decoders—Fig. 3

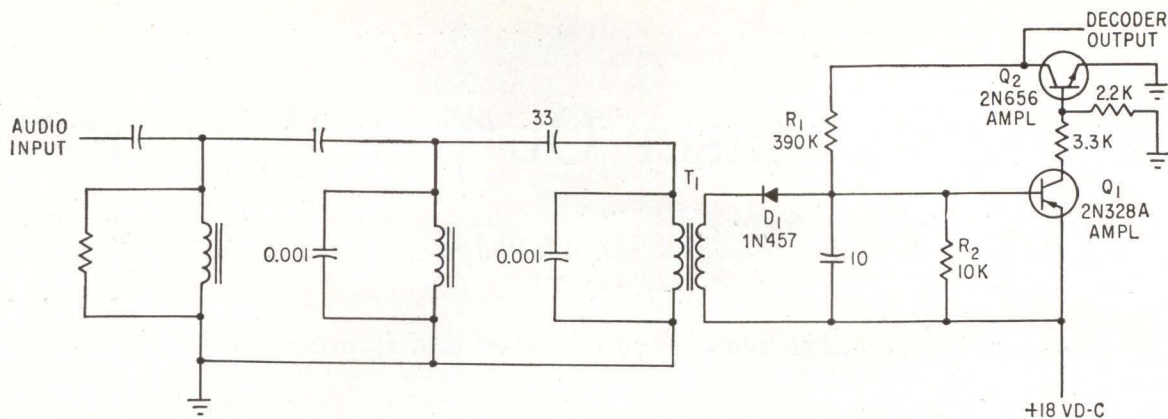

THERE ARE 20 similar decoders in the system, each tuned to its particular frequency and operating its own relay—Fig. 4

provided through D_1 and an RC filter network. Final amplifier Q_7 is biased at approximately 3 v on the base for proper limiting.

Limiter amplifier T_7 feeds discriminator primary T_8 which is link coupled to the secondary T_9 . Capacitor divider network C_1 and C_2 tunes the primary at the second i-f and provides coupling to the center tap of the transformer secondary. Transformer secondary is tuned by C_3 .

At center frequency, the voltages developed across R_1 and R_2 by diodes D_5 and D_6 are equal in magnitude and series-opposing. Frequency deviations caused by frequency modulation alter the relative magnitudes of the voltages across R_1 and R_2 producing an output voltage proportional to deviation.

Output of the discriminator circuit is applied through audio gain control R_3 and coupling capacitor C_4 to the two-stage audio amplifier consisting of Q_{12} , a common-emitter amplifier-operated class-A, d-c coupled to Q_{13} . Zener diode D_7 holds the first stage emitter at a-c ground and provides a constant emitter reference voltage. Quiescent current for D_7 is provided by R_4 and Q_{12} while R_5 and R_6 provide negative feedback for gain stability. The output of Q_{13} , operating as an emitter follower, is taken across R_7 and coupled to the decoder driver modules.

First local oscillator Q_{10} is a common-base crystal oscillator whose frequency is multiplied by doublers Q_9 and Q_8 to achieve the correct mixing frequency at D_1 . First frequency doubler Q_9 is biased for optimum harmonic generation and the collector circuit is tuned to the sec-

ond harmonic of the oscillator frequency. Second frequency doubler Q_8 functions similarly to the first. Output of Q_8 is coupled to the mixer through a double-tuned network for selectivity and impedance matching. Second local oscillator Q_{11} is the same as Q_{10} and is also crystal controlled. Output of Q_{11} is transformer-coupled to second mixer Q_3 .

Supply voltages for the r-f assembly are obtained from 6 and 12-v inputs. Both voltages are regulated by zener diodes mounted in the housing. The 6-v input supplies base biasing for all stages except the audio amplifier. Emitter voltages are derived from the 12-v input. Dual chokes L_1 , L_2 and L_3 decouple the r-f assembly.

DECODER DRIVE—Output of the receiver audio amplifier is a-c coupled to the decoder drive, shown in Fig. 3, through Sensistor R_1 to compensate for amplifier gain characteristics with changes of temperature.

The decoder driver is a two-stage amplifier with a class-AB, push-pull output. Grounded-emitter amplifier Q_1 is transformer-coupled to the output stage. The push-pull output circuit is transformer-coupled to the decoder channels across the collector outputs.

To stabilize frequency and phase response of the overall circuit, negative feedback is used from the final stage output to the input of Q_1 through a frequency-selective RC feedback network.

Diode D_1 connected between ground and the center tap of T_1 varies the base voltage of Q_2 and Q_3 to compensate for base-emitter voltage changes with temperature while

R_2 and R_3 provide emitter-current limiting.

DECODERS—The audio output of the decoder driver is applied to each of the 20 decoders. A typical decoder is shown in Fig. 4. The LC filter in each decoder is tuned to the discrete frequency of each channel tone and adjusted for a 3-db bandwidth of 4-percent of the tone center frequency. Selectivity of each filter is sufficient to give at least 35-db adjacent channel rejection. Output of the filter is transformer-coupled to detector D_1 , which rectifies the audio tone and applies the d-c voltage to a two-stage d-c amplifier. Positive feedback around the amplifier through R_1 holds Q_1 on with minimum input signal level thus reducing relay chatter. Resistor R_2 maintains the base and emitter voltages of Q_1 almost identically, thereby assuring that the amplifier is cutoff with no signal input. Presence of an audio tone of the proper frequency reduces the d-c output voltage and causes the appropriate dpdt output relay to energize.

The first ten decoder channels are mounted in the receiver package, and the remaining ten are mounted in the command decoder package. Five decoder channel relays may be actuated simultaneously.

This dual command receiver flew successfully on the Mercury sub-orbital missions of Shepard and Grissom and on the orbital flights of Glenn, Carpenter and Shirra. These units have performed perfectly with no failures on more than 100 flights of various types of missiles.

Measuring Laser Output With RAT'S

Pulsed output energy of a laser beam is trapped and absorbed in a bundle of fine proportional to the energy absorbed and is practically independent of the

By R. M. BAKER *Advisory Engineer, Electronics Div., Westinghouse Defense Center, Baltimore, Maryland*

A UNIQUE calorimeter suited to measuring the pulsed output energy of lasers has been developed. Beam energy is trapped and absorbed in a bundle of fine insulated copper wire called the bolometer unit. The change in resistance of this unit is proportional to energy absorbed and is practically independent of the distribution of energy within the unit. The bolometer unit is used in a conventional bridge circuit, and beam energy is measured by galvanometer deflection. It has been used to measure the c-w power output of the helium-neon laser.

The "rat's nest" calorimeter was conceived and developed specifically to measure the energy in the output pulse of a ruby laser.

More conventional calorimeters absorb the energy in a small quantity of liquid or in a small piece of solid material and use a thermocouple to measure the temperature rise. Knowing the heat capacity of the absorbing material, the temperature

WHAT'S IN A NAME?

The author originally tried to call his device a "fine-wire" calorimeter, but popular usage has settled on the more colorful and descriptive name of "rat's nest" because the bolometer unit contains a jumble of 1,000 feet of enameled copper wire

rise is a measure of the energy absorbed. There exist the usual problems of absorbing as large a fraction of the incident energy as possible and knowing the fraction of total energy absorbed. These problems can be overcome, but one basic problem remains: the necessity of obtaining temperature equalization before the temperature rise is measured. In a liquid, this requires stirring; in a solid, waiting for equalization by thermal conduction.

Either way, heat is lost before equilibrium is reached, which introduces an error in the determination of the total energy absorbed.

In the rat's nest calorimeter the incident beam impinges on and is absorbed in a bundle of fine enameled copper wire (bolometer unit). The change in resistance of the wire is a measure of the total energy absorbed and, since the change in resistance is independent of the volume distribution of heat in the wire, there is no need to wait for temperature equalization. It is also easier to measure this change in resistance than to measure the small change in the output voltage of a thermocouple. Since this is a calorimetric device, relatively insensitive to wave length of the incident radiation, it can measure the radiation from any source in the visible and infrared regions of the spectrum.

BOLOMETER UNIT—The heart of the rat's nest calorimeter is the

RAT'S NEST CALORIMETER used to measure the main beam energy output of a short-pulse ruby laser, using an integral beam-splitter (a piece of flat glass set at an angle) to reflect a small amount of the beam into the active bolometer unit

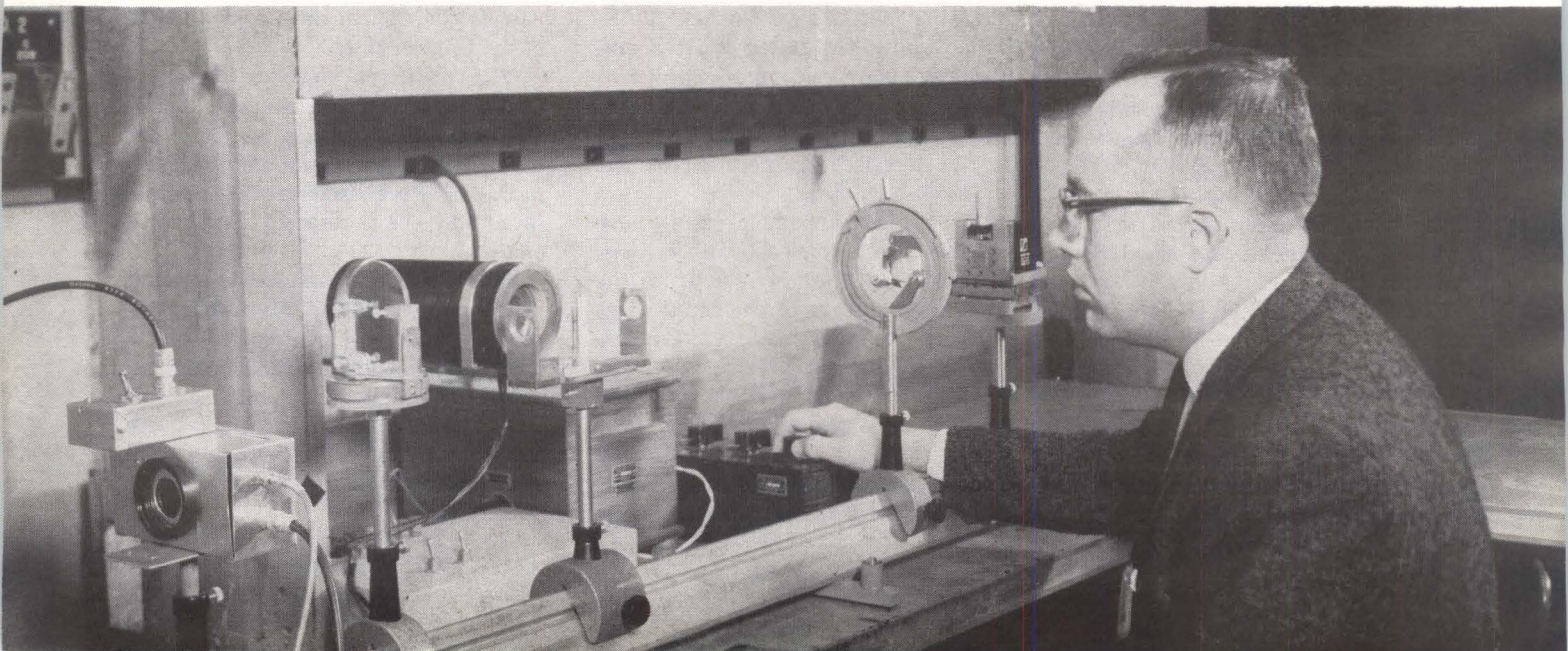

NEST CALORIMETER

insulated copper wire, whose change in resistance is

distribution of energy within the unit

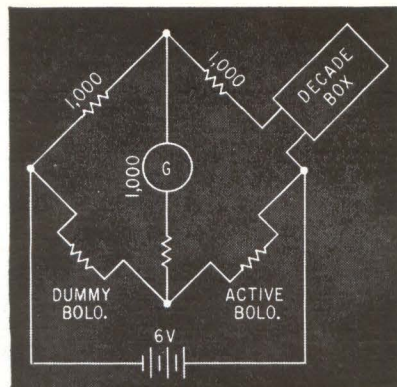

BRIDGE CIRCUIT of rat's nest calorimeter—Fig. 1

bolometer. This consists of approximately 1,000 feet (980 ohms) of No. 40 B&S gage enameled copper wire loosely and randomly packed into a 50-milliliter beaker silvered on the inside. The ends of the fine wire are brought out to flexible leads and a flat glass window is placed over the open end of the beaker to minimize the disturbing effect of air currents. The incident beam to be measured enters through this window. Two similar bolometer units, one active and one dummy, are arranged in a conventional bridge circuit (Fig. 1). The active bolometer unit receives the radiant energy to be metered, and the dummy minimizes galvanometer drift resulting from changes in ambient temperature. This total assembly is the rat's nest calorimeter.

CALORIMETRIC EQUATION—

Typically, the pulse length of a ruby laser is 5×10^{-4} second with a total energy of about 10 joules. When such a pulse is fired into the active rat's nest bolometer, the beam is successively scattered and absorbed by the individual wires, until the total energy is absorbed and appears as temperature rise in the wire. If a short section of wire has resistance R_0 before the shot, its resistance after will be

$$R^1 = R_0^1 (1 + \alpha \Delta \theta) \text{ ohms} \quad (1)$$

where α is the temperature coefficient of resistance, and $\Delta \theta$ is the temperature rise. The change in resistance is

$$\Delta R^1 = R_0^1 \alpha \Delta \theta \text{ ohms} \quad (2)$$

If this short section of wire absorbs an energy E^1 joules, has a mass M^1 grams, and a specific heat c , it will experience a temperature rise

$$\Delta \theta = \frac{E^1}{4.19 M^1 c} \text{ deg C} \quad (3)$$

Combining Eq. 2 and 3 gives for the change in resistance of this section of wire,

$$\Delta R^1 = \frac{R_0^1 E^1}{4.19 M^1 c} \text{ ohms} \quad (4)$$

The total resistance change of the bolometer unit is the summation of ΔR^1 over all the wire sections that make up the total length of wire. If the wire is of uniform cross section, R_0^1/M^1 is equal to R_0/M , the ratio of corresponding quantities for the total length of wire. If it is assumed that α and c are independent of temperature, it follows from Eq. 4 that the total change in resistance of the bolometer unit is

$$\begin{aligned} \Delta R &= \frac{\alpha R_0}{4.19 M c} \sum E^1 \\ &= \frac{\alpha R_0}{4.19 M c} E \text{ ohms} \end{aligned} \quad (5)$$

where E is the total energy absorbed. This shows that the change in resistance ΔR is directly proportional to total energy absorbed and is independent of how the energy is distributed in the wire mass, provided: (1) the wire is of uniform cross section and (2) the temperature coefficient of resistance α and specific heat c of the wire are independent of temperature. These are reasonable assumptions if the temperature rise of the wire is not too great.

In using the bolometer unit to measure energy, invert Eq. 5 to read

$$E = \frac{4.19 M c}{\alpha R_0} \Delta R \text{ joules} \quad (6)$$

Substituting the values of M/R_0 , c , and α for No. 40 copper wire, Eq. 6 becomes

$$E = 1.40 \Delta R \text{ joules} \quad (7)$$

This is the calorimetric equation, but corrections are needed. The 0.0003-inch thick layer of varnish

insulation (specific heat 0.40 and density 1.40 gms per cm^3) increases the thermal capacity of each element of wire length by 29 percent, the window reflects 8 percent of the normal incident beam energy, and the measured back scattering from the wire mass is found to be about 18 percent. Applying these corrections, Eq. 7 becomes

$$E = 2.38 \Delta R \text{ joules} \quad (8)$$

This is the final equation expressing incident beam energy in resistance change of the bolometer unit. The corrections are only approximate. The 18-percent back scatter is the result of a single measurement at 6,900 Angstroms. This is a true calorimetric measurement with relatively minor corrections. The total thermal capacity of the wire mass (including insulation) can be determined experimentally by discharging a known amount of energy into it from a capacitor, and the window reflection and back scatter from the wire mass may be accurately measured at several wave lengths.

USING THE CALORIMETER—

Equation 8 suggests that the resistance of the active bolometer unit be measured before and after a shot and that the change in resistance determine beam energy. Actually, it is more convenient and accurate to observe the galvanometer swing following the shot. By switching a known small resistance in the active bolometer branch, determine a factor $N = d/\Delta R$ (scale divisions of galvanometer deflection per ohm). Equation 8 may then be written

$$E = \frac{2.38}{N} \Delta d \text{ joules} \quad (9)$$

This is the working equation giv-

ing beam energy in galvanometer deflection. Assume that N for the galvanometer is 190 mm per ohm. Equation 9 becomes $E = 0.0126 d$ joules. An energy of 0.01 joule corresponds to a deflection of nearly one millimeter and is easily detectable. This corresponds to typical operation as the device is presently used.

The use procedure may be summarized as follows: (1) balance bridge so that the galvanometer indicates conveniently on scale; (2) switch a known resistance (say, 0.1 ohm) in the active bolometer branch of the bridge and note galvanometer deflection to determine scale divisions per ohm (N); (3) substitute N in Eq. 9 to obtain the working equation $E = kd$ joules. The calorimeter is now ready for use.

Figure 2 (left) shows the "rat's nest" calorimeter calibrating a phototube power energy measuring device. The ruby laser head (left) fires a pulse directly into the active bolometer unit (top right). The phototube device is located just to the right of the laser head. A fine vertical wire scatters a small fraction of the beam energy onto the photocathode of the phototube, the output of which is displayed and photographed as a time resolved power trace on a cathode-ray oscilloscope. The phototube device is calibrated by comparing the area under its power-versus-time trace with total pulse energy as read by the calorimeter. The integration may be performed electrically in the output circuit of the phototube device so that total pulse energy for comparison with the calorimeter is

presented as a step or ramp function change in the cro trace.

The scattering wire used with the phototube (Fig. 2 left) is actually a sampling device. It provides at the photocathode a proportional sample of the main beam at a suitable low level of intensity, and leaves the main beam unaltered and available for use.

Although the rat's nest bolometer unit is not so limited in the energy it can absorb, its usefulness will be greatly extended if it is used with a sampling device. The lead photo shows an improved bolometer with a practical beam-sampling device. The two bolometer units have been mounted in a common cylindrical insulating housing to reduce galvanometer drift to a minimum, and a piece of flat glass set at an angle in the laser beam reflects a small fraction of it into the active bolometer unit. As with the scattering wire, this method of sampling leaves the main beam unaltered and available for use. This is a typical setup used in studying material removal and impulse produced by the focused laser beam.

The rat's nest calorimeter is an absolute energy measuring device, but when used with a sampling device it must be calibrated. A setup is shown in Fig. 2 (right). Two complete calorimeters are used. The one on the right intercepts and measures the energy in the transmitted beam while the one in the center measures the energy in the reflected beam. The ratio of the two readings gives the factor to be applied to the calorimeter with sampling plate attached. The two readings may also determine the

percent reflection from the two surfaces of the glass plate. With the plate at 45 degrees, this was found consistently to be about 9 percent. Once the calorimeter with the sampling device is calibrated, it becomes a portable instrument that can be inserted in any beam to measure its energy. Since the calorimeter is an absolute energy measuring device, the calibration of the calorimeter with sampling device is simply a calibration of the sampling device.

CONCLUSIONS—The rat's nest calorimeter is simple in principle and easy to use. It is both a standard for calibrating phototubes or other detectors, and a useful general-purpose laboratory instrument. The inherent time constant is on the order of 10^{-4} second so it can be used with a fast detector or recorder if desired. Repeative use will build up a temperature differential between the active and dummy bolometers and if a slow detector like a galvanometer is used, drift will ultimately limit the accuracy of measurement. Ordinary enamel insulation on the bolometer wire is damaged if energy density exceeds about 10 joules per cm^2 in a one millisecond pulse, or a somewhat lower density in a one-tenth microsecond pulse. This limitation is overcome by expanding or sampling the beam to be measured. The energy flux or power from a continuous source may be measured by observing the energy absorbed over a short time interval. The beam power of a helium-neon laser (about 1 mw) was successfully measured in this way.

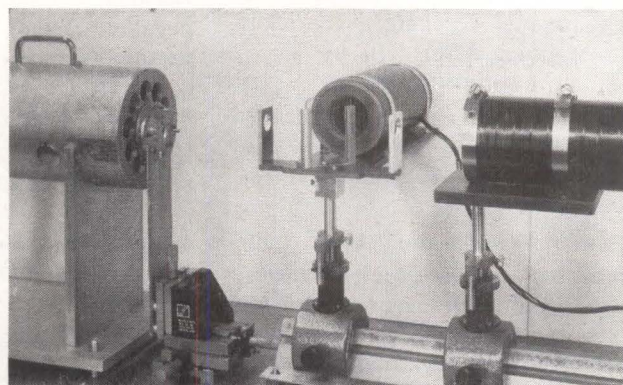
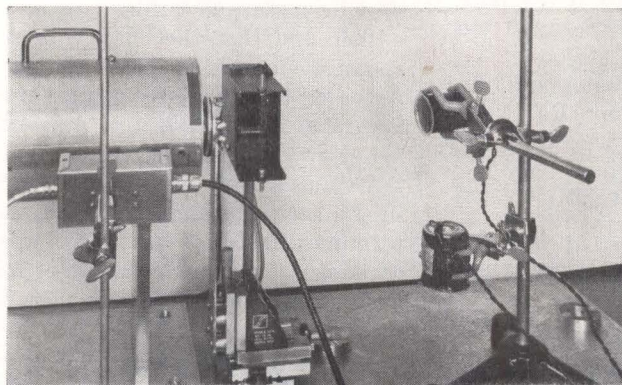

CALORIMETER SETUP: to calibrate scattering wire and phototube (left); to calibrate a second calorimeter, using an integral beam-splitter (right)—Fig. 2

COAX CABLE delay determines oscillator frequency. Engineer reads off frequency from digital meter

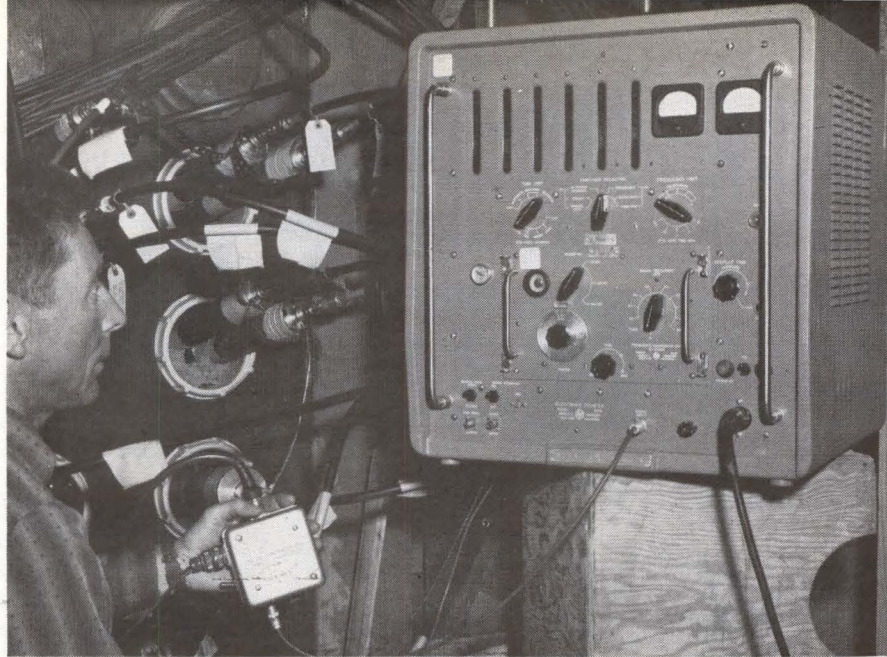

Getting Subnanosecond Precision In Coax Cable Delay Measurements

Ingenious method for determining delay time is to send a pulse down the line and have the reflected pulse retrigger the pulse generator to produce sustained oscillations. Resulting pulse repetition rate is then proportional to cable delay and can be measured with a digital pulse counter

By E. F. LAINE
Lawrence Radiation Laboratory,
Livermore, California

A PROBLEM FREQUENTLY encountered in nuclear detection work is the recording of time-versus-amplitude of fast, single-transient

pulses. The signals produced by multiplier phototubes and other pulse detectors must then be transmitted, by coaxial cable, to a high-frequency oscilloscope equipped with timing marks and precision sweeps. The display is then photographed for data reduction.

Since the signals may originate at differing times from different detectors, all the delays in a system must be known. Representative are transit time of the signal from point of origin to the detector, transit time of the detector, transit time of transmission cable, and the time to the deflection plates of the oscilloscopes. Usually the longest delay is in the transmission cable.

The velocity of propagation of the coaxial cable is not constant. In time-delay measurements, the aim is to simulate the high-frequencies of the signal itself, and this is done by generating steep-edged pulses in the test equipment.

The cables most prominently used

SIMPLICITY IS THE AIM

There are many ways of killing a cat besides choking it with cream. So too in measuring the time delay of coaxial cables. It's no good looking to propagation velocity as a key to delay-time since this parameter is not constant. One simple method is to compare the unknown cable with a calibrated cable of the same type. But the best way is to let instruments do all the work and have the engineer come along for the final reading. This is what happens here

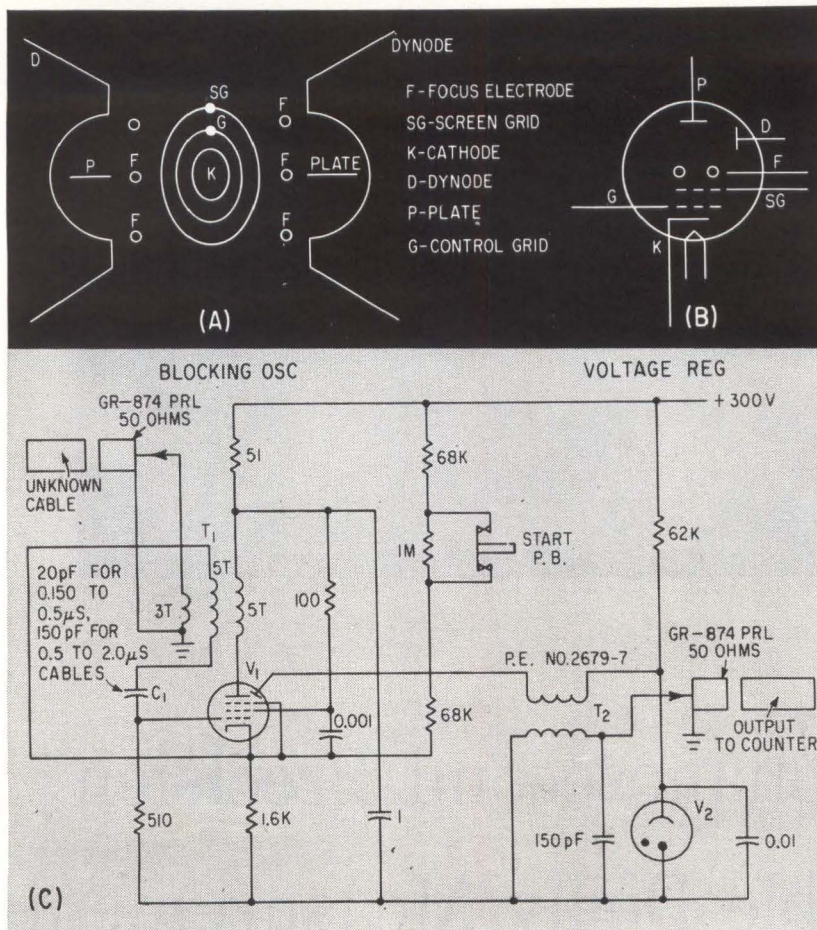

PHYSICAL LAYOUT of secondary emission tube (A) and schematic representation of same tube (B); secondary emission tube in 10-nanosecond pulse generator, (C), with each reflected pulse causing the circuit to emit a fresh output—Fig. 1

are given in the table. Their lengths vary from a few hundred feet to as much as several thousand feet.

MEASURING TECHNIQUES —

Some of the cable-measuring methods used in the past ranged from simple techniques with medium precision to complex arrangements with but little better precision. In the simplest system a calibrated precision variable delay is periodically substituted for the unknown cable, until the leading edges of the output pulses match. The reading on the calibrated delay is then equal to the delay of the unknown cable.

A more complex system requires special oscilloscopes having sweep generators and time markers, and depends for its accuracy upon the interpretation of the oscillograms¹. Accuracy to within about 5 ns is possible.

A later method developed to speed up the measurements used a counter to determine the time taken by a pulse to travel down the line and

return to its starting point². With care in calibration, discriminator settings, and impedance matching, this method gives accuracies of one nanosecond.

All these methods are satisfactory from an accuracy standpoint but suffer from operator error and possibility of misalignment; they are also time consuming and require trained talent to supervise the data taking.

SIMPLER SYSTEM—

The method to be described was originally developed as a chronotron circuit³. Thermionic secondary emission tubes have been used widely for generating pulses in the millimicrosecond range⁴. These tubes have a higher ratio between saturation current and electrode capacitance than ordinary vacuum tubes, with a resultant faster rise time for the same voltage level. They are constructed as shown in Fig. 1A, while Fig. 1B is a typical schematic. The major portion of the primary elec-

trons strike the secondary emitting surface (dynode). The plate, being at a higher potential, attracts these secondary electrons.

With this type of structure, positive feedback can be used from dynode to grid, or plate to cathode, to generate fast rising pulses. Figure 1C is a schematic of the vacuum tube model which was first constructed. Here an EPP-60 secondary emission tube V_1 is connected in a blocking oscillator circuit. A transformer in the plate circuit provides positive feedback to the grid and also couples an output pulse to the cable being measured. The transformer turns ratio is adjusted to give the impedance match.

With the tube nonconducting, a single pulse is applied to the cathode to bring the tube into conduction. The blocking oscillator action then forms a single fast pulse, approximately 10 nanoseconds wide at the base. This pulse propagates down the cable to be measured and returns from the open-circuited end without inversion. The reflected pulse is then coupled into the grid through transformer T_1 , and initiates a new regenerative pulse. The pulse repetition rate (prf) is governed by the length of the cable and the regeneration time of the tube-transformer combination. Any 10-megacycle counter is adequate to measure this frequency, using a period count.

USING AVALANCHE CIRCUITS

—A transistor version of this circuit was also constructed as shown in Fig. 2. Here an avalanche transistor Q_1 in the pulse forming circuit is initially nonconducting. A single-pulse pushbutton furnishes the triggering pulse to Q_1 base. Positive feedback is provided by capacitive coupling to the collector.

Application of the trigger pulse avalanches the transistor and applies this pulse to the cable being measured. The pulse propagates down the coaxial line and is reflected without inversion from the open-circuited far end. Upon returning it is coupled to Q_1 collector, initiating a new avalanched pulse. The prf is governed by the cable length, and the regeneration time in the transistor circuit. A millimeter indicates when the units are operating. If either unit has introduced two pulses or more within the

cable, it will show on the millimeter as increased current.

The vacuum-tube model output couples to the counter through a transformer in the dynode circuit. This method provides isolation from the measuring circuit, as well as a low resistance d-c path for the dynode and pulse shaping for the counter. The transistor pulser uses an extra transistor Q_2 for similar reasons.

CALIBRATION — The regeneration times of these pulsers were found as follows. The pulser output was first connected to 100 nanoseconds of $\frac{3}{8}$ -inch 50-ohm Styroflex (T_1), then started and allowed to run until stable readings were obtained on a 10-second period count. (Only the last two digits of the 10-megacycle counter would change.) The pulser was then connected to T_2 , which was a roll of 100-nanosecond $\frac{3}{8}$ -inch, 50-ohm Styroflex, and another reading taken.

The two cable reels were then connected in series (the connecting jumper was always on one reel) and a third reading, T_{12} , taken. The regeneration time Δt is then $(T_1 + T_2 - T_{12})$. The vacuum tube version regeneration time was 12 nanoseconds, the transistor version 2 nanoseconds.

The effect of differential pulse shape distortion increasing the re-

TABLE—TYPES OF CABLES MEASURED

RG 8/U	50 ohm	Solid dielectric
RG 7/U	100 ohm	Semi-air
$\frac{1}{2}$ inch diam	Foamflex 50 and 100 ohm	Semi-air dielectric
$\frac{7}{8}$ inch diam	Styroflex 50 and 100 ohm	Air dielectric
$1\frac{1}{8}$ inch diam	Styroflex 50 and 100 ohm	Air dielectric
$3\frac{1}{8}$ inch diam	Styroflex 50 ohm	Air dielectric

generation time when long cables are used was investigated. In this case T_1 was 100 nanoseconds of $\frac{3}{8}$ -inch, 50-ohm Styroflex and T_2 was 800 nanoseconds of RG 8/U. The same regeneration times were obtained as stated before.

SHORT CABLES—To measure the delay of short cables it is necessary to include a fixed bias cable of the same impedance. This bias cable can be of any convenient length and its delay need not be known. It serves only to prevent excessive currents from being drawn in the pulsers due to the high duty cycle if the short cables were used directly. A reading is taken on the bias cable, the short cable is then added, and the difference is double the transit time of the short cable. This method was used to determine the delay through a GR 874 elbow, which was found to be 0.2388 nanosecond.

The speed of taking readings

on many cables, and the simplicity and ruggedness of these units makes this measuring method desirable. These techniques also lend themselves to pulsed oscillators, chronotrons, and digital delay applications where they can give many hundreds of seconds of delay with nanosecond accuracy.

The circuits of the transistor model were developed by R. E. Werner and the vacuum-tube version by L. D. Clendenen of LRL, Livermore. This work was performed under the auspices of the U.S. Atomic Energy Commission.

REFERENCES

- (1) R. C. Epps, Coaxial Line Measuring Techniques, Final Report LER 105-1, Mar. 6, 1956.
- (2) A. Villaire and P. Compton, Cable Shooting Using the Method of the Mean of Several Hundred Independent Measurements with the El Dorado, Lawrence Radiation Laboratory Internal Memo to M. McCraven, Dec. 29, 1961.
- (3) Ian Lewis and F. H. Wells, Millimicrosecond Pulse Techniques, Pergamon Press, 1959.
- (4) Jan A. Narud, The Secondary Emission Pulse Circuit; its Analysis and Application, Cruft Laboratory, Harvard University, Cambridge, Mass., April 5, 1957.

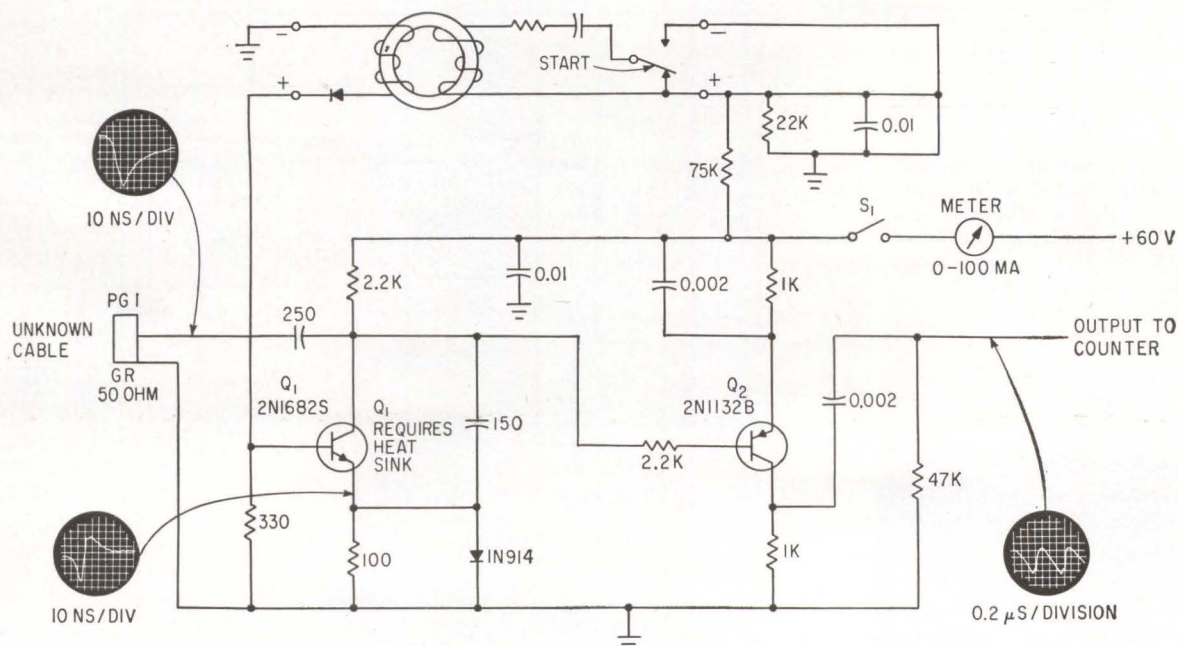

TRANSISTOR VERSION uses capacitive feedback between collector and emitter to provide regeneration. Second transistor shapes the counter pulse; meter in supply line indicates average current; its reading is proportional to pulse recurrence rate—Fig. 2

Novel FEEDBACK LOOP Stabilizes

Performance of audio generator is independent of load or transistor parameters.

AUDIO OSCILLATORS usually have an oscillator section followed by an amplifier to isolate load variations. More efficient use of components can result when the oscillator and amplifier circuits are combined to form a single oscillator stage with sufficient power to drive the load directly. However, load variations must then be considered in the design.

Transistor circuits have the advantages of good reliability, small size, and low power dissipation, but transistors are far less stable than vacuum tubes with respect to temperature changes, operating-point and supply voltage variations.

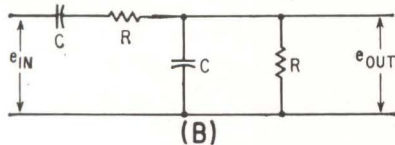
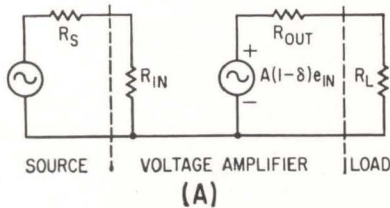

EQUIVALENT circuit of a voltage amplifier with feedback for frequencies not near resonance (A). Frequency determining part of Wien-bridge oscillator used in the audio generator—(B)—Fig. 1

OUTPUT WAVEFORM of the oscillator shows no detectable crossover distortion

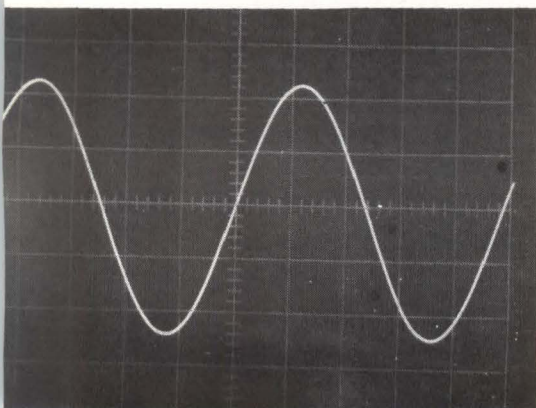

Extensive negative feedback is used in this circuit both to minimize the effects of the unstable transistor characteristics and to make the oscillator independent of load variations. With this feedback the amplifier gain mainly depends on stable resistors. The result is low distortion and excellent amplitude and frequency stability.

OPTIMUM LOOP GAIN — The

performance of a feedback amplifier is usually equated with the ratio of open-loop gain to closed-loop gain, and this leads to the notion that the more loop gain, the better. This is partially true for tube circuits, which closely approach ideal voltage amplifiers, but it can be misleading with transistor amplifiers.

To illustrate the point, consider a voltage amplifier, represented by

LOOP MAKES THE DIFFERENCE

In this generator a negative feedback loop stabilizes not only the oscillator, but the amplifier as well. Using a feedback loop as an amplifier stabilizer is not new; but using a loop to stabilize the oscillator-amplifier combination is, as far as we know, a new approach.

One side advantage of the oscillator with optimum feedback: it can be manufactured cheaply. Its output is largely independent of transistor parameters and transistor sorting is unnecessary

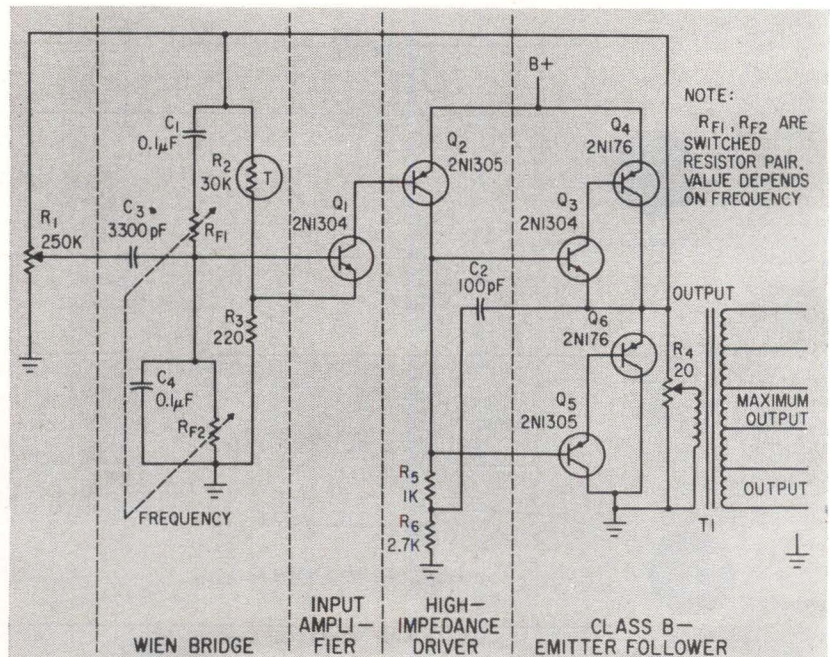

COMPLETE CIRCUIT diagram of the oscillator-amplifier; the negative feedback path goes from the output, to thermistor R_2 and resistor R_5 —Fig. 2

Audio Oscillator

By ROBERT G. FULKS

General Radio Company,
West Concord, Massachusetts

Circuit is economical because transistors need not be preselected

the equivalent circuit of Fig. 1A. The voltage gain of the amplifier in this circuit is approximately equal to the theoretical gain A less an error term $A\epsilon$

$$\frac{e_{out}}{e_{in}} \cong A(1 - \epsilon) \quad (1)$$

$$\epsilon = \delta + \frac{R_s}{R_{in}} + \frac{R_{out}}{R_L} \quad \text{if } \epsilon \ll 1 \quad (2)$$

where R_{in} = the input resistance, $A(1 - \delta)e_{in}$ = a controlled voltage source, A = the ratio of feedback resistors, R_{out} = the output resistance, R_s = the source resistance and R_L = the load resistance. The positive feedback in an oscillator alters this picture at resonant frequency, but becomes less important at other frequencies. It is usually unimportant at the frequencies of the distortion and noise components, so it is valid to consider the amplifier separately.

Since each of the error terms is a function of the nonlinear and variable characteristics of transistors, each should be as small as possible; an optimum amplifier minimizes the three error terms. Thus, by increasing the loop gain, one or more of the terms may decrease but the most important term may be left large.

Consider designing a high impedance emitter follower circuit. The input impedance of one stage is $R_{in} = \beta R_L$. If three stages are cascaded the overall current gain increases to $\beta_1 \beta_2 \beta_3$. However, the collector impedance of the first stage shunts and limits the input impedance to a few megohms; and much higher input impedance with less loop gain can be realized.

PRACTICAL DESIGN—A practical example of optimum feedback amplifier design is seen in the General Radio type 1311-A audio oscillator. The frequency-determining part of its Wien-bridge network is shown in Fig. 1B. The voltage transfer ratio can be written as

$$\frac{e_{out}}{e_{in}} = \frac{1}{3 + j\left(\frac{f_0}{f} - \frac{f}{f_0}\right)} \quad (3)$$

where $f_0 = 1/2\pi RC$ which becomes equal to $\frac{1}{2}$ at the resonant frequency f_0 . To form an oscillator, the overall system gain must be unity; therefore, the associated amplifier must have a voltage gain of +3. This figure is the gain, A , in Eq. 1. The input resistance, R_{in} , should be much higher than the source resistance, R_s , presented by the network, and the output resistance, R_{out} , should be much lower than the load resistance, R_L .

The circuit shown in Fig. 2 is a schematic diagram of the oscillator circuit. The negative feedback path consists of a thermistor, R_s , and a resistor, R_3 . The thermistor, a small bead unit sealed in an evacuated bulb, limits the amplitude of oscillation at a point where the amplifier gain is +3. The complete amplifier is direct-coupled with d-c feedback for good bias stability. Phase-compensation networks are used to insure high-frequency stability as is common in most high-performance feedback circuits.

The power level desired indicated the use of a class-B output stage. To eliminate the crossover distortion without the use of temperature-sensitive bias networks usually associated with class-B circuits, the output stage is driven from a high-impedance driver. This technique is based on the fact that the current gain of a transistor is reasonably constant at low currents, whereas transconductance drops rapidly at low input voltages because of nonlinear input resistance.

The complementary output circuit has a single-ended output and eliminates the need for a closely coupled output transformer.

The single-ended input eliminates the need for a phase splitter or driver transformer. The collector of Q_2 forms the high-impedance

source for driving the output stage. The capacitor C_2 keeps both ends of the collector resistor, R_5 , at roughly the same potential, so it will appear in the circuit as a high impedance.

The characteristics of the complete amplifier are $R_{in} \cong 10$ megohms, $R_{out} \cong 5$ milliohms, and $\delta \cong 0.4 \times 10^{-3}$.

The source impedance presented to the amplifier from the frequency network varies from 15,000 ohms to 80 ohms, depending on the position of the frequency switch, and is 800 ohms at 1 Kc. The load impedance (R_L) reflected by the output transformer at full load is about 6 ohms. Using these values in Eq. 3, the overall error with which the gain ratio differs from ratio of the two feedback resistors is less than

$$\epsilon \approx 0.4 \times 10^{-3} + 0.1 \times 10^{-3} + 0.8 \times 10^{-3} = 1.3 \times 10^{-3}$$

The gain of the amplifier is 99.9 percent dependent on the ratio of resistors, and 0.1 percent dependent on active devices. As a result, variations in the characteristics of transistors due to temperature and line-voltage changes and to aging result only in extremely small changes in the overall characteristics of the oscillator. A frequency is typically changed less than ± 0.01 percent by a ± 10 percent change in line voltage. The effective nonlinearities in the transistors are similarly attenuated, so that the harmonic distortion caused by the amplifier is less than 0.1 percent under these conditions. At low frequencies, the transformer and the time constant of the thermistor add some distortion, while at high frequencies some added distortion is caused by the decreasing current gain of the power transistors.

BIBLIOGRAPHY

- J. R. Macdonald, "Nonlinear Distortion Reduction by Complementary Distortion," *IRE Trans on Audio*, Vol. AU-7 No. 5, September-October, 1959.
J. J. Faran and R. G. Fulks, "High-Impedance Drive for the Elimination of Crossover Distortion," *IRE Trans on Audio*, Vol. AU-10 No. 4, July-August, 1962.

Rapid Evaluation of Complex Receiving Systems

By H. H. REED

Systems Engineer,
Space Systems & Antenna Div.,
Collins Radio Company,
Dallas, Texas

IN THE DESIGN and evaluation of receiving systems, it is often desirable to determine both noise figure and system sensitivity for the units involved. These units may be receiver stages or system components such as preamplifiers, multicou-

plers and receivers.

Noise figure in decibels for cascaded units is given by:

$$F_{db} = 10 \log \left(F_1 + \frac{F_2 - 1}{G_1} + \frac{F_3 - 1}{G_1 G_2} + \dots + \frac{F_n - 1}{G_1 G_2 \dots G_{n-1}} \right)$$

where F_n = Noise figure of n^{th} unit as a power ratio, G_n = Available gain of the n^{th} unit as power ratio.

The nomograph of Fig. 1 gives system noise figure for two units in cascade. Usually, analysis of the first two units or stages will

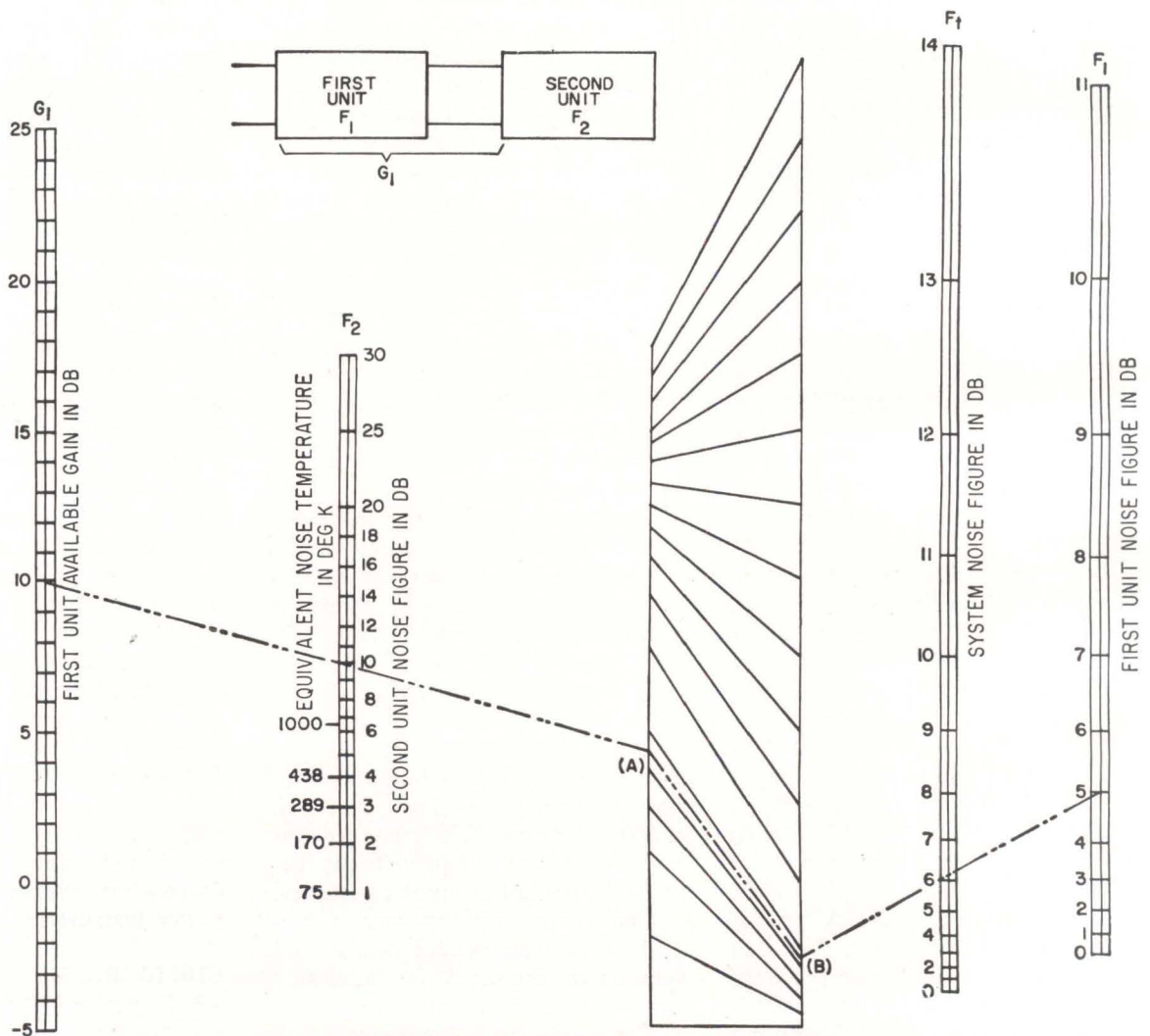

GRAPHICAL DETERMINATION of system noise figure also includes values for equivalent noise temperature—Fig. 1

IN 45 SECONDS

45 DIFFERENT TESTS

150 TEST CONDITIONS!

BETTER
MEASURING
FROM



While originally designed as a system tester for Doppler Radar, the extreme versatility of the Electro Instruments Digital Multimeter permitted Raytheon to check the integrated circuit elements of the Apollo Spacecraft systems. The EI system performed 45 different tests under 150 test conditions in *45 seconds!* These test operations formerly required 45 minutes of manual effort.

As demonstrated by this fully automatic system tester created for Raytheon, your key to greater speed, higher reliability, significant cost savings and lower investment lies in EI *all solid state* Digital Multimeters.

Your desires for similar savings, whether they be in connection with spacecraft, components or purely industrial processes, can be realized with digital measuring. Available to you in this regard are instruments for measuring DC volts, AC volts, DC ratios, resistance, capacitance, inductance and impedance. EI *all solid state* Digital Multimeters provide swift, accurate answers to your measurement and display problems. Put digital measuring to work for you now — the benefits will be worth your while.

For full details on EI's individual digital instruments, or our complete capabilities in the field of measurement, display and recording — write direct in care of Department MA-1.

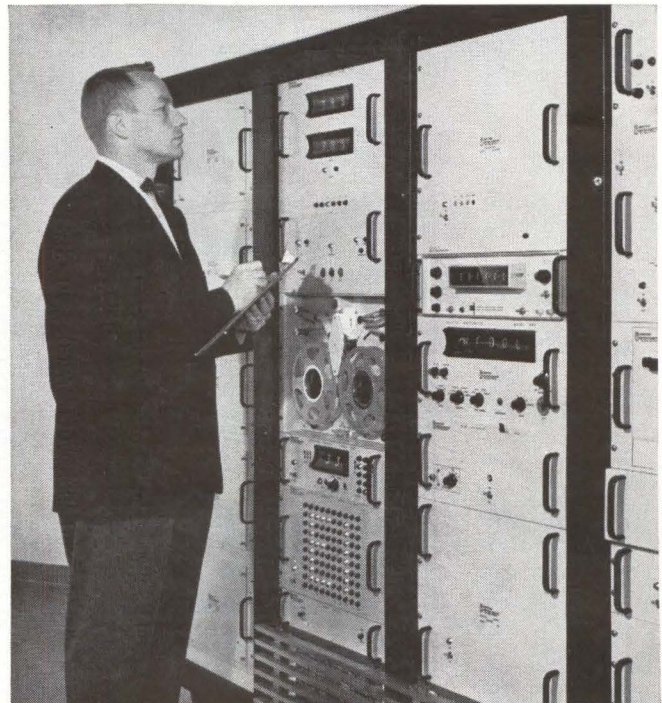

Versatile . . . cost cutting automatic system tester built for RAYTHEON by Electro Instruments.



Electro Instruments, Inc.
8611 Balboa Avenue, San Diego 12, California

SYSTEM NOISE FIGURE AND SENSITIVITY

When receiving system consists of several units in cascade such as preamplifiers, multicouplers and receivers, these convenient nomographs can help evaluate performance as to noise figure and sensitivity. Second unit performance can also be expressed as equivalent noise temperature

provide an accurate noise figure. If more than two units must be considered, the last two units in the signal path should be combined first. For example, if a preamp, multicoupler and receiver are being considered, obtain the system noise figure for the receiver and multicoupler first. Use this noise figure as F_2 in the next operation where the preamp parameters, F_1 and G_1 , become controlling factors.

In Fig. 1, the second-unit-noise-figure scale also has values shown in equivalent noise temperature.

System sensitivity in $-dbm$ may be determined from: $-dbm = 144 - 10 \log BW_{kc} - F_{db} - 10 \log (T/290)$ where $-dbm =$

sensitivity in decibels below one milliwatt, BW_{kc} = effective bandwidth of the last i-f in kc, F_{db} = noise figure in decibels and T is temperature in degrees Kelvin.

Figure 2 is a nomograph by which system sensitivity may be rapidly determined; if the temperature is other than room temperature, 290K, the value on the temperature scale may be used to modify the sensitivity.

The sensitivity scale for an ambient temperature of 290K is also scaled in microvolts across a 50-ohm resistive load at the system input terminals.

The sensitivity indicated is that required to produce an output signal-to-noise ratio of 0 db, or 1:1.

For example, assume a preamplifier with 12 db gain and 5 db noise figure, connected by a transmission line to a receiver having a noise figure of 10 db. The last i-f stage of the receiver has a bandwidth of 1.0 Mc. At the frequency of interest, the transmission line has 2 db of attenuation. Available preamp gain is 12 db - 2 db = 10 db. In Fig. 1, a line through the 10 db points on the G_1 and F_2 scales intersects the scaling column at point A and is scaled to its equivalent, point B. A straight line between point B and 5 db on the F_1 scale intersects the F_1 scale at 6 db, the system noise figure.

The sensitivity is obtained by drawing a line on the nomograph of Fig. 2 through the 6-db point on the noise-figure scale and the 1 Mc point on the bandwidth scale. This line intersects the sensitivity scale at -107 dbm or 1.0 microvolt across 50 ohms.

If the temperature rises to 400K, the system sensitivity is degraded to approximately -105 dbm.

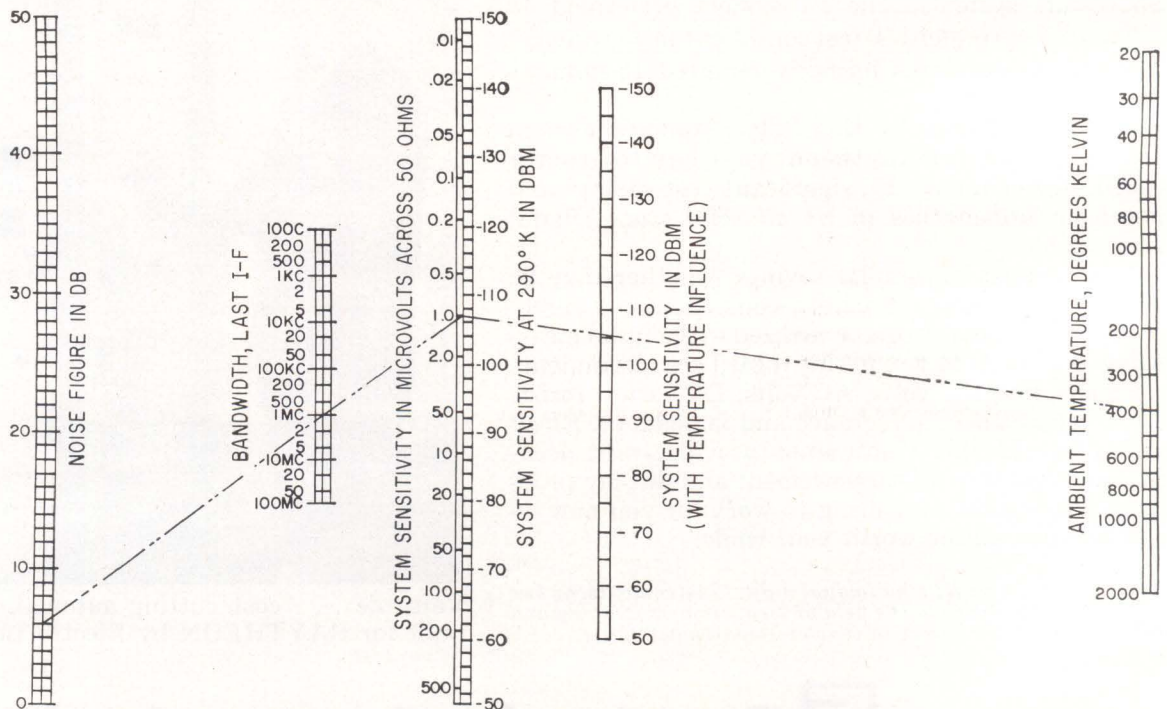

WIDE-RANGE temperature scale allows rapid determination of system sensitivity under varying conditions—Fig. 2

...from the house of zeners



Hot 'n Cold Baths at  **semcor**

NEW SEMCOR-DESIGNED TEST CONSOLE FOR TEMPERATURE COMPENSATED REFERENCE ELEMENTS

QUESTION: what do you do when you've invented a product so new that no existing test facility is adequate?

ANSWER: invent one!

And that's exactly what happened when this question came up recently at 3540 West Osborn Road in Phoenix, Arizona ... home of Nuclear Corporation of America's U.S. Semcor Division.

Semcor, a pioneer in the original development of the diffused junction temperature-compensated reference element ... developed a reference element so new that it was years ahead of present testing facilities.

As a result, Semcor personnel designed and built a unique new Semcor exclusive: a testing console consisting of precision-controlled temperature baths. These baths take the reference elements from -80°C to $+200^{\circ}\text{C}$.

Once again, Semcor's Three R's ... Research, Reliability and Results ... have accomplished not only greater reliability for one of the most important devices in the component industry, but a significant step toward the automation of precision-controlled testing for this type of precision device.

Precision-manufactured with the emphasis on reliability, Semcor's TCRE offers the industry's widest temperature range: -55°C to $+185^{\circ}\text{C}$... temperature coefficients as low as $.0005\%/^{\circ}\text{C}$ over wide range. Flangeless package design permits easier application in printed circuits. Also available with protective Semcoat finish. **For further information and data sheets ... clip and mail coupon below.**

U. S. SEMCOR
3540 W. OSBORN ROAD
PHOENIX 19, ARIZONA

Please send Data Sheets on 

Semcor-tested Temperature-compensated Reference Elements

NAME _____

ADDRESS _____

CITY _____ ZONE _____ STATE _____

COMPANY _____

TITLE _____

Your nearest representative is waiting to show you how Pioneering Pays Off ... at Semcor!

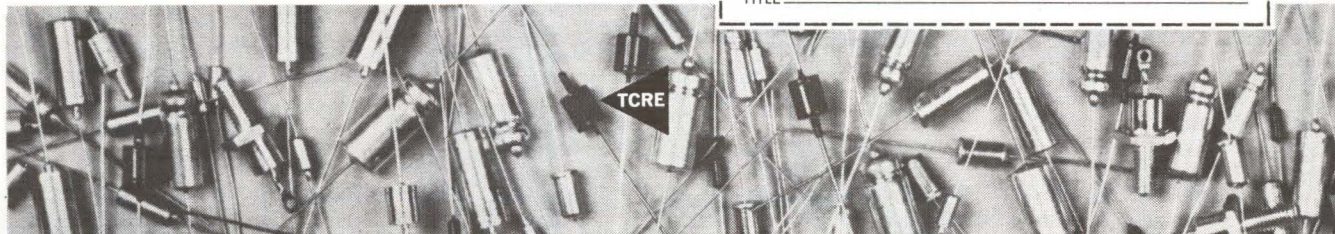

New Telemetry Antenna Adds Flexibility

Dipole flat plate array overcomes problems of end-fire antennas

VHF ANTENNA arrays of end-fire elements, commonly used for tracking applications, exhibit both electrical and mechanical limitations. The electrical limitations stem from the high sidelobes associated with end-fire arrays, and the shift of electrical boresight with frequency and polarization. The mechanical limitations, resulting from the overhung mass of the end-fire elements, are large moments of inertia, cross-section and swept volume. A program undertaken by Rantec to develop a more sophisticated type of antenna resulted in the array shown on the cover. This antenna, called a Dipole Flat Plate Antenna (DFP) is based on a de-

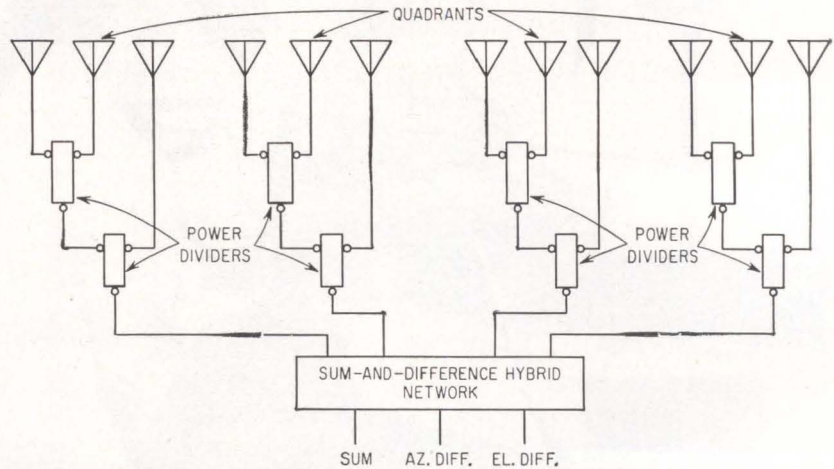

CORPORATE FEED structure supplies all four quadrants from sum-and-difference network—Fig. 1

sign concept that permits flexibility to meet specific requirements.

Electrically, the DFP antenna is an array of orthogonal dipole elements spaced to generate only one

principal beam. The antenna aperture is divided into four quadrants, and the dipoles in each quadrant are fed by a corporate structure using suitable power dividers. There are two feed structures for each quadrant; the four quadrants are then combined in a standard sum-and-difference hybrid network (see Fig. 1).

It is the array concept that gives the DFP its desirable characteristics. The synthesis of an aperture using an array of discrete sources yields the most complete aperture control obtainable, according to Rantec. The theoretical work can be used to obtain either the lowest sidelobe level for a given beamwidth, or the narrowest beamwidth consistent with a prescribed sidelobe level. The antenna can therefore be optimized for a particular application. For example the DFP antenna shown was designed for minimum sidelobes in the sum channel principal planes; the measured patterns show a sum-channel sidelobe level of -28 db (see Fig. 2).

Almost as important as aperture control is the high efficiency of the array-type antenna, especially for aperture sizes of only a few wavelengths. The aperture blocking associated with the feed structure of

Transparent Phosphor Improves CRT

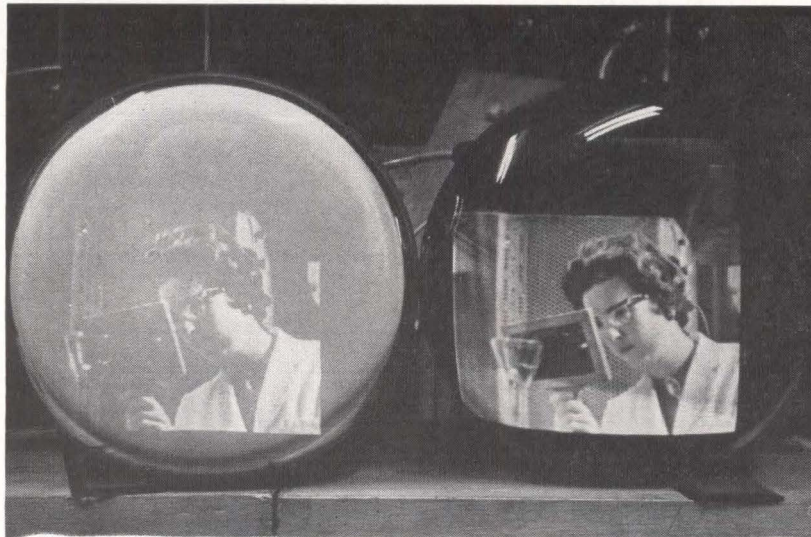

HIGH CONTRAST obtained from a transparent phosphor tube is shown above, right, compared to conventional cathode-ray tube, left, photographed in bright ambient light. Developed at Hirst Research Centre of the General Electric Co. in Wembley, Middlesex, England, the phosphor is vacuum-deposited on the tube faceplate. Tube is then baked to render the screen luminescent, and the phosphor is then coated with a black backing to absorb extraneous light and conceal the hot cathode.

NEW FROM EAI!



Solid-State, High Speed, Ultra-Stable, Automatic, Programmable AC/DC DVM for \$6,250

Key specifications of the outstanding new EAI Series 5002 AC/DC solid-state digital voltmeter are:

- Range and Resolution: 0.0001 to 1199.9 volts
- Absolute Accuracy, DC: $\pm 0.01\% \pm 1$ digit, AC: $\pm 0.06\% + 1$ digit to 5 kc, $\pm 0.1\% + 1$ digit to 10 kc
- Stability: 6 months without recalibration
- Reading time max., DC: 10 ms.**, AC: 160 ms.**
- Input impedance, DC: 10 megohms constant, AC: 1 megohm resistive
- Size: 8 1/4 inch by 19 inch RETMA panel

Features include automatic ranging or remote command of range, function, trigger, etc.; complete electrical outputs; overrange protection; in-line, in-plane display; and simple DC calibration for both AC and DC inputs.

**without range or polarity change

Other EAI solid-state instruments with comparable resolution, accuracy, stability, speed and reliability are:



Series 5000 4 digit DC voltmeter

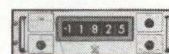

Series 5001 4 digit with overrange, automatic and programmable DC voltmeter



Series 5101 4 digit with overrange, automatic and programmable DC volt-ohmmeter

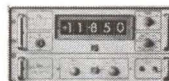

Series 5003 4 digit with overrange, automatic and programmable AC/DC volt-ohmmeter

Write today for detailed descriptive literature.

EAI

ELECTRONIC ASSOCIATES, INC. Long Branch, New Jersey



Private Eye Protection

SOLID TANTALUM CAPACITORS WITH CONSISTENTLY HIGH QUALITY

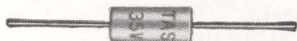

Mallory Type TAS series sets new standards of reliability . . . consistently meet MIL requirements for electrical and environmental characteristics. Four MIL sizes, .33 to 330 mfd, 50 to 6 volts. Write for Bulletin 4-40E.

Literally dozens of private eyes at our plant at Greencastle, Indiana, take a hard, close look at every tantalum capacitor we make. All the way from raw tantalum powder or foil to complete capacitor, Mallory inspectors were watching, measuring, testing, checking. And there were dozens of "mechanical eyes", too, in our testing processes—automatic machines that supplement human eyes to pass judgment on every capacitor we make . . . to probe, measure, classify, accept or reject.

The result: consistently high quality. Our Type TAS solid tantalum line, for example, checks out with stability, DC leakage, dissipation factor and environmental performance well within MIL specs—on *every* lot.

Exact methods of quality control are typical of the advanced facilities we have engineered into our Greencastle plant . . . first in the industry to be built exclusively for tantalum capacitor production, and first to fly the Signal Corps RIQAP pennant. Find out about the superior products that this plant produces, by writing to Mallory Capacitor Company, Indianapolis 6, Indiana . . . a division of P. R. Mallory & Co. Inc.

WET SLUG, FOIL AND SOLID TANTALUM CAPACITORS

P. R. MALLORY & CO. INC.
MALLORY

CIRCLE 50 ON READER SERVICE CARD

Mallory tantalum capacitors delivered from stock at factory prices by these distributors:

- Baltimore, Md.**
Radio Electric Service
- Binghamton, N.Y.**
Wehle Electronics
- Birmingham, Ala.**
MG Electronics & Equipment Co.
- Boston, Mass.**
Cramer Electronics
DeMambro Radio Supply Co.
Lafayette Radio
QPL House, Inc.
- Bridgeport, Conn.**
Westconn Electronics
- Buffalo, N.Y.**
Summit Distributors, Inc.
- Chicago, Ill.**
Allied Electronics Corp.
Newark Electronics Corp.
- Cincinnati, Ohio**
United Radio
- Cleveland, Ohio**
Pioneer Electronics
- Dallas, Texas**
Engineering Supply Co.
Hall-Mark Electronic Corp.
- Dayton, Ohio**
Stotts-Friedman Co.
- Denver, Colo.**
Denver Electronics
- Houston, Texas**
Harrison Equipment Co., Inc.
Lenert Company
- Indianapolis, Ind.**
Graham Electronics
- Los Angeles, Calif.**
California Electronics
Kierulff Electronics, Inc.
Lynch Electronics
Radio Product Sales
- Minneapolis, Minn.**
Northwest Electronics Corp.
- Montreal, Que.**
Canadian Electrical Supply Co.
- Muskegon, Mich.**
Fitzpatrick Electric Co.
- Nashville, Tenn.**
Electra Dist. Co.
- Newark, N.J.**
Lafayette Radio
- New York, N.Y.**
Harrison Radio Corp.
Harvey Radio Co., Inc.
Lafayette Radio
Milo Electronics
Terminal Hudson Electronics
- Oakland, Calif.**
Elmar Electronics, Inc.
- Oklahoma City, Okla.**
Radio, Inc.
- Orlando, Fla.**
East Coast Electronics
- Ottawa, Ont.**
Wackid Radio-TV Lab.
- Palo Alto, Calif.**
Zack Electronics
- Perth Amboy, N.J.**
Atlas Electronics
- Philadelphia, Pa.**
Herbach & Rademan
Philadelphia Electronics
- Phoenix, Ariz.**
Kierulff Electronics, Inc.
- Pittsburgh, Pa.**
Radio Parts Co.
- Salt Lake City, Utah**
Kimball Electronics
- San Antonio, Texas**
Perry Shankle
- San Francisco, Calif.**
Kierulff Electronics, Inc.
- St. Louis, Mo.**
Olive Electronics
- Seattle, Wash.**
F. B. Connelly Co.
- Springfield, N.J.**
Federated Purchaser, Inc.
- Tampa, Florida**
Thurow Electronics, Inc.
- Toronto, Ont.**
Alpha Aracon Radio Co.
Electro Sonic Supply
Wholesale Radio & Electronics
- Tulsa, Okla.**
Engineering Supply Co.
- Washington, D.C.**
Capitol Radio Wholesalers
Electronic Industrial Sales
- White Plains, N.Y.**
Westchester Electronic Supply Co., Inc.
- Winston-Salem, N.C.**
Electronic Wholesalers Inc.

CIRCLE 51 ON READER SERVICE CARD

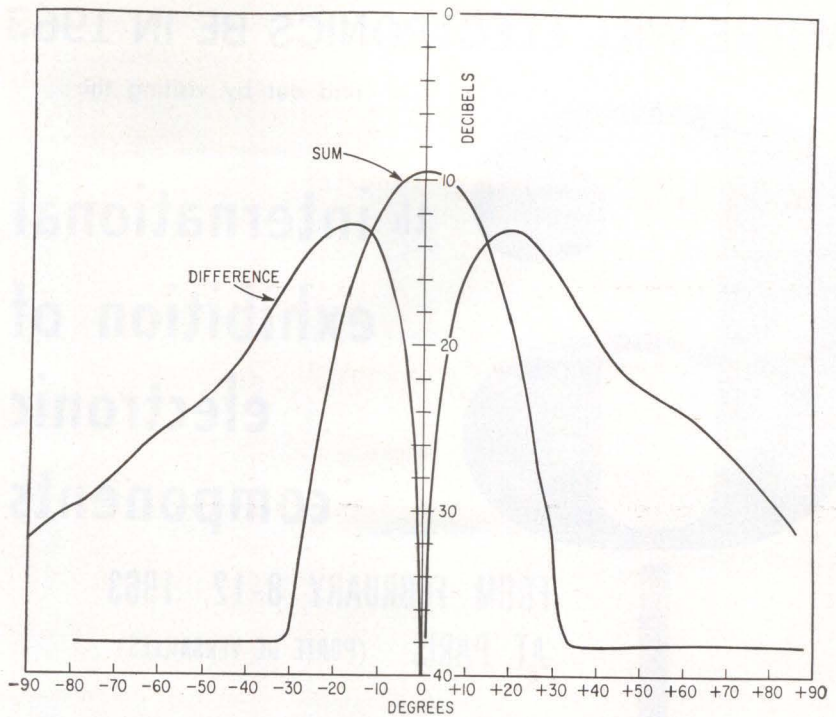

AZIMUTH PATTERN for horizontal polarization of beam, at a frequency of 237 Mc—Fig. 2

paraboloids is completely eliminated. The 12-foot aperture has a measured efficiency of 80 percent at 237 Mc at the sum channel output of the sum-and-difference hybrid network.

CROSSED DIPOLES — Use of crossed dipole radiators permits complete polarization diversity. The two linear polarizations are inherently available from the separately fed orthogonally oriented dipole elements. These may be combined as desired to produce any polarization; the most common uses are right and left hand polarization, which are obtained most simply by a 3-db hybrid junction having 90 degrees phase shift.

Although most commonly used as a simultaneous lobing antenna, the DFP antenna provides tracking flexibility in that any of the common tracking methods can be used, such as sequential lobing and conical scanning. The crossover level can be varied simply and, since scanning is electrical, the scanning speed is easily varied.

Mechanically, the DFP antenna consists of a number of pressurized crossed dipole radiators attached to a grid of trusses covered with a ground screen. The design results in a rigid structure of flat form

factor with a relatively thin cross section (about 2 feet). The rigid structure, coupled with the low crossed dipole radiators, combine to give a stable electrical boresight. Measured shift with frequency 215-260 Mc is 0.3 degrees, total spread, and with polarization, 0.2 degrees, total spread.

The flat configuration makes it possible to mount the antenna with its center of gravity close to the axis of rotation. This reduces the required amount of counterweight, giving a twofold reduction in the overall moment of inertia. The flat form factor also permits mounting of components such as hybrids, power splitters, preamplifiers and filters on the back surface so that the entire antenna is dynamically balanced around the two axes. The packaging and the reduced inertia result in either a reduction in complexity and power of the servo system, or, alternatively, in an increase in maximum scan or slewing speed. In severe winds the array can be stowed so that it lies in the horizontal plane and presents a minimum cross-sectional area to the wind, according to Rantec.

Because of its flexibility with regard to aperture control, polarization diversity and method of tracking, the dipole array antenna is well

WHERE WILL ELECTRONICS BE IN 1963?

find out by visiting the

6

th international exhibition of electronic components

FROM FEBRUARY 8-12, 1963
AT PARIS (PORTE DE VERSAILLES)

THE GREATEST WORLD-WIDE EXPOSITION OF THE ELECTRONICS INDUSTRY

Components, tubes and semiconductors,
measurement & control instrumentation
electro-acoustical equipment



Send Now For Full Details

FEDERATION NATIONALE DES INDUSTRIES ELECTRONIQUES

23, rue de Lubeck, Paris—16e—Tel: PASsy 01-16

3rd international congress of quantum electronics

Under the auspices of the French Section
of the I.R.E. and the S.F.E.R.

From FEBRUARY 10-15, 1963
MAISON DE L'UNESCO
Information: 7, rue de Madrid—Paris 8e

suitable for vhf applications that require a medium-gain antenna (18 to 20 db). The low sidelobes, high aperture efficiency, flat form factor, low moment of inertia and small cross-section particularly suit the antenna for shipboard installation.

Weapon Design Models Are Tried Out in Simulator

PASADENA, CALIF.—Combined analog and digital computer system is simulating submarine and torpedo characteristics for antisubmarine warfare research at the hydrodynamics simulation facility of the U.S. Naval Ordnance Test Station.

The system, employing a Univac 490 real-time digital computer, presents active and passive acoustic characteristics of a submarine, and a simulated water environment for the torpedo and its target. Relative torpedo-target acoustic information permits the torpedo to search, detect, and home on the simulated target.

The analog system defines parameters used to design weapon hardware. The breadboard then replaces its analog equivalent in the simulation and while analysis con-

Relay Tracker

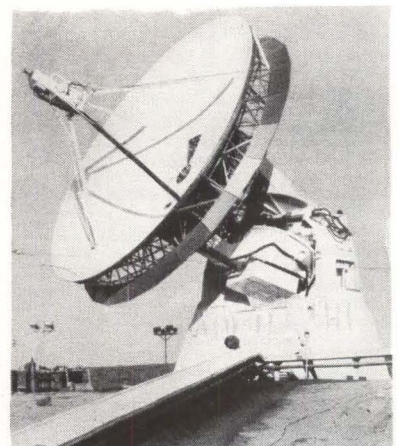

OVERHEAD tracking and communications with Relay satellite will be the specialty of this 40-foot-dish antenna system. It will be the Relay project's western terminus near Barstow, Calif. Built by Philco for NASA, it has a double-elevation mount, does not move in azimuth. Three-channel monopulse receiver, servo and digital equipment are all solid-state

tinues, is modified until the desired results are achieved. This smooths the transition from mathematical model to hardware.

Test runs show that the system duplicates water results almost perfectly, reducing the number of sea runs required and eliminating ship and shore equipment and target submarines previously necessary for testing.

Infrared System Tracks Missiles During Launch

HIGH RESOLUTION infrared tracking system developed by ITT has been installed at Cape Canaveral to track space vehicles during launch when ground signal returns interfere with radar.

The system uses a high degree of background suppression because of the brightly lighted cumulus clouds frequently encountered in Florida. It is equipped to handle dynamic ranges of 100,000:1 due to its close proximity to large missiles at launch and the requirement to track small missiles at great range. One detector cell provides radiometric and tracking information.

The optical unit is mounted on an AN/FPS-16 radar pedestal, and guides the pedestal until radar tracking is reliable.

Automatic Camera Will Plot Meteorite Trails

PHOTOELECTRIC SENSORS will control a network of cameras being built to photograph shooting stars and trace their paths. Cameras will operate only on clear nights. One sensor at each camera station will turn on power when the sky is dark enough. Another sensor will find out if the weather is clear by checking visibility of the North Star.

The network will consist of 16 stations about 150 miles apart across seven Midwestern states. Photos are expected to add to information on meteors and their origin, and to help plot landing points on earth. The net is being established by the Smithsonian Astrophysical Observatory with a \$240,000 grant from NASA.

Fred Roberts can show you ...

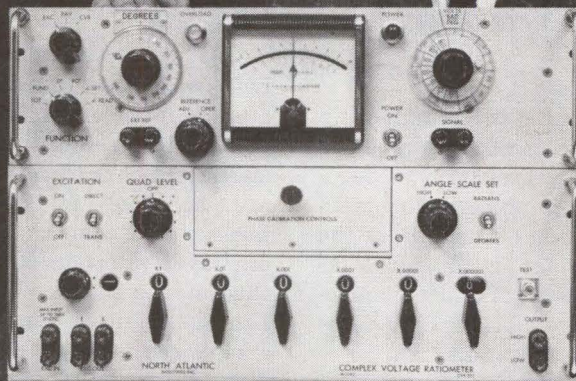

Director of Marketing, North Atlantic Industries

how to measure ac ratios regardless of quadrature

North Atlantic's Complex Voltage Ratiometer is a completely integrated test set for measuring grounded 3 terminal networks. By providing self-calibrated quadrature injection, the Model CVR-551 permits calibrated meter readings of phase angle up to 30° or 300 milliradians full scale, and, in addition, provides direct readings of in-phase and quadrature voltages. As an added feature, the integral Phase Angle Voltmeter* and AC Ratio Box can be used independently. Abridged specifications follow:

In-Phase Ratio Range, R_I 000000 to ± 1.111110 with full accuracy
Phase Angle Range, α ± 1.0 to ± 300 milliradians
 ± 0.1 to $\pm 30^\circ$
 (in 6 calibrated ranges)
Frequency Any specified frequency, 50 cps to 3KC
Input Ratio Error, R_I $\pm (.001 + \frac{.0001}{R_I} + \delta \tan \alpha)$ % of reading
Phase Angle Error, α $\pm .0003$ radians or $\pm .017^\circ$ (low ranges)
 $\pm 3\%$ full scale (high ranges)
Phase Angle Voltmeter* (independently used) $\pm 2\%$ full scale
 1 millivolt to 300 volts
 (in 12 calibrated ranges)
A.C. Ratio Box (independently used) 1 ppm terminal linearity
 $.35f$ (300 volts max)

North Atlantic's CVR* line includes 2 and 3 frequency models. All models available with optional 10 ppm Ratio Box control of quadrature injection.

Send for data sheet or contact your local North Atlantic sales representative now for complete information.

*Trademarks



NORTH ATLANTIC industries, inc.
 TERMINAL DRIVE, PLAINVIEW, L. I., NEW YORK • Overbrook 1-8600

Interconnections Pose Design Problems

Situation aggravated by rapid advance of modern circuits and new blocks

PROBLEM of interconnecting miniature components and modules for high-density packaging is forcing industry to experiment with various approaches to minimize the space needed for conductors, increase reliability of such connection and arrive at low cost techniques for mass production.

Despite concentrated development work in this field, only a few novel methods of interconnection have reached the production stage.

The electronics industry is now at a crossroads in selecting interconnection systems which will fit requirements for the new generation of electronic equipment. De-

signers are still faced with the fact that entire circuits of a system now weight less than the interconnection board.

One space-saving approval that has been used successfully is to stack a number of thin layers of printed interconnections, one above another. Connection between layers are achieved by plated-through holes which connect the circuit of one layer to others and to the surface of the board. This technique has been used successfully by Photocircuits, Inc. of Glen Cove, New York, in their Encapsulayer boards. Demand for further space savings have resulted in miniaturized manufacturing processes having smaller minimum spacings between layers, smaller holes and etch lines, and more compatible techniques for interconnecting integrated circuits, such as Fair-

child's Micrologic and Texas Instruments' Solid Circuits.

Some mass production problems still have to be solved by Photocircuits to meet demands of modern integrated circuits, but company plans to ready production on miniaturized manufacturing processes for their Encapsulayer circuits within the next month or so.

WEAK LINK—Representatives of about 40 companies were recently invited by Photocircuits to air their needs and present their interconnection problems. And the consensus of opinion is that interconnections are now the weak link in the reliability chain.

Progress is being made, however, in several areas. Sal DeNuzzo of Hazeltine reported on the weight and space problem, and announced that his firm is getting etch lines for connections down to 3 mils in width using half-ounce copper. At present copper foil thicknesses most widely used are 0.00135 in. which weighs one ounce per sq ft of area; and 0.0027-in., which weighs two ounces per sq ft of area. The 3-mil etch lines are about 6 months away, according to DeNuzzo, and Photocircuits will incorporate these techniques in miniaturized interconnections.

EXPENSE—One unsolved problem for interconnections involves efficient techniques for solving expensive design the layout of interconnecting boards. Specialists are trying to evolve computer programming techniques to determine practical design for multilayer interconnections. Right now logic diagrams for complicated systems are difficult to figure out efficiently. Automatic checkout techniques are needed to check complicated wiring configurations. Computer programming can be a boon to circuit design. It was reported that IBM has been working on the problem for some time, and some of their men have worked out interconnection

Duplexer Operates In Excess of 1 Mw

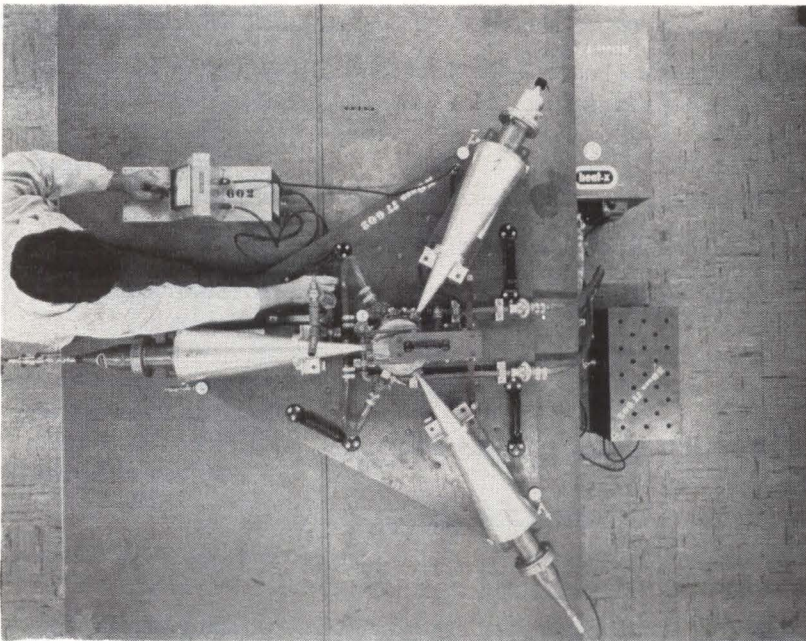

HIGHEST level of operation attained by Y-circulator is claimed for experimental model shown above. Model was designed for shipboard radar, enables transmission and reception on same antenna. Unit was designed and built by Electronic Communications, Inc., further work is now in progress on other versions

ASCOP multiplier phototubes

INSENSITIVE

to 400 G's during launch

SENSITIVE

from 1100 to 13,000 Å in orbit

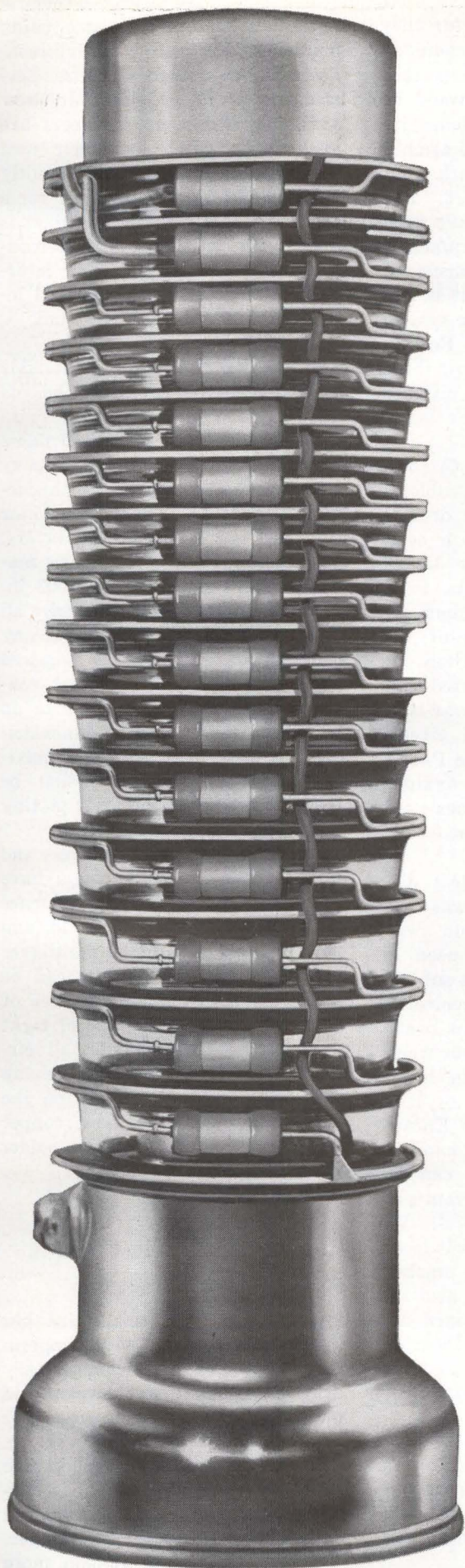

Now, from the Princeton Division of Electro-Mechanical Research, Inc., comes a line of multiplier phototubes that are ideal for aerospace applications or other uses that demand a combination of brute strength and precise response.

ASCOP multiplier phototubes have proved themselves in many satellite applications, as well as in the rough-and-tumble environment of oil field exploration. Their unique vertebrate construction enables them to withstand up to 400 G's of shock and ambient temperatures as high as 150° C. Yet their range of spectral response is unmatched in the industry.

When you specify ASCOP multiplier phototubes, you have a wide range of choices which gives you almost unlimited application flexibility. You can choose, for example, from 22 basic models, or you can consult with EMR's technical staff on a design especially tailored to your application. You have a choice too among a wide variety of window material, including glass, sapphire and lithium fluoride. These materials matched with the proper photo cathode can give you a sensitivity from 1100 to 13,000 Å. You also have a choice of silastic rubber or other materials in which the voltage divider network will be encapsulated.

Best of all, there's no speculation about the performance level of your ASCOP photomultiplier. Every tube is individually factory calibrated, and shipped with a "pedigree" of guaranteed performance data that eliminates field recalibration. These data include spectral response, dark current, and voltage/gain characteristics.

Get the complete story on EMR's ASCOP multiplier phototubes. For information that will help you select a tube that's right for your application, fill in the coupon below.

**ELECTRO-MECHANICAL
RESEARCH, INC.**

Princeton Division
Princeton, N. J.



Sec. 114
Electro-Mechanical Research, Inc.
Princeton Division, Princeton, N. J.

- Please send me more information about your multiplier phototubes.
- Please send me information about your neutron generators.
- Please have a salesman call on me.

Name _____ Title _____
Company _____
Address _____
City _____ Zone _____ State _____

Acoustical Components of Superior Quality

JAPAN PIEZO supplies 80% of Japan's crystal product requirements.

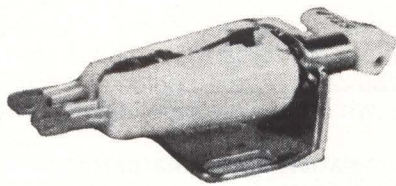
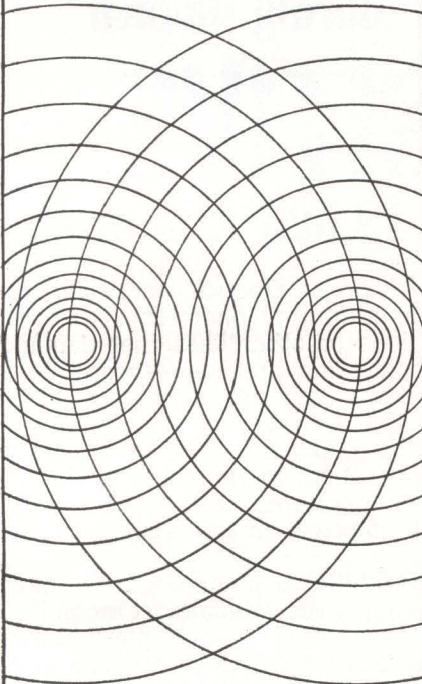

STEREO CARTRIDGE

Crystal — "PIEZO" Y-130

X'TAL STEREO CARTRIDGE

At 20°C, response: 50 to 10,000 c/s with a separation of 16.5 db. 0.6 V output at 50 mm/sec. Tracking force: 6 ± 1 gm. Compliance: 1.5×10^{-6} cm/dyne. Termination: $1M\Omega + 150$ pF.

Write for detailed catalog on our complete line of acoustical products including pickups, microphones, record players, phonograph motors and many associated products.



**JAPAN PIEZO
ELECTRIC CO., LTD.**

Kami-renjaku, Mitaka, Tokyo, Japan

design mathematically. This work sounds impressive, but so far they have kept this work under company wraps. Photocircuits reports that an IBM 7090 Computer would be needed to program problems involved in efficient design of complicated printed wiring networks, but right now cost is too high. Bell Labs reported that they have been working on wiring programming for about 5 years. Consensus of opinion is that right now it is less expensive to use a two-man system for checkout of circuits. Feeling was expressed that right now there is no economic incentive to produce the entire circuit system by using computers.

The Institute of Printed Circuits is working on multilayer problems involved in printed circuit design, and this group will form a committee that will investigate design needs for multilayer circuits, techniques that will lead to sound design, and a consideration of the possibility for standardization.

L. L. Grant of MIT reported that one company is using Kovar-laminated sheets for printed circuit boards, and engineers at the Photocircuits Seminar seemed anxious to be familiar with processes used in working with the Kovar.

WELDING—Another subject discussed at the seminar was the strong move underway to do away with soldering techniques used in printed circuits. The whole subject of soldering vs welding seemed to be an explosive one. Circuit board engineers also discussed laser welding and thermocompression bonding.

Right now Photocircuit's Encapsulayer techniques can accommodate a three-layer circuit that can be kept to a weight of one gram per sq. inch. According to J. W. Kopesky of RCA, his group is looking into connections for smaller size boards. His group is also investigating semispherical board design, and techniques for incorporating flexible boards. Similar interest was expressed by NASA engineers.

Opinion expressed by some engineers attending the Photocircuits seminar was that the graphic approach, using epoxy base materials to interconnect modules might be good for 4 to 5 years.

It was reported that both General Dynamics and Aerojet are using machines that will weld interconnections to printed circuits. Several new welding devices are now available, and some engineers are exploring welding for their own needs. Many modules are presently being made by welding, but some engineers feel that this method is limited to intramodular interconnections. Past attempts to interconnect modules by this method into larger units did not work out.

STANDARD LAYERS—Materials used in designing multilayer boards utilizing the plated-through holes technique include G-10, G-10 flame retardant (FR-4) or G-11 epoxy glass base. For standard manufacturing process copper conductor thickness is 2 oz. on internal layers. Thickness of individual base material layers can be from 0.003 in. to 0.012 in. One board can have all layers of the same thickness or any combination of thickness required by electrical or dimensional considerations. Any shape or size up to 22 in. in the longest dimension can be manufactured. The maximum overall thickness cannot be more than 3 times the after plating diameter of the small hole.

Encapsulayers with 20 layers and up to 0.150 in. in thickness have been manufactured. Any sequence of circuit, ground or shield and power layers within the multilayer board is possible. Circuits can be placed on both outside surfaces of the board, but in the case of tight dimensional requirements, all circuits must be encapsulated leaving only pads or landless holes on the surface. Plating is now copper nickel gold. Copper nickel solder will be available soon.

New Dielectric Coolant Now In Production

SILICONE fluid that maintains low dielectric losses over wide temperature range is now commercially available. Coolant was developed to meet requirements of proposed Air Force spec MIL-S-27875.

Fluid has operating temperature range of -130 to 400 F. Low viscosity permits higher pumping rates and gives rapid heat transfer. Viscosity is said to remain more

uniform with temperature changes than any organic fluid. Fluid has only 4 percent weight loss after four hours at 392 F. Fluid, known as Dow Corning 331, provides a dielectric environment that protects electronic systems from effects of high altitude, humidity or air-borne contamination.

The coolant has been field evaluated for several months, is now in full production at Dow Corning's Midland, Michigan plant.

Using Scrap Silicon

SCRAP silicon, heretofore considered as waste, can be converted to usable material, according to Geoscience Instruments Corp., N. Y. C. Company offers a process to salvage endpieces and scrap silicon obtained in slicing. Pieces are sorted and returned double-face lapped wafers, either to exact specifications or about 2 mils thicker than final requirements. All unusable scrap is returned.

A minimum of 2,000 scrap and endpieces have to be supplied. While company offers no guarantee on yield or delivery on production runs, they claim yields approach 80 percent. Charges are made for good slices only.

Company reports that several device manufacturers are utilizing this service, while licensing agreements are being negotiated.

Adhesive Connections Speed Circuit Assembly

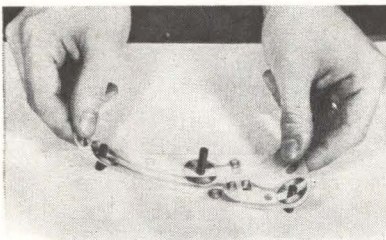

SELF-ADHESIVE circuits hold foil pieces in exact alignment and insulate the surface. Technique may be mass produced to exact tolerances, according to Morgan Adhesives Co., Stow, Ohio. Circuits are made of copper or aluminum foil. A piece of self-adhesive Mylar on the face of the circuit protects the foil from abrasion and increases the adhesive area for a tighter bond.



ACTUAL SIZE

MIDGET TOOLS FOR MINIATURIZED WORK!

Midget tools for work on miniature assemblies are another Utica specialty. We have designed and stock the industry's broadest line of midget pliers and other special hand tools for working with ease in the most confined places. All are precision, finely finished tools. All are backed by famous full guarantee. See for yourself! Contact your Utica distributor or write for our latest hand tool catalog.

**Utica Drop Forge and Tool Div.
Kelsey-Hayes Company
Orangeburg, S. C.**

tools the experts use!

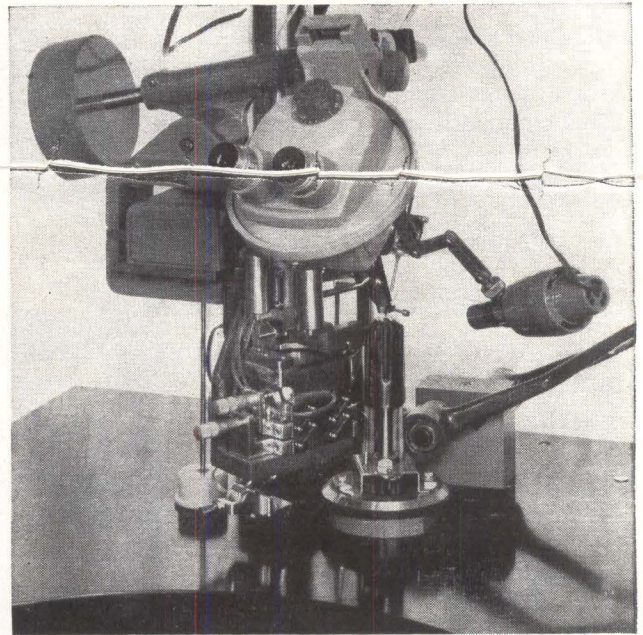
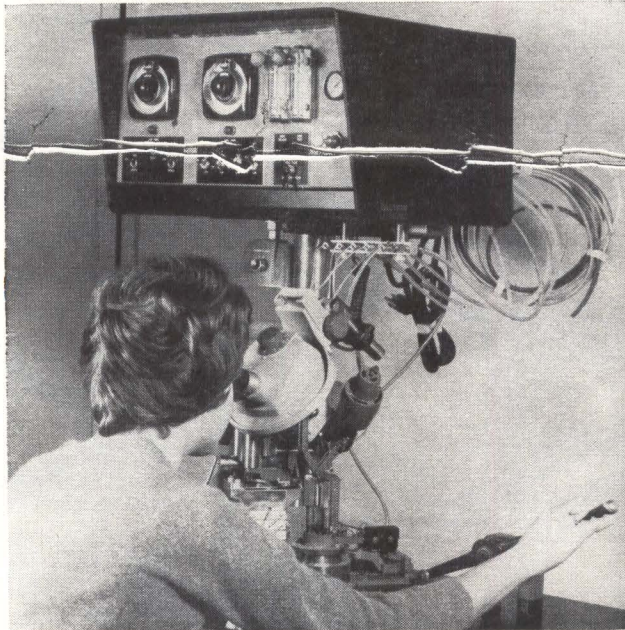

BIRD-BEAK bonding tool and wire feed are positioned with "chessman joystick" riding on table and "z-lever," both shown in close-up at right. Close-up also shows bird-beak tool, heating column and micrometer and adjusted weight mechanisms for setting bond force from 0 to 250 grams

Machine Simplifies Bonding Process

Uniform control enables wire cutoff right next to bond

By DELMAR RING

Kulicke and Soffa Manufacturing Co.
Fort Washington, Pennsylvania

MECHANICAL PROGRAMMING of thermocompression bonding of lead wires to transistors, microcircuit components and terminal posts

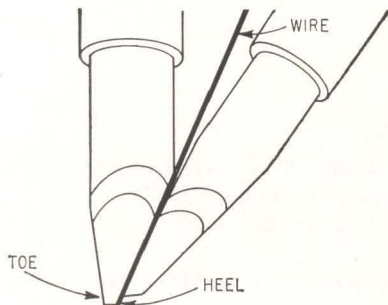

GROOVE in bonding surface of bonding tool's left jewel goes from toe to heel and up side. Wire-feed tube is formed when other jewel is clamped against first—Fig. 1

by the bird-beak bonder machine promotes bonding uniformity. Programming enables machine to take over control of most of the bonding variables from the operator. This includes a smooth severing motion that takes advantage of wire's weakest cross-section, located right next to bond. Wire is easily broken-off at this point without damaging wired device.

The bird-beak machine evolved from a series of bonding machines developed at K & S. Its name is descriptive of machine's bonding-tool shape and tool motion. Tool consists of two jewels as shown in Fig. 1. The one at the left has a horizontal bonding surface at its lower end that has a carefully shaped groove which contains the incoming wire. The groove curves around the jewel's heel and up its side. Thus, when the second jewel is clamped against the first a tube is formed through which the wire is fed to the bonding area.

Machine's binocular optical system enables operator to observe tool's position under magnification.

A "chessman joystick" riding on machine's table positions tool at a desired position to within 20-millionths of an inch. A "z-lever" enables tool to contact header in a

THERMOCOMPRESSION BONDING PROBLEM

Originally, thermocompression bonding involved positioning a fine wire over a heated bonding area on device to be wired, followed by pressing of wire with a pressure tool so that it would flow and bond. Lowering of the tool at an increased pressure or use of a cutting tool then severed wire. The resulting cutoff pressure was often damaging to the device, requiring that the wire be extended and bonded to a post prior to cutting it. One of the recent techniques for eliminating this additional operation is bird-beaking bonding

e B G

Make sure you know your electronics BUYERS' GUIDE

Review THE CONTENTS PAGE

- **PRODUCT LISTINGS**, streamlined by engineers for engineers.
- **COMPANY STATISTICS**: number of employees, product lines, names of key people, dollar volume.
- **EDITORIAL INDEX** to electronics for July 1961 through June, 1962.
- **ABSTRACTS** of Feature Articles in the current Editorial Index.

eBG

HAS MUCH FOR YOU
BE SURE TO USE IT
ALL... REVIEW
THE CONTENTS PAGE

LOOKING
FOR
COMMUNICATION
CHANNEL
ECONOMY?

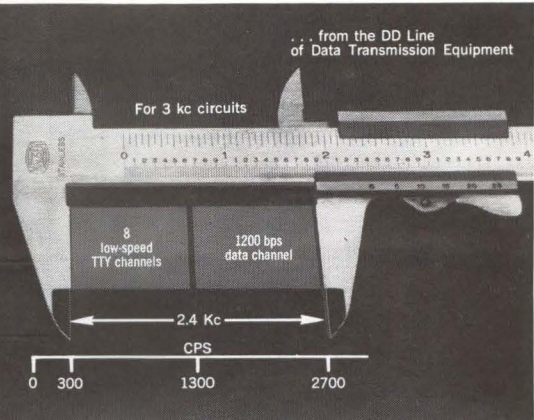

The economical use of communication channels, especially leased wire facilities, is an important factor in data transmission systems engineering. One of the prime considerations is increasing channel utilization. A recent development at Rixon offers a method to achieve this. By adding special "channel-splitting" filters to our DD Line modems, two independent sub-channels are created on a single line. This technique makes a wide range of applications possible; for example, one channel could be used to transmit a 1200 bps data stream, and the other is available for transmitting another 1200 bps data stream, up to eight TTY signals, or even voice.

Result? Increased modem flexibility, total bandwidth utilization, and better system economy, to name a few; in short, "more service per dollar of bandwidth." For more information about "channel-splitting" techniques or hardware, contact us.

Visit us at IEEE, March 25-28,
Booth 3034-3035

RIXON ELECTRONICS, INC.

2121 INDUSTRIAL PARKWAY—MONTGOMERY INDUSTRIAL PARK—SILVER SPRING, MARYLAND
TELEPHONE: 622-2121 TWX: 301 622-2292

CIRCLE 201 ON READER SERVICE CARD

AIRBORNE CAPCODER

CAPACITIVE CHARGE TRANSFER
ANALOG-DIGITAL
CONVERTER



OC 1001
100 CUBIC INCHES

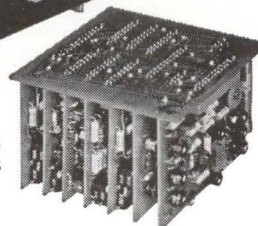

OC 1002
55 CUBIC INCHES

Patents applied for

- 10 bits plus parity bit
 - Serial binary, NRZ output
 - 250,000 bits per second
 - 22,700 encodings per second
 - Command encoding
 - Small size and enhanced reliability due to circuit simplification
 - Input —2.5 volts to +2.5 volts
 - Over 1 megohm input impedance
 - Inherent sample and hold
 - 1.3 microsecond sampling aperture
 - Wide temperature limits
 - MIL-E-5272C environment
 - Low power consumption
- Other speeds and resolutions available*



TOWSON LABORATORIES, INC.

200 E. JOPPA RD. BALTIMORE 4, MARYLAND VALLEY 5-6361

CLOSED-CYCLE maser COOLING

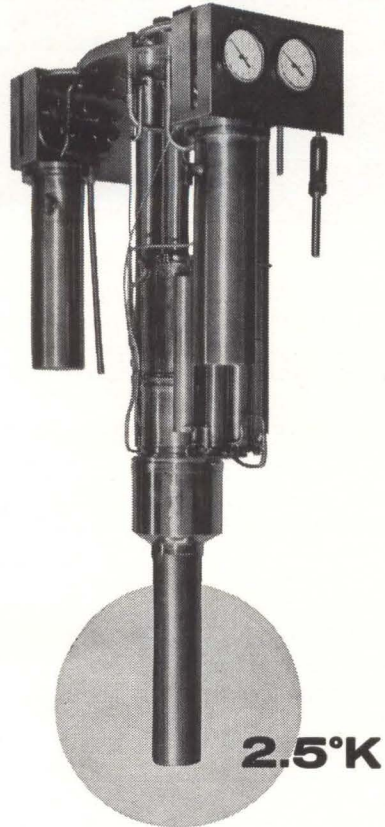

This cryostat is part of an Air Products closed-cycle 2.5°K maser refrigerator supplied to the Bell Telephone Laboratories under its contract with the Army Ordnance Missile Command.

A completely self-contained refrigerator, it does not require an external source of cryogenic liquids. Other features:

- Reaches 2.5°K in 2½ hours
- Operates through all antenna orientations
- Cools down automatically
- Designed for field operation
- Light-weight, oil-free compressors

Air Products provides a complete line of cryogenic refrigeration systems operating as "warm" as 80°K. Today, these systems are helping industry and government customers solve a wide range of problems requiring cryogenic temperatures.

Let Air Products put this experience and proved capability to work on your problem. For further information write:

CRYOGENIC REFRIGERATION SYSTEMS
DEFENSE AND SPACE DIVISION



Air Products and Chemicals
INC.
ALLENTOWN, PENNSYLVANIA

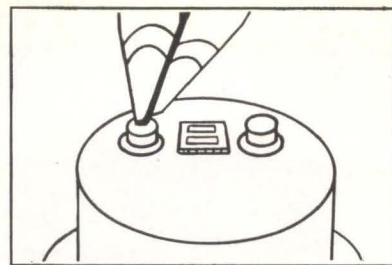

(A)

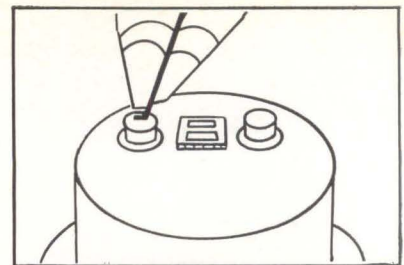

(B)

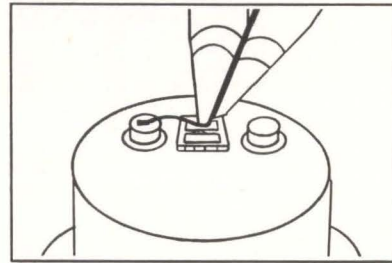

(C)

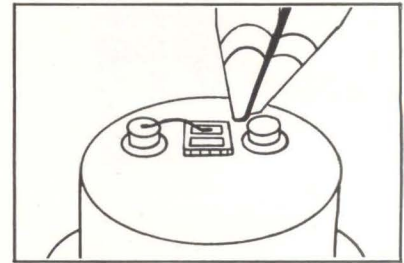

(D)

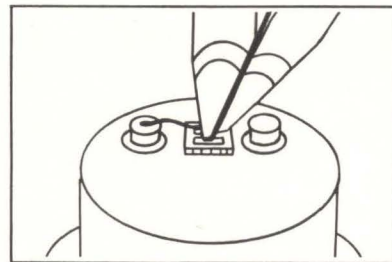

(E)

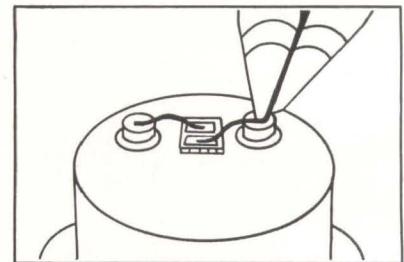

(F)

WIRE breaks right next to bond because of machine-tool motion and clamping action. Machine operates at high speed with most bonding variables under its control rather than operator's—Fig. 2

temperature-controlled heat column, which provides temperatures up to 450 degrees C.

BOND—The bond formed by present machine is rectangular. Its length is a function of the length of the tool's horizontal face. Several successive, contiguous bonds can be made to extend the bond length.

Size and shape of the bond is determined by wire diameter, shape and dimensions of groove and width of tool. These factors are combined to produce a bond such as in Fig. 2B of desired rectangular size using existing machines. Within certain limits, it is possible to design future bird-beak machines so that wire can be bonded to areas of various sizes and shapes.

PROCEDURE—Using binocular optical system, operator positions tool over the bonding area while depressing z-lever. Tool descends to contact header in heat column—

machine is preadjusted so that bonding surface of the tool is parallel to the bonding area surface. Dead-weight load on the tool is also preset, fixing bonding force. When tool makes contact with bonding area, a timer is started and tool is automatically held in position for a preset period while making bond. Thus time, temperature and bonding force are controlled by the machine. Fig. 2A shows position of tool during this interval.

At end of time cycle, tool is automatically raised a preselected amount, from 0.000 to 0.004 inch. This avoids any scraping or damage to either tool or wired device during subsequent tool motion. Fig. 2B shows new position.

The operator now releases z-lever. The tool rises to a high-level stop which has been set to a point just above the highest bonding level used during sequence.

Using chessman joy-stick, tool is now moved into position over next

LAPP HEAVY-DUTY ENTRANCE INSULATORS

bonding area (Fig. 2C), and, since in sequence illustrated, wire is to be cut-off after this bond, operator adds this operation to machine cycle with a foot-switch control. Again, operator lowers tool, bond is made, and tool raised slightly. To make cut-off, machine moves tool horizontally a preset amount to load tool with wire, wire is clamped, and tool again moves horizontally to sever wire (Fig. 2D). Repeat procedure in Fig. 2E and 2F completes sequence.

NO TAB—Tests show that the weakest cross-section of wire after bonding is immediately adjacent to bond. Therefore, when stress is applied to wire in manner described, the wire is broken so that no tab is left. Actually, the wire elongates 10 to 15 percent of its diameter leaving severed ends slightly rounded. But for all practical purposes, it does not extend appreciably beyond the bond area. Cut-off and loading motions are controlled to an accuracy of 0.0001 inch.

LOADING MOTION — Distance tool moves as it severs wire is not critical as long as it moves far enough to break it. The "loading" motion which immediately precedes this is critical, however. Machine must be adjusted so that, after the wire is severed, a proper length of wire lies under tool's bonding surface for first bond of following series. The length of this motion is always preset before using the machine.

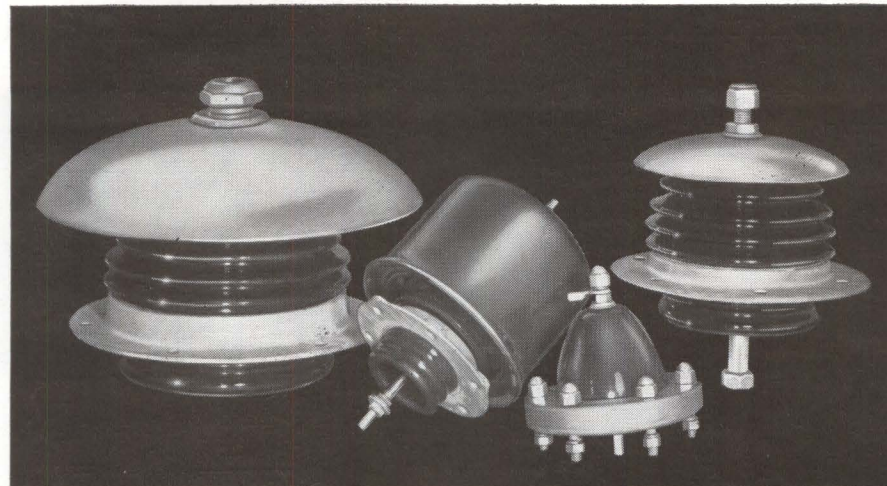

...in all these standard sizes to save you time and money

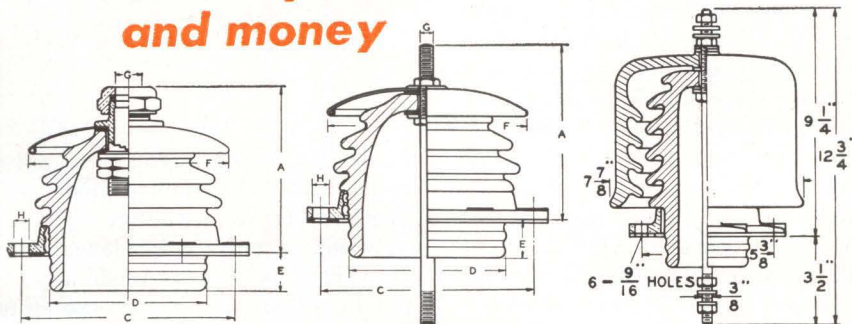

TYPE A
Permits use of continuous pipe conductor though the insulator.

TYPE B
Stud secured to porcelain bowl.

TYPE C—NO. 11896
Similar to Type B, but with porcelain hood added.

DIMENSIONS IN INCHES—FLASHOVER AND RADIO RATINGS

Catalog Number	Type	A	C	D*	E	F	G	H	DRY FO 60 kv eff.	Radio Rating kv eff.	
10030	A	12 $\frac{3}{4}$	14 $\frac{5}{8}$	12 $\frac{1}{2}$	1	16	2	Max.**	$\frac{5}{16}$	80	16
9553	A	10 $\frac{1}{2}$	12	9 $\frac{3}{4}$	2 $\frac{1}{2}$	16	1 $\frac{1}{2}$	Max.**	$\frac{5}{16}$	70	12
9554	A	7 $\frac{1}{16}$	9	7 $\frac{1}{2}$	2	9 $\frac{1}{4}$	1 $\frac{1}{2}$	Max.**	$\frac{5}{16}$	55	8
22913	A	6 $\frac{7}{8}$	7 $\frac{3}{4}$	6 $\frac{1}{2}$	1 $\frac{1}{2}$	7 $\frac{1}{4}$	1	Max.**	$\frac{5}{16}$	45	9 $\frac{1}{2}$
7321	B	12 $\frac{1}{2}$	14 $\frac{5}{8}$	12 $\frac{1}{2}$	1 $\frac{1}{2}$	13 $\frac{3}{8}$	$\frac{3}{4}$	$\frac{1}{16}$	$\frac{5}{16}$	80	16
5363	B	10 $\frac{5}{8}$	12	9 $\frac{3}{4}$	2 $\frac{1}{2}$	16	$\frac{3}{4}$	$\frac{5}{16}$	$\frac{5}{16}$	70	12
8141	B	6 $\frac{1}{2}$	7 $\frac{3}{4}$	6 $\frac{1}{2}$	1 $\frac{1}{2}$	7 $\frac{1}{4}$	$\frac{1}{2}$	$\frac{5}{16}$	$\frac{5}{16}$	45	9 $\frac{1}{2}$
22611	B	8 $\frac{3}{4}$	5 $\frac{5}{8}$	4 $\frac{1}{4}$	1 $\frac{1}{2}$	8 $\frac{1}{2}$	$\frac{3}{8}$	$\frac{5}{16}$	$\frac{5}{16}$	55	9 $\frac{1}{2}$
10300	B	6 $\frac{1}{2}$	5 $\frac{5}{8}$	4 $\frac{1}{4}$	1 $\frac{1}{2}$	5 $\frac{1}{4}$	$\frac{3}{8}$	$\frac{5}{16}$	$\frac{5}{16}$	45	8

*D is mounting hole diameter.

**Always specify outside diameter of conductor.

Hydraulics for Wiring

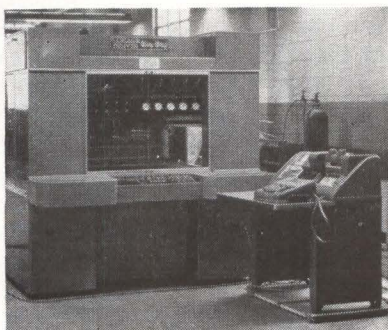

HYDRAULIC, pneumatic and electrical components are combined in automatic wire-wrap machine produced by Gardner-Denver. Complete installation includes machine, card-reader and machine control cabinet

Lapp

WRITE for Bulletin 301-R.
Lapp Insulator Co., Inc.,
201 Sumner Street, LeRoy, N. Y.

Checking Pulse Coincidence at 100-Mc Rate

High-speed logic module delivers 5-ns output pulse when coincidence occurs

ANNOUNCED by General Applied Science Laboratories, Inc., Merrick and Stewart Aves., Westbury, L.I., New York, are the Nanocard series of 100-Mc logic modules for use in spectrometry, scintillation counting and nuclear particle detection counting. Modules use both transistors and germanium tunnel diodes and include pulse-height limiters, discriminators, multichannel coincidence circuits, a four-fold fanout and a scaler. The typical coincidence circuit shown in the sketch has four *yes* and one *no* input, all d-c coupled. The four *yes* inputs are grounded-base buffer transistors operated class A. Input pulses are standardized by turn off of series diodes in the collectors. Shunt diodes clamp collector voltage after turn off to permit rapid turn on. When no input pulses are present, all collector series diodes are on, biasing the tunnel diode to low-voltage state. When all collector

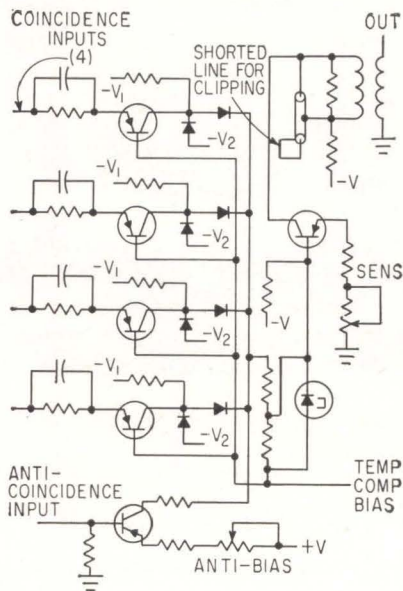

diodes turn off, signifying pulse coincidence, the tunnel diode will switch to the high-voltage state for duration of pulse coincidence, thus delivering an output. When any input is not connected, corresponding buffer transistor current is cut off so that input is effectively out of the circuit. This allows the number of connected inputs to determine the coincidence configuration. The circuit will handle coincidence con-

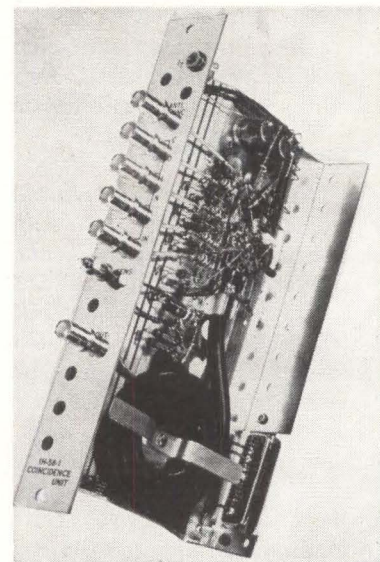

figuration at 100 Mc, output pulse is nominal 5 ma negative, 5 nsec wide and double clipped for automatic base line restoration. All inputs are at least 5 ma negative with 1 nsec extra overlap required for the *no* input. Except for power busses, printed circuits are not used because of special technique required for low-inductance grounds.

CIRCLE 301, READER SERVICE CARD

Solid-State A-C Converter Has 0.05-Percent Accuracy

ON THE MARKET from Cimron Corporation, 1152 Morena Blvd, San Diego 10, California, the solid-state a-c converter models 6700A

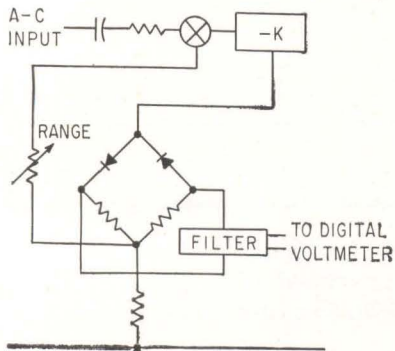

and 6701A are designed for use with the model 6000 and 7000 series of d-c digital voltmeters. Range is 0.00000 to 999.99 v a-c in four ranges with accuracy typically within 0.05-percent of reading between 50 cps and 5 Kc. Between 20 cps and 20 Kc, accuracy is typically 0.1 percent of reading. Stability is better than 0.03-percent full scale for at least 90 days under laboratory conditions. Resolution is 0.005-percent reading or 1 digit, linearity is within 0.01-percent full scale from 50 cps to 5 Kc and within 0.02-percent full scale between 30 cps and 10 Kc. Input impedance is 10

megohms shunted by less than 50 pf and the device is protected against overvoltages of 1,000 v a-c or d-c except 0.9999 v range which is 500 v a-c or d-c. As shown in the sketch, conversion is by a full wave averaging circuit operating within a high-gain feedback loop. Selected precision feedback resistors determine range. (302)

Switching 5 Amperes With a 0.0125- μ w Signal

RECENTLY announced by Development Associates, 2600-E de la Vina

Street, Santa Barbara, California, the Limitec-I magnetically-amplified relay can handle up to 5 amperes per contact of a 3 pdt relay with input signals as small as 0.0125 microwatt. Both *NO* and *NC* contacts are available and a 5-v, 10-ma d-c reference supply is provided to allow excitation for a d-c bridge or potentiometer. The relay may be adjusted to operate directly from signals in

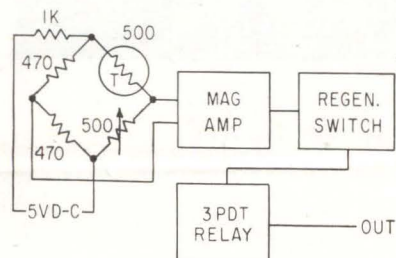

the microampere or millivolt range over a wide span of excitation. Directly operable from thermocouples, break sensing can be provided. As shown in the sketch, a high-gain magnetic amplifier drives the mechanical load relay through a transistor regenerative switch thus switching substantial loads without intermediate amplification or additional slave relays. The unit is approximately 3-in. on each side and weighs less than 24 ounces with amplifier, d-c reference supply and replaceable 3pdt relay. (303)

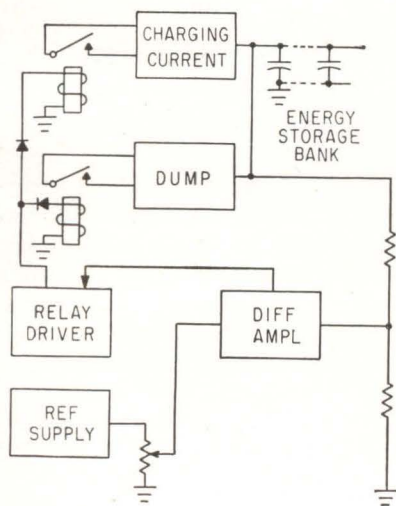

Calibrated Laser Supply Is Relay Regulated

INTRODUCED by Optech, Inc., 102 Grand Street, Westbury, New York,

the Oportay series of calibrated laser power supplies feature single-dial, direct-reading setting of energy output, calibrated between 50, 500, 1,000 and 2,000 joules with an accuracy of ± 10 percent of dial reading. Charging voltage ranges from 850 to 2,200 v depending on joule output. Trigger output is a 15 Kv pulse to actuate flash lamps, sync output is 10 v negative and either manual or automatic triggering is available. The device is basically a bank of energy-storage capacitors whose charge is automatically regulated at the value selected by relays controlled from a difference amplifier. Capacitor bank voltage is compared with a stable reference supply by the differential amplifier. Voltage differences actuate either a charging or dumping relay, depending on polarity and relay contacts energize the proper circuit to supply or remove sufficient charge to bring the voltage within the chosen tolerance band. A lockout relay prevents internal triggering when capacitor bank is not to tolerance. The trigger circuit is a capacitor, charged to 300 v, discharging through an autotransformer. An internal rate generator provides adjustable, automatic signals at intervals from 5 to 150 seconds. (304)

Detecting 0.01-Percent Oxygen in Gas Mixtures

DEVELOPED by The Hays Corporation, Michigan City, Indiana, the model 632 low-range oxygen analyzer is sensitive to within 0.01-percent O_2 and is unaffected by hydrogen in the carrier gas. With 100-percent hydrogen or helium concentration, the device maintains 2-percent range accuracy. Five sets of dual ranges are featured to assist tracking. Output is 50 mv at 1 ma with 500 mv at 1 ma maximum. Sensitivity is 0.01 percent of O_2 . Operation is based on stable paramagnetic characteristic of oxygen and the relationship between temperature and paramagnetism. As shown in the sketch, a glass tube having a transverse gas passage has two identical nickel windings wound around the gas passage. These windings form two legs of a Wheat-

stone bridge. One winding is located between the poles of a perma-

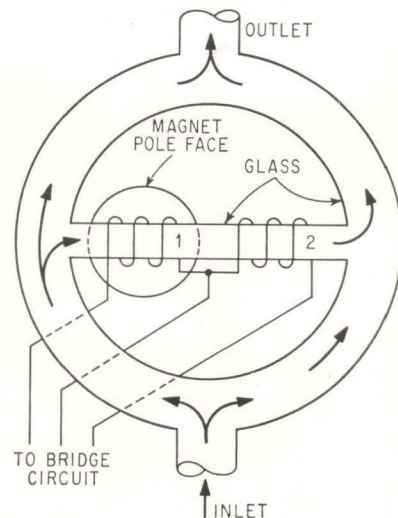

nent magnet. If the gas sample is paramagnetic (contains oxygen), it is attracted by the magnetic field and pulled into the transverse field where it is heated by winding 1. With increasing temperature, gas paramagnetism decreases. The cooler gas then pushes the heated gas out of the magnetic field producing continuous gas flow, called magnetic wind. This wind cools winding 1 relative to winding 2 and resulting temperature difference changes resistance thus unbalancing the bridge. Unbalance is amplified and read out. (305)

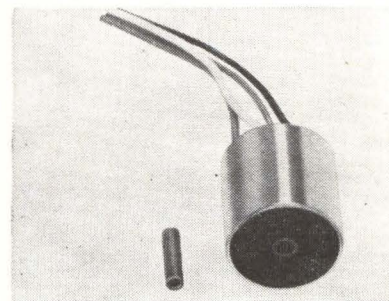

Transducers Measure Linear Displacement

SANBORN CO., 175 Wyman St., Waltham 54, Mass., offers a line of d-c differential transformers for measuring linear displacements from ± 0.050 in. to ± 3.0 in. without external carrier systems, phasing problems, etc. Each of the d-c input-d-c output units contains a modu-

ACTON

Laboratories, Inc.

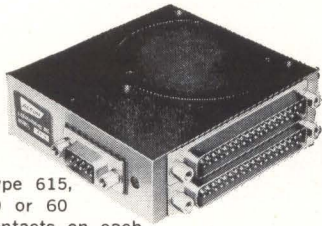

Type 615,
30 or 60
contacts on each
of 1 or 2 poles

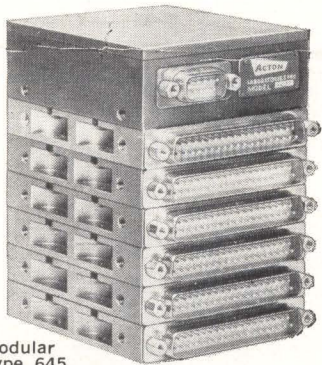

Modular
Type 645,
1 to 6 poles,
up to 60
contacts per pole

ROTOFLEX*

*TRADE MARK

Precision Telemetry Commutators

FOR AIRCRAFT, MISSILE, SPACE CRAFT DATA

- Patented frictionless pressure contacts actuated by isolated rolling bearing
- Noise approaches theoretical minimum
- Thirteen basic types, including modular designs with up to 360 contacts, and miniature units
- Speeds up to 60 rps
- MBB or BBM switching
- Special switching sequences available
- 28 vdc or 115 vac, 400 cps self contained motors
- Up to 50,000,000 cycle life

Rotoflex precision commutators provide maximum reliability in time division multiplexing of these and many other high and low level data parameters: temperature, vibration, voltage, pressure, radiation, ionization, acceleration, ablation.

ACTON

Laboratories, Inc.

533 Main Street,
Acton, Massachusetts

A Subsidiary of Bowmar
Instrument Corporation

SEND FOR
ROTOFLEX BROCHURE



© 1963 Acton Laboratories, Inc.

lator input circuit and demodulator and filter output circuit. Besides saving the space, power and cost of separate complex carrier systems, these transducers also eliminate phase shift correction, balancing, and harmonic and quadrature null problems.

CIRCLE 306, READER SERVICE CARD

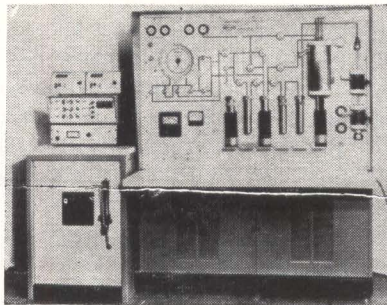

Carbon Dating System Employs Methane

SHARP LABORATORIES, INC., La Jolla, Calif., announces a complete carbon dating laboratory designed for production and sale to laboratories and research centers. The CDL-14 laboratory employs the carbon-14 method for dating carbon-containing samples up to 45,000 years old. It uses methane for the counting gas because the chemistry is fast and foolproof. No radon is introduced by the reagents; it is more insensitive to impurities and gives good plateaus even when mixed with 500 ppm water or oxygen. The CDL-14 includes shielding, sample detector, cosmic ray guard counter, all required electronics including automatic printout of essential data along with a complete apparatus for converting the sample to counting gas. (307)



Nuclear Detectors Come in Four Sizes

MOLECHEM, INC., P. O. Box 531, Princeton, N. J., has available 4 sizes of transmission type surface barrier detectors. Total depletion may be obtained in detectors ranging in thickness from 75 μ to 1,000 μ . Several of the 1 mm thick types

may be stacked to form a composite detector with 2 or 3 mm effective depletion depth. (308)

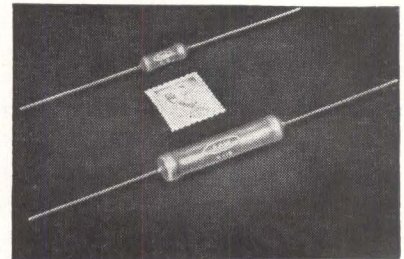

Power Resistors Are Silicone Coated

DALE ELECTRONICS, INC., P.O. Box 488, Columbus, Neb., has added to its G series two silicone coated precision power resistors rated at 6 and 15 w. Resistance range: 10 to 30,000 ohms (6 w) and 10 to 175,000 ohms (15 w). Temperature coefficient: 0.00002/deg C. Operating temperature range: -55 to 275 C. Price range: \$2.34 to \$3.38 each in quantities of 100. (309)

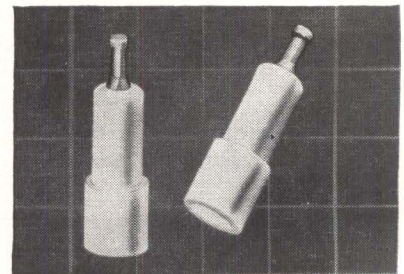

H-V Test Point Has Press-Fit Design

SEAELECTRO CORP., 139 Hoyt St., Mamaroneck, N. Y., offers the SKT-0803 Press-Fit high voltage test point. Designed for circuits carrying high voltages and requiring test points or external connections, while still offering all the advantages of the Teflon-insulated Press-Fit design whereby installation is fast and positive, and lends itself to tightly-packed circuitry. It is 0.780 in. overall with an above-chassis shoulder of 0.250 in. (310)

High Strength Alloy

ANACONDA AMERICAN BRASS CO., 414 Meadow St., Waterbury, Conn., has developed a copper-aluminum-man-

ganese-nickel alloy which has exhibited nominal values of 205,000 psi tensile strength and 200,000 psi yield strength in small diameter wire at room temperature. (311)

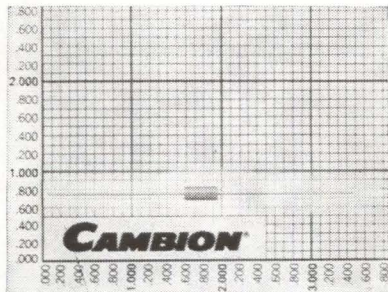

Tunable Coil Form Has Live P-C Leads

CAMBRIDGE THERMIONIC CORP., 445 Concord Ave., Cambridge 38, Mass., announces a molded diallyl phthalate printed circuit tunable coil form. It has live p-c leads, is mounted and tuned horizontally and, with its above board height of just 0.300 in. when mounted, is ideal for drawer-type installations. The new form mounts on a 0.250 in. by 0.500 in. p-c grid. (312)

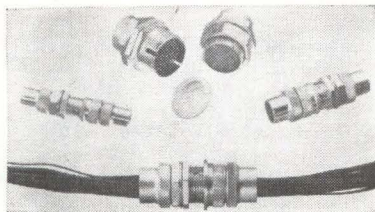

Multipin Connectors With Foolproof Keying

TAMAR ELECTRONICS DIVISION, 2045 West Rosecrans Ave., Gardena, Calif. Microminiature connector line includes straight plugs and receptacles with either 7, 19, 37, or 61 pins and socket contacts. Sizes range from 0.380 max diameter on 7 pin configuration to 0.870 max diameter for 61 contacts. Plug length is 0.835, receptacle length 1.02 in all sizes. Wire accommodations are 24 gage type ET or 26 gage type E per MIL W 16878. Minimum voltage breakdown test 1000 v a-c rms 60 cps with 2½ amp max in these configurations. Contact resistance is 0.5 milliohm max. A four key system eliminates possibility of mis-mating. (313)

NOW!
RECORD VOLTS, OHMS, MILLIAMPS
 with **ONE RECORDER**
 ... **NO EXTRAS!**



ONLY
\$595
 COMPLETE

New Bausch & Lomb V.O.M.-5 RECORDER

... an all-new, complete 5-inch strip-chart recorder that breaks all precedent in the field... brings you the finest features of potentiometric recorders for one low price. Compare these exclusive advantages, all these "extras" at no extra cost, with any other recorder in its class.

- Five voltage ranges, 10 millivolts to 500 volts D.C.—full scale deflection.
- Six linear ohms scales, 1-to-100,000 ohms full scale, with zener diode D.C. supply.
- Four D.C. current ranges—10 microamperes to 100 milliamperes.
- Off balance input impedance—over 10 megohms.
- Five chart speeds, 400-to-1 range.
- Event marker, with interchangeable pens.
- Function switch with mechanical pen letdown.
- Operates in flat, 30° tilt, or wall-mounted position.
- Compact—only 4¾" x 14½" x 11¾".
- Portable—only 16 lbs.

And more. Lots more! Mail the coupon now for the whole story on this new 5-speed recorder with versatility-plus!

BAUSCH & LOMB

BAUSCH & LOMB INCORPORATED
 62338 Bausch Street
 Rochester 2, N. Y.

Please demonstrate the V.O.M.-5 Recorder at my convenience.
 Send Recorder Catalog D-2032.

Name Title

Company

Address

City Zone State

ULTRA-FLEXIBLE PULSE-GROUP GENERATOR/MODULATOR



5 IDENTICAL, INDEPENDENT CHANNELS

Build coded pulse trains with complete, independent control of pulse width and delay and every modulation, synchronization, trigger, marker, and gate facility a reasonable man could want! 0.1 μ sec rise and decay time, output 20 V into 100 Ω markers every μ sec, 10-10,000 cps group rep. rate, 0.2-2 μ sec pulse-width range, 0-300 μ sec delay (group width). Inexpensive, simple to operate, laboratory quality — hundreds of applications, from bench to console . . . **MODEL MP-1A.**

Call your POLARAD Field Engineer for a prompt, free demonstration!



POLARAD
ELECTRONIC INSTRUMENTS
A Division of Polarad Electronics Corporation
World Leader in Microwave Instrumentation
34-02 D Queens Blvd., Long Island City 1, New York

CIRCLE 202 ON READER SERVICE CARD

Planning to change your address?

Use the form below to indicate a change of address. Because our issues are addressed in advance, please try to allow at least 5 weeks for change of address to become effective. Attach the address label from your most recent issue in the space provided below.

(Please print the following information for proper service)

Title or position

Name

Chief Job Responsibility

Distributor
Manufacturer

Company and Div.

Product or Service Approx. No. of Employees

Address

City Zone State or Prov.

Mail to home address below:

Address

City Zone State or Prov.

Mail to: Fulfillment Manager, **electronics**
330 West 42nd Street, New York City 36, N. Y.

***Paste present mailing label or address**

from wrapper or envelope here.

Literature of the Week

PHASE SENSITIVE CONVERSION North Atlantic Industries, Inc., Terminal Drive, Plainview, N. Y. Bulletin TB-104 presents a basic description of a-c signal measurement by phase sensitive conversion techniques. **CIRCLE 314, READER SERVICE CARD**

PRECISION PRESSURE GAGE Texas Instruments Inc., 3609 Buffalo Speedway, Houston 6, Texas. Bulletin S-140 is a four-page brochure describing a new precision pressure gage. (315)

MICROMINIATURE CONNECTORS Continental Connector Corp., 34-63 56th St., Woodside 77, N. Y. A 6-page brochure covers series MM-22 ruggedized microminiature plug and socket connectors. (316)

MICA CAPACITORS Sangamo Electric Co., Springfield, Ill. Bulletin describes a line of molded, wire-lead, mica dielectric capacitors. (317)

PLOTTER SUBROUTINES California Computer Products, Inc., 305 Muller Ave., Anaheim, Calif. Bulletin 120A describes subroutines for easier and faster generation of plotter commands in medium and high scale computers. (318)

GLASS DELAY LINES Corning Electronic Components, Corning Glass Works, Raleigh, N. C. A 12-page manual outlines history, theory, design and application of glass ultrasonic delay lines for digital uses. (319)

SURFACE PROTECTED MAGNETIC TAPES Minnesota Mining and Mfg. Co., 2501 Hudson Rd., St. Paul, Minn. Bulletin describes technical factors involved in the use of surface protected magnetic tapes. (320)

RANDOM NOISE B & K Instruments, Inc., 3044 W. 106th St., Cleveland 11, O., has available a technical handbook on applications and generation of audio-frequency random noise. (321)

P-C CAPACITORS Hopkins Engineering Co., P.O. Box 191, San Fernando, Calif. Bulletin describes a range of metallized Mylar capacitors for printed circuit packaging. (322)

FACILITIES BROCHURE Lear Siegler, Inc., Instrument division, 110 Ionia Ave., Grand Rapids, Mich., offers a 4-color brochure on its Aerospace Development Center. (323)

FACILITIES CBS Laboratories, High Ridge Road, Stamford, Conn., offers a 12-page brochure describing the resources and facilities of its Electron Tube Department. (324)

PANEL INSTRUMENTS The Triplett Electrical Instrument Co., Bluffton, O., has published catalog 21-I covering a wide line of panel meters. (325)

SCR DRIVES Electric Regulator Corp., 40 Pearl St., Norwalk, Conn., has

available a 6-page booklet on advanced silicon controlled rectifier drives. (326)

D/A CONVERTER Correlated Data Systems Corp., 1007 Air Way, Glendale, Calif. A 2-page bulletin describes a pcm telemetry digital to analog converter. (327)

VOLTAGE TUNABLE MAGNETRONS Power Tube Dept., General Electric Co., Schenectady 5, N. Y. A 28-page technical bulletin, PT-68, discusses theory and operation of voltage tunable magnetrons. (328)

STEPPING SWITCHES Systems Division of Beckman Instruments, Inc., 2400 Harbor Blvd., Fullerton, Calif. The "how" and "why" of stepping switch reliability are discussed in a recent technical bulletin. (329)

ELECTROLUMINESCENCE Sylvania Electric Products Inc., 1100 Main St., Buffalo 9, N. Y. Booklet discusses the theory of electroluminescence, and Sylvania's capabilities in this light source field. (330)

INSTRUMENTATION Fairchild Semiconductor, 545 Whisman Road, Mountain View, Calif. Catalog describes a variety of test equipment for incoming inspection, engineering evaluation and manufacturing final test. (331)

R-F COMPONENTS Applied Research Inc., 76 S. Bayles Ave., Port Washington, N. Y. Data sheet describes attenuators, terminations and impedance matching transformers for use in applications over the d-c to 2,500 Mc range. (332)

ENCAPSULANT Dow Corning Corp., Midland, Mich., offers a brochure on Sylgard 183 encapsulant, a solventless silicone resin designed for potting, embedding or encapsulating electronic devices. (333)

MYLAR INSULATION PRODUCTS Inmanco Inc., 571 West Washington Blvd., Chicago 6, Ill., has available an illustrated bulletin on its products made from Dupont Mylar polyester film. (334)

R-F CHOKES Nytronics, Inc., 550 Springfield Ave., Berkeley Heights, N. J. Catalog sheet gives performance data on Essex miniature and subminiature r-f chokes. (335)

STANDARDIZED MODULE PROGRAM Hill Electronics, Inc., Mechanicsburg, Pa., Leaflet covers standardized module program, initiated to provide customized frequency sources at near shelf-item cost. (336)

FRACTIONAL H-P MOTORS U.S. Industries, Inc., 6312 Hollister Ave., Goleta, Calif., has released a 60-page fractional horsepower electric motor catalog and engineering reference manual. (337)

WIRE WOUND RESISTORS International Resistance Corp., 401 N. Broad St., Philadelphia 8, Pa. High temperature power wire wound resistors, featuring fireproof inorganic construction, are described in bulletin P-7. (338)



New, economical
15/16" dia. 5-watt wirewound
variable resistors

Versatile Series AW

Available with: 1 Bushing Mounting 2 Twist Tab Mounting 3 Pull-on, Push-off Switch 4 Straight Tandems 5 Concentric Tandems. (The new Series AW wirewound controls can also be used with CTS Series 45 15/16" dia. 1/2-watt carbon control to make any combination of straight or concentric tandems desired.) Series AW can be supplied in L and T pads. Element wire can be soldered to end terminals if required.

Priced less than larger diameter lower wattage commercial wirewound variable resistors. Unique high temperature heat resistant winding core and liner permit a 5-watt rating at 25°C, or a 4-watt rating at 55°C derated to no load at 105°C. Resistance range is one ohm through 25,000 ohms, linear taper. The unit is completely enclosed for full protection.

Write for Catalog 2100. (West Coast Inquiries to Chicago Telephone of California, Inc., 1010 Sycamore Ave., So. Pasadena, Calif.)

CTS OF ASHEVILLE, INC.
SKYLAND, NORTH CAROLINA



SUBSIDIARY OF **CTS CORPORATION** • ELKHART, INDIANA

compulsion

...**electronics** generates more of it than any other publication edited for electronic engineers.

Make a magazine compelling reading for your customers and prospects, and an optimum climate for your advertising has been created.

This optimum climate for thoughtful advertising readership is one reason you can be sure your advertising works best when you concentrate it in **electronics**.

electronics  **BASIC IN A MERCURIAL MARKET**

The McGraw-Hill magazine for electronic engineers. Published every Friday. 330 W. 42 St., N. Y. 36. ABC/ABP



A black and white photograph of a hand holding a magazine. The hand is wearing a white shirt cuff. The magazine cover has the word "electronics" in orange. In the background, there is a laboratory setting with glassware and a circular logo with a sine wave.

more about compulsion

If a magazine tells you more about your industry's technology than any other, and almost always does so first, any responsible, ambitious engineer is apt to find it compulsive reading. He reaches the sensible conclusion that not to read such a magazine could cost him much in technical knowledge, and much in opportunity to get ahead in his business faster than most.

For 32 years *electronics* has dedicated itself to being *first* with its industry's important news and technological breakthroughs. It has the biggest editorial staff of any electronics publication. It has continuous access to McGraw-Hill's worldwide news services. Its editors average 35% of their time out in the field. It puts an editor on a plane to Europe as quickly as it sends one across the Hudson River. It edits and prints more editorial pages than any other electronics publication.

It has often been said that seldom has any publication so fully deserved to carry its industry's name. *electronics* is the Electronics Industry. And because of this, it is the closest thing there is to compulsive reading in this young and explosive industry.

In a market served by more than 50 publications which are readily available to engineers for free, *electronics* has 57,000 paid subscribers. These subscribers are alert, responsible, and ambitious far above the average. They exert tremendous buying power. They can very conceivably make or break your products' sales future in the \$14-billion electronics market. And they are all yours to reach and sell through the advertising pages of *electronics*.

Polarad Completes Decentralization



KEY FIGURES in the reorganization of Polarad Electronics Corporation are, left to right, Frank J. Skwarek, D. L. Jaffe, and Herbert W. Pollack

FORMATION of two autonomous divisions of Polarad Electronics Corp., Long Island City, N. Y., to be known as Polarad Electronic Instruments and Radiometrics, has been announced by D. L. Jaffe, Polarad's chairman of the board and president.

Polarad Electronic Instruments will be responsible for all aspects of the catalog microwave test equipment line, while Radiometrics will be concerned with defense electronics research, development, and production efforts. Herbert W. Pollack has been appointed president of Polarad Electronic Instruments, and Frank J. Skwarek has been named president of Radiometrics.

Purpose of the reorganization, the announcement stated, is to strengthen Polarad's capabilities to serve both defense and industrial electronics markets. Since each market involves totally different approaches, Jaffe said, the complete separation into two distinct divisions is expected to permit the fuller development of manpower, techniques, and product lines which will be optimized for each of the markets.

The present corporate structure of Polarad Electronics Corporation consists of the two aforementioned autonomous divisions plus four domestic subsidiaries: Federal Scien-

tific Corp., Telemetal Products, Inc., Telewave Laboratories, Inc., and Sterling Transformer Corp.; and a foreign subsidiary, Polarad France.



General Precision Promotes Dietrich

ROBERT A. DIETRICH has been appointed director of the Research Center of General Precision's newly formed Information Systems Group in Glendale, Calif.

The Research Center conducts research and development programs in basic and applied areas of computer and information-systems technology.

Dietrich was formerly director of technical planning for General Precision's Librascope division, which is now a unit of the Information Systems Group.

In addition to 10 years service

with Librascope in key research and engineering positions, Dietrich has served as a research officer for the Atomic Energy Commission in Oak Ridge, Tenn.

Sylvania Appoints Wilson Boothroyd

WILSON P. BOOTHROYD has joined Sylvania Electronic Systems as associate director of Equipment Laboratories at its central operation in Buffalo, N. Y.

In the newly created position, Boothroyd is responsible for the operation's microwave communications laboratory, radio communications laboratory, electronic countermeasures laboratory, and navigation and instrumentation laboratory. He formerly was with the Philco Corp. in Philadelphia.

Daystrom Combines Two Divisions

DAYSTROM, INC., Murray Hill, N. J., is combining its Military Electronics division, Archbald, Pa., and its Weston Instruments division, Newark, N. J., into a new unit to be known as Weston Instruments and Electronics division.

Daystrom president J. B. Montgomery named Louis H. Aricson, vice president of Daystrom and general manager of Weston, to head the new combined unit. Howard J. Warnken will continue as general manager of the Archbald plant.

Operations will continue at both Archbald and Newark.

Epsco Announces Three Promotions

EPSCO INCORPORATED, Cambridge, Mass., has appointed Irving S. Oscar to the position of chief engineer of its Systems division.

Oscar, who joined Epsco in 1960 as senior systems engineer, heads the list of appointments in the move to strengthen and preserve the engineering integrity of the company's largest division. He will guide current contracts and new product development in the division's major product areas of aerospace pcm telemetering, both air

4 electronics BUYERS' GUIDE and Reference Issue exclusives

1. Direct line of communications between buyer and seller.
2. Gives vital company statistics.
3. Contains electronics editorial Index.
4. Abstracts features from electronics editorial Index.

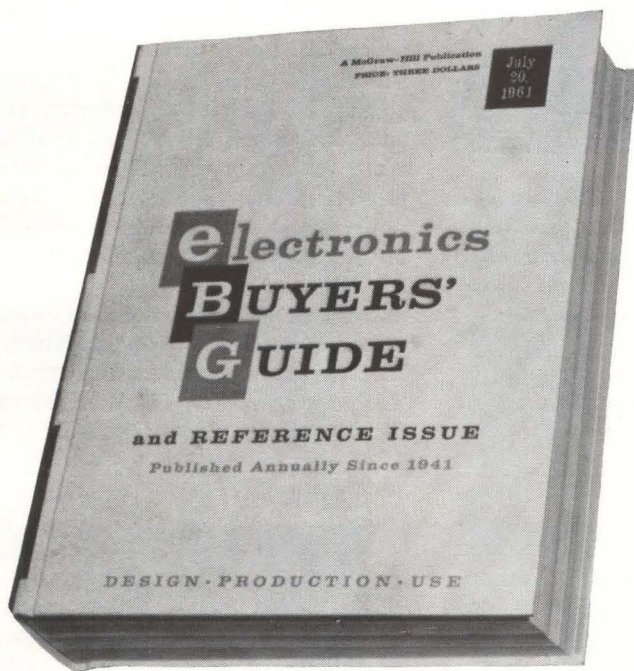

Whatever the product,
you'll find it properly listed
in the BUYERS' GUIDE

February 1, 1963

NEW SELF-DECODING NUMERICAL READOUT AND PULSE COUNTER

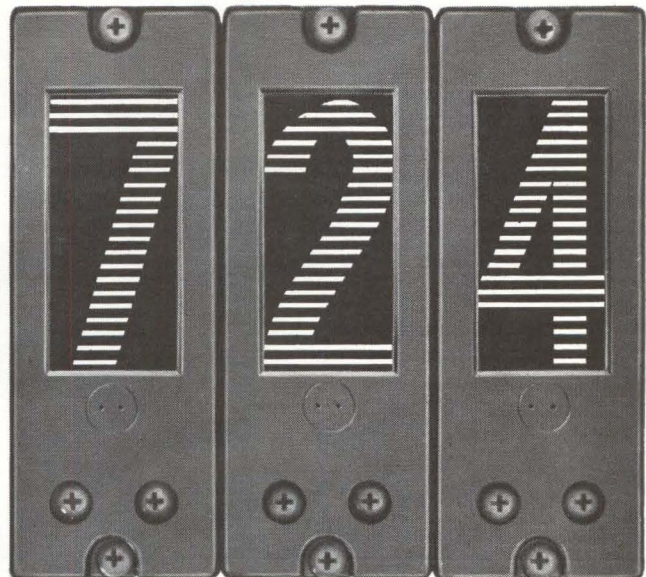

QUANTITY PRICES FROM \$40.00 EACH

■ The new Kauke readout is a simple, rugged, visual display unit that converts 1-2-4-8 code, parallel input, into numerical characters. ■ It is electro-mechanically operated, with enclosed construction, and features single or grouped front panel mounting with exceptionally wide-angle viewing. ■ Simple and inexpensive accessories broaden its use to provide a wide variety of applications and special conditions.

DESIGN Character is changed by simple stepping motor . . . can be used as decoder or counter (up to 50 steps per sec.)

MEMORY Once the displayed character corresponds to input code, the character is retained indefinitely.

POWER Low drive power, only 200 ma at 24v. No drive power is used while character is being displayed.

APPLICATION FLEXIBILITY

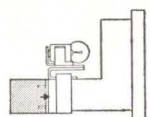

Plug-In Adapter
Allows for 4-line parallel input from low level logic.

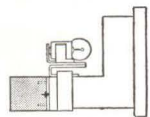

Count Module
Provides carry pulse, simultaneous zero-set, and verification.

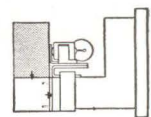

Buffer Storage
Accepts microsecond logic input while previous input appears.

■ Write today for complete detailed specifications.

KAUKE and COMPANY, INC.
E-M Products Division
1632 Euclid Street • Santa Monica, California

CIRCLE 73 ON READER SERVICE CARD 73

been announced by Gabriel M. Gianini, president of the parent company.

Meyer replaces Martin Koenigsberg who is assuming a new post with the parent organization.

Prior to his election, Meyer was senior vice president and chief engineer of Hammarlund.

PEOPLE IN BRIEF

Thomas M. Trainor promoted to mgr. of systems projects at Adler Electronics. **Max Bleich** leaves Cornell-Dubilier to join Filtron Co., Inc. as plant mgr. **Walter J. Levison** advances to v-p in charge of the Optical Systems div. of Itek Corp. **Howard E. Harry**, formerly with Minneapolis-Honeywell, appointed chief engineer of the military engineering div. of Zenith Radio Corp. **Ralph J. Heintz**, ex-Aerojet General Corp., named quality control engineer for Kentucky Electronics, Inc. **Ralph R. Ragan**, recently of MIT's Instrumentation Laboratory, now mgr. of Raytheon's Missile & Space div. Sudbury, Mass., operation. Sylvania ups **George L. Downs** and **Hunter C. Harris** to deputy program mgr. and technical director, respectively, of the Minuteman ground electronics program. **C. B. Appleman** promoted to mgr. of the Gulf States district operation for GE's Defense Programs Operation. **James E. Ray**, ex-Elco Corp., named operations mgr. for Semtran Instruments, Inc. **Joseph R. Mazzola**, from General Instrument Corp. to Fairchild Camera and Instrument Corp. as manufacturing mgr. for the Clifton facility of the Defense Products div. **Hans Udo von Schultz**, formerly with Bendix Corp., appointed director of engineering at U. S. Sonics Corp. **Virgil S. Thurlow**, previously with Systems Development Corp., now senior scientist at Systems Programming Corp. The Hoover Co. advances **A. J. W. Novak** to g-m of its Electronics div. **George A. Woodsum** leaves Manson Laboratories to join MB Electronics as an applied scientist in the Advanced Products div.

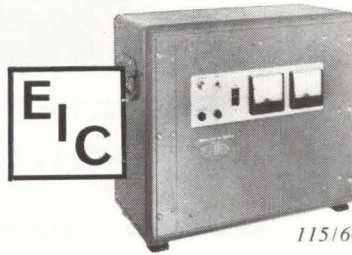

**50 amp
power supplies
0.1% regulation**

115/60-BER-12/600, in case

Model	Output Voltage*	Ripple	Delivery	Price
115/60-BER-12/600	12	1 mv, rms	From stock	\$945

*Output voltage adjustable over $\pm 17\%$ range.

This supply has magnetic circuit breakers for overload protection, metered outputs, and remote sensing capability. Optional features include modifications for parallel operation and remote programming. Available for 19-inch racks or in case mountings.

Write for complete specifications on this and many other EIC power supplies.

ELECTRODYNAMIC INSTRUMENT CORPORATION
 SUBSIDIARY OF REED ROLLER BIT COMPANY
 TWX 713-571-341 / RI 8-2760 1841 Old Spanish Trail — Houston 25, Texas
 Cable: EICORP — Houston

EIC REPRESENTATIVES

CLYDE M. SALISBURY CO., San Francisco, 1453 Seventh Ave. — MO 4-0586 • REPCO SALES, Miami, 401 N.W. 71st Street — PL 7-2911 • ELECTRONIC SALES, INC., Denver 22, 2641 S. Ivy Street — SK 6-4148 • WALLACE AND WALLACE, Los Angeles 15, 1206 Maple Ave. — RI 7-0401 • BRANCH OFFICE: P. O. Box 30201, Dallas 30 — EM 1-0174.

CIRCLE 204 ON READER SERVICE CARD

SHAKE IT, DROP IT DRILL IT! EVEN RESISTS! MAGNETRONS!

NETIC & CO-NETIC MAGNETIC SHIELDS PERMANENTLY PROTECT YOUR COMPONENTS . . . never require rejuvenation . . . have negligible residual magnetism . . . make your sensitive components impervious to outside magnetic disturbances.

Because of their proven reliability, both are widely used in satellites and missiles as well as on the ground to protect recording tapes, components or systems. The proprietary characteristics of these alloys enable you to design compactly and to improve overall performance.

The Magnetic Shield Division has the industry's widest choice of magnetic shields for components and structures, ranging from micromodules to mobile shielded rooms. Tell us your shielding requirement and let us help solve it.



MAGNETIC SHIELD DIVISION

Perfection Mica Company / EVERGLADE 4-2122

1322 N. ELSTON AVENUE, CHICAGO 22, ILLINOIS

ORIGINATORS OF PERMANENTLY EFFECTIVE NETIC CO-NETIC MAGNETIC SHIELDS

electronics

WEEKLY QUALIFICATION FORM FOR POSITIONS AVAILABLE

ATTENTION: ENGINEERS, SCIENTISTS, PHYSICISTS

This Qualification Form is designed to help you advance in the electronics industry. It is unique and compact. Designed with the assistance of professional personnel management, it isolates specific experience in electronics and deals only in essential background information.

The advertisers listed here are seeking professional experience. Fill in the Qualification Form below.

STRICTLY CONFIDENTIAL

Your Qualification form will be handled as "Strictly Confidential" by ELECTRONICS. Our processing system is such that your form will be forwarded within 24 hours to the proper executives in the companies you select. You will be contacted at your home by the interested companies.

WHAT TO DO

1. Review the positions in the advertisements.
2. Select those for which you qualify.
3. Notice the key numbers.
4. Circle the corresponding key number below the Qualification Form.
5. Fill out the form completely. Please print clearly.
6. Mail to: Classified Advertising Div., ELECTRONICS, Box 12, New York 36, N. Y. (No charge, of course).

COMPANY	SEE PAGE	KEY #
APPLIED PHYSICS LABORATORY, The Johns Hopkins University, Silver Springs, Maryland	78	1
ATOMIC PERSONNEL INC., Philadelphia, Penna.	124*	2
DOUGLAS AIRCRAFT CO., Missile & Space Systems Division Santa Monica, California	115*	3
GENERAL DYNAMICS/ELECTRONICS Rochester 1, N. Y.	79	4
JET PROPULSION LABORATORY Pasadena, Calif.	125*	5
PAN AMERICAN WORLD AIRWAYS INC. Guided Missiles Range Div. Patrick AFB, Fla.	77	6
SPACE TECHNOLOGY LABORATORIES, INC. Sub. of Thompson Ramo Wooldridge Inc. Redondo Beach, California	13*	7
SPERRY MICROWAVE ELECTRONICS CO. Div. of Sperry Rand Corp. Clearwater, Florida	126*	8
TECH-OHM ELECTRONICS Long Island 6, N. Y.	79	9

*These advertisements appeared in the Jan. 25th issue.

(cut here)

electronics WEEKLY QUALIFICATION FORM FOR POSITIONS AVAILABLE

(cut here)

(Please type or print clearly. Necessary for reproduction.)

Personal Background

NAME

HOME ADDRESS

CITY ZONE STATE

HOME TELEPHONE

Education

PROFESSIONAL DEGREE(S)

MAJOR(S)

UNIVERSITY

DATE(S)

FIELDS OF EXPERIENCE (Please Check)

2163

- | | | |
|--|--|---------------------------------------|
| <input type="checkbox"/> Aerospace | <input type="checkbox"/> Fire Control | <input type="checkbox"/> Radar |
| <input type="checkbox"/> Antennas | <input type="checkbox"/> Human Factors | <input type="checkbox"/> Radio-TV |
| <input type="checkbox"/> ASW | <input type="checkbox"/> Infrared | <input type="checkbox"/> Simulators |
| <input type="checkbox"/> Circuits | <input type="checkbox"/> Instrumentation | <input type="checkbox"/> Solid State |
| <input type="checkbox"/> Communications | <input type="checkbox"/> Medicine | <input type="checkbox"/> Telemetry |
| <input type="checkbox"/> Components | <input type="checkbox"/> Microwave | <input type="checkbox"/> Transformers |
| <input type="checkbox"/> Computers | <input type="checkbox"/> Navigation | <input type="checkbox"/> Other |
| <input type="checkbox"/> ECM | <input type="checkbox"/> Operations Research | <input type="checkbox"/> |
| <input type="checkbox"/> Electron Tubes | <input type="checkbox"/> Optics | <input type="checkbox"/> |
| <input type="checkbox"/> Engineering Writing | <input type="checkbox"/> Packaging | <input type="checkbox"/> |

CATEGORY OF SPECIALIZATION

Please indicate number of months experience on proper lines.

	Technical Experience (Months)	Supervisory Experience (Months)
RESEARCH (pure, fundamental, basic)
RESEARCH (Applied)
SYSTEMS (New Concepts)
DEVELOPMENT (Model)
DESIGN (Product)
MANUFACTURING (Product)
FIELD (Service)
SALES (Proposals & Products)

CIRCLE KEY NUMBERS OF ABOVE COMPANIES' POSITIONS THAT INTEREST YOU

1 2 3 4 5 6 7 8 9 10 11 12 13 14 15 16 17 18 19 20 21 22 23 24 25

ENGINEERS • SCIENTISTS

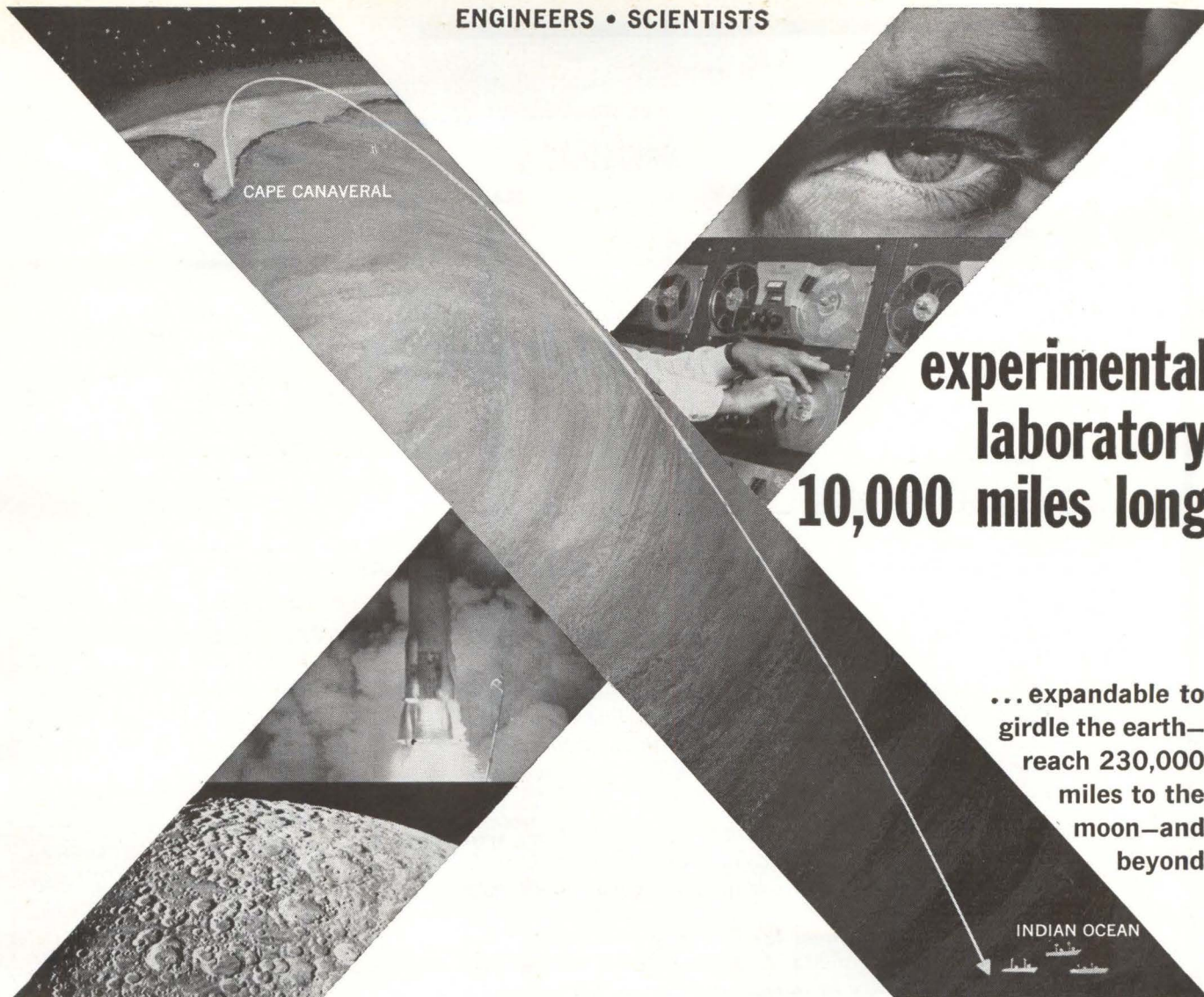

experimental
laboratory
10,000 miles long

... expandable to
girdle the earth—
reach 230,000
miles to the
moon—and
beyond

INDIAN OCEAN

ENGINEERS and SCIENTISTS LOOKING FOR "BIG-SYSTEM" CHALLENGES will find them with PAN AM at the Atlantic Missile Range.

This is the giant laboratory where the nation's major missile systems and space vehicles come for their crucial flight tests, research, and development, under a true operating environment. It's more than hemisphere long, for ballistic missiles. Linked with other national ranges, it provides orbital coverage and impact location, as in recent Mercury launches. Right now, Advanced Planning Groups are working to raise its capabilities to encompass recording all relevant data from lunar flights, including voice communications. Already solutions for problems of data acquisition from the interplanetary missions of the 70's are under study. □ Taken all together—this is a task of great magnitude in which PAN AM's Guided Missiles Range Division is by no means alone. In carrying out the triple responsibilities assigned the Division by the USAF for range planning, engineering, and operation, PAN AM cooperates with many segments of American industry:

- GMRD, by designing individual range instrumentation systems to match the requirements of each new program, collaborates with Range Users, who create the new vehicles and spacecraft.
- GMRD works closely with the radar, telemetry, computer and communication industries providing specifications and technical direction for the development of new equipment.
- GMRD and its subcontractors operate and service the tracking and other electronic equipment of the range.

In addition, PAN AM provides launch and operations support at Cape Canaveral and Down Range.

IF YOU ARE INTERESTED IN CONTRIBUTING TO THE NEW RANGE TECHNOLOGY, INQUIRE ABOUT THE FOLLOWING POSITIONS:

Systems Engineers & Program Managers, EE, Physicists with specialized knowledge in any major area of range instrumentation
Instrumentation Planning Engineers, EE, Physicists with specialized knowledge in advanced instrumentation systems
Technical Staff & Advance Planning Groups MS, PhD—Physics • Electronics • Mathematics • Celestial Mechanics • Astronomy

Why not write us today, describing your interests and qualifications in any of the areas above. Address Dr. Charles Carroll, Dept. 28B-1, Pan American World Airways, Incorporated, P.O. Box 4465, Patrick Air Force Base, Florida.

*Carrying on Range Planning, Engineering and Operation of Atlantic Missile Range for the USAF since 1953. An equal opportunity employer.



GUIDED MISSILES RANGE DIVISION
PATRICK AIR FORCE BASE, FLORIDA

ELECTRONIC ENGINEERS FOR SATELLITE DESIGN PROJECTS

TRANSIT • TRAAC • ANNA

Several Engineers are urgently needed to assist in designing memory systems for APL-developed TRANSIT, TRAAC and ANNA satellites. These are coincident current memories containing some 25,000 ferrite cores and 200 transistors driven by 1½ watts. Counting, scaling, satellite control and other functions as well as protective (fail-safe) circuits are integrated with the memories. Solutions will require many new and novel concepts.

Accepted applicants will be primarily concerned with magnetic logic and circuitry. They will collaborate closely with packaging designers to assure survival in severe launch and orbital environments. Simplified circuits, fewer components and easier fabrication leading to long life are major objectives. The positions require BS or MSEE degrees and a minimum of three years' experience in transistor circuit design for digital equipment.

A second assignment involves design, assembly and test of a small computer for shipboard doppler navigation. This is a low-speed serial device employing new and unique concepts of program control. Appointment to this group will afford an opportunity to learn magnetic design if desired. Respondents should have a BS or MS degree in EE or Physics, elementary understanding of computer logic, and experience in transistor design.

APL's modern and well equipped facilities are located an equal distance between Washington, D. C. and Baltimore, giving you a choice of country, suburban, or city living. Several nearby universities offer graduate study. Public schools in the area rate among the best in the nation.

Direct your inquiry to:
Professional Staff Appointments

The Applied Physics Laboratory · The Johns Hopkins University

8633 Georgia Avenue, Silver Spring, Maryland
(A residential suburb of Washington, D.C.)

An equal opportunity employer



Are you a COMPLETELY INFORMED electronics engineer?

Today you may be working in microwaves. But on what project will you be working tomorrow? You *could* have read **electronics** this past year and kept abreast of, say, microwave technology. *There were 96 individual microwave articles between July, 1961 and June, 1962!*

But suppose tomorrow you work in some area of standard electronic components, in semiconductors, in systems? Would you be up-to-date in these technologies? Did you read the more than 3,000 editorial pages that **electronics'** 28-man editorial staff prepared last year?

electronics is edited to keep you current *wherever* you work in the industry, *whatever* your job function(s). If you do not have your own copy of **electronics**, subscribe today via the Reader Service Card in this issue. Only 7½ cents a copy at the 3 year rate.

electronics

RESISTOR ENGINEER

with experience in power wire-wound resistors.

TECH-OHM ELECTRONICS
36-11 33rd St. Long Island City 6, N. Y.
Stillwell 6-2274

SELLING OPPORTUNITY AVAILABLE

Representatives wanted for large modern printed circuit and electronic manufacturing plant. All territories of United States open. RW-1454, Electronics, Classified Adv. Div., PO Box 12, New York 36, N. Y.

SEARCHLIGHT SECTION

(Classified Advertising)

BUSINESS OPPORTUNITIES
EQUIPMENT - USED or RESALE

DISPLAYED RATE

The advertising rate is \$27.25 per inch for all advertising appearing on other than a contract basis. Contract rates quoted on request. AN ADVERTISING INCH is measured $\frac{1}{8}$ inch vertically on one column, 3 columns—30 inches—to a page. EQUIPMENT WANTED or FOR SALE ADVERTISEMENTS acceptable only in Displayed Style.

UNDISPLAYED RATE

\$2.70 a line, minimum 3 lines. To figure advance payment count 5 average words as a line.

PROPOSALS, \$2.70 a line an insertion.

BOX NUMBERS count as one line additional in undisplayed ads.

DISCOUNT OF 10% if full payment is made in advance for four consecutive insertions of undisplayed ads (not including proposals).

FOR RESEARCH — DEVELOPMENT & EXPERIMENTAL WORK

Over 10,000 different electronic parts: waveguide, radar components and parts, test sets, pulseurs, antennas, pulse xmfrs, magnetrons, IF and pulse amplifiers, dynamotors, 400 cycle xmfrs, 584 ant. pedestals, etc.
PRICES AT A FRACTION OF ORIGINAL COST!
COMMUNICATIONS EQUIP CO.
343 CANAL ST., N. Y. 13, WO 6-4045
CHAS. ROSEN (Formerly at 131 Liberty St.)

CIRCLE 950 ON READER SERVICE CARD

RADIO RESEARCH INSTRUMENT CO.

AUTO-TRACK & TELEMETRY ANTENNA PEDESTALS
3 & 10 CM. SCR. 584 AUTOTRACK RADARS.
AN/TPS-10 SEARCH. AN/TPS-10 HT. FINDERS.
AN/FPM-32GCA. AN/APS-10 NAVIG. & WEATHER.
AN/APS-15B PRECISION. AN/APQ-35B PRECISION.
AN/APS-31A SEARCH. DOZENS MORE.
5-1-2 MEGAWATT HIGH POWER PULSERS.

RADIO RESEARCH INSTRUMENT CO.
550 Fifth Ave., New York Judson 6-4691

RADAR SYSTEMS & COMPONENTS/ IMMEDIATE DELIVERY

CIRCLE 951 ON READER SERVICE CARD

FOR SALE

HUMIDITY, COLD, AND CYCLING CHAMBERS; DIFFUSION, SOLDERING, AND ALLOYING FURNACES; MISCELLANEOUS EQUIPMENT

Reply to

FS-1353, Electronics
P.O. Box 12, New York 36, N. Y.

CIRCLE 952 ON READER SERVICE CARD

EQUIPMENT WANTED

Wanted: Working Model of Daven-type Scanning Disc Television Receiver, circa 1928 Write Mr. R. J. Newman, Daven Div. of General Mills, Livingston, N. J.

LET'S TALK About the New Field of AEROSPACE GROUND ELECTRONICS!

The rapidity with which we are reaching further and further into outer space . . . the many new and as yet completely unexplored related technologies . . . are giving birth to a vital new field—Aerospace Ground Electronics.

To be sure, ground support equipment, test equipment design and the like are involved. But the enormity of the tasks which lie ahead require different approaches than before and can only be described in new terms, and by the creation of a new master-field.

General Dynamics/Electronics is very active in Aerospace Ground Electronics and expects to become even more heavily involved. Our preliminary ideas in the field evolve from the disciplines listed below. If you have the required background, we would like to explore the possibilities of AGE with you.

SYSTEMS ENGINEERING

Broad knowledge of Aerospace Ground Electronics design. Will analyze aerospace electronic sub-systems for test requirements and determine test equipment needs. Experience in Air Force Shop or Naval Carrier Installations desirable, with emphasis on equipment layout, intercabling, work flow analysis, operational and calibration procedures.

PROJECT ENGINEERING

Project Engineers to supervise design and integration of test equipments and test stations. Should be familiar with all types of testing equipment and techniques in one or more of the following areas.

- Flight Control Systems
- Radar
- HF-UHF Navigation & Communication Equipment
- Microwave Equipment
- Antenna Systems
- Electronic Countermeasures

DESIGN ENGINEERING

MICROWAVE—Engineers experienced in the design of signal generators and receivers in the following frequency bands: L, S, C, T, Ku, Ka. Should also know techniques for remote control of frequency and signal amplitude.

LOW FREQUENCY—Experience in the design of audio and sweep signal generators and servo systems test equipment. Knowledge of remote control of audio generator frequency and output using digital techniques is desirable, or in cathode ray tube sweep circuits.

HF-UHF—Engineers with experience in the design of HF and UHF signal generators, using both transistorized and vacuum tube circuitry. Knowledge of techniques for digital selection of frequency, such as frequency synthesis, and remote control of signal amplitude required.

CIRCUIT DESIGN

Digital and Pulse engineers with experience in the design of transistorized logic circuits, pulse generators and other digitally controlled circuits such as numerical indicators.

Assignments Immediately Available in:

RELIABILITY SPACE NAVIGATION

ADVANCED DEVELOPMENT & ENGINEERING DESIGN
OF DATA & RADIO COMMUNICATIONS

Send us your qualifications now. A discussion can be arranged.
Address Mr. R. W. Holmes, Dept. 22.

GENERAL DYNAMICS | ELECTRONICS
ROCHESTER
AN EQUAL OPPORTUNITY EMPLOYER

1400 N. Goodman St., Rochester 1, New York



electronics IS EDITED TO KEEP YOU FULLY INFORMED— a "well-rounded" engineer

What's your *present* job in electronics? Do you work on computers? (**electronics** ran 158 articles on computers between July, 1961 and June, 1962!) Are you in semiconductors? (For the same period, **electronics** had 99 articles, not including transistors, solid-state physics, diodes, crystals, etc.) Are you in military electronics? (**electronics** had 179 articles, not including those on aircraft, missiles, radar, etc.)

In all, **electronics'** 28-man editorial staff provided more than 3,000 editorial pages to keep you abreast of all the technical developments in the industry. No matter where you work today or in which job function(s), **electronics** will keep you fully informed. Subscribe today via the Reader Service Card in this issue. Only 7½ cents a copy at the 3 year rate.

electronics

INDEX TO ADVERTISERS



Audited Paid Circulation

• Acton Laboratories, Inc. 66	• Radio Corporation of America...4th Cover
Air Products & Chemicals, Inc..... 62	• Raytheon Company 11
Ampex Corporation 26	Research Products Corp..... 12
Artisan Organs 74	• Rixon Electronics, Inc..... 61
Bausch & Lomb, Inc..... 67	• Sierra Electronic Div. of Philco..... 6
• CTS of Asheville, Inc. Sub. of CTS Corp..... 69	Spectra-Strip Wire & Cable Corp..... 24
Colorado Research Co. Div. of Bell & Gossett Co..... 5	Sprague Electric Co.....9, 20
Computer Control Co..... 21	Texas Instruments Incorporated Industrial Products Group..... 23
• Electrodynamic Instrument Corporation 75	Towson Laboratories, Inc..... 61
Electro Instruments, Inc..... 45	U. S. Semicor 47
Electro Mechanical Research, Inc..... 55	• United Transformer Corp.....2nd Cover
Electronic Associates, Inc..... 49	• Utica Drop Forge & Tool Div., Kelsey-Hayes Co. 50
Electronic Research Associates, Inc... 17	
• Fairchild Semiconductor Corp...82, 3rd Cover	
• Federation Nationale des Industries Electroniques 52	
Gudebrod Bros. Silk Co., Inc..... 25	
• Japan Piezo Electric Co., Ltd..... 56	
Jerrold Electronics Corp..... 4	
Kauke & Co., Inc..... 73	
• Lapp Insulator Co., Inc..... 63	
Machlett Laboratories, Inc..... 19	
• Magnetic Shield Division of Perfection Mica Co. 75	
Mallory and Co., Inc., P. R.....50, 51	
Mechanical Enterprises Inc..... 74	
Motorola Semiconductor Products Inc. 13	
• North Atlantic Industries, Inc..... 53	
• Northeastern Engineering, Inc..... 12	
• Perfection Mica Co. Magnetic Shield Div..... 75	
• Polarad Electronic Instruments Div. of Polarad Electronic Corp..... 68	
• Potter Instrument Co., Inc..... 15	

CLASSIFIED ADVERTISING

F. J. Eberle, Business Mgr.

EMPLOYMENT OPPORTUNITIES77, 78, 79

EQUIPMENT (Used or Surplus New) For Sale 79

INDEX TO CLASSIFIED ADVERTISERS

Applied Physics Laboratory The Johns Hopkins University..... 78
• Communications Equipment Co..... 79
General Dynamics/Electronics 79
Pan American Guided Missiles Range Div. 77
• Radio Research Instrument Co..... 79
Tech-Ohm Electronics 79

• See advertisement in the July 25, 1962 issue of Electronics Buyers' Guide for complete line of products or services.

This Index and our Reader Service Numbers are published as a service. Every precaution is taken to make them accurate, but **electronics** assumes no responsibilities for errors or omissions.

electronics



Audit Bureau
of Circulations



Associated Business
Publications

Audited Paid Circulation

JAMES T. HAUPTLI

Advertising Sales Manager

R. S. QUINT:
Assistant Publisher Buyers'
Guide and Business Manager
FRED STEWART:
Promotion Manager
B. ANELLO:
Market Services Manager

RICHARD J. TOMLINSON:
Production Manager
GEORGE E. POMEROY:
Classified Manager
HUGH J. QUINN:
Circulation Manager

ADVERTISING REPRESENTATIVES

ATLANTA (9):
Michael H. Miller, Robert C. Johnson
1375 Peachtree St. N.E., Trinity 5-0523
(area code 404)

BOSTON (16):
William S. Hodgkinson, Donald R. Furth
McGraw-Hill Building, Copley Square,
Congress 2-1160 (area code 617)

CHICAGO (11):
Harvey W. Wernecke, Robert M. Denmead
645 North Michigan Avenue, Mohawk 4-5800
(area code 312)

CLEVELAND (13):
Paul T. Fegley
55 Public Square, Superior 1-7000
(area code 216)

DALLAS (1):
Frank Le Beau
The Vaughn Bldg., 1712 Commerce St.
Riverside 7-9721 (area code 214)

DENVER (2):
J. W. Patten
Tower Bldg., 1700 Broadway,
Alpine 5-2981 (area code 303)

HOUSTON (25):
Joseph C. Page, Jr.
Prudential Bldg., Halcombe Blvd.,
Riverside 8-1280 (area code 713)

LOS ANGELES (17):
Peter S. Carberry, Ashley P. Hartman,
W. C. Gries
1125 W. 6th St., Huntley 2-5450
(area code 213)

NEW YORK (36):
Donald H. Miller, Henry M. Shaw,
George F. Werner
500 Fifth Avenue, LO-4-3000
(area code 212)

PHILADELPHIA (3):
Warren H. Gardner, William J. Boyle
6 Penn Center Plaza, LOcust 8-4330
(area code 215)

SAN FRANCISCO (11):
R. C. Alcorn
255 California Street, Douglas 2-4600
(area code 415)

LONDON W1:
Edwin S. Murphy Jr.
34 Dover St.

FRANKFURT/Main:
Matthée Herfurth
85 Westendstrasse

GENEVA:
Michael R. Zeynel
2 Place du Port

"Headquarters for Business Information"

McGraw-Hill Technical and Business Publications

American Machinist/Metal-
working Manufacturing
Aviation Week and Space
Technology
Business Week
Chemical Engineering
Chemical Week
Coal Age
Construction Methods and
Equipment
Construction Daily
Control Engineering
Electrical Construction
and Maintenance
Electrical Merchandising Week
Electrical Newsletter
Electrical West

Electrical Wholesaling
Electrical World
Electronics
Engineering Digest
Engineering and Mining Journal
E & MJ Metal and Mineral
Markets
Engineering News-Record
Factory
Fleet Owner
Industrial Distribution
National Petroleum News
Nucleonics
Nucleonics Week
Platt's Oilgram News
Platt's Oilgram Price Service
Power

Product Engineering
Purchasing Week
Science Week
Textile World

Overseas only:
Automobile International
(English, Spanish)
Ingenieria Internacional
Construccion (Spanish)
International Management
(English, Spanish
Portuguese editions)
Metalworking Production
(Great Britain)

Available by subscription only — to qualified persons actively engaged in the field of the publication. For subscription rates and information describing the editorial coverage of any of the above publications, write to: *Subscription Manager, Circulation Department, McGraw-Hill Publishing Company, 330 West 42nd Street, New York 36, N. Y.*



Are you selling the whole buying team

Tough competition *demands* that the electronics man be reached and *sold* wherever you find him: *Research, Design, Production, and Management.* Only advertising in **electronics** reaches all four... the same men your salesmen call on. Put your advertising where it works *hardest*....

in **electronics**

NIMS

NATIONWIDE IMPROVED MAIL SERVICE PROGRAM

For Better Service Your Post Office Suggests

That You Mail Early In The Day!

SUPERIOR MICRODIODE PACKAGING:

ADAM DIODE

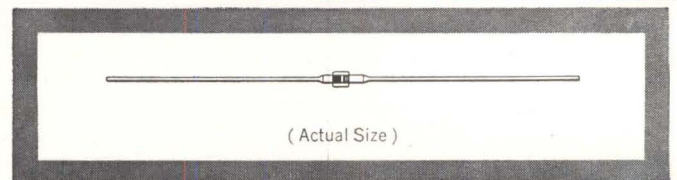

- **SMALL** — sandwich construction — no whisker.
- **STRONG** — true hermetic seal. No pressure contacts.
- **MECHANICAL STRENGTH** — stud-to-cathode and stud-to-anode solder-down.
- **VERSATILE** — replacement type for any of 276 silicon diodes.

WITH PLANAR* RELIABILITY

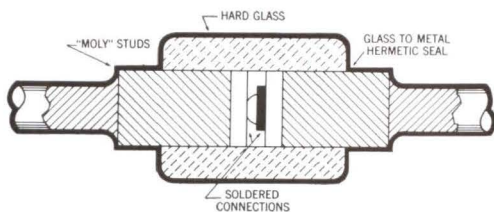

FDA 101

BV	75 Volts	Min.	@ $I_R = 5.0 \mu A$
I_R	$0.1 \mu A$	Max.	@ $V_R = 50 V$
V_F	1.0 V	Max.	@ $I_F = 20 mA$
t_{rr}	$2.0 m\mu sec$	Max.	@ $I_f = 10 mA, V_r = 6.0 mA$
C	3.0 pf	Max.	@ $V_R = 0V$

Available directly from distributor stocks.

Data sheet sent on request.

FAIRCHILD
SEMICONDUCTOR

A DIVISION OF FAIRCHILD CAMERA AND INSTRUMENT CORPORATION
545 WHISMAN RD., MOUNTAIN VIEW, CALIF. • YORKSHIRE 8-8161 • TWX-415-969-9165

* A patented Fairchild process.

CIRCLE 901 ON READER SERVICE CARD

From 3 Decades of Electron Tube Manufacturing Experience

RCA VACUUM GAUGE TUBES

...NEW IMPROVED TYPES FOR ULTRA-HIGH VACUUM SYSTEMS

Four new developmental vacuum gauge tubes, operating on the ionization principle, are now available from RCA. These are: RCA-J1856, J1856A, J1859, and J1859A. They are designed to meet the range— 10^{-3} to 2×10^{-10} Torr—required for ultra-high vacuum systems.

Excellent choices for improved reliability in many space applications, these RCA tubes feature metal-to-metal connections. There's a choice of either the Kovar sleeve type or the demountable gold-seal type for convenient attachment to the vacuum chamber.

New ionization types feature non-burnout filament, maximum temperature of 450°C during repeated "bakeouts," and Bayard-Alpert structure. This "inverted" structure places the filament outside the grid. The ion collector is inside and coaxial with the grid. This special configuration permits lower gas pressure readings because it minimizes photoelectric emission from the ion collector. Also, outgassing is greatly reduced.

RCA-J1856, J1856A, J1859, and J1859A comprise a family of vacuum gauge tubes because of their common basic structure, ratings, and typical operation. They complement a line already available commercially from RCA—for 30 years a leader in vacuum tube technology.

For complete details on these new types and others in the line, see your RCA Industrial Tube Representative.

Booklet ICE-278 contains complete information on RCA Vacuum Gauge Tubes for research, production and testing. For your free copy, write: Section B-19-Q-1, Commercial Engineering, RCA Electron Tube Division, Harrison, N. J.

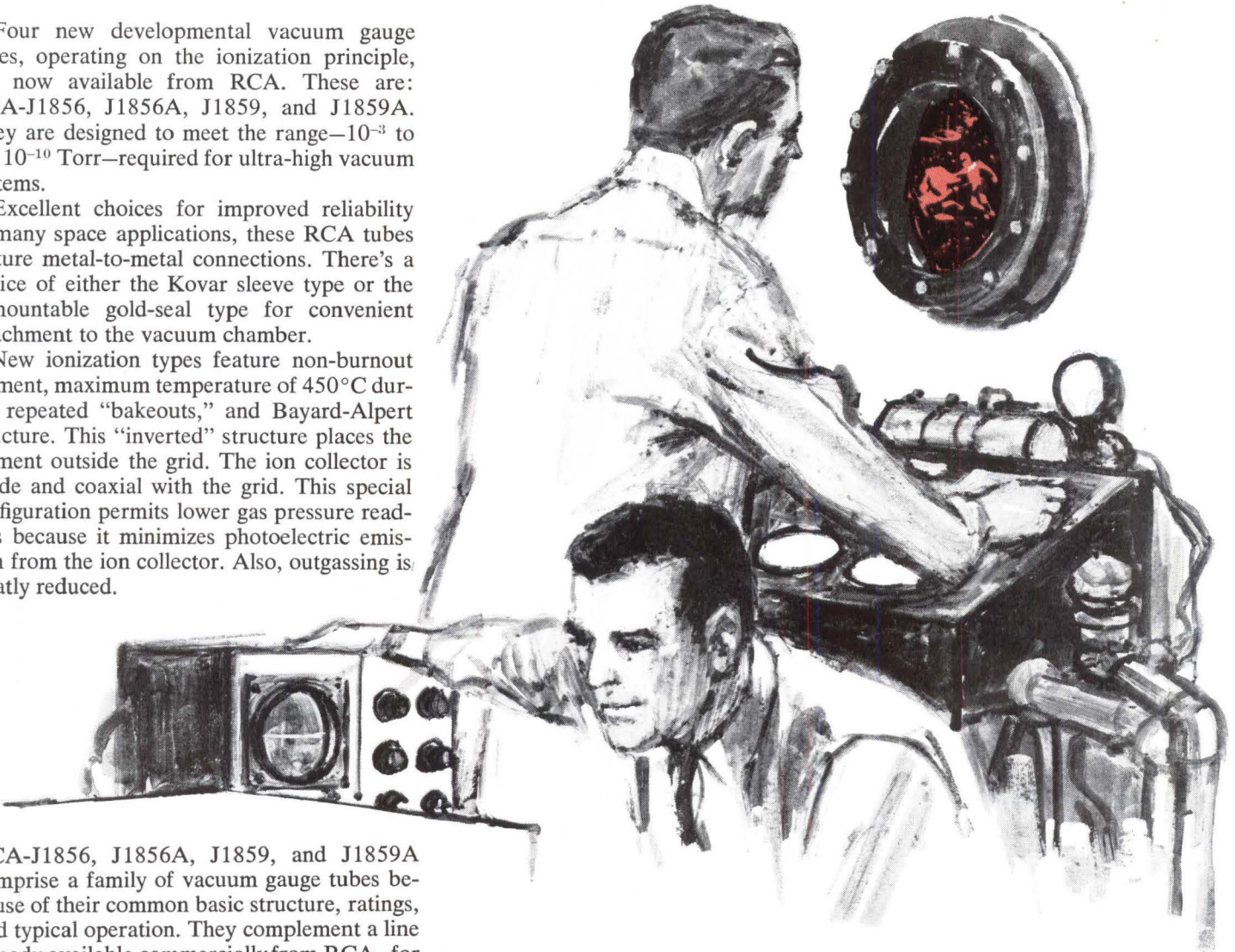

INDUSTRIAL TUBE PRODUCTS FIELD OFFICES

OEM SALES: Newark 2, N. J., 744 Broad St., 485-3900 • Chicago 54, Ill., Suite 1154, Merchandise Mart Plaza, 527-2900 • Los Angeles 22, Calif., 6801 E. Washington Blvd., RA 3-8361 • GOVERNMENT SALES: Harrison, N. J., 415 South Fifth St., 485-3900 • Dayton 2, Ohio, 224 N. Wilkinson St., BA 6-2366 • Washington 7, D. C., 1725 "K" St., N. W., FE 7-8500 • INTERNATIONAL SALES: RCA International Div., Clark, N. J., 382-1000.



The Most Trusted Name in Electronics