

INTEGRITY SERIES POWERMILL™ CLIMBER (CLPM)

OPERATION MANUAL

M051-00K98-0003 REV A



Life Fitness
WHAT WE LIVE FOR

CORPORATE HEADQUARTERS

Columbia Centre III, 9525 West Bryn Mawr Avenue, Rosemont, Illinois 60018 • U.S.A.

847.288.3300 • FAX: 847.288.3703

Service phone number: 800.351.3737 (toll-free within U.S.A., Canada)

Global Website: www.lifefitness.com

INTERNATIONAL OFFICES

AMERICAS

North America Life Fitness, Inc.

Columbia Centre III
9525 West Bryn Mawr Avenue
Rosemont, IL 60018 U.S.A
Telephone: (847) 288 3300
Fax: (847) 288 3703
Service Email: customersupport@lifefitness.com
Service Website: www.lifefitness.com/parts
Sales/Marketing Email:
commercialsales@lifefitness.com
Operating Hours: 7:00 am-6:00 pm (CST)

Brazil Life Fitness Brasil

Av. Cidade Jardim, 900
Jd. Paulistano
São Paulo, SP 01454-000
BRAZIL
SAC: 0800 773 8282
Telephone: +55 (11) 3095 5200
Fax: +55 (11) 3095 5201
Service Email: suporte@lifefitness.com.br
Sales/Marketing Email: lifefitness@lifefitness.com.br
Service Operating Hours:
9:00 - 17:00 (BRT) (Monday-Friday)
Store Operating Hours:
9:00 -20:00 (BRT) (Monday-Friday)
10:00 - 16:00 (BRT) (Saturday)

Latin America & Caribbean* Life Fitness Inc.

Columbia Centre III
9525 West Bryn Mawr Avenue
Rosemont, IL 60018 U.S.A
Telephone: (847) 288 3300
Fax: (847) 288 3703
Service Email: customersupport@lifefitness.com
Sales/Marketing Email:
commercialsales@lifefitness.com
Operating Hours: 7:00am-6:00pm (CST)

EUROPE, MIDDLE EAST, & AFRICA (EMEA)

Netherlands & Luxemburg Life Fitness Atlantic BV

Bijdorpplein 25-31
2992 LB Barendrecht
THE NETHERLANDS
Telephone: (+31) 180 646 666
Fax: (+31) 180 646 699
Service Email: service.benelux@lifefitness.com
Sales/Marketing Email:
marketing.benelux@lifefitness.com
Operating Hours: 9.00h-17.00h (CET)

United Kingdom & Ireland Life Fitness UK LTD

Queen Adelaide
Ely, Cambs, CB7 4UB
Telephone: General Office (+44)
1353.666017
Customer Support (+44) 1353.665507
Fax: (+44) 1353.666018
Service Email: uk.support@lifefitness.com
Sales/Marketing Email: life@lifefitness.com
Operating Hours:
General Office: 9.00am - 5.00pm (GMT)
Customer Support: 8.30am - 5.00pm (GMT)

Germany & Switzerland Life Fitness Europe GMBH

Siemensstraße 3
85716 Unterschleißheim
GERMANY
Telephone: (+49) 89.31 77 51.0 (Germany)
(+41) 0848 000 901 (Switzerland)
Fax: (+49) 89.31 77 51.99 (Germany)
(+41) 043 818 07 20 (Switzerland)
Service Email: kundendienst@lifefitness.com
Sales/Marketing Email:
kundenberatung@lifefitness.com
Operating Hours: 08.30 -16.30h (CET)

Austria Life Fitness Austria

Vertriebs G.m.b.H.
Dückerstraße 7-9/3/36
1220 Vienna
AUSTRIA
Telephone: (+43) 1.61.57.198
Fax: (+43) 1.61.57.198.20
Service Email: kundendienst@lifefitness.com
Marketing/Sales Email:
kundenberatung@lifefitness.com
Operating Hours: 08:30-16.30.h (MEZ)

Spain Life Fitness IBERIA

C/Frederic Mompou 5,1ª^a
08960 Sant Just Desvern Barcelona
SPAIN
Telephone: (+34) 93.672.4660
Fax: (+34) 93.672.4670
Service Email: servicio.tecnico@lifefitness.com
Sales/Marketing Email: info.iberia@lifefitness.com
Operating Hours:
9.00h-18.00h (Monday-Thursday)
8.30h-15.00h (Friday)

Belgium Life Fitness Benelux NV

Parc Industriel de Petit-Rechain
4800 Verviers
BELGIUM
Telephone: (+32) 87 300 942
Fax: (+32) 87 300 943
Service Email: service.benelux@lifefitness.com
Sales/Marketing Email:
marketing.benelux@lifefitness.com
Operating Hours: 9.00h -17.00h (CET)

Italy

Life Fitness Europe GmbH

Siemensstraße 3
85716 Unterschleißheim
GERMANY
Telephone: (+39) 02-55378611
Service: 800438836 (In Italy)
Fax: (+39) 02-55378699
Service Email: assistenza@lifefitness.com
Sales/Marketing Email: info@lifefitnessitalia.com
Operating Hours: 08:30 - 16:30h (CET)

All Other EMEA Countries & Distributor Business C-EMEA*

Bijdorpplein 25-31
2992 LB Barendrecht
THE NETHERLANDS
Telephone: (+31) 180 646 644
Fax: (+31) 180 646 699
Service Email: service.db.cemea@lifefitness.com
Sales/Marketing Email:
marketing.db.cemea@lifefitness.com
Operating Hours: 9.00h-17.00h (CET)

ASIA PACIFIC (AP)

Japan Life Fitness Japan

Japan Nippon Brunswick Bldg., #8F
5-27-7 Sendagaya
Shibuya-Ku, Tokyo
Japan 151-0051
Telephone: (+81) 3.3359.4309
Fax: (+81) 3.3359.4307
Service Email: service@lifefitnessjapan.com
Sales/Marketing Email: sales@lifefitnessjapan.com
Operating Hours: 9.00h-17.00h (JAPAN)

China and Hong Kong Life Fitness Asia Pacific LTD

Room 2610, Miramar Tower
132 Nathan Road
Tsimshatsui, Kowloon
HONG KONG
Telephone: (+852) 2891.6677
Fax: (+852) 2575.6001
Service Email: HongKongEnquiry@lifefitness.com
Sales/Marketing Email:
ChinaEnquiry@lifefitness.com
Operating Hours: 9.00h-18.00h

All Other Asia Pacific countries & distributor business Asia Pacific*

Room 2610, Miramar Tower
132 Nathan Road
Tsimshatsui, Kowloon
HONG KONG
Telephone: (+852) 2891.6677
Fax: (+852) 2575.6001
Service Email: HongKongEnquiry@lifefitness.com
Sales/Marketing Email:
ChinaEnquiry@lifefitness.com
Operating Hours: 9.00h-18.00h

Also check www.lifefitness.com for local representation or distributor/dealer.

TABLE OF CONTENTS

1. Getting Started	5
1.1 Safety Instructions	5
1.2 Set Up	9
2. Console Overlay	11
2.1 Console Overlay Overview	11
2.2 Console Overlay Descriptions	12
2.3 Reading Rack, Accessory Trays, & Bottle Holders	15
2.4 Thumb Control on Handlebars	16
3. Heart Rate Zone Training®	17
3.1 Why Heart Rate Zone Training Exercise	17
3.2 Heart Rate Monitoring	18
4. The Workouts	19
4.1 Workout Descriptions	19
4.2 Workout Set Up & Data Entry Options	25
4.3 Workout Modes	27
5. Service Menu	28
5.1 Entering and Using the Service Menu	28
5.2 Manager's Configuration (Optional Settings)	29
6. Service and Technical Data	30
6.1 Preventive Maintenance Tips	30
6.2 Preventive Maintenance Schedule	31
6.3 Troubleshooting the Optional Polar® Telemetry Heart Rate Chest Strap	32
6.4 Troubleshooting the iPod®	33
6.5 Troubleshooting the Lifepulse™ System Sensors	34
6.6 How to Obtain Product Service / Serial Number Location	34
7. Specifications	35
7.1 Integrity Series PowerMill Climber (CLPM)	35
7.2 Warranty Information	36

© 2014 Life Fitness, A division of Brunswick Corporation. All Rights Reserved. Life Fitness is a registered trademark of Brunswick Corporation. Discover, FitPower, Heart Rate+, LFconnect, Lifepulse, Lifescape, MaxBlox, PowerMill, SureStepSystem, Swipe and Workout Landscape are trademarks of Brunswick Corporation. FitLinxx is a trademark of Integrated Fitness Corp. Polar is a registered trademark of Polar Electro, Inc. iPad, iPhone and iPod are registered trademarks of Apple Inc. Android is a trademark of Google Inc. PM-038-13. (3.14) Fitlinxx is a trademark of Fitlinxx, Inc. Polar is a registered trademark of Polar Electro, Inc. Gym Wipes® is a registered trademark of The 2XL Corporation. PureGreen 24 is a trademark of Pure Green.

Before using this product, it is essential that this ENTIRE operation manual and ALL installation instructions be read. It describes equipment setup and instructs members on how to use it correctly and safely.

Avant toute utilisation de ce produit, il est indispensable de lire ce manuel d'utilisation dans son INTÉGRALITÉ, ainsi que TOUTES les instructions d'installations. Ce manuel explique comment installer l'équipement et comment l'utiliser correctement et sans danger.

FCC Warning - Possible Radio / Television Interference

Note: *This equipment has been tested and found to comply with the limits for a Class A digital device, pursuant to part 15 of the FCC rules. These limits are designed to provide reasonable protection against harmful interference when the equipment is operated in a commercial environment. This equipment generates, uses and can radiate radio frequency energy, and if not installed and used in accordance with the operation manual, may cause harmful interference to radio communications. Operation of this equipment in a residential area is likely to cause harmful interference in which case the user will be required to correct the interference at his own expense.*



CAUTION: Any changes or modifications to this equipment could void the product warranty.



Mise en garde: Tout changement et toute modification de ce matériel peut annuler la garantie du produit.

Any service, other than cleaning or user maintenance, must be performed by an authorized service representative.

This Operation Manual describes the functions of the following product:

Integrity Series PowerMill™ Climber (CLPM)

See “Specifications” in this manual for product specific features.

Statement of Purpose:

- The Life Fitness PowerMill Climber is a commercial exercise machine that enables users to scale a revolving staircase at a wide variety of speeds.



CAUTION: Health-related injuries may result from incorrect or excessive use of exercise equipment. LIFE FITNESS STRONGLY recommends seeing a physician for a complete medical exam before undertaking an exercise program, particularly if the user has a family history of high blood pressure or heart disease, is over the age of 45, smokes, has high cholesterol, is obese, or has not exercised regularly in the past year.

If, at any time while exercising, the user experiences faintness, dizziness, pain, or shortness of breath, he or she must stop well immediately.



MISE EN GARDE: Liés à la santé des blessures peuvent résulter de l'utilisation incorrecte ou excessive de l'équipement d'exercice. LIFE FITNESS recommande FORTEMENT de consulter un médecin pour subir un examen médical complet avant de commencer tout programme d'exercice, et tout particulièrement si l'utilisateur a des antécédents familiaux d'hypertension ou de troubles cardiaques, s'il a plus de 45 ans, s'il fume, s'il a du cholestérol, s'il est obèse ou n'a pas fait d'exercice régulièrement depuis un an.

Si, pendant l'utilisation de l'appareil, l'utilisateur ressent un malaise, des vertiges, des douleurs ou des difficultés à respirer, il doit s'arrêter immédiatement.

1 GETTING STARTED

1.1 IMPORTANT SAFETY INSTRUCTIONS

Read all instructions before using the Life Fitness PowerMill.



CAUTION: Any changes or modifications to this equipment could void the product warranty.

- **DANGER:** To reduce the risk of electrical shock, always unplug this Life Fitness product before cleaning or attempting any maintenance activity.
- **WARNING:** To reduce the risk of burns, fire, electric shock, or injury, it is imperative to connect each product to a properly grounded electrical outlet. See *Grounding Instructions*.
- **WARNING:** Heart rate monitoring systems may be inaccurate. Over exercising may result in serious injury or death. If you feel faint, stop exercising immediately.
- **WARNING:** Keep a distance of at least 3 ft. (1 m) behind and 1 ft. (0.3 m) on each side of the Life Fitness PowerMill clear of any obstructions, including walls, furniture, and other equipment.
 - The product should never be left unattended when plugged in. Disconnect from the electrical outlet when not in use, and before putting on or taking off parts. To disconnect, turn power OFF on the ON/OFF switch, then remove plug from electrical outlet.
 - Never operate a Life Fitness product if it has a damaged power cord or electrical plug, or it has been dropped, damaged, or even partially immersed in water. Contact Life Fitness Customer Support Services.
 - Position the product so that the power cord plug to the wall is accessible to the user. Make sure that the power cord is not knotted or twisted and that it is not trapped under any equipment or other objects.
 - If the electrical supply cord is damaged, it must be replaced by the manufacturer, an authorized service agent, or a similarly qualified person to avoid a hazard.
 - Always follow the console instructions for proper operation.
 - This appliance is not intended for use by persons (including children) with reduced physical, sensory, or mental capabilities, or lack of experience or knowledge unless they have supervision or been given instruction concerning the use of the appliance by a person responsible for their safety.
 - Do not use this product outdoors, near swimming pools or in areas of high humidity.
 - Never operate a Life Fitness product with the air openings blocked. Keep air openings free of lint, hair, or any other obstructing material.
 - Never insert objects into any opening in these products. If an object should drop inside, turn off the power, unplug the power cord from the outlet, and carefully retrieve it. If the item cannot be reached, contact Life Fitness Customer Support Services.
 - Never place liquids of any type directly on the unit, except in an accessory tray or holder. Containers with lids are recommended.

- Do not use this product in bare feet. Always wear shoes. Wear shoes with rubber or high-traction soles. Do not use shoes with heels, leather soles, cleats or spikes. Make sure no stones are embedded in the soles.
- Keep children away from the Life Fitness PowerMill Climber.
- Keep all loose clothing, shoelaces, and towels away from moving parts.
- Do not reach into, or underneath, the unit or tip it on its side during operation.
- Do not allow other people to interfere in any way with the user or equipment during a workout.
- Allow LCD consoles to “normalize” with respect to temperature for one hour before plugging the unit in and using.
- Use these products for their intended use as described in this manual. Do not use attachments that have not been recommended by the manufacturer.
- Keep the power cord away from heated surfaces. Do not pull the equipment by the power cord as a handle. Do not run the power cord on the floor under or along the side of the PowerMill. Refer to Step 17 for proper power cord routing.
- Handrails may be held to enhance stability as needed, but are not for continuous use.
- Never walk or jog backwards on the PowerMill Climber.
- Do not use this product in areas where aerosol spray products are being used or where oxygen is being administered. Such substances create the danger of combustion and explosion.
- Read all warnings on the product prior to starting a workout.
- If warnings are missing or damaged, please contact Life Fitness immediately for replacement warning labels. Warning labels are shipped with every product and should be installed before product is used. Life Fitness is not responsible for missing or damaged warning labels.
- Unlike bikes, cross-trainers, or the traditional paddle stairclimbers, this is a motorized product. This motorized product causes stair steps to descend at variable rates and therefore operates on different planes simultaneously. While operating the product during a typical workout, the user is forced to fully concentrate on coordinating his or her efforts on the moving stairs. Therefore, the user cannot see if anyone or any thing approaches from the rear. For these reasons this unit is **designed for use only in a controlled setting. The PowerMill Climber is not designed for use in the home and should not be used in an environment where children or animals might have access.**
- When it is necessary to immobilize the product, set the display to read SELECT WORKOUT. (Press the PAUSE / STOP key twice if not already there.) Hold down the LEVEL DOWN arrow key and press the PAUSE / STOP key. The product now displays “IMMOBILIZED”. The product can’t be operated in this state. The motor is disabled. The product will remain in this state across resets, power cycles, etc. To restore normal operation, repeat the same key sequence: hold down the LEVEL DOWN arrow key and press the PAUSE / STOP key. The product will display “SELECT WORKOUT”.

**SAVE THESE INSTRUCTIONS FOR
FUTURE REFERENCE.**

1 DÉMARRAGE

1.1 CONSIGNES DE SÉCURITÉ IMPORTANTES

Veillez lire toutes les instructions avant d'utiliser ce produit.

- **MISE EN GARDE:** Tout changement et toute modification de ce matériel peut annuler la garantie du produit.
- **DANGER:** Pour réduire les risques de décharge électrique, toujours débrancher cet appareil LIFE FITNESS avant nettoyage ou toute mesure d'entretien.
- **AVERTISSEMENT:** Pour réduire les risques de brûlures, d'incendies, de décharges électriques ou de blessures, chaque appareil doit absolument être branché sur une prise électrique correctement mise à la terre. Reportez-vous aux Instructions de mise à la terre.
- **AVERTISSEMENT:** Des systèmes de surveillance de fréquence cardiaque peuvent être inexacts. Trop d'exercices peuvent entraîner des blessures sérieuses, voire mortelles. En cas de sensation d'évanouissement, arrêter immédiatement l'entraînement.
- **AVERTISSEMENT:** Gardez une distance d'au moins 1 m (3 ft.) libre de toute obstruction derrière le PowerMill Climber, y compris aucun mur, meuble ou autre appareil, et de 0.3 m (1 ft.) de chaque côté du PowerMill Climber.
 - Ne laissez jamais l'appareil sans surveillance lorsqu'il est branché. Débranchez-le systématiquement après son utilisation, et avant l'ajout et le retrait de pièces. Pour débrancher, mettre l'appareil hors tension au niveau de l'interrupteur d'alimentation, puis retirer la fiche de la prise électrique.
 - Ne jamais faire fonctionner un produit LIFE FITNESS dont la fiche ou le cordon d'alimentation est endommagé, ni aucun appareil qui serait tombé ou aurait été endommagé ou même partiellement plongé dans l'eau. Appeler le service clientèle de LIFE FITNESS.
 - Placer ce produit de manière à ce que l'utilisateur puisse accéder à la fiche du cordon d'alimentation. Assurez-vous que le cordon d'alimentation n'est pas noué ou tordu et qu'il n'est pas coincé sous un autre appareil ou sous tout autre objet.
 - Si le cordon d'alimentation électrique est endommagé, il doit être remplacé par le fabricant, par un réparateur agréé ou par une personne qualifiée afin d'éviter tout danger.
 - Les instructions de la console doivent toujours être suivies pour obtenir un fonctionnement correct.
 - Cet appareil n'est pas prévu pour être utilisé par des personnes (y compris les enfants) dont les capacités physiques, sensorielles ou mentales sont réduites, ou des personnes dénuées d'expérience ou de connaissance, sauf si elles ont pu bénéficier, par l'intermédiaire d'une personne responsable de leur sécurité, d'une surveillance ou d'instructions préalables concernant l'utilisation de l'appareil.
 - Ne pas utiliser ce produit à l'extérieur, près d'une piscine ou dans des endroits très humides.
 - Ne jamais faire fonctionner d'appareil LIFE FITNESS dont les orifices d'aération seraient bloqués. Les garder exempts de peluches, de cheveux ou de toute obstruction.

- Ne jamais placer aucun liquide directement sur l'appareil, sauf dans le plateau pour accessoires ou un support prévu à cet effet. Il est recommandé d'utiliser des conteneurs munis de couvercles.
- Ne pas utiliser cet appareil pieds nus. Toujours porter des chaussures. Porter des chaussures avec des semelles en caoutchouc ou fournissant une très bonne adhérence. Ne pas utiliser de chaussures à talons, à semelles en cuir ou munies de crampons. S'assurer qu'aucun caillou n'est incrusté dans les semelles.
- Gardez le PowerMill Climber Life Fitness hors de portée des enfants.
- Éloigner les vêtements lâches, les lacets et les serviettes des pièces en mouvement.
- Ne pas placer les mains sous l'appareil ou dans l'appareil, et ne pas le renverser sur le côté pendant le fonctionnement.
- Ne laisser personne déranger de quelque manière que ce soit l'utilisateur ou interférer avec l'équipement durant un entraînement.
- Laisser les consoles ACL se « normaliser » pendant une heure quant à la température avant le branchement et l'utilisation de l'appareil.
- Cet appareil ne doit être employé que pour l'usage auquel il est destiné, conformément aux directives du manuel. Ne pas utiliser d'accessoires qui ne sont pas recommandés par le fabricant.
- Tenir le cordon d'alimentation à l'écart de toute surface chauffée. Ne pas tirer l'appareil par le cordon d'alimentation; ne pas utiliser le cordon comme poignée. Ne pas faire passer le cordon d'alimentation sur le sol sous ou sur le côté de la PowerMill Climber. Reportez-vous aux sections 1.2 pour la disposition adéquate du cordon d'alimentation.
- Les rampes latérales peuvent servir à rétablir son équilibre, mais ne sont pas destinées à un usage continu.
- Ne jamais marcher ni courir à reculons sur le PowerMill Climber.
- Ne pas utiliser ce produit dans des salles où des vaporisateurs aérosols sont employés ou bien où de l'oxygène est administré. Ces substances créent des risques de combustion et d'explosion.
- Lisez tous les avertissements sur chaque produit avant de démarrer un exercice.
- Si les avertissements sont absents ou endommagés, veuillez contacter immédiatement Life Fitness afin de les faire remplacer. Les étiquettes d'avertissement sont livrées avec chaque produit et doivent être installées avant leur utilisation. Life Fitness ne peut être tenu responsable lorsque des étiquettes d'avertissement sont absentes ou endommagées.
- À la différence des vélos, cross-trainers et steppers traditionnels à pédale, il s'agit d'un appareil motorisé. Cet appareil motorisé permet de faire descendre les marches d'escalier à des vitesses variables et opère donc à différents niveaux simultanément. Au cours d'un entraînement classique sur cet appareil, l'utilisateur doit se concentrer afin de coordonner ses efforts sur les escaliers en mouvement. Il n'a donc pas la possibilité de voir si quelqu'un ou quelque chose s'approche par l'arrière. Cette unité est dès lors uniquement conçue pour être utilisée dans un environnement contrôlé. Le PowerMill Climber n'est pas conçu pour être utilisé à domicile et ne doit en aucun cas être utilisé dans un environnement auquel les enfants ou animaux ont accès.
- Si vous devez immobiliser l'appareil, réglez l'affichage sur SÉLECTIONNER EXERCICE. (Pour ce faire, appuyez deux fois sur la touche PAUSE / STOP.) Maintenez la touche NIVEAU VERS LE BAS enfoncée et appuyez sur la touche PAUSE / STOP. L'appareil affiche désormais le message « IMMOBILISÉ ». En mode Immobilisé, l'appareil ne peut être utilisé. Le moteur est désactivé. L'appareil restera immobilisé, même s'il est réinitialisé, mis hors tension, puis à nouveau sous tension, etc. Le mode de fonctionnement normal ne peut être rétabli qu'au moyen de la même séquence de touches : maintenez la touche NIVEAU VERS LE BAS enfoncée et appuyez sur la touche PAUSE / STOP. L'appareil affiche désormais « SÉLECTIONNER EXERCICE ».

**CONSERVER CES INSTRUCTIONS
POUR TOUT USAGE ULTÉRIEUR.**

1.2 SET UP

WHERE TO PLACE THE POWERMILL CLIMBER

Following all safety instructions in Section 1.1, move the PowerMill Climber to the location in which it will be used. See Section 7, *Specifications*, for the dimensions of the footprint. The location must have a minimum ceiling height of 9 feet (2.7 meters). Allow at least 3 ft. (1 m) behind the Life Fitness PowerMill Climber and 1 ft. (0.3 m) on each side. Grasp the handlebars and use the step assists to mount the PowerMill Climber. To dismount, stop the PowerMill Climber, grasp the handlebars, and use the step assists to back off the machine.

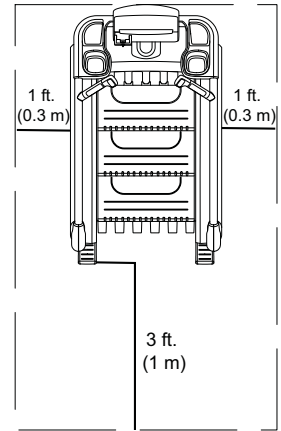

HOW TO STABILIZE THE POWERMILL CLIMBER

After placing the PowerMill Climber in position, check the unit's stability by attempting to rock it. Any slight rocking indicates that the unit must be leveled. There are four stabilizing feet on the PowerMill Climber. Check the front and back stabilizing feet to determine which foot does not rest fully on the floor. Rotate the foot counterclockwise to lower it. Recheck the stability and adjust again as needed until the PowerMill Climber is stable and no longer rocks. Lock the adjustment into position by tightening the jam nut against the stabilizer bar with an open end 17mm wrench.

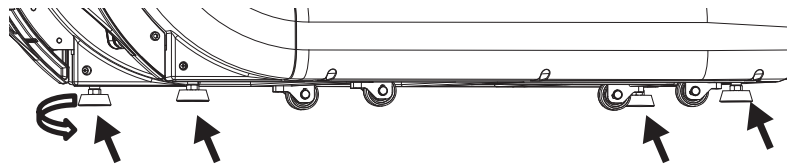

GROUNDING INSTRUCTIONS

This Life Fitness product must be properly grounded. If the unit malfunctions or breaks down, proper grounding provides a path of least resistance for the electric current, which reduces the risk of shock to anyone touching or using the equipment. Each unit is equipped with an electrical cord, which includes an equipment grounding conductor and a grounding plug. The plug must be inserted into an outlet that has been properly installed and grounded in accordance with all local codes and ordinances.



A temporary adapter **MUST NOT BE USED** to connect this plug to a two-pole receptacle in North America. If a properly grounded, 15-amp outlet is not available, one must be installed by a qualified electrician. For use on a nominal 120-V circuit, this product has a grounding plug that looks like the one in the accompanying illustration. Make sure that the product is connected to an outlet having the same configuration as the plug.

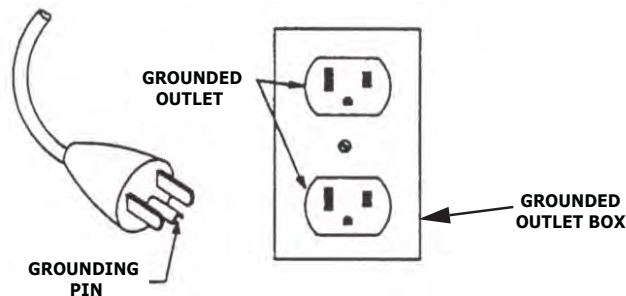

DANGER: A risk of electrical shock may result from improper connection of the equipment-grounding conductor. Check with a qualified electrician if in doubt as to proper grounding technique. **DO NOT** modify the plug provided with the product. If it will not fit an electrical outlet, have a proper outlet installed by a qualified electrician. Any modification to the electrical plug will result in a voided warranty.

PLUG IN THE POWERMILL CLIMBER

The Life Fitness PowerMill Climber has an internal power supply. Insert the power cord connector into the inlet connector on the PowerMill Climber and plug the other end of the cord into the wall outlet. Make sure that the power cord shield is secured in place to prevent the power cord from being kicked out. Turn on the ON / OFF switch next to the inlet connector and check that the console LED's light up. If not, check the inlet connector and the wall plug connections and make sure that the wall outlet has power.

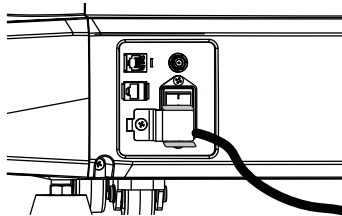

SERVICE ACCESS PORT

The two interchangeable type RJ45 networking ports (A) are located on the back of the display console. These network ports, located behind the display console rear access door, allow for console and motor controller software updates.



2 CONSOLE OVERLAY

2.1 CONSOLE OVERLAY OVERVIEW

The computerized display console allows the user to tailor a workout to personal fitness abilities and goals and to monitor progress. With this easy-to-use console, the user can track fitness improvement from one workout to the next.

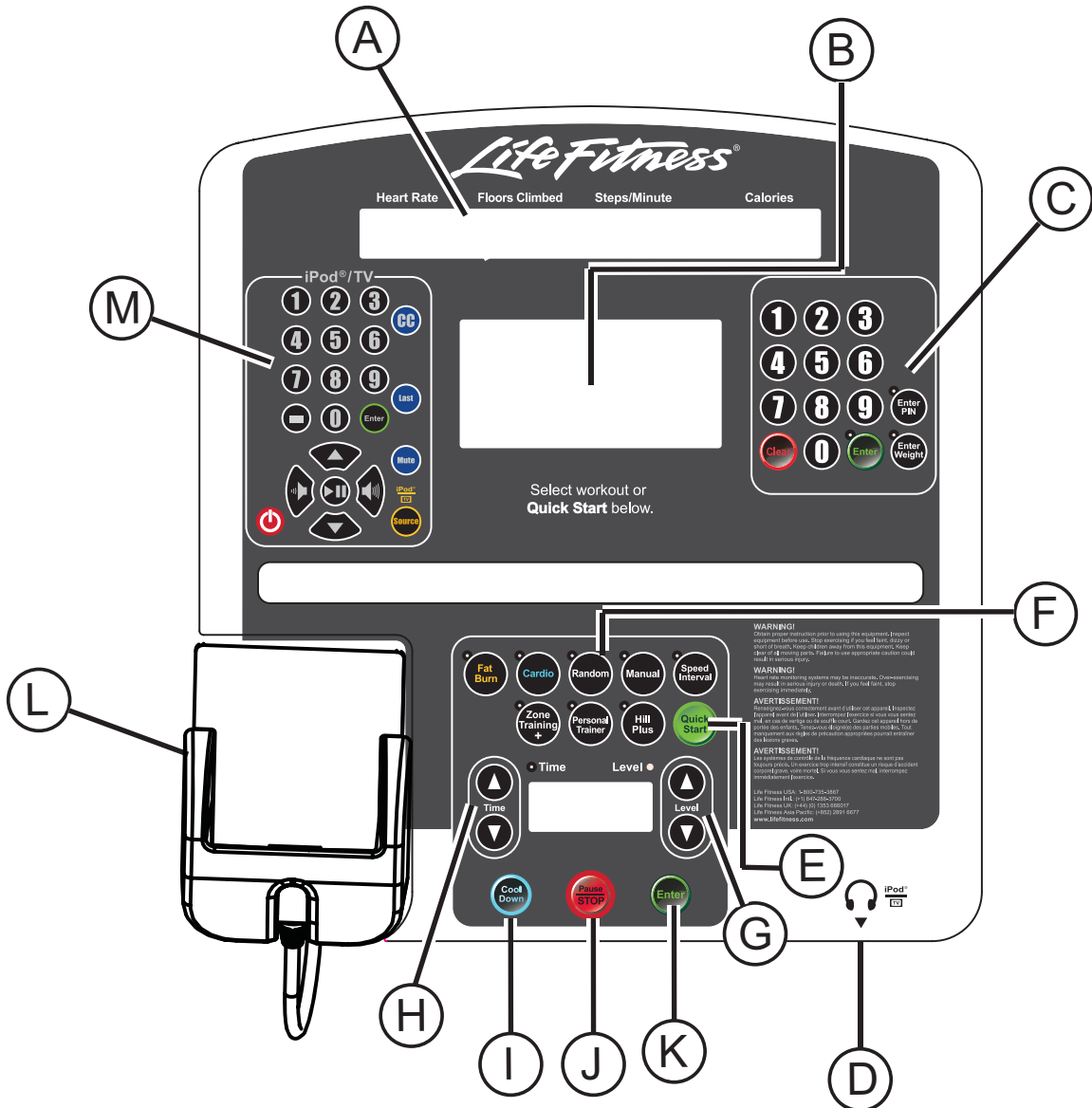

2.2 CONSOLE OVERLAY DESCRIPTIONS

- A. MESSAGE CENTER: This window displays step-by-step instructions for setting up a workout. During a workout, it displays statistics about the progress of the workout:
- **Level:** programmed resistance level.
 - **Heart Rate:** the detected heart rate if the user is wearing the Polar telemetry heart rate chest strap or grasping the Lifepulse system sensors.
 - **Steps per Minute:** the rate of steps climbed per minute.
 - **Total Steps Climbed:** the number of steps climbed since beginning the workout.
 - **Total Floors Climbed:** the number of floors climbed since beginning the workout.
 - **Calories:** the number of calories burned since beginning the workout.
 - **Time:** time elapsed since the start of the workout.

If configured to do so, the MESSAGE CENTER displays any or all of these three values each time the intensity level changes during the workout:

- **Calories per Hour:** the rate of calories burned per hour.
- **Watts:** effort level in Watts. The Watt is a unit of power output or the expression of the mechanical rate of work.
- **METs:** effort level in METs. The MET is an expression of the rate of work for the human body at rest, or a metabolic equivalent; one MET is approximately equal to the metabolism of a person at rest.

Note: *The Watts display and the Calories per Hour display cannot be turned on at the same time.*

See Section 5 for information about enabling the MESSAGE CENTER to display these additional settings.

- B. WORKOUT PROFILE window: This window displays shapes, made of columns of lights, that represent the levels of intensity in a workout-in-progress. The height of the first column on the left side of the window is proportional to the current level of intensity.

During a **FAT BURN, CARDIO, HEART RATE HILL, HEART RATE INTERVAL, or EXTREME HEART RATE WORKOUT**, which requires the use of a Polar® telemetry heart rate chest strap or the Lifepulse system sensors, the Workout Profile window displays a flashing heart shape to request the user's heart rate signal. If the console does not detect a signal, the MESSAGE CENTER displays the prompt "NEED HEART RATE - PLACE HANDS ON SENSORS OR USE TELEMTRY STRAP". If the console does not receive the signal within three minutes, the workout automatically is converted to a **MANUAL** program.

- C. NUMERIC KEYPAD: These keys are used for workout program parameter entry only. Use the numeric entry keys to enter data such as age, weight, time, level, and steps per minute rate (SPM). The NUMERIC KEYPAD can also be used to start a QUICK START workout at a given SPM rate or change the SPM rate during a QUICK START or MANUAL workout.
- **ENTER PIN:** Log on to the FitLinxx Interactive Fitness Network using a dedicated PIN Number. A FitLinxx Interactive Fitness Network shall be supported through the CSAFE console port connector as a CSAFE Compatible Device.
 - **ENTER WEIGHT:** Press to enter weight anytime during a workout.
 - **ENTER:** Press to confirm workout setup entries.
 - **CLEAR:** Press when programming a workout, to clear incorrect data, such as weight or age, before pressing the ENTER key. Pressing CLEAR once during a workout stops it immediately and pause mode is entered. Pressing CLEAR twice displays the workout summary. Pressing CLEAR three times causes the MESSAGE CENTER to display "SELECT WORKOUT OR PRESS QUICK START" for a new workout.

Note: *The keys on the NUMERIC KEYPAD are NOT used for entertainment device control.*

- D. HEADPHONE JACK: Headphones must be plugged into the bottom of the console to access sound for optional entertainment systems. The jack is not a user-replaceable feature. Contact Life Fitness Customer Support Services for more information

- E. **QUICK START:** Press this key to begin a manual workout immediately, without having to select a workout program. Once the workout is in progress, use the UP / DOWN ARROW keys located on the handlebars, or the LEVEL ARROW keys on the console overlay, to change the intensity level or workout duration as desired.
- F. **WORKOUT SELECTION keys:** Use these keys to select a workout program and / or enter or change the current workout parameters.
- ***Fat Burn***
 - ***Manual***
 - ***Personal Trainer***
 - ***Cardio***
 - ***Speed Interval***
 - ***Hill Plus***
 - ***Random***
 - ***Zone Training+***
- G. **LEVEL ARROW keys:** Press these keys to increase or decrease the resistance level.
- H. **TIME ARROW keys:** Press these keys to increase or decrease the duration of a workout and cool down phase.
- I. **COOL DOWN key:** Workout programs end automatically in a Cool Down mode, which lowers the resistance level. Press the COOL DOWN key at any desired point during a workout to go immediately into Cool Down mode. In this phase of a workout the body begins to remove lactic acid and other accumulated by-products of exercise, which build up in muscles during a workout and contribute to muscle soreness. The console automatically adjusts each workout's Cool Down level according to the individual user's performance.
- J. **PAUSE / STOP:** Press this key once to pause the workout. Pause mode shall stop the stairs and hold the current workout settings and information.

The workout will end and go to Workout Summary mode if the PAUSE / STOP key is pressed while in Pause mode.

The workout will only continue if the ENTER key is pressed per the "PAUSED - PRESS ENTER TO RESUME" message. Anytime a workout is resumed the step rate or level will be set to its minimum value.

Additionally, a circular-shaped STOP button is located at the center of the panel below the display console. Press the button to stop the stairs and the current workout.



- K. **ENTER key:** Press this key to confirm entries of workout setup values, as displayed in the MESSAGE CENTER.
- L. **iPOD HOLDER:** Users can attach an iPod via a 30-pin connector. Use the iPod keypad controls to play, or your iPod controls to select a song or video and begin playing.

M. iPod / TV keypad: These keys are used to control optional entertainment systems.

Note: These keys are NOT used for workout program data entry.

M1 NUMERIC KEYS: Press these keys to enter channels (TV / CSAFE).

M2 CC: Use this key to enable the Closed Caption Choice (TV / CSAFE).

M3 LAST: Press this key to see the last channel viewed (TV only).

M4 ENTER: Use this key to enter entertainment selections (TV / CSAFE).

M5 MUTE: Press this key to turn off the sound (Current Selected Source).

M6 SOURCE SELECT: Use this key to select TV, iPod, or optional AUX (auxiliary) audio source.

M7 PLAY / PAUSE: Use this key to play or pause the current track (iPod only).

M8 UP / DOWN ARROW KEYS: Use these keys to change channels (TV) or to select the next track and previous Track (iPod).

M9 POWER: Use this key to turn the power On and Off (TV only).

M10 LEFT and RIGHT ARROW KEYS: Use these keys to adjust the volume up and down (Current Selected Source).

M11 DIGITAL TV TUNER SUB-CHANNEL ENTRY KEY (-): Use this key to enter Digital TV channels (TV / CSAFE).

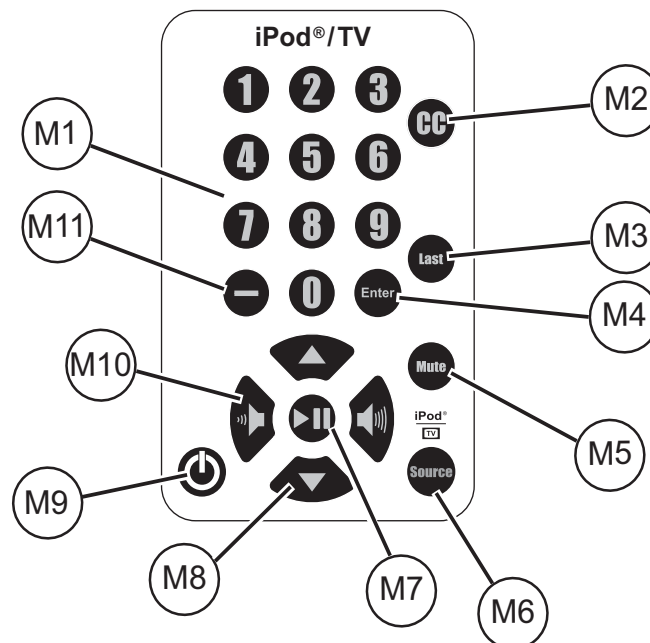

2.3 READING RACK, ACCESSORY TRAYS, AND BOTTLE HOLDERS

An integrated READING RACK (A) for supporting a book or magazine is located at the base of the upper panel of the console. The ACCESSORY TRAYS (B) provide a storage space for small items such as personal stereos and cell phones. The WATER BOTTLE HOLDERS (C) provide easy storage for water bottles and/or personal objects.

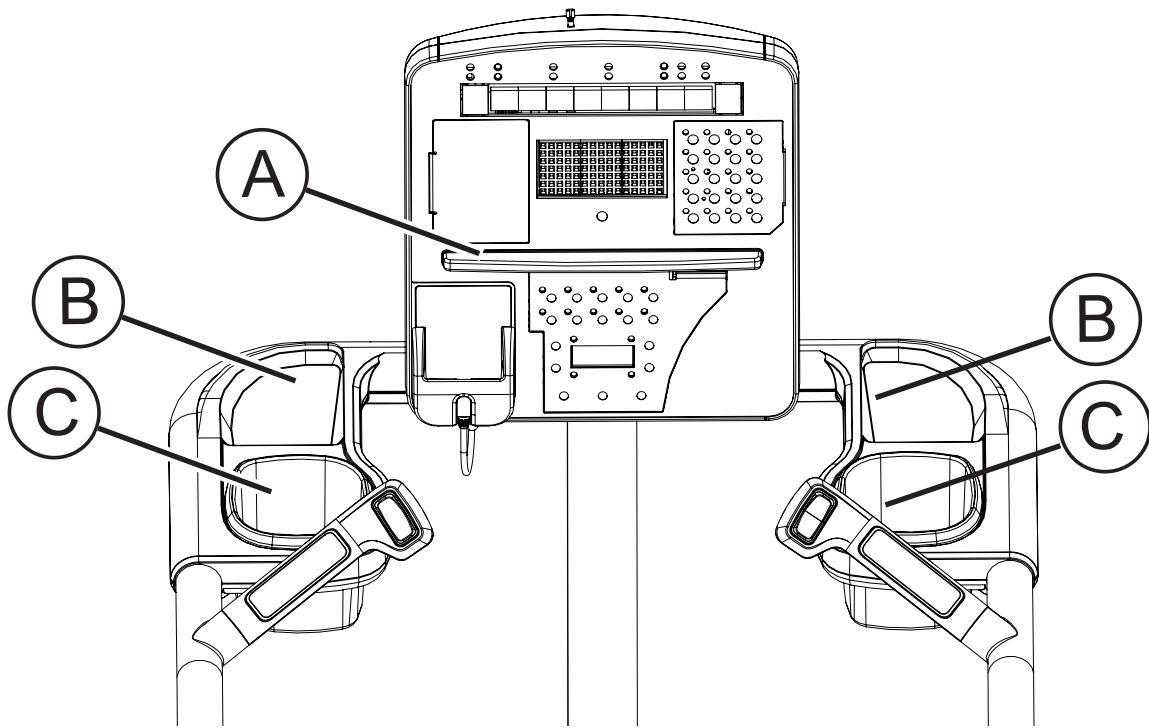

2.4 THUMB CONTROLS ON HANDLEBARS

The following keys are located on the handlebars for easy accessibility:

- GO / QUICK START (D)
- PAUSE / STOP (E)
- LEVEL INCREASE (F)
- LEVEL DECREASE (G)

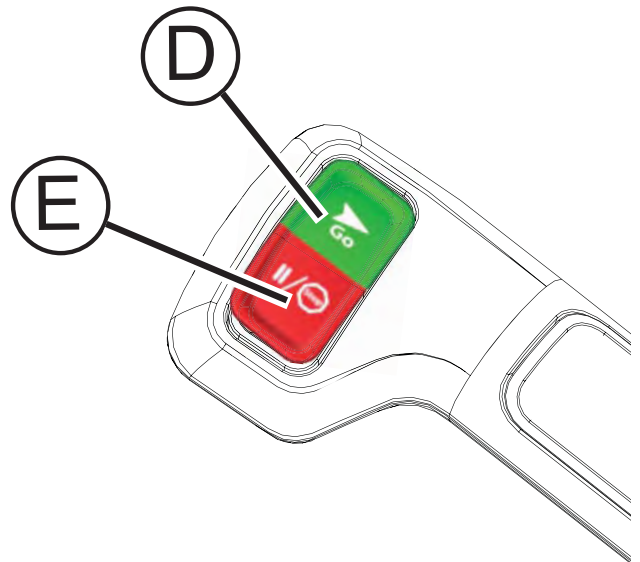
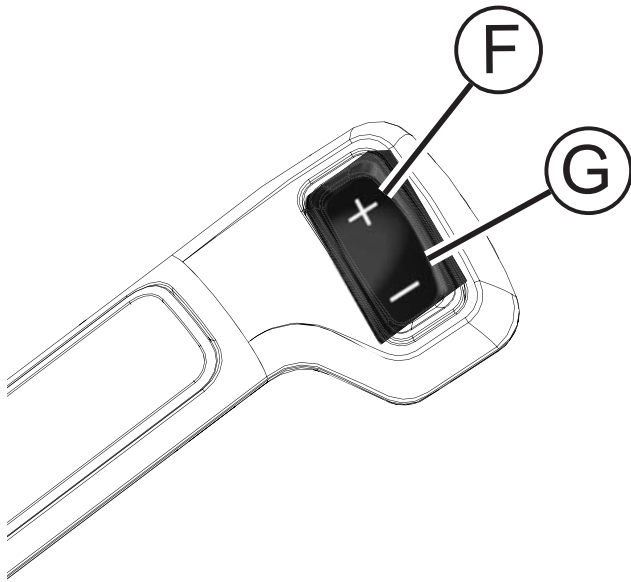

3 HEART RATE ZONE TRAINING®

3.1 WHY HEART RATE ZONE TRAINING EXERCISE?

Research shows that maintaining a specific heart rate while exercising is the optimal way to monitor the intensity of a workout and to achieve maximum results. That is the idea behind the Life Fitness Heart Rate Zone Training approach to exercise.

Zone Training identifies an exerciser's ideal heart rate range, or zone, for burning fat or increasing cardiovascular fitness. The zone is a percentage of the theoretical maximum (HRmax), and its value depends on the workout. The maximal heart rate formula is defined by the American College of Sports Medicine's "Guidelines for Exercise Testing and Prescription", 8th Edition, 2010. HRmax equals to 206.9 minus the total of 0.67 multiplied by a person's age.

$$\text{HR Max} = 206.9 - (0.67 * \text{age})$$

The Life Fitness PowerMill Climber features these exclusive workouts designed to take full advantage of the benefits of Heart Rate Zone Training+ exercise:

- FAT BURN • CARDIO • HEART RATE HILL™ • HEART RATE INTERVAL™ • EXTREME HEART RATE™

Note: Consulting a fitness trainer is recommended for defining specific fitness goals and designing a workout program.

The Heart Rate Zone Training workout programs measure heart rate. Wear the telemetry heart rate chest strap, or grip the contact heart rate sensors, to enable the on-board computer to monitor the heart rate during a workout. The computer automatically adjusts the level to maintain the target heart rate based on the actual heart rate.

Age	Theoretical Maximum Heart Rate	65% (Fat Burn)	80% (Cardio)
10	200	130	160
20	194	126	155
30	187	121	149
40	180	117	144
50	173	113	139
60	167	108	133
70	160	104	128
80	153	100	123
90	147	95	117
99	141	91	112

3.2 HEART RATE MONITORING

THE LIFEPUULSE™ DIGITAL HEART RATE MONITORING SYSTEM

The patented Lifepulse system sensors (B) are the built-in heart rate monitoring system on this product. For the most accurate reading possible, during a workout:

- Grasp the sensors firmly.
- Hold each sensors at the midpoints.
- Keep hands steady and in place.

The console displays the heart rate within 10 to 40 seconds after the user grasps the sensors. The following factors may affect a Lifepulse reading:

- incorrect hand placement on the sensors,
- upper body activity, lotion or dirt on hands, and
- excessive or insufficient pressure used when gripping the sensors.

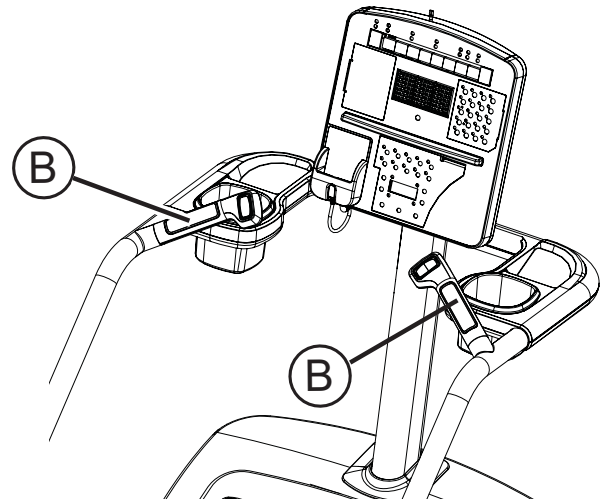

THE OPTIONAL POLAR® TELEMETRY HEART RATE CHEST STRAP

The Polar telemetry heart rate monitoring system transfers heart rate signals to the console when electrodes are pressed against the skin. These electrodes are attached to a Polar telemetry heart rate chest strap that the user wears during the workout. The Polar telemetry heart rate chest strap is optional. Contact Life Fitness Customer Support Services to order.

See the diagram to the right of this paragraph for correct positioning of the Polar telemetry heart rate chest strap. The electrodes (A), which are the two grooved surfaces on the underside of the strap, must remain wet to transmit accurately the electrical impulses of the heart back to the receiver. Moisten the electrodes. Then, secure the Polar telemetry heart rate chest strap as high under the chest muscles as possible. The strap should be snug, but comfortable enough to allow for normal breathing.

The transmitter strap delivers an optimal heart rate reading when the electrodes are in direct contact with bare skin. However, it functions properly through a thin layer of wet clothing. If it becomes necessary to re-moisten the Polar telemetry heart rate chest strap electrodes, grasp the center of the strap, pull it away from the chest to expose the two electrodes, and re-moisten them.

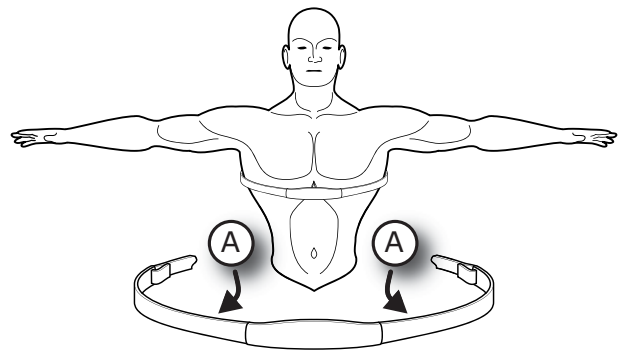

Note: If the Lifepulse system sensors are grasped while the chest strap is worn, and if the signals from the sensors are valid, the on-board computer uses these sensor signals for calculating the heart rate instead of those transmitted by the Polar telemetry heart rate chest strap.

4 THE WORKOUTS

4.1 WORKOUT DESCRIPTIONS

This section lists the Life Fitness PowerMill Climber pre-programmed workouts. The following workouts are accessible via the Workout Selection keys.

- **QUICK START** is the fastest way to begin exercising. After the QUICK START key is pressed, a constant-level workout begins. The intensity level does not change automatically. The intensity level will be set at either Level 1 (or Level 0 if the Level Zero option is enabled - see Section 5.2, *Manager's Configuration*). Optionally the user can change their steps per minute rate directly using the Numeric Keypad. **Note:** *QUICK START workouts will start accumulating calories using a default weight until the user enters in a value via the ENTER WEIGHT KEY.*
- **MANUAL** is a constant effort workout in which the user can change the intensity level at any time. Optionally the user can change their steps per minute rate directly using the Numeric Keypad or change their Level using the Level arrow keys.

LEVEL TO STEPS PER MINUTE COMPARISON CHART

* This level is only available if "Level Zero - Warm Up Level On/Off" is set to ON.

LEVEL	SPM
0 *	12
1	20
2	28
3	36
4	44
5	52
6	60
7	68
8	75
9	82
10	89
11	96
12	103
13	110
14	117
15	124
16	130
17	136
18	142
19	148
20	154
21 **	160
22 **	166
23 **	172
24 **	177
25 **	182

** These levels are only available if "Level 21 -25 - Performance Levels On/Off" are set to ON. These levels are only accessible during MANUAL and SPEED INTERVAL workouts.

- **RANDOM** is an interval training workout of constantly changing intensity levels that occur in no regular pattern or progression.
- **FAT BURN** is a low-intensity workout. The user must either wear a Polar telemetry heart rate chest strap, or grasps the Lifepulse sensors continuously. The program adjusts the intensity level, based on the actual heart rate, to maintain the rate at 65% of the theoretical maximum.
- **CARDIO** is a higher intensity workout for more fit users, maximizing cardiovascular benefits and total calories burned. The user must either wear a Polar telemetry heart rate chest strap, or grasps the Lifepulse sensors continuously. The program automatically adjusts the intensity level, based on the actual heart rate, to maintain the rate at 80% of the theoretical maximum.
- **SPEED INTERVAL** allows the user to toggle between user defined SLOW and FAST intensity levels. The SPEED INTERVAL button will flash throughout the workout. The user can toggle the levels at any time during the workout by pressing the SPEED INTERVAL button. The current level will appear in the level display window.

The preset SLOW and FAST levels cannot be changed during a workout. The levels can be adjusted at any time during a workout using the LEVEL ARROW keys.

HILL PLUS WORKOUTS

- **KILIMANJARO** is a HILL workout in which the intensity levels gradually incline toward one ultimate peak and then gradually decline.
- **AROUND THE WORLD** is an interval-training workout in which the hills resemble scenes of various geographical areas.
- **CASCADES** is a two-peak workout in which intensity levels gradually increase and decrease.
- **FOOTHILLS** is a rolling hill workout with low intensity levels.
- **INTERVAL** is a HILL workout in which intensity levels rise and fall. The higher levels gradually incline toward a peak and then gradually decline.
- The Life Fitness-patented **HILL** workout offers a variety of configurations for interval training. Intervals are periods of intense aerobic exercise separated by regular periods of lower-intensity exercise. The WORKOUT PROFILE window represents these high and low intervals as columns of light, which together have the appearance of hills and valleys. Each column represents one interval. The overall duration of the workout determines the length of each interval.

1 to 9 minutes: A workout with a duration of less than 10 minutes is insufficient for the HILL program to complete all four phases adequately. The program therefore condenses a workout of this duration at various stages.

10 to 19 minutes: The interval durations initially are set at 30 seconds for a 10-minute workout. For every minute added by the user "on the fly", each interval increases by three seconds. A 15-minute workout consists of 20 intervals at 45 seconds each.

20 to 99 minutes: All intervals last 60 seconds. If the user adds minutes to the pre-set duration while the workout is in progress, the program adds hills and valleys that are identical to the first eight intervals of the Interval Training phase. This pattern repeats until the workout is completed.

ZONE TRAINING+ WORKOUTS

- **HEART RATE HILL™** combines the standard HILL workout profile with the concept of Heart Rate Zone Training. The user wears a Polar telemetry heart rate chest strap or grasps the Lifepulse sensors continuously. The default target heart rate is calculated as 80% of the theoretical maximum(HRmax), but the user can adjust the target rate during the workout setup. All hills and valleys are percentages of HRmax.

This program takes the user through three different hills based on the target heart rate. The first hill brings the heart rate to 70% of HRmax. The second hill increases the rate to 75% of HRmax. The third hill matches the Target Heart Rate bringing the heart rate to 80% of HRmax. The valley is always defined as 65% of HRmax.

After a standard three-minute warm-up, the workout progresses toward the first hill and heart rate goal. Once the user reaches 70% of HRmax, the hill continues for one minute. When the minute expires, the level decreases into a valley. Once the user's heart rate falls to 65% of HRmax, the valley continues for one minute, then the next hill begins with its corresponding heart rate goal. After the user completes the third hill/valley pair, the program returns to the first hill and repeats the cycle as long as the duration allows. At the end of the duration, the workout goes into a cool down phase. If the heart rate goes above the theoretical maximum for more than 45 seconds, the PowerMill Climber automatically goes into pause mode. The program does not proceed to a new heart rate goal until the user reaches the current goal.

- **HEART RATE INTERVAL™** also combines the standard HILL workout profile with the concept of Heart Rate Zone Training. The default target heart rate is calculated as 80% of the theoretical maximum (HRmax), but the user can adjust the target rate during the workout setup.

The workout alternates between a hill, which brings the heart rate up to the target rate of 80% of HRmax, and a valley which brings the heart rate down to 65% of HRmax. After a standard three-minute warm-up, the workout progresses toward the first hill and heart rate goal. Once the goal is reached, the hill continues for three minutes, then the level decreases into a valley. Once the 65% of HRmax goal is reached, the valley continues for three minutes, after which the next hill begins. The user's fitness level determines the number of hills and valleys encountered within the duration. At the end of the duration, the workout goes into a cool down phase. If the heart rate goes above the theoretical maximum for more than 45 seconds, the PowerMill Climber automatically goes into pause mode. The program does not proceed to a new heart rate goal until the user reaches the current goal.

- **EXTREME HEART RATE™** is designed to help more experienced users to break through fitness improvement plateaus. The workout alternates between two target heart rates as quickly as possible. The effect is similar to that of running sprints. The user must wear a Polar telemetry heart rate chest strap or grip the Lifepulse sensors throughout the workout. When setting up the workout, the user enters a target heart rate.

After a standard three-minute warm-up, the intensity increases, until the user reaches the target heart rate goal of 85% of the theoretical maximum(HRmax). That target rate is maintained for a stabilizing period. Then, the intensity decreases. When the heart rate falls to the 65% of HRmax goal, it is maintained there for a stabilizing period. The program repeats the alternating intensity levels, continuing this pattern throughout the duration. The program does not proceed to a new heart rate goal until the user reaches the current goal.

PERSONAL TRAINER WORKOUTS

- **WATTS** is a program that targets a rate of effort equal to a desired number of Watts. The user may enter the desired Watts resistance value in 1W increments between a minimum and maximum range based on the user's weight and working speed range.
- **METS** is a program that targets a rate of effort equal to a certain number of METs.
- **WFI SUBMAX PROTOCOL (International Association of Fire Fighters)** is a submaximal assessment test used by the International Association of Fire Fighters to determine fitness for fire department duty. The purpose is to estimate a users VO_2 max value. The score is based on the length of time required to reach the target heart rate.

The test is comprised of a warm-up period, test period, and cool down period. The test varies the step rate at fixed intervals and concludes when the user's heart rate has reached the target heart rate goal for 15 seconds. A score will be shown in the Workout Summary. The target heart rate threshold value is calculated using a formula based on user's age. At one minute into Cool Down a recovery heart rate will be sampled and recorded. The user's test time at which the heart rate exceeded the target heart rate and a calculated VO_2 max value will be shown in the Workout Summary. If a recovery heart rate value was recorded it will also be shown.

TIME	SPM
<i>Warm-up Phase</i>	
00:00 - 01:00	46
01:01 - 02:00	46
02:01 - 03:00	53
<i>Testing Phase</i>	
03:01 - 04:00	65
04:01 - 05:00	75
05:01 - 06:00	82
06:01 - 07:00	89
07:01 - 08:00	97
08:01 - 09:00	104
09:01 - 10:00	111
10:01 - 11:00	118
11:01 - 12:00	126
12:01 - 13:00	133
13:01 - 14:00	140
14:01 - 15:00	147
15:01 - 16:00	155
<i>Recovery Phase</i>	
00:01 - 01:00	39
01:01 - 02:00	39

- **CPAT (Candidate Physical Ability Test)** is a test used to predict the ability to perform basic fire fighting tasks developed by the International Association of Fire Fighters. The test is designed to simulate the critical tasks of climbing stairs in full protective clothing while carrying a high-rise pack (hose bundle) and climbing stairs in full protective clothing carrying fire fighter equipment. This test challenges your aerobic capacity, lower body muscular endurance and ability to balance. The test starts out with a 20-second warm up period at a set stepping rate of 50 steps per minute followed by the 3-minute test at a set stepping rate of 60 steps per minute.

LIFE FITNESS FIT TEST (PERSONAL TRAINER WORKOUT)

- The LIFE FITNESS Fit Test estimates cardiovascular activity and can be used to monitor improvements in endurance every 4 - 6 weeks.
- The Fit Test is considered to be a submax VO_2 (volume or oxygen) test and gauges how well the heart supplies oxygenated blood to the exercising muscles and how efficiently those muscles receive oxygen from the blood.
- Physicians and exercise physiologists generally regard this test as a good measure of aerobic capacity.
- Workout duration is 5 minutes total. Take the Fit Test under similar circumstances each time. For the most accurate Fit Test results, you should perform the Fit Test on three consecutive days and average the three scores.
- To receive a proper Fit Test score, the work done must be within a training heart rate zone that is 60% to 85% of the theoretical maximum heart rate (HRmax).

The user must grasp the hand sensors when prompted, or wear a Polar telemetry heart rate chest strap as the test score calculation is based on a heart rate reading. Your heart rate is dependent on many factors, including:

- amount of sleep the previous night (*at least 7 hours is recommended*)
- time of day
- time you last ate (*2 - 4 hours after the last meal is recommended*)
- time since you last drank a liquid containing caffeine or alcohol, or smoked a cigarette (*at least 4 hours is recommended*)
- time since you last exercised (*at least 6 hours is recommended*)

Suggested exertion levels should be used as a guideline for setting up the Fit Test program. The goal is to elevate the user's heart rate to a level that is between 60%-85% of their theoretical maximum heart rate.

	Inactive	Active	Very Active
PowerMill Climber	L1 - L4	L3 - L7	L6 - L11

Within each suggested range, use these additional guidelines:

Lower Half of Range	Upper Half of Range
higher age	lower age
lower weight	higher weight <i>(in cases of excessive weight, use lower half of range)</i>
shorter	taller

The computer will not accept:

- heart rates less than 52 or greater than 200 beats per minute
- body weights less than 75 lbs. (34 kg) or greater than 400 lbs. (182 kg)
- ages below 10 or over 99 years
- data input that exceeds human potential

After the 5-minute FIT TEST is completed, a FIT TEST score and rating will be displayed.

Please note that the estimated VO₂ max scores achieved will be 10-15% lower on stationary exercise bikes than those achieved on other Life Fitness cardiovascular equipment. Stationary cycling has a higher rate of isolated muscle fatigue of the quadriceps when compared to walking / running on a treadmill, climbing on a stair climber, or utilizing a cross-trainer. This higher rate of fatigue corresponds to lower levels of estimated VO₂ max scores.

Relative Fitness Classification for MEN

Rating	<i>Elite</i>	<i>Excellent</i>	<i>Very Good</i>	<i>Above Average</i>	<i>Average</i>	<i>Below Average</i>	<i>Low</i>	<i>Very Low</i>
Estimated VO₂ Max (ml/kg/min) per Age category								
20 - 29 years	55+	53 - 54	50 - 52	45 - 49	40 - 44	38 - 39	35 - 37	<35
30 - 39 years	52+	50 - 51	48 - 49	43 - 47	38 - 42	36 - 37	34 - 35	<34
40 - 49 years	51+	49 - 50	46 - 48	42 - 45	37 - 41	34 - 36	32 - 33	<32
50 - 59 years	47+	45 - 46	43 - 44	39 - 42	34 - 38	32 - 33	29 - 31	<29
60+ years	43+	41 - 42	39 - 40	35 - 38	31 - 34	29 - 30	26 - 28	<26

Relative Fitness Classification for WOMEN

Rating	<i>Elite</i>	<i>Excellent</i>	<i>Very Good</i>	<i>Above Average</i>	<i>Average</i>	<i>Below Average</i>	<i>Low</i>	<i>Very Low</i>
Estimated VO₂ Max (ml/kg/min) per Age category								
20 - 29 years	47+	45 - 46	43 - 44	38 - 42	33 - 37	31 - 32	28 - 30	<28
30 - 39 years	44+	42 - 43	40 - 41	36 - 39	31 - 35	29 - 30	27 - 28	<27
40 - 49 years	42+	40 - 41	38 - 39	34 - 37	30 - 33	28 - 29	25 - 27	<25
50 - 59 years	37+	35 - 36	33 - 34	30 - 32	26 - 29	24 - 25	22 - 23	<22
60+ years	35+	33 - 34	31 - 32	27 - 30	24 - 26	22 - 23	20 - 21	<20

LIFE FITNESS developed this rating scale based on VO₂ max percentile distributions referenced in *American College of Sports Medicine's Guidelines for Exercise Testing and Prescription* (8th E. 2010). It is designed to provide a qualitative description of a user's VO₂ max estimation, and a means of assessing initial fitness level and tracking improvement.

4.2 WORKOUT SET UP & DATA ENTRY OPTIONS

Reference the following charts for workout setup instructions and data parameters required for input.

STANDARD WORKOUTS	HILL PLUS WORKOUTS	PERSONAL TRAINER WORKOUTS
<p>Press the following Workout Selection keys:</p>	<p>Press HILL PLUS key repeatedly to select the following:</p>	<p>Press PERSONAL TRAINER key repeatedly to select the following:</p>
<p>QUICK START Press QUICK START Enter weight * Enter steps per minute rate ** Begin workout</p>	<p>HILL Enter weight Enter time Select level Begin workout</p>	<p>WATTS Enter weight Enter time Enter Watts Begin workout</p>
<p>MANUAL Press MANUAL Enter weight Enter time Select level Begin workout</p>	<p>AROUND THE WORLD Enter weight Enter time Select level Begin workout</p>	<p>METS Enter weight Enter time Enter METs Begin workout</p>
<p>RANDOM Press RANDOM Enter weight Enter time Select level Begin workout</p>	<p>CASCADES Enter weight Enter time Select level Begin workout</p>	<p>FIT TEST Enter weight Enter age Enter gender Select level Begin workout</p>
<p>FAT BURN Press FAT BURN Enter weight Enter time Enter age Accept target heart rate Begin workout</p>	<p>FOOTHILLS Enter weight Enter time Select level Begin workout</p>	<p>WFI PROTOCOL Enter weight *** Enter height Enter age Begin workout</p>
<p>CARDIO Press CARDIO Enter weight Enter time Enter age Accept target heart rate Begin workout</p>	<p>INTERVAL Enter weight Enter time Select level Begin workout</p>	
<p>SPEED INTERVAL Press SPEED INTERVAL Enter weight Enter time Select a low and high level Begin workout</p>	<p>KILIMINJARO Enter weight Enter time Select level Begin workout</p>	

* QUICK START workouts will start accumulating calories using a default weight until the user enters in their weight via the ENTER WEIGHT key.

** Users can start a QUICK START workout at a given steps per minute rate using the NUMERIC KEYPAD (see Section 5.2 *Manager's Configuration*). During QUICK START / MANUAL workouts users can change their steps per minute rate using the NUMERIC KEYPAD.

*** Weight is used for BMI calculation only.

WORKOUT SET UP & DATA ENTRY OPTIONS (CONTINUED)

ZONE TRAINING+
<p>Press ZONE TRAINING + key repeatedly to select the following:</p>
<p style="text-align: center;">HEART RATE HILL</p> <p style="text-align: center;">Enter weight Enter time Enter age Accept target heart rate Begin workout</p>
<p style="text-align: center;">HEART RATE INTERVAL</p> <p style="text-align: center;">Enter weight Enter time Enter age Accept target heart rate Begin workout</p>
<p style="text-align: center;">EXTREME HEART RATE</p> <p style="text-align: center;">Enter weight Enter time Enter age Accept target heart rate Begin workout</p>

USER INPUT RANGES

WEIGHT	AGE	TIME	LEVEL	STEPS PER MINUTE
75 - 400 lbs. (34 - 181 kg) Default: 165 lbs (75 kg)	10 - 99	1 - 99 minutes Default: 60 minutes	Configurable * : 0 - 20 Default: 1 - 25	Configurable * : 12 - 185 Default: 20 - 185
			<p><i>* If the "Level Zero" option is enabled the minimum level becomes 0 and minimum SPM is 12.</i></p> <p><i>* If the "Level 21 - 25" option is disabled then maximum level is 20 and maximum SPM is 159.</i></p> <p><i>Levels 21 - 25 and corresponding SPM rates of 160 to 185 are only allowed in MANUAL and SPEED INTERVAL workouts.</i></p>	

WATTS	METs
<p><i>Dependent on user weight</i></p> <p>Absolute minimum = 1 Absolute maximum = 1105</p>	<p><i>Dependent on user weight</i></p> <p>Absolute minimum = 2.2 Absolute maximum = 21.3</p>

4.3 WORKOUT MODES

MARATHON MODE

MARATHON MODE has no preset goal nor can a user set a goal. It allows the user to workout indefinitely. A workout in MARATHON MODE ends only if the user chooses to end it or a stop system is activated. This mode is enabled / disabled in Manager's Configuration (see Section 5.2). While setting up a workout, enter a time value greater than the upper limit displayed on the console. Once the upper limit is exceeded, the MESSAGE CENTER will display "MARATHON MODE". Within a workout, MARATHON MODE can be immediately ended by pressing the TIME key. Pressing the TIME key makes it possible to set a Time Goal as long as it's not less than the time already spent in the current workout.

PAUSE MODE

Press the PAUSE / STOP key once. PAUSE mode stops the stairs and holds the current workout settings and information. Pressing the CLEAR key also pauses a workout. The workout clock will count backwards to indicate the remaining time left in PAUSE mode.

COOL DOWN MODE

The COOL-DOWN mode begins when the user reaches the workout goal OR presses the COOL DOWN key during a workout in progress.

- If a workout is NOT a heart rate program, the resistance level will be reduced in half.
- If a workout IS a heart rate program, the software will find the resistance level that is closest to the final heart rate resistance and use that resistance level reduced by half.
- After each elapsed minute in the COOL DOWN mode, resistance shall be reduced in half until Level 1 is reached. Once Level 1 is reached it stays at Level 1.

WORKOUT SUMMARY MODE

The MESSAGE CENTER displays the following information:

- total floors climbed
- total steps climbed
- total calories burned
- total elapsed time

ENDING WORKOUTS EARLY

To end a workout before the pre-set duration expires, press the CLEAR key once to enter PAUSE mode. Press the CLEAR key twice to transition the system to the WORKOUT SUMMARY mode. Press the CLEAR key three times to select a new workout. Press the PAUSE / STOP key to stop the workout and transition to the WORKOUT SUMMARY mode.

SWITCHING WORKOUTS "ON-THE-FLY"

It is possible, during a workout, to switch to another workout program. After a switch, the console retains all the progress information about the workout since its beginning. To change workouts "on-the-fly," press the desired WORKOUT SELECTION key and press ENTER. This feature is available for all workouts with dedicated WORKOUT SELECTION Keys **excluding** FIT TEST type workouts. The user will be prompted to enter in any missing data as needed for the newly selected workout.

5 SERVICE MENU

A special service menu is available to managers and other authorized personnel to allow access to certain information, diagnostics tests and configuration settings.

5.1 ENTERING AND USING THE SERVICE MENU

To enter the Service Menu press and hold down PAUSE / STOP key on the Console keypad while pressing and releasing the CLEAR key. The PAUSE / STOP key must continue to be held until the system enters the Service Menu State.

The Service Menu consists of the following submenus:

- **DIAGNOSTIC (TEST / SERVICE)**

The Diagnostics submenu allows technicians to run system diagnostics. Use the UP / DOWN arrow keys to navigate through the list. Press the ENTER key to select desired utility. Press the CLEAR key once to exit the current diagnostic utility or press repeatedly to exit the Diagnostic Menu.

- **INFORMATION**

The Information submenu will display information identifying the software version numbers and their associated part numbers as well as the version numbers of other installed software components. Use this menu when it is necessary to identify the version / part numbers installed on the product. Use the UP / DOWN arrow keys to navigate through the list of items. Press the ENTER key to select desired item. Press the CLEAR key once to exit the current diagnostic utility or press repeatedly to exit the Information Menu.

- **MAINTENANCE**

The Maintenance submenu contains a specific set of maintenance utilities for logging maintenance events. Use the UP / DOWN arrow keys to navigate through the list. Press the ENTER key to select desired event. Press the CLEAR key to exit the Maintenance Menu.

- **CONFIGURATION (OPTIONAL SETTINGS)**

The Manager's Configuration submenu allows the manager to configure options for the product. See the next page for a list of configuration options (Optional Settings). Use the TIME UP / DOWN arrow keys for navigation through the options. Use the LEVEL UP / Down arrow keys to change settings. Press the CLEAR key once to exit the current diagnostic utility or press repeatedly to exit the Configuration Menu.

5.2 MANAGER'S CONFIGURATION (OPTIONAL SETTINGS)

SETTING	DEFAULT	DESCRIPTION
Maximum Workout Duration	60 Minutes	This feature allows the setting of maximum workout duration limits.
English / Metric Units	English (International: Metric)	This option sets the measurement unit type for weight and height.
Telemetry	On	Switching on the telemetry feature makes it possible to use the Polar-compatible Heart Rate Zone Training exercises with a Polar telemetry heart rate chest strap for monitoring the heart rate.
Pause Time Out	1 Minute	This sets the maximum time during which a workout can remain in pause mode.
Watts Display	Off (International: On)	If this option is enabled, the MESSAGE CENTER displays the Watts equivalent of the step rate.
METs Display	Off	If this option is enabled, the MESSAGE CENTER displays the METs equivalent of the step rate.
Calorie Per Hour (CPH) Display	On (International: Off)	If this option is enabled, the MESSAGE CENTER displays the number of calories burned per hour during the workout.
Steps Climbed Display	Off	If this setting is enabled, the total number of steps climbed is periodically shown during a workout.
Max Acceleration Rate	3	This sets the rate at which the PowerMill Climber accelerates to the selected speed, ranging from one (slowest) to five (fastest).
Max Deceleration Rate	3	This sets the rate at which the PowerMill Climber decelerates to the selected speed, ranging from one (slowest) to five (fastest).
Quick Start Via Numeric Keys	Allowed	This setting controls whether the user can start a Quick Start workout by entering a desired steps per minute rate via the Numeric Keypad keys.
System Beeps	On	Enable/Disable system beeps.
Marathon Mode	Off	This option allows the user to workout indefinitely.
iPod Video	On	This feature allows control over allowing iPod video tracks to be played on the Life Fitness Attachable TV, if present. If enabled by selecting the On setting, and an iPod video track is selected, the video shall be routed to the TV. Otherwise, the video shall not.
AUX Source	Auto	This setting allows control over whether or not an optional CSAFE compatible audio device attached to the CSAFE connector shall be selectable as an audio source with the Source Select key.
TV GAIN	2	This setting allows control over the console earphone volume range for the Life Fitness Attachable TV Source. The range of settings are from 0 (Low) to 7 (High).
On / Off Lvl 0 - WarmUp Level	Off	This option, if enabled, controls whether or not Level 0 may be used in program setup or during a workout. Level 0 corresponds to intensity levels below Level 1.
On / Off Lvl 21 - 25 PerfMode	On	This option controls whether or not Levels 21 through 25 may be used in program setup or during a workout (MANUAL and SPEED INTERVAL workouts ONLY).

6 SERVICE AND TECHNICAL DATA

6.1 PREVENTIVE MAINTENANCE TIPS

Life Fitness products are backed by the engineering excellence and reliability of Life Fitness and are one of the most rugged and trouble-free pieces of exercise equipment on the market today. Commercial Life Fitness equipment are among the most popular of aerobic trainers in health clubs, colleges and military facilities worldwide.

Note: *Safety of the equipment can be maintained only if the equipment is examined regularly for damage or wear. Keep the equipment out of use until defective parts are repaired or replaced.*

REMARQUE: *pour conserver un matériel sûr, il convient de l'inspecter régulièrement afin de déceler tout signe d'usure ou d'endommagement. N'utilisez pas l'appareil tant que les pièces défectueuses n'ont pas été réparées ou remplacées.*

The following preventive maintenance tips will keep the Life Fitness product operating at peak performance:

- Locate the product in a cool, dry place.
- Clean the top surface of the steps regularly.
- Clean the display console and all exterior surfaces with an approved or compatible cleaner (see *Life Fitness Approved Cleaners*) and a microfiber cloth.
- Long fingernails may damage or scratch the surface of the console; use the pad of the finger to press the selection buttons on the console.

Life Fitness Approved Cleaners *(United States Availability Only)*

Two preferred cleaners have been approved by Life Fitness reliability experts: PureGreen 24 and Gym Wipes. Both cleaners will safely and effectively remove dirt, grime and sweat from equipment. PureGreen 24 and the Antibacterial Force formula of Gym Wipes are both disinfectants that are effective against MRSA and H1N1. PureGreen 24 is available in a spray which is convenient for gym staff to use. Apply the spray to a microfiber cloth and wipe down the equipment. Use PureGreen 24 on the equipment for at least 2 minutes for general disinfection purposes and at least 10 minutes for fungus and viral control. Gym Wipes are large, durable pre-moistened wipes to use on the equipment before and after workouts. Use Gym Wipes on the equipment for at least 2 minutes for general disinfection purposes.

Contact Customer Support Services to order these cleaners (1-800-351-3737 or email: customersupport@lifefitness.com).

Life Fitness Compatible Cleaners

Mild soap and water or a mild non-abrasive household cleaner can also be used to clean the display and all exterior surfaces. Use a soft microfiber cloth only. Apply the cleaner to the microfiber cloth before cleaning. DO NOT use ammonia or acid based cleaners. DO NOT use abrasive cleaners. DO NOT use paper towels. DO NOT apply cleaners directly to the equipment surfaces.

6.2 PREVENTIVE MAINTENANCE SCHEDULE

Item	Weekly	Monthly	Quarterly	Biannually	Comments
Console Overlays	<i>Clean</i>			<i>Inspect</i>	
Cup Holder	<i>Clean</i>	<i>Inspect</i>			
Console Mounting Bolts				<i>Inspect</i>	
Frames	<i>Clean</i>			<i>Inspect</i>	
Plastic Covers	<i>Clean</i>	<i>Inspect</i>			
Lifepulse Sensors	<i>Clean / Inspect</i>				
Leg Levelers		<i>Inspect / Adjust</i>			
Side Hand Rails	<i>Clean</i>			<i>Inspect</i>	
Steps	<i>Clean</i>			<i>Inspect</i>	
TURN OFF AND UNPLUG THE POWERMILL PRIOR TO PERFORMING THE MAINTENANCE ITEMS BELOW!					
Step Chains			<i>Inspect</i>	<i>Clean / Lubricate</i>	<i>Clean and lightly lubricate with 30w oil on a cloth.</i>
Drive Chain			<i>Inspect</i>	<i>Clean / Lubricate / Adjust</i>	<i>Clean and lightly lubricate with 30w oil on a cloth.</i>
Chain Sprockets			<i>Inspect</i>	<i>Clean / Lubricate</i>	<i>Wipe off excess old grease and lightly apply lithium based grease to sprocket teeth.</i>
Motor Belt				<i>Inspect</i>	
Bearing Tracks				<i>Inspect / Lubricate</i>	<i>Wipe off excess old grease and lightly apply lithium based grease to tracks.</i>
MCB Heat Sink				<i>Inspect / Clean</i>	<i>Make sure heat sink is free of debris.</i>
Electrical Connections				<i>Inspect</i>	

6.3 TROUBLESHOOTING THE OPTIONAL POLAR® TELEMETRY HEART RATE CHEST STRAP

Malfunction	Probable Cause	Corrective Action
Heart rate reading is initially detected and functioning normally but then is lost.	Use of personal electronic devices, such as cell phones and portable MP3 players, causes external noise interference.	Remove the source of noise or reposition the exercise equipment.
	Equipment is in close proximity to other sources of noise such as audio/video equipment, fans, two way radios, and high voltage/high current power lines.	
Heart rate readings are abnormally elevated.	Television sets and/or antennas, cell phones, computers, cars, high voltage power lines, motor driven exercise equipment, and another heart rate transmitter within 3 ft. (0.9 m) generate electromagnetic interference.	Move the product a few inches away from the probable cause, or move the probable cause a few inches away from the product, until the heart rate readings are accurate.
Heart rate reading is erratic or absent entirely.	Belt transmitter electrodes are not wet enough to pick up accurate heart rate readings.	Wet the belt transmitter electrodes (see <i>The Optional Polar® Telemetry Heart Rate Chest Strap</i>).
	Belt transmitter electrodes are not laying flat against the skin.	Ensure the belt transmitter electrodes are laying flat against the skin (see <i>The Optional Polar® Telemetry Heart Rate Chest Strap</i>).
	Belt transmitter needs cleaning.	Wash the belt transmitter with mild soap and water.
	Belt transmitter is not within 3 ft. (0.9 m) of the heart rate receiver.	Make sure the chest strap transmitter is within 3 ft. (0.9 m) of the heart rate receiver.
	Polar telemetry heart rate chest strap battery is depleted.	Contact LIFE FITNESS Customer Support Services for instructions on how to have the Polar telemetry heart rate chest strap replaced.
	Polar telemetry heart rate chest strap did not lock in with the heart rate receiver.	<p>Make sure the Polar telemetry heart rate chest strap is properly attached to the user's chest and move closer to the heart rate receiver inside the console. Wait up to 10 seconds for the heart rate to display on the console. The overall range of the heart rate strap is approximately 3 ft. (0.9 m) after it communicates with the receiver. The strap must be 1.5 - 2 ft. (0.5 - 0.6 m) away from the receiver in order to start communicating. When the display shows a heart rate value stay within 3 ft. (0.9 m).</p> <p><i>Notes:</i></p> <ol style="list-style-type: none"> 1. Ensure proper adherence of the Polar telemetry heart rate chest strap to user's chest. 2. Ensure proper conductivity between the electrodes and user's chest. 3. If needed, use the Polar watch to verify chest strap's operation.

6.4 TROUBLESHOOTING THE IPOD®

Malfunction	Probable Cause	Corrective Action
Cannot control iPod using console keypad controls.	iPod is not fully connected due to interference with after market iPod protective cases.	Remove after market iPod protective case and reconnect.
Cannot hear iPod.	iPod paused.	Use iPod keypad controls on console to play a selection.
	Source selected is not currently set to iPod.	Press Source Select key until iPod is displayed.
	Mute key is pressed.	Press Mute key to unmute iPod source.
Cannot control iPod volume using console keypad controls.	Headphones are plugged into iPod instead of console headphone jack.	Plug headphones into console headphone jack.
	Volume control on iPod is being used with headphones plugged into console jack.	Use console iPod keypad volume controls.
Console displays a message that tells me to update my iPod firmware.	The iPod is not compatible due to its outdated firmware.	Visit www.apple.com for instructions on how to update your iPod device firmware.
Console displays a message that tells me "iPod COMMUNICATION TIMEOUT".	Use of older third generation (or earlier) iPod is not supported.	Use newer iPod model.
	iPod battery charge is extremely low.	Charge iPod to a minimum level before using.
Cannot see iPod video on Life Fitness Attachable TV when played.	No TV is attached.	Attach a Life Fitness Attachable TV.
	Source select is switched to TV instead of iPod.	Press Source Select until the iPod message is displayed.
	iPod was connected while currently playing a video selection (<i>known Apple issue with iPod device firmware</i>).	Stop video play. Navigate to your video selection and restart video using either the iPod or console keypad controls.
	Audio track containing video begins playing as part of an audio playlist (<i>known Apple issue with iPod device firmware</i>).	Play track as a video selection.
Cannot navigate iPod menus.	Use of console keypad controls to navigate iPod menus.	Use iPod controls to navigate menus and select playlists. Use console keypad controls to Play/Pause and to change volume and tracks.
Cannot control iPod volume using iPod slider ring.	Use of iPod slider ring controls to adjust iPod volume when headphones are plugged into the console jack.	Use console volume arrow keys to control volume.
No controls to change playlist on console.	Use of console keypad controls to change playlist on iPod.	Select playlist on iPod using iPod controls.

6.5 TROUBLESHOOTING THE LIFE PULSE SYSTEM SENSORS

If the heart rate reading is erratic or missing, do the following:

- Dry the hands if necessary to prevent slipping.
- Apply hands to all four sensors; two in each hand.
- Grasp the sensors firmly.
- Apply constant pressure around the sensors.

6.6 HOW TO OBTAIN PRODUCT SERVICE / SERIAL NUMBER LOCATION

1. Verify the symptom and review the operating instructions. The problem may be unfamiliarity with the product and its features and workouts.
2. Locate and write down the serial number of the unit which is located near the right hand step assist. The serial number is visible from the staircase side (inside) of the unit by the right, rear step assist.
3. Contact Life Fitness Customer Support Services.

7 SPECIFICATIONS

7.1 INTEGRITY SERIES POWERMILL CLIMBER (CLPM)

Designed use:	Heavy / Commercial
Maximum user weight:	400 lbs. / 181 kg
Display type:	Dual level alphanumeric LED console
Workouts, goals, & modes:	Quick Start, Manual, Cardio, Fat Burn, Heart Rate Hill, Heart Rate Interval, Extreme Heart Rate, WFI Submax Protocol, CPAT Test, Fit Test, Watts, Random, Hill, Around the World, Cascades, Foothills, Interval, Kiliminjaro, Custom 2 Speed Interval, Custom Interval Heart Rate and Hill, METs, Marathon Mode, Time-Based Goal, Cool Down Mode, Calories Goal, Floors Climbed Goal
Display readout:	Time, total calories burned, steps per minute, total floors climbed, total steps climbed, calories per hour, heart rate, target heart rate, Watts, METs, workout profile, level
Resistance levels:	26 (0-25) <i>Resistance system is speed dependent.</i>
Heart rate monitoring options:	Lifepulse™ digital heart rate monitoring with DSP (digital signal processing) and Polar® telemetry (<i>optional chest strap required</i>)
Network capabilities:	CSAFE-Ready, FitLinxx™ Certified
Ports (2):	Type RJ45, interchangeable Network ready connection and Fitness Entertainment port (power compliant with FitLinxx CSAFE specification dated August 4, 2004: 4.75VDC to 10VDC; maximum current of 85mA).
iPod power and charging:	5Vdc @ 500mA
iPod Compatibility:	Play / Pause Volume Control / Mute Previous Track / Next Track (Button Tap) Scan Forward / Scan Back (Button Hold)
Headphone jack:	3.5mm Stereo, 150mW max
Power requirements:	100 - 240 volts, 50/60Hz, 3 Amps

INTEGRITY CONSOLE		
	PHYSICAL DIMENSIONS	SHIPPING DIMENSIONS
Length:	15 in. / 38 cm	16 in. / 41 cm
Width:	4 in. / 10 cm	5.5 in. / 14 cm
Height:	14.25 in. / 36 cm	18.5 in. / 47 cm
Weight:	5 lbs. / 2 kg	7 lbs. / 3 kg

7.2 WARRANTY INFORMATION

WHAT IS COVERED:

This LIFE FITNESS commercial exercise equipment ("Product") is warranted to be free of all defects in material and workmanship.

WHO IS COVERED:

The original purchaser or any person receiving a newly purchased Product as a gift from the original purchaser. Warranty will be voided on subsequent transfers.

HOW LONG IS IT COVERED:

All coverage is provided by specific Product according to the guidelines listed on the chart below.

WHO PAYS TRANSPORTATION & INSURANCE FOR SERVICE:

If the Product or any covered part must be returned to a service facility for repairs, We, LIFE FITNESS, will pay all transportation and insurance charges for the first year. You are responsible for transportation and insurance charges during the second and third years (if applicable).

WHAT WE WILL DO TO CORRECT COVERED DEFECTS:

We will ship to you any new or rebuilt replacement part or component, or, at our option, replace the Product. Such replacement parts are warranted for the remaining portion of the original warranty period.

WHAT IS NOT COVERED:

Any failures or damage caused by unauthorized service, misuse, accident, negligence, improper assembly or installation, debris resulting from any construction activities in the Product's environment, rust or corrosion as a result of the Product's location, alterations or modifications without our written authorization or by failure on your part to use, operate and maintain the Product as set out in your Operation Manual ("Manual").

One type RJ45 interchangeable Network ready and Fitness Entertainment port is supplied with the Product. This port complies with the FitLinxx CSAFE specification dated August 4, 2004 stating: 4.75VDC to 10VDC; maximum current of 85mA. Any Product damage caused by a load exceeding this FitLinxx CSAFE specification is not covered by warranty.

All terms of this warranty are void if this product is moved beyond the continental borders of the United States of America (excluding Alaska, Hawaii and Canada) and are then subject to the terms provided by that country's local authorized LIFE FITNESS representative.

WHAT YOU MUST DO:

Retain proof of purchase; use, operate and maintain the Product as specified in the Manual; notify Customer Support Services of any defect within 10 days after discovery of the defect; if instructed, return any defective part for replacement or, if necessary, the entire Product for repair.

OPERATION MANUAL: It is VERY IMPORTANT THAT YOU READ THE MANUAL before operating the Product. Remember to perform the periodic maintenance requirements specified in the Manual to assure proper operation and your continued satisfaction.

HOW TO GET REPLACEMENT PARTS & SERVICE:

Refer to page one of this manual for your local service contact information. Reference your name, address and the serial number of your Product (consoles and frames may have separate serial numbers). They will tell you how to get a replacement part, or, if necessary, arrange for service where your Product is located.

EXCLUSIVE WARRANTY:

THIS LIMITED WARRANTY IS IN LIEU OF ALL OTHER WARRANTIES OF ANY KIND EITHER EXPRESSED OR IMPLIED, INCLUDING BUT NOT LIMITED TO THE IMPLIED WARRANTIES OF MERCHANTABILITY AND FITNESS FOR A PARTICULAR PURPOSE, AND ALL OTHER OBLIGATIONS OR LIABILITIES ON OUR PART. We neither assume nor authorize any person to assure for us any other obligation or liability concerning the sale of this Product. Under no circumstances shall we be liable under this warranty, or otherwise, of any damage to any person or property, including any lost profits or lost savings, for any special, indirect, secondary, incidental or consequential damages of any nature arising out of the use of or inability to use this Product. Some states do not allow the exclusion or limitation of implied warranties or of liability for incidental or consequential damages, so the above limitations or exclusions may not apply to you.

CHANGES IN WARRANTY NOT AUTHORIZED:

No one is authorized to change, modify or extend the terms of this limited warranty.

EFFECT OF STATE LAWS:

This warranty gives you specific legal rights and you may have other rights which vary from state to state.

OUR PLEDGE TO YOU:

Our Products are designed and manufactured to the highest standards. We want you completely satisfied with our Products and will do everything possible under the terms of this warranty to keep you secure in knowing you have bought the best!

		90 Days	6 Months	1 Year	2 Years	7 Years
PowerMill Climber	Frame					X
	Electrical & Mechanical Components				X	
	Labor			X		
	Console Overlay		X			
Optional Attachable TV	Electrical & Mechanical Components				X	
	Labor	X				