



WAC

LANDSCAPE LIGHTING

2018 NEW PRODUCT SUPPLEMENT

# HARDSCAPE WITH DUAL CCT AND INTEGRAL BRIGHTNESS CONTROL



## Transformer

*For 12V Grand Accent, Accent, Mini Accent,  
Mini Wall Wash and Dual CCT Hardscape*

- IP65 Rated
- 12V to 15V taps
- Knock outs for power and photosensor connections
- 3-prong outlet for timer
- Outdoor rated stainless steel

## Model

|                    |  |
|--------------------|--|
| <b>9075-TRN-SS</b> | 75W Max<br>Dimensions: 13.97" L x 5.35"W x 5.63"H                      |
| <b>9150-TRN-SS</b> | 150W Max<br>Dimensions: 18.90" L x 6.69"W x 6.30"H                     |
| <b>9300-TRN-SS</b> | 300W Max<br>Dimensions: 18.90" L x 6.69"W x 6.30"H                     |
| <b>9600-TRN-SS</b> | 600W Max (2 x 300W outputs)<br>Dimensions: 14.49" L x 10.08"W x 5.94"H |

# HARDSCAPE

New with Dual CCT and Integral Brightness Control  
New Sand and Graphite Finishes to Match Stonework



**7181-27/30** 18 inches



**7121-27/30** 12 inches



**7061-27/30** 6 inches



**7031\*** 3 inches

\* Due to its compact size, the 7031 is dedicated in either 2700K or 3000K. Lead Wire remains on the side of the fixture.

12V

**Input:** 9-15VAC  
**Lumens:** Up to 330 lm  
**CRI:** 90+  
**Rated Life:** 50,000 hours

- Integral brightness control  
Select color temperature option\*
- Hardscape easily detaches from capstone bracket after installation
- Corrosion-resistant aluminum alloy
- Factory-sealed water tight fixture
- Transformer required (sold separately)
- Tightly spaced and diffused LEDs for even illumination
- Direct burial gel-filled wire nuts included

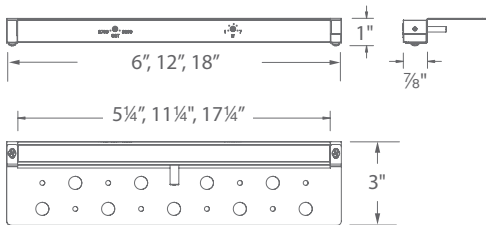

7061, 7121, 7181

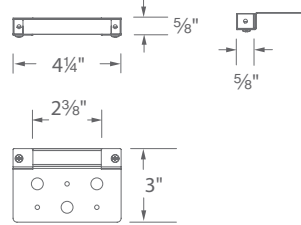

7031\*



Select Warm White or Pure White light (2700K or 3000K)



Continuously adjustable brightness



6 foot of lead wire located on center fixture for ease of measurements



Removable stainless steel capstone bracket and rotating mounting clips included

| Length | Model                            | Color Temp                             | Wattage     | Max Lumens | Finishes   |
|--------|----------------------------------|--|-------------|------------|--|
| 3" *   | <b>7031-27</b><br><b>7031-30</b> | 2700K Warm White*<br>3000K Pure White* | 1.4W, 2.5VA | 40         | <b>BZ</b> Bronze on Aluminum<br><b>GH</b> Graphite<br><b>SD</b> Sand |
| 6"     | <b>New</b> <b>7061-27/30</b>     | 2700K Warm White<br>3000K Pure White   | 4.5W, 5.6VA | 120        |  |
| 12"    | <b>New</b> <b>7121-27/30</b>     | 2700K Warm White<br>3000K Pure White   | 7.0W, 7.3VA | 225        |  |
| 18"    | <b>New</b> <b>7181-27/30</b>     | 2700K Warm White<br>3000K Pure White   | 8.5W, 8.5VA | 330        |  |

Example: **7181-27/30SD**

# GRAND ACCENT 740-2000 LUMENS

New



## MOONLIGHTING EFFECT

Introducing the latest addition to our family of landscape accent lights, now with even more light output. When mounted high in trees and pointing downward, Grand Accent creates a beautiful moonlighting effect with a cool white light and superior lumen output.

- New 4000K Color Temperature option resembles moonlight
- Adjustable beam 15° to 60°
- Continuously adjustable lumen output 740-2000 lm

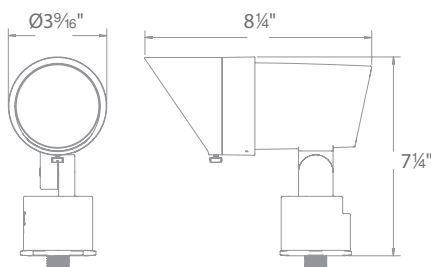

Mounting stake and direct burial gel filled wire nuts Included

### 12V

- Integral brightness control
- Adjustable beam angle 15°-60°
- One fixture replaces 50W to 100W halogen accent light
- Transformer required (sold separately)

**Input:** 9-15VAC  
**Power:** 15W to 35W / 21VA -44VA  
**Lumens:** 740 lm to 2000 lm  
**Beam Angle:** 15° to 60°  
**CRI:** 85  
**Rated Life:** 45,000 hours

### Color Temperature

|                  |                    |
|------------------|--------------------|
| 2700K            | Warm White         |
| <b>5211-27BZ</b> | Bronze on Aluminum |
| <b>5211-27BK</b> | Black on Aluminum  |
| 3000K            | Pure White         |
| <b>5211-30BZ</b> | Bronze on Aluminum |
| <b>5211-30BK</b> | Black on Aluminum  |
| 4000K            | Cool White         |
| <b>5211-40BZ</b> | Bronze on Aluminum |
| <b>5211-40BK</b> | Black on Aluminum  |

### Accessories For Grand Accent

|                    |  |  |
|--------------------|--|--|
| Grand Accent Snoot | <b>5211-SNOOT-BZ</b><br><b>5211-SNOOT-BK</b>                                   | Bronze on Aluminum<br>Black on Aluminum              |
| 6" Long Shroud     | <b>5211-LSHR-BZ</b><br><b>5211-LSHR-BK</b>                                     | Bronze on Aluminum<br>Black on Aluminum              |
| Optics             | <b>LENS-25-AMB</b> Amber<br><b>LENS-25-GRN</b> Green<br><b>LENS-25-RED</b> Red | <b>LENS-25-BLU</b> Blue<br><b>LENS-25-FR</b> Frosted |

# MINI ACCENT 45-365 LUMENS

Now available in Black



1838 listed (12V)  
1598 listed (120V)



Mounting stake and direct burial gel filled wire nuts Included

## 12V

- Integral brightness control
- Adjustable beam angle 10° to 50°
- One fixture replaces 20W to 35W halogen accent light
- Transformer required (sold separately)

**Input:** 9-15VAC  
**Power:** 1W to 7W / 2VA -10.5VA  
**Lumens:** 45 lm to 365 lm  
**Beam Angle:** 10° to 50°  
**CRI:** 85  
**Rated Life:** 70,000 hours

|             |                   |                    |
|-------------|-------------------|--------------------|
|             | 2700K             | Warm White         |
|             | <b>5111-27BZ</b>  | Bronze on Aluminum |
|             | <b>5111-27BBR</b> | Bronze on Brass    |
| <b>New!</b> | <b>5111-27BK</b>  | Black on Aluminum  |
|             | 3000K             | Pure White         |
|             | <b>5111-30BZ</b>  | Bronze on Aluminum |
|             | <b>5111-30BBR</b> | Bronze on Brass    |
| <b>New!</b> | <b>5111-30BK</b>  | Black on Aluminum  |

### Accessories For Mini Accent

|  |   |  |
|--|---|--|
| <br>Mini Accent Snoot | <b>5111-SNOOT-BZ</b><br><b>5111-SNOOT-BBR</b><br><b>5111-SNOOT-BK</b> | Bronze on Aluminum<br>Bronze on Brass<br>Black on Aluminum |
| <br>5" Long Shroud    | <b>5111-LSHR-BZ</b><br><b>5111-LSHR-BBR</b><br><b>5111-LSHR-BK</b>    | Bronze on Aluminum<br>Bronze on Brass<br>Black on Aluminum |

|   |   |   |
|---|---|---|
| <br>Optics | <b>LENS-16-AMB</b> Amber<br><b>LENS-16-GRN</b> Green<br><b>LENS-16-RED</b> Red<br><b>LENS-16-BLU</b> Blue | <b>LENS-16-FR</b> Frosted<br><b>LENS-16-SPR</b> Spread<br><b>LENS-16-BEL</b> Elongating |
|---|---|---|

# ACCENT 190-1045 LUMENS

Now available in Black



Mounting stake and direct burial gel filled wire nuts Included

## 12V

- Integral brightness control
- Adjustable beam angle 10° to 60°
- One fixture replaces 35W to 75W halogen accent light
- Transformer required (sold separately)

**Input:** 9-15VAC  
**Power:** 2W to 16W / 2VA -23VA  
**Lumens:** 190 lm to 1045 lm  
**Beam Angle:** 10° to 60°  
**CRI:** 85  
**Rated Life:** 70,000 hours

|             |                   |                    |
|-------------|-------------------|--------------------|
|             | 2700K             | Warm White         |
|             | <b>5011-27BZ</b>  | Bronze on Aluminum |
|             | <b>5011-27BBR</b> | Bronze on Brass    |
| <b>New!</b> | <b>5011-27BK</b>  | Black on Aluminum  |
|             | 3000K             | Pure White         |
|             | <b>5011-30BZ</b>  | Bronze on Aluminum |
|             | <b>5011-30BBR</b> | Bronze on Brass    |
| <b>New!</b> | <b>5011-30BK</b>  | Black on Aluminum  |

## 120V Transformer Not Required

**Input:** 110V - 120VAC  
**Power:** 3.5W to 14.5W  
**Lumens:** 100 lm to 900 lm  
**Beam Angle:** 15° to 60°  
**CRI:** 85  
**Rated Life:** 45,000 hours

|             |                   |                    |
|-------------|-------------------|--------------------|
|             | 3000K             | Pure White         |
|             | <b>5012-30BZ</b>  | Bronze on Aluminum |
|             | <b>5012-30BBR</b> | Bronze on Brass    |
| <b>New!</b> | <b>5012-30BK</b>  | Black on Aluminum  |

### Accessories For Accent

|   |   |  |
|---|---|--|
| <br>Accent Snoot   | <b>5010-SNOOT-BZ</b><br><b>5010-SNOOT-BBR</b><br><b>5010-SNOOT-BK</b> | Bronze on Aluminum<br>Bronze on Brass<br>Black on Aluminum |
| <br>6" Long Shroud | <b>5010-LSHR-BZ</b><br><b>5010-LSHR-BBR</b><br><b>5010-LSHR-BK</b>    | Bronze on Aluminum<br>Bronze on Brass<br>Black on Aluminum |

|   |  |   |
|---|--|---|
| <br>Optics | <b>LENS-20-AMB</b> Amber<br><b>LENS-20-GRN</b> Green<br><b>LENS-20-RED</b> Red | <b>LENS-20-BLU</b> Blue<br><b>LENS-20-FR</b> Frosted<br><b>LENS-20-SPR</b> Spread |
|---|--|---|

# MINI WALL WASH

## WITH DUAL CCT AND INTEGRAL BRIGHTNESS CONTROL



1838 listed (12V)

### 12V

- Integral brightness control  
Select color temperature option
- A uniform wide distribution wall wash from a small form factor
- Mounting stake and direct burial gel-filled wire nuts all included
- Transformer required (sold separately)

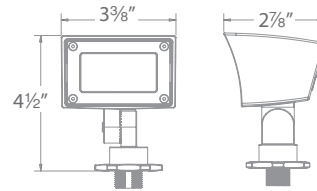

**Input:** 9-15VAC  
**Power:** 1W to 8W / 2-12VA  
**Lumens:** 80 lm to 420 lm  
**Beam Angle:** Symmetrical (70° by 95°)  
**CRI:** 85+  
**Rated Life:** 60,000 hours  
**CCT:** 2700K & 3000K  
 Warm White & Pure White

**5121-27/30BZ** Bronze on Aluminum  
**5121-27/30BBR** Bronze on Brass  
**5121-27/30BK** Black on Aluminum

A uniform wide distribution wall wash from a small form factor

### Accessories For Mini Wall Wash

|                           |                     |         |
|---------------------------|---------------------|---------|
| Mini Wall Wash Optics<br> | <b>LENS-2X3-AMB</b> | Amber   |
|                           | <b>LENS-2X3-GRN</b> | Green   |
|                           | <b>LENS-2X3-RED</b> | Red     |
|                           | <b>LENS-2X3-BLU</b> | Blue    |
|                           | <b>LENS-2X3-FR</b>  | Frosted |
|                           | <b>LENS-2X3-SPR</b> | Spread  |



3000K  
Pure White light

8 Watts



3000K  
Pure White light

4 Watts



2700K  
Warm White light

4 Watts



# WALL WASH

Now available in Black



1838 listed (12V)  
1598 listed (120V)

## 12V

- Integral brightness control
- Mounting stake and direct burial gel-filled wire nuts all included with 12V
- Transformer required (sold separately)

**Input:** 9-15VAC  
**Power:** 2W to 16W / 2 - 23VA  
**Brightness:** 190 lm to 980 lm  
**Beam Angle:** 15° upward (50° by 80°)  
**CRI:** 85  
**Rated Life:** 70,000 hours



## 120V Transformer Not Required

- Integral brightness control

**Input:** 110V - 120VAC  
**Power:** 3.5W to 14.5W  
**Brightness:** 95 lm to 855 lm  
**Beam Angle:** 15° upward (50° by 80°)  
**CRI:** 85  
**Rated Life:** 45,000 hours

2700K Warm White  
**5021-27BZ** Bronze on Aluminum  
**5021-27BBR** Bronze on Brass  
**5021-27BK** Black on Aluminum New!

3000K Pure White  
**5021-30BZ** Bronze on Aluminum  
**5021-30BBR** Bronze on Brass  
**5021-30BK** Black on Aluminum New!

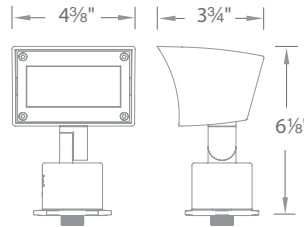

3000K Pure White  
**5022-30BZ** Bronze on Aluminum  
**5022-30BBR** Bronze on Brass  
**5022-30BK** Black on Aluminum New!

### Accessories For Wall Wash

|                      |                     |         |
|----------------------|---------------------|---------|
| Wall Wash Optics<br> | <b>LENS-2X4-AMB</b> | Amber   |
|                      | <b>LENS-2X4-GRN</b> | Green   |
|                      | <b>LENS-2X4-RED</b> | Red     |
|                      | <b>LENS-2X4-BLU</b> | Blue    |
|                      | <b>LENS-2X4-FR</b>  | Frosted |
|                      | <b>LENS-2X4-SPR</b> | Spread  |

### Accessories For Mini Accent, Accent, Grand Accent, Mini Wall Wash and Wall Wash

|                            |  |  |   |   |
|----------------------------|--|--|---|---|
| Additional Stake           |  | <b>9000-ST9-BZ</b>   | Bronze  | Durable PC stake  |
| Surface Mount Flange/Stake |  | <b>5000-SCP-BZ</b><br><b>5000-SCP-BBR</b>  | Bronze on Aluminum<br>Bronze on Brass             | Includes three 7 inch threaded stainless steel stabilizing pins for ground mounting or surface mounts with four screws or over a junction box |
| Guardian Mount             |  | <b>9000-SP9-BZ</b>   | Stainless Steel                                   | Heavy duty stainless steel spike to position fixture Formed from a single plate of stainless steel  |
| Gutter Mount Bracket       |  | <b>5000-GM-BZ</b>  | Stainless Steel                                   | Stainless Steel universal bracket for mounting in gutter  |
| Tree Mount Junction Box    |  | <b>5000-TCP-BZ</b>   | Bronze on Aluminum                                | Bronze on Aluminum box with Stainless steel mounting screws. Two 1/2" NPT threaded holes  |
| Rod L-Coupler              |  | <b>5000-LCO-BZ</b>   | Bronze  |   |
| Extension Rods             |  | <b>5000-X04-BZ</b><br><b>5000-X08-BZ</b><br><b>5000-X12-BZ</b><br><b>5000-X18-BZ</b><br><b>5000-X24-BZ</b> | 4 in<br>8 in<br>12 in<br>18 in<br>24 in<br>Bronze | Extends distance between light accent and Surface Mount Canopy, Stake, or Tree Mount box  |

## 2' RECESSED INGROUNDS + INDICATORS





# 2" RECESSED INGROUNDS + INDICATORS

Now available in a single directional light

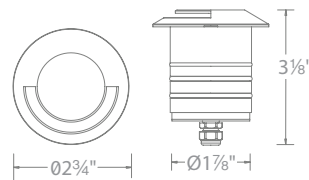
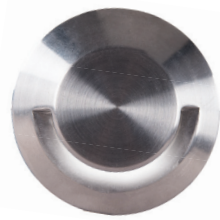

|   |   | Model                                | Finishes                |
|---|---|--------------------------------------|-------------------------|
| <b>2" SINGLE DIRECTION</b><br>Optional spring clip accessory included | <b>Input</b> 9-15VAC<br><b>Power</b> 4.1W / 6.6VA<br><b>Brightness</b> 5 lm<br><b>Color Temp</b> 3000K<br><b>CRI</b> 85<br><b>Rated Life</b> 70,000 hours | <b>2091-3055</b><br><b>2091-30BS</b> | Stainless Steel         |
|   | 6' lead wire included   |                                      | Bronzed Stainless Steel |

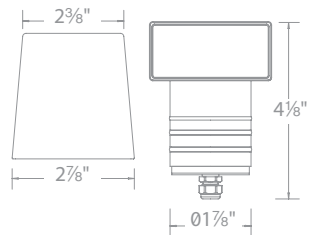

|  |  | Model                                | Finishes                |
|--|--|--------------------------------------|-------------------------|
| <b>2" GROUND HOOD</b><br>Optional spring clip accessory included | <b>Input</b> 9-15VAC<br><b>Power</b> 4.1W / 6.6VA<br><b>Brightness</b> 25 lm<br><b>Color Temp</b> 3000K<br><b>CRI</b> 85<br><b>Beam Angle</b> Asymmetrical<br><b>Rated Life</b> 70,000 hours | <b>2081-3055</b><br><b>2081-30BS</b> | Stainless Steel         |
|  | 6' lead wire included  |                                      | Bronzed Stainless Steel |

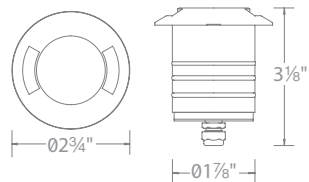
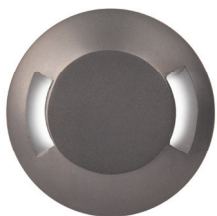

|   |   | Model                                | Finishes                |
|---|---|--------------------------------------|-------------------------|
| <b>2" BI-DIRECTIONAL</b><br>Optional spring clip accessory included | <b>Input</b> 9-15VAC<br><b>Power</b> 4.1W / 6.6VA<br><b>Brightness</b> 5 lm<br><b>Color Temp</b> 3000K<br><b>CRI</b> 85<br><b>Rated Life</b> 70,000 hours | <b>2071-3055</b><br><b>2071-30BS</b> | Stainless Steel         |
|   | 6' lead wire included   |                                      | Bronzed Stainless Steel |

## Accessories



**2000-CON-PVC**  
 2" Concrete Pour Kit  
 (18" PVC pipe included)

For installation in concrete. Mounts over a 4" outdoor rated junction box.

# 12V RECTANGULAR STEP & WALL LIGHTS



# LOW VOLTAGE STEP LIGHTS



**Input:** 9 - 15VAC  
**Power:** 2W 3.1VA  
**Brightness:** Up to 38 lm  
**CRI:** 90+  
**Rated Life:** 60,000 hours

- Corrosion-resistant aluminum alloy, or cast stainless steel construction
- Fits into 2" x 4" junction box with minimum inside dimensions of 3"L x 2"W x 2.5"D
- IP66 rated, Protected against high-pressure water jets
- 100 - 10% MLV dimming
- Landscape transformer required (sold separately)

|  |  | Model  | Color Temp              | Finishes  |
|--|--|--|-------------------------|---|
|  |  | <b>4071-27</b><br><b>4071-30</b><br><b>4071-AM</b> | 2700K<br>3000K<br>Amber | <b>BK</b> Black on Aluminum<br><b>BZ</b> Bronze on Aluminum<br><b>WT</b> White on Aluminum<br><b>SS</b> Stainless Steel |
|  |  | <b>4051-27</b><br><b>4051-30</b><br><b>4051-AM</b> | 2700K<br>3000K<br>Amber | <b>BK</b> Black on Aluminum<br><b>BZ</b> Bronze on Aluminum<br><b>WT</b> White on Aluminum                              |
|  |  | <b>4061-27</b><br><b>4061-30</b><br><b>4061-AM</b> | 2700K<br>3000K<br>Amber | <b>BK</b> Black on Aluminum<br><b>BZ</b> Bronze on Aluminum<br><b>WT</b> White on Aluminum                              |
|  |  | <b>4031-27</b><br><b>4031-30</b><br><b>4031-AM</b> | 2700K<br>3000K<br>Amber | <b>BK</b> Black on Aluminum<br><b>BZ</b> Bronze on Aluminum<br><b>WT</b> White on Aluminum                              |
|  |  | <b>4041-27</b><br><b>4041-30</b><br><b>4041-AM</b> | 2700K<br>3000K<br>Amber | <b>BK</b> Black on Aluminum<br><b>BZ</b> Bronze on Aluminum<br><b>WT</b> White on Aluminum                              |
|  |  | <b>4091-27</b><br><b>4091-30</b><br><b>4091-AM</b> | 2700K<br>3000K<br>Amber | <b>BK</b> Black on Aluminum<br><b>BZ</b> Bronze on Aluminum<br><b>WT</b> White on Aluminum                              |

Example: **4071-27SS**

Transformer Required (sold separately)

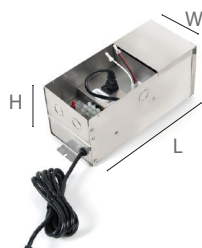

| Model              |  |
|--------------------|--|
| <b>9075-TRN-SS</b> | 75W Max<br>Dimensions: 13.97" L x 5.35"W x 5.63"H                      |
| <b>9150-TRN-SS</b> | 150W Max<br>Dimensions: 18.90" L x 6.69"W x 6.30"H                     |
| <b>9300-TRN-SS</b> | 300W Max<br>Dimensions: 18.90" L x 6.69"W x 6.30"H                     |
| <b>9600-TRN-SS</b> | 600W Max (2 x 300W outputs)<br>Dimensions: 14.49" L x 10.08"W x 5.94"H |

MINI TIKI LED AREA LIGHT



# TIKI & MINI TIKI LED AREA LIGHT

IP66  1838 listed

Now available in a 15inch size

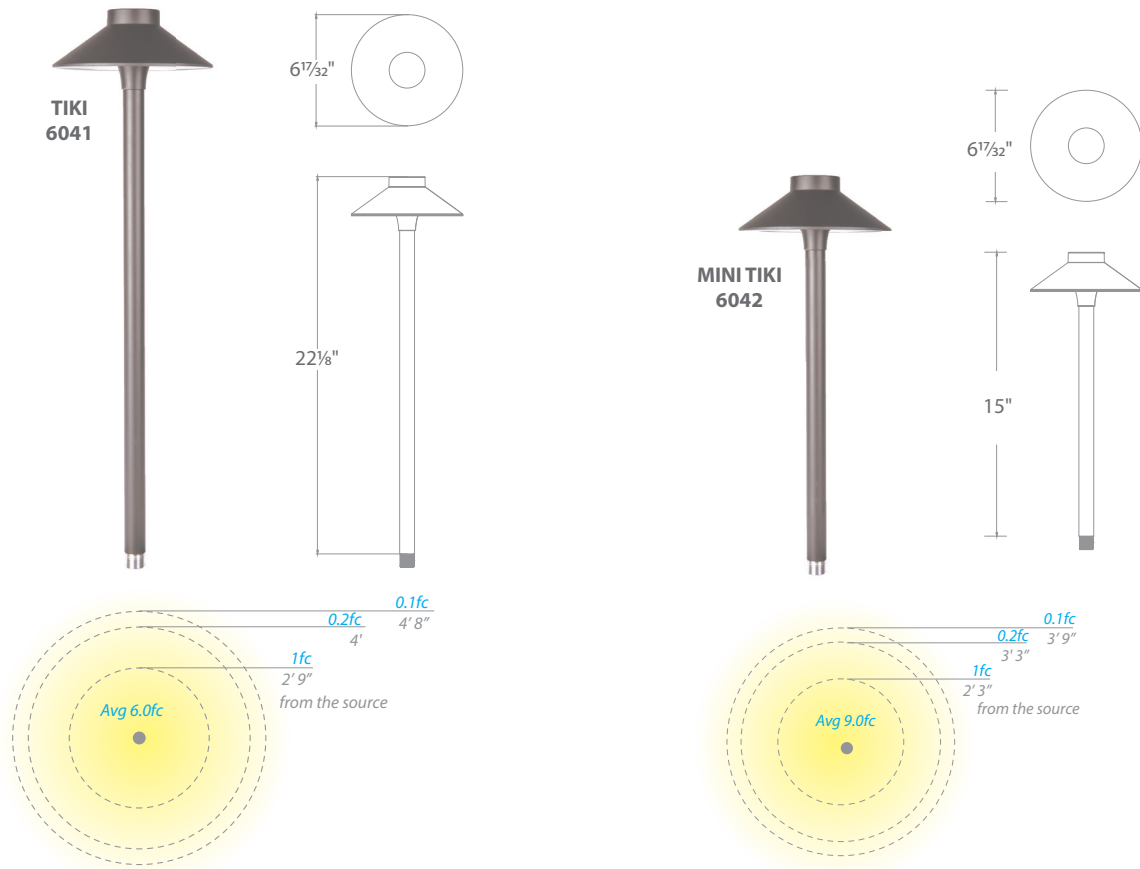



- Sturdy side mount design works well in applications where directional illumination is desired
- **Recommended spacing for installation :**  
 Residential: 7ft to 9ft  
 Commercial: 5ft to 7ft

|                    |              | Model           | Color Temp                 | Finishes                     |
|--------------------|--------------|-----------------|----------------------------|------------------------------|
| <b>Input:</b>      | 9 - 15VAC    | <b>6041</b> 22" | <b>27</b> 2700K Warm White | <b>BZ</b> Bronze on Aluminum |
| <b>Power:</b>      | 6.5W, 9.5VA  |                 |                            |                              |
| <b>Brightness:</b> | Up to 225 lm | <b>6042</b> 15" | <b>30</b> 3000K Pure White | <b>BK</b> Black on Aluminum  |
| <b>CRI:</b>        | 90           |                 |                            |                              |
| <b>Rated Life:</b> | 60,000 hours |                 |                            |                              |

**Example: 6042-30BK**

Mounting stake, 6 foot lead wire, and direct burial gel filled wire nuts included

### Accessories

|                            |   |   |                                       |   |
|----------------------------|---|---|---------------------------------------|---|
| Additional Mounting Stake  |  | <b>9000-ST9-BZ</b>                        | Bronze                                | Durable PC stake  |
| Surface Mount Flange/Stake |  | <b>5000-SCP-BZ</b><br><b>5000-SCP-BBR</b> | Bronze on Aluminum<br>Bronze on Brass | Includes three 7 inch threaded stainless steel stabilizing pins for ground mounting or surface mounts with four screws or over a junction box |
| Guardian Mount             |  | <b>9000-SP9-BZ</b>                        | Stainless Steel                       | Heavy duty stainless steel spike to position fixture<br>Formed from a single piece of metal   |

Now available in a Higher Power Option and Architectural Black

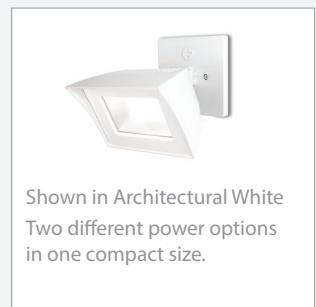
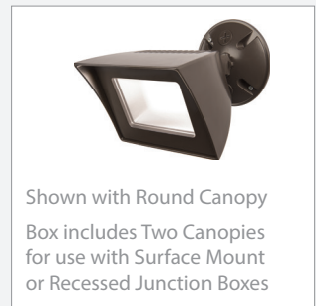

**Input:** 120V  
**CRI:** 90  
**Dimming:** 100% - 10% ELV  
**Rated Life:** 54,000 hours

- Breathable waterproof technology and factory-sealed LED light engine ensures fixture can maintain stable atmospheric pressure and prevent condensation
- Die-cast aluminum construction
- 120V direct wire—no driver needed
- 1/2" threaded heavy-duty mounting arm
- Photo or motion sensor sold separately

|  |                       |                  | Power | Comparable | Color Temp           | Delivered Lumens | Finish   |
|--|-----------------------|------------------|-------|------------|----------------------|------------------|--|
|  | Flood                 | <b>WP-LED335</b> | 35.5W | 100W HID   | 30 3000K<br>50 5000K | 2450<br>2730     | <b>aBK</b> Architectural Black<br><b>aBZ</b> Architectural Bronze<br><b>aGH</b> Architectural Graphite<br><b>aWT</b> Architectural White |
|  | <b>New!</b> Flood Pro | <b>WP-LED354</b> | 53W   | 150W HID   | 35 3500K             | 3445             |  |

Example: **WP-LED354-35-aWT**

**MOTION SENSOR (120V)** available in 3 complementary colors



**PHOTOSENSOR (120V)** available in 3 complementary colors

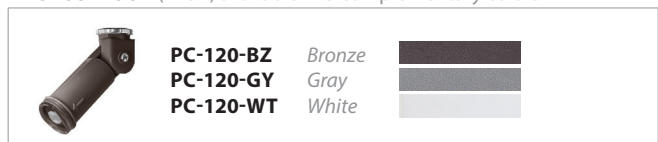



# Endurance™ LED SINGLE & DOUBLE SPOT

Now available in Architectural Black



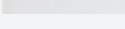

**Input:** 120V  
**CRI:** 85  
**Dimming:** 100% - 10% ELV  
**Rated Life:** 39,000 hours\*

- Factory-sealed LED light engine
- Die-cast aluminum construction
- 120V direct wire - no driver needed
- Photo or motion sensor sold separately

|  | Power | Comparable  | Color Temp | Delivered Lumens | Finish   |
|--|-------|-------------|------------|------------------|--|
|  | 15W   | 75W Halogen | 30         | 965              | <b>aBK</b> Architectural Black  <b>New!</b><br><b>aBZ</b> Architectural Bronze <br><b>aGH</b> Architectural Graphite <br><b>aWT</b> Architectural White  |
|  |       |             | 50         | 1030             |  |

Example: **WP-LED415-30-aWT**

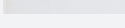
|  | Power | Comparable      | Color Temp | Delivered Lumens | Finish   |
|--|-------|-----------------|------------|------------------|--|
|  | 30W   | 2 x 75W Halogen | 30         | 965 x2           | <b>aBK</b> Architectural Black  <b>New!</b><br><b>aBZ</b> Architectural Bronze <br><b>aGH</b> Architectural Graphite <br><b>aWT</b> Architectural White  |
|  |       |                 | 50         | 1030 x2          |  |

Example: **WP-LED430-30-aBZ**

\*WAC Lighting is committed to using the best LEDs available to provide even higher efficacies and improved illumination qualities. Newer LEDs may have only 6,000 hours of actual test data from LM80 reports. While our thermal test results indicate expected lifetimes even better than the previous generation published at 50,000+ hours, we may only report 6X the actual tested hours. The published rated hours above does not represent our expectation of how long you'll be able to enjoy this quality LED luminaire. We will update the rated hours when additional test results are available.



## MOTION SENSOR (120V) available in 3 complementary colors



|                  |        |   |
|------------------|--------|---|
| <b>MS-120-BZ</b> | Bronze |  |
| <b>MS-120-GY</b> | Gray   |  |
| <b>MS-120-WT</b> | White  |  |

## PHOTOSENSOR (120V) available in 3 complementary colors



|                  |        |   |
|------------------|--------|---|
| <b>PC-120-BZ</b> | Bronze |  |
| <b>PC-120-GY</b> | Gray   |  |
| <b>PC-120-WT</b> | White  |  |



WAC  
LANDSCAPE LIGHTING

Many LED luminaire designs within contain patent pending features.  
WAC Lighting will not hesitate to enforce its intellectual property rights through injunctive relief  
and seek further relief through damages if it has reason to believe the patents are being infringed upon.

---

WAC Lighting retains the right to modify the design of our products at any time as part of the company's continuous improvement program.  
Please refer to our website for the latest product specifications. Copyright 2018  
[waclandscapelighting.com](http://waclandscapelighting.com)