

4030 Art. 1283  
6030 Art. 1284

- D** **Gebrauchsanweisung**  
Bewässerungssteuerung

---

- GB** **Operating Instructions**  
Watering Controller

---

- F** **Mode d'emploi**  
Programmateur

---

- NL** **Gebruiksaanwijzing**  
Besproeiingscomputer

---

- S** **Bruksanvisning**  
Kontrollpanel

---

- DK** **Brugsanvisning**  
Vandingskontrol-system

---

- FIN** **Brugsanvisning**  
Kastelunohjauslaite

---

- N** **Brugsanvisning**  
Vanningstimer kontrollenhet

---

- I** **Istruzioni per l'uso**  
Centralina

---

- E** **Manual de instrucciones**  
Programación de riego

---

- P** **Instruções de utilização**  
Comando de rega

# GARDENA Watering Controller 4030 / 6030



Translation of the original instructions from German.

Please read these operating instructions carefully and observe the information they contain. Use these operating instructions to familiarise yourself with the product, the proper use and the safety instructions.



For safety reasons, children and young people under the age of 16, as well as people not familiar with these operating instructions, should not use this product. Persons with reduced physical or mental abilities may use the product only if they are supervised or instructed by a responsible person. Children must be supervised to ensure that they do not play with the product. Never operate the product when you are tired, ill or under the influence of alcohol, drugs or medicine.

→ Please keep these instructions in a safe place.

## Contents

1. Where to Use your GARDENA Watering Controller .....	15
2. Safety Instructions .....	16
3. Function .....	16
4. Initial Operation .....	17
5. Operation .....	19
6. Putting Out of Operation .....	25
7. Trouble-Shooting .....	25
8. Technical Data .....	26
9. Service / Warranty .....	26

## 1. Where to Use Your GARDENA Watering Controller

### Proper use

The Watering Controller is suitable for use indoors and in outdoor locations protected against rain.

This Watering Controller is part of a garden irrigation system. Recommended accessories: the watering valve (24 V) **Art. 1278**, the valve boxes **Art. 1254 / 1255** and the connection cable **Art. 1280** and the cable clips **Art. 1282**.

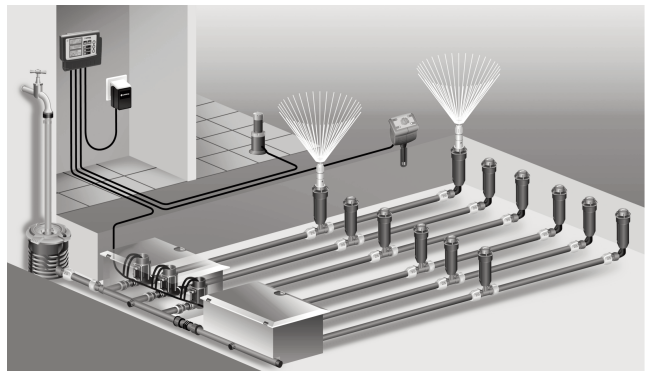

These products allow you to set up fully automatic irrigation systems, which can be designed to cater for varying water requirements of different plant areas and ensure that the entire system functions correctly in case of insufficient water supply.

Compliance with the operating instructions provided by GARDENA is a prerequisite for proper use of the Watering Controller.



The Watering Controller must be used only for controlling commercially available 24 V (AC) valves. The electric power consumption per channel must not exceed 600 mA (a GARDENA Irrigation Valve Art. 1278 requires 150 mA).

## 2. Safety Instructions

### Watering Controller:



The Watering Controller must only be operated with the 24-V (AC) power supply unit provided.

→ Protect the 24-V (AC) power supply unit from moisture when connected.

The Watering Controller is not splash proof.

In order not to lose any data in the event of power failure, an alkaline 9V block battery (type 6LR61) must be used for buffering data. We recommend using batteries manufactured by Duracell and Energizer (do not use rechargeable batteries).

## 3. Function

### Keypad:

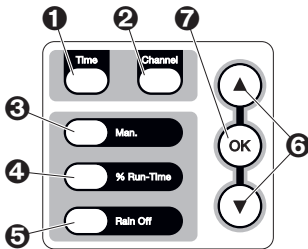

- 1 Time key:** Selects date and time.
- 2 Channel key:** Calls the channels.
- 3 Man. key:** Manually opens / closes individual channels.
- 4 % Run-Time key:** Calls up the % run-time function.
- 5 Rain Off key:** Selects a watering break.
- 6 ▲-▼ keys:** Changes data already entered. (If you press and hold down the ▲-▼ keys you can change data in the quick run-through mode.)
- 7 OK key:** Confirms the settings you selected using the ▲-▼ keys.

### Watering Controller display:

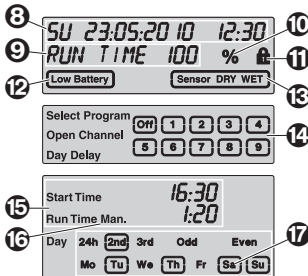

- 8 Date and time display:** Indicates the day of the week, date and current time.
- 9 Status display:** Indicates the current programming or watering status.
- 10 % Run-Time display:** Sets the duration of watering between 10 - 200% for all channels.
- 11 Key lock:** Protects against unintentional changing of settings (the reset function cannot be locked).
- 12 Battery status display:** When the **Low Battery** display flashes, the battery is almost empty and has to be replaced. When the **Low Battery** display appears, the battery is empty or no battery has been inserted. The **Low Battery** display is re-set once the new battery has been inserted.

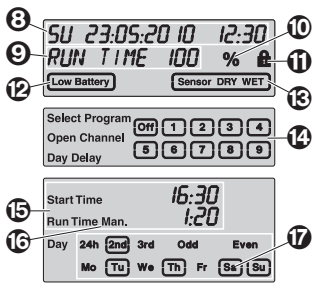

- 13 Sensor display:**  
If the sensor is inserted, the **DRY** or **WET** status report appears. When **WET** is displayed the watering programs are disabled.
- 14 Program / channel display:**  
Indicates which program of the particular channel is being programmed. If a channel is currently open, the frame of the opened watering channel flashes.
- 15 Display of watering times:**  
Indicates the start time and duration of watering.
- 16 Manual watering display:**  
When manual watering is selected, **Run Time Man.** is displayed.
- 17 Watering cycles / watering days:**  
To display the watering cycles (**24 h** every day, **2nd** every 2nd day, **3rd** every 3rd day, **Odd** every odd day **Even** every even day) or the programmed watering days (**Mo, Tu, We, Th, Fr, Sa, Su**).

## 4. Initial Operation



**ATTENTION !**  
The Watering Controller is ruined if the power supply unit is connected to terminals other than the 24 V AC terminals!  
→ Connect the power supply unit to the 24 V AC terminals only!

### Connecting your Watering Controller:

Before programming your Watering Controller, install a 9-V battery to prevent loss of data if a power failure occurs.

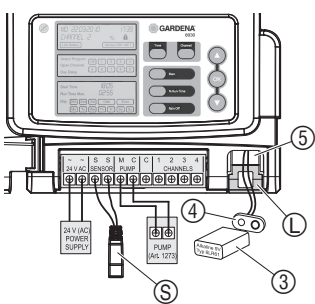
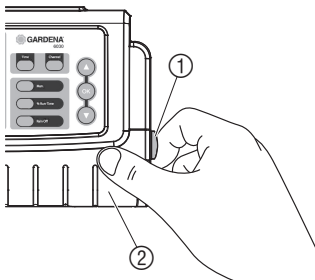

1. Release snap lock ① and open cover ②.
2. Connect the cable of the power supply unit to the **24 V AC** terminals.
3. Connect the cables for the valves (e.g. 7-wire GARDENA Connection Cable **Art. 1280** for up to 6 valves) to the terminals for the channels (**CHANNELS 1...**) and **C** (see also **“Connecting the valves”**).
4. If required, connect the sensor (e.g. GARDENA Moisture Sensor **Art. 1188**) using the accompanying adapter cable ⑤ and connect the latter to the **SENSOR** terminals.
5. If necessary (e.g. **Art. 1273**) connect the cable for the master channel to the **PUMP** terminals (see **“Master channel”**).
6. Remove the empty battery as necessary: Depress the clip ④ (the battery is released) and remove the empty battery.
7. Attach the battery ③ to the battery clip ④ and insert it into the battery compartment ⑤.
8. Close cover ② and let snap lock ① engage.
9. Plug the mains plug of the 24 V (AC) power supply unit into a mains socket.

After this it is necessary to set the date and time (see **5. Operation “Setting the date and time”**).

## Master Channel:

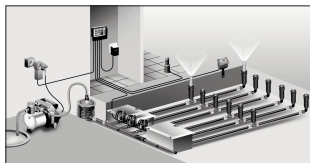

## Connecting the valves:

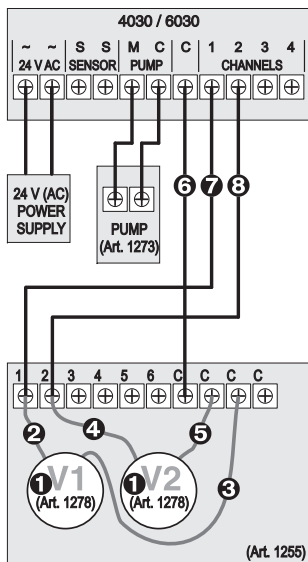

The master channel is a channel that can be operated at the same time as other channels. This is important, for example, if you want to use a pump to supply your irrigation system with water and if the pump should always be activated each time an irrigation valve is activated.

The pump can be operated, for example, using the **GARDENA Pump Control Art. 1273** that is connected to the master channel.

The example shows the connection of 2 valves **Art. 1278** in the Valve Box **Art. 1255** to the Watering Controller **4030/6030**. As the output of the Watering Controller is 24 V AC (alternating current) for switching the valves, it does not matter which of the two cables of a valve is inserted into **C**.

## Labelling the valves:

- 1 Label the valves (**1 – 6**), so that the channels (**CHANNELS 1, CHANNELS 2, ...**) of the Watering Controller can be clearly assigned to the valves.

## Connecting the valves to the Valve Box:

- 2 Connect one cable of the valve **V1** to the cable terminal **1** of the valve box.
- 3 Connect the other cable of the valve **V1** to a cable terminal **C** of the valve box (All 4 cable terminals **C** are interconnected and equivalent to one another).
- 4 Connect one cable of the valve **V2** to the cable terminal **2** of the valve box.
- 5 Connect the other cable of the valve **V2** to a cable terminal **C** of the valve box.

*Other valves can be connected similarly to **V1** and **V2**.*

## Connecting the Watering Controller to the Valve Box:

- 6 Connect a cable terminal **C** of the Watering Controller to a cable terminal **C** of the valve box. Both cable clips **C** are connected to each other and equivalent.
- 7 Connect the cable terminal of channel **1 CHANNELS 1** to the cable terminal **1** of the valve box.
- 8 Connect the cable terminal of channel **2 CHANNELS 2** to the cable terminal **2** of the valve box.

*Other channels can be connected similarly to **CHANNELS 1** and **CHANNELS 2**.*

## Cable cross-section of the connection cable:

The maximum permissible distance between the Watering Controller and the valve depends on the cross-section of the connection cable. For a distance of 30 m, the cross section is 0.5 mm<sup>2</sup> and 0.75 mm<sup>2</sup> for a distance of 45 m. No more than 3 valves must be in operation at the same time.

The GARDENA connection cable **Art. 1280** is 0.5 mm<sup>2</sup> in size and is 15 m long. Up to 6 valves can be connected using this cable. The connection cable can be connected so that it is watertight using the cable clip **Art. 1282**.

**Wall-mounting the Watering Controller:**

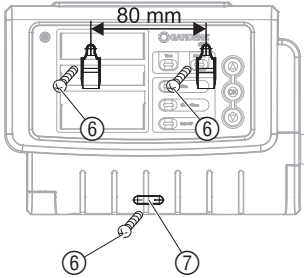

The two screws (not supplied) for attaching the Watering Controller have to be screwed into place 80 mm apart and the screw head diameter must not exceed 8 mm.

1. Screw the screws ⑥ into the wall 80 mm apart.
2. Attach the Watering Controller.
3. Release snap lock ① and open cover ② (see “Connecting your Watering Controller”) and mark hole for screw ⑥ of the elongated hole ⑦.
4. Screw the screw ⑥ into the elongated hole ⑦ for fixation.
5. Close cover ② and let snap lock ① engage.

## 5. Operation

### 5.1 Basic Programming Date and Time (Time Key)

You can end the programming mode at any time by pressing the **Time** key.

**Setting the date and time:**

You must set the date and time before you can set the watering programs. The day of the week is selected automatically using the date. When the **Time** key is pressed, all the valves are closed as a precaution.

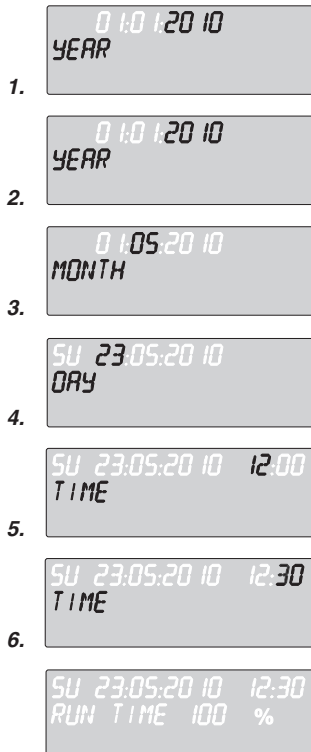

1. Plug in the power supply unit – or – press the **Time** key.  
*YEAR and date-year flash in the display.*
2. Select the date-year using the ▲-▼ keys (e.g. **2010**) and confirm by pressing the **OK** key.  
*MONTH and date-month flash.*
3. Select the date-month using the ▲-▼ keys (e.g. **05**) and confirm by pressing the **OK** key.  
*DAY and date-day flash.*
4. Select the date-day using the ▲-▼ keys (e.g. **23**) and confirm by pressing the **OK** key.  
*TIME and time-hours flash.*
5. Select the time-hours using the ▲-▼ keys (e.g. **12** hours) and confirm by pressing the **OK** key.  
*TIME and time-minutes flash.*
6. Select the time-minutes using the ▲-▼ keys (e.g. **30** minutes) and confirm by pressing the **OK** key.

*The date and time have been set and the main level is displayed.*

## Watering Programs (Channel Key)

**Prerequisite: The date and time have been set.**

To give you a better overview, we recommend that before starting to enter the watering data you enter the data for your valves into the watering plan in the appendix of these operating instructions. You can save 3 watering programs for each channel (a maximum of 3 programs x 4 (Art. 1283) / 6 (Art. 1284) channels = 12 (1283) / 18 (1284) programs).

### Ending the programming mode prematurely:

You can exit the programming mode prematurely at any time.

→ Press the **Channel** key twice.

*The main level is displayed.*

### Setting the watering programs:

#### PLEASE NOTE!

**If two programs overlap on one channel, this results in the total watering duration being less than planned.**

**If two programs overlap on different channels, the water pressure may drop to an extent such that watering is inadequate or the pop-up sprinklers fail to extend.**

→ **Make sure that the watering times of the programs do not overlap.**

#### Selecting the channel and program memory location:

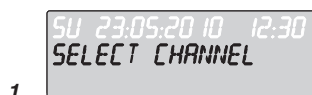

1. Press the **Channel** key.

**SELECT CHANNEL** and the channel flash.

You can end the programming mode at any time by pressing the **Channel** key.

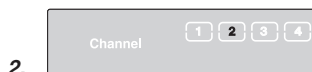

2. Select the channel using the ▲-▼ keys (e.g. channel **2**) and confirm by pressing the **OK** key.

**Channel** appears on the display (e.g. **2**) and

**Select Program** and the program memory location flash.

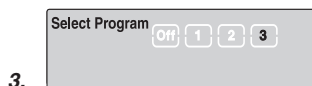

3. Select the program memory location using the ▲-▼ keys (e.g. program memory location **3**) and confirm by pressing the **OK** key.

**Start Time** and the hours for the watering start time flash.



#### Setting the watering start time:

4. Select the hours for the watering start time using the ▲-▼ keys (e.g. **16**) and confirm by pressing the **OK** key.

**Start Time** and the minutes for the watering start time flash.



5. Select the minutes for the watering start time using the ▲-▼ keys (e.g. **30**) and confirm by pressing the **OK** key.

**Run Time** and the hours for watering duration flash.



#### Setting the watering duration:

**(This always corresponds to 100% run-time)**

6. Select the hours for watering duration using the ▲-▼ keys (e.g. **1** hour) and confirm by pressing the **OK** key.

**Run Time** and the minutes for watering duration flash.



7. Select the minutes for watering duration using the ▲-▼ keys (e.g. **20** minutes) and confirm by pressing the **OK** key.

**24h** flashes.

### Setting the watering cycle / watering days:

#### (a) Watering cycle:

Watering options are every 24 hours “**24h**”, every second day “**2nd**”, every third day “**3rd**”, every “**Odd**” day odd or every even day “**Even**”.

#### (b) Watering days:

Every day **Mo, Tu, We, Th, Fr, Sa, Su** can be individually set.



8. (a) **Watering cycle:**

Using the ▲-▼ keys, select the desired watering cycle (e.g. **2nd** = every 2nd day) and confirm by pressing the **OK** key.

*The watering cycle (e.g. **2nd**) and the preview for the week (e.g. **Su, Tu, Th, Sa**) are shown on the display in frames.*

The days in the preview for the week are always with respect to the day of the week set in the system (e.g. Sunday **Su**).

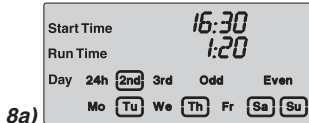

– or –

#### (b) Watering days:

Using the ▲-▼ keys, select the desired day of the week (e.g. **Mo** = Monday) and select / deselect the day by pressing the **OK** key.

*The selected watering days (e.g. **Mo, We, Fr**) are shown on the display in frames.*

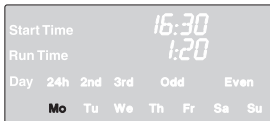

9. Press the **Channel** key and set up more watering programs.

*The program is saved and **SELECT CHANNEL** and the channel flash (program step 1.).*

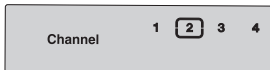

10. Press the **Channel** key.

*The programs have been set up and the main level is displayed.*



The main level displays the next programmed watering. In this example: watering on 2 (**Channel 2**), watering start time 16:30 (**Start Time 16:30**) on Monday (**Mo**).

Programming of the Watering Controller is now completed, i.e. the valves installed open / close entirely automatically and therefore water at the programmed times.

### Changing an existing watering program:

You can change an existing program stored in one of the 3 program memory locations without having to create the program from scratch.

The data for the watering start time, duration, and cycle are preset; therefore you only need to change the specific values of the watering program you want to change. You can transfer all other values from “Setting the watering programs” by pressing the **OK** key.



## 5.2 Special Functions

### Blocking a channel:

If **Program Off** is selected as program memory location for a channel, the respective channel is blocked and the watering programs of the channel are no longer executed. The programs of the channel are retained.

You can end the programming mode at any time by pressing the **Channel** key.

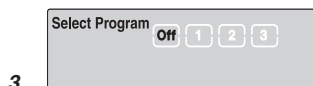
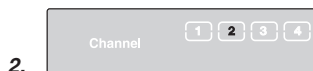
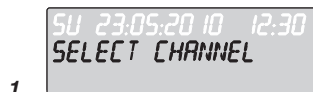

1. Press the **Channel** key.  
*SELECT CHANNEL* and the channel flash.
2. Select the channel using the **▲-▼** keys (e.g. channel **2**) and confirm by pressing the **OK** key.  
**Channel** appears on the display (e.g. **2**) and **Select Program** and the program memory location flash.
3. Select the program memory location **Off** using the **▲-▼** keys and confirm by pressing the **OK** key.  
*SELECT CHANNEL* flashes in the display.
4. Press the **Channel** key.  
*CHANNEL OFF* and the channel (e.g. channel **2**) is shown in the display.

If several channels are blocked, **CHANNELS OFF** is displayed. If the run time % is not equal to 100, the display alternates every 3 seconds between **CHANNEL OFF** and **RUN TIME %**.

### Manual Watering (Man Key)

#### Manual watering:

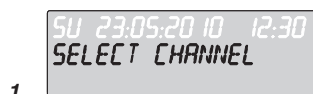

The manual watering duration can be set between 0 to 59 min. Channels which are already open are displayed in frames.



1. Press the **Man.** key.  
*SELECT CHANNEL* and the channel flash.
2. Select the channel desired using the **▲-▼** keys (e.g. channel **4**) and confirm by pressing the **OK** key.  
**Run Time Man.** and minutes flash in the display.
3. Select the manual watering duration (**00:30** minutes are preset) using the **▲-▼** keys (e.g. **00:15**) and confirm by pressing the **OK** key.  
*Manual watering starts and the frame around the active channel flashes.*

If the watering duration is not confirmed within 10 seconds by pressing the **OK** key, the watering begins with the watering duration selected.



### Ending active watering prematurely:

- 
- 

You can exit active watering (programmed or started manually) prematurely without changing the programs.

- Press the **Man.** key.  
*SELECT CHANNEL* and the channel flash.
- Select the active channel desired (in the frame e.g. channel 4) using the **▲-▼** keys and confirm by pressing the **OK** key.  
*Watering is ended and the main level is displayed.*

### Water all channels manually:

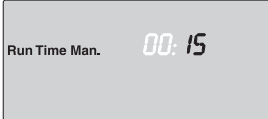
- 
- 
- 

If all the channels are to be enabled manually, the channels are opened manually one after the other with the manual watering duration.

- Press and hold down the **OK** key.
- Also press and hold down the **Man.** key for 3 seconds.  
*Run Time Man., MANUAL ALL* and minutes flash in the display.
- Select the manual watering duration (**00:30** minutes are preset) using the **▲-▼** keys (e.g. **00:15**) and confirm by pressing the **OK** key.  
*Manual watering starts with channel 1, MANUAL ALL and the frame around the active channel flashes.*



If the watering duration is not confirmed within 10 seconds by pressing the **OK** key, the watering begins with the watering duration displayed.

You can exit watering all the channels prematurely by pressing the **OK** key + **Man.** key for 3 seconds.

## Percentage Watering Duration (% Run-Time Key)

You can end the programming mode at any time by pressing the **Run-Time** key.

### % run-time-function:

- 
- 

The programmed watering durations of all the watering programs can be changed centrally in 10 % increments from 10 % to 200 %, without having to change the individual programs (e.g. if you wish to water your garden less in the autumn than in the summer). **ATTENTION!** If the run-time % figures are above 100 %, programs may overlap as a result (see "Setting the watering programs").

- Press the % **Run-Time** key.  
*RUN TIME %* and the percentage watering duration flash.
- Select the figure for the percentage watering duration using the **▲-▼** keys (e.g. *RUN TIME 60 %*) and confirm by pressing the **OK** key.  
*The percentage watering duration has been transferred and the main level is displayed.*

E.g. In case of 60% run-time, a programmed watering duration of 60 min. is reduced to 36 min.

**Note:**

When the percentage of the watering duration is changed the display of the originally programmed watering durations in the programs stays as it is. When setting up / modifying a program, this is automatically set to **100 % RUN-TIME**. The **% RUN-TIME** does not apply to manual watering.

## Watering Breaks (Rain Off Key)

You can end the programming mode at any time by pressing the **Rain Off** key.

### Rain Off function:

If watering is not necessary, e.g. due to lengthy rainfall, a watering break can be set. All the programs can be set for a 1 to 9-day break (**1** to **9**) or they can all be blocked (**Off**), in which case manual watering is still possible.



1. Press the **Rain Off** key.

***RAIN OFF** and **Off** is displayed.*



2. Using the **▲-▼** keys, set the desired break (e.g. 3 days **3**).

***Day Delay** and the frame flash.*

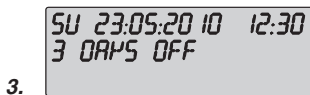

3. Confirm the break by pressing the **OK** key.

*The selected break (e.g. 3 days **3 DAYS OFF**) is displayed and the programs are suspended for the break selected.*

From 2 days onwards, the remaining break period displayed in hours (**48H OFF** (48 hours) ... **1H OFF** (1 hour)).

To deselect the **Rain Off** function the Rain Off key has to be pressed.

### Key lock:

The keypad can be locked to protect against unintentional changing of the settings.



1. Press and hold down the **OK** key.
2. Also press and hold down the **Rain Off** key for 3 seconds.

*The lock symbol is displayed.*

To disable the key lock, the **OK** key + **Rain Off** key have to be pressed and held down for 3 seconds.

## Reset function:

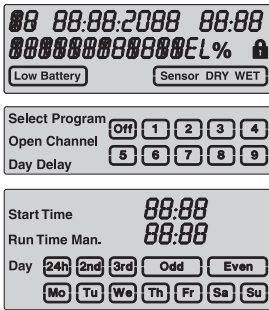

**The Watering Controller is reset to the default setting and all the program data is deleted.**

1. Press and hold down the **OK** key.
  2. Also press and hold down the **Channel** key for 3 seconds.  
*The lock symbol is displayed.*
- All the symbols of the display light up for 2 seconds.
  - The program data for **all** programs is deleted.
  - The date and time are retained.
  - The key lock is cancelled.

A reset can be triggered at any time.

**Tip:** Should you have any questions about operating and programming your Watering Controller, please do not hesitate to contact your nearest GARDENA Service Centre.

## 6. Putting Out of Operation

### Wintering / Storage:

The watering controller is frost-proof. No measures are required when frost commences. Legibility of the display is restricted below 0 °C.

- Check battery status display before the power supply unit is disconnected.

### Important:

Only dispose of batteries when they are flat.

- Return flat batteries to the place you bought them **or** dispose of them properly at your local recycling/disposal centre.

### Disposal:

(in accordance with  
Directive 2012/19/EU)



The product must not be added to normal household waste. It must be disposed of in line with local environmental regulations.

- Important: Make sure that the unit is disposed of via your municipal recycling collection centre.

## 7. Trouble-Shooting

Fault	Possible Cause	Remedy
No display	External temperature below 0 °C or above +60 °C.	→ Wait until the external air temperature returns to the operating temperature range.
<b>AC OFF</b> is indicated on the display (the programs are retained)	The power supply unit is not plugged in.	→ Plug the power supply unit into a mains socket.
<b>OVERLOAD</b> is indicated on the display (the programs are retained).	The power supply is overloaded because valves from other manufacturers have been used.	→ Only so many valves may be opened at the same time that the total power consumption does not exceed 800 mA.
	Cabling of the valves has a short circuit.	→ Cable the valves properly (see 4. Initial Operation "Connecting the valves").



In the event of other faults please contact **GARDENA Service**.  
Repairs should only be carried out by **GARDENA service centres or dealers**  
authorised by **GARDENA**.

## 8. Technical Data

<b>Power supply from power supply unit:</b>	24 V (AC) / 800 mA (sufficient for 5 simultaneously open GARDENA Watering Valves Art. 1278)
<b>Power supply for memory in case of mains power failure:</b>	9 V block battery (type 6LR61)
<b>Life of the battery:</b>	At least 1 year (to retain data if there is a mains failure)
<b>Operating temperature range:</b>	From 0 °C to +60 °C
<b>Temperature range for storage:</b>	-20 °C to +70 °C
<b>Air humidity:</b>	max. 95 % relative humidity
<b>Soil moisture/rain sensor connection:</b>	GARDENA-specific
<b>Program saved when replacing battery:</b>	Yes (if power supply unit connected)
<b>Number of channels:</b>	Art. 1283: 4 channels and one master channel Art. 1284: 6 channels and one master channel
<b>Number of program-controlled watering cycles per channel:</b>	Up to 3
<b>Watering duration per program:</b>	1 minute to 24 min. (10 % Run-Time) 1 minute to 3 h 59 min. (100 % Run-Time) 2 minutes to 7 h 58 min. (200 % Run-Time)

## 9. Service / Warranty

### *Warranty*

GARDENA guarantees this product for 2 years (from date of purchase). This guarantee covers all serious defects of the unit that can be proved to be material or manufacturing faults. Under warranty we will either replace the unit or repair it free of charge if the following conditions apply:

- The unit must have been handled properly and in keeping with the requirements of the operating instructions.
- Neither the purchaser or a non-authorized third party have attempted to repair the unit.

GARDENA will not replace Watering Controllers with defects resulting from incorrect installation of the battery or leaking batteries.

This manufacturer's guarantee does not affect the user's existing warranty claims against the dealer/seller.

If you have any problems with your watering controller, please contact our Customer Service or return the defective unit together with a short description of the problem directly to one of the GARDENA Service Centres listed on the back of this leaflet.

Channel \_\_\_\_

Prog.	<i>START TIME</i>	<i>RUN TIME</i>	24 h	2nd	3rd	Odd	Even	Mo	Tu	We	Th	Fr	Sa	Su
1														
2														
3														

Channel \_\_\_\_

Prog.	<i>START TIME</i>	<i>RUN TIME</i>	24 h	2nd	3rd	Odd	Even	Mo	Tu	We	Th	Fr	Sa	Su
1														
2														
3														

Channel \_\_\_\_

Prog.	<i>START TIME</i>	<i>RUN TIME</i>	24 h	2nd	3rd	Odd	Even	Mo	Tu	We	Th	Fr	Sa	Su
1														
2														
3														

Channel \_\_\_\_

Prog.	<i>START TIME</i>	<i>RUN TIME</i>	24 h	2nd	3rd	Odd	Even	Mo	Tu	We	Th	Fr	Sa	Su
1														
2														
3														

Channel \_\_\_\_

Prog.	<i>START TIME</i>	<i>RUN TIME</i>	24 h	2nd	3rd	Odd	Even	Mo	Tu	We	Th	Fr	Sa	Su
1														
2														
3														

Channel \_\_\_\_

Prog.	<i>START TIME</i>	<i>RUN TIME</i>	24 h	2nd	3rd	Odd	Even	Mo	Tu	We	Th	Fr	Sa	Su
1														
2														
3														

## **D Produkthaftung**

Wir weisen ausdrücklich darauf hin, dass wir nach dem Produkthaftungsgesetz nicht für durch unsere Geräte hervorgerufene Schäden einzustehen haben, sofern diese durch unsachgemäße Reparatur verursacht oder bei einem Teileaustausch nicht unsere Original GARDENA Teile oder von uns freigegebene Teile verwendet werden und die Reparatur nicht vom GARDENA Service oder dem autorisierten Fachmann durchgeführt wird. Entsprechendes gilt für Ergänzungsteile und Zubehör.

## **GB Product Liability**

We expressly point out that, in accordance with the product liability law, we are not liable for any damage caused by our units if it is due to improper repair or if parts exchanged are not original GARDENA parts or parts approved by us, and, if the repairs were not carried out by a GARDENA Service Centre or an authorised specialist. The same applies to spare parts and accessories.

## **F Responsabilité**

Nous vous signalons expressément que GARDENA n'est pas responsable des dommages causés par ses appareils, dans la mesure où ces dommages seraient causés suite à une réparation non conforme, dans la mesure où, lors d'un échange de pièces, les pièces d'origine GARDENA n'auraient pas été utilisées, ou si la réparation n'a pas été effectuée par le Service Après-Vente GARDENA ou l'un des Centres SAV agréés GARDENA. Ceci est également valable pour tout ajout de pièces et d'accessoires autres que ceux préconisés par GARDENA.

## **NL Productaansprakelijkheid**

Wij wijzen er nadrukkelijk op, dat wij op grond van de wet aansprakelijkheid voor producten niet aansprakelijk zijn voor schade ontstaan door onze apparaten, indien deze door onvakkundige reparatie veroorzaakt zijn, of er bij het uitwisselen van onderdelen geen gebruik gemaakt werd van onze originele GARDENA onderdelen of door ons vrigegeven onderdelen en de reparatie niet door de GARDENA technische dienst of de bevoegde vakman uitgevoerd werd. Ditzelfde geldt voor extra-onderdelen en accessoires.

## **S Produktansvar**

Tillverkaren är inte ansvarig för skada som orsakats av produkten om skadan beror på att produkten har reparerats felaktigt eller om, vid reparation eller utbyte, andra än Original GARDENA reservdelar har använts. Samma sak gäller för kompletteringsdelar och tillbehör.

## **DK Produktansvar**

Vi gør udtrykkeligt opmærksom på at i henhold til produktansvarsloven er vi ikke ansvarlige for skader forårsaget af vores udstyr, hvis det skyldes uautoriserede reparationer eller hvis dele er skiftet ud og der ikke er anvendt originale GARDENA dele eller dele godkendt af os, eller hvis reparationerne ikke er udført af GARDENA-service eller en autoriseret fagmand. Det samme gælder for ekstra udstyr og tilbehør.

## **FIN Tuotevastuu**

Korostamme nimenomaan, että tuotevastuulain nojalla emme ole vastuussa laitteistamme johtuneista vahingoista, mikäli nämä ovat aiheutuneet epäasianmukaisesta korjauksesta tai osia vaihdettaessa ei ole käytetty alkuperäisiä GARDENA- varaosia tai hyväksymiämme osia ja korjauksen on suorittanut muu kuin GARDENA -huoltokeskus tai valtuuttamamme ammattihenkilö. Tämä pätee myös lisäosiin ja lisävarusteisiin.

## **I Responsabilità del prodotto**

Si rende espressamente noto che, conformemente alla legislazione sulla responsabilità del prodotto, non si risponde di danni causati da nostri articoli se originati da riparazioni eseguite non correttamente o da sostituzioni di parti effettuate con materiale non originale GARDENA o comunque da noi non approvato e, in ogni caso, qualora l'intervento non venga eseguito da un centro assistenza GARDENA o da personale specializzato autorizzato. Lo stesso vale per le parti complementari e gli accessori.

## **E Responsabilidad de productos**

Advertimos que conforme a la ley de responsabilidad de productos no nos responsabilizamos de daños causados por nuestros aparatos, siempre y cuando dichos daños hayan sido originados por arreglos o reparaciones indebidas, por recambios con piezas que no sean piezas originales GARDENA o bien piezas autorizadas por nosotros, así como en aquellos casos en que la reparación no haya sido efectuada por un Servicio Técnico GARDENA o por un técnico autorizado. Lo mismo es aplicable para las piezas complementarias y accesorios.

## **P Responsabilidade sobre o produto**

Queremos salientar que segundo a lei da responsabilidade do fabricante, nós não nos responsabilizaremos por danos causados pelo nosso equipamento, quando estes ocorrerem em decorrência de reparações inadequadas ou da substituição de peças por peças não originais da GARDENA, ou peças não autorizadas. A responsabilidade tornar-se-á nula também depois de reparações realizadas por oficinas não autorizadas pela GARDENA. Esta restrição valerá também para peças adicionais e acessórios.

<p><b>DE EG-Konformit�tserkl�ring</b></p> <p>Der Unterzeichnete Husqvarna AB, 561 82 Huskvarna, Sweden best�tigt, dass die nachfolgend bezeichneten Ger�te in der von uns in Verkehr gebrachten Ausf�hrung die Anforderungen der harmonisierten EU-Richtlinien, EU-Sicherheitsstandards und produktspezifischen Standards erf�llen. Bei einer nicht mit uns abgestimmten �nderung der Ger�te verliert diese Erkl�rung ihre G�ltigkeit.</p>	<p>Bezeichnung des Ger�tes: Bew�sserungssteuerung  Description of the unit: Watering Controller  D�signation du mati�riel : Programmeur  Omschrijving van het apparaat: Besproeiingscomputer  Produktbeskrivning: Vandingskontroll-system  Beskrivelse af enhederne: Watering Controller  Laitteiden nimitys: Watering Controller  Descripci�n del producto: Centralina  Descripci�n de la mercanc�a: Programaci�n de riego  Descri��o do aparelho: Comando de rega</p>																								
<p><b>GB EU Declaration of Conformity</b></p> <p>The undersigned Husqvarna AB, 561 82 Huskvarna, Sweden, hereby certifies that, when leaving our factory, the units indicated below are in accordance with the harmonised EU guidelines, EU standards of safety and product specific standards. This certificate becomes void if the units are modified without our approval.</p>	<table border="0"> <tr> <td>Typ:</td> <td>Art.-Nr.:</td> <td>Type:</td> <td>Varenr. :</td> </tr> <tr> <td>Type:</td> <td>Art. No.:</td> <td>Tyypit:</td> <td>Art.-n:o. :</td> </tr> <tr> <td>Type:</td> <td>R�f�rence :</td> <td>Modello:</td> <td>Art. :</td> </tr> <tr> <td>Typ:</td> <td>Art. nr.:</td> <td>Tipo:</td> <td>Art. N�:</td> </tr> <tr> <td>Typ:</td> <td>Art.nr.:</td> <td>Tipo:</td> <td>Art. N�:</td> </tr> <tr> <td>4030</td> <td>1283</td> <td>6030</td> <td>1284</td> </tr> </table>	Typ:	Art.-Nr.:	Type:	Varenr. :	Type:	Art. No.:	Tyypit:	Art.-n:o. :	Type:	R�f�rence :	Modello:	Art. :	Typ:	Art. nr.:	Tipo:	Art. N�:	Typ:	Art.nr.:	Tipo:	Art. N�:	4030	1283	6030	1284
Typ:	Art.-Nr.:	Type:	Varenr. :																						
Type:	Art. No.:	Tyypit:	Art.-n:o. :																						
Type:	R�f�rence :	Modello:	Art. :																						
Typ:	Art. nr.:	Tipo:	Art. N�:																						
Typ:	Art.nr.:	Tipo:	Art. N�:																						
4030	1283	6030	1284																						
<p><b>F Certificat de conformit� aux directives europ�ennes</b></p> <p>Le constructeur, soussign� : Husqvarna AB, 561 82 Huskvarna, Sweden, d�clare qu'� la sortie de ses usines le mati�riel neuf d�sign� ci-dessous �tait conforme aux prescriptions des directives europ�ennes �nonc�es ci-apr�s et conforme aux r�gles de s�curit� et autres r�gles qui lui sont applicables dans le cadre de l'Union europ�enne. Toute modification port�e sur ce produit sans l'accord express de Husqvarna supprime la validit� de ce certificat.</p>	<p>EU-Richtlinien : EU Retningslinier :  EU directives : EY-direktivit� :  Directives europ�ennes : Directive UE :  EU-richtlijnen : Normativa UE :  EU direktiv : Directrices da UE :  2004/108/EC 2006/95/EC  2011/65/EC</p>																								
<p><b>NL EU-overeenstemmingsverklaring</b></p> <p>Ondergetekende Husqvarna AB, 561 82 Huskvarna, Sweden, bevestigt, dat het volgende genoemde apparaat in de door ons in de handel gebrachte uitvoering voldoet aan de eis van, en in overeenstemming is met de EU-richtlijnen, de EU-veiligheidsstandaard en de voor het product specifieke standaard. Bij een niet met ons afgestemde verandering aan het apparaat verliest deze verklaring haar geldigheid.</p>	<p>Harmonisierte EN :  EN 60730-1 EN 61558-2-6  EN 60730-2-8</p>																								
<p><b>S EU Tillverkarintyg</b></p> <p>Undertecknad firma Husqvarna AB, 561 82 Huskvarna, Sweden, intygar h�rmed att nedan n�mnda produkter �verensst�mmer med EU:s direktiv, EU:s s�kerhetsstandard och produktspecifikation. Detta intyg upph�r att g�lla om produkten �ndras utan v�rt tillst�nd.</p>	<p>Hinterlegte Dokumentation : GARDENA Technische Dokumentation M. Kugler 89079 Ulm  Deposited Documentation : GARDENA Technical Documentation M. Kugler 89079 Ulm  Documentation d�pos�e : Documentation technique GARDENA M. Kugler 89079 Ulm</p>																								
<p><b>DK EU Overensstemmelse certificat</b></p> <p>Undertegnede Husqvarna AB, 561 82 Huskvarna, Sweden bekr�fter hermed, at enheder listet herunder, ved afsendelse fra fabrikken, er i overensstemmelse med harmoniserede EU retningslinier, EU sikkerhedsstandarder og produkt-specifikationsstandarder. Dette certifikat tr�der ud af kraft hvis enhederne er �ndret uden vor godkendelse.</p>	<p>Anbringingsjahr der CE-Kennzeichnung :  Year of CE marking :  Date d'apposition du marquage CE :  Installatiejaar van de CE-aanduiding :  CE-M�rknings�r : 2010  CE-M�rknings�r :  CE-merkin kiinnitysvuosi :  Anno di rilascio della certificazione CE :  Colocaci�n del distintivo CE :  Ano de marca�o pela CE :</p>																								
<p><b>FIN EY-vaatimustenmukaisuusvakuutus</b></p> <p>Allekirjoittanut Husqvarna AB, 561 82 Huskvarna, Sweden vakuuttaa, ett� allamainitut laitteet t�ytt�v�t tehtaaltamme l�htiss�s�n yhdenmukaistettujen EY-direktiivien, EY-turvallisuusstandardien ja tuotekohtaisten standardien vaatimukset. Laitteisiin tehdyt muutokset, joista ei ole sovittu kanssamme, johtavat t�m�n vakuutuksen raukeamiseen.</p>	<p>Ulm, den 11.11.2014  Ulm, 11.11.2014  Fait � Ulm, le 11.11.2014  Ulm, 11-11-2014  Ulm, 2014.11.11.  Ulm, 11.11.2014  Ulmissa, 11.11.2014  Ulm, 11.11.2014  Ulm, 11.11.2014  Ulm, 11.11.2014  Ulm, 11.11.2014</p> <p>Der Bevollm�chtigte  Authorized representative  Repr�sentant l�gal  Gemachtigde  Beh�rig Firmatecknare  Teknisk direkt�r  Valtuutettu edustaja  Rappresentante autorizzato  Representante autorizado  Representante autorizado</p>																								
<p><b>E Declaraci�n de conformidad de la UE</b></p> <p>El que suscribe Husqvarna AB, 561 82 Huskvarna, Sweden, declara que la presente mercanc�a, objeto de la presente declaraci�n, cumple con todas las normas de la UE, en lo que a normas t�cnicas, de homologaci�n y de seguridad se refiere. En caso de realizar cualquier modificaci�n en la presente mercanc�a sin nuestra previa autorizaci�n, esta declaraci�n pierde su validez.</p>	<p>Os abaixo mencionados Husqvarna AB, 561 82 Huskvarna, Sweden, por este meio certificam que ao sair da f�brica o aparelho abaixo mencionado est� de acordo com as directrizes harmonizadas da UE, padr�es de seguran�a e de produtos espec�ficos. Este certificado ficar� nulo se a unidade for modificada sem a nossa aprova�o.</p> <p style="text-align: right;">   Reinhard Pompe  (Vice President) </p>																								



**Deutschland / Germany**

**GARDENA GmbH**  
Central Service  
Hans-Lorenser-Straße 40  
D-89079 Ulm  
Produktfragen:  
(+49) 731 490-123  
Reparaturen:  
(+49) 731 490-290  
service@gardena.com

**Albania**

**COBALT Sh.p.k.**  
Rr. Sriti Kodra  
1000 Tirana

**Argentina**

Husqvarna Argentina S.A.  
Av. del Libertador 5954 –  
Piso 11 – Torre B  
(C1428ARP) Buenos Aires  
Phone: (+54) 11 5194 5000  
info.gardena@  
ar.husqvarna.com

**Armenia**

Garden Land Ltd.  
61 Tigran Mets  
0005 Yerevan

**Australia**

Husqvarna Australia Pty. Ltd.  
Locked Bag 5  
Central Coast BC  
NSW 2252  
Phone: (+61) (0) 2 4352 7400  
customer.service@  
husqvarna.com.au

**Austria / Österreich**

Husqvarna Austria GmbH  
Consumer Products  
Industriezeile 36  
4010 Linz  
Tel.: (+43) 732 77 01 01-90  
consumer.service@  
husqvarna.at

**Azerbaijan**

Firm Progress  
a. Aliyev Str. 26A  
1052 Baku

**Belgium**

**GARDENA Belgium NV/SA**  
Sterrebeekstraat 163  
1930 Zaventem  
Phone: (+32) 2 720 92 12  
Mail: info@gardena.be

**Bosnia / Hercegovina**

**SILK TRADE d.o.o.**  
Industrijska zona Bukva bb  
74260 Tešanj

**Brazil**

Husqvarna do Brasil Ltda  
Av. Francisco Matarazzo,  
1400 – 19º andar  
São Paulo – SP  
CEP: 05001-903  
Tel: 0800-112252  
marketing.br.husqvarna@  
husqvarna.com.br

**Bulgaria**

Хускварна България ЕООД  
Бул. „Андрей Липчев“ № 72  
1799 София  
Тел.: (+359) 02/9753076  
www.husqvarna.bg

**Canada / USA**

**GARDENA Canada Ltd.**  
100 Summerlea Road  
Brampton, Ontario L6T 4X3  
Phone: (+1) 905 792 9330  
info@gardencanada.com

**Chile**

Maquinarias Agroforestales  
Ltda. (Maga Ltda.)  
Santiago, Chile  
Avda. Chesterton  
# 8355 comuna Las Condes  
Phone: (+56) 2 202 4417  
Dalton@maga.cl  
Zipcode: 7560330

**Temuco, Chile**

Avda. Valparaíso # 01466  
Phone: (+56) 45 222 126  
Zipcode: 4780441

**China**

Husqvarna (China) Machinery  
Manufacturing Co., Ltd.  
No. 1355, Jia Xin Rd.,  
Ma Lu Zhen, Jia Ding Dist.,  
Shanghai  
201801  
Phone: (+86) 21 59159629  
Domestic Sales  
www.gardena.com.cn

**Colombia**

Husqvarna Colombia S.A.  
Calle 18 No. 68 D-31, zona  
Industrial de Montevideo  
Bogotá, Cundinamarca  
Tel. 571 2922700 ext. 105  
jairo.salazar@  
husqvarna.com.co

**Costa Rica**

Compania Exim  
Euroiberoamericana S.A.  
Los Colegios, Moravia,  
200 metros al Sur del Colegio  
Saint Francis – San José  
Phone: (+506) 297 68 83  
exim\_euro@racsa.co.cr

**Croatia**

**SILK ADRIA d.o.o.**  
Josipa Lončara 3  
10090 Zagreb  
Phone: (+385) 1 3794 580  
silk.adria@zg.t-com.hr

**Cyprus**

Med Marketing  
17 Digeni Akritia Ave  
P.O. Box 27017  
1641 Nicosia

**Czech Republic**

Husqvarna Česko s.r.o.  
Türkova 2319/5b  
149 00 Praha 4 – Chodov  
Bezpłatná infolinika:  
800 100 425  
servis@cz.husqvarna.com

**Denmark**

**GARDENA / Husqvarna**  
Consumer Outdoor Products  
Salgsafdelning Danmark  
Box 9033  
S-200 39 Malmö  
info@gardena.dk

**Dominican Republic**

**BOSQUESA, S.R.L**  
Carretera Santiago Licey  
Km. 5 ½  
Esquina Copal II,  
Santiago  
Dominican Republic  
Phone: (+809) 736-0333  
joserbosquesa@claro.net.do

**Ecuador**

Husqvarna Ecuador S.A.  
Arupos E1-181 y 10 de  
Agosto Quito, Pichincha  
Tel. (+593) 22800739  
francisco.jacom@  
husqvarna.com.ec

**Estonia**

Husqvarna Eesti OÜ  
Consumer Outdoor Products  
Kesk tee 10, Aaviku küla  
Rae vald  
Harju maakond  
75305 Estonia  
kontakt.etj@husqvarna.ee

**Finland**

Oy Husqvarna Ab  
Consumer Outdoor Products  
Lauttarhankatu 8 B / PL 3  
00581 HELSINKI  
info@gardena.fi

**France**

Husqvarna France  
9/111 Allée des pierres mayettes  
92635 Gennevilliers Cedex  
France  
http://www.gardena.com/fr  
N° AZUR: 0 810 00 78 23  
(Prix d'un appel local)

**Georgia**

**ALD Group**  
Bellashvili 8  
1159 Tbilisi

**Great Britain**

Husqvarna UK Ltd  
Preston Road  
Aycliffe Industrial Park  
Newton Aycliffe  
County Durham  
DL5 6UP  
info.gardena@  
husqvarna.co.uk

**Greece**

Π. ΠΑΠΑΔΟΠΟΥΛΟΣ ΑΕΒΕ  
Λεωφ. Αθηνών 92  
Αθήνα  
T.K. 104 42  
Ελλάδα  
Τηλ. (+30) 210 5193100  
info@papaopoulos.com.gr

**Hungary**

Husqvarna Magyarorszáig Kft.  
Ezred u. 1-3  
1044 Budapest  
Telefon: (+36) 1 251-4161  
vevoszolgalat.husqvarna@  
husqvarna.hu

**Iceland**

O. Johnson & Kaaber  
Túnguhalsi 1  
110 Reykjavik  
oj@ojk.is

**Ireland**

Husqvarna UK Ltd  
Preston Road  
Aycliffe Industrial Park  
Newton Aycliffe  
County Durham  
DL5 6UP  
info.gardena@  
husqvarna.co.uk

**Italy**

Husqvarna Italia S.p.A.  
Via Como 72  
23868 VALMADRERA (LC)  
Phone: (+39) 0341.203.111  
info@gardenaitalia.it

**Japan**

**KAKUICHI Co. Ltd.**  
Sumitomo Realty &  
Development Kojimachi  
BLDG., 8F  
5-1 Nibanncyo  
Chiyoda-ku  
Tokyo 102-0084  
Phone: (+81) 33264 4721  
m\_ishihara@kaku-ichi.co.jp

**Kazakhstan**

**LAMED Ltd.**  
155/1, Tazhibayevoi Str.  
050060 Almaty  
IP Schmidt  
Abayvenue 3B  
110 005 Kostanay

**Korea**

Kyung Jin Trading Co.,LTD.  
107-4, SunDuk Bld.,  
YangJae-dong,  
Seocho-gu,  
Seoul, (zipcode: 137-891)  
Phone: (+82) (0)2 574-6300

**Kyrgyzstan**

Alye Maki  
av. Molodaya Guardir J 3  
720014  
Bishkek

**Latvia**

Husqvarna Latvija  
Consumer Outdoor Products  
Bākuži iela 6  
LV-1024 Rīga  
info@husqvarna.lv

**Lithuania**

UAB Husqvarna Lietuva  
Consumer Outdoor Products  
Aiteiles pl. 77C  
LT-52104 Kaunas  
centras@husqvarna.lt

**Luxembourg**

Mugesius Jules Neuberger,  
rue Jacques Stas  
Luxembourg-Gasperich 2549  
Case Postale No. 12  
Luxembourg 2010  
Phone: (+352) 40 14 01  
api@neuberger.lu

**Mexico**

AFOSA  
Av. Lopez Mateos Sur # 5019  
Col. La Calima 45070  
Zapopan, Jalisco  
Mexico  
Phone: (+52) 33 3818-3434  
cornejo@afosa.com.mx

**Moldova**

Convel S.R.L.  
290A Muncestli Str.  
2002 Chisinau

**Netherlands**

**GARDENA Nederland B.V.**  
Postbus 50176  
1305 AD ALMERE  
Phone: (+31) 36 521 00 00  
info@gardena.nl

**Neth. Antilles**

Jonka Enterprises N.V.  
Sta. Rosa Weg 196  
P.O. Box 8200  
Curaçao  
Phone: (+599) 9 767 66 55  
pjm@jonka.com

**New Zealand**

Husqvarna New Zealand Ltd.  
PO Box 76-437  
Manukau City 2241  
Phone: (+64) (0) 9 9202410  
support.nz@husqvarna.co.nz

**Norway**

**GARDENA**  
Husqvarna Consumer  
Outdoor Products  
Salgskontor Norge  
Kleiverveien 6  
1540 Vesby  
info@gardena.no

**Peru**

Husqvarna Perú S.A.  
Jr. Ramón Cárcamo 710  
Lima 1  
Tel: (+51) 1 3320400 ext. 416  
juan.remuzog@  
husqvarna.com

**Poland**

Husqvarna  
Poland Spółka z o.o.  
ul. Wysockiego 15 b  
03-371 Warszawa  
Phone: (+48) 22330 96 00  
gardena@husqvarna.com.pl

**Portugal**

Husqvarna Portugal, SA  
Lagoa – Albarraque  
2635 – 595 Rio de Mouro  
Tel.: (+351) 21 922 85 30  
Fax : (+351) 21 922 85 36  
info@gardena.pt

**Romania**

Madex International Srl  
Soseaua Adului 117-123,  
RO 013603  
Bucuresti, S 1  
Phone: (+40) 21 352.76.03  
madex@ines.ro

**Russia / Россия**

ООО „Хускварна“  
141400, Московская обл.,  
г. Химки,  
улица Ленинградская,  
владение 39, стр.6  
РО 013603  
Бucypecти, С 1  
Phone: (+40) 21 352.76.03  
madex@ines.ro

**Serbia**

Domel d.o.o.  
Autoput za Novi Sad bb  
11273 Belgrade  
Phone: (+381) 118 48 88 12  
miroslav.jejina@domel.rs

**Singapore**

Hy-Ray PRIVATE LIMITED  
401, rue Paimoin  
#02-08 Tat Ann Building  
Singapore 571785  
Phone: (+65) 6253 2277  
shying@hyray.com.sg

**Slovak Republic**

Husqvarna Česko s.r.o.  
Türkova 2319/5b  
149 00 Praha 4 – Chodov  
Bezpłatná infolinika:  
800 154 044  
servis@sk.husqvarna.com

**Slovenia**

Husqvarna Austria GmbH  
Consumer Products  
Industriezeile 36  
4010 Linz  
Tel.: (+43) 732 77 01 01-90  
consumer.service@  
husqvarna.at

**South Africa**

Husqvarna  
South Africa (Pty) Ltd  
Postnet Suite 250  
Private Bag X6,  
Cascades, 3202  
South Africa  
Phone: (+27) 33 846 9700  
info@gardena.co.za

**Spain**

Husqvarna España S.A.  
C/ Basauri, nº 6  
La Florida  
28023 Madrid  
Phone: (+34) 91 708 05 00  
atencioncliente@gardena.es

**Suriname**

Agrofix n.v.  
Verlengde Hogestraat #22  
Phone: (+597) 472426  
agrofix@strinet  
Pobox: 2006  
Paramaribo  
Suriname – South America

**Sweden**

Husqvarna AB  
S-561 82 Huskvarna  
info@gardena.se

**Switzerland / Schweiz**

Husqvarna Schweiz AG  
Consumer Products  
Industriestrasse 10  
5506 Mägenwil  
Phone: (+41) (0) 62 887 37 90  
info@gardena.ch

**Turkey**

**GARDENA Dost Diş Ticaret**  
Mümesilliik A.Ş.  
Sanayi Cad. Adil Sokak  
No: 1/B Kartal  
34873 Istanbul  
Phone: (+90) 216 38 93 939  
info@gardena-dost.com.tr

**Ukraine / Україна**

ТОВ «Хусварна Україна»  
вул. Васильківська, 34,  
офіс 204-г  
03022, Київ  
Тел. (+380) 044 498 39 02  
info@gardena.ua

**Uruguay**

FELI SA  
Entre Rios 1083 CP 11800  
Montevideo – Uruguay  
Tel: (+598) 2203 18 44  
info@felisa.com.uy

**Venezuela**

Corporación Casa y Jardín C.A.  
Av. Caroni, Edif. Trezmen, PB.  
Colinas de Bello Monte.  
1050 Caracas.  
TIF: (+58) 212 992 33 22  
info@casayjardin.net.ve

**1283-20.960.03/0315**

© GARDENA  
Manufacturing GmbH  
D-89070 Ulm  
http://www.gardena.com