

2013

Corporate Social Responsibility Report

Continuous Growth with a Sustainable Society

ANRITSU CORPORATION

www.anritsu.com/csr



CSR

CSR Report Digest



Anritsu

Contents

Company Profile	1
Business Outline	3
Top Commitment	5
Resolving Social Issues Digest	7
Material Issues for Anritsu Group CSR	11
Stakeholder Dialogue	13
CSR Management	17
Goal 1	18
Goal 2	25
Goal 3	37
Goal 4	54
CSR Results for FY12, CSR Objectives for FY13	57
GRI Content Index	58
Independent Review and Response to	60
Independent Review	

Editorial Policy

We report our CSR activities for FY2012 in “CSR Report 2013,” which is published in digest form as a printed pamphlet and in greater detail as a PDF. The digest version seeks to shed light on how each of our businesses addresses social issues and to report on discussions that took place during the stakeholder dialogue—held for the second consecutive year—and on material CSR issues for the Anritsu Group, all in a manner that is easy to understand. For the PDF version, our aim is to reach more stakeholders by organizing information under 12 material issues identified through materiality assessment and then describe concrete activities for each of them.

www.anritsu.com/csr

For details on financial performance, please refer to our annual report or website at : www.anritsu.com/ir

Guidelines used as reference
 • ISO 26000 : 2010 • GRI 3.1

Reporting Period

This report covers the period from April 1, 2012 to March 31, 2013, and also includes some activities before and after that period.

Boundary Definitions

This report covers Anritsu Corporation only or the Anritsu Group Companies, according to subject and definitions as follows:
 -“Anritsu” or “Anritsu Group” refers to both Anritsu Corporation and the entire Anritsu Group.
 -“Anritsu Corporation” refers to Anritsu Corporation in Japan only.
 -“Group Company (or Companies)” refers to a group company (or companies) or all group companies, excluding Anritsu Corporation in either case.

Date of issue: September 1, 2013
 Further inquiries: CSR Promotion Team,
 Corporate Communication Department, Anritsu Corporation
 Tel: +81-46-296-6514
 Fax: +81-46-225-8358
 URL: <http://www.anritsu.com/>
 (The next CSR report is scheduled for release in September 2014)

Company Profile

Headquarters address:
 5-1-1 Onna, Atsugi-shi, Kanagawa, Japan
 Company founded: 1895
 Capital: 19,052 million yen*¹
 Net sales: 94,685 million yen*²
 No. of shareholders: 11,229*¹
 No. of employees: 3,771 (consolidated)*¹
 831 (non-consolidated)*¹
 No. of suppliers and partners: 804*¹



*1 As of March 31, 2013 *2 Consolidated, year ended March 2013

Net sales

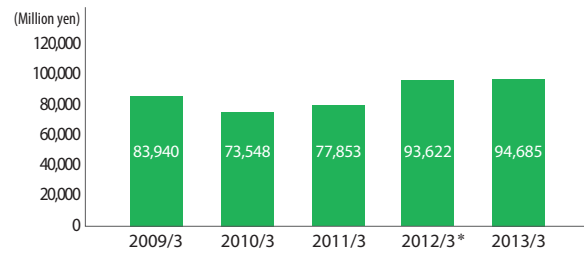

*IFRS applied from the year ended March 2012.

Consolidated net sales by business (Year ended March 2013)

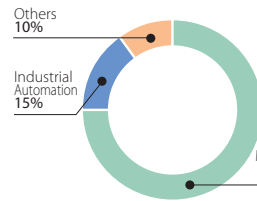

Consolidated net sales by region (Year ended March 2013)

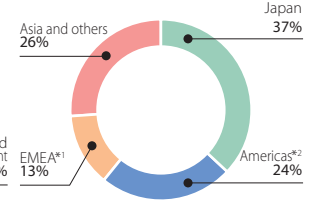

*1 Europe, the Middle East and Africa
 *2 The United States, Canada, Mexico and Brazil

Consolidated operating income / ratio of operating income to net sales

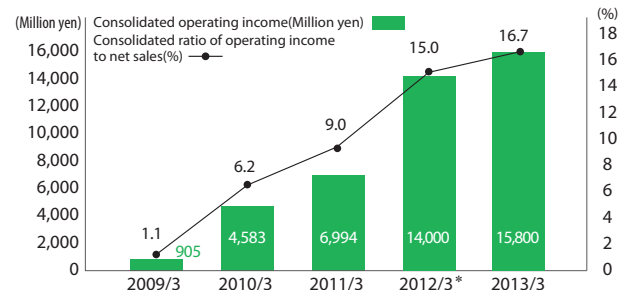

*IFRS applied from the year ended March 2012.

R&D expenses / ratio of R&D expenses to net sales

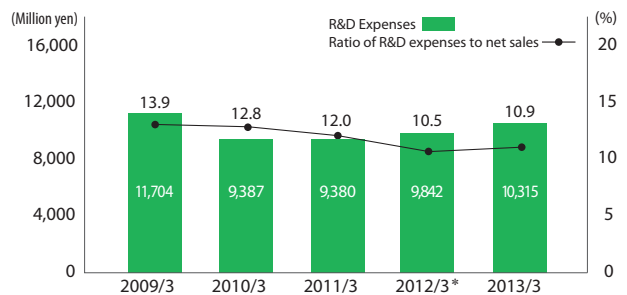

*IFRS applied from the year ended March 2012.

Number of employees (Anritsu Group)

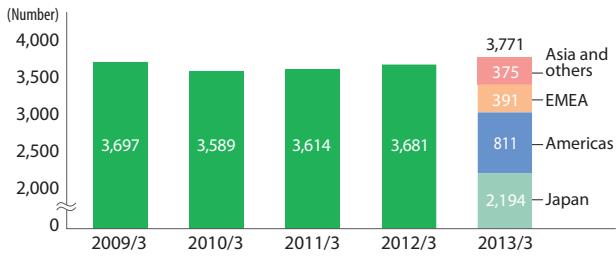

Percentage of female employees worldwide (As of the end of January, 2013)

	Japan	The Americas	EMEA	Asia and others	Total
Percentage of female employees (No. of female employees ÷ No. of total employees)	17%	31%	25%	31%	22%
Percentage of female managers to male managers (No. of female managers ÷ No. of female employees) ÷ (No. of male managers ÷ No. of male employees) expressed as %.	8%	59%	82%	57%	45%

Employee data (Group companies in Japan)

	FY2009	FY2010	FY2011	FY2012
Total No. of employees of Group companies in Japan	2,274	2,240	2,206	2,194
Male	1,988	1,952	1,927	1,900
Female	286	288	279	294
Foreign nationals	25	20	16	24
Non-regular employees	305	376	463	625
Average age	40.9	40.3	41.5	41.5
Average working years	18.1	18.5	18.6	18.1
Ratio of employees with Disabilities (non-consolidated)	1.76	1.98	2.25	1.95
Ratio of employees with Disabilities (The Anritsu Group in Japan)	1.37	1.50	1.56	1.62
Planned ratio (Reference)	1.80	1.80	1.80	1.80

Labor accidents (Japan)

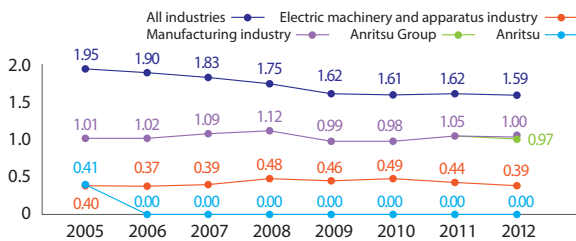

CO₂ emissions from total energy use

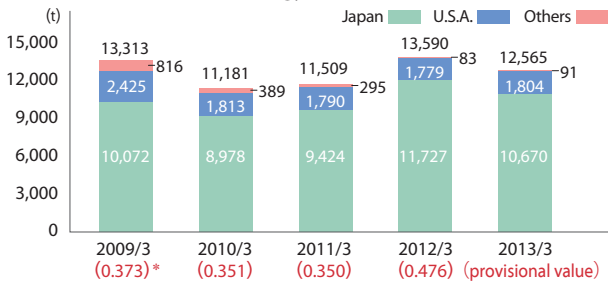

*Emission factors for electricity in regions excluding the United States are shown in parentheses. The emission factor for the United States is 0.285. Past emissions have been revised based on actual figures for each fiscal year. Due to rounding, figures may not add up to the totals shown.

Water consumption

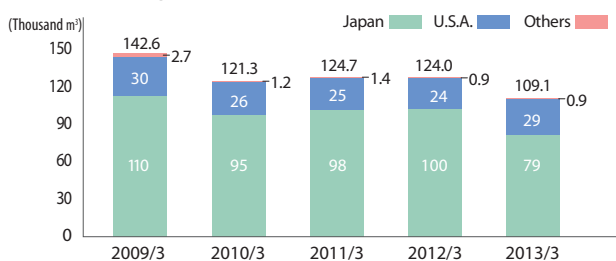

*Due to rounding, figures may not add up to the totals shown.

Major Group Companies in Japan

- Anritsu Industrial Solutions Co., Ltd.
Development, manufacture, sales, repair, maintenance and other services for industrial machinery
- Tohoku Anritsu Co., Ltd.
Manufacture of information communication equipment and measuring instruments
- Anritsu Customer Services Co., Ltd.
Calibration, repair, maintenance and EMC / HALT testing of measuring instruments
- Anritsu Engineering Co., Ltd.
Development of software and hardware
- Anritsu Networks Co., Ltd.
Development, sales, system design, maintenance and services of information communication products
- Anritsu Devices Co., Ltd.
Development, manufacture and sales of optical devices
- Anritsu Kousan Co., Ltd.
Resale and recycling of measuring instruments, design services and production of documents
- Anritsu Real Estate Co., Ltd.
Real estate leasing
- Anritsu Pro Associe Co., Ltd.
Operation of shared service center for accounting, financial affairs, payroll calculation and benefits
- AT Techmac Co., Ltd.
Manufacture and sales of cutting and sheet metal parts and unit assembly articles

Major Group Companies outside Japan

U.S.A.

- Anritsu U.S. Holding, Inc. (U.S.A.)
- Anritsu Company (U.S.A.)
- Anritsu Instruments Company (U.S.A.)
- Anritsu Industrial Solutions U.S.A. Inc. (U.S.A.)
- Anritsu Electronics Ltd. (Canada)
- Anritsu Eletronica Ltda. (Brazil)
- Anritsu Company S.A. de C.V. (Mexico)

EMEA

- Anritsu EMEA Ltd. (U.K.)
- Anritsu Ltd. (U.K.)
- Anritsu Industrial Solutions Europe Ltd. (U.K.)
- Anritsu GmbH (Germany)
- Anritsu S.A. (France)
- Anritsu S.r.l. (Italy)
- Anritsu Solutions S.r.l. (Italy)
- Anritsu A/S (Denmark)
- Anritsu AB (Sweden)
- Anritsu Solutions S.R.L. (Romania)

Asia and others

- Anritsu Company Ltd. (China)
- Anritsu Electronics (Shanghai) Co., Ltd. (China)
- Anritsu (China) Co., Ltd.
- Anritsu Industrial Solutions (Shanghai) Co., Ltd. (China)
- Anritsu Industrial Systems (Shanghai) Co., Ltd. (China)
- Anritsu Company, Inc. (Taiwan)
- Anritsu Corporation, Ltd. (Korea)
- Anritsu Pte. Ltd. (Singapore)
- Anritsu India Private Ltd. (India)
- Anritsu Industrial Solutions (Thailand) Co., Ltd. (Thailand)
- Anritsu Pty. Ltd. (Australia)

The Anritsu Group business is woven into everyday life.

Bringing greater convenience and comfort to people's lives

— Measurement solutions for mobile broadband services —



Voice communication/E-mail

Anytime, anywhere

Videos/Music

Large volume data transmission

SNS/Games

Connect and expand

Medical Services/Welfare

Remote examination and diagnosis

Education

Learn and explore

Smart electrical appliances

Controlled via smartphone

Supporting infrastruc

— Measurement solutions for



Mobile phone base station

Checking base station service areas

Optical fiber

Locating optical fiber line breakage

Anritsu provides solutions for a safe and secure society

Connecting, monitoring and detecting...

Anritsu supports everyday life and business in a variety of areas, including information communication, food processing, pharmaceuticals and image monitoring for a safer, more secure and comfortable society.

Making your life safe

— Various solutions for everyday life in food safety, disaster monitoring and ophthalmic examinations —



Contaminant inspection

Detecting contaminants

Weight inspection

Detecting missing products and defects

Weighing

Ensuring the proper volume

Remote monitoring

Monitoring dam water levels

Disaster Prevention/Mitigation

Video monitoring of accidents and disasters

Medical equipment

Light source for ophthalmic equipment

Solutions for everyday life

secure broadband networks —



Communication networks

Network monitoring and quality assurance

Data centers

Realizing higher speed communication facilities

Sharing a Vision for Tomorrow to Create Value with the Anritsu Way



August 2013

Hirokazu Hashimoto
Representative Director,
President

The Source of Our Longevity Lies in Providing Social Value

Fiscal 2012 was the first year of our GLP2014 mid-term business plan, and we got off to a fine start by achieving all of our management targets. We are making steady progress toward our “2020 Vision,” which expresses what we hope to achieve by 2020.

Since our founding in 1895, we have steadfastly pursued business in the fields of information and communications. A hundred years ago, in 1914, the “TYK radio telephone” manufactured by Annaka Electric Company, Anritsu’s predecessor, was released as the world’s first commercial wireless phone. After introducing the precursor of the smartphone to the world, Anritsu applied the expertise it gained to other fields, including the measurement technology behind the evolution and development of mobile broadband services, as well as to contaminant detectors and checkweighers for food and pharmaceuticals. These achievements have positioned us to face today’s challenges and opportunities.

Companies are typically thought to have a life expectancy of about thirty years. I believe Anritsu owes its longevity to the

way we have constantly stood at the forefront of the times. We have served as the vanguard, creating new value and meeting society’s needs and remaining faithful to the spirit of “Sincerity, Harmony and Enthusiasm” and our aspiration for being “Original & High Level” as stated in our corporate philosophy.

As we move forward, the mission of the Anritsu Group will be to continue leveraging our unique strengths to address social problems. That is my conviction.

The Passion behind the “Visionary Partnership”

The goal of our “2020 Vision” is to become a global market leader by creating unique value for our customers and society. We are refining our brand with our eyes firmly on this goal. We began this project with lively discussions across the Anritsu Group to identify what makes us who we are. We then summarized our thoughts on the proven strengths of Anritsu and on how to apply them. The result was the phrase: “Visionary partnership to innovate for tomorrow’s society.” We aspire to build on our practical knowledge, foresight and creativity based on ample

experience from more than 110 years of corporate history and promote win-win collaborations by working closely and on equal terms with our customers, and contributing to the advance of a safe, secure and prosperous society. Our next step is to develop ways to more directly and effectively express our promise to customers and society. This will certainly not end up in a mere exercise of words. We intend to reform both our mindset and our corporate culture to meet stakeholder expectations by establishing ourselves as a reliable, cutting-edge brand that is worthy of a global market leader in both name and substance.

Supplying Products to the World from the Symbol of Reconstruction

Two years have passed since the Great East Japan Earthquake. Anritsu has constructed a new factory in Koriyama City, Fukushima Prefecture, and the prefecture has recognized the investment as vital support for overall reconstruction. We hope the new factory bolsters reconstruction in the Koriyama area by creating and stabilizing employment. Our Koriyama employees are highly motivated and working enthusiastically to turn the factory into a symbol of reconstruction.

With the start of operations at the new factory, we have established a system for expanded production of printed circuit boards, which had previously plateaued. In addition to supplying greater manufacturing stability, having two production bases has strengthened our business continuity plan (BCP). The new factory also embodies the concept of “a high-tech factory in harmony with a verdant environment” through the use of solar panels to generate electricity, recycled construction materials, LED lighting for the entire

building, and native vegetation. It ranks among the world’s premier examples of environmentally sound construction. As a company that plays a major role in the evolution of information and communication systems and in the quality assurance of food and pharmaceuticals, Anritsu is responsible for providing customers with products and support services under all circumstances. Our new Koriyama site serves as the “great mother factory” of the Anritsu Group for meeting the expectations of our customers.

The Anritsu Way of Contributing to a Society Connected by ICT

People, goods and information are now connected across time and space, creating new industries and services amid ongoing efforts to build a social system that offers greater safety, security and comfort. Wireless communication technology has been a driving force behind these developments, and high-speed mobile networks are supporting every aspect of our daily lives, from medicine, education and social welfare to disaster prevention and the construction of “smart cities.” On the other hand, the volume of data traffic has risen dramatically, and smartphone communication failures are making the news.

As we find ourselves within the vortex of big data coursing through networks, how can we play our part in constructing a stable “connectable system” and contribute to building a safer, more secure and more comfortable society? Anritsu keeps this aspiration in mind throughout its business pursuits. We are resolved to continue developing and sharing visions for a new society with our customers and creating value the Anritsu way.

United Nations Global Compact

Since March 2006, Anritsu has practiced the ten principles of the United Nations Global Compact, and has linked these principles with its own CSR efforts to firmly establish them throughout Group activities worldwide.



Company Philosophy, Vision and Policy

Anritsu is promoting CSR activities by implementing the basic principles of its company philosophy, vision and policy into practice; by respecting the Global Compact that Anritsu upholds as a global enterprise; and by adhering to the Anritsu Group Charter of Corporate Behavior that sets out concrete values and behavioral guidelines.

<p>◆ Company Philosophy Contribute to the development of a safe, secure, and prosperous global society by offering Original & High Level products and services with sincerity, harmony, and enthusiasm</p>
<p>◆ Company Vision Achieve continuous growth with sustainable superior profits through innovation using all knowledge of all parties Be a global market leader through innovation with a market-driven and customer-centric focus</p>
<p>◆ Company Policy 1. Make energetic organization synthesizing the knowledge of all employees 2. Capture growth drivers through innovation 3. Be a leader in the global market 4. Contribute to the creation of a society that is friendly to people and the Earth as a good corporate citizen</p>

2020 VISION

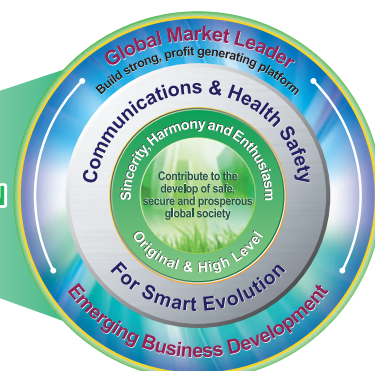

1

Test and Measurement

Bringing Greater Convenience and Comfort to People's Lives

Test and Measurement Solutions that Sustain Mobile and Wireless Information and Communication

Anritsu provides the measuring instruments that play a crucial role in the development and quality assurance of diverse communication systems and applications in the ever-evolving fields of information and communications.

Mobile Broadband Services that Change the Way the World Connects

The number of mobile phone subscribers now exceeds six billion, and is rapidly approaching the total world population of seven billion, making such phones essential communication tools for daily life and business. In recent years, mobile phones have outgrown their primary use as tools for voice communication, playing a greater role in enjoying music and video in addition to email and social networking services (SNS). Smartphones, which opened the way to mobile broadband services, continue to spread at an accelerated pace, and their production is estimated to reach 1.5 billion units by 2017. The development of high-speed mobile communication services called Long Term Evolution (LTE) is also gathering speed, and an estimated 424 carriers in 126 countries are expected to adopt LTE starting in 2014. Smartphones and tablets offer easy access to the latest information and enable speedy transmission and receipt of clear video and still images. They are also expected to contribute to solving many social issues. We are already

making greater use of these devices as part of the social infrastructure in sending early warnings on rapid changes in weather and the occurrence of earthquakes to minimize damage, and in collecting information and confirming the safety of families in the event of a disaster.

Moreover, we can offer distance-learning opportunities for children who cannot easily attend school, thereby filling a gap and helping to address inequalities in education. In the domain of healthcare, we are approaching the day when people will be able to enjoy the benefits of high-quality diagnosis and easy access to advanced medical treatment wherever they live in the world.

T&M*1 Solutions based on the Latest LTE Standard

International standards have been established for mobile communication systems, and companies that develop and manufacture mobile terminals and the chip sets installed in them are required to conduct tests under diverse

Rapidly expanding LTE worldwide

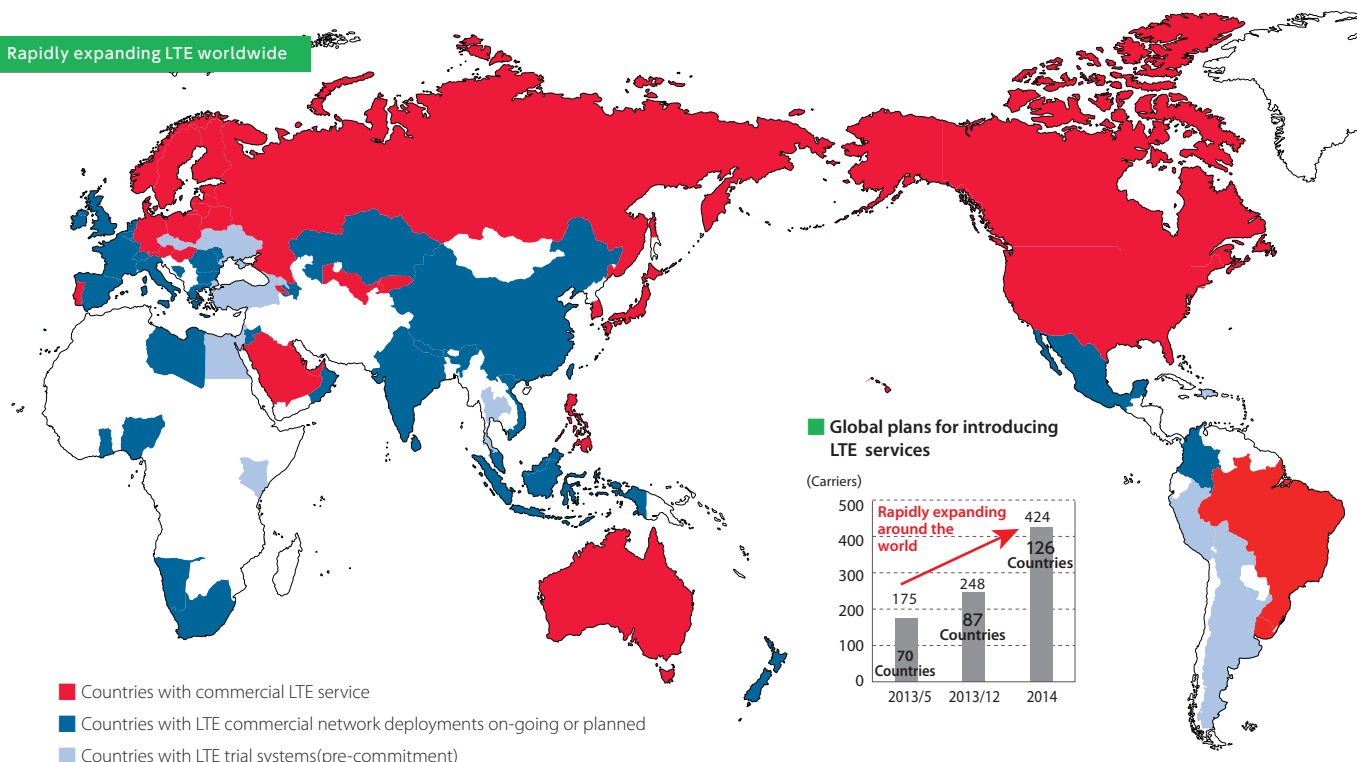

Source: GSA Evolution to LTE Report (2012.01.05)



conditions to confirm that their equipment complies with these standards.

Anritsu has earned customer trust as the leading company in the test and measurement systems used for this purpose. In particular, we have outpaced the competition in developing a testing system approved by screening and verification institutions for LTE—the fastest communication standard currently in commercial use—as well as for LTE-Advanced, the next-generation standard for even faster LTE. In addition, we also provide measuring instruments for assessing the quality of radio waves transmitted by antennas, cables and base stations in establishing and

expanding infrastructure for wireless communication, and have captured a major share of the market.

Anritsu's test and measurement business supports the evolution and development of ICT*2 and the construction of a comfortable social infrastructure by offering solutions that encompass the development and manufacturing of the most advanced mobile devices as well as the construction and maintenance of wireless communication infrastructures.

*1 Test and Measurement

*2 Information and Communication Technology

Development Phase

50% market share*

No. 1 in the world



We led the industry in R&D in the area of communication standards for third-generation (3G) mobile phones by providing solutions that became the de facto standard. We are building on this track record and customer trust to contribute to the research and development of the next-generation LTE communication standard.

*Anritsu estimates

Manufacturing/Mass Production Phase

30–40% market share*

No. 3 in the world

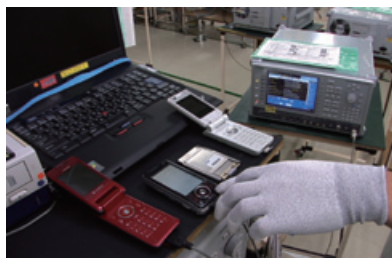

We support manufacturing and mass production by providing measuring instruments suitable for the specific production systems at our customers' sites. These instruments are used during the manufacturing and inspection processes in production lines for mobile devices, such as smartphones and tablets.

Network Construction/Maintenance

70–80% market share*

No. 1 in the world



We were the first in the industry to offer handheld measuring instruments that met mobile needs at construction and maintenance sites. These solutions contribute to the global expansion of wireless communication networks as the de facto standard in measuring instruments for base station construction and maintenance.

Embracing the Newest Standard for the Next Generation

Executive Vice President, Anritsu Corporation / President, Anritsu Company (U.S.A.) **Frank Tiernan**

Virtually all nations of the world are actively building-out and enhancing their wireless communication infrastructures as they recognize the many significant social and economic benefits of so doing. Currently, for those at the forefront, this means installing LTE based systems. Some nations will transition to LTE from third generation systems while others will proceed directly from second generation ones. In support of this activity Anritsu provides a complete line of LTE-compatible measuring equipment and is already developing technology for LTE-Advanced, the next generation standard.

LTE-Advanced is projected to support speeds up to ten times faster than LTE. Commercial service is scheduled to begin in the United States as early as 2014, and soon thereafter in Japan. Most equipment vendors have started manufacturing and the demand for Test and Measurement equipment is also growing. In February 2013, Anritsu became the first in the industry to release a single-box RF tester equipped with LTE-Advanced compatible software.

We believe part of our ongoing corporate social responsibility is to supply Test and Measurement equipment supporting the world's communication infrastructure thereby enabling people of the world to make the deep human connections essential for a true feeling of brotherhood. In practical terms this means actively supplying the LTE and LTE-Advanced equipment needed by our customer partners today while at the same time working to develop the next generation standards they will need tomorrow.

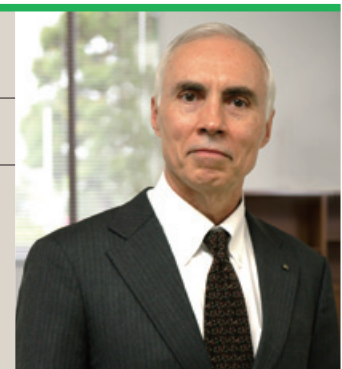



2 Industrial Automation Ensuring Security in Your Daily Life

Diverse Quality Assurance Solutions that Sustain Food Safety through Contaminant Detection, Weight Testing and Quality Control Systems

Anritsu Industrial Solutions Co., Ltd. ensures the quality of the food and pharmaceutical production lines of its customers as its primary business domain by providing original quality assurance solutions.

Ensuring the Safety and Security of Products We Swallow

Building prosperous societies around the world requires satisfying the desire for food that can be eaten with greater safety and security. This means protecting fresh and processed foods from contaminants and only distributing products that have passed designated tests. Pharmaceuticals that are taken orally to alleviate sickness and improve health are subject to even more stringent testing. Any mistake in quantity or combination could turn into a matter of life and death.

Anritsu offers a variety of solutions for ensuring the quality of food and pharmaceuticals.

Taking Japanese Levels of Quality Overseas

The roots of Anritsu Industrial Solutions' business lie in the highly sensitive displacement sensors we developed in the early 1960s. Since that time, we have delivered a steady

stream of solutions based on our own unique technology and creative approach.

For example, we provide checkweighers that can instantly measure the weight of products moving at high speed on production lines, as well as X-ray inspection systems and metal detectors that can detect contaminants less than a millimeter in size in test objects at food and pharmaceuticals production plants. These instruments play an extremely vital role in conducting comprehensive inspections before products are shipped. Since introducing them to the market, we have delivered over sixty thousand checkweighers and over forty thousand contaminant detectors—X-ray inspection systems and metal detectors—to customers in Japan and overseas.

There is a growing need around the world for safety and security. Under our business strategy of "local production for local consumption," Anritsu Industrial Solutions continues to apply the experience and expertise gained through dealing with Japan's stringent quality control systems to deliver quality assurance solutions for food placed on tables and pharmaceuticals for treating injuries and illnesses across the globe.



Anritsu is There for You, Wherever You Are

Vice President, Anritsu Industrial Solutions Co., Ltd. **Masumi Niimi**

We are currently strengthening our worldwide sales and maintenance network. This year, in response to the expanding markets for quality inspection in emerging Asian countries, we opened and began production at our new factory in Shanghai, China. We also added production capacity at our factory in Thailand, which was launched five years ago. We plan to offer services everywhere in the world that are no different from those offered in Japan.

We intend to contribute to the global community through our core business by consistently providing original solutions that leverage the strengths of our comprehensive in-house system, and to realize safe and secure food and pharmaceuticals in partnership with our customers.



3 Information and Communications

Supporting the Infrastructure of Our Daily Life

Ensuring Safe, Secure and Efficient Connections for Society, Anytime and Anywhere

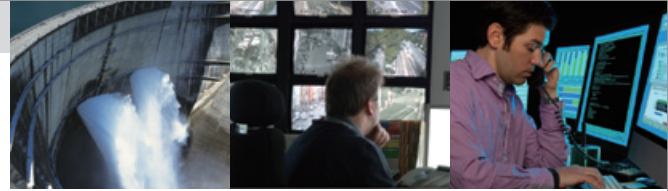

Anritsu Networks Co., Ltd. helps construct social and communications infrastructures that promote a safer, more secure society, and provides for a more prosperous world connected by networks.

The Growing Volume of Global Data Communication

IP traffic continues to grow worldwide, and is estimated to triple between 2012 and 2017. Meanwhile, the number of devices with mobile connections is expected to exceed the global population by the end of fiscal 2013. Mobile networks inevitably go through fixed lines in the process of expansion, placing an increasing strain on IP networks. Our networked society is faced with the major challenge of balancing efficiency with service quality, expanding line capacity despite limited network capacity.

Introduction Example: The Shinshu University campus network

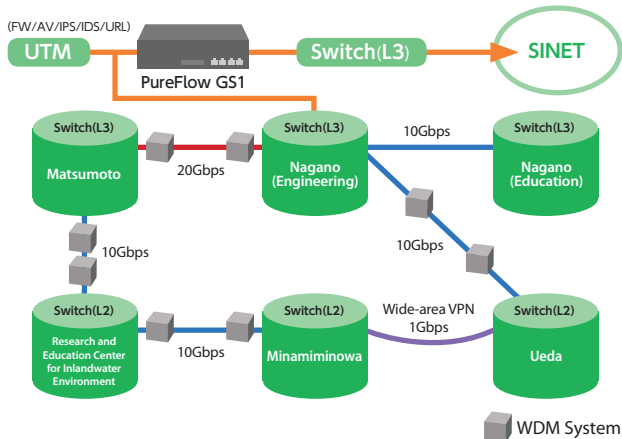

Anritsu's Contribution to Network Systems

Even under this challenging network environment, mission-critical data such as financial transactions and emergency information in times of disaster must be transmitted without fail. As a specialized manufacturer of bandwidth control systems that guarantee stable communication in IP networks, Anritsu boasts the No.1 track record in system installment in Japan*. Our bandwidth control systems are used at many government institutions, educational institutions and companies.

While wide area networks (WANs) are IP-based, a number of companies are still using analog communication facilities and equipment. Anritsu provides IP converters that connect these analog facilities with WANs to help customers use their assets efficiently and make the transition to digital systems.

* Based on number of units installed.

Efficient use of existing assets using the IP converter

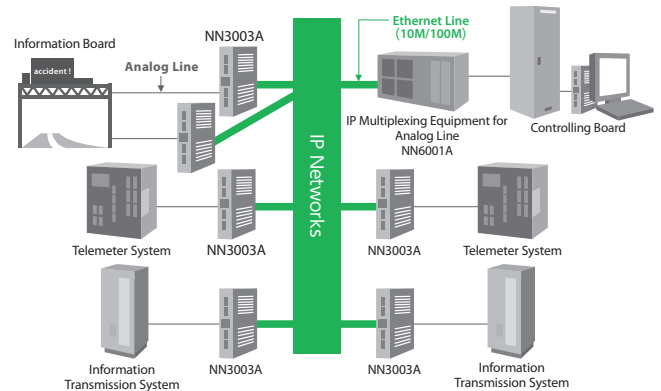

Building Connections – Our Aspiration Behind “Being Smart and Skillful”

Senior Manager, Corporate Strategy Department, Anritsu Networks Co., Ltd. **Norio Aizawa**

Our bandwidth control systems make maximum use of the line bandwidth of IP networks to significantly reduce line costs and enhance the quality of service (QoS). We also help customers effectively use their assets by providing IP converters that connect their analog communication facilities to the IP network.

We will continue to promote our customers' businesses by offering services under our banner of “being smart and skillful” in building connections.



Adding Two Strategic CSR Issues to Our Global CSR and Business Strategies

To be a trusted partner for all stakeholders, the Anritsu Group has incorporated the response to human rights issues and promotion of local CSR as two strategic CSR issues that we believe must be addressed to achieve CSR management worthy of a global market leader.

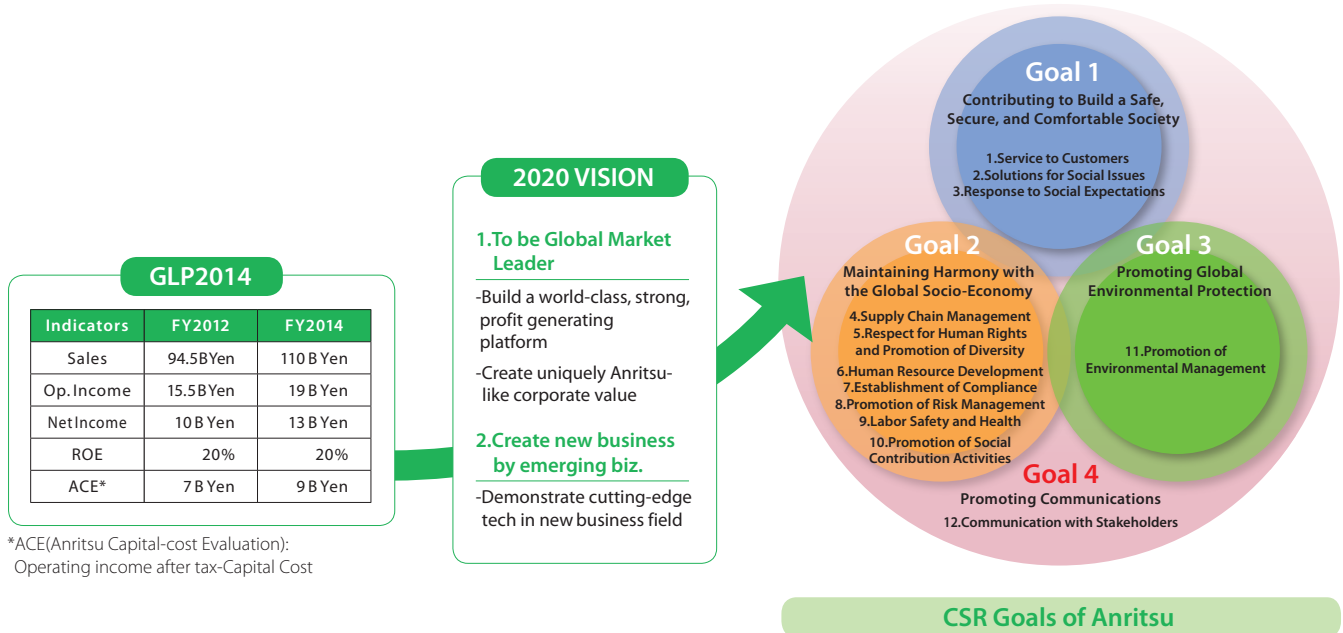

*ACE(Anritsu Capital-cost Evaluation): Operating income after tax-Capital Cost

CSR Results for Fiscal 2012, CSR Objectives for Fiscal 2013

We have been focusing our efforts on the 12 important issues with particular emphasis on the following 5 material issues.

Unless otherwise specified, the content of objectives in this table covers operations of Anritsu Corporation and its Group Companies in Japan.

Performance evaluation ○ : fully attained △ : attained 50% or more

CSR Goal	Key Issues	Results for Fiscal 2012	Evaluation	Objectives for Fiscal 2013
Goal 1 Contributing to Build a Safe, Secure, and Comfortable Society	Service to customers	(1) Held a presentation in China and shared CS Action Guidelines. (2) Conducted CS training for new employees, managers and staff in charge. (3) Prepared a list of customer contact points, launched pilot CRM system.	○ ○ ○	(1) Share the CS Action Guidelines. (2) Conduct CS training in China. (3) Enhance customer support center.
Goal 2 Maintaining Harmony with the Global Socio-Economy	Supply chain management	(1)Held a kickoff meeting for the Global Supply Chain Committee, and began construction of a supply chain integrating the four bases in Japan, the U.S., Europe and China. (2) Improved defect and on-time delivery rates, conducted process audits at 18 companies to improve our RoHS compliance rate. (3)Conducted a corporate ethics survey for FY2012 (54 responses from 47 companies; no violations reported). (4)Collected data relevant to BCM from 1,766 sites centered on secondary suppliers and beyond.	○ ○ ○ ○	(1) Develop a global SCM system (Promote GSCC). (2) Establish audit system for hazardous substances. (3) Establish response to conflict minerals (Promote CSR procurement). (4) Strengthen BCM and governance systems.
	Respect for human rights and promotion of diversity Human resource development	(1) Expanded recruitment of foreign nationals by offering an internship in China and recruiting in Philippines. (2) Established an evaluation system for developing human resources, and decided to conduct a trial in fiscal 2013. (3) Established a dedicated division for developing job categories for the elderly and people with disabilities at a Group company to consider dispatching personnel to companies inside and outside the Group and explore possibilities for new businesses. (4) Implemented a global employee satisfaction survey (Japan, U.S., and China).	○ ○ △ ○	(1) Establish recruitment of foreign nationals. (2) Complete draft of an evaluation system for developing human resources. (3) Formulate a proposal for developing job types and categories for the elderly and people with disabilities. (4) Recommencement of GHRC (Global Human Resource Committee) activities.
Goal 3 Promoting Global Environmental Protection	Promotion of environmental management	(1) Waste reduction and recycling - Emitted waste was 114.5 tons (Japan). [targeting below 160.4 tons] - Volume of landfill waste reduced by 42% compared to fiscal 2010 (USA). [targeting 5% reduction] (2) Resource and energy conservation - Reduced energy consumption by 24.6% compared to fiscal 2006(Japan). [targeting 9% reduction] - Reduced energy consumption by 40% compared to fiscal 2010(USA). [targeting 5% reduction] (3) Eco Products (Anritsu Group companies in Japan) - Completed development of all 6 targeted products as environmentally conscious products. - Completed development of all 3 targeted products that can save resources by 10% or more. - Completed development of all 2 targeted products with at least a 30% improvement in power efficiency.	○ ○ ○ ○ ○ ○ ○	(1) Waste reduction and recycling - Maintain waste emission under 160.4 tons (Japan). - Reduce volume of landfill waste by 20% compared to fiscal 2010 (USA). (2) Resource and energy conservation - Reduce energy consumption (crude oil equivalent) by 1.0% on average by 2020 compared to fiscal 2012 (Japan). - Reduce energy consumption by 5.0% compared to fiscal 2010 (USA). (3) Eco Products (Anritsu Group companies in Japan) - Ratio of environmentally conscious products of all products covered:100% - Ratio of products that can save resources by 10% or more of all products covered: 100% - Ratio of products that are 30% or more power efficient of all products covered: 100%
Goal 4 Promoting Communications	Communication with stakeholders	(1) Held stakeholder dialogue and reported results in the CSR Report. (2) Distributed and promoted the use of the CSR Report in regions across the globe.	○ ○	(1) Promote communication through stakeholder dialogues. (2) Research the status of CSR communication in each global region.

USA is represented by Anritsu Company (U.S.A.)

The Two Strategic CSR Issues

As noted in the most recent publication of ISO26000—the international standard for corporate social responsibility—public expectations of companies are undergoing changes. At the same time, Anritsu is dealing with the continuing globalization of its businesses, led by the measurement business. As a result, each region is increasingly called upon to exercise initiative in promoting local activities and regional collaboration.

Under these circumstances, we are pursuing CSR management to achieve our “2020 Vision,” which expresses what we hope to achieve by 2020 as a group by following our GLP2014 mid-term business plan, which lists the milestones we must meet to achieve our vision.

Anritsu’s Response to Human Rights Issues

The globalization of our business has brought more opportunities to procure what we need from suppliers outside Japan and to set up production, sales and support services locally. In addition, we must pay due consideration to human rights issues, not only with respect to the Anritsu Group in Japan and abroad, but throughout the entire value chain, including our regional suppliers.

The first item in the Anritsu Group Charter of Corporate Behavior is “Protecting Human Rights,” and in the Anritsu Group Code of Conduct—which sets out the more concrete principles of behavior based on the Charter—respect for human rights is mentioned first and foremost in our Basic

Attitude.

We pay due consideration to human rights issues in our relationship with business partners by including “Considerations of human rights and labor” in the Anritsu Basic Rules of Procurement. We have also established and are requesting their cooperation with the Anritsu CSR Procurement Guideline, which prohibits child labor and forced labor. In particular, we support international control of conflict minerals, and are currently focusing on fulfilling our social responsibility with other companies in the supply chain by promoting initiatives for monitoring and ultimately ending the use of conflict minerals.

Promoting CSR Locally

With respect to our response to human rights issues mentioned above, the human resource department in the Americas, Europe and Asia are responsible for CSR in their respective regions. The corporate division at headquarters leads the way in developing and promoting the Anritsu Group Charter of Corporate Behavior and Anritsu Group Code of Conduct. The division ascertains customer satisfaction, conducts employee satisfaction surveys worldwide, and maintains open communications as a way to better understand the goals, issues and status of CSR efforts in each region.

To achieve our goal of establishing a CSR management system that supports global business development, the CSR Promotion Committee, chaired by the President, acts as the final decision-making entity for promoting CSR activities appropriate for each region through cross-sectional collaboration with Group companies.

Materiality Assessment—Methodology and Results

In 2008, Anritsu conducted a materiality assessment based on discussions conducted with thirty key persons inside the Group on 142 items of proper corporate behavior expected by society. These have been categorized by stakeholder, with due consideration for objectivity and completeness.

Of the 142 items, the 12 items plotted within the domains delineated in red were identified as themes with particular importance for the Anritsu Group and have been designated as our core material issues.

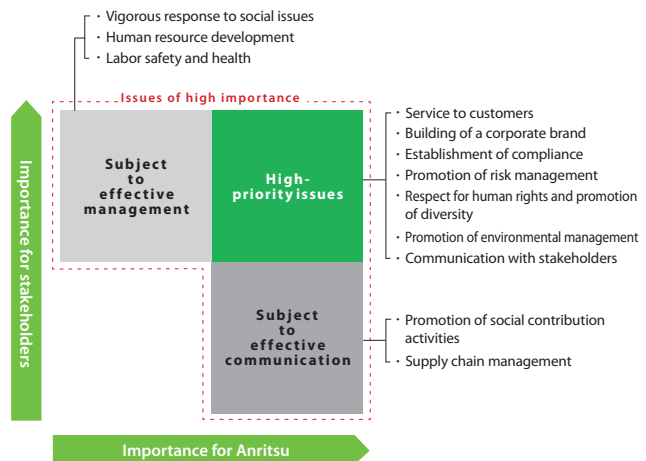

Embodying CSR Commensurate with the Global Expansion of the Anritsu Group

Anritsu places a high priority on “Promoting Communications,” one of its four CSR Goals. It is our fundamental commitment and the backbone for CSR management as a whole. We invited the three experts who participated in the dialogue held last year to gather once again for a review of our latest efforts in fiscal 2012.



Facilitator: Sustainability Accounting Co., Ltd. Takashi Fukushima

Fukushima: We do not want the stakeholder dialogue to be a short-lived event held only for the sake of this report. That is why we are conducting this dialogue with the same participants as last year. Let us begin by having the Anritsu representatives present an overview of the company's business performance during fiscal 2012, the efforts taken in response to last year's dialogue, and the challenges at hand.

Taniai: Fiscal 2012 marked the first year of our GLP2014 mid-term business plan, and we got off to a good start by achieving nearly all our targets.

In our Measurement business—which accounts for 75% of net sales—mobile-related sales increased from 45% to 50%. By region, sales declined in Japan from 30% to 25% of the global total and grew in the Americas from 25% to 30%. The relative percentage of overseas to domestic sales increased from 61% to 65%. We saw steady demand for measuring instruments used in the development of LTE-compatible terminals and the production of smartphones, while the ratio of overseas sales rose significantly in the second half of

the year.

We got a solid performance from our Industrial Automation business, both in Japan and overseas. Moving proactively to reinforce support for our global customers, we expanded production at our existing factory in Thailand and opened a new plant in Shanghai. We also made considerable progress in reforming the structure of our Information and Communications business—positioned under Other businesses—which led to improved profits.

Dohi: During last year's dialogue, we discussed how Anritsu should proceed with CSR management as we globalize our business. We are currently coordinating our actions with the staff in charge of personnel, who also serve as our CSR liaisons in each region. Out of the many possible concerns, we chose to begin addressing the issue of conflict minerals as our human rights focus. We added “nonuse of conflict minerals” to the Anritsu Basic Rules of Procurement, and requested our business partners to follow an English-language version of the Anritsu CSR Procurement Guidelines that we created and also use. Conducting audits

of local subsidiaries and overseas suppliers—which actually cover more than just the use of conflict minerals—is still a challenge.

We designated the promotion of local CSR activities as another goal. Last October, we held a meeting of managers



Senior Manager, CSR Promotion Team,
Anritsu Corporation
Masahiko Dohi

in China at which we explained our CSR efforts, including compliance. In our CSR report for this year, we will highlight different local topics in the English and Chinese versions. In addition, with regard to the KPI framework you suggested we adopt, we have started working in areas where we are ready to move forward such as the environment. We will continue to consider real-life situations and get to work on them.

Shared Values for Promoting Global CSR

Fukushima: I would now like to ask the experts to offer their feedback, including specific points they have noted or new perspectives they could provide on Anritsu's efforts since last year.

Yamaguchi: During last year's dialogue, we thoroughly discussed ways to pursue CSR at a global level. Once you start giving concrete form to these ideas in regions with different cultures and business customs, you encounter many situations in which Japanese methods just don't work. You need to express shared global values to set the context.



Vice President Anritsu Corporation
Tetsuo Kawabe

Kawabe: At Anritsu we have been promoting our company philosophy of "Sincerity, Harmony and Enthusiasm" worldwide. The aspects of sincerity and enthusiasm in particular have become well established in all regions. Survey results clearly indicate that Anritsu is considered to be honest and sincere. Moreover, a high-tech company like ours with a history of nearly 120 years is quite rare, and I believe this is a result of our enthusiasm for consistently taking on the

challenges of new technology. We hope to build on these foundations to create values that are uniquely identified with Anritsu and can be shared globally.

When we explained our CSR approach at the managers' meeting in China, we came away with the impression that we were not fully understood. This year we would like to start by learning about how the competition and our customers engaged in international businesses continue to carry out such high-level CSR efforts to better understand Anritsu's current position.

Akabane: One effective way to disseminate CSR globally may be to incorporate elements of CSR into the personnel reviews of top local managers and performance indicators. For example, take "social contribution through our core business," which the president stated as being part of the Top Commitment in the CSR Report for fiscal 2012, and make that count for a few percent. You could also transfer decision-making authority, however limited in scope, to the people that concurrently serve as CSR liaisons, then provide them with a small budget and let them take the initiative on projects rooted in local needs.



Director, CSR Asia Japan
Makiko Akabane

 CSR Asia Japan
<http://csr-asia-japan.com/>

Goto: I think you could promote global CSR through a flexible management style befitting a Japanese company with a long history. You may not even need to follow the style of major Western companies, which declare and promote the same values worldwide. For example, you may be able to reinforce the sense of involvement by gathering local comments right from the production stage if you switch to English for CSR reports. I offered this recommendation several years ago, and I believe it is a hurdle that a company like Anritsu can surmount, since you already provide regional websites.

Producing a Report that Highlights Concrete Commitments

Akabane: While this is also true of common global values, I hope your CSR report will highlight the company's concrete commitments. In preparation for participating in this second dialogue, I reviewed the Japanese, English and Chinese versions of your "CSR Report Digest" and websites. While these versions comprehensively reported on CSR topics and

felt sufficiently sincere, they didn't explain Anritsu's specific priorities, and no single topic was particularly memorable. Anritsu could raise its profile by communicating concrete commitments, perhaps by declaring its intention to become the world's number one company in occupational safety as a specific commitment that embodies its sincerity.

Dohi: This time around, we emphasized responding to human rights issues, reflecting the fact that each region expects a corporate response to conflict minerals, in addition to the promotion of local CSR, which we have been discussing, as two strategic CSR issues. Human rights issues in particular are not limited to a specific area; they require cross-sectional efforts spanning the entire organization. That is why we positioned it as a priority CSR issue.

Yamaguchi: From a management perspective, these two issues require the company to make an effort in the areas of management risk and raising the efficiency of local operations. Concrete commitments should be more closely aligned with the direction of the core business, while at the same time being easier to pursue by expressing them clearly. Perhaps quality has become so thoroughly ingrained in the company's operations that it doesn't need to be singled out as a separate concrete commitment. However, human rights is a major issue to tackle head on. One way to address it is to use the issue of conflict minerals as a springboard for expanding into broader areas of human rights as audits of business partners begin to reveal specific

human rights concerns inherent in the supply chain. I think the best course would be to start with conflict minerals and generate added value.

You don't have to focus exclusively on negative topics. For example, in the area of human rights and labor, you could take on such challenges as raising the skill level of human resources or further working on the company's proven strengths in workplace safety. You could select topics by considering what the company needs to reach the next level on a global scale.

Kawabe: The situation surrounding conflict minerals indeed requires a unified, cross-regional response from the standpoint of business risk. The same is true with bribery. Although Anritsu has become known for its sincerity, pitfalls remain, and we cannot claim to exercise complete control over the supply chain, including agents. We started

in Asia, where we are expanding our business, and we are considering how best to respond. Audits are one option.

Yamaguchi: What is the status of your project for developing emerging businesses that you spoke about during our dialogue last year?

Taniai: This year we are determining the direction we should take. Along the way, we are discussing Anritsu's ideal state in the future, the optimal direction for developing our current businesses, and the best way to leverage our proprietary technology to contribute to the world. This makes it imperative to clarify our corporate philosophy and establish a firm direction. Otherwise we will not be able to unite our employees around the world and demonstrate our considerable capabilities.



Vice President and Director
Anritsu Corporation
Toshisumi Taniai

Goto: When I previously offered my help in formulating Anritsu's CSR Goals, participants suggested "safety and security" as the keywords for Goal 1. Safety and security have been placed at the center of the 2020 VISION, and I expect the company will continue its efforts toward this goal until the target year. Safety and security, however, can be broadly interpreted, and spoken by one person may have an entirely different meaning to the person hearing them. I think you may need to discuss this and dig a little deeper to ascertain exactly what you mean by "safety and security."

Fukushima: How you define these terms could determine your approach to conflict minerals or human rights—that is, whether the focus is on CSR procurement in the supply chain or compliance. The discussion is likely to have a variety of aspects.

Yamaguchi: For some companies, focusing on safety and security as a compliance issue may narrow the scope of activity. That may satisfy customer requirements but not generate any added value. Since you are prepared to tackle the issue, I hope you will do so in a way that allows for future development by making the entire process transparent from the beginning.



Director, Caux-Round Table-Japan
Toshimune Yamaguchi

 Caux Round Table – Japan
<http://www.crt-japan.jp/>

Akabane: A company listed in the United States would tend to view this as a compliance issue. If you are supplying products to a U.S.-listed company, however, it would be considered a supply chain issue. Mr. Yamaguchi's suggestion offers an alternative. You could start with conflict minerals and then broaden your scope into other issues, such as the use of child labor and forced labor.

Identifying and Improving Environmental Impact throughout the Product Lifecycle

Fukushima: Please tell us about the status of your efforts on the environment over the past year.



Senior Manager, Environment and Quality Promotion Dept., Anritsu Corporation
Kazuhiro Takasugi

Takasugi: In our CSR report for fiscal 2012, we declared our intention to identify and reduce our environmental impact throughout the lifecycles of our products. To understand the current situation, we are expanding the range of Scope 3 data^{*1} collection using the GHG protocol^{*2} as a reference. In fiscal 2012, we received and duly responded to our first survey request from the CDP^{*3}. We plan to further itemize our CO₂ emissions to reduce our environmental impact, while identifying an appropriate KPI

linked to our overall management indicators.

*1 CO₂ emissions generated by the use and disposal of products, and CO₂ emissions related to logistics, business trips and employee commuting.

*2 The international standard for corporate reporting of greenhouse gases using a set format.

*3 Carbon Disclosure Project

Goto: You took another major step forward. Last year I suggested that you consider an efficiency indicator (basic unit) combined with financial indicators, but I believe the absolute volume of CO₂ emissions will suffice. If possible, I think the best approach would be to set an overall global target which is then broken down into regional targets. You mentioned the ES survey in your CSR report for fiscal 2012. Can you tell us about the content of that survey?

Taniai: We conduct a global employee satisfaction survey that includes content tailored to local situations as well as general questions to confirm how well employees understand our company philosophy. The surveys for Japan contain many questions, and employee satisfaction tends to be high.

Goto: You might consider using the existing ES survey framework as a kind of benchmark. I know that at least one foreign pharmaceuticals company surveys degree of engagement, which is considered similar to satisfaction, and then tracks the results as a KPI.

Yamaguchi: I think graphic or visual representations of activities, including KPIs, can serve as a gateway to better engagement. The disclosure of information can stimulate lively discussions. Take care, however, to avoid tracking irrelevant KPIs. For example, do not try to quantify human rights efforts by tracking the number of training sessions as a KPI.



ideaship Inc.
Daisuke Goto

ideaship
<http://www.ideaship.info/>

Relationships with NGOs and NPOs

Akabane: Anritsu has designated communication with stakeholders as Goal 4, which includes holding a dialogue with NGOs and NPOs. In the expert hearings that CSR Asia conducted in March of this year, NGOs and NPOs appeared at the top of the list of sectors expected to have the greatest impact on CSR activities in Asia. There are a variety of NGOs and NPOs, from organizations that are involved in advocacy activities^{*4} to those primarily interested in surveys and research. As Anritsu pursues global development, it may want to consider increasing opportunities for communication or engagement with an NGO, for example. At present, Anritsu operates an industrial automation factory in Thailand, while another factory has commenced operations in Shanghai, China. While these may be B2B operations, high-tech companies tend to stand out, and could become targets of attack by NPOs and NGOs. Please proceed with a concurrent effort on risk management, taking into account environmental issues such as water resources.

*4 Issuing policy statements on certain issues.

Dohi: We deeply appreciate the opinions of our stakeholders, and will continue to engage in activities that are uniquely associated with Anritsu.

CSR through our Core Business

Based on its company philosophy of "Sincerity, Harmony and Enthusiasm," Anritsu takes corporate social responsibility in its business operations from economic, social and environmental perspectives, with due respect for laws and regulations, ethics, and social norms. Anritsu also aims to build and elevate its corporate and brand values via better communication and better relationships with stakeholders.

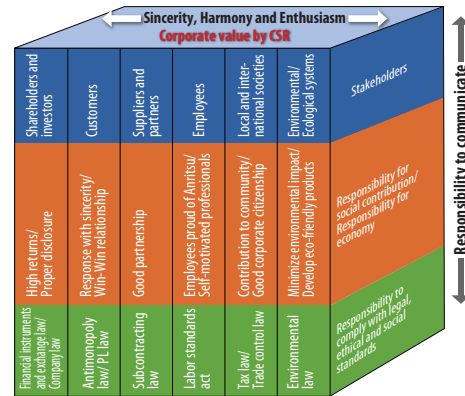

CSR Promotion System

The CSR Promotion Committee set up in November 2004 is chaired by the President so that top management can lead CSR promotion. In addition, the CSR Promotion Center was organized as a dedicated department to encourage unified activities across a broad array of departments. The center is now called the CSR Promotion Team, and it serves under the Corporate Communication Department as the secretariat of the CSR Promotion Committee to support Anritsu's CSR activities in line with the committee's policies. CSR cannot be fulfilled by the efforts of any single department or organization. The cooperation of all departments of Anritsu and Group companies is essential for success. With this in mind, and to ensure effectiveness, Anritsu Corporation's departments in charge of individual CSR fields, including customer satisfaction and quality, human rights and social contribution, lead activities through cross-sectional cooperation across Group companies. The CSR Promotion Team serves as the secretariat. We identify and analyze the current situation of individual areas from a CSR perspective and strive to address issues of improvement for the future of Anritsu.

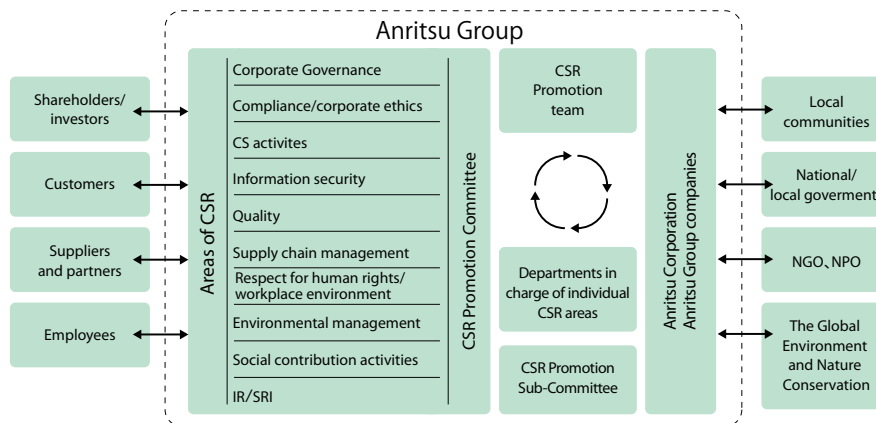

Promotion of Global CSR

To promote CSR activities on a global scale and deepen communication with our stakeholders across the world, the Anritsu Group is exchanging information internally based on a regional system and annual schedule.

Each year, regional staff report to the Head Office CSR Promotion Team on the ten items listed at right. These regional reports include plans for the current fiscal year that are submitted between April and June, progress (mid-term) reports on the plans between October and December, and annual reviews between March and April of the following year.

Our Global System

- Headquarters : Corporate Communication Department
- Americas : Human Resource Department, Anritsu Company (U.S.A.)
- EMEA : Human Resource Department, Anritsu EMEA Ltd. (U.K.)
- Asia : Human Resource Department, Anritsu Company Ltd. (China)

Action Items

- CS Activities, Quality Improvement
- Quality Improvement
- Health and Safety
- Compliance
- Supply Chain
- Information Security
- Protecting Human Rights
- Valuing Employees
- Promotion of Environmental Management
- Conducting Social Contribution Activities

Basic Concept

Under its action guideline, "We will become a CS enterprise deeply trusted by customers," Anritsu believes each employee must be cordial when serving customers and closely communicate with them in order to meet their needs, while at the same time identifying their needs and challenges. We establish win-win relationships with customers and propose new value that delivers customer satisfaction.

Because it is vital that employees who directly contact with customers have the right mindset, we place priority on programs that focus on employee awareness, training and recognition.

CS Promotion Framework

The Anritsu Group in Japan encourages mutual sharing of CS issues and improvement activities through the Japan CS Committee, which consists of representatives from Anritsu Group companies. Every three years, we formulate a mid-term plan and undertake improvements based on the plan. Toward our goal of becoming a CS company deeply trusted by customers, we reviewed our customer contact points in fiscal 2012. We also verified the status of the customer-related databases each division manages to identify internal issues we must overcome to construct a centralized contact points in fiscal 2013.

We also held a meeting in China to unify our global CSR guidelines.

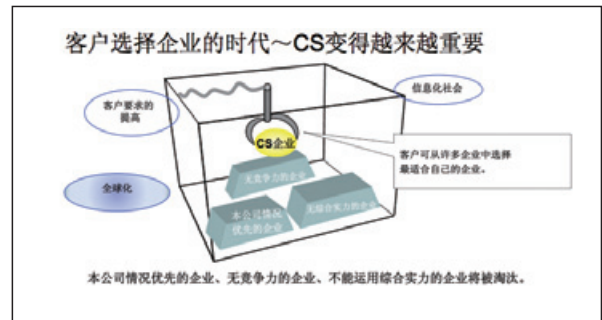

Chart used for a meeting in China

Global Service

The Anritsu Group maintains 24 service centers in 16 countries to provide reliable services for our global customers. Anritsu Customer Services Co., Ltd. pursues business through three pillars of service: maintenance, including calibration and repair of measuring instruments; testing, such as EMC*; and support, including technical support for customers in Japan and support for service units overseas. In the area of global support services, the company supplies Anritsu product service centers with maintenance parts and technical support including calibration repairs.

To ensure consistent service to customers worldwide, we conduct simultaneous CS surveys in every country to reflect the voice of our customers in improvement efforts. For example, in fiscal 2011, we upgraded our web-based service request and logistics systems in Japan to more effectively address customer requests and complaints.

Seeking further improvements, in fiscal 2012 we began developing a new web-based service to replace our existing system in the second half of fiscal 2013. In addition, the Anritsu Industrial Solutions Co., Ltd. maintenance network now covers about forty countries and provides reliable maintenance services to customers operating on a global level.

* Electromagnetic Compatibility



CS Surveys

As part of its efforts to raise customer satisfaction levels, the Anritsu Group conducts a survey and then formulates and promptly implements improvement plans based on customer feedback.

Anritsu Customer Services Co., Ltd. conducts a customer satisfaction survey on topics such as repair and calibration services, support services, EMC testing services and email newsletters.

The repair and calibration services part of the survey asks customers about their level of satisfaction on such items as collection and delivery, responses at the contact points, accuracy of operations and delivery time.

We systematically improve items that score lower than the previous year, and strive daily to further enhance customer satisfaction on items that score higher than the previous year.

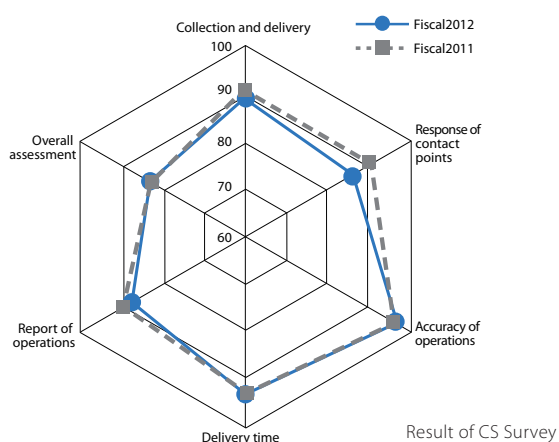

In a survey conducted by the Anritsu Company (U.S.A.), 94% of customers responded that they were either "extremely satisfied" or "satisfied" in terms of overall customer satisfaction. These activities ensure that customers are able to safely use our products and services.

CS Recognition Program

We introduced our CS Award in fiscal 2008 to recognize employees for their contributions to enhancing customer satisfaction. We present this award to employees in operations that are difficult to quantitatively assess, using positive feedback from customers to provide a support system that encourages them to deliver better-than-expected customer satisfaction. Our employees are aware that their work is in some way connected to the many stakeholders that surround Anritsu. Anritsu's stakeholders include our customers and business partners, various external organizations, government agencies, financial institutions and other business associates as well as local communities. In fiscal 2012, we



CSR Award recipients

changed the CS Award to the CSR Award to reflect the broader purpose of recognizing employee contributions that go beyond customer service, including efforts to improve the environment, society and our brand. Many employees have earned this reward.

Employee Training

To deepen CS awareness among employees, we provide collective training for managers, staff in charge and new employees.

For example, we implemented collective training for all new managers in the manager training program launched in fiscal 2011. In fiscal 2012, we continued to conduct parallel training for newly appointed managers and for staff in charge, and integrated training content to ensure that CS awareness was shared within the same division. In addition, we sought to boost motivation by using the corporate magazine to report on the CSR Awards and introduce related employee activities.



CS Training

Operations of Each Group Company

The Anritsu Group gathers customer feedback through CS questionnaires, customer contact points and sales activities. The opinions and requests are then reviewed by the CS Committee and incorporated into ongoing improvements.

Customer Support Center Inaugurates Full-scale Operation

Anritsu Industrial Solutions Co., Ltd. opened a customer support center in fiscal 2011 that operates 24 hours a day, 365 days a year, to establish a system for enabling customers to contact maintenance engineers at any time. In fiscal 2012 we linked the IT Support Center to the customer information database, creating a system for promptly responding to customer inquiries.

Looking ahead, we plan to utilize customer information to offer preventive maintenance services.

We also set up a dedicated contact point within the Support Center for customers who order parts, allowing us to respond more quickly to these customer orders.



Customer Support Center

Requirement Definition Process for Eliminating Missing Requirements, Gaps and Ambiguities

Anritsu Engineering Co., Ltd. has established and operates a requirement definition process, through which information and status updates are shared by the technology, sales and quality management departments in a timely manner. Prior to production, thorough research and reviews are conducted followed by customer approval to prevent missing requirements, gaps and ambiguities between customer specifications and final products. In fiscal 2012, we continued to operate under the requirement definition process from consultation to receipt of order.



Consideration of technical feasibility

Agreement with customer

Requirement Definition Process

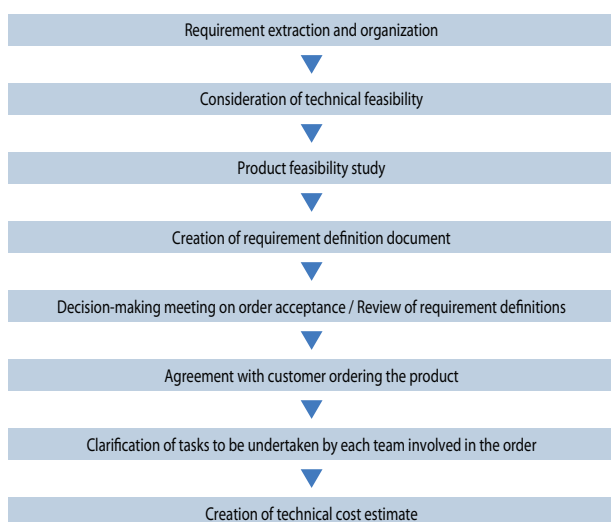

Various Technical Supports

Anritsu Networks Co., Ltd. provides customers with a wide range of technical support, from product delivery and installation to system equipment and repair functions. The technical support contact point responds within a single business day to inquiries on all types of equipment via mail and phone. Our actions reflect our desire to support customer operations by maximizing equipment and systems functions.

Technical Supports

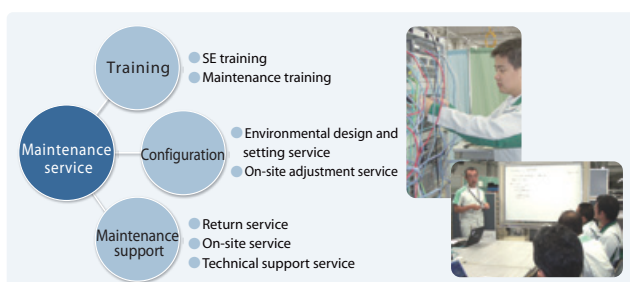

Quality Management

Basic Concept

Anritsu Corporation has established quality policies and action guidelines under its corporate philosophy, "Contribute to the development of a safe, secure and prosperous global society by offering Original & High Level products and services with sincerity, harmony, and enthusiasm," and firmly implement them in order to provide products and services that satisfy customers and society.

Quality Policy

We work with sincerity, harmony, and enthusiasm to create products that satisfy customers and society.

Quality Policy Action Guidelines

- Eliminate product defects through dedicated attention to detail
- Take the entire process into consideration by maintaining the policy of "your next process is the customer"
- Proactively suggest improvements

Quality Management Promotion

Anritsu develops a consistent global framework, from product design and development to production, services and maintenance, under ISO9001 international quality management standards for quality assurance. Continuous improvements are also being made as we effectively implement the PDCA cycle.

The Anritsu Group's Quality Management

The measuring instruments we provide are, in effect, the "mother machines" for the quality management our customers conduct. Our products must therefore demonstrate unwavering high quality. As with our measuring instruments, the products the Anritsu Industrial Solutions Co., Ltd. and the Anritsu Group supply are manufactured under stringent quality controls under the ISO 9001 quality management system. Ensuring product quality also requires upholding the quality management of our quantitative standards, such as length and mass. Under a traceability framework compatible with national standards, the Anritsu Group regularly inspects and calibrates the measuring instruments we use for to maintain our high standards.



ISO 9001 management system certificates

Basic Concept

Anritsu seeks to skillfully apply its highly advanced technology to solve social issues in partnership with our customers and achieve our goal of creating value that is uniquely Anritsu.

Receives World's First Test Case Approval for its System Meeting the LTE-Advanced Standard

The global proliferation of smartphones and tablet devices has led to an explosive rise in mobile data traffic. To provide users with a more reliable communications environment, carriers worldwide are focusing on introducing a high-speed version of LTE (Long Term Evolution) called LTE-Advanced, and service is set to begin in North America in 2013.

Commercial development of LTE-Advanced terminals to be used in North America requires RF conformance tests based on a format certified by the PTCRB*, which is responsible for formulating testing standards, to objectively validate that terminals conform with international quality standards.

Anritsu has consistently led the competition in achieving test case validations for 3G/LTE conformance testing, thereby fostering their commercial development.

Moreover, Anritsu has utilized the technology it developed working on LTE and LTE-Advanced to become the first in the industry to obtain PTCRB approval.

Mobile communications systems bring greater comfort and convenience to our daily lives and businesses, and there is an urgent need to construct high-speed mobile communications systems that can cope with the rapid rise in mobile data traffic.

Anritsu will therefore continue to vigorously support the development of both LTE-Advanced and LTE.



*Personal Communication Service Type Certification Review Board: The organization that formulates network operations and testing standards for the certification of mobile terminals.

Supporting the Efficient Production of Smartphone Communication Modules

Palm-sized smartphones are equipped with functions for communicating by voice; accessing the Internet; downloading movies, video and music; and playing games, giving users

access to a rich variety of applications anytime and anywhere. Smartphone shipments have grown every year, and are expected to reach around 1.5 billion units by 2017.

As a result, the production of communication modules that control smartphone functions also continues to expand, challenging manufacturers to enhance production efficiency. To meet this challenge, Anritsu developed the MT8870A universal wireless test set, which can be used to simultaneously test up to 16 types of communication modules.

We will soon enter a phase in which smartphones spread to emerging countries and become part of the infrastructure for creating prosperous lifestyles. Anritsu will continue to focus on delivering measurement solutions that support the global popularity of smartphones.

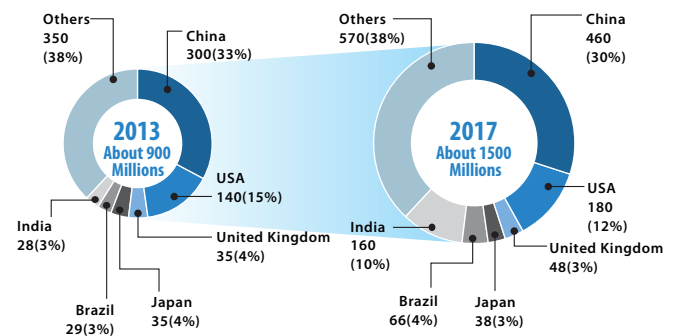

Forecast for smartphone shipments, by region (Source: IDC)

Recognized as Top Global Test and Measurement Company of 2012

Anritsu received the "2012 Global Test & Measurement Company of the Year Award" from Frost & Sullivan (head office: United States; hereafter "F&S"). F&S is a global market research and marketing company that provides research, analysis and consulting services for diverse industries. It presents the "Frost and Sullivan Global Company of the Year Award" to spotlight companies that demonstrate outstanding growth potential. F&S selected Anritsu for the 2012 award in recognition of our growth strategy and market leadership.

<Key Aspects Recognized by F&S>

-In addition to forging solid partnerships with customers and offering product development and proposal capabilities that respond to market needs, Anritsu notably outperformed key competitors in providing test solutions for the LTE market.

-Anritsu demonstrated outstanding performance in the mobile segment, including products such as the MT8820C Radio Communication Analyzer, a one-box tester for developing and manufacturing terminals; the MD8430A/MD8475A signaling testers used as base station simulators for diverse mobile communications systems; and the Spectrum Master MS272xC series and Site Master S331D—handheld measuring instruments used in the construction and maintenance of base stations.



Frost&Sullivan

Easing the Transition—Switching TV Broadcasting from Tokyo Tower to Tokyo Skytree

Tokyo Tower had been broadcasting television signals to the Kanto region since 1954. That task, however, was transferred to Tokyo Skytree on May 31, 2013 to ensure a more stable transmission from a greater height.

For areas with poor audiovisual reception prior to this transition, the level of reception was analyzed using test signals (CW signals, or continuous wave signals) transmitted from Tokyo Skytree. Various handheld measuring instruments made by Anritsu, including the Spectrum Master MS2711E, were adopted for this project to measure reception quality and signal strength.

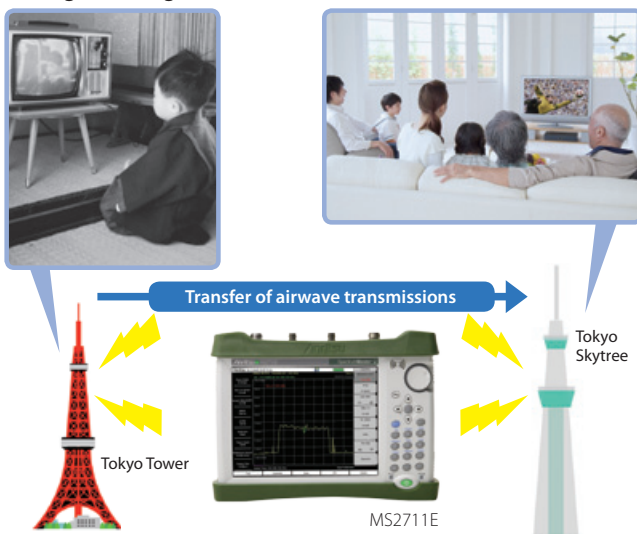

Handheld measuring instrument adopted to ease the transfer of television signal transmission from Tokyo Tower to Tokyo Skytree

Detecting Missing Products to Ensure the Joy of Eating

X-ray inspection systems used at food processing plants are capable of detecting metal as well as bone, stone, glass and other contaminants, and the market for these instruments has grown every year. Anritsu Industrial Solutions Co., Ltd. also strives to meet other customer needs beyond detecting contaminants, including detecting missing products. For example, several types of entrees and side dish items are packed into boxed meals and delivered to facilities for the elderly. Anritsu Industrial Solutions developed an X-ray inspection system that can detect if products in these meals are missing, ensuring the delivery of complete meals and helping to bring smiles to the table.

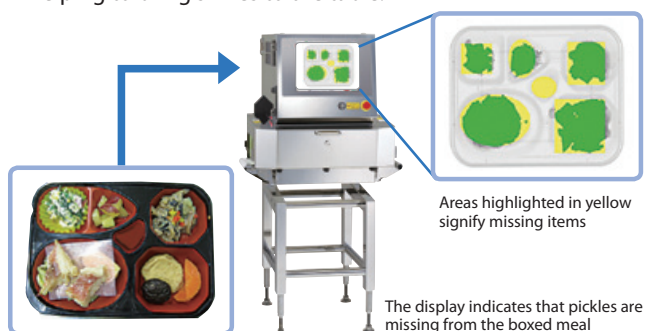

Rebuilding Iwate Prefecture's Fisheries Industry

Anritsu Industrial Solutions Co., Ltd. supplies contaminant detectors and checkweighers that are essential for ensuring the quality of food products and pharmaceuticals. Fishery and food processing is the core industry of the Sanriku region, and its reconstruction has become a key element for reestablishing a foundation for the livelihood of those affected by the Great East Japan Earthquake in 2011. As part of this effort, Iwate Prefecture introduced a program for lending equipment at no cost to operators of food processing businesses affected by the earthquake. Originally launched in the cities of Kamaishi, Otsuchi and Ofunato, the program was expanded to areas along the Sanriku region's entire coastline in August 2012 due to popular demand.

Anritsu Industrial Solutions has assisted the program by lending 12 metal detectors and checkweighers free of charge, which are still in use today. On October 26, 2012, the governor of Iwate Prefecture presented a certificate of gratitude to Anritsu in recognition of its efforts.



KD8013AW



Certificate of gratitude from the governor of Iwate Prefecture

Contributions in the Energy, Industry and Medical Services Sectors

Anritsu Devices Co., Ltd. manufactures key semiconductor devices used in advanced information communications equipment and sophisticated medical equipment.

We strive to meet the social needs of the next-generation optical network by offering high-output, high-efficiency Pump Laser modules used in fiber optical amplifiers (erbium doped fiber amplifiers, or EDFAs) as our core product, as well as gain chips for wavelength-tunable light sources (ITLAs). We also provide position sensors for microencoders, current sensors used at plants, and superluminescent diodes (SLDs), which are attracting attention for use as incoherent light sources in optical coherent tomography (OCT) as applied in medicine. We intend to contribute in the areas of energy and medical services through these products. We also handle light sources for gas sensors and high-speed devices.



Manufacturing process for devices

Supporting the Installation and Upgrading of Remote Monitoring Equipment Systems for a Growing Range of Purposes

Local governments and government agencies use remote monitoring systems for waterworks and road networks. The areas that require such monitoring have recently expanded, driving demand for new installations as well as for remote monitor and control equipments that support the integration and stable operation of communications lines used by existing equipment. In addition, railway companies, electric power companies and gas companies are placing higher priority on monitoring facilities from the standpoint of safety and security, requiring the use of more remote monitoring systems in these sectors as well.

In view of this market environment, Anritsu Networks Co., Ltd. has expanded its lineup of remote monitor and control equipments. During fiscal 2012 we developed the NH3000 series, which is ideal for constructing large- and medium-scale remote monitoring systems; the NH2500 series, which is best suited for constructing small-scale systems; and the NH6000 series, which can easily integrate standalone control units. Customers can construct or upgrade the ideal remote monitoring systems for their specific purposes and budgets.

■ Remote monitoring systems for urban functions



Helping Create a 3D Map of the Milky Way

The National Astronomical Observatory of Japan's VERA Project is designed to create an accurate three-dimensional map of the Milky Way. This grand project seeks to unravel the structure and evolution of our galaxy. Four observation posts equipped with 20-meter antennas (in Oshu City, Iwate Prefecture; Ogasawara Village, Tokyo; Satsumasendai City, Kagoshima Prefecture; and Ishigaki City, Okinawa Prefecture) sync up to create a super-giant radio telescope with a diameter of 2,300 kilometers capable of probing the distant edges of the Milky Way. Each observation post receives a signal from the same radio star. We can accurately calculate the distance to the radio star and its momentum using the difference in the times the signal was received at each post. Since the difference in time between the posts is miniscule, however, the project requires a "clock" that can measure time with extreme precision. This is where Anritsu's hydrogen maser atomic clock comes in. The VERA Project adopted our clock because it deviates by less than one second every 30 million years. On October 5, 2012, a ceremony was held in Oshu City to commemorate the tenth anniversary of the day observations began. Anritsu received a certificate of gratitude from the National Astronomical Observatory in recognition of its role in the project. Anritsu's hydrogen maser atomic clock is helping researchers to develop new theories about the Milky Way, which remains shrouded in mystery.

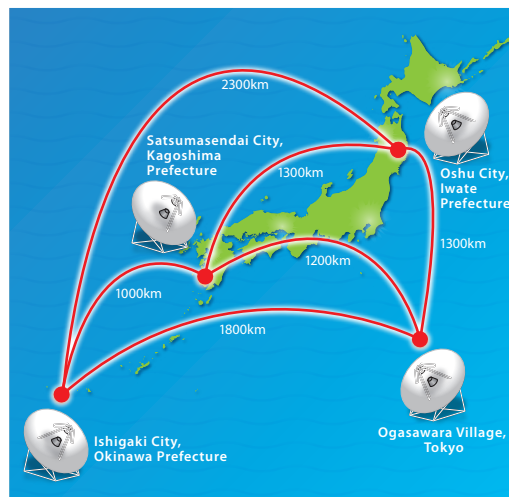
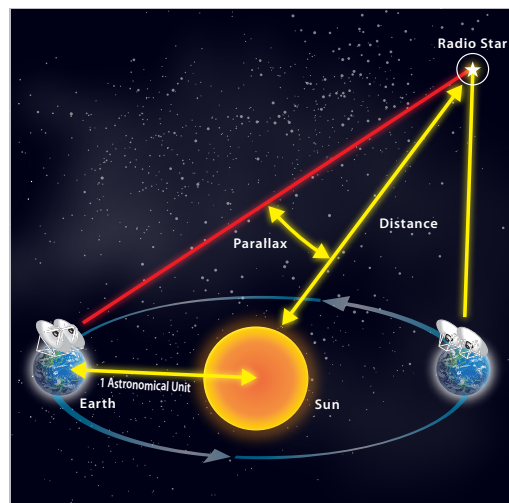

VERA

Basic Concept

Anritsu gives priority to proactively responding to global social expectations through its business activities.

Agree to the Global Compact

Since March 2006, Anritsu has practiced the ten principles of the United Nations Global Compact, and has linked these principles with its own CSR efforts to firmly establish them throughout Group activities worldwide.

Global Compact (GC) and Related Activities

Anritsu's CSR activities during fiscal year 2012 relate to the ten principles of the Global Compact. The United Nation's Global Compact Office has selected Anritsu CSR Report 2007 as one that matches their Notable COP (Communication on Progress) policies.



The Ten Global Compact Principles			Anritsu's Major Actions in Fiscal Year 2012	Related Pages
Overall		Applying the ten GC principles	<ul style="list-style-type: none"> The Anritsu Group Charter of Corporate Behavior, which reflects the spirit of the Global Compact, now serves as the basis of our group activities. We began applying the Anritsu Group Code of Conduct to our activities on a global scale. Promoting compliance, Anritsu Corp. and the Group companies made efforts to prevent violations and to establish more pleasant workplaces by (1) familiarizing employees with Anritsu Code of Conduct; (2) promoting groupwide education, including training by organizational levels; (3) avoiding risks on ethical matters via questionnaire survey; and (4) preventing violation of ethics rules via help-lines inside and outside the company. 	Anritsu Group Charter of Corporate Behavior Anritsu Group Code of Conduct Establishment of Compliance
Human Rights	Principle 1	Businesses should support and respect the protection of internationally proclaimed human rights; and	<ul style="list-style-type: none"> Anritsu Corp. and the Group Companies promoted activities to secure workplace safety and health. 	Labor Safety and Health
			<ul style="list-style-type: none"> We included a clear statement on protecting human rights in the CSR Procurement Guidelines intended for suppliers and partners, and requested their compliance. 	Supply Chain Management
	Principle 2	make sure that they are not complicit in human rights abuses.	<ul style="list-style-type: none"> Anritsu Corp. and the Group Company surveyed the actual status of harassment to employee by ethics questionnaire. We opened an external helpline to address harassment and other compliance issues. 	Establishment of Compliance
			<ul style="list-style-type: none"> Anritsu Corp. requested that its suppliers and partners not be complicit in human rights abuses 	Supply Chain Management
Labor Standards	Principle 3	Businesses should uphold the freedom of association and the effective recognition of the right to collective bargaining;	<ul style="list-style-type: none"> Based on employees' requests, and in order to improve work-life balance, Anritsu Corp. and the Group Companies continued to improve labor conditions. 	Respect for Human Rights and Promotion of Diversity
	Principle 4	the elimination of all forms of forced and compulsory labour;	<ul style="list-style-type: none"> We sought to establish the Charter of Corporate Behavior and Code of Conduct worldwide. Anritsu Corp. requested that its suppliers and partners not be complicit in forced and compulsory labor. 	Anritsu Group Charter of Corporate Behavior Anritsu Group Code of Conduct Supply Chain Management
	Principle 5	the effective abolition of child labour; and	<ul style="list-style-type: none"> We sought to establish the Charter of Corporate Behavior and Code of Conduct worldwide. Anritsu Corp. requested that its suppliers and partners not be complicit in child labor. 	Anritsu Group Charter of Corporate Behavior Anritsu Group Code of Conduct Supply Chain Management
	Principle 6	the elimination of discrimination in respect of employment and occupation.	<ul style="list-style-type: none"> Anritsu Corp. and the Group Companies promoted employment across borders. 	Respect for Human Rights and Promotion of Diversity
Environment	Principle 7	Businesses should support a precautionary approach to environmental challenges;	<ul style="list-style-type: none"> Anritsu Corp. and the Group Companies promoted Eco-Factory and Eco-Office activities. 	Eco-Office and Eco-Factory
			<ul style="list-style-type: none"> Anritsu Corp. and the Group Companies in Japan continued environmental accounting. 	Environmental Accounting (fiscal 2012)
	Principle 8	undertake initiatives to promote greater environmental responsibility, and;	<ul style="list-style-type: none"> Anritsu committed to Eco-Management. 	Eco-Management and Eco-Mind
			<ul style="list-style-type: none"> Anritsu promoted activities of Eco-Minded Employees. Anritsu continued its efforts to prevent of global warming. 	Eco-Management and Eco-Mind Eco-Office and Eco-Factory
Principle 9	encourage the development and diffusion of environmentally friendly technologies.	<ul style="list-style-type: none"> Anritsu Group in Japan promoted development of environmentally conscious products. 	Eco-Products Development	
Anti-Corruption	Principle 10	Businesses should work against corruption in all its forms, including extortion and bribery.	<ul style="list-style-type: none"> Established the Anritsu Group Guidelines on Prevention of Extortion and Bribery. Anritsu Corp. and the Group Companies in Japan circulated case study sheets on anticorruption measures to educate employees. 	Establishment of Compliance
			<ul style="list-style-type: none"> Provided clear information about our prohibition of transactions with antisocial forces in "Requests," which is given to suppliers and partners, and sought to reinforce their awareness of this issue. 	Supply Chain Management

Goal 2 Establishment of Compliance

Basic Concept

By promoting sound and fair corporate behavior that addresses social concerns beyond basic adherence to ethical standards, laws and regulations, Anritsu continually advances key measures for strengthening its Ethics/Compliance Promotion system and to enhancing ethical awareness among employees.

We believe it is important to develop a deep awareness of our corporate social responsibility, comply with laws and regulations in all aspects of our corporate activity, and act according to social ethics.

Compliance Promotion System

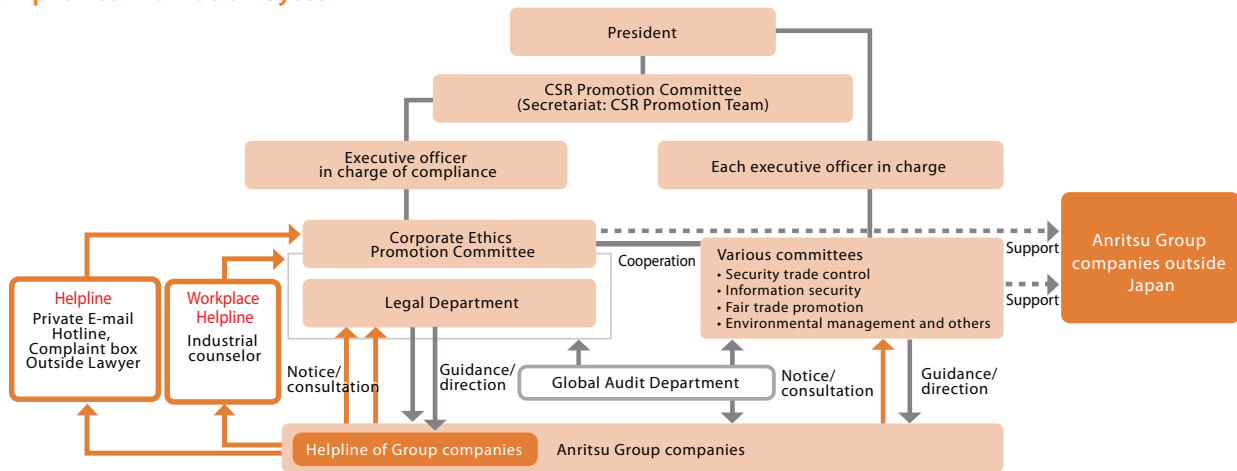

Corporate Ethics Promotion Committee and Ongoing Improvement Activities (annual)

The Anritsu Group in Japan set up a Corporate Ethics Promotion Committee under its compliance promotion system. The committee's membership consists of representatives from individual departments related to corporate ethics and from Group companies. It plans, supports and implements Group compliance activities, and its major responsibilities include the review and analysis of responses to the corporate ethics survey conducted during Corporate Ethics Month (October), followed by a one-year development cycle for an annual action program and implementation monitoring as well as the assessment of compliance outcomes based on the survey to ensure continuous improvement.

■ Compliance Promotion Activities

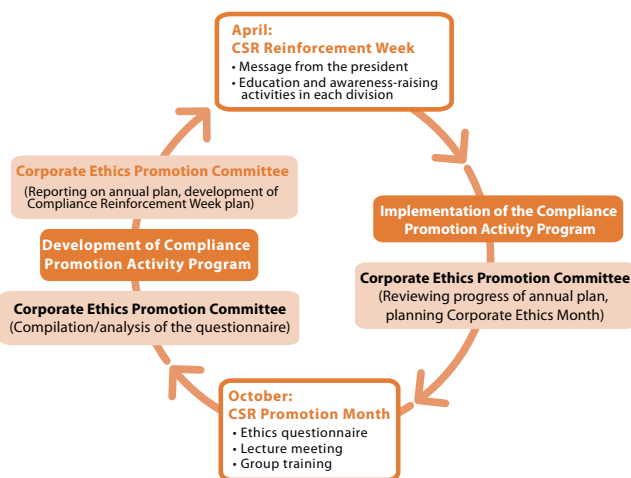

■ Corporation Ethics Promotion Committee Composition Departments



Compliance Promotion Activities

Two Events We Promote

During the Anritsu's CSR Reinforcement Week in early April and CSR Promotion Month in October, Anritsu holds workshops and events, including lectures by invited speakers, training, and specialized instruction by the department participating in the Corporate Ethics Promotion Committee. The company also conducts an ethics survey for Anritsu employees, temporary workers, and other staff in Japan.

- Training by organizational level (e.g., new recruits, newly promoted managers)
- Individual/specialized training by separate committee or department
- Lecture meeting with invited external speakers (once or twice a year)
- Lending and showing of videos or DVDs



Group training

Lecture meeting with experts

The survey targets regular employees and temporary staff of the Anritsu Group in Japan—as well as employees of partners, suppliers, and other staff—to confirm the effectiveness of compliance promotion activities and identify areas for improvement in individual organizational units. Analysis, examination and deliberation over the questionnaire results are fed back to the management of the individual organizational units to be used in drawing up future compliance promotion activity programs and other actions.

Compliance Situation of the Antimonopoly Law and Internal Audit

To confirm the conduct of fair and free sales activities, the Anritsu Group in Japan conducts internal audits of the activity status and order intake/sales process of the sales departments (including local bases) once a year. In conjunction with the internal audit, we also conduct compliance training (Act on Prohibition of Private Monopolization and Maintenance of Fair Trade; Act against Delay in Payment, etc. to Subcontractors; export controls; etc.)

Helpline

To prevent violations of ethics and laws and maintain pleasant workplace conditions, Anritsu Group Companies in Japan operate the Helpline, which accepts internal reports and requests for consultation. Lawyers are available from outside the company for employees to consult for legal advice. In addition, Legal Consultation Days (twice a month) are held to provide legal consultation on internal problems as well as any other topics affecting the lives of employees.

Furthermore, in October 2012 we began running our Workplace Helpline, assigning its operation to a third party so that consultation is provided by industrial counselors rather than employees within the Anritsu Group. The Workplace Helpline maintains strict rules of confidentiality and accepts requests for consultation outside office hours—including on holidays—as well as in English (on designated days), giving employees better access to the service.

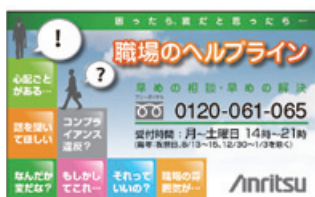

Information card promoting the Workplace Helpline

Guidelines on Preventing Extortion and Bribery / Publication of Case Study Sheets

Guidelines on Preventing Extortion and Bribery

Bribery is a serious issue throughout the world. Particularly stringent bribery laws have been enacted in the United States and the United Kingdom. These laws are not limited to incidents within the respective countries but extend to incidents that occur outside them as well. Extortion and bribery represent major compliance risks for the Anritsu Group, which conducts business on a global scale, and we are therefore working on preventive measures.

While the Anritsu Group Code of Conduct already prohibits extortion and bribery, we sought to more firmly uphold this prohibition throughout the group in Japan and overseas by establishing the Anritsu Group Guidelines on Prevention of Extortion and Bribery in April 2012. We also conduct training in how to prevent bribery for staff working in sales divisions in Japan who are at high risk of encountering such situations.

Case Study Sheets

Every month, Anritsu Group in Japan selects concrete cases that have actually occurred or could occur, under the two themes of daily life and business, and publishes these as Case Study Sheets that include concise advice and explanation. Sheets are posted on our intranet and as a printed poster. The sheets are used as educational tools of individual organizational units. A total of 146 cases have been published as of March 2013.

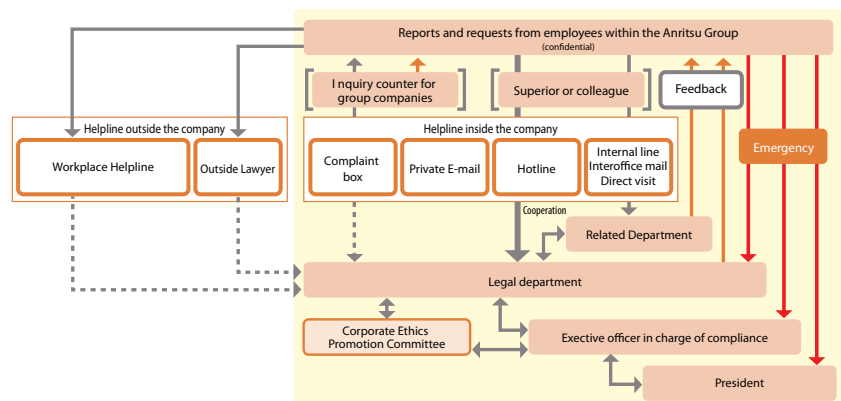

Basic Concept

Anritsu has identified seven major risk categories: (1) management decision-making and business operations; (2) legal violations; (3) environmental preservation; (4) quality of product and service; (5) import/export management; (6) information security, and; (7) disasters. For each category, a chief administrator has been assigned to carry out analysis and evaluation while establishing rules and guidelines. This administrator also conducts education and training to raise the level of risk management and ensure ongoing business development.

Enhancing Corporate Value through Internal Controls

Basic Concept and Policies

Anritsu believes its global business development depends upon effectively controlling factors that could inhibit the attainment of its goals and transforming risks into a source of competitive advantage. To this end, we will further reinforce the collaborative relationships established with Group companies in and outside of Japan through the process of improving our internal control system. We will also upgrade our risk management to enhance corporate value.

Promotion/Management System

Anritsu has established basic internal control system regulations and set up an Internal Control Committee, chaired by an executive officer appointed by the President, to oversee the overall improvement and operation of internal controls concerning the financial reporting of Anritsu and Group companies. Furthermore, the Global Audit Department, our internal audit division, is in charge of promoting risk management through business audits.

Specific Activities and Topics in Fiscal 2012

In fiscal 2012, we conducted training sessions for management-level employees (department and section heads) at all Group companies in Japan as part of our group-wide effort to reinforce enterprise risk management. We also sought to strengthen our position against material risks, including compliance through such actions as holding discussions at the head office sales department to talk through practical risks related to business.

Strategic improvements were implemented against potential risks identified during the evaluation process. An external auditor therefore concluded that the Anritsu Group's internal controls for the fiscal year ended March 2012 were as effective as in the previous year. This evaluation was based on the group-wide corporate philosophy and ethics, control of accounting policy and procedures, and control of IT infrastructure and business processes related to financial reporting.

Koriyama Second Business Office Commences Operations

Operations have commenced at the Koriyama Second Business Office, which serves as the mother factory that consolidates the Anritsu Group's automated assembly processes for printed circuit boards. We plan to expand production in Fukushima with several goals in mind. In addition to supporting the reconstruction effort in a region severely affected by the Great East Japan Earthquake, we hope to shorten delivery times through an organized logistics network and to consolidate core technologies in Japan. Anritsu products will be shipped from the Tohoku region for delivery to customers around the world.



Koriyama Second Business Office

Information Security Management

Basic Concept

Anritsu is making a continuous effort to maintain and enhance information security through its information security management system.

Management System (Information Security Management)

Anritsu's management system is overseen by the Information Management Committee, which consists of key executive officers from each business division and Group company. Two subcommittees—the Information Security Subcommittee, comprised of representatives from business divisions in Japan, and the Global Security Committee, whose members include representatives of IT departments at overseas Group companies—report to the Information Management Committee. The Information Management Committee formulates basic policies on information management for the entire Group, and the Information Security Subcommittee and the Global Security Committee develop annual action plans and concrete measures. The plans these high-level bodies formulate are implemented through the actions of each department. Anritsu uses this management system to oversee its annual PDCA cycle.

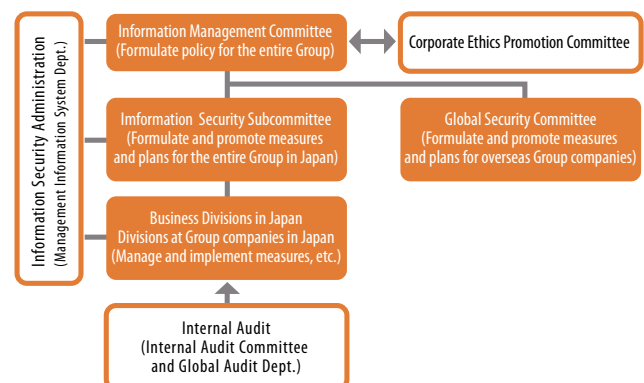

■ Major Activities in Fiscal 2012

● Risk Assessment Related to Information Security and Countermeasure Development

The ongoing evolution of business and IT environments means the nature of threats to IT systems are also continually changing. We therefore conduct an annual risk assessment to address changes in the risks we face. In fiscal 2012, we took action to address risks in the following two areas:

- Response to Targeted Cyber Attacks (risk due to changes in the external environment)

The frequency of cyber attacks targeting classified corporate and personal information has increased around the world, causing information leaks and other damage. In fiscal 2011, Anritsu hired a specialized vendor to conduct a risk assessment, which revealed several vulnerabilities related to accessing the Internet from inside the company. In fiscal 2012, we addressed this problem by installing a filter that limits access to Web content and an Internet access restriction tool that prevents communication with illicit external servers. These measures significantly reduced the risks of intrusion by illicit programs via our website and information leaks to illicit external servers.

- Construction of Site for Managing Material Information (risk due to changes in the internal environment)

Until recently, we were storing material information on file servers and protecting against leaks by designating access rights. However, some aspects of security—such as the management of those access rights and the procedures for handling files—had been left up to the users, and we had not reduced risks to acceptable levels. Furthermore, our internal audit had revealed issues with how access rights were being managed at a specific department. To address these vulnerabilities, we constructed a site for managing material information utilizing rights management with file encryption. Several departments are already using the site.

As a result, even when a user mistakenly transmits a file outside the company, the content of the encrypted file will remain confidential, thereby minimizing the risk of data leakage. We plan to expand this system across the entire company.

● Promoting Employee Education Activities

- Officer and Employee Education

We conduct annual training activities for officers and employees of Anritsu Group in Japan on security issues using scripted video re-enactments and by holding discussion sessions. In fiscal 2012, we showed a video on targeted cyber-attacks and smartphone security at each division, and followed that with a discussion by division members to deepen our shared awareness of security.

● Education for New Employees and Others

We provide onsite security education on an as-needed basis for new employees, mid-career employees, onsite workers and temporary staff.

- Education for Employees in the Asian Region

We conducted security education for employees at sales offices in the Asian region. The region, however, consists of ten offices scattered across seven countries, making it difficult to provide thorough education on such issues as security. Increased IT investments in this region have further elevated the importance of security issues, and we therefore commenced an initiative throughout the region in fiscal 2012 to provide regular education.

● Response to BCP

We had been consolidating our key servers at our Osaka Data Center since FY2011 under our BCP. We completed the transfer in July 2012, and conducted recovery training in October. We developed a scenario for the training, implemented recovery operations according to instructions in the recovery manual, and assessed the validity of the manual and the targeted time for recovery. We corrected problems that emerged in the process, and will continue to take the necessary actions to ensure secure recovery.

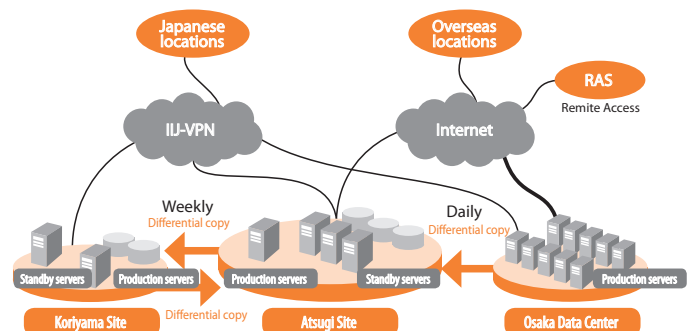

Basic Concept

We believe it is important to strengthen our relations of trust with suppliers and partners in our procurement activities to achieve growth for the entire supply chain. We strive to respond to the expectations and demands of society across the entire supply chain by emphasizing the development of stronger partnerships through the involvement of suppliers and partners in various ways, as well as through compliance with relevant laws and regulations, business practices and social norms.

Anritsu Basic Rules of Procurement and Requests

To fulfill its social responsibility in the future, Anritsu believes it must develop activities across the supply chain, including our business partners as well as within the Group. We established Basic Rules of Procurement and transaction-related requests for suppliers and partners, revised them in line with the ever-changing business environment and sought to better understand our suppliers and partners through activities such as budget briefings and letters of request from executive officers in charge.

Requests

1. Observance of laws and social norms
Observance of relevant laws, prohibition of child labor, forced labor and cheap labor; and prohibition of discrimination and transaction with antisocial forces
2. Environmental considerations
Realization of environmental measures in line with Anritsu's Green Procurement Guidelines, environmental requirements, etc.
3. Ensuring good quality, supply at fair prices and maintenance of delivery schedules
4. Preventing leakage of secret information and respect for intellectual property rights
5. Prompt response to contingencies and timely, appropriate information disclosure

Basic Rules for Procurement

1. Selection of suppliers and partners
Anritsu always keeps the door open to new potential suppliers and partners inside and outside Japan, in a spirit of fairness and impartiality. Anritsu objectively selects suppliers and partners based on proper standards - focusing on quality, price, delivery schedules and environmental measures.
2. Partnership
Anritsu builds mutually beneficial relationships with all suppliers and partners through sound business practices.
3. Compliance and secrecy protection
Anritsu conducts business in full compliance with relevant laws, and does not disclose information acquired through business with suppliers and partners to any third party without these suppliers' and partners' prior consent.
4. Activity based on ethical concepts
Personnel involved in procurement keep in mind at all times the importance of performing assignments fairly, free of personal interests with suppliers and partners, while maintaining sound relationships with these parties.
5. Considerations of human rights and labor
Anritsu respects human rights and promotes industrial hygiene, safety and security, and requests that suppliers and partners agree to this policy and promote these activities as part of their supply chain operations. Anritsu may reconsider relationships with suppliers and partners if their business operations are linked with human rights violations, such as the use of child labor, racial and sexual discrimination, etc. Furthermore, we will work together with our suppliers and partners regarding non-use of conflict minerals that lead to these human rights issues.
6. Environmental considerations
Anritsu stipulates Green Procurement Guideline and promotes green procurement by purchasing parts and materials that have been proven less damaging to the environment.

Report on Important Theme: "Conflict Minerals as a Human Rights issue"

Following the 2012 adoption of the final rule of Section 1502—the conflict minerals provision of the U.S. Financial Reform Bill—Anritsu declared its support and began working with its supply chain to prevent the use of conflict minerals in Anritsu products. We also hold briefings for our business partners to prevent any oversights. We respond to customer inquiries related to this issue by requesting investigations by business partners in Japan and abroad. We also channel this information to the Conflict Minerals Working Group at our headquarters to accumulate information in a shared database.

Response to Customers in Japan

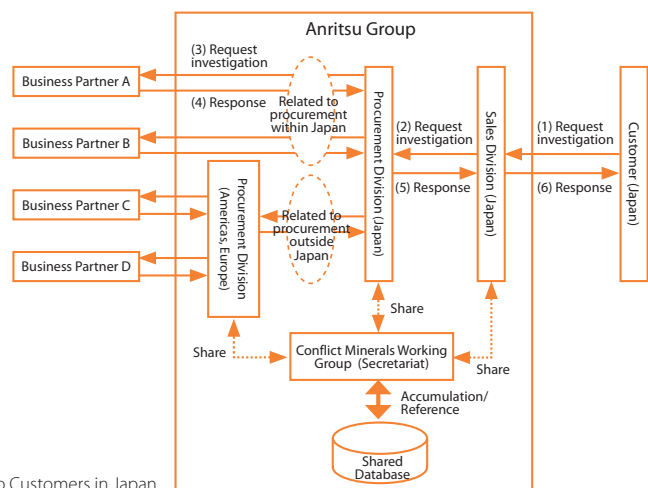

Promoting CSR Procurement

Anritsu believes that promoting CSR procurement requires a concerted effort with our suppliers and partners.

In fiscal 2010, we sought to give more concrete form to our existing Basic Rules on Procurement by formulating and posting to our website the Anritsu Group Corporate Procurement Guidelines in compliance with the "Supply-Chain CSR Deployment Guidebook" published by the JEITA (Japan Electronics and Information Technology Industries Association).

In fiscal 2012, we created an English-language version of the Corporate Procurement Guidelines, posted them on our regional websites, and encouraged suppliers and partners to review them.

Furthermore, to stay abreast of regulatory revisions, including environmental considerations, we conduct briefings to share information and provide support to suppliers and partners in their efforts to promote CSR activities.

Exhibition of Products Our Partners Make

We held an exhibition at the Anritsu head office featuring products manufactured by sixty of our suppliers and partners. The exhibition acquainted development engineers at Anritsu with new products and new technologies such as components for wireless communications (for example, Bluetooth, Wi-Fi, LTE-Advanced) and optical networks (40/100G), as well as general-purpose electric parts, optical parts and components that ensure electromagnetic compatibility (EMC).

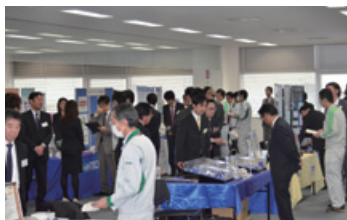

Introducing new products and technologies

CSR Procurement Survey

We established our CSR Procurement Guidelines in fiscal 2010. In conjunction with that, in fiscal 2011 we sent a survey to 77 major business partners that supply materials for our Test & Measurement business and received 66 responses, approximately 85% of the total. We also requested the cooperation of 440 other business partners in promoting CSR procurement and received letters of consent from approximately 86% of them. In fiscal 2012, we set up "Direct Delivery" mailboxes in the negotiation rooms of our head office and the Koriyama Business Office in an effort to promote CSR procurement based on the direct feedback of our partners and survey results.

We will continue to strengthen relations of trust with our suppliers and partners by using such tools as the survey to consistently support their CSR promotion activities and to ensure that CSR procurement is practiced in a fair, just and sound manner.

Efforts on Business Continuity Plans (BCPs)

The stable procurement of materials for parts production lies at the very backbone of any manufacturing company's BCP. Even before the Great East Japan Earthquake, Tohoku Anritsu Co., Ltd., and the Koriyama Business Office of Anritsu Corporation, which serve as the manufacturing base of the Anritsu Group, had recognized the serious risks posed by natural disasters such as earthquakes and created a BCP to deal with them. The BCP is clearly set out concrete steps for each process in the event of a disaster.

With the cooperation of our partners, we also created a database on the status of bases owned by business partners to immediately identify and minimize any risks following a disaster, and constructed a system to facilitate the in-house sharing of this information. We plan to improve and reinforce this system to incorporate the entire supply chain into the database, which we will utilize to ensure that the supply chain recovers quickly in the event of a disaster and to support partners affected by such events.

Column

TDK-Lambda Corporation

Deputy Senior Manager, East Japan Sales Department 1, Domestic Sales Division **Shigeya Mochihara**

For nearly forty years, TDK-Lambda has been doing business with the Anritsu Group in the areas of switching power supplies and noise filters.

We stand in complete agreement with the CSR Procurement Guidelines established under the Anritsu company philosophy and the company's CSR efforts, and intend to actively participate as a business partner that contributes to society in a variety of ways.

Looking ahead, we will steadily implement improvements and changes we can undertake on our own, while bringing greater reliability and strength to those we work in concert with the Anritsu Group as part of our QU activities to forge an even more powerful partnership with Anritsu. We will maintain our efforts to earn customer trust alongside Anritsu products.



Overseas Topic (Global Supply Chain Committee)

Anritsu maintains three main development locations in the United States, Europe and Japan. Parts have been procured through an approval process using assessment criteria established at each location. Consequently, the selection of the same part can involve a time-consuming approval process based on different criteria. To eliminate this inefficiency, Anritsu is establishing a globally unified set of assessment criteria with the approval of each location to optimize the mutual use of the supply chain. We intend to promote parts procurement through global collaboration.

Basic Concept

Given the rapid evolution of business worldwide, we believe it is important to attract a diverse workforce in terms of nationality, gender, age and views on work. This enables us to develop systems and programs that allow every individual to demonstrate their strengths based on their lifestyles, and to provide safe, secure and comfortable working conditions.

Human Rights Training and Plan

To cultivate sensitivity for human rights among Anritsu employees, we incorporated experiential learning—such as using a wheelchair or simulating the experience of elderly persons—into the human rights portion of our new employee education program. The training was conducted in cooperation with the Aozora Voluntary Group for the Promotion of Social Welfare Education based in Atsugi City. We also implemented a number of activities like organizational level training to foster an awareness of human rights within and outside the company on issues that require constant vigilance, such as discrimination against minority groups, sexual harassment and abuse of power in the workplace, and to improve communication.

To emphasize human rights throughout the supply chain, the Anritsu CSR Procurement Guidelines contain articles calling for the abolition of forced labor and prohibition of inhuman treatment, child labor and discrimination.

Creating Jobs for People with Disabilities

While the employment ratio of people with disabilities for fiscal 2012 (as of December 2012) declined from the previous year to 1.95%, we were still able to meet legal mandates. However, the legally mandated employment ratio was raised to 2.0% as of April 1, 2013. To meet this higher requirement, we will continue our recruitment efforts and workplace improvements while establishing greater cooperation for people with disabilities and expanding the range of available jobs so they can better apply their strengths.

As of the end of December

	2009/12	2010/12	2011/12	2012/12
Planned ratio (non-consolidated)	1.80%	1.80%	1.80%	1.80%
Actual ratio (non-consolidated)	1.76%	1.98%	2.25%	1.95%
Ref: Actual ratio (in Japan, consolidated)	1.37%	1.50%	1.56%	1.61%

Employee Data: Group companies in Japan

Employee Data of Group companies in Japan as of the End of March (eg., data for fiscal 2012 is as of March 31, 2013)

	FY2010	FY2011	FY2012
Total No. of employees of Group companies in Japan	2,240	2,206	2,194
Male	1,952	1,927	1,900
Female	288	279	294
Foreign nationals	20	16	24
Non-regular employee	376	463	625
Average age	40.3	41.5	41.5
Average working years	18.5	18.6	18.1
Ratio of Employees with Disabilities (non-consolidated) %	1.98	2.25	1.95
Ratio of Employees with Disabilities (The Anritsu Group in Japan) %	1.50	1.56	1.62
Planned ratio (Reference)	1.80	1.80	1.80

Employee Data: Anritsu Corporation

Anritsu Corporation Employee Data as of the End of March (eg., data for fiscal 2012 is as of March 31, 2013)

		FY2009	FY2010	FY2011	FY2012
No. of employees: Figures in parentheses refer to number of managers included in total count	Male	719 (171)	711 (165)	711 (176)	712 (174)
	Female	112 (5)	114 (4)	113 (4)	119 (4)
	Total	831 (176)	825 (169)	824 (180)	831 (178)
Average age	Male	40.1	41	41.4	41.7
	Female	35.8	36.4	37.1	37.3
	Total	39.5	40.3	40.9	41.0
Average working years	Male	16.4	17.4	17.5	17.6
	Female	13.3	13.8	14.4	14.5
	Total	15.9	16.9	17.1	17.1
Annual rated working hours		1,860.00	1,875.50	1,875.50	1,860.00
Average days of paid holidays used per year		11.2	14.6	15.6	14.2
No. of employees who took paid childcare leave		11	6	9	8
No. of employees whose employment has been extended beyond normal retirement age (for hiring employees over retirement age)	No. of eligible employees	16	19	18	19
	No. of employees over retirement age hired	5	11	15	14

Diversity

Anritsu emphasizes the creation of a safe, secure and comfortable workplace environment in which employees can enrich their lives and develop their careers.

In regard to supporting women in their career development, we are proactively working to establish a workplace environment that supports balancing work and childcare. This includes providing programs for paid leave, maternity leave and reinstatement, both before and after childbirth and during childrearing. To ensure that employees applying for these programs can balance work and family with greater peace of mind—regardless of gender—we disseminate information companywide to establish familiarity with the programs and raise awareness to inspire greater understanding.

Worldwide Percentages of Female Employees

		Japan	Americas	EMEA	Asia and Others	Total
Percentages of female employees (No. of female employees / Total employees)	FY2012	17%	31%	25%	31%	22%
	FY2011	14%	31%	26%	27%	23%
Percentages of female managers to male Managers ((No. of female managers / No. of female employees) / (No. of male managers / No. of male employees))	FY2012	8%	59%	82%	57%	45%
	FY2011	14%	59%	60%	54%	48%

Employee Support Program in America

The Wellness Program for employees that the Anritsu Company (U.S.A.) offers includes Bike to Work Days, hiking and marathons.

These programs not only improve the health of employees through participation and physical exercise, but also enliven communication among them.

- Bike to Work Day
- Hiking in the state park
- Half-marathons and other events



Bike to Work Day



Hiking in the state park

Balancing Work and Family

Anritsu Corporation is preparing the third stage of its three-year plan (see chart below) and taking the necessary measures to advance employees' work-life balance. In fiscal 2012, for example, we placed greater emphasis on the user's perspective by conducting a survey of employees who had taken advantage of related programs. We also widened the eligibility for shorter schedules for working parents (now for employees with children in the sixth grade and under), and introduced a new program for subsidizing the cost of using family support centers. We will continue to promote such initiatives in fiscal 2013.

Anritsu Corporation's Action Plan to Support Child Welfare 3rd Stage (April 1, 2012 to March 31, 2015)

Objectives	Measures
Allow men and women employees to take leave for child-raising with greater peace of mind.	Enhance child-raising leave program, widened the eligibility for shorter schedules for working parents, etc.
Reinforce system to help parent employees with temporary child-raising service charges.	Subsidize child-raising service charges at a family support center run by a local government.
Enhance understanding among employees that we support greater work-family balance in child-raising.	Launch website on programs that support child-raising and achieving work-life balance, etc.

Global Recruiting Actions

Borderless Recruiting

Anritsu Corporation and Group companies in Japan conduct recruitment activities regardless of nationality through such means as participating in recruiting fairs* held by universities outside Japan and employing foreign students in Japanese universities. As of the end of March 2013, 28 Anritsu Group employees of foreign nationality are working in Japan. In addition, four foreign nationals hired in Japan are currently stationed overseas.

* Forums for information exchange and mutual understanding between job applicants and employers

Revitalizing Employee Communications

Anritsu conducts an employee satisfaction survey to determine how well employees understand the company's direction and systems, the effectiveness of workplace communications and the level of job satisfaction.

In fiscal 2011, surveys were conducted in the Americas and Japan. The identification of issues as well as the development and implementation of improvement programs are currently underway in each region.

Beyond these surveys, President Hashimoto directly communicates with all Group employees through "Hashimoto's Room," a content-rich site in which he regularly comments on issues directly related to management as well as general topics of the day.

In addition, the president presents awards to employees while visiting their job sites as a way to revitalize communication between management and employees.

Basic Concept

Anritsu believes in the importance of being an organization in which employees feel they are contributing to society and growing while being vibrant and actively achieving the company's goals. With this belief, we constantly strive to create a workplace in which employees can grow through their work.

Education/Training System

Anritsu Corporation focuses on on-the-job training as a framework for supporting every employee in identifying the areas of work that are in line with their individual interests and developing the skills that enable them to realize their aspirations. Programs that are shared among all Anritsu Group companies in Japan include new recruit orientation, training by organizational level, correspondence courses and language studies, which all support the professional development of every Group employee.

Development of core human resources	Specialized Training by Job Style	Others
<p>Manager</p> <p>Global Leader Development Program/Management training/Training newly assigned managers</p>	<p>Technical Training</p> <p>Electricity and electronics / Optical technology /Signal processing/FPGA/Communications and networks/Project management/Production and quality/Process improvement/Intellectual property</p>	<p>Self-development support</p> <p>Correspondence course/E-learning/Foreign conversation</p>
<p>Middle Management/leader</p> <p>Management training/Leadership training</p>	<p>Sales training</p> <p>Business etiquette/Sales practice/Legal affairs/Response to customers/marketing/Product knowledge/Sales management</p>	<p>Career development support</p> <p>Career design training/Life plan training/Self-assessment system/Open recruitment within the company</p>
<p>New recruit</p> <p>New recruit follow-up training/New recruit training</p>		<p>Global human resource development</p> <p>Global employee exchange program/Cross-cultural communication</p>

Education and Training in Fiscal 2012

In fiscal 2012, we revised the training content for mid-career employees. The objective is to develop the mindset needed to become valued staff members who can achieve more as leaders in the workplace and as team members, as evaluated from the perspectives of five primary roles that mid-career employees are expected to take in their mid-thirties.

We held an overnight seminar for new employees to teach them the basics of business through the keywords "contribution" and "study."

They were divided into groups to tackle problems, which strengthened their sense of solidarity, while the experience of overcoming obstacles gave them the confidence to take their first step forward as mature members of society.



Global Human Resource Development

Anritsu is working to expand its business overseas, primarily in the area of test and measurement. Developing human resources capable of leading these overseas businesses represents a key challenge for achieving growth in the coming years.

We think it is particularly important to raise the level of language proficiency as the foundation for developing global human resources.

With respect to language proficiency, we offer group and private lessons in English conversation taught by trainers who are native speakers of the language, and many employees are working hard at self-improvement every day.

We will be focusing on providing education and training to develop global human resources, including lessons in languages other than English and training sessions to help our employees understand different cultures.

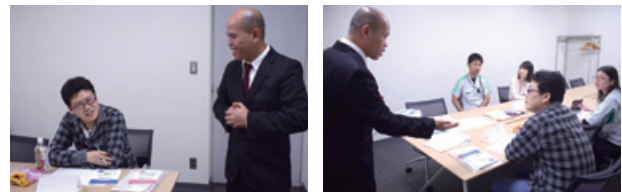

English Conversation Class

Global Training for the Test & Measurement Business

We held our 2012 Global Training session at headquarters for about two weeks in April. Each year, sales engineers working in the Test & Measurement business at Anritsu's sites outside Japan gather to exchange information on market trends as well as the latest news on major customers and Anritsu strategy, and to learn about products by attending lectures and operating the actual equipment. Approximately eighty engineers working in the wireless and wired areas participated in the training, with the support of about forty employees serving as trainers.



Wired Training

Basic Concept

Our Charter of Corporate Behavior calls for “Respect for employees.” Anritsu believes that in order to enable every employee to fully achieve their potential, it is important to secure employee safety and health and to create an ideal workplace.

Safety and Health, Health Management System

The Anritsu Group in Japan established a safety and health management system that complies with Japan’s Occupational Safety and Health Act. Industrial health staff, led by industrial physicians and counselors assigned to the Health Management Center, provide support services to maintain the health of group employees.

Major Efforts for Safety and Health, Health Management

- Having the Safety and Health Committee review activity status and formulate plans to prevent employees from accidents
- Reducing the risk of accidents by conducting inspections before introducing, relocating or changing equipment, or when purchasing chemical materials
- Enhancing the awareness of safety and health through training at different organizational levels, and providing training on specific issues such as risk assessment
- Providing safe, secure and comfortable workplaces by assessing working environments and conducting periodic inspections
- Conducting health checkups—initial, periodic, special, and for expatriates, as well as follow-up examinations
- Screening through questionnaire and industrial physician interviews to those who work extended hours to prevent impaired health
- Raising health awareness through lectures by industrial physicians, for example, on preventing lifestyle diseases
- Mental healthcare education and counseling for managers



Safety and Health Committee meeting



Mental health seminar

Labor Accident

As in the previous fiscal year, no accidents leading to absence from work were reported in the Anritsu Group in Japan during fiscal year 2012. At the end of March 2013, Anritsu Corporation in Atsugi reached a record of 14.04 million labor-hours without any accidents, and as of the publication of this report, the record of no accident performance continues.

Frequency Rate of Lost-worktime Injuries (per million hours)

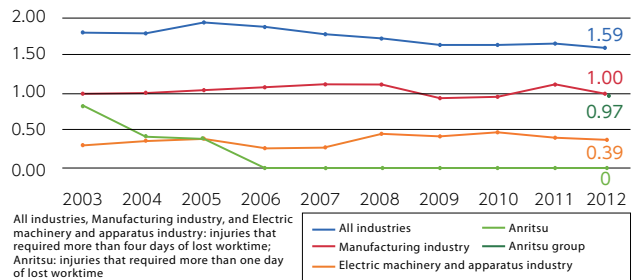

Seminars and Lectures in Anritsu

In fiscal 2012, four commuting accidents occurred in the Anritsu Group in Japan, a decrease from the five incidents in fiscal 2011. As in the previous year, however, sporadic accidents occurred while commuting by bicycle. In view of the prevailing public trend toward requiring bike riders to comply with traffic rules, we developed training programs aimed at preventing accidents, such as traffic safety seminars, in cooperation with the Atsugi Police Department. These programs focus on traffic laws and measures to prevent accidents specifically for bicycle riders. Meanwhile, the ratio of abnormalities found in regular health checkups for Group employees in Japan continues to steadily increase in line with the national trend, centered on lifestyle-related categories such as liver function and fats. In fiscal 2012, our industrial health staff offered guidance for individual employees based on health checkup results. We also promoted health education opportunities, such as lectures by industrial physicians on preventing lifestyle diseases.



Traffic safety seminar



Lectures by industrial physicians

Overseas Topic (OHSAS 18001 Certification)

In May 2012, Anritsu EMEA Ltd. in the United Kingdom obtained certification for OHSAS 18001 (2007 version), the international standard for labor safety and health. These standards for management practice comply with labor standard laws and regulations in various countries and mandates companies to effectively oversee labor safety and health. The objective is to raise the level of labor safety and health as well as labor productivity and the overall awareness of labor safety.



Basic Concept

Anritsu contributes to society through its business operations while at the same time pursuing activities that benefit the development of the local community as a corporate citizen.

Community-based social contribution programs are at the center of these initiatives under the three pillars of partnerships for educating youth, contributing to local communities and protecting the environment (biodiversity conservation), and we carry out activities that our employees can participate in continuously.

Partnerships for Educating Youth

■ Kanagawa Science Summer Sponsored by Kanagawa Prefecture

With the encouragement of the Kanagawa Environmental Conservation Association, Anritsu participated in the 12th "Kanagawa Science Summer" event organized by Kanagawa Prefecture. In cooperation with the association, we focused on the environment and manufacturing. Our program consisted of a talk and a "Let's Make a Radio – Children's Science and Environment Class," designed to familiarize children with wireless technology through building a radio. The one-day event was held during the children's summer vacation and attended by 36 participants comprising 18 Kanagawa Prefecture elementary school children each paired with a parent.



Kanagawa Science Summer

■ Fun Science Laboratory Sponsored by the Atsugi City School Board, Kanagawa Prefecture

There has been a growing concern with regard to young people's waning interest in science. At the suggestion of the Atsugi City School Board, Anritsu has offered "Fun Science Laboratory" at neighboring elementary schools since fiscal 2007 with the aim of raising children's interest in science through a variety of experiences. In fiscal 2012, we explained the basics of electricity in lectures entitled "How to Generate Electricity" and "What is a Battery?" We also conducted science experiments to demonstrate the mechanism of a battery in order to stimulate further interest. Many of the participating children told us the event had been exciting and fun.



Fun Science Laboratory

■ Workplace Experience for Junior High School Students

For many years, Anritsu has supported local educational programs that offer junior high school students the opportunity to experience actual work at companies and stores in the community. In fiscal 2012, we received requests from two neighboring schools.

A workplace experience at Anritsu took place at the recycling center of Anritsu Kousan Co., Ltd., where students disassembled personal computers and also learned how to sort equipment components by material. We also provided environmental training on recycling.



Workplace Experience

Support for Youth Sports Competitions

■ Anritsu Cup Atsugi City Invitational Boys' Soccer Competition

Anritsu Corporation has been supporting the annual Atsugi City Boys' Soccer Competition held in February since 1995, Anritsu's centennial year. This year, 32 teams participated. Following a flurry of brilliant plays, the local team was thrilled to win the competition for the first time in nine years.



City Boys' Soccer Competition

■ Supporting the Atsugi City Kids' Softball Competition

Anritsu Corporation has been supporting the Anritsu Cup Atsugi City Kids' Softball Competition since fiscal 2011. This year, 14 teams competed in the fall rookies' tournament and blew away the chilly December weather with their enthusiasm.



Atsugi City Kids' Softball Competition

■ Anritsu Cup Dodge Ball Competition

Anritsu Corporation co-sponsored the 1st Anritsu Cup Dodge Ball Competition in fiscal 2012, with 16 teams taking part in the heated event. Anritsu Group employees also participated as team coaches in the sports competition, which is deeply rooted in the local community.



Dodge Ball Competition

Contributing to Local Communities

Collaborating with the Local Community

Anritsu Corporation is headquartered in the Amadera Industrial Park and is a member of the Amadera Industrial Park Council. Anritsu heads the council's environmental committee and participates in the quarterly cleanups of the Amadera region and biannual plastic bottle cap collections in collaboration with other members in the area.

Collecting Plastic Bottle Caps

The Anritsu Group in Japan collects plastic bottle caps in collaboration with the Amadera Industrial Park Council. The caps are sold as resin material with the proceeds used to purchase polio vaccines. This year, proceeds from the combined total of caps collected by the Anritsu Group and the Amadera Industrial Park Council were used to donate 650 doses of the vaccine.



Collected caps

Autumn Camp in Konan 2012

Radioactive contamination in Koriyama City has been preventing children from playing in the open air. The Koriyama PTA Federation and the Kindergarten PTA Federation organized an autumn camp where the children could play all day long. The Anritsu Group fully supported the event, which was organized by Koriyama City, the location of our Koriyama Business Office and Tohoku Anritsu Co., Ltd. We also co-sponsored the event with Save the Children Japan, Consumers Cooperative CO-OP Fukushima and Ryohin Keikaku Co., Ltd. A total of 24 people including Anritsu employees and workers from partner companies assisted with preparations and provided support for the day's activities.



Autumn Camp

Issuance of a Fire Company Supporter Business Sign

A Fire Company Supporter Business sign was issued to the Anritsu headquarters for being a business office that actively supports the activities of the local fire company.



Fire Company Supporter Business sign

Protecting the Environment (Biodiversity Conservation)

Donating to Forest Development through the Sales of Soft Drink Vending Machines

The Anritsu Corporation headquarters in Atsugi donates part of its sales proceeds from vending machines to the Green Fund in Japan. In fiscal 2012, Anritsu raised funds equivalent to 109 Japanese spindle trees and 70 Yoshino cherry trees, also equivalent to 1,536 square meters (9,596 square meters in total) of afforestation or 518 kilograms (3,237 kilograms in total) of absorbed carbon dioxide. This year, we received a certificate of gratitude from the Kanagawa Trust Midori Foundation in recognition of our achievement.



Certificate of Gratitude received for Green Fund activities

Participating in Mt. Fuji Green Fund Afforestation Efforts

Given the significant public concern over global warming, Anritsu Group employees in Japan took part in an environmental initiative called Mt. Fuji Green Fund Afforestation, which consists of various afforestation activities, in response to an invitation by Ricoh Leasing Co., Ltd. The activities are part of an ambitious, 80-year project to restore the forest at the foot of Mt. Fuji that was destroyed by a typhoon in 1996. Employees volunteered as a contribution to improving the environment by working on the activities in November 2012. In addition, children accompanying the participants learned about the value of nature by observing animals and plants during a "Woodcraft school." Over 100 volunteers participated, eleven of whom were from Anritsu.



Group photo



Woodcraft school

Community Clean-up Efforts

Every year, Anritsu Group companies in Japan organize clean-ups of the areas surrounding the Head Office of Anritsu Corporation and Tohoku Anritsu Co., Ltd. In fiscal 2012, the Head Office of Anritsu Corporation carried it out keeping up with Amadera clean-up campaign by Conference of the Amadera Industrial Park Council. A large number of employees participated in the project by picking up litter and weeding around the company. We also participate in community environmental preservation activities and other community projects such as the Sagami River Clean-up Campaign.



Scene from clean-up work

Providing Environmentally Conscious Products that Meet Global Standards

Senior Vice President, Chief Environmental Office **Junkichi Shirono**

Anritsu products are used in countries and regions around the world and must satisfy the diverse legal environmental standards of each country as well as the requirements of each customer. We therefore believe it is highly important to both comply with global environmental laws and regulations and design and develop environmentally conscious products that meet global standards for energy efficiency, resource conservation and reduced harmful substances in each stage of the product lifecycle, from parts procurement, manufacturing, shipping, and customer use to recycling. To that end, we strive to accurately identify and reduce our environmental impact, such as CO₂ emissions, in each stage of the product lifecycle. The Anritsu Group will continue conducting environmental management to meet the expectation of all our stakeholders.

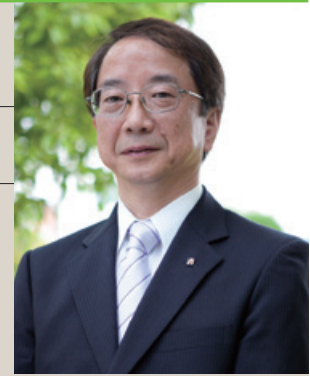

Eco Management, Eco Mind

Developing corporate environmental management group-wide, Anritsu further advances its activities toward the creation of Eco-Office, Eco-Factory and Eco-Products with Eco-Minded Employees.



The Anritsu Group's Environmental Principle

Anritsu strives to give due consideration to the environment in both the development and manufacture of our products. Through sincerity, harmony and enthusiasm we will endeavor to foster a prosperous society at one with nature.

Action Guidelines

We create Eco-Office, Eco-Factory and Eco-Products with the Eco-Mind of every one of our employees.

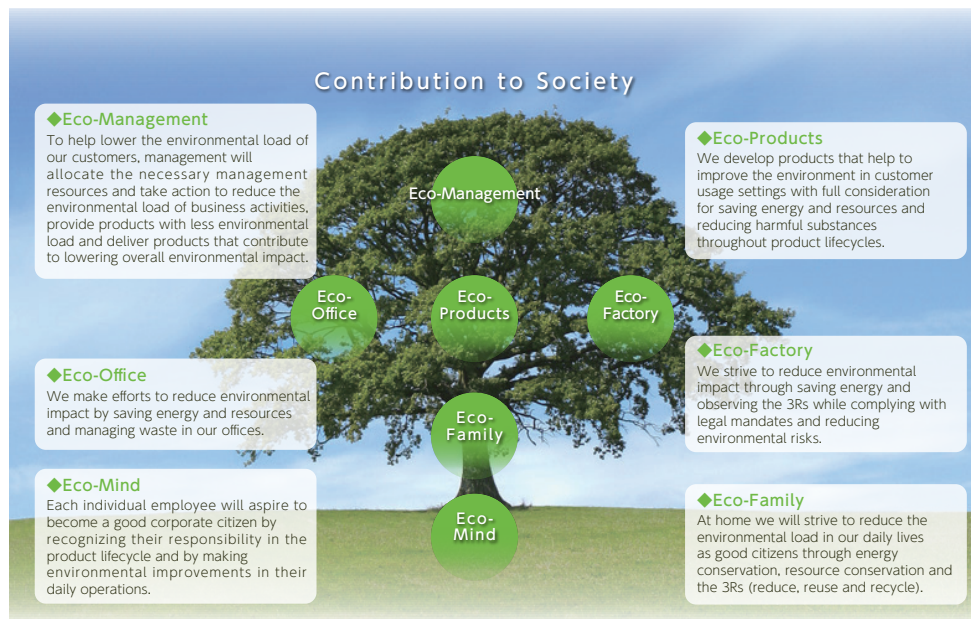

The articles in "Preserving the Global Environment" cover Anritsu Corp. and the following Group Companies:

Group Companies in Japan:	Anritsu Industrial Solutions Co., Ltd.	Tohoku Anritsu Co., Ltd.	Anritsu Customer Services Co., Ltd.
	Anritsu Devices Co., Ltd.	Anritsu Networks Co., Ltd.	Anritsu Engineering Co., Ltd.
	Anritsu Kousan Co., Ltd.	AT Techmac Co., Ltd.	Anritsu Pro Associe Co., Ltd.
Group Companies outside Japan:	Anritsu Company (U.S.A.)	Anritsu Ltd. (U.K.)	Anritsu A/S (Denmark)

Environmental Management at Anritsu

The Anritsu Group is pursuing environmental management worldwide by taking into account the entire product lifecycle using the environmental strategy illustrated in the figure. Concretely, we are focusing on four key policies : “Provision of energy/resource-saving products” and “Provision of products with reduced harmful substances” in product development; “Promotion of energy conservation” in our business operations; and “Strengthening of Eco-Mind and environmental communication,” which supports the entire strategy. We will also continue to maintain and improve the efforts of “Promotion of 3Rs (Reduce, Reuse, Recycle)” and “Reduction of chemical substances and risk countermeasures” in business activities.

In addition, we have established the Basic Rules of Biodiversity Conservation, reflecting due consideration for the relationship between Anritsu’s business structure and biodiversity. We believe implementing these rules will help mitigate climate change, the loss of habitat from overexploitation and pollution.

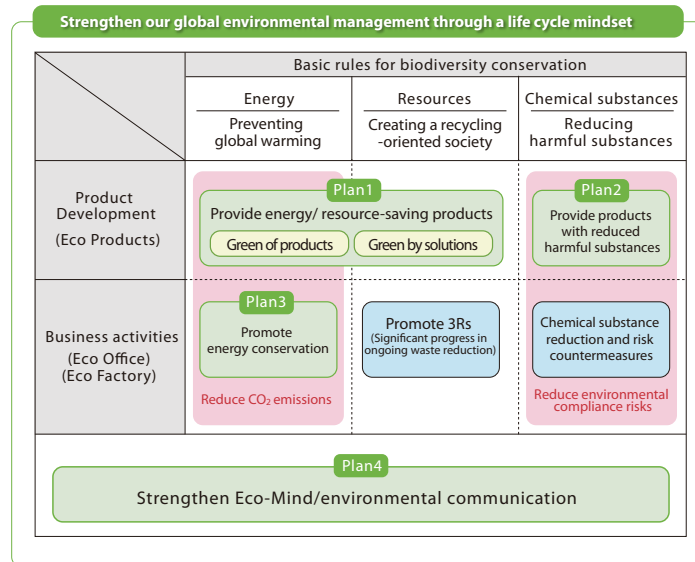

The Anritsu Group is applying a lifecycle approach to its global environmental management. We intend to reduce our environmental impact from the dual perspectives of developing environmentally conscious products that consider the entire product lifecycle and identifying and making improvements in the environmental impact of all our locations around the world.

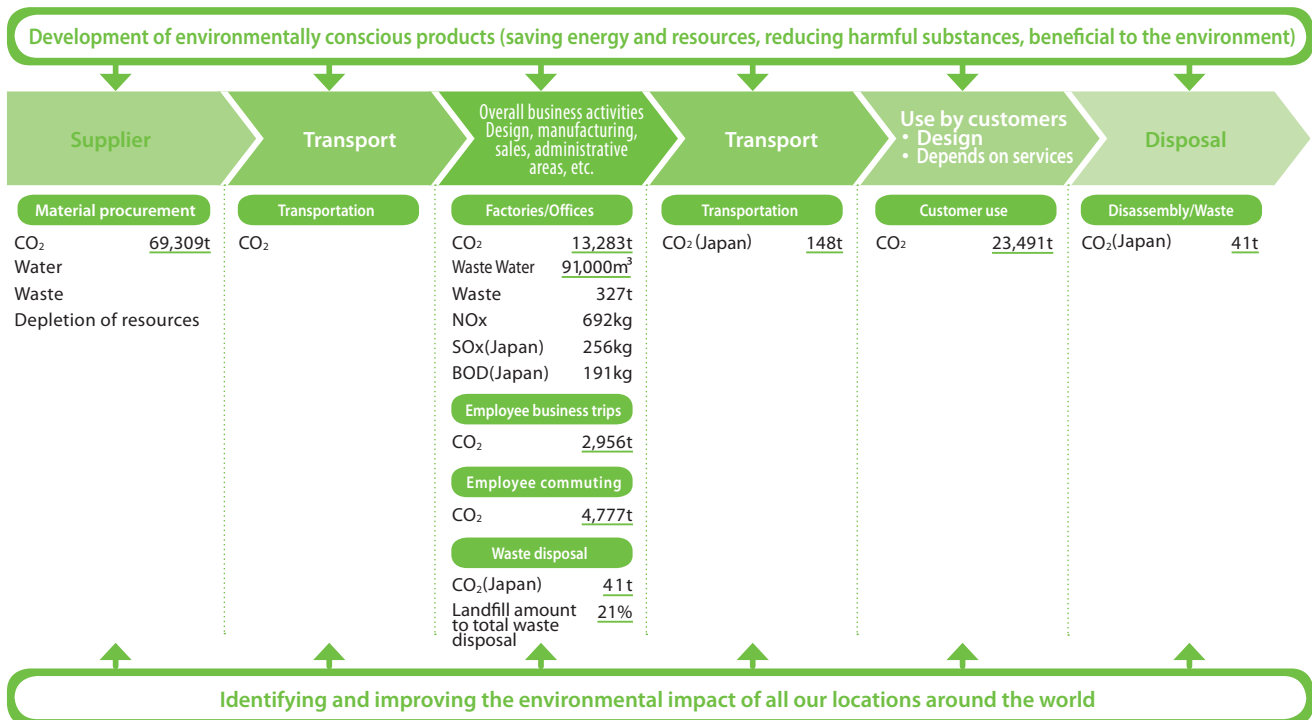

*In the diagram above, quantitative data is provided only for items for which environmental impact has been identified to date.

*Figures are calculated in accordance with the “Basic guidelines on calculating greenhouse gas emissions in the supply chain.”

*Underlined figures indicate that the scope of data collected for these items was expanded from fiscal 2011. For detailed information, please refer to the Detailed Data.

Environmental Management Promotion System

In response to increasing demand for global efforts, including responses to the European RoHS directive and the environmental expectations of customers, we reviewed our environmental management promotion system in fiscal 2005 and set up a Global Environment Management Meeting to deliberate and decide on environment-related matters. In Japan, the Environment Management Committee, Product Assessment Committee and Promotion of RoHS Group Meeting respectively promote the environmental management system, the development of environmentally conscious products and the elimination of harmful substances in products.



Environmental Management Organization (Japan)

The environmental management organization of the Anritsu Group in Japan promotes environmental management activities under the leadership of the director of environmental management (Anritsu Corporation's vice president in charge of overall environmental management).

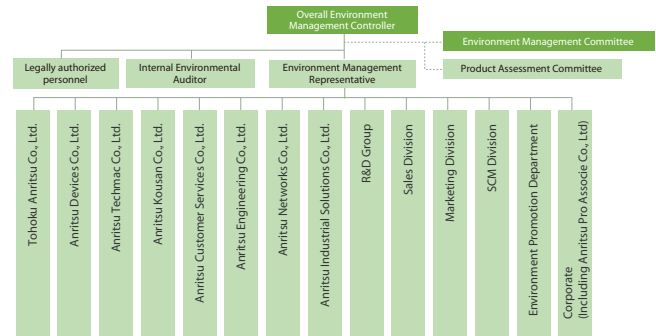

After consolidating Anritsu Device Co., Ltd. operations at the Atsugi site in March 2012, we ceased operations at the Tanasawa site. Following the opening of a new plant by AT Techmac Co., Ltd. in May 2013 (Hiratsuka City, Kanagawa Prefecture), we opened the new Hiratsuka site.



Environmental Management Systems

The Anritsu Group has established environmental management systems at major production sites in Japan and the United States and has obtained ISO 14001 certification.

Registration Company	
Anritsu Corporation(Headquarter)	
Certification Date : August 1998 Update : February 2013 Certification Organization : JQA/JQA-EM0210*	
<ul style="list-style-type: none"> · Anritsu Corporation · Anritsu Industrial Solutions Co., Ltd. · Anritsu Customer Services Co., Ltd. · Anritsu Networks Co., Ltd. 	<ul style="list-style-type: none"> · Anritsu Engineering Co., Ltd. · Anritsu Kousan Co., Ltd. · AT Techmac Co., Ltd. · Anritsu Pro Associe Co., Ltd. · Anritsu Devices Co., Ltd. · Tohoku Anritsu Co., Ltd.
*Expanded the scope of ISO14001 accreditation to include Tohoku Anritsu Co., Ltd., which independently acquired certification in October 1999.	
Anritsu Company(USA) Address : 490 Jarvis Drive Morgan Hill, CA 95037	
Certification Date : March 2007 Update : March 2013 Certification Organization : NQA/EN12275	

Environmental Audit

In fiscal 2012, we received an external environmental recertification audit including the combined assessment of ISO 9001 (quality management system) and ISO 27001 (information security management system). One item that required minor improvement was discovered.

In addition, we conducted two internal environmental audits of the conformance and effectiveness of our environmental management system and environmental performance in June and compliance status in December, resulting in 34 and 3 indications of nonconformance, respectively. We report on and improve common Group issues through the Environment Management Committee.



On-site patrol by ISO14001 certification institution

Efforts to Preserve Biodiversity

Basic Policy for Conserving Biodiversity

The business operations of the Anritsu Group benefit and influence the ecosystem supported by diverse organisms at the same time. Preserving the biodiversity which is the foundation of the ecosystem is therefore a vital concern for environmental management. The basic policy of the Anritsu Group is to encourage activities that reduce our environmental impact associated with our business operations and to preserve biodiversity through social contribution efforts that protect the natural environment.

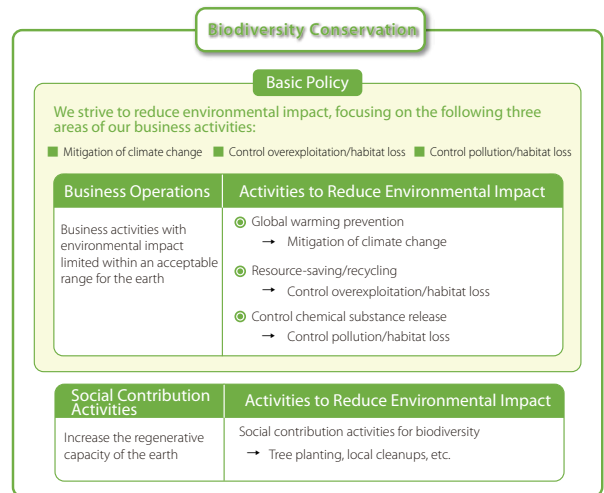

Acknowledging the Current Situation

We work to conserve biodiversity fully recognizing that the Anritsu Group's business activities enjoy various benefits from the biodiversity of the surrounding ecosystem, and that these business activities, in turn, impact biodiversity.

Biodiversity Relevance Map

We created a relevance map based on the Japan Business Initiative for Conservation and Sustainable Use of Biodiversity format to better understand the relationships between our business activities and biodiversity. The map illustrates our relationship with ecosystems and helps identify areas of major impact. The result is reflected in our Basic Policy for Conservation of Biodiversity.

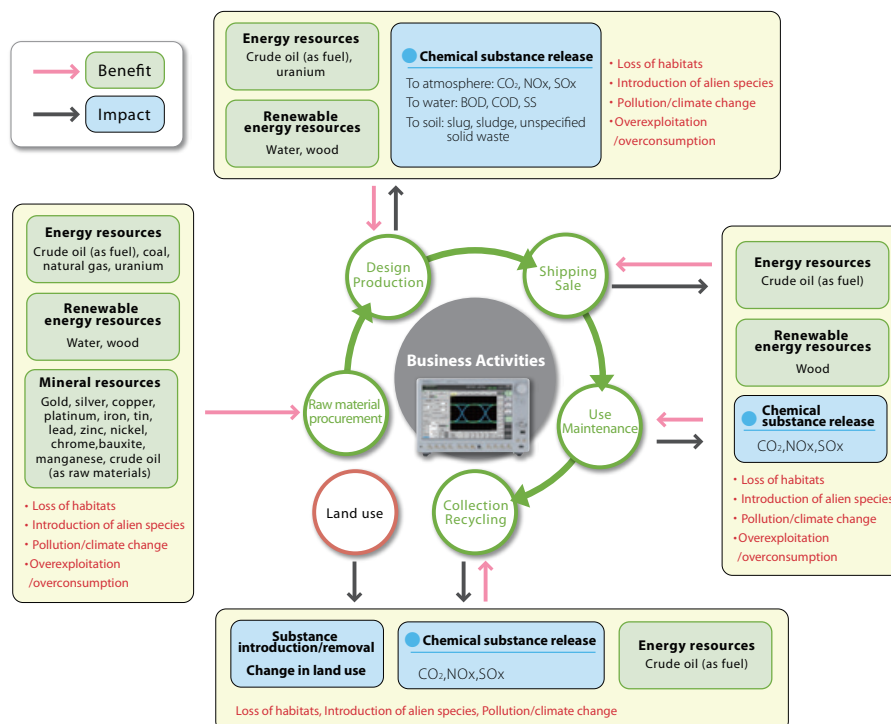

Joined Nippon Keidanren's Declaration of Biodiversity

Anritsu has endorsed Nippon Keidanren's Declaration of Biodiversity and participates as a promotion partner to exercise leadership in creating a society that values and supports biodiversity.

Environmental Education for Employees

To raise the environmental awareness of each employee and encourage them to actively engage in environmental activities, we provide general education through e-learning every year for all Anritsu Group employees as well as environmental education programs designed for each job type and rank. These programs are also attended by employees of business partners under consignment.

Educational Programs		
New employee education	Internal auditor training program	Internal auditor follow-up education
General education	Education for technology departments	Education for sales departments
Onsite consignment worker education	High-pressure gas handler courses	Chemical substances manager training



Ecological Education

Eco-Mind Survey of Employees

To measure the degree to which we share Eco-Mind awareness, we conduct a survey of all Anritsu Group employees in Japan.

In fiscal 2012, we significantly revised the survey questions and format and also changed its name from the "Environmental Awareness Survey" to the "Eco-Mind Survey." We redesigned the questionnaire based on the notion that a highly eco-minded person is someone who can act on behalf of the environment and aligned it with our environmental policy and behavioral guidelines. Questions were primarily focused on determining whether action is being taken toward creating the Eco Office (promoting conservation, promoting the 3Rs and reducing environmental compliance risks). In addition to workplace activities, we asked questions about activities at home and about participant awareness with regard to efforts undertaken by Anritsu.

"Excellent Eco-Persons," who scored above 90 points on the survey, accounted for 13.2% of the respondents. We intend to increase the ratio of "Excellent Eco-Persons" by motivating employees to participate in environmental activities through the Eco-Mind Survey and through other actions in response to survey results.

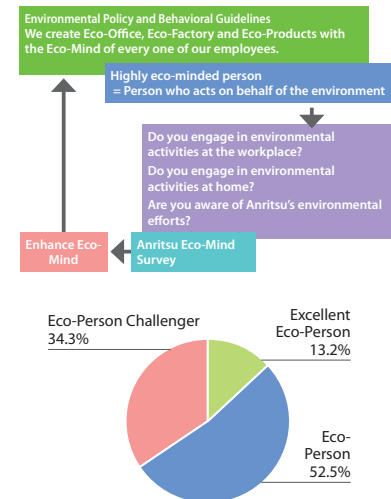

Promoting Environmental Communication

We disseminate information inside and outside the company with a firm belief in the vital importance of raising stakeholder awareness of our environmental activities and gaining their support in Anritsu's efforts to protect the global environment.

To provide environmental information tailored for each group of stakeholders, we publish an "Environment Leaflet" for customers and "Eco Club" for employees, in addition to our CSR report on the website, environmental advertisements and environment-related Web features.



Environment Leaflet for customers



Eco Club for employees

Column

We Received Our First CDP Questionnaire!

Environment Promotion Team, Environment and Quality Promotion Dept., Anritsu Corporation **Akihiko Asai**

In February 2012, Anritsu received its first questionnaire from the CDP (Carbon Disclosure Project), an international non-governmental organization based in London that requests and evaluates the content of reports from companies on measures against global warming. While we receive several questionnaires related to the environment every year, CDP's questionnaire requires in-depth responses, particularly with respect to climate change management, risks and opportunities, and volume of CO₂ emissions, and thus a wide range of environmental data must be provided.

CDP's questionnaires are sent to the top 500 Japanese companies in market capitalization, a group that now includes Anritsu. Since there are international investors behind the CDP who are waiting with great interest to closely observe how corporations respond to the issue of global warming, the names of companies that do not provide a response are labeled in the public eye as "non-responsive companies," even though the survey is not mandatory.

We had some difficulty responding to questions in the "Scope 3" category, which includes CO₂ emissions related to the use and disposal of products and CO₂ emissions associated with logistics, employee business trips and commuting, areas for which we had not collected data. All of our departments worked hard together right up to the submission deadline, but unfortunately we were only able to answer 2 of the 15 "Scope 3" questions. As a result of the evaluation, we scored 72 out of 100 points on disclosure and received a "C" grade for performance on a scale ranging from A, A-, B, C, D E, and None. We will work with Group companies and our departments to answer more of these questions and improve our information disclosure.



Energy-saving Activities at Factories and Offices

Energy conservation represents a key means for reducing CO₂ emissions associated with global warming. Anritsu is pursuing ongoing efforts to save electric power, which accounts for about 95% of its energy consumption (in crude oil equivalent). We have been conserving energy by upgrading equipment, such as ice thermal storage units, inverters for air conditioning and lighting equipment, and low-loss transformers, while replacing older models with energy-saving equipment.

In fiscal 2012, we insulated walls and windows, upgraded to inverter lighting equipment at the Atsugi site, and upgraded to high efficiency air conditioners and introduced inverter lighting equipment at the Tohoku site. Despite factors that are raising electric power consumption, such as increased production at the Tohoku site, our electric power consumption decreased by 8.9% from fiscal 2011. We will continue to work on energy conservation as a top priority of our environmental management.

Reference

We calculated CO₂ emissions resulting from the use of all energy sources at Anritsu Group companies in Japan using the emission factor provided by the Federation of Electric Power Companies of Japan for electricity, and the emission factor adopted by the Law Concerning the Promotion of the Measures to Cope with Global Warming (revised March 29, 2006) for energy sources other than electricity (the actual figure for fiscal 2011 was temporarily used as the emission factor for fiscal 2012).

CO₂ emissions associated with electric power vary each fiscal year according to the supply situation of each electric power company. Therefore, some fiscal years show an increase in CO₂ emissions, despite reductions in electric energy consumption.

Change in electric energy use (Antirsu Group companies in Japan)

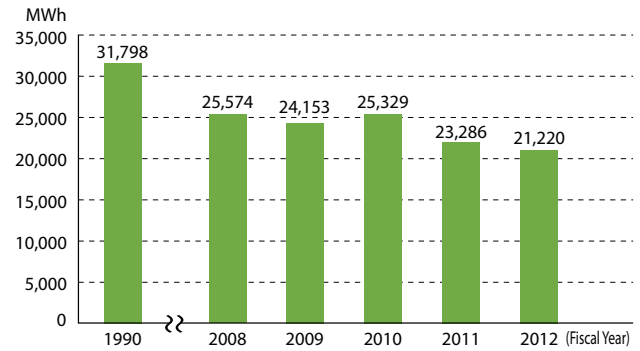

Reference CO₂ emissions from total energy use (Antirsu Group companies in Japan)

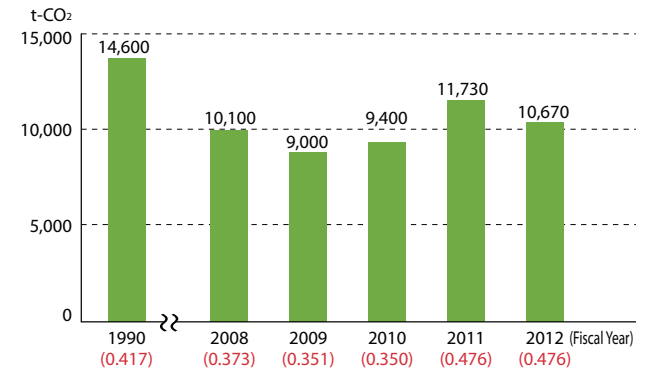

Emission coefficient by the Federation of Electric Power Companies of Japan (provisional value for fiscal 2012)

Efforts Related to Cool Biz and Warm Biz

The Anritsu Group in Japan has been involved in Cool Biz and Warm Biz since fiscal 2005. In fiscal 2012, we widened our Cool Biz period to May 7 until October 31 (from May 23 to September 30 in fiscal 2011) and to November 1 until March 31 for Warm Biz (from December 1 to March 31 in fiscal 2011). As a result, we were able to reduce electricity use compared with the previous fiscal year by 5.7% during the Cool Biz period and by 13.5% during the Warm Biz period. Major activities are listed below.

Major Activities	
Switching off unnecessary lighting	Strict management of air conditioning
Installing blinds for heat pumps	Green curtains
Cultivating awareness through a company magazine and promotional banners	Visualizing electricity use (status of real-time demand disclosed on the Intranet)

Environmental Measures Taken at Our New Factory

One grand concept behind our Koriyama Second Office was to build a safe, secure factory that also preserves the environment. The photograph shows the new factory's solar power generating facility, which has a maximum output of 200 kilowatts.

Apart from solar power generation, the new factory features insulated outer walls and windows, control of air conditioning by zone, LED lighting for all buildings, use of natural daylight, facilities for conserving energy and water, use of recycled wood, and green areas with indigenous plant species. It ranks among the world's premier examples of environmentally conscious factories.



Solar Power Generating facility of Koriyama Second Office

Compliance Status

We strive to ensure compliance by adopting voluntary management standards that are more demanding than statutory regulations. In fiscal 2012, compliance levels at the Atsugi, Tanasawa and Tohoku sites remained lower than required, with no violations in water quality, air quality or noise. We received a complaint about noise during demolition of the buildings at the Atsugi site and responded by immediately temporarily suspending the work and implementing a noise reduction effort. Looking ahead, we will further reduce our environmental impact through ongoing maintenance while maintaining full compliance.

Wastewater discharge from operations

In the past we used large volumes of water in industrial processes such as manufacturing printed wiring boards as well as coating and plating at the Atsugi site. In 2002, we have completely discontinued all these processes and dramatically reduced industrial effluent containing harmful substances. Although we use alkaline cleaning solutions for the degreasing equipment at the Hiratsuka site, all the water is disposed as industrial waste, leaving no wastewater discharge from operations. In addition, water used for rinsing equipment is circulated between filters and ion-exchange resin equipment so it can be reused as rinse water as part of our efforts to reduce water use and waste. No facility at the Tohoku site currently uses harmful substances.

■ Wastewater discharge from operations

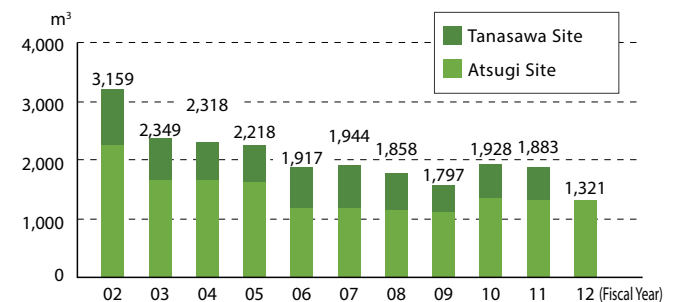

Atsugi Site : Atsugi City regarding discharge into public sewage systems

Item ^{*1}	Emission standard [mg/l]		Measured value [mg/l]		
	Regulation value	Voluntary control value	Average	Min.	Max.
pH	5.0-9.0	5.7-8.7	7.5	7.0	8.0
SS	600	300	8.0	< 2.0	35.0
BOD	600	300	4.8	1.1	21.0
Normal hexane extracts Mineral oil	5	3	< 1.0	< 1.0	1.0
Normal hexane extracts Organic oil	30	18	< 1.0	< 1.0	1.0
Iodine consumption	220	90	1.8	< 1.0	2.5
Fluorine	8	4.8	0.9	0.2	1.7
Total cyanide	1	0.4	< 0.01	< 0.01	< 0.01
Nitrogen	380	125	0.8	< 0.2	4.3
Boron	-	-	-	-	-
Chromium	-	-	-	-	-
Dissolved iron	10	4	0.15	< 0.05	0.60
Copper	3	1.2	< 0.05	< 0.05	< 0.05
Zinc	2	1.2	0.10	< 0.05	0.20
Dissolved manganese	-	-	-	-	-
Nickel	1	0.6	< 0.05	< 0.05	< 0.05
Lead	0.1	0.06	0.01	< 0.01	0.03

Tohoku Site : regulations by Fukushima Prefecture

Item ^{*1}	Emission standard [mg/l]		Measured value [mg/l]		
	Regulation value	Voluntary control value	Average	Min.	Max.
pH	5.8-8.6	6.0-8.4	7.3	7.1	7.5
SS	70	30	3.6	1.1	4.5
BOD	40	20	6	1	10
Dissolved iron	10	4	Below the detection limit (0.05mg/l)	(⁻)	(⁻)
Copper	2	0.8	0.01	(⁻)	(⁻)
Zinc	2	1.2	0.1	(⁻)	(⁻)
Nickel	2	0.8	Below the detection limit (0.01mg/l)	(⁻)	(⁻)
Lead	0.1	0.08	Below the detection limit (0.05mg/l)	(⁻)	(⁻)
Number of colon bacillus (piece/m ³)	3000	2400	0	0	0

*1 Items subject to the laws and regulations but excluded from this list were not used as raw materials and therefore not measured.

*2 There is no max. or min. records as survey is conducted only once a year.

Prevention of Air Pollution

Having eliminated the coating process in 2000, no facility at the Atsugi site generates air pollution subject to legal regulations. The Tohoku site operates heavy oil boilers subject to the Air Pollution Control Law. The boilers are operated on a voluntary management standard to control air quality. No facility at the Hiratsuka site generates air pollution subject to legal regulations.

Tohoku Site : Air Pollution Control law

Item	Emission standard		Measured value
	Regulation value	Voluntary control value	
Smuts [g/m ³ N]	0.3	0.18	below the detection limit (0.005mg/l)
Sulfur oxide [m ³ N/h]	4.37	2.63	0.05
Nitrogen oxide [ppm]	180	170	93

 Environmental Data of Each Site

Noise

We are implementing a variety of efforts to detect abnormalities at an early stage, including a system of prior examination before introducing equipment, equipment inspections at the beginning of every operation and regular patrols on the premises.

We also regularly monitor noise levels at borders every year. Results show that measured noise levels not only meet legal standards but fall below our own voluntary standards as well.

Prior to the start of operations at the Hiratsuka site, there was a noise risk in part of an area used for plate processing. We addressed the issue by moving particularly noisy equipment to a soundproofed room. We also found that the noise level of an exhaust vent was near the upper limit of our voluntary standards and promptly took action, which included the use of a noise reducing cover.

Exhaust vent with a noise reduction cover



Soundproofed room

Atsugi Site : regulations by Kanagawa Prefecture

Measured point	Regulation value [dB] [daytime]	Voluntary control value [dB] [daytime]	Measured value [dB] [daytime]
At the eastern border line	70	68	60
At the western border line	70	68	55
At the southern border line	70	68	52
At the northern border line	70	68	60

Touhoku Site : regulations by Fukushima Prefecture

Measured point	Regulation value [dB] [daytime]	Voluntary control value [dB] [daytime]	Measured value [dB] [daytime]
At the eastern border line	75	73	47
At the western border line	75	73	50
At the southern border line 1	75	73	60
At the southern border line 2	75	73	51

Hiratsuka Site : regulations by Kanagawa Prefecture

Measured point	Regulation value [dB] [daytime]	Voluntary control value [dB] [daytime]	Measured value [dB] [daytime]
At the eastern border line	65	64	60
At the western border line	65	64	48
At the southern border line	75	73	63
At the northern border line	75	73	50

 Environmental Data of Each Site

Groundwater Management

With regard to organochlorine substances, we completely eliminated the use of trichloroethylene in 1970 and 1,1,1-trichloroethane in 1993. The Atsugi site draws groundwater from its own well and therefore continues to monitor water quality, including regularly testing for the presence of six organochlorine substances.

In fiscal 2012, levels of tetrachloroethylene were higher than permitted under environmental standards. Anritsu, however, has never used this substance, and soil analysis has confirmed that we were not the cause of the contamination. We will nevertheless continue to monitor the site.

Atsugi Site

Item	Environmental standard level [mg/l]	Measured value [mg/l]
Trichloroethylene	0.03	0.004
Tetrachloroethylene ^{*1}	0.01	0.081
1,1,1-trichloroethane	1	< 0.0005
1,1-dichloroethylene	0.1	< 0.002
Dichloromethane	0.02	(⁻²)
Cis-1,2-dichloroethylene	0.04	0.016

*1 Tetrachloroethylene surpassed acceptable level, but Atsugi site has never used it.

*2 Results for fiscal 2008 were below the detection limit (0.002 mg/l) and therefore not measured.

 Environmental Data of Each Site

Risk Countermeasures

The Atsugi site operates an inorganic wastewater treatment facility to detoxify wastewater from inorganic wastewater release section and other corporate sources. In 2001, we converted the facility to a double-tank system to address the risk of soil contamination from the leakage of untreated water that could result from the destruction of a buried tank during an earthquake. In 2002, we constructed a breakwater around a clarifier tank (a part of the facility for removing the heavy-metal containing sediment generated in the preceding process through gravitational sedimentation) to modify the structure so that any liquids leaking from the tank, as a result, for example, of damage from an earthquake, would flow into a reserve tank rather than leaking outside. At the Tohoku site, water could be discharged from boilers in the event of an earthquake, for example, at pH levels that exceed regulatory standards; we therefore implemented countermeasures by installing a pH monitor and an emergency cutoff valve to stop water discharge. In addition, each site has developed response procedures to address the potential leakage of chemical substances due to human error or natural disaster.

Regular equipment inspections and training are also conducted in preparation for unexpected events.



Clarifier

Water Resources

We have been reducing water use at the Atsugi site over the years through efforts such as monthly leakage inspections, upgrading to water saving toilets and using circulated water in facilities. We will continue to use water effectively.

■ Water consumption (Anritsu Group in Japan)

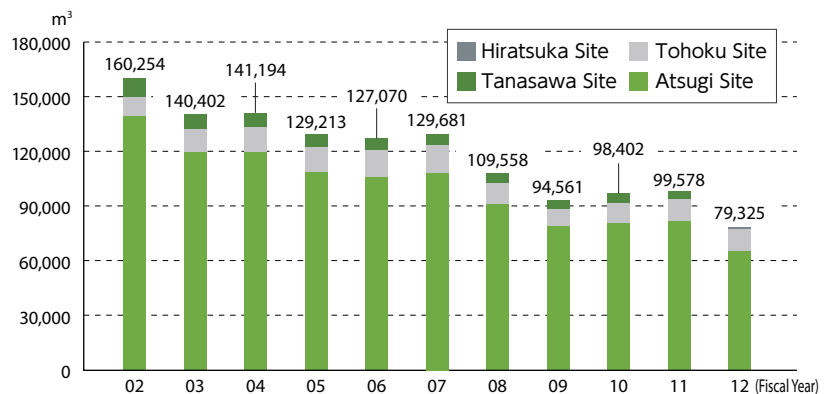

Chemical Substances Management

Utilization of chemical substances by the Anritsu Group companies in Japan is determined through a prior assessment system.

Substances banned from use or limited are selected in consideration of legal regulations and hazardousness, and we regulate the substances that cause ozone layer depletion and global warming. Each department inputs into a computer database the amounts of chemical substances purchased, used and disposed within a three-month period in order to compile statistics of the entire company for each law regarding chemical substances, including those covered by the Pollutant Release and Transfer Register (PRTR) Law.

The number of substances subject to the PRTR (Pollutant Release and Transfer Register) Law and handled at our sites changed significantly due to a revision of the law that excluded from the list liquid bisphenol A epoxy resin, an ingredient used at the Atsugi site, while adding new ingredients, including methylnaphthalene, which is an additive agent, to heavy oil used as fuel at the Tohoku site. More than one ton of methylnaphthalene was handled at the Tohoku site in fiscal 2012 and reported accordingly. Because it is burned in a boiler, very little methylnaphthalene is externally released; nevertheless, we will reduce the amount we handle by reducing our use of heavy oil.

More than one ton of methylnaphthalene was handled at the Tohoku site in fiscal 2012 and reported accordingly. Because it is burned in a boiler, very little methylnaphthalene is externally released; nevertheless, we will reduce the amount we handle by reducing our use of heavy oil.

PCB Management

At the Atsugi site, we tightly control condensers of electric devices, fluorescent ballasts and pressure sensitive copying paper that contain polychlorinated biphenyl (PCB) within the storage standards for specially controlled industrial waste. Storage status is reported annually to the prefecture under the Law concerning Special Measures for Promotion of Proper Treatment of PCB Waste. In 2006, analysis conducted while upgrading an extra high-voltage transformation installation identified a small amount of PCB in two large transformers. In the course of replacing transformers in 2010, we identified a small amount of PCB in the insulation oil of decrepit equipment and issued an additional notification in June 2011. In 2005, we filed an early request for the treatment of PCBs with the Japan Environmental Safety Corporation.

Waste Reduction

We have carried out education to achieve zero emissions* so that each employee promotes the 3Rs as a company-wide activity, and practice thorough separation of waste collected in our offices and product lines.

As a result, the Anritsu Group in Japan achieved zero emissions in 2004.

The amount of waste has been reduced almost to the minimum, and we are currently working on maintaining this level as an annual goal.

*Zero emissions: Recycling all waste. Anritsu defines this as achieving a final landfill disposal rate of less than 0.5%.

Examples of separate collection of waste

By thorough classification collection, we are working to reduce waste.



Use Regulates Chemical Substances of Anritsu Group	
Banned substances	Class of 7 substances: CFC (Chlorofluorocarbons), halon, arbon tetrachloride, 1,1,1-trichloroethane, HBFC (Hydrobromofluorocarbons), bromochloroethane, methyl bromide
Limited-use substances	Class of 7 substances: HCFC (Hydrochlorofluorocarbons), trichloroethylene, tetrachloroethylene, dichloromethane, HFC (Hydrofluorocarbons), PFC (Perfluorocarbons), SF6(sulfur hexafluoride)

Chemical Substances Management under PRTR Law

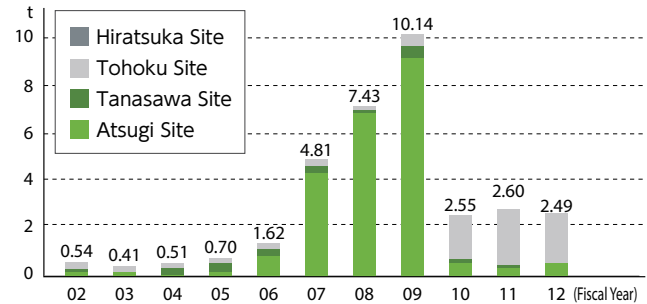

The amount of waste by type (Anritsu Group companies in Japan)

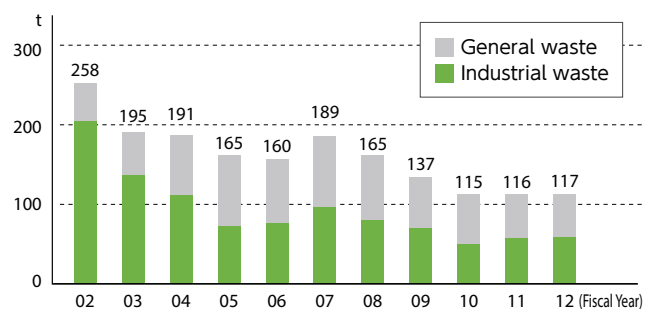

Waste reduction through the introduction of earthworm farm

We have promoted the reduction of waste by introducing an earthworm farm that decomposes leaves and weeds.

By earthworm farm introduction, we have reduced approximately 5 tons of waste a year since fiscal 2009. In addition, humus broken down by an earthworm farm becomes a fertilizer which is rich in nutritive value. We have been utilizing it effectively at the company to grow a green curtain of bitter gourds and sunflowers.

Eco-Logistics

■ Overview of Eco-Logistics

- **Delivery** : The carrier takes out the product from a returnable box and delivers it to the place customer has designated. After delivery, the returnable box is brought back by the carrier.
- **Pick up** : The carrier picks up the product after they wrapped with the packaging materials they brought by themselves.
- **Response to carrier** : We maintain transport quality by conducting in-depth discussions between carrier and Anritsu to build a safety system on transport.

■ Comparison of conventional cardboard packaging with Eco-Logistics

	Conventional cardboard packaging	Eco-Logistics
At delivery	Customer needs to dispose a lot of packaging materials. : A large amount of waste. : Cost of waste disposal will be expensive.	Customer needs to dispose only a few packaging materials. : Small amount of waste. : Enable to reduce the cost of waste disposal.
At pick up	Customers package by themselves with the packaging materials sent by Anritsu. : Customer's product packaging operation occurs. : New packaging materials are required. = Waste occurs.	Carrier picks up the product after wrapping it with their packaging materials. : Customer's product packaging operation becomes unnecessary. : New packaging materials are unnecessary. = Waste reduction.

■ An example of delivery

The product is first covered with polyethylene bag to prevent from scratches and dust, and then packaged in returnable box. The product and attached equipment box are packaged as in the left picture.



Carrier removes the product from the returnable box.



The product and attached equipment box are delivered to customer, covered with polyethylene bag for protection. Invoice is attached to the product. After delivery, carrier brings back the returnable box and packaging materials.



■ Reduction of packaging material waste.

For returnable box, customer only needs to dispose the polyethylene bag that covers the product.

Comparing the traditional cardboard packaging with returnable containers, waste emissions by packaging materials for customer will be greatly improved, which is about 94% reduction by weight. (Assuming that returnable box is used 20 times)

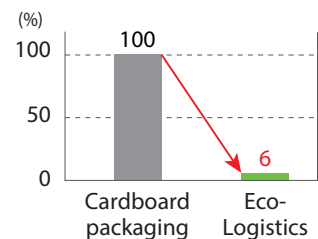

Recycling Center

Anritsu led the measuring instrument industry in establishing the Recycling Center at Anritsu Kousan Co., Ltd., in 2000. Anritsu Kousan obtained a license to engage in the industrial waste disposal business in September 2002 and started operating in fiscal 2003.

The Recycling Center has been rigorously separating waste since fiscal 2005. Once completely sorted, all waste emitted from the Recycle Center is recycled.

The Recycling Center also promotes the reuse and refurbishment of used products.

Refurbished measuring instruments are products used for demonstration. Although these products are recycled, they are highly reliable after being reconditioned and calibrated by Anritsu, the original manufacturer, and are provided with a one-year guarantee. Anritsu Kousan, acting as a sales agent, sells the products to universities and other educational institutions in Japan, thus extending the lives of the products.

■ Recycling System

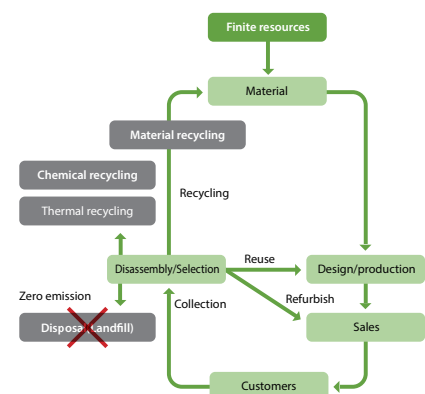

Eco Products Development

Based on the lifecycle concept, Anritsu is promoting environmental efforts across the product lifecycle, from product design, parts procurement and manufacturing to shipment, customer use and recycling. To accelerate the provision of environmentally conscious products as a pillar of environmental management, Anritsu is actively pursuing efforts whereby it utilizes its own technologies to comply with environmental regulations around the world and conducts high-quality product assessment from the early design stage of every product's development.



Complying with Product Environmental Regulations Worldwide

The European Union (EU) enacted the WEEE Directive in 2005, the RoHS Directive in 2006, the REACH regulations in 2007 and the ErP Directive in 2009. Environmental regulation of products centered on the EU has been expanding throughout the world. Moreover, product environmental regulations now require prompt response. Communication, information sharing and the unified response of Group companies outside Japan are facilitated by the Global Environment Management Meeting, for example.

Global Product Assessment Implementation Guidelines

The development of environmentally conscious products has been conducted separately as product assessment in Anritsu Group companies in Japan and as DfE (Design for Environment) in Anritsu Company (U.S.A.). Anritsu established global product assessment standards and global product assessment implementation guidelines to integrate these methods so that Anritsu Group companies could develop environmentally conscious products within a unified, global standard in 2008. In fiscal 2012, we responded to environmental regulations and customer requirements by revising the product assessment criteria for the Anritsu Group in Japan.

Operational Procedure

Global product assessment (target setting, design review, and evaluations) is incorporated into the product development process (including target setting, test production and evaluation) prior to commercialization. To ensure objective and responsible product assessment, Anritsu conducts third-party evaluation by the Quality Management Department and other entities, and initiates follow-up actions if targets have not been achieved.

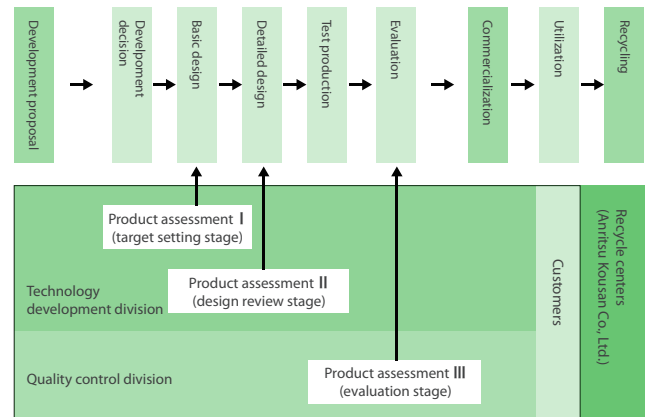

* Follow-ups are conducted as needed at each stage of product assessment.

Evaluation Items

Evaluation items in the global product assessment cover basic factors such as improvements in volume, mass and power consumption against a reference product. Additional items for evaluation include resource savings and the reduction of harmful substances and overall environmental impact throughout production, physical distribution, use and disposal.

Resource saving; Reduced load during manufacturing	<ul style="list-style-type: none"> -Reduced volume and mass -Adoption of reusable or recyclable components -Expanded functionality and longer operating life -Use of recycled paper for operation manuals -Reduction of consumable supplies -Reduction of surface treatment -Reduction of difficult-to-process materials
Reduced harmful substances	<ul style="list-style-type: none"> -Elimination of banned substances in products -Reduction of substances subject to RoHS Directive -Compliance with RoHS Directive -Reduction of other harmful substances
Reduced load in physical distribution	<ul style="list-style-type: none"> -Reduction of packing materials -Use of recycled paper for packing materials -Ease of transport after collection
Reduced load during use	<ul style="list-style-type: none"> -Reduced power consumption during operation -Inclusion of a standby mode -Designed to lower power consumption -Clear instructions on power-saving functions
Reduced load at time of disposal	<ul style="list-style-type: none"> -Fewer parts -Reduced use of difficult-to-recycle materials -Designed for easy dismantling and disassembly -Identification of the material on resin components -Reduced variety of materials and use of common materials -Recycle labeling on batteries -Response to WEEE Directive -Response to Chinese RoHS

Eco Product Program

Environmentally Conscious Products

Anritsu Group certifies the Excellent Eco Product and Eco Product as environmentally conscious products based on the results of global product assessment.

● Excellent Eco Product :

Product that meets Excellent Eco Product requirements

● Eco Product :

Product that meets Eco Product requirements

● Assessed Product :

Product that meets Assessed Product requirements

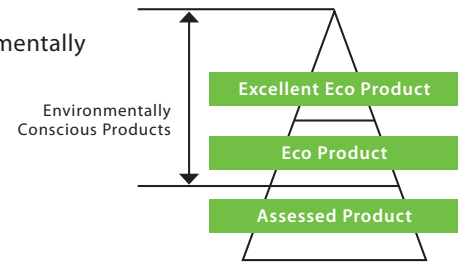

Major Environmentally Conscious Criteria for Excellent Eco Products

- Top industry ranking for environmentally conscious properties
- Environmental information ready for disclosure
- CO₂ emission evaluated by Life Cycle Assessment (LCA)
- Environmental management system in place at the relevant business entity and main production site

In the Excellent Eco Product, environmental information on the mark and the product is described in parallel in the catalog etc.

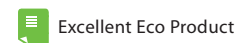

Excellent Eco-Products Recognized in Fiscal 2012

Saving Space and Electricity by Measuring Four Test Modules Simultaneously

Product Development Department, R&D Division, Anritsu Corporation **Yasunori Yamada**

The universal wireless test set MT8870A is a measuring instrument developed specifically for mass manufacturing communication modules. It can accommodate up to four transmitter/receiver test modules, enabling the simultaneous measurement of four test devices, such as mobile phones, smartphones and modules assembled into phones. By doing this we contribute to raising the productivity of terminal manufacturers.

There is demand from customers who want to measure as many terminals as possible within a short span of time. We therefore developed a product that is capable of simultaneously measuring four test devices packed into the same size unit as our conventional products, which required significant downsizing. We were able to reduce the number of circuits by limiting the functionality of the product to production-line adjustments and mobile terminal inspection. We also managed to significantly reduce the number of parts and power consumption by using the latest FPGA to integrate the digital circuits. As a result, we reduced volume by 50%, mass by 50% and power consumption by 60% compared to conventional products.

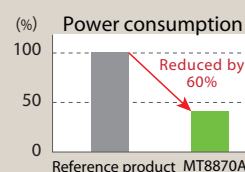
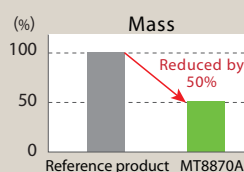
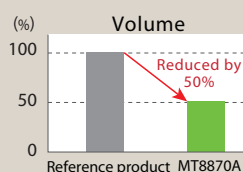

Universal wireless test set
MT8870A

Excellent Eco-Products Recognized in Fiscal 2012

The KLS5421A Solder Paste Inspector is installed in the latter portion of cream solder printers on the mounting line for electronic components. The system conducts pass-or-fail inspection by quantitatively measuring aspects of the cream solder on printed circuit boards (height, volume and area). It offers highly accurate measurement by spot-irradiating targets using laser beams from two angles to scan the printed cream solder while accurately reproducing even minute solder shapes as a 3D profile.

To convert it into an environmentally conscious product, we worked to streamline the assembly process by reducing excess parts and maintaining a simple structure while also cutting costs. Concrete actions included integrating multiple circuit boards, reducing the length of excess cable after reviewing parts configuration and cable wiring, optimizing structural parts by using thinner sheets and simplifying the shape of parts while also satisfying strength requirements, and using fewer parts to reduce weight and size. This enabled us to reduce mass by 6%, volume by 46% and power consumption by 11% compared with conventional products. Moreover, a more efficient use of space made it possible to extend the measurable size of the circuit boards by 50 millimeters in length and width within the same-sized housing.



Solder Paste Inspector
KLS5421A

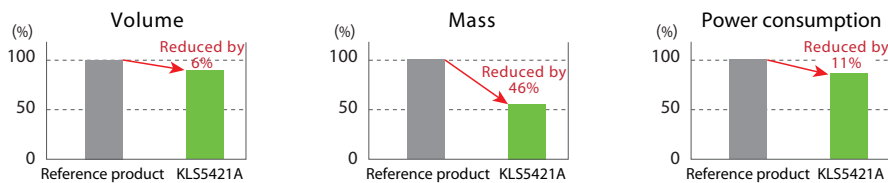

Promotion of Supply Chain Management

The provision of environmentally conscious products requires the use of parts and materials that reduce environmental impact. Within the framework of its Green Procurement Guidelines, Anritsu is working on green procurement to preferentially procure environmentally conscious parts and materials across the company.

Green Procurement

Anritsu undertakes green procurement in accordance with its Green Procurement Guidelines established in June 1999 to promote the provision of environmentally conscious products by our suppliers.

Since Anritsu Corporation's environmental partner company certification system was launched in 2001, the company has been evaluating the status of Anritsu suppliers' environmental management systems (EMS) and product assessment procedures in order to procure environmentally conscious products from greener suppliers and to encourage environmental activities in our supply chain.

In fiscal 2009, we incorporated into the system a means for assessing the management status of chemical substances in products to strengthen and improve the efficiency of supplier evaluation.

In fiscal 2011, we introduced the concept of preserving biodiversity to our activities and began implementing initiatives to deepen supplier understanding of biodiversity preservation.

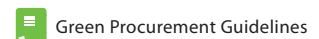

Green Procurement Guidelines

Management of Chemical Substances Contained in Products

Ensuring no harmful substances are in our products requires proper and continuing chemical substance management by suppliers and companies further upstream. To this end, the Anritsu Group in Japan has been visiting domestic and overseas suppliers since fiscal 2006 to review their systems for controlling chemical substances.

In fiscal 2012, we strengthened our incoming inspection system and revised our method for assessing suppliers to enhance efficiency.



Briefing for business partners

Group Environmental Impact Data*1 (fiscal 2012)

Anritsu quantifies its environmental impact and environmental protection activities in monetary and physical units in order to assess and upgrade the efficiency of these activities. We disclose the results to enable our stakeholders to gain a deeper understanding of our environmental actions.

The environmental impact mass balance of the Anritsu Group's global business activities is summarized below. Percentage changes from fiscal year 2011 are in parentheses.

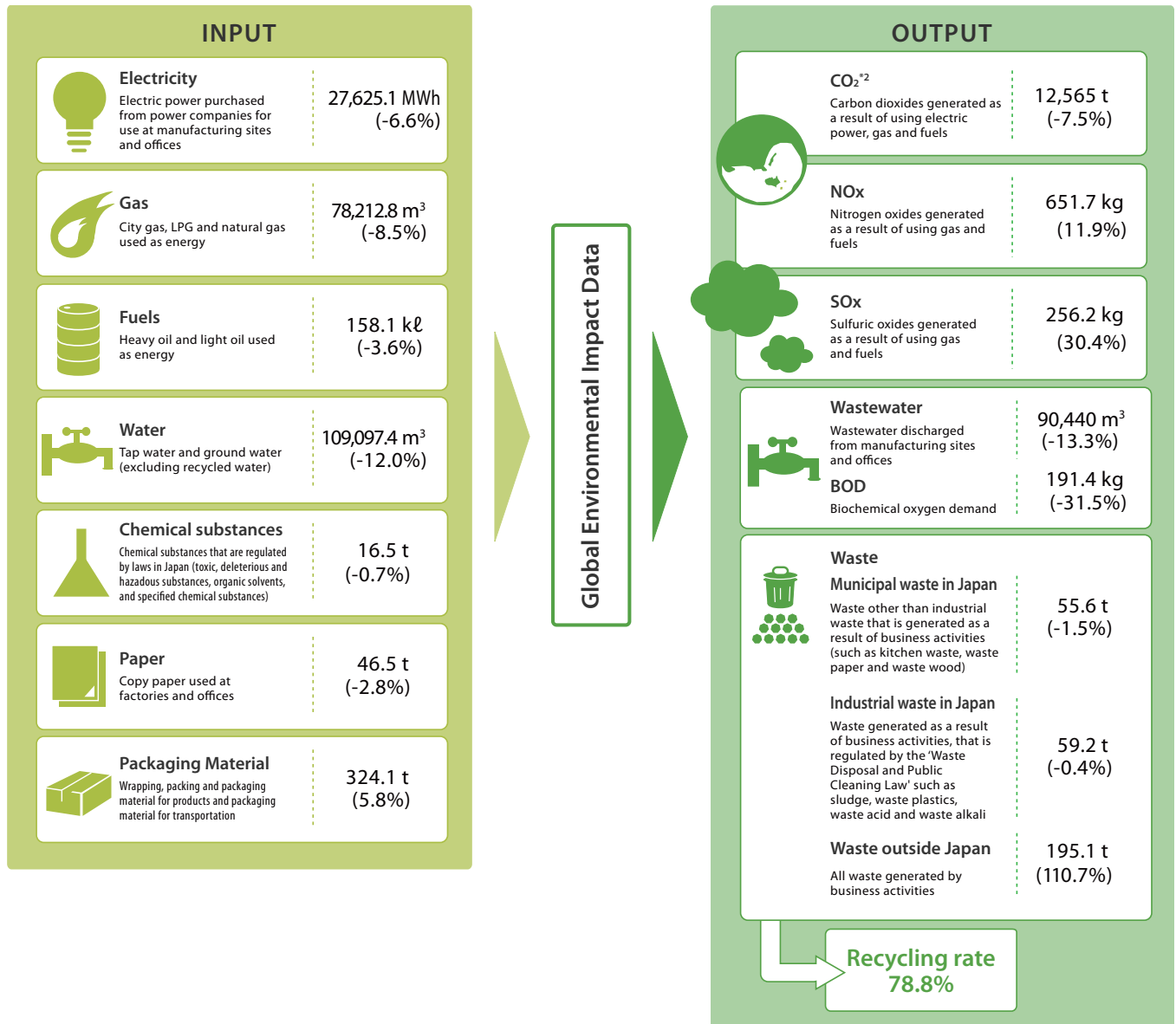

 Environmental Performance Data Sheet

For a breakdown of the data, please refer to the Environmental Performance Data Sheet.

*1 Environmental impact expressed in the form of a balance sheet in which substances entering the company are identified and listed by name and mass in one column and substances and mass exiting the company are identified and listed in the other column to more clearly display the relationship between business activities and environmental impact.

*2 Calculations for energy sources other than electricity for sites both in and outside Japan are based on the emission factor under the Act on Promotion of Global Warming Countermeasures, as revised March 29, 2006. Calculation of CO₂ emission volume from electricity use in the United States is based on the emission factor of 0.285, while CO₂ emission volume from electricity use in regions other than the United States is based on the emission factor provided by the Federation of Electric Power Companies of Japan (actual figure for fiscal 2011: 0.476).

Environmental Accounting (fiscal 2012)

In fiscal 2012, investment for environmental conservation decreased by 19.6% compared to the previous fiscal year, despite upgrades to Hf inverter fluorescent lighting and construction work to install insulation sheets for the inner walls of buildings. Costs also decreased by 8.2% as an increase in costs related to soil contamination for preventing pollution were offset by a decrease in costs for resource recycling and costs for monitoring and measuring environmental impact. The 15.1% increase in economic impact was due in part to our consistent efforts to systematically replace air conditioners with higher efficiency options and our annual energy-saving activities, such as the Cool Biz and Warm Biz initiatives.

- Aggregate scope: Anritsu Corp. and Group Companies in Japan
- Period: April 1, 2012 to March 31, 2013

Figures in brackets are the results from FY 2011

Environmental conservation cost				Benefits		
Category	Breakdown		Investment (in million yen)	Cost (in million yen)	Economic benefits (in million yen)	Environmental impact reduction benefits
Business area cost	Pollution prevention cost		0.0 [1.8]	41.0 [23.2]	146.1 [146.1]	
	Global environmental conservation cost	Prevention of global warming	17.0 [19.4]	12.3 [7.6]	135.7 [98.0]	3,346 (t-CO ₂) [1,891 (t-CO ₂)]
		Resource circulation cost	Resource recycling/ utilization activities		62.4 [95.4]	0
	Waste disposal cost			31.5 [29.5]	12.2 [9.1]	
Upstream/ downstream cost	Green purchasing/procurement cost			23.2[23.0]	38.4 [31.2]*	1,076(t-CO ₂) [643(t-CO ₂)]*
	Design of environmentally conscious products			22.3 [32.0]		
	Recycling and treatment of products, containers and packaging			0.0 [0.5]		
Administration cost	Environmental education/training			26.6 [19.5]	0	
	Operation and maintenance of EMS and internal audit			46.4 [45.8]	0	
	Environmental load monitoring and measurement cost			18.2 [32.8]	0	
	Personnel expenses for environmental management			4.9 [5.2]	0	
	Greening and upkeep of greenery			9.8 [10.5]	0	
Social activity cost	Support to community groups, environmental conservation bodies, etc.			1.2 [1.3]	0	
	Disclosure of information			8.1 [7.9]	0.0 [2.4]	
R&D cost	Research and development to reduce environmental loads			0.4 [2.0]	0	
Environmental remediation cost	Cost incurred for recovery from environmental degradation			0.0 [0.0]	0	
Total			17.0 [21.2]	308.4 [336.0]	332.4 [286.7]	
Total after the removal of Upstream/downstream cost					294.0 [255.5]	
Percentage change from FY2011 to FY 2012			-19.6%	-8.2%	15.1%	

* Estimated environmental impact reduction benefits when products are in use. Reduction of electric power: 2,261 MWh [1,837 MWh]

The Anritsu Group is gradually switching to energy-saving equipment as part of our ongoing effort to reduce greenhouse gases.

In fiscal 2012, we upgraded 798 units of fluorescent lighting to higher efficiency options based on the inverter method. We also attached switching strings to lights so they could be switched off individually. Through these efforts, we were able to achieve energy savings of around 15%.

We will continue expanding our energy-saving measures and further reduce our greenhouse gas emissions.

- Cost of upgrading to inverter fluorescent lighting: 13.3 million yen
- Reduction in CO₂ emissions: 9.0 tons/year



Inverter fluorescent lighting

History of Anritsu's Environmental Management Activities

History of Anritsu's Environmental Management Activities

2012	Ceased operations at the Tanasawa site due to the consolidation of Anritsu Device Co., Ltd. operations at the Atsugi site. Created the new Hiratsuka site following the opening of a new plant by AT Techmac Co., Ltd. (Hiratsuka City, Kanagawa Prefecture).
2011	Contributed to local communities through activities such as the Radiation Seminars for PTAs in Koriyama City, Fukushima Prefecture.
2010	Received the Kanagawa Prefecture award for meritorious service in environmental improvement (for promoting a recycling-oriented society) as a company from the Governor of Kanagawa Prefecture.
2009	Joined the promotion partners for Nippon Keidanren's Declaration of Biodiversity.
2008	Expanded the scope of ISO14001 certification to the Anritsu business sites.
2007	Wins the Kanagawa Global Environment Award 2007. Anritsu Company (U.S.A.) acquired ISO14001 certification.
2006	Wins President Award from the Atsugi Area Waste Renewal Conference. Anritsu Company (U.S.A.) wins Excellence Award for 2006 from Morgan Hill, California.
2005	Tohoku Anritsu Co., Ltd. wins an excellence award for the business division in a zero emission activity proposals contest sponsored by the Fukushima Prefectural Government. The first Global Environment Management Meeting is held at Anritsu Ltd. (U.K.)
2004	Revised "Anritsu Group Green Procurement Guidelines". Anritsu group Companies in Atsugi, Tanasawa, and Tohoku sites achieved zero emission.
2003	Integrated ISO14001 certification to include Anritsu group companies in Atsugi, Tanasawa, and Tohoku sites.
2002	Organized Environment Promotion Center unified disparate environment-related departments. Expanded ISO14001 certification to include Tanasawa Site and Anritsu group in the Atsugi area. Acquired the Industrial Waste Disposal Contractor License for Recycling Center in Japan.
2000	Anritsu Limited (U.K.) acquired ISO14001 certification. Established the Anritsu Eco-Product system. Established the Recycling Center.
1999	Published "Anritsu Green Procurement Guidelines - for product development". Tohoku Anritsu Co., Ltd. acquired ISO14001 certification.
1998	Acquired ISO14001 certification for Atsugi Site (Japan). Atsugi site was commended by the Manager of the Kanto International Trade and Industry Bureau as an excellent 'green' factory. Organized the Environmental Engineering Group in the Technology Division. Organized the Lead-free Soldering Committee.
1997	Established Anritsu's environmental policy.
1996	Joined the "Green Purchasing Network". Established the Anritsu Environment Manual. Decommissioned the facilities specified in the Air Pollution Control Act (kerosene boilers) at Atsugi Site.
1995	Received the Atsugi Site Waste Renewal Conference Chairman's Award.
1994	Reorganized the ZP Committee at Atsugi Site into the Environment Management Committee. Organized the Product Assessment Committee.
1993	Ended use of all ozone-depleting substances (except refrigerants and fire extinguishing chemicals) companywide. Organized the Environment Management Committee. Made adjustments to comply with statutory nickel-cadmium regulations. Established an environmental principle and environment management system regulations. Investigated flame retardant bromic substances and disposal methods. Organized the Energy Reduction Subcommittee.
1992	Received the Atsugi Site Waste Renewal Conference Chairman's Award.
1991	Atsugi Site received the Japan Greening Center President's Award.
1990	Started centralized purchase and distribution of chemical substances. Organized the Environment Management Section within the General Affairs Department at Atsugi Site.
1987	Constructed elevated pipelines system of inorganic wastewater processing at Atsugi Site.
1981	Atsugi Site received an Excellent Environment Preservation Award from the Kanagawa Prefecture Central Area Administration Center.
1980	Atsugi Site was commended as a Kanagawa Prefecture 'green' model factory.
1979	Atsugi Site was commended by the Kanagawa Environmental Conservation Association for its excellent environmental conservation practices.
1978	Connected waste water other than rain water to the public sewage system at Atsugi Site.
1974	Introduced an activated sludge processing facility as the kitchen drain water processing.
1970	Established the Zero Pollution (ZP) Committee at Atsugi Site.
1962	Constructed a wastewater treatment facility after opening a chemical engineering plant at Atsugi Site.

Communication with Stakeholders

Anritsu establishes partnerships by pro-actively disclosing information and dialoguing with stakeholders throughout its business activities.



Customers

Anritsu recognizes the importance of delivering prompt technical support to customers and quickly responding to complaints. The company is also establishing systems for support focused on the future and global information sharing so that it can provide safety and security to customers.

■ Mobile World Congress 2013

Anritsu participates in numerous tradeshows to deepen customer understanding of Group products. At the latest Mobile World Congress—the world’s largest tradeshow for wireless communication, held this year in Barcelona, Spain—we exhibited our measuring and monitoring solutions for LTE-Advanced, the next-generation communication standard after LTE.

Under the theme “Accelerating LTE-Advanced Development,” we presented our base station simulation functions using the MD8430A signaling tester and the Rapid Test Designer (RTD). We also demonstrated the verification functions for carrier aggregation^{*1}—the technology used for boosting communication speeds for LTE-Advanced—using a reference terminal installed with Qualcomm Inc.’s commercial chip.

*1: Technology for enhancing peak or average communication speeds by bundling multiple carrier waves to expand bandwidth.



Mobile World Congress 2013

■ Launching Our Site in India

International corporations have recently been developing facilities and investing in the Indian market to pursue development related to mobile devices and manufacturing mobile devices and base stations for use in that country. Anritsu’s local subsidiary, Anritsu India Private Ltd., has opened a branch office in Noida in the suburbs of Delhi. Noida is an important area where Anritsu’s key customers—including leading global mobile device manufacturers—are located, and many of our radio communication analyzers are being used on our customers’ production lines. We are also planning to open a service center there to provide even faster support for customers strengthening their development systems in India.



Employees at Anritsu India Private Limited

■ International Food Machinery and Technology Exhibition

Anritsu Industrial Solutions Co., Ltd. participated in FOOMA JAPAN 2012, an exhibition of technology and products related to food machinery, equipment and peripheral equipment that was held at Tokyo Big Sight last June.

We offered a demonstration in the System Exhibit Corner on detecting contaminants from raw materials using the X-ray Inspection System for chicken meat, a system we were exhibiting for the first time. In the Presentation Corner, we constructed a simulation in which visitors could directly experience production line monitoring and diagnosis, to showcase our individual barcode-based recognition technology and surveillance cameras as well as our incorporation of wireless LAN.

During the demonstrations we introduced our new X-ray Inspection System, which offers even higher sensitivity for detecting soft contaminants in products such as pasta, candy, cheese and precut vegetables.

Customers enjoyed these promotional interactive exhibits, as evidenced by the 2,564 responses we received to our questionnaire. We intend to directly apply this feedback to future product development and sales.



FOOMA JAPAN 2012

Shareholders and Investors

We are proactively disclosing information and encouraging interactive communication to more effectively meet the needs of shareholders and investors and applying their feedback to improve our business and IR activities.

Disclosure Policy

Anritsu will disclose accurate information at any time to every stakeholders with good faith and positive attitude by observing the related laws.

Action policy
1. Anritsu will disclose accurate information - in clear and plain speech - actively with timely and promptness; and - broadly with equality
2. Anritsu will place a strict control on information management and strive to prevent insider trading.

System for Investor Relation Activities

In its communications with shareholders and investors, Anritsu Corporation strives to achieve higher shareholder satisfaction by transparently conveying its corporate value in stock prices and return to shareholders. To this end, we conduct IR activities under the leadership of the IR Promotion Team of the Corporate Communication Department. Comments by shareholders and investors are shared with our Information Disclosure Committee, which includes members of management, and at the IR Promotion Meeting along with information on the participation of those responsible for IR activities in the Management Strategy Center, Accounting and Control and Legal Departments. This feedback is also used for improving information disclosure and business activities.

Recognition by External Organizations

Anritsu Corporation has been included in the portfolios of MS-SRI: Morningstar Socially Responsible Investment Index of Morningstar Japan K.K. as well as many other SRI funds. The company is also a consecutive recipient of the Award for Excellence in Internet Investor Relations awarded by Gomez and Nikko Investor Relations.

In recognition of our growth strategy and market leadership, market research firm Frost & Sullivan also honored us with the 2012 Global Frost & Sullivan Award for Company of the Year in the test & measurement category.

*As of April 1, 2013



Activities from Fiscal 2012 to the First Quarter of Fiscal 2013

Since Anritsu Corporation conducts business worldwide that does not come into direct contact with general consumers, we think it is very important to inform our shareholders as faithfully as possible of our business structure, framework for generating profits and other factors that affect our business results. Our ongoing activities include quarterly briefings for international institutional investors; roundtable conferences for shareholders after our general shareholders' meeting; annual reports, business reports and other publications; disclosure of information and shareholder/investor questionnaires on our website; and posting of IR information on external financial information sites.

From fiscal 2012 to May 2013, in addition to quarterly financial reports and an explanation of our new Mid-term Business Plan, we reported on the procurement of 10 billion yen of yen-based convertible bonds with subscription rights to share in the Euro market and an equity offering. We also responded to inquiries and comments from shareholders and investors. To expand our shareholder base we actively communicate with a broad range of investors by conducting overseas IR activities, holding briefings for individual investors, and exhibiting reference materials at IR forums



Results briefing for institutional investors



Shareholders' roundtable conference at Anritsu Gallery held after the general shareholders' meeting

Shareholder Composition (as of March 31, 2013)

Please refer to the Stock Info., Bonds and Rating page on our corporate website.



<http://www.anritsu.com/en-us/About-Anritsu/Investor-Relations/Stock-Bond-Info/Stock-Information-Bond-Rating.aspx>

Business Partners

Strengthening trust with business partners is vital to achieving mutual growth. We value forging even stronger partnerships involving the participation of our business partners in meeting society's expectations and needs through the operations of the entire supply chain.

■ Business Partner Gathering

On January 11, 2013, we hosted a business partners gathering that drew 259 representatives of 132 Anritsu business partners from Japan and overseas. We shared a progress report on initiatives related to our "2020 VISION" and our mid-term business plan, and requested their cooperation in the Anritsu CSR Procurement Guideline for building an even stronger supply chain.



Presented awards to our valued business partners

Partnerships with NGOs and NPOs

In addition to contributing to society through our business activities, Anritsu also pursues activities that support regional development as a member of the regional community. One way we provided support in fiscal 2012 in the area affected by the Great East Japan Earthquake was to work with Save the Children Japan as a sponsor of the Autumn Camp in Konan for children prevented from playing outdoors because of the disaster.

We will continue to partner in similar activities that serve the needs of the regional community.



Autumn Camp in Konan 2012

 Save the Children Japan
<http://www.savechildren.or.jp/jpnem/eng/index.html>

Employees

The increasing globalization of our businesses and diversification of work styles have raised the importance of respect for human rights and the promotion of diversity. Moreover, from the perspectives of recruiting human resources and revitalizing internal communications, we are emphasizing systems and workplace environments that allow diverse personnel to work in comfort.

■ Revitalizing Communication with Employees

"Hashimoto's Room" is a communication channel through which President Hashimoto shares information with the entire Group, including his thoughts on everyday topics as well as issues directly related to management. He imparts his thoughts, values and messages to all employees of the Anritsu Group, including his assessment of business performance, our progress on the mid-term business plan, and future strategies. The site is translated into English and Chinese and updated weekly.

President Hashimoto and other executive managers also visit Group companies in Asia, Europe and the United States, creating opportunities for direct communication with employees in each region.

Alongside these efforts, we also conduct employee satisfaction surveys to monitor how well they understand the direction of the company, the relative penetration of our corporate philosophy and policy, workplace communication, and the general sense of fulfillment at work. In fiscal 2012, we conducted surveys in the United States, the Asia-Pacific region and Japan, and we are working to identify issues faced by each region to formulate and execute plans for improvement.

■ Labor Union

In fiscal 2012, the Anritsu Labor Union celebrated its 60th anniversary. To ensure continuous growth with profit for the entire Anritsu Group, the labor union has cooperated with management while maintaining a robust organizational structure, working for the comfort and affluence of its members and contributing to society. In fiscal 2012, the union held four labor-management conferences in addition to special committee meetings and seminars for new members. It also organized a number of social events, including a potato dig and a skiing and snowboarding trip as well as a fundraiser to support earthquake reconstruction during Green Festa 2012 held at the Anritsu headquarters.



Seminars for new members



Skiing and snowboarding trip

CSR Results for Fiscal 2012, CSR Objectives for Fiscal 2013

Unless otherwise specified, the content of objectives in this table covers operations of Anritsu Corporation and its Group Companies in Japan.

Performance evaluation ○: fully attained △: attained 50% or more

CSR Goal	Key Issues	Objectives for Fiscal 2012	Results for Fiscal 2012	Evaluation	Objectives for Fiscal 2013
Goal 1 Contributing to Build a Safe, Secure, and Comfortable Society	Service for Customers	(1) Share the CS Action Guidelines. (2) Provide CS education through in-house and external lecturers. (3) Set up a customer contact point.	(1) Held a presentation in China and shared CS Action Guidelines. (2) Conducted CS training for new employees, managers and staff in charge. (3) Prepared a list of customer contact points, launched pilot CRM system.	○ ○ ○	(1) Share the CS Action Guidelines. (2) Conduct CS training in China. (3) Enhance customer support center.
	Solutions for Social Issues	Global expansion of timely communication via CSR news column.	Began global expansion of timely communication via CSR news column.	△	(1) Implement brand strategy. (2) Continue global expansion of CSR news.
	Response to Social Expectations	Identify issues and implement priority measures based on the mid-term business plan.	Designated "response to human rights issues" and "promotion of local CSR" as key strategic goals. (1) Addressed conflict minerals as a human rights issue of the supply chain. (2) Regularly confirmed progress on activities at locations outside Japan and promoted communication.	○ ○	(1) Implement global response to conflict minerals. (2) Share CSR issues with representatives in locations outside Japan and address issues at each site.
Goal 2 Maintaining Harmony with the Global Socio-Economy	Establishment of Compliance	(1) Global: formulate and implement measures for enhancing awareness on compliance, primarily targeting the Chinese locations. (2) Implement new measures for enhancing awareness on compliance at group companies in Japan.	(1) Held a seminar entitled "Guideline for Preventing Bribery" in China and began explaining guidelines for preventing bribery and extortion in the United States. (2) Opened "Workplace Helpline" as an external helpline.	○ ○	(1) Implement measures for enhancing awareness on compliance, targeting Chinese and other locations outside Japan. (2) Conduct Group compliance and harassment seminars in Japan.
	Promotion of Risk Management (Information Security)	(1) Web filtering Implement web filtering for Internet access control. (2) Security education Conduct information security education for new employees using video during CSR Promotion Month. (3) ISMS ^{*1} certification Undergo ISMS audit by an external organization. (4) Improve IT control Address internal control requirements identified through ITGC ^{*2} assessment. (5) Internal audit on information management Implement an internal audit on information management.	(1) Completed in the first quarter. (2) Completed education for new employees in the first quarter and video-based security training during CSR Promotion Month in the third quarter. (3) Completed activities for the ISMS Promotion Committee and conducted an external audit in the third quarter. (4) Implementation in progress. (5) Implemented in the second quarter.	○ ○ ○ ○ ○	(1) Strengthen management of confidential information. (2) Security education (3) Maintain ISMS certification. (4) Address ITGC/AC observations. (5) Internal audit on information management
	Promotion of Risk Management (Internal Controls)	(1) Promote risk management practices at each division (reduce dependence on individual staff). (2) Reduce risk and enhance operational quality through an operational audit based on the risk approach. (3) Fully grasp practical trade transactions between Anritsu Group companies and expand effective auditing of trade compliance based on the risk approach.	(1) Held a workshop for sales and other divisions in the Test and Measurement Business. Held workshop-style managerial training (attendance: approximately 180). Including the training for division leaders held in fiscal 2011, approximately 60% of management-level employees have attended the training. (2) Conducted an operational audit in the development division, SCM division, Japanese and U.S. subsidiaries. (3) Conducted an audit for trade compliance. In particular, examined loaned demonstration products and audited the local management system of U.S. subsidiaries.	○ ○ ○	(1) Promote implementation of risk management at each division of every Anritsu Group subsidiary. (Activities to reduce material risks) (2) Enhance operational quality through design and implementation of an audit plan based on the risk approach.
	Supply Chain Management	(1) Develop a global SCM system. (2) Promote regular monitoring of suppliers. (3) Promote CSR procurement. (4) Strengthen BCM and governance systems.	(1) Held a kickoff meeting for the Global Supply Chain Committee, and began construction of a supply chain integrating the four bases in Japan, the U.S., Europe and China. (2) Improved defect and on-time delivery rates, conducted process audits at 18 companies to improve our RoHS compliance rate. (3) Conducted a corporate ethics survey for FY2012 (54 responses from 47 companies; no violations reported). (4) Collected data relevant to BCM from 1,766 sites centered on secondary suppliers and beyond.	○ ○ ○ ○	(1) Develop a global SCM system (Promote GSCC). (2) Establish audit system for hazardous substances. (3) Establish response to conflict minerals (Promote CSR procurement). (4) Strengthen BCM and governance systems.
	Respect for Human Rights and Promotion of Diversity Human Resource Development	(1) Expand recruitment of foreign nationals and establish an employment framework. (2) Establish an evaluation system for developing human resources. (3) Develop job types and categories for the elderly and people with disabilities. (4) Implement a global employee satisfaction survey.	(1) Expanded recruitment of foreign nationals by offering an internship in China and recruiting in Philippines. (2) Established an evaluation system for developing human resources, and decided to conduct a trial in fiscal 2013. (3) Established a dedicated division for developing job categories for the elderly and people with disabilities at a Group company to consider dispatching personnel to companies inside and outside the Group and explore possibilities for new businesses. (4) Implemented a global employee satisfaction survey (Japan, U.S., and China).	○ ○ △ ○	(1) Establish recruitment of foreign nationals. (2) Complete draft of an evaluation system for developing human resources. (3) Formulate a proposal for developing job types and categories for the elderly and people with disabilities. (4) Recommencement of GHRC (Global Human Resource Committee) activities.
	Labor Safety and Health	(1) Plan and implement the Action Plan to Support Child Welfare (balancing work and child rearing). (2) Review BCP and implement summer electricity usage measures.	(1) Widened the eligibility for taking childcare hours to include employees with children up to the sixth grade. Established a subsidy for use of family support centers operated by local governments, to be implemented starting in fiscal 2013. 1 male employee obtained childcare leave. (2) Reviewed the fire-fighting plan and disaster prevention training as a disaster prevention activity and first-response activity in times of a disaster.	○ ○	(1) Launch a website on programs for childcare and support for balancing work and child-raising. (2) Establish a disaster prevention system (formulate a BCP plan for the headquarters).
	Promotion of Social Contribution Activities	(1) Promote community contribution activities worldwide. (2) Strengthen social contribution for youth education.	(1) Advanced communication with locations around outside Japan and confirmed our contribution to local communities. (2) Supported "Autumn Camp," sponsored by Koriyama PTA with the participation of volunteers and held "Kanagawa Science Summer" in Kanagawa Prefecture and provided volunteers.	○ ○	(1) Promote collaboration with NGOs and NPOs. (2) Promote social contribution activities at locations outside Japan.
Goal 3 Promoting Global Environmental Protection	Promotion of Environmental Management	(1) Waste reduction and recycling - Maintain waste emission under 160.4 tons (Japan). - Reduce volume of landfill waste by 5% compared to fiscal 2010 (USA). (2) Resource and energy conservation - Reduce energy consumption (crude oil equivalent) by 9.0% compared to fiscal 2006 (Japan). - Reduce energy consumption by 5.0% compared to fiscal 2010 (USA) (3) Eco Products (Anritsu Group companies in Japan) - Ratio of environmentally conscious products of all products covered: 100% - Ratio of products that can save resources by 10% or more of all products covered: 100% - Ratio of products that are 30% or more power efficient of all products covered: 100%	(1) Waste reduction and recycling - Emitted waste was 114.5 tons (Japan). [targeting below 160.4 tons] - Volume of landfill waste reduced by 42% compared to fiscal 2010 (USA). [targeting 5% reduction] (2) Resource and energy conservation - Reduced energy consumption by 24.6% compared to fiscal 2006 (Japan). [targeting 9% reduction] - Reduced energy consumption by 40% compared to fiscal 2010 (USA). [targeting 5% reduction] (3) Eco Products (Anritsu Group companies in Japan) - Completed development of all 6 targeted products as environmentally conscious products. - Completed development of all 3 targeted products that can save resources by 10% or more. - Completed development of all 2 targeted products with at least a 30% improvement in power efficiency.	○ ○ ○ ○ ○ ○ ○ ○	(1) Waste reduction and recycling - Maintain waste emission under 160.4 tons (Japan). - Reduce volume of landfill waste by 20% compared to fiscal 2010 (USA). (2) Resource and energy conservation - Reduce energy consumption (crude oil equivalent) by 10% on average by 2020 compared to fiscal 2012 (Japan). - Reduce energy consumption by 5.0% compared to fiscal 2010 (USA). (3) Eco Products (Anritsu Group companies in Japan) - Ratio of environmentally conscious products of all products covered: 100% - Ratio of products that can save resources by 10% or more of all products covered: 100% - Ratio of products that are 30% or more power efficient of all products covered: 100%
Goal 4 Promoting Communications	Communication with Stakeholders	(1) Hold stakeholder dialogues and reported results in the CSR Report. (2) Distribute and promote the use of the CSR Report in regions across the globe.	(1) Held stakeholder dialogue and reported results in the CSR Report. (2) Distributed and promoted the use of the CSR Report in regions across the globe.	○ ○	(1) Promote communication through stakeholder dialogues. (2) Research the status of CSR communication in each global region.

-USA is represented by Anritsu Company (U.S.A.)

*1 Information Security Management System: System for verifying appropriate management of information assets by an organization through an assessment conducted by a third party based on a set of standards.

*2 IT general control: Internal control activity for guaranteeing an environment that ensures the effective functioning of application control.

Item	Indicator	Report Page
1. Strategy and Analysis		
1.1	Statement from the most senior decisionmaker of the organization about the relevance of sustainability to the organization and its strategy.	5-6
1.2	Description of key impacts, risks, and opportunities.	5-6, 7-12
2. Organizational Profile		
2.1	Name of the organization.	Back Cover
2.2	Primary brands, products, and/or services.	3-4, 7-10
2.3	Operational structure of the organization.	1-2
2.4	Location of organization's headquarters.	1
2.5	Number and names of countries where the organization operates.	1-2
2.6	Nature of ownership and legal form.	1
2.7	Markets served.	1-4, 7-10
2.8	Scale of the reporting organization.	1-4, 7-10
2.9	Significant changes during the reporting period regarding size, structure, or ownership.	None
2.10	Awards received in the reporting period.	55
3. Report Parameters		
3.1	Reporting period (e.g., fiscal/calendar year) for information provided.	1
3.2	Date of most recent previous report (if any).	1
3.3	Reporting cycle.	1
3.4	Contact point for questions regarding the report or its contents.	1
3.5	Process for defining report content.	1, 11-12, 54-56
3.6	Boundary of the report.	1
3.7	State any specific limitations on the scope or boundary of the report.	1
3.8	Basis for reporting on entities that can significantly affect comparability from period to period and/or between organizations.	None
3.9	Data measurement techniques and the bases of calculations.	34, 38, 42-45
3.10	Reasons for any re-statements of information provided in earlier reports.	None
3.11	Significant changes from previous reporting periods in 3.6 or 3.9	37
3.12	Table identifying the location of the Standard Disclosures in the report.	58-59
4. Governance, Commitments and Engagement		
4.1	Governance structure of the organization.	Website (corporate governance)
4.2	Indicate whether the Chair of the highest governance body is also an executive officer.	Website (corporate governance)
4.3	State the number and gender of members of the highest governance body that are independent and/or non-executive members.	Website (corporate governance)
4.4	Mechanisms for shareholders and employees to provide recommendations or direction to the highest governance body.	Compliance promotion system, shareholders' meeting and Investors visiting. 55, 56
4.5	Linkage between compensation for management, and the organization's performance (including social and environmental performance).	Website (corporate governance)
4.6	Processes in place for the highest governance body to ensure conflicts of interest are avoided.	Website (Anritsu Group Charter of Corporate Behavior, Chapter 5)
4.8	Internally developed statements of mission or values, codes of conduct, and principles relevant to economic, environmental, and social performance and the status of their implementation.	6, 17
4.9	Procedures of the highest governance body for overseeing the organization's identification and management of economic, environmental, and social performance.	17
4.11	Explanation of whether and how the precautionary approach or principle is addressed by the organization.	5-6
4.12	Externally developed economic, environmental, and social charters, principles, or other initiatives to which the organization subscribes or endorses.	5-6
4.14	List of stakeholder groups engaged by the organization.	54
4.15	Basis for identification and selection of stakeholders with whom to engage.	54
4.16	Approaches to stakeholder engagement.	54-56
4.17	Key topics and concerns that have been raised through stakeholder engagement, and how the organization has responded to them.	13-16
Economic		
	Management Approach	Website (Mid-term business plan), 11-12
EC1	Direct economic value generated and distributed, including revenues, operating costs, employee compensation, donations and other community investments, retained earnings, and payments to capital providers and governments.	1
EC2	Financial implications and other risks and opportunities for the organization's activities due to climate change.	Annual Report
EC3	Coverage of the organization's defined benefit plan obligations.	Annual Report
EC4	Significant financial assistance received from government.	NA
EC6	Policy, practices, and proportion of spending on locally-based suppliers at significant locations of operation.	29-30
EC7	Procedures for local hiring and proportion of senior management hired from the local community at locations of significant operation.	31
EC8	Development and impact of infrastructure investments and services provided primarily for public benefit.	35-36

Item	Indicator	Report Page
Environmental		
	Management Approach	37
EN1	Materials used by weight or volume.	51
EN3	Direct energy consumption by primary energy source.	51
EN4	Indirect energy consumption by primary source.	51
EN5	Energy saved due to conservation and efficiency improvements.	42
EN6	Initiatives to provide energy-efficient or renewable energy based products and services, and reductions in energy requirements as a result of these initiatives.	48-50
EN8	Total water withdrawal by source.	51
EN9	Water sources significantly affected by withdrawal of water.	43
EN10	Percentage and total volume of water recycled and reused.	43
EN14	Strategies, current actions, and future plans for managing impacts on biodiversity.	40
EN15	Number of IUCN Red List species and national conservation list species with habitats in areas affected by operations, by level of extinction risk.	NA
EN16	Total direct and indirect greenhouse gas emissions by weight.	51
EN17	Other relevant indirect greenhouse gas emissions by weight.	38
EN18	Initiatives to reduce greenhouse gas emissions and reductions achieved.	42
EN20	NO, SO, and other significant air emissions by type and weight.	51
EN21	Total water discharge by quality and destination.	51
EN22	Total weight of waste by type and disposal method.	46, 47, 51
EN23	Total number and volume of significant spills.	NA
EN26	Initiatives to mitigate environmental impacts of products and services, and extent of impact mitigation.	48-50
EN27	Percentage of products sold and their packaging materials that are reclaimed by category.	44, 48-50
EN28	Monetary value of significant fines and total number of non-monetary sanctions for noncompliance with environmental laws and regulations.	NA
EN29	Significant environmental impacts of transporting products and other goods and materials used for the organization's operations, and transporting members of the workforce.	38
EN30	Total environmental protection expenditures and investments by type.	52
Labor Practices and Decent Work		
	Management Approach	31-34
LA1	Total workforce by employment type, employment contract, and region.	31
LA15	Return to work and retention rates after parental leave, by gender.	31
LA7	Rates of injury, occupational diseases, lost days, and absenteeism, and total number of work-related fatalities, by region and by gender.	2, 34
LA8	Education, training, counseling, prevention, and risk-control programs in place to assist workforce members, their families, or community members regarding serious diseases.	34
LA11	Programs for skills management and lifelong learning that support the continued employability of employees and assist them in managing career endings.	33
LA13	Composition of governance bodies and breakdown of employees per category according to indicators of diversity.	2, 31-33
Human Rights Performance Indicators		
	Management Approach	29-30, 31-32
HR3	Total hours of employee training on policies and procedures concerning aspects of human rights that are relevant to operations.	26
HR4	Total number of incidents of discrimination and corrective actions taken.	NA
HR6	Operations and significant suppliers identified as having significant risk for incidents of child labor, and measures taken to contribute to the effective abolition of child labor.	24, 29
HR7	Operations and significant suppliers identified as having significant risk for incidents of forced or compulsory labor, and measures to contribute to the elimination of all forms of forced or compulsory labor.	24, 29
HR9	Total number of incidents of violations involving rights of indigenous people and actions taken.	NA
Society Performance Indicators		
	Management Approach	35, 36
SO3	Percentage of employees trained in organization's anti-corruption policies and procedures.	26
SO4	Actions taken in response to incidents of corruption.	NA
SO7	Total number of legal actions for anticompetitive behavior, anti-trust, and monopoly practices and their outcomes.	NA
SO8	Monetary value of significant fines and total number of non-monetary sanctions for noncompliance with laws and regulations.	NA
Product Responsibility Performance Indicators		
	Management Approach	18-20
PR2	Total number of incidents of non-compliance with regulations and voluntary codes concerning health and safety impacts of products and services during their life cycle, by type of outcomes.	NA
PR4	Total number of incidents of non-compliance with regulations and voluntary codes concerning product and service information and labeling, by type of outcomes.	NA
PR5	Practices related to customer satisfaction, including results of surveys measuring customer satisfaction.	18-20
PR7	Total number of incidents of non-compliance with regulations and voluntary codes concerning marketing communications, including advertising, promotion, and sponsorship by type of outcomes.	NA
PR8	Total number of substantiated complaints regarding breaches of customer privacy and losses of customer data.	NA
PR9	Monetary value of significant fines for noncompliance with laws and regulations concerning the provision and use of products and services.	NA

Independent Review



Director, CSR Asia Japan
Makiko Akabane

Anritsu endeavors to consistently respond to the needs of the times and has steadfastly invested in R&D regardless of prevailing circumstances so that it can continue to offer cutting-edge technology to address society's needs. In the Top Commitment section I note that President Hashimoto, in seeking to refine the corporate brand, has summarized his message in the phrase: "Visionary Partnership to innovate for tomorrow's society." This communicates to your internal and external stakeholders the lofty aspiration of turning the Anritsu Group into a global enterprise both in name and fact, and provides an outstanding expression of how CSR has been incorporated into the management philosophy of the Anritsu Group. I would like to offer my observations on our "Anritsu Group CSR Report 2013" from the standpoint of turning the Anritsu Group into a global enterprise.

One expectation of a global enterprise is a high level of commitment to supply chain management as it relates human rights. Since 2012, this has emerged as the top priority in the results of an annual survey of CSR experts conducted by CSR Asia. While the issue carries considerable risks, companies are increasingly being called upon to disclose information on their local factories and overseas business partners. It is important to raise the awareness of local worksites through education and communication.

In pursuing the globalization of its CSR activities, the Anritsu Group has created a framework in which local Human Resource department are entrusted with the responsibility of regionally promoting CSR in the Americas, Europe and Asia. Using a localized framework to address social issues such as human rights allows for a much faster response than would be possible through a centralized effort by

the headquarter, and also ensures that the company's actions are locally appropriate. It is important to clarify the responsibility and authority involved in the effort so that organizations in each part of the world can act responsibly and with confidence when dealing with complicated social issues.

Anritsu places great emphasis on stakeholder communications, designating it as Goal 4. To avoid turning this dialogue into a fleeting event conducted for the purposes of the report, we have positioned the conversation over the past two years as a fixed-point observation by having the same participants as last year. I think the promptness with which the company has been responding to suggestions offered by stakeholders in these dialogues demonstrates the sincerity of the Anritsu Group.

With respect to stakeholder communications, one area I would like to see the company apply additional effort in is the dialogue with NGOs and NPOs, which is also part of Goal 4. In CSR Asia's annual expert hearings, NGOs and NPOs have collectively appeared at the top of the list since 2011 as the sector expected to have the greatest impact on CSR activities in Asia. When we turn our attention to other global enterprises, they have clearly adopted a highly strategic approach for dialogue and collaboration with NGOs and NPOs. High-tech companies like Anritsu stand out from industrial machinery factories in Thailand and Shanghai, and its Group companies and/or supply chain may draw criticism from NGOs. Recognizing Anritsu's aspiration to become a global enterprise, I recommend that the company take a more strategic approach to deepening its relationships with NGOs and NPOs.

Response to Independent Review

We sincerely appreciate Ms. Akabane's evaluation of our report, which describes the relationship between our CSR activities and business operations in fiscal 2012.

We created a section entitled "Solutions for Social Issues" (p. 7-10) in the hope of instilling a deeper understanding among more stakeholders about how our core business contributes to society. As in the previous year, we invited the same three experts to participate in our stakeholder dialogue. The suggestions that Ms. Akabane offered in her Independent Review regarding the supply chain and human rights, promotion of global CSR and dialogue with NGOs and NPOs were also noted by dialogue participants as key themes for Anritsu's future activities.

While we will address the issue of supply chain and human rights by focusing on our response to conflict minerals, we plan to deepen our efforts on globalization in the promotion of global CSR by clarifying the scope of activities and responsibilities of the local divisions, as suggested by Ms. Akabane. We also intend to consider the nature and development of our relationship with NGOs and NPOs from a strategic standpoint.

We are resolved to continue promoting our CSR activities by incorporating Ms. Akabane's recommendations and the other feedback we received from our many stakeholders.

CSR Promotion Team, Corporate Communication Department
Anritsu Corporation

Anritsu

Discover What's Possible™

ANRITSU CORPORATION

5-1-1 Onna, Atsugi-shi, Kanagawa, 243-8555 Japan

TEL: +81-46-223-1111

<http://www.anritsu.com>