

2011 CSR Report Corporate Social Responsibility

The Yokogawa Group aims to benefit society by providing solutions that protect the environment and being a positive influence for social change. On this page you can read about some of our CSR activities over the past year.



Interview of Top Leaders

Shuzo Kaihori

President & CEO,
Yokogawa Electric Corporation

Mizue Unno

Managing Director,
So-Tech Consulting Inc.



Ms. Unno, who has been conducting a review of Yokogawa's CSR activities since 2010, discusses with President Kaihori which CSR activities are most appropriate for Yokogawa.

Special Features

Meeting the Growing Demand for Energy While Protecting the Environment



Ensuring Safe and Secure Factory Operations



Human Resources Development in the Middle East



Rebuilding East Japan after the Earthquake

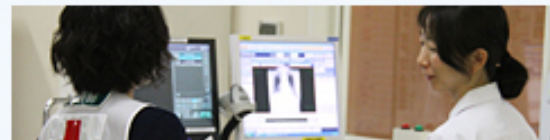

Environmental Management



Yokogawa believes that protecting the environment is a top-priority management issue. We therefore promote environmental management while providing solutions that will help our customers reduce their energy consumption and protect the environment.

Human Rights and the Yokogawa Workforce



We respect human rights and support our diverse workforce by providing career development opportunities and fostering an open workplace. The Group is also working to improve the safety and health of its employees.

Yokogawa Corporate Citizenship



To develop the next generation, we have devoted resources to initiatives that include the Yokogawa Science Class, the provision of educational support to mentally and physically challenged children, and cooperation with NPOs in achieving the UN Millennium Development Goals.

Customer Satisfaction and Quality Assurance

We are engaged in activities that maintain high quality in every aspect of our business — from product sales to maintenance — and take the customer perspective to ensure high satisfaction with our products and services.

Supplier Relations

We have put in place a management system that covers each of our business processes, including purchasing and sales, to ensure that social and environmental concerns are given proper consideration in all our dealings with suppliers.

Yokogawa's Approach to CSR

Yokogawa has specific action guidelines and a CSR promotion organization that are based on our corporate philosophy and standards of business conduct.

Corporate Governance and Compliance

We emphasize corporate governance and compliance-oriented management to become a healthier and more open company.

About the 2011 CSR Report

The 2011 CSR Report gives a complete overview of the CSR activities of the Yokogawa Group. Further key information is also provided in our annual report.

Our Group prepares its CSR Report in three versions--the "Global Version," "Japanese Version" and "Chinese Version"--in order to provide useful information for the benefit of all stakeholders.

- **Global Version (This page)**

Provide stakeholders worldwide with information on what the Group is doing globally. (Language: English)

- **Japan Version**

Provide stakeholders in Japan with information on what the Group is doing globally, as well as significant, local-community activities in Japan. (Language: Japanese)

- **China Version**

Provide stakeholders in China with information devoted chiefly to the activities of certain group companies in China. (Language: Chinese)

- **Annual report**

- Period covered by this report

April 1, 2010 through March 31, 2011

Where appropriate, information on events occurring outside this period may be included.

- Scope of data

This report covers Yokogawa Electric and its Group companies. When data having a different scope is provided, that is noted.

- Company names

In this report, "Yokogawa" and "Yokogawa Group" refer to the entire organization, "Yokogawa Electric" is only used with reference to Yokogawa Electric Corporation.

- Reference Guidelines

Environmental Reporting Guidelines (Fiscal year 2007 Version), published by the Ministry of the Environment, Japan

Environmental Accounting Guidelines (Fiscal year 2005 Version), published by the Ministry of the Environment, Japan

Sustainability Reporting Guidelines 2006, published by the Global Reporting Initiative

How Yokogawa Can Help to Achieve Sustainability

Mizue Unno, Managing Director So-Tech Consulting Inc.
Shuzo Kaihori, President & CEO Yokogawa Electric Corporation



Ms. Unno has been conducting a review of Yokogawa's CSR activities since 2010 and has discussed with President Kaihori CSR activities which distinguish Yokogawa. Ms. Unno has a particular interest in the relationship between CSR and Yokogawa Group strategies and business that are closely linked with energy and safety issues, namely measurement and control. She also is interested in the long-term viability of communities in emerging markets.

Rebuilding efforts after the earthquake

Unno : Yokogawa Electric reportedly came through the Great East Japan Earthquake without any major damage to its facilities. Has this disaster had an indirect impact on your business?

Kaihori : I would first like to express my heartfelt condolences to the victims of the earthquake that struck Japan's Tohoku region. We fervently hope for an early recovery of the disaster-stricken area, and towards this end will do our utmost to lend the region support.

Regarding the impact of this disaster on the Yokogawa Group, our key factories in Singapore, China, Tokyo, and Yamanashi (Japan) fortunately didn't suffer any direct damage. However, some of our customers in the materials industry and in the power, gas, water supply/treatment, and other infrastructure related sectors were significantly affected. In the aftermath of the earthquake, our most important role is to help these customers rebuild their factories.



Mizue Unno

Managing Director, So-Tech Consulting Inc., providing Japanese firms advice and support in the areas of sustainability and CSR

The energy industry a new era

Unno : Yokogawa makes plant control equipment and systems. What specifically are you doing to help your customers who have been affected by the earthquake?

Kaihori : Plant control systems are like the brain and nerves of the human body. So, the first step at the affected plants is to repair the machinery and other components that carry out the equivalent of the body's motor functions, after which we can attend to the control systems and other equipment that

function as a facility's brain and nerves. We are doing everything we can to support our customers so that their plants can resume normal operations as soon as possible.

Unno : Yokogawa also has deep ties to the energy industry, but the recent earthquake is changing the way people think about energy. How has this tragedy affected your business?



Kaihori : Previously, people were interested in energy within the context of global warming and resource depletion. Since the earthquake, however, safety has become a new keyword when it comes to energy. Natural energy sources are also drawing attention. Of course, it is difficult to immediately switch all power generation to natural sources, and we believe we are in a transition, or bridging period, in our march toward this goal. The Yokogawa Group must develop secondary battery-related products and other innovations that allow us to harness natural energy sources, and must stay abreast of global developments in this field to play an important role during this bridging period. We believe that the Yokogawa Group's mission is to be a force for global progress that shows respect for our fellow human beings and protects nature.

Unno : I believe you're saying that you must strive for sustainability as you go about your business activities. The Yokogawa Group's measurement and control technologies are of direct relevance to the energy industry, which means your business can come up with energy solutions and contribute in making a more sustainable society. By taking a strategic approach in this, you will be able to enhance your corporate value.

Kaihori : Plant control systems are like the brain and nerves of the human body. So, the first step at the affected plants is to repair the machinery and other components that carry out the equivalent of the body's motor functions, after which we can attend to the control systems and other equipment that function as a facility's brain and nerves. We are doing everything we can to support our customers so that their plants can resume normal operations as soon as possible.

Helping Customers improve safety and environmental management

Kaihori : Also, in China and Southeast Asia steel mills and petrochemical plants that consume a lot of energy are using our systems. We diagnosed problems at several of our customers' factories and proposed solutions that could allow them to operate and use energy more efficiently. Our customers, particularly those that are leading global companies, are constantly searching for ways to improve efficiency, enhance safety, and protect the environment, and they are very interested in the advanced technologies of Japan and best practices from around the world. The use of our products results in significant reductions of NO_x, SO_x, and other harmful chemical substances that are generated when fossil fuels are burned, making plants cleaner and safer for the environment. By introducing to our

customers around the world Yokogawa technologies that have long been in wide use here in Japan, we believe that we can contribute to society.

Unno : Yokogawa expects to provide with not only sales of very high quality products to customers, but also broader solutions for business and society at large.

Kaihor : One of our strengths is the ability to provide reliable products and services that our customers can count on 365 days a year. In addition, we must continually go a step further and think ahead from now on. In other words, we must pursue a comprehensive solutions approach that helps our customers improve efficiency and employee safety and protect the environment.

Support of sustainable development on a community basis

Unno : By the way, Yokogawa, like other companies, is focusing on emerging markets which are expected to grow further. You must dig deeper to understand what customers can actually gain by using Yokogawa products. To expand the customer base in a specific area, it is important to win the trust of the stakeholders who live there. You must work together with local companies to find solutions to issues faced by their community. To do this, it is necessary to understand the needs of stakeholders such as local government bodies, companies, and citizens. Rather than focusing just on philanthropy, it's important to think about how you can contribute through your business activities.



Kaihor : Emerging economies and developing nations have the basic need to become prosperous, and for that purpose they use energy and resources. We provide the products needed to do that. Also, these markets are now thinking they cannot go on forever with the current formula of relying on foreign capital and engineers to manufacture products. Let me explain. Our Group is handling many projects in Saudi Arabia, Abu Dhabi, and other oil- and gas-producing countries in the Middle East, and we've realized that there is a strong need to utilize local talent. As software production, including engineering, can be done anywhere, they want us to hire people from their countries to create this software locally, not at our sites in Japan and Singapore. Even though we'd like to do this, we cannot always find enough people who have the required skills. That's why we are starting from the very beginning, such as by partnering with universities in Saudi Arabia, sending lecturers, and receiving interns. We are passing on measurement and control related engineering skills to university students and giving them opportunities to work with our employees and actually use this knowledge.

Unno : Is it like operating a school within the company?



An engineering educational facility in the Dhahran Techno Valley established by Yokogawa

Kaihor : It's not a school per se; it's an internship program that lets students work in our Saudi Arabia office. We also have unique training programs that give trainees the opportunity to visit our sites in Singapore and Japan. Additionally, we're running an internship program in collaboration with a local educational institution in Abu Dhabi, in the United Arab Emirates. The UAE is one of the few countries in the Middle East where women are encouraged to work, but actually there aren't enough job openings yet for women. So, our Abu Dhabi office began hiring female interns in 2011, starting with a group of five.

Unno : After graduation, will these students join the Yokogawa Group?

Kaihor : Some will go to work for us in Saudi Arabia, and others will take positions at our customers. Either way, it's a good thing for us. By investing our resources and technologies in a country and providing education to locals, we can ensure the long-term viability of our business in that country. We want to apply this strategy elsewhere.

Unno : Technical development and human resource development are areas that are of great interest to emerging countries, so it would be effective to clearly and systematically demonstrate in these markets, with their different cultures, that Yokogawa is dedicated to these programs. That is a given in Japan and it doesn't need to be explained to Japanese, but in other cultures an active effort must be made to promote this aspect of your business. ISO26000 (Guidance on Social Responsibility) includes a section called "Community Involvement and Development" that stresses the importance of benefiting the local community and enabling the people there to stand on their own two feet by, for example, helping them acquire new skills and creating jobs. This, in turn, is a basic and important element for ensuring the long-term viability of local communities.

Kaihor : There are many things we should do in the areas of CSR and philanthropy, but we want to focus on those things that we do best. Providing training in measurement and control is not something that every company can do. By continuing to contribute in this way to countries and regions without thinking too much about short-term gains, we can help to put them on a more solid economic footing and eventually will reap benefits such as increased business inquiries. This way of thinking is very different from how we conduct our business in advanced nations, where efficiency and cost are given top priority. In factories, our products often have to keep operating for more than 10 years, so we can't just sell our products, pocket the money, and say goodbye. We must consider how to ensure the long-term viability of our business through such activities as fostering local talent.



A Special polymer plant of Nitriflex in Brazil controlled by Yokogawa's system

Unno : You're talking about ensuring the long-term viability of your business and local communities as well.

Kaihoru : As a matter of fact, in addition to providing training in engineering, we're also starting to collaborate in R&D with one of the Saudi Arabian universities that I mentioned earlier. We've suggested research themes and proposed joint research with the university, local companies, our customers, and other parties. There are many interesting themes that can best be studied in Saudi Arabia, such as marine pollution and efficient exploration for natural resources.

Unno : In the CSR field, such involvement with the local community is regarded as "stakeholder engagement." It is based on the concept that local stakeholders are potential business partners. Personally, I believe that a business can attain sustainability more easily by adopting this premise from the beginning. Particularly in energy and infrastructure projects in emerging countries, stakeholder engagement is a must from the standpoint of managing business risks.

Respecting human rights and improving occupational safety



Kaihoru : That's right. Commonsense varies from one country to another, just like with social customs, religion, and many other things. We conduct business around the globe in advanced, emerging, and developing nations — so we make sure to follow local customs and rules. Take human rights, for example. What it means varies from country to country. People's perceptions of the importance of preventing corruption also differ in advanced and emerging nations. Of course, as a company we need unified, global action guidelines. That's why we joined the United Nations Global Compact in 2009 and adopted its principles on human rights, labor standards, the environment, and anti-corruption as the standards for our Group companies around the world.

Unno : Human rights and labor issues were highlighted in the ISO26000 standard and the United Nations Global Compact, and global awareness of these issues has increased.

Kaihoru : As I mentioned earlier, I think of the three key themes — improving efficiency, enhancing safety, and protecting the environment — all the time. Of these, labor safety is an area where our customers, especially leading companies in advanced nations that do business in the oil and materials industries, are fairly ahead. For example, these customers are requiring us to gather and submit on a regular basis various types of hard data on labor safety for work done on our premises and at customer sites. The reality is that today we won't receive orders unless we can prove the safety of our work practices. Furthermore, these leading companies in advanced nations are investing in emerging and developing nations, and are conducting business there based on a similar safety policy. Naturally, efforts to enhance safety will become more widespread around the world, especially in the energy and materials industries.

Unno : As citizen's perceptions of what is important evolve around the world, companies are asked to rethink the way they conduct business and manage their organizations. Gone is the time in which businesses only had to think about costs in order to sell products.

Kaihori : From now on, it will become more important to provide solutions, including consultation, rather than products by thinking from the customer's viewpoint. We are doing business with customers in various industries, so we can, for example, utilize our experience in the medical field to provide solutions based on best practices to our customers in the food industry. High product quality has been our strength throughout our long history, but now we're combining this with consulting and engineering services that add value, in order to provide total solutions to our customers.

Unno : I'm sure that the concept of sustainability is firmly ingrained in this.

Kaihori : Since the collapse of Lehman Brothers, emerging and developing nations have gained significant momentum. Citizen's perceptions of what is important have clearly changed, too. Prosperity is no longer just about financial gain. I believe it is important for us to address the question of how we will achieve sustainability at the global and community level. Yokogawa will not waver from its mission of being a force for global progress that shows respect for our fellow human beings and protects nature.



Unno : We look forward to hearing more about sustainability-oriented activities at Yokogawa.

Meeting the Growing Demand for Energy While Protecting the Environment

Contribution to Energy Conservation and Environmental Protection around the World



As the demand for energy continues to grow in emerging economies and energy-saving efforts become increasingly important, we are asked to switch to safer and naturally occurring energy sources. Additionally, governments are stepping up their environmental regulations in order to curb CO₂ emissions and reduce the pollution caused by harmful chemical substances. Therefore, companies must introduce new technologies, procedures and methods in order to comply with the stricter regulations. Yokogawa, drawing on its technical expertise in measurement and controls, helps its customers around the world save energy and achieve factory operations that have low environmental impact.

Energy-Saving Plant Diagnostics



We conducted energy-saving diagnoses of customers' plants in China and Thailand. Efficient energy usage thereby reduces not only environmental impact but also costs.

- Diagnosis of CO₂ Emission Reduction Potential of Large Iron Mill in China
- Energy Saving Diagnostics at chemical plants in Thailand

Continuous Monitoring of Harmful Emissions



Yokogawa America do Sul Ltda. (Brazil) provides a system for the continuous monitoring of NO_x, SO₂ and other harmful substances in the emissions generated from industrial factories in various fields, including petroleum, chemical, pulp and paper, and mining. Additionally, it provides assistance in meeting the environmental regulations for CO₂ and H₂S (hydrogen sulfide).

- Yokogawa America do Sul Ltda.
- Continues Emission Monitoring System

Aiming for Precise Prediction of Climate Change and Weather

Systems that Support Weather Forecasting in Japan (Yokogawa Denshikiki)



Yokogawa Denshikiki, a member of the Yokogawa Group, received a blanket order in May 2010 to supply ground-based weather observation systems for use at weather observation stations throughout Japan. The forecasting of typhoons and other forms of severe weather, together with the warnings and alerts, and the resultant understanding of climate change, are all backed by Yokogawa's quality.

Growing Use of Rechargeable Batteries for Reusable Energy, Smart Grids, Etc.



WEBFREX3ES

Various types of measuring equipment and control systems by Yokogawa, such as the online thickness gauges needed to control the quality of separators and electrodes that are key components of rechargeable batteries, are now in operation at facilities manufacturing or developing rechargeable batteries. Since 2010, Yokogawa has developed new technologies to embody a deterioration diagnosis system that accurately evaluates the service life of lithium ion batteries.

- Yokogawa Releases WEBFREX3ES Online Thickness Gauge for Measuring the Coating Weight of Electrode Materials in Lithium-ion Batteries

Accurate Prediction of Climate Change and Weather

Global climate change and abnormal weather in various parts of the world have become the subjects of frequent reporting in recent years. Additionally, people are now more conscious of the importance of preparing for an earthquake, fire, flood, etc. These natural disasters are closely related to weather phenomena, and consequently the understanding of weather conditions is a key to effective prevention. Additionally, fire-fighting and disaster-prevention activities are critically important, particularly if such an event occurs.

One of our missions at Yokogawa Denshikiki is to take part in the global effort to prevent natural disasters and thereby contribute to the security and safety of people under the theme of "Measurement and Information on the Natural Environment." We develop various products that incorporate our proprietary technologies so that we can achieve the above mission. These include weather observation systems capable of accurate, high-quality measurements, and observation systems for slurries of mud and rocks, for which measurement is considered technically difficult.

Our weather observation systems have capably supported the weather observation community in Japan for many years. However, in May 2010 the stable quality, adaptability and functionality we provide for these systems were suitably recognized when we received a blanket order from the Meteorological Agency of Japan to update all its ground-based weather observation stations. The Agency will introduce our systems at all 156 of its stations, including weather centrals, over the next five years, and will operate them for a period of 15 years.



Ueno Special Regional Weather Observation Stations (Mie Prefecture)



Utsunomiya Local Weather Central (Tochigi Prefecture)

Ground-based weather observation systems form the core of weather observation capabilities for the Agency. Each system consists of a set of measuring equipment comprising an anemometer, rain gauge, thermometer, hygrometer, heliograph, actinometer, barometer and visibility meter, as well as system modules to gather and manage observation data from that equipment. The data thus collected is used by the Agency to issue advisories and warnings as well as to forecast weather, so these systems require higher observation accuracy and quality than does the simplified observation system (Amedas). Moreover, the data is sent to the United Nations World Meteorological Organization (WMO) as official data from Japan. It is also used in various countries to study the impact of climate change and global weather on food production and water, prevent/mitigate natural disasters and so forth.

To Protect the Global Environment

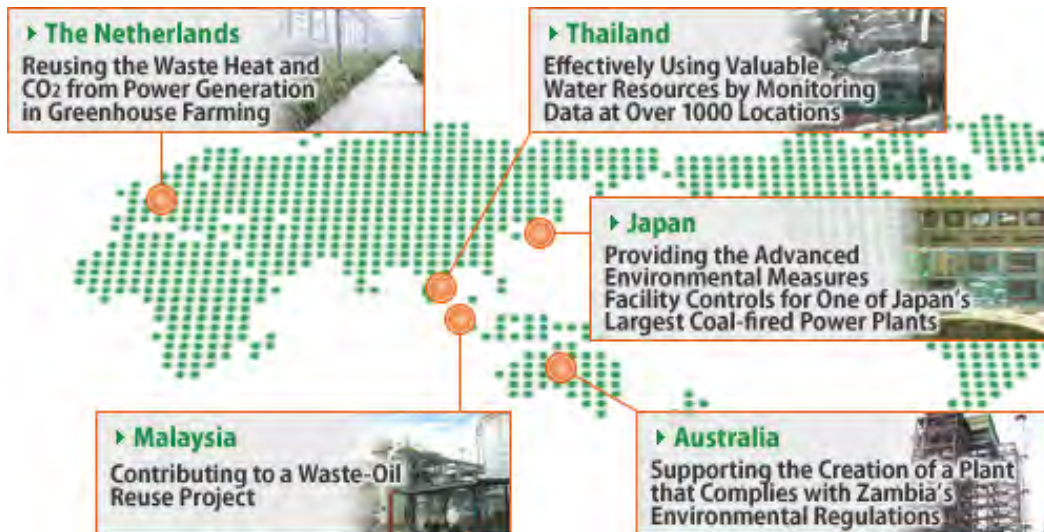

TOPIC 001 ENECO Energie (The Netherlands)

Reusing the Waste Heat and CO₂ From Power Generation in Greenhouse Farming



ENECO Energie is one of the three main energy companies in the Netherlands. It provides a variety of services, including the supply of electricity, gas and heat.

At its ROCA power station, it generates electricity by burning gas. Moreover, it is engaged in an environmentally friendly project by which the heat and CO₂ produced from that process are used in agriculture. Necessary for plant growth and photosynthesis, heat and CO₂ are transported by pipeline to the greenhouses of nearby farmers. This also contributes to reducing energy consumption and CO₂. With the system supplied by Yokogawa, STARDOM controllers, which are suitable for use in networks, have been installed in the greenhouses, and ENECO Energie remotely monitors and controls them through Internet cables. Moreover, provisions have been made so that each farmer can provide necessary instructions, and obtain information, through ENECO Energie's website.

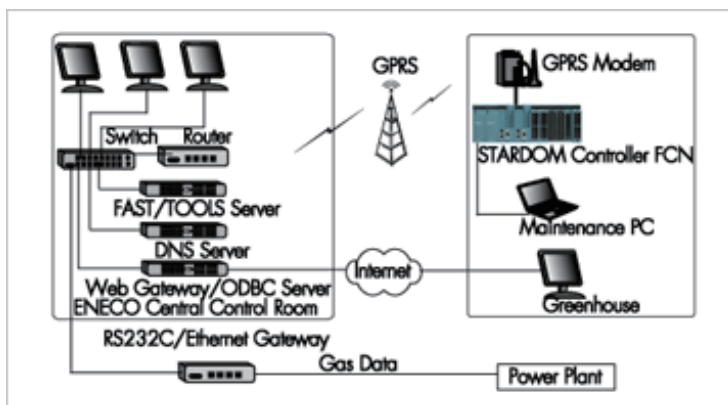

STARDOM controller installed in the site cabinet

TOPIC 002 Metropolitan Water Authority (thailand)

Effectively Using Valuable Water Resources by Monitoring Data at Over 1000 Locations

The Metropolitan Water Authority(MWA) supplies water to 1.8 million people in and around the city of Bangkok. To deal with the growing demand for water from the rapidly expanding city, MWA is also building a water-supply network divided into over 1000 blocks. With this network, however, water leakage and water loss, caused by pipe damage, equipment malfunction, inaccurate meters and more, had become a chronic problem, leading to water shortages.

In an MWA project in which Yokogawa participated, the goal was to reduce water loss by 30% by accurately monitoring pressure and flow in the water-supply network and promptly identifying places where leaks occurred. Thus, more than 200 STARDOM controllers and 1000 pressure transmitters and flowmeters were installed at key points in the network, and a system that centrally monitors the network via telephone lines was introduced as well. As a result, it has become possible to centrally monitor, in real time, data received from over 1000 block stations, and to immediately discover burst pipes and other abnormalities and readily identify leak locations. Thanks to this system, water loss has been greatly reduced and water resources are being more effectively used.



TOPIC 003 Aidwich Enviro-management Adn Bhd (Malaysia)

Contributing to a Waste-Oil Reuse Project

Recycling waste oil is less environmentally burdensome, and more cost-efficient, than refining new fossil fuel. Aidwich Enviro-Management provides such a service at its plant in Kemaman, Trengganu, Malaysia. Waste oil collected from various places by tanker truck and other means is brought to the plant, mixed in the ideal proportions and then stored, after which it goes through various refining processes, being transformed into diesel oil, naphtha, fuel oil, and other high-quality, value-added petroleum products.

Yokogawa's CENTUM CS 3000 R3 control system and field instruments were installed at the plant, where they are used to control all operations, from the loading and unloading of oil tanks to refining, shipping, and the emergency shutdown system.

Thanks to a system that combines highly reliable products with effective engineering and cooperative customers, stable waste-oil recycling has been realized.



TOPIC 004 Xstrata Technology's Mufulia Copper Smelter (Australia)

Supporting the Creation of a Plant that Complies with Zambia's Environmental Regulations

The Mufulira Copper Smelter processes more than 400,000 tons of copper ore a year. With the aging of the facilities, however, the electric furnace had been rebuilt.

A new smelter was now to be installed; and in order for it to comply with Zambia's environmental regulations, a sulfuric acid plant that would remove the sulfur oxide, particulate matter, and other environmental pollutants from the smelter's off-gas also had to be constructed.

In Australia, Yokogawa built a control system for the entire facility – smelter, acid supply, sulfuric acid plant, etc. – and shipped it to Zambia. So that local staff could operate the control system, Yokogawa also cooperated in their long-term training.

We believe that carrying out such environmental efforts and local support in developing countries will become increasingly important.



TOPIC 005 The Electric Power Development Co.'s Tachibanawan Thermal Power Station (Japan)

Providing the Advanced Environmental Measures Facility Controls for One of Japan's Largest Coal-fired Power Plants

The Tachibanawan Thermal Power Station, owned by the Electric Power Development Co., Ltd., is located in Anan City, Tokushima Prefecture. With two 1,050 MW coal-fired generating units that began operating in 2000, it is one of the largest coal-fired power plants in Japan. A source of power for a wide area in western Japan, it stably supplies electricity to four regional utilities: Kansai Electric Power Co., Chugoku Electric Power Co., Shikoku Electric Power Co., and Kyushu Electric Power Co. Consideration was given to ensuring that the power station's design harmonized with the surrounding landscape. Moreover, as environmental protection measures, flue gas desulfurization systems and other state-of-the-art environmental facilities were installed to remove the NO_x (nitrogen oxides),

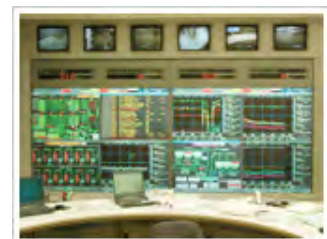

SO_x (sulfur oxides) and ash dust. Part of the removed coal ash is reused as cement material. For the integrated monitoring and control of these extensive environmental facilities – gas desulfurization systems, electrostatic precipitator, coal storage and conveying facilities, ash treatment facilities, waste-water treatment facilities – Yokogawa's CENTUM CS 3000 is used. To centrally monitor the facilities, which are widely spread out and include approximately 30,000 data points, Yokogawa created a user-friendly interface equipped with two mouse-operated 100-inch screens and a guide system that employs surveillance monitors and sound. Thus, Yokogawa's control technology is helping to reduce the environmental burdens on the surrounding area while supporting the stable supply of electricity.

Energy Saving Diagnostics over the Lifecycle of a Plant (Thailand)

Yokogawa participated in the planning of “Survey on energy saving by IT” which was launched in 2009 by the Ministry of Economy, Trade & Industry (METI) and the Green IT Promotion Council (GIPC). Yokogawa then performed energy saving diagnostics at two of its customers' plants in Thailand.

Energy Saving Diagnostics at Two Factories in Thailand

From October 2009 to January 2010, Yokogawa performed diagnostics for energy saving at the plants of two customers who use the Yokogawa control systems. The diagnostics were done as part of the “Survey on energy saving by IT”, started by the METI and GIPC. InsightSuiteAE, Yokogawa's equipment diagnostic system, was used as a tool to collect and analyze process data, and to perform a high-precision simulation of the energy-saving effects using multivariate analysis technology. This enables one to predict the effects of energy savings, and to actualize them without modifying the existing system.

Rayong Olefins Co., Ltd.

Rayong Olefins Co., Ltd. (ROC) is the second largest petrochemical company in Thailand, producing 1.2 million tons of olefin products annually in Rayong, Thailand. The diagnostics revealed that the following energy savings were possible per year, for every single unit of heat exchanger and 13 units of ethylene cracking furnaces.

- Electricity: 807,000 kWh (450 tons- CO₂)
- Steam: 1,700 tons (270 tons- CO₂)
- Fuel: 300 tons (800 tons- CO₂)



ROC plant

Energy saving diagnostics were performed against heat exchangers and ethylene cracking furnaces, two of the most energy-consuming equipments.

Heat exchangers tend to lose their heat transfer efficiency with operations due to fouling inside the shell and the tubes causing an increase in energy consumption. As a result, cleaning of the shell and inside the tubes in regular maintenance is necessary. ROC has several hundred units of heat exchangers; however, without the proper tools to measure their heat performance, they must rely on experience to determine the equipment to be cleaned. To solve this problem, InsightSuiteAE was installed to measure the fouling buildup of the heat exchangers up to date. Then, future estimated extent of each fouling buildup is calculated and an appropriate maintenance schedule was proposed to the customer.

Ethylene cracking furnaces also have several coil tubes set inside, through which ethylene raw materials (e.g., naphtha) flow and are thermally decomposed. Over time, the coke buildup inside these coil tubes lowers the furnaces' heat transfer efficiency. This increases their energy consumption, necessitating regular decoking which means removal of the coke buildup. Currently, ROC does not have the means to measure the extent of the coke buildup. Without this measurement, they must use equal amounts of steam to decarbonize in all coil tubes, regardless of the extent of the buildup for each coil tube. This means that more steam is used than necessary for the coil tubes with only small amounts of buildup. To solve this problem, InsightSuiteAE was installed to perform multivariate statistical analysis on 220,000 operational points, and the appropriate amount of steam was available for each coil tube according to its measured coke buildup. For this control, Yokogawa proposed the steam supply optimization algorithm of Exapilot, its operation efficiency improvement package, to ROC.



Diagnostics in progress

■ Thai Acrylic Fibre Co., Ltd.

Thai Acrylic Fibre Co., Ltd. (TAF), a member of the Aditya Birla Group of India, produces 100,000 tons of one of the world's three best quality acrylic fibers each year at their Saraburi, Thailand plant. At this plant, Yokogawa's diagnostics revealed that the current operating condition (two lines) could be improved to yield the following energy savings per year:

- Steam: 3,100 tons (490 tons- CO₂)
- Electricity: 6,400 kWh (4 tons- CO₂) (As a side-effect of control valves' stability)

Diagnostics were performed on the drying machine, which uses the most amount of steam in the entire plant, and on the plant's main control valves. InsightSuiteAE's diagnostic devices for the control loops and the control valves were installed to check the temperature control conditions. The results showed that the temperature controller of the drying machine is unstable, causing more steam to be consumed than necessary, and that the control valves are unsettled, causing wasting of air.

Yokogawa's Contributions

These efforts were made as part of Yokogawa's new service-based solution called "VigilantPlant Service™", announced in February 2010. With VigilantPlant Services™, Yokogawa works with its customers to detect and solve various problems and to maintain the effectiveness of the plant throughout its lifecycle.

For this occasion, Yokogawa worked in collaboration with its customers in Thailand who use Yokogawa control systems, by adding InsightSuiteAE and Exapilot on their existing system and performing energy saving diagnostics. As a result, potential opportunities for significant energy savings were identified. Based on these findings, Yokogawa and its customers will be looking into ways to improve the controllability that actualizes energy savings.

In order to continue the energy-saving efforts throughout the lifecycle of a plant, it is important to not only offer solutions, but also to educate the local users and provide long-term support. Yokogawa recognizes its responsibility as a global provider of control systems, and is committed to promoting global energy conservation, not only by offering products and solutions, but also by supporting its customers' plants with a long-term perspective.

Ensuring Safe and Secure Factory Operations

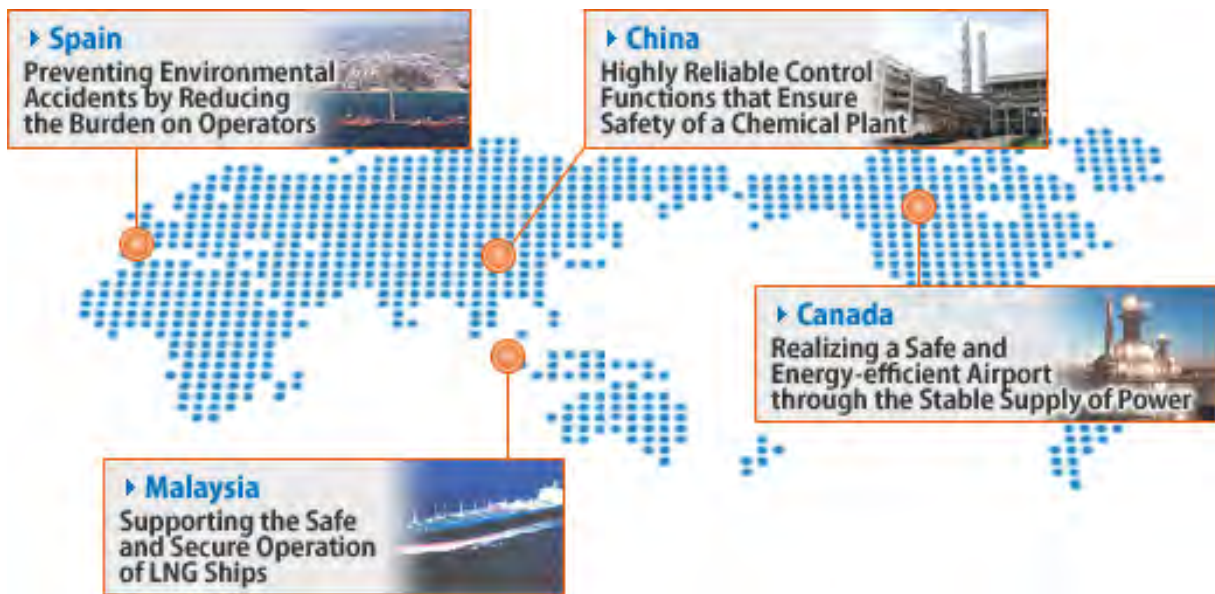

TOPIC 001 CEPSA (Spain)

Preventing Environmental Accidents by Reducing the Burden on Operators

CEPSA is Spain's second largest oil company, and its refinery in Alegegiras is its largest. This refinery produces all kinds of fuel products, including propane, butane, gasoline, jet fuel, gas-oil and fuel-oil, as well as high-quality petrochemical products such as benzene, toluene and xylene. At its offsite facilities for shipping, receiving and transport, it needs to control a complicated pipeline network used for moving and mixing crude oil. This network has a total length of 220 kilometers, and is normally involved in carrying out at least 100 jobs (shipping, receiving and transport jobs) at any one time. Accordingly, an integrated, highly reliable system able to solve the various problems that occur in such operations was needed.



Using Yokogawa's abundant offsite experience, an OMS (Oil Movement and Storage) system was installed. The resulting benefits include the following.

- Improved security monitoring during operations in the offsite area
- Reduction in operational errors that cause product contamination
- Prevention of environmental problems caused by tank overflow and other factors
- Reduction of burdens on operators through automation of operations

Operators can now understand the entire area; and operability has been increased, and safety greatly improved, by functions that can be conducted with a single button. Yokogawa's control technology has made it possible to increase the efficiency and the safety of operations at the same time.

Highly Reliable Control Functions that Ensure Safety of a Chemical Plant

Yunnan Dawai Ammonia Co., Ltd. manufactures 500,000 tons of ammonia annually through coal gasification and air separation processes. With this manufacturing method, unlike the more commonly used methods of manufacturing ammonia from natural gas or crude oil, combustion is free of smoke emissions.

On the other hand, the procedures for controlling the coal gasification process are extremely complicated, and adjusting the heat, feed amounts, coal-to-oxygen ratio and steam-to-oxygen ratio is considered quite difficult. However, with the CENTUM CS 3000's module control function and sequence control function, settings can easily be created for those factors.

The coal gasification process involves a maximum temperature of 1500°C and 40 bars of pressure, so a high level of safety is also required. If an accident were to occur, the effects on the surrounding area would be enormous, and the environmental damage incalculable. Countering such risk, the CENTUM CS 3000's reliability and ease of use are making an enormous contribution to the plant's safety.



Realizing a Safe and Energy-efficient Airport through the Stable Supply of Power

Toronto Pearson International Airport is located in a million-person city in eastern Canada and near eight US states. In 2003, it shared the same power network with the surrounding area, and was troubled by frequent power outages caused by shortages of electricity. This was an extremely serious problem. It meant that the airport couldn't reliably fulfill its function as a public facility, and that its very ability to ensure the safety of air traffic was at risk. What was clearly needed was a safe, reliable, independent source of electricity available 24 hours a day, year-round, without interruption.

As a result of considering both reliability and cost performance, a gas turbine cogeneration power plant from General Electric was selected. Yokogawa took charge of the plant's monitoring and control system.

Thanks to the new plant, it became possible to provide this international airport, an important part of the surrounding social infrastructure, with a stable supply of electricity, and airport safety and security have improved as well. Moreover, by effectively using the heat obtained from the plant's power generation and supplying the regional power network with any surplus power produced, the plant is playing a major role in conserving energy and reducing environmental burdens.

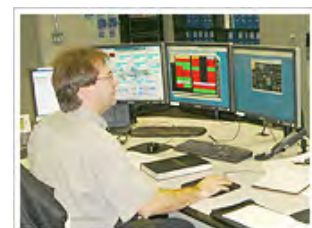

Supporting the Safe and Secure Operation of LNG Ships

The Malaysia International Shipping Corp. is Malaysia's largest maritime shipping company, and has ships exclusively used for carrying LNG (liquid natural gas). Until recently, for their operation and their cargo monitoring and control system, MISC used antiquated panel instrumentation and programmable logic controllers (PLCs). To extend the life of the ships, it was necessary to replace this system. The boiler control was also outdated and inefficient.



If something happens to a ship after it has left port and is alone at sea, the danger is greater than near land. Moreover, systems have to perform effectively in a unique installation environment subject to, among other things, irregular movements caused by wind and waves and fluctuations in a power source dependent on the boilers. Installing Yokogawa's CENTUM CS 3000 improved the visibility of information and made it possible to predict changes and promptly deal with them. Moreover, the system itself is highly reliable, thereby increasing the safety of the ships and improving the punctuality of operations and the fuel efficiency of the boilers.

Human Resource Development in the Middle East

Yokogawa Middle East B.S.C. (c) (YME), located in Bahrain, is a regional hub of the Yokogawa Group, handling large-scale energy development projects involving oil, gas, etc., throughout the Middle East. With the rapid economic development of the Middle East in recent years, YME is also experiencing growth. In this period of growth, YME is contributing to human resource development and job creation, both of which bring benefits to the region.

Here is a report from YME showing its substantial achievements in the field of science and engineering education.



- Corporate Social Responsibility towards Human Treasure Enrichment in the Middle East (YME)

Corporate Social Responsibility towards Human Treasure Enrichment in the Middle East

Yokogawa Middle East B.S.C.(c) (YME) oversees the operations and development of this energy-rich region from its headquarters in the Kingdom of Bahrain. YME has accomplished a phenomenal growth and is emerging as the undisputed market leader.

The meteoric growth placed severe demands on YME as it adapted to cope with the challenges arising from the need to deliver one mega-project after another. Even under such stringent circumstances, YME was constantly aware of its social responsibility and aligned its strategies to supplement the drives of the local governments to become knowledge-based economies. YME's host countries believed that achieving such a status would help them to produce and disseminate knowledge, leading to great economic benefits while enriching all fields of humanity.

At YME, we strongly believe that the investment in human development by enhancing the skills of society's youth and knowledge-thirsty national workforces will constitute one of the most valuable contributions that YME could make towards the realization of our corporate social responsibilities. Consequently, YME embarked on a structured program to establish collaborations with universities and organizations that promoted the development and investment of human resources.

These programs were meticulously designed to develop and enhance the skills through the transfer of knowledge, and simultaneously promote an exchange of cultures. The hands-on engagement in the Yokogawa workplace provided a deep insight into the rich Japanese work culture by emphasizing the importance of ethics, teamwork, integrity, commitment and service to customers. Involvement in extra-curricular activities such as social and sporting events, and visits to historically and culturally significant locations in Japan, promoted an understanding and respect for the Japanese ethos and way of life. A key to appreciating any nation's history and culture is by learning their language- YME conducts Japanese language courses to further this goal.



Japanese Drum Ceremony at Yokogawa Saudi Arabia (YME-KSA)



YME Football Tournament

The collaboration efforts with academic institutes are briefed as follows:

King Fahd University of Petroleum and Minerals (KFUPM), Dhahran-Kingdom of Saudi Arabia:

KFUPM is a leading university in the region focused on the needs of the Oil & Gas Industry. YME has a long-standing relationship with KFUPM. In order to facilitate effective collaboration, YME established an engineering facility in the Dhahran Techno Valley, a technology park established by KFUPM.

Some of the activities are as follows:

- Yokogawa Saudi Arabia (YME-KSA) launched a Graduate Engineer Training Program in 2007, under which trainee engineers were put through a rigorous curriculum for 1 year involving off- and on-the-job training regimes. The value of this training was enhanced through involvement in prestigious projects.



- Six groups of trainees involving 60 graduate engineers have already completed this training program.
- Additionally, students from KFUPM participated in short-term programs such as summer internships and lectures on special topics such as Advanced Process Control techniques, including some programs which were delivered to many students by a trainer from Yokogawa headquarters in Japan.
- Special laboratory sessions were conducted to supplement the KFUPM regular courses.
- YME-KSA has provided equipment including DCS and Stardom to the university and offers technical support to optimize utilization for training by the students.
- YME-KSA regularly participates in and sponsors events including technical symposiums, workshops, and career days.
- Joint research projects between YME-KSA and the university are ongoing and these constitute a major contribution by Yokogawa.



Jubail Industrial College (JIC), Jubail- Kingdom of Saudi Arabia:

JIC, located in the Jubail Industrial City, is a renowned technical college which concentrates on technology more than engineering. Associate of Science and Bachelor of Technology graduates from JIC are highly regarded. The collaboration with JIC includes the following efforts:

- The students have to undergo Industrial Training in their final semester leading to their graduation. YME-KSA is one of the few private companies that have the privilege of delivering this training, which is a rare distinction.
- 3 groups of trainees involving 30 students have already been enrolled in the training programs within one year of its commencement.
- YME-KSA supplies a DCS to the college and is closely working with the JIC faculty to ensure the system is used effectively to train the students.



Yanbu Industrial College (YIC), Yanbu- Kingdom of Saudi Arabia:

YIC, located in the Yanbu Industrial City, is a technical college which is accredited by A.B.E.T. (Accreditation Board for Engineering and Technology Inc. U.S.A.). Associate of Science and Bachelor of Science graduates from YIC are in high demand from the industry. Collaborative efforts with YIC similar to those of JIC are currently being established.

- YME-KSA conducted a training opportunity campaign in the summer of 2011 at YIC which involved more than 200 students.
- Discussions are ongoing to expand the scope of collaboration through mentoring on the students' design projects, lab program enhancement, the joint-delivery of training to industry through the continuing education programs, and so on.



University of Bahrain (UOB), Kingdom of Bahrain:

UOB is the national university of Bahrain. YME enjoys a long and solid relationship with the College of Engineering in particular. Several collaborative efforts successfully completed include:

- Membership in the Industrial Advisory Committee. This enhances the curriculums of the Bachelor of Engineering and Master of Engineering at the Chemical and Instrumentation Colleges, leading to accreditation by A.B.E.T. in 2009.
- Several groups of trainees have participated in summer internships at YME. Additionally, 20 Graduate Engineers were inducted into the 2-year training program. This is part of YME's commitment to train 50 graduate engineers over a 5-year period from 2010.
- YME regularly participates at the Career Open Day, and jointly with the University delivers special training courses to the industries as part of the continuing education programs. Typical topics such as "Transmitters and transmission signal modes", "Expose on Control Systems", are very popular.

The Petroleum Institute (PI), United Arab Emirates:

PI was founded in 2001 with the goal of establishing itself as a world-class institution in engineering education and research in areas of significance to the oil, gas and wider energy industries. The PI's sponsors and affiliates include Abu Dhabi National Oil Company (ADNOC) and four major international oil companies. Currently PI offers Bachelor degrees in Chemical, Electrical, Mechanical, Petroleum and Petroleum Geosciences, as well as Master of Engineering degrees in Chemical, Electrical, Mechanical and Petroleum Engineering.

YME-Abu Dhabi established a Memorandum of Understanding with PI in 2009, and is working closely to expand the areas of collaboration shown below:

- Bachelor of Science students have been enrolled in the summer internship program before they enter the final year of their study. YME is the only company other than the major stakeholder ADNOC that has earned the privilege to deliver this program. YME has accepted the first group of students from the Electrical and Chemical Engineering Departments. Five female students are in this group, reflecting Yokogawa's quest to promote development across the entire spectrum of society. This program, scheduled for 2 months in the summer of 2011, involves hands-on experience on Mega Projects which are being executed in Abu Dhabi. This program includes a 2-week visit to a Yokogawa manufacturing facility in Japan, to promote understanding of Japanese culture, spirit of team work, and systems.
- A group of students from PI visited Yokogawa Abu Dhabi engineering facility in April 2011 as a part of a field trip. This will be a regular feature for male and female students separately every semester.
- YME is extending support to the laboratories and mentoring to the students on their senior design projects.





Other collaborative efforts in the pipeline:

YME has begun preliminary discussions with the Qatar University and is also planning to pursue collaboration with the University of Oman and Kuwait.

Rebuilding Eastern Japan

The Group companies have made a variety of contributions in the aftermath of the Great East Japan Earthquake. Of course, our hearts go out to the victims of this terrible tragedy and their families, and we sincerely hope that all the affected areas will soon recover.

Helping to Rebuild Customers' Factories

The Great East Japan Earthquake affected a number of companies dealing with social infrastructure systems such as power supply, gas supply and water supply/sewage, as well as manufacturers of parts and materials. We at Yokogawa continue to do our utmost to help the affected customers quickly resume operations at their factories and facilities.

"Integrated Image Information System" Enabled Prompt Medical Aid in Affected Areas

Ishinomaki Red Cross Hospital is located in Ishinomaki City, Miyagi Prefecture, which suffered massive damage due to the Great East Japan Earthquake.

As the traffic systems and communication networks were disrupted, and supplies were exhausted, Ishinomaki Red Cross Hospital worked desperately to continue providing medical services as the only disaster relief center in the region still equipped with medical functions. Yokogawa Medical Solutions' "ShadeQuest," Integrated Image Information System, in place at the hospital, facilitated prompt medical aid to people from the areas affected by the disaster.

"ShadeQuest" allows the doctor and patient to view the digital images captured by CT, MRI, etc., directly on the PC screen instead of having to expose and develop films. The earthquake cut off the supply of films, but Ishinomaki Red Cross Hospital was able to continue examining patients with "ShadeQuest".

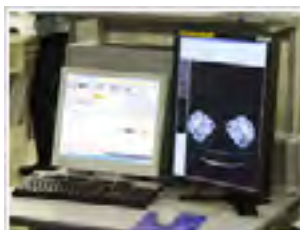

"ShadeQuest" eliminates the need for additional space in which to store a massive amount of films. Additionally, it reduces the manpower needed to manage/transport films and limits the consumption of materials used to manufacture films. It also serves as an environmental solution, because the system prevents the creation of environmental pollution that would otherwise occur with developing solutions and associated waste.

Today's "wired" hospitals cannot do without imaging systems capable of managing images captured by CT, MRI and other radiological test systems in digital form. Yokogawa Medical Solutions supports the frontline of medical service by providing "ShadeQuest" to university hospitals, key regional hospitals and other medical facilities throughout Japan.

Contributions to NPO/NGOs and Donations to Victims

Yokogawa Group companies in Japan and abroad, as well as their employees, donated the following amounts to the victims or made contributions to NPOs, NGOs and other organizations conducting relief efforts in the affected areas:

Contributor	Recipient	Amount
Yokogawa Group	Japan Platform*	50,000,000 yen
Yokogawa Group Employee Charity Fund	Japan Platform* , etc.	Approx. 10,400,000 yen
Yokogawa Group (affiliates in Japan)	Japan Red Cross, etc.	3,600,000 yen
Yokogawa Group (affiliates overseas)	Red Cross in each country, etc.	Approx. 21,300,000 yen**

* Japan Platform: An international humanitarian organization with the participation of Japanese NGOs, companies and government agencies, whose mission is to provide efficient, prompt emergency assistance to refugees and victims of natural disasters.

** All amounts were converted to Japanese yen.

Provision of Relief Supplies

Yokogawa Electric Corporation provided the following sanitary goods from its emergency stockpile to aid the victims of the March 11 earthquake in Japan's Tohoku region.

Through the Tokyo Metropolitan Government	
Alcohol gel disinfectant	80 x 500 ml bottles and 600 x 40 ml bottles
Wet tissues	480 x 100 sheet dispensers
To Keio Medical Relief Teams	
Surgical masks	20,000
Disposable waterproof surgical gowns	500
Disposable waterproof aprons	500

Yokogawa has established the corporate philosophy and the standards of business conduct applied to all the group companies. These policies clearly describe Yokogawa's corporate responsibility.

Also, the Yokogawa Group Compliance Guidelines give clear rules and guidelines relating to human rights, obedience to the law, workplace safety, hygiene, etc.

Yokogawa's Approach to CSR

Yokogawa's Contribution to Society through its Core Business

An enterprise should sustain itself and grow with the changing society. Yokogawa's corporate philosophy states that its goal is "to contribute to society through broad-ranging activities in the areas of measurement, control, and information." As Yokogawa takes pride in the fact that it is supporting the industries in the world, it is fulfilling our responsibility to society.

In addition, to address the issues that society and global environment are facing, Yokogawa contributes to the society by utilizing the "technology for measurements, controls, and information." It utilizes these methods in the areas of energy conservation solutions, new energy development support, energy load measurement and analysis, and medical and pharmaceutical development support.

Responsibility to Stakeholders

In Standards of Business Conduct for the Yokogawa Group, five "Basic Principles" are defined: Realizing the Yokogawa Philosophy, Customer Satisfaction, Observance of Laws and Regulations, Respect for Human Rights, and Order and Safety of Community and Society. In addition, the Basic Attitude of the Yokogawa Group defines its contribution to global environmental protection and relationship with the stakeholders. Abiding by these principles, work is in progress to meet the expectations of stakeholders, which includes employees, customers, and stockholders.

At Yokogawa, all employees are considered an asset (human resource), and as such, it strives to continually improve its work environment and proactively provide its employees with opportunities to develop their abilities. In addition, it strives to meet the expectations of its customers, with its motto since the inception, "Quality First." Being also mindful as "good citizens," as declared in its corporate philosophy, Yokogawa is actively engaged with local communities and social action programs through its employee volunteers.

Corporate Governance

To support a healthy and continued growth, Yokogawa is working to strengthen its corporate governance, striving to increase the transparency of the decision making by our Board of Directors and to enhance the audit functions. At the same time, Yokogawa is maintaining its internal control system to execute the business appropriately and effectively. In addition, as a business that is trusted by society through its fair and honest business activities, Yokogawa makes an effort to cultivate a corporate culture that gives compliance the highest priority above all else.



CSR Promotion Structure

In 2008, a designated department for CSR was newly established. In 2009, departments in charge of compliance, environmental protection, occupational labor and safety, and corporate citizenship were consolidated into the CSR Department, which was set up within the Audit and Compliance Headquarters that oversees internal control. The result is a structure for more comprehensive CSR activities across the entire group.

The United Nations Global Compact

In January 2009, Yokogawa participated in the "United Nations Global Compact," an international initiative that promotes 10 principles concerning human rights, environment, and corruption prevention in. As of February 2010, 7,542 groups are participating in the world, and Yokogawa is the 76th Japanese company to participate in it. An effort has been ongoing to share the ethos and the standard of the Global Compact with all workers within the Group and all the customers connected through its supply chains.



Mizue Unno

Managing Director, So-Tech Consulting Inc.

After graduating from Chiba University Graduate School of Horticulture, Ms. Unno worked for various consulting firms including Roland Berger Strategy Consultants until she founded So-Tech Consulting Inc. in 1996. At present she provides Japanese firms advice and support in practical corporate activities in the areas of sustainability and CSR from a global management perspective. She is also a part-time graduate school lecturer of the University of Tokyo and serves as a member in various government committees. Publications include “Understanding the Basics of Corporate Social Responsibility (CSR)” (Chuokei Publishing Co.).

For this assessment I made an inspection visit to the Kofu Plant, one of Yokogawa Electric Corporation’s major plants and I also interviewed the staff in charge of CSR. After carefully reading the CSR report, I formed the following opinion.

Basic understanding of CSR: Development of Strategic CSR

Many people still associate CSR with corporate activities relating to compliance, thoroughness in corporate ethics, or volunteer service in the community. Essentially, there is a tendency for CSR to be viewed as a series of corporate initiatives where “individual employees go back to the basics of providing sincere service to give something back to society through acts of goodwill.”

In CSR in the world at large, however, emphasis is placed on the issue of how corporations “can link CSR to resolving social issues relevant to their companies by integrating CSR into their overall business activities.” This point is clearly stated in ISO26000, the recently issued international standard for social responsibility, which views CSR as activities that should be strongly linked to sustainability (sustainable development).

CSR does not end at risk measures or services performed by a company as a good corporate citizen. Developing strategic CSR as a positive factor that will create opportunities in business and that can be linked to increasing competitiveness is important.



Development of strategic CSR

CSR activities at Yokogawa Electric at present are for the most part centered on risk management. Furthermore, while products and solutions at present individually contribute to reducing the impact on the environment and society, there is little indication of a view of integrating sustainability into the overall business strategy as a business opportunity, and this is unfortunate.

Measuring and control instruments, which comprise the mainstay business of the company, are a product group that contributes considerably to reducing the environmental impact on the customer-use side and efficient operations on the plant side. This business is considered an axis that contributes to sustainability in concerted efforts with customers and can therefore be considered strategic CSR. Today, as the world aims for long-term development on a global scale, one of Yokogawa Electric's strengths is that it engages in business that is linked to resolving environmental problems. This goes beyond very early CSR initiatives in the sense that the business strategy of Yokogawa Electric can be said to be integrated as sustainability management.

I understand that Yokogawa Electric's superior technology has been one of its notable characteristics. The challenge for the company in the future will be how it will align this technology and its products with social needs to benefit society as a whole. In this regard, I believe that it would be beneficial for the company to review its business strategy not only in terms of "meeting customer needs" but also in terms of "how it can connect meeting the needs of society as a whole to resolving issues."

At that time it will be important to shift priority to areas where aiming for sustainability applies. Until now oil-related business including refineries have taken center stage but in an age of sustainability attention will increasingly focus on the development of clean energy as an alternative to oil and the development of water treatment systems. Attention is also shifting from energy conservation through individual devices and facilities to overall efficiency at a wide-area municipal level through integrated, regionally based "smart energy." In this regard, there are expectations for Yokogawa Electric's future sustainability strategy in terms of how it will become involved in this area.

Fundamental CSR Part of the Strategy

From the viewpoint of integrating CSR into an overall strategy in the area of sustainability, your current activities can be described as a combination of basic CSR areas plus governance. Although there are initiatives in CSR already integrated into the internal control system in areas such as labor management, the environment, and health and safety, the aspect of "management" seems to dominate. Even when it comes to fundamental CSR activities, rather than pushing them as a framework of "activities that should be done," I believe it would be better to aim for management that encourages the development of a self-motivated environmental and social consciousness in the course of everyday work activities.

CSR activities in overseas operations will be of particular importance in the future. ISO26000 covers a number of topics such as human rights and labor practices from the perspective of emerging and developing nations. In a globalized economy, more and more responsibility is being placed on multinational corporations. Therefore, the issues described below will need to be tackled systematically.

- Labor Practices

Workplace health and safety, the employment environment, and human rights issues are all imperative areas. In the case of Yokogawa Electric, which has overseas group companies with employees of mixed races and nationalities, these apply not only to your own companies but also work sites at customer plants, and this can be said to be quite a difficult challenge. Consideration of a framework not only for working conditions but also work practices that encompass personnel training and skills development is essential.

- Supply Chain

CSR expectations are not limited to within the company but extend to the activities of the supply chain and business partners. In the same way that Yokogawa Electric's plants undergo CSR inspections from customer companies, the activities of the suppliers are also subject to scrutiny. In addition to instructions in the Supply Chain CSR Guidelines, the company is expected to ascertain in concrete terms how these guidelines are being practiced.

- Community involvement

While Yokogawa Electric is proactive in domestic community activities, in the future it must also bring into its sights how well it is performing overseas in those areas where there are expectations. Nowadays the company is also expected not only to provide local services through CSR as it has but also to support local autonomy through activities that will raise the skills of the region and employees. As a company this will be an initiative that is considered an investment in society rather than an expense.

Yokogawa Electric is expected to engage not only in those initiatives that all corporate enterprises are familiar with but also strategic community involvement activities that combine the company's line of business and the special features of its operations.

CSR Rating by the Dow Jones Sustainability Indexes



Yokogawa Electric Corporation has been selected to the Dow Jones Sustainability Asia Pacific Index (DJSI Asia Pacific) and to the Dow Jones Sustainability World Enlarged Index (DJSI World Enlarged).

The DJSI is a leading corporate social responsibility index developed jointly by Dow Jones of the United States and Sustainability Asset Management (SAM) Group, a Swiss research and rating company. The selection of a company to the DJSI is based on a wide ranging analysis of economic, environmental, and social criteria. In 2010, 600 major companies in the Asia Pacific were surveyed for the DJSI Asia Pacific, and of this total 143 companies were selected, including 73 Japanese companies. For the DJSI World Enlarged index, which was launched in November, 2,500 major companies around the world were surveyed and a total of 513 companies were selected.

CSR Rating by SAM (Sustainable Asset Management)



Yokogawa Electric Corporation, in February 2011, was selected as the "sector mover" in the electronic equipment sector of "The Sustainability Yearbook 2011," published by SAM (Sustainable Asset Management), which conducts research and analysis of companies comprising the Dow Jones Sustainability Indexes.

SAM analyzes 2,500 companies in key 58 industries around the world from the three aspects of economy, environment and society, and publishes 409 companies in "The Sustainability Yearbook" as companies contributing to the realization of a sustainable society. Forty-one Japanese companies, including Yokogawa Electric Corporation, are currently included on the list. The "sector mover" status that Yokogawa has received is given to the company whose actual contributions to sustainable society have seen the most improvement in its respective industry over the previous year.

Socially Responsible Investment Stock Index by Morningstar (Japan)

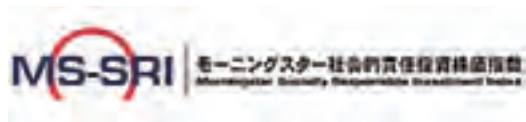

Yokogawa Electric Corporation, as of July 2010, is one of 150 companies constituting the MS-SRI (Morningstar Socially Responsible Investment Index), which is an SRI stock index established by Morningstar (Japan).

**"Leading Company in Socially Responsible Management" (in Japan),
by the Japan Research Institute, Limited**

Yokogawa Electric Corporation, in February 2011, was selected as a company leading in the areas of social responsibility, governance, environmental management and provision of business solutions to social issues, from among 2,000 companies including those listed in the first section of the Tokyo Stock Exchange.

2011 "Global Customer Value Enhancement Award" by Frost & Sullivan



Yokogawa Electric Corporation has received the 2011 "Global Customer Value Enhancement Award" from Frost & Sullivan, a leading global research firm.

- Press Release (April 13, 2011)

"Ideal Companies to Work for in 2010" by Nikkei Inc. (Japan)

Yokogawa Electric Corporation, as of September 2010, was ranked 103rd among the 1,568 "Ideal Companies to Work for in 2010," such companies having been selected by Nikkei Inc., based on their personnel administration systems and utilization condition of those systems.



The Yokogawa Group's Environmental Management

We at Yokogawa regard conservation of global environment as an important management issue and strive to implement the environmental management needed to address it.

Specifically, we help our customers be "green" by, for example, developing products that allow for harmonious coexistence of mankind with nature and providing environmental solutions that help analyze/

improve environmental impact generated through their business activities, just as we actively endeavor to reduce the environmental impact in our business operations.



Environmental Policy of the Yokogawa Group

In conformity with Basic Environmental Management Rules for the Yokogawa Group(GM-850), each site of the Group shall strive, in all its activities, to:

1 Establish, maintain, and improve its environmental management system.

Each site establishes an environmental management system in order to promote and continuously improve its global environmental conservation activities. To maintain and improve the system, each site accurately evaluates the burden of its activities on the environment including climate change, biodiversity and water resources, sets environmental objectives and targets that are technically and economically viable, and carries out environmental audits.

2 Provide environmental training.

Each site actively provides training for global environmental conservation to ensure that employees understand the Environmental Philosophy, Code of Conduct for Environmental Conservation, and Environmental Policy of the Yokogawa Group to improve their environmental awareness, and to act autonomously with consideration of the environment in both their work and life in the local community.

3 Abide by legal regulations.

Each site abides by laws, legal regulations, and other requirements applied to environmental aspects, in order to proactively conserve the global environment.

4 Carry out resource recycling-based operations.

Throughout its activities, each site endeavors to utilize energy and resources efficiently, to prevent global warming, to reduce waste, and to promote the reuse and recycling of resources with the aim of eliminating emissions.

5 Minimize environmental pollution.

Each site strives to eliminate the use of substances that adversely impact the environment, such as toxic chemicals, and ozone-destroying substances, by using safe substitutes or employing safe technologies to avoid the risk of environmental pollution.

6 Create environmentally friendly products.

Each site develops and produces environmentally friendly “green” products in consideration of the environmental burden throughout the products’ lifecycles, from material purchase, manufacture, and distribution to their use and disposal.

7 Supply society with environmental solutions.

Each site supplies society with value-added products and services for conserving the earth’s environment through measurement, control, and information technologies.

8 **Contribute to local communities.**

Each site encourages its employees to participate in environmental conservation activities under their own initiative as good corporate citizens.

9 **Make environmental information available to the public.**

Each site actively makes environmental information, including its environmental policy and conservation activities, available to the general public.

April 2011

Shuhei Sakuno

Senior Vice President

Audit & Compliance Headquarters

Yokogawa Electric Corporation

Organization

To promote the environmental management principle of the Yokogawa Group, we established the "Yokogawa Group Green Promotion Committee" with the aim of stepping up group-wide efforts to conserve the global environment and prevent climate change. The Committee, chaired by the Yokogawa Group's Environmental Officer, provides leadership the Yokogawa Group companies throughout inside and outside Japan in order to drive environmental management and implement various measures designed to conserve the global environment and prevent climate change.

Organization of Environmental Management Promotion

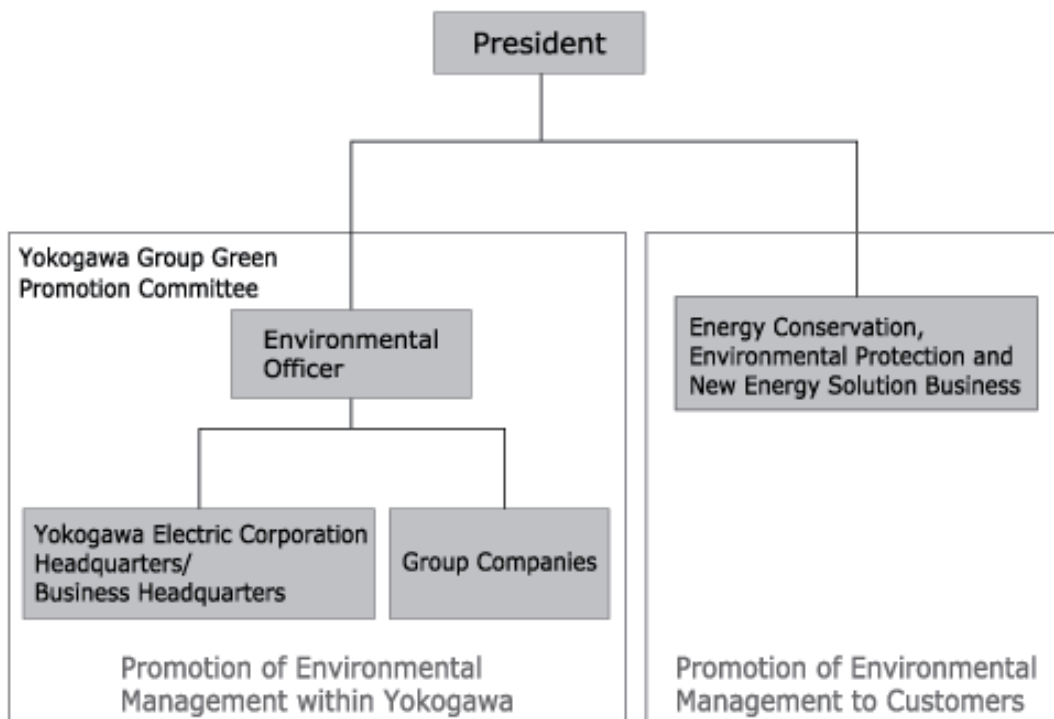

ISO14001 Certifications

Yokogawa Group's ISO 14001-certified sites (including KES*) are as follows:

ISO14001

As of the end of March 2011

Factories		Date Certified
Yokogawa Electric Corporation Headquarters & Main Factory		July 1997
Yokogawa Manufacturing Corporation Consolidated certification covering Komine, Kofu, Ome, Uenohara and Headquarters Factories		July 1997
Yokogawa Meters & Instruments Corporation		July 1997
Yokogawa Field Engineering Service Corporation		February 2000
Yokogawa Denshikiki Co., Ltd.		November 2000
Yokogawa Digital Computer Corporation		September 2007
Suzhou Yokogawa Meter Company	China (Suzhou)	May 1998
Yokogawa Shanghai Instrumentation Co., Ltd.	China (Shanghai)	March 2000
Yokogawa Sichuan Instrument Co., Ltd.	China (Chongqing)	December 2000
Yokogawa Electric China Co., Ltd.	China (Suzhou)	May 2004
Yokogawa Electric Asia Pte. Ltd.	Singapore	October 1998
Yokogawa Engineering Asia Pte. Ltd.	Singapore	August 2001
P.T. Yokogawa Manufacturing Batam	Indonesia	April 2000
Yokogawa Corporation of America	USA	June 2005
Yokogawa Electronics Manufacturing Korea Co., Ltd.	South Korea	December 2004
Yokogawa Measuring Instruments Korea Corp.	South Korea	March 2007
Yokogawa Philippines, Inc.	Philippines	June 2007

* "KES" refers to the KES Environmental Management System Standard.

Environmental milestones

Various global environmental conservation activities had been carried out before Yokogawa Kofu office was certified with the ISO14001 certification in 1997 followed by officially implementing the environmental management system across the entire Yokogawa group. The environmental practices of Yokogawa group since 1971 are listed below in chronological order.

History of Environmental Practices of Yokogawa (in time series)

1971		Yokogawa establishes a pollution prevention organization
1974	July	Yokogawa completes construction of wastewater treatment facilities to comply with ordinance of Tokyo compliant with municipal bylaws
1987	May	Yokogawa begins environmental assessment studies
1989	October	Yokogawa establishes a chlorofluorocarbon (CFC) reduction committee
1991	April	Yokogawa sets up an organization to promote an Environment management
	August	Yokogawa starts "Save the Earth" campaign
1993	February	Yokogawa appoints a Vice President of Environmental Management and forms a Global Environment Committee
	July	Yokogawa establishes a voluntary environmental activities plan
1994	August	Yokogawa reports the results of voluntary environmental activities in fiscal year 1993
	December	Yokogawa completely eliminates specific CFCs and trichloroethane for cleaning
1995	June	Yokogawa Board of Directors decided to obtain ISO14001 certification and merge a voluntary environmental activity plan into ISO14001 plan.
	October	Yokogawa reorganize a Global Environment Committee
1996	March	Yokogawa establishes corporate rules for environmental management
	May	Yokogawa forms a Global Environment Committee at Yokogawa Electric Headquarters & Main Factory, Kofu Office (current Yokogawa Manufacturing Kofu Factory), and Komine Factory (current Yokogawa Manufacturing Komine Factory). Solar power generators for disaster use installed at Yokogawa Electric Headquarters & Main Factory. Yokogawa signs a disaster prevention accord with Musashino City.
1997	April	Issued "Green Times", a company newsletter
	July	The Kofu Office (current Yokogawa Manufacturing Kofu Factory) obtains ISO14001 certification
1998	February	Yokogawa Electric Headquarters & Main Factory and the Komine Factory (current Yokogawa Manufacturing Komine Factory) obtain ISO14001 certification
	May	Two co-generation power generators (585 kw) go online at the new main building of Yokogawa Electric Headquarters & Main Factory
	June	Yokogawa begins publishing Yokogawa Environmental Catalogue
1999	September	Yokogawa publishes Yokogawa Environmental Report 1999. Also the company introduces environmental accounting and makes data available to public.
	November	Yokogawa introduces environmental labeling (Type II)

2000	July	Yokogawa Electric Headquarters & Main Factory reached its goal of generating zero landfilled waste
	August	Yokogawa introduces Japan's first returnable container recycling service for customers
	September	Yokogawa publishes Yokogawa Group Environmental Report 2000 and introduces third-party verification system
	November	Suzhou Yokogawa Meter Co. joins the China-Japan 3E (Energy, Environment, and Economy) Research Project and is selected as a model company for environmental accounting study
2001	Marth	Yokogawa establishes The principles of Yokogawa Group Environmental Management Standards.
	July	Yokogawa publishes Yokogawa Group Environmental Report 2001
	September	Three Yokogawa sites receive comprehensive ISO14001 certification
	November	The Kofu Office (current Yokogawa Manufacturing Kofu Factory) reached its goal of generating zero landfill waste
2002	February	The Yokogawa Manufacturing Akiruno Office (current Yokogawa Manufacturing Komine Factory) accomplishes its goal of generating zero landfill waste. The Kofu Office (current Yokogawa Manufacturing Kofu Factory) installs a light through type solar power generating system
	July	Yokogawa publishes Yokogawa Group Environmental Report 2002
	Augst	Four Yokogawa sites receive comprehensive ISO14001 certification
2003	February	The Econo-Pilot energy-saving system for water pumps receive the Agency of Natural Resources and Energy Director-General's Award at the Energy Conservation Award ceremony. The Kofu Office (current Yokogawa Manufacturing Kofu Factory) receives award from the Director-General of the Kanto Bureau of Economy, Trade and Industry in recognition of its achievements in reducing energy consumption.
	July	Yokogawa publishes Yokogawa Group Environmental Report 2003
	October	The Plant of newly established Yokogawa Electric China starts operations in Suzhou as an environmentally aware manufacturing site
2004	March	New environmentally optimized facilities at the Yokogawa Manufacturing Komine Factory and Kofu Factory start operations
	June	Yokogawa publishes Yokogawa Group Environmental Management Report 2004
	August	Yokogawa Electric Headquarters & Main Factory obtain a separate ISO14001 certification
2005	March	Energy Conservation Guided Tours start at the Yokogawa Manufacturing Kofu Factory
	April	Yokogawa joins the Team Minus 6% national campaign
	June	Yokogawa publishes Yokogawa Group Environmental Management Report 2005
2006	March	Yokogawa Manufacturing Kofu Factory and Komagane Factory attain zero CO ₂ emissions
	September	Yokogawa publishes Yokogawa Group Sustainability Report 2006
	October	Yokogawa introduces the Green Power Certification System (300,000kwh) The Kanazawa Office receives the New Office Promotion Award, Environment Award and Good Design Award for architectural design

2007	June	Yokogawa publishes Yokogawa Group Corporate Social Responsibility Report 2006
	September	Yokogawa Group establishes the Energy Conservation and Environment Protection Solution Division in order to promote environmental management solutions to customers
2008	June	Yokogawa publishes Yokogawa Group Corporate Social Responsibility Report 2007
2009	May	Yokogawa completely abolishes the usage of HCFC
	June	Yokogawa publishes Environmental Report 2009 on its website.
	October	The Kofu Office receives "Green IT Award 2009 Minister of Economy, Trade and Industry Award" for its energy-saving activities
2010	February	The ESCO business receives the 2009 Energy Conservation Grand Prize

Environmentally Friendly Products

Yokogawa actively develops environmentally friendly products through the implementation of its own strict standards of design and assessment for long-term usability, energy-saving performance and other aspects. New products are evaluated for energy consumption as well as the emission of carbon dioxide (CO₂), nitrogen oxide (NO_x) and sulfur oxide (SO_x) based on our Lifecycle Assessment (LCA) standards.

Example Product: FA-M3V Series Leading Edge Controller

A new series of FA-M3 range-free controllers, known collectively as "FA-M3V", was introduced in January 2011.

The calculation results of the "FA-M3V" series based on our Life-Cycle Assessment (LCA) standards show that they have cut the CO₂ emission by 94.6%, NO_x emission by 94.1% and SO_x emission by 94.6% compared to similar products.



Leading Edge Controller
FA-M3V Series

- FA-M3V Leading Edge Controller

The FA-M3V supports faster, more accurate industrial machinery/equipment such as electronic component/electronic device assembly systems and semiconductor manufacturing apparatus.

Lifecycle Assessment (LCA) Reference Comparison Chart

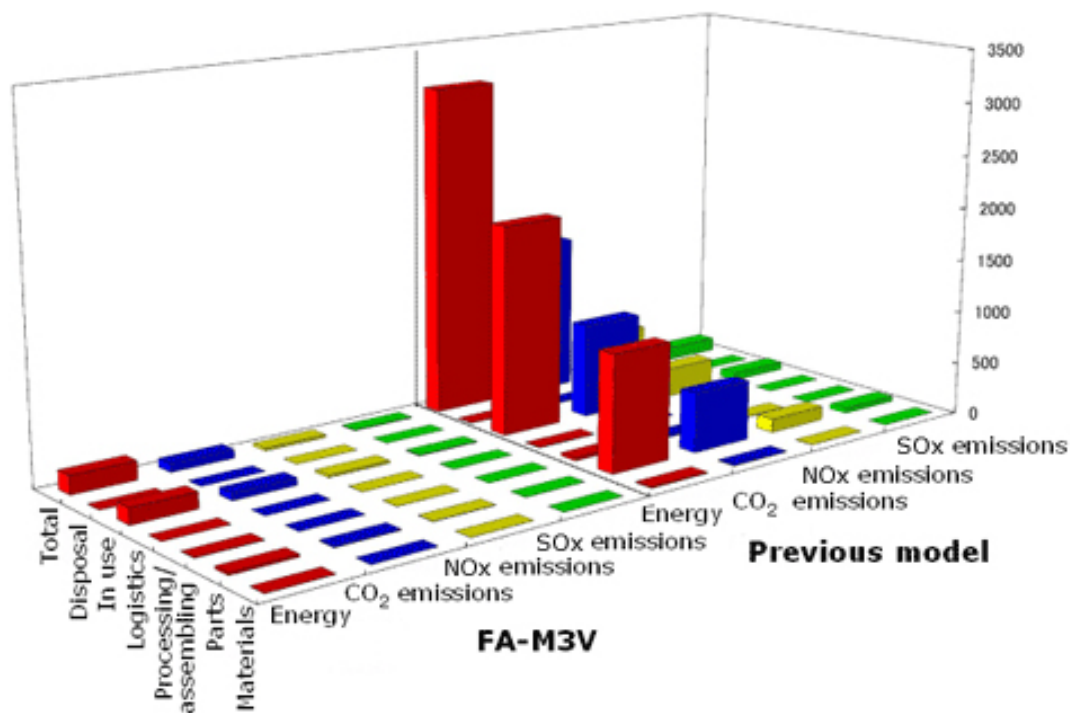

Example Product: FLXA21™ Modular 2-Wire pH/ORP Analyzer

The two-wire liquid analyzer "FLXA21™", released in April 2010, is a modular liquid analyzer that permits the connection of two sensors to a single transmitter through the two-wire method. Calculation results of the "FLXA21™" based on our lifecycle assessment (LCA) standards show that they have cut the CO₂ emission by 12.0% and NO_x emission by 22.5% compared to similar products.



FLXA21™ Modular 2-Wire pH/ORP Analyzer

Example Product: FVX110 Fieldbus Segment Indicator

The field-mount indicator "FVX110", which conforms to the FOUNDATION™ fieldbus digital communication protocol for industrial applications, was released in September 2010. Field-mount analog indicators that employ the analog communication method can each display only one process quantity that is input from one field instrument. However, because the "FVX110" is capable of displaying 16 process quantities input from multiple field instruments, the number of field-mount indicators that must be introduced can be dramatically reduced.



FVX110 Fieldbus Segment Indicator

Example Product: UTAdvanced Serie Digital Indicating Controllers

Three models — the program controllers "UP55A" and "UP35A" and the "UM33A" digital indicator alarm — were added to the "ATAdvanced®" digital indicating controller series in August 2010. The new models cut power consumption by 20% or more compared to conventional models with similar features. Designed to suppress internal heat generation, these models are 35% slimmer than conventional models in the dimension of depth. Measuring just 65 mm deep, these new controllers significantly contribute to the size reduction and space savings of modern instrument panels.



UTAdvanced Serie Digital Indicating Controllers

(1) Environmental Assessment Standards for Product Design

We have established assessment standards in eight areas: ease of recycling and treatment, resource conservation, energy conservation, long-term usability, ease of collection and transport, safety and environmental protectiveness, information disclosure, and packaging. These standards are used in conducting assessments during each inspection (initial design, intermediate design, and final design).

(2) Lifecycle Assessment (LCA) Standards

The LCA standards are used for preliminary assessments of energy use, CO₂ emissions, NO_x emissions, SO_x emissions, and the like throughout the lifecycle of a product. These standards are used in conducting assessments during each inspection (initial design, intermediary design, and final design).

(3) Environmentally Friendly Product Design Guidelines

These guidelines establish design and machining and assembly methods that incorporate long-life design, energy conservation design, resource conservation design, and materials and parts selection guidelines, as well as standards for the recycling and disposal of products.

(4) Standards on Toxic Substances in Products

These standards guide the selection of environmentally friendly parts and materials in the design stage. The standards stipulate the elimination or reduction of substances a total of 44 substance groups: 15 prohibited substance groups and 14 voluntarily controlled substance groups specified in the Green Procurement Study Standardization Guidelines, and substances in 15 voluntarily controlled substance groups nominated by the Group.

(5) Recycled Product Design Standards

These standards encourage the three Rs: the reduction of waste and the reuse and recycling of used products.

(6) Environmentally Friendly Material Selection Standards

These standards state that the use of halogen-based flame retardants is to be avoided. The standardized specifications of materials also state that the use of structural steel plates containing hexavalent chromium is to be avoided and assign chrome-free steel plates as a substitute.

(7) Energy-saving Design Guidelines

These guidelines state that energy is to be conserved in the manufacturing and product use stages. They introduce energy conservation design technologies for products and manufacturing.

Environmentally Friendly Design and Assessment Standards

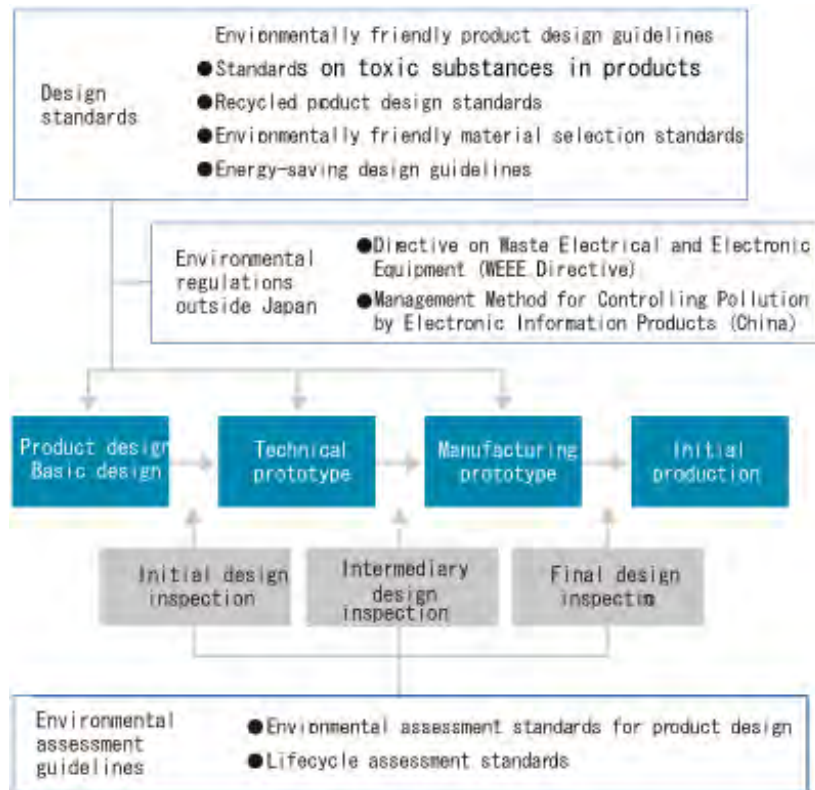

Environmental Assessment Standards for Product Design

(1) When	Initial design inspection/intermediate design inspection/ final design inspection
(2) Assessment items	Twenty-nine items in eight fields; ease of recycling and treatment, resource conservation, energy conservation, long-term usability, ease of collection and transport, safety and environmental protectiveness, information disclosure, and packaging.
(3) Evaluation criteria	Score is zero points if legal regulations are not satisfied, four points if legal regulations are satisfied and an improvement of 30% or more is achieved, three points for an improvement of 15% or more, two points for an improvement of 5% or more, and one point for an improvement of less than 5%.
(4) Pass/fail judgment criteria	In order to pass, there must be no assessment items with a score of zero points, and the total score must be greater than that of the old model. A "failed" judgment is given if any of the assessment items has a score of zero points or if the total score is the same as or lower than that of the old model. The improvement guidelines target an improvement of 25% or more, and more than anything seek to incorporate environmental-burden reduction into design.

Environmental Solutions

Yokogawa has always been an active contributor to the improvement of production efficiency in regard to measurement, control and information. These efforts have allowed us to reduce cost while cutting CO₂ emissions and saving energy.

Thus Yokogawa provide solutions to further enhance the energy saving in a practical way by using the experience and know-how accumulated over many years.

In the areas of environment and new energy, we are working to embody new environments and energy systems by drawing on Yokogawa's expertise in control systems that incorporate total monitoring, facility control, performance management, safety instrumentation, wireless communication and various sensor technologies.

Diagnosis of CO₂ Emission Reduction Potential of Large Iron Mill in China

Yokogawa's "Energy-Saving Diagnosis" has helped customers save energy and enhance their environmental management through the optimization of controls and operations, based on the precise understanding of such plants and the conditions that influence their operation. For example, in 2010 we conducted an energy-saving diagnosis for the Wuhan iron mill of the Wuhan Iron and Steel (Group) Corporation, a leading ironworks company in China.



The improvement of energy efficiency at iron mills is a priority challenge in the worldwide effort to prevent global warming, because such plants use large amounts of coal daily for the production of materials used in social infrastructures and consumable goods.

Accordingly, for the Wuhan iron mill we diagnosed the heat-management controllability of the cold rolling and annealing processes, which are essential to the assurance of product quality. As a result, we found that by improving the controllability, approximately 14,000 tons of CO₂ emission could be reduced by the overall plant.

This is just one example of Yokogawa's commitment to continued support for our customers and their efforts to save energy. We consistently strive to preserve the global environment.

* This diagnosis was conducted as part of the "IT Energy-saving Diagnosis Project" implemented by the Ministry of Economy, Trade and Industry and Green IT Promotion Council.

Efforts on Solar Heat, Marine Biomass and Ocean Thermal Energy, and Plans Going Forward

The blessings of the sun are stored by the earth as thermal, motion and photosynthesis energies.

Because 70% of the earth is covered by ocean, the majority of that energy is held in the seas around us. "Solar heat" is the most efficient energy of all. By collecting solar heat and utilizing it for power generation and the desalination of seawater, the blessings of the sun can be utilized efficiently.

We are also increasingly interested in "Ocean Thermal Energy Conversion," where the temperature difference between the seawater at the surface and deep down is used to generate electricity, as a natural energy source not affected by weather, seasonal changes and other environmental factors.

Plants that grow through photosynthesis work as recycling pumps, absorbing CO₂ while producing oxygen and energy. However, there are challenges to overcome in the use of corn and sugarcane as biomass materials, such as the need to cut trees and the possibility of triggering food shortages. Therefore, "Marine Biomass" is an effort to employ the vastness of the seas to grow seaweed, from which it is possible to produce biofuels and other high-value-added chemical products. Yokogawa, by identifying the potential of the sun and ocean, is working to harness these natural sources of energy.

Goals and Achievements

Goals and Achievements in Fiscal Year 2010

Environmental Policy of the Yokogawa Group	Fiscal Year 2010 (main sites)		Self Evaluation
	Target/Goal	Results	
EMS establishment, maintenance, and improvement	Confirm and achieve environmental conservation action targets that are closely integrated with our business practices.*3	<ul style="list-style-type: none"> ▪ 140 themes closely integrated with business operations ▪ An internal audits conducted and effective environmental system confirmed 	Good
	Promote useful activities in line with existing business.*2	28 useful environmental activities promoted	
Implementation of environmental education	<ul style="list-style-type: none"> ▪ Provide all employees with basic environmental education that can be applied to activities undertaken on their own initiative.*3 ▪ Provide specialized environmental education to those who are engaged in business activities that have a particularly significant impact on the environment.*3 	100% achieved	Good
Legal compliance	Monitor/measure items specified by the applicable legal requirements, and work to comply with those requirements.*2	Monitored/measured items specified by the applicable legal requirements; the results met the regulation values set for the respective items. Completed corrective measures to address the areas in which the legal standards were exceeded.*2	Medium
	Entrench preventive maintenance management related to wastewater treatment facilities.*2	Took measures and conducted emergency training by assuming potential risks to ensure thorough preventive maintenance and management.*2	
	Build an organizational structure while developing mid- and long-term plans to comply with the "Energy-saving Law" and "The ordinance of Tokyo."*2	Built an organizational structure, and developed mid- and long-term plans.*2	

Promotion of resource recycling-based management	Reduce CO2 emissions <ul style="list-style-type: none"> by 33.1 % per unit floor space, compared to fiscal year 1990 (to 96.7 kg-CO2/m² in emissions) *1 Reduced to 17,585 t-CO2/year*2 	Reduce CO2 emissions <ul style="list-style-type: none"> 37.9 % reduction (to 89.8 kg-CO2/m² in emissions) Reduced to 15,258 t-CO2/year 	Good
	Reduce total waste <ul style="list-style-type: none"> by 22 % compared to fiscal year 2003 (593 t/year in total generation)*1 Reduced to 3,142 t/year*2 	Reduce total waste <ul style="list-style-type: none"> 39% reduction (460 t/year in total generation) Reduced to 3,002 t/year 	Good
	Resource saving Deploy green production lines and make improvements at 11 lines*2	Resource saving Achieved resource-saving improvements, including on manufacturing lines and for equipment, at 11 lines (Improvement of product packing materials, etc.)	Good
Minimization of environmental pollutants	Collect information from the industry and other companies through external committee meetings, etc.*1	Information collected by attending external committee meetings	Good
	Reduce toluene and xylene by 1,950 kg.*2	2,503 kg reduction	
	Promote lead-free soldering and achieve 100% application in planned products.*2	Application to all planned products achieved	
Development of environmentally friendly products	Reduce CO2 emissions of developed products by more than 25%.*1	Five models shipped	Good
	Promote green procurement <ul style="list-style-type: none"> Introduce returnable tote boxes and pallets to three more client companies.*2 Provide suppliers with guidance and support on legal compliance.*2 	Promote green procurement <ul style="list-style-type: none"> Returnable tote boxes introduced to four more client companies Ongoing preparation to provide suppliers with guidance and support on legal compliance 	
Provision of environmental solutions	<ul style="list-style-type: none"> Increase sales of environmentally friendly products*1 Show visitors energy-saving efforts at the Kofu Factory*1 	Achieved	Good
Contribution to society through environmental conservation	Promote contributions to society through participation in nature conservation and social and community activities.*1	Participated in community clean-up activities and "Lights Off" campaign, etc.	Good
	Implementation of nature conservation and social and community activities.*2	A total of 26 social contribution activities carried out	

Disclosure of environmental conservation information	Promote information disclosure and enhance efforts to communicate with communities.*1	Published CSR report, Web edition	Good
	Improve website.*2	Publish improvement activities at each factory so that they can be applied wherever possible.	

Main sites: Yokogawa Electric Corporation Headquarters & Main Factory and Yokogawa Manufacturing Corporation

*1: Goals of Yokogawa Electric Corporation Headquarters & Main Factory

*2: Yokogawa Manufacturing Corporation

*3: Common goals

Compliance with Environmental Laws and Internal Audits

Yokogawa is doing everything possible to switch to alternative technologies to ensure full compliance with the laws, agreements and regulations designed to prevent environmental pollution and reduce substances that place a burden on the environment. In 2010 we again endeavored to ensure full compliance with the environmental laws, regulations, agreements, etc., and had no major violations. Each year we regularly receive inspections by external auditors and internal audits.

Introduction of Copper-Ion Continuous Monitoring System

Yokogawa Manufacturing Ome Factory

Manufacturing of printed circuit boards uses water to clean copper on boards. At our Ome factory, the wastewater from the cleaning process is monitored daily. Because the copper content in wastewater is regulated as 3 mg/L or less by the relevant standard under the Water Pollution Prevention Law, the Ome factory monitors wastewater based on its voluntary standard of 2.4 mg/L or less.

Previously, a pack test would be conducted every hour in order to check the wastewater. To shorten the time required for checking and allow for the visual control of readings to reinforce monitoring, the Ome factory has introduced a copper-ion continuous monitoring system. If the continuous monitoring system detects an abnormal reading (equal to or above 2.0 mg/L, which is lower than the voluntary standard), the wastewater valve is automatically switched in order to return the wastewater to the treatment bath.

With the introduction of this copper-ion continuous monitoring system, not only has automated monitoring become possible but also a mechanism is now in place to prevent wastewater containing abnormally high levels of copper from being released in the event that such abnormal reading is detected.

Copper-Ion Continuous Monitoring System



Flow of Wastewater Treatment (Outline)

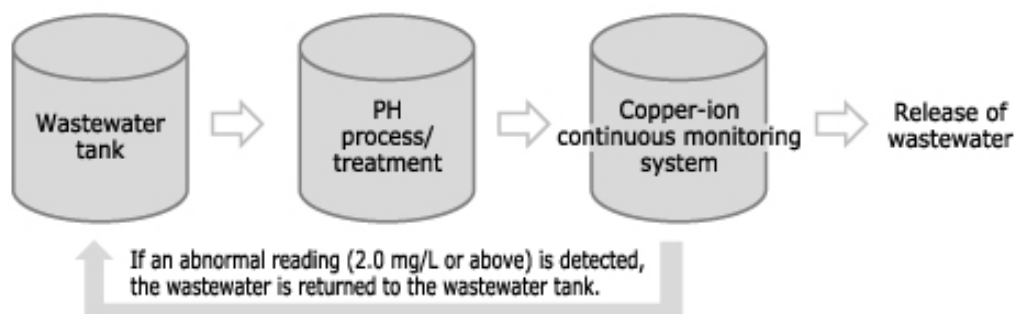

Conserving Water and Soil

The Yokogawa Group has conducted soil and water studies at former production sites in accordance with its proprietary control standards, starting before the enactment of Japan's Soil Contamination Countermeasures Law. The Group will continue to comply with the revised Soil Contamination Countermeasures Law put in effect in April 2010.

Environmental Auditing

Internal Audits

The environmental internal audits for ISO14001 consist of systems, legal compliance, and performance audits. Internal audits were conducted at all departments at least once during the year. Although some inconsistencies and items to be watched were identified, these were quickly addressed and corrected.

Internal Audit Inspection Items

Systems audit	Audit of organizations/systems, target management, education, operations management/corrections, and other data to check whether the system is functioning effectively
Legal compliance audit	Audit of the operation and monitoring of regulated values (qualifications, notice submissions, and measurement data) and other data to check whether legal and other requirements are being followed
Performance audit	Audit of targets and actual results, regulated values, and other data to check whether the self-determined operation items are being implemented properly

Annual Surveillance

Regular inspections (renewal inspection or surveillance) were conducted at each of Yokogawa's ISO14001-certified group companies by an ISO14001 certifying organization in order to maintain ISO14001 certification.

Environmental Impact

The Yokogawa Group calculates the annual volume of the energy and material inputs for its business activities (including manufacturing, sales, and service) as well as their annual output of waste and other matter into the air and water. This analysis helps the Group effectively use resources, improve energy efficiency, and improve the waste recycling rate.

Overview of Environmental Impact

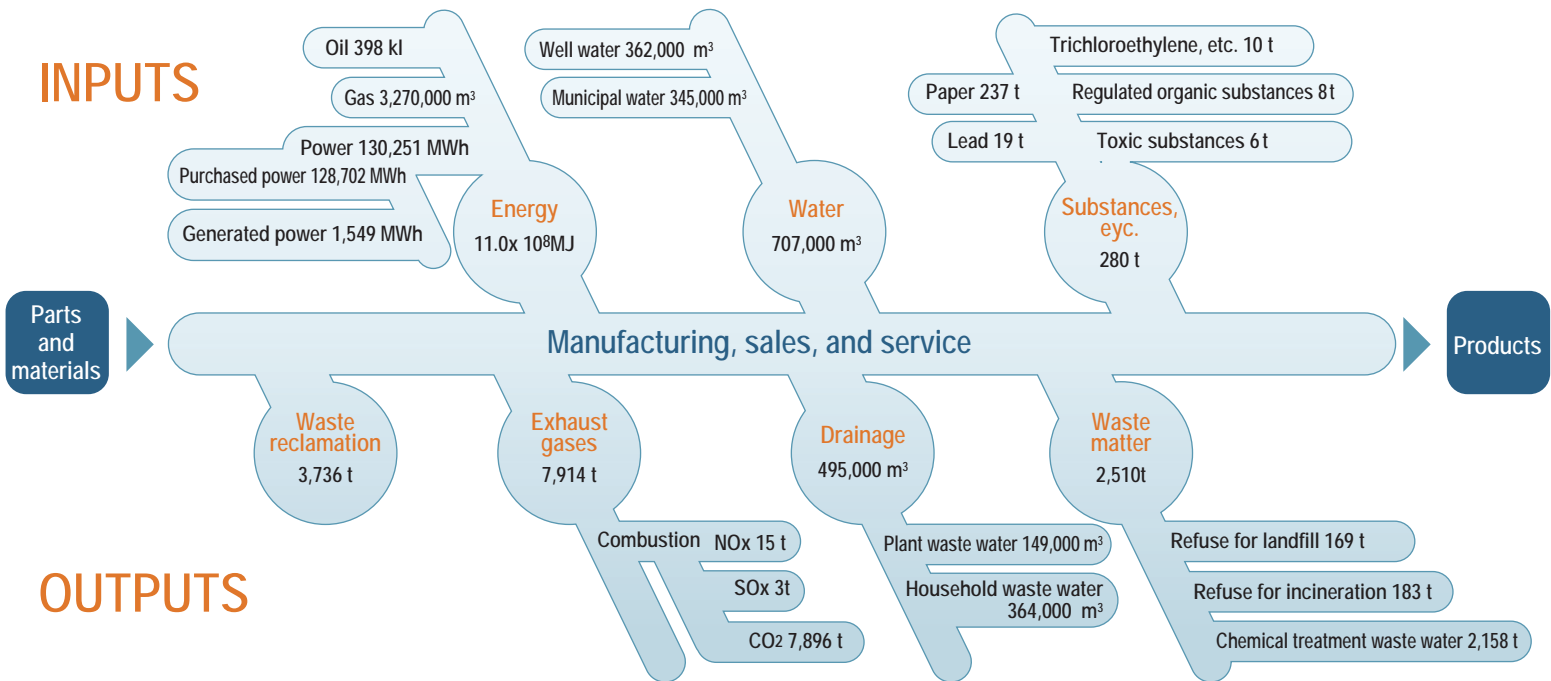

Environmental Accounting

In accordance with the Ministry of the **Environment's Environmental Accounting Guidelines** (2005 edition), Yokogawa calculates the costs of its environmental activities and quantifies their economic impact.

Environmental Conservation Costs

(Millions of yen)

Category	Item	Main Initiatives	Capital Investment	Related Costs
Costs for reducing environmental impact of factories (areas of operation)	Pollution prevention costs	Monitoring and measurement	2.8	409.0
	Global environmental conservation costs	Energy savings	267.0	160.6
	Resource recycling costs	Minimize generation of waste matter	0.2	143.4
Costs for reducing environmental impact of procurement and logistics		Green procurement	0	8.6
Environmental conservation costs in EMS activities		EMS updates, education	0	177.6
Environmental conservation costs in community activities		Environmental events	0	28.1
Costs for correcting damage to the environment		Soil recovery	0	0
		Total	270.0	927.3

Environmental Conservation Effects

Category	Description of Effect (unit)	FY2009	FY2010	Effect
Resource expenditure	Total amount of energy consumed (10 ⁸ MJ)	11	11	0
	Total amount of water resources consumed (km ³)	669	707	-38
Global warming prevention	CO ₂ emissions (t)	7,645	7,896	-251
	CO ₂ emissions on unit sales (t-CO ₂ /100 million yen)	3.3	3.3	0
Air pollution	NO _x emissions (t)	14	15	-1
	SO _x emissions (t)	3	3	0

Economic Effects of Environmental Conservation Measures — Intrinsic Effect

(Millions of yen)

Description of Effect	Amount
Reduction in expenditure due to recycling (sale of valuable resources, etc.)	42.9
Reduction in expenditures due to energy savings (power, etc.)	13.6
Reduction in expenditures due to resource savings (reduced use of paper and water, etc.)	6.5
Total	63.0

* Data was taken from ISO14001-certified manufacturing sites.

Improvement of Production Line

Yokogawa is working to improve its production lines by reducing the environmental burden generated by each line. We are reducing the use of substances that cause air, water and soil pollution and are cutting CO₂ emissions through the use of electricity to preserve the environment while reducing costs.

Improvement of Packing Materials

Yokogawa Manufacturing Kofu Factory

Our Kofu factory has improved the packing of accessories on its EJA/EJX (differential pressure transmitter/pressure transmitter) assembly lines. On these lines, products and accessories are bundled and small accessories such as screws are packed together for protection. Previously, accessories were packed using a vacuum packing machine by heating a plastic film to hermetically seal the content. However, this process required not only plastic films, air gaskets and other materials but also electricity for the heating and operation of the machine. Accordingly, ways to simplify this process had been examined for some time.

Subsequent to repeated studies based on cardboard, a material already used for packing of some accessories, along with improvement of strength of cardboard material and adoption of common shapes, the plastic film packing process was fully switched to cardboard packing by adopting a common process that could be used for all models.

This has resulted in improved work efficiency and annual electricity savings of approximately 17 megawatt-hours, as well as the reduction of plastic films, air gaskets and other packing materials, now that plastic film packing is no longer required.



Plastic film packing



Improved cardboard packing

Comments from Persons in Charge

In changing the shapes of the cardboard used for packing accessories, we made detailed adjustments to designs in order to enhance strength, sizes of openings in which to place screws, etc., striving toward perfection. We are confident that, after a thorough review of packing materials, shapes, etc., we have contributed to the reduction of packing materials and other resources on the customer's side at the time of unpacking.



Kenji Ogino, Hiroshi Nagai,
Manufacturing Engineering
Division
Manufacturing Engineering
Dept.
Yoshimori Seshita,
Kofu Factory Manufacturing
Dept.
Yokogawa Manufacturing

Reduction of Waste Materials by Changing Stainless Sheet Thicknesses

■ Yokogawa Manufacturing Komine Factory

The stainless parts of products are manufactured by punching parts of each thickness out of a single stainless sheet of that thickness. If more parts have the same thickness, more parts can be punched out from a single stainless sheet, which in turn improves the work efficiency and material yield.

At the Komine factory, thicknesses of stainless sheets were examined from the standpoint of the performance of each machine in the factory, as well as the cost and environment. For each product, the thicknesses of stainless parts were consolidated to the greatest extent possible after consulting the Development Department and ensuring the strength and other safety aspects of the product.

The consolidation of stainless sheet thicknesses has made it possible to manufacture all parts within the performance limits of machines at the factory. In turn, this has enabled complete in-house production, improved the work efficiency and reduced the use of stainless materials that would otherwise have been wasted. Waste stainless materials are sold to dealers to be recycled.

This is only one example of the improvement efforts that are constantly sought and practiced at Yokogawa Manufacturing. Various activities are in progress to cut costs while reducing the environmental burden, in close communication between the Development Department and Manufacturing Department.



Stainless material
after parts have been punched out



Yokogawa's own
WEBFREX3ES

Global Warming Prevention

To step up our efforts to conserve the global environment and counter the problem of global warming, in 2010 we instituted the "Yokogawa Group Green Promotion Committee." As for the CO₂ emission reduction targets of the Yokogawa Group (Japan), we have set targets for different phases—2010 to 2014, 2015 to 2019, and 2020—and are implementing measures to reduce CO₂ emissions. Our CO₂ emission reduction measures include the use of inverter lighting, the introduction of high-efficiency cooling/heating equipment and the utilization of green power, among other innovations. Going forward, we will implement more emission-reduction measures by making our energy data more transparent via "InfoEnergy", an energy-saving support system for Yokogawa products already at work at our key manufacturing factories.

CO₂ Emission Reduction Targets and Performance for Yokogawa Group (Japan)

The Yokogawa Group (Japan) set its CO₂ reduction target for 2020.

By using the annual average emissions from 2005 to 2007 as a reference level (56,560 t-CO₂), we have set reduction targets for three phases in order to achieve the level set for 2020.

The specific reduction targets are 7% of total emissions from 2010 to 2014 (263,005 t-CO₂), 18% of total emissions from 2015 to 2019 (231,895 t-CO₂), and 20% for 2020 (45,248 t-CO₂). We are steadily implementing activities designed to achieve our reduction targets.

In 2010, the Yokogawa Group (Japan) generated 48,468 tons of CO₂.

Graph of CO₂ Emission Reduction Targets and Performance for Yokogawa Group (Japan)

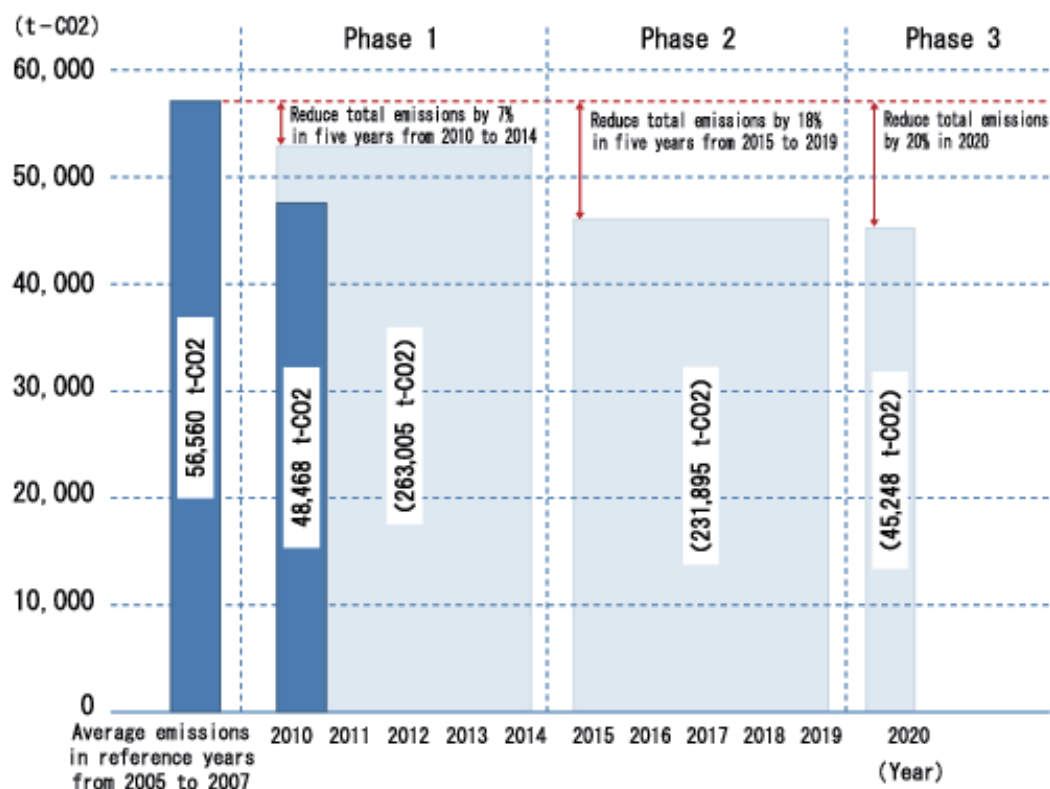

Reduction of Environmental Burdens by Updating Heat Sources

Yokogawa Electric, Komagane Site

Our Komagane site has updated the refrigerators and heavy-oil boilers that are used as heat sources for utilities.

As the time at which to update turbo refrigerators and absorption-type refrigerators used for the air-conditioning of clean rooms and the manufacture of ultra-pure water, etc., drew nearer, the Komagane site examined ways to use this as an opportunity to enhance the efficiency of its operations.

The absorption-type refrigerators used heavy oil as fuel, and their operating efficiency was lower than that of the turbo-type refrigerators. However, the turbo-type refrigerators used CFC (R11) refrigerant and thus their continued use was deemed difficult. To solve those problems, the Komagane site introduced high-efficiency air-cooling chillers (which cool air for use in cooling and heating) as heat sources to replace the refrigerators. For the further improvement of operating efficiency, an "EconoPilot" system was installed to operate the cooling-water pumps. The switch to air-cooling chillers not only improved the operating efficiency of the facility but also allowed the site to cease the use of CFC refrigerant and thereby reduce its environmental impact.

The heavy-oil boilers, however, were changed to LPG (liquefied petroleum gas) boilers, and the change is expected to reduce CO₂ emissions by 160 tons (15%) from the previous year's level. Accordingly, the boiler chimneys essential for heavy-oil systems and underground tanks in which to store heavy oil are no longer necessary. Thus there is very little emission of sulfur (SO_x) that was formerly generated through the burning of heavy oil. Overall, the Komagane site has not only achieved improved operating efficiency and reduced its environmental impact but has also eliminated the risks associated with older facilities, such as the leakage of heavy oil from aging underground tanks.

Our products

- Energy-saving support system InfoEnergy
Monitor energy consumption and control equipment at the same time. (Yokogawa's product)
- Feed-water pump energy-saving control system EconoPilot
Energy-saving control system for secondary air-conditioning pumps to feed cold/warm water for use in air conditioning. (Yokogawa's product)

High-efficiency Air-cooling Chillers



Comments from Persons in Charge

The facility update has improved the operating efficiency of machines and our work efficiency. However, it is important not to stop there but instead get familiar with each facility and thereby ensure its proper maintenance and management.

We use "InfoEnergy" for the air-conditioning management of clean rooms. Because the system allows us to share information—and because it automatically sends e-mails to relevant personnel whenever an abnormal value is detected—any problem that occurs can be analyzed quickly. This also helps us maintain and control quality. Going forward, we will create energy management standards by which to achieve even greater efficiency in the operation of our facilities.



Nobuyuki Morioka,
Tooru Matsuzawa
Semiconductor Headquarters
Silicon Device
Development Dept,
Yokogawa Electric

Thorough Management of Day-to-Day Operations

Yokogawa Manufacturing, Kofu Factory

At the Kofu factory, which is Yokogawa's key manufacturing plant in Japan, "InfoEnergy" terminals are provided at strategic locations to manage energy by allowing personnel to visually check power consumption onscreen. Additionally, "Enerize" has been introduced to the manufacturing lines of Differential Pressure and Pressure Transmitter in order to facilitate the management of the energy actually used for manufacturing a product. The visual data is sent to each department in order to prompt active feedback on improvement ideas and requests from employees on site, all of whom are encouraged to be aware of power usage.

In 2010, the Kofu factory introduced "EnerizeE3," the latest version of "Enerize" offering enhanced data analysis functions. The new version analyzes power consumption for each department, budget, area and purpose of use (100 V for lighting, 200 V for facilities, etc.) and performs the "drill-down" analysis of basic unit data, thus making it easier to identify the causes of increased power consumption. The day-to-day management of power consumption is an essential part of site operation, and EnerizeE3, offering the benefit of visual management in the details of power consumption, will surely lead to further improvements.

Our products

- Energy-saving support system InfoEnergy
Monitor energy consumption and control equipment at the same time. (Yokogawa's product)
- Factory energy operation support system EnerizeE3
A system that integrates energy information with production information to help energy-saving in production processes. (Yokogawa's product)

EnerizeE3 Screen Showing Energy Consumption in Basic Units on Production Lines



Ongoing Eco-Commute Challenge

Yokogawa Manufacturing Kofu Factory

As part of Yokogawa's effort to curb global warming, the Kofu factory has been running the "Eco-Commute Challenge"—a declaration of commitment to reduce the environmental impact associated with commuting—since 2009. More than 600 employees are participating in the Eco-Commute Challenge by, for example, shutting off their car engines instead of idling, or by commuting on a motorcycle or bicycle instead of a car. According to the survey conducted about a year after the start of the program, many employees were doing something green every day, or at least two or three times a week, and more than half of all employees are "eco-commuters." The survey results were also presented to the Yamanashi Prefectural Government for use in the planning of mobility management measures.*

* Mobility management measures: Measures aimed at urging companies, residents, etc., to voluntarily switch from cars to public transportation systems, bicycles, walking and other, greener modes of transportation.

Declaration of Eco Drive

Yokogawa Manufacturing, Ome Site

The Ome City Liaison Council for the Environment, whose members include companies throughout Ome City, is actively promoting "Eco Drive" as part of the city's effort to conserve the environment. At our Ome site, an "Eco Drive" sticker is attached to each of the employee-commuter buses and company vehicles.

Employees are given instructions on the proper use of the brakes and accelerator and urged to drive safely, and drivers follow the Eco Drive practices. Employees can also attach the sticker to their private cars, if they want to do so, and use the Eco Drive principle in daily life.



Introduction of the "Green Power Certificate" System

Yokogawa Electric

A portion of the electricity used by the headquarters building of Yokogawa Electric come from "Green Power" harnessed through "biomass generation" (300,000 kWh/year).



Chemical Substance Control and Reduction

Yokogawa strictly manages chemicals that are harmful to the global environment and the human body. In addition, the reduction of using such chemicals by developing and introducing alternative processes is promoted.

Switching to Halogen-Free Solder Resist Inks

Yokogawa Manufacturing Ome Factory

The process of manufacturing printed circuit boards must include a step to apply "solder resist ink," which is a coating material, to prevent solder and dust from directly attaching to the copper surface of the printed circuit board. This coating material generally contains chlorine, bromine and other halogen-based pigments, thus giving rise to concerns of dioxins, which are generated when the pigments are burned as part of the scrapping process. Also, some highly toxic bromine-containing flame retardants are already prohibited in the EU bloc, and various other countries are moving to control other bromine-containing flame retardants.

In keeping pace with these movements, our Ome factory, which produces printed circuit boards, eliminated all the solder resist inks traditionally used as coating materials for printed circuit boards and changed to halogen-free inks containing little chlorine and bromine (in compliance with the JPCA standard).

To maintain the same levels of accuracy and production volume achieved with the conventional solder resist inks, adjustment and evaluation were repeated for each process prior to the introduction. In particular, detailed adjustments were made to the exposure process (where UV light is irradiated to harden the necessary parts of the ink), because any increase in the UV irradiation time, no matter how small, would adversely affect the production volume. Eventually, all solder resist inks were switched to halogen-free inks, but the quality levels as well as production volumes were maintained.

Printed Circuit Board (* solder resist ink indicated in green)



General Flow of Solder Resist Printing on Printed Circuit Board

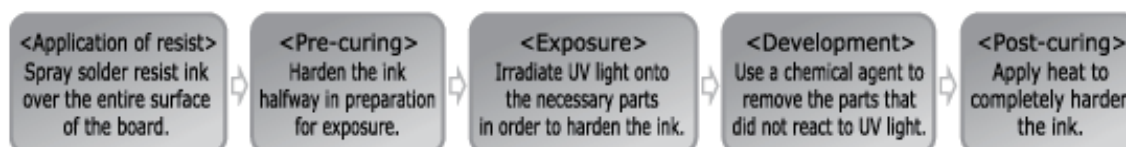

PRTR Substances

The amount of substances reported under PRTR* requirements (1,000 kg/year or more handled) is shown in the table.

* PRTR System:

PRTR SYSTEM...The PRTR, or Pollutant Release and Transfer Register, was established to enable society as a whole to manage chemical substances through the disclosure of toxic chemical emissions data and other information.

Fiscal Year 2010 PRTR Data

Factory	Factory substance	Amount used (kg)	Amount emitted (kg)				Amount transferred (kg)	
			Air	Public water area	Soil	Landfill	Sewage system	Outside site
Yokogawa Electric Sagamihara Factory	Ferric chloride	1,515	0	0	0	0	0	0
Yokogawa Electric Komagane Factory	Hydrazine	1,467	0	800	0	0	0	660
	Hydrogen fluoride and its water-soluble salt	1,265	0	120	0	0	0	1,100
	Ferric chloride	2,095	0	0	0	0	0	0
Yokogawa Manufacturing Kofu Factory	Lead	2,534	0	0	0	0	0	0
Yokogawa Manufacturing Komine Factory	Xylene	1,900	1,200	0	0	0	0	720
	Toluene	2,000	1,200	0	0	0	0	760
Yokogawa Manufacturing Ome Factory	Water-soluble copper salts	31,213	0	0	0	0	17	4,500
	Formalin	2,560	440	0	0	0	13	1,700
	Ferric chloride	5,130	0	0	0	0	0	0
Yokogawa Denshikiki Hadano Factory	Nitriiotriacetic acid	1,279	0	0	0	0	0	0

Waste Reduction

The "3R" concept (Reduction, Reuse, and Recycling) promoted by the Yokogawa Group is indispensable to global environmental conservation. The Yokogawa Group defines zero emissions as recycling and reusing 99% or more of the total amount of waste generated. Up to now, six main factories including the Yokogawa Electric's headquarters have met the goals of zero emissions.

Unit-sales-basis Waste Emissions and Reduction Rates (Compared to Fiscal year 1995)

The waste emissions in fiscal year 2010 amounted to 0.19 t per 100 million yen on a unit sales basis (612 tons in total), and its reduction rate was 88.8% (compared to Fiscal year 1995)

Unit-sales-basis Waste Emissions and Reduction Rates (compared to Fiscal year 1995)

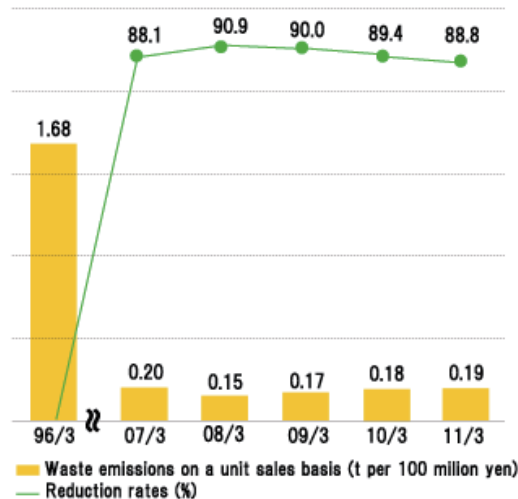

Reduction of Effluent via Introduction of a Treatment Facility

Yokogawa Electric, Sagamihara Site

Our Sagamihara site had actively examined ways to reduce waste acids containing arsenic (As), an industrial waste subject to special control. Such waste acids amounted to 81,600 kg, accounting for 64% of the total 128,400 kg of waste materials generated in 2009.

Previously, waste acids containing arsenic in various concentrations were put together and handed to a waste treatment service as industrial waste subject to special control. In 2010, the Sagamihara site introduced an effluent treatment facility and began treating effluent of relatively low concentrations of approximately 0.2 mg/L, which accounted for a majority of the effluent from the site.

The water quality standard specified by the Sewage Service Act requires that the content of arsenic must be 0.1 mg/L or less. The new effluent treatment facility absorbs the arsenic from the effluent by filtering the liquid through ion-exchange resin to keep the arsenic concentration to a level below (or even less than) 0.01 mg/L, just one-tenth of the level required by the water-quality standard. This treatment capability had allowed the Sagamihara site to dramatically reduce the amount of waste acids subject to special control to 4,660 kg in 2010.

Breakdown of Waste Materials Generated at the Sagamihara Site in 2009

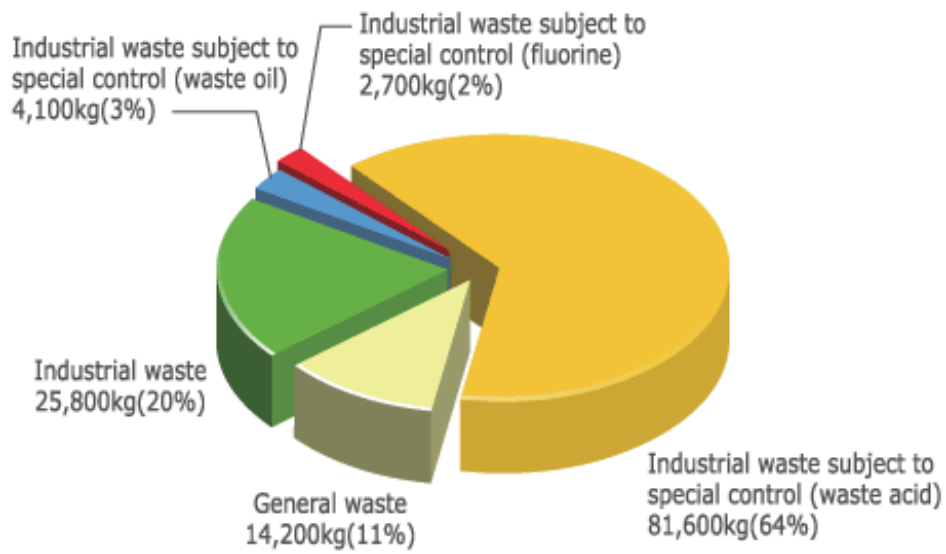

Reuse of Wooden Pallets

Yokogawa Manufacturing, Uenohara Site

At our Uenohara site, where products are shipped to various locations inside and outside of Japan, the wooden pallets used for the protection and transport of products accounted for a substantial portion of the waste materials generated there. By collaborating with suppliers, the Uenohara site introduced a comprehensive program to recycle wooden pallets in 2010. As a result, 13 tons of waste materials were reduced that year—a significant increase over the previous year's level.



Green Procurement and Green Purchases

Various laws and regulations have been put in place, such as the Home Appliance Recycling Law and Law for Promotion of Effective Utilization of Resources in Japan, as well as the Waste Electrical and Electronic Equipment (WEEE) and Restriction of Hazardous Substances in EEE (RoHS) Directives outside Japan. With this background, Yokogawa aims at building a sustainable society in various areas of its business activities.

Based on the principle "Resource procurement with less environmental load = Offering environmentally friendly products", Yokogawa proactively promotes green procurement activities that are environmentally friendly.

Green Procurement Guidelines

Under the philosophy to contribute to building a sustainable society in various areas of business activities, Yokogawa has created the "Green Procurement Guidelines" to promote green procurement activities.

Green Purchasing

Yokogawa joined the "Green Purchasing Mass Campaign" hosted by the Green Purchasing Network, using posters, etc., to invite employees to participate.



Green Purchasing Mass Campaign poster

Promoting Biodiversity

In line with the environmental policy of the Yokogawa Group, all group companies are working to preserve biodiversity.

"Tokyo Greenship Action": A Collaborative Effort Between Local NPO and Residents to Protect the Woodlands

Yokogawa Electric

Since 2009, Yokogawa has been a participant in "Tokyo Greenship Action," a collaborative effort among the city of Tokyo, local NPOs, and businesses to conserve and revive the woodlands in the hills of Tokyo, and contribute to their biodiversity.



Participation in the Tenryu River Water Quality Survey

Yokogawa Electric Komagane Factory

At our Komagane factory, situated along the Tenryu River in Nagano Prefecture, employees and their families are participating in the "Family Water Quality Survey" organized by the Nagano Techno Foundation. The survey was initiated under two themes: restoring the "Tenryu River where we can swim" and building a "recycling-oriented society." This year's survey is the tenth edition of this local event. Every participating family uses a simple water quality analyzer called "Pack Test" to study the water quality at a nearby area of the river and submit a report. The items examined by the water quality survey include water clarity and life forms in the river.



Participation in a Volunteer Tree-Planting Drive

Yokogawa Manufacturing Kofu Factory

Yokogawa Manufacturing's Kofu factory participated in a volunteer tree-planting drive held at the Suigen no Mori (forest for water sources) near Shousenkyo Gorge, in Kofu City. Organized by Kofu City and its Waterworks Department, the event attracted a total of 120 volunteers from companies and organizations in Kofu, including eight employees of our Kofu factory. On the day of the event, volunteers planted approximately 750 seedlings of Japanese cypress cedar and *Alnus hirsute*. The Kofu factory will continue to work with the local government to organize and participate in activities designed to protect water sources.



Artificial Hill Built in the Headquarters in the Image of the Woods in Musashino

In an empty lot, which was left after part of the building was torn down at the headquarters campus, an artificial hill was made by planting a green lawn and plants. The artificial hill has 37 types of plants such as serrata oak, sawtooth oak, and storax, which are designed in the image of the woods in Musashino. In addition, the azaleas planted along the walkway bloom in the spring, welcoming visitors.



Protecting Large Trees in the City of Musashino

In the city of Musashino, where Yokogawa Electric's headquarters is located, there are approximately 2,000 large trees in the city designated as "environmentally protected." It is under a program called "2000 Large Trees/Symbolic Trees Plan", which has been in place since 1994. Fifty large trees within the premise of Yokogawa Electric's headquarters have been designated under this program and are protected as such.



"Tokyo Greenship Action" to Protect the Woodlands of Tokyo

Yokogawa participates in "Tokyo Greenship Action", a collaborative effort among the city of Tokyo, and local NPOs and businesses to preserve and revive the woodlands in the hilly areas of Tokyo, and to contribute to biodiversity. Yokogawa has been a participant since 2009.

About the Target Area (Tatemachi Landscape Conservation Area, Hachioji)

The target area for 2009 was the Tatemachi Landscape Conservation Area of Hachioji (24,392 square meters); a highly accessible conservation area located near the residential part of the Tama hills in Hachioji, Tokyo. Serrata and Sawtooth oaks take up more than half of the area, and Black Locust and Japanese Zelkova (Keyaki) trees can be seen. In addition, a river flows through the conservation area, which is a habitat for fireflies. Local volunteer groups, such as the "Association to Promote Firefly Proliferation", come here regularly to cut grass and thin shrubs.

Once a well-groomed woodland, this area became an abandoned forest without proper care, such as planting, thinning, and tree cutting. Hence, "Tokyo Greenship Action" aims to preserve the scenery of this beautiful hilly area, and to grow a rich variety of biota by continually cutting grass, cutting down and removing dead trees, and planting new ones.

Activities in 2010

Yokogawa participated in the "Tokyo Greenship Action" held on June 26 (Saturday), 2010, in the greenery preservation area of Tatemachi, Hachioji City, for a second consecutive year. Sixteen family members of employees from our Group companies, totaling 32 people, joined the volunteers from the NPO Green Support Hachioji and Ebara Corporation. The participants checked the "acorn" trees planted last year (November 2009) and were satisfied to see that they had become firmly rooted. To help the young trees continue their growth, the participants also cut away weeds that were growing so rampantly as to cover the entire trees. In the evening, the group received a lecture on the ecology of fireflies from a local expert and watched the fireflies dance along the river in the preservation, like stars that had come to earth.

These are some of the comments received from the participants: "The fireflies reminded me of how important nature is. They made me think that I must do what I can in daily life to save the environment." "Trees are disappearing throughout Japan, and it was a great opportunity to realize this stark reality." "Through this volunteer activity I was able to meet people of different generations and learn about nature close to our life. It was a valuable experience, and I want to use the knowledge I have acquired in my work."

■ Helping the Disabled Return to Work

The lunchboxes given to the participants on the day of the Tokyo Greenship Action event were purchased from "House of Dandelion," a food delivery service in Hino City, Tokyo, where people with various disabilities work. The participants enjoyed the freshly made, delicious lunches that had been delivered to the site. Purchasing lunchboxes from a company that employs challenged individuals, like House of Dandelion, is one of many things Yokogawa is doing to help the disabled return to work.



Weeds growing out of control



Weeding



Everyone gathered around the bamboo shoots they had dug out.



Handiwork using cypress



Lunchboxes purchased from House of Dandelion



Employees making lunches at House of Dandelion

Cultivating Future Human Resources



Yokogawa Science Classes addressing the fundamental technologies that are the basis for Yokogawa's business-optics, electrics, radio, etc.

Community Involvement



The Yokogawa Group's various locations each work to benefit their local communities in ways to address their own specific needs.

United Nations Millennium Development Goals (MDGs)



Yokogawa is working with an NGO to promote "reduction of infant mortalities" and "improvement of health of pregnant and parturient women," both of which are among the Millennium Development Goals (MDGs) set forth by the United Nations.

Disaster Assistance



Donations and Financial Assistances for NGOs Made by Yokogawa

Cultivating Future Human Resources

Yokogawa's business is built on its technical strengths in measurement, control, and information, and thereby supports science education in primary schools. The company's hope is that this will develop an interest in science and technology among the next generation. Yokogawa employees also volunteer to serve as instructors at colleges and research institutions. The company also provides materials (such as instruments and research funds) as part of its wide range of support.

Yokogawa Science Classes (Japan)

Concerned that children were not being sufficiently educated in science, Yokogawa started offering the Yokogawa Science Classes in 2006 for primary-school children. The classes are currently offered on several weekends each year in Tokyo. These classes address the fundamental technologies that are the basis for Yokogawa's business—optics, electrics, radio, etc. Instructors are generally employee volunteers, who often find that their contact with children helps them grow as well. Programs like this are a way to deepen the company's ties with its surrounding communities, as well as a way to encourage an interest in science and technology in the next generation.



Community Involvement

The Yokogawa Group's various locations each work to benefit their local communities in ways to address their own specific needs.

Athletic event to stabilize local economic relations (Singapore)

Three Yokogawa Group companies in Singapore participated in the Economic Development Board's Heritage Relay on January 18, 2011, in order to mark the 50th anniversary celebration of Singapore Economic Development Board. Fifty companies were chosen to be part of the Heritage Relay, and Yokogawa was one of the 50 iconic sites across Singapore. Moreover, 30 runners from Yokogawa competed in the relay. We are honored to have been chosen as one of iconic sites, because it shows our significant contributions to Singapore's economic development and growth over the years.



Fund-raising event for a nursing home for the aged (Singapore)

In August 2010, approximately 20 staff members of Yokogawa Engineering Asia Pte. Ltd. (YEA) signed up as volunteers to raise funds for "Lions Home," a nursing facility for the aged, by selling flags to the public. Twenty YEA employees, along with 1,800 other volunteers, raised approximately S\$81,000 for that day. The amount raised will be applied to holistic and comprehensive nursing care to the residents of Lions Home.

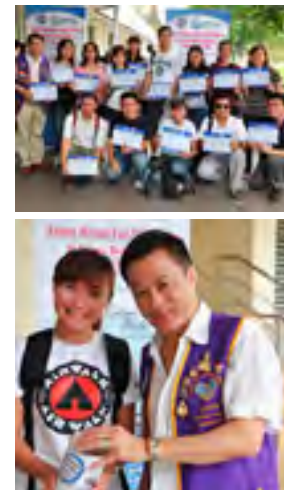

Cookie-baking workshop for disadvantaged families (Singapore)

In November 2010, YEA held a cookie-baking workshop in its staff cafeteria. The event was performed with the local organization "Students Care Service Centre" of Singapore, aiming to help disadvantaged families. The event was designed to provide an opportunity for families to bond and share positive experiences. Approximately 20 employee volunteers participated in the workshop.



Supporting Physically Challenged Children (China)

Labor-union members of Yokogawa Electric China Co., Ltd., visited a welfare facility for disabled children in Suzhou in May 2011, where they donated 140 pairs of summer shoes and 124 pairs of socks to the children living at the facility. The children in turn gave a dance performance featuring sign-language moves, and a remarkable friendship with the visiting Yokogawa employees was established.



A tree-planting drive to create “Chongqing, the City of Woodlands” (China)

In March 2010, 33 employees of Yokogawa Sichuan Instrument Co., Ltd. (CYS) planted trees at the Miaozigang Memorial Forest at Nanshan, in the city of Chongqing. Chongqing has actively created woodlands as a means to promote afforestation, restore the natural ecosystem and stabilize the surface soil. CYS planted more than 30 trees as part of the campaign, and will continue to take part in various environmental conservation activities in order to raise employee awareness regarding the importance of environmental protection.



Donating lunch money to a primary school (South Korea)

Yokogawa Electric Korea Co., Ltd. (YKO) donated 6 million Korean won to a nearby primary school in March 2011. The amount will be used as lunch money for 12 students who require financial assistance. Each year YKO contributes money to help financially disadvantaged students attend school.



Distributing coal for heating to elderly residents living alone (South Korea)

Yokogawa Electronics Manufacturing Korea Co., Ltd. (YMF-K) distributed briquette coal for heating to the nearby homes of elderly people living alone. Sixty-six volunteers, including the families of YMF-K employees, brought coal to the elderly. Each year YMF-K puts together events such as this as part of its effort to support the community.



Achieving the United Nations Millennium Development Goals (MDGs)

Working for "Reduction of Infant Mortality" and "Improvement of the Health of Pregnant and Parturient Women" in Indonesia

Yokogawa has been working to improve the health of mothers and children through Peoples Hope Japan (a certified NPO) in Serang, Indonesia.

The province of Serang is located 80 km west of the capital, Jakarta. Generally, the people of Serang live in poor villages scattered throughout the state. Two of the most serious problems in Serang are that many pregnant women and babies are dying due to complications at childbirth, while infants and children under five years old suffer from malnutrition.

Peoples Hope Japan trained midwives, and educated expectant women and women of child-bearing age on the guidelines for healthy pregnancy. In 2009 the group built a regional health center to help with safe deliveries of babies. Staffed by resident midwives, the center can handle deliveries 24 hours a day. The region has approximately 500 women of child-bearing age, and each year about 100 babies are born.

Additionally, in 2010, we worked to improve the nutrition of children, mainly through the regional health center, by delivering nutritious lunches, providing education on nutrition, developing healthful menus and so forth. Through these efforts we could improve the nutrition of infants and children under five years old — the group that was suffering from particularly poor nutrition.

These activities are part of greater efforts to achieve the United Nations' Millennium Development Goals.

Millennium Development Goals	
Goal 4 (Reduction of infant mortality)	Reduce, by 2015, the mortality of infants under five months to one-third the level in 1990.
Goal 5 (Improved health of pregnant and parturient women)	Reduce, by 2015, the mortality of pregnant and parturient women to one-fourth the level in 1990.



Village clinic before the birth center and health clinic was established



Birth center and health clinic (midwife stationed 24 hours)



Maternal and child health education at the health center



Nutrition improvement education to mothers

Disaster Assistance

Yokogawa is always looking for ways to provide assistance in the wake of severe natural disasters that affect its business activities.

Disaster Assistance Provided in Recent Years

Time	Disaster	Beneficiary	Amount donated
March 2011	East Japan Earthquake	Japan Platform	50 million yen
July 2010	Foot-and-Mouth Epidemic in Miyazaki Prefecture	Takanabe-cho, Miyazaki Prefecture	1 million yen
January 2010	Haiti Earthquake	Japan Platform	1 million yen
October 2009	Indonesia Sumatra Earthquake	Japan Platform	1 million yen
August 2008	Rainstorm in Kanazawa City	Japan Red Cross	1 million yen
May 2008	China Sichuan Earthquake	Japan Red Cross	10 million yen
May 2008	Myanmar Cyclone	Japan Red Cross	5 million yen

Activities to Improve Customer Satisfaction

We at Yokogawa strive to achieve greater customer satisfaction at our offices and factories around the world.

Yokogawa Electric (Japan) has conducted a customer satisfaction survey since 2008 on all customers who have received a product seminar at our training centers in Japan. The results are tabulated and analyzed, and the comments are shared among all employees on the company's intranet in order to help improve product functions and services.

The Group companies are also obtaining feedback from customers through e-mailed surveys, customer visits, mailed questionnaires and conversations at product seminars, so as to provide more satisfactory products and services.

Examples of Measures Taken by Group Companies to Achieve Greater Customer Satisfaction (FY2010)

Group company	Measure
Yokogawa Electric (Japan)	Conducted a survey of 1,250 customers who are product users in Japan, shared the results internally and implemented countermeasures where needed.
Yokogawa Meters & Instruments (Japan)	Conducted seminars attended by approximately 300 customers at 23 locations around the world in order to help customers gain knowledge and improve skills while also receiving their honest feedback.
Yokogawa Field Engineering Service (Japan)	Conducted a survey of key customers and obtained feedback regarding what they wanted, then made corresponding improvements.
YDC Corporation (Japan)	Mailed postcards printed with questions and conducted interviews in order to study the levels of customer satisfaction; the responses were analyzed and reflected in our business activities.
Yokogawa Electric Asia Pte. Ltd (Singapore)	Sent e-mails to customers in order to confirm their satisfaction levels. The average score of all customer respondents was a commendable 4.39 on a five-point scale.
Yokogawa Taiwan Corp.	Conducted trainings to increase customer satisfaction. Fifty-eight employees participated and discussed their products and services using "fish bone chart".
Yokogawa America do Sul Ltda. (Brazil)	Contacted all customers who purchased Yokogawa products or services via e-mail in order to confirm their levels of satisfaction; the average score of all customer respondents was greater than 90%.



Excellent customer service and compliant handling training at Yokogawa Taiwan

Quality First Approach

Since the establishment, we have implemented our quality management system across all processes, as we are convinced that Quality First Approach is the basis of customer satisfaction. All the main Group companies have attained ISO9001 certification starting with Yokogawa Electric in 1992 and working on delivery of the same quality worldwide.

We have continuously valued our customers' feedback to develop satisfactory products, and have gained a high level of satisfaction from our customers with respect to the accuracy and functionality of our products.

The basic quality policy

1. Quality management is carried out in order to implement customer focus based on "Quality First," which is the spirit of foundation, and "Healthy and Profitable Management" through improvements in management quality.
2. Products that meet statutory and regulatory requirements as well as customer requirements are supplied.
3. Appropriate quality management systems conforming to the International Standard ISO 9001 requirements are established and implemented. In addition, the effectiveness of those systems is continually improved.
4. Customer requirements are fulfilled and customer satisfaction is increased through the results of quality activities in all organizations and personnel. For this purpose, each employee must feel that the quality of his or her work has a direct bearing on product quality, and that the company believes in "Quality First".
5. The head of each organization is responsible for the quality of the relevant businesses. The responsibilities include ensuring that adequate resources are made available.

Improvement of the Management Structure as Part of Internal Control

As part of the Yokogawa Group's internal control, Yokogawa's management structure governs the overall business processes, including its relationship with customers and suppliers. For the sales and procurement processes in the supply chain, Yokogawa Group's "Group Sales Operations Code" and "Group Procurement Code" have been defined based on its Corporate Philosophy and Standards of Business Conduct, to ensure fair and equitable transactions. Yokogawa observes the local ordinances of the country and regions with whom we do business, and focuses on establishing a supply chain that considers environmental protection.

In 2008, the Yokogawa Group Supply Chain CSR Guideline, which is compliant with JEITA*, was created and published. In addition, Yokogawa's basic procurement policy, which is summarized in three points, is used as a set of principles to guide its every day operations. In 2009, a network of responsible parties of Yokogawa Group's sales and procurement processes was built as a foundation for all supply chain CSR activities.

Three Basic Procurement Principles

1. Create an ethical, clear, and open corporate culture and establish ourselves as a company that can be trusted by society.
2. Promote socially responsible procurement activities throughout the supply chain, including not only the Yokogawa Group, but also the suppliers of Yokogawa.
3. Comprehensively evaluate and select suppliers, giving priority to our commitment to being a good corporate citizen.

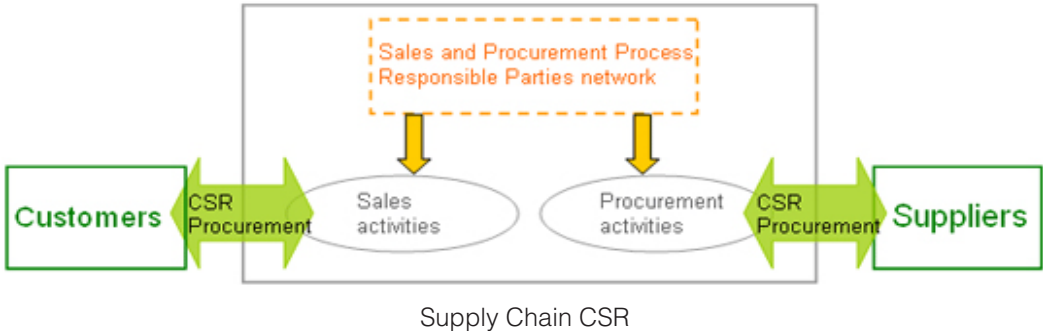

Strengthening of Partnerships with the Suppliers

Yokogawa Electric, in order to reinforce its partnerships, is actively organizing events on a regular basis to promote discussion and deepen trust with key suppliers and their management teams.



For example, each year we host the "Supplier Policy Presentation Meeting", in which we explain our management policy, business plan, purchasing strategy, etc., to the suppliers.

Additionally, we organize "Component Exhibitions" and "Technical Seminars" through the Purchasing Department in order to introduce the products of suppliers, along with market trends, component trends and other relevant information, to the product development teams of companies within the Yokogawa Group.

Portal Site Connecting Suppliers with Yokogawa

Yokogawa has launched a portal site connecting the suppliers and Yokogawa engineers to improve the quality of information and work efficiency in adopting and designing of parts. As a result, accurate information from the suppliers can be shared internally in a timely manner. In addition, because it follows the standard format specified by JEITA*, the work efficiency for both the suppliers and Yokogawa has improved, from adopting to designing of parts.

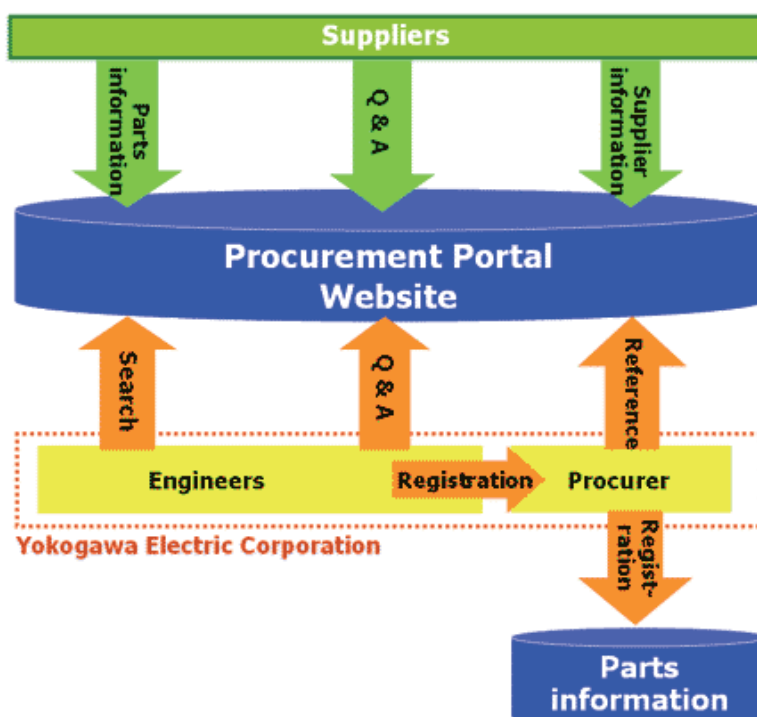

*JEITA: Japan Electronics and Information Technology Industries Association

Developing and Using Global-Minded Human Resources

Employees Are Valuable as Yokogawa's "Human Assets"

We at Yokogawa have established a compliance guideline that requires us to comply with the international standards on human rights; consider the different geographical and cultural backgrounds of other employees when working with them; refrain from discrimination on the basis of race, nationality, sex, religion, age or disability of any kind; and drive home these principles to all our Group companies. One of the strengths — actually a requirement — of Yokogawa is the ability to maintain and utilize a pool of diverse talents as we carry forth our global expansion. Thus we capitalize upon the skills of our employees, with their diverse ethnic backgrounds and nationalities, so that we can make decisions from a global perspective. We also provide our employees with various opportunities to help develop their careers, promote a healthful work-life balance, and actively employ persons with disabilities.

Occupational Safety and Health

In 2006, the Yokogawa Group established the "Yokogawa Group Health and Safety Policy" and began implementing the Occupational Safety and Health Management System (OSHMS). Since 2007, the Yokogawa Group has implemented the OSHMS in each of its companies to promote a higher level of safety and health by making continual improvements through risk assessment and other methods.

Human Rights

Yokogawa has explicitly defined respect for human rights as part of the group's overall goals, in its Philosophy, Standards of Business Conduct, and Group Management Standards. The company has also set up compliance hotlines for everyone working at Yokogawa as a way to avoid human-rights violations before they happen.

Philosophy

Yokogawa's corporate philosophy defines "contributing to society" as a corporate mission, and calls for its employees to be good citizens.

Based on this philosophy, Yokogawa uses measurement, control and information as tools to contribute to social infrastructures that support people's daily living such as energy, communications, waterworks, etc, and to contribute to industry infrastructures, to make them run more efficiently and to help people work more safely. This philosophy is practiced by every employee and in all of the countries where Yokogawa operates, its employees have been willing volunteers, helping out when natural disasters occur.

Standards of Business Conduct

One of the five pillars in our Standards of Business Conduct explicitly states that the company will uphold respect for human rights and respect the dignity of all. Some of the particular courses of action that follow from this are preventing harassment, discrimination, privacy intrusions and maintaining an overall healthy workplace.

Yokogawa Group Management Standards

The Yokogawa Group Management Standards, which states in writing the basic policies required of group management, applies to every branch of the Yokogawa group. It gives clear rules and guidelines relating to human rights, obedience to the law, workplace safety, hygiene, etc.

The Yokogawa Group Compliance Guidelines make the following statement regarding human rights:

03 Respect for basic human right

The Yokogawa Group always respects the basic human rights and personal dignity of every person with whom we are involved.

27 Equal Opportunity

Thanks to our fair and impartial personnel system operating under the basic policy of the Yokogawa Group, each employee is afforded equal opportunities in hiring, placement, promotion, pay rises, training, etc. An employee in a position of management or leadership must have a basic knowledge of the labor laws of the country in question, and must have a thorough knowledge of labor contracts

and work regulations. It is important that he or she work on the basis of this knowledge to maintain a workplace free of unfair discrimination, engaging in ample communication with his or her subordinates and ensuring that day-to-day personnel management goes smoothly.

■ **28 Prohibition of forced labor/child labor**

Forced labor in any form whatsoever is not to be allowed; nor is any person to be made to work against their will; nor is it acceptable for children below the minimum working age of each country to be employed.

Care must be taken to ensure that we do not support inhumane conduct even indirectly, for example through the actions of business partners.

■ **29 Ensuring health and safety**

In addition to observing the laws relating to occupational safety and health, we have established our own independent standards and are striving to improve safety and health. We are working on a program of improvements to ensure the safety of every employee working for the Yokogawa Group, promote better health, and create a pleasant working environment. Each and every employee must act to cooperate with the safety and health measures that have been decided upon.

■ **30 Prohibition of harassment**

No form of harassment whatsoever is acceptable, whether it be sexual harassment, stalking, or power harassment. We respect each other as individual human beings, and have built up a corporate atmosphere in which harassment is not accepted.

■ Attention to human rights in the supply chain

Following its Group Management Standards, Yokogawa upholds their philosophy for human rights throughout its supply chain. The Supply Chain CSR Guidelines include guidelines prohibiting forced labor, inhumane treatment and infringements of human rights, child labor, and discrimination, while ensuring appropriate wages, regulated working hours, and the right to freedom of association, and vendors are asked to follow these guidelines.

■ UN Global Compact

Yokogawa has declared its support for the UN Global Compact. The company respects the human-rights guidelines proclaimed in the Global Compact, and upholds international human-rights standards.

Career Development and Work Life Balance

Career development for the growth of both employees and organization

We carry out HR measures to realize “the right person on the right job” so that each employee is able to perform at their full capacity.

We have created a system where the employees are able to notify their short-term and mid-term career plans to their managers and also promote their acquired skills and experiences to the managers of other department. These systems allow the employees to autonomously build their own careers.

Under the job opportunity system, employees are able to submit their career plans without approval from his/her superiors. Such a system helps to expedite the speedy deployment of the resources especially under the circumstances where there is a manpower requirement due to new business or project.

Additionally, we have a training program for select employees to help develop the skills and qualities needed to become future global leaders.

"Refresh & Challenge" Program to Support Employees Work-Life Balance

We provide a program to help the employees design their career and life when they reach a turning point in his or her career. This is an awareness program for managing health and for building future life plan.

As the program name "Refresh & Challenge" suggests, participants are given a fixed number of off days after the training for refreshing themselves physically and mentally. The program provides ideas to support the employees in setting new goals.

In particular, in the training provided for employees at the age of 45, participants are able to take 15 days of leave from work. They can utilize this leave freely. Some of the participants join the training course to obtain qualifications and others review their future plans on private life and career. These 15 days of leave help the employees to regain their motivation and energy.



Improving Employee Motivation by Promoting Work-Life Balance

We make an effort to provide a work environment where the employees are able to gain satisfaction while maintaining a good balance between their work and private life.

For instance, the employees are able to utilize work hours for child-care and nursing of elderly family members, in additions to the number hours specified under the statutory benefit. We have also introduced a system to provide financial support to our employees who are raising children. Employees under such conditions are able to receive 100,000 yen annually per children.

Many of our employees, both male and female, are making full use of other company supports such as flexible working hours or paid maternal leave. These systems are helping increase employees' motivation.

In September 2006, we opened a day care center near Yokogawa Headquarters.

The center is contributing to the local communities as it can be utilized by both the employees of Yokogawa and the people living in the vicinities.

In fiscal year 2007, Yokogawa was certified by the Chief of the Tokyo Labor Bureau as an Enterprise Supporting Balanced Work and Family life.

■ **Comment from an Employee who Took a Maternal Leave**

● **Fumiko Sasaki in HR headquarters**

At Yokogawa, there is a good support system for child-care, and many employees utilize them.

I was able to take a maternal leave without hesitation or concern in view of the strong support provided by the company.

I took time off until my child was 18 months old, and I was able to spend enough time with him. It was a valuable period for me.

Also, it was a good opportunity to think about my work from new point of view.

Lifestyle and working style change due to events such as marriage, childbirth and child-raising.

I am thankful for the support system that helped me to continue working at Yokogawa after childbirth.

Value Sharing Program

Yokogawa has been in business for nearly 96 years. Inevitably, given such a long period of time, the company would pass through many difficulties and challenges. How has the organization managed to get through those difficult times and survive all the challenges? It has been the resilience of Yokogawa's people. A spirit of challenge and a sense of strong commitment have made all the difference.

Mr. Tamisuke Yokogawa, the founder of Yokogawa, was a doctor of architectural engineering who contributed greatly to the modernization of Japan. At the twentieth-anniversary ceremony, Mr. Yokogawa made the following statement: "I started the company, hoping to contribute to the development of Japan. From now on, I would like to supply products that can contribute to the development of the world." This principle of the founder has been inherited by succeeding generations, and it continues to be the basis of Yokogawa operation.

Since early 2010, the corporate value-sharing program has been carried out for all employees of the Yokogawa group companies. Up to March 2011, the program has been conducted at 42 group companies at more than 20 different countries worldwide.

The program is intended to create awareness of the fundamental values of Yokogawa and to find ways in which the Yokogawa DNA could be applied and put into action in situations that employees face each day in their work. In the session, there are interactive case studies, exercises, context-based discussions and individual and team presentations, all of which are focused on identifying our core values and finding ways to put them into practice.

Participants in the value-sharing workshops have the opportunity to reflect on and learn what needs to be changed in their current approach in order to take something that is good and make it truly great, namely our organization. Based on the insights shared in the program sessions, various initiatives have been rolled out at many companies, and those initiatives can help put the core values to work.

Yokogawa's core values are at the heart of what we do as a business. The values the company reinforces give it the competitive edge that differentiates us from our competitors.

Value sharing program at the group companies



Yokogawa India Ltd.



Yokogawa Measuring
Instruments Korea Corp.



Yokogawa America do
Sul Ltda.(Brazil)

Employee Assistance Program

Promotion of EAP for a healthy, rewarding company life

We have introduced the Employee Assistance Program (EAP), which is designed to help employees more fully demonstrate their skills instead of being too stressed to conduct their work as effectively as possible.

Yokogawa's EAP, in particular, provides a comprehensive set of mental-health support programs, such as those for the prevention and early detection of stress, early care and treatment, and assistance for returning to work after a leave of absence for recuperation. It is our goal to ensure a healthy, fulfilling work environment for all our employees.

Key activities under EAP

Education/PR	Utilize e-mail and web pages to provide relevant information that will help employees gain a better understanding of mental health.
Group training	Conduct company-wide training programs (based on voluntary participation) and level-specific training programs to promote the prevention and early detection of stress.
Stress check	Based on the results of the stress check, identify causes of stress in the workplace. Implement employee-led programs and activities, with the Company's support, in order to prevent, contain and remove these causes so as to ensure a more comfortable workplace.
Assistance for returning to work	To care for the employee who suffers from mental health problems or takes a leave of absence for recuperation, and to ensure the smooth reinstatement of those who return to work after recovery so as to prevent them from falling into the same problems again, we have implemented a system to provide proper support for each individual or workplace depending on the seriousness of the condition or situation.
Consultation	We have a system to help our employees seek consultation within the company or from external institutions specialized not only in mental health but also in various areas of concern including career issues.

Employment of People with Disabilities

Employing and developing people with disabilities

Yokogawa has hired persons with disabilities since the establishment of its Normalization Project in 1992. We continue to meet the legal employment rate for such individuals, and our skilled employees with disabilities are engaged in all areas of our business, from engineering and manufacturing to administration.

The Yokogawa Group promotes the employment of disabled persons, with each company hiring and utilizing people facing different physical and mental challenges who can better contribute to the specific business of the company. Over the past several years, the ratio of employees with disabilities within the Group has, to a significant degree, exceeded the legal requirement.

Yokogawa will continue to provide employment and career opportunities for people with disabilities.

Disability employment rate

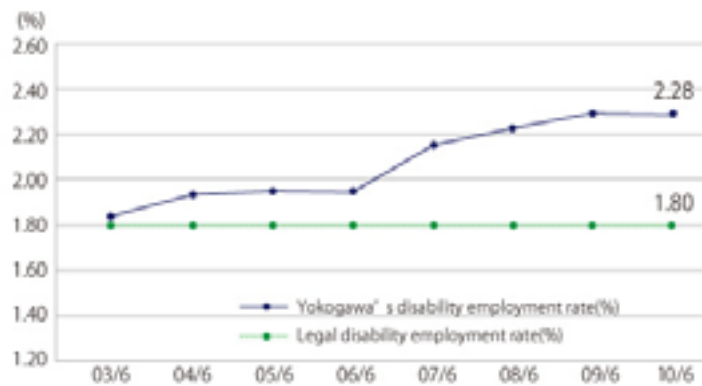

A special subsidiary for the employment of disabled persons

Since the 1999 establishment of Yokogawa Foundry Corporation with the purpose of hiring persons with mental disabilities, we have provided a range of training programs for our employees with disabilities so that they can try different types of work and thereby discover their unique value as contributors to the success of our business.

Taking on challenges to receive public qualifications and participate in external events (fy 2010)

Passed the Second Grade Bookkeeping Test administered by the Japan Chamber of Commerce and Industry

I passed the 125th Second Grade Bookkeeping Test administered by the Japan Chamber of Commerce and Industry in June 2010, and I certainly worked very hard to pass the test. When I began my study of bookkeeping, I had little knowledge of commercial or industrial bookkeeping. I didn't understand the questions, and I did poorly on my first exam. However, I refused to give up. When I finally passed the test on my thirteenth try, I was overjoyed. Now I'm learning abacus and studying for the Kanji Test.

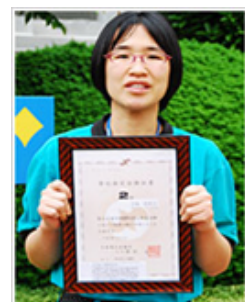

Yumeno Chishima

Passed the Second Grade Information Technology Skills Test (Spreadsheet) administered by the Japan Testing Association

I took the Japan Information Technology Skills Test in February 2011. It was my fifth try at this qualification exam for the Second Grade, and after improving my score from 0 at the first test to 40, 58 and 62 on the second, third and fourth tries, I finally passed the test with a score of 98. The biggest challenge I faced in preparing for the test was to memorize judgment functions and cell verifications, but I'm very happy that my efforts have paid off. My next goal is to pass the First Grade Test.



Takehiko Adachi

National Skills Competition for People with Disabilities (Abilympics 2010)

Tokyo Meet

- Gold medal winner (PC Data Entry Category)
— Atsuhiko Takahashi
- Bronze medal winner (Office Assistant Category)
— Takahiro Uehara



Osaka Meet

- Silver medal winner (PC Data Entry Category)
— Takehiko Adachi
- Bronze medal winner (PC Data Entry Category)
— Shizuko Tsuji



Many of our employees have participated in the Abilympics every year. Their results have been phenomenal, including a silver medal in the 2007 International Abilympics and another silver medal at the 2008 National Abilympics.

Occupational Safety and Health

In 2006, the Yokogawa Group established the "Yokogawa Group Safety and Health Policy" and began implementing the Occupational Safety and Health Management System (OSHMS). Since 2007, the Yokogawa Group has implemented the OSHMS in each of its companies to promote a higher level of safety and health by making continual improvements through risk assessment and other methods.

Operation of the Occupational Safety and Health Management System (OSHMS)

Recognizing that "safety and health are a basic responsibility of the management," the Yokogawa Group implements OSHMS to ensure the safety and health of all of its employees and its sub-contractors. Improvements are made in phases, with constant assessments to eliminate or minimize potential risks. Regular evaluations and reviews of the activities are also done through audits. The effectiveness of the system has improved by combining conventional activities, such as safety patrols, and countermeasures against occupational incidences and near misses.



Management audit at Yokogawa Electric China Co., Ltd. (Suzhou)

The Yokogawa Group companies in and outside Japan share the same safety and health objectives for all workers, including subcontractors. Moreover, seventeen Yokogawa Group companies have acquired certifications in compliance with OHSAS18001*1, which is internationally recognized.

*1. Occupational Health and Safety Assessment Series. A certification standard for Occupational Safety and Health Management System.

Safety and Health Education

To ensure that the "Yokogawa Group Safety and Health Policy" is adhered to across the entire Yokogawa Group, the "Safety and Health Handbook," which contains basic information and day-to-day rules regarding safety and health, has been created and distributed to all staff and engineers at every Yokogawa Group company. To maintain and improve all levels of activities throughout, persons in charge, committee members and newly appointed personnel are educated through safety and health committee workshops, as well as on-site safety training at customer plants and factories.



Safety and Health Handbook

Occupational Incident and Accident Data

The Yokogawa Group has been gathering and analyzing information on occupational accidents experienced by Group companies in and outside Japan on a quarterly basis since 2007, when it introduced OSHMS, as part of an effort to eliminate/reduce occupational accidents and improve the quality of activities thus implemented.

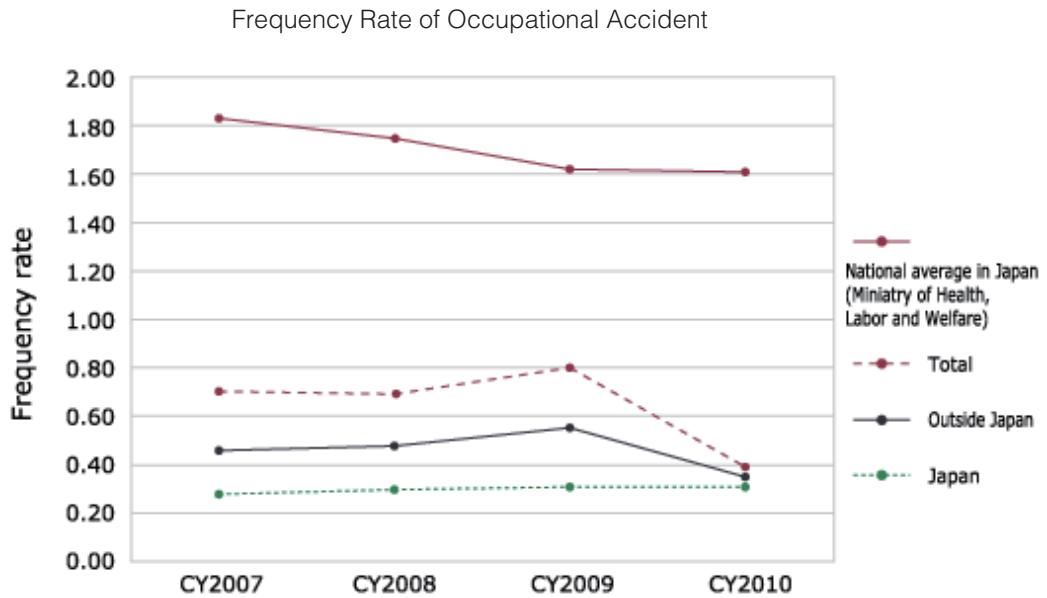

$FR = (\text{No. of workers having occupational accident with lost days} / \text{total working hours}) \times 1,000,000$

Corporate Social Responsibility Management

Yokogawa is actively engaged in fulfilling its corporate social responsibilities in the areas of society and environment, business activities, human resources, and management.

Aiming to be a company that is trusted in the global markets, we have positioned compliance as our number one management priority. We have also strengthened our internal control system and risk management.

Corporate Governance

Yokogawa's basic system of corporate governance including business execution system, board of directors, board of auditors, and whole structure

Compliance

System to promote compliance, compliance training, compliance hotline, and global opinion survey

Risk Management

Risk survey, classification of risks, management system, and risk reporting

Information Security

Information security measures to address three aspects: people, equipment, and information technology

Quality Control

Yokogawa's policy and management system for **Quality First Approach** and ISO9001 certification

Internal Control System

At Yokogawa, "internal control" is a management process in which business resources, such as human resources, assets, and budgets, etc., are allocated appropriately and moved functionally to increase the corporate value. An internal control system is constructed as a means to achieve internal control; this is used to control both the positive and negative aspects. By doing this, Yokogawa aims at improving the corporate value of the entire Group.

The Structure of the Internal Control System

The internal control system of the Yokogawa Group consists of 10 control systems and 4 subsystems as shown in the table below: Each control system sweeps across all divisions that are conducting business activities.

Internal Control Systems	Subsystems	Primary laws (excerpt)
Business Ethics		General law, Whistleblower Protection Act, etc.
Decision Making		Corporate law etc.
Quality Management		Laws concerning products, such as Product Liability Act and Measurement Act, etc.
Labor Management		Labor Standards Act, Act on Securing, Etc. of Equal Opportunity and Treatment between Men and Women in Employment, etc.
Environmental, Safety and Health		General environmental laws, Industrial Safety and Health Act, etc.
Information Security Management		Unfair Competition Prevention Act, Act on the Protection of Personal Information, etc.
Export Control		Foreign Exchange Law, etc.
Financial Reporting	Financial reporting	Financial Instruments and Exchange Act
	Procurement management	Financial Instruments and Exchange Act, Act against Delay in Payment of Subcontract Proceeds, Etc. to Subcontractors
	Insider Trading Prevention	Financial Instruments and Exchange Law
	Information Disclosure	Corporate law, Financial Instruments and Exchange Law, etc.
Crisis Management		General laws
Corporate Auditing Infrastructure		Corporate law

In addition, each internal control system consists of a layered structure as shown in the figure below. The system clarifies the roles, e.g., 1. execution of PDCA cycle at the site, and 2. oversight of PDCA cycle from a specialized perspective.



Internal Control Systems and CSR

There are two sides to CSR activities that fulfill the corporate social responsibilities: one side has to do with managing relations outside the company, e.g., stakeholders, and the other side has to do with managing the internal affairs of the Group. The internal control system of Yokogawa chiefly manages the activities of the entire Group concerning corporate ethics, quality, personnel management, and occupational safety and health, etc. In the figure below, B and C correspond to the internal control systems. The figure indicates that the CSR activities are promoted by appropriate operation of the internal control system.

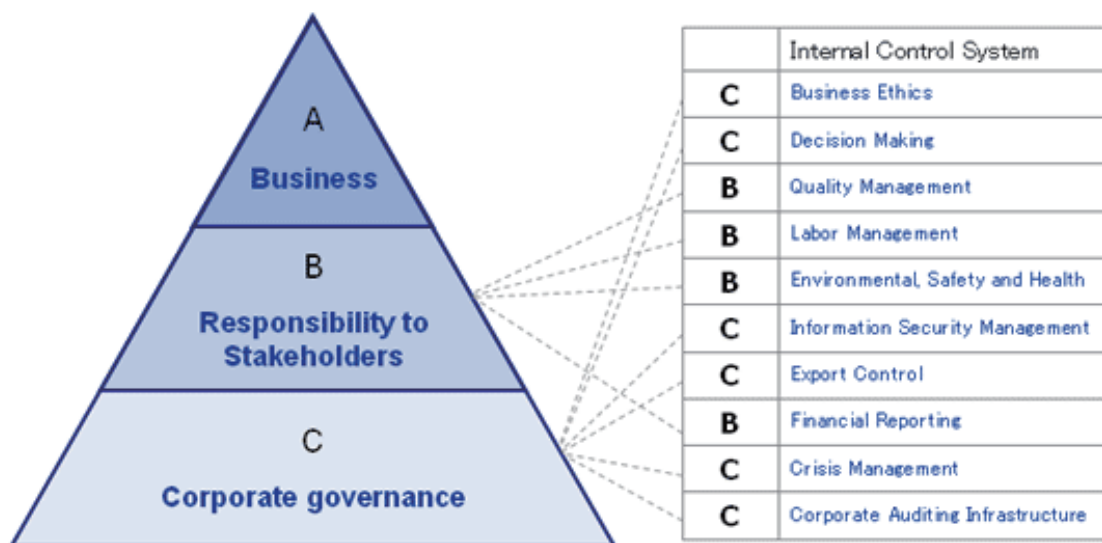

Compliance

Yokogawa promotes compliance management strongly throughout its entire group, with the slogan, "compliance above everything else". It aims to be a healthy and open business with two pillar foundations: "corporate culture that encourages ethical conduct" and "systems to prevent unethical conduct."



Provision of Compliance Promotion Structure

To build a "corporate culture that encourages ethical conduct" and "systems to prevent unethical conduct," a compliance promotion structure has been set in place globally. In Japan, compliance facilitators, who are advisors in the workplace, drive activities designed to communicate and entrench compliance awareness. A leader is selected from among the compliance facilitators in each organization, and all leaders gather at the "Compliance Committee" meeting held on a regular basis in order to share information and monitor progress.

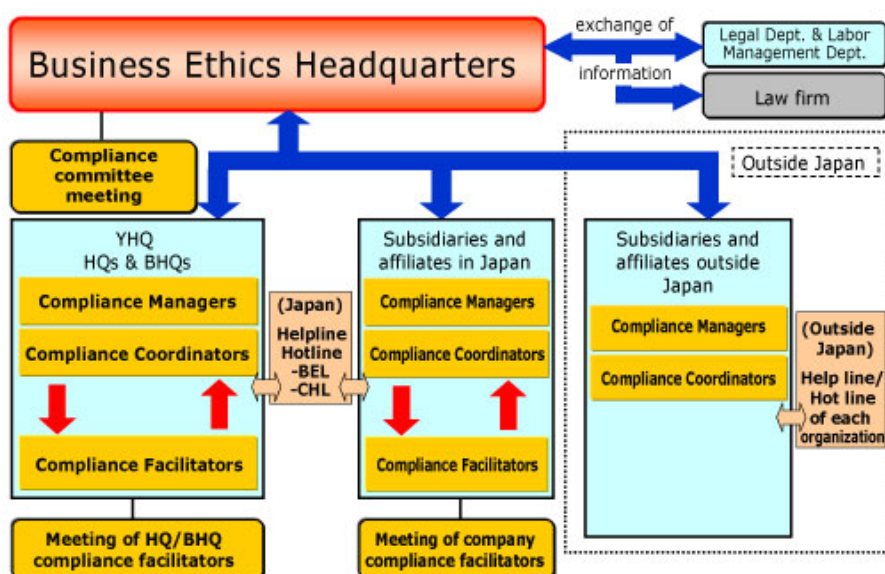

Conducting Enlightenment Activities

Compliance training and business ethics campaign are conducted.

Use of Consultation and Reporting System

To quickly identify and address compliance issues, a report and inquiry channel has been established. In Japan two hotlines are available: an internal hotline (Business Ethics Line: BEL) and an external hotline, staffed with lawyers (Compliance Hotline: CHL). The identity of the reporting employee is kept confidential, and a prompt investigation is conducted in compliance with the Manual of Investigation. Overseas, we have reporting systems with which to share information.

Performing of Global Awareness Survey

An awareness survey regarding compliance is conducted for all Yokogawa Group employees every year. By analyzing the results by workplace and functions, the results are utilized to facilitate the planning of the following year's activities.

Enlightenment Activities

Conducting Compliance Training

Yokogawa conducts compliance education and training to foster employees' awareness of compliance and a corporate culture that emphasizes fair, clear and open business conducts. In the fiscal year 2010, Yokogawa conducted the following training/education programs to help foster awareness of compliance throughout the Group.

- Compliance Training for managers of the Yokogawa Group in Japan
- Compliance Education for new managers in Japan
- Compliance Training for general employees of Yokogawa Group in Japan
- Compliance Education for employees who are to be posted outside Japan
- Compliance Education for new employees of Yokogawa Group
- Compliance Training for employees of overseas subsidiaries



Education for New Employees in Japan



Training for Managers in Japan



Training in Singapore



Training in South Korea

Use of Compliance Guidelines

Subsequent to the Japanese version of "Compliance Guidelines for Yokogawa Group" issued in 2007, in the following years English, Chinese and Portuguese versions were published. In 2010, compliance coordinators at overseas subsidiaries used those guidelines to strengthen their compliance training.

Compliance News Issued

The "Compliance News" is issued bimonthly to all Group employees. It features timely discussions designed to raise awareness of compliance among all employees.



Revised Misconduct Case Studies Issued

The "Misconduct Case Studies" originally issued in 2008, was revised again in 2010 by adding/supplementing new examples and "Points on Conversation in Workplace" was added to the latest handbook. The handbook is used as a study material in employee training programs and study group sessions held in the workplace.

Compliance Week

"Compliance Week" in which all employees of Group companies throughout Japan participated, was held again in the fiscal year 2010 to help "permeate and embed awareness of compliance" The week consisted of the following:

- A message from the head of Business Ethics Headquarters regarding "Compliance above everything else."
- E-learning for all employees to help deepen their understanding of compliance.
- A "Compliance Slogans Contest" was held. Out of the 550 entries submitted, 15 entries were given an award of excellence and were featured in the company newsletter, on posters and the intranet, and employees at each workplace chanted a selected different slogan each day.



Poster Featuring Winning Compliance Slogans



Employees Chanting a Compliance Slogan

Risk Management

Risk Survey

We are conducting a risk survey for all domestic and foreign affiliates and for the headquarters in the Yokogawa Group. The survey is conducted as a self-assessment of the state of risk extraction and risk management, using a risk survey sheet based on the book, **Learn Risk Management from Leading Companies -- Practice Text**, issued by METI. "Risk" is defined as something that could affect the management of the Yokogawa Group. We further define risks that occurred in the past or is currently occurring as "explicit risks", and foreseeable risks that have not yet surfaced as "implicit risks".

METI: the Ministry of Economy, Trade and Industry

Classification of Risks

The risks extracted from the survey were classified into two categories, "corporate risks" and "business risks". "Corporate risks" deal with the Yokogawa Group's internal control systems, and is handled from each perspective (e.g. quality, environment-health and safety, and information security, etc.) "Business risks" deal with our decision making. They are classified into "1. risks relating to the external environment", "2. risks relating to achieving business plan", "3. risks relating to partnerships with other companies", and "4. risks relating to human resources (recruiting, training, and utilization, etc.)".

Risk Management

We use the PDCA cycle management to avoid, reduce, transfer and retain risks. The risk map is used to analyze situations in risk management.

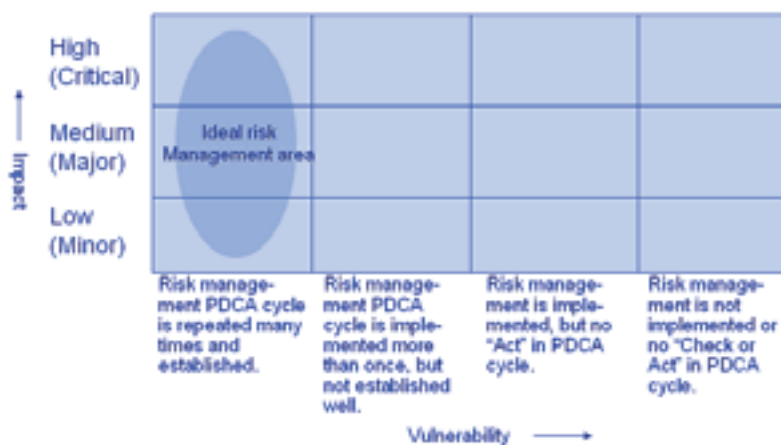

Approach to Risk Assessment

The Yokogawa Group's risk map places crisis events (High), semi-crisis events (Medium) and minor events (Low) along the vertical axis representing the "impact of risk." Each crisis event is defined according to a set of rules specified by the Group. The horizontal axis represents the "degree of vulnerability of risk management," as measured on four levels from the PDCA (Plan, Do, Check, Act) viewpoints recommended by the International Division of the Institute of Internal Auditors. The general risk-occurrence frequency is also analyzed for each risk thus identified.

Reporting the Results of the Risk Survey and Risk Management

We reported the results of the risk survey and the risk management at the board and management meetings. We are continuously reducing the risks that are not well managed, and are also strengthening our risk management. Some of the examples for strengthening risk management include "counter-measures against the new flu pandemic", "strengthening information security", and "business continuity management in preparation for large earthquakes".

Escalation of Information

In the event of a disaster, accident, or incident that can seriously impact the Yokogawa Group companies' management and/or the lives of their officers and employees, the concerned organization must take prompt action to minimize the damage by gathering information and reporting back to the Group's top management.

To address this issue, we have created the "Guidelines for Reporting Disasters, Accidents, and Incidents". These guidelines have been prepared to advise all departments and affiliates in the Yokogawa Group on the reporting procedures to follow in the event of such disasters.

The Yokogawa Group works together with customers to provide them with solutions. To protect important information entrusted to us by our stakeholders, we implement information security measures to address three aspects: people, equipment, and information technology (IT).

People: Information Security Training

An important way to protect information is to raise the security awareness of each employee by training them on how to handle information. To ensure that Yokogawa's employees appreciate on the importance of information security and keep their knowledge up to date, the Yokogawa Group uses an e-learning system to annually provide training to all employees. Based on the belief that "a good beginning makes a good ending," the Group provides training to new employees who are entering straight out of university or in mid-career to familiarize them with the rules of their new workplace. We also review the details and results of the training through information security audits.

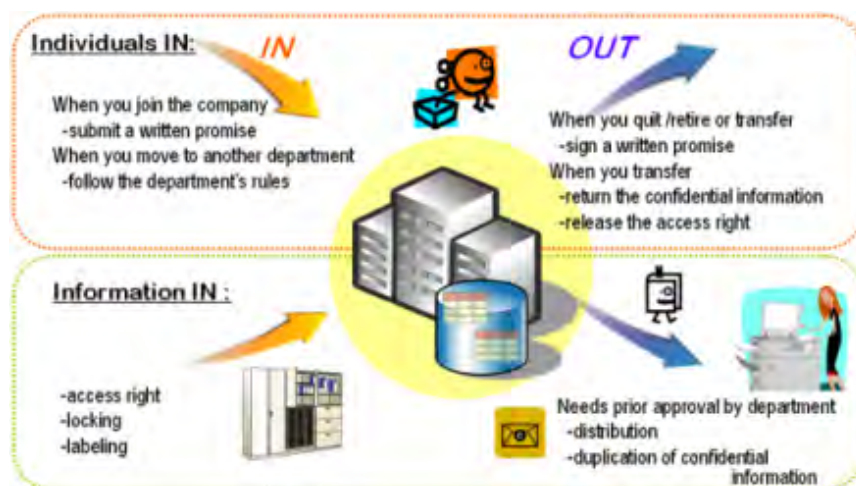

Image from ISMS text

Equipment: Continuous Improvement

We implement anti-theft, fire-prevention, and other security measures to protect locations where information is stored. Our facilities and equipment are kept under continual surveillance, and efforts are made to replace obsolete facilities and equipment with state-of-the-art ones. For R&D facilities that require advanced security, we implement a variety of security measures including the introduction of iris authentication for facility access control and the use of storage cabinets that can only be unlocked with an employee ID card.



Opening a locked cabinet with an employee ID card

Information Technology (IT): Protection Behind the Scenes

The most vulnerable point with regards to information security breaches is people. People can leak information by mistake and misuse information out of ignorance. IT systems provide ways to prevent such human errors.

1. Measures to prevent data leakage from PCs

We create a more secure environment by installing antivirus software, implementing biometric authentication, using data encryption, and more.

2. Anti-spam measures

We have implemented an anti-spam filtering system, because spam mail is not only bothersome but also includes malicious mail that may cause data leakage and virus infection.

3. Network connection device management

To protect against unauthorized access and data leakage, we prevent unregistered PCs and related devices from being connected to the network.

Organization

There is an Information Security Management Committee that discusses and determines information security measures and policies. In addition, there is an information security department or section for each of the Yokogawa Group's headquarters and business headquarters, as well as for each Group company. A PDCA, or Plan-Do-Check-Act, cycle is implemented to ensure information security activities are implemented smoothly.

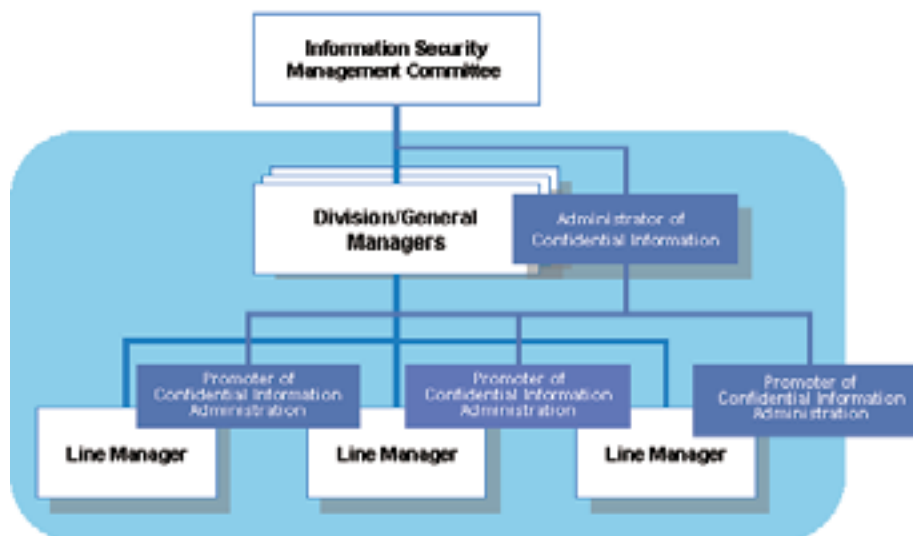

Information security organization of Yokogawa Electric Corporation

The United Nations has put forward a set of ten principles, The UN Global Compact, relating to human rights, labor, the environment, and anti-corruption. On January 5, 2009, Yokogawa signed on as a participating company.

Kofi Annan, former Secretary-General of the UN, first proposed the Global Compact at the World Economic Forum in 1999; the UN officially launched it in 2000. Participating companies are expected to uphold and practice international standards relating to human rights, labor, the environment, and anti-corruption.

Today, Yokogawa does business around the world and its actions affect economies, societies, and the environment. Recognizing its role as a global company, it abides by international norms and actively works to address urgent international issues such as the environment and human rights.

Below are the ten principles of the UN Global Compact, followed by Yokogawa's efforts in each area:

Human Rights

Principle 1:

Businesses should support and respect the protection of internationally proclaimed human rights; and

Principle 2:

make sure that they are not complicit in human rights abuses.

Yokogawa's Efforts:

- **Human rights policies**
- **Extends CSR through the supply chain**
- **United Nations Millennium Development Goals (MDGs)**

Labor Standards

Principle 3:

Businesses should uphold the freedom of association and the effective recognition of the right to collective bargaining;

Principle 4:

the elimination of all forms of forced and compulsory labor;

Principle 5:

the effective abolition of child labor; and

Principle 6:

the elimination of discrimination in respect of employment and occupation.

Yokogawa's Efforts:

- **Encourages the use of human resources with an emphasis on diversity**
- **Employs the disabled**
- **Maintains workplace safety and hygiene**

Environment

Principle 7:

Businesses should support a precautionary approach to environmental challenges;

Principle 8:

tundertake initiatives to promote greater environmental responsibility; and

Principle 9:

encourage the development and diffusion of environmentally friendly technologies.

Yokogawa's Efforts:

- Environmental management
- Contribute to a Sustainable Future
- Environmental equipment and instruments

Anti-Corruption

Principle 10:

Businesses should work against corruption in all its forms, including extortion and bribery

Yokogawa's Efforts:

- Business Ethics and Compliance

Yokogawa Electric Corporation

CSR Department

2-9-32 Nakacho, Musashino-shi, Tokyo 180-8750, Japan

Phone: +81-422-52-7797 Facsimile: 81-422-52-4197

<http://www.yokogawa.com/csr/>