

M300XL

USER GUIDE v1.0

VUZIX[®]
View the Future[®]

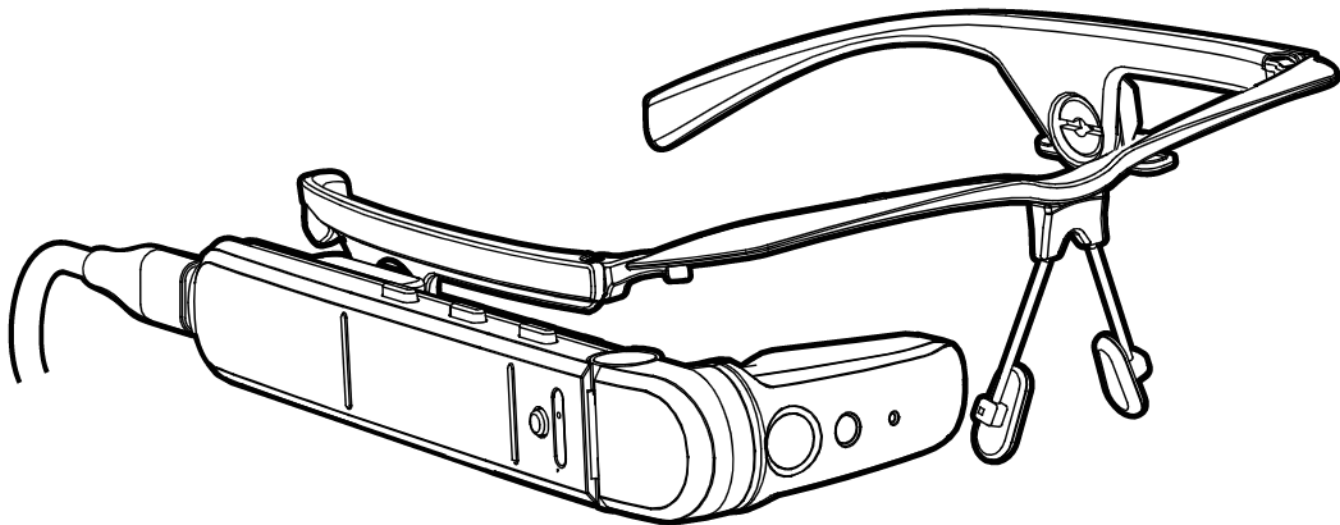

CONGRATULATIONS ON YOUR NEW VUZIX M300XL SMART GLASSES SYSTEM

THE NEXT GENERATION OF SMART GLASSES FOR HANDS-FREE MOBILE COMPUTING

Your M300XL Smart Glasses System is an ergonomically designed, wearable Android-based computer with Wi-Fi connectivity, voice-command functionality and HD camera – right out of the box, including:

- Main Unit with Adjustable Display Screen
- Smart Glasses Frames (without lenses)
- 1 Micro USB Charge Cable - 6'
- 1 Micro USB Lanyard/Power Cable - 18"
- Soft Case for Storage
- USB-A External Battery Pod
- Ear Hooks
- Alternate Nose Bridge
- Wi-Fi Adapter
- Safety and Warranty Guide

CHARGING FOR FIRST-TIME USE (for visual reference, see pg 4, fig. 1)

1. Connect the M300XL micro USB lanyard (short) cable to battery pod and main unit.
2. Plug 6' USB cable to external power source (Preferably USB DCP/CDP 1.5A or greater)
3. Check the LED light on battery pod for charging progress. When all three blue LED's are solid, (not flashing), unit is fully charged.
4. Charging time is 120 minutes to fully power the battery pod and main unit. A full charge provides 1-3 hours dependent upon usage. Battery life can be extended with use of VUZIX battery pack or standard USB battery pack.

HOT SWAPPABLE BATTERY CAPABILITY

The M300XL's unique design features a back-up battery embedded in the main unit to allow up to 60 seconds for swapping a discharged battery pod with a fully charged replacement.

SETTING UP YOUR M300XL

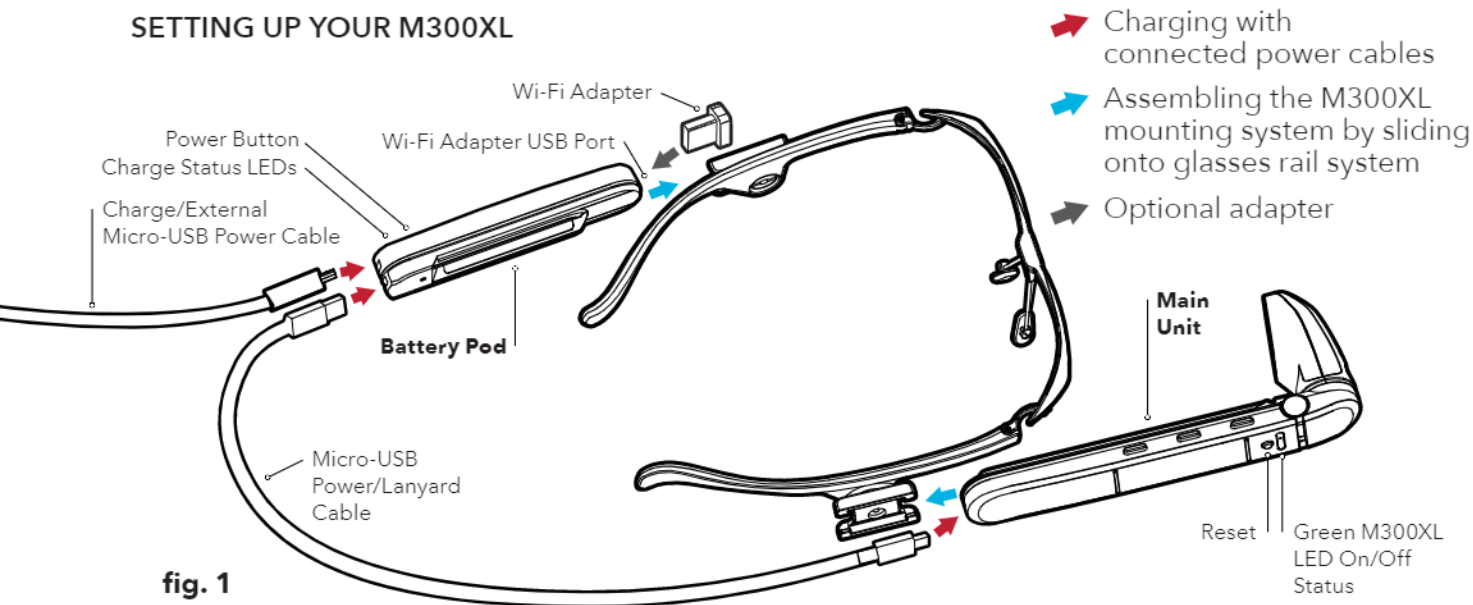

fig. 1

1. Assemble as shown.
 2. Charge fully.
 3. To turn on, press and hold Power Button on the Battery Pod until LEDs light up.
 4. To turn off, press and hold Power Button until blue LEDs turn off.
- NOTE:** Green M300XL Status LED will go off after 1-2 minutes.

ASSEMBLING YOUR M300XL SMART GLASSES SYSTEM

1. Before attaching the main unit to either side of the smart glasses frames, determine your dominant eye for optimum use of M300XL.
2. Attach the main unit to your preferred side of the smart glasses mount on the frames by sliding the mounting rail onto the temple mount on the frames. Once properly fitted, the unit will be adjustable by sliding forward or backward.
3. Using the same mounting process, attach the battery pod to the other side of the smart glasses frames.
4. If not already connected, please refer to figure 1 on page 04 to connect the power cable between the main unit and battery pod.
5. When ready to wear your M300XL Smart Glasses, lift the power cable over your head to rest on your shoulders for added convenience as a ready-to-wear lanyard.

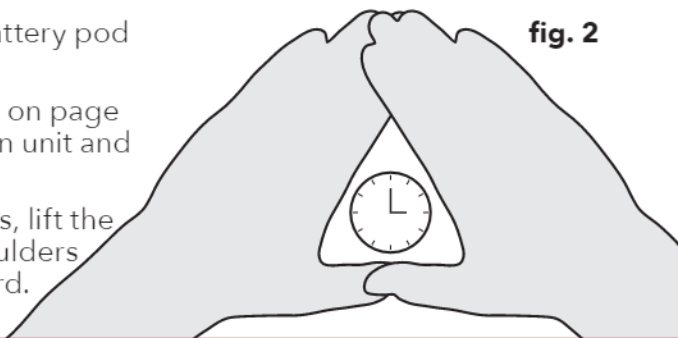

fig. 2

DETERMINE YOUR DOMINANT EYE

As shown in fig. 2, extend your hands, placing them together to make a small triangle between your thumbs and knuckle. Keeping both eyes open, center a nearby object inside the triangle. Close each eye one at a time. Notice how the object moves out of view when one eye is closed? When the object remains in view, the open eye is your dominant eye.

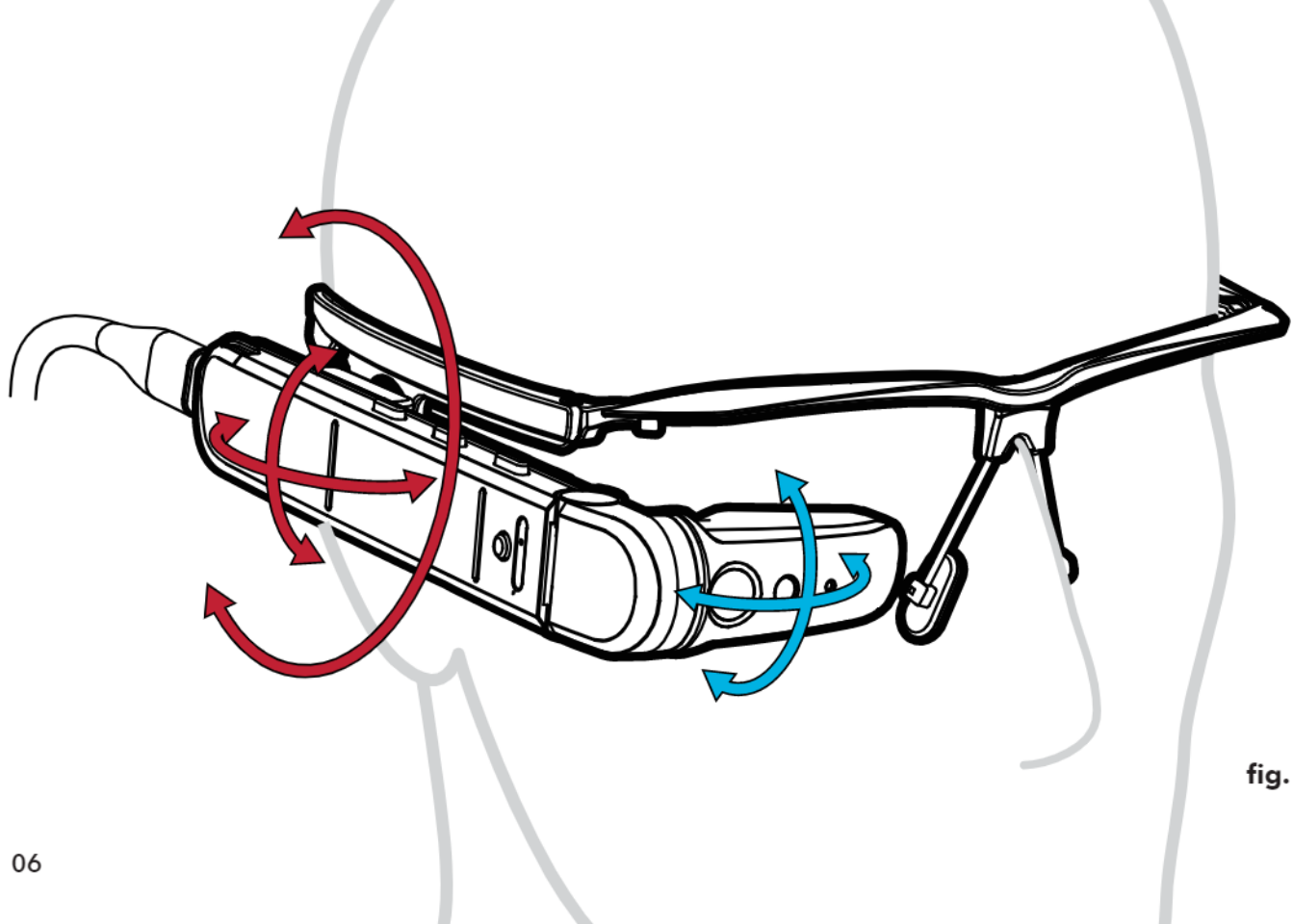

fig. 3

WEARING THE M300XL

1. Make sure your smart glasses frames are resting comfortably on your head. The frames can be worn over the top of the majority of regular prescription eyewear. The nose bridge of the frames can be adjusted to fit comfortably - and securely. Optional nose bridge provided for maximum comfort and fit.
2. After mounting the main unit as described on page 04, slide the main unit backward or forward for preferred distance between your dominant eye and the viewing display. The main unit may also be raised and lowered by vertical adjustment (as seen in figure 3).
3. Power on by pressing the power button on the side of the battery pod.
4. Adjust the display until you can comfortably view the full image (as shown in figure 3).
5. Additional mounting options – including frames with prescription lenses, safety frames, hard hat and headband mounts – can be found online at Vuzix.com under Products > M300XL Smart Glasses > Accessories.

NAVIGATING THE M300XL

For optimal ease of use, the M300XL Smart Glasses System offers multiple modes of interaction, including touch control buttons, touchpad or speech recognition using built-in dual noise-cancelling microphones.

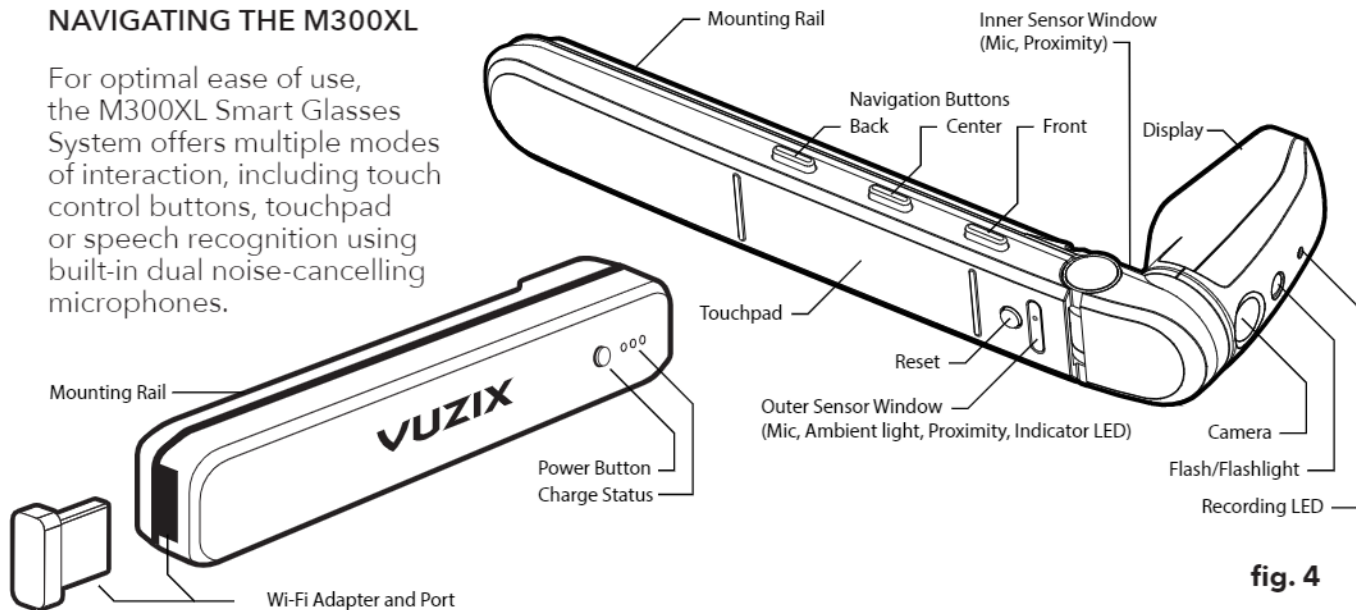

fig. 4

BATTERY POD POWER BUTTON

Short press: when off - power on device
Long press: opens menu with options to Power-off, reset, enable functions or turn on flashlight

M300XL RESET BUTTON

Eight second press: powers off M300XL, (does not effect the battery pod)

TOUCH BUTTON NAVIGATION:

Short press for primary functions:

front: forward navigation

center: back navigation

back: select

Long press (approx one sec) touch for secondary functions:

front: right-click menu

center: exit to home menu

back: back one step

TOUCHPAD NAVIGATION:

The 2-axis pad responds to up and down or back-to-front finger swipes.

Tap to select.

VOICE COMMANDS:

To enable speech recognition, toggle on in Settings. The M300XL Speech Recognition can now be activated with the "Hello Vuzix" keyword. The M300XL will listen for voice commands for 15 seconds by default.

For more information on voice commands and custom configuration, refer to the M300XL online documentation.

www.vuzix.com/support

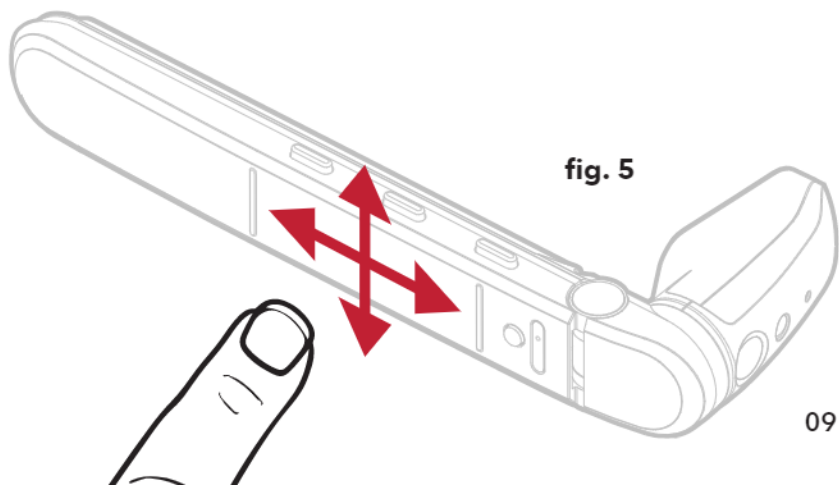

WI-FI ADAPTER INSTRUCTIONS

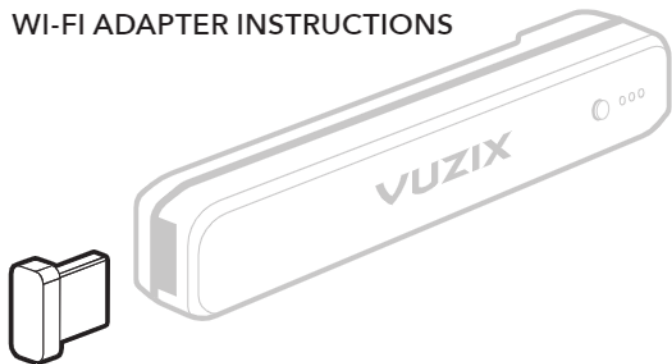

The M300XL has a built-in Wi-Fi radio that meets many customers' needs. The USB Wi-Fi Adapter improves performance in environments where all Wi-Fi access points on the same SSID are configured for the same 2.4GHz channel.

The USB Wi-Fi Adapter is inserted into the front-facing USB-A port on the M-Series On-Frame Battery, USB-A.

The device will use the built-in radio, unless the USB adapter is selected using this procedure.



1. Open the Settings application and navigate to Wi-Fi
2. Long-press the front-most button to bring up the menu
3. Select Advanced
4. Toggle the USB Wi-Fi adapter selection to the enabled state

The USB Wi-Fi Adapter has a blue LED that indicates it is in use.

NOTE: Whenever the settings are in this mode and Wi-Fi is enabled the device cannot communicate with a computer over USB. You must disable Wi-Fi or disable this setting to connect with a computer.

Also, the USB cable from the computer must be plugged directly into the Micro-USB port of the device itself, not the battery.

CONNECTING TO WI-FI

QR code setup:

1. Open Scanner from the main carousel.
2. The easiest way to connect to Wi-Fi is by scanning a QR code—QR codes can be securely created using www.vuzix.com/wifiQR and scanned directly from your phone or computer screen.
3. Center available QR code in viewfinder to scan.

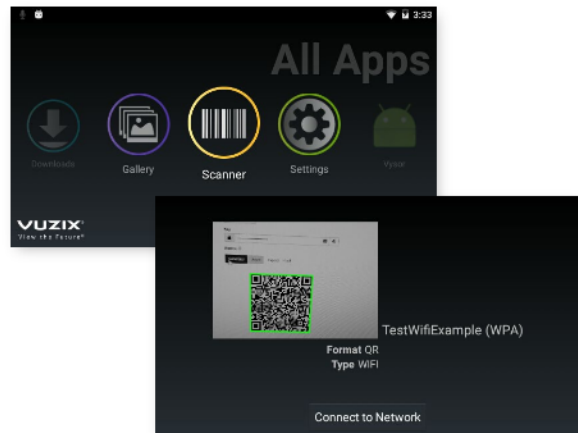

Manual setup:

1. At the home page, select the **Settings** app.
2. In Settings, select the **Wi-Fi** menu option and then press the select button to activate Wi-Fi.
3. Once the list of available networks populates, highlight the preferred network and select.
4. Enter password using displayed keyboard, select **Connect**.

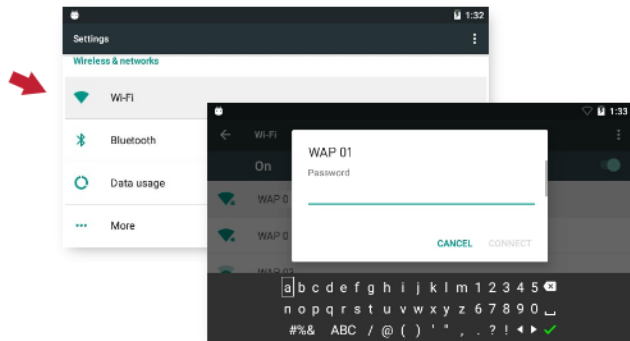

PREINSTALLED APPLICATIONS

The M300XL comes preinstalled with a number of standard applications, such as **Camera**, **Gallery** and **QR and Barcode Scanner**.

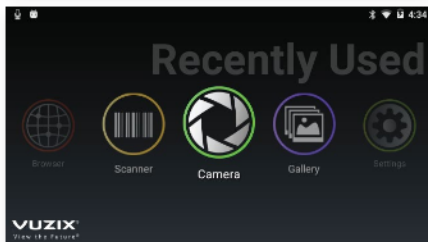
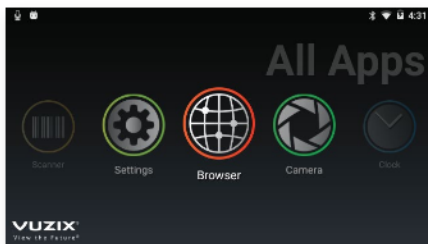

APPLICATION MENU

The **M300XL Application Carousel** has multiple sections for helping organize and easily access your most commonly used M300XL applications. Swiping up/down on the touchpad or a long press on the center button when at the home screen will toggle between an **All Apps** section, an automatically populated **Recently Used** section and a **Favorites** section.

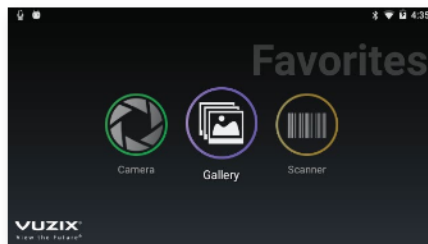

For more information on managing your applications, refer to the M300XL online documentation.

www.vuzix.com/support

REGISTERING YOUR DEVICE

1. Register for or log onto your **Vuzix App Store** account from a computer or phone at appstore.vuzix.com
2. Follow the instructions on the website
3. Once registered, you will see the serial number of your M300XL under your account. (see figure 6 for serial number location)

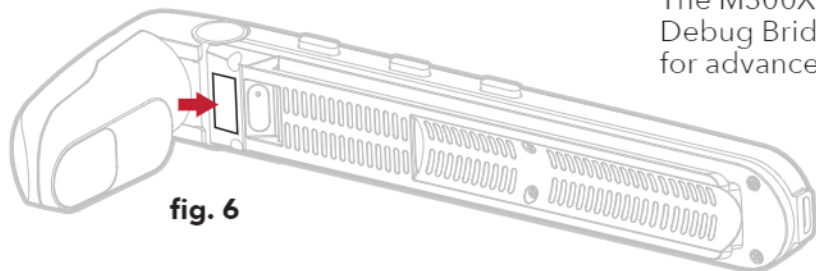

fig. 6

INSTALLING APPLICATIONS

Applications can be installed on the M300XL via the **Vuzix App Store**. App Store will install and manage applications via an OTA (Over the Air) mechanism, and will require Wi-Fi connectivity.

For instructions and additional information about installing applications and using the Vuzix App Store, refer to the M300XL Online Manual.

www.vuzix.com/support

The M300XL supports ADB (Android Debug Bridge) as an alternate mechanism for advanced users to install applications.

GETTING THE LATEST UPDATES

The M300XL will automatically check for updates once it is connected to Wi-Fi. Click Update on the following pop-up.

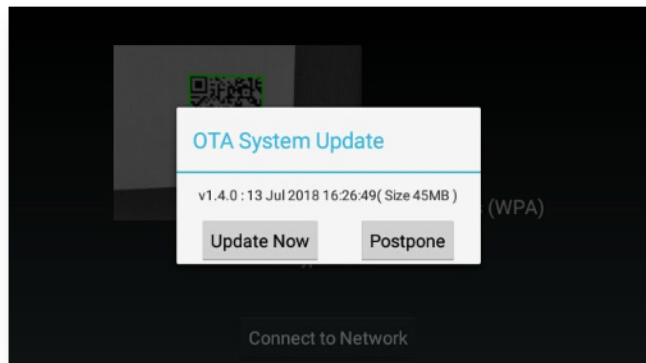

NOTE: If your corporate firewall prevents access to the external website, your system administrator may provide additional settings for your M300XL or may provide a software update offline.

[THIS PAGE INTENTIONALLY LEFT BLANK]

LEARNING MORE

Visit www.vuzix.com/support/Downloads_Drivers to reference a comprehensive online user's manual or contact technical_support@vuzix.com for additional information and assistance.

FOR MORE INFORMATION ON THE M300XL
AND ACCESSORIES, VISIT:

vuzix.com | vuzix.eu | vuzix.jp

©Vuzix 2019. This user guide is subject to change.
Please read the safety section of the user's manual before using this product.
All trademarks belong to respective owners.

446PB0004-05 - M300XL USER GUIDE