

**MAXIMUS VII
RANGER**

ASUS®

Motherboard

E9798

Revised Edition V2
September 2014

Copyright © 2014 ASUSTeK COMPUTER INC. All Rights Reserved.

No part of this manual, including the products and software described in it, may be reproduced, transmitted, transcribed, stored in a retrieval system, or translated into any language in any form or by any means, except documentation kept by the purchaser for backup purposes, without the express written permission of ASUSTeK COMPUTER INC. ("ASUS").

Product warranty or service will not be extended if: (1) the product is repaired, modified or altered, unless such repair, modification or alteration is authorized in writing by ASUS; or (2) the serial number of the product is defaced or missing.

ASUS PROVIDES THIS MANUAL "AS IS" WITHOUT WARRANTY OF ANY KIND, EITHER EXPRESS OR IMPLIED, INCLUDING BUT NOT LIMITED TO THE IMPLIED WARRANTIES OR CONDITIONS OF MERCHANTABILITY OR FITNESS FOR A PARTICULAR PURPOSE. IN NO EVENT SHALL ASUS, ITS DIRECTORS, OFFICERS, EMPLOYEES OR AGENTS BE LIABLE FOR ANY INDIRECT, SPECIAL, INCIDENTAL, OR CONSEQUENTIAL DAMAGES (INCLUDING DAMAGES FOR LOSS OF PROFITS, LOSS OF BUSINESS, LOSS OF USE OR DATA, INTERRUPTION OF BUSINESS AND THE LIKE), EVEN IF ASUS HAS BEEN ADVISED OF THE POSSIBILITY OF SUCH DAMAGES ARISING FROM ANY DEFECT OR ERROR IN THIS MANUAL OR PRODUCT.

SPECIFICATIONS AND INFORMATION CONTAINED IN THIS MANUAL ARE FURNISHED FOR INFORMATIONAL USE ONLY, AND ARE SUBJECT TO CHANGE AT ANY TIME WITHOUT NOTICE, AND SHOULD NOT BE CONSTRUED AS A COMMITMENT BY ASUS. ASUS ASSUMES NO RESPONSIBILITY OR LIABILITY FOR ANY ERRORS OR INACCURACIES THAT MAY APPEAR IN THIS MANUAL, INCLUDING THE PRODUCTS AND SOFTWARE DESCRIBED IN IT.

Products and corporate names appearing in this manual may or may not be registered trademarks or copyrights of their respective companies, and are used only for identification or explanation and to the owners' benefit, without intent to infringe.

Offer to Provide Source Code of Certain Software

This product contains copyrighted software that is licensed under the General Public License ("GPL"), under the Lesser General Public License Version ("LGPL") and/or other Free Open Source Software Licenses. Such software in this product is distributed without any warranty to the extent permitted by the applicable law. Copies of these licenses are included in this product.

Where the applicable license entitles you to the source code of such software and/or other additional data, you may obtain it for a period of three years after our last shipment of the product, either

(1) for free by downloading it from <http://support.asus.com/download>

or

(2) for the cost of reproduction and shipment, which is dependent on the preferred carrier and the location where you want to have it shipped to, by sending a request to:

ASUSTeK Computer Inc.
Legal Compliance Dept.
15 Li Te Rd.,
Beitou, Taipei 112
Taiwan

In your request please provide the name, model number and version, as stated in the About Box of the product for which you wish to obtain the corresponding source code and your contact details so that we can coordinate the terms and cost of shipment with you.

The source code will be distributed WITHOUT ANY WARRANTY and licensed under the same license as the corresponding binary/object code.

This offer is valid to anyone in receipt of this information.

ASUSTeK is eager to duly provide complete source code as required under various Free Open Source Software licenses. If however you encounter any problems in obtaining the full corresponding source code we would be much obliged if you give us a notification to the email address gpl@asus.com, stating the product and describing the problem (please DO NOT send large attachments such as source code archives, etc. to this email address).

Contents

Safety information.....	vi
About this guide.....	vii
MAXIMUS VII RANGER specifications summary	ix
Package contents.....	xiii
Installation tools and components	xiv
Chapter 1: Product Introduction	
1.1 Special features.....	1-1
1.1.1 Product highlights.....	1-1
1.1.2 ROG Gaming Features	1-3
1.1.3 ROG Exclusive Features.....	1-4
1.1.4 ASUS Special Features	1-4
1.1.5 ROG rich bundled software.....	1-5
1.2 Motherboard overview	1-6
1.2.1 Before you proceed.....	1-6
1.2.2 Motherboard layout	1-7
1.2.3 Central Processing Unit (CPU)	1-9
1.2.4 System memory	1-10
1.2.5 Expansion slots.....	1-24
1.2.6 Onboard buttons	1-27
1.2.7 Onboard LEDs	1-31
1.2.8 Internal connectors.....	1-39
Chapter 2: Basic Installation	
2.1 Building your PC system.....	2-1
2.1.1 Motherboard installation.....	2-1
2.1.2 CPU installation.....	2-3
2.1.3 CPU heatsink and fan assembly installation	2-4
2.1.4 DIMM installation.....	2-6
2.1.5 ATX Power connection.....	2-7
2.1.6 SATA device connection	2-8
2.1.7 Front I/O Connector	2-9
2.1.8 Expansion Card installation.....	2-10
2.2 BIOS update utility.....	2-11
2.3 Motherboard rear and audio connections	2-12
2.3.1 Rear I/O connection	2-12
2.3.2 Audio I/O connections.....	2-13
2.4 Starting up for the first time.....	2-17
2.5 Turning off the computer	2-17

Chapter 3: BIOS setup

3.1	Knowing BIOS	3-1
3.2	BIOS setup program	3-2
	3.2.1 EZ Mode.....	3-3
	3.2.2 Advanced Mode	3-4
3.3	My Favorites	3-7
3.4	Extreme Tweaker menu	3-8
3.5	Main menu	3-23
3.6	Advanced menu	3-26
	3.6.1 CPU Configuration	3-27
	3.6.2 PCH Configuration	3-30
	3.6.3 PCH Storage Configuration.....	3-31
	3.6.4 System Agent Configuration	3-33
	3.6.5 USB Configuration	3-35
	3.6.6 Platform Misc Configuration.....	3-36
	3.6.7 Onboard Devices Configuration.....	3-37
	3.6.8 APM Configuration	3-39
	3.6.9 Network Stack Configuration.....	3-40
	3.6.10 ROG Effects.....	3-40
3.7	Monitor menu	3-41
3.8	Boot menu	3-44
3.9	Tool menu	3-50
	3.9.1 ASUS EZ Flash 2 Utility	3-50
	3.9.2 ROG Secure Erase	3-50
	3.9.3 Graphics Card Information.....	3-61
	3.9.4 ASUS Overclocking Profile	3-61
	3.9.5 ASUS SPD Information	3-62
	3.9.6 ROG OC Panel H-Key Configure.....	3-63
3.10	Exit menu	3-64
3.11	Updating BIOS	3-65

Chapter 4: Software support

4.1	Installing an operating system	4-1
4.2	Support DVD information	4-1
	4.2.1 Running the support DVD	4-1
	4.2.2 Obtaining the software manuals.....	4-2
4.3	Software information	4-3
4.4	AI Suite 3	4-3

4.5	Dual Intelligent Processors 5	4-6
	5-Way Optimization.....	4-6
	Turbo Processing Unit (TPU).....	4-7
	Energy Processing Unit (EPU).....	4-9
	DIGI+	4-10
	Fan Xpert 3	4-11
	Turbo App	4-12
	USB 3.0 Boost.....	4-13
	EZ Update.....	4-14
	System Information	4-15
	USB BIOS Flashback.....	4-17
	USB Charger+.....	4-18
	Push Notice.....	4-19
4.6	ROG Audio features	4-22
	Sonic Studio	4-22
	Sonic SenseAmp.....	4-24
	Sonic SoundStage	4-26
	DTS Connect.....	4-27
4.7	Sonic Radar II	4-28
4.8	GameFirst III	4-30
4.9	KeyBot	4-33
4.10	ASUS Media Streamer	4-35
4.11	ASUS Disk Unlocker	4-37
4.12	RAMDisk	4-38
4.13	MemTweakIt	4-41
4.14	ROG CPU-Z	4-43

Chapter 5: RAID support

5.1	RAID configurations	5-1
	5.1.1 RAID definitions	5-1
	5.1.2 Installing Serial ATA hard disks	5-2
	5.1.3 Setting the RAID item in BIOS	5-2
	5.1.4 Intel® Rapid Storage Technology Option ROM utility.....	5-3
5.2	Creating a RAID driver disk	5-7
	5.2.1 Creating a RAID driver disk without entering the OS.....	5-7
	5.2.2 Creating a RAID driver disk in Windows®.....	5-8
	5.2.3 Installing the RAID driver during Windows® OS installation.....	5-8

Appendices

Notices	A-1
ASUS contact information	A-4

Safety information

Electrical safety

- To prevent electrical shock hazard, disconnect the power cable from the electrical outlet before relocating the system.
- When adding or removing devices to or from the system, ensure that the power cables for the devices are unplugged before the signal cables are connected. If possible, disconnect all power cables from the existing system before you add a device.
- Before connecting or removing signal cables from the motherboard, ensure that all power cables are unplugged.
- Seek professional assistance before using an adapter or extension cord. These devices could interrupt the grounding circuit.
- Ensure that your power supply is set to the correct voltage in your area. If you are not sure about the voltage of the electrical outlet you are using, contact your local power company.
- If the power supply is broken, do not try to fix it by yourself. Contact a qualified service technician or your retailer.

Operation safety

- Before installing the motherboard and adding devices on it, carefully read all the manuals that came with the package.
- Before using the product, ensure all cables are correctly connected and the power cables are not damaged. If you detect any damage, contact your dealer immediately.
- To avoid short circuits, keep paper clips, screws, and staples away from connectors, slots, sockets and circuitry.
- Avoid dust, humidity, and temperature extremes. Do not place the product in any area where it may become wet.
- Place the product on a stable surface.
- If you encounter technical problems with the product, contact a qualified service technician or your retailer.

About this guide

This user guide contains the information you need when installing and configuring the motherboard.

How this guide is organized

This guide contains the following parts:

- **Chapter 1: Product introduction**
This chapter describes the features of the motherboard and the new technology it supports. It includes description of the switches, jumpers, and connectors on the motherboard.
- **Chapter 2: Basic Installation**
This chapter lists the hardware setup procedures that you have to perform when installing system components.
- **Chapter 3: BIOS setup**
This chapter tells how to change system settings through the BIOS Setup menus. Detailed descriptions of the BIOS parameters are also provided.
- **Chapter 4: Software support**
This chapter describes the contents of the support DVD that comes with the motherboard package and the software.
- **Chapter 5: RAID support**
This chapter describes the RAID configurations.

Where to find more information

Refer to the following sources for additional information and for product and software updates.

1. **ASUS website**
The ASUS website (www.asus.com) provides updated information on ASUS hardware and software products.
2. **Optional documentation**
Your product package may include optional documentation, such as warranty flyers, that may have been added by your dealer. These documents are not part of the standard package.

Conventions used in this guide

To ensure that you perform certain tasks properly, take note of the following symbols used throughout this manual.



DANGER/WARNING: Information to prevent injury to yourself when trying to complete a task.



CAUTION: Information to prevent damage to the components when trying to complete a task



IMPORTANT: Instructions that you **MUST** follow to complete a task.



NOTE: Tips and additional information to help you complete a task.

Typography

Bold text

Indicates a menu or an item to select.

Italics

Used to emphasize a word or a phrase.

<Key>

Keys enclosed in the less-than and greater-than sign means that you must press the enclosed key.

Example: <Enter> means that you must press the Enter or Return key.

<Key1> + <Key2> + <Key3>

If you must press two or more keys simultaneously, the key names are linked with a plus sign (+).

MAXIMUS VII RANGER specifications summary

<p>CPU</p>	<p>LGA1150 socket for New 4th Generation and 5th Generation Intel® Core™ i7/Intel® Core™ i5/ Intel® Core™ i3, Pentium® and Celeron® processors</p> <p>Supports 22nm CPU</p> <p>Supports Intel® Turbo Boost Technology 2.0</p> <p>* The Intel® Turbo Boost Technology 2.0 support depends on the CPU types.</p> <p>* Refer to www.asus.com for Intel CPU support list</p>
<p>Chipset</p>	<p>Intel® Z97 Express Chipset</p>
<p>Memory</p>	<p>Dual channel memory architecture</p> <p>4 x DIMM, max. 32GB, DDR3 3200 (O.C.) / 3100 (O.C.) / 3000 (O.C.) / 2933 (O.C.) / 2800 (O.C.) / 2666 (O.C.) / 2600 (O.C.) / 2500 (O.C.) / 2400 (O.C.) / 2200 (O.C.) / 2133 (O.C.) / 2000 (O.C.) / 1866 (O.C.) / 1800 (O.C.) / 1600 / 1333 MHz, non-ECC, un-buffered memory</p> <p>Supports Intel® Extreme Memory Profile (XMP)</p> <p>* Hyper DIMM support is subject to the physical characteristics of individual CPUs.</p> <p>** Please refer to Memory QVL (Qualified Vendors List) for details.</p>
<p>Expansion slots</p>	<p>2 x PCIe 3.0/2.0 x16 slots (Red, single at x16 or dual at x8/x8 mode)</p> <p>1 x PCIe 2.0 x16 slot (Black, max. at x4 mode)*</p> <p>3 x PCIe 2.0 x1 slots**</p> <p>* The PCIe 2.0 x16 slot (PCIEX4_3) shares bandwidth with PCIe 2.0 x1 slots and M.2 connector. The default setting is Auto mode.</p> <p>** The PCIe 2.0 x1 slots (PCIEX1_2 and PCIEX1_3) are disabled when the PCIe 2.0 x16 slot (PCIEX4_3) operates under M.2 mode.</p> <p>** The PCIe 2.0 x1 slots (PCIEX1_2 and PCIEX1_3) and the M.2 connector are disabled when the PCIEX4_3 operates under PCIe X4 mode.</p>
<p>VGA</p>	<p>Integrated Intel® HD Graphics Processor</p> <p>HDMI with maximum resolution of 4096 x 2160 @ 24Hz / 2560 x 1600 @ 60Hz</p> <p>DVI-D maximum resolution of 1920 x 2000 @ 60Hz</p> <p>RGB with maximum resolution of 1920 x 2000 @ 60Hz</p> <p>Intel® InTru™ 3D, Intel® Quick Sync Video, Intel® Clear Video HD Technology, and Intel® Insider™</p>
<p>Multi-GPU support</p>	<p>Support NVIDIA® SLI™ Technology / AMD CrossFireX™ Technology</p>

(continued on the next page)

MAXIMUS VII RANGER specifications summary

<p>Storage</p>	<p>Intel® Z97 Express Chipset: 6 x SATA 6 Gb/s ports* - Intel® Rapid Storage Technology 13 supports RAID 0, 1, 5, and 10 - Intel® Smart Response Technology, Intel® Rapid Start Technology, and Intel® Smart Connect Technology* 1 x M.2 Socket 3 with M Key, type 2260/2280 storage devices support** * The supported functions depend on the CPU installed. ** Supports PCIe interface only.</p>
<p>LAN</p>	<p>1 x Intel® I218-V Gigabit LAN Anti-surge Ethernet port ROG GameFirst III</p>
<p>Audio</p>	<p>ROG SupremeFX Audio 8-Channel High Definition Audio - SupremeFX Shielding Technology - ELNA® Premium Audio Capacitors - Content Protection for Full Rate lossless DVD Audio, Blu-ray DVD, and HD-DVD audio content playback - Jack-detection, Multi-streaming, Front Panel Jack-retasking, Gold Plated Audio Jacks - Optical S/PDIF out port at back panel Audio Feature: - Sonic Radar II - Sonic Studio - Sonic SoundStage - Sonic SenseAmp - DTS Connect</p>
<p>USB</p>	<p>Intel® Z97 Express Chipset 6 x USB 3.0 ports (4 ports at back panel [blue], 2 ports at mid-board [red])* 7 x USB 2.0 ports (2 ports at back panel, 5 ports at mid-board)** * Supports ASUS USB 3.0 Boost, UASP standard on the Intel® native USB 3.0 is only supported under Windows® 8 / 8.1. ** 1 x USB 2.0 port (USB13) shares with ROG extension (ROG_EXT) port.</p>
<p>Back I/O Ports</p>	<p>1 x PS/2 keyboard/mouse combo port 2 x USB 2.0 ports 1 x USB BIOS Flashback button 1 x Optical S/PDIF out 1 x HDMI port 1 x RGB (VGA) port 1 x DVI-D (DVI) port 4 x USB 3.0 ports [blue] 1 x Anti-surge LAN (RJ45) port 6 x 8-channel golden plated audio jacks</p>

(continued on the next page)

MAXIMUS VII RANGER specifications summary

ROG Exclusive Features	<p>Extreme Engine Digi+ III</p> <ul style="list-style-type: none">- Full digital CPU/DRAM power- NexFET™ Power Block MOSFET- New Alloy Chokes- 10K Black Metallic Capacitors <p>KeyBot</p> <ul style="list-style-type: none">- CPU Level Up- XMP- DirectKey <p>ROG RAMDisk</p> <p>UEFI BIOS features</p> <ul style="list-style-type: none">- Extreme Tweaker- Tweaker's Paradise- ROG SSD Secure Erase- GPU.DIMM Post- O.C. Profile- Graphics Card information Preview- Push Notice
Special Features	<p>ASUS Dual Intelligent Processors 5</p> <ul style="list-style-type: none">- 5-way Optimization Tuning Key, consolidating DIGI+ Power Control, TPU, EPU, and Fan Xpert 3 <p>ASUS Exclusive Features</p> <ul style="list-style-type: none">- AI Suite 3- USB 3.0 Boost- USB Charger+- AI Charger+- Disk Unlocker <p>ASUS EZ DIY</p> <ul style="list-style-type: none">- Push Notice- X.M.P.- USB BIOS Flashback- ASUS CrashFree BIOS 3- ASUS EZ Flash 2- ASUS C.P.R. (CPU Parameter Recall) <p>MemOK!</p> <p>ASUS Q-Design</p> <ul style="list-style-type: none">- ASUS Q-Code- ASUS Q-Shield- ASUS Q-Connector- ASUS Q-LED (CPU, DRAM, VGA, Boot Device LED)- ASUS Q-Slot- ASUS Q-DIMM

(continued on the next page)

MAXIMUS VII RANGER specifications summary

Internal Connectors	<ul style="list-style-type: none"> 1 x USB 3.0 connector (supports additional two USB 3.0 ports) 3 x USB 2.0 connectors (support additional five USB 2.0 ports, one connector shares with ROG_EXT header) 1 x ROG Extension (ROG_EXT) header 6 x SATA 6Gb/s connectors 1 x 4-pin CPU fan connector 1 x 4-pin CPU optional fan connector 3 x 4-pin Chassis fan connectors 1 x 24-pin EATX power connector 1 x 8-pin EATX 12V Power connector 1 x Clear CMOS jumper 1 x Power-on button 1 x Reset button 1 x MemOK! button 1 x Front panel audio connector (AAFP) 1 x System panel connector 1 x TPM connector 1 x Sonic SoundStage button 1 x KeyBot button
BIOS Features	64 Mb Flash ROM, UEFI AMI BIOS, PnP, DMI 2.7, WfM 2.0, SM BIOS 2.7, ACPI 5.0, Multi-language BIOS, ASUS EZ Flash 2, ASUS CrashFree BIOS 3, My Favorites, Quick Note, Last Modified log, F12 PrintScreen, F3 Shortcut functions, and ASUS DRAM SPD (Serial Presence Detect) memory information
Manageability	WfM2.0, DMI2.7, WOL by PME, PXE
Software	<ul style="list-style-type: none"> Drivers ROG GameFirst III ROG RAMDisk ROG CPU-Z ROG MemTweakIt Kaspersky® Anti-Virus DAEMON Tools Pro Standard ASUS WebStorage Home Cloud ASUS Utilities
Form Factor	ATX Form Factor, 12 in. x 9.6 in. (30.5 cm x 24.4 cm)



Specifications are subject to change without notice.

Package contents



Check your motherboard package for the following items.

Motherboard	ROG MAXIMUS VII RANGER
Cables	2 x 2-in-1 SATA 6 Gb/s cables 1 x SLI® bridge
Accessories	1 x I/O Shield 1 x 12-in-1 ROG cable label 1 x 2-in-1 Q-Connector kit 1 x ROG Door Hanger
Application DVD	ROG motherboard support DVD
Documentation	User guide

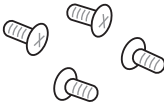

If any of the above items is damaged or missing, contact your retailer.

Installation tools and components

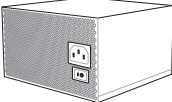
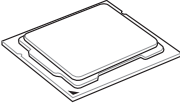
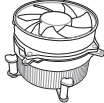
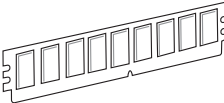
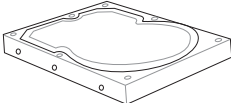
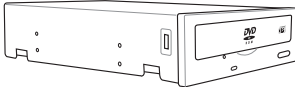
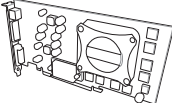
	
<p>1 bag of screws</p>	<p>Phillips (cross) screwdriver</p>
	
<p>PC chassis</p>	<p>Power supply unit</p>
	
<p>Intel LGA 1150 CPU</p>	<p>Intel LGA 1150 compatible CPU Fan</p>
	
<p>DDR3 DIMM</p>	<p>SATA hard disk drive</p>
	
<p>SATA optical disc drive (optional)</p>	<p>Graphics card (optional)</p>



The tools and components in the table above are not included in the motherboard package.

Product introduction

1

1.1 Special features

1.1.1 Product highlights

Republic of Gamers

The Republic of Gamers offers you the best of the best. We offer the best hardware engineering, the fastest performance, the most innovative ideas, and we welcome the best gamers to join in. In the Republic of Gamers, mercy rules are only for the weak, and bragging rights means everything. We believe in making statements and we excel in competitions. If your character matches our trait, then join the elite Republic of Gamers and make your presence felt.

LGA1150 socket for New 4th Generation and 5th Generation Intel® Core™ i7/ Intel® Core™ i5/ Intel® Core™ i3, Pentium®, and Celeron® processors

This motherboard supports new 4th generation and 5th generation Intel® Core™ i7/Intel® Core™ i5/Intel® Core™ i3, Pentium®, and Celeron® processors in the LGA1150 package. It provides great graphics and system performance with its GPU, dual-channel DDR3 memory slots, and PCI Express 2.0/3.0 expansion slots.

Intel® Z97 Express Chipset

Intel® Z97 Express Chipset is a single chipset that supports the LGA1150 socket for 4th generation and 5th generation Intel® Core™ i7/Intel® Core™ i5/Intel® Core™ i3, Pentium®, and Celeron® processors. It utilizes the serial point-to-point links, which increases bandwidth and enhances the system's performance. It natively supports up to six USB 3.0 ports, six SATA 6 Gb/s ports, and M.2 support for faster data retrieval. It also enables the iGPU function for Intel® integrated graphics performance.

PCIe® 3.0

PCIe® 3.0 (PCIe 3.0) is the PCIe bus standard that provides twice the performance and speed of PCIe 2.0. It provides an optimal graphics performance, unprecedented data speed and seamless transition with its complete backward compatibility to PCIe 1.0/2.0 devices.

SLI®/CrossFire™ On-Demand

This motherboard features a unique PCIe 3.0 bridge chip to support multi-GPU SLI®/CrossFireX™ graphics cards for an unrivalled gaming performance. With the Intel® Z97 platform to optimize the PCIe allocation of multiple GPUs, it supports up to 2-WAY GPU SLI® or CrossFireX™ configuration.

M.2 Support

This motherboard features the M.2 slot, which shares bandwidth with PCIe x2 slot to speed up data transfer up to 10 Gb/s. This helps enhance the performance of your Solid State Drive (SSD) that is dedicated only to the operating system. The M.2 slot provides support for faster access to data and applications, and quicker wake up time for your system.



-
- Supports PCIe interface only.
 - Supports 2260 (22 mm x 60 mm) and 2280 (22 mm x 80 mm) SSD cards.
-

Complete USB 3.0 integration

This motherboard offers you the strategic USB 3.0 accessibility for both the front and rear panels, allowing you to experience the convenience of the latest plug and play connectivity solution at speed up to ten times faster than USB 2.0.

1.1.2 ROG Gaming Features

SupremeFX

The re-engineered ROG-exclusive SupremeFX audio technology features an onboard 8-channel high-definition sound of true audiophile-grade performance that is equal in power, clarity, and range to dedicated sound cards. Its unique Red Line Shielding and special metallic cover provides pristine sound and a highly attractive look for the motherboard that is in keeping with the ROG style. The Japan-made premium ELNA capacitor ensures warm natural sound with exceptional clarity for all your gaming and multimedia activities. SupremeFX revolutionizes the way you hear games, movies, music, and even other people via chat - letting you rule and discover a totally whole new dimension of superior audio.

Sonic Radar II

Sonic Radar II features the exclusive audio enhancement that enhances in-game sound for better hearing awareness. It has a customizable user interface with a stealthy overlay display that shows what opponents and teammates are up to including information on the precise direction and origin of gunshots, footsteps, and call-outs when playing first person shooting (FPS) games.

Sonic Studio

Sonic Studio is an audio tuning software that simulates 7.1 channels even through a stereo (2.0-channel) headset with its virtual surround-sound function. It comes with six superb audio controls including Reverb, Bass Boost, Equalizer, Voice Clarity, Smart EQ (Smart Volume), and Virtual Surround.

Sonic SoundStage

Sonic SoundStage is an on-board solution that improves audio experience when you connect your front-panel headset. It works with any operating system and on any game. You can choose from any of the four presets or manually fine tune your own setting to fire up your game.

Sonic SenseAmp

Sonic SenseAmp is an exclusive ROG invention that automatically detects your headset's impedance and adjusts the built-in amp accordingly. Sonic SenseAmp makes tuning your high-quality headphones as simple as plugging them in.

GameFirst III

ASUS GameFirst III is a network management software that features four preset packet prioritized profiles (Optimization, Game, Media Streaming and File Sharing) facilitating user's need. Users can also manually allocate bandwidth and adjust priority settings of each application to run faster and smoother.

Intel® Ethernet

This LAN solution from Intel features high TCP and UDP throughput with lower CPU utilization for a smooth networking experience. It has advanced features including advanced interrupt-handling, low-power consumption, and Intel Stable Image Platform Program (SIPP) support thanks to its compatibility with the Intel CPU and chipset.

1.1.3 ROG Exclusive Features

Extreme Engine Digi+ III

Extreme Engine Digi+ III offers you a hardcore power delivery for a challenging and extreme gaming enjoyment. It utilizes the best components such as NexFET™ Power Block MOSFETs, new alloy chokes, and super-premium 10K black metallic solid state capacitors. The NexFET™ Power Block MOSFETs combine great durability and up to 90% efficiency under normal operation. Super-premium 10K Black Metallic solid state capacitors are forged for overclocking and the most extreme demands, lasting up to five times longer than generic capacitors with 20% wider temperature tolerance.

RAMDisk

RAMDisk reserves part of system memory and turns it into actual storage, so you can place favorite app and game cache files in it to enjoy high-speed RAM performance while accessing them. With the Dynamic Memory Allocation function, it can also release the unused memory of RAMDisk back to the system when needed. Plus, this extends SSD lifespan and keeps your main storage optimized for really important tasks, and you get auto data backup and restore.



NOTE: RAMDisk only supports 64-bit operating systems.

CPU Level Up

With ROG's CPU Level Up, overclocking has never been so easy, or cost-free. Simply select the processor that you want to overclock to, and the motherboard will do the rest.

1.1.4 ASUS Special Features

AI Suite 3

With its user-friendly interface, ASUS AI Suite 3 consolidates all the exclusive ASUS features into one simple-to-use software package. It allows you to supervise fan speed control, voltage and sensor readings. This all-in-one software offers diverse and ease to use functions, with no need to switch back and forth between different utilities.

USB 3.0 Boost

ASUS USB 3.0 Boost, which supports USB 3.0 standard UASP (USB Attached SCSI Protocol), significantly increases a USB device's transfer speed up to 170% faster than the already impressive USB 3.0 transfer speed. It automatically accelerates data speeds for compatible USB 3.0 peripherals without the need for any user interaction.

USB BIOS Flashback

USB BIOS Flashback offers a hassle-free updating solution for your ultimate convenience. Install a USB storage device containing the BIOS file, press the BIOS Flashback button for about three seconds, and the UEFI BIOS is automatically updated even without entering the existing BIOS or operating system. It also allows you to regularly check for UEFI BIOS updates, and download the latest BIOS automatically.

1.1.5 ROG rich bundled software

KeyBot

KeyBot is a built-in microprocessor that provides instant upgrade to your keyboard. You can configure and assign macros to specific keys on your keyboard to perform specific or several task at the same time. You can also configure your PC to wake up in CPU Level UP, XMP, or directly to BIOS mode.



This feature supports USB keyboards only.

Kaspersky® Anti-Virus

Kaspersky® Anti-Virus Personal offers premium anti virus protection for individual users and home offices. It is based on advanced anti virus technologies. The product incorporates the Kaspersky® Anti-Virus engine, which is renowned for malicious program detection rates that are among the industry's highest.

DAEMON Tools Pro Standard

DAEMON Tools Pro offers essential functionality to backup CD, DVD and Blu-ray discs. It converts optical media into virtual discs and emulates devices to work with the virtual copies. DAEMON Tools Pro organizes data, music, video, and photo collections on a PC, notebook, or netbook.

ROG CPU-Z

ROG CPU-Z is a customized ROG version utility authorized by Intel's CPU Identification (CPUID) that allows you to gather information of the main devices of your system. It gives you the information and status of your CPU, motherboard, memory, and the whole component. Use the ROG look of reporting your system's current information with ROG CPU-Z.

MemTweakIt

MemTweakIt is a DRAM efficiency tool that allows you to read DRAM timings and allows you to post and share your DRAM configuration scores to the ROG website.

DTS Connect

To get the most out of your audio entertainment across all formats and quality levels, DTS Connect combines two enabling technologies, DTS Neo:PC™ up mixes stereo sources (CDs, MP3s, WMAs, internet radio) into as many as 7.1 channels of incredible surround sound. Consumers can connect their PC to a home theatre system. DTS Interactive is capable of performing multichannel encoding of DTS bitstreams on personal computers, and sending encoded bitstreams out of a digital audio connection (such as S/PDIF or HDMI) designed to deliver audio to an external decoder.

1.2 Motherboard overview

1.2.1 Before you proceed

Take note of the following precautions before you install motherboard components or change any motherboard settings.



-
- Unplug the power cord from the wall socket before touching any component.
 - Before handling components, use a grounded wrist strap or touch a safely grounded object or a metal object, such as the power supply case, to avoid damaging them due to static electricity.
 - Hold components by the edges to avoid touching the ICs on them.
 - Whenever you uninstall any component, place it on a grounded antistatic pad or in the bag that came with the component.
 - Before you install or remove any component, ensure that the ATX power supply is switched off or the power cord is detached from the power supply. Failure to do so may cause severe damage to the motherboard, peripherals, or components.
-

1.2.2 Motherboard layout

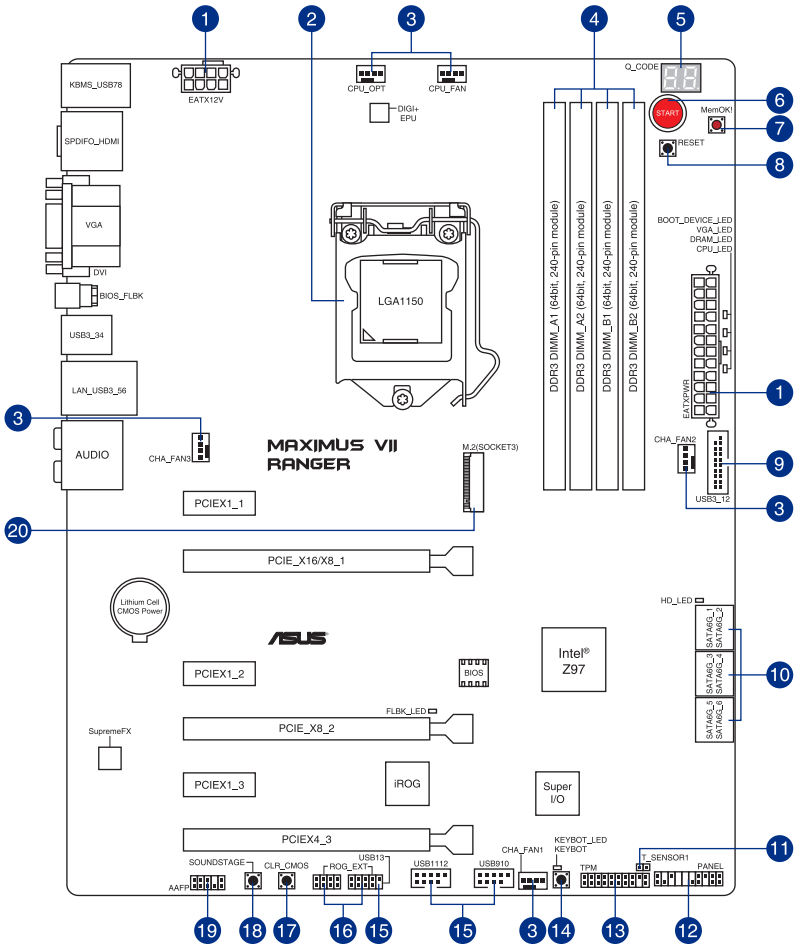

Refer to **Internal connectors** and **Rear I/O connection** for more information about rear panel connectors and internal connectors.

Layout contents

Connectors/Jumpers/Buttons and switches/Slots	Page
1. ATX power connectors (24-pin EATXPWR; 8-pin EATX12V)	1-45
2. LGA1150 CPU Socket	1-9
3. CPU, chassis, and optional fan connectors (4-pin CPU_FAN; 4-pin CPU_OPT; 4-pin CHA_FAN1-3)	1-44
4. DDR3 DIMM slots	1-10
5. Q_Code LEDs	1-33
6. START (Power-on) button	1-27
7. MemOK! button	1-28
8. RESET button	1-27
9. USB 3.0 connectors (20-1 pin USB3_12)	1-41
10. Intel® Z97 Serial ATA 6 Gb/s connectors (7-pin SATA6G_1-6 [red])	1-40
11. T_Sensor connector (2-pin T_SENSOR1)	1-48
12. System panel connector (20-8 pin PANEL)	1-46
13. TPM connector (20-1 pin TPM)	1-47
14. KeyBot button (KeyBot)	1-29
15. USB 2.0 connectors (10-1 pin USB1112; USB13)	1-42
16. ROG Extension connector (18-1 pin ROG_EXT)	1-47
17. Clear CMOS button (CLR_CMOS)	1-29
18. Sonic SoundStage button (SOUNDSTAGE)	1-30
19. Front panel audio connector (10-1 pin AAFP)	1-43
20. M.2 (Socket 3)	1-48

1.2.3 Central Processing Unit (CPU)

The motherboard comes with a surface mount LGA1150 socket designed for the New 4th Generation and 5th Generation Intel® Core™ i7/ Intel® Core™ i5/ Intel® Core™ i3, Pentium® and Celeron® processors

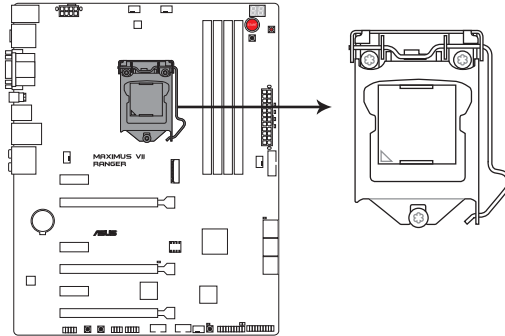

MAXIMUS VII RANGER CPU LGA1150



Ensure that you install the correct CPU designed for LGA1150 socket only. **DO NOT** install a CPU designed for LGA155 and LGA1156 sockets on the LGA1150 socket.



- Ensure that all power cables are unplugged before installing the CPU.
 - Upon purchase of the motherboard, ensure that the PnP cap is on the socket and the socket contacts are not bent. Contact your retailer immediately if the PnP cap is missing, or if you see any damage to the PnP cap/socket contacts/motherboard components. ASUS will shoulder the cost of repair only if the damage is shipment/transit-related.
 - Keep the cap after installing the motherboard. ASUS will process Return Merchandise Authorization (RMA) requests only if the motherboard comes with the cap on the LGA1150 socket.
 - The product warranty does not cover damage to the socket contacts resulting from incorrect CPU installation/removal, or misplacement/loss/incorrect removal of the PnP cap.
-

1.2.4 System memory

The motherboard comes with four Double Data Rate 3 (DDR3) Dual Inline Memory Modules (DIMM) slots.



A DDR3 module is notched differently from a DDR or DDR2 module. DO NOT install a DDR or DDR2 memory module to the DDR3 slot.

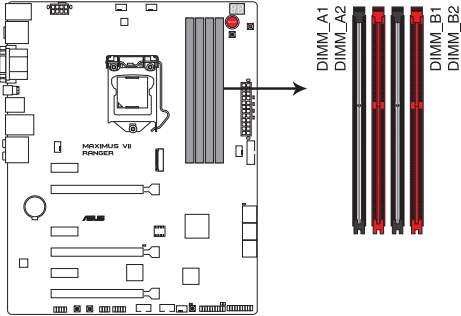

MAXIMUS VII RANGER 240-pin DDR3 DIMM sockets

Recommended memory configurations

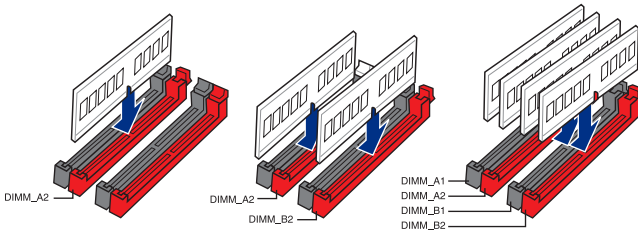

Memory configurations

You may install 1 GB, 2 GB, 4 GB and 8 GB unbuffered and non-ECC DDR3 DIMMs into the DIMM sockets.



-
- Memory module with memory frequency higher than 2133 MHz and its corresponding timing or the loaded XMP profile is not the JEDEC memory standard. The stability and compatibility of these memory modules depend on the CPU's capabilities and other installed devices.
 - You may install varying memory sizes in Channel A and Channel B. The system maps the total size of the lower-sized channel for the dual-channel configuration. Any excess memory from the higher-sized channel is then mapped for single-channel operation.
 - According to Intel CPU spec, DIMM voltage below 1.65V is recommended to protect the CPU.
 - Always install DIMMs with the same CAS latency. For optimal compatibility, we recommend that you install memory modules of the same version or date code (D/C) from the same vendor. Check with the retailer to get the correct memory modules.
 - Due to the memory address limitation on 32-bit Windows OS, when you install 4GB or more memory on the motherboard, the actual usable memory for the OS can be about 3GB or less. For effective use of memory, we recommend that you do any of the following:
 - a) Use a maximum of 3GB system memory if you are using a 32-bit Windows OS.
 - b) Install a 64-bit Windows OS when you want to install 4GB or more on the motherboard.
 - c) For more details, refer to the Microsoft® support site at <http://support.microsoft.com/kb/929605/en-us>.
 - This motherboard does not support DIMMs made up of 512Mb (64MB) chips or less (Memory chip capacity counts in Megabit, 8 Megabit/Mb = 1 Megabyte/MB).
-



-
- The default memory operation frequency is dependent on its Serial Presence Detect (SPD), which is the standard way of accessing information from a memory module. Under the default state, some memory modules for overclocking may operate at a lower frequency than the vendor-marked value. To operate at the vendor-marked or at a higher frequency, refer to section **3.4 Extreme Tweaker menu** for manual memory frequency adjustment.
 - For system stability, use a more efficient memory cooling system to support a full memory load (4 DIMMs) or overclocking condition.
-

MAXIMUS VII RANGER Motherboard Qualified Vendors Lists (QVL)

DDR3 3200 MHz capability

Vendors	Part No.	Size	SS/DS	Chip Brand	Chip NO.	Timing	Voltage	DIMM socket support (Optional)	
								2	4
AVEXIR	AVD3UH32001304G-4C(XMP)	16GB (4x 4GB)	SS	-	-	13-15-15-35	1.65V	•	•
G.SKILL	F3-3200C12Q-16GTXDG(XMP)	16GB (4x 4GB)	SS	-	-	12-15-15-35	1.65V	•	•

DDR3 3100 MHz capability

Vendors	Part No.	Size	SS/DS	Chip Brand	Chip NO.	Timing	Voltage	DIMM socket support (Optional)	
								2	4
AVEXIR	AVD3UH31001204G-4C(XMP)	16GB (4x 4GB)	SS	-	-	12-14-14-35	1.65V	•	•
A-DATA	AX3U3100W4G12-DMV(XMP)	8GB (2x 4GB)	SS	-	-	12-14-14-36	1.65V	•	•

DDR3 3000 MHz capability

Vendors	Part No.	Size	SS/DS	Chip Brand	Chip NO.	Timing	Voltage	DIMM socket support (Optional)	
								2	4
AVEXIR	AVD3UH30001204G-4BZ1(XMP)	16GB (4x 4GB)	SS	-	-	12-14-14-35	1.65V	•	•
APACER	78.BAGHN.AFL0C	16GB (4x 4GB)	SS	-	-	12-14-14-35	1.65V	•	•
G.SKILL	F3-3000C12Q-16GTXDG(XMP)	16GB (4x 4GB)	SS	-	-	12-14-14-35	1.65V	•	•
G.SKILL	F3-3000C12D-8GTXDG(XMP)	8GB (2 x 4B)	SS	-	-	12-14-14-35	1.65V	•	•
CORSAIR	CMY8GX3M2A-3000C12R(XMP)	8GB (2 x 4B)	SS	-	-	12-14-14-36	1.65V	•	•

DDR3 2666 MHz capability

Vendors	Part No.	Size	SS/DS	Chip Brand	Chip NO.	Timing	Voltage	DIMM socket support (Optional)	
								2	4
Apacer	78.BAGFF.AFC0C(XMP)	8GB (2x 4GB)	DS	-	-	12-13-13-35	-	•	•
Apacer	78.BAGFR.AFD0C(XMP)	8GB (2x 4GB)	DS	-	-	12-13-13-35	-	•	•
Apacer	78.CAGFF.AFD0C(XMP)	16GB (2x 8GB)	DS	-	-	12-13-13-35	-	•	•
CORSAIR	CMD16GX3M4A2666C11 (Ver5.12)(XMP)	16GB (4x 4GB)	DS	-	-	11-13-13-35	1.65	•	•
G.SKILL	F3-2666CL10Q-16GBZHD(XMP)	16GB (4x 4GB)	DS	-	-	10-12-12-31	1.65	•	•
GEIL	GOC332GB2666C11QC(XMP)	32GB (4x 8GB)	DS	-	-	11-13-13-32	1.65	•	•
KINGSTON	KHX26C11T2K2/8X(XMP)	8GB (2x 4GB)	SS	-	-	2666-11-13-13-32	1.65	•	

DDR3 2500 MHz capability

Vendors	Part No.	Size	SS/DS	Chip Brand	Chip NO.	Timing	Voltage	DIMM socket support (Optional)	
								2	4
G.SKILL	F3-20000CL10Q-16GBZHD(XMP)	16GB (4x 4GB)	DS	-	-	10-11-11-31	1.65	•	•

DDR3 2400 MHz capability

Vendors	Part No.	Size	SS/DS	Chip Brand	Chip NO.	Timing	Voltage	DIMM socket support (Optional)	
								2	4
A-DATA	AX3U2400W4G11-DMV(XMP)	8GB (2x 4GB)	SS	-	-	11-13-13-35	1.65	•	•
A-DATA	AX3U2400W8G11-DMV(XMP)	16GB (2x 8GB)	DS	-	-	11-13-13-35	1.65	•	•
Apacer	78.BAGFL.AFD0C(XMP)	8GB (2x 4GB)	DS	-	-	11-12-12-30	-	•	•
Apacer	783BAGF3.AFD0C(XMP)	8GB (2x 4GB)	DS	-	-	11-11-11-30	-	•	•
CORSAIR	CMD16GX3M2A2400C10 (Ver4.21)(XMP)	16GB (2x 8GB)	DS	-	-	10-12-12-31	1.65	•	•
CORSAIR	CMD32GX3M4A2400C10 (Ver5.29)(XMP)	32GB (4x 8GB)	DS	-	-	10-12-12-31	1.65	•	•
CORSAIR	CMY16GX3M2A2400C10A (Ver4.21)(XMP)	16GB (8x 2GB)	DS	-	-	10-12-12-31	1.65	•	•
CORSAIR	CMY16GX3M2A2400C10R (Ver4.21)(XMP)	16GB (2x 8GB)	DS	-	-	10-12-12-31	1.65	•	•
CORSAIR	CMZ16GX3M2A2400C10 (Ver4.21)	16GB (2x 8GB)	DS	-	-	10-12-12-31	1.65	•	•
G.SKILL	F3-19200CL10Q2-64GBZHD(XMP)	64GB (8x 8GB)	DS	-	-	10-12-12-31	1.65	•	•
G.SKILL	F3-19200CL10Q-32GBZHD(XMP)	32GB (4x 8GB)	DS	-	-	10-12-12-31	1.65	•	
G.SKILL	F3-19200CL11Q-16GBZHD(XMP)	16GB (4x 4GB)	DS	-	-	11-11-11-31	1.65	•	•
G.SKILL	F3-19200CL9D-4GBPIS(XMP)	4G (2x 2G)	DS	-	-	9-11-9-28	1.65	•	
G.SKILL	F3-19200CL9Q-16GBZMD(XMP)	16GB (4x 4GB)	DS	-	-	9-11-11-31	1.65	•	•
G.SKILL	F3-2400C11Q-32GXM(XMP)	32GB (4x 8GB)	DS	-	-	11-13-13-31	1.65	•	•
GEIL	GOC316GB2400C10QC(XMP)	16GB (4x 4GB)	DS	-	-	10-11-11-30	1.65	•	•
GEIL	GOC316GB2400C11QC(XMP)	16GB (4x 4GB)	DS	-	-	11-11-11-30	1.65	•	•
Kingston	KHX2400C11D3K4/8GX(XMP)	8GB (4x 2GB)	SS	-	-	11-13-11-30	1.65	•	•
KINGSTON	KHX24C11K4/16X(XMP)	16GB (4x 4GB)	DS	-	-	11-13-13-30	1.65	•	•
KINGSTON	KHX24C11T2K2/8X(XMP)	8GB (2x 4GB)	DS	-	-	-	1.65	•	•
KINGSTON	KHX24C11T3K2/16X(XMP)	16GB (2x 8GB)	DS	-	-	2400-11-13-13-32	1.65	•	
KINGSTON	KHX24C11T3K4(XMP)	16GB (4x 4GB)	DS	-	-	2400-11-13-13-30	1.65	•	•
KINGSTON	KHX24C11T3K4/32X(XMP)	32GB (4x 8GB)	DS	-	-	9-9-9-24	1.65	•	•
Mushkin	997122R(XMP)	16GB (2x 8GB)	DS	-	-	2400-10-12-12-28	1.65	•	•
Silicon Power	SP004GXYU240NSA(XMP)	4GB	SS	-	-	2400-11-13-13-32	-	•	•
Transcend	TX2400KLN-8GX(XMP)	8GB (2x 4GB)	DS	-	-	2400-11-12-11-29	1.6	•	•

DDR3 2200 MHz capability

Vendors	Part No.	Size	SS/DS	Chip Brand	Chip NO.	Timing	Voltage	DIMM socket support (Optional)	
								2	4
GEIL	GET34GB2200C9DC(XMP)	4GB (2x 2GB)	DS	-	-	9-10-9-28	1.65	•	•
GEIL	GET38GB2200C9ADC(XMP)	8GB (2x 4GB)	DS	-	-	9-11-9-28	1.65	•	•

DDR3 2133 MHz capability

Vendors	Part No.	Size	SS/DS	Chip Brand	Chip NO.	Timing	Voltage	DIMM socket support (Optional)	
								2	4
A-DATA	AX3U2133W4G10-DR(XMP)	8GB (2x 4GB)	SS	-	-	10-11-11-30	1.65	•	•
A-DATA	AX3U2133W8G10-DR(XMP)	16GB (2x 8GB)	DS	-	-	10-11-11-30	1.65	•	•
Apacer	78.BAGE4.AFD0C(XMP)	8GB (2x 4GB)	DS	-	-	9-9-9-24	-	•	•
Apacer	AHU04GFB33CAQ3R(XMP)	4GB	DS	-	-	11-13-13-31	-	•	•
CORSAIR	CMD16GX3M2A2133C9 (Ver4.21)(XMP)	16GB (2x 8GB)	DS	-	-	9-11-11-31	1.65	•	•
CORSAIR	CMD32GX3M4A2133C9 (Ver4.21)(XMP)	32GB (4x 8GB)	DS	-	-	9-11-11-31	1.65	•	•
CORSAIR	CMD8GX3M2A2133C9 (Ver1.5)(XMP)	8GB (2x 4GB)	DS	-	-	9-11-10-27	1.5	•	•
CORSAIR	CMD8GX3M2B2133C9 (Ver5.12)(XMP)	8GB (2x 4GB)	DS	-	-	9-11-11-31	1.65	•	•
CORSAIR	CMY8GX3M2A2133C11R (Ver4.21)(XMP)	8GB (2x 4GB)	DS	-	-	11-11-11-27	1.5	•	•
CORSAIR	CMZ8GX3M2A2133C11R (Ver4.21)(XMP)	8GB (2x 4GB)	DS	-	-	11-11-11-27	1.5	•	•
G.SKILL	F3-17000CL11Q2-64GBZLD(XMP)	64GB (8x 8GB)	DS	-	-	11-11-11-30	1.5	•	•
G.SKILL	F3-17000CL9Q-16GBXLD(XMP)	16GB (4x 4GB)	DS	-	-	9-11-9-28	1.65	•	•
G.SKILL	F3-17000CL9Q-16GBZH(XMP)	16GB (4x 4GB)	DS	-	-	9-11-10-28	1.65	•	•
G.SKILL	F3-2133C10Q-32GSR(XMP)	32GB (4x 8GB)	DS	-	-	10-12-12-31	1.5	•	•
G.SKILL	F3-2133C11Q-32GZL(XMP)	32GB (4x 8GB)	DS	-	-	11-11-11-31	1.5	•	•
KINGSTON	KHX2133C11D3K4/16GX(XMP)	16GB (4x 4GB)	DS	-	-	11-12-11-30	1.65	•	•
KINGSTON	KHX21C11T3FK8/64X(XMP)	64GB (8x 8GB)	DS	-	-	9-9-9-24	1.5	•	•
Silicon Power	SP004GXLYU213NSA(XMP)	4GB	SS	-	-	2133-11-12-11-30	-	•	•
Silicon Power	SP008GXLYU213NSA(XMP)	8GB	DS	-	-	2133-11-12-11-30	-	•	•
Transcend	TX2133KLN-16GK(XMP)	16GB (2x 8GB)	DS	-	-	2133-10-11-10-27	1.6	•	•
Transcend	TX2133KLN-8GK(XMP)	8GB (2x 4GB)	DS	-	-	2133-10-11-10-27	1.6	•	•

DDR3 2000 MHz capability

Vendors	Part No.	Size	SS/DS	Chip Brand	Chip NO.	Timing	Voltage	DIMM socket support (Optional)	
								2	4
AEXEA	AXA3ES4GK2000LG28V(XMP)	4GB (2x 2GB)	DS	-	-	-	1.65	•	•
Asint	SLA302G08-ML2HB(XMP)	4GB	DS	Hynix	H5TQ2G83BFRH9C	9-9-9-27	-	•	•
GEIL	GUP34GB2000C9DC(XMP)	4GB (2x 2GB)	DS	-	-	9-9-9-28	1.65	•	•

DDR3 1866 MHz capability

Vendors	Part No.	Size	SS/ DS	Chip Brand	Chip NO.	Timing	Voltage	DIMM socket support (Optional)	
								2	4
CORSAIR	CMD16GX3M2A1866C9 (Ver5.29) (XMP)	16GB (2x 8GB)	DS	-	-	1866 9-9-9-27	1.5	•	
CORSAIR	CMD16GX3M4A1866C9 (Ver4.13) (XMP)	16GB (4x 4GB)	DS	-	-	9-10-9-27	1.5	•	•
CORSAIR	CMD16GX3M4A1866C9 (Ver8.16) (XMP)	16GB (4x 4GB)	DS	-	-	9-10-9-27	1.5	•	•
CORSAIR	CMD32GX3M4A1866C9 (Ver3.24) (XMP)	32GB (4x 8GB)	DS	-	-	9-10-9-27	1.5	•	•
CORSAIR	CMD8GX3M2A1866C9 (Ver4.13) (XMP)	8GB (2x 4GB)	DS	-	-	-	1.5	•	•
CORSAIR	CMD8GX3M2A1866C9 (Ver5.12) (XMP)	8GB (2x 4GB)	DS	-	-	9-10-9-27	1.5	•	
CORSAIR	CMD8GX3M2A1866C9 (Ver8.16) (XMP)	8GB (2x 4GB)	DS	-	-	9-10-9-27	1.5	•	
CORSAIR	CMT32GX3M4X1866C9(Ver3.23) (XMP)	32GB (4x 8GB)	DS	-	-	9-10-9-27	1.5	•	•
CORSAIR	CMY16GX3M2A1866C9 (Ver 4.21) (XMP)	16GB (2x 8GB)	DS	-	-	9-10-9-27	1.5	•	•
CORSAIR	CMY8GX3M2A1866C9 (Ver3.24) (XMP)	8GB (2x 4GB)	DS	-	-	9-10-9-27	1.5	•	•
CORSAIR	CMZ16GX3M2A1866C10 (Ver5.29) (XMP)	16GB (2x 8GB)	DS	-	-	10-11-10-30	1.5	•	•
CORSAIR	CMZ16GX3M2A1866C9(XMP)	16GB (2x 8GB)	DS	-	-	1866-9-10- 9-27	1.5	•	•
CORSAIR	CMZ32GX3M4X1866C10 (Ver3.23) (XMP)	32GB (4x 8GB)	DS	-	-	10-11-10-27	1.5	•	•
CORSAIR	CMZ32GX3M4X1866C10(Ver3.23) (XMP)	32GB (4x 8GB)	DS	-	-	10-11-10-27	1.5	•	•
CORSAIR	CMZ8GX3M2A1866C9 (Ver8.16) (XMP)	8GB (2x 4GB)	DS	-	-	9-10-9-27	1.5	•	•
CORSAIR	CMZ8GX3M2A1866C9(XMP)	8GB (2x 4GB)	DS	-	-	9-10-9-27	1.5	•	
CORSAIR	CMZ8GX3M2A1866C9G (Ver5.12) (XMP)	8GB (2x 4GB)	DS	-	-	1866 9-10- 9-27	1.5	•	•
Crucial	BLE8G3D1869DE1TX0.16FED(XMP)	16GB (2x 8GB)	DS	-	-	1866-9-9-9-27	1.5	•	•
Crucial	BLE4G3D1869DE1XT0.16FMD(XMP)	4GB	DS	-	-	9-9-9-27	1.5	•	•
G.SKILL	F3-14900CL10Q-32GBZL(XMP)	32GB (4x 8GB)	DS	-	-	10-11-10-30	1.5	•	•
G.SKILL	F3-14900CL9D-8GBSR(XMP)	8GB (2x 4GB)	DS	-	-	9-10-9-28	1.5	•	•
G.SKILL	F3-14900CL9Q-16GBXL(XMP)	16GB (4x 4GB)	DS	-	-	9-10-9-28	1.5	•	•
G.SKILL	F3-14900CL9Q-16GBZL(XMP)	16GB (4x 4GB)	DS	-	-	9-10-9-28	1.5	•	•
G.SKILL	F3-14900CL9Q-16GBZL(XMP)	16GB (4x 4GB)	DS	-	-	9-10-9-28	1.5	•	•
G.SKILL	F3-1866C10Q2-64GZM(XMP)	64GB (2x 8GB)	DS	-	-	10-11-10-30	1.5	•	•
G.SKILL	F3-1866C10Q2-64GZM(XMP)	64GB (2x 8GB)	DS	-	-	10-11-10-30	1.5	•	•
G.SKILL	F3-1866C9Q-32GXM(XMP)	32GB (4x 8GB)	DS	-	-	9-10-9-28	1.5	•	•
GEIL	GEEL316GB1866C9DC(XMP)	16GB (2x 8GB)	DS	-	-	1866-9-10- 9-28	1.65	•	•
KINGSTON	KHX1866C9D3K2/8GX(XMP)	8GB (2x 4GB)	DS	-	-	-	1.65	•	•
Silicon Power	SP004GXLYU186NSA(XMP)	4GB	SS	-	-	1866-9-11- 9-27	-	•	•
Silicon Power	SP008GXLYU186NSA(XMP)	8GB	DS	-	-	1866-9-11- 9-27	-	•	•

DDR3 1800 MHz capability

Vendors	Part No.	Size	SS/DS	Chip Brand	Chip NO.	Timing	Voltage	DIMM socket support (Optional)	
								2	4
G.SKILL	F3-14400CL9D-4GBRL(XMP)	4GB (2x 2GB)	DS	-	-	9-9-9-24	1.65	•	•

DDR3 1600 MHz capability

Vendors	Part No.	Size	SS/DS	Chip Brand	Chip NO.	Timing	Voltage	DIMM socket support (Optional)	
								2	4
A-DATA	AD3U1600W4G11	4GB	SS	A-DATA	3WCD-1211A	11-11-11-28	-	•	•
A-DATA	AD3U1600W8G11	8GB	DS	A-DATA	3WCD-1211A	11-11-11-28	-	•	•
A-DATA	ADDU1600W4G11-B	4GB	SS	A-DATA	DWND-1211A	9-9-9-24	-	•	•
A-DATA	ADDU1600W8G11-B	8GB	DS	ELPIDA	J4208EBBG-GN-F	9-9-9-24	-	•	•
A-DATA	AX3U1600W4G9-DB(XMP)	8GB (2x 4GB)	SS	-	-	9-9-9-24	1.5	•	•
A-DATA	AX3U1600W8G9-DB(XMP)	16GB (2x 8GB)	DS	-	-	9-9-9-24	1.5	•	•
AMD	AE32G1609U1-U	2GB	SS	AMD	23EY4587MB6H	-	1.5	•	•
AMD	AE34G1609U2-U	4GB	DS	AMD	23EY4587MB6H	-	1.5	•	•
AMD	AP38G1608U2K(XMP)	8GB (2x 4GB)	DS	-	-	9-9-9-28	1.65	•	•
Apacer	78.B1GE3.9L10C	4GB	DS	Apacer	AM5D5908DEQSCK	-	1.65	•	•
Apacer	78.B1GET.9K00C	4GB	SS	Apacer	AM5D6008BQQSCK	11-11-11-28	-	•	•
Apacer	78.C1GET.9K10C	8GB	DS	Apacer	AM5D6008BQQSCK	11-11-11-31	-	•	•
Apacer	AHU04GFA60C9Q1D (XMP)	4GB	DS	-	-	9-9-9-27	1.65	•	•
Apacer	AHU04GFA60C9Q3R (XMP)	4GB	DS	-	-	11-11-11-28	-	•	•
Apacer	AHU08GFA60CBT3R (XMP)	8GB	DS	-	-	9-9-9-24	-	•	•
Asint	SLA302G08-EGG1C(XMP)	4GB	DS	Asint	302G08-GG1C	9-9-9-27	-	•	•
Asint	SLA302G08-EGJ1C(XMP)	4GB	DS	Asint	302G08-GJ1C	9-9-9-27	-	•	•
Asint	SLA302G08-EGN1C	4GB	DS	ASint	302G08-GN1C	-	-	•	•
Asint	SLA304G08-ENG1B	4GB	SS	Asint	304G08-GN1B	9-11-11-28	-	•	•
Asint	SLB304G08-EGJ1B(XMP)	8GB	DS	-	-	9-9-9-27	-	•	•
Asint	SLB304G08-EGN1B	8GB	DS	ASint	304G08-GN1B	-	-	•	•
SLZ302G08-EGN1C	2GB	SS	ASint	302G08-GN1C	-	-	-	•	•

(continued on the next page)

DDR3 1600 MHz capability

Vendors	Part No.	Size	SS/DS	Chip Brand	Chip NO.	Timing	Voltage	DIMM socket support (Optional)	
								2	4
AVD3U16000904G-2CW(XMP)	8GB (2x 4GB)	DS	-	-	11-11-11-28	1.5	•	•	
CMD16GX3M2A1600C9 (Ver8.21) (XMP)	16GB (2x 8GB)	DS	-	-	9-9-9-24	1.5	•		
CMD8GX3M2A1600C8 (Ver5.12) (XMP)	8GB (2x 4GB)	DS	-	-	1600 8-8-8-24	1.5	•	•	
CMD8GX3M2A1600C9 (Ver2.12) (XMP)	8GB (2x 4GB)	DS	-	-	9-9-9-24	1.5	•	•	
CML16GX3M2A1600C10 (Ver2.21) (XMP)	16GB (2x 8GB)	DS	-	-	10-10-10-27	1.5	•	•	
CML16GX3M4X1600C8(Ver 2.12) (XMP)	16GB (4x 4GB)	DS	-	-	Heat-Sink Package	1.5	•		
CML8GX3M2A1600C9 (Ver7.12) (XMP)	8GB (2x 4GB)	DS	-	-	9-9-9-24	1.5	•	•	
CMV8GX3M1A1600C11	8GB	DS	-	-	11-11-11-30	-	•	•	
CMX8GX3M2A1600C9 (Ver3.19) (XMP)	8GB (2x 4GB)	SS	-	-	9-9-9-24	1.65	•	•	
CMZ16GX3M2A1600C10 (Ver.3.24) (XMP)	16GB (2x 8GB)	DS	-	-	10-10-10-27	1.5	•	•	
CMZ16GX3M4A1600C9(XMP)	16GB (4x 4GB)	DS	-	-	9-9-9-24	1.5	•	•	
CMZ16GX3M4X1600C9 (Ver8.16) (XMP)	16GB (4x 4GB)	DS	-	-	1600-9-9-9-24	1.5	•	•	
CMZ32GX3M4X1600C10 (Ver2.2) (XMP)	32GB (4x 8GB)	DS	-	-	10-10-10-27	1.5	•	•	
CMZ4GX3M1A1600C9 (Ver8.16) (XMP)	4GB (1x 4GB)	DS	-	-	9-9-9-24	1.5	•	•	
CMZ8GX3M1A1600C10 (Ver3.23) (XMP)	8GB (1x 8GB)	DS	-	-	10-10-10-27	1.5	•		
CMZ8GX3M1A1600C10 (Ver8.21) (XMP)	8GB (1x 8GB)	DS	-	-	10-10-10-27	1.5	•		
CMZ8GX3M2A1600C8(XMP)	8GB (2x 4GB)	DS	-	-	8-8-8-24	1.5	•	•	
CMZ8GX3M2A1600C9(XMP)	8GB (2x 4GB)	DS	-	-	9-9-9-24	1.5	•		
BLS4G3D1609DS1S00.16 FMR(XMP)	4GB	DS	-	-	1600-9-9-9-24	1.5	•	•	
BLT4G3D1608DT1TX0.16 FM(XMP)	4GB	DS	-	-	8-8-8-24	1.5	•	•	
M2X2G64CB88G7N-DG(XMP)	2GB	SS	Elixir	N2CB2G80GN-DG	9-9-9-28	-	•	•	
M2X4G64CB88G5N-DG(XMP)	4GB	DS	Elixir	N2CB2G80GN-DG	9-9-9-28	-	•	•	
HMT351U6CFR8C-PB	4GB	DS	Hynix	H5TQ2G83CFR	-	-	•		
HMT41GU6MFR8C-PB	8GB	DS	Hynix	H5TQ4G83MFR	-	-	•		
FLGE85F-C8KL9A(XMP)	2GB	SS	KINGMAX	N/A	9-9-9-28	-	•	•	
FLGF85F-C8KL9A(XMP)	4GB	DS	KINGMAX	N/A	9-9-9-28	-	•	•	

(

on the next page)

DDR3 1600 MHz capability

Vendors	Part No.	Size	SS/DS	Chip Brand	Chip NO.	Timing	Voltage	DIMM socket support (Optional)	
								2	4
F3-12800CL9D-8GBSR2(XMP)	8GB (2x 4GB)	DS	-	-	9-9-9-24	1.25	•	•	
F3-12800CL9Q-16GBXL(XMP)	16GB (4x 4GB)	DS	-	-	9-9-9-24	1.5	•	•	
F3-12800CL9Q-16GBZL(XMP)	16GB (4x 4GB)	DS	-	-	9-9-9-24	1.5	•	•	
F3-1600C9Q-32GXM(XMP)	32GB (4x 8GB)	DS	-	-	-	1.5	•	•	
GUP34GB1600C7DC(XMP)	4GB (2x 2GB)	DS	-	-	7-7-7-24	1.6	•	•	
GVP38GB1600C8QC(XMP)	8GB (4x 2GB)	DS	-	-	8-8-8-28	1.6	•	•	
KHX16009CD3K2/8GX(XMP)	8GB (2x 4GB)	DS	-	-	9-9-9-27	1.65	•	•	
KHX1600C9D3B1/4G(XMP)	4GB	SS	-	-	9-9-9-27	1.65	•	•	
KHX1600C9D3K3/12GX(XMP)	12GB (3x 4GB)	DS	-	-	9	1.65	•	•	
KHX1600C9D3K3/6GX(XMP)	6GB (3x 2GB)	DS	-	-	9	1.65	•	•	
KHX1600C9D3K3/6GX(XMP)	6GB (3x 2GB)	DS	-	-	9	1.65	•	•	
KHX1600C9D3K4/16GX(XMP)	16GB (4x 4GB)	DS	-	-	9-9-9-24	1.65	•	•	
KHX1600C9D3K6/24GX(XMP)	24GB (6x 4GB)	DS	-	-	9	1.65	•	•	
KHX1600C9D3K8/32GX(XMP)	32GB (8x 4GB)	DS	-	-	9-9-9-27	1.65	•	•	
KHX1600C9D3LK2/8GX(XMP)	8GB (2x 4GB)	DS	-	-	9-9-9-24	1.35	•	•	
KHX1600C9D3P1K2/8G	8GB (2x 4GB)	DS	-	-	9	1.5	•	•	
KHX16C10B1K2/16X(XMP)	16GB (2x 8GB)	DS	-	-	-	1.5	•	•	
KHX16C9K2/16	16GB (2x 8GB)	DS	-	-	1333-9-9-9-24	1.5	•	•	
KHX16C9P1K2/16	16GB (2x 8GB)	DS	-	-	-	1.5	•	•	
KVR16N11/4	4GB	DS	KINGSTON	D2568JPUCPGGBU	11-11-11-28-1	-	•	•	
KVR16N11/4	4G	DS	Hynix	H5TQ2G83CFRPBC	-	1.5	•	•	

(continued on the next page)

DDR3 1600 MHz capability

Vendors	Part No.	Size	SS/DS	Chip Brand	Chip NO.	Timing	Voltage	DIMM socket support (Optional)	
								2	4
MT16JTF1G64AZ-1G6D1	8GB	DS	MICRON	D9PBC	-	1.5	•		
MT16JTF1G64AZ-1G6E1	8GB	DS	Micron	D9QBJ	-	-	•	•	
MT16KTF51264AZ-1G6M1	4GB	DS	MICRON	D9PFJ	11-11-11-28	-	•		
MT16KTF51264AZ-1G6M1	4GB	DS	MICRON	D9PFJ	-	-	•		
MT8JTF51264AZ-1G6E1	4GB	SS	Micron	D9QBJ	-	-	•	•	
MT8KTF25664AZ-1G6M1	2GB	SS	MICRON	D9PFJ	-	-	•	•	
PV316G160C9K(XMP)	16GB (2x 4GB)	SS	-	-	1600-9-9-9-24	1.5	•	•	
PV316G160C9K(XMP)	16GB (2x 8GB)	SS	-	-	1600-9-9-9-24	1.5	•	•	
AL9F8L93B-GN2E	4GB	SS	PSC	A3P4GF3BLF	-	-	•		
ALAF8L93B-GN2E	8GB	DS	PSC	A3P4GF3BLF	-	-	•		
SMD-4G28N1P-16KM	4GB	SS	ELPIDA	J4208BBBG-GN-F	1600	-	•	•	
SMD-4G68HP-16KZ	4GB	DS	Hynix	H5TQ2G83BFRPBC	-	1.5	•	•	
SMD-4G68NG-16KK	4GB	DS	ELPIDA	J2108BDBG-GN-F	-	-	•	•	
SMD-8G28NP-16KM	8GB	DS	ELPIDA	J4208BBBG-GN-F	1600	-	•	•	
SP002GBLTU160V02(XMP)	2GB	SS	S-POWER	20YT5NG	9-11-11-28	1.5	•	•	
SP004GBLTU160V02(XMP)	4GB	DS	S-POWER	20YT5NG	9-9-9-24	1.5	•		
SP004GXLJU160NSA(XMP)	4GB	SS	-	-	1600-9-9-9-27	-	•	•	
SP008GXLJU160NSA(XMP)	8GB	DS	-	-	1600-9-9-9-27	-	•	•	
TED34GM1600C11BK	4GB	DS	Hynix	H5TC2G83EFR	11-11-11-28	1.5	•	•	
TED38GM1600C11BK	8GB	DS	Hynix	H5TQ4G83AFR	11-11-11-28	1.5	•	•	
TLD34G1600HC9BK(XMP)	8GB (2x 4GB)	DS	-	-	9-9-9-24	1.5	•	•	
TLD38G1600HC9BK(XMP)	16GB (2x 8GB)	DS	-	-	9-9-9-24	1.5	•	•	
TXD34096M1600HC9-D(XMP)	4GB	DS	Hynix	H5TC2G83BFRH9A	9-9-9-24	1.5	•	•	
TS1GLK64V6H(620945)	8GB	DS	SAMSUNG	K4B4G0846B	-	-	•	•	
TS1GLK64W6H	8GB	DS	SAMSUNG	K4B4G0846B	11-11-11-28-1	-	•	•	
TS512MLK64W6H	4GB	SS	SAMSUNG	K4B4G0846B	11-11-11-28-2	-	•	•	
84E44G93UM-16BPSYW	4GB	SS	UMAX	U2S96D30TP-16	1600-11-11-11-28	-	•	•	
84E48G93UM-16BPSYW	8GB	DS	UMAX	U2S96D30TP-16	1600-11-11-11-28	-	•	•	

DDR3 1333 MHz capability

Vendors	Part No.	Size	SS/ DS	Chip Brand	Chip NO.	Timing	Voltage	DIMM socket support (Optional)	
								2	4
ACTICA	ACT1GHU64B8F1333S	1GB	SS	SAMSUNG	K4B1G0846F	-	-	•	•
ACTICA	ACT1GHU72C8G1333S	1GB	SS	SAMSUNG	K4B1G0846F(ECC)	-	-	•	•
ACTICA	ACT2GHU64B8G1333M	2GB	DS	Micron	D9KPT	-	-	•	•
ACTICA	ACT2GHU72D8G1333M	2GB	DS	Micron	D9KPT(ECC)	-	-	•	•
ACTICA	ACT2GHU72D8G1333S	2GB	DS	SAMSUNG	K4B1G0846F(ECC)	-	-	•	•
ACTICA	ACT4GHU64B8H1333H	4GB	DS	Hynix	H5TQ2G83AFR	-	-	•	•
ACTICA	ACT4GHU72D8H1333H	4GB	DS	Hynix	H5TQ2G83AFR(ECC)	-	-	•	•
AMD	AE32G1339U1-U	2GB	SS	AMD	23EY4587MB3H	-	1.5	•	•
AMD	AE34G1339U2-U	4GB	DS	AMD	23EY4587MB3H	-	1.5	•	•
Apacer	78.A1GC6.9L1	2GB	DS	Apacer	AM5D5808FEQSBG	9	-	•	•
Apacer	78.B1GDE.9L10C	4GB	DS	Apacer	AM5D5808CEHSBG	9	-	•	•
Asint	SLA302G08-EDJ1C	2GB	SS	ASint	302G08-DJ1C	-	-	•	•
Asint	SLA304G08-EDJ1B	4GB	SS	Asint	304G08-DJ1B	9-10-10-26	-	•	•
Asint	SLB304G08-EDJ1B	8GB	DS	Asint	304G08-DJ1B	9-9-9-24	-	•	•
Asint	SLZ302G08-EDJ1C	4GB	DS	ASint	302G08-DJ1C	-	-	•	•
ATP	AQ12M72E8BKH9S	4GB	DS	SAMSUNG	K4B2G0846C(ECC)	-	-	•	•
BUFFALO	D3U1333-1G	1GB	SS	Elpida	J1108BFBG-DJ-F	-	-	•	•
BUFFALO	D3U1333-2G	2GB	DS	Elpida	J1108BFBG-DJ-F	-	-	•	•
BUFFALO	D3U1333-4G	4GB	DS	NANYA	NT5CB256M8BN-CG	-	-	•	•
CORSAIR	CMV4GX3M2A1333C9	4GB (2x2GB)	SS	-	N/A	9-9-9-24	-	•	•
CORSAIR	CMV8GX3M2A1333C9	8GB (2x4GB)	DS	-	N/A	9-9-9-24	-	•	•
CORSAIR	CMX8GX3M1A1333C9 (Ver2.2)	8GB	DS	-	-	9-9-9-24	1.5	•	•
CORSAIR	CMX8GX3M1A1333C9 (Ver3.23)	8GB	DS	-	-	9-9-9-24	1.5	•	•
CORSAIR	CMX8GX3M2A1333C9 (XMP)	8GB (2x4GB)	DS	-	-	9-9-9-24	1.5	•	•
EK Memory	EKM324L28BP8-113	4GB (2x2GB)	DS	-	-	9	-	•	•
G.SKILL	F3-10600CL9D-4GBNT	4GB (2x2GB)	DS	G.SKILL	D3 128M8CE9 2GB	9-9-9-24	1.5	•	•
G.SKILL	F3-10666CL9D-8GBRL	8GB (2x4GB)	DS	-	-	9-9-9-24	1.5	•	•
G.SKILL	F3-10666CL9D-8GBRL	8GB (2x4GB)	DS	-	-	9-9-9-24	1.5	•	•
G.SKILL	F3-10666CL9D-8GBXL	8GB (2x4GB)	DS	-	-	9-9-9-24	1.5	•	•
GEIL	GET316GB1333C9QC	16GB (4x4GB)	DS	-	-	9-9-9-24	1.5	•	•

(continued on the next page)

DDR3 1333 MHz capability

Vendors	Part No.	Size	SS/DS	Chip Brand	Chip NO.	Timing	Voltage	DIMM socket support (Optional)	
								2	4
GEIL	GG34GB1333C9DC	4GB (2x2GB)	DS	GEIL	GL1L128M88BA115FW	9-9-9-24	1.3	•	•
GEIL	GG34GB1333C9DC	4GB (2x2GB)	DS	GEIL	GL1L128M88BA15B	9-9-9-24	1.3	•	•
GEIL	GVP34GB1333C9DC	4GB (2x2GB)	DS	-	-	9-9-9-24	1.5	•	•
GEIL	GVP38GB1333C7CQ	8GB (4x2GB)	DS	-	-	7-7-7-24	1.5	•	•
GEIL	GVP38GB1333C9DC	8GB (2x4GB)	DS	-	-	9-9-9-24	1.5	•	•
GoodRam	GR1333D364L9/2G	2GB	DS	Qimonda	IDSH1G-03A1F1C-13H	-	-	•	•
Hynix	HMT125U6TFR8A-H9	2GB	DS	Hynix	H5TC1G83TFR	-	-	•	•
INNODISK	M3UN-2GHJBC09	2GB	SS	Hynix	H5TQ2G83CFRH9C	9-9-9-24	-	•	•
INNODISK	M3UN-4GHJAC09	4GB	DS	Hynix	H5TQ2G83CFRH9C	9-9-9-24	-	•	•
KINGMAX	FLFE85F-B8KL9	2GB	DS	KINGMAX	KFB8FNXL-BNF-15A	-	-	•	•
KINGMAX	FLFE85F-C8KL9	2GB	SS	KINGMAX	KFC8FNLBF-GXX-12A	-	-	•	•
KINGMAX	FLFE85F-C8KL9	2GB	SS	KINGMAX	KFC8FNLXF-DXX-15A	-	-	•	•
KINGMAX	FLFE85F-C8KM9	2GB	SS	Kingmax	KFC8FNMXF-BXX-15A	-	-	•	•
KINGMAX	FLFF65F-C8KL9	4GB	DS	KINGMAX	KFC8FNLXF-DXX-15A	-	-	•	•
KINGMAX	FLFF65F-C8KM9	4GB	DS	Kingmax	KFC8FNMXF-BXX-15A	-	-	•	•
KINGSTON	KVR1333D3E9S/4G	4GB	DS	Elpida	J2108ECSE-DJ-F	9	1.5	•	•
KINGSTON	KVR1333D3N9H/4G	4GB	DS	ELPIDA	J2108BDBG-GN-F	-	1.5	•	•
KINGSTON	KVR1333D3N9H/8G	8GB	DS	ELPIDA	J4208EASE-DJ-F	9-9-9-24	1.5	•	•
KINGSTON	KVR13N9S8H/4	4GB	SS	ELPIDA	J4208BBBG-GN-F	-	1.5	•	•
KINGTIGER	F10DA2T1680	2GB	DS	KINGTIGER	KTG1333PS1208NST-C9	-	-	•	•
KINGTIGER	KTG2G1333PG3	2GB	DS	-	-	-	-	•	•
Mach Xtreme	MXD3U133316GQ	16GB (4x4GB)	DS	-	-	-	-	•	•
Mach Xtreme	MXD3V13332GS	2GB	SS	Mach Xtreme	C2S46D30-D313	-	-	•	•
MICRON	MT8JTF25664AZ-1G4M1	2GB	SS	MICRON	D9PFJ	-	-	•	•
OCZ	OCZ3G1333LV4GK	4GB (2x2GB)	DS	-	-	9-9-9	1.65	•	
OCZ	OCZ3G1333LV8GK	8GB (2x4GB)	DS	-	-	9-9-9	1.65	•	
OCZ	OCZ3G1333LV8GK	8GB (2x4GB)	DS	-	-	9-9-9	1.65	•	
OCZ	OCZ3RPR1333C9LV8GK	8GB (2x4GB)	DS	-	-	9-9-9	1.65	•	
Patriot	PG38G1333EL(XMP)	8GB	DS	-	-	-	1.5	•	•

(continued on the next page)

DDR3 1333 MHz capability

Vendors	Part No.	Size	SS/ DS	Chip Brand	Chip NO.	Timing	Voltage	DIMM socket support (Optional)	
								2	4
Patriot	PGD316G1333ELK (XMP)	16GB (2x8GB)	DS	-	-	9-9-9-24	1.5	•	•
Patriot	PSD32G13332	2GB	DS	Patriot	PM128M8D3BU-15	9	-	•	•
RiDATA	C304627CB1AG22Fe	2GB	DS	RiDATA	C304627CB1AG22Fe	9	-	•	•
RiDATA	E304459CB1AG32Cf	4GB	DS	RiDATA	E304459CB1AG32Cf	9	-	•	•
SAMSUNG	M378B5273CH0-CH9	4GB	DS	SAMSUNG	K4B2G0846C	-	-	•	•
Silicon Power	SP001GBLTE133S01	1GB	SS	NANYA	NT5CB128M8AN-CG	-	-	•	•
Silicon Power	SP001GBLTU133S02	1GB	SS	S-POWER	10YT3E5	9	-	•	•
Silicon Power	SP002GBLTU133V02	2GB	SS	S-POWER	20YT3NG	9-9-9-24	-	•	•
Silicon Power	SP004GBLTU133V02	4GB	DS	S-POWER	20YT3NG	9-9-9-24	-	•	•
Team	TED34096M1333HC9	4GB	DS	Team	T3D2568LT-13	-	-	•	•
Transcend	JM1333KLNH-8G(623654)	8GB	DS	Transcend	TK963EBF3	-	-	•	•
Transcend	TS1GLK64V3H(620053)	8GB	DS	MICRON	D9QBJ	-	-	•	•



Side(s): SS - Single-sided DS - Double-sided DIMM support:

- (1) Supports one (1) module inserted into any slot as Single-channel memory configuration. We suggest that you install the module into A2 slot.
- (2) Supports two (2) modules inserted into either the red slots or the black slots as one pair of Dual-channel memory configuration. We suggest that you install the modules into slots A2 and B2 for better compatibility.
- (4) Supports four (4) modules inserted into both the red and black slots as two pairs of Dual-channel memory configuration.



- ASUS exclusively provides hyper DIMM support function.
- Hyper DIMM support is subject to the physical characteristics of individual CPUs. Load the X.M.P. settings in the BIOS for the hyper DIMM support.
- Visit the ASUS website for the latest QVL.

1.2.5 Expansion slots



Unplug the power cord before adding or removing expansion cards. Failure to do so may cause you physical injury and damage motherboard components.

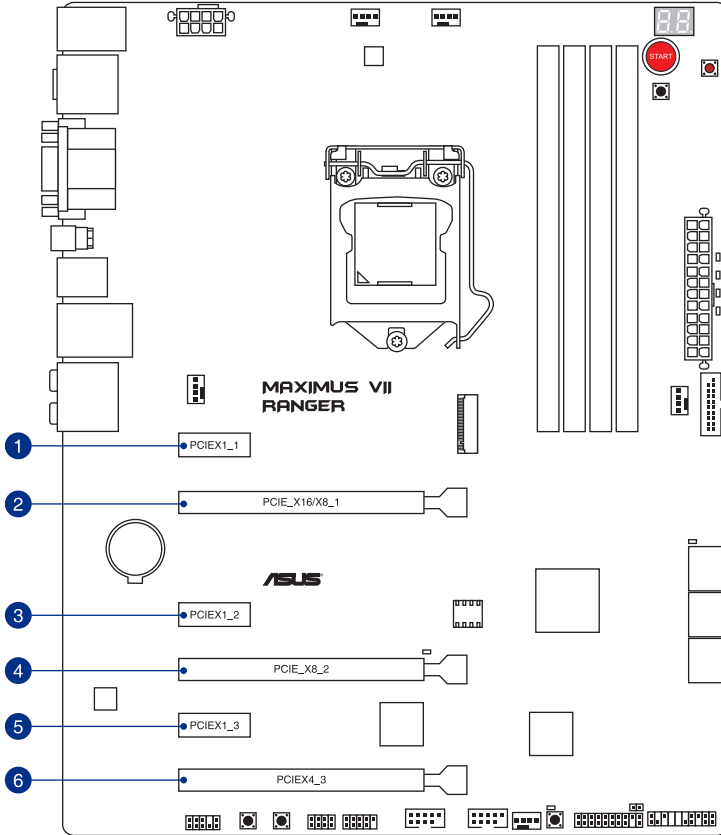

Slot No.	Slot Description
1	PCIe 2.0 x1_1 slot
2	PCIe 3.0/2.0 x16/x8_1 slot
3	PCIe 2.0 x1_2 slot
4	PCIe 3.0/2.0 x8_2 slot
5	PCIe 2.0 x1_3 slot
6	PCIe 2.0 x4_3 slot

IRQ assignments for this motherboard

	A	B	C	D	E	F	G	H
PCIe_x16/x8_1	shared	–	–	–	–	–	–	–
PCIe_x8_2	–	shared	–	–	–	–	–	–
PCIe_x4_3	shared	–	–	–	–	–	–	–
PCIe_x1_1	–	shared	–	–	–	–	–	–
PCIe_x1_2	–	–	shared	–	–	–	–	–
PCIe_x1_3	–	–	–	shared	–	–	–	–
I.G.F.X	shared	–	–	–	–	–	–	–
Intel LAN Controller	–	–	–	–	shared	–	–	–
SATA #0	–	–	–	shared	–	–	–	–
SATA #1	–	–	–	shared	–	–	–	–
High Definition Audio	–	–	–	–	–	–	shared	–
EHCI #0 (USB 2.0)	–	–	–	–	–	–	–	shared
EHCI #1 (USB 2.0)	–	–	–	–	shared	–	–	–
XHCI (USB 3.0)	–	–	–	–	–	shared	–	–

VGA Configuration	PCIe operating mode	
	PCIe_x16/x8_1	PCIe_x8_2
Single VGA/PCIe card	x16 (Recommend for single VGA)	N/A
Dual VGA/PCIe card	x8	x8



- We recommend that you provide sufficient power when running CrossFireX™ or SLI® mode.
- Connect a chassis fan to the motherboard connector labeled CHA_FAN1-3 when using multiple graphics cards for better thermal environment.
- New 4th and 5th generation Intel® Core™ processors support PCIe 3.0 speed rate.



PCIe_x16/x8_1 slot switches to x8 mode when PCIe_x8_2 slots are occupied.

PCIe operating mode

Motherboard Layout

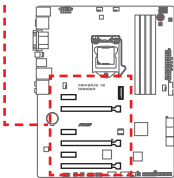
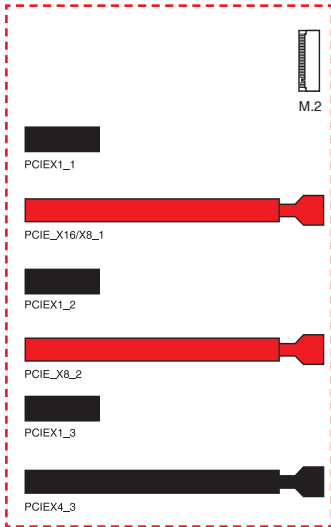

	Modes				
	Auto	PCIe X1	M.2	PCIe X4	
M.2	-	-	-	x2	-
PCIEX1_1	x1	x1	x1	x1	x1
PCIEX16/X8_1	-	-	-	-	-
PCIEX1_2	x1	-	x1	-	-
PCIEX8_2	-	-	-	-	-
PCIEX1_3	x1	-	x1	-	-
PCIEX4_3	x2	x4	x2	x2	x4



- There are two possible scenarios in Auto Mode:
 1. By default, PCIeX4_3 slot runs at X2 mode with all slots enabled and the M.2 connector is disabled. This default scenario happens when there is no card installed on the PCIeX4_3 slot.
 2. When you install a card on PCIeX4_3 slot, this slot runs at X4 mode for high performance support. PCIeX1_2, PCIeX1_3, and M.2 connector are all disabled.
- In PCIe X1 Mode, the PCIeX4_3 slot runs at X2 mode with all slots enabled. M.2 connector is disabled.
- In M.2 Mode, the PCIeX4_3 slot runs at X2 mode and M.2 connector is enabled. PCIeX1_2 and PCIeX1_3 are disabled.
- In PCIe X4 Mode, the PCIeX4_3 slot runs at X4 mode for high performance support. The PCIeX1_2, PCIeX1_3, and M.2 connector are disabled.
- To configure the PCIeX4_3 slot bandwidth option in BIOS, refer to the **Onboard Devices Configuration** section on the **BIOS Setup** chapter.

1.2.6 Onboard buttons

Onboard buttons allow you to fine-tune performance when working on a bare or open-case system. This is ideal for overclockers and gamers who continually change settings to enhance system performance.

1. Power-on button (START)

The motherboard comes with a power-on button that allows you to power up or wake up the system. The button also lights up when the system is plugged to a power source indicating that you should shut down the system and unplug the power cable before removing or installing any motherboard component.

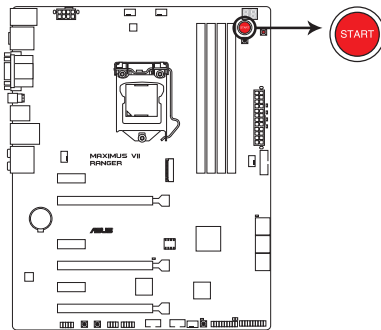

MAXIMUS VII RANGER Power on button

2. RESET button (RESET)

Press the reset button to reboot the system.

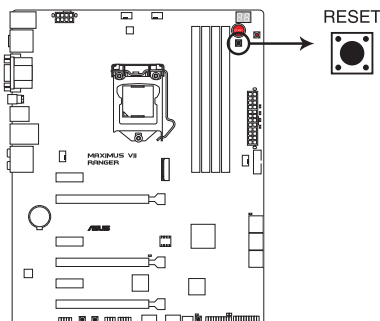

MAXIMUS VII RANGER Reset button

3. MemOK! button (MemOK!)

Installing DIMMs that are not compatible with the motherboard may cause system boot failure, and the DRAM_LED near the MemOK! button lights continuously. Press the MemOK! button until the MEMOK_LED memory compatibility tuning for successful boot.

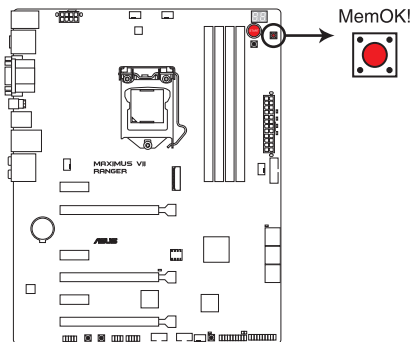

MAXIMUS VII RANGER MemOK! button



- Refer to section **Onboard LEDs** for the location of the MEMOK_LED.
- The DRAM_LED also lights up when the DIMM is not properly installed. Turn off the system and reinstall the DIMM before using the MemOK! function.
- The MemOK! button does not function under Windows® OS environment.
- During the tuning process, the system loads and tests failsafe memory settings. It takes about 30 seconds for the system to test one set of failsafe settings. If the test fails, the system reboots and test the next set of failsafe settings. The blinking speed of the MEMOK_LED increases, indicating different test processes.
- Due to memory tuning requirement, the system automatically reboots when each timing set is tested. If the installed DIMMs still fail to boot after the whole tuning process, the DRAM_LED lights continuously. Replace the DIMMs with ones recommended in the Memory QVL (Qualified Vendors Lists) in this user manual or on the ASUS website at www.asus.com.
- If you turn off the computer and replace DIMMs during the tuning process, the system continues memory tuning after turning on the computer. To stop memory tuning, turn off the computer and unplug the power cord for about 5–10 seconds.
- If your system fails to boot up due to BIOS overclocking, press the MemOK! button to boot and load the BIOS default settings. A message will appear during POST reminding you that the BIOS has been restored to its default settings.
- We recommend that you download and update to the latest BIOS version from the ASUS website at www.asus.com after using the MemOK! function.

4. Clear CMOS button (CLR_CMOS)

Press this button to clear the BIOS setup information only when the systems hangs due to overlocking.

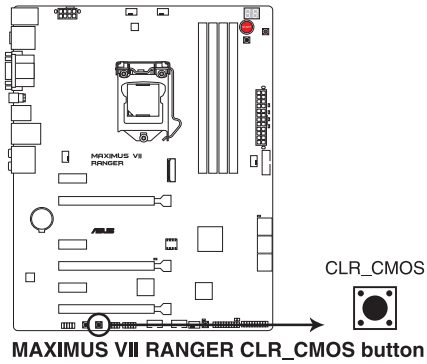

5. KeyBot button (KeyBot)

Press this button to activate the KeyBot feature.

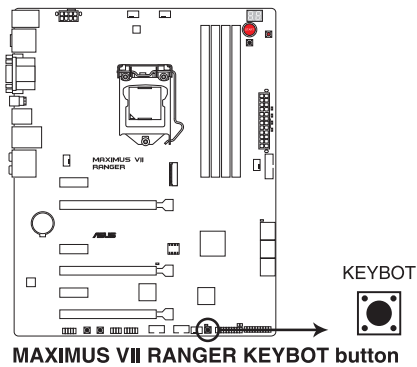

- The KeyBot feature supports USB keyboards only.
- For more information about the KeyBot feature, refer to the Software Support chapter of this user guide.

6. Sonic SoundStage button (SOUNDSTAGE)

Press this button to activate the Sonic SoundStage feature.

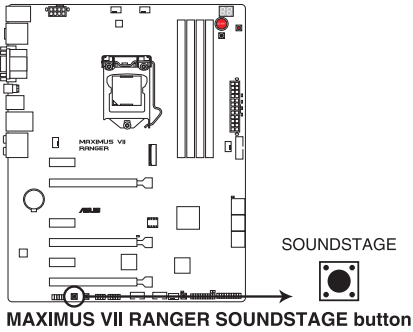

- The debug code on the Q-Code LED shows the current Sonic SoundStage profile when you press the Sonic SoundStage button.
- For more information about Sonic SoundStage, refer to the **Software Support** chapter of this user guide.

1.2.7 Onboard LEDs

1. Hard Disk LED (HD_LED)

The Hard Disk LED is designed to indicate the hard disk activity. It blinks when data is being written into or read from the hard disk drive. The LED does not light up when there is no hard disk drive connected to the motherboard or when the hard disk drive does not function.

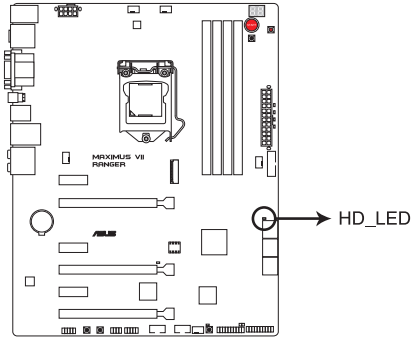

MAXIMUS VII RANGER Hard Disk LED

2. Q LEDs (BOOT_DEVICE_LED, VGA_LED, DRAM_LED, CPU_LED)

Q LEDs check key components (CPU, DRAM, VGA card, and booting devices) in sequence during motherboard booting process. If an error is found, the corresponding LED flashes until the problem is solved. This user-friendly design provides an intuitive way to locate the root problem within seconds.

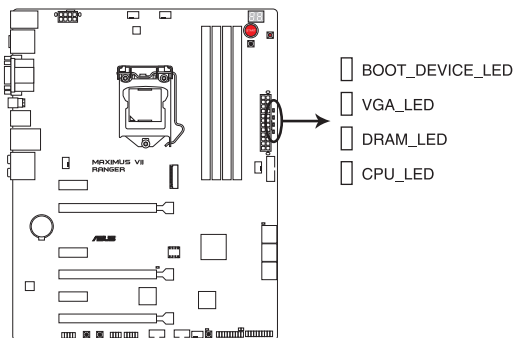

MAXIMUS VII RANGER CPU/ DRAM/ VGA/ BOOT_DEVICE LED

3. KeyBot LED (KEYBOT_LED)

This LED lights up when the KeyBot button is pressed.

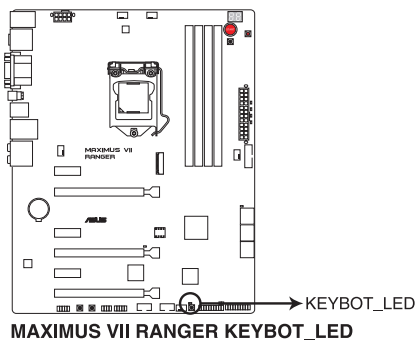

4. USB BIOS Flashback LED (FLBK_LED)

This LED flashes when you press the BIOS Flashback button for BIOS update.

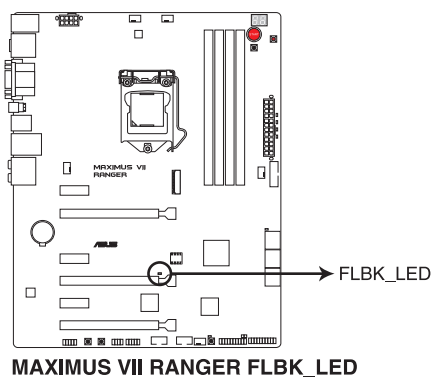

5. Q-Code LEDs

The Q-Code LED design provides you with a 2-digit error code that displays the system status. Refer to the Q-Code table on the following page for details.

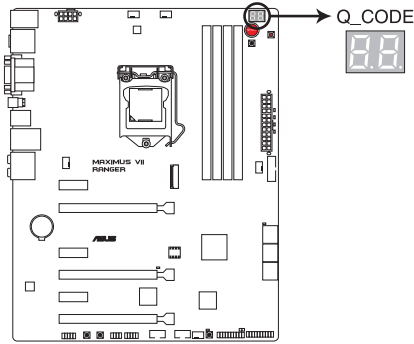

MAXIMUS VII RANGER Q-Code LED

Q-Code table

Code	Description
00	Not used
01	Power on. Reset type detection (soft/hard).
02	AP initialization before microcode loading
03	System Agent initialization before microcode loading
04	PCH initialization before microcode loading
06	Microcode loading
07	AP initialization after microcode loading
08	System Agent initialization after microcode loading
09	PCH initialization after microcode loading
0B	Cache initialization
0C – 0D	Reserved for future AMI SEC error codes
0E	Microcode not found
0F	Microcode not loaded
10	PEI Core is started
11 – 14	Pre-memory CPU initialization is started
15 – 18	Pre-memory System Agent initialization is started
19 – 1C	Pre-memory PCH initialization is started
2B – 2F	Memory initialization
30	Reserved for ASL (see ASL Status Codes section below)
31	Memory Installed
32 – 36	CPU post-memory initialization
37 – 3A	Post-Memory System Agent initialization is started
3B – 3E	Post-Memory PCH initialization is started
4F	DXE IPL is started
50 – 53	Memory initialization error. Invalid memory type or incompatible memory speed
54	Unspecified memory initialization error
55	Memory not installed
56	Invalid CPU type or Speed
57	CPU mismatch
58	CPU self test failed or possible CPU cache error
59	CPU micro-code is not found or micro-code update is failed

(continued on the next page)

Q-Code table

Code	Description
10	PEI Core is started
11 – 14	Pre-memory CPU initialization is started
15 – 18	Pre-memory System Agent initialization is started
19 – 1C	Pre-memory PCH initialization is started
2B – 2F	Memory initialization
30	Reserved for ASL (see ASL Status Codes section below)
31	Memory Installed
32 – 36	CPU post-memory initialization
37 – 3A	Post-Memory System Agent initialization is started
3B – 3E	Post-Memory PCH initialization is started
4F	DXE IPL is started
50 – 53	Memory initialization error. Invalid memory type or incompatible memory speed
54	Unspecified memory initialization error
55	Memory not installed
56	Invalid CPU type or Speed
57	CPU mismatch
58	CPU self test failed or possible CPU cache error
59	CPU micro-code is not found or micro-code update is failed
5A	Internal CPU error
5B	Reset PPI is not available
5C – 5F	Reserved for future AMI error codes
E0	S3 Resume is started (S3 Resume PPI is called by the DXE IPL)
E1	S3 Boot Script execution
E2	Video repost
E3	OS S3 wake vector call
E4 – E7	Reserved for future AMI progress codes
E8	S3 Resume Failed
E9	S3 Resume PPI not Found
EA	S3 Resume Boot Script Error
EB	S3 OS Wake Error
EC – EF	Reserved for future AMI error codes

(continued on the next page)

Q-Code table

Code	Description
F0	Recovery condition triggered by firmware (Auto recovery)
F1	Recovery condition triggered by user (Forced recovery)
F2	Recovery process started
F3	Recovery firmware image is found
F4	Recovery firmware image is loaded
F5 – F7	Reserved for future AMI progress codes
F8	Recovery PPI is not available
F9	Recovery capsule is not found
FA	Invalid recovery capsule
FB – FF	Reserved for future AMI error codes
60	DXE Core is started
61	NVRAM initialization
62	Installation of the PCH Runtime Services
63 – 67	CPU DXE initialization is started
68	PCI host bridge initialization
69	System Agent DXE initialization is started
6A	System Agent DXE SMM initialization is started
6B – 6F	System Agent DXE initialization (System Agent module specific)
70	PCH DXE initialization is started
71	PCH DXE SMM initialization is started
72	PCH devices initialization
73 – 77	PCH DXE Initialization (PCH module specific)
78	ACPI module initialization
79	CSM initialization
7A – 7F	Reserved for future AMI DXE codes
90	Boot Device Selection (BDS) phase is started
91	Driver connecting is started
92	PCI Bus initialization is started
93	PCI Bus Hot Plug Controller Initialization
94	PCI Bus Enumeration
95	PCI Bus Request Resources

(continued on the next page)

Q-Code table

Code	Description
96	PCI Bus Assign Resources
97	Console Output devices connect
98	Console input devices connect
99	Super IO Initialization
9A	USB initialization is started
9B	USB Reset
9C	USB Detect
9D	USB Enable
9E – 9F	Reserved for future AMI codes
A0	IDE initialization is started
A1	IDE Reset
A2	IDE Detect
A3	IDE Enable
A4	SCSI initialization is started
A5	SCSI Reset
A6	SCSI Detect
A7	SCSI Enable
A8	Setup Verifying Password
A9	Start of Setup
AA	Reserved for ASL (see ASL Status Codes section below)
AB	Setup Input Wait
AC	Reserved for ASL (see ASL Status Codes section below)
AD	Ready To Boot event
AE	Legacy Boot event
AF	Exit Boot Services event
B0	Runtime Set Virtual Address MAP Begin
B1	Runtime Set Virtual Address MAP End
B2	Legacy Option ROM Initialization
B3	System Reset
B4	USB hot plug
B5	PCI bus hot plug

(continued on the next page)

Q-Code table

Code	Description
B6	Clean-up of NVRAM
B7	Configuration Reset (reset of NVRAM settings)
B8– BF	Reserved for future AML codes
D0	CPU initialization error
D1	System Agent initialization error
D2	PCH initialization error
D3	Some of the Architectural Protocols are not available
D4	PCI resource allocation error. Out of Resources
D5	No Space for Legacy Option ROM
D6	No Console Output Devices are found
D7	No Console Input Devices are found
D8	Invalid password
D9	Error loading Boot Option (LoadImage returned error)
DA	Boot Option is failed (StartImage returned error)
DB	Flash update is failed
DC	Reset protocol is not available

ACPI/ASL Checkpoints

Code	Description
0x01	System is entering S1 sleep state
0x02	System is entering S2 sleep state
0x03	System is entering S3 sleep state
0x04	System is entering S4 sleep state
0x05	System is entering S5 sleep state
0x10	System is waking up from the S1 sleep state
0x20	System is waking up from the S2 sleep state
0x30	System is waking up from the S3 sleep state
0x40	System is waking up from the S4 sleep state
0xAC	System has transitioned into ACPI mode. Interrupt controller is in PIC mode.
0xAA	System has transitioned into ACPI mode. Interrupt controller is in APIC mode.

1.2.8 Internal connectors

1. Intel® Z97 Serial ATA 6 Gb/s connectors (7-pin SATA6G_1-6 [red])

These connectors connect to Serial ATA 6 Gb/s hard disk drives via Serial ATA 6 Gb/s signal cables.

If you installed Serial ATA hard disk drives, you can create a RAID 0, 1, 5, and 10 configuration with the Intel® Rapid Storage Technology through the onboard Intel® Z97 chipset.

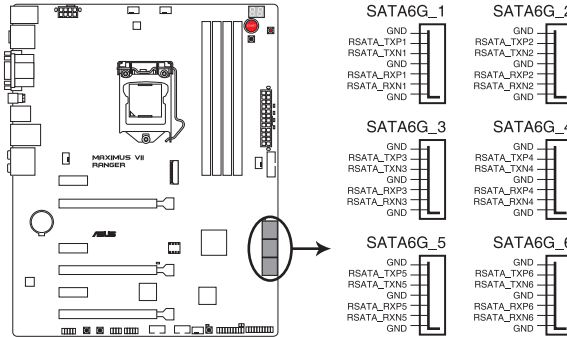

MAXIMUS VII RANGER Intel® SATA 6 Gb/s connectors

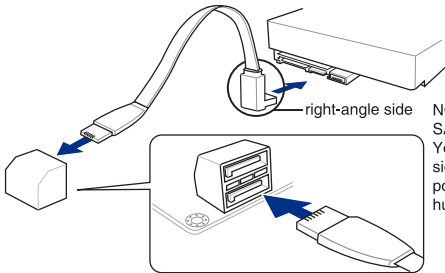

NOTE: Connect the right-angle side of SATA signal cable to SATA device. You may also connect the right-angle side of SATA cable to the onboard SATA port to avoid mechanical conflict with huge graphics cards.



- These connectors are set to **[AHCI Mode]** by default. If you intend to create a Serial ATA RAID set using these connectors, set the SATA Mode item in the BIOS to **[RAID Mode]**. Refer to section **SATA Configuration** for details.
- Before creating a RAID set, refer to section **RAID configurations** or the manual bundled in the motherboard support DVD.
- When using NCQ, set the SATA Mode in the BIOS to **[AHCI Mode]**. Refer to section **SATA Configuration** for details.

2. USB 3.0 connector (20-1 pin USB3_12)

This connector allows you to connect a USB 3.0 module for additional USB 3.0 front or rear panel ports. With an installed USB 3.0 module, you can enjoy all the benefits of USB 3.0 including faster data transfer speeds of up to 5Gbps, faster charging time for USB-chargable devices, optimized power efficiency, and backward compatibility with USB 2.0.

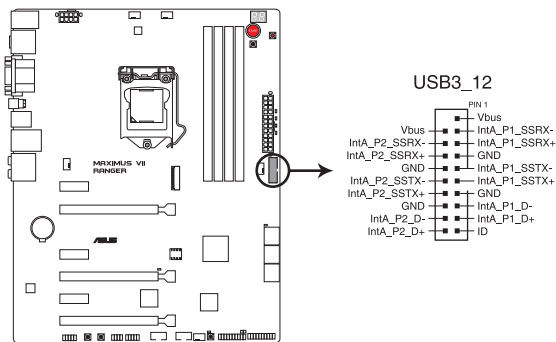

MAXIMUS VII RANGER USB3.0 connector



The USB 3.0 module is purchased separately.



- These connectors are based on xHCI specification. We recommend you to install the related driver to fully use the USB 3.0 ports under Windows® 7, Windows® 8, and Windows® 8.1.
 - The plugged USB 3.0 device may run on xHCI or EHCI mode depending on the operating system's setting.
-

3. USB 2.0 connectors (10-1 pin USB13, USB1112; USB910)

These connectors are for USB 2.0 ports. Connect the USB module cable to any of these connectors, then install the module to a slot opening at the back of the system chassis. These USB connectors comply with USB 2.0 specification that supports up to 480 MBps connection speed.

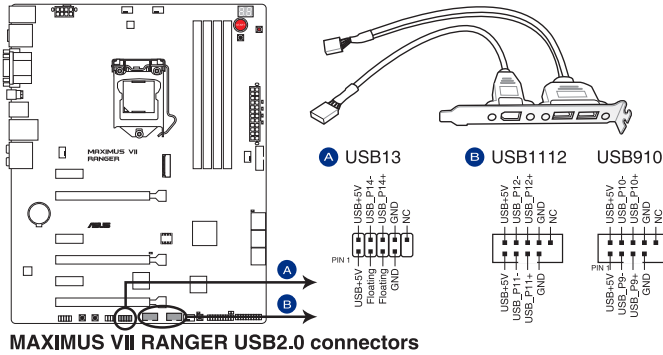

Never connect a 1394 cable to the USB connectors. Doing so will damage the motherboard!



You can connect the front panel USB cable to the ASUS Q-Connector (USB) first, and then install the Q-Connector (USB) to the USB connector onboard if your chassis supports front panel USB ports.



2 x USB 2.0 ports (USB13) at mid-board shares with ROG extension (ROG_EXT) port.

4. Front panel audio connector (10-1 pin AAFP)

This connector is for a chassis-mounted front panel audio I/O module that supports either HD Audio or legacy AC '97 audio standard. Connect one end of the front panel audio I/O module cable to this connector.

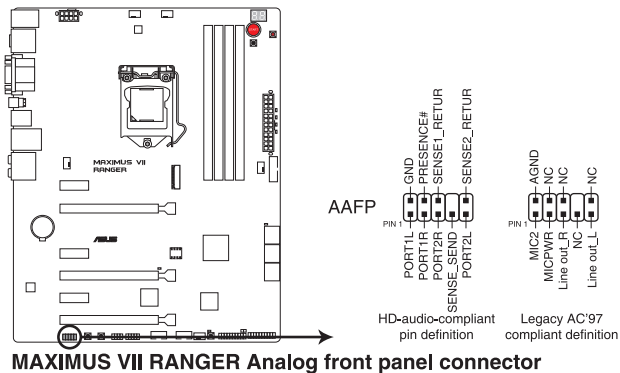

- We recommend that you connect a high-definition front panel audio module to this connector to avail of the motherboard's high-definition audio capability.
- If you want to connect a high-definition or an AC'97 front panel audio module to this connector, set the **Front Panel Type** item in the BIOS setup to **[HD]** or **[AC97]**.

5. CPU, chassis, and optional fan connectors (4-pin CPU_FAN; 4-pin CPU_OPT; 4-pin CHA_FAN1-3)

Connect the fan cables to the fan connectors on the motherboard, ensuring that the black wire of each cable matches the ground pin of the connector.

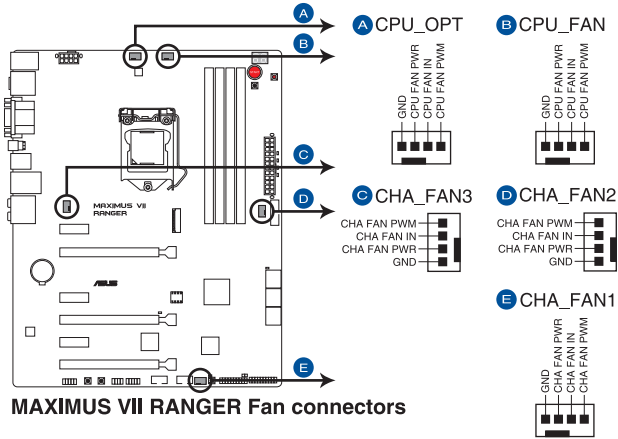

- DO NOT forget to connect the fan cables to the fan connectors. Insufficient air flow inside the system may damage the motherboard components. These are not jumpers! Do not place jumper caps on the fan connectors!
- Ensure to fully insert the 4-pin CPU fan cable to the CPU fan connector.



The CPU_FAN connector supports the CPU fan of maximum 1A (12 W) fan power.

6. ATX power connectors (24-pin EATXPWR; 8-pin EATX12V)

These connectors are for ATX power supply plugs. The power supply plugs are designed to fit these connectors in only one orientation. Find the proper orientation and push down firmly until the connectors completely fit.

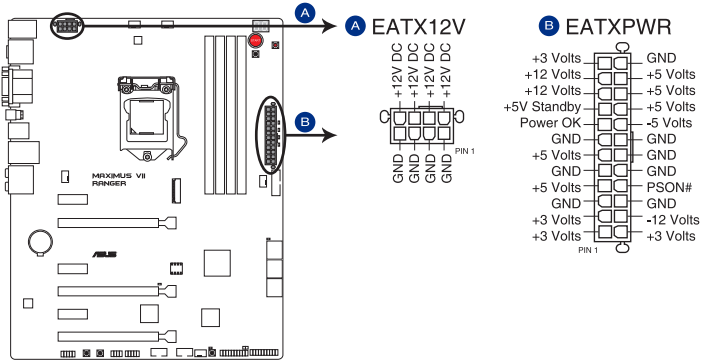

MAXIMUS VII RANGER ATX power connectors



- For a fully configured system, we recommend that you use a power supply unit (PSU) that complies with ATX 12 V Specification 2.0 (or later version) and provides a minimum power of 350 W.
- Do not forget to connect the 4-pin/8-pin EATX12 V power plug. Otherwise, the system will not boot.
- We recommend that you use a PSU with a higher power output when configuring a system with more power-consuming devices. The system may become unstable or may not boot up if the power is inadequate.
- If you want to use two or more high-end PCIe x16 cards, use a PSU with 1000W power or above to ensure the system stability.
- If you are uncertain about the minimum power supply requirement for your system, refer to the Recommended Power Supply Wattage Calculator at <http://support.asus.com/PowerSupplyCalculator/PSCalculator.aspx?SLanguage=en-us> for details.

7. System panel connector (20-8 pin PANEL)

This connector supports several chassis-mounted functions.

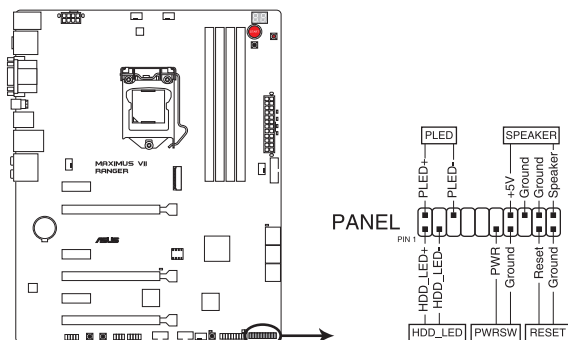

MAXIMUS VII RANGER System panel connector

- **System power LED (2-pin PLED)**

This 2-pin connector is for the system power LED. Connect the chassis power LED cable to this connector. The system power LED lights up when you turn on the system power, and blinks when the system is in sleep mode.

- **Hard disk drive activity LED (2-pin HDD_LED)**

This 2-pin connector is for the HDD Activity LED. Connect the HDD Activity LED cable to this connector. The HDD LED lights up or flashes when data is read from or written to the HDD.

- **System warning speaker (4-pin SPEAKER)**

This 4-pin connector is for the chassis-mounted system warning speaker. The speaker allows you to hear system beeps and warnings.

- **ATX power button/soft-off button (2-pin PWRSW)**

This connector is for the system power button. Pressing the power button turns the system on or puts the system in sleep or soft-off mode depending on the BIOS settings. Pressing the power button for more than four seconds while the system is ON turns the system OFF.

- **Reset button (2-pin RESET)**

This 2-pin connector is for the chassis-mounted reset button for system reboot without turning off the system power.

8. ROG Extension - ROG_EXT connector (18-1 pin ROG_EXT)

This connector is for the OC Panel, Front Base, and the other ROG device.

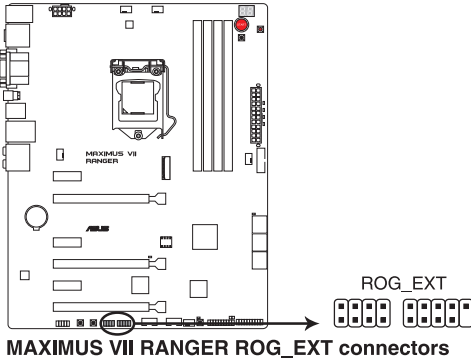

- The OC Panel and Front Base are purchased separately.
- Visit www.asus.com for more information about the OC Panel and Front Base.

9. TPM connector (20-1 pin TPM)

This connector supports a Trusted Platform Module (TPM) system, which securely store keys, digital certificates, passwords and data. A TPM system also helps enhance the network security, protects digital identities, and ensures platform integrity.

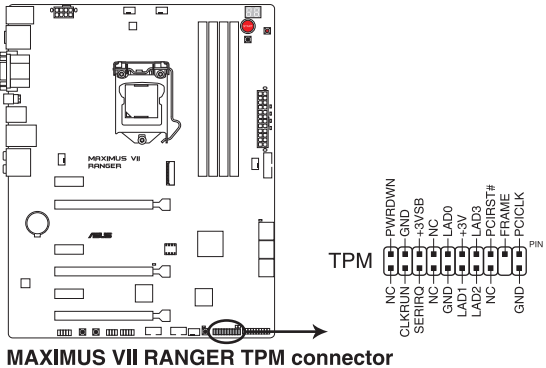

10. T_Sensor connector (2-pin T_SENSOR1)

This connector is for the thermistor cable that allows you to monitor the temperature of your motherboard's critical components and connected devices.

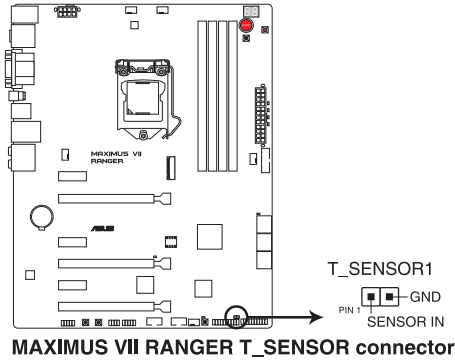

11. M.2 (Socket 3)

The M.2 (Socket 3) with M Key supports type 2260 (22 mm x 60 mm) and 2280 (22 mm x 80 mm) PCIe interface storage devices.

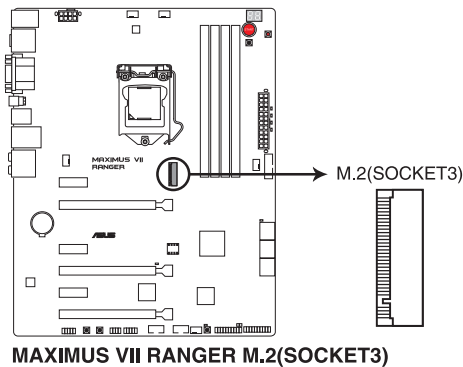

Basic Installation

2

2.1 Building your PC system

2.1.1 Motherboard installation



The diagrams in this section are for reference only. The motherboard layout may vary with models, but the installation steps are the same for all models.

1. Install the ASUS Q-Shield to the chassis rear I/O panel.

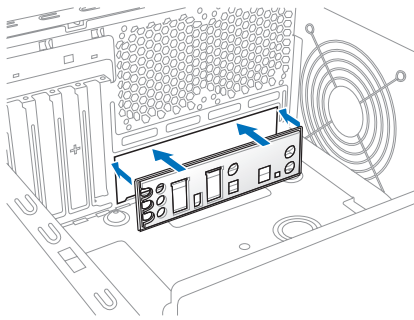

2. Place the motherboard into the chassis, ensuring that its rear I/O ports are aligned to the chassis' rear I/O panel.

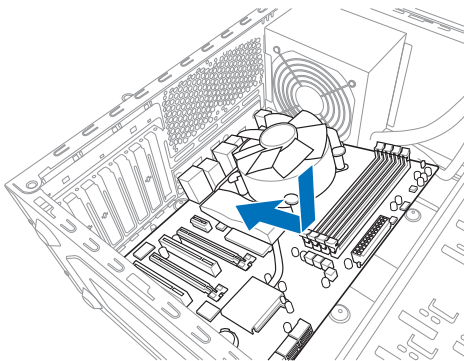

3. Place nine screws into the holes indicated by circles to secure the motherboard to the chassis.

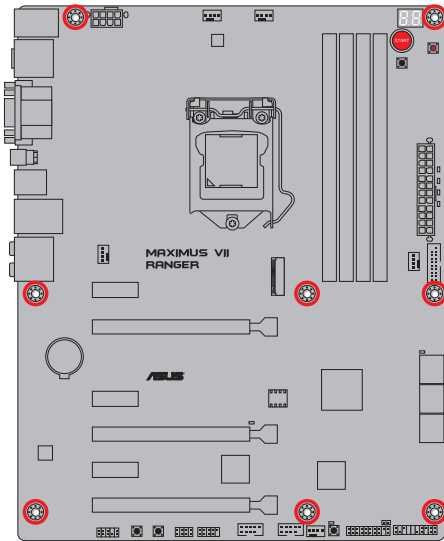
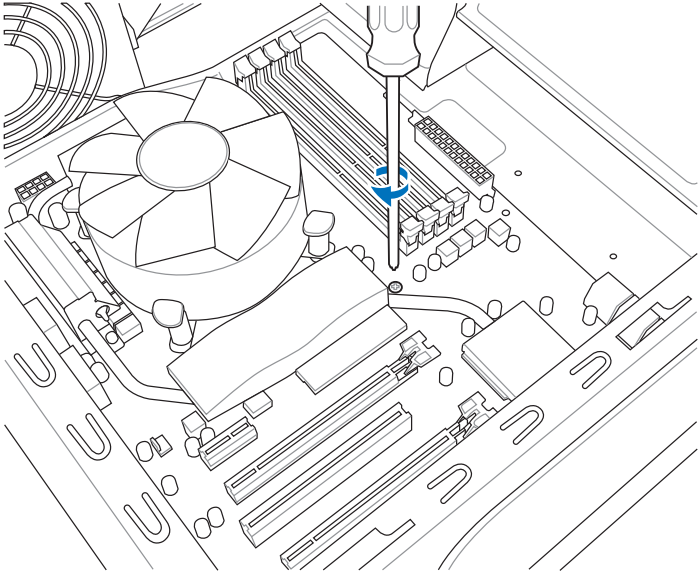

DO NOT over tighten the screws! Doing so can damage the motherboard.

2.1.2 CPU installation



Ensure that you install the correct CPU designed for LGA1150 socket only. DO NOT install a CPU designed for LGA1155 and LGA1156 sockets on the LGA1150 socket.

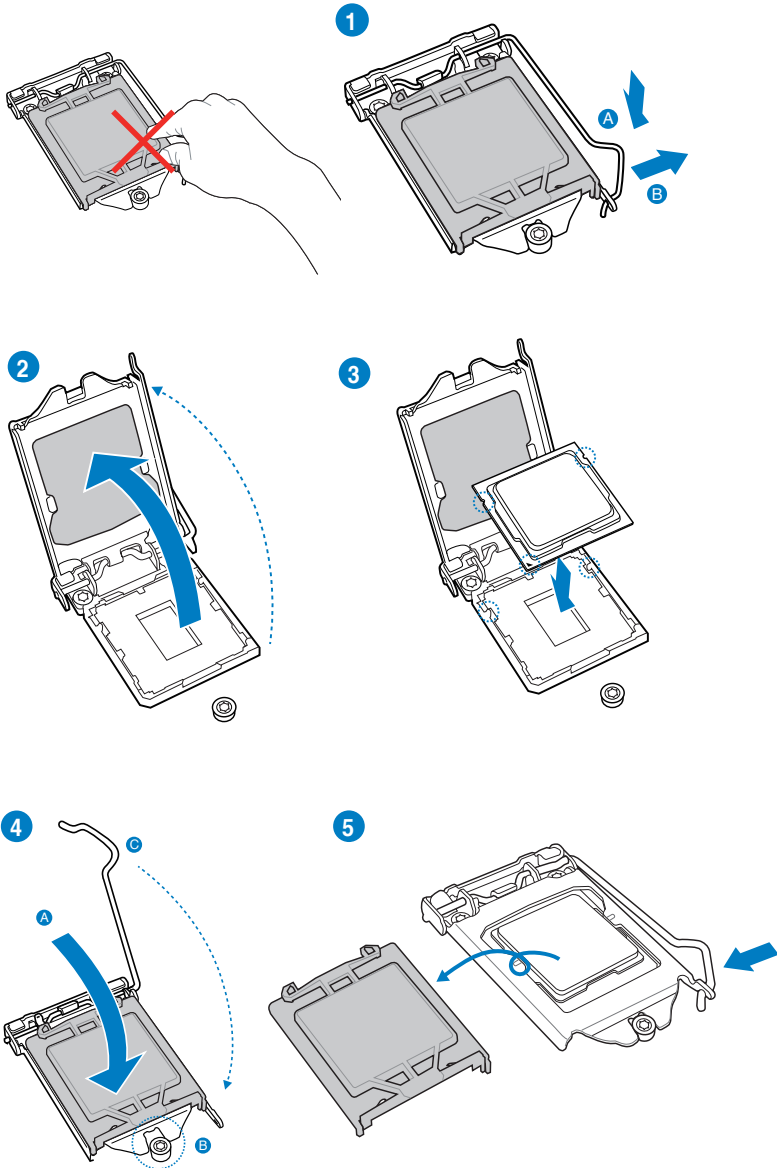

2.1.3 CPU heatsink and fan assembly installation

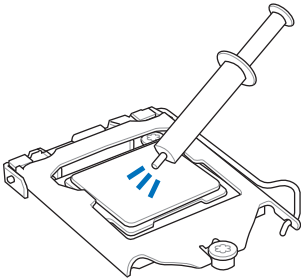

Apply the Thermal Interface Material to the CPU heatsink and CPU before you install the heatsink and fan if necessary.

To install the CPU heatsink and fan assembly

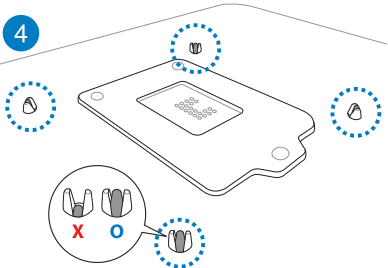
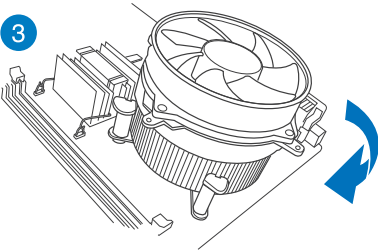
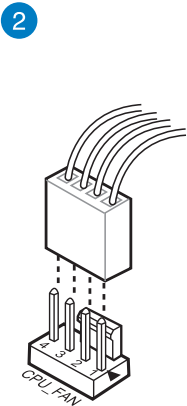
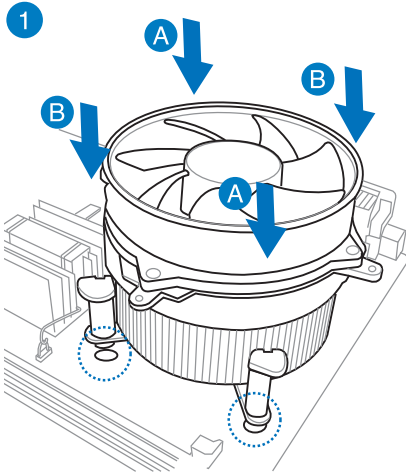

To uninstall the CPU heatsink and fan assembly

1

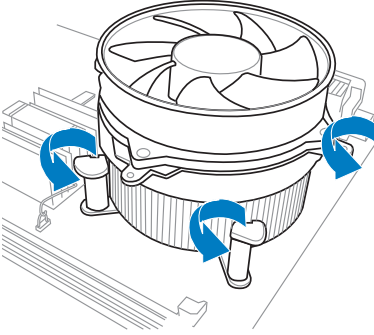

2

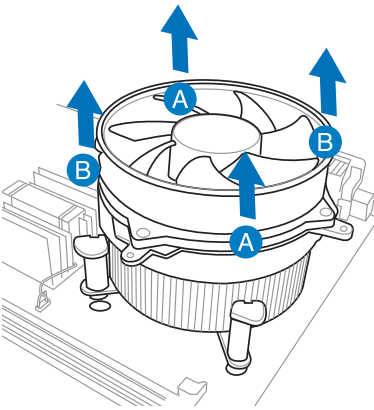

2.1.4 DIMM installation

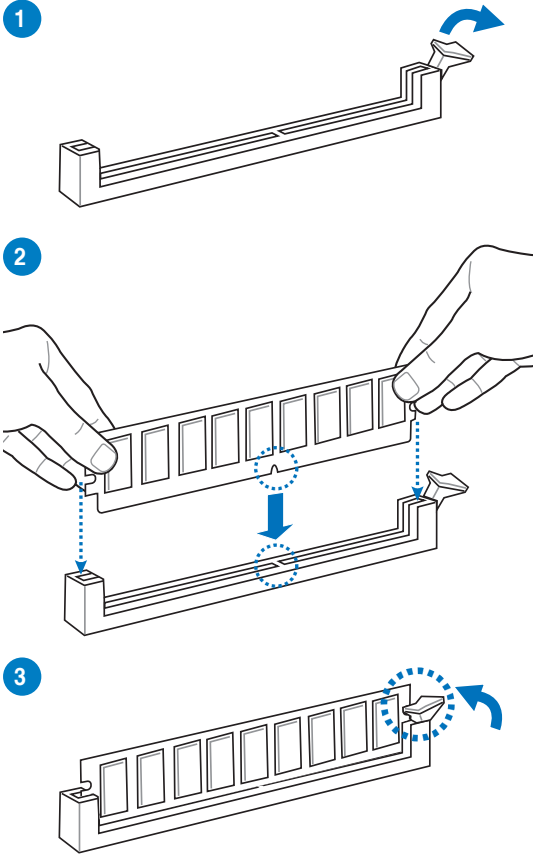

To remove a DIMM

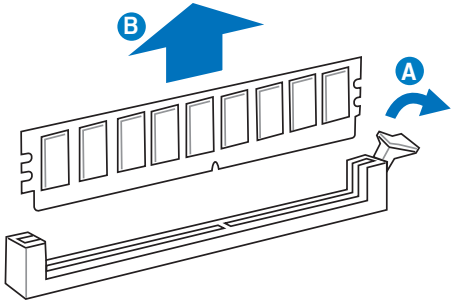

2.1.5 ATX Power connection

1

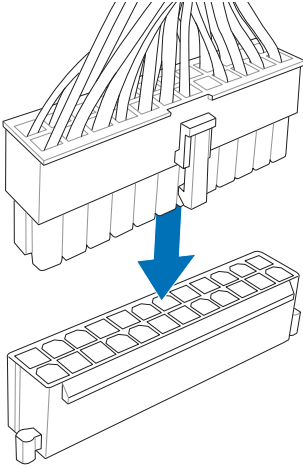

2

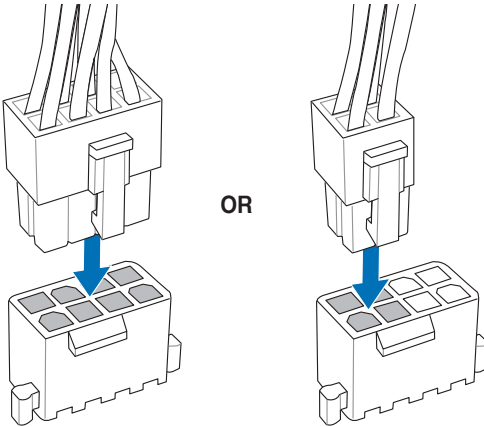

2.1.6 SATA device connection

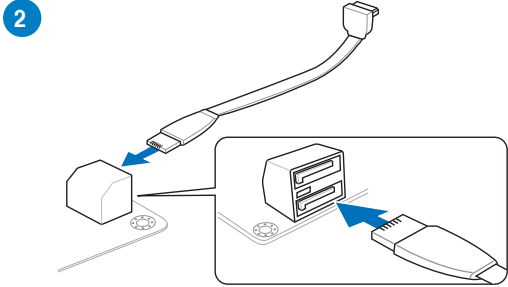
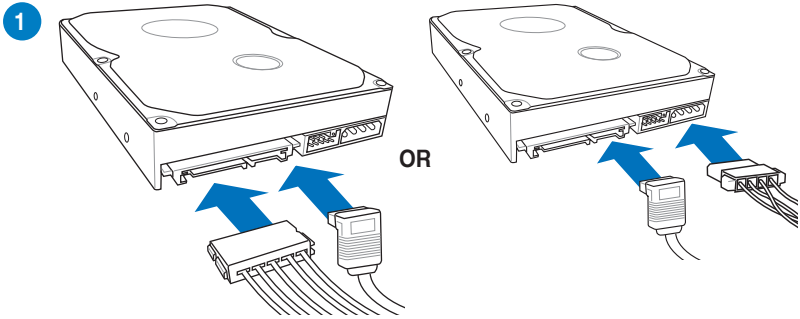

2.1.7 Front I/O Connector

To install ASUS Q-Connector

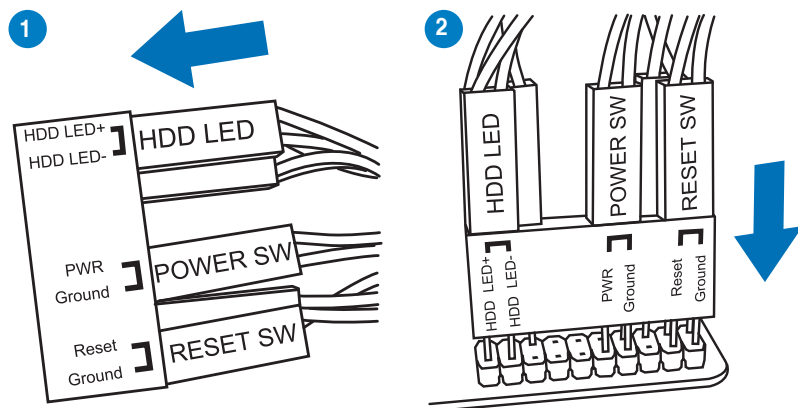

To install USB 2.0 connector

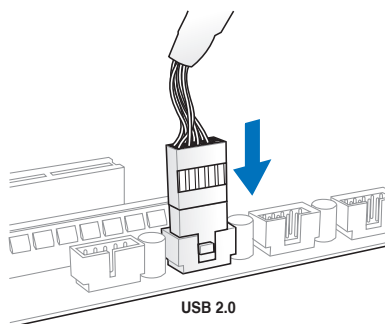

To install front panel audio connector

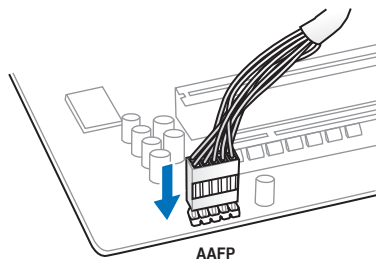

To install USB 3.0 connector

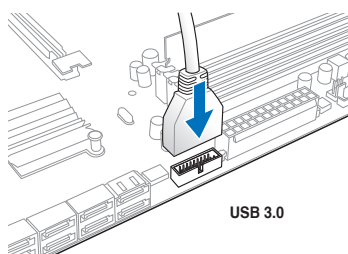

2.1.8 Expansion Card installation

To install PCIe x16 cards

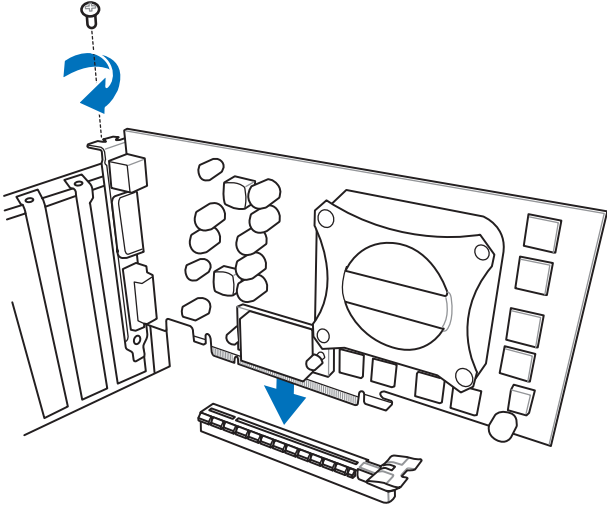

2.2 BIOS update utility

USB BIOS Flashback

USB BIOS Flashback allows you to easily update the BIOS without entering the existing BIOS or operating system. Simply insert a USB storage device to the USB port, press the USB BIOS Flashback button for three seconds, and the BIOS is updated automatically.

To use USB BIOS Flashback:

1. Download the latest BIOS file from the ASUS website.
2. Extract and rename the BIOS image file to **M7R.CAP**.
3. Copy **M7R.CAP** to the root directory of your USB storage device.
4. Turn off the system and connect the USB storage device to the USB BIOS Flashback port.
5. Press the USB BIOS Flashback button.



A flashing light indicates that the BIOS Flashback function is enabled. The light goes out when the process of updating the BIOS is complete.

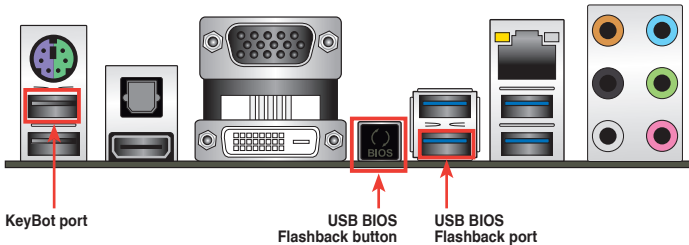

- For more BIOS update utilities in BIOS setup, refer to the section **Updating BIOS** in Chapter 3.
- Connect your USB keyboard on the KeyBot port if you want to use the KeyBot feature.



Updating BIOS may have risks. If the BIOS program is damaged during the process and results to the system's failure to boot up, please contact your local ASUS Service Center.

2.3 Motherboard rear and audio connections

2.3.1 Rear I/O connection

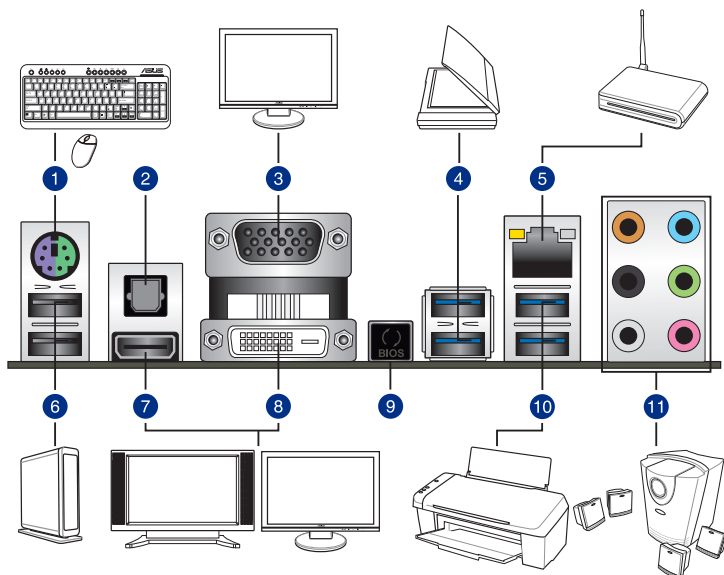

Rear panel connectors

1. PS/2 Keyboard/Mouse combo port
2. Optical S/PDIF OUT port
3. VGA port
4. Intel® USB 3.0 ports 3 and 4. Lower port supports USB BIOS Flashback feature.
5. LAN (RJ-45) port*
6. Intel® USB 2.0 ports 7 and 8. Upper port supports the KeyBot feature.
7. HDMI port
8. DVI port
9. USB BIOS Flashback button
10. Intel® USB 3.0 ports 5 and 6.
11. Audio I/O ports**

* and **: Refer to the tables on the next page for LAN port LEDs, and audio port definitions.



- Due to USB 3.0 controller limitation, USB 3.0 devices can only be used under Windows® OS environment and after the USB 3.0 driver installation.
- USB 3.0 devices can only be used as data storage only.
- We strongly recommend that you connect USB 3.0 devices to USB 3.0 ports for faster and better performance for your USB 3.0 devices.
- Due to the design of the Intel® 9 series chipset, all USB devices connected to the USB 2.0 and USB 3.0 ports are controlled by the xHCI controller. Some legacy USB devices must update their firmware for better compatibility.

* LAN ports LED indications

Activity Link LED		Speed LED	
Status	Description	Status	Description
OFF	No link	OFF	10 Mbps connection
ORANGE	Linked	ORANGE	100 Mbps connection
BLINKING	Data activity	GREEN	1 Gbps connection

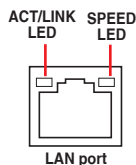

** Audio 2.1, 4.1, 5.1 or 7.1-channel configuration

Port	Headset 2.1-channel	4.1-channel	5.1-channel	7.1-channel
Light Blue	Line In	Line In	Line In	Line In
Lime	Line Out	Front Speaker Out	Front Speaker Out	Front Speaker Out
Pink	Mic In	Mic In	Mic In	Mic In
Orange	–	–	Center/Sub woofer	Center/Sub woofer
Black	–	Rear Speaker Out	Rear Speaker Out	Rear Speaker Out
Gray	–	–	–	Side Speaker Out

2.3.2 Audio I/O connections

Audio I/O ports



Connect to Headphone and Mic



Connect to Stereo Speakers

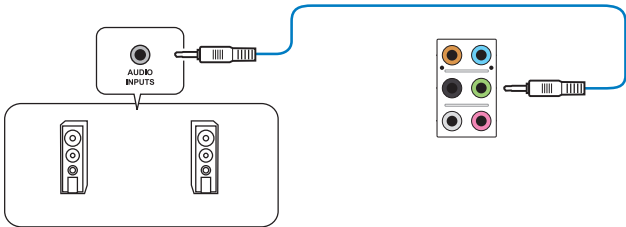

Connect to 2.1 channel Speakers

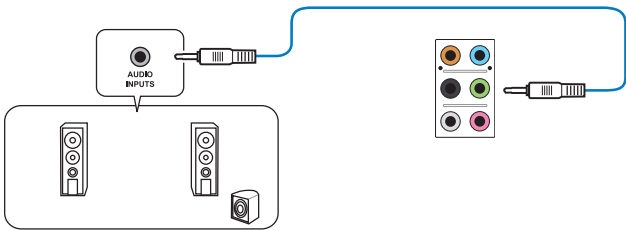

Connect to 4.1 channel Speakers

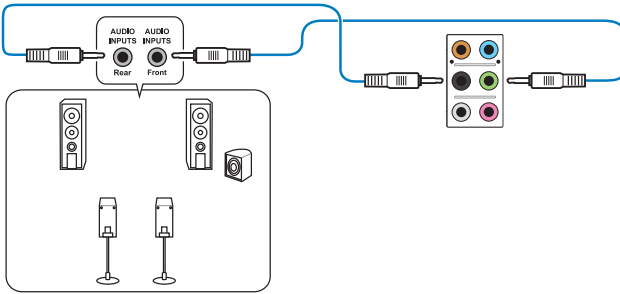

Connect to 5.1 channel Speakers

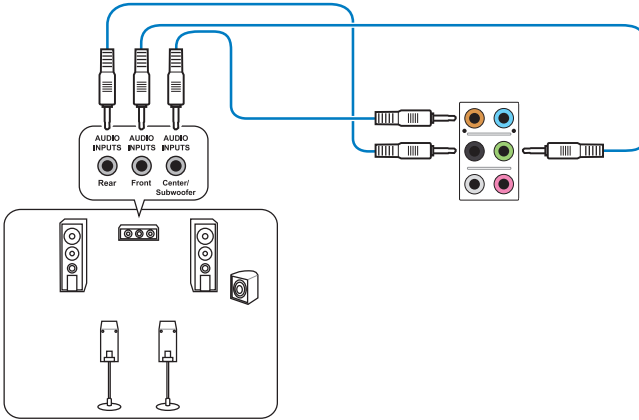

Connect to 7.1 channel Speakers

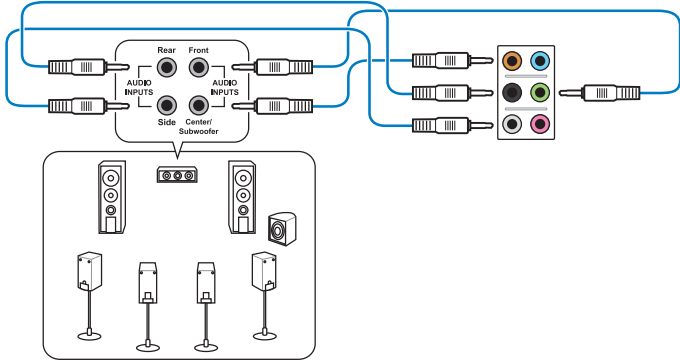

2.4 Starting up for the first time

1. After making all the connections, replace the system case cover.
2. Ensure that all switches are off.
3. Connect the power cord to the power connector at the back of the system chassis.
4. Connect the power cord to a power outlet that is equipped with a surge protector.
5. Turn on the devices in the following order:
 - a. Monitor
 - b. External SCSI devices (starting with the last device on the chain)
 - c. System power
6. After applying power, the system power LED on the system front panel case lights up. For systems with ATX power supplies, the system LED lights up when you press the ATX power button. If your monitor complies with the “green” standards or if it has a “power standby” feature, the monitor LED may light up or change from orange to green after the system LED turns on.

The system then runs the power-on self tests (POST). While the tests are running, the BIOS beeps (refer to the BIOS beep codes table) or additional messages appear on the screen. If you do not see anything within 30 seconds from the time you turned on the power, the system may have failed a power-on test. Check the jumper settings and connections or call your retailer for assistance.

BIOS Beep	Description
One short beep	VGA detected Quick boot set to disabled No keyboard detected
One continuous beep followed by two short beeps then a pause (repeated)	No memory detected
One continuous beep followed by three short beeps	No VGA detected
One continuous beep followed by four short beeps	Hardware component failure

7. At power on, hold down the <Delete> key to enter the BIOS Setup. Follow the instructions in Chapter 3.

2.5 Turning off the computer

While the system is ON, press the power button for less than four seconds to put the system on sleep mode or soft-off mode, depending on the BIOS setting. Press the power button for more than four seconds to let the system enter the soft-off mode regardless of the BIOS setting.

BIOS setup

3

3.1 Knowing BIOS



The new ASUS UEFI BIOS is a Unified Extensible Interface that complies with UEFI architecture, offering a user-friendly interface that goes beyond the traditional keyboard-only BIOS controls to enable a more flexible and convenient mouse input. You can easily navigate the new UEFI BIOS with the same smoothness as your operating system. The term “BIOS” in this user manual refers to “UEFI BIOS” unless otherwise specified.

BIOS (Basic Input and Output System) stores system hardware settings such as storage device configuration, overclocking settings, advanced power management, and boot device configuration that are needed for system startup in the motherboard CMOS. In normal circumstances, the default BIOS settings apply to most conditions to ensure optimal performance. **DO NOT change the default BIOS settings** except in the following circumstances:

- An error message appears on the screen during the system bootup and requests you to run the BIOS Setup.
- You have installed a new system component that requires further BIOS settings or update.



Inappropriate BIOS settings may result to instability or boot failure. **We strongly recommend that you change the BIOS settings only with the help of a trained service personnel.**



When downloading or updating the BIOS file, rename it as **M7R.CAP** for this motherboard.

3.2 BIOS setup program

Use the BIOS Setup to update the BIOS or configure its parameters. The BIOS screen include navigation keys and brief onscreen help to guide you in using the BIOS Setup program.

Entering BIOS at startup

To enter BIOS Setup at startup, press <Delete> during the Power-On Self Test (POST). If you do not press <Delete>, POST continues with its routines.

Entering BIOS Setup after POST

To enter BIOS Setup after POST:

- Press <Ctrl>+<Alt>+<Delete> simultaneously.
- Press the reset button on the system chassis.
- Press the power button to turn the system off then back on. Do this option only if you failed to enter BIOS Setup using the first two options.



-
- The BIOS setup screens shown in this section are for reference purposes only, and may not exactly match what you see on your screen.
 - Ensure that a USB mouse is connected to your motherboard if you want to use the mouse to control the BIOS setup program.
 - If the system becomes unstable after changing any BIOS setting, load the default settings to ensure system compatibility and stability. Select the **Load Optimized Defaults** item under the **Exit** menu or press hotkey <F5>. See section **Exit Menu** for details.
 - If the system fails to boot after changing any BIOS setting, try to clear the CMOS and reset the motherboard to the default value. See section **Onboard buttons** for more information on how to erase the RTC RAM via the Clear CMOS button.
 - The BIOS setup program does not support the bluetooth devices.
-

BIOS menu screen

The BIOS Setup program can be used under two modes: **EZ Mode** and **Advanced Mode**. You can change modes from the **Exit** menu or from the **Exit/Advanced Mode** screen.

3.2.1 EZ Mode

The EZ Mode provides you an overview of the basic system information, and allows you to select the display language, system performance, mode and boot device priority. To access the Advanced Mode, click **Exit/Advanced Mode**, then select **Advanced Mode** or press <F7> hot key for the advanced BIOS settings.



The default screen for entering the BIOS setup program can be changed. Refer to the **Setup Mode** item in section **Boot menu** for details.

Displays the system properties of the selected mode. Click < or > to switch EZ System Tuning modes

Displays the CPU/motherboard temperature, CPU voltage output, CPU/chassis/power fan speed, and SATA information

Selects the display language of the BIOS setup program

Creates storage RAID and configures system overclocking

Information: MAXIMUS VII RANGER BIOS Ver. 0217, Intel(R) Core(TM) i5-4440 CPU @ 3.10GHz, Speed: 3100 MHz, Memory: 4096 MB (DDR3 1600MHz)

DRAM Status: DIMM_A1: N/A, DIMM_A2: N/A, DIMM_B1: N/A, DIMM_B2: GEIL 4096MB 1600MHz

SATA Information: P1: N/A, P2: N/A, P3: N/A, P4: N/A, P5: N/A, P6: N/A

Intel Rapid Storage Technology: On

CPU FAN: 4591 RPM

EZ System Tuning: Quiet, Performance, Energy Saving (Normal)

Boot Priority: Choose one and drag the items. Switch all

Buttons: X.M.P Disabled, Default(F5), Save & Exit(F10), Advanced Mode(F7), Boot Menu(F8)

Displays the CPU Fan's speed. Click the button to manually tune the fans

Loads optimized default settings

Enables or disables the Intel Rapid Storage Technology

Saves the changes and resets the system

Click to go to Advanced mode

Click to display boot devices

Selects the boot device priority



The boot device options vary depending on the devices you installed to the system.

3.2.2 Advanced Mode

The Advanced Mode provides advanced options for experienced end-users to configure the BIOS settings. The figure below shows an example of the Advanced Mode. Refer to the following sections for the detailed configurations.



To switch from EZ Mode to Advanced Mode, click **Advanced Mode(F7)** or press **F7** hotkey.

The screenshot shows the ASUS UEFI BIOS Utility in Advanced Mode. The interface includes a top menu bar with options like Language, MyFavorite(F3), Qfan Control(F6), EZ Tuning Wizard(F11), Quick Note(F9), and Hot Keys. The main area is divided into several sections:

- My Favorites:** Lists target frequencies for Turbo-Mode (3300MHz), DRAM (1600MHz), Cache (3300MHz), DMI/PEG (100MHz), and CPU Graphics (1100MHz).
- AI Overclock Tuner:** A dropdown menu currently set to 'Auto', with options for Auto, Manual, and XMP.
- ASUS MultiCore Enhancement:** A section for adjusting CPU core ratios, including 1-Core, 2-Core, 3-Core, and 4-Core Ratio Limits, and Min. CPU Cache Ratio.
- Hardware Monitor:** A sidebar on the right displaying real-time system metrics:

CPU	
Frequency	Temperature
3100 MHz	82 °C
BCLK	Vcore
100.0 MHz	0.944 V
Ratio	
31x	
Memory	
Frequency	Voltage
1600 MHz	1.501 V
Capacity	
4096 MB	
Voltage	
+12V	+5V
12.288 V	5.080 V
+3.3V	
3.344 V	

At the bottom, there is a 'Last Modified' section and a 'Goes back to EZ Mode' button labeled 'EzMode(F7)|->'. A copyright notice at the very bottom reads 'Version 2.16.1240. Copyright (C) 2014 American Megatrends, Inc.'

Labels in the diagram point to various elements: 'Configuration fields' points to the top menu; 'Pop-up Menu' points to the AI Overclock Tuner dropdown; 'Menu bar' points to the top navigation; 'Quick Note (F9)' points to the top right; 'Scroll bar' points to the right edge; 'Hot Keys' points to the bottom right; 'Sub-menu item' points to 'Extreme Tweaker'; 'Menu items' points to the list of target frequencies; 'General help' points to the information icon; 'Last modified settings' points to the 'Last Modified' text; and 'Goes back to EZ Mode' points to the 'EzMode(F7)|->' button.

Menu bar

The menu bar on top of the screen has the following main items:

My Favorites	For saving the frequently-used system settings and configuration.
Extreme Tweaker	For changing the overclocking settings
Main	For changing the basic system configuration
Advanced	For changing the advanced system settings
Monitor	For displaying the system temperature, power status, and changing the fan settings.
Boot	For changing the system boot configuration
Tool	For configuring options for special functions
Exit	For selecting the exit options and loading default settings

Menu items

The highlighted item on the menu bar displays the specific items for that menu. For example, selecting **Main** shows the Main menu items.

The other items (My Favorites, Extreme Tweaker, Advanced, Monitor, Boot, Tool, and Exit) on the menu bar have their respective menu items.

Submenu items

A greater than sign (>) before each item on any menu screen means that the item has a submenu. To display the submenu, select the item and press <Enter>.

Language

This button above the menu bar contains the languages that you can select for your BIOS. Click this button to select the language that you want to display in your BIOS screen.

MyFavorite(F3)

This button above the menu bar shows all BIOS items in a Tree Map setup. Select frequently-used BIOS settings and save it to MyFavorite menu.



Refer to section **My Favorites** for more information.

Qfan Control(F6)

This button above the menu bar displays the current settings of your fans. Use this button to manually tweak the fans to your desired settings.

EZ Tuning Wizard(F11)

This button above the menu bar allows you to view and tweak the overclocking settings of your system. It also allows you to change the motherboard's SATA mode from AHCI to RAID mode.

Quick Note (F9)

This button above the menu bar allows you to key in notes of the activities that you have done in BIOS.



-
- The quick Note function does not support the following keyboard functions: delete, cut, copy and paste.
 - You can only use the alphanumeric characters to enter your notes.
-

Hot keys

This button above the menu bar contains the navigation keys for the BIOS setup program. Use the navigation keys to select items in the menu and change the settings.

Scroll bar

A scroll bar appears on the right side of a menu screen when there are items that do not fit on the screen. Press the Up/Down arrow keys or <Page Up> / <Page Down> keys to display the other items on the screen.

General help

At the top right corner of the menu screen is a brief description of the selected item. Use <F12> key to capture the BIOS screen and save it to the removable storage device.

Configuration fields

These fields show the values for the menu items. If an item is user-configurable, you can change the value of the field opposite the item. You cannot select an item that is not user-configurable.

A configurable field is highlighted when selected. To change the value of a field, select it and press <Enter> to display a list of options.

Last Modified button

This button shows the items that you last modified and saved in BIOS Setup.

3.3 My Favorites

My Favorites is your personal space where you can easily save and access your favorite BIOS items.

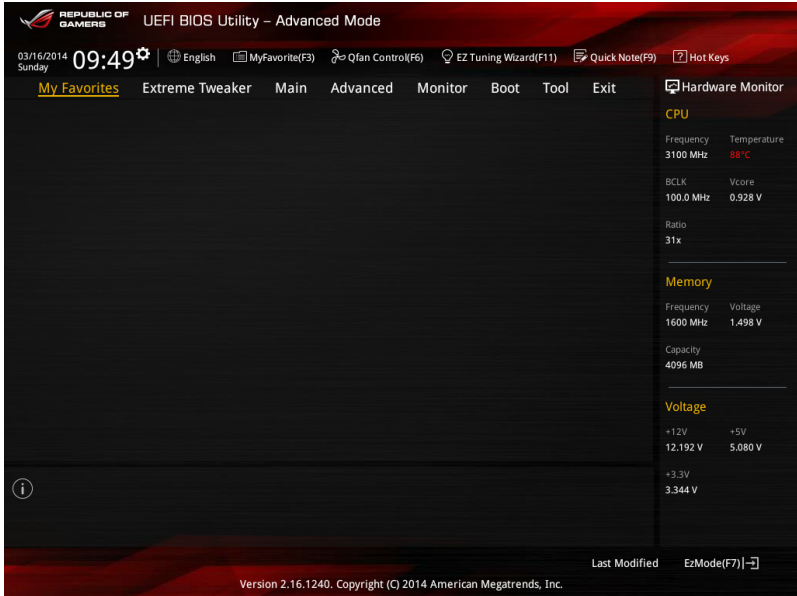

Adding items to My Favorites

To add frequently-used BIOS items to My Favorites:

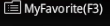
1. Press <F3> on your keyboard or click  to open Setup Tree Map screen.
2. On the Setup Tree Map screen, select the BIOS items that you want to save in My Favorites screen then click the plus sign (“+”) to save it in My Favorites screen.



You cannot add the following items to My Favorite items:

- Items with submenu options
- User-managed items such as language and boot order
- Configuration items such as Memory SPD Information, system time and date.

3.4 Extreme Tweaker menu

The Extreme Tweaker menu items allow you to configure overclocking-related items.



Be cautious when changing the settings of the Extreme Tweaker menu items. Incorrect field values can cause the system to malfunction



The configuration options for this section vary depending on the CPU and DIMM model you installed on the motherboard.

Scroll down to display other BIOS items.

Ai Overclock Tuner [Auto]

Allows you to select the CPU overclocking options to achieve the desired CPU internal frequency. Configuration options:

- [Auto] Loads the optimal settings for the system.
- [Manual] Allows you to individually set overclocking parameters.
- [X.M.P.] If you install memory modules supporting the eXtreme Memory Profile (X.M.P.) Technology, choose this item to set the profiles supported by your memory modules for optimizing the system performance.



The [X.M.P.] configuration option appears only when you install memory modules supporting the eXtreme Memory Profile(X.M.P.) Technology.



When the **Ai Overclock Tuner** is set to [Manual] or [XMP], the following items appear.

Filter PLL [Auto]

Set this item to high BCLK (base clock) mode when using a very high BCLK to improve overclocking capability. Configuration options: [Auto] [Low BCLK mode] [High BCLK mode]

BCLK Frequency [100]

This item allows you to set the BCLK (base clock) frequency to enhance the system performance. Use the <+> or <-> to adjust the value. The values range from 80.0 MHz to 300.0 MHz.



When **Ai Overclock Tuner** is set to [XMP], the XMP mode supported by the installed memory module is displayed.

ASUS MultiCore Enhancement [Auto]

[Auto] This item allows you to maximize the overclocking performance optimized by ASUS core ratio settings.

[Disabled] This item allows you to set to default core ratio settings.

CPU Core Ratio [Synch All Cores]

This item allows you to set the CPU core ratio limit per core or synchronize automatically to all cores.

Configuration options: [Auto] [Sync All Cores] [Per Core]



When the CPU Core Ratio is set to **[Synch All Cores]**, the following item appears:

1-Core Ratio Limit [Auto]

Select **[Auto]** to apply the CPU default Turbo Ratio setting or manually assign a 1-Core Limit value that must be higher than or equal to the 2-Core Ratio Limit.



When the CPU Core Ratio is set to **[Per Core]**, the following item appears:

1-Core Ratio Limit [Auto]

Select **[Auto]** to apply the CPU default Turbo Ratio setting or manually assign a 1-Core Limit value that must be higher than or equal to the 2-Core Ratio Limit.

2-Core Ratio Limit [Auto]

Select **[Auto]** to apply the CPU default Turbo Ratio setting or manually assign a 2-Core Limit value that must be higher than or equal to the 3-Core Ratio Limit.

3-Core Ratio Limit [Auto]

Select **[Auto]** to apply the CPU default Turbo Ratio setting or manually assign a 3-Core Limit value that must be higher than or equal to the 4-Core Ratio Limit.

4-Core Ratio Limit [Auto]

Select **[Auto]** to apply the CPU default Turbo Ratio setting or manually assign a 4-Core Limit value that must be higher than or equal to the 3-Core Ratio Limit.



If you assign a value for more Core Ratio Limit, do not set the less Core Ratio Limit to **[Auto]**.

Min. CPU Cache Ratio [Auto]

Allows you to set the minimum possible ratio on the Uncore part of the processor. Use the <+> or <-> keys to adjust the value. The values depend on the CPU installed.

Max. CPU Cache Ratio [Auto]

Allows you to set the maximum possible ratio on the Uncore part of the processor. Use the <+> or <-> keys to adjust the value. The values depend on the CPU installed.

Internal PLL Overvoltage [Auto]

This item allows you to enable the internal PLL Overvoltage for K-SKU CPUs to get the extreme overclocking capability.

Configuration options: [Auto] [Enabled] [Disabled]

CPU Ratio Tuner [Auto]

Enable this item to enhance the performance of non-K series CPUs. Configuration options: [Auto] [Enabled] [Disabled]

BCLK Frequency : DRAM Frequency Ratio [Auto]

Allows you to set the BCLK frequency to DRAM frequency ratio.

[Auto] The BCLK frequency to DRAM frequency is set to the optimized settings.

[100:133] The BCLK frequency to DRAM frequency ratio is set to 100:133.

[100:100] The BCLK frequency to DRAM frequency ratio is set to 100:100.

DRAM Frequency [Auto]

This item allows you to set the memory operating frequency. The configurable options vary with the BCLK (base clock) frequency setting. Select the auto mode to apply the optimized setting.

Configuration options: [DDR3-800MHz] [DDR3-1066MHz] [DDR3-1333MHz] [DDR3-1400MHz] [DDR3-1600MHz] [DDR3-1800MHz] [DDR3-1866MHz] [DDR3-2000MHz] [DDR3-2133MHz] [DDR3-2200MHz] [DDR3-2400MHz] [DDR3-2600MHz] [DDR3-2666MHz] [DDR3-2800MHz] [DDR3-2933MHz] [DDR3-3000MHz] [DDR3-3200MHz] [DDR3-3400MHz]

Xtreme Tweaking [Disabled]

This item may help improve some benchmarks performance. Configuration options: [Enabled] [Disabled]

Max. CPU Graphics Ratio [Auto]

Allows you to automatically optimize the CPU Graphics Ratio or manually set a value for an optimal CPU Graphics Ratio. Use the <+> or <-> keys to adjust the CPU graphics ratio. The minimum value depends on the installed CPU.



The ratio may vary depending on the system loading.

CPU Level Up [Auto]

Allows you to select a CPU level, and the related parameters will be automatically adjusted according to the selected CPU level.



The CPU level values depends on the CPU installed in your system.

EPU Power Saving Mode [Disabled]

Allows you to enable or disable the EPU power saving function.

Configuration options: [Disabled] [Enabled]

DRAM Timing Control

The subitems in this menu allow you to set the DRAM timing control features. Use the <+> and <-> keys to adjust the value. To restore the default setting, type [auto] using the keyboard and press the <Enter> key.

Primary Timings

DRAM CAS# Latency [Auto]

Configuration options: [Auto] [1] – [31]

DRAM RAS# to CAS# Delay [Auto]

Configuration options: [Auto] [1] – [31]

DRAM RAS# PRE Time [Auto]

Configuration options: [Auto] [1] – [31]

DRAM RAS# ACT Time [Auto]

Configuration options: [Auto] [1] – [63]

DRAM COMMAND Rate [Auto]

Configuration options: [Auto] [1] – [2]

Secondary Timings

DRAM RAS# to RAS# Delay [Auto]

Configuration options: [Auto] [1] – [15]

DRAM REF Cycle Time [Auto]

Configuration options: [Auto] [1] – [511]

DRAM Refresh Interval [Auto]

Configuration options: [Auto] [1] – [65535]

DRAM WRITE Recovery Time [Auto]

Configuration options: [Auto] [1] – [16]

DRAM READ to PRE Time [Auto]

Configuration options: [Auto] [1] – [15]

DRAM FOUR ACT WIN Time [Auto]

Configuration options: [Auto] [1] – [255]

DRAM WRITE to READ Delay [Auto]

Configuration options: [Auto] [1] – [15]

DRAM CKE Minimum pulse Width [Auto]

Configuration options: [Auto] [1] – [15]

DRAM CAS# Write Latency [Auto]

Configuration options: [Auto] [1] – [31]

RTL IOL control

DRAM RTL Initial Value [Auto]

Configuration options: [Auto] [1] - [63]

DRAM RTL(CHA_R0D0) [Auto]

Configuration options: [Auto] [1] - [63]

DRAM RTL(CHA_R0D1) [Auto]

Configuration options: [Auto] [1] - [63]

DRAM RTL(CHA_R1D0) [Auto]

Configuration options: [Auto] [1] - [63]

DRAM RTL(CHA_R1D1) [Auto]

Configuration options: [Auto] [1] - [63]

DRAM RTL(CHB_R0D0) [Auto]

Configuration options: [Auto] [1] - [63]

DRAM RTL(CHB_R0D1) [Auto]

Configuration options: [Auto] [1] - [63]

DRAM RTL(CHB_R1D0) [Auto]

Configuration options: [Auto] [1] - [63]

DRAM RTL(CHB_R1D1) [Auto]

Configuration options: [Auto] [1] - [63]

DRAM IO-L(CHA_R0D0) [Auto]

Configuration options: [Auto] [1] - [15]

DRAM IO-L(CHA_R0D1) [Auto]

Configuration options: [Auto] [1] - [15]

DRAM IO-L(CHA_R1D0) [Auto]

Configuration options: [Auto] [1] - [15]

DRAM IO-L(CHA_R1D1) [Auto]

Configuration options: [Auto] [1] - [15]

DRAM IO-L(CHB_R0D0) [Auto]

Configuration options: [Auto] [1] - [15]

DRAM IO-L(CHB_R0D1) [Auto]

Configuration options: [Auto] [1] - [15]

DRAM IO-L(CHB_R1D0) [Auto]

Configuration options: [Auto] [1] - [15]

DRAM IO-L(CHB_R1D1) [Auto]

Configuration options: [Auto] [1] - [15]

Third Timings

tRDRD [Auto]

Configuration options: [Auto] [1] - [7]

tRDRD_dr [Auto]

Configuration options: [Auto] [1] - [15]

tRDRD_dd [Auto]

Configuration options: [Auto] [1] - [15]

tWRRD [Auto]

Configuration options: [Auto] [1] - [63]

tWRRD_dr [Auto]

Configuration options: [Auto] [1] - [15]

tWRRD_dd [Auto]

Configuration options: [Auto] [1] - [15]

tWRWR [Auto]

Configuration options: [Auto] [1] - [7]

tWRWR_dr [Auto]

Configuration options: [Auto] [1] - [15]

tWRWR_dd [Auto]

Configuration options: [Auto] [1] - [15]

Dec_WRD [Auto]

Configuration options: [Auto] [0] [1]

tRDWR [Auto]

Configuration options: [Auto] [1] - [31]

tRDWR_dr [Auto]

Configuration options: [Auto] [1] - [31]

tRDWR_dd [Auto]

Configuration options: [Auto] [1] - [31]

Misc.

MRC Fast Boot [Auto]

Allows you to enable, disable or automatically set the MRC fast boot.

Configuration options: [Auto] [Enabled] [Disabled]

DRAM CLK Period [Auto]

Configuration options: [Auto] [1] - [14]

Channel A DIMM Control [Enable Both DIMMS]

Allows you to enable or disable the Channel A DIMM slots with the following configuration options: [Enable Both DIMMS] [Disable DIMM0] [Disable DIMM1] [Disable Both DIMMS]

Channel B DIMM Control [Enable Both DIMMS]

Allows you to enable or disable the Channel B DIMM slots with the following configuration options: [Enable Both DIMMS] [Disable DIMM0] [Disable DIMM1] [Disable Both DIMMS]

Scramble Setting [Optimized (ASUS)]

Set this item to [Optimized (ASUS)] to enhance system stability.

Configuration options: [Optimized (ASUS)] [Default (MRC)]

MCH Full Check [Auto]

Enable this item to enhance the stability of your system. Disable this item to enhance the DRAM overclocking capability. Configuration options: [Auto] [Enabled] [Disabled]

DQ Sense Amplifier [Auto]

Reducing usually helps overclocking and over-voltage.

Configuration options: [Auto] [+16] – [-29]

DQS Sense Amplifier [Auto]

Reducing usually helps overclocking and over-voltage. Configuration options: [Auto] [+16] – [-29]

CMD Sense Amplifier [Auto]

Reducing usually helps overclocking and over-voltage. Configuration options: [Auto] [+16] – [-29]

DRAM Additional Training [Auto]

Reducing usually helps overclocking and over-voltage. Configuration options: [Auto] [Enabled] [Disabled]

Skew Control**Transmitter Rising Slope [Auto]**

Configuration options: [Auto]

Transmitter Falling Slope [Auto]

Configuration options: [Auto]

Transmitter Control Time [Auto]

Configuration options: [Auto]

Receiver Rising Slope [Auto]

Configuration options: [Auto]

Receiver Falling Slope [Auto]

Configuration options: [Auto]

Receiver Control Time [Auto]

Configuration options: [Auto]

GPU.DIMM Post

Automatically detects and displays the information about the devices or memory installed on the PCIe and DIMM slots. The field shows N/A if there are no devices installed on the slots.

External DIGI+ Power Control

CPU Load-line Calibration [Auto]

Load-line is defined by Intel® specification and affects CPU power voltage. The CPU working voltage decreases proportionally to CPU loading. Higher load-line calibration could get higher voltage and good overclocking performance, but increases the CPU and VRM thermal conditions. Select from levels 1 to 9 to adjust the CPU power voltage from 0% to 125%.

Configuration options [Auto] [Level 1] - [Level 9]



The actual performance boost may vary depending on your CPU specification.



DO NOT remove the thermal module. The thermal conditions should be monitored.

CPU VRM Switching Frequency [Auto]

This item affects the VRM transient response speed and the component thermal production. Select [Manual] to configure a higher frequency for a quicker transient response speed.

Configuration options: [Auto] [Manual]



DO NOT remove the thermal module. The thermal conditions should be monitored.



The following item appears only when you set the CPU VRM Switching Frequency to [Manual].

Fixed CPU VRM Switching Frequency (KHz) [300]

This item allows you to set a higher frequency for a quicker transient response speed. Use the <+> or <-> to adjust the value. The values range from 300 KHz to 500 KHz with an interval of 50 KHz.



Do not remove the thermal module when the manual mode is selected. The thermal conditions should be monitored.



The following item appears only when the CPU VRM Switching Frequency is set to [Auto].

VRM Spread Spectrum [Disabled]

This item allows to enhance the system stability. Configuration options: [Disabled] [Enabled]

CPU Power Phase Control [Auto]

This item allows you to set the power phase control of the CPU.

Configuration options: [Auto] [Standard] [Optimized] [Extreme]



DO NOT remove the thermal module when setting this item to [Power Phase Response]. The thermal conditions should be monitored.

CPU Power Duty Control [T.Probe]

DIGI + VRM Duty Control adjusts the current of every VRM phase and the thermal conditions of every phase component.

- [T. Probe] Select to set the VRM thermal balance mode.
[Extreme] Select to set the VRM current balance mode.



DO NOT remove the thermal module. The thermal conditions should be monitored.

CPU Current Capability [Auto]

This item provides a total power range for CPU overclocking. A higher value setting provides higher power consumption delivery and extends the overclocking frequency range simultaneously.

Configuration options: [Auto] [100%] [110%] [120%] [130%] [140%]

CPU Input Boot Voltage [Auto]

VCCIN for the CPU right at boot. Configuration options: [Auto] [0.800] – [2.440V]

Tweakers' Paradise

The subitems in this menu allow you to set the CPU ratio and features.

BCLK Tuning

VCCIN Shadow Voltage [Auto]

Pseudo Voltage for VCCIN. Configuration options: [Auto] [0.800] – [2.440V]

Termination Anti-Aliasing [Auto]

Termination Anti-Aliasing can be enabled to smooth out the change of the PLL Termination Voltage, which may sometimes help to yield a better O.C. result.
Configuration options: [Auto] [Disabled] [Enabled]

Initial PLL Termination Voltage [Auto]

Initial Voltage at which CPU BCLKs are terminated. Maintaining a level close to CPU Input Voltage will help BCLK Overclock.
Configuration options: [Auto] [0.0000] - [3.0000]

PLL Termination Reset Voltage [Auto]

PLL Termination Reset Voltage. Configuration options: [Auto] [0.0000] - [3.0000]

Eventual PLL Termination Voltage [Auto]

Eventual PLL Termination Voltage. Configuration options: [Auto] [0.0000] - [3.0000]

PCH ICC Voltage [Auto]

Power Supply for the Integrated Clock Controller. Lower may be better.

Clock Crossing Boot Voltage [Auto]

The instantaneous voltage value when the rising edge of BCLK DN is equal to the falling edge of the BCLK DP.

Clock Crossing Reset Voltage [Auto]

The instantaneous voltage value when the rising edge of BCLK DN is equal to the falling edge of the BCLK DP.

Clock Crossing Voltage [Auto]

The instantaneous voltage value when the rising edge of BCLK DN is equal to the falling edge of the BCLK DP.

Internal CPU Power Management

The subitems in this menu allow you to set the CPU ratio and features.

Enhanced Intel SpeedStep Technology [Enabled]

Allows the operating system to dynamically adjust the processor voltage and cores frequency to decrease the average power consumption and decrease average heat production. Configuration options: [Enabled] [Disabled]

Turbo Mode [Enabled]

Allows you to enable your processor cores to run faster than the base operating frequency when it is below power, current and specification limit. Configuration options: [Disabled] [Enabled]



The following items appear only when you set the Turbo Mode to **[Enabled]**.

Turbo Mode Parameters

Long Duration Package Power Limit [Auto]

Allows you to limit the Turbo Ratio's time duration that exceeds the TDP (Thermal Design Power) for maximum performance. Use the <+> and <-> keys to adjust the value. The values range from 1W to 4096W.

Package Power Time Window [Auto]

Also known as Power Limit 1, and allows you to maintain the time window for Turbo Ratio over TDP (Thermal Design Power). Use the <+> and <-> keys to adjust the value. The values range from 1 second to 127 seconds.

Short Duration Package Power Limit [Auto]

Also known as Power Limit 2, and allows you to provide rapid protection when the package power exceeds the Power Limit 1. Use the <+> and <-> keys to adjust the value. The values range from 1W to 4096W.

CPU Integrated VR Current Limit [Auto]

Allows you to set a higher current limit to prevent frequency and power throttling when overclocking. Use the <+> and <-> keys to adjust the value. The values range from 0.125 to 1023.875 with a 0.125 interval.

CPU Internal Power Switching Frequency

Frequency Tuning Mode [Auto]

Allows you to increase or decrease the switching frequency of the internal regulator. Decrease to help consume less power or increase to help voltage stability. When this item is set to [+] or [-], the Frequency Tuning Offset appears and allows you to set its value from 0% to 6%.

CPU Internal Power Fault Control

Thermal Feedback [Auto]

Allows the CPU to take precautionary actions when the thermal conditions of the external regulator exceeds the threshold.

Configuration options: [Auto] [Disabled] [Enabled]

CPU Integrated VR Fault Management [Auto]

Allows you to prevent tripping the Fully Integrated Voltage Regulator when doing over-voltage. Configuration options: [Auto] [Disabled] [Enabled]



We recommend to set this item to **[Disable]** when overclocking.

CPU Internal Power Configuration

CPU Integrated VR Efficiency Management [Auto]

Allows you to improve power saving when the processor is in low power state. Disable this item to make the Fully Integrated Voltage Regulator work in high performance at all times.

Configuration options: [Auto] [High Performance] [Balanced]

Power Decay Mode [Auto]

Allows you to enable this item to improve the power saving on the Fully Integrated Voltage Regulator as the processor goes into low current state.

Configuration options: [Auto] [Disabled] [Enabled]

Idle Power-in Response [Auto]

Allows you to set the slew rate for the Fully Integrated Voltage Regulator as it enters manual override mode.

Configuration options: [Auto] [Regular] [Fast]

Idle Power-out Response [Auto]

Allows you to set the slew rate for the Fully Integrated Voltage Regulator as it exits manual override mode.

Configuration options: [Auto] [Regular] [Fast]

Power Current Slope [Auto]

Allows you to adjust the gradient of the high-speed active phase current balance during load transients to eliminate current imbalance, resulting from a load current oscillating near the switching frequency.

Configuration options: [Auto] [LEVEL -4] - [LEVEL 4]

Power Current Offset [Auto]

Allows you to increase or decrease the output current sensed by the CPU. It finds the balance between optimal regulating while staying below the current threshold.

Configuration options: [Auto] [100%] [87.5%] [75.0%] [62.5%] [50.0%] [37.5%] [25.0%] [12.5%] [0%] [-12.5%] [-25.0%] [-37.5%] [-50.0%] [-62.5%] [-75.0%] [-87.5%] [-100%]

Power Fast Ramp Response [Auto]

Allows you to increase to enhance the response of the voltage regulator during the load transient. Configuration options: [Auto] [0.00] - [1.50]

CPU Internal Power Saving Control

Power Saving Level 1 Threshold [Auto]

Lower value provides sufficient overclocking tolerance to enlarge the overclocking potential. Higher value provides better power-saving condition. Use <+> or <-> key to adjust the value. The values range from 0A to 80A at 1Amp increment.

Power Saving Level 2 Threshold [Auto]

Lower value provides sufficient overclocking tolerance to enlarge the overclocking potential. Higher value provides better power-saving condition. Use <+> or <-> key to adjust the value. The values range from 0A to 50A at 1Amp increment.

Power Saving Level 3 Threshold [Auto]

Lower value provides sufficient overclocking tolerance to enlarge the overclocking potential. Higher value provides better power-saving condition. Use <+> or <-> key to adjust the value. The values range from 0A to 30A at 1Amp increment.

CPU Core Voltage [Auto]

Configures the amount of Voltage fed to the cores of the processor. Increase when increasing Core Frequency. Use <+> or <-> key to adjust the value. The values range from 1.050000V to 2.200000V at 0.003125V increment. Configuration options: [Auto] [Manual Mode] [Offset Mode]



Appear only when you set the CPU Core Voltage to **[Manual Mode]**.

CPU Core Voltage Override [Auto]

Allows you to configure the CPU Core voltage.



The following items appear only when you set the CPU Core Voltage to **[Offset Mode]**.

Offset Mode Sign [+]

- [+] To offset the voltage by a positive value.
- [-] To offset the voltage by a negative value.

CPU Core Voltage Offset [Auto]

This item allows you to configure the CPU core voltage offset value.

CPU Cache Voltage [Auto]

Use<+> or <-> key to adjust the value. The values range from 0.001V to 1.920V at 0.001V increment. Configuration options: [Auto] [Manual Mode] [Offset Mode]



Appear only when you set the CPU Cache Voltage to **[Manual Mode]**.

CPU Cache Voltage Override [Auto]

This item allows you to configure the amount of voltage fed to the CPU uncores including its cache.



The following items appear only when you set the CPU Core Voltage to **[Offset Mode]**.

Offset Mode Sign [+]

- [+] To offset the voltage by a positive value.
- [-] To offset the voltage by a negative value.

CPU Cache Voltage Offset [Auto]

This item allows you to configure the CPU cache voltage offset value.

CPU Graphics Voltage [Auto]

Configures the amount of Voltage fed to the onboard graphics unit on the processor. Increase when increasing IGPU Frequency. Configuration options: [Auto] [Manual Mode] [Offset Mode] [Adaptive Mode]



Appear only when you set the CPU Graphics Voltage to **[Manual Mode]**.

CPU Graphics Voltage Override [Auto]

This item allows you to configure the amount of voltage fed to the CPU uncores including its cache.



The following items appear only when you set the CPU Graphics Voltage to **[Offset Mode]**.

Offset Mode Sign [+]

[+] To offset the voltage by a positive value.

[-] To offset the voltage by a negative value.

CPU Graphics Voltage Offset [Auto]

This item allows you to configure the CPU Graphics voltage offset value.

The following item appears only when you set the CPU Core Voltage to **[Adaptive Mode]**.

Offset Mode Sign [+]

[+] To offset the voltage by a positive value.

[-] To offset the voltage by a negative value.

CPU Graphics Voltage Offset [Auto]

This item allows you to configure the CPU graphics voltage offset value.

Additional Turbo Mode CPU Core Voltage [Auto]

This item allows you to set the amount of voltage fed to the CPU cores when running in turbo mode. Increase the voltage when configuring a high CPU core frequency. The voltage you set is affected by the offset value. Use the <+> or <-> keys to adjust the value. The values range from 0.001V to 1.920 V with a 0.001 V interval.

CPU System Agent Voltage Offset Mode Sign [+]

[+] To offset the voltage by a positive value.

[-] To offset the voltage by a negative value.

CPU System Agent Voltage Offset [Auto]

This item allows you to set the amount of voltage fed to the system agent of the CPU including its PCIe controller and the PCU (power control unit). Increase the voltage to enhance the overlocking capability.

You can use the <+> or <-> keys to adjust the value. The values range from 0.001 V to 0.999 V with a 0.001 V interval.

CPU Analog I/O Voltage Offset Mode Sign [+]

- [+] To offset the voltage by a positive value.
- [-] To offset the voltage by a negative value.

CPU Analog I/O Voltage Offset [Auto]

This item allows you to set the amount of voltage fed to the analog portion of the I/O on the CPU. By default, this item takes the standard value of the installed CPU. Increase the amount of voltage to enhance the overclocking capability.

You can use the <+> or <-> keys to adjust the value. The values range from 0.001 V to 0.999 V with a 0.001 V interval.

CPU Digital I/O Voltage Offset Mode Sign [+]

- [+] To offset the voltage by a positive value.
- [-] To offset the voltage by a negative value.

CPU Digital I/O Voltage Offset [Auto]

This item allows you to set the amount of voltage fed to the digital portion of the I/O on the processor. By default, this item takes the standard value of the installed CPU. Increase the amount of voltage to enhance the overclocking capability.

You can use the <+> or <-> keys to adjust the value. The values range from 0.001 V to 0.999 V with a 0.001 V interval.

SVID Support [Auto]

Set this item to **[Enabled]** when overclocking your system. Disabling this item stops the CPU from communicating with the external voltage regulator.

Configuration options: [Auto] [Disabled] [Enabled]



The following items appear when SVID Support is set to **[Auto]** or **[Disabled]**.

Initial CPU Input Voltage [Auto]

This is the VCCIN for the CPU during initial part of POST. Use the <+> or <-> keys to adjust the value. The values range from 0.800 V to 2.440 V with a 0.010 V interval.

Eventual CPU Input Voltage [Auto]

This is the VCCIN for the CPU just before the CPU loads. Use the <+> or <-> keys to adjust the value. The values range from 0.800 V to 2.440 V with a 0.010 V interval.

DRAM Voltage [Auto]

This item allows you to set the DRAM voltage. You can use the <+> or <-> keys to adjust the value. The values range from 1.20 V to 1.92 V with a 0.005 V interval.



According to Intel® CPU specifications, DIMMs with voltage requirement over 1.65 V may damage the CPU permanently. We recommend that you install the DIMMs with the voltage requirement below 1.65 V.

PCH Core Voltage [Auto]

This item allows you to set the Core voltage for the PCH (Platform Controller Hub). You can use the <+> or <-> keys to adjust the value. The values range from 0.70 V to 1.80 V with a 0.0125 V interval.



- The values of the CPU PLL Voltage, CPU Manual Voltage, CPU Offset Voltage, iGPU Manual Voltage, iGPU Offset Voltage, DRAM Voltage, VCCSA Voltage, VCCIO Voltage, and PCH Voltage items are labeled in different color, indicating the risk levels of high voltage settings.
- The system may need better cooling system for a more stable performance under high voltage settings.

PCH VLX Voltage [Auto]

This item allows you to set the I/O voltage on the PCH (Platform Controller Hub). You can use the <+> or <-> keys to adjust the value. The values range from 1.2000 V to 2.0000 V with a 0.0125 V interval.

VTTDDR Voltage [Auto]

This item allows you to set the termination voltage for the system memory. You can use the <+> or <-> keys to adjust the value. The values range from 0.6000 V to 1.0000 V with a 0.0125 V interval.

DRAM CTRL REF Voltage [Auto]

This item allows you to set the DRAM reference voltage on the control lines from the memory bus. You can use the <+> or <-> keys to adjust the value. The values range from 0.39500x to 0.63000x with a 0.00500x interval.



To set a value for the DRAM reference voltage, we recommend you to set a value close to the standard value which is 0.500000x.

DRAM DATA REF Voltage on CHA/CHB [Auto]

This item allows you to set the DRAM reference voltage on the data lines on Channels A and B. You can use the <+> or <-> keys to adjust the value. The values range from 0.39500x to 0.63000x with a 0.00500x interval.



To set a value for the DRAM reference voltage, we recommend you to set a value close to the standard value which is 0.500000x.

CPU Spread Spectrum [Auto]

This item allows you to enhance the BCLK overclocking capability or reduce the EMI (electromagnetic disturbance) generated by the BCLK. Set this item to [Enabled] for EMI reduction, or set this item to [Disabled] to enhance BCLK overclocking.

Configuration options: [Auto] [Disabled] [Enabled]

BCLK Recovery [Enabled]

This item allows you to enable the BCLK Recovery feature.

Configuration options: [Disabled] [Enabled] [Ignore]

3.5 Main menu

The Main menu screen appears when you enter the Advanced Mode of the BIOS Setup program. The Main menu provides you an overview of the basic system information, and allows you to set the system date, time, language, and security settings.

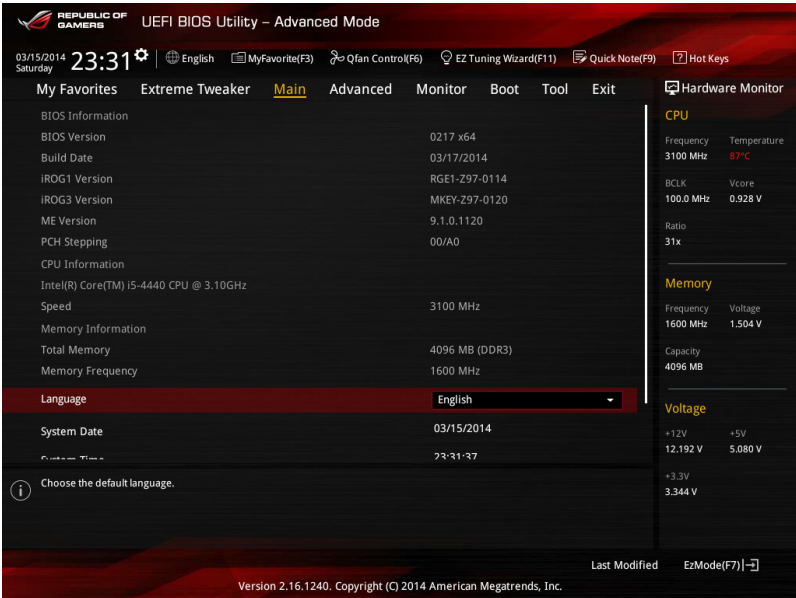

Security

The Security menu items allow you to change the system security settings.

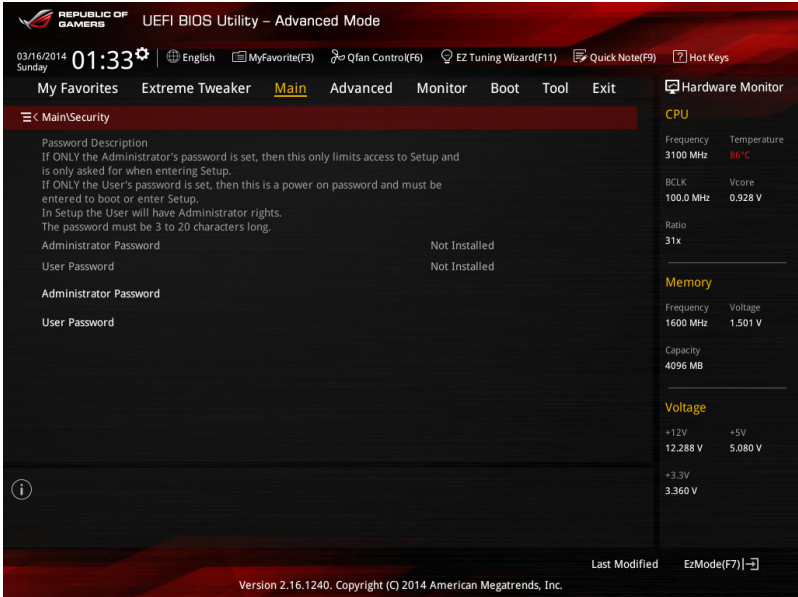

- If you have forgotten your BIOS password, erase the CMOS Real Time Clock (RTC) RAM to clear the BIOS password. See section 1.2.6 **Onboard buttons and switches** for information on how to erase the RTC RAM via the Clear CMOS button.
- The Administrator or User Password items on top of the screen show the default [Not Installed]. After you set a password, these items show [Installed].

Administrator Password

If you have set an administrator password, we recommend that you enter the administrator password for accessing the system. Otherwise, you might be able to see or change only selected fields in the BIOS setup program.

To set an administrator password:

1. Select the **Administrator Password** item and press <Enter>.
2. From the **Create New Password** box, key in a password, then press <Enter>.
3. Confirm the password when prompted.

To change an administrator password:

1. Select the **Administrator Password** item and press <Enter>.
2. From the **Enter Current Password** box, key in the current password, then press <Enter>.
3. From the **Create New Password** box, key in a new password, then press <Enter>.
4. Confirm the password when prompted.

To clear the administrator password, follow the same steps as in changing an administrator password, but press <Enter> when prompted to create/confirm the password. After you clear the password, the **Administrator Password** item on top of the screen shows **Not Installed**.

User Password

If you have set a user password, you must enter the user password for accessing the system. The User Password item on top of the screen shows the default Not Installed. After you set a password, this item shows Installed.

To set a user password:

1. Select the **User Password** item and press <Enter>.
2. From the **Create New Password** box, key in a password, then press <Enter>.
3. Confirm the password when prompted.

To change a user password:

1. Select the **User Password** item and press <Enter>.
2. From the **Enter Current Password** box, key in the current password, then press <Enter>.
3. From the **Create New Password** box, key in a new password, then press <Enter>.
4. Confirm the password when prompted.

To clear the user password, follow the same steps as in changing a user password, but press <Enter> when prompted to create/confirm the password. After you clear the password, the **User Password** item on top of the screen shows **Not Installed**.

3.6 Advanced menu

The Advanced menu items allow you to change the settings for the CPU and other system devices.



Be cautious when changing the settings of the Advanced menu items. Incorrect field values can cause the system to malfunction.

REPUBLIC OF GAMERS UEFI BIOS Utility – Advanced Mode

03/15/2014 Saturday 23:32 English MyFavorite(F3) Qfan Control(F6) EZ Tuning Wizard(F11) Quick Note(F9) Hot Keys

My Favorites Extreme Tweaker Main **Advanced** Monitor Boot Tool Exit Hardware Monitor

- > CPU Configuration
- > PCH Configuration
- > PCH Storage Configuration
- > System Agent Configuration
- > USB Configuration
- > Platform Misc Configuration
- > Onboard Devices Configuration
- > APM Configuration
- > Network Stack Configuration
- > ROG Effects

Hardware Monitor

CPU

Frequency	Temperature
3100 MHz	88°C

BCLK	Vcore
100.0 MHz	0.928 V

Ratio
31x

Memory

Frequency	Voltage
1600 MHz	1.501 V

Capacity
4096 MB

Voltage

+12V	+5V
12.288 V	5.080 V

+3.3V
3.344 V

Version 2.16.1240. Copyright (C) 2014 American Megatrends, Inc.

3.6.1 CPU Configuration

The items in this menu show the CPU-related information that the BIOS automatically detects.



The items in this menu may vary based on the CPU installed.



Intel Adaptive Thermal Monitor [Enabled]

This item allows you to protect the CPU by decreasing its frequency as it reaches the thermal throttle point. The thermal monitor includes TM1 (Thermal monitor 1), TM2 (Thermal monitor 2), and EMTTM (Enhanced Multi-threaded Thermal Monitoring).

Configuration options: [Disabled] [Enabled]

Active Processor Cores [All]

This item allows you to select the number of CPU cores to activate in each processor package.

Configuration options: [All] [1] [2] [3]

Limit CPUID Maximum [Disabled]

When set to [Enabled], this item allows the legacy OS to boot even without support for CPUs with extended CPUID functions.

Configuration options: [Disabled] [Enabled]

Execute Disable Bit [Enabled]

Execute Disable prevents certain classes of malicious buffer overflow attacks when combined with a supporting OS (SuSE Linux 9.2, RedHat Enterprise 3 Update 3).

Configuration options: [Disabled] [Enabled]

Intel Virtualization Technology [Disabled]

When set to **[Enabled]**, a VMM can utilize the additional hardware capabilities provided by Vanderpool Technology.

Configuration options: [Disabled] [Enabled]

Hardware Prefetcher(L2 Cache) [Enabled]

This item allows the CPU to prefetch commands and data in the L2 cache, reduces the DRAM loading time and improves the system performance.

Configuration options: [Disabled] [Enabled]

Adjacent Cache Line Prefetcher [Enabled]

This item allows the mid level cache (L2) to prefetch adjacent cache lines, reducing the DRAM loading time and improves the system performance.

Configuration options: [Disabled] [Enabled]

Boot Performance Mode [Max Non-Turbo Performance]

This item allows you to select the CPU performance state during system boot before the operating system takes control. The CPU runs at a selected performance ratio based on CPU configuration.

Configuration options: [Max Non-Turbo Performance] [Max Battery] [Turbo Performance]

Dynamic Storage Accelerator [Disabled]

This item allows you to accelerate the performance of the SSDs (Solid-State Drives) by dynamically adjusting the power management during heavy multitasking.

Configuration options: [Enabled] [Disabled]

CPU Power Management Configuration

This item allows you to manage and configure the CPU's power.

Enhanced Intel SpeedStep Technology [Enabled]

This item allows your system to adjust the CPU's voltage and cores frequency, resulting in decreased power consumption and heat production.

[Disabled] The CPU runs at its default speed.

[Enabled] The system controls the CPU speed.

Turbo Mode [Enabled]

This item allows you to automatically set the CPU cores to run faster than the base operating frequency when it is below the operating power, current and temperature specification limit.

Configuration options: [Enabled] [Disabled] CPU states [Auto]

CPU C-States [Auto]

This item allows you to set the power saving of the CPU states.

Configuration options: [Auto] [Disabled] [Enabled]



The following items appear only when you set the CPU states to **[Enabled]**.

Enhanced C1 State [Enabled]

This item allows your CPU to reduce power consumption when the system is in idle mode.

Configuration options: [Enabled] [Disabled]

CPU C3 Report [Enabled]

This item allows you to disable or enable the CPU C3 report to the operating system.

Configuration options: [Enabled] [Disabled]

CPU C6 Report [Enabled]

This item allows you to disable or enable the CPU C6 report to the operating system.

Configuration options: [Enabled] [Disabled]

C6 Latency [Short]

This item allows you to set the duration of C6 latency for C6 state.

Configuration options: [Short] [Long]

CPU C7 Report [CPU C7s]

This item allows you to disable or enable the CPU C7 report to the operating system.

Configuration options: [Disabled] [CPU C7] [CPU C7s]

C7 Latency [Long]

This item allows you to set the duration of C7 latency for C7 state.

Configuration options: [Short] [Long]

Package C-States Support [Auto]

This item allows you to set the a C-state support for the CPU package.

Configuration options: [Auto] [Enabled] [C0/C1] [C2] [C3] [C6] [CPU C7] [CPU C7s]

3.6.2 PCH Configuration

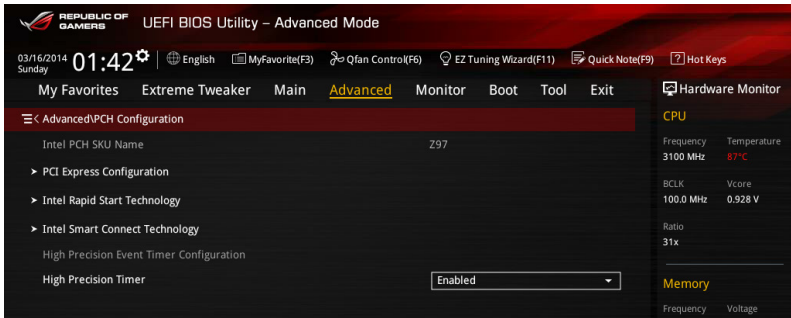

PCI Express Configuration

This item allows you to configure the PCI Express slots.

PCI-E Speed [Auto]

This item allows your system to automatically select the PCI Express port speed. When set to [Gen1], the PCI-E port runs at PCI-E 1.0 speed. When set to [Gen2], the PCI-E port runs at PCI-E 2.0 speed.

Configuration options: [Auto] [Gen1] [Gen2]

Intel Rapid Start Technology [Disabled]

This item allows you to enable or disable Intel® Rapid Start Technology.

Configuration options: [Enabled] [Disabled]



The following items appear only when you set the Intel® Rapid Start Technology to [Enabled].

Entry on S3 RTC Wake [Enabled]

The system automatically wakes up and set to Rapid Start Technology S3 mode.

Configuration options: [Enabled] [Disabled]

Entry After [0]

This item only appears when Entry on S3 RTC Wake is set to [Enabled].

This allows you to set the RTC wake-up timer at S3 entry. The time ranges from 0 minute (immediately) to 120 minutes.

Active Page Threshold Support [Enabled]

The system automatically goes into sleep mode when the partition size is not enough for the Intel® Rapid Start Technology to work.

Configuration options: [Enabled] [Disabled]

Active Memory Threshold [0]

This item only appears when Active Page Threshold Support is set to [Enabled]. This item supports Intel Rapid Storage Technology when the partition size is greater than the Active Page Threshold size. When set to zero (0), it will go to Auto mode and checks if the partition size is enough at S3 entry.

Hybrid Hard Disk Support [Disabled]

This item allows you to enable or disable the hybrid hard disk support for a faster resume time.

Configuration options: [Enabled] [Disabled]

Intel Smart Connect Technology Support [Disabled]

This item allows the system to support Intel Smart Connect Technology that periodically refreshes selected applications when the system is in sleep mode.

Configuration options: [Enabled] [Disabled]

High Precision Time [Enabled]

This item enables or disables the High Precision Event Timer.

Configuration options: [Enabled] [Disabled]

3.6.3 PCH Storage Configuration

While entering Setup, the BIOS automatically detects the presence of SATA devices. The SATA Port items show **Empty** if no SATA device is installed to the corresponding SATA port. Scroll down to display the other BIOS items.

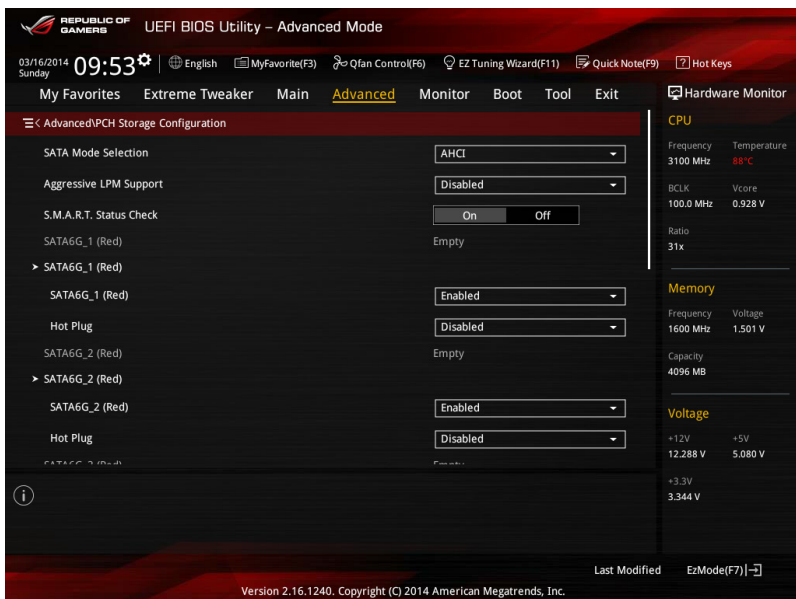

SATA Mode Selection [AHCI]

This item allows you to set the SATA configuration.

- [Disabled] Disables the SATA function.
- [IDE] Set to [IDE] when you want to use the Serial ATA hard disk drives as Parallel ATA physical storage devices.
- [AHCI] Set to [AHCI] when you want the SATA hard disk drives to use the AHCI (Advanced Host Controller Interface). The AHCI allows the onboard storage driver to enable advanced Serial ATA features that increases storage performance on random workloads by allowing the drive to internally optimize the order of commands.
- [RAID] Set to [RAID] when you want to create a RAID configuration from the SATA hard disk drives.



The following item appears only when you set the SATA Mode Selection to **[RAID]**.

Alternate ID [Disabled]

This item allows you to enable or disable Report alternate ID.

Configuration options: [Disabled] [Enabled]

Aggressive LPM Support [Disabled]

This item is designed for LPM (link power management) support with a better energy saving conditions. When set to [Enabled], the hot plug function of SATA ports are disabled.

Configuration options: [Disabled] [Enabled]

S.M.A.R.T. Status Check [On]

S.M.A.R.T. (Self-Monitoring, Analysis and Reporting Technology) is a monitoring system that shows a warning message during POST (Power-on Self Test) when an error occurs in the hard disks. Press <Enter> to set this item On or Off.

Configuration options: [On] [Off]

SATA6G_1 (Red) - SATA6G_6 (Red)

Press <Enter> to rename the Intel SATA ports.

SATA6G_1 (Red) - SATA6G_6 (Red) [Enabled]

This item allows you to enable or disable the selected SATA port.

Configuration options: [Disabled] [Enabled]

Hot Plug [Disabled]

These items appears only when the SATA Mode Selection is set to **[AHCI]** and allows you to enable or disable SATA Hot Plug Support.

Configuration options: [Disabled] [Enabled]

3.6.4 System Agent Configuration

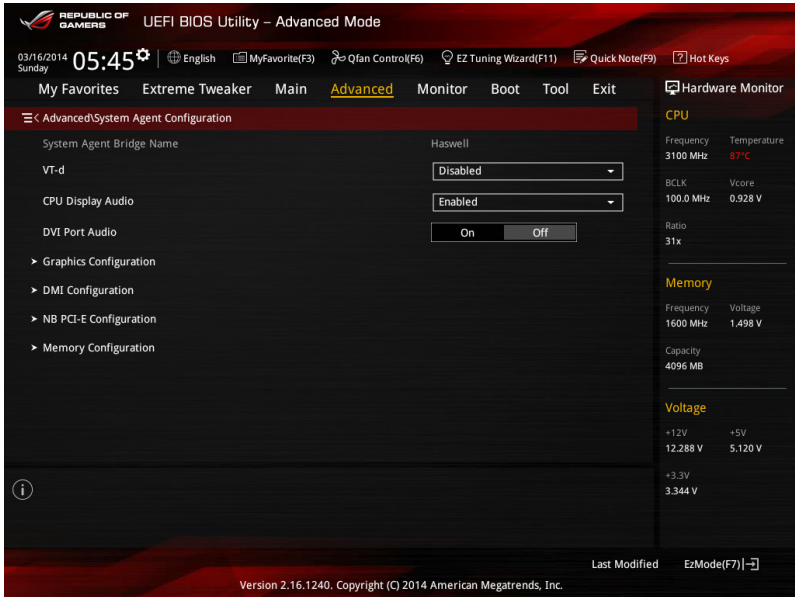

VT-d [Disabled]

Allows you to enable virtualization technology function on memory control hub.

- [Enabled] Enables the function.
- [Disabled] Disables this function.

CPU Display Audio [Enabled]

Enable this item for the CPU display audio support.

Configuration options: [Enabled] [Disabled]

DVI Port Audio [Off]

Enable this item to support audio output for certain DVI monitors. Press <Enter> to turn this item On or Off. Configuration options: [On] [Off]

Graphics Configuration

Allows you to select a primary display from iGPU, and PCIe graphical devices.

Primary Display [Auto]

- [Auto] The primary display will be set to PCI-E when a PCI-E graphic card is detected.
- [CPU Graphics] Force the primary display to be from the CPU Graphics.
- [PCI-E] Force the primary display to be from the PCI-E graphic cards.

CPU Graphics Memory [Auto]

Allows you to select the amount of system memory allocated to DVMT 5.0 used by the CPU graphics.

Configuration options: [Auto] [32M] [64M] [96M] [128M] [160M] [192M] [224M] [256M] [288M] [320M] [352M] [384M] [416M] [448M] [480M] [512M]

Render Standby [Auto]

Allows you to enable the Intel® Graphics Render Standby support to reduce iGPU power use when the system is idle.

Configuration options: [Auto] [Disabled] [Enabled]

CPU Graphics Multi-Monitor [Disabled]

Enable this item for the Intel graphics render standby support to reduce the iGPU power consumption when the system is idle. Configuration options: [Disabled] [Enabled]

DMI Configuration

Enable this item for the DMI (Direct media interface) to run at PCI-E 2.0 speed.

DMI Gen 2 [Enabled]

Configuration options: [Enabled] [Disabled]

NB PCI-E Configuration

Allows you to configure the NB PCI Express settings.

PCIEx16_1/2 Link Speed [Auto]

Allows you to select the operating speed of the PCI-EX16_1 /2 speed.

Configuration options:

- | | |
|--------|--|
| [Auto] | The system will automatically select the PCI-E x16 port speed. |
| [Gen1] | The PCI-EX16 port will run at PCI-E 1.0 speed. |
| [Gen2] | The PCI-EX16 port will run at PCI-E 2.0 speed. |
| [Gen3] | The PCI-EX16 port will run at PCI-E 3.0 speed. |

Memory Configuration

Allows you to configure the memory configuration parameters.

Memory Scrambler [Enabled]

Allows you to enable or disable the Memory Scrambler support.

Configuration options: [Enabled] [Disabled]

Memory Remap [Enabled]

Allows you to enable remapping the memory above 4GB.

Configuration options: [Enabled] [Disabled]

3.6.5 USB Configuration

The items in this menu allow you to change the USB-related features.

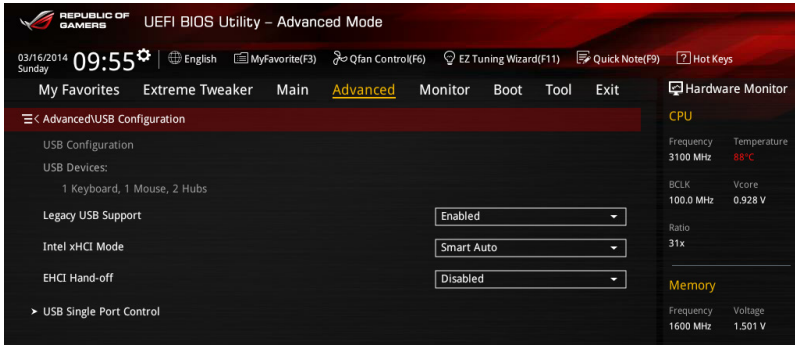

The **USB Devices** item shows the auto-detected values. If no USB device is detected, the item shows **None**.

Legacy USB Support [Enabled]

- [Disabled] The USB devices can be used only for the BIOS setup program. It cannot be recognized in boot devices list.
- [Enabled] Enables the support for USB devices on legacy operating systems (OS).
- [Auto] Allows the system to detect the presence of USB devices at startup. If detected, the USB controller legacy mode is enabled. If no USB device is detected, the legacy USB support is disabled.

Intel xHCI Mode [Smart Auto]

- [Smart Auto] Once the xHCI driver has been detected, the USB 3.0 mode will be supported during both POST and operating system.
- [Auto] xHCI controller will be enabled and run at USB 3.0 mode when the xHCI driver is installed in the operating system.
- [Enabled] Enables the xHCI controller.
- [Disabled] Disables the xHCI controller.

EHCI Hand-off [Disabled]



This item is set to [Disabled] by default for the EHCI (enhanced host controller interface) support by EHCI drivers in operating systems.

- [Disabled] Support EHCI by EHCI drivers for operating systems with EHCI support.
- [Enabled] Support EHCI by BIOS for operating systems without EHCI support.

USB Single Port Control

Allows you to enable or disable the individual USB ports.



Refer to the **Motherboard layout** section for the location of the USB ports.

3.6.6 Platform Misc Configuration

The items in this menu allow you to configure the platform-related features.

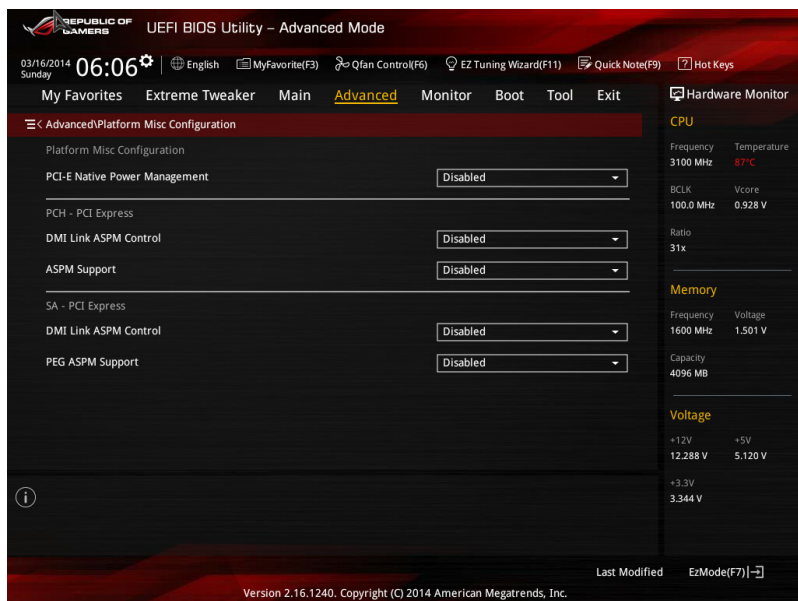

PCI-E Native Power Management [Disabled]

Enable this item to enhance the PCI-E power saving condition.

Configuration options: [Disabled] [Enabled]



The following item appears only when you set the PCI Express Native Power Management to **[Enabled]**.

Native ASPM [Disabled]

Enable this item for the Windows Vista operating system to control the Active State Power Management (ASPM) support for devices.

[Enabled] Vista controls the ASPM support for the device.

[Disabled] BIOS controls the ASPM support for the device.

PCH - PCI Express

DMI Link ASPM Control [Disabled]

This item is for the control of the Active State Power Management on both NB and SB side of the DMI link. Configuration options: [Enabled] [Disabled]

ASPM Support [Disabled]

Select the ASPM states for energy saving conditions. Configuration options: [Disabled] [L0s] [L1s] [L0sL1] [Auto]

SA - PCI Express

DMI Link ASPM Control [Disabled]

Enable the PCH side ASPM for energy saving support. Configuration options: [Disabled] [L0s] [L1s] [L0sL1]

PEG ASPM Control [Disabled]

Select the ASPM states for energy saving conditions. Configuration options: [Disabled] [Auto] [ASPM L0s] [L1] [L0sL1]

3.6.7 Onboard Devices Configuration

Scroll down to view the other BIOS items.

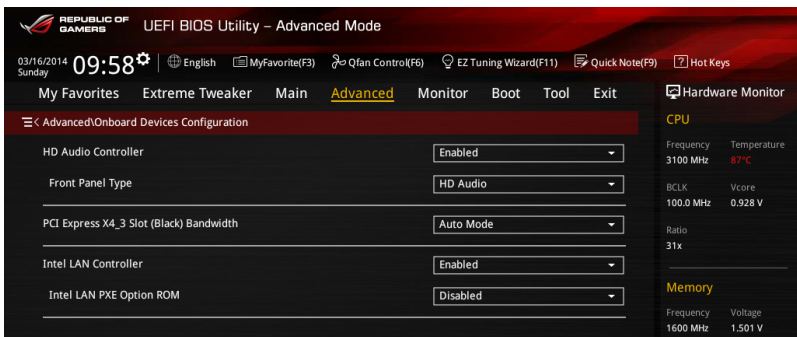

HD Audio Controller [Enabled]

[Enabled] Enables the High Definition Audio Controller.

[Disabled] Disables the controller.



The following items appear only when you set the HD Audio Controller to **[Enabled]**.

Front Panel Type [HD Audio]

[HD Audio] Sets the front panel audio connector (AAFP) mode to high definition audio.

[AC97] Sets the front panel audio connector (AAFP) mode to legacy AC'97

SPDIF Out Type [SPDIF]

[SPDIF] Sets to an SPDIF audio output.

[HDMI] Sets to an HDMI audio output.

PCI Express X4_3 Slot (Black) Bandwidth [Auto Mode]

- [Auto Mode] Two scenarios when Auto Mode is selected:
1. PCIeX4_3 slot runs at X2 mode with all slots enabled. M.2.(Socket 3) connector are disabled.
 2. PCIeX4_3 slot runs at X4 mode for high performance support. PCIeX1_2, PCIeX1_3, and M.2.(Socket 3) connector are disabled.
- [PCIe X1 Mode] PCIeX4_3 slot runs at X2 mode with all slots enabled. M.2 (Socket 3) module is enabled. M.2.(Socket 3) connector is disabled.
- [M.2 Mode] PCIeX4_3 slot runs at X2 mode for M.2 connector support. PCIeX1_2 and PCIeX1_3 are disabled.
- [PCIe X4 Mode] PCIeX4_3 slot runs at X4 mode for high performance support. PCIeX1_2, PCIeX1_3, and M.2 connector are disabled.

Intel LAN Controller [Enabled]

This item allows you to enable or disable the Intel LAN Controller.

Configuration options: [Disabled] [Enabled]

Intel LAN PXE Option ROM [Disabled]

This item appears only when Intel LAN Controller is set to **[Enabled]**. This item allows you to enable or disable the Intel LAN preboot execution environment (PXE) option ROM. Configuration options: [Disabled] [Enabled]

3.6.8 APM Configuration

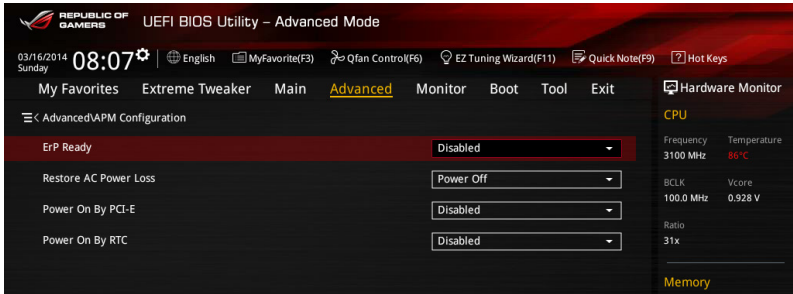

ErP Ready [Disabled]

Allows you to switch off some power at S4+S5 or S5 to get the system ready for ErP requirement. When set to **[Enabled]**, all other PME options will be switched off.

Configuration options: [Disabled] [Enabled(S4+S5)] [Enabled(S5)]

Restore AC Power Loss [Power Off]

[Power Off] The system goes into OFF state after an AC power loss.

[Power On] The system goes into ON state after an AC power loss.

[Last State] The system goes into either OFF or ON state, whatever the system state was before the AC power loss.

Power On By PS/2 Keyboard [Disabled]

Allows you to disable or specify the keys in the PS/2 keyboard that you can use to activate Power On.

Configuration options: [Disabled] [Space Bar] [Ctrl-Esc] [Power Key]

Power On By PCI-E [Disabled]

[Disabled] Disables the PCIE/PCI devices to generate a wake-on-LAN feature of the Intel®/Realtek LAN device or other installed PCIE LAN devices.

[Enabled] Enables the PCIE/PCI devices to generate a wake-on-LAN feature of the PCIE LAN devices.

Power On By RTC [Disabled]

[Disabled] Disables RTC to generate a wake event.

[Enabled] Generates a wake event and configure the real-time clock (RTC) alarm date.

3.6.9 Network Stack Configuration

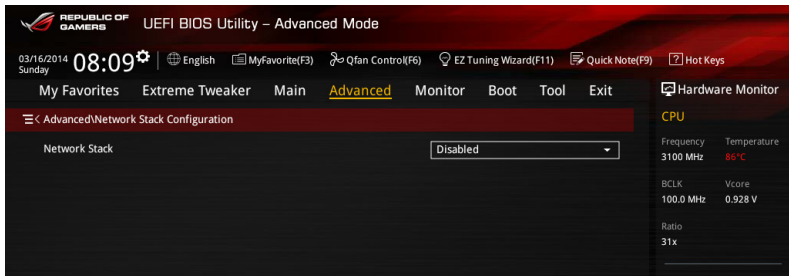

Network Stack [Disabled]

This item allows you to disable or enable the UEFI network stack.

Configuration options: [Disabled] [Enable]



The following items appear only when you set the Network Stack to [Enabled].

Ipv4/Ipv6 PXE Support [Enabled]

Allows you to enable or disable the Ipv4/Ipv6 PXE boot option.

Configuration options: [Disabled] [Enabled]

3.6.10 ROG Effects

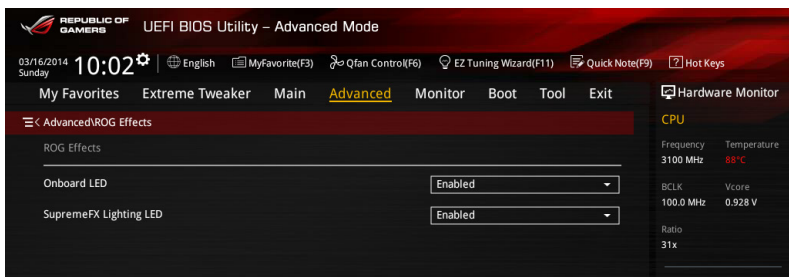

Onboard LED [Enabled]

This item allows you to enable all the onboard LEDs. Configuration options: [Enabled] [Disabled]

SupremeFX Lighting LED [Enabled]

This item allows both Red line LED and SupremeFX logo LED turn on or off at the same time by your setting. Configuration options: [Enabled] [Disabled]

3.7 Monitor menu

The Monitor menu displays the system temperature/power status, and allows you to change the fan settings.

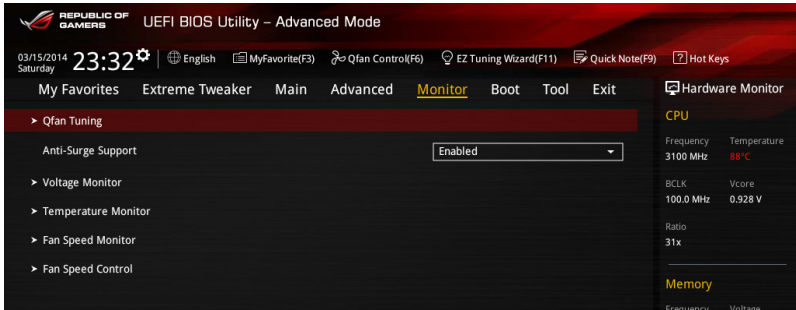

Qfan Tuning

Click this item to automatically detect the lowest speed and configure the minimum duty cycle for each fan.

Anti Surge Support [Enabled]

Enable this item for Over Voltage Protection (OVP) and Under Voltage Protection (UVP) functions.

Configuration options: [Disabled] [Enabled]

Voltage Monitor

CPU Core 0-3 Voltage; CPU Cache Voltage; CPU System Agent Voltage; CPU Analog I/O Voltage; CPU Digital I/O Voltage; CPU Input Voltage; DRAM Voltage; PCH Voltage; 3.3V Voltage; 5V Voltage; 12V Voltage

The onboard hardware monitor automatically detects the voltage output through the onboard voltage regulators. Press <Enter> and select [Ignore] if you do not wish to display the detected temperatures.

Temperature Monitor

CPU Temperature; MB Temperature; SENSOR1 Temperature [xxx°C/xxx°F]

The onboard hardware monitor automatically detects and displays the CPU, and motherboard. Press <Enter> and select [Ignore] if you do not wish to display the detected temperatures.

Fan Speed Monitor

CPU FAN Speed; CPU Optional Fan Speed; Chassis FAN 1-3 Speed

The onboard hardware monitor automatically detects and displays the CPU fan, chassis fan, and optional fan speed in rotations per minute (RPM). If any of the fans is not connected to the motherboard, the field shows [N/A]. These items are not user-configurable. Press <Enter> and select [Ignore] if you do not wish to display the detected temperatures.

Fan Speed Control

CPU Q-Fan Control [Auto]

- | | |
|------------|---|
| [Disabled] | Detects the type of CPU fan installed and automatically switches the mode control. When a 3-pin CPU fan is installed, select this mode for the DC mode Q-Fan control. |
| [Auto] | Enables the CPU Q-Fan control feature in PWM mode for 4-pin CPU fan. |
| [DC Mode] | Disables the Q-Fan control. |
| [PWM Mode] | Disables the Q-Fan control. |

The following items appear only when you set the CPU Q-Fan Control to **[Auto]**.

CPU Fan Speed Lower Limit [300 RPM]

This item allows you to set the low limit warning for CPU Fan speed.

Configuration options: [Ignore] [200 RPM] [300 RPM] [400 RPM] [500 RPM] [600 RPM]

CPU Fan Profile [Standard]

This item allows you to set the appropriate performance level of the CPU fan.

- | | |
|------------|--|
| [Standard] | Set to make the CPU fan adjust automatically depending on the CPU temperature. |
| [Silent] | Set to minimize the fan speed for quiet CPU fan operation. |
| [Turbo] | Set to achieve maximum CPU fan speed. |
| [Manual] | Set to assign the detailed fan speed control parameters. |



The following items appear only when you set the CPU Fan Profile to **[Manual]**.

CPU Upper Temperature [70]

Use the <+> or <-> keys to adjust the upper limit of the CPU temperature. The values range from 20°C to 75°C.

CPU Fan Max. Duty Cycle (%) [100]

Use the <+> or <-> keys to adjust the maximum CPU fan duty cycle. The values range from 20% to 100%. When the CPU temperature reaches the upper limit, the CPU fan will operate at the maximum duty cycle.

CPU Middle Temperature [45]

Displays the lower limit of the CPU temperature.

CPU Fan Middle. Duty Cycle (%) [60]

Use the <+> or <-> keys to adjust the maximum CPU fan duty cycle. The values range from 20% to 100%. When the CPU temperature reaches the upper limit, the CPU fan will operate at the maximum duty cycle.

CPU Lower Temperature [40]

Displays the lower limit of the CPU temperature.

CPU Fan Min. Duty Cycle(%) [60]

Use the <+> or <-> keys to adjust the minimum CPU fan duty cycle. The values range from 0% to 100%. When the CPU temperature is under 40°C, the CPU fan will operate at the minimum duty cycle.

Chassis Fan 1/2/3 Q-Fan Control [DC Mode]

- [Disabled] Disables the Chassis Q-Fan control feature.
- [DC mode] Enable the chassis Q-Fan control in DC mode for 3-pin chassis fan.
- [PWM mode] Enable the chassis Q-Fan control in PWM mode for 4-pin chassis fan.

Chassis Fan 1/2/3 Q-Fan Source [CPU]

The assignment fan will be controlled according to the selected temperature source.
Configuration options: [CPU] [MB] [T_SENSOR1]



For T_SENSOR1, connect a Thermistor cable to the T_SENSOR1 header then place the other end to the component to get the temperature.

Chassis Fan 1/2/3 Fan Speed Low Limit [300 RPM]

This item appears only when you enable the **Chassis Q-Fan Control** feature and allows you to disable or set the chassis fan warning speed.

Configuration options: [Ignore] [200 RPM] [300 RPM] [400 RPM] [500 RPM] [600 RPM]



The following items appears only when you set the Chassis1/Chassis2/Chassis3 Q-Fan Control feature to **[Enabled]**.

Chassis1/Chassis2/Chassis3 Fan Profile [Standard]

This item allows you to set the appropriate performance level of the chassis fan.

- [Standard] Sets to [Standard] to make the chassis fan automatically adjust depending on the chassis temperature.
- [Silent] Sets to [Silent] to minimize the fan speed for quiet chassis fan operation.
- [Turbo] Sets to [Turbo] to achieve maximum chassis fan speed.
- [Manual] Sets to [Manual] to assign detailed fan speed control parameters.



The following four items appear only when you set **Chassis1/Chassis2/Chassis3 Fan Profile** to **[Manual]**.

Chassis Fan 1/2/3 Upper Temperature [70]

Use the <+> or <-> keys to adjust the upper limit of the CPU temperature. The values range from 20°C to 75°C.

Chassis Fan 1/2/3 Max. Duty Cycle (%) [100]

Use the <+> or <-> keys to adjust the maximum CPU fan duty cycle. The values range from 20% to 100%. When the CPU temperature reaches the upper limit, the CPU fan will operate at the maximum duty cycle.

Chassis Fan 1/2/3 Middle Temperature [45]

Displays the lower limit of the CPU temperature.

Chassis Fan 1/2/3 Fan Middle. Duty Cycle (%) [60]

Use the <+> or <-> keys to adjust the maximum CPU fan duty cycle. The values range from 20% to 100%. When the CPU temperature reaches the upper limit, the CPU fan will operate at the maximum duty cycle.

Chassis Fan 1/2/3 Lower Temperature [40]

Displays the lower limit of the CPU temperature.

Chassis Fan 1/2/3 Min. Duty Cycle(%) [60]

Use the <+> or <-> keys to adjust the minimum CPU fan duty cycle. The values range from 0% to 100%. When the CPU temperature is under 40°C, the CPU fan will operate at the minimum duty cycle.

Use the <+> and <-> keys to adjust the minimum chassis fan duty cycle. The values range from 60% to 100%. When the chassis temperature is under 40°C, the chassis fan will operate at the minimum duty cycle.

Allow Fan Stop [Disabled]

This function allows the fan to run at 0% duty cycle when the temperature of the source is dropped below the lower temperature. Configuration options. [Disabled] [Enabled]

3.8 Boot menu

The Boot menu items allow you to change the system boot options.

Scroll down to display the other BIOS items.

The screenshot shows the UEFI BIOS Utility in Advanced Mode. The top bar includes the date and time (03/15/2014 Saturday 23:33), language (English), and various utility shortcuts. The main menu has tabs for My Favorites, Extreme Tweaker, Main, Advanced, Monitor, **Boot**, Tool, and Exit. The Boot menu is expanded, showing the following options:

- Fast Boot: Enabled
- SATA Support: All Devices
- USB Support: Partial Initialization
- PS/2 Keyboard and Mouse Support: Auto
- Network Stack Driver Support: Disabled
- Next Boot after AC Power Loss: Normal Boot
- DirectKey (DRCT): Enabled
- Boot Logo Display: Auto
- POST Delay Time: 3 sec
- Boot up NumLock State: Enabled
- Wait For 'F1' If Error: Enabled

A note at the bottom left states: "Enabled/Disabled boot with initialization of a minimal set of devices required to launch active boot option. Has no effect for BBS boot options."

The Hardware Monitor panel on the right shows the following data:

- CPU**: Frequency 3100 MHz, Temperature 85°C
- BCLK**: 100.0 MHz, **Vcore**: 0.928 V
- Ratio**: 31x
- Memory**: Frequency 1600 MHz, Voltage 1.501 V
- Capacity**: 4096 MB
- Voltage**: +12V 5.080 V, +5V 3.344 V, +3.3V

Fast Boot [Enabled]

[Disabled] Allows your system to go back to its normal boot speed.

[Enabled] Allows your system to accelerate the boot speed.



The following items appear only when you set the Fast Boot to **[Enabled]**.

SATA Support [All Devices]

[All Devices] All devices connected to SATA ports are available during POST. This process extends the POST time.

[Hard Drive Only] Only hard drives connected to SATA ports are detected during POST.

[Boot Drive Only] Only boot drives connected to a SATA ports are detected during POST.

USB Support [Partial Initialization]

[Disabled] All USB devices will not be available until OS boot up for a fastest POST time.

[Full Initialization] All USB devices will be available during POST. This process will extend the POST time.

[Partial Initialization] For a faster POST time, only USB ports with keyboard and mouse connections will be detected.

PS/2 Keyboard and Mouse Support [Auto]

Allows you to disable or have full system control of the PS/2 devices' availability during POST. Configuration options: [Auto] [Disabled] [Full Initialization]

Network Stack Driver Support [Disabled]

[Disabled] Select to skip the network stack driver from loading during POST.

[Enabled] Select to load the network stack driver during POST.

Next Boot after AC Power Loss [Normal Boot]

[Normal Boot] Returns to normal boot on the next boot after an AC power loss.

[Fast Boot] Accelerates the boot speed on the next boot after an AC power loss.

DirectKey (DRCT) [Enabled]

[Enabled] Allow the system to turn on and go to the BIOS setup directly when the reset button is pressed.

[Disabled] The system will only turn on or off when the reset button is pressed.



You have to connect the 2-pin connector of the chassis reset button cable on the onboard DRCT header to support this function.

Boot Logo Display [Disabled]

[Auto] Auto adjustments for Windows requirements.

[Full Screen] Maximize the boot logo size.

[Disabled] Hid the logo during POST.

The following items appears only when you set the Boot Logo Display item to **[Disabled]**.



Post Report [5 sec]

This item This item allows you to select a desired waiting time of the POST report from 0 to 10 seconds or until <ESC> is pressed.

The following items appears only when you set the Boot Logo Display item to **[Full Screen]** or **[Auto]**.



Post Delay Time [3 sec]

This item This item allows you to select a desired additional POST waiting time to easily enter the BIOS Setup. You can only execute the POST delay time during normal boot. The values range from 0 to 10 seconds.

This feature only works when set under normal boot.



Boot up NumLock State [Enabled]

[Enabled] Set the power-on state of the NumLock to **[On]**.

[Disabled] Set the power-on state of the NumLock to **[Off]**.

Wait For 'F1' If Error [Enabled]

Enable this item for the system to pause until the F1 key is pressed when any error occurs. Configuration options: [Disabled] [Enabled]

Option ROM Messages [Enabled]

[Enabled] The Option ROM Messages will be shown during the POST.

[Disabled] Only the ASUS logo will be shown during the POST.

Interrupt 19 Capture [Disabled]

Enable this item to allow the option ROMs to trap the interrupt 19. Configuration options: [Enabled] [Disabled]

Above 4G Decoding [Disabled]

This item enables or disables 64-bit capable devices to be decoded in above 4G address space if your system supports 64-bit PCI Decoding. Configuration options: [Enabled] [Disabled]

Setup Mode [Advanced Mode]

[Advanced Mode] This item allows you to go to Advanced Mode of the BIOS after POST.

[EZ Mode] This item allows you to go to EZ Mode of the BIOS after POST.

CSM (Compatibility Support Module)

This item allows you to configure the CSM (Compatibility Support Module) items to fully support the various VGA, bootable devices and add-on devices for better compatibility.

Launch CSM [Enabled]

- [Auto] The system automatically detects the bootable devices and the add-on devices.
- [Enabled] For better compatibility, enable the CSM to fully support the non-UEFI driver add-on devices or the Windows® UEFI mode.
- [Disabled] Disable the CSM to fully support the non-UEFI driver add-on devices or the Windows® UEFI mode.



The following items appear only when you set the Launch CSM to **[Enabled]**.

Boot Devices Control [UEFI and Legacy OPROM]

This item allows you to select the type of devices that you want to boot.

Configuration options: [UEFI and Legacy OPROM] [Legacy OPROM only] [UEFI only]

Boot from Network Devices [Legacy OPROM first]

This item allows you to select the type of network devices that you want to launch.

Configuration options: [Legacy OPROM first] [UEFI driver first] [Ignore]

Boot from Storage Devices [Legacy OPROM first]

This item allows you to select the type of storage devices that you want to launch.

Configuration options: [Both, Legacy OPROM first] [Both, UEFI first] [Legacy OPROM first] [UEFI driver first] [Ignore]

Boot from PCI-E/PCI Expansion Devices [Legacy OPROM first]

This item allows you to select the type of PCI-E/PCI expansion devices that you want to launch.

Configuration options: [Legacy OPROM first] [UEFI driver first]

Secure Boot

This item allows you to configure the Windows® Secure Boot settings and manage its keys to protect the system from unauthorized access and malwares during POST.

OS Type [Windows UEFI mode]

- [Windows UEFI Mode] This item allows you to select your installed operating system. Execute the Microsoft® Secure Boot check. Only select this option when booting on Windows® UEFI mode or other Microsoft® Secure Boot compliant OS.
- [Other OS] Get the optimized function when booting on Windows® non-UEFI mode. Microsoft® Secure Boot only supports Windows® UEFI mode.

Key Management

Clear Secure Boot keys

This item appears only when you load the default Secure Boot keys. This item allows you to clear all default Secure Boot keys.

Save Secure Boot Keys

This item allows you to save the PK (Platform Keys) to a USB storage device.

PK Management

Delete PK

This item allows you to delete the PK from your system. Once the PK is deleted, all the system's Secure Boot keys will not be active.

Configuration options: [Yes] [No]

Load Default PK

This item allows you to load the downloaded PK from a USB storage device.



The PK file must be formatted as a UEFI variable structure with time-based authenticated variable.

KEK Management



Key-exchange Key (KEK) refers to Microsoft® Secure Boot Key-Enrollment Key (KEK).

Delete KEK

Allows you to delete the KEK from your system.

Configuration options: [Yes] [No]

Load Default KEK

Allows you to load the downloaded KEK from a USB storage device.

Append Default KEK

Allows you to load the additional KEK from a storage device for an additional db and dbx loaded management.



The KEK file must be formatted as a UEFI variable structure with time-based authenticated variable.

DB Management

Delete the db

Allows you to delete the db file from your system.

Configuration options: [Yes] [No]

Load Default db

Allows you to load the downloaded db from a USB storage device.

Append Default db

Allows you to load the additional db from a storage device so that more images can be loaded securely.



The dbx file must be formatted as a UEFI variable structure with time-based authenticated variable. DBX Management

DBX Management

Delete the dbx

Allows you to delete the dbx file from your system.

Load Default dbx

Allows you to load the downloaded dbx from a USB storage device.

Configuration options: [Yes] [No]

Append Default dbx

Allows you to load the additional dbx from a storage device so that more db's images cannot be loaded.



The dbx file must be formatted as a UEFI variable structure with time-based authenticated variable.

Boot Option Priorities

These items specify the boot device priority sequence from the available devices. The number of device items that appears on the screen depends on the number of devices installed in the system.



- To access Windows® OS in Safe Mode, press <F8 > after POST (Windows® 8 not supported).
 - To select the boot device during system startup, press <F8> when ASUS Logo appears.
-

Boot Override

These items displays the available devices. The number of device items that appears on the screen depends on the number of devices installed in the system. Click an item to start booting from the selected device.

3.9 Tool menu

The Tools menu items allow you to configure options for special functions. Select an item then press <Enter> to display the submenu.

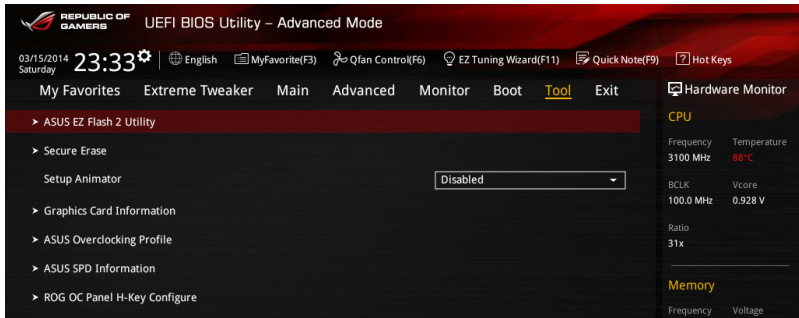

3.9.1 ASUS EZ Flash 2 Utility

Allows you to run ASUS EZ Flash 2. When you press <Enter>, a confirmation message appears. Use the left/right arrow key to select between [Yes] or [No], then press <Enter> to confirm your choice.



For more details, refer to section ASUS EZ Flash 2 utility.

3.9.2 ROG Secure Erase

SSD speeds may lower over time as with any storage medium due to data processing. Secure Erase completely and safely cleans your SSD, restoring it to factory performance levels.



Secure Erase is only available in AHCI mode. Ensure to set the SATA mode to AHCI. Click **Advanced > SATA Configuration > AHCI**.

To launch ROG SSD Secure Erase, click **Tool > ROG SSD Secure Erase** on the Advanced mode menu.



Check the ASUS support site for a full list of SSDs tested with Secure Erase. The drive may become unstable if you run Secure Erase on an incompatible SSD.



- The time to erase the contents of your SSD may take a while depending on its size. Do not turn off the system during the process.
- Secure Erase is only supported on Intel SATA port. For more information about Intel SATA ports, refer to section 1.2.2 of this manual.

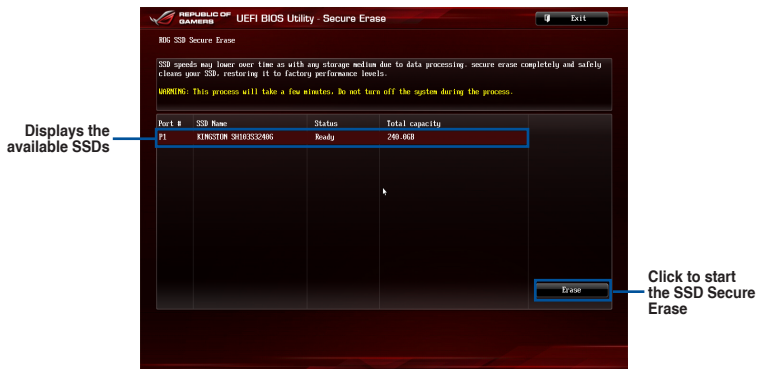

Status definition:

- **Frozen.** The frozen state is the result of a BIOS protective measure. The BIOS guards drives that do not have password protection by freezing them prior to booting. If the drive is frozen, a power off or hard reset of your PC must be performed to proceed with the Secure Erase.
- **Locked.** SSDs might be locked if the Secure Erase process is either incomplete or was stopped. This may be due to a third party software that uses a different password defined by ASUS. You have to unlock the SSD in the software before proceeding with Secure Erase.

3.9.3 Graphics Card Information

This item displays the information about the graphics card installed in your system.

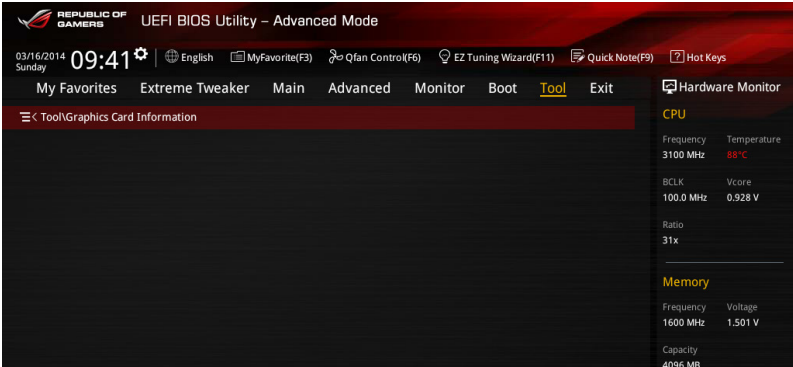

3.9.4 ASUS Overclocking Profile

This item allows you to store or load multiple BIOS settings.

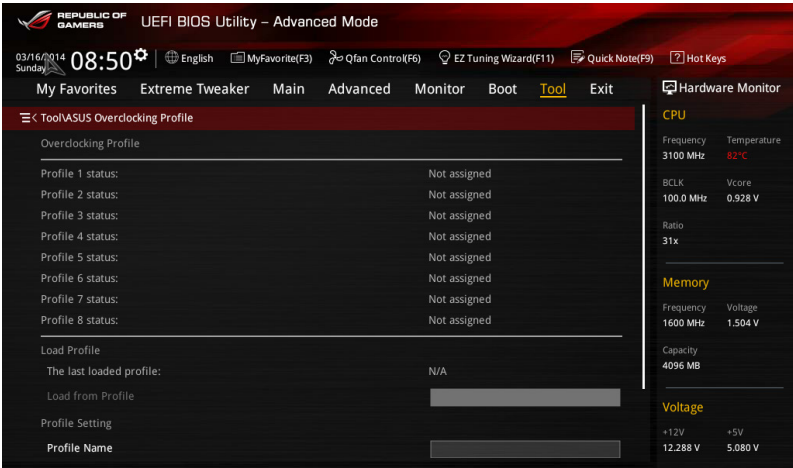

Profile Name

Key in the profile name to save current BIOS settings to profile 1 to 8.

Save to Profile

Saves the current BIOS settings to profile number 1 to 8.

3.9.5 ASUS SPD Information

Allows you to view the DRAM SPD information.

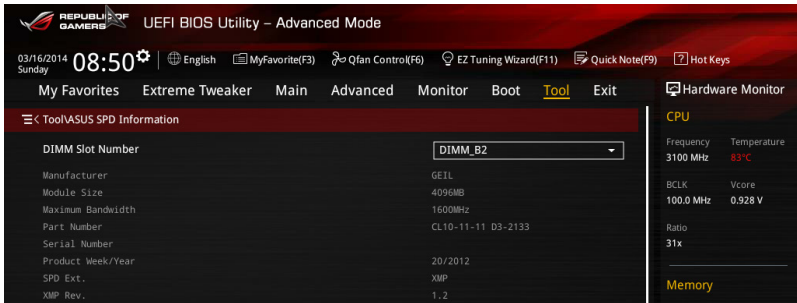

DIMM slot number [DIMM_B2]

Allows you to select the DIMM slot number to show the plugged DRAM Serial Presence Detect (SPD) information. Configuration options: [DIMM_A1] [DIMM_A2] [DIMM_B1] [DIMM_B2]



Some DRAM manufacturers may not be recognized.

3.9.6 ROG OC Panel H-Key Configure

The ROG OC Panel H-Key Configure allows you to input and save values on the CPU core voltage, CPU input voltage, BCLK Frequency, and CPU ratio in the UEFI BIOS. The saved values can be synchronized to a compatible OC Panel device and these values can be tweaked or configured using the OC Panel without going to the BIOS menu.

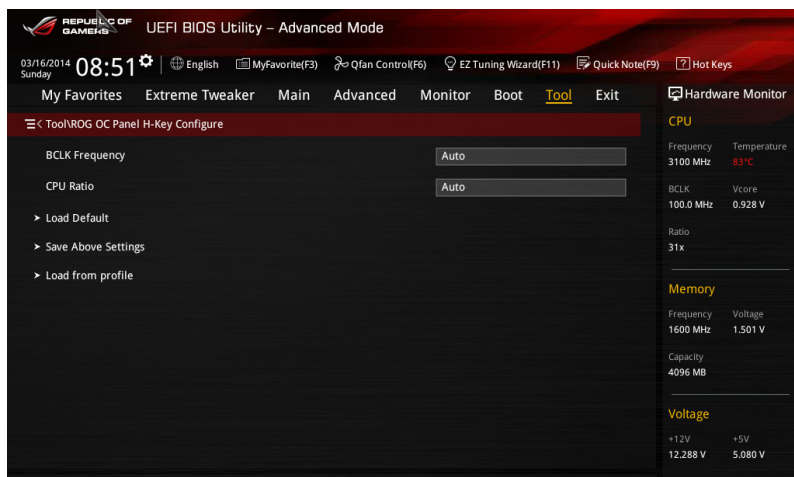

BCLK Frequency [Auto]

This item allows you to input values to the Base Clock (BCLK) Frequency that ranges from 80 MHz to 300 MHz.

CPU Ratio [Auto]

This item allows you to adjust the CPU ratio. The CPU ratio may vary according to the model of the processor.

Load Default

This item allows you to load the default values of the CPU Core Voltage, CPU Input Voltage, BCLK Frequency, and CPU Ratio.

Save Above Settings

This item allows you to save the new values of the CPU Core Voltage, CPU Input Voltage, BCLK Frequency, and CPU Ratio.

Load from profile

This item allows you to load the previous values of the CPU Core Voltage, CPU Input Voltage, BCLK Frequency, and CPU Ratio.

3.10 Exit menu

The Exit menu items allow you to load the optimal default values for the BIOS items, and save or discard your changes to the BIOS items. You can access the EZ Mode from the Exit menu.

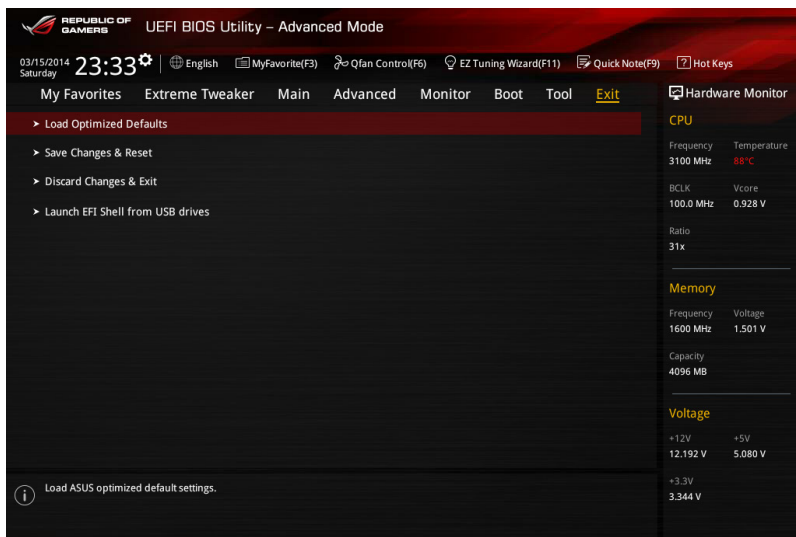

Load Optimized Defaults

This option allows you to load the default values for each of the parameters on the Setup menus. When you select this option or if you press <F5>, a confirmation window appears. Select Yes to load the default values.

Save Changes & Reset

Once you are finished making your selections, choose this option from the Exit menu to ensure the values you selected are saved. When you select this option or if you press <F10>, a confirmation window appears. Select **Yes** to save changes and exit.

Discard Changes & Exit

This option allows you to exit the Setup program without saving your changes. When you select this option or if you press <Esc>, a confirmation window appears. Select **Yes** to discard changes and exit.

Launch EFI Shell from filesystem device

This option allows you to attempt to launch the EFI Shell application (shellx64.efi) from one of the available filesystem devices.

3.11 Updating BIOS

The ASUS website publishes the latest BIOS versions to provide enhancements on system stability, compatibility, and performance. However, BIOS updating is potentially risky. If there is no problem using the current version of BIOS, DO NOT manually update the BIOS. Inappropriate BIOS updating may result to system's failure to boot. Carefully follow the instructions in this chapter to update your BIOS when necessary.



Visit <http://www.asus.com> to download the latest BIOS file for this motherboard.

The following utilities allow you to manage and update the motherboard BIOS setup program.

1. EZ Update: Updates the BIOS in Windows® environment.
2. ASUS EZ Flash 2: Updates the BIOS using a USB flash drive.
3. ASUS CrashFree BIOS 3: Restores the BIOS using the motherboard support DVD or a USB flash drive when the BIOS file fails or gets corrupted.
4. ASUS BIOS Updater: Updates the BIOS in DOS environment using the motherboard support DVD and a USB flash disk drive.

3.11.1 EZ Update

The EZ Update is a utility that allows you to update the motherboard BIOS in Windows® environment.



- EZ Update requires an Internet connection either through a network or an ISP (Internet Service Provider).
 - This utility is available in the support DVD that comes with the motherboard package.
 - Refer to section **EZ Update** for more information.
-

3.11.2 ASUS EZ Flash 2

ASUS EZ Flash 2 allows you to update the BIOS without having to use a bootable floppy disk or an OS-based utility.



Before you start using this utility, download the latest BIOS from the ASUS website at www.asus.com.

To update the BIOS using EZ Flash 2:

1. Insert the USB flash disk that contains the latest BIOS file to the USB port.
2. Enter the Advanced Mode of the BIOS setup program. Go to the Tool menu to select ASUS EZ Flash Utility and press <Enter> to enable it.

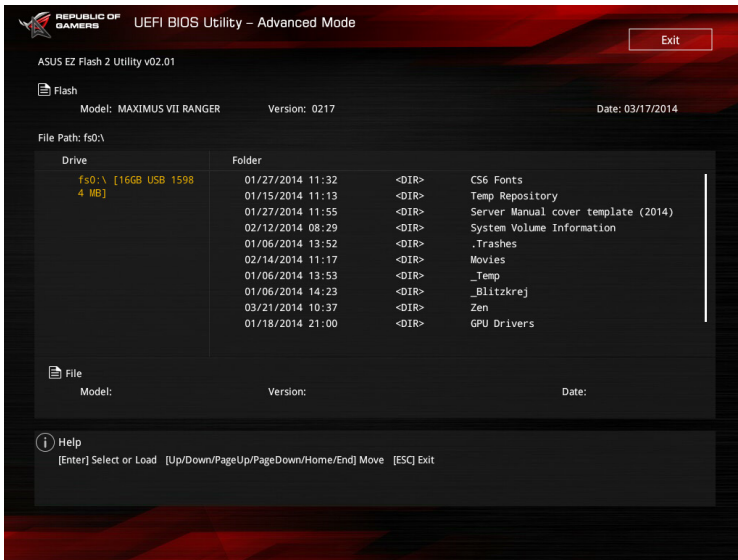

3. Press <Tab> to switch to the Drive field.
4. Press the Up/Down arrow keys to find the USB flash disk that contains the latest BIOS, and then press <Enter>.
5. Press <Tab> to switch to the Folder Info field.
6. Press the Up/Down arrow keys to find the BIOS file, and then press <Enter> to perform the BIOS update process. Reboot the system when the update process is done.



-
- This function can support devices such as a USB flash disk with FAT 32/16 format and single partition only.
 - DO NOT shut down or reset the system while updating the BIOS to prevent system boot failure!
-



Ensure to load the BIOS default settings to ensure system compatibility and stability. Select the Load Optimized Defaults item under the Exit menu. See section **3.10 Exit Menu** for details.

3.11.3 ASUS CrashFree BIOS 3

The ASUS CrashFree BIOS 3 utility is an auto recovery tool that allows you to restore the BIOS file when it fails or gets corrupted during the updating process. You can restore a corrupted BIOS file using the motherboard support DVD or a USB flash drive that contains the BIOS file.



The BIOS file in the motherboard support DVD may be older than the BIOS file published on the ASUS official website. If you want to use the newer BIOS file, download the file at <http://support.asus.com> and save it to a USB flash drive.

Recovering the BIOS

To recover the BIOS:

1. Turn on the system.
2. Insert the motherboard support DVD to the optical drive, or the USB flash drive containing the BIOS file to the USB port.
3. The utility automatically checks the devices for the BIOS file. When found, the utility reads the BIOS file and enters ASUS EZ Flash 2 automatically.
4. The system requires you to enter BIOS Setup to recover the BIOS setting. To ensure system compatibility and stability, we recommend that you press <F5> to load default BIOS values.



DO NOT shut down or reset the system while updating the BIOS! Doing so can cause system boot failure!

3.11.4 ASUS BIOS Updater

ASUS BIOS Updater allows you to update the BIOS in DOS environment.



The screen captures used in this section are for reference only and may not be exactly the same as actually shown on your computer screen.

Before updating BIOS

- Prepare the motherboard support DVD and a USB flash drive.
- Download the latest BIOS file and BIOS Updater from <http://support.asus.com> and save them in your USB flash drive.



NTFS is not supported under DOS environment. Ensure that your USB flash drive is in single partition and in FAT32/16 format.

- Turn off the computer.
- Ensure that your computer has a DVD optical drive.

Booting the system in DOS environment

To boot the system in DOS:

1. Insert the USB flash drive with the latest BIOS file and BIOS Updater to the USB port.
2. Boot your computer then press <F8> to launch the select boot device screen.
3. When the select boot device screen appears, insert the Support DVD into the optical drive then select the optical drive as the boot device.

```
Please select boot device:
-----
E1:  ASUS DVD-E818A6T  (4069MB)
     USB DISK 2.0  (3824MB)
UEFI: (FAT)  USB DISK 2.0  (3824MB)
Enter Setup
-----

↑ and ↓ to move selection
ENTER to select boot device
ESC to boot using defaults
```

- When the booting message appears, press <Enter> within five (5) seconds to enter FreeDOS prompt.

```
ISOLINUX 3.20 2006-08-26 Copyright (C) 1994-2005 H. Peter Anvin
A Bootable DVD/CD is detected. Press ENTER to boot from the DVD/CD.
If no key is pressed within 5 seconds, the system will boot next priority
device automatically. boot:
```

- On the FreeDOS prompt, type **d:** then press <Enter> to switch the disk from Drive C (optical drive) to Drive D (USB flash drive).

```
Welcome to FreeDOS (http://www.freedos.org) !
C:> d:
D:>
```

Updating the BIOS file

To update the BIOS file:

- On the FreeDOS prompt, type **bupdater /pc /g** and press <Enter>.

```
D:> bupdater /pc /g
```

- On the BIOS Updater screen, press <Tab> to switch from Files panel to Drives panel then select **D:**.

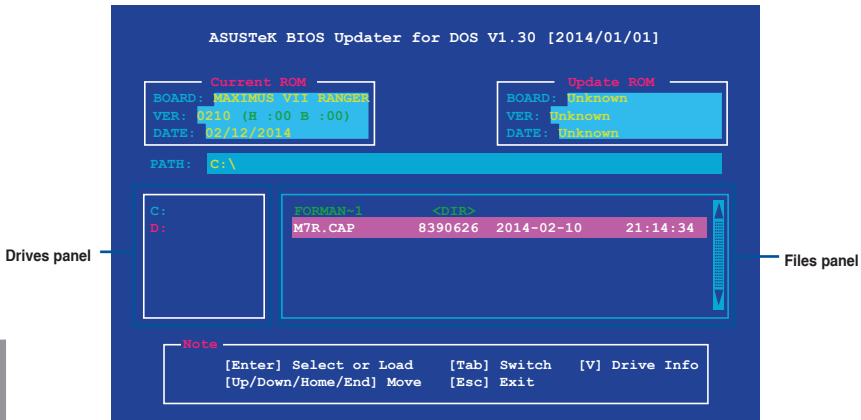

- Press <Tab> to switch from Drives panel to Files panel then press <Up/Down or Home/End> keys to select the BIOS file and press <Enter>.

4. After the BIOS Updater checks the selected BIOS file, select **Yes** to confirm the BIOS update.



The BIOS Backup feature is not supported due to security regulations.

5. Select **Yes** then press <Enter>. When BIOS update is done, press <ESC> to exit BIOS Updater.
6. Restart your computer.



DO NOT shut down or reset the system while updating the BIOS to prevent system boot failure.



Ensure to load the BIOS default settings to ensure system compatibility and stability. Select the **Load Optimized Defaults** item under the **Exit BIOS** menu. See section **3.10 Exit menu** for details.

Software support

4

4.1 Installing an operating system



- This motherboard supports Windows® 7, Windows® 8, Windows® 8.1 32/64-bit operating systems (OS).
- Motherboard settings and hardware options vary. Use the setup procedures presented in this chapter for reference only. Refer to your OS documentation for detailed information.

4.2 Support DVD information



The contents of the support DVD are subject to change at any time without notice. Visit www.asus.com for updates.

4.2.1 Running the support DVD



Ensure that you have an Administrator account before running the support DVD in Windows® 7, Windows® 8, or Windows® 8.1 OS.

To run the support DVD:

1. Place the Support DVD into the optical drive.
2. In the **AutoPlay** dialog box, click **Run ASSETUP.exe**.

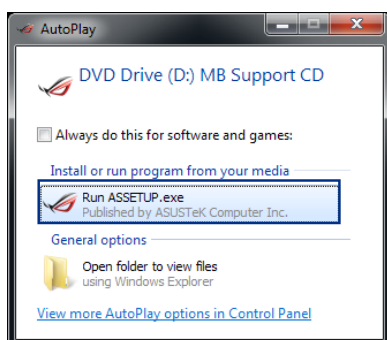

If the **AutoPlay** dialog box does not appear, browse the contents of the support DVD and double-click or tap `\\bin\ASSETUP.EXE` to launch the **ASUS motherboard support DVD** main menu.

Support DVD main menu

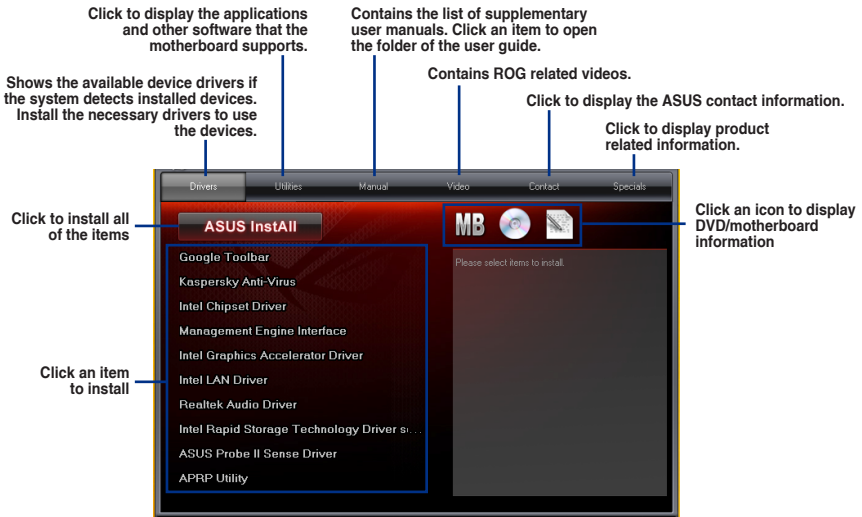

4.2.2 Obtaining the software manuals

The software manuals are included in the support DVD. Follow the instructions below to get the necessary software manuals.



The software manual files are in Portable Document Format (PDF). Install the Adobe® Acrobat® Reader from the **Utilities** tab before opening the files.

To read about your motherboard's utility guide:

1. Click **Manual** tab > **ASUS Motherboard Utility Guide**.

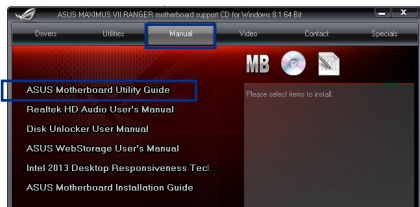

2. From the **Manual** folder, open the folder of the software manual that you wish to read.

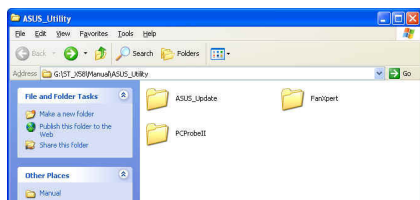

3. Some software manuals are provided in different languages. Open the language's folder to view the software manual.

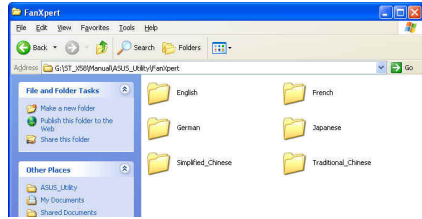

The screenshots in this section are for reference only. The actual software manuals containing in the support DVD vary by models.

4.3 Software information

Most of the applications in the support DVD have wizards that will conveniently guide you through the installation. View the online help or readme file that came with the software application for more information.

4.4 AI Suite 3

AI Suite 3 is an all-in-one interface that integrates several ASUS utilities and allows you to launch and operate these utilities simultaneously.

Installing AI Suite 3



Ensure that you have an Administrator account before installing AI Suite 3 in Windows® 7, Windows® 8, or Windows® 8.1 OS.

To install AI Suite 3 on your computer:

Windows® 7 OS

1. Place the Support DVD into the optical drive.
2. In the **AutoPlay** dialog box, click **Run ASSETUP.exe** then select the **Utilities** tab

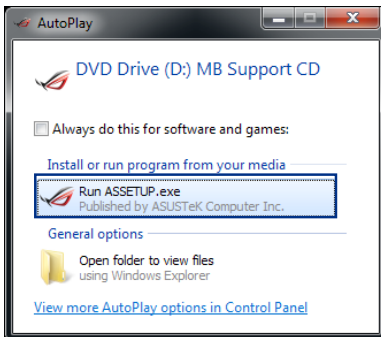

3. From the **Utilities** tab, click **AI Suite 3** then follow the succeeding onscreen instructions.

Windows® 8 / Windows® 8.1 OS

1. Place the Support DVD into the optical drive then follow onscreen instructions.
2. From the **ASUS motherboard support DVD** main menu, select the **Utilities** tab and click **AI Suite 3**.
3. Follow the succeeding onscreen instructions.

If the **ASUS motherboard support DVD** main menu did not appear, try the following steps:

- a. Go to the **Start Screen** then click or tap the **Desktop** app.
- b. On the lower left corner of the Desktop, click or tap **File Explorer**  then select your DVD drive and tap or double-click the **Setup** application.

Launching AI Suite 3

Windows® 7 OS

From the Desktop, click **Start > All Programs > ASUS > AI Suite 3 > AI Suite 3**.

You can also launch AI Suite 3 in Windows® 7 by clicking  on the Notification area.

Windows® 8 / Windows® 8.1 OS

To launch AI Suite 3 in Windows® 8, tap the **AI Suite 3** app on the Start Screen (or if you're using a mouse, click the **AI Suite 3** app on the Start screen).

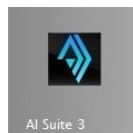

AI Suite 3 Main menu

The AI Suite 3 main menu gives you easy-access controls and insight to what's going on with your computer - allowing you to optimize performance settings while at the same time ensuring system stability.

The AI Suite main menu includes a quick-access menu bar that allows you to swiftly launch any of the integrated ASUS utilities. Click or tap  on the top-right corner of the menu to launch the menu bar.



The AI Suite 3 screenshots in this section are for reference only and can vary depending on motherboard model.

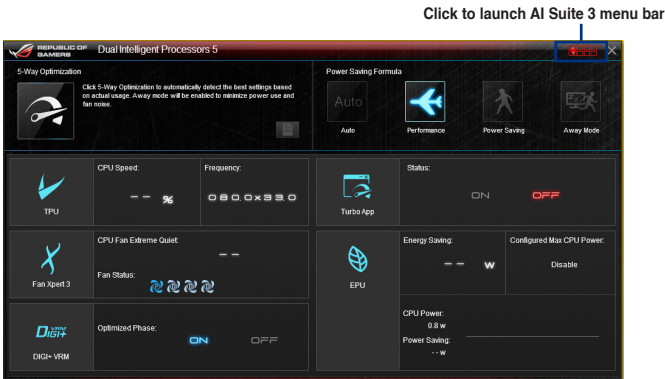

AI Suite 3 main menu bar

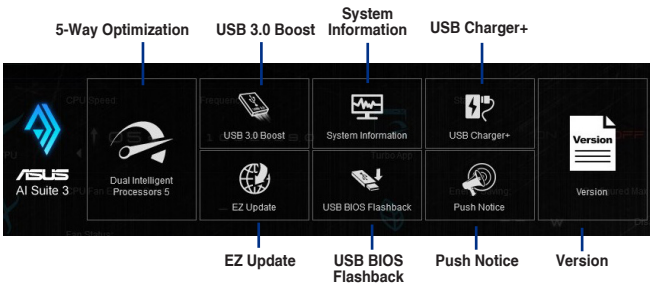

- Some functions in the AI Suite 3 main menu in this user guide may vary depending on the motherboard model.
- Refer to the software manual in the support DVD or visit the ASUS website at www.asus.com for detailed software configuration.

4.5 Dual Intelligent Processors 5

ASUS Dual Intelligent Processors 5 combines TPU, EPU, DIGI+ Power Control, Fan Xpert 3, and Turbo App functions to push the system's performance to its optimal potential. It automatically balances the system's performance, power saving, levels, and fan settings via the user-friendly AI Suite 3 utility.

5-Way Optimization

The 5-Way Optimization function dynamically optimizes your PC based on real-time usage to provide the best system status. It covers the essential areas such as CPU performance, energy saving, stable digital power, cool and quiet fan control, and includes tailored settings for your apps to ensure your PC is ready for gaming, entertainment, productivity, or just about anything.

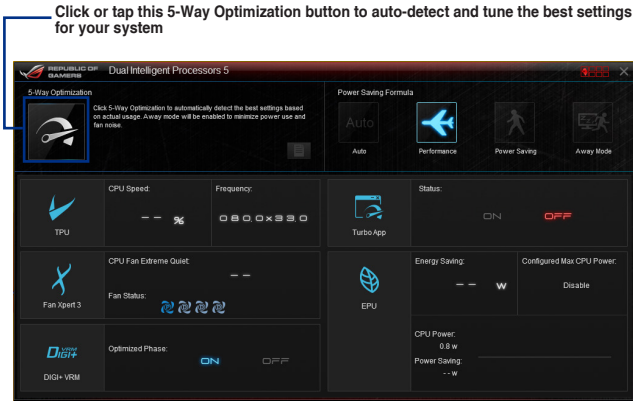

DO NOT remove your fan during the tuning process.

Turbo Processing Unit (TPU)

TPU allows you to manually adjust the CPU frequency, CPU cache, core frequencies, DRAM frequency, and related voltages for an enhanced system stability and a performance boost.



Refer to the CPU documentation before adjusting CPU voltage settings. Setting a high voltage may damage the CPU permanently, and setting a low voltage may lead to an unstable system.



For system stability, the TPU settings are not saved in the BIOS and are not loaded during system bootup. Save your overclocking settings as a TPU profile and manually load this profile after system bootup.

Using TPU

CPU Frequency

Click or tap ◀ or ▶ to adjust the Base Clock Frequency, CPU Ratio, and CPU Cache Ratio

Click or tap ◀ or ▶ to select the number of cores to adjust

Tick to enable Group Tuning

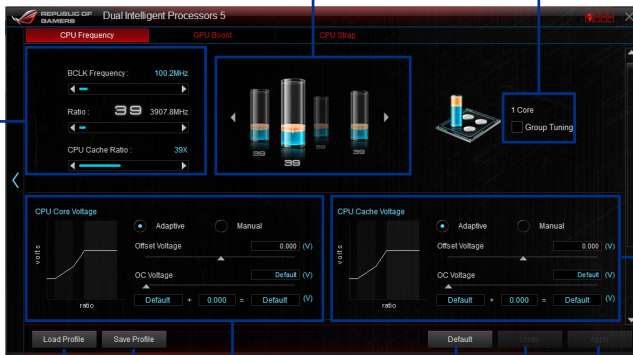

Scroll down to view other items

CPU Cache Voltage adjustments

Click or tap to load the saved profile

CPU Core Voltage adjustments

Click to load the default values

Click or tap to apply the adjustments

Click or tap to save the adjustment into a profile

Click or tap to undo the adjustments



- Set the CPU Ratio Setting item in BIOS to **[Auto]** before using the CPU Frequency in TPU. Refer to the **BIOS** chapter of your motherboard's user guide for details.
- The CPU Frequency bars show the status of the CPU cores, which vary with your CPU model.

GPU Boost

CPU Graphics Voltage Adjustments

The screenshot shows the 'GPU Boost' window with a 'CPU Graphics Voltage Adjustments' panel. The panel includes a 'Max. CPU Graphics Freq' slider set to 800 MHz, a 'CPU Graphics Voltage' graph, and radio buttons for 'Adaptive' (selected) and 'Manual'. Below these are 'Offset Voltage' (0.000 V), 'OC Voltage' (Default V), and a 'Default' button. At the bottom of the window are 'Load Profile', 'Save Profile', and 'Default' buttons. Annotations with arrows point to these buttons and the voltage adjustment section.

Click to load the saved profile

Click to save the adjustment into a profile

Click to enable the default settings

Click to apply the adjustments

Click to undo the adjustments

Energy Processing Unit (EPU)

EPU is a real-time system power-saving chip that automatically detects the current system load and intelligently moderates power usage. It offers a total system-wide energy optimization, reduces fan noise, and extends the lifespan of your hardware components.

Using EPU

The screenshot shows the ASUS EPU utility window titled "Dual Intelligent Processors 5". The interface includes a top navigation bar with tabs for "Auto", "Performance", "Power Saving", "Away Mode", and "Global Setting". The "Auto" mode is currently selected. The main content area displays several settings: "Voltage Decrement" with radio buttons for "Auto" (selected) and "User"; "Configured Max CPU Power" set to "25 W" with a slider; "Fan Profile" set to "Silent (ASUS)" with a dropdown arrow; and "Mute" with a checkbox. A left sidebar shows "Away Mode" with a play button icon. At the bottom, there are buttons for "Default", "Reset", and "Apply".

Click to configure the settings in Auto mode

Click to configure the settings in High Performance mode

Click to configure the settings in Max Power Saving mode

Click to configure the settings in Away mode

Click to configure the Global settings

Click ◀ or ▶ to adjust the configured Max CPU Power

Click ▼ to select a fan profile

Tick to select a setting for Voltage Decrement

Click to enable the default settings

Click to undo the adjustments

Click to apply the adjustments



- When you enable Configured Max CPU Power for advanced energy saving condition, the CPU frequency may display 800 MHz in the Windows® OS information of your computer. However, the true CPU frequency varies depending on the wattage that you manually set. You can adjust the CPU wattage from the lowest base on your preferred default value.
- Configured Max CPU Power may decrease the total power delivery to the CPU and affects the CPU performance under system heavy load. To restore your system to its default settings, reboot your computer.

DIGI+

ASUS DIGI+ Power Control features the revolutionary and innovative digital VRM and DRAM Voltage controllers. These controllers offers ultra-precise memory and voltage tuning for optimal system efficiency, stability and performance.



The following screens are for reference only. Configuration options varies depending on the motherboard model.

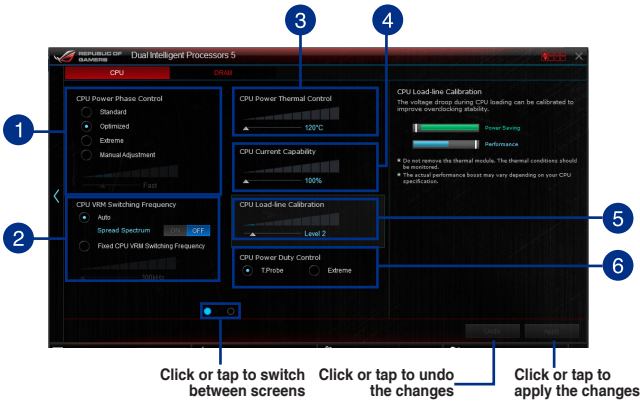

- 1 CPU Power Phase Control**
Increase the phase number under a heavy system load to get more transient and better thermal performance. Reduce the phase number under a light system load to increase the VRM efficiency.
- 2 CPU VRM Switching Frequency**
Enables spread spectrum to enhance system stability.
- 3 CPU Power Thermal Control**
A higher temperature brings a wider CPU power thermal range and extends the overclocking tolerance to enlarge the overclocking potential.
- 4 CPU Current Capability**
CPU Current Capability provides a wider total power range for overclocking. A higher value brings a wider total power range and extends the overclocking frequency range simultaneously.
- 5 CPU Load-line Calibration**
It allows you to adjust the voltage range to control the CPU Load-line. Adjust to a high value for system performance or to a low value for power efficiency.
- 6 CPU Power Duty Control**
CPU Power Duty Control adjusts the current of every VRM phase and the thermal conditions of every phase component.

Fan Xpert 3

ASUS Fan Xpert 3 provides customizable settings of your fans for a cooler and more quiet computing environment. With its fan Auto Tuning feature, ASUS Fan Xpert 3 automatically tweaks the settings of CPU and chassis fans to achieve their best cooling performance. ASUS Fan Xpert 3 also supports hardware level PWM/DC combo mode for the CPU and chassis fans. You can also reduce the CPU fan speed below the default minimum for a noiseless operation during light loads.

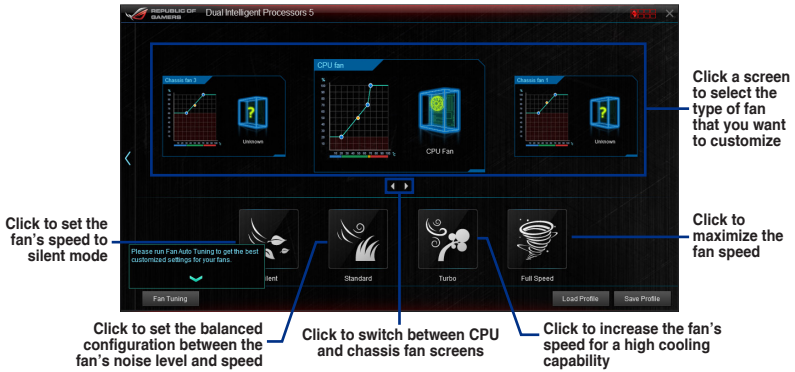

Turbo App

Turbo App allows you customize the system performance, network priority, and audio setting of an application.

When an application is on the Turbo App List, you can allocate the CPU frequency, assign a network priority, and define the audio setting of the selected application.

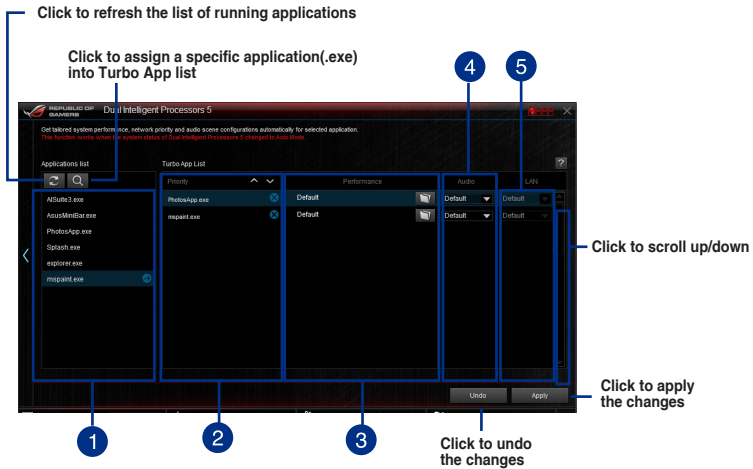

- 1 Applications list pane**
Displays all the running applications on your system.
- 2 Turbo App List pane**
Displays the applications added to the Turbo App List.

* Only applications on the Turbo App List can be configured.

- 3 Performance pane**
Allows you to assign the CPU performance to a selected application.
- 4 Audio pane**
Allows you to manually assign a preset audio configuration to a selected application.
- 5 LAN pane**
Allows you assign the network priority to a selected application.

USB 3.0 Boost

USB 3.0 Boost technology supports UASP (USB Attached SCSI Protocol) that automatically speeds up the transfer rates of your USB storage devices.

Launching USB 3.0 Boost

To launch USB 3.0 Boost, click or tap  on the top-right corner of the AI Suite 3 main menu, then select **USB 3.0 Boost**.

Using the USB 3.0 Boost

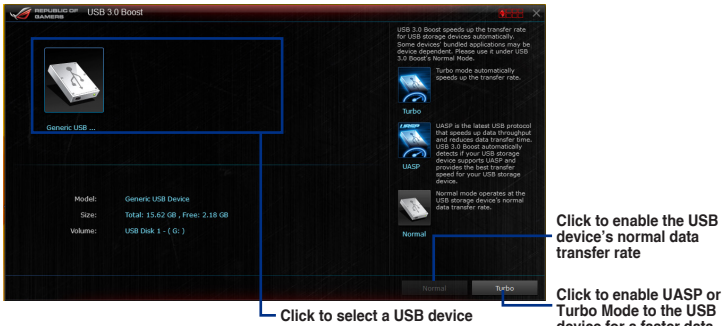

Ensure to connect your USB 3.0 device to the USB 3.0 ports that support USB 3.0 Boost. Refer to the **Rear I/O connection** section of your user guide for more details.



- USB 3.0 Boost automatically detects the USB 3.0 devices that support UASP. For a list of UASP-supported USB 3.0 devices, visit the ASUS website at www.asus.com.
- The data transfer speed varies with USB devices. For a higher data transfer performance, use a USB 3.0 device.

EZ Update

EZ Update is a utility that allows you to automatically update your motherboard's software, drivers, or BIOS.

With this utility, you can also manually update the BIOS and select the boot logo that will display during POST.

Launching EZ Update

To launch EZ Update, click or tap  on the top-right corner of the AI Suite 3 main menu, then click **EZ Update** on the AI Suite 3 main menu bar.

EZ Update screen

Click to automatically update your motherboard's driver, software and firmware

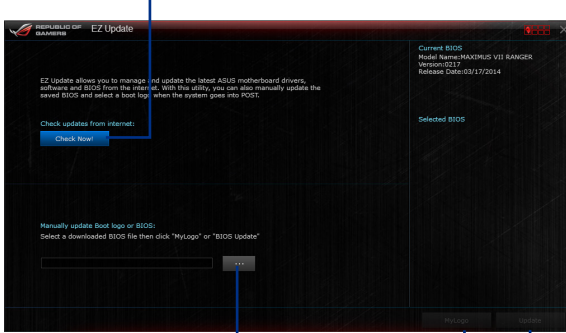

Click to search and select the BIOS file

Click to select a boot logo

Click to update the BIOS

System Information

This utility displays the detailed information and settings of the installed motherboard, CPU, and memory.

Launching the System Information

To launch System Information, click or tap  on the top-right corner of the AI Suite 3 main menu, then select **System Information**.

Viewing the motherboard information

Click or tap the **MB** tab to view the motherboard's information.

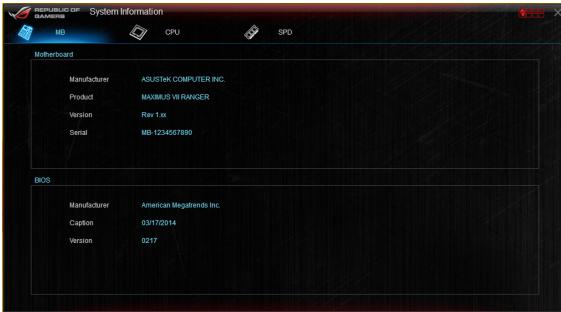

Viewing the CPU information

Click or tap the **CPU** tab to view the processor's information.



Viewing the SPD information

Click or tap the **SPD** tab to view the memory's information.



USB BIOS Flashback

USB BIOS Flashback allows you to check and save the latest BIOS version to a USB storage device. Use this utility to quickly check for the latest available BIOS and set the BIOS download schedule.

Launching USB BIOS Flashback

To launch USB BIOS Flashback, click or tap  on the top-right corner of the AI Suite 3 main menu, then select **USB BIOS Flashback**.



USB BIOS Flashback is available only in selected motherboard models.

Using USB BIOS Flashback

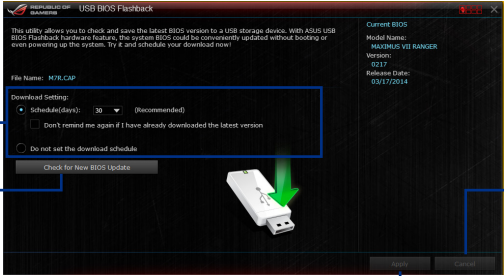

The screenshot shows the USB BIOS Flashback utility window. It includes a title bar, a main text area with instructions, a 'Download Setting' section with radio buttons for 'Schedule (days)' (set to 30) and 'Do not set the download schedule', a 'Check for New BIOS Update' button, and a 'Current BIOS' section with fields for Model Name, Version, and Release Date. A USB drive icon with a green arrow is shown in the center. Callouts point to the 'Schedule (days)' dropdown, the 'Check for New BIOS Update' button, the 'Do not set the download schedule' radio button, and the 'Apply' and 'Cancel' buttons.

Set a schedule for the BIOS Update download

Click to check for a new BIOS update available for download

Click or tap to cancel the download schedule setting

Click or tap to apply the download schedule setting

Scheduling the BIOS download

1. In the Download Setting field, tick **Schedule (days)** then select the number of days for the BIOS download schedule.
2. Click or tap **Apply** to save the BIOS download schedule. Click or tap **Cancel** to cancel the download schedule.

USB Charger+

USB Charger+ allows you to quick-charge your portable USB devices even if your computer is off, in sleep mode, or in hibernate mode.



Before using USB Charger+, ensure to disable the ErP Ready item in the BIOS. To do this, go to **Advanced > APM > ErP Ready** in the Advanced mode then set this item to [Disabled].



USB Charger+ is available only in selected motherboard models.

Launching USB Charger+

To launch USB Charger+, click or tap  on the top-right corner of the AI Suite 3 main menu, then select **USB Charger+**.

Using USB Charger+

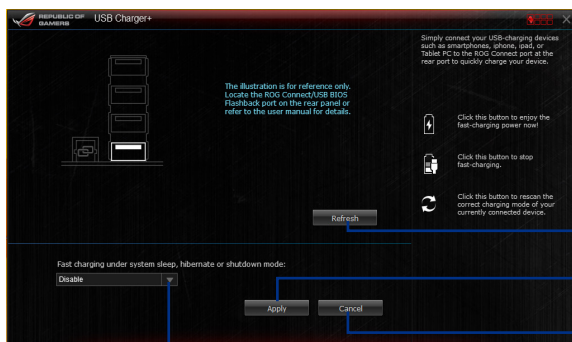

Click or tap to refresh the list

Click or tap to apply the settings

Click or tap to discard the settings

Click or tap to select the type of USB device that you wish to charge when the system is off



Ensure to connect your USB device into the USB port that supports this utility. Refer to section **2.3.1 Rear I/O connection** of your user manual for more details.



- USB Charger+ does not support USB hubs, USB extension cables, and generic USB cables.
- USB Charger+ may not recognize some ASUS devices due to varying design.

Push Notice

This utility allows you get the detailed status of your system to your smart device. You can also send messages to your smart device using this utility.



Before using this utility, ensure that you pair your computer with your smart device. For pairing information, refer to section **Pairing your computer and smart device**.

Launching Push Notice on your computer

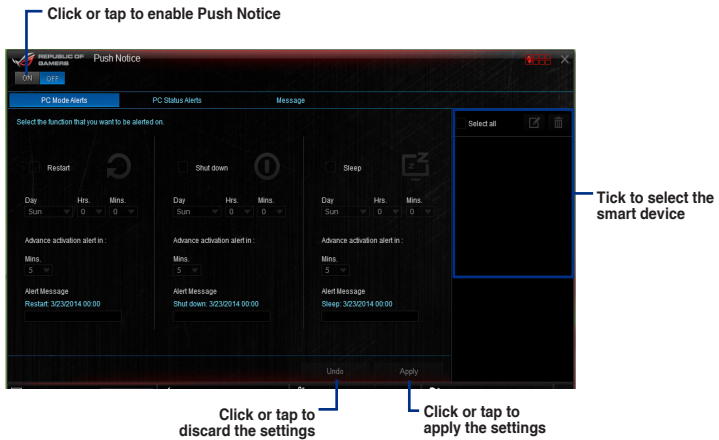

To launch Push Notice, click or tap  on the top-right corner of the AI Suite 3 main menu, then select **Push Notice**.

Push Notice screen



The screenshot shows the Push Notice utility window with three columns for PC Mode Alerts, PC Status Alerts, and Message. The PC Mode Alerts column includes Restart, Shut down, and Sleep options, each with a time selection grid (Day, Hrs, Mins) and an Alert Message field. The Message column has a 'Select all' button. Annotations include: 'Click or tap to enable Push Notice' pointing to the ON/OFF toggle; 'Tick to select the smart device' pointing to the 'Select all' button; 'Click or tap to discard the settings' pointing to the Undo button; and 'Click or tap to apply the settings' pointing to the Apply button.



You can also enable the Push Notice via the Push Notice shortcut on the lower-right corner of your screen. To do this, click or tap << then click or tap  then select .

Pairing your computer and smart device

To pair your computer and smart device:

1. On your smart device, tap  to launch Push Notice.
2. Tap **Push Scan** then tap the name of your computer that you want to pair with.



To pair your computer and smart device, ensure that both are connected to the same wireless network.

Setting up PC Mode alerts of your computer

This feature allows you to restart, shut down, or put your computer to sleep mode and sends an alert to your smart device.

Tick these to enable mode alerts

Set the day and time to enable the PC modes
Set the minutes to send the alert before the PC mode/s activation

Key in your messages for more information

Tick to select the smart device

Setting up PC Status alerts

This feature allows you to send alerts of the unusual activities of the voltage, temperature, and fan settings of your computer to your smart device.

Tick to select and send alerts to your smart device



Tick to send alert when the selected items are back to its normal status

Tick to select the smart device

Sending messages to your smart device

This feature allows you to send messages to your smart device.



You can also send messages via the Push Notice messaging shortcut on the lower-right corner of your screen. To do this, click or tap << then click or tap  then select .

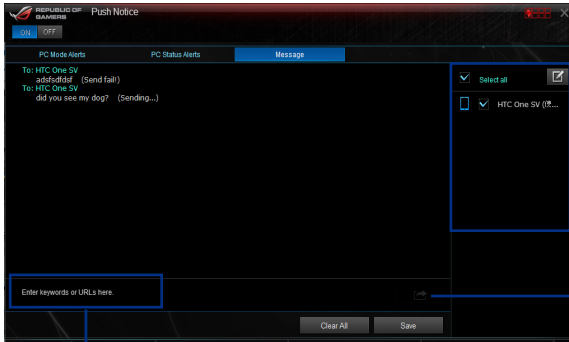

Tick to select the smart device

Click or tap to send your message

Click or tap to key in your message

Viewing your computer status on your smart device



Tap on your smart device to launch Push Notice.

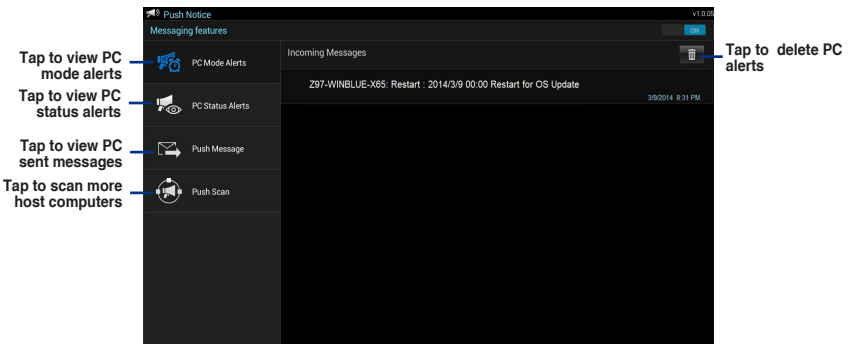

Tap to view PC mode alerts

Tap to view PC status alerts

Tap to view PC sent messages

Tap to scan more host computers

Tap to delete PC alerts

4.6 ROG Audio features

Installing the Software

Follow the installation wizard to install the Realtek® Audio Manager driver from the support DVD that is bundled with the motherboard.

If the Realtek® audio software is correctly installed, you will find the Realtek® HD Audio Manager icon on the taskbar. Double-click or tap on the icon to display the Realtek® HD Audio Manager.

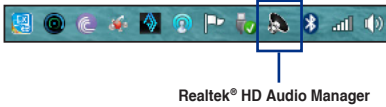

Sonic Studio

Sonic Studio is an audio suite that offers six audio controls: Reverb, Bass Boost, Equalizer, Voice Clarity, Smart EQ (Smart Volume), and Virtual Surround is dedicated for 2-channel headset and offers one of the best virtual surround technology for gaming.

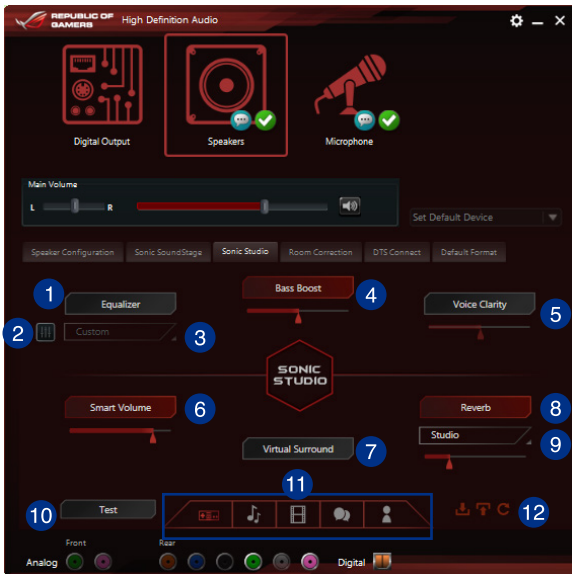

- 1 **Equalizer switch**
Click to enable. This item allows you to adjust the parametric EQ settings according to your preference.
- 2 **Equalizer advanced settings**
This item available only when the Equalizer switch is enabled. This item allows you to configure the Equalizer settings. You can manually set or customized your setting or choose from any of the preset equalizer settings available.
- 3 **Equalizer presets**
Displays the current or selected equalizer preset.
- 4 **Bass Boost switch**
Click to boosts the bass effects. Use the slider to adjust the sound of the bass effect.
- 5 **Voice Clarity switch**
Click to enable this item. Voice clarity extracts human voice for better dialog/audio communication or to hear vocals more clearly when listening to a music.
- 6 **Smart EQ (Smart Volume) switch**
Dynamically adjust the EQ so you can hear more details.
- 7 **Virtual Surround switch**
This item lets you experience 7.1 CH virtual surround from your headset when enabled.
- 8 **Reverb switch**
The Reverb effect is part of the Virtual Sound Stage effects that lets you choose other reverb presets.
- 9 **Reverb presets**
Click to choice and select a reverb effect from the different environmental spaces for reverb effects.

This item is only available when the Reverb switch is enabled.
- 10 **Test tone**
Click this button to start the test for the selected preset profile.
- 11 **Preset profiles**
Click any of the preset profiles. Choose from Gaming, music, movie, or communication.
- 12 **Profile import/export**
Allows you to Import, export, or revert to the default setting of a profile.

Sonic SenseAmp

Sonic SenseAmp is an exclusive ROG invention that is a built-in headphone AMP on onboard audio with three AMP levels adjustment. It detects your headphone's impedance and adjusts the built-in AMP accordingly.



Sonic SenseAmp only works on front panel.

When you plug a headphone into the front headphone jack, Sonic SenseAmp displays a pop-up window that displays "Detecting headphone impedance".

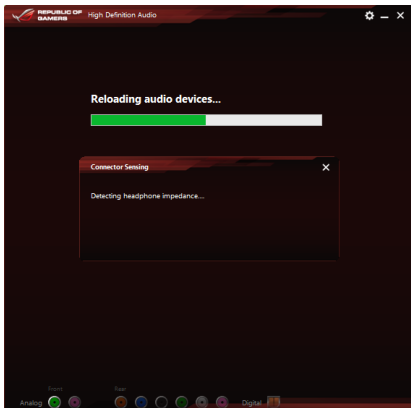

After detecting the headphone's impedance, Sonic SenseAmp displays another pop-up window similar to the one shown below.

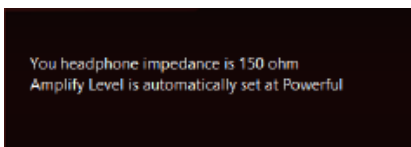

Refer to the table below on the behavior of Sonic SenseAmp when adjusting the impedance of the detected headphone:

32 ohm	Amplify Level is automatically set at Performance
150 ohms	Amplify Level is automatically set at Powerful
> 150 ohms	Amplify Level is automatically set at Extreme
Other device	The device plugged in detected as other device

After you close the pop-window, Sonic SenseAmp enters speaker configuration and displays the adjusted headphone impedance.

Click to manually adjust the amplify level
Displays the impedance of your headphone

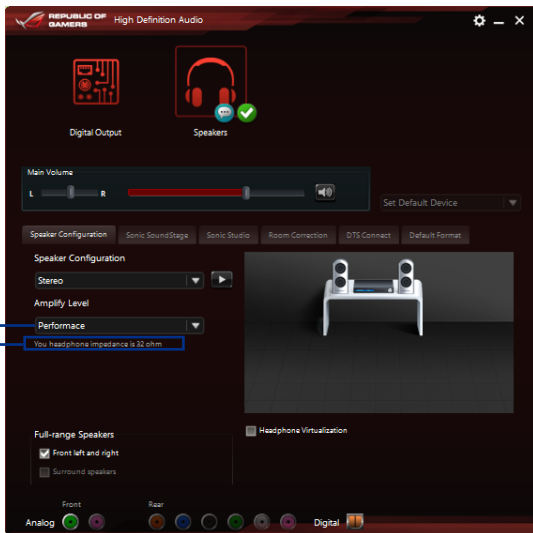

Sonic SoundStage

Sonic SoundStage is a hardware based sound solution for virtual Sound Stage that offers four preset gaming profiles: FPS, Racing, Combat and Sport.



- This feature is only available for front panel Headphone output.
- You can enable this feature by enabling the dedicated SoundStage button on your motherboard. Refer to the section of your motherboard's user guide for the location of the SoundStage button.

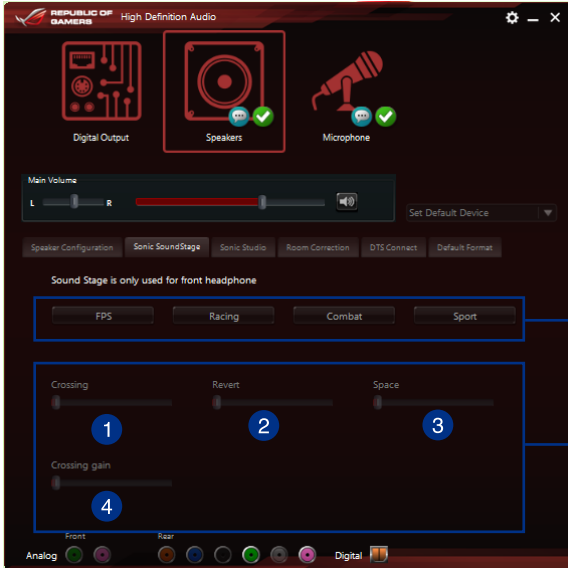

Click any of the four preset gaming profiles

Use the slider to manually adjust the setting of an item

- 1 Crossing**
Move the slider to adjust the amount of cross channel mixing.
- 2 Revert**
Move the slider to revert the main audio source.
- 3 Space**
Move the slider to adjust and virtualize the space sound.
- 4 Crossing gain**
This item only works when Crossing and Revert is enabled. Move the slider to adjust the hardness of the wall.

DTS Connect

DTS Connect delivers excellent audio entertainment across all formats and works with 4, 5.1 and 7.1 channels of incredible surround sound . It also allows you to connect your PC to a home theatre system.



Control settings panel

4.7 Sonic Radar II

Sonic Radar II is designed for First Person Shooting (FPS) games and shows the precise direction and intensity of where a sound is coming from. It features a simple and friendly user-interface and also features sound enhancers to amplify desired sound effects.

Display Menu

Customize the settings for each game including Transparency, Signal, Size, and Remanency.

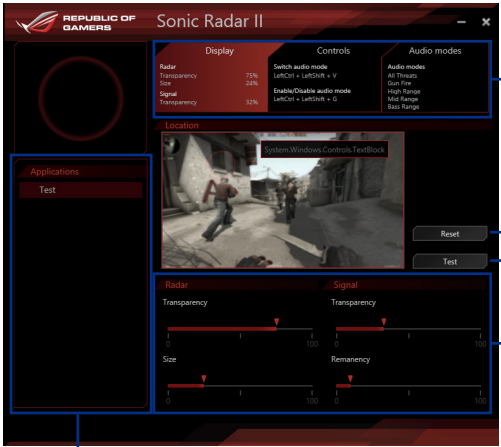

Displays the options available. Click a tab to select an option. Each option has its own settings and menus.

Click to reset to the default settings
Click to start the test tone

Use the sliders to adjust the settings

Displays the list of games

Control Menu

Allows you to configure shortcut keys.

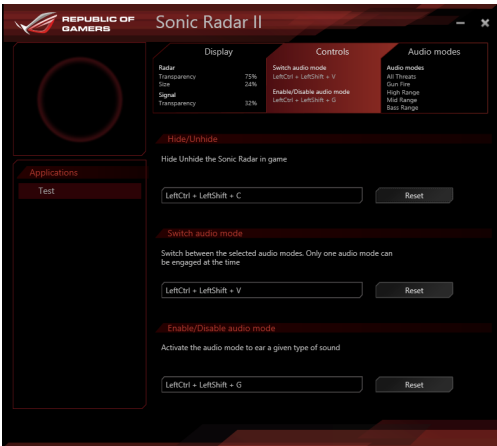

Audio Mode/Radar Selection menu

Allows you to configure the sound enhancers.

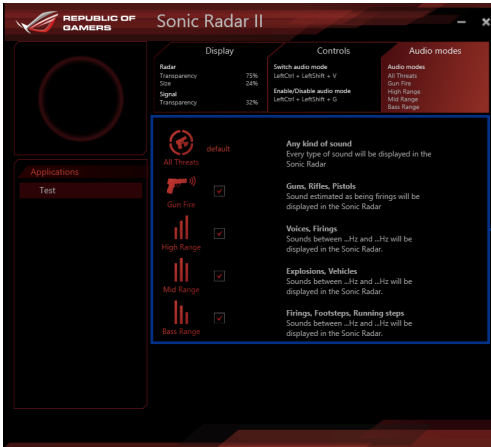

Audio Mode/Radar Selection are enabled with shortcut keys in the game. Refer to the **Controls** tab for more information about the shortcut key settings.

4.8 GameFirst III

GameFirst III is a network management software that features four preset packet prioritized profiles (Optimization, Game, Media Streaming and File Sharing) facilitating different user scenarios. Users can also manually allocate bandwidth and adjust priority settings of each application to run faster and smoother.

To use GameFirst III, double-click  on the desktop.

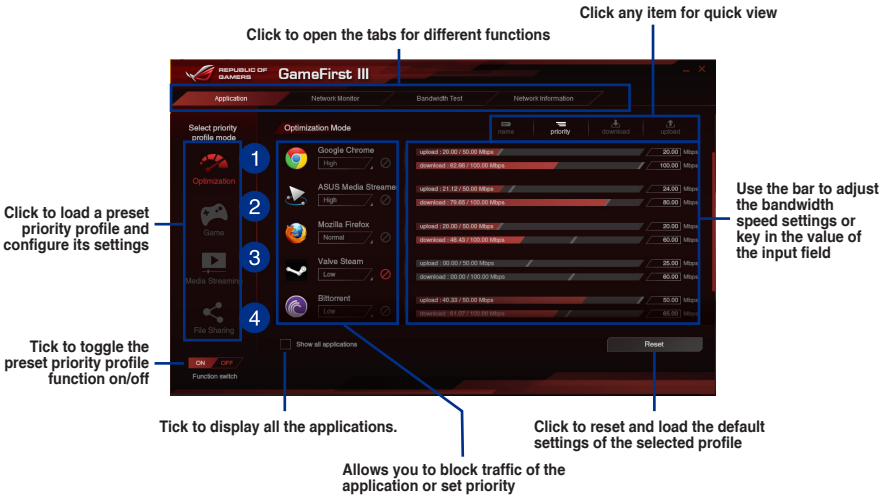

- 1 Optimization Mode**
Game packets are prioritized and other packets also optimized.
- 2 Game Mode**
Game packets given top priority.
- 3 Media Streaming Mode**
Media-streaming packets given top priority.
- 4 File Sharing Mode**
File-sharing packets given top priority.

Network Monitor

Top 5 application

Displays the top 5 bandwidth consuming applications currently used.

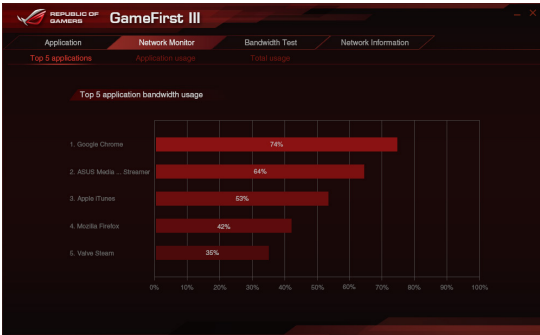

Application usage

Displays the individual downloading and uploading bandwidth of currently used applications.

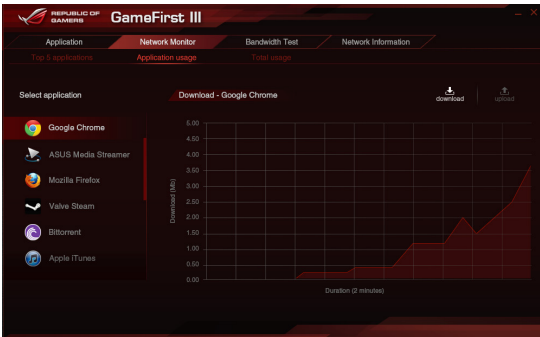

Total usage

Displays the total downloading and uploading bandwidth of the currently used applications.

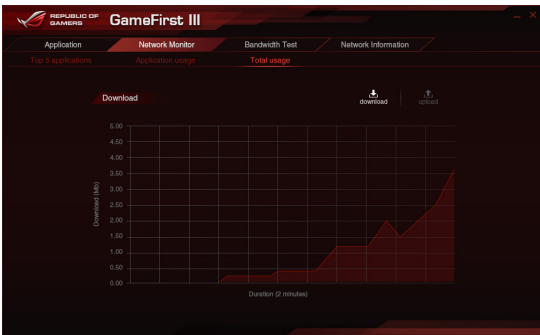

Bandwidth Test

You can use this feature to test the Internet Service Provider (ISP) speed or manually key in the desired uploading/downloading speed and apply the speed if needed.

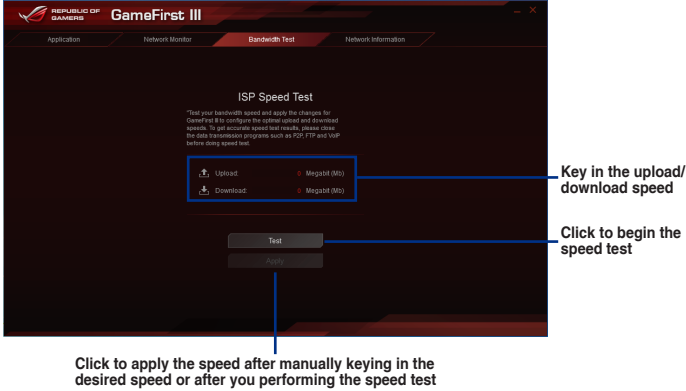

Using the Network Information

Displays information about the physical network card such as speed, physical address, IP address, subnet mask, and default gateway.



4.9 KeyBot

KeyBot is a built-in microprocessor that provides instant upgrade to your keyboard. You can configure and assign macros to specific keys on your keyboard to perform specific or several task at the same time. You can also configure your PC to wake up in CPU Level UP, XMP, or directly to BIOS mode.

To use KeyBot:

1. Press the KeyBot button on the motherboard.



The KeyBot feature is enabled when the KEYBOT_LED light is on.

2. Connect the USB keyboard into the dedicated KeyBot USB port.



Refer to the **Rear I/O connection** or the **USB BIOS Flashback** section for more information about the location of the KeyBot USB port.

3. Double-click  on the desktop to launch the KeyBot application on your PC.

Click to import or export configuration files

Click to configure Macro keys, Smart login, Function keys, and Shortcut settings

Tick to toggle the KeyBot function on/off

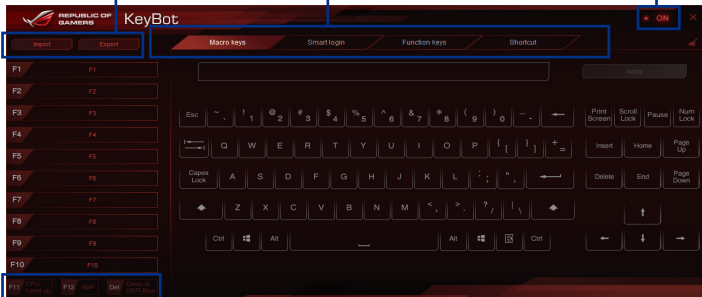

Click any of the items to perform a specific tasks, or click their corresponding keys on the keyboard

Smart login

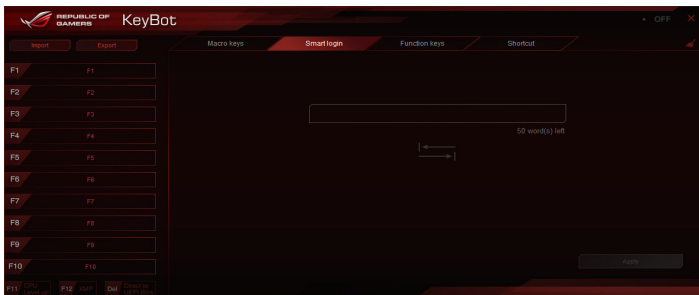

Function Keys



Shortcut

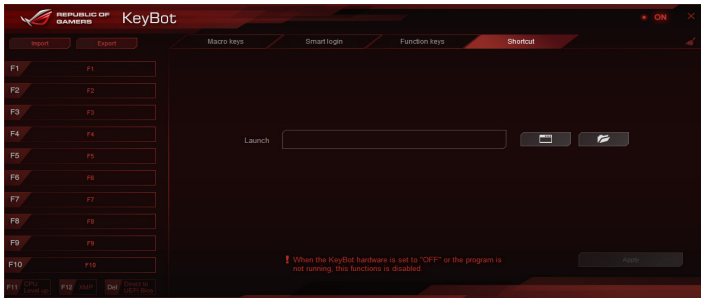

4.10 ASUS Media Streamer

ASUS Media Streamer allows you to enjoy your PC's multimedia content anywhere. You can pipe music from your PC or stream your favorite movie to a smart TV using your PC or smart device.



- Ensure to enable the DLNA setting of your devices first.
- ASUS Media Streamer supports NFC function.



- Ensure to install ASUS HomeCloud on your PC.
- An Internet connection is required to fully utilize this feature.

To use ASUS Media Streamer:

On your computer, click **ASUS HomeCloud** then select **Media Streamer**. On your device, click or tap **Media Streamer**.

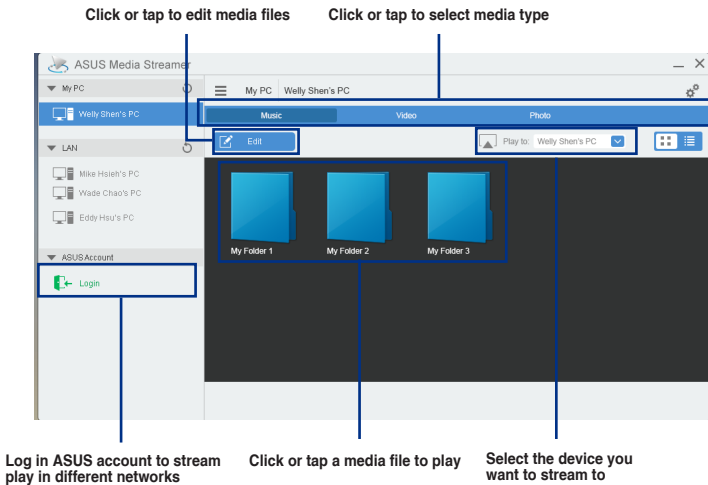

Adding and deleting media files

Drag and drop or tick files to add or delete.

Click to add or create a new folder

Click to add the selected files

Click to delete selected files

Click to proceed with the deletion or addition of files

Click to cancel changes



The following media formats are supported: .3gp, .mp4, .m4a, .aac, .ts, .flac, .mp3, .mid, .xmf, .mxmf, .rtttl, .rtx, .ota, .imy, .ogg, .mkv, .wav, .jpg, .gif, .png, .bmp, .webp, .webm

4.11 ASUS Disk Unlocker

This ASUS exclusive utility provides an easy-to-use interface to identify and utilize all drive space in hard disk drives (HDD).



ASUS Disk Unlocker is supported only on Windows® 7 and Windows® 8.



To launch ASUS Disk Unlocker, click .

Click to open the help file that shows the detailed information on how to use ASUS Disk Unlocker

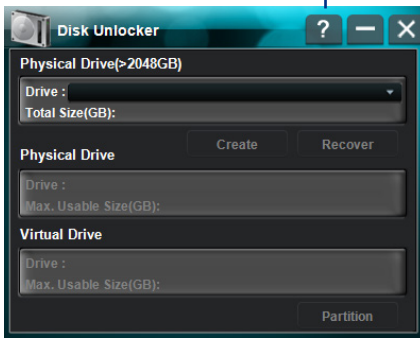

ASUS Disk Unlocker Help file

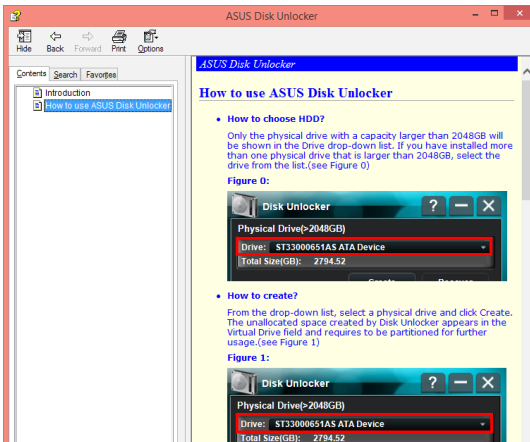

4.12 RAMDisk

RAMDisk is a data-storage software that reserves a part of your system's memory and turns it into a high-speed virtual drive where you can store cache files and game apps for instant access. The Dynamic Memory Allocation function can release the unused memory of RAMDisk back to the system when needed and helps extend the lifespan of your SSD or HDD.



The following folders are not suitable for RAMDisk optimization. Moving them into the RAMDisk might negatively affect the performance of your system.

- **Swap file/Page file:** The swap file is a permanent storage space used as the virtual memory expansion of the system memory. Moving the swap file into the RAM Disk simply defeats the whole purpose of having it and may affect your system's performance.
- **Startup folders:** Since RAMDisk loads during boot up together with the contents of the Junction folders, changing the location of the startup folders may cause system error and disable loading your RAMDisk.



To launch RAMDisk, click

Creating/Deleting a RAMDisk drive

Your RAMDisk drive allows you to place your favorite applications and files into RAM so you can utilize your RAM speed for better read/write performance. The files that are stored inside the RAMDisk are automatically backed up every time your PC is turned off.



The startup time may take a while, depending on the size of your RAMDisk drive.

To create RAMDisk drives:

Click to create RAMDisk drives

Click the drop-down arrow to choose a drive name for your RAMDisk

Tick to enable Dynamic Memory Allocation function

Move the slider to the right to set the size allocation

Click to finish creating the RAMDisk drive

Disk	Size	Format	Delete
P:	16MB		

To delete or format an existing RAMDisk drive:

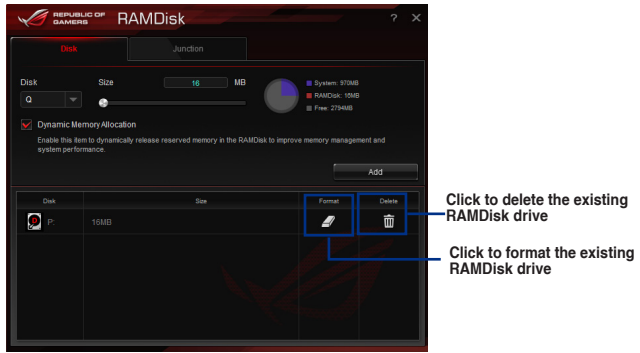

The format function is available only if you enable the Dynamic Memory Allocation function on your disk.

Creating/Deleting a Junction Point

A junction point creates a link that remaps the original contents into the RAMDisk, enabling access to the desired application or data to be done purely within the original file location.

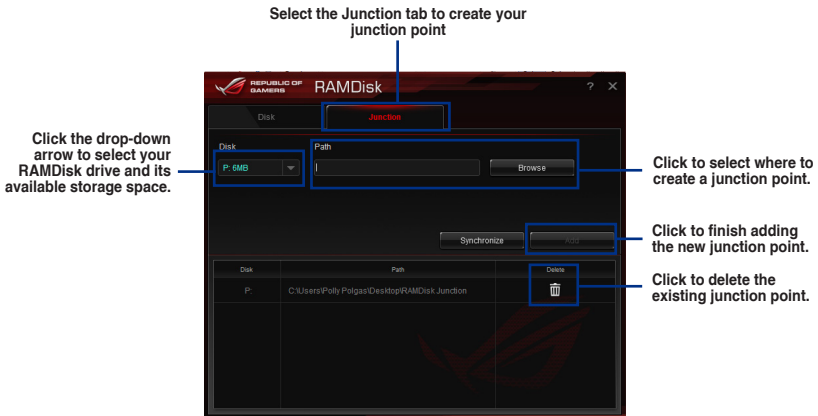

Synchronizing backup files

After creating a junction point, RAMDisk automatically creates a backup folder in the file's original location. Use RAMDisk to manually synchronize updates with these backup files.

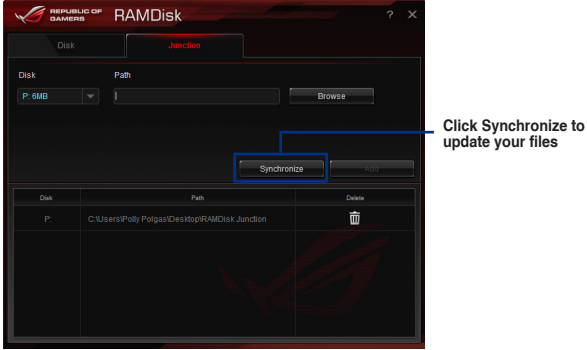

Validating and saving your MemTweakIt settings

To validate and save your configuration online:

1. Launch MemTweakIt and click **Validate**.
2. In **Online Mode**, key in your ASUS account ID and password, and click **Submit**.



Your configuration will be displayed in MemTweakIt webpage.

To validate and save your configuration manually:

1. Launch MemTweakIt and click **Validate**.
2. In **Manual Mode**, click **Save Validation File**.
3. Key in a file name for your configuration file and click **Submit**.
4. Click **validation webpage**.

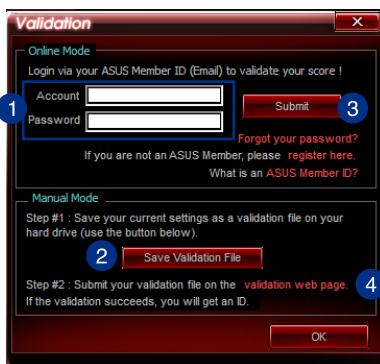

5. In **MemTweakIt - Validation File Upload** window, key in your ASUS account ID and password.
6. Click **Browse**, locate the saved .cvf file, and click **Open**.
7. Click **Submit**.

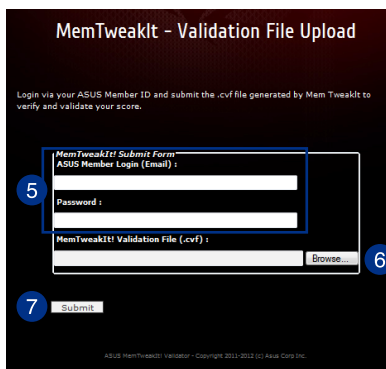

Your configuration will be displayed in MemTweakIt webpage.

4.14 ROG CPU-Z

This utility gathers information about the main devices installed in your system and displays it in an ROG custom layout. ROG CPU-Z provides you information and status of your CPU, motherboard, memory, graphics card, and other components installed in your system. You can generate a report about your system info and send or post it on the CPU-Z website.

To use ROG CPU-Z, double-click  on the desktop.

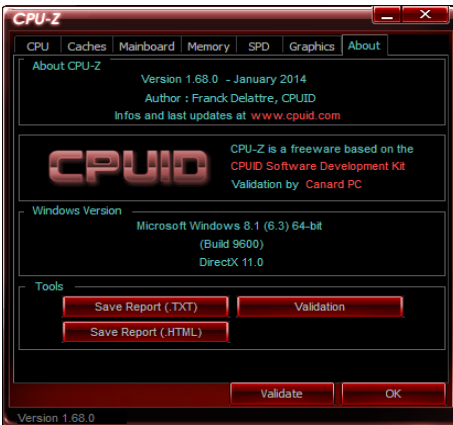
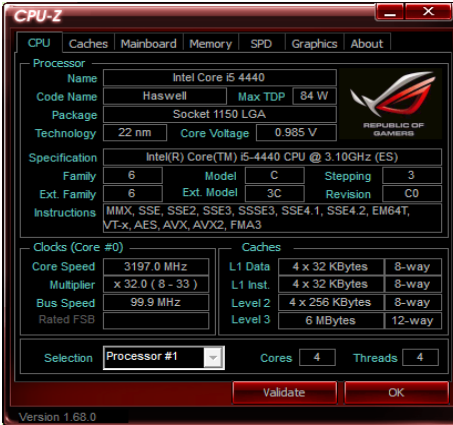

RAID support

5

5.1 RAID configurations

The motherboard comes with the Intel® Rapid Storage Technology that supports RAID 0, RAID 1, RAID 10 and RAID 5 configuration.



If you want to install a Windows® operating system to a hard disk drive included in a RAID set, you have to create a RAID driver disk and load the RAID driver during OS installation. Refer to section 5.2 **Creating a RAID driver disk** for details.

5.1.1 RAID definitions

RAID 0 (Data striping) optimizes two identical hard disk drives to read and write data in parallel, interleaved stacks. Two hard disks perform the same work as a single drive but at a sustained data transfer rate, double that of a single disk alone, thus improving data access and storage. Use of two new identical hard disk drives is required for this setup.

RAID 1 (Data mirroring) copies and maintains an identical image of data from one drive to a second drive. If one drive fails, the disk array management software directs all applications to the surviving drive as it contains a complete copy of the data in the other drive. This RAID configuration provides data protection and increases fault tolerance to the entire system. Use two new drives or use an existing drive and a new drive for this setup. The new drive must be of the same size or larger than the existing drive.

RAID 5 stripes both data and parity information across three or more hard disk drives. Among the advantages of RAID 5 configuration include better HDD performance, fault tolerance, and higher storage capacity. The RAID 5 configuration is best suited for transaction processing, relational database applications, enterprise resource planning, and other business systems. Use a minimum of three identical hard disk drives for this setup.

RAID 10 is data striping and data mirroring combined without parity (redundancy data) having to be calculated and written. With the RAID 10 configuration you get all the benefits of both RAID 0 and RAID 1 configurations. Use four new hard disk drives or use an existing drive and three new drives for this setup.

5.1.2 Installing Serial ATA hard disks

The motherboard supports Serial ATA hard disk drives. For optimal performance, install identical drives of the same model and capacity when creating a disk array.

To install the SATA hard disks for a RAID configuration:

1. Install the SATA hard disks into the drive bays.
2. Connect the SATA signal cables.
3. Connect a SATA power cable to the power connector on each drive.

5.1.3 Setting the RAID item in BIOS

You must enable the RAID function in the BIOS Setup before creating RAID sets using SATA HDDs. To do this:

1. Enter the BIOS Setup during POST.
2. Go to the **Advanced** menu > **SATA Configuration**, and then press <Enter>.
3. Set the SATA Mode item to [RAID Mode].
4. Save your changes, and then exit the BIOS Setup.



Refer to Chapter 3 for details on entering and navigating through the BIOS Setup



Due to chipset limitation, when SATA ports are set to RAID mode, all SATA ports run at RAID mode together.

5.1.4 Intel® Rapid Storage Technology Option ROM utility

To enter the Intel® Rapid Storage Technology Option ROM utility:

1. Turn on the system.
2. During POST, press <Ctrl> + <I> to display the utility main menu.

```
Intel(R) Rapid Storage Technology - Option ROM - v10.5.1.1070
Copyright(C) 2003-10 Intel Corporation. All Rights Reserved.

[ MAIN MENU ]
1. Create RAID Volume      4. Recovery Volume Options
2. Delete RAID Volume     5. Acceleration Options
3. Reset Disks to Non-RAID 6. Exit

[ DISK/VOLUME INFORMATION ]

RAID Volumes:
None defined.

Physical Devices:
Port Device Model      Serial #      Size  Type/Status (Vol ID)
0  ST3160812AS         9LS0HJA4     149.0GB Non-RAID Disk
1  ST3160812AS         9LS0F4HL     149.0GB Non-RAID Disk
2  ST3160812AS         3LS0JYL8     149.0GB Non-RAID Disk
3  ST3160812AS         9LS0BJ5H     149.0GB Non-RAID Disk

[↑↓]-Select      [ESC]-Exit      [ENTER]-Select Menu
```

The navigation keys at the bottom of the screen allow you to move through the menus and select the menu options.



The RAID BIOS setup screens shown in this section are for reference only and may not exactly match the items on your screen.



The utility supports maximum four hard disk drives for RAID configuration.

Creating a RAID set

To create a RAID set:

1. From the utility main menu, select **1. Create RAID Volume** and press <Enter>. The following screen appears:

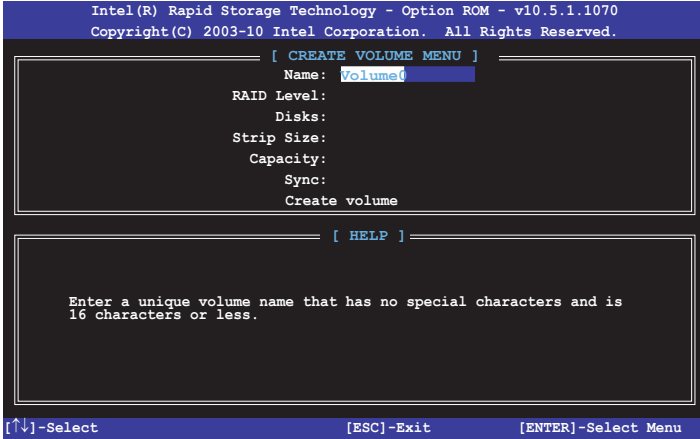

2. Enter a name for the RAID set and press <Enter>.
3. When the RAID Level item is selected, press the up/down arrow key to select a RAID level to create, and then press <Enter>.
4. When the Disks item is selected, press <Enter> to select the hard disk drives you want to include in the RAID set. The SELECT DISKS screen appears:

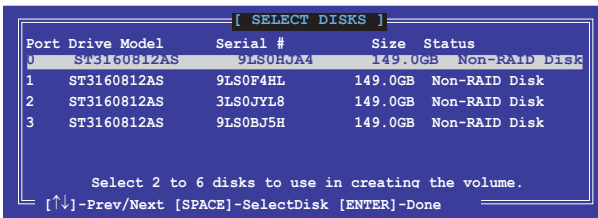

5. Use the up/down arrow key to select a drive, and then press <Space> to select. A small triangle marks the selected drive. Press <Enter> after completing your selection.
6. Use the up/down arrow key to select the stripe size for the RAID array (for RAID 0, 10 and 5 only), and then press <Enter>. The available stripe size values range from 4KB to 128KB. The following are typical values:
 - RAID 0: 128KB
 - RAID 10: 64KB
 - RAID 5: 64KB



We recommend a lower stripe size for server systems, and a higher stripe size for multimedia computer systems used mainly for audio and video editing.

7. When the **Capacity** item is selected, enter the RAID volume capacity that you want and press <Enter>. The default value indicates the maximum allowed capacity.
8. When the **Create Volume** item is selected, press <Enter>. The following warning message appears:

WARNING: ALL DATA ON SELECTED DISKS WILL BE LOST
Are you sure you want to create this volume? (Y/N):

9. Press <Y> to create the RAID volume and return to the main menu, or <N> to go back to the CREATE VOLUME menu.

Deleting a RAID set



Be cautious when deleting a RAID set. You will lose all data on the hard disk drives when you delete a RAID set.

To delete a RAID set:

1. From the utility main menu, select **2. Delete RAID Volume** and press <Enter>. The following screen appears:

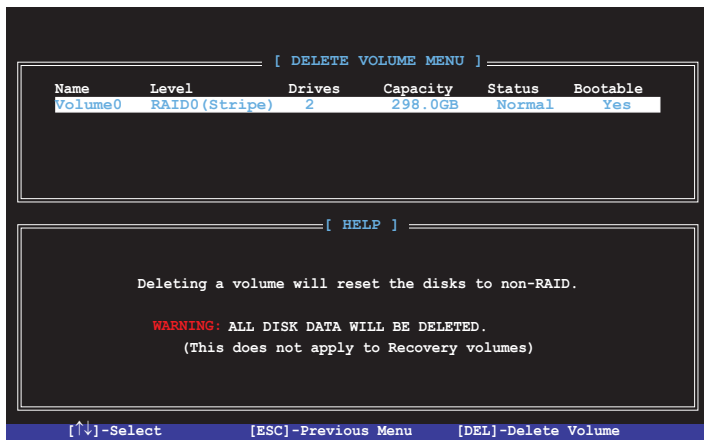

2. Use the up/down arrow key to select the RAID set you want to delete, and then press . The following warning message appears:

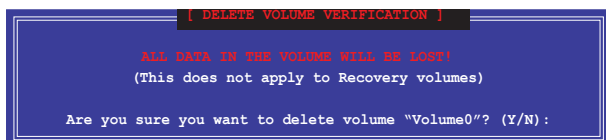

3. Press <Y> to delete the RAID set and return to the utility main menu, or press <N> to return to the DELETE VOLUME menu.

Exiting the Intel® Rapid Storage Technology Option ROM utility

To exit the utility:

1. From the utility main menu, select **5. Exit**, and then press <Enter>. The following warning message appears:



5.2 Creating a RAID driver disk

A floppy disk with the RAID driver is required when installing a Windows® operating system on a hard disk drive that is included in a RAID set.



The motherboard does not provide a floppy drive connector. You have to use a USB floppy disk drive when creating a SATA RAID driver disk.

5.2.1 Creating a RAID driver disk without entering the OS

To create a RAID driver disk without entering the OS:

1. Boot your computer.
2. Press during POST to enter the BIOS setup utility.
3. Set the optical drive as the primary boot device.
4. Insert the support DVD into the optical drive.
5. Save changes and exit BIOS.
6. When the Make Disk menu appears, press <1> to create a RAID driver disk.
7. Insert a formatted floppy disk into the USB floppy disk drive, then press <Enter>.
8. Follow the succeeding screen instructions to complete the process.

5.2.2 Creating a RAID driver disk in Windows®

To create a RAID driver disk in Windows®:

1. Start Windows®.
2. Plug the USB floppy disk drive and insert a floppy disk.
3. Place the motherboard support DVD into the optical drive.
4. Go to the **Make Disk** menu, and then click **Intel AHC/RAID Driver Disk** to create a RAID driver disk.
5. Select **USB floppy disk drive** as the destination disk.
6. Follow the succeeding screen instructions to complete the process.



Write-protect the floppy disk to avoid a computer virus infection.

5.2.3 Installing the RAID driver during Windows® OS installation

To install the RAID driver for Windows® 7 or later OS:

1. During the OS installation, click **Load Driver** to allow you to select the installation media containing the RAID driver.
2. Insert the USB flash drive with RAID driver into the USB port or the support DVD into the optical drive, and then click **Browse**.
3. Click the name of the device you've inserted, go to **Drivers > RAID**, and then select the RAID driver for the corresponding OS version. Click **OK**.
4. Follow the succeeding screen instructions to complete the installation.



Before loading the RAID driver from a USB flash drive, you have to use another computer to copy the RAID driver from the support DVD to the USB flash drive.

Appendices

Notices

Federal Communications Commission Statement

This device complies with Part 15 of the FCC Rules. Operation is subject to the following two conditions:

- This device may not cause harmful interference.
- This device must accept any interference received including interference that may cause undesired operation.

This equipment has been tested and found to comply with the limits for a Class B digital device, pursuant to Part 15 of the FCC Rules. These limits are designed to provide reasonable protection against harmful interference in a residential installation. This equipment generates, uses and can radiate radio frequency energy and, if not installed and used in accordance with manufacturer's instructions, may cause harmful interference to radio communications. However, there is no guarantee that interference will not occur in a particular installation. If this equipment does cause harmful interference to radio or television reception, which can be determined by turning the equipment off and on, the user is encouraged to try to correct the interference by one or more of the following measures:

- Reorient or relocate the receiving antenna.
- Increase the separation between the equipment and receiver.
- Connect the equipment to an outlet on a circuit different from that to which the receiver is connected.
- Consult the dealer or an experienced radio/TV technician for help.



The use of shielded cables for connection of the monitor to the graphics card is required to assure compliance with FCC regulations. Changes or modifications to this unit not expressly approved by the party responsible for compliance could void the user's authority to operate this equipment.

IC: Canadian Compliance Statement

Complies with the Canadian ICES-003 Class B specifications. This device complies with RSS 210 of Industry Canada. This Class B device meets all the requirements of the Canadian interference-causing equipment regulations.

This device complies with Industry Canada license exempt RSS standard(s). Operation is subject to the following two conditions: (1) this device may not cause interference, and (2) this device must accept any interference, including interference that may cause undesired operation of the device.

Cet appareil numérique de la Classe B est conforme à la norme NMB-003 du Canada. Cet appareil numérique de la Classe B respecte toutes les exigences du Règlement sur le matériel brouilleur du Canada.

Cet appareil est conforme aux normes CNR exemptes de licence d'Industrie Canada. Le fonctionnement est soumis aux deux conditions suivantes :

- (1) cet appareil ne doit pas provoquer d'interférences et
- (2) cet appareil doit accepter toute interférence, y compris celles susceptibles de provoquer un fonctionnement non souhaité de l'appareil.

Canadian Department of Communications Statement

This digital apparatus does not exceed the Class B limits for radio noise emissions from digital apparatus set out in the Radio Interference Regulations of the Canadian Department of Communications.

This class B digital apparatus complies with Canadian ICES-003.

VCCI: Japan Compliance Statement

VCCI Class B Statement

情報処理装置等電波障害自主規制について

この装置は、情報処理装置等電波障害自主規制協議会（VCCI）の基準に基づくクラスB情報技術装置です。この装置は家庭環境で使用されることを目的としていますが、この装置がラジオやテレビジョン受信機に近接して使用されると、受信障害を引き起こすことがあります。

取扱説明書に従って正しい取り扱いをして下さい。

KC: Korea Warning Statement

B급 기기 (가정용 방송통신기자재)

이 기기는 가정용(B급) 전자파적합기기로서 주로 가정에서 사용하는 것을 목적으로 하며, 모든 지역에서 사용할 수 있습니다.

*당해 무선설비는 전파혼신 가능성이 있으므로 인명안전과 관련된 서비스는 할 수 없습니다.

REACH

Complying with the REACH (Registration, Evaluation, Authorisation, and Restriction of Chemicals) regulatory framework, we published the chemical substances in our products at ASUS REACH website at <http://csr.asus.com/english/REACH.htm>.



DO NOT throw the motherboard in municipal waste. This product has been designed to enable proper reuse of parts and recycling. This symbol of the crossed out wheeled bin indicates that the product (electrical and electronic equipment) should not be placed in municipal waste. Check local regulations for disposal of electronic products.



DO NOT throw the mercury-containing button cell battery in municipal waste. This symbol of the crossed out wheeled bin indicates that the battery should not be placed in municipal waste.

ASUS Recycling/Takeback Services

ASUS recycling and takeback programs come from our commitment to the highest standards for protecting our environment. We believe in providing solutions for you to be able to responsibly recycle our products, batteries, other components as well as the packaging materials. Please go to <http://csr.asus.com/english/Takeback.htm> for detailed recycling information in different regions.

Google™ License Terms

Copyright© 2014 Google Inc. All Rights Reserved.

Licensed under the Apache License, Version 2.0 (the “License”); you may not use this file except in compliance with the License. You may obtain a copy of the License at:

<http://www.apache.org/licenses/LICENSE-2.0>

Unless required by applicable law or agreed to in writing, software distributed under the License is distributed on an “AS IS” BASIS, WITHOUT WARRANTIES OR CONDITIONS OF ANY KIND, either express or implied.

See the License for the specific language governing permissions and limitations under the License.

ASUS contact information

ASUSTeK COMPUTER INC.

Address 15 Li-Te Road, Peitou, Taipei, Taiwan 11259
Telephone +886-2-2894-3447
Fax +886-2-2890-7798
E-mail info@asus.com.tw
Web site www.asus.com.com/

Technical Support

Telephone +86-21-38429911
Fax +86-21-5866-8722, ext. 9101#
Online support <http://www.asus.com/tw/support/>

ASUS COMPUTER INTERNATIONAL (America)

Address 800 Corporate Way, Fremont, CA 94539, USA
Telephone +1-510-739-3777
Fax +1-510-608-4555
Web site <http://www.asus.com/us/>

Technical Support

Support fax +1-812-284-0883
Telephone +1-812-282-2787
Online support <http://www.service.asus.com/>

ASUS COMPUTER GmbH (Germany and Austria)

Address Harkort Str. 21-23, D-40880 Ratingen, Germany
Fax +49-2102-959911
Web site <http://www.asus.com/de>
Online contact <http://eu-rma.asus.com/sales>

Technical Support

Telephone +49-1805-010923*
Support Fax +49-2102-9599-11
Online support <http://www.asus.com/de/support/>

DECLARATION OF CONFORMITY

Per FCC Part 2, Section 2.1077(a)



Responsible Party Name: **Asus Computer International**

Address: **800 Corporate Way, Fremont, CA 94539.**

Phone/Fax No: **(510)739-3777/(510)608-4555**

hereby declares that the product

Product Name : Motherboard

Model Number : MAXIMUS VII RANGER

Conforms to the following specifications:

- FCC Part 15, Subpart B, Unintentional Radiators

Supplementary Information:

This device complies with part 15 of the FCC Rules. Operation is subject to the following two conditions: (1) This device may not cause harmful interference, and (2) this device must accept any interference received, including interference that may cause undesired operation.

Representative Person's Name : Steve Chang / President

Signature : Steve Chang

Date : Mar. 28, 2014

Ver. 126001



EC Declaration of Conformity

We, the undersigned,

represent:
 ASUSTeK COMPUTER INC.
 4F, No. 150, LITE REI, PEYOU, TAIPEI 112, TAIWAN
 Country: TAIWAN
 Authorized representative in Europe:
 ASUS COMPUTER GmbH
 HARBORT STR. 21-23, 40880 RATINGEN
 Country: GERMANY

declare the following apparatus:

Product name : **Motherboard**
 Model name : **MAXIMUS VII RANGER**

conform with the essential requirements of the following directives:

- §2004/108/EC-EMC Directive**
- EN 55022:2005/A2:2006
 - EN 61000-3-2:2006/A2:2009
 - EN 55013:2001/A1:2003/A2:2006
 - 1999/5/EC-RATE Directive**

- EN 300 328 V1.7.1 (2006-10)
- EN 300 440-2 V1.4 (2010-08)
- EN 300 440-3 V1.4 (2010-08)
- EN 301 511 V9.0/2 (2009-03)
- EN 301 511 V10.0/2 (2011-05)
- EN 301 511 V11.0/2 (2011-11)
- EN 301 883 V1.6 (2011-11)
- EN 302 544-2 V1.1 (2009-01)
- EN 302 544-2 V1.1.1 (2009-01)
- EN 303 609:2001
- EN 303 610:2001
- EN 62479:2010
- EN 62479:2010
- EN 62311:2008

- §2006/95/EC-LVD Directive**
- EN 60950-1:1A2:2011
 - EN 60965:2012 /A12:2011

- 2009/128/EC-EP Directive**
- Regulation (EC) No. 1275-2008
 - Regulation (EC) No. 642:2009

- §2011/65/EU-ROHS Directive**
- Regulation (EC) No. 617:2013

Ver. 130816



(EC conformity marking)

Position : **CEO**
 Name : **Jerry Shen**

Jerry Shen

Declaration Date: 24/03/2014

