R E A D F I R S T

RadioRA®



Wireless Central Lighting Control

RA-SBT-CHR, RB-SBT-CHR

Setup and Installation Guide For a RadioRA® Chronos™ System Bridge and Timeclock

A Step-by-Step Guide for Installion, Programming, and Operation

Note: Please leave this manual with homeowner.

This guide replaces the Setup Guide (P/N 044-001) included with a system Repeater.

Important Application Notes

1. It is recommended that only one GRAFIK Eye® Control Unit be wired to each GRAFIK Eye Interface. Multiple GRAFIK Eye Control Units may be wired (linked) to the same GRAFIK Eye Interface, however, all GRAFIK Eye Control Units on that link will respond in unison to the commands from the GRAFIK Eye Interface. ALL GRAFIK Eye Control Units wired to the same Interface will carry out ALL commands from the GRAFIK Eye Interface (i.e. go to GRAFIK Eye scene 3, Turn OFF, etc...). Interface commands cannot be sent to one individual GRAFIK Eye Control Unit on a link of multiple GRAFIK Eye Control Units.
 - This application may be desired if multiple GRAFIK Eye Control Units are in the same room and it is intended that the same scene be selected on each GRAFIK Eye Control Unit simultaneously.
 - Lutron does **not** recommend using one GRAFIK Eye Interface to linked GRAFIK Eye Control Units located in more than one room.
2. Scene 1 on a GRAFIK Eye Control Unit is the default scene for ALL ON, SECURITY, and FLASH MODES. It is recommended that Scene 1 on GRAFIK Eye Control Units be set to full intensity with a fade time of zero seconds.
3. Setting the light levels for GRAFIK Eye scenes should be done prior to any operations in this Setup Guide.
4. A GRAFIK Eye scene may be added to any RadioRA® Master Control button which has been previously programmed without altering that buttons existing programming.
5. See RadioRA Application Note No.48 (P/N 366-730) for steps to activate GRAFIK Eye scenes 5-16 from a RadioRA Master Control.
6. For information on integrating your RadioRA system with a photocell, telephone interface, shade motor control, etc... see the RadioRA Application Notes on our web page at www.lutron.com/applicationnotes/index.html.
7. RadioRA lighting control systems use radio frequency technology for communication. Currently, RadioRA lighting control systems are available in two frequencies. To determine the frequency of a RadioRA product, examine the model number on the product's unit label. The labels are located on the side of all "wallbox" products, and on the bottom of all "tabletop" products.

The second letter in all RadioRA model numbers indicates the product's frequency. For example: RA-6D is an "A" frequency product, whereas RB-6D is a "B" frequency product.

Note: Do not mix RadioRA "A" and "B" frequency products within the same system. Products with different frequencies **are not** compatible.

If you have any questions concerning the installation or operation of this product, please call the **Lutron Technical Support Center at 1-800-523-9466**.

System Operation Notes

The installer should be aware of the following:

1. In order to install the Chronos™ System Bridge as the Main Repeater in an existing system, all devices in the system must be returned to their factory defaults prior to installation of the Chronos System Bridge.
2. When using a Whole-home Button on a Master Control, there will be a delay between when the Whole-home Button is pressed and when the scene activates. The delay will typically be approximately 2 seconds. This applies for scenes that contain zones of lighting in one system or in both systems. The delay does not apply when the button is activated via RS-232.
3. For Whole-home Buttons that contain lighting in both System 1 and System 2, the scene will activate one system at a time, with a delay in between. The delay is typically 3 seconds. The system that the Master Control is in determines which half of the scene activates first.
4. Only unprogrammed Master Control buttons can be used as Whole-home Buttons. All local programming must be erased from a Master Control button before it can be assigned as a Whole-home Button.
5. When using Cordless Tabletop Master Controls, the Master Control LEDs will not update when the Master Control is first awakened from a "sleep" state.
6. When using Master Controls with Raise/Lower buttons with the Chronos System Bridge, the Raise/Lower buttons will not work on Whole-home scenes.

Compatibility Information

Using the Chronos™ System Bridge with Older RadioRA® Lighting Zone Controls

On *RadioRA* Dimmers, Switches, and GRAFIK Eye® Interfaces shipped prior to January 1, 2001, the Legacy setting for fade times must be used. Raise/Lower functions from Master Controls and the Level Capture feature are also not supported by these devices shipped prior to January 1, 2001.

Using the Chronos System Bridge with Older RadioRA Master Controls and Interfaces

The *Chronos* System Bridge Whole-home scenes will not work with Master Controls shipped prior to January 1, 2001. The buttons on these Master Controls do not send programming necessary to activate the *Chronos* System Bridge scenes. Also, this feature was not supported in RA-RS232 and RA-IR Interfaces shipped prior to September 1, 2001. For this reason, these older devices cannot be used to activate Whole-home scenes.

Using the RA-SCI Switch Closure Interface

The Switch Closure Interface cannot be used to activate Whole-home scenes. The security mode inputs on the Switch Closure Interface will not work across systems. If a security system is connected to the RA-SCI security inputs, it should be moved to the security input on the *Chronos* System Bridge. Refer to Section 6 for instructions on setting up the *Chronos* System Bridge contact closure inputs.

Using the RAMC-MFE-WH Security Mode Inputs

The security mode input on the RAMC-MFE-WH will not work across systems. If a security system is connected to the RAMC-MFE-WH security input, it should be moved to the security input on the *Chronos* System Bridge. Refer to Section 6 for instructions on setting up the *Chronos* System Bridge contact closure inputs.

Using Security mode from a RA-RS232 Interface

Security mode activated from an RA-RS232 Interface will not work across systems. If a third-party system is connected to an existing RA-RS232 Interface, it should be moved to the RS-232 port on the *Chronos* System Bridge. Refer to Section 5 for instructions on setting up the *Chronos* System Bridge RS-232 port.

Consumer Information



This symbol is intended to alert the user to the presence of important installation and operating instructions.



Danger

This *RadioRA*® system must not be used to control equipment, other than lighting, which is not visible from every master or local control location. It also must not be used to control equipment which could create hazardous situations such as entrapment if operated accidentally. Examples of equipment which must not be controlled by this *RadioRA* system include (but are not limited to) motorized gates, garage doors, industrial doors, and microwave ovens, heating pads, etc. It is the installer's responsibility to ensure that the equipment, other than lighting, being controlled is visible from every master or local control location and that only suitable equipment is connected to this *RadioRA* system.

FCC Information

Note: This equipment has been tested and found to comply with the limits for a Class B digital device, pursuant to Part 15 of the FCC rules. These limits are designed to provide reasonable protection against harmful interference in a residential installation. This equipment generates, uses and can radiate radio frequency energy and, if not installed in accordance with the instructions, may cause harmful interference to radio communications. However, there is no guarantee that interference will not occur in a particular installation. If this equipment does cause harmful interference to radio or television reception, which can be determined by turning the equipment off and on, the user is encouraged to try to correct the interference by one or more of the following measures:

- Reorient or relocate the receiving antenna.
- Increase the separation between the equipment and receiver.
- Connect the equipment into an outlet on a circuit different from that to which the receiver is connected.
- Consult the dealer or an experienced radio/TV technician for help.

Caution: Changes or modifications not expressly approved by Lutron Electronics Co. could void the user's authority to operate this equipment.

Using This Guide

This guide is divided into sections. Each section deals with a particular feature or set of features of the Chronos™ System Bridge. Depending on the design of the RadioRA® system and the intended use for the Chronos System Bridge, some sections may not apply. The figure below shows the sections containing critical information for each listed feature, in the order that the sections should be read.



Bridge / Main Repeater

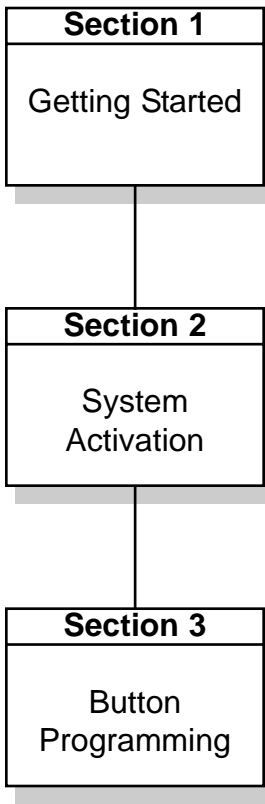

Time Clock

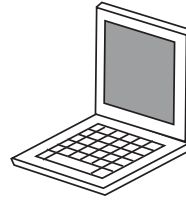
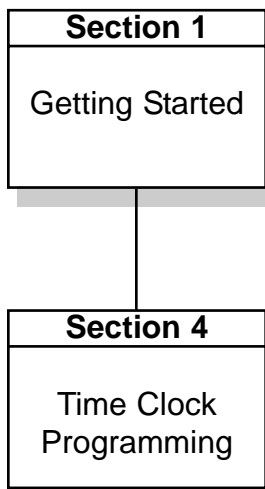

RS-232

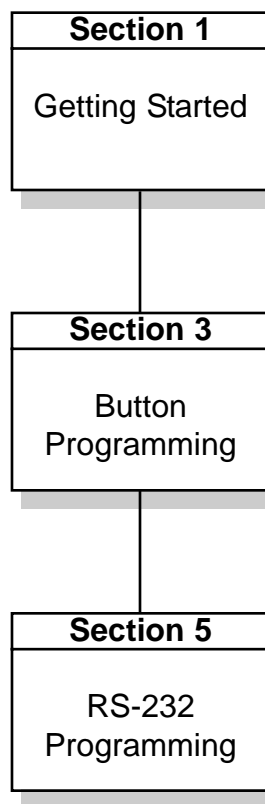

Contact Closures / Security

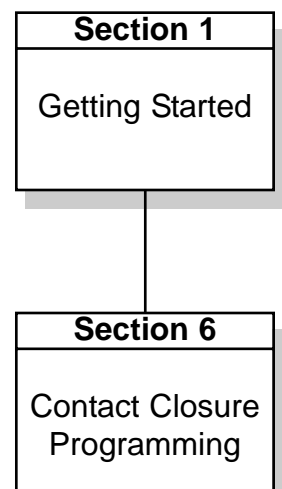

Table of Contents

Section 1 - Getting Started

System Overview

RadioRA System Components	7
Chronos System Bridge Features	8
System Layout	9
Chronos System Bridge Hardware Identification	11

Installing the Chronos

Installation	12
Using the LCD and Buttons	15
Using the Keyboard Port.....	16

System Configuration

System Configuration and Features	17
---	----

Initial Chronos System Bridge Configuration

Setting the Initial Chronos System Bridge Configuration	18
---	----

Section 2 - System Activation

Activating the System

Activate Auxiliary Repeaters.....	20
Activate Controls	22

Section 3 - Button Programming

Button Programming Overview

Local Button Programming Overview	25
ROOMS and SCENES Overview	26
Local Buttons, Phantom Buttons, and Whole-home Buttons	27

Local Button Programming

Assigning a Column of Buttons as ROOMS or SCENES.....	28
Assigning Lighting Zone Controls to Buttons	30
Setting Light Levels/GRAFIK Eye and GRAFIK RA Scene Selection for Buttons.....	32
Programming the ALL ON and ALL OFF Buttons.....	34

Advanced Local Programming

Copying Local Button Programming	36
Erasing Local Button Programming	38

Whole-home/Phantom Button Programming

Set Phantom Button Names	40
Set Phantom Button Types (ROOM or SCENE)	41
Assigning Lighting Zone Controls to Phantom Buttons	42
Setting Light Levels/GRAFIK Eye Scene Selection for Phantom Buttons.....	44
Setting Button Properties for Phantom Buttons	46
Assigning Phantom Buttons to Master Controls	47
Testing Phantom Button Programming	48
Erasing Phantom Button Programming	48

Using the Button Copy Feature

Copying Existing Chronos Programming	49
Copying Programming from Master Controls to the Chronos System Bridge	50

Section 4 - Time Clock Programming

Astronomical Time Clock Programming

Setting the Chronos System Bridge Date and Time	52
Creating Time Clock Scenes.....	55
Testing Time Clock Scenes.....	59
Erasing Time Clock Scenes	60

Table of Contents - Continued

Astronomical Time Clock Programming - Continued

Creating Time Clock Events	61
Viewing and Modifying Time Clock Events	63
Deleting a Time Clock Event.....	64
Setting the Time Clock Home / Away Mode	65

Section 5 - RS-232 Programming

RS-232 Port Programming

Overview	66
Configuring the RS-232 Serial Port	67
Assigning Zone Numbers	68
Assigning Master Control Numbers.....	70
Phantom Button Programming.....	72

Section 6 - Contact Closure Programming

Contact Closure Programming

Setting Up a General Purpose Contact Closure Input for Scene Control	73
Setting Up a General Purpose Contact Closure Input for Time Clock Mode Control.....	76
Setting Up the Security Contact Closure Input.....	77
Testing Contact Closure Inputs	79

Section 7 - User Preferences

Dimmer Locked Presets

Enable Dimmer Locked Presets	80
Disable Dimmer Locked Presets	82

Asymmetric Fade Rates

Changing Asymmetric Fade Rates.....	83
-------------------------------------	----

Section 8 - Additional Information

Diagnostic Tools

Viewing the Address Usage and Detecting Missing Devices	84
Viewing Device Information	86
Using FLASH Mode	87
Using BEEP Mode	89
Using System BEEP Mode	91

Adding a Switch Closure Input, RS-232, or IR Interface

Activating a Switch Closure Input Interface, RS-232 Interface, or Infrared (IR) Interface	92
---	----

Returning Components to Default Factory Settings

Master Controls	94
Dimmers	95
Switches	96
GRAFIK Eye Interface	97
Repeaters	98
Switch Closure Interface	99
RS-232 Interface.....	100
IR Interface	101
Chronos System Bridge	102

Using RadioRA Master Controls with Raise/Lower

Using RadioRA Master Controls with Raise/Lower	103
--	-----

Glossary

Definitions of Common Terms	104
-----------------------------------	-----

Troubleshooting Guide

Troubleshooting	105
-----------------------	-----

RadioRA® System Components

Lighting Zone Controls:

Replace existing switches with *RadioRA* Dimmers, Switches, and GRAFIK Eye® Preset Lighting Controls.

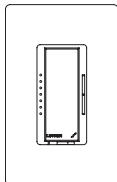

Dimmer

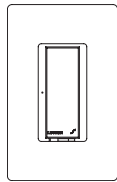

Switch

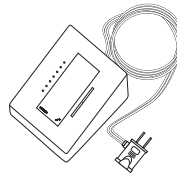

Lamp Dimmer



GRAFIK Eye Preset Lighting Control

Master Controls:

Master Controls provide control of any or all *RadioRA* Lighting Zone Controls.

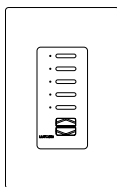

Wall-mounted Master Controls

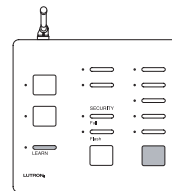
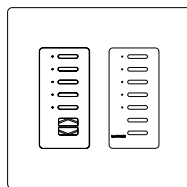

Multi-function Entry Master Control and Visor Control Transmitter



System Interface Master Controls—RS-232, Switch Closures, and Infrared (IR)

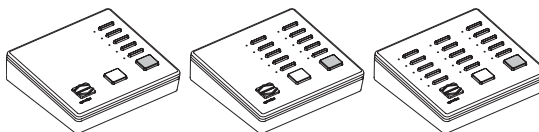

Tabletop Master Controls

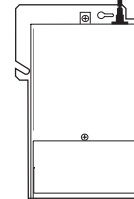

Chronos™ System Bridge and Timeclock:

The *Chronos* System Bridge provides timeclock capability, RS-232 and contact closure input interfacing, the ability to bridge two *RadioRA* systems, and acts as a system's Main Repeater.

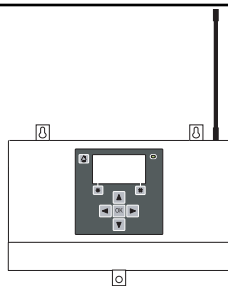

Chronos System Bridge and Timeclock

RF Signal Repeater:

Repeaters provide system setup and diagnostic functions, and provide an additional path for communications between system devices.

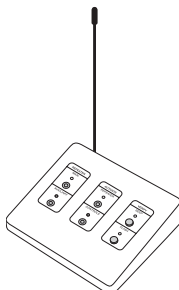

Repeater

Chronos™ System Bridge Features

System Bridge

The *Chronos* System Bridge bridges two RadioRA® systems for a total of 64 Lighting Zone Controls and 24 Master Controls.

17 Whole-home Scenes

The *Chronos* System Bridge provides 17 whole-home scenes which can be accessed via any button on a Master Control or via the RS-232 connection.

Astronomic Time Clock

The time clock provides an additional 13 whole-home scenes that can be activated by up to 100 programmable time clock events. These events can be scheduled relative to sunrise / sunset or time of day.

Contact Closure Inputs

One security and two general-purpose contact closure inputs allow interfacing to security and other third-party systems.

LCD User Interface

The interactive LCD interface guides the user through setting up whole-home scenes, time clock events, RS-232 device mapping, and other system settings.

Advanced Diagnostics

The *Chronos* System Bridge provides advanced diagnostics through the LCD, simplifying system setup and troubleshooting.

Main Repeater

When bridging two systems, the *Chronos* System Bridge always acts as the Main Repeater in both systems. The *Chronos* System Bridge may also act as the Main Repeater in a single system.

RS-232 Interface

The RS-232 interface allows for integration with third-party systems.

System Overview

System Layout

Step 1 Determine if Bridging is Required

Bridging is required if:

- More than 32 Lighting Zone Controls exist, or
- More than 12 Master Controls exist

Step 2 For Bridging Two Systems

For optimal light response time, devices in System 1 and System 2 should not be used in the same room. Splitting the two systems, as shown below, is recommended.

Determine location of System 1 and System 2.

Examples:

- a. System 1: 1st Floor (see illustration below)
System 2: 2nd Floor
- b. System 1: East Wing
System 2: West Wing
- c. System 1: Interior
System 2: Exterior

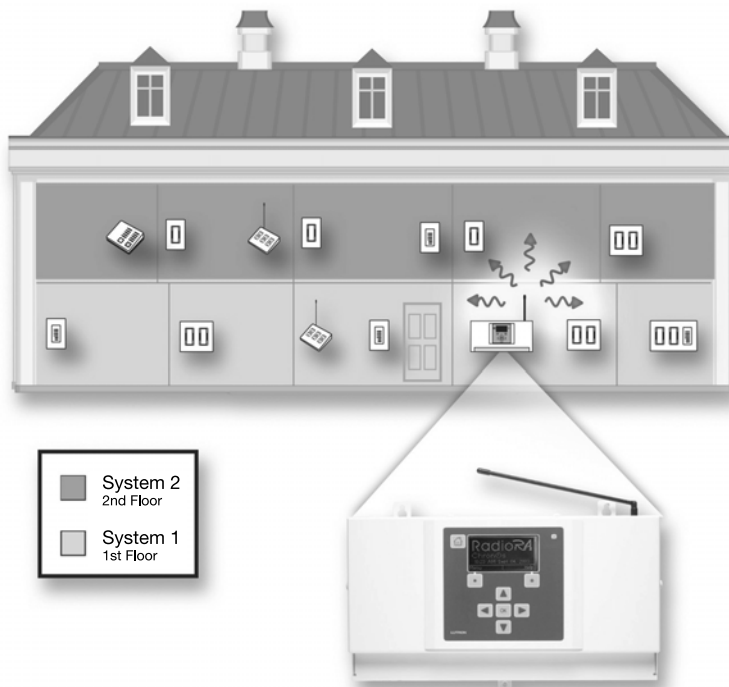

Step 3 Repeater, Chronos™ System Bridge, Lighting Zone Controls, and Master Control Placement

Place the *Chronos* System Bridge and Repeaters to provide appropriate RF coverage within each system.

Repeaters

- Place System 1 Repeaters within 60 feet (18 m) of each other
- Place System 2 Repeaters within 60 feet (18 m) of each other

Chronos System Bridge

- Place the *Chronos* System Bridge within 60 feet (18 m) of a Repeater in each system

Lighting Zone Controls and Master Controls

- Place System 1 Controls within 30 feet (9 m) of System 1 Repeaters or *Chronos* System Bridge
- Place System 2 Controls within 30 feet (9 m) of System 2 Repeaters or *Chronos* System Bridge

1st Floor View—System 1

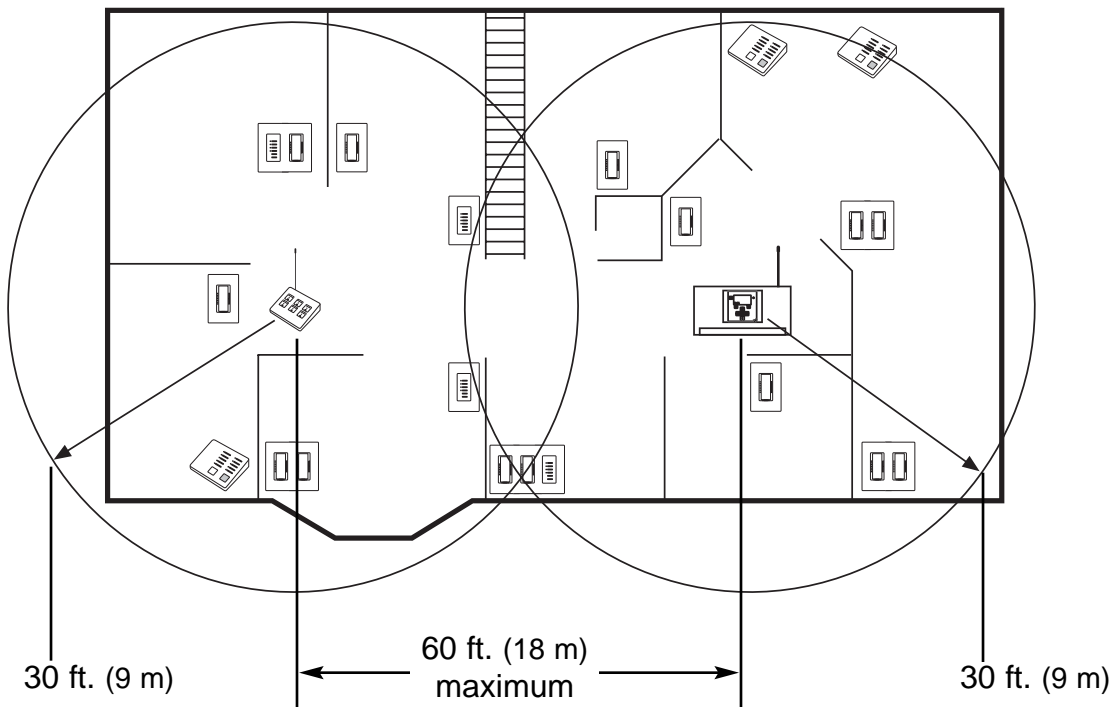

Chronos™ System Bridge Hardware Identification

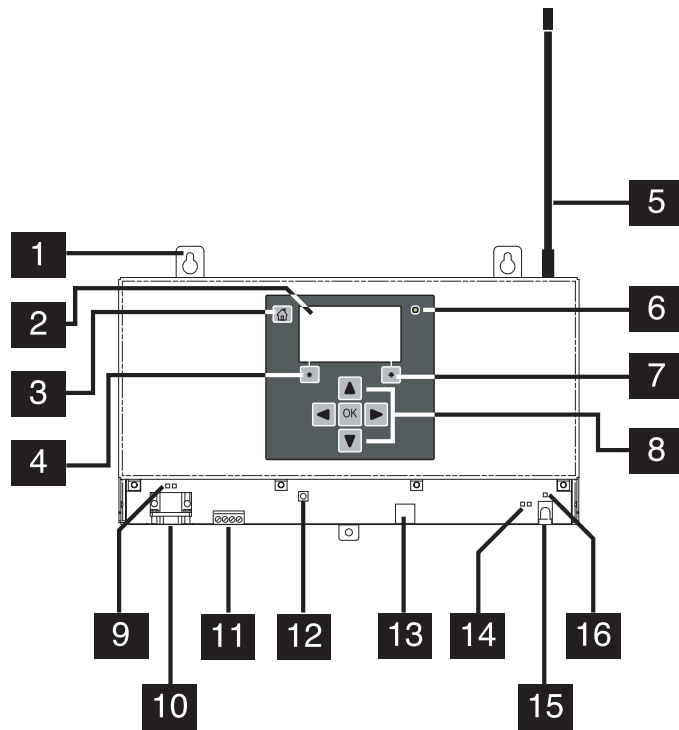

- 1. Mounting Tab**
Three mounting tabs (2 at top, 1 at bottom) for installation
- 2. LCD Screen**
Provides a simple, menu-driven interface
- 3. Home Button**
Returns to the Home Screen from any other screen
- 4. * Soft Key**
Performs the action listed in the bottom left corner of the LCD
- 5. RF Antenna**
Orient antenna vertically for best performance
- 6. LCD Power LED**
- 7. # Soft Key**
Performs the action listed in the bottom right corner of the LCD
- 8. Navigation Buttons**
For navigating menus and changing settings
- 9. RS-232 Activity LEDs**
Indicate when RS-232 communications are present
- 10. RS-232 Port**
For communication with third-party systems
- 11. Contact Closure Inputs**
For interfacing to security and other systems
- 12. Initialization Switch**
For resetting the *Chronos* System Bridge
- 13. Keyboard Port**
For navigation and data entry with a standard keyboard (PS/2-compatible connector)
- 14. RF Activity LEDs**
Indicate when RF communications are present
- 15. Power Input Jack**
Input jack for use with the power adapter provided with the *Chronos* System Bridge
- 16. Power LED**
Indicates when the *Chronos* System Bridge is powered

Installing the Chronos™ System Bridge

Installation

Read all instructions completely before installation.

Important Installation Notes

1. Install in accordance with all national and local electrical codes.
2. Use only the AC adapter provided by Lutron with your *Chronos* System Bridge. Using an adapter not rated at the following specifications could damage the *Chronos* System Bridge and possibly overheat the AC adapter.
 - Input: 120 V ~ 50/60 Hz
 - Output: 18 V ~ / 300 mA Class 2
3. Operate in ambient temperatures between 32°F (0°C) and 104°F (40°C), 0-90% humidity, non-condensing.
4. To clean, wipe with a clean damp cloth. **DO NOT** use any chemical solutions.
5. **DO NOT** ground the *Chronos* System Bridge. **DO NOT** mount the *Chronos* System Bridge in a metal enclosure.
6. Do not paint the *Chronos* System Bridge.
7. The range and performance of the RadioRA System is highly dependent on a variety of complex factors such as:
 - Distance between system components
 - Geometry of the home
 - Construction of walls separating system components
 - Electrical equipment located near system components

Step 1 Find a suitable location for the *Chronos* System Bridge

Place the *Chronos* System Bridge in a convenient and accessible location. Access to input and output wiring should be considered when selecting the mounting location. The *Chronos* System Bridge should be placed in an area where it cannot be inadvertently changed, and at a height inaccessible to children.

Note: Master Controls and Lighting Zone Controls must be located within 30 feet (9 m) of the *Chronos* System Bridge or an Auxiliary Repeater. Auxiliary Repeaters must be located within 60 feet (18 m) of the *Chronos* System Bridge or one another. For more information refer to "Repeater, *Chronos* System Bridge, and Zone/Master Control Placement" on page 10.

Step 2 Mount the *Chronos* System Bridge

Remove the port cover from the *Chronos* System Bridge by gently pulling up on the front edge to disengage the snaps.

Attach *Chronos* System Bridge to wall using the wall anchors and screws provided.

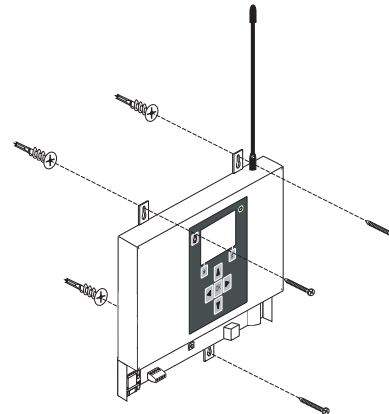

Note: For best performance, antenna should be oriented vertically.

Step 3 Wiring to Input Devices

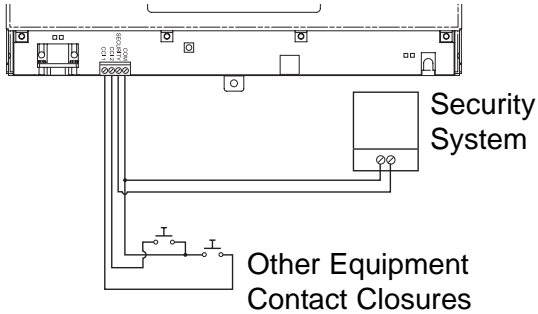

Note:

- Input devices can be driveway sensors, photocells, security systems, etc.

Contact Closure Compatibility: The input closures are intended for use with devices that provide maintained or momentary outputs in the form of dry contact closure or open collector outputs meeting the following criteria:

- On saturation voltage: $< 1.0 V_{DC}$ at 2 mA
- Off leakage current: $< 10.0 \mu A$ at 12 V_{DC}
- Outputs must stay in the closed or open state for at least 40 msec in order to be recognized by the Chronos System Bridge

If there is any question as to whether the contact closure device is compatible with these specifications, contact the manufacturer of that device.

Contact Closure Wiring:

Caution - DO NOT apply voltage between any two terminals on the Chronos System Bridge contact closure input terminal block. This will cause improper operation and could damage the Chronos System Bridge and the connected equipment.



DANGER -

- Do not connect line voltage power to the Chronos System Bridge.
- Connecting line voltage power or improper wiring can result in personal injury or damage to the Chronos System Bridge or to other equipment.
- All external control equipment must maintain Class 2 isolation.

Step 4 Connect the RS-232 Cable

Connect a DB9 male RS-232 cable to the RS-232 connector.

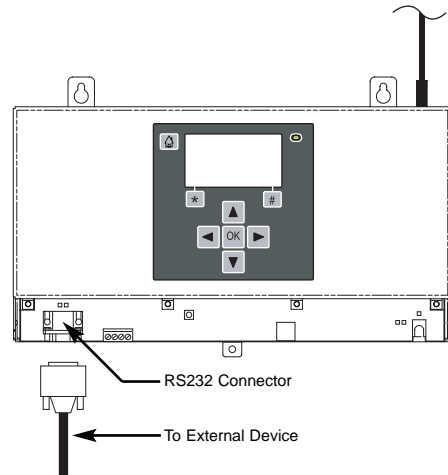

To select the proper RS-232 cable for your application, see the RadioRA RS-232 Protocol and Programming Guide (P/N 044-038).

Installing the Chronos™ System Bridge

Step 5 Plug in the AC Adapter to the Chronos System Bridge

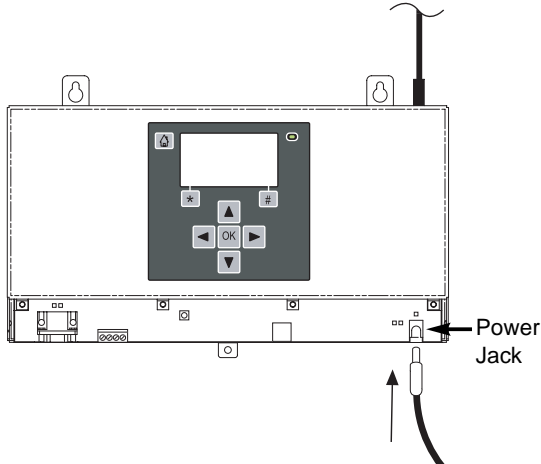

Step 6 Plug in the AC Adapter to wall receptacle

Plug the AC Adapter into a 120 V~, 50/60 Hz wall receptacle.

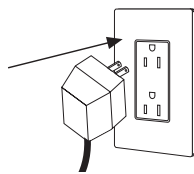

? If the Power LED above the power jack labeled "PWR IN" is not on when powered, ensure that the AC adapter is installed properly and that there is power at the receptacle. If problem persists, call the Lutron Technical Support Center at (800) 523-9466.

Note: When the *Chronos* System Bridge is powered up for the first time, the following screen should be shown on the LCD:

Chronos Configuration	
Main Repeater - - - - -	No
Bridge Systems - - - - -	No
RS-232 Interface - - - - -	No
Help	Done

Step 7 Replace port cover

Replace the cover by inserting the two tabs on the back of the cover into the slots on the *Chronos* System Bridge.

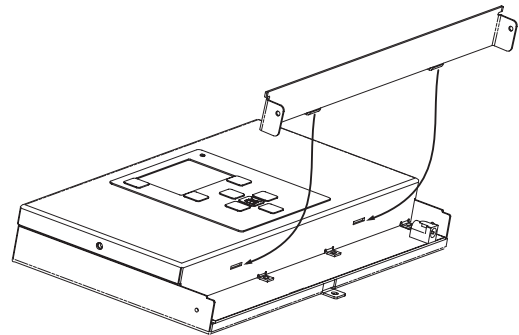

Gently press down on the front edge to engage the snaps.

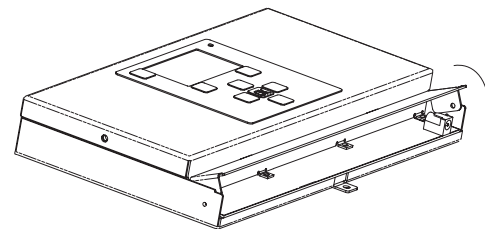

Using the LCD and Buttons

Basic Navigation

Navigation through the menu system is very simple. The ▲ and ▼ buttons are used to highlight an item in a menu. The **OK** button is used to select the highlighted item.

The * and # buttons are called soft keys. The function of the soft keys changes as indicated by the text directly above them on the LCD. Examples of soft key functions are “Back”, “Next”, “Help”, and “Cancel”.

The 🏠 button is used to return to the home screen from any other screen. When on the home screen, pressing 🏠 will display the status screen.

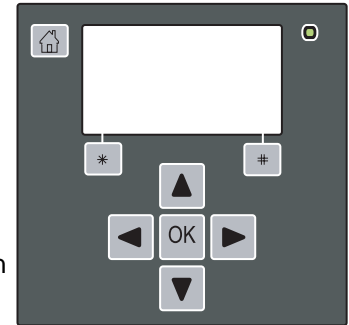

Data Entry

There are 2 basic types of screens used for data entry.

On single-row edit screens, the ◀ and ▶ buttons are used to move from one data field to another. The ▲ and ▼ buttons are used to change the value of the data field.

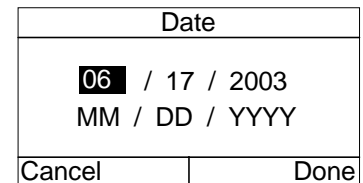

On multi-row edit screens, the ▲ and ▼ buttons are used to move from one data field to another. The ◀ and ▶ buttons are used to change the value of the data field.

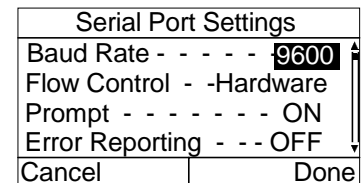

On screens where data is being edited, the soft keys will always be “Cancel” and “Done”. The “Done” soft key must be used to confirm and accept changes.

Sleep Mode

When the Chronos System Bridge has been idle for 30 minutes, the LCD will go into Sleep Mode. At this point, the LCD will turn off. A single press of any button will bring the LCD out of Sleep Mode.

Installing the Chronos™ System Bridge

Using the Keyboard Port

The keyboard port is compatible with standard PS/2 keyboards with 6-pin mini-DIN connectors. A keyboard can be connected to the *Chronos* System Bridge for navigation and data entry. The keys on the keyboard are used as follows:

Keyboard Key	Chronos Button	Function
		Change value or move to next or previous item
		Accept selection
		Go to home screen
OR		Perform * soft key function
OR		Perform # soft key function
to + to to + +	(none)	Data Entry—characters/keys supported are A - Z, a - z, 0 - 9, Space, Backspace, Delete, #, %, &, *, (,), -, _, ', and :
	(none)	Back or Cancel (where available)
	(none)	Help

System Configuration

System Configuration and Features

System Configuration and Features Available

	Bridged Systems (Chronos™ System Bridge used as the Main Repeater* in both sys- tems)	Single System (Chronos System Bridge used as a Main Repeater*)	Single System (Chronos System Bridge not used as a Main Repeater)
Main Repeater* System 1	✓	✓	N/A
Main Repeater* System 2	✓	N/A	N/A
Time Clock	✓	✓	✓
Whole-home Buttons	✓	N/A	N/A
Phantom Buttons	✓	✓	✓
Contact Closure Inputs	✓	✓	✓
RS-232 Port	✓	✓	✓

System Maximums

	System Bridge (Chronos System Bridge used as the Main Repeater* in both sys- tems)	Single System (Chronos System Bridge used as a Main Repeater*)	Single System (Chronos System Bridge not used as a Main Repeater)
Maximum # Lighting Zone Controls	64	32	32
Maximum # Master Controls	24	12	12
Maximum # Repeaters System 1	3	3	4
Maximum # Repeaters System 2	3	N/A	N/A

* When using the Chronos System Bridge as the Main Repeater, all devices of an existing RadioRA® system must be reset to the factory default settings and reprogrammed.

Setting the Initial Chronos System Bridge Configuration

Step 1 Go to the Chronos System Bridge Configuration Menu

The Chronos System Bridge will display the **Chronos Configuration screen** when powered for the first time or whenever the unit is returned to factory defaults. This screen is also accessible via the **Main Menu**.

Chronos Configuration	
Main Repeater -----	No
Bridge Systems -----	No
RS-232 Interface -----	No
Help	Done

Use ◀ and ▶ to change the value of the selected setting. Use ▲ and ▼ to move to the next / previous setting.

Step 2 Configure the Chronos System Bridge

Modify the settings based on how the Chronos System Bridge will be used in the system. The settings are as follows:

Main Repeater

Set this value to “Yes” if the Chronos System Bridge will be the Main System Repeater. This setting can only be changed later by returning the Chronos System Bridge to factory defaults. **Note:** In order to bridge systems, **Main Repeater** must be set to “Yes”. The Chronos System Bridge will automatically set **Main Repeater** to “Yes” when **Bridge Systems** is set to “Yes”.

Bridge Systems

Set this value to “Yes” if the Chronos System Bridge will be used to bridge two RadioRA® systems. Otherwise, leave this value “No”. This setting can be changed from “No” to “Yes” later, if desired; however, this setting can only be changed from “Yes” to “No” by returning the Chronos System Bridge to factory defaults.

RS-232 Interface

Set this value to “Yes” if the RS-232 interface will be used for communication to other systems. This setting can be changed later, if desired.

Note: The Time Clock is always active. To use the Chronos System Bridge as a Time Clock only, leave all configurations at “No” and go to Step 3b.

Step 3a Accept the Chronos System Bridge Configuration

Once the desired settings have been selected, press **“Done” (# button)**.

If the Chronos System Bridge is configured as the Main Repeater, it will then initialize by acquiring house addresses and master control addresses.

Initializing System 
Acquiring House Code - Pass
Acquiring Addresses - - Wait

Initializing System
System Initialized successfully. Press OK to continue.

Initial Chronos™ System Bridge Configuration

Step 3b Accept the Chronos Configuration

Once the desired settings have been selected, press “Done” (# button).

If the Chronos System Bridge is not configured to be the Main Repeater, it will present instructions on activating into an existing system.

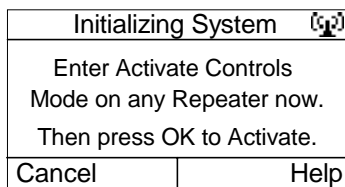

Press and hold the ACTIVATE CONTROLS button on a Repeater until the green ACTIVATE CONTROLS LED turns on (approximately 3 seconds).

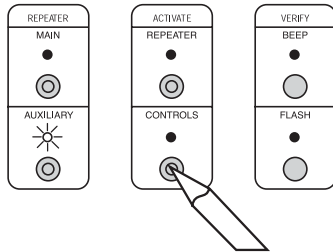

The green ACTIVATE CONTROLS LED on **ALL** Repeaters will turn ON.

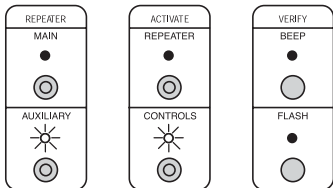

Press **OK** to activate the Chronos System Bridge.

Once the Chronos System Bridge has completed initialization, the following screen will be displayed:

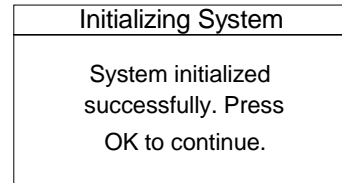

Press **OK** to complete the initialization. The Home Screen will be displayed.

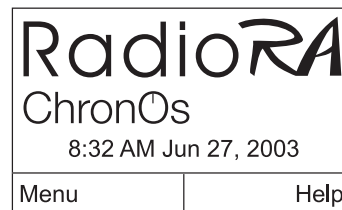

Activating the System

Activate Auxiliary Repeaters

This procedure needs to be performed only if the Chronos™ System Bridge is configured as a Main Repeater. If the Chronos System Bridge is not configured as a Main Repeater, skip this procedure. Repeaters must be in their permanent location in order to be activated. Note: Additional Auxiliary Repeaters (up to 3 Repeaters total per system) can be added to a system to increase range and improve reliability.

Ensure all system devices are powered up and operating prior to adding any Auxiliary Repeaters.

Step 1 Go to System Setup

Main Menu

↳ System Setup

Note: If the Chronos System Bridge is configured to bridge systems, the Main Menu will contain a System 1 Setup and a System 2 Setup. These steps should be repeated for both systems.

Step 2 Put the Chronos System Bridge into Activate Repeater Mode

From System Setup, select Activate Aux Repeaters.

System Setup	
Activate Aux Repeaters	
Activate Controls	
Address Usage	
Diagnostics	
Back	Help

The number of repeaters currently in the system is displayed. This number will update as new repeaters are activated.

Activate Aux Repeaters (4/2)	
Begin Activating Aux Repeaters in System 1	
Auxiliary Repeaters - - - - 0	
Help	Done

Step 3 Activate Auxiliary Repeater Nearest to the Chronos System Bridge

Press and hold the ACTIVATE REPEATER button until the green ACTIVATE REPEATER LED begins to flash (approximately 3 seconds).

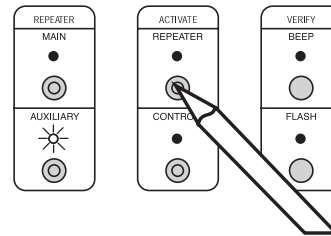

Green ACTIVATE REPEATER LED will stay on when Repeater has been activated.

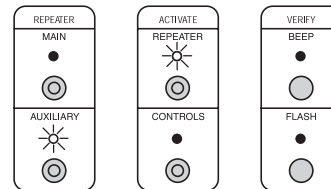

Step 4 Activate remaining Repeaters

Repeat Step 3 for each remaining Repeater, starting with the next closest Repeater (maximum of 3 Auxiliary Repeaters).



If the ACTIVATE REPEATER LED on an Auxiliary Repeater turns orange, consult the Troubleshooting Guide.

Activating the System

Step 5 Complete Repeater activation

Press “Done” (# button) on the Chronos™ System Bridge. The green ACTIVATE REPEATER LED on ALL auxiliary repeaters will turn off. The AUXILIARY LED will remain on.

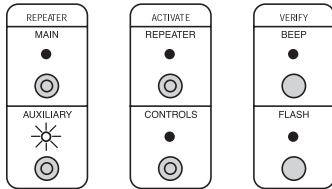

- Repeater activation is now complete.
- Proceed to Activate Controls on page 22.

Activating the System

Activate Controls

This procedure needs to be performed only if the Chronos™ System Bridge is configured as a Main Repeater. If the Chronos System Bridge is not configured as a Main Repeater, skip this procedure. All controls must be operating (Dimmers and Switches must be wired to a light) in order to be activated.

Step 1 Go to the System Setup Menu

Main Menu

➤ System Setup

Note: If the Chronos System Bridge is configured to bridge systems, the **Main Menu** will contain a **System 1 Setup** and a **System 2 Setup**. These steps should be repeated for both systems.

Step 2 Put the System in Activate Controls Mode

From **System Setup**, select **Activate Controls** OR press and hold the **ACTIVATE CONTROLS** button on any auxiliary Repeater until the green **ACTIVATE CONTROLS** LED turns ON (approximately 3 seconds).

System Setup	
Activate Aux Repeaters	
Activate Controls	
Address Usage	
Diagnostics	
Back	Help

The number of devices and Master Controls currently in the system is displayed. These numbers will update as new Zone Controls and Master Controls are activated. The green **ACTIVATE CONTROLS** LED on **ALL** auxiliary repeaters will turn ON.

Activate Controls	
Begin Activating Controls in System 1	
Zone Controls - - - - -	0
Master Controls - - - - -	0
Help	Done

Step 3 Activate a Master Control

Go to any Master Control.

Press any button.

- All LEDs will flutter, then
- Top and bottom row will flash alternately

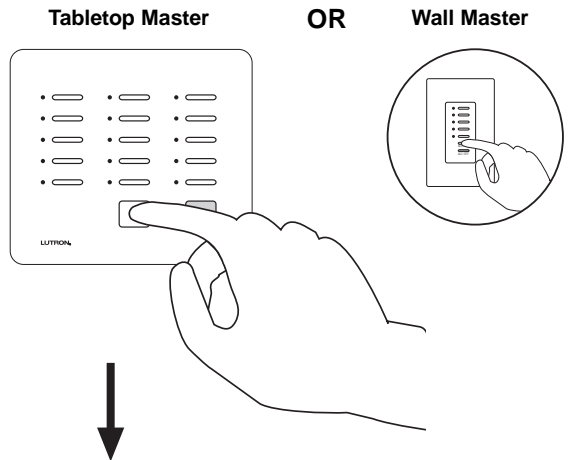

The middle row of LEDs will turn ON when the Master Control has been activated.

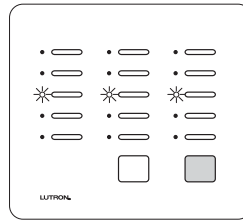

If a Master Control fails to respond as described above, consult the *Troubleshooting Guide*.

- Repeat Step 3 to activate any remaining Master Controls.

Activate one Master Control at a time. Wait for the middle row of LEDs to turn ON before activating the next Master Control.

Activating the System

Step 4 Activate a Lighting Zone Control

Go to any Dimmer, Switch or GRAFIK Eye®/GRAFIK RA™ Control Unit. Turn the Dimmer or Switch ON or OFF by pressing the tapswitch. On a *GRAFIK Eye*/*GRAFIK RA* Control Unit, change the selected scene by pressing a scene button.

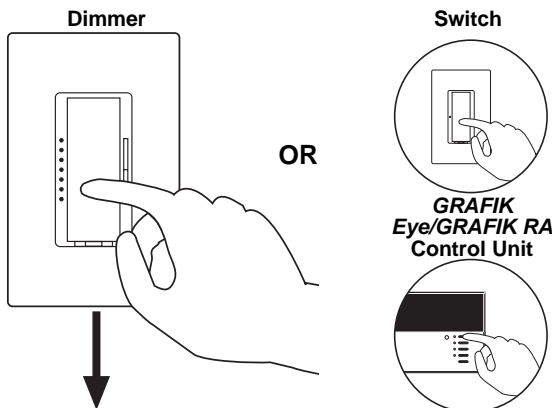

The light(s) that the Lighting Zone Control operates will turn ON and OFF a few times when it has been activated.

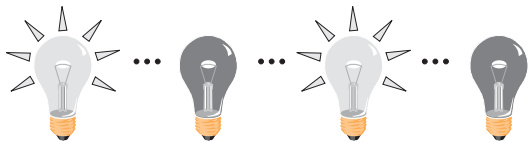

If a Lighting Zone Control fails to respond as described above, consult the *Troubleshooting Guide*.

- Repeat Step 4 to activate any remaining Lighting Zone Controls.



Activate one Lighting Zone Control at a time. Wait for the control to flash its light(s) before activating any remaining controls.

- Proceed to Step 5 when all Lighting Zone Controls have been activated.

Note: When a Lighting Zone Control is properly activated, the Zone Controls count on the *Chronos* System Bridge screen will increment by one.

Step 5 Complete Control Activation

Press “Done” (# button) on the *Chronos* System Bridge OR press and hold the ACTIVATE CONTROLS button on any auxiliary Repeater until the green ACTIVATE CONTROLS LED turns off (approximately 3 seconds). The green ACTIVATE CONTROLS LED on ALL auxiliary repeaters will turn off. The AUXILIARY LED will remain on.

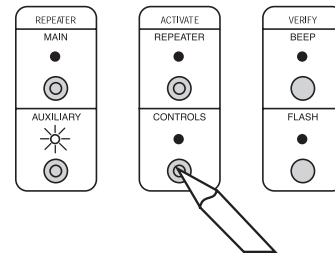

Step 6 Verify that all Controls have been activated

From **System Setup**, select **Diagnostics**.

Diagnostics - System 1	
Flash Mode -----	No
Beep Mode -----	No
Global Beep Mode ----	No
Back	Help

Use ◀ or ▶ to activate Flash Mode.

Master Controls, if activated, will flash all their LEDs. Make note of any Master Controls that are not activated.

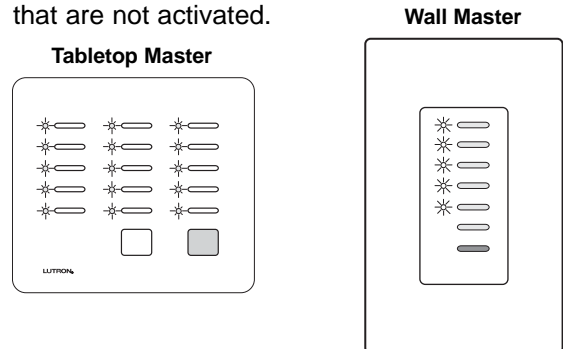

Activating the System

Lighting Zone Controls, if activated, will flash the light(s) they control. Make note of any Lighting Zone Controls that are not activated.

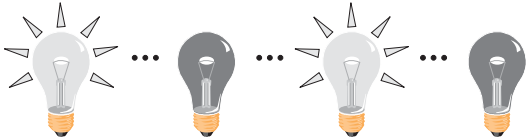

After verifying that all Master Controls and Lighting Zone Controls are activated, press ◀ or ▶ on the Chronos™ System Bridge to set Flash to **No** OR press and hold the FLASH button on any Repeater until the green FLASH LED turns off (approximately 3 seconds).

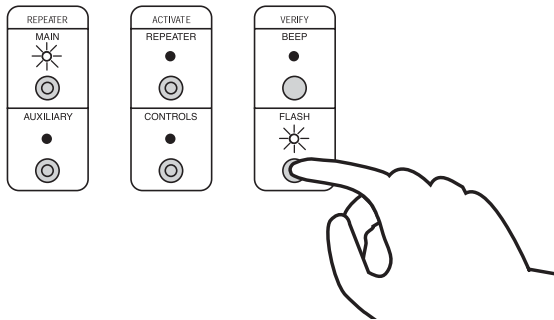

If any Master Control or Lighting Zone Control has not been activated, repeat Steps 1 through 5, starting on page 21.

- **Master Controls and Lighting Zone Controls are now activated.**
- **Repeat Activate Auxiliary Repeaters and Activate Controls for System 2 if the Chronos System Bridge is set up as a bridge.**
- **When both systems have been activated, proceed to Local Button Programming Overview on page 25.**

Local Button Programming Overview

1. Select a Master Control to be Programmed

2. Set Columns

Each column of buttons on a Master Control can be programmed to be either ROOM or SCENE buttons. All button columns are factory set as ROOM buttons. Refer to Rooms and Scenes Overview (page 26) for an explanation of Rooms and Scenes. Refer to pages 28-29 for details on assigning a column of buttons as ROOMS or SCENES.

3. Program ROOM and SCENE Buttons

Each button on a Master Control can be programmed to affect any or all of the Lighting Zone Controls in the system.

a. Assign Controls

By default, ROOM and SCENE buttons have no controls assigned to them. To assign controls to each button, perform the steps detailed on pages 30 and 31. Assign all Lighting Zone Controls that will be affected by the button being programmed. For SCENE Buttons, also assign all Lighting Zone Controls that will be turned OFF by the button being programmed.

b. Set Light Levels

Lighting Zone Controls assigned to each button may be set to desired light levels to fit the mood or activity programmed. To set light levels for each button, perform the steps detailed on pages 32 and 33. Dimmer light levels default to 100% for ROOM Buttons and 50% for SCENE Buttons. Switches default to ON and GRAFIK Eye®/GRAFIK RA™ Control Units default to Scene 1.

4. Program ALL ON and ALL OFF Buttons

ALL ON Buttons always turn ON Dimmers (to 100%), Switches, and *GRAFIK Eye*/*GRAFIK RA* Control Units (to Scene 1). ALL OFF Buttons always turn these controls OFF. By default, all Lighting Zone Controls are assigned to all of the ALL ON and ALL OFF Buttons. To unassign controls from the ALL ON and ALL OFF Buttons, perform the steps detailed on pages 34 and 35.

5. Repeat for all Master Controls

Advanced Local Button Programming

To copy Local Button programming from one Master Control to another, perform the steps detailed on page 36.

To clear Local Button programming, perform the steps detailed on pages 38 and 39.

Button Programming Overview

Rooms and Scenes Overview

What is a Room Button?

A Room button is used to monitor the On/Off status of a light or group of lights. For instance, in the Family Room, the Recessed Lights, Wall Sconces, and Accent Lights make up all the lights in the room. Assigning all of those lights to one button would allow the monitoring of all those lights. If any of the lights are On, the Room button's LED will be ON. Pressing the button will turn all of the lights in the room off. If all of the lights in the Family Room are Off, the LED will be off. Pressing the button will turn all of the lights in the room on to their pre-selected level.

What is a Scene Button?

A Scene button is used to create a mood or emotion in a room. In a Family Room, a couple common scenes are watch "TV" and watch a "Movie." Pressing a Scene button sets the mood by setting all assigned Dimmers to their pre-selected level. A Scene button's LED on a Master Control will be on if, and only if, that Scene button was pressed on that Master Control. So, when a Scene button is pressed from a Master Control, the assigned lights will go to their pre-selected level (including Off) and the Scene button's LED will turn on. Pressing the Scene button again will turn all of the lights assigned to that button off. A Scene button's LED will remain on as long as all of the assigned lights are still at their pre-selected level. If a light changes level, either from another Master Control button or via local control, the Scene button's LED will turn OFF.

ROOMS and SCENES Examples

Initially, all of the lights are OFF. Our ROOM button, called Family, is off because all of the lights in the Room are OFF. Our two SCENE buttons, TV and Movie, are off because the lights are not at the pre-selected levels for those SCENES.



Pressing the Family button turns ON all of the lights assigned to the button. The Family LED turns ON because atleast one of the lights in the room is on.



Pressing the TV button sets the mood for watching TV. In this SCENE, all of the lights in the room at set to 50%. Since the TV button was pressed and the lights are on at their pre-selected level, the TV LED turns ON. The Family LED remains on because atleast one of the lights in the ROOM is still ON.



Pressing the Movie button sets the mood for watching a movie. In this SCENE, the recessed lights and wall sconces turn OFF and the Accent Lights turn On to 50%. The Movie SCENE is active so the Movie LED is ON. The lights are no longer at their pre-selected level for watching TV so the TV SCENE turns OFF. Like before, the Family LED is still ON because atleast one of the lights in the ROOM is still ON.



Pressing the Movie button again will turn all of the lights in the ROOM OFF. The lights are no longer at their pre-selected level for the Movie SCENE so the Movie LED turns OFF. Since all of the lights in the ROOM are OFF, the Family LED turns OFF.



Pressing the Movie SCENE will recall the lights to the Movie setting. As before, the Movie and Family LEDs are ON.



Now the Recessed Lights have been turned on by pressing the button on the Dimmer. The lights are no longer at their pre-selected level for the Movie SCENE so the Movie LED turns OFF. The Family LED remains on because atleast one of the lights in the ROOM is still ON.



The Family LED indicates that atleast one of the lights ROOM is still ON. To turn OFF all of the lights in the ROOM, press the Family button. With all of the lights in the ROOM OFF, the Family LED turns OFF.



Button Programming Overview

Local Buttons, Phantom Buttons, and Whole-home Buttons

Local Buttons

A Local Button is a Master Control button used to activate zones of lighting within a single system. A Local Button is programmed locally at the Master Control, or copied from a button on another Master Control. Any or all zones of lighting within the same system as the Master Control can be assigned to the button. Each column of local buttons can be assigned as either ROOM buttons or SCENE buttons.

A Local Button would typically be used when all of the lighting to be controlled by the button is in the same area as the Master Control.

Phantom Buttons

A Phantom Button is a "virtual" button that resides in the Chronos™ System Bridge and is used to activate lighting in a single system or both systems. Any or all zones of lighting within a single system or both systems can be assigned to Phantom Buttons. Each Phantom button can be assigned as either a ROOM button or a SCENE button.

Phantom Buttons can be activated via Master Control Whole-home Buttons (see below) or via the *Chronos* System Bridge RS-232 port.

Whole-home Buttons

Whole-home Buttons are available when using the *Chronos* System Bridge to bridge two RadioRA® systems. A Whole-home button is a Master Control button that can be used to activate zones of lighting in both systems. Programming of Whole-home Buttons is accomplished at the *Chronos* System Bridge with Phantom Buttons.

A Whole-home Button would be used whenever lighting in both systems is to be controlled by a Master Control.

Local Button Programming

Assigning a Column of Buttons as ROOMS or SCENES

Each column of buttons on a Master Control can be programmed to be either ROOM or SCENE buttons. All button columns are factory set as ROOM buttons. Refer to Rooms and Scenes Overview (page 26) for an explanation of Rooms and Scenes. For an overview of the Master Control programming process, refer to page 25.

 Changing a column assignment from ROOM to SCENE (or vice versa) will delete all previous programming in that column of buttons.

Step 1 Begin ROOM/SCENE assignment

Simultaneously press and hold the 3rd, 5th, and ALL OFF buttons in the right most column until an LED in each column of the Master Control which you are programming begins to flash (approximately 3 seconds).

Note: On a 5 button Raise/Lower Wall Master, press and hold the 3rd, 5th, and Lower buttons.

Tabletop Master OR Wall Master

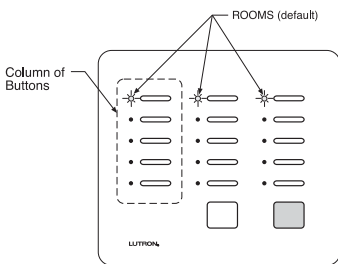
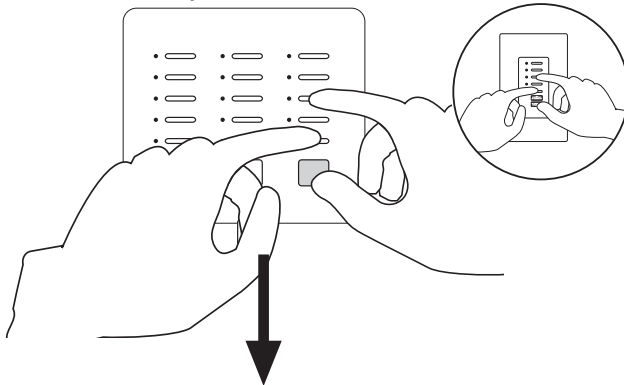

If the first LED in a column is flashing, the buttons in that column are set as ROOM buttons.

If the second LED in a column is flashing, the buttons in that column are set as SCENE buttons.

Note: The bottom row of LED s will flash when external control is enabled. This feature needs to be enabled for Whole-home buttons to function.

Step 2 Changing ROOM/SCENE assignments

Press the 1st button in a column to make that column a ROOM column, or press the 2nd button to make it a SCENE column.

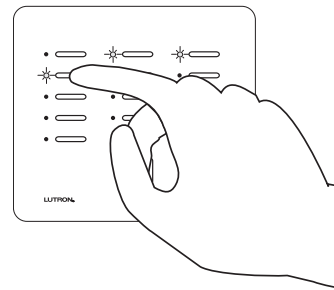

Shown: Setting left most column as SCENE buttons.

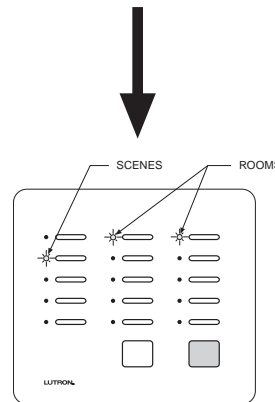

Local Button Programming

Step 3 Complete ROOM/SCENE assignment

Simultaneously press and hold the 3rd, 5th, and ALL OFF buttons in the right most column until the LEDs stop flashing (approximately 3 seconds).

Note: On a 5 button Raise/Lower Wall Master, press and hold the 3rd, 5th, and Lower buttons.

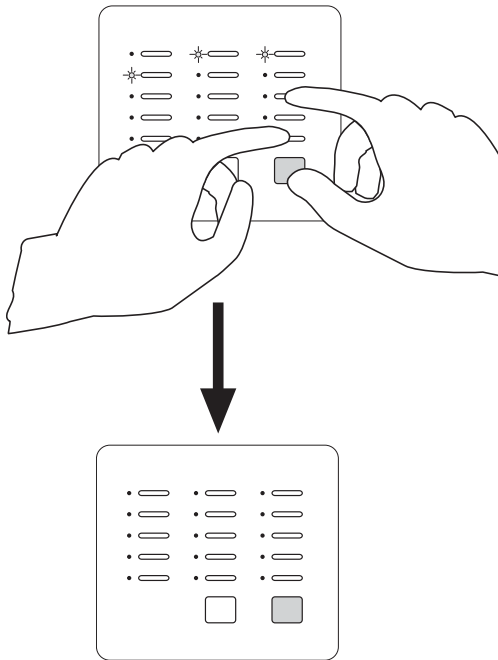

Step 4 Label columns

Apply the supplied ROOMS or SCENES labels to the space provided over each button column.

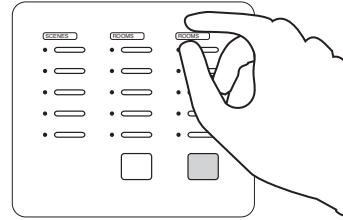

- Proceed to Assigning Lighting Zone Controls to Local Buttons on page 30.

Local Button Programming

Assigning Lighting Zone Controls to Local Buttons

Each button on a Master Control can be programmed to affect any or all of the Lighting Zone Controls in the system. By default, ROOM and SCENE buttons have no controls assigned to them. To assign controls to each button, perform the following steps. For an overview of the Master Control programming process, refer to page 25.

Step 1 Begin assigning Lighting Zone Controls to buttons

Simultaneously press and hold the 2nd and 4th buttons in the right most column until the upper right LED begins to flash (approximately 3 seconds).

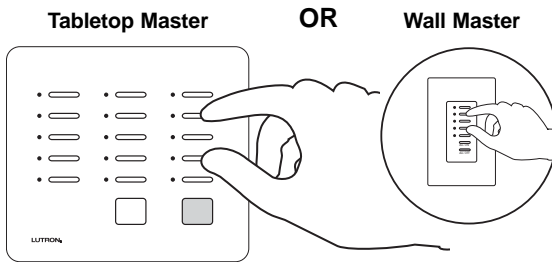

Upper right LED flashes.

Step 2 Select a Button

Press the button to be programmed. Its LED will begin to flash.

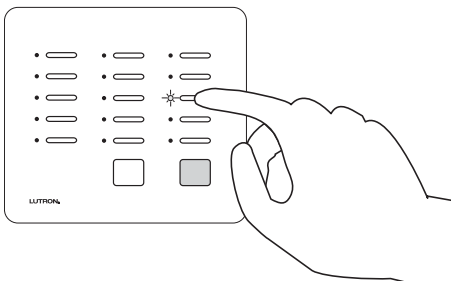

Step 3 Assign Lighting Zone Controls

Assign Dimmers or Switches to the Master Control button by turning the Controls ON. Assign all Dimmers and Switches to be affected by this button. For SCENE Buttons, include Dimmers and Switches which are to be turned OFF by the button.

Assign a GRAFIK Eye®/GRAFIK RA™ Control Unit to the Master Control button by pressing one of the GRAFIK Eye/GRAFIK RA Control Unit scene buttons. Assign all GRAFIK Eye/GRAFIK RA Control Units to be affected by this button. For SCENE Buttons, include GRAFIK Eye/GRAFIK RA Control Units which are to be turned OFF by the button.

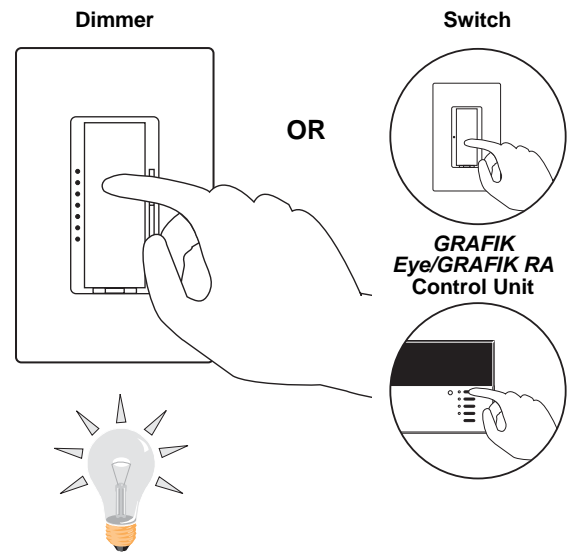

Notes:

- GRAFIK Eye/GRAFIK RA Control Units will automatically turn on to Scene 1 once assigned.
- If the wrong Lighting Zone Control is assigned to a Master Control button, turn the Lighting Zone Control OFF to unassign it.



Step 4 Program additional buttons

Repeat Steps 2 and 3 for any additional buttons to be programmed.

- Proceed to Step 5 when all buttons on this Master Control have been programmed.

Step 5 Complete assigning Lighting Zone Controls

Simultaneously press and hold the 2nd and 4th buttons in the right most column until all LEDs begin to flutter (approximately 3 seconds).

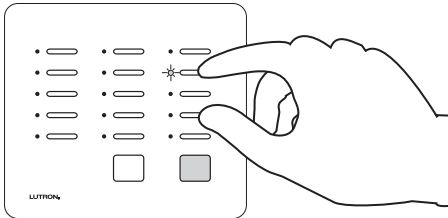

- Repeat Steps 1 through 5 for any additional Master Controls.
- Proceed to Setting Light Levels/*GRAFIK Eye* Scene Selection for Local Buttons on page 32.

Local Button Programming

Setting Light Levels/GRAFIK Eye® and GRAFIK RA® Scene Selection for Local Buttons

Lighting Zone Controls assigned to each button may be set to desired light levels to fit the mood or activity programmed. Dimmer light levels default to 100% for ROOM Buttons and 50% for SCENE Buttons. Switches default to ON and *GRAFIK Eye/GRAFIK RA* Control Units default to Scene 1. For an overview of the Master Control programming process, refer to page 25.

Step 1 Begin setting light levels/selecting *GRAFIK Eye* and *GRAFIK RA* scenes

Simultaneously press and hold the 1st and 5th buttons in the right most column until the upper right LED begins to blink (approximately 3 seconds).

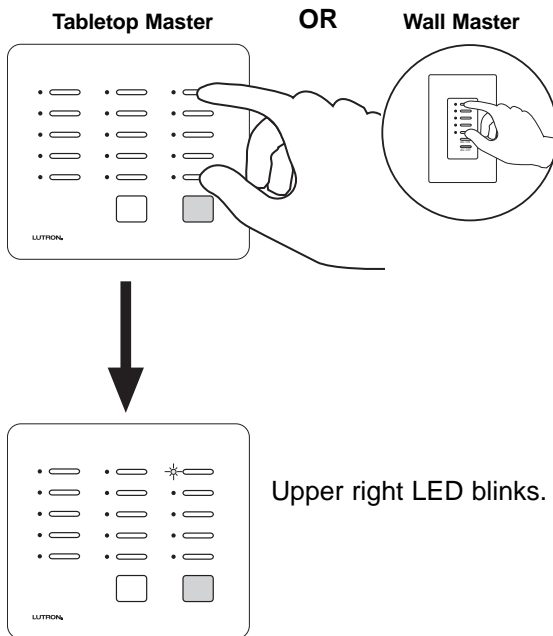

Step 2 Select a Button

Press and release the button that you want to program. Its LED will begin to blink.

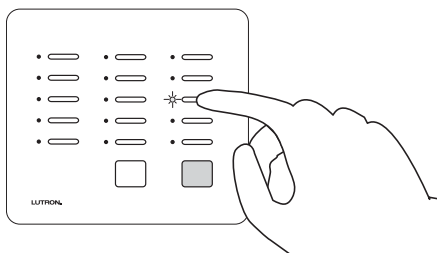

Lighting Zone Controls that have been assigned to that button will turn ON. Controls not assigned to that button will turn OFF.

Step 3 Set light levels for Dimmers and Switches

Go to any **assigned** Dimmer. Adjust this Dimmer's programmed light level for the selected button using the dimming rocker. For SCENE Buttons, turn the Dimmer OFF if it is to be turned OFF when this button is pressed.



Go to any **assigned** Switch. For SCENE Buttons, turn the Switch OFF if it is to be turned OFF when this button is pressed.

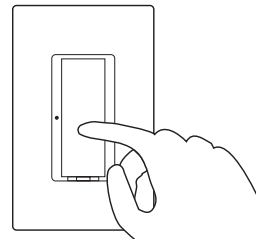

Step 4 Select a *GRAFIK Eye/GRAFIK RA* scene

Go to any **assigned** *GRAFIK Eye/GRAFIK RA* Control Unit. Select from pre-programmed scenes (1 through 4) by turning that scene ON. For SCENE Buttons, select the Off Scene if the Control Unit is to be turned off when this button is pressed.

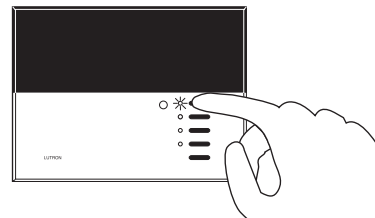

Note: See Application Note #48 for details on selecting Scenes 5-16.

Local Button Programming

Step 5 Program additional buttons

Perform Steps 2-4 (whichever apply) for any additional buttons to be programmed.

- To copy the button programming from one Master Control to another Master Control, see Copying Local Button Programming on page 36.
- Proceed to Step 6 when all buttons on this Master Control have been programmed.

Step 6 Complete setting light levels/selecting GRAFIK Eye® and GRAFIK RA® scenes

Simultaneously press and hold the 1st and 5th buttons in the right most column until all LEDs begin to flutter (approximately 3 seconds).

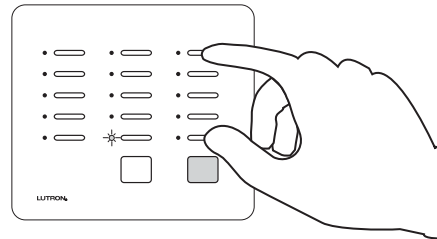

- Repeat Steps 1 through 6 to set the light levels/select *GRAFIK Eye* and *GRAFIK RA* scenes on any remaining Master Controls.
- Proceed to Programming the ALL ON and ALL OFF Buttons on page 34.

Local Button Programming

Programming the ALL ON and ALL OFF Buttons

ALL ON Buttons always turn ON Dimmers (to 100%), Switches, and GRAFIK Eye®/GRAFIK RA™ Control Units (to Scene 1). ALL OFF Buttons always turn these controls OFF. By default, all Lighting Zone Controls are assigned to all of the ALL ON and ALL OFF Buttons. To unassign controls from the ALL ON and ALL OFF Buttons, perform the following steps. For an overview of the Master Control programming process, refer to page 25.

 These programming steps only apply to Master Controls equipped with ALL ON and ALL OFF buttons.

Step 1 Begin the ALL ON/ALL OFF button programming

On the Master Control to be programmed, simultaneously press and hold the 2nd and 4th buttons in the right most column until the upper right LED begins to flash (approximately 3 seconds).

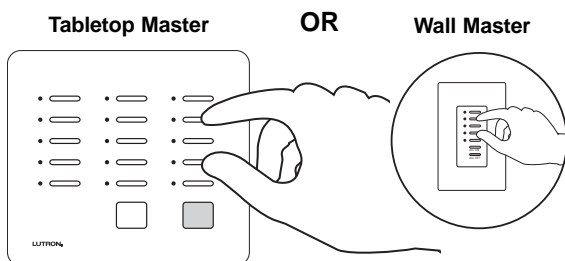

Upper right LED flashes.

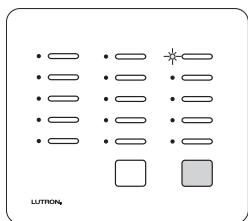

Step 2 Select a button

Press the ALL ON or ALL OFF button on the Master Control to be programmed.

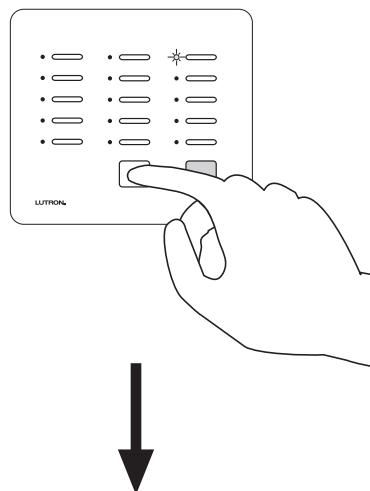

For the ALL ON button, the LEDs in all columns will simultaneously cycle from bottom to top.

For the ALL OFF button, the LEDs in all columns will simultaneously cycle from top to bottom.

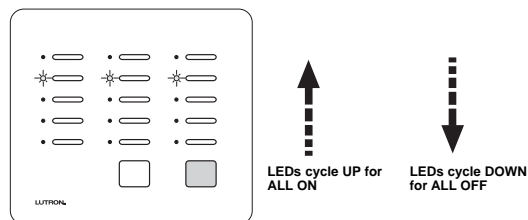

 All Lighting Zone Controls will turn on.

Local Button Programming

Step 3 Remove Lighting Zone Controls

Turn OFF the Lighting Zone Control(s) that are to be removed from the ALL ON or ALL OFF button being programmed.

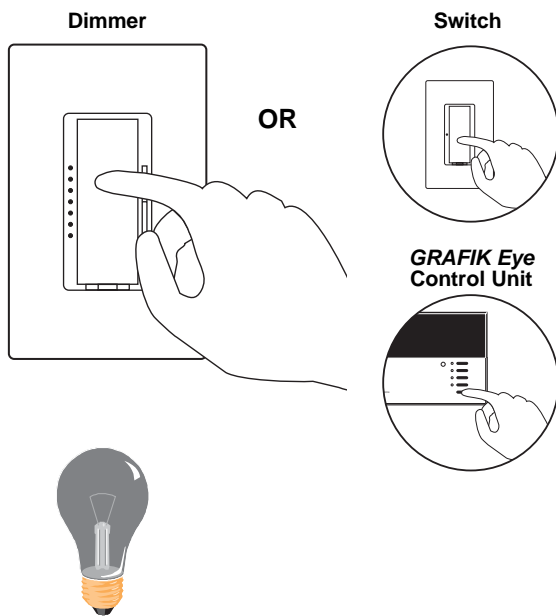

If the wrong Lighting Zone Control is removed from the ALL ON or ALL OFF button, turn the Lighting Zone Control ON to reassign it.



- Repeat Steps 2 and 3 to program the remaining ALL ON or ALL OFF button on the Master Control.

Step 4 Complete the ALL ON and ALL OFF button programming

Simultaneously press and hold the 2nd and 4th buttons in the right most column until all LEDs begin to flutter (approximately 3 seconds).

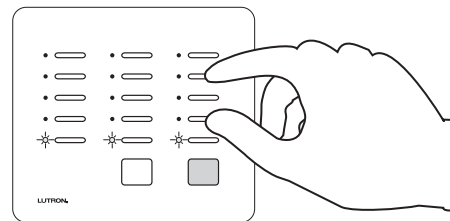

- Repeat Steps 1 through 4 to re-program the ALL ON and ALL OFF buttons on any additional Master Controls.
- The local button programming is now complete.

Advanced Local Programming

Copying Local Button Programming

Local Button programming can be copied from a button on one Master Control to a button on another Master Control. To copy button programming, perform the following steps.



Note: The buttons may be copied as follows:

- ROOM Buttons may be copied to ROOM Buttons
- SCENE Buttons may be copied to SCENE Buttons

Step 1 Begin Copying Button Programming

On the Master Control to be programmed, simultaneously press and hold the 1st and 5th buttons in the right most column until the upper right LED begins to blink (approximately 3 seconds).

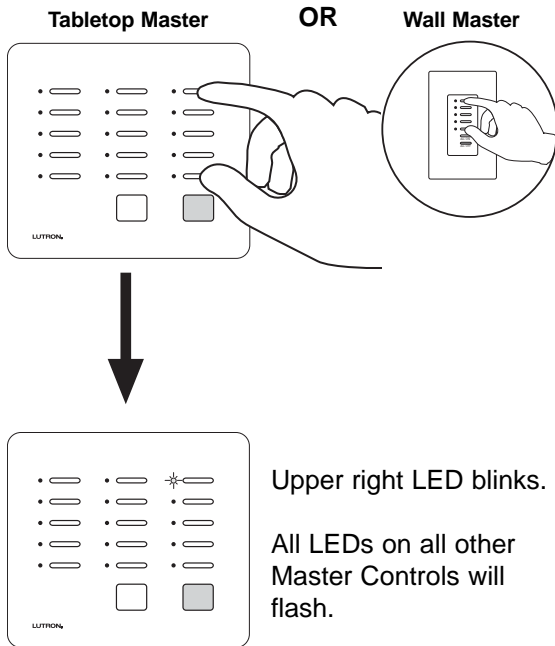

Note: To copy to an ALL ON or ALL OFF button, you must enter Assignment Mode (buttons 2 and 4) rather than Level Set Mode (buttons 1 and 5). Only SCENES may be copied to an ALL ON or ALL OFF button, never ROOMS. The ALL ON will still turn lights on to 100% and the ALL OFF button will still turn lights off, but by copying, you may choose which lights are affected. ALL ON and ALL OFF buttons may also be copied to and from each other in the same way.

Step 2 Select the button to be programmed

Press and release the button to be programmed. Its LED will begin to blink.

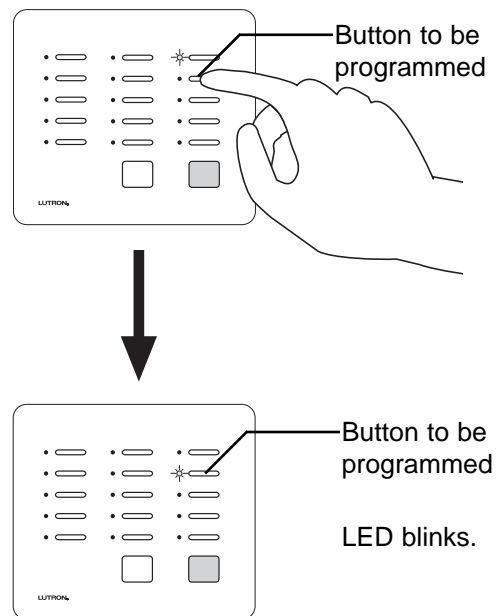

Step 3 Select the button to copy

On a previously programmed Master Control, press and hold the programmed button to copy until its LED turns off (approximately 3 seconds).

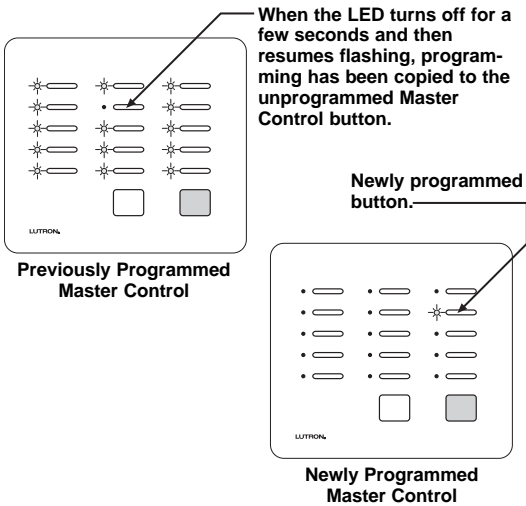
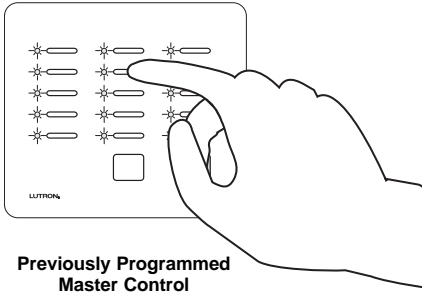

- Repeat Steps 2 and 3 for all Master Control buttons to copy programming to.

Step 4 Complete Copy Button Programming

Simultaneously press and hold the 1st and 5th buttons in the right most column until all LEDs begin to flutter (approximately 3 seconds).

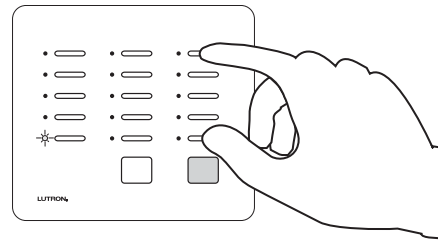

- Repeat Steps 1 through 4 to copy button programming on any remaining unprogrammed Master Controls.
- Copying Master Control button programming is complete.

Erasing Local Button Programming

Erasing Local Button Programming will remove all Lighting Zone Controls assigned to a Master Control button.



Note: Erasing programming on the ALL ON or ALL OFF buttons will reassign **all** controls to these buttons.

Step 1 Begin Erasing Button Programming

Simultaneously press the 2nd and 4th buttons in the right most column until the upper right LED begins to flash (approximately 3 seconds).

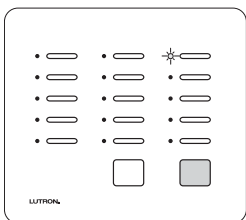
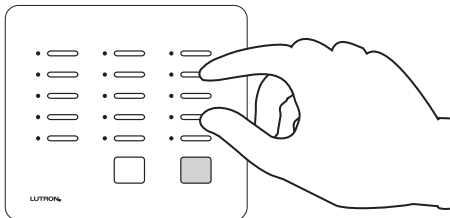

Upper right LED flashes.

Step 2 Select button to erase

Press and hold the button to be erased until its LED begins to flutter (approximately 3 seconds).

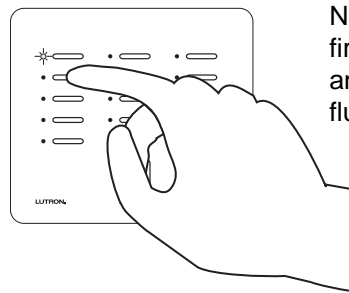

Note: The LED will first flash (slower) and then begin to flutter (faster).

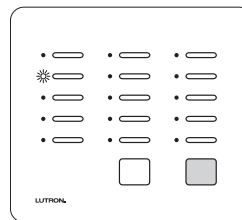

LED will flutter for only 3 seconds. Step 3 must be initiated while the LED is still fluttering.

Step 3 Erase button

While the LED is fluttering, press the ALL OFF or Lower button in the right most column.

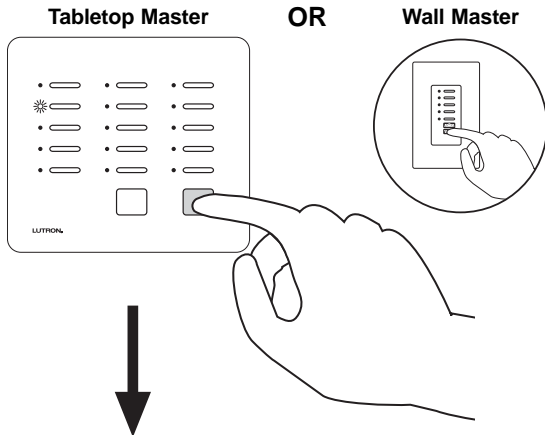

The LED will stop fluttering and begin to flash. All Lighting Zone Controls will turn off, and programming is now erased from that Master Control button.

Note: When erasing the ALL ON or ALL OFF buttons, all Lighting Zone Controls will be re-assigned to the buttons; therefore, they will turn ON.

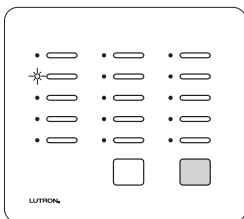

- Repeat Steps 2 and 3 for all Master Control buttons with programming to be erased.

Step 4 Complete Erasing Button Programming

Simultaneously press the 2nd and 4th buttons in the right most column until all LEDs begin to flutter (approximately 3 seconds).

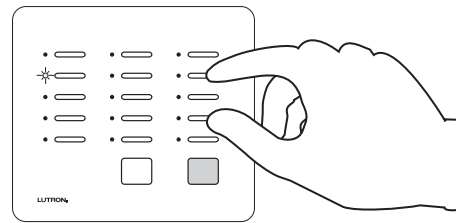

- Erasing Master Control button programming is complete.

Whole-home/Phantom Button Programming

Set Phantom Button Names

Phantom Buttons are "virtual" buttons that reside in the Chronos™ System Bridge and are used to activate lighting in a single system or both systems.

Whole-home Buttons are created by assigning Dimmers, Switches, or GRAFIK Eye® Control Units from 2 systems to a single Phantom Button.

Note: If the Chronos System Bridge is not configured to bridge systems or to use RS-232, Phantom Buttons are not available and this procedure does not apply.

Step 1 Go to Phantom Button Setup

If bridging two systems:

Main Menu

- ↳ Whole-home Button Setup
 - ↳ Phantom Button Setup

If not bridging systems:

Main Menu

- ↳ Phantom Button Setup

Step 2 Set Button Names

Phantom Button Setup

- ↳ Set Button Names

Phantom Button Setup	
Set Names	
Set Types to RM / SC	
Assign Zones	
Set Zone Levels	
Back	Help

The list of phantom buttons is displayed:

Select Button to Name	
1. RM - Btn 1	
2. RM - Btn 2	
3. RM - Btn 3	
4. RM - Btn 4	
Back	Select

Use ▲ and ▼ to select the button to name, and press "Select" (# button).

Set Name	
Name: H o m e _ _ _ _	
Cancel	Done

Using the ▲, ▼, ◀, and ▶ keys, or an attached keyboard, change the button name to the desired name. Press "Done" (# button) when finished.

Whole-home/Phantom Button Programming

Set Phantom Button Types (ROOM or SCENE)

Note: If the Chronos™ System Bridge is not configured to bridge systems or to use RS232, Phantom Buttons are not available and this procedure does not apply.

Step 1 Set Button Types

If bridging two systems:

Main Menu

- ↳ Whole-home Button Setup
 - ↳ Phantom Button Setup
 - ↳ Set Types to RM / SC

If not bridging systems:

Main Menu

- ↳ Phantom Button Setup
 - ↳ Set Types to RM / SC

Step 2 Select Phantom Button

Select Button to Set Type	
1. RM - Home	
2. RM - Btn 2	
3. RM - Btn 3	
4. RM - Btn 4	
Back	Select

Use the ▲ and ▼ buttons to highlight a Phantom Button. Press **“Select” (# button)** to change selected button from ROOM to SCENE or SCENE to ROOM.

Note: Changing the button type will erase any programming currently on the button. If there is programming on the button, the following confirmation screen will be displayed when **“Select” (# button)** is pressed:

Are you sure?	
Change Home to Scene?	
CAUTION – THIS WILL ERASE ALL PROGRAMMING ON THIS BUTTON	
Cancel	Yes

Press **“Yes” (# button)** to confirm the change, or **“Cancel” (* button)** to cancel the change.

Note: The ALL ON and ALL OFF buttons (Phantom Buttons 16 and 17) can only be SCENES.

Whole-home/Phantom Button Programming

Assigning Lighting Zone Controls to Phantom Buttons

Note: If the Chronos™ System Bridge is not configured to bridge systems or to use RS-232, Phantom Buttons are not available and this procedure does not apply.

Step 1 Go to Assign Zones

If bridging two systems:

Main Menu

- ↳ Whole-home Button Setup
 - ↳ Phantom Button Setup
 - ↳ Assign Zones

If not bridging two systems:

Main Menu

- ↳ Phantom Button Setup
 - ↳ Assign Zones

Step 2 Assign Zones

Select Button to Assign	
1. RM - Home	
2. RM - Btn 2	
3. RM - Btn 3	
4. RM - Btn 4	
Exit	Select

Use ▲ and ▼ to highlight a Phantom Button. Press **“Select” (# button)** to enter Assignment Mode for the highlighted button. The following screen will be displayed when Assignment Mode is initiated:

Assign Zones
Entering Assignment Mode... (⏏)

Once Assignment Mode has been initiated, the following screen will be displayed:

Assign Zones (⏏)	
Turn on devices to be assigned to Home.	
Copy Button	Continue

Note: To use the Copy Button Feature, refer to pages 49-51.

Step 3 Assign Lighting Zone Controls to the Phantom Button

Assign Dimmers or Switches to the Phantom Button by turning the Controls ON. Assign all Dimmers and Switches to be affected by this button. For SCENE Buttons, include Dimmers and Switches which are to be turned OFF by the button.

Assign a GRAFIK Eye®/GRAFIK RA™ Control Unit to the Phantom Button by pressing one of the *GRAFIK Eye*/*GRAFIK RA* Control Unit scene buttons. Assign all *GRAFIK Eye*/*GRAFIK RA* Control Units to be affected by this button. For SCENE Buttons, include *GRAFIK Eye*/*GRAFIK RA* Control Units which are to be turned OFF by the button.

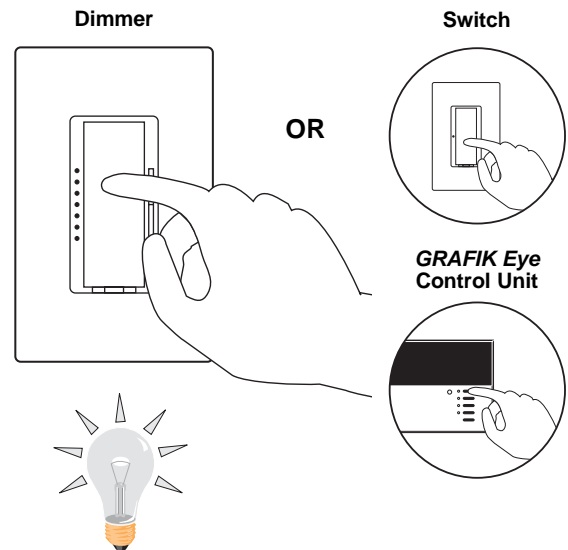

Notes:

- *GRAFIK Eye*/*GRAFIK RA* Control Units will automatically turn on to Scene 1 once assigned.
- If the wrong Lighting Zone Control is assigned to a Phantom Button, turn the Lighting Zone Control OFF to unassign it.



Step 4 Select next Phantom Button

Press “Continue” (# button) to display the list of Phantom Buttons:

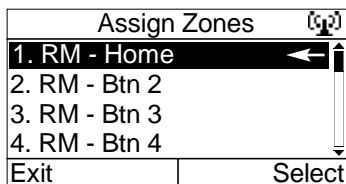

Note: The system is still in Assignment Mode, as indicated by the icon in the upper right hand corner of the screen. The arrow on the right of the screen indicates which Phantom Button is currently in Assignment Mode.

Use the ▲ and ▼ buttons to select a Phantom Button. Press “Select” (# button) to enter Assignment Mode for the selected Phantom Button.

Repeat Steps 3 and 4 for any additional Phantom Buttons.

Press “Exit” (* button) to finish assigning zones.

- Proceed to Setting Light Levels/GRAFIK Eye® and GRAFIK RA™ Scene Selection for Phantom Buttons on page 44.

Whole-home/Phantom Button Programming

Setting Light Levels/GRAFIK Eye® and GRAFIK RA™ Scene Selection for Phantom Buttons

Note: If the Chronos™ System Bridge is not configured to bridge systems or to use RS-232, Phantom Buttons are not available and this procedure does not apply. Dimmers can be set to a variable light level or turned off. Switches can be turned on or off. *GRAFIK Eye* Control Units can be set to any scene or turned off.

Step 1 Go to Set Levels

If bridging two systems:

Main Menu

- ↳ Whole-home Button Setup
 - ↳ Phantom Button Setup
 - ↳ Set Zone Levels

If not bridging systems:

Main Menu

- ↳ Phantom Button Setup
 - ↳ Set Zone Levels

Step 2 Select Phantom Button

Select Button to Set Levels	
1. RM - Home	
2. RM - Btn 2	
3. RM - Btn 3	
4. RM - Btn 4	
Back	Select

Use ▲ and ▼ to highlight a Phantom Button. Press “Select” (# button) to enter Level Set Mode for the highlighted button. The following screen will be displayed while Level Set Mode is initiated:

Set Zone Levels
Entering Level Set Mode...

Once Level Set Mode has been initiated, the following screen will be displayed:

Set Zone Levels	
Set light levels for devices assigned to Home.	
Copy Button	Continue

Note: To use the Copy Button Feature, refer to pages 49-51.

Step 3 Set light levels for Dimmers

For ROOM Phantom Buttons, use the dimming rocker to adjust the light level of any Dimmer(s) assigned to the Phantom Button. This is the light level that the Dimmers will turn on to when the ROOM button is pressed on.

For SCENE Phantom Buttons, use the dimming rocker to adjust the light level of any Dimmer(s) assigned to the Phantom Button OR use the toggle button to turn the dimmer off if it is to be turned OFF when the Phantom Button is activated.

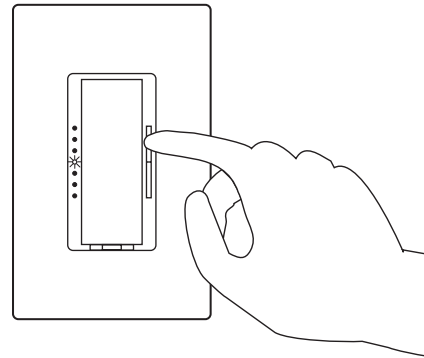

While setting light levels

- Dimmers assigned to a ROOM Phantom Button cannot be turned off.
- Dimmers not assigned to this Phantom Button cannot be turned on.

Whole-home Button Programming

Step 4 Select a GRAFIK Eye® scene

For ROOM Phantom Buttons, select one of the Scenes (1 through 4) on a *GRAFIK Eye* Control Unit by turning that Scene ON.

For SCENE Phantom Buttons, select one of the Scenes on a *GRAFIK Eye* Control Unit by turning that Scene ON OR select the Off Scene on the *GRAFIK Eye* Control Unit if it is to be turned OFF when the Phantom Button is activated.

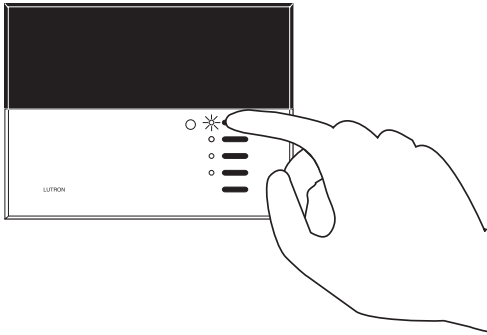

While setting light levels

- *GRAFIK Eye* Control Units assigned to a ROOM Phantom Button cannot be turned OFF.
- *GRAFIK Eye* Control Units not assigned to this Phantom Button cannot be turned ON.

Step 5 Select next Phantom Button

Press “Continue” (# button) to display the list of Phantom Buttons:

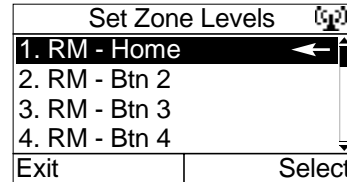

Note: The system is still in Level Set Mode, as indicated by the icon in the upper right hand corner of the screen. The arrow on the right of the screen indicates which Phantom Button is currently in Level Set Mode.

Use the ▲ and ▼ buttons to highlight a Phantom Button. Press “Select” (# button) to enter Level Set Mode for the highlighted Phantom Button.

Repeat Steps 3 and 4 for any additional Phantom Buttons.

Press “Exit” (* button) to exit Level Set Mode.

- Proceed to Setting Button Properties for Phantom Buttons on page 46.

Whole-home/Phantom Button Programming

Setting Button Properties for Phantom Buttons

Note: If the Chronos™ System Bridge is not configured to bridge systems or to use RS-232, Phantom Buttons are not available and this procedure does not apply.

Step 1 Go to Set Properties

If bridging two systems:

Main Menu

- ↳ Whole-home Button Setup
 - ↳ Phantom Button Setup
 - ↳ Set Properties

If not bridging systems:

Main Menu

- ↳ Phantom Button Setup
 - ↳ Set Properties

Step 2 Select Phantom Button

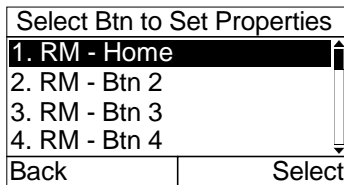

Use ▲ and ▼ to highlight a Phantom Button. Press “Select” (# button) to set button properties for the highlighted button. The following screen will be displayed:

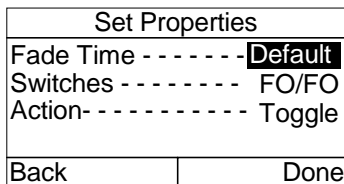

Use ◀ and ▶ to change the value of the selected setting. Use ▲ and ▼ to select the next / previous setting.

Fade Time determines the fade time of the selected scene. The options are Default (1 second ON, 3 seconds OFF), 1 second, 3 seconds, 10 seconds, 30 seconds, 1 minute, 4 minutes, and Legacy.



If the system contains Dimmers, Switches, or GRAFIK Eye® Interfaces that were manufactured prior to January 1, 2001, the Legacy setting **MUST** be used.

Switches determines whether any switches in the selected scene operate:

- First On / First Off (FO/FO)
- First On / Last Off (FO/LO).
- Last On / First Off (LO/FO)
- Last On / Last Off (LO/LO).

The options for **Action** are Toggle and Single Action. When activating a Toggle Phantom Button from a Master Control, a button press will turn the scene:

- ON if it is OFF
- OFF if it is ON

When activating a Single Action Phantom Button from a Master Control, a button press will always turn the scene ON.

Press “Done” (# button) when changes are complete.

- Repeat for any additional Phantom Buttons.

Assigning Phantom Buttons to Master Controls

When a Whole-home Button is linked to a Master Control button, the Whole-home Button type (ROOM or SCENE) does not have to match the other button types on the Master Control being linked to (i.e. a column of buttons on a Master Control could have 4 ROOM buttons and one Whole-home SCENE button).

Note:

- If the Chronos™ System Bridge is not configured to bridge systems, Phantom Buttons cannot be assigned to Master Controls and this procedure does not apply.
- Chronos System Bridge Whole-home scenes will not work with Master Controls shipped prior to January 1, 2001. The buttons on these Master Controls do not send programming necessary to activate Chronos System Bridge scenes. Also, this feature was not supported in RA-RS232 and RA-IR Interfaces shipped prior to September 1, 2001. For this reason, these older devices cannot be used to activate Whole-home scenes.

Step 1 Go to Link to Master Controls

Main Menu

- ↳ Whole-home Button Setup
 - ↳ Link to Master Controls

Step 2 Select Phantom Button

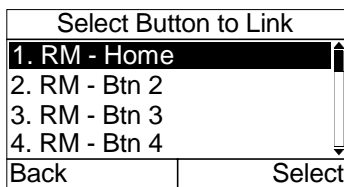

Use ▲ and ▼ to highlight a Phantom Button. Press **“Select” (# button)** to begin assigning Master Control Buttons to the highlighted Phantom Button. The following screen will be displayed:

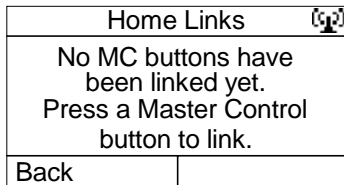

Pressing a Master Control button will bring up the following screen:

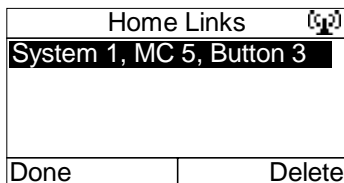

Press **“Done” (* button)** to complete assigning Master Control Buttons to the highlighted Phantom Button.

Press **“Delete” (# button)** to delete the link from the highlighted Master Control button.

Whole-home/Phantom Button Programming

Testing and Erasing Phantom Button Programming

Note: If the ChronoS™ System Bridge is not configured to bridge systems or to use RS-232, Phantom Buttons are not available and this procedure does not apply.

Testing

Step 1 Go to Test a Scene

If bridging two systems:

Main Menu

- ↳ Whole-home Button Setup
 - ↳ Phantom Button Setup
 - ↳ Test Buttons

If not bridging systems:

Main Menu

- ↳ Phantom Button Setup
 - ↳ Test Buttons

Step 2 View and Toggle Buttons

A list of buttons and their current state is displayed.

Test Buttons	
1. RM - Morning - ON	
2. RM - Btn 2 - OFF	
3. RM - Btn 3 - OFF	
4. RM - Btn 4 - OFF	
Back	Toggle

Use ▲ and ▼ to select a scene. Press **“Toggle” (# button)** to toggle the button ON and OFF.

Repeat for all Phantom Buttons to be tested.

Press **“Back” (* button)** to return to **Manage Scenes**.

- **Testing Phantom Buttons is now complete.**

Erasing

Step 1 Go to Phantom Button Setup

If bridging two systems:

Main Menu

- ↳ Whole-home Button Setup
 - ↳ Phantom Button Setup
 - ↳ Erase a Button

If not bridging systems:

Main Menu

- ↳ Phantom Button Setup
 - ↳ Erase a Button

Step 2 Select the Phantom Button to erase

Select Button to Erase	
1. RM - Home	
2. RM - Btn 2	
3. RM - Btn 3	
4. RM - Btn 4	
Back	Select

Use ▲ and ▼ to highlight the Phantom Button to erase. Press **“Select” (# button)** to proceed to the next step.

Step 3 Erase Phantom Button

Are you sure?	
Erase Home?	
Cancel	Yes

Press **“Yes” (# button)** to erase all programming for the selected Phantom Button. Press **“Cancel” (* button)** to cancel the erase operation.

Note: Erasing Button 16 (All On) or Button 17 (All Off) will reassign ALL zones to that button.

Using the Button Copy Feature

Copying Existing Chronos™ System Bridge Programming

Button copy is used to copy all programming from one button to another button. The Button Copy feature is available from the Assign Zones and Set Zone Levels screens for Phantom Buttons, Time Clock Scenes, and CCI Scenes.

Note: ROOM Buttons may only be copied to ROOM Buttons, and SCENE Buttons may only be copied to SCENE Buttons.

Step 1 Go to Assign Zones or Set Zone Levels

Phantom Buttons:

If bridging two systems:

Main Menu

- ↳ Whole-home Button Setup
 - ↳ Phantom Button Setup
 - ↳ Assign Zones or Set Zone Levels

If not bridging two systems:

Main Menu

- ↳ Phantom Button Setup
 - ↳ Assign Zones or Set Zone Levels

Time Clock Scenes:

Main Menu

- ↳ Time Clock Setup
 - ↳ Manage Scenes
 - ↳ Assign Zones or Set Zone Levels

Contact Closure Input (CCI) Scenes:

Main Menu

- ↳ Contact Closure Setup
 - ↳ CCI 1 or CCI 2 or Security Setup
 - ↳ Assign Zones or Set Zone Levels (CCI 1, CCI 2) or Full Zone Assign / Flash Zone Assign (Security)

Step 2 Select button or scene to copy to

Use ▲ and ▼ to highlight the button or scene to be copied to. Press **“Select”** (# button) to enter Zone Assignment Mode or Level Set Mode for the button/scene selected.

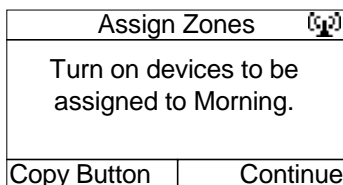

Step 3 Select the type of button or scene to copy from

From the **Assign Zones** or **Set Zone Levels** screen for the selected button or scene, press **“Copy Button”** (* button).

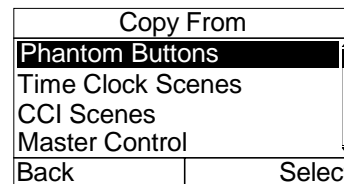

Use ▲ and ▼ to highlight the type of button or scene to be copied from. Highlight **Phantom Buttons**, **Time Clock Scenes**, or **CCI Scenes**.

To exit without making changes, press **“Back”** (* button). To proceed to the next step, press **“Select”** (# button).

Step 4 Select the button or scene to copy from

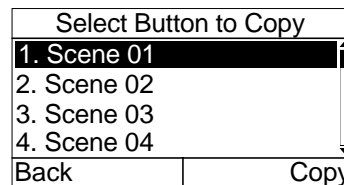

Use ▲ and ▼ to highlight the button or scene to be copied from.

To exit without making changes, press **“Back”** (* button). To copy the programming from the highlighted item, press **“Copy”** (# button).

Press **“Continue”** (# button) when the button has been copied.

Repeat Steps 2-4 for additional buttons to be copied.

Press **“Exit”** (# button) to exit Assignment Mode / Level Set Mode.

Using the Button Copy Feature

Copying Programming from Master Controls to the Chronos™ System Bridge

The Button Copy feature can be used to copy programming from a Master Control button to a Button / Scene on the Chronos System Bridge. When using the Chronos System Bridge to bridge two systems, Button Copy can be used to merge programming from one Master Control button in each system onto one Button / Scene on the Chronos System Bridge. **Note:** ROOM Buttons may only be copied to ROOM Buttons, and SCENE Buttons may only be copied to SCENE Buttons.

Step 1 Go to Assign Zones or Set Zone Levels

Phantom Buttons:

If bridging two systems:

Main Menu

- ↳ Whole-home Button Setup
 - ↳ Phantom Button Setup
 - ↳ Assign Zones or Set Zone Levels

If not bridging two systems:

Main Menu

- ↳ Phantom Button Setup
 - ↳ Assign Zones or Set Zone Levels

Time Clock Scenes:

Main Menu

- ↳ Time Clock Setup
 - ↳ Manage Scenes
 - ↳ Assign Zones or Set Zone Levels

Contact Closure Input (CCI) Scenes:

Main Menu

- ↳ Contact Closure Setup
 - ↳ CCI 1 or CCI 2 or Security Setup
 - ↳ Assign Zones or Set Zone Levels (CCI 1, CCI 2) or Full Zone Assign / Flash Zone Assign (Security)

Step 2 Select button or scene to copy to

Use ▲ and ▼ to highlight the button or scene to be copied to. Press “Select” (# button) to enter Zone Assignment Mode or Level Set Mode for the button/scene selected.

Assign Zones 	
Turn on devices to be assigned to Morning.	
Copy Button	Continue

Step 3 Select the type of button or scene to copy from

From the Assign Zones or Set Zone Levels screen for the selected button or scene, press “Copy Button” (* button).

Copy From	
Phantom Buttons	
Time Clock Scenes	
CCI Scenes	
Master Control	
Back	Select

Use ▲ and ▼ to highlight Master Control.

To exit without making changes, press “Back” (* button). To proceed to the next step, press “Select” (# button).

Step 4 Select the Master Control button to copy from

Select Button to Copy 	
Press and hold a SCENE button on a Master Control in order to copy over the programming.	
Back	Help

All LEDs on Master Controls will be blinking. Press and hold the Master Control button to be copied from, until the LED for that button turns OFF.

Press “Continue” (# button) when the button has been copied. Repeat Steps 2-4 for additional buttons to be copied.

Press “Exit” (# button) to exit Assignment Mode / Level Set Mode.

To merge additional programming from a Master Control button in the other system (when bridging only), continue to Step 5.

Using the Button Copy Feature

Step 5 Select Master Control button in the other system to copy from

Use ▲ and ▼ to highlight the same button or scene (from the previous steps) to be copied to. Press **“Select” (# button)** to enter Zone Assignment Mode or Level Set Mode for the button/scene selected.

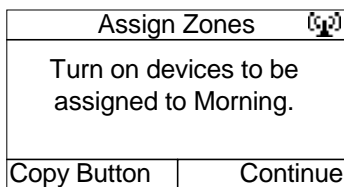

From the **Assign Zones** or **Set Zone Levels** screen for the selected button or scene, press **“Copy Button” (* button)**.

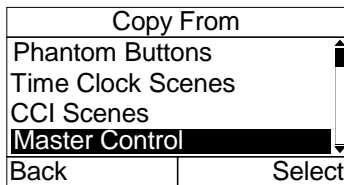

Use ▲ and ▼ to highlight Master Control.

To exit without making changes, press **“Back” (* button)**. To proceed to the next step, press **“Select” (# button)**.

Step 6 Select the Master Control button to copy from

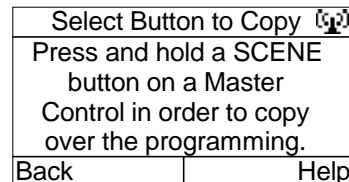

All LEDs on Master Controls will be blinking. Press and hold the Master Control button to be copied from, until the LED for that button turns OFF.

Press **“Continue” (# button)** when the button has been copied.

Repeat Steps 2-6 to copy to additional buttons.

Press **“Exit” (# button)** to exit Assignment Mode / Level Set Mode.

Note: In order to merge programming from two Master Control buttons, the Master Control used in this step must be on a different system from the Master Control used in Step 2. If the button pressed in this step is on the same system as the Master Control in Step 2, all programming for the button copied in Step 2 will be overwritten.

- Copying Buttons from Master Controls to Chronos System Bridge is now complete.

Astronomical Time Clock Programming

Setting the Chronos™ System Bridge Date and Time

Step 1 Go to Time / Date Settings

Main Menu

- Time Clock Setup
 - Time / Date Settings

Step 2 Set the System Time

From **Time / Date Settings**, select **Time**.

Time	
09 : 14 AM	
HH : MM	
Cancel	Done

Use ▲ and ▼ to change the selected field. Use ◀ and ▶ to highlight the next / previous field.

To cancel the changes, press **“Cancel”** (* button).
To accept the changes, press **“Done”** (# button).

Step 3 Set the System Date

From the **Time / Date Settings Menu**, select **Date**.

Date	
06 / 17 / 2003	
MM / DD / YYYY	
Cancel	Done

Use ▲ and ▼ to change the selected field. Use ◀ and ▶ to highlight the next / previous field.

To cancel the changes, press **“Cancel”** (* button).
To accept the changes, press **“Done”** (# button).

Step 4 Go to Location

From **Time / Date Settings**, select **Location**.

Step 5 Choose Set Location Method

The location can be set by State and City or by Latitude and Longitude. Use ▲ and ▼ to highlight the selection. To exit without making changes, press **“Previous”** (* button). To proceed to the next step, press **“Next”** (# button).

Set Location Method	
State and City	
Latitude and Longitude	
Cancel	Next

Set Location Method	
State and City	
Latitude and Longitude	
Cancel	Next

Astronomical Time Clock Programming

Step 6a Set Location by State and City

Use ▲ and ▼ to highlight the correct state. Press “Next” (# button) to accept the selection.

Select State	
Pennsylvania	
Rhode Island	
South Carolina	
South Dakota	
Previous	Next

A list of cities for the state selected will be shown. Use ▲ and ▼ to highlight the nearest city. Press “Next” (# button) to accept the selection.

Select City	
Coopersburg	
Philadelphia	
Pittsburgh	
State College	
Previous	Next

Step 6b Set Location by Latitude and Longitude

Use ▲ and ▼ to select the correct value for the highlighted field. Use ◀ and ▶ to highlight the next / previous field. Press “Next” (# button) to accept the selection.

Set Latitude and Longitude	
Latitude	Longitude
4 0.5 N	075.4 W
Previous	Next

Note: There are several websites that allow the user to look up Latitude and Longitude settings by entering a local zipcode.

Step 7 Set Time Zone

Use ▲ and ▼ to select correct Time Zone. Press “Next” (# button) to accept the selection.

Set Time Zone	
Eastern Time	
GMT -04:00	
GMT -03:00	
GMT -02:00	
Previous	Finish

Press “Finish” (# button) to accept all of the location settings.

Step 8 Set Daylight Savings

From **Time / Date Settings**, select **Daylight Savings**.

Daylight Savings	
Automatically adjust clock for Daylight Savings?	
Yes	
Cancel	Done

Use ◀ and ▶ to change the Daylight Savings setting.

To cancel the changes, press “Cancel” (* button). To accept the changes, press “Done” (# button).

Step 9 Set Time Format

From **Time / Date Settings**, select **Time Format**.

Time Format	
12 Hr.	
Cancel	Done

Use ▲ and ▼ to change between 12 and 24 hour format.

To cancel the changes, press **“Cancel”** (* button).

To accept the changes, press **“Done”** (# button).

Astronomical Time Clock Programming

Creating Time Clock Scenes

Up to 13 scenes can be programmed for activation by the Astronomical Time Clock.

Step 1 Go to Manage Scenes

Main Menu

- ▶ Time Clock Setup
 - ▶ Manage Scenes

Step 2 Set the Scene Names

From **Manage Scenes**, select **Set Scene Names**.

Select Scene to Name	
1. Scene 1	
2. Scene 2	
3. Scene 3	
4. Scene 4	
Back	Select

Use ▲ and ▼ to highlight a scene to name. Press **“Select” (# button)** to proceed to the next step.

Set Name	
Name: M o r n i n g _	
Cancel	Done

Use the ▲ and ▼ keys, or a connected keyboard, to change the selected character. Use ◀ and ▶ to move to the previous / next character. Press **“Cancel” (* button)** to cancel changes. Press **“Done” (# button)** to accept changes.

Step 3 Assign Zones

From **Manage Scenes**, select **Assign Zones**. The list of Time Clock scenes is displayed:

Select Scene to Assign	
1. Morning	
2. Scene 2	
3. Scene 3	
4. Scene 4	
Back	Select

Use ▲ and ▼ to highlight a scene. Press **“Select” (# button)** to enter Assignment Mode for the selected scene. The following screen will be displayed when Assignment Mode is initiated:

Assign Zones
Entering Assignment Mode...

Once Assignment Mode has been initiated, the following screen will be displayed:

Assign Zones	
Turn on devices to be assigned to Morning.	
Copy Button	Continue

Note: To use the Copy Button Feature, refer to pages 49-51.

Astronomical Time Clock Programming

Step 4 Assign Zones

Assign Dimmers or Switches to the selected Time Clock Scene by turning the Controls ON. Assign all Dimmers and Switches to be affected by the Scene, including Dimmers and Switches which are to be turned OFF by the Scene.

Assign GRAFIK Eye®/GRAFIK RA™ Control Units to the selected Time Clock Scene by pressing one of the *GRAFIK Eye*/*GRAFIK RA* Control Unit scene buttons. Assign all *GRAFIK Eye*/*GRAFIK RA* Control Units to be affected by the Scene, including *GRAFIK Eye*/*GRAFIK RA* Control Units which are to be turned OFF by the Scene.

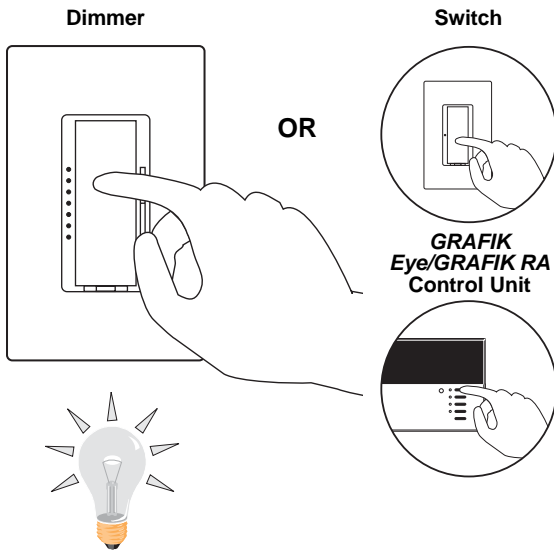

Notes:

- *GRAFIK Eye*/*GRAFIK RA* Control Units will automatically turn on to Scene 1 once assigned.
- If the wrong Lighting Zone Control is assigned to a Time Clock Scene, turn the Lighting Zone Control OFF to unassign it.



Step 5 Complete Zone Assignment

Press “Continue” (# button) to display the list of Time Clock scenes:

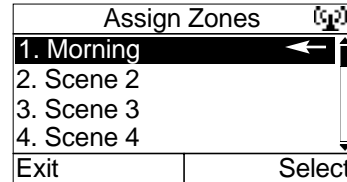

Note: The system is still in Assignment Mode, as indicated by the icon in the upper right hand corner of the screen. The arrow on the right of the screen indicates which scene is currently in Assignment Mode.

Use ▲ and ▼ buttons to highlight a new Time Clock scene. Press “Select” (# button) to enter Assignment Mode for the highlighted scene.

Repeat Steps 4 and 5 for any remaining scenes.

Press “Exit” (* button) to exit Assignment Mode.

Astronomical Time Clock Programming

Step 6 Enter Level Set Mode

From **Manage Scenes**, select **Set Zone Levels**. The list of Time Clock Scenes is displayed:

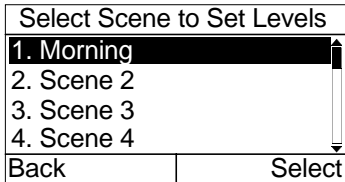

Use ▲ and ▼ to highlight a Time Clock Scene. Press **“Select” (# button)** to enter Level Set Mode for the highlighted button. The following screen will be displayed while level set mode is initiated:

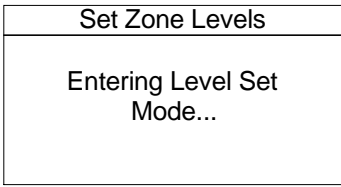

Once Level Set Mode has been initiated, the following screen will be displayed:

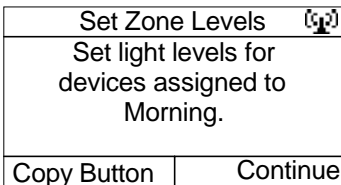

Note: To use the Copy Button Feature, refer to pages 49-51.

Step 7 Set light levels and GRAFIK Eye®/GRAFIK RA™ Scenes

Use the dimming rocker to adjust the light level of any Dimmer(s) assigned to the Time Clock Scene OR use the toggle button to turn the Dimmer or Switch off if it is to be turned OFF when the Time Clock Scene is activated.

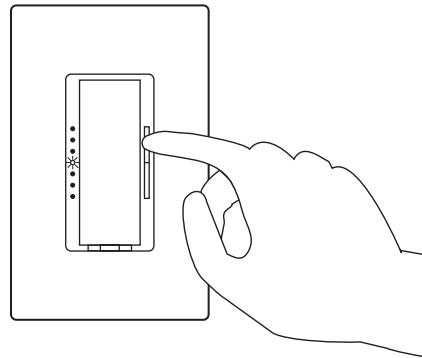

Select one of the Scenes on a *GRAFIK Eye/GRAFIK RA* Control Unit by turning that scene, OR select the Off Scene button on the *GRAFIK Eye/GRAFIK RA* Control Unit if it is to be turned OFF when the Time Clock Scene is activated.

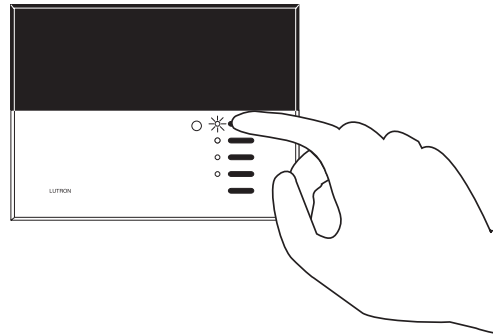

Astronomical Time Clock Programming

Step 8 Complete Setting Levels

Press “Continue” (# button) to display the list of Time Clock scenes:

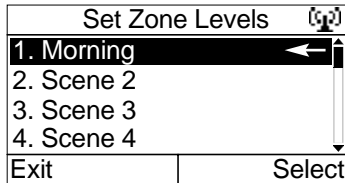

Note: The system is still in Level Set Mode, as indicated by the icon in the upper right hand corner of the screen. The arrow on the right of the screen indicates which scene is currently in Level Set Mode.

Use ▲ and ▼ buttons to highlight a new Time Clock scene. Press “Select” (# button) to enter Level Set Mode for the highlighted scene.

Repeat Steps 7 and 8 for any remaining scenes.

Press “Exit” (* button) to exit Level Set Mode.

- Proceed to Testing Time Clock Scenes on page 59.

Testing Time Clock Scenes

Step 1 Go to Test a Scene

Main Menu

- ↳ Time Clock Setup
 - ↳ Manage Scenes
 - ↳ Test Scenes

Step 2 View and Toggle Scenes

A list of scenes and their current state is displayed.

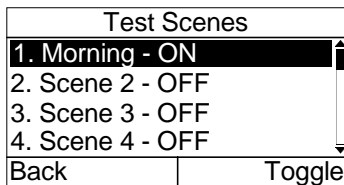

Use ▲ and ▼ to select a scene. Press **“Toggle”** (# button) to toggle the scene ON and OFF.

Repeat for all Time Clock Scenes to be tested.

Press **“Back”** (* button) to return to **Manage Scenes**.

- **Testing Time Clock Scenes is now complete.**

Astronomical Time Clock Programming

Erasing Time Clock Scenes

Step 1 Go to Manage Scenes

Main Menu

- ↳ Time Clock Setup
 - ↳ Manage Scenes
 - ↳ Erase a Scene

Step 2 Select the Scene to erase

Select Scene to Erase	
1. Morning	
2. Scene 2	
3. Scene 3	
4. Scene 4	
Back	Select

Use ▲ and ▼ to highlight the Scene to erase. Press “Select” (# button) to proceed to the next step.

Step 3 Erase Scene

Are you sure?	
Erase Morning?	
Cancel	Yes

Note: Erasing a Time Clock Scene will erase both the name and all programming for the scene.

Press “Yes” (# button) to erase all programming for the selected Time Clock Scene. Press “Cancel” (* button) to cancel the erase operation.

- Erasing Time Clock Scenes is now complete.

Astronomical Time Clock Programming

Creating Time Clock Events

Up to 100 Time Clock Events may be programmed to each activate one of 13 programmed Time Clock Scenes. For details on programming Time Clock Scenes, refer to pages 55 through 60.

Step 1 Go to Add Event

Main Menu

- ▶ Time Clock Setup
 - ▶ Manage Timed Events
 - ▶ Add Event

Step 2 Set Event Name

Set Event Name	
Name: W a k e u p _ _	
Cancel	Next

Use the ▲ and ▼ keys, or a connected keyboard, to change the selected character. Use ◀ and ▶ to move to the previous / next character. Press “Next” (# button) to proceed to the next step.

Step 3a Set Event Schedule

Event Schedule	
All Days	
Event occurs every day.	
Previous	Next

Use ▲ and ▼ to change whether the event should occur on **All Days**, **Selected Days**, **Weekdays** only, or **Weekends** only.

Note: **Weekdays** = Sunday 12:00 pm - Friday 11:59 am, and **Weekends** = Friday 12:00 pm - Sunday 11:59 am.

For **All Days**, **Weekdays**, or **Weekends**, press “Next” (# button) to proceed to Step 4.

For **Selected Days**, press “Next” (# button) to proceed to Step 3b.

Step 3b Select Days

Select Days						
S	M	T	W	Th	F	S
<input checked="" type="checkbox"/>	<input type="checkbox"/>	<input type="checkbox"/>	<input type="checkbox"/>	<input type="checkbox"/>	<input type="checkbox"/>	<input type="checkbox"/>
✓ = Selected						
Previous			Next			

Use ◀ and ▶ to highlight the desired box. Use ▲ and ▼ to place or remove a checkmark in the box. Place a checkmark in each box under the days that the Time Clock Event should occur.

Press “Next” (# button) to proceed to the next step.

Step 4 Set Event Time

Event Time	
Type	Time
Fixed Time	06: 35 PM (hh:mm)
Previous	Next

Event Time	
Type	Offset
Sunrise	+ 01: 35 (hh:mm)
Previous	Next

There are three types of Time Clock events:

- Fixed Time
- Sunrise
- Sunset

Fixed Time events are events that will activate at a specific time. The **Time** field is used to set the exact hour and minute at which the event will be activated.

Sunrise and **Sunset** events will be activated based on the sunrise or sunset times for the current day. The **Time** field is used to specify an offset from sunrise or sunset. A negative offset will cause the event to happen prior to sunrise/sunset. A positive offset will cause the event to activate after sunrise/sunset.

Use ▲ and ▼ to change the value of the highlighted field. Use ◀ and ▶ to highlight the previous / next field. Press “Next” (# button) to proceed to the next step.

Astronomical Time Clock Programming

Step 5 Select Scene to Activate

Select Scene to Activate	
1. Morning	▲
2. Scene 2	
3. Scene 3	
4. Scene 4	▼
Previous	Next

Use ▲ and ▼ to highlight a scene to activate. Press “Next” (# button) to accept the selection.

Step 6 Set Event Action

Event Action	
Action -----	Scene ON
Event Type -----	Normal
Fade Time -----	Default
Switches -----	FO/FO
Previous	Finish

The Event Action settings determine what happens when the event is activated.

Action determines whether the scene is turned ON or OFF.

Event Type determines whether the event activates the selected scene based on the Time Clock Mode.

- **Normal** - The event will activate in both **Home** and **Away** modes.
- **Home Only** - The event will activate only when the mode is **Home**.
- **Away Only** - The event will activate only when the mode is **Away**.

Note: The activation time for an Away event will vary in order to make the residence appear lived-in. The Away event will activate within 20 minutes (+/-) of the scheduled time.

Fade Time determines the fade time of the selected scene. The options are Default (1 second ON, 3 seconds OFF), 1 second, 3 seconds, 10 seconds, 30 seconds, 1 minute, 4 minutes, and Legacy.

If the system contains Dimmers that were manufactured prior to January 1, 2001, the Legacy setting **MUST** be used.

Switches determines whether any switches in the selected scene operate:

- First On / First Off (FO/FO)
- First On / Last Off (FO/LO).
- Last On / First Off (LO/FO)
- Last On / Last Off (LO/LO).

Repeat Steps 1-6 to create additional Time Clock Events.

Press “Finish” (# button) to accept the changes.

- **Time Clock Event Programming is now complete.**

Viewing and Modifying Time Clock Events

Step 1 Go to View / Modify Event

Main Menu

- ↳ Time Clock Setup
 - ↳ Manage Timed Events
 - ↳ View / Modify Event

Step 2 View an Event

View / Modify Event	
1. SR +1:35Hrs. Wakeup	
2. FT 22:00 Goodnite	
3. SS - 1:00 Outdoor	
4. SS + 1:00 Porch	
Done	Details

Use ▲ and ▼ to highlight an event. Press “Details” (# button) to view the highlighted event.

Step 3 Modify an Event

View / Modify Event	
Name: Wakeup	
Schedule: All Days	
Time: Sunrise + 1:35Hr	
Scene: Morning	
Back	Change

Use ▲ and ▼ to highlight the desired setting. Press “Back” (* button) to return to the event list. Press “Change” (# button) to modify the selected setting.

Note: The screen to modify the selected setting will be the same as the screen for that was used when creating the event. For details, see “Creating Time Clock Events” on page 61.

Press “Done” (* button) to return to Manage Timed Events.

Astronomical Time Clock Programming

Deleting a Time Clock Event

Deleting a Time Clock Event will only delete the event. The Time Clock Scene associated with that Event will remain programmed.

Step 1 Go to Delete Event

Main Menu

- ↳ Time Clock Setup
 - ↳ Manage Timed Events
 - ↳ Delete Event

Step 2 Delete an Event

Delete Event	
1. SR +1:35 Wakeup	
2. FT 22:00 Goodnite	
3. SS - 1:00 Outdoor	
4. SS + 1:00 Porch	
Back	Delete

Use ▲ and ▼ to highlight an event. Press “Back” (* button) to return to **Manage Timed Events**. Press “Delete” (# button) to delete the selected event.

Are you sure?	
Delete Wakeup Event?	
Cancel	Yes

Press “Yes” (# button) to confirm deleting the event. Press “Cancel” (* button) to cancel the delete operation.

- Time Clock Event is now deleted.

Astronomical Time Clock Programming

Setting the Time Clock Home / Away Mode

The time clock built into Chronos™ System Bridge has two modes – Home and Away. These allow the time clock to run certain events only while the homeowner is out, so that it appears someone is in the house. Convenience events, such as a morning scene, can be set to only run while someone is there.

Step 1 Go to Set Home / Away Mode

Main Menu

↳ Time Clock Setup

↳ Set Home / Away Mode

Set Home / Away Mode	
Home	
Runs only Home and Normal Time Clock Events.	
Cancel	Done

Use ◀ and ▶ to change the Time Clock Mode setting. Press “Cancel” (* button) to return to **Time Clock Setup**. Press “Done” (# button) to accept the mode setting.

The Time Clock Home / Away Mode can also be changed from the Chronos Status screen. This screen is accessed by pressing  (**Home Button**) from the Home Screen.

Note: If the Time Clock Mode is being controlled by one of the Contact Closure Inputs, changes will not be allowed from this screen. The following message will be displayed:

Set Mode	
Note: CCI 1 is currently controlling the Time Clock Mode. Press OK to Continue.	
Cancel	Done

For details on programming a Contact Closure Input to control Time Clock Home / Away Mode, see page 76.

• **Time Clock Mode is now set.**

RS-232 Port Programming

Overview

This section contains information on how to setup the Chronos™ System Bridge for RS-232 integration with other systems. The RadioRA® RS-232 Protocol and Programming Guide (P/N 044-038) contains information regarding the RS-232 command set and how to interface the *Chronos* System Bridge with equipment external to the *RadioRA* System. The *Chronos* System Bridge RS-232 port allows an external device to control *RadioRA* lighting loads and provides an external device with feedback of *RadioRA* activity.

Zone Numbers must be assigned to have an external device:

- Individually control a zone.
- React when a zone is changed locally.

Master Control Numbers must be assigned to have an external device:

- React when a Master Control button is pressed.
- Control the LED of a Master Control button which has no *RadioRA* loads assigned to it.
- React when a Raise/Lower button is pressed on a Master Control.
- React when a Cordless Master Control wakes up or goes to sleep.

Phantom Buttons must be assigned to have an external device:

- Activate Phantom Buttons 1-15, ALL ON (Phantom Button 16), or ALL OFF (Phantom Button 17).
- Monitor the status of Phantom LEDs 1-15.

For details on the commands required to perform the above functions, refer to the *RadioRA* RS-232 Protocol and Programming Guide (P/N 044-038).

Depending on the application, Zone Numbers, Master Control Numbers, or Phantom Buttons may not have to be assigned.

RS-232 Port Programming

Configuring the RS-232 Serial Port

When communicating with RS-232 equipment, it is necessary to set up communication parameters correctly to talk with the interfacing equipment. Consult the interfacing equipment instructions for proper Baud Rate and Flow Control settings.

Step 1 Go to RS-232 Setup

Main Menu

- ↳ RS-232 Setup
- ↳ Serial Port Setup

Step 2 Set Serial Port Settings

Serial Port Settings	
Baud Rate - - - - -	9600
Flow Control - -	Hardware
Prompt - - - - -	ON
Error Reporting - - -	OFF
Cancel	Done

Use ◀ and ▶ to change the value of the highlighted setting. Use ▲ and ▼ to move to the next / previous setting.

The settings are as follows:

Baud Rate

- 9600
- 115200

If communication problems are experienced, especially with a laptop, use 9600 baud.

Flow Control

- None
- Hardware

Turning hardware flow control ON is recommended for maximum reliability.

Prompt

- ON
- OFF

Turn ON or OFF the “!” prompt that is issued when the Chronos™ System Bridge is ready to receive a new RS-232 command.

Error Reporting

- ON
- OFF

Turn ON or OFF the notification of errors when an invalid RS-232 command is received.

Local Zone Change

- ON
- OFF

Turn ON or OFF notification when a zone is adjusted locally.

Button Press

- ON
- OFF

Turn ON or OFF notification when a button is pressed on a Master Control.

LED Map

- ON
- OFF

Turn ON or OFF automatic updates of the state of the Phantom LEDs.

Zone Map

- ON
- OFF

Turn ON or OFF automatic updates of the ON/OFF states of the zones.

System Mode

- ON
- OFF

Turn ON or OFF notification of RadioRA® System Mode changes.

Press “Done” (# button) when changes are complete.

- Proceed to Assigning Zone Numbers on page 68.

RS-232 Port Programming

Assigning Zone Numbers

Zone Numbers are only necessary if the Chronos™ System Bridge serial port will be used to directly control individual zones or if RS-232 feedback is desired when a zone changes. Prior to assigning zone numbers, fill out the Zone Number worksheets (for each system) found in the RadioRA® RS-232 Protocol and Programming Guide (P/N 044-038).

Step 1 Go to Device Number Setup

Main Menu

↳ RS-232 Setup

↳ Device Number Setup

Note: If the Chronos System Bridge is bridging two systems, device number setup must be done for each system. **Device Number Setup** will appear as below:

Device Number Setup	
System 1 Device Numbers	
System 2 Device Numbers	
Back	Help

Use ▲ and ▼ to highlight the system, and press **OK** to proceed to the next step.

Step 2 Select a Zone Number to assign

From **Device Number Setup**, select **Assign Zone Numbers**.

Assign Zone Numbers	
Zone Number -----	1
Zone is Unassigned	
Help	Done

Use ▲ and ▼ to change the Zone Number to be assigned.

Step 3 Assign a Lighting Zone Control to a Zone Number

Assign a Dimmer or Switch to the selected Zone Number by turning the Dimmer or Switch ON.

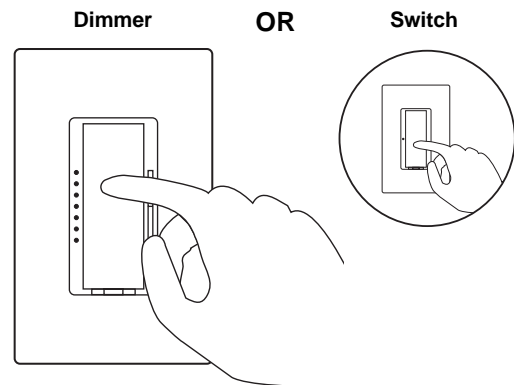

Assign a GRAFIK Eye®/GRAFIK RA™ Control Unit to the selected Zone Number by changing the scene of the GRAFIK Eye/GRAFIK RA Control Unit.

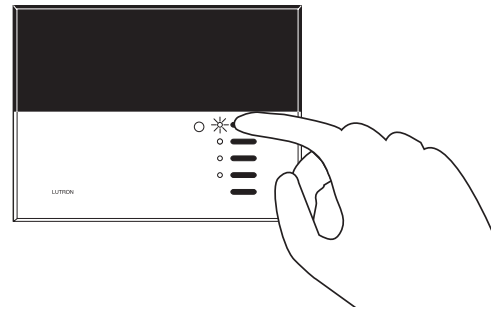

If the wrong Lighting Zone Control is assigned to a Zone Number, simply assign the correct Lighting Zone Control to the Zone Number.

RS-232 Port Programming

When a Lighting Zone Control is assigned, the screen will change to:

Assign Zone Numbers	
Zone has been assigned successfully.	
	Continue

Press **“Continue” (# button)** to continue assigning Zone Numbers.

Assign Zone Numbers	
Zone Number - - - - -	1
Zone is Assigned	
Help	Done

Repeat Steps 2 and 3 for any remaining Zone Numbers to be assigned.

Press **“Done” (# button)** to return to **Device Number Setup**.

- **Zone Numbers are now assigned. Proceed to Assigning Master Control Numbers on page 70.**

RS-232 Port Programming

Assigning Master Control Numbers

Master Control Numbers are only necessary if:

- The Chronos™ System Bridge RS-232 port will be used to control the LEDs on a Master Control
 - RS-232 Feedback is desired when a Master Control button is pressed
 - RS-232 Feedback is desired when a Cordless Master Control wakes up or goes to sleep
- Prior to assigning Master Control numbers, fill out the Master Control Number worksheets (for each system) found in the RadioRA® RS-232 Protocol and Programming Guide (P/N 044-038).

Step 1 Go to Device Number Setup

Main Menu

↳ RS-232 Setup

↳ Device Number Setup

Note: If the Chronos System Bridge is bridging two systems, device number setup must be done for each system. **Device Number Setup** will appear as below:

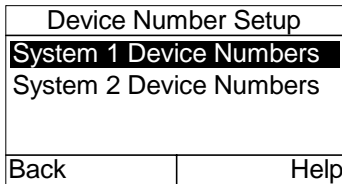

Use ▲ and ▼ to highlight the system, and press **OK** to proceed to the next step.

Step 2 Select a Master Control Number to assign

From **Device Number Setup**, select **Assign Control Numbers**.

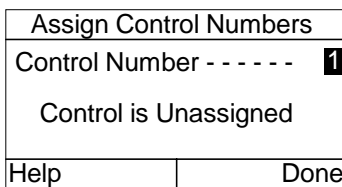

Use ▲ and ▼ to change the Control Number to be assigned.

Step 3 Assign a Master Control to a Control Number

Assign a Master Control to the selected Control Number by pressing the **ALL ON** button. For Master Controls with Raise/Lower buttons, press any *programmed* button.

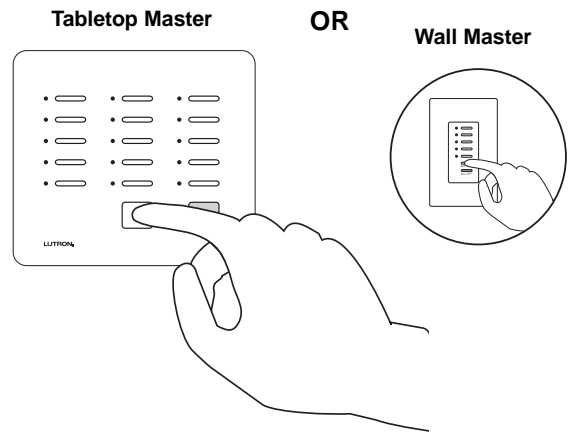

Assign a Switch Closure Interface to a Control Number by activating any previously **programmed** input channel (1-5) on the Switch Closure Interface. An input channel can be activated by an external device or by jumpering a wire between the input channel and Common.

Switch Closure Interface

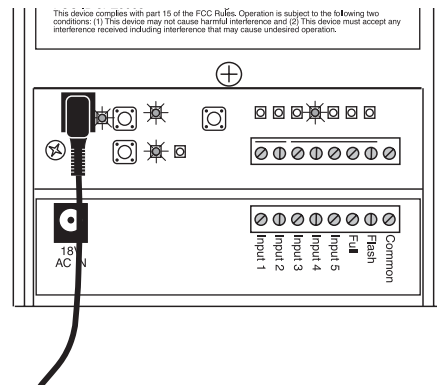

RS-232 Port Programming

Assign an Infrared Interface or RS-232 Interface to a Control Number by pressing the Up or Down button on the interface until the ALL ON (SCENE 16) is on the interface's display. After the ALL ON (SCENE 16) is on the display, press and release the Select button.

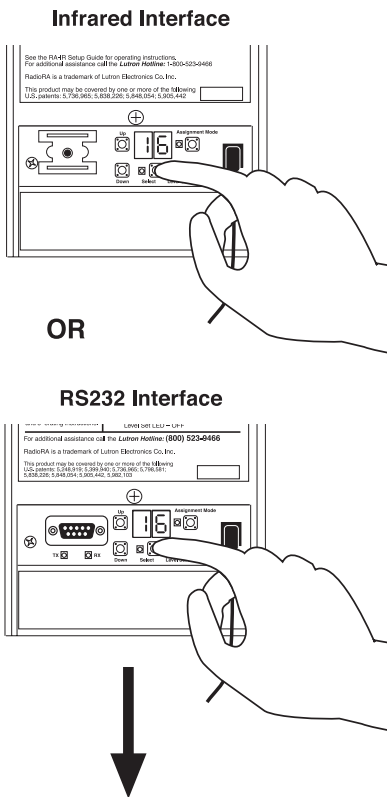

! If the wrong Master Control / Interface is assigned to a Control Number, simply assign the correct Master Control / Interface to the Control Number.

When a Master Control is assigned, the screen will change to:

Assign Control Numbers	
Control has been assigned successfully.	
	Continue

Press **“Continue” (# button)** to continue assigning Control Numbers.

Assign Control Numbers	
Control Number - - - - -	1
Control is Assigned	
Help	Done

Repeat steps 2 and 3 for any remaining Control Numbers to be assigned.

Press **“Done” (# button)** to return to Device Number Setup.

- Master Control Numbers are now assigned.

Phantom Button Programming

Note: When the Chronos™ System Bridge is configured to bridge two systems, Phantom Button Setup will be on the Whole-home Button Setup menu. When Chronos System Bridge is not configured to bridge systems, Phantom Button Setup will be on the Main Menu. For instructions on setting up Phantom Buttons, see pages 40-

If the **Chronos System Bridge** is configured to bridge systems:

Main Menu	
System 1 Setup	
System 2 Setup	
Time Clock Setup	
Whole-home Button Setup	
Back	Help

From the **Main Menu**, select **Whole-home Button Setup**.

Whole-home Button Setup	
Phantom Button Setup	
Link to Master Controls	
Back	Help

From **Whole-home Button Setup**, select **Phantom Button Setup**.

Phantom Button Setup	
Set Names	
Set Types to RM / SC	
Assign Zones	
Set Zone Levels	
Back	Help

Refer to pages 40-48 for details on Phantom Button Programming.

If the **Chronos System Bridge** is not configured to bridge systems:

Main Menu	
System Setup	
Time Clock Setup	
Phantom Button Setup	
Contact Closure Setup	
Back	Help

From the **Main Menu**, select **Phantom Button Setup**.

Phantom Button Setup	
Set Names	
Set Types to RM / SC	
Assign Zones	
Set Zone Levels	
Back	Help

Refer to pages 40-48 for details on Phantom Button Programming.

Contact Closure Programming

Setting up a General Purpose Contact Closure Input for Scene Control

Contact Closure Inputs 1 and 2 (CCI 1 and CCI 2) can be programmed to activate a unique lighting scene. Follow the procedure below to program these closures. **Note:** The Contact Closure Inputs have a 15 second delay after applying power, before the inputs may be used.

Step 1 Go to Contact Closure Setup

Main Menu

▶ Contact Closure Setup

From **Contact Closure Setup**, select either **CCI 1** or **CCI 2**.

Step 2 Setup Contact Closure Type

CCI 1 Setup	
Set Type -----	Scene
Closure Settings	
Assign Zones	
Set Zone Levels	
Back	Help

Use ◀ and ▶ to set the type to Scene, only if the type is not already set to Scene.

Step 3 Setup Closure Settings

From **CCI 1 (or CCI 2) Setup**, select **Closure Settings**.

Closure Settings	
Closure Type	
Maintained	
Cancel	Done

Use ▲ and ▼ to select either Momentary or Maintained for the Closure Type. Press **“Done” (# button)** to accept the setting.

Maintained Input Example

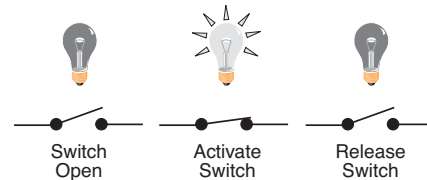

A Maintained switch closure will turn an input SCENE ON. Input SCENE remains ON until the switch closure is released. When released, the input SCENE returns to OFF.

Momentary Input Example

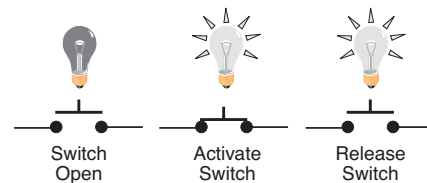

A Momentary switch closure will turn a SCENE ON. The input SCENE remains ON after the switch closure has been released, until the status of a Dimmer or Switch in that SCENE is changed.

Contact Closure Programming

Step 4 Assign Lighting Zone Controls to the CCI

From **CCI Setup**, select **Assign Zones**.

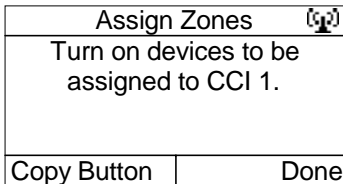

Note: To use the Copy Button Feature, refer to pages 49-51.

Assign Dimmers or Switches to the CCI by turning the controls ON, including Dimmers or Switches that are to be turned OFF when the CCI is activated.

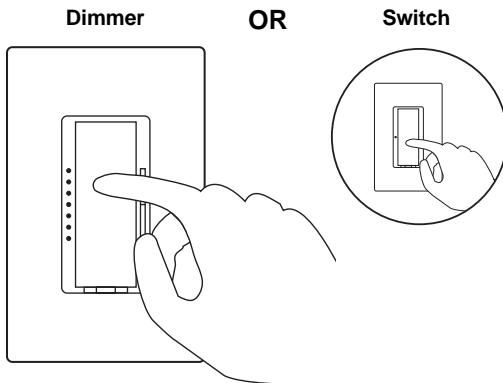

Assign GRAFIK Eye®/GRAFIK RA™ Control Units to the CCI by selecting a *GRAFIK Eye*/*GRAFIK RA* scene. Assign all *GRAFIK Eye*/*GRAFIK RA* Control Units that will be affected by this CCI, including those Control Units that are to be turned OFF when the CCI is activated.

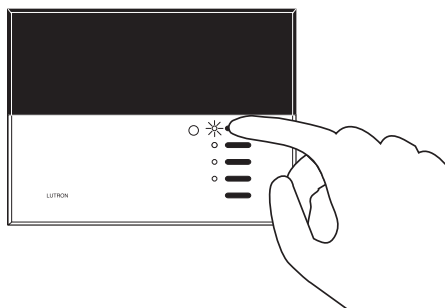

Press “Done” (# button) to return to **CCI Setup**.

Step 5 Set light levels and *GRAFIK Eye*/*GRAFIK RA* Scenes

From **CCI Setup**, select **Set Levels**.

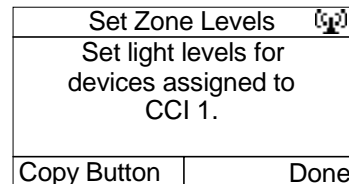

Note: To use the Copy Button Feature, refer to pages 49-51.

Use the dimming rocker to adjust the light level of any Dimmer(s) assigned to the CCI OR use the toggle button to turn Dimmers or Switches OFF if they are to be turned OFF when the CCI is activated.

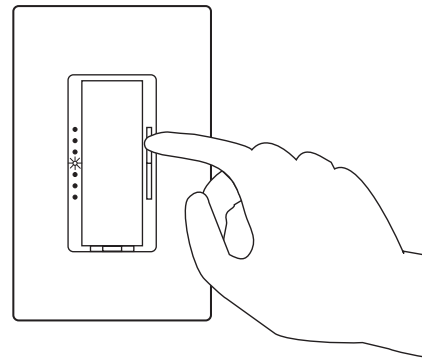

Select one of the preprogrammed scenes on a *GRAFIK Eye*/*GRAFIK RA* Control Unit by turning that scene ON OR select the Off Scene on the *GRAFIK Eye*/*GRAFIK RA* Control Unit if it is to be turned OFF when the CCI is activated.

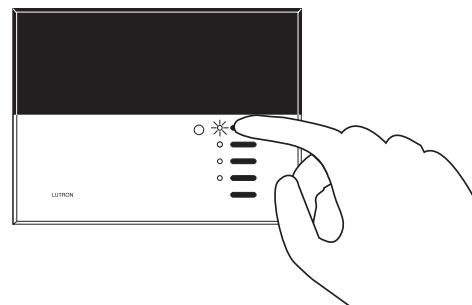

Press “Done” (# button) to return to **CCI Setup**.

Step 6 Set Actions

From **CCI Setup** select **Set Actions**.

Set CCI Actions	
Fade Time -----	Default
Switches -----	FO/FO
Cancel	Done

Use ◀ and ▶ to change the value of the selected setting. Use ▲ and ▼ to select the next / previous setting.

Fade Time determines the fade time of the selected CCI. The options are Default (1 second ON, 3 seconds OFF), 1 second, 3 seconds, 10 seconds, 30 seconds, 1 minute, 4 minutes, and Legacy.



If the system contains Dimmers, Switches, or GRAFIK Eye® Interfaces that were manufactured prior to January 1, 2001, the Legacy setting **MUST** be used.

Switches determines whether any switches for the selected CCI operate:

- First On / First Off (FO/FO)
- Last On / Last Off (LO/LO)
- First On / Last Off (FO/LO)
- Last On / First Off (LO/FO)

Repeat Steps 1-6 for any remaining Contact Closure Inputs that need to be set up.

Press **“Done”** (# button) when changes are complete.

- **Setting up a General Purpose Contact Closure Input for Scene Control is complete.**

Contact Closure Programming

Setting up a General Purpose Contact Closure Input for Time Clock Mode Control

Either CCI 1 or CCI 2 can be programmed to control the mode of the Time Clock (Home or Away). Follow the procedure below to program a closure to control the Time Clock Mode.

Step 1 Go to Contact Closure Setup

Main Menu

► Contact Closure Setup

From **Contact Closure Setup**, select either **CCI 1** or **CCI 2**.

Step 2 Setup Contact Closure Type

CCI 2 Setup	
Set Type - - -	Clock Mode
Closure Settings	
Test CCI	
Back	Help

Use ◀ and ▶ to set the type to Clock Mode.

Note: Only one CCI can be set to control the mode of the Time Clock.

Step 3 Setup Closure Settings

From **CCI 1 (or CCI 2) Setup**, select **Closure Settings**.

Closure Settings	
When the CCI is closed, the home owner is	
Away	
Cancel	Done

Use ▲ and ▼ to select whether a closure of the CCI indicates Home or Away. Press **“Done” (# button)** to accept the setting.

- **The CCI is now set up for Time Clock Mode Control.**

Contact Closure Programming

Setting up the Security Contact Closure Input

The Security Contact Closure Input is a special input that can be programmed to turn lights on to Full or to Flash lights (1 second ON, 1 second OFF) when a contact closure output is detected from a security panel. Typically, interior lights are programmed to come on to full and exterior lights are programmed to flash, thereby drawing attention to the home. When the system is in Security Mode, all system devices will be locked out from local operation. When Security Mode is exited (contact closure is released) system controls resume normal operation. Follow the procedure below to program which lights will turn on to Full and which lights will Flash.

Step 1 Go to Security Setup

Main Menu

- ↳ Contact Closure Setup
- ↳ Security Setup

Step 2 Assign Zones to Full

From **Security Setup**, select **Assign Zones to Full**.

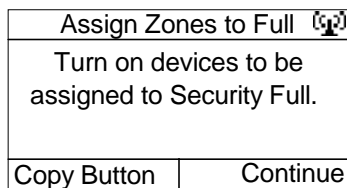

Assign Dimmers or Switches by turning the controls ON.

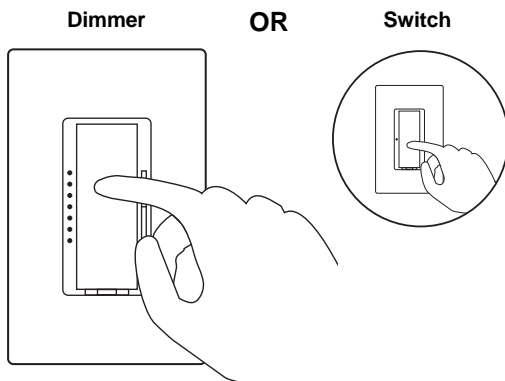

Note: To use the Copy Button Feature, refer to pages 49-51.

Assign a GRAFIK Eye®/GRAFIK RA™ Control Unit by selecting a *GRAFIK Eye*/*GRAFIKRA* scene.

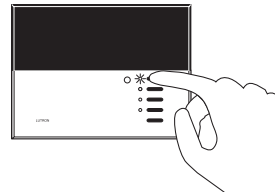

If the wrong Lighting Zone Control is assigned to Security Full, turn the Lighting Zone Control OFF to unassign it.

Press **“Continue” (# button)** to return to **Security Setup**.

- Continued on next page.

Contact Closure Programming

Step 3 Assign Zones to Flash

From **Security Setup**, select **Assign Zones to Flash**.

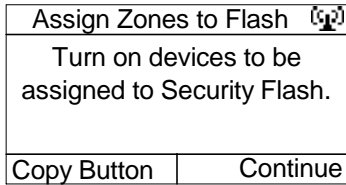

Assign Dimmers or Switches by turning the controls ON.

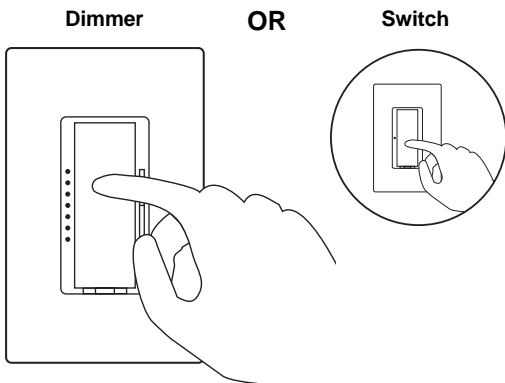

Assign a GRAFIK Eye[®]/GRAFIK RA[™] Control Unit by selecting a *GRAFIK Eye*/*GRAFIK RA* scene.

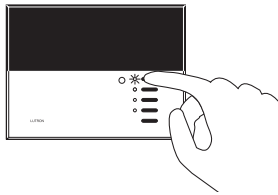

If the wrong Lighting Zone Control is assigned to Security Flash, turn the Lighting Zone Control OFF to unassign it.

Press **“Continue” (# button)** to return to **Security Setup**.

Press **“Exit” (* button)** to return to **Contact Closure Setup**.

- **Security Contact Closure Input Setup is complete.**

Contact Closure Programming

Testing Contact Closure Inputs

The Contact Closure Inputs may be manually toggled to allow for testing. Follow the procedure below to test the Contact Closure Inputs. **Note:** The override function is only temporary. The actual CCI state will be restored after leaving the Test CCI screen.

Step 1 Go to Contact Closure Setup

Main Menu

↳ Contact Closure Setup

From **Contact Closure Setup**, select **CCI 1 Setup**, **CCI 2 Setup**, or **Security Setup**.

Step 2 Enter Test Mode

CCI 2 Setup	
Assign Zones	
Set Zone Levels	
Set Properties	
Test CCI	
Back	Help

Use ▲ and ▼ to scroll down and select **Test CCI**. Press “OK” to enter **Test Mode**.

Test CCI 2	
CCI 2 State - Open	
CCI 2 Scene - Off	
Type - Maintained	
Temporary Override - Off	
Back	Override On

Press “**Override On**” (# button) to toggle the CCI states, or press “**Back**” (* button) to return to the previous menu.

Press “**Back**” (* button) again to return to the **Contact Closure Setup** menu to test additional Contact Closure Inputs.

Note: The override function is only temporary. The actual CCI state will be restored after leaving the Test CCI screen.

Dimmer Locked Presets

Enable Dimmer Locked Presets

On Dimmers that have the push-in/pull-out FASS™ switch, there are two options for preset light levels: Locked Presets Enabled and Locked Presets Disabled.

Locked Presets Enabled: The dimmer will always turn on to the predetermined “locked” level anytime the dimmer is turned on with a single tap of the tapswitch.

Locked Presets Disabled: Anytime the dimmer is turned on with a single tap of the tapswitch, the dimmer will turn on to the light level that the dimmer was adjusted to the previous time the light was on.

What do I want? If you always want the dimmer to come on to the same light level anytime you turn it on, choose the Enable Locked Presets option. Remember that you can always double tap the tapswitch when you want the lights to come on to full intensity. If it is important that the light return to the light level previously used, select the Disable Locked Presets option.

Locked Presets are disabled in the Dimmers’ default state. Locked Presets may be enabled through the Chronos™ System Bridge. **Note:** Enabling or Disabling Locked Presets will affect all dimmers (with the push-in/pull-out FASS) in all systems affected by the Chronos System Bridge.

Step 1 Go to Dimmer Locked Presets

Main Menu

↳ User Preferences

↳ Dimmer Locked Presets

Dimmer Locked Presets	
Enable Locked Presets	
Disable Locked Presets	
Cancel	Next

Use ▲ and ▼ to highlight the desired option, and press **OK** to proceed to the next step.

Step 2 Enable Locked Presets

Enable Locked Presets	
Dimmers will always go to the same locked level when turned on locally.	
Previous	Next

Press “Next” (# button) to go to the next step.
Press “Previous” (* button) to cancel the enable operation.

Step 3 Select Locked Presets Option

Enable Locked Presets	
Set a new locked level for all dimmers or locally adjust individual levels?	
Locally Adjust	
Previous	Next

Enable Locked Presets	
Set a new locked level for all dimmers or locally adjust individual levels?	
Set New Level	
Previous	Next

Use ▲ and ▼ to toggle between **Locally Adjust** and **Set New Locked Level**. When the desired option is highlighted, press “Next” (# button) to go to the next step. Press “Previous” (* button) to return to the previous screen.

Locally Adjust: Follow Step A on next page.

Set New Locked Level: Follow Step B on next page.

Dimmer Locked Presets

Enable Dimmer Locked Presets (continued)

A. Locally Adjust Option

Enable Locked Presets	
Go to each dimmer and adjust the current light level to the desired Locked Preset.	
Previous	Next

Set the desired Locked Preset light level at each Dimmer.

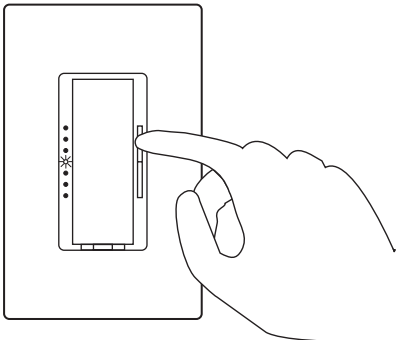

When all Dimmers are set to the desired levels, press “Next” (# button) to go to Step 4. Press “Previous” (* button) to return to the previous screen.

B. Set New Locked Level Option:

Enable Locked Presets	
Select the new Locked Preset light level.	
90%	
Previous	Next

Use ▲ and ▼ to adjust the light level up and down. Once the desired light level is selected, press “Next” (# button) to go to Step 4. Press “Previous” (* button) to return to the previous screen.

Step 4 Go to Dimmer Locked Presets

When the Locally Adjusted or New Locked Preset has been set, the following screen is displayed:

Enable Locked Presets	
Allow Locked Presets to be changed locally by quad-tapping the dimmer?	
No	
Previous	Next

Use ▲ and ▼ to toggle between **Yes** and **No**. Selecting **Yes** will allow the Locked Presets to be changed locally at the Dimmers at any time, by quad-tapping the Dimmer and then setting the new level. Selecting **No** will not allow any local changes.

Once **Yes** or **No** is selected, press “Next” (# button) to continue. Press “Previous” (* button) to return to the previous screen.

Are you sure?	
Enable Locked Presets?	
Previous	Yes

Press “Yes” (# button) to confirm enabling Locked Presets. Press “Previous” (* button) to return to the previous screen.

Enabling Locked Presets is now complete.

Quad Tap Procedure

1. Quickly tap the tapswitch 4 times. The dimmer will enter Change Preset Mode, indicated by the dimmer’s LED flashing quickly at the current Locked Preset level.
2. Use the Raise/Lower rocker to adjust the Locked Preset. **Note:** If the dimmer is inactive for 6 seconds, any changes will be discarded and the dimmer will return to Normal Mode.
3. Quickly tap the tapswitch 4 times to save the new locked preset level.

Dimmer Locked Presets

Disable Dimmer Locked Presets

Step 1 Go to Dimmer Locked Presets

Main Menu

↳ User Preferences

↳ Dimmer Locked Presets

Dimmer Locked Presets	
Enable Locked Presets	
Disable Locked Presets	
Cancel	Next

Use ▲ and ▼ to highlight the desired option, and press **OK** to proceed to the next step.

Step 2 Disable Locked Presets

Disable Locked Presets	
Dimmers will always go to the previous locally adjusted light level when turned on locally.	
Previous	Next

Press **“Next”** (**# button**) to disable Locked Presets. Press **“Previous”** (*** button**) to cancel the disable operation.

Are you sure?	
Disable Locked Presets?	
Previous	Yes

Press **“Yes”** (**# button**) to confirm disabling Locked Presets. Press **“Previous”** (*** button**) to return to the previous screen.

Locked Presets are now disabled.

Asymmetric Fade Rates

Changing Asymmetric Fade Rates

Dimmers that have the push-in/pull-out FASS™ have Asymmetric Fade Rate capability built in. When Asymmetric Fade Rates are enabled, the dimmers will turn on quickly and turn off slowly. When Asymmetric Fade Rates are disabled, the dimmers will turn on and off at the same rate.

This feature is disabled in the Dimmers' default state. Asymmetric Fade Rates may be enabled through the Chronos™ System Bridge. **Note:** Enabling or Disabling Asymmetric Fade Rates will affect all dimmers (with the push-in/pull-out FASS) in all systems affected by the Chronos System Bridge.

Step 1 Go to Asymmetric Fade Rates

Main Menu

↳ User Preferences

↳ Asymmetric Fade Rates

Asymmetric Fade Rates	
Enable Asymmetric Fade	
Disable Asymmetric Fade	
Cancel	Next

Use ▲ and ▼ to highlight the desired option, and press **OK** to proceed to the next step.

Step 2 Enable or Disable Asymmetric Fade

To Enable Asymmetric Fade:

Enable Asymmetric Fade	
Dimmers will turn on quickly and turn off slowly.	
Previous	Next

Press **“Next” (# button)** to enable Asymmetric Fade. Press **“Previous” (* button)** to cancel the enable operation.

Are you sure?	
Enable Asymmetric Fade?	
Previous	Yes

Press **“Yes” (# button)** to confirm enabling Asymmetric Fade. Press **“Previous” (* button)** to return to the previous screen.

Asymmetric Fade is now enabled.

To Disable Asymmetric Fade:

Disable Asymmetric Fade	
Dimmers will turn on and off at the same rate.	
Previous	Next

Press **“Next” (# button)** to disable Asymmetric Fade. Press **“Previous” (* button)** to cancel the disable operation.

Are you sure?	
Disable Asymmetric Fade?	
Previous	Yes

Press **“Yes” (# button)** to confirm disabling Asymmetric Fade. Press **“Previous” (* button)** to return to the previous screen.

Asymmetric Fade is now disabled.

Viewing Address Usage and Detecting Missing Devices

The Address Usage screen is a useful tool that shows the total number of Repeater, Lighting Zone Control, and Master Control addresses allocated in the system. This can be helpful in system setup and in troubleshooting.

Note: If the Chronos™ System Bridge is not set up as a Main Repeater, or to bridge systems, this section does not apply.

Step 1 Go to System Setup

Main Menu

↳ System Setup

↳ Address Usage

Note: If the Chronos System Bridge is configured to bridge systems, the Main Menu will contain a **System 1 Setup** and a **System 2 Setup**. These steps should be repeated for both systems.

Step 2 Query for Addressed Devices

The Chronos System Bridge can query the system for devices to see if any addressed devices are missing.

Address Usage	
Auxiliary Repeaters - - -	2
Zone Controls - - - - -	17
Master Controls - - - - -	6
Back	Query

From **Address Usage**, use ▲ and ▼ to highlight **Auxiliary Repeaters**, **Zone Controls**, or **Master Controls** to query. Press **“Query” (# button)** to query the system. The Chronos System Bridge will query the system and display the results.

Querying System 1
Querying for Master Controls... 

System 1 Query Results
Found 5 of 6 Master Controls.
Requery <input type="checkbox"/> Continue <input type="checkbox"/>

Note: **“Query” (# button)** will only be available when one or more of the selected device type have been activated.

If all devices are accounted for, pressing **“Continue” (# button)** will return to **Address Usage**.

If all devices are not accounted for:

Zone Controls and Repeaters
Proceed to **Step 3** on the next page.

Master Controls

Missing Master Controls may be attributed to Cordless Master Controls that are asleep. Pressing **“Continue” (# button)** will bring up the following screen:

Missing Master Controls 	
1 Master Control in System 1 is missing. Wake up any Cordless Master Controls now.	
Requery <input type="checkbox"/>	Done <input type="checkbox"/>

Wake up any Cordless Master Controls by pressing any button on the Control.

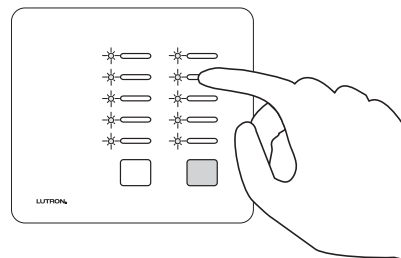

After all Cordless Master Controls have been awakened, press **“Requery” (* button)** to query the system again.

If all devices are accounted for, pressing **“Continue” (# button)** will return to **Address Usage**.

If all devices are **not** accounted for, press **“Done” (# button)** to proceed to the next step.

Step 3 Remove Missing Addresses

A screen listing missing devices will be displayed.

System 1 Results	
1. Missing MC 1	
Exit	Delete

Press ▲ and ▼ to select a device. Press “Exit” (* button) to return to **Address Usage** without making any changes. Press “Delete” (# button) to delete the missing device from the system. The following screen will be displayed:

Are you sure?	
Delete Missing Master Control?	
Cancel	Yes

Press “Yes” (# button) to delete the selected Control. Press “Cancel” (* button) to cancel the delete operation.



Note: Deleting a Control will completely remove it from the system.

Viewing Device Information

Device Information Mode is used to display information about system devices.

Step 1 Enter Device Information Mode

From the *Chronos* System Bridge:

Main Menu

↳ System Setup

↳ Device Information

System Setup	
Activate Controls	
Address Usage	
Diagnostics	
Device Information	
Cancel	Next

Press “Next” (# button) on the Chronos™ System Bridge to enter Device Information Mode.

Device Information 	
To obtain device information, press any device now.	
Back	Help

Step 2 Get Device Information

To display information about a particular device, press any button on the device. The *Chronos* System Bridge will update the device information and then display the results.

Device Information 	
Updated!	
Back	Help

Device Information 	
Type - - - -	Master Control
System - - - - -	1
Address - - - - -	12
Control Number - - - - -	2
Back	Help

Device Information Details:

Repeaters

Type

- Main Repeater or Auxiliary Repeater

System

- 1, 2, or Unaddressed

Address

- 1, 2, 3, or Unaddressed

Master Controls

Type

- Master Control

System

- 1, 2, or Unaddressed

Address

- 1-12, or Unaddressed

Control Number

- The RS232 device number used for identifying the device to external equipment, or Unassigned.

Button Number

- 1-17

Button Type

- Local SC (Scene) or Local RM (Room)
- All On
- All Off
- Linked
- No Pgm (not programmed)

Linked To

(Note: This will be displayed only if the button type is Linked.)

- Phantom “N” (where N is the Whole-home Phantom Button that the Master Control Button is linked to)

Zone Controls

Type

- Zone Control

System

- 1, 2, or Unaddressed

Address

- 1-32 or Unaddressed

Zone Number

- The RS232 device number used for identifying the device to external equipment, or Unassigned.

Using FLASH Mode

FLASH Mode is used to verify that a Control has been activated correctly. **Note:** If the Chronos™ System Bridge is not set up as a Main Repeater, this option will not be available on the Chronos System Bridge.

Step 1 Enter FLASH Mode

From the Chronos System Bridge (as a Main Repeater only):

- Main Menu
- ▶ System Setup
- ▶ Diagnostics

Diagnostics	
Flash Mode - - - - -	Yes
Beep Mode - - - - -	No
System Beep Mode - - -	No
Back	Help

Use ▼ to highlight **Flash Mode**. Use ▶ to set **Flash Mode** to **Yes**.

From a Repeater:

Press and hold the FLASH button on any Repeater until the green FLASH LED turns ON (approximately 3 seconds).

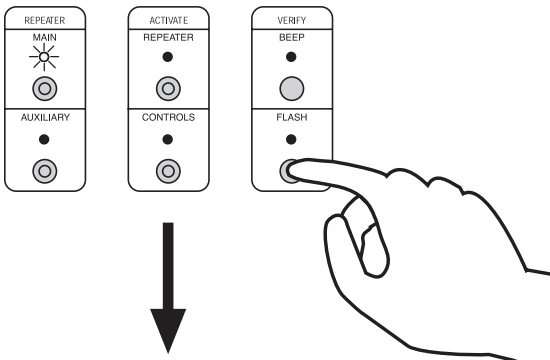

Green FLASH LED on all Repeaters will turn ON.

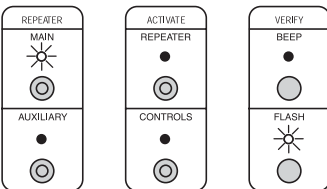

Step 2 Check all Controls

Master Controls and Interfaces, if activated, will flash all their LEDs. Make note of any Master Controls or Interfaces which are not activated.

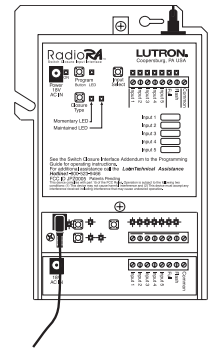
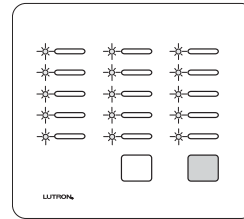

Lighting Zone Controls, if activated, will flash the light(s) they control. Make note of any Lighting Zone Controls that are not activated.

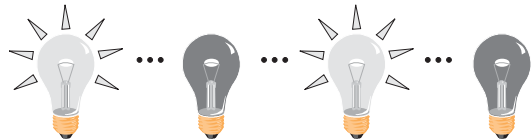

Step 3 Exit FLASH Mode

From the Chronos™ System Bridge (as a Main Repeater only):

From **Diagnostics**, highlight **Flash Mode**. Use ◀ to set **Flash Mode** to **No**.

Diagnostics	
Flash Mode - - - - -	No
Beep Mode - - - - -	No
System Beep Mode - - -	No
Back	Help

From a Repeater:

After checking all Controls, press and hold the FLASH button on any Repeater until the green FLASH LED turns OFF (approximately 3 seconds).

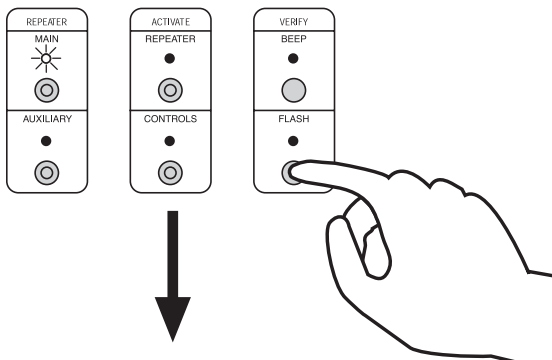

Green FLASH LED on that Repeater will go OFF. MAIN or AUXILIARY LED will stay ON.

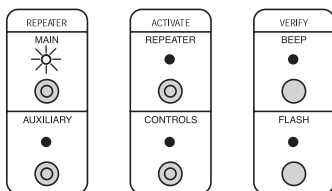

Note: If any device is activated (button press, turned on or off, etc.) or if a Cordless Master Control enters Sleep Mode, Flash Mode will exit.

Using BEEP Mode

BEEP Mode is used to verify that the Chronos™ System Bridge or a Repeater can 'hear' a particular control.

Note: If the Chronos System Bridge is not set up as a Main Repeater, this option will not be available.

Step 1 Enter BEEP Mode

From the **Chronos System Bridge (as a Main Repeater only)**:

Main Menu
 ▶ System Setup
 ▶ Diagnostics

Diagnostics	
Flash Mode -----	No
Beep Mode -----	Yes
System Beep Mode ---	No
Back	Help

Use ▼ to highlight **Beep Mode**. Use ▶ to set **Beep Mode** to Yes.

From a Repeater:

Press and hold the BEEP button on the Repeater you are checking until the green BEEP LED turns ON (approximately 3 seconds).

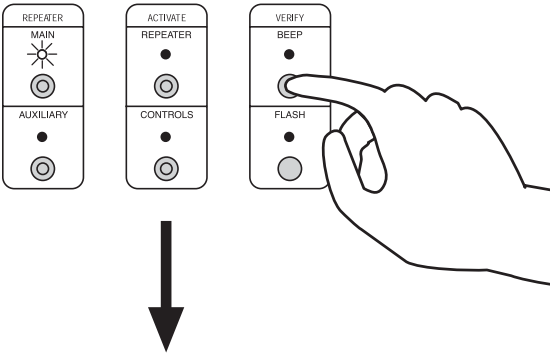

Green BEEP LED on that Repeater only will be ON.

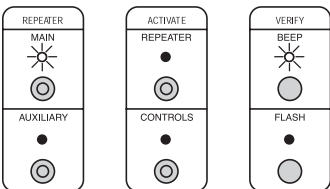

Step 2 Check a Control

Turn the Lighting Zone Control ON or OFF, press the ALL ON or ALL OFF button on a Master Control.

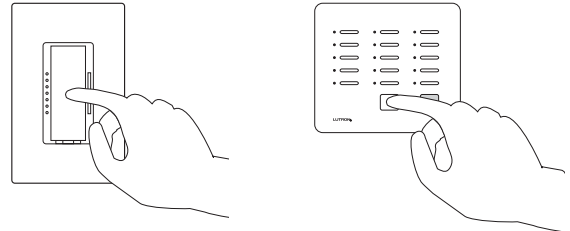

Step 3 Repeater or Chronos System Bridge response

If the Repeater or Chronos System Bridge can 'hear' the control, it will produce multiple audible beeps immediately after the button is pressed.

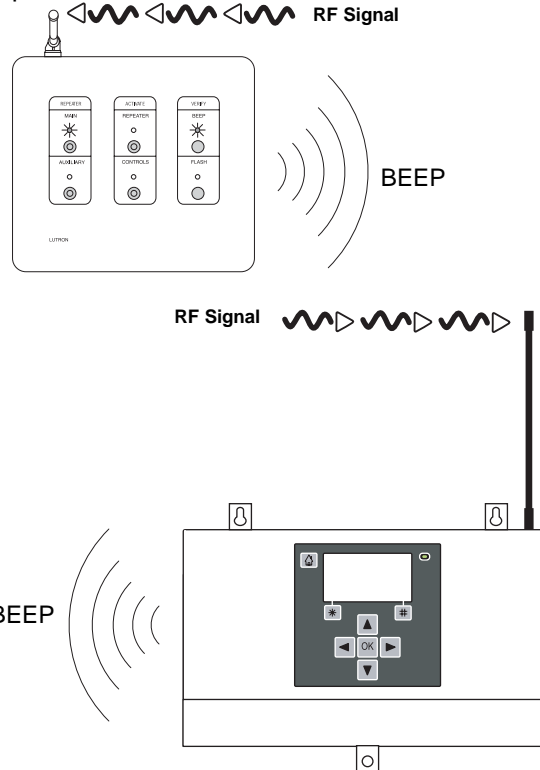

Step 4 Exit BEEP Mode

From the Chronos™ System Bridge (as a Main Repeater only):

From **Diagnostics**, highlight **Beep Mode**. Use ◀ to set **Beep Mode** to **No**.

Diagnostics	
Flash Mode - - - - -	No
Beep Mode - - - - -	No
System Beep Mode - - -	No
Back	Help

From a Repeater:

Press and hold the BEEP button on the Repeater you are checking until the green BEEP LED turns OFF (approximately 3 seconds).

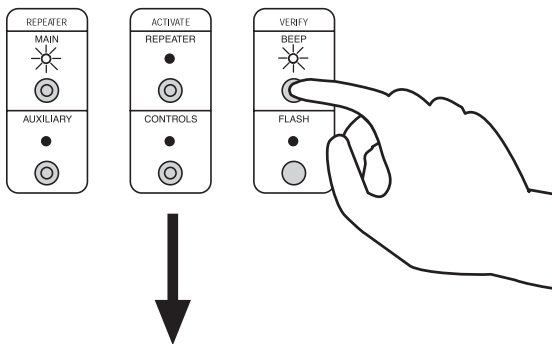

Green BEEP LED on that Repeater will go OFF. MAIN or AUXILIARY LED will stay ON.

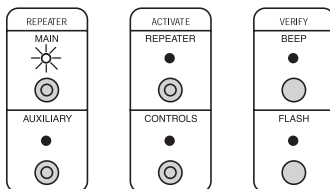

Using System BEEP Mode

System BEEP Mode is used to verify that the Chronos™ System Bridge and all Repeaters in a system can 'hear' a particular control. **Note:** If the Chronos System Bridge is not set up as a Main Repeater, this option will not be available.

Step 1 Enter System BEEP Mode

Main Menu
 ▶ System Setup
 ▶ Diagnostics

Diagnostics	
Flash Mode -----	No
BEEP Mode -----	No
System BEEP Mode - - -	Yes
Back	Help

Use ▼ to highlight **System BEEP Mode**. Use ▶ to set **System BEEP Mode** to **Yes**.

Step 2 Check a Control

Turn the Lighting Zone Control ON or OFF, press the ALL ON or ALL OFF button on a Master Control.

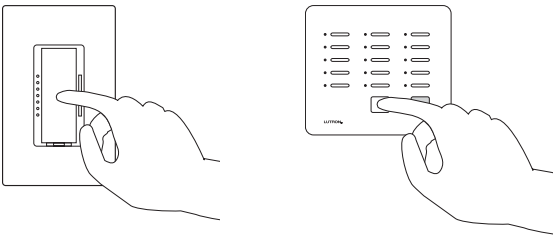

Step 3 Repeater response

The Chronos System Bridge and all Repeaters that can 'hear' the control will produce multiple audible beeps immediately after the button is pressed.

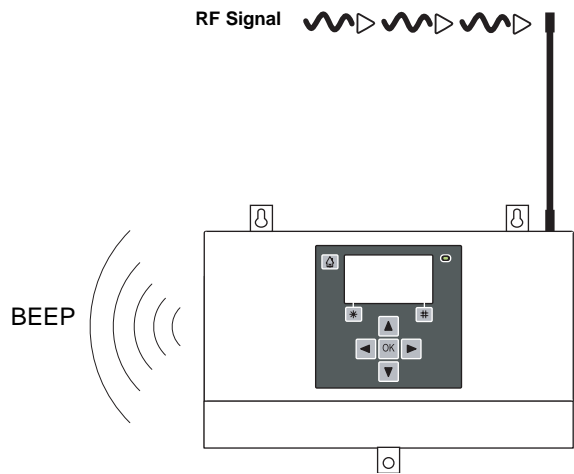
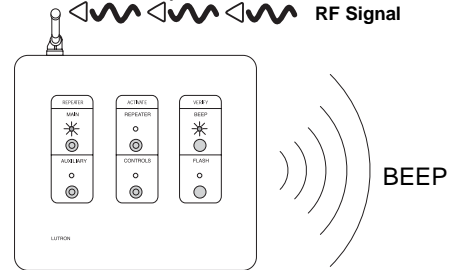

Step 4 Exit BEEP Mode

From **Diagnostics**, highlight **System BEEP Mode**. Use ◀ to set **System BEEP Mode** to **No**.

Diagnostics	
Flash Mode -----	No
BEEP Mode -----	No
System BEEP Mode - - -	No
Back	Help

Adding a Switch Closure Input, RS-232, or IR Interface

Activating a Switch Closure Input Interface, RS-232 Interface, or Infrared (IR) Interface



The Switch Closure Interface has a 15 second delay after applying power. During this time the Power LED will blink. When the Power LED stays ON, the unit is ready for operation.

Step 1 Begin Interface activation

From the Chronos™ System Bridge (as a Main Repeater only):

Main Menu
➤ System Setup

System Setup	
Activate Aux Repeaters	
Activate Controls	
Address Usage	
Diagnostics	
Back	Help

From System Setup, select Activate Controls

Activate Controls	
Begin Activating Controls in System 1	
Zone Controls -----0	
Master Controls ----- 0	
Help	Done

The number of devices and Master Controls currently in the system is displayed. These numbers will update as new Zone Controls and Master Controls are activated. The green ACTIVATE CONTROLS LED on ALL Auxiliary Repeaters will turn ON.

From a Repeater:

Press and hold the ACTIVATE CONTROLS button on *any* Repeater until the green ACTIVATE CONTROLS LED turns ON (approximately 3 seconds).

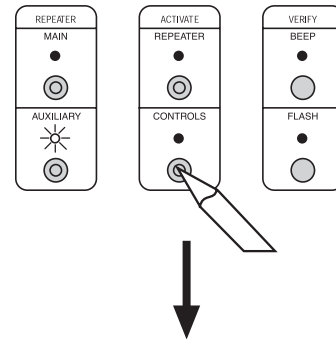

The green ACTIVATE CONTROLS LED on ALL Repeaters will turn ON.

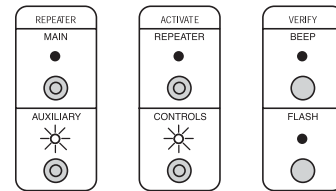

Adding a Switch Closure Input, RS-232, or IR Interface

Step 2 Activate Interface

Press any button.

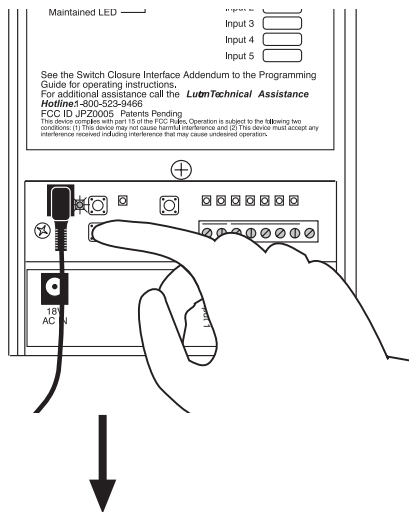

- All input LEDs will flutter, then
- **Switch Closure Input Interface:** the Flash LED and Input 1 LED will alternately flash.
RS-232 or IR Interface: the top and bottom row of the display will alternately flash.

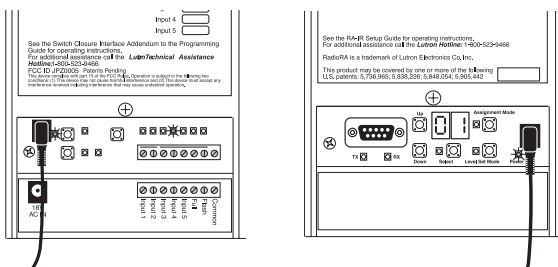

Input 4 LED will remain ON when the Switch Closure Input Interface has been activated.

Display will flash 01 when the RS-232 Interface or IR Interface are activated.

Step 3 Complete Interface activation

Press “Done” (# button) on the Chronos™ System Bridge OR press and hold the ACTIVATE CONTROLS button on any auxiliary Repeater until the green ACTIVATE CONTROLS LED turns off (approximately 3 seconds). The green ACTIVATE CONTROLS LED on ALL auxiliary repeaters will turn off. The AUXILIARY LED will remain on.

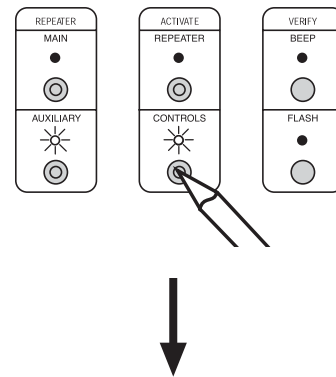

The green ACTIVATE CONTROLS LED on **ALL** Repeaters will turn OFF. The MAIN or AUXILIARY LED will remain on.

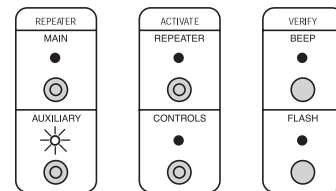

- The Interface is now activated.
- To program the input channels on the Switch Closure Input Interface, refer to the RadioRA® Setup Guide (P/N 044-001).

Returning Components to Default Factory Settings

Master Controls

 Returning a Master Control to Default Factory Settings will **permanently delete all current programming information**. **Do not do this unless you are sure that it is necessary.** For more information call the *Lutron Technical Support Center*.

Step 1 Begin returning to Default Factory Settings

 Ensure that the Chronos™ System Bridge is not in Activate Controls Mode, or the ACTIVATE REPEATER LED or ACTIVATE CONTROLS LED on any Repeater is **NOT ON** before proceeding. If either LED is ON, press the corresponding button until it's LED turns OFF (approximately 3 seconds).

Press and hold the 1st, 3rd and 5th buttons in the right most column until the corresponding LEDs begin to flash (approximately 3 seconds).

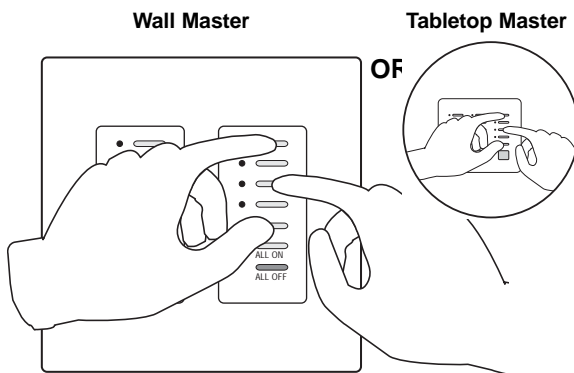

LEDs will flash for only 3 seconds.

Step 2 Complete returning to Default Factory Settings

While the 1st, 3rd, and 5th LED are flashing, press and hold the 2nd and 4th buttons in the right most column until all the LEDs flash.

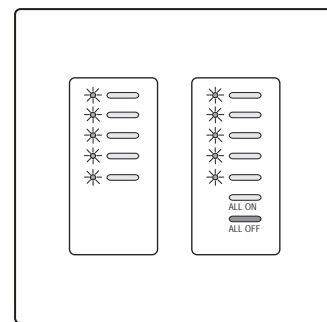
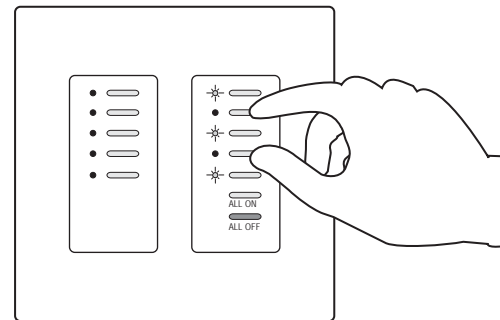

All LEDs will turn OFF, indicating that the Master Control has been returned to Default Factory Settings.

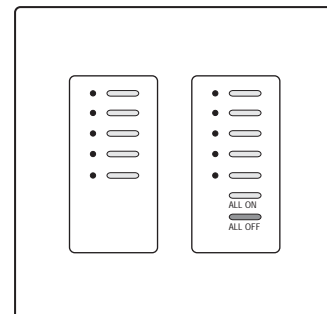

Returning Components to Default Factory Settings

Dimmers

 Returning a Dimmer to Default Factory Settings will permanently delete all current programming information. **Do not do this unless you are sure that it is necessary.** For more information call the **Lutron Technical Support Center**.

Step 1 Turn FASS™ switch OFF

 Ensure that the Chronos™ System Bridge is not in Activate Controls Mode, or the ACTIVATE REPEATER LED or ACTIVATE CONTROLS LED on any Repeater is **NOT ON** before proceeding. If either LED is ON, press the corresponding button until its LED turns OFF (approximately 3 seconds).

Move the Front Accessible Service Switch (FASS) to the OFF position, or unplug Dimmer if it is a Lamp Dimmer.

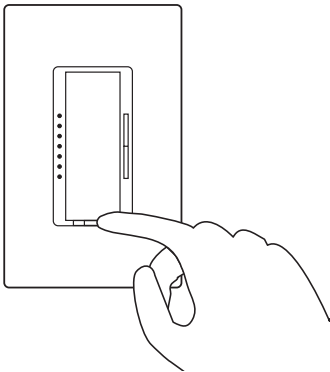

Step 2 Turn FASS switch back ON

Press and hold the raise rocker and the paddle switch while turning the FASS switch ON (or plugging Lamp Dimmer in) until the LEDs begin to chase upward.

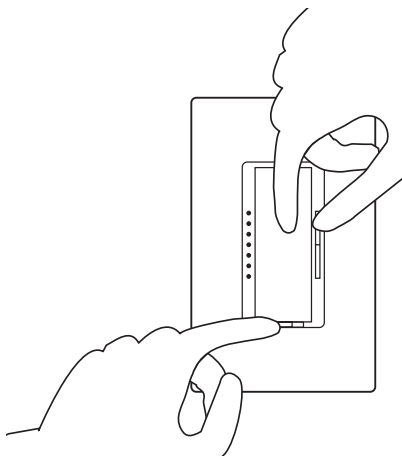

 If the LEDs chase downward, continue with Step 3, then repeat Steps 1-3 again.

Step 3 Return to Default Factory Settings

While the LEDs are chasing upward, simultaneously press and release the lower rocker and the paddle switch.

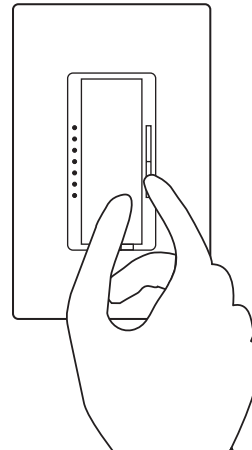

The light that the Dimmer controls will turn ON and OFF a few times indicating that the Dimmer has been returned to Default Factory Settings. The Dimmer will turn on to 50% when the process is complete.

Returning Components to Default Factory Settings

Switches

 Returning a Switch to Default Factory Settings will permanently delete all current programming information. **Do not do this unless you are sure that it is necessary.** For more information call the **Lutron Technical Support Center**.

Step 1 Turn FASS™ switch OFF

 Ensure that the Chronos™ System Bridge is not in Activate Controls Mode, or the ACTIVATE REPEATER LED or ACTIVATE CONTROLS LED on any Repeater is **NOT ON** before proceeding. If either LED is ON, press the corresponding button until its LED turns OFF (approximately 3 seconds).

Move the Front Accessible Service Switch (FASS) to the OFF position.

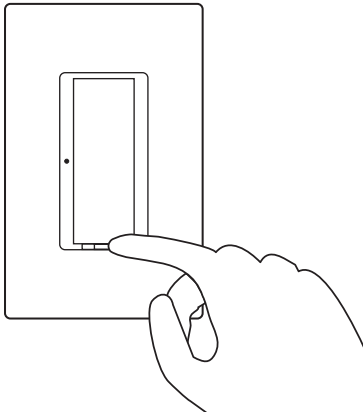

Step 2 Turn FASS switch back ON

Press and hold the paddle switch while turning the FASS switch ON until the LED begins to flash. The light the Switch controls will remain OFF.

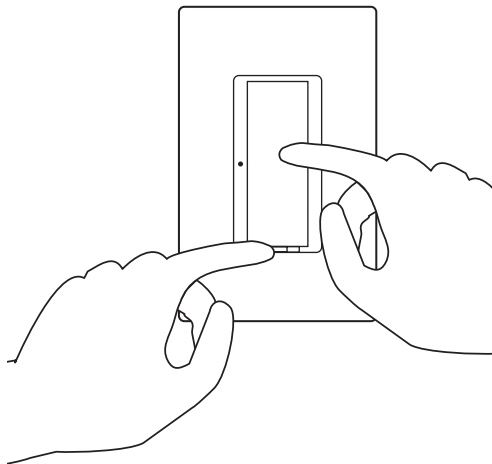

 If the LED **does not** flash, continue with Step 3, then repeat Steps 1-3 again.

Step 3 Return to Default Factory Settings

Release and then press and hold the paddle switch for 2 seconds.

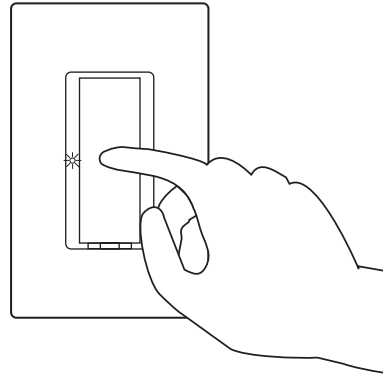

The light the Switch controls will turn ON and OFF a few times indicating that the Switch was returned to Default Factory Settings.

Returning Components to Default Factory Settings

GRAFIK Eye® Interface and GRAFIK RA® Control Unit

 Returning a *GRAFIK Eye* Interface or *GRAFIK RA* Control Unit to Default Factory Settings will permanently delete all current programming information. **Do not do this unless you are sure that it is necessary.** For more information call the *Lutron Technical Support Center*.

Step 1 Remove faceplate

 Ensure that the Chronos™ System Bridge is not in Activate Controls Mode, or the ACTIVATE REPEATER LED or ACTIVATE CONTROLS LED on any Repeater is **NOT ON** before proceeding. If either LED is ON, press the corresponding button until its LED turns OFF (approximately 3 seconds).

Remove the faceplate from the *GRAFIK Eye* Interface or *GRAFIK RA* Control Unit.

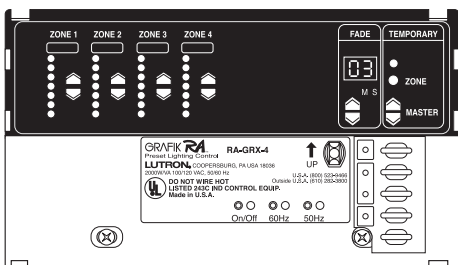
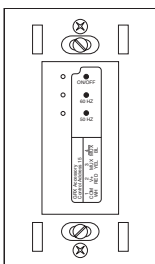

Step 2 Return to Default Factory Settings

Press and hold the ON/OFF button until the orange LED begins to blink (approximately 5 seconds).

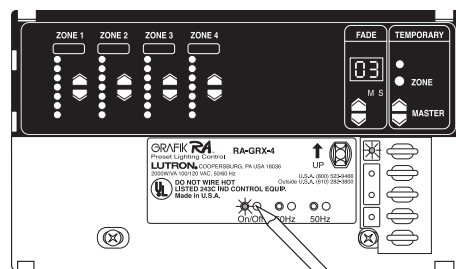
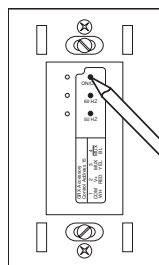

The *GRAFIK Eye*/*GRAFIK RA* Control Unit will turn ON and OFF a few times indicating that the *GRAFIK Eye* Interface or *GRAFIK RA* Control Unit has been returned to Default Factory Settings. Reattach the *GRAFIK Eye* Interface or *GRAFIK RA* Control Unit faceplate.

Returning Components to Default Factory Settings

Repeaters

 Returning a Main Repeater to Default Factory Settings will **permanently delete all current programming information**. **Do not do this unless you are sure that it is necessary**. Return all other devices in your system to Default Factory Settings before returning your Main Repeater to Default Factory Settings. For more information call the **Lutron Technical Support Center**.

Step 1 Begin returning to Default Factory Settings

 Ensure that the Chronos™ System Bridge is not in Activate Controls Mode, or the ACTIVATE REPEATER LED or ACTIVATE CONTROLS LED on any Repeater is **NOT ON** before proceeding. If either LED is ON, press the corresponding button until it's LED turns OFF (approximately 3 seconds).

Press and **hold** (do not release) the BEEP button. The green BEEP LED will turn ON after approximately 3 seconds.

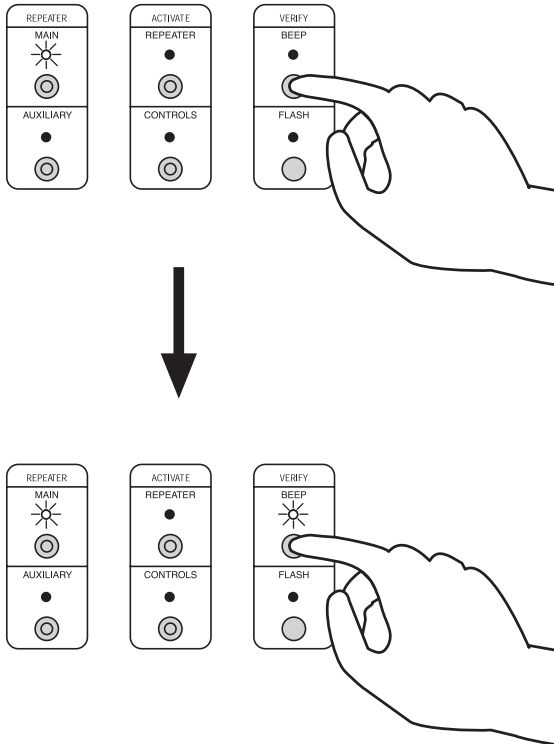

Step 2 Complete returning to Default Factory Settings

While holding the BEEP button, press and hold the ACTIVATE REPEATER button until the ACTIVATE REPEATER LED flashes alternately green and orange.

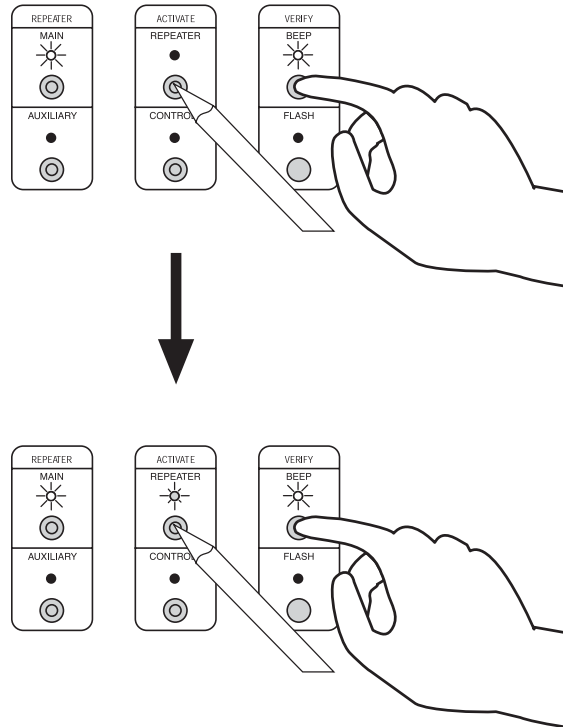

Release both buttons. All LEDs will flash once and only the AUXILIARY LED will stay ON, indicating that the Repeater has been returned to Default Factory Settings.

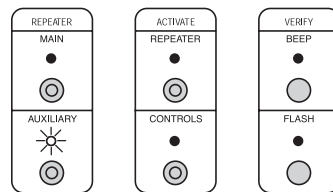

Returning Components to Default Factory Settings

Switch Closure Interface

 Returning a Switch Closure Interface to Default Factory Settings will permanently delete all current programming information. **Do not do this unless you are sure that it is necessary.** For more information call the **Lutron Technical Support Center**.

Step 1 Begin returning to Default Factory Settings

 Ensure that the Chronos™ System Bridge is not in Activate Controls Mode, or the ACTIVATE REPEATER LED or ACTIVATE CONTROLS LED on any Repeater is **NOT ON** before proceeding. If either LED is ON, press the corresponding button until it's LED turns OFF (approximately 3 seconds).

Press and hold all three buttons until Input LEDs 1, 4, and Flash begin to flash (approximately 3 seconds).

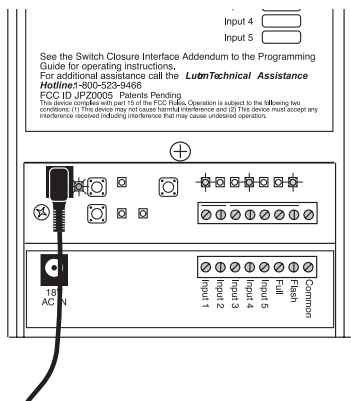
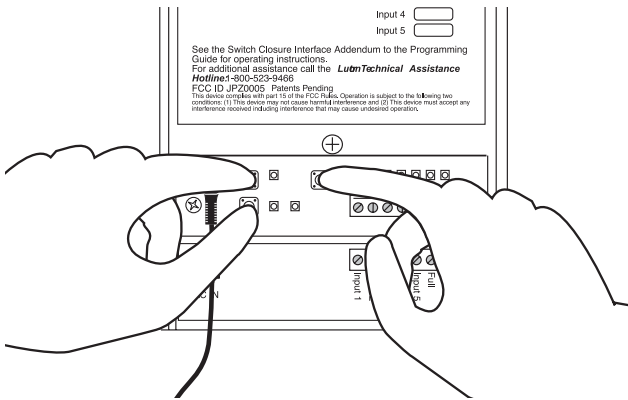

LEDs will flash for only 3 seconds.

Step 2 Complete returning to Default Factory Settings

Press and hold the Program and Closure Type buttons until the Switch Closure Interface resets (all LEDs will flash).

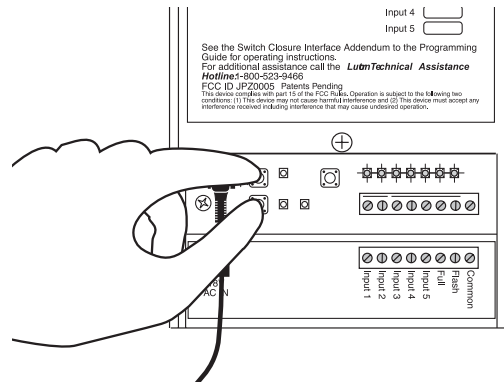

All LEDs (except the Power LED) will turn OFF indicating that the Switch Closure Interface has been returned to Default Factory Settings.

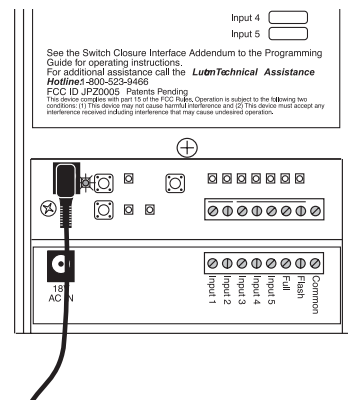

Returning Components to Default Factory Settings

RS-232 Interface



Returning an RS-232 Interface to Default Factory Settings will **permanently delete all current programming information**. **Do not do this unless you are sure that it is necessary.** For more information call the **Lutron Technical Support Center**.

Step 1 Begin Returning to Default Factory Settings



Ensure that the Chronos™ System Bridge is not in Activate Controls Mode, or the **ACTIVATE REPEATER LED** or **ACTIVATE CONTROLS LED** on any Repeater is **NOT ON** before proceeding. If either LED is ON, press the corresponding button until its LED turns OFF (approximately 3 seconds).

Press and hold the Up and Assign buttons until the display turns OFF and the LEDs begin to flutter (approximately 3 seconds).

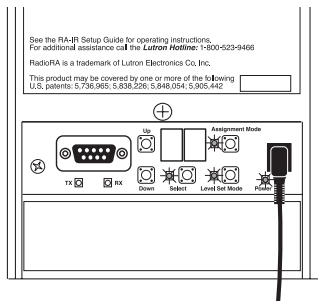
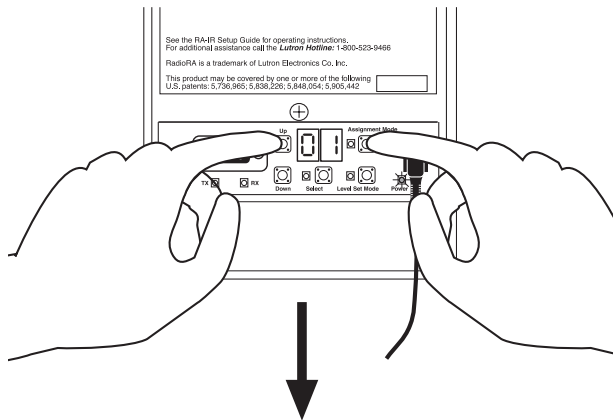

LEDs will flash for only 3 seconds.

Step 2 Return to Default Factory Settings

While the LEDs are fluttering, press and hold the Down and Level Set buttons until the Interface resets ("--" will be on the display).

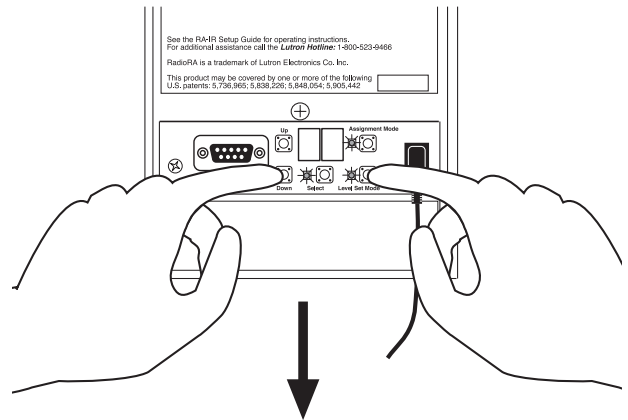

All LEDs (except the Power LED) will turn OFF and the display will show "--" indicating that the Interface has been returned to Default Factory Settings.

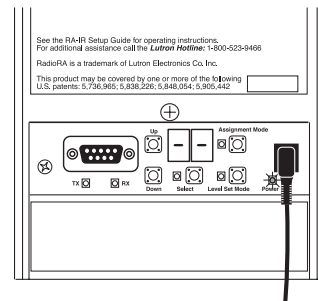

Returning Components to Default Factory Settings

IR Interface



Returning an IR Interface to Default Factory Settings will **permanently delete all current programming information**. **Do not do this unless you are sure that it is necessary.** For more information call the **Lutron Technical Support Center**.

Step 1 Begin Returning to Default Factory Settings



Ensure that the Chronos™ System Bridge is not in Activate Controls Mode, or the **ACTIVATE REPEATER LED** or **ACTIVATE CONTROLS LED** on any Repeater is **NOT ON** before proceeding. If either LED is ON, press the corresponding button until its LED turns OFF (approximately 3 seconds).

Press and hold the **Up** and **Assign** buttons until the display turns OFF and the LEDs begin to flutter (approximately 3 seconds).

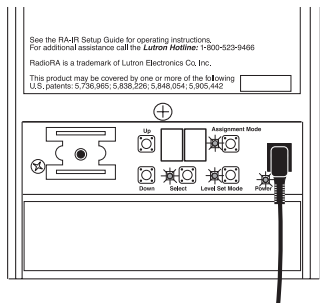
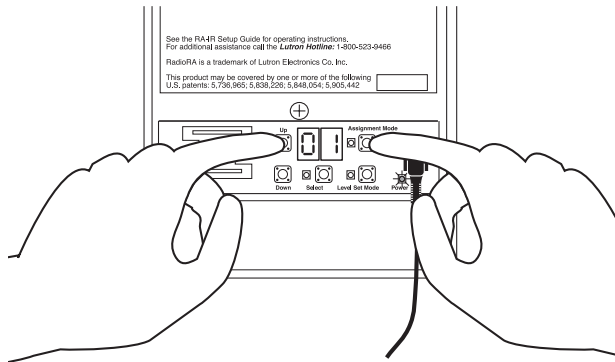

LEDs will flash for only 3 seconds.

Step 2 Return to Default Factory Settings

While the LEDs are fluttering, press and hold the **Down** and **Level Set** buttons until the Interface resets (“- -” will be on the display).

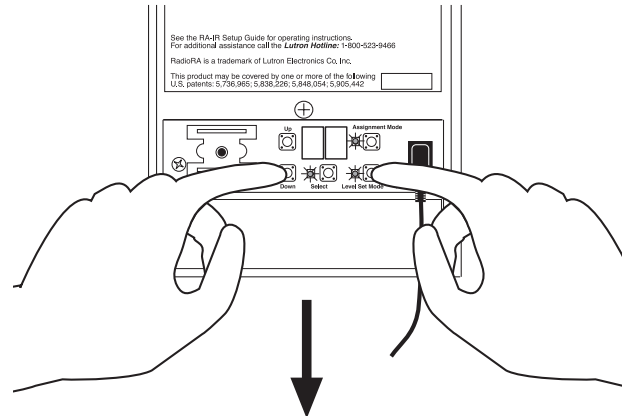

All LEDs (except the Power LED) will turn OFF and the display will show “- -” indicating that the Interface has been returned to Default Factory Settings.

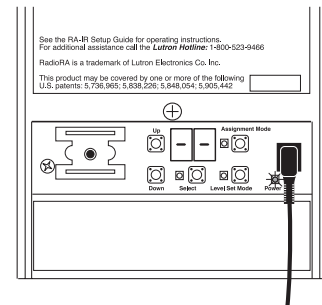

Returning Components to Default Factory Settings

Chronos™ System Bridge

 Returning a *Chronos* System Bridge to Default Factory Settings will **permanently delete all current programming** information. If the *Chronos* System Bridge is the main repeater in one system, or bridging two systems, return all other devices to Default Factory Settings before returning the *Chronos* System Bridge to Default Factory Settings. **DO NOT do this step unless you are absolutely sure it is necessary.** For more information call the *Lutron Technical Support Center*.

Step 1 Begin Returning to Default Factory Settings

 Ensure that the ACTIVATE REPEATER LED or ACTIVATE CONTROLS LED on any Repeater is **NOT ON** before proceeding. If either LED is ON, press the corresponding button until it's LED turns OFF (approximately 3 seconds).

Press and hold ▲ and ▼. Continue to hold the buttons for approximately 4 seconds.

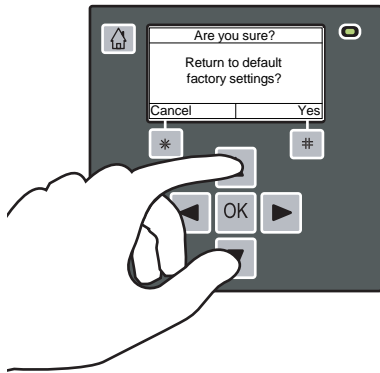

Do not release the buttons. The following screen will appear:

Are you sure?	
Return to default factory settings?	
Cancel	Yes

Step 2 Complete Returning to Default Factory Settings

To cancel the operation, simply release ▲ and/or ▼ or press "Cancel" (* button).

To complete the process of returning the *Chronos* System Bridge to Default Factory Settings, continue to hold ▲ and ▼, and then press "Yes" (# button).

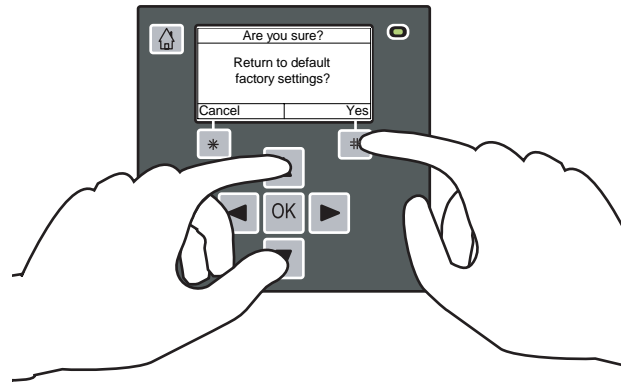

The *Chronos* System Bridge will reset and return to the *Chronos* Configuration screen.

Chronos Configuration	
Main Repeater	No
Bridge Systems	No
RS-232 Interface	No
Back	Done

Using RadioRA® Master Controls with Raise/Lower

On Master Controls equipped with Raise/Lower buttons, you can remotely adjust the light levels of all the Dimmers, and GRAFIK Eye® Control Units assigned to a particular Master Control button.

How Raise/Lower works

The Raise/Lower buttons affect a specific Master Control button. By default the upper right-hand button on the Master Control. As an example, if the Dimmer in the Kitchen were assigned to the upper right-hand button on the Master Control, pressing the Raise button would increase the light level of the Kitchen's Dimmer.

Note: Raise/Lower will work with Master Control buttons having Local Programming only. Whole-home Buttons are unaffected by Raise / Lower.

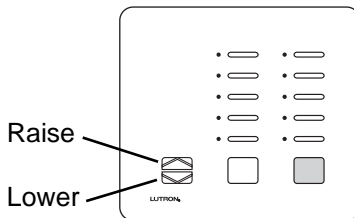

How to change which Dimmers you raise or lower

You can easily change which Master Control button is affected by the Raise/Lower button, quickly tap twice the Master Control button that you want to be affected by the Raise/Lower buttons. That Master Control button's LED will blink for about 2 seconds to indicate that the Raise/Lower buttons are now affecting that Master Control button.

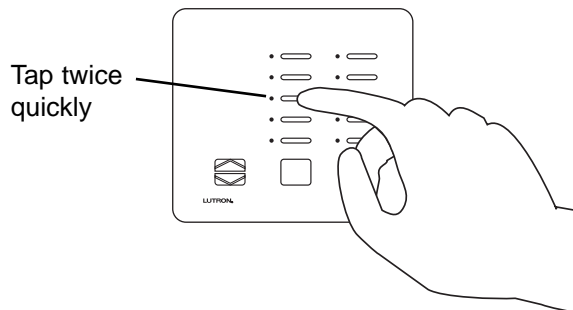

How LED status is affected

If you Raise a Dimmer that is initially OFF, the Dimmer will turn ON and increase its intensity to the desired level. Three seconds after the Raise button is released, the Dimmer's status will be broadcast to the entire system. Any Master Control ROOM LEDs, which have that Dimmer assigned to them, will turn ON since that Dimmer is now ON. Any Master Control SCENE LEDs, which have that Dimmer assigned to them, will turn OFF since the lights are no longer at their preset level for that SCENE.

System Functionality

The Raise/Lower buttons are designed to work with *RadioRA* Dimmers and *GRAFIK Eye* Control Units only. *RadioRA* Switches are not affected by Raise/Lower. Dimmers or *GRAFIK Eye* Control Units which have OFF as their preset level for a particular Scene will not be affected by Raise/Lower commands when the Raise/Lower buttons are affecting that Scene. Dimmers cannot be lowered to OFF.

Note: The functionality described above pertains to *RadioRA* Dimmers and Switches which shipped after January 1, 2001 and *GRAFIK Eye* Interfaces which shipped after February 1, 2001. Contact the Lutron Technical Support Center at 1-800-523-9466 for information on using Raise/Lower Master Controls with older dimming devices.

Definitions of Common Terms

Master Control - A RadioRA® Master Control is a system control point that provides control of lights throughout a home. Master Controls can be wall mounted, tabletop, or cordless. Other system Master Controls are the Switch Closure Interface, the Infrared Interface, or the RS-232 Interface.

Master Control Number - Master Control Numbers are used to identify *RadioRA* Master Controls via the RS-232 port on the Chronos™ System Bridge.

Phantom Buttons - Phantom Buttons are “virtual” buttons in the *Chronos* System Bridge. Though there are no physical buttons that represent these Phantom Buttons, they work very similarly to buttons on *RadioRA* Master Controls. Each Phantom Button can be assigned either as a ROOM or SCENE.

Phantom LEDs - Phantom LEDs are “virtual” LEDs in the *Chronos* System Bridge. Though there are no physical LEDs that represent these Phantom LEDs, they work very similarly to LEDs on *RadioRA* Master Controls. Phantom LEDs 1–15 are associated with Phantom Buttons 1–15, respectively.

ROOM Button - A ROOM button is a programmable button whose LED is ON when any lighting zone assigned to that button is ON at any level. When issuing an “ON” command, a ROOM button may only turn zones ON, not OFF.

SCENE Button - A SCENE button is a programmable button whose LED is ON when the SCENE associated with that button has been activated. The LED will go out when the light zone changes level or receives a command to change level, even if the new level is the same as its preset level. The LED will also go out if the SCENE is turned OFF. When issuing an “ON” command, a SCENE button may turn zones ON or OFF.

Zone - A zone is any individual *RadioRA* Dimmer, Switch, or GRAFIK Eye® Interface. A *RadioRA* System has a maximum of 32 zones.

Zone Number - Zone Numbers can be used to identify any individual zone (one Dimmer, Switch, or *GRAFIK Eye* Control Unit) in your *RadioRA* System via the RS-232 port on the *Chronos* System Bridge.

Zone Control - A device that controls a zone of lighting or a shade, such as a Dimmer, Switch, or *GRAFIK Eye* Control Unit.

Troubleshooting Guide

Proper operation of the RadioRA® System is based upon a complex series of radio frequency (RF) communications between system components. As such, it is highly dependent upon proper system installation and programming of controls.

If there are any difficulties programming or operating the *RadioRA* system, please refer to this guide. Many symptoms of common system activation or programming errors are contained in this Troubleshooting Guide. If there is a problem with the system not described here, or if there are any questions, call the **Lutron Technical Support Center**.

	Symptom	Possible Cause	Remedy
I	The Chronos™ System Bridge LCD screen does not light up.	No power to the <i>Chronos</i> System Bridge.	Verify that there is power to the <i>Chronos</i> System Bridge. Verify the PWR IN and LCD Power LEDs are lit.
		The <i>Chronos</i> System Bridge is in Sleep Mode.	Press any button on the <i>Chronos System Bridge</i> to wake it up.
II	ACTIVATE REPEATER LED on a Repeater begins flashing orange.	The Repeater has been installed within RF communication range of a neighboring system, and has been assigned an identical house code.	If Repeater is a Main, cycle Repeater power and try again. If Repeater is an Auxiliary, return all System components to Default Factory Settings, then restart the System Activation Procedure.
III	ACTIVATE REPEATER LED on an AUXILIARY Repeater begins alternately flashing green and orange.	The AUXILIARY Repeater is out of RF communication range of the MAIN Repeater.	Move the AUXILIARY Repeater to a new location in closer physical proximity to the MAIN Repeater.
		The MAIN Repeater is not in ACTIVATE REPEATER mode.	Place MAIN Repeater in ACTIVATE REPEATER mode
IV	ACTIVATE CONTROLS LED on MAIN or AUXILIARY Repeater turns ON and then back OFF when attempting to go into ACTIVATE CONTROLS mode.	Your system has encountered a neighboring system within RF communication range also in ACTIVATE CONTROLS mode.	Discontinue activating your <i>RadioRA</i> system until activation of the neighboring system is complete.
V	After activating a Dimmer, Switch or GRAFIK Eye® Control Unit, the control changes state, but does not flash the light(s) it controls.	Dimming or switching control is out of RF communication range of nearest system Repeater or <i>Chronos</i> System Bridge.	Move a system Repeater closer to the control in question, or add another Repeater.
		System is not in ACTIVATE CONTROLS mode.	Place system in ACTIVATE CONTROLS mode.
VI	After activating a Master Control, the Master Control LEDs flutter for approximately 5 seconds then go out.	Master is out of RF communication range of nearest system Repeater or <i>Chronos</i> System Bridge.	Move a system Repeater closer to the Master Control in question, or vice versa, or add another Repeater.
		System not in ACTIVATE CONTROLS mode.	Place system in ACTIVATE CONTROLS mode.
		Control already activated to another system.	Return Control to Default Factory Settings, then try activating again.
VII	A Tabletop Master Control, IR Interface, RS-232 Interface, or Switch Closure Interface appears not to be working at all.	No power available to unit.	Ensure that the plug on the rear of the unit is inserted fully and that the unit is plugged into a live wall receptacle. Check that the receptacle is not controlled by a switch. Check that breaker is on and not tripped.
		Faulty power supply.	Swap power supplies with another Master Control or Repeater and check unit for power. Switch Closure Interface power supply is compatible only with <i>Chronos</i> System Bridge.

Troubleshooting Guide

	Symptom	Possible Cause	Remedy
VIII	A Dimmer, Switch or GRAFIK Eye [®] Control Unit appears not to be working at all.	Burned out or missing light bulb	Replace light bulb.
		Front Accessible Service Switch (FASS [™]) is in the OFF position.	Turn <i>FASS</i> on (refer to operation guide included with the Dimmer or Switch).
		No power available to unit.	Check that breaker is on and not tripped.
		Unit has been wired incorrectly.	Refer to wiring instructions supplied with unit.
IX	A Dimmer, Switch or <i>GRAFIK Eye</i> Control Unit performs normally when operated manually, but fails to respond to Master Control button pushes.	The Dimmer, Switch or <i>GRAFIK Eye</i> Control Unit may be out of RF communication range of the nearest Repeater.	Verify that the Dimmer, Switch or <i>GRAFIK Eye</i> Control Unit is in range of a Repeater by placing the system in BEEP mode.
		The Dimmer, Switch, <i>GRAFIK Eye</i> Control Unit or Master Control has been incorrectly activated.	Verify that each control has been activated correctly by placing the system into FLASH mode.
		Master Control was not programmed properly.	Reprogram Master Control.
		The Master Control may be out of RF communication range of the nearest Repeater.	Verify whether the Master Control is in range of a Repeater by placing the system in BEEP mode.
		A noise source (such as a motor or computer) is interfering with the RF communications.	Move the noise source away from the affected control (or vice versa if the control is a Tabletop Master). If it is not possible to move the noise source, move a Repeater closer to the affected control.
		Poor power line frequency regulation (RadioRA [®] <i>GRAFIK Eye</i> Interface).	Use a 24VAC transformer to power the <i>GRAFIK Eye</i> Interface.
X	Dimmers, Switches or <i>GRAFIK Eye</i> Control Units do not respond, or respond intermittently, to various master button pushes and no LEDs are lit on the nearest Repeater.	No power available to Repeater.	Ensure that plug on the rear of the unit is inserted fully and that the unit is plugged into a live wall receptacle.
		Repeater has faulty power supply.	Swap power supplies with another Repeater or Master Control and check unit for power. <i>If the repeater still appears to be inoperable after verifying that it has power, or all LEDs on the Repeater remain unlit after verifying it has power, please call the Lutron Technical Support Center.</i>
XI	After attempting to activate a Switch Closure Interface, all Input LEDs flutter and then go out.	Switch Closure Input Interface is out of RF communication range of nearest system Repeater.	Move the Switch Closure Interface closer to a System Repeater.
		System is not in ACTIVATE CONTROLS mode.	Place system in ACTIVATE CONTROLS mode.

Troubleshooting Guide

	Symptom	Possible Cause	Remedy
XII	A Whole-home scene does not activate when the linked button on a Master Control is pressed.	The Phantom Button is not linked to the Master Control.	Link the Phantom Button to the Master Control from the Whole-home Button Setup menu.
		The scene contains Dimmers shipped prior to January 1, 2001.	From the Phantom Button Setup menu, select Set Properties, and set the Fade Time to 'Legacy'.
	In a bridged system, unable to link a Master Control button to a Phantom Button.	Button already has local programming on it.	Erase the local programming.
		External Control is not enabled on the Master Control.	Enable External Control on the Master Control.
		Master Control was shipped prior to January 1, 2001.	Replace the Master Control with one shipped after January 1, 2001.
	The LED for a Whole-home Button on a Cordless Master Control is not in the correct state.	Cordless LEDs are not updated when a Cordless Master Control wakes up.	Use corded or wall-mounted Master Controls where accurate LED feedback is required.
	Pressing a Whole-home Button on a Master Control turns the Whole-home scene ON, but not OFF.	The Whole-home Button is set to Single Action.	Set the button to Toggle from the Phantom Button Setup menu, under Properties.
Master Control Buttons 1-15 will not link to Whole-home buttons. However, All On and All Off will link.	Master Control was shipped prior to January 1, 2001.	Replace the Master Control with one shipped after January 1, 2001.	
XIII	RX LED not flashing when sending an RS-232 command to the Chronos™ System Bridge.	RS-232 cable not connected to both devices.	Check cable connections.
		Incorrect type of RS-232 cable.	Verify cable, see the RadioRA® RS-232 Protocol and Programming Guide (P/N 044-038).
	No RS-232 feedback and TX LED is flashing.	RS-232 cable not connected to both devices.	Check cable connections.
		Incorrect type of RS-232 cable.	Verify cable, see the <i>RadioRA</i> RS-232 Protocol and Programming Guide (P/N 044-038).
		External device using incorrect baud rate.	Verify baud rate of external devices matches the baud rate setting on the Chronos™ System Bridge.
	No RS-232 feedback and TX LED is not flashing.	<i>Chronos</i> System Bridge RS-232 feedback not enabled.	Configure <i>Chronos</i> System Bridge RS-232 feedback.
		Flow control set incorrectly.	Verify flow control setting from the RS-232 Setup menu.
	No RS-232 feedback from <i>Chronos</i> System Bridge when a Master Control button is pressed.	Master Control does not have a Master Control Number.	Verify the Master Control Number.
		Master Control button press feedback is not turned on.	Turn on Master Control button feedback from the RS-232 Setup menu.

Troubleshooting Guide

	Symptom	Possible Cause	Remedy
	No RS232 feedback from Chronos™ System Bridge when a Dimmer, Switch, or GRAFIK Eye® Control Unit's level is changed locally.	Dimmer, Switch, or <i>GRAFIK Eye</i> Control Unit does not have a Zone Number.	Verify the Zone Number.
		Local Zone Change feedback is not turned ON.	Turn on Local Zone Change feedback from the RS-232 Setup menu.
XIV	CCI scene does not activate when contact closure is closed.	Incorrect wiring.	Verify proper wiring.
		CCI scene is not programmed.	Program the CCI scene from the CCI Setup menu.
		CCI configured for scene control.	Verify that the CCI is configured for scene control from the CCI Setup menu.
		Wrong Closure Type.	Verify the Closure Type setting (maintained or momentary) is correct from the CCI Setup menu.
	The Time Clock mode does not change when the CCI is closed.	Incorrect wiring.	Verify proper wiring.
		CCI not configured for Time Clock mode control.	Verify that the CCI is configured for scene control from the CCI Setup menu.
XV	A Time Clock scene activated at the wrong time.	Event programming incorrect.	Verify the event programming from the Manage Events menu.
		Time / Date settings incorrect.	Verify the time, date, and location settings from the Time Clock Setup menu.
	The Time Clock scene did not activate at all.	Event programming incorrect.	Verify the event programming from the Manage Events menu.
		The scene contains Dimmers or Switches manufactured prior to January 1, 2001.	Set the Fade Time to 'Legacy' from the Manage Events menu.
		Incorrect scene action.	Verify that the action is set to 'Scene On' from the Manage Events menu.
		Time Clock in wrong mode.	Check the Time Clock Mode from the Chronos Status screen. Verify this matches the type for the event from the Manage Events menu.

Limited Warranty

Lutron will, at its option, repair or replace any unit that is defective in materials or manufacture within one year after purchase. For warranty service, return unit to place of purchase or mail to Lutron Electronics Co., Inc. at 7200 Suter Rd., Coopersburg, PA 18036-1299, postage pre-paid.

THIS WARRANTY IS IN LIEU OF ALL OTHER EXPRESS WARRANTIES, AND THE IMPLIED WARRANTY OF MERCHANTABILITY IS LIMITED TO ONE YEAR FROM PURCHASE. THIS WARRANTY DOES NOT COVER THE COST OF INSTALLATION, REMOVAL OR REINSTALLATION, OR DAMAGE RESULTING FROM MISUSE, ABUSE, OR DAMAGE FROM IMPROPER WIRING OR INSTALLATION. THIS WARRANTY DOES NOT COVER INOPERABILITY RESULTING FROM INTERFERENCE, INCORRECT INSTALLATION, OR ENVIRONMENTAL FACTORS. THIS WARRANTY DOES NOT COVER INCIDENTAL OR CONSEQUENTIAL DAMAGES. LUTRON'S LIABILITY ON ANY CLAIM FOR DAMAGES ARISING OUT OF OR IN CONNECTION WITH THE MANUFACTURE, SALE, INSTALLATION, DELIVERY, OR USE OF THE UNIT SHALL NEVER EXCEED THE PURCHASE PRICE OF THE UNIT.

This warranty gives you specific legal rights, and you may have other rights which vary from state to state. Some states do not allow the exclusion or limitation of incidental or consequential damages, or limitation on how long an implied warranty may last, so the above limitations may not apply to you. This product may be covered under one or more of the following U.S. patents: 5,798,581; 5,838,226; 5,848,054; 5,905,442; 6,687,487; and corresponding foreign patents. U.S. and foreign patents pending. Lutron, RadioRA, the RadioRA logo, the sunburst logo and GRAFIK Eye are registered trademarks, and Chronos, GRAFIK RA and FASS are trademarks of Lutron Electronics Co., Inc.

Technical Assistance

If you have questions concerning the installation or operation of this product, call the **Lutron Technical Support Center**. Please provide exact model number when calling.

+1.800.523.9466 (U.S.A., Canada, and the Caribbean)

Other countries call +1.610.282.3800

Fax +1.610.282.3090

Visit our web site at www.lutron.com

World Headquarters

Lutron Electronics Co., Inc.

7200 Suter Road

Coopersburg, PA 18036-1299 U.S.A.

TOLL FREE: +1.800.523.9466 (U.S.A., Canada, and the Caribbean)

Tel: +1.610.282.3800

Fax: +1.610.282.3090

Lutron Electronics Co., Inc., reserves the right to make improvements or changes in its products without prior notice. Although every attempt is made to ensure that this information is accurate and up to date, please check with Lutron to confirm product availability, latest specifications and suitability for your application.