

CHILTON'S **THE ELECTRONIC ENGINEER**



Brighten your light applications by learning about optoelectronic emitters

Course on MOS ICs, part 5c
WESCON keeps up with the times
Optoelectronics course, part 2a

When is a power supply not just a power supply?

This is Kepco's JQE 100-10MHS Power Supply. It looks and is built much like the many hundreds of similar power supplies made by power supply companies. It will produce an adjustable voltage 0-100V, with a 10-turn front panel control—will drive loads up to 10 amperes and is backed by a 5-year warranty.

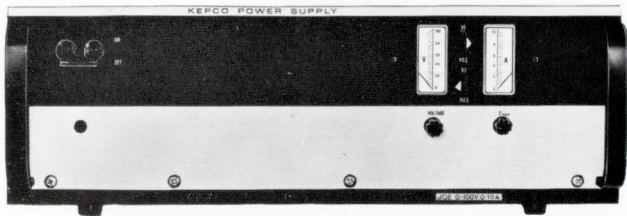

That's where the resemblance to the product of other power supply companies stops. The JQE 100-10MHS is made by Kepco, the power *CONTROL* company.

This means that you can manipulate its output to suit your purposes. You can use it as a 1 kW, d-c power amplifier and use as much of its 500,000 volts per volt d-c gain as you please. With that suffix "HS," the JQE will allow you to modulate its output with signals of your choice up to about 300 Hz for full 100V peak-to-peak swing. For 10V p-p modulation, you've got a 3 kHz bandwidth.

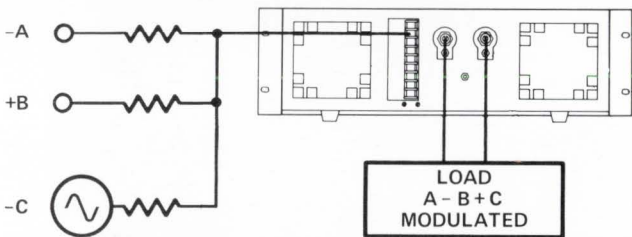

Would you like to sum several signals? Connect the JQE as a summing amplifier and use it to perform arithmetic operations.

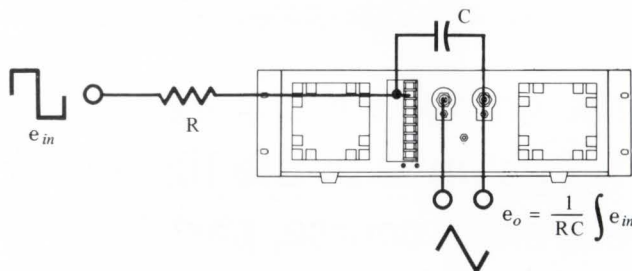

With a capacitor connected to its convenient feedback terminals, your JQE makes a dandy integrator.

KEPCO®

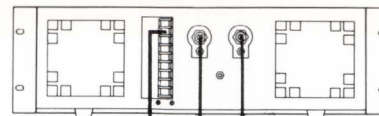

$$I_o = \frac{I_b R_{cc}}{R_s}$$

(I_b = Ref. current)

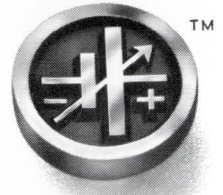

Bring feedback from a current sensor and it will regulate current.

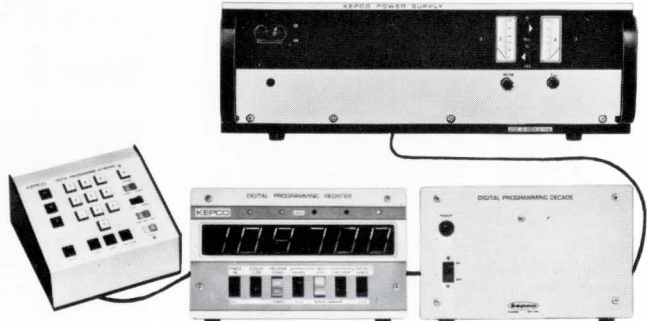

Vary its feedback and input resistors digitally and you'll have a computer-controlled voltage source. We make an excellent digital programmer to work with our controllable power supplies (the Kepco DPD, DPR, DPK Digital Programming System).

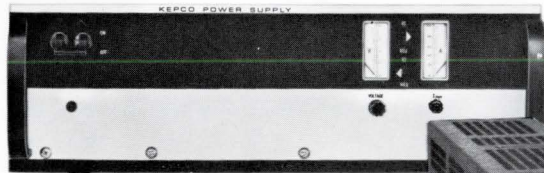

Typical Full Rack Model

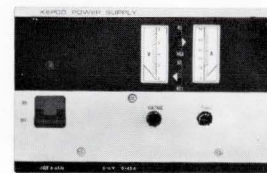

Typical 1/2 Rack Model



Typical 1/4 Rack Model

There are thirty-one (31) different JQE models in all sizes and output voltages from 0-6 to 0-150 volts up to 1125 watts . . . modules, too.



Our new Catalog B-703 is just off the press with details on the JQE and other fine Kepco power controllers. We would like to send you a copy.

Write Dept. DL-19

PETP FILM CAPACITORS

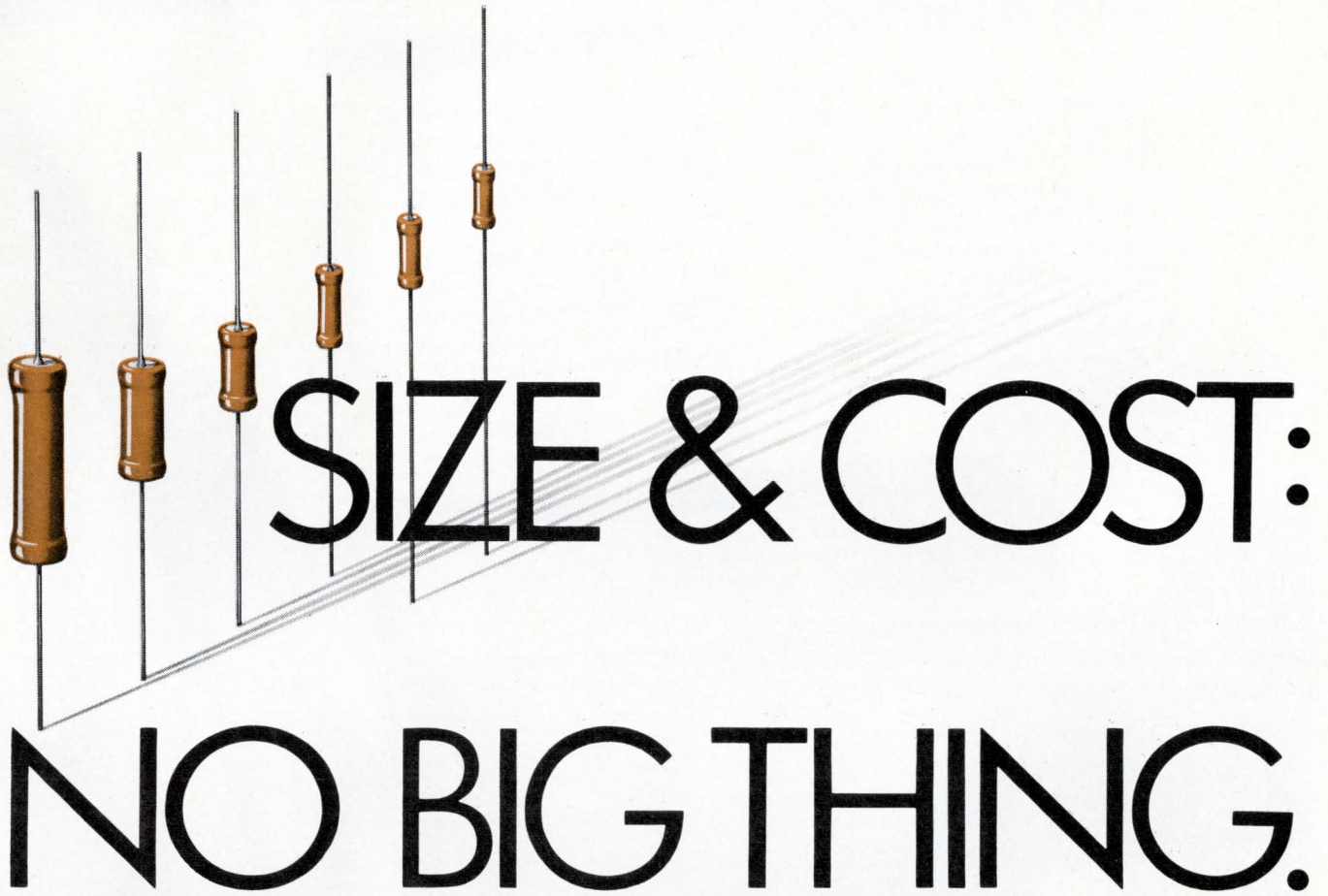

SIZE & COST:

NO BIG THING.

EASIER THAN EVER TO FIT
YOUR BOARD & BUDGET.

BROAD LINE GETS BROADER.
8 LOWER CAPACITANCE VALUES
(100 pF thru 390 pF @ 200 V).

Type 192P Pacer[®] Polyester Film Capacitors are mass-produced to beat the space/cost squeeze in commercial and industrial applications. Extended-foil PETP film sections with metal end caps provide best possible non-inductive construction. End caps also act as moisture barriers. Ideal for automatic insertion on printed wiring boards. Expanded line includes capacitance values from 100 pF to .47 μ F. Voltage range, 80 to 600vdc. Write for Bulletin 2066C.

Technical Literature Service
Sprague Electric Company
233 Marshall Street
North Adams, Mass. 01247



THE BROAD-LINE PRODUCER OF ELECTRONIC PARTS

4SM-0143

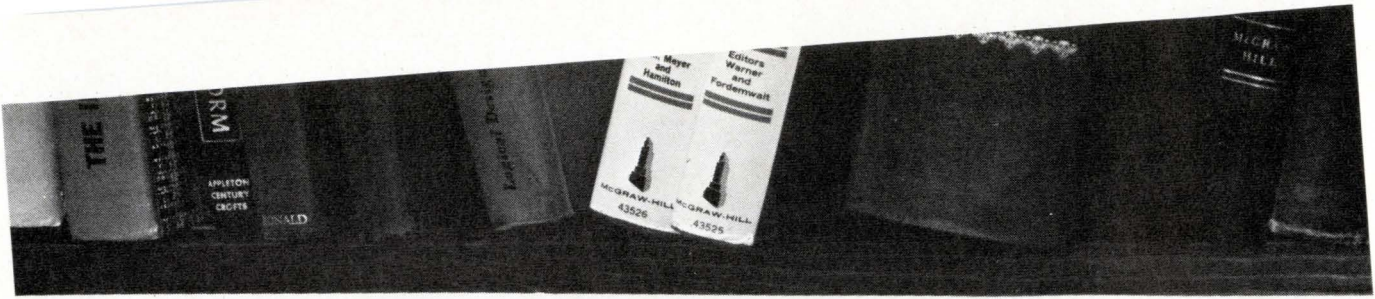

Buy a library for your computer

Subroutines, micro-programs, functions, encoders and decoders, log tables and logic tables, now you can get any or all of them for your computer. All it takes is a Datapac read-only-memory.

With a Datapac U-core ROM you can change your data contents in minutes, simply by plugging in a new data board. You can even modify or change the data on any given data board right in your own facility. Nothing in a Datapac ROM is engraved in stone. Or etched in silicon.

Datapac memories come in various models and sizes to accommodate anywhere from 1000 to 983,040 bits. They're fast, reliable, and reasonably priced.

And if that's not enough, send for our new brochure. It's full of descriptions and diagrams and specs. It's free. And it may start you on the road to a lot of beautiful memories. DATAPAC Incorporated, 3839 South Main Street, Santa Ana, California 92702. (714) 546-7781.



CHILTON'S **THE
ELECTRONIC
ENGINEER**

August 1970 Vol. 29 No. 8

Departments

Editorial	6
It happened last month	10
Up to date	12
Bay soundings	21
Western column	44
Seminars	48
Welcome	49
New product features	70
Microworld new products	76
Lab instruments	80
New products	84
Abstracts	91
Literature	93
Ad index	99
Product index	100

COVER

This month's portion of our Optoelectronics course deals with solid-state emitters—the light sources. Originally, we were going to present both the emitters/sources and sensors/detectors in one issue. But, there was so much information available that we elected to break Part 2 into two smaller parts, 2a and 2b. Part 2a, presented in this issue, is comprised of two articles—see pages 29 and 36. The photo on our cover highlights the light sources by clever photography of a Motorola device energized with probes.

FEATURES

WESCON—keeping up with the times	24
Here it is, ladies and gentlemen! Despite some big-name dropouts, a three-ring show starring strong technical sessions and domestic and foreign exhibitors. By Stephen A. Thompson	
Optoelectronics—part 2A Let the light shine out	29
Not a song from the Broadway show, "Hair," but a careful exposition of various light emitters from simple flat structures to the most complex arrays. By Lin Wetterau, Millis Miller and Dr. R. Haisty	
Emitter packaging and performance	36
Understanding the packaging fundamentals and performance parameters is essential to ensure maximum chip efficiency and minimum cost for your application. By Dr. M. G. Coleman, R. W. Gurtler and A. London	
MOS integrated circuits—part 5C	53
That famous dynamic duo, LSI and MOS, brought a new lease on life to the associative memory. By Arthur J. Boyle	
MOS associative memories	54
Whether you call it an AM or a CAM (associative or contents-addressable memory), it still offers storage and logic for your sorting, merging and pattern recognition applications. By Leon D. Wald	
Designing wideband amplifiers: let the computer help	59
If your application is between 100 kHz and 1 GHz, set your specs, establish your models, choose your program, and leave the designing to the computer. By John A. Eisenberg	
IC Ideas	63
● Pulse rate filter	By Quon S. Chow
● Low frequency function generator	By Barry Schwartz
● Next pulse synchronizer	By Don M. Evans
● Digital AFSK	By Arleigh B. Baker

For automated manufacturing you need

NEMS

DNC1500

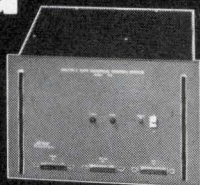

Because...

we supply a complete system operable by:

1. Computer Control
2. Manual Control
3. Paper Tape
4. Magnetic Tape



The NEMS DNC1500 is actually a specially designed mini-computer. It is especially valuable when used with computer control, because it frees the main computer for other duties during repetitive

operations. X-Y positioning of production equipment for insertion operations, drilling, milling, plotting, etc. is performed under the digital control of the mini-computer.

The DNC1500 slews heavy loads at speeds of up to 600 inches per minute. We guarantee accuracy at full speed! Standard resolution of the DNC1500 is 500 micro-inches, assured by the use of 8 BCD digits. Optional resolutions of 100 or 10 micro-inches are available.

For complete information on the NEMS DNC1500, contact: C. G. Chapel, Product Manager

NEMS

National Electro-Mechanical Systems, Inc.
Box R, 32 Broad Ave., Binghamton, N.Y. 13904 • Phone 607 723-9561

**THE
ELECTRONIC
ENGINEER**

Vol. 29 No. 8

August 1970

K. Robert Brink, *Publisher*
Alberto Socolovsky, *Editor*
John E. Hickey, Jr., *Managing Editor*
Smedley B. Ruth, *Associate Editor*
Sheldon Edelman, *Western Editor S.F.*
Stephen A. Thompson, *Western Editor L.A.*
Arthur J. Boyle, *Technical Editor*
John McNichol, *Assistant Editor*
Dr. O. M. Salati, *Consultant*
Anne Axe, *Editorial Assistant*
Alice C. Bach, *Editorial Assistant*
Lynda Rothstein, *Editorial Assistant*
Deborah P. Wilkins, *Editorial Assistant*
Mae Moyer, *Editorial Reader Service*
Andrew Mittelbrunn, *Chilton Art Director*
Phaue Featherson, *Artist*
George Baker, *Washington News Bureau*
Neil Regeimbal,

Chilton   

Executive and Editorial Offices:
One Decker Square, Bala-Cynwyd, Pa. 19004
Tel. (215) SH 8-2000

Address Mail to: 56th & Chestnut Sts.
Philadelphia, Pa. 19139

Western Offices:
Stephen A. Thompson, 1543 W. Olympic Blvd., Los Angeles,
Calif. 90015
Tel. (213) DU 7-1271

Sheldon Z. Edelman, 199 First St. Rm. 335
Los Altos, Calif. 94022
Tel. (415) 941-6655

Chilton Officers & Directors: Chairman of the Board: G. C. Buzby; President: R. E. McKenna; Financial Vice-President: S. Appleby; Senior Vice-Presidents: J. Kofron, L. King; Publishing Vice-Presidents: C. W. Hevner, W. A. Barbour, R. H. Groves, K. Robert Brink; Treasurer: James Miades; Secretary: J. A. Montgomery, Jr.; Other Directors: T. J. Casper, S. H. Collmann, R. Rimbach, Jr., J. P. Kushnerick, R. O. Nelson; Asst. Secretary: I. C. Holloway.

Monthly publication of Chilton Company, Chestnut & 56th Sts., Phila., Pa. 19139. (Area Code 215) SHerwood 8-2000. Controlled circulation postage paid at Philadelphia, Pa. \$1 a copy. Subscription rates U. S. and U. S. Possessions: 1 yr. \$12.00; 2 yrs. \$20.00. Canada 1 year \$14.00; 2 yrs. \$25.00. All other countries 1 yr. \$20.00; 2 yrs. \$35.00. © Chilton Company 1970. Title Reg. U.S. Patent Office. Reproduction or reprinting prohibited except by written authorization.

The Chilton Electronics and Instrumentation Group •
The Electronic Engineer ■ Instruments and Control
Systems ■ Instrument & Apparatus News ■ Medical
Electronics News ■ Electronic Component News

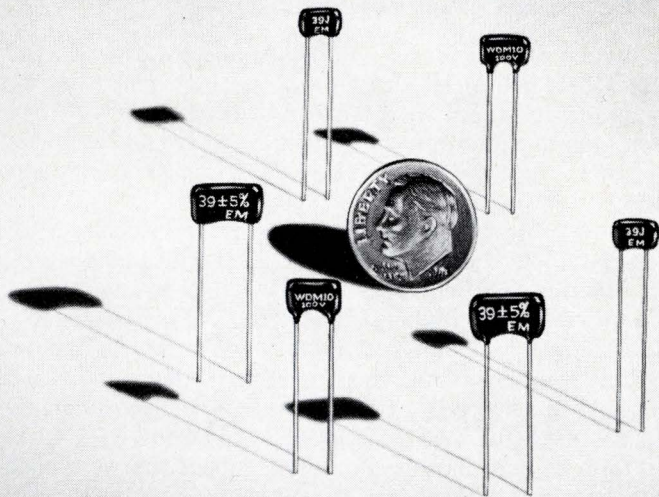

They're Small and Reliable*

EL-MENCO DM5 — DM10 — DM15 — ONE COAT DIPPED MICA CAPACITORS

STYLE	WORKING VOLTAGE	CHARACTERISTIC	CAPACITANCE RANGE
DM5	50VDC	C	1pF thru 400pF
		D, E	27pF thru 400pF
		F	85pF thru 400pF
DM5	100VDC	C	1pF thru 200pF
		D, E	27pF thru 200pF
		F	85pF thru 200pF
DM10	100VDC	C	1pF thru 400pF
		D, E	27pF thru 400pF
		F	85pF thru 400pF
DM15	100VDC	C	1pF thru 1500pF
		D, E	27pF thru 1500pF
		F	85pF thru 1500pF
DM5	300VDC	C	1pF thru 120pF
		D, E	27pF thru 120pF
		F	85pF thru 120pF
DM10	300VDC	C	1pF thru 300pF
		D, E	27pF thru 300pF
		F	85pF thru 300pF
DM15	300VDC	C	1pF thru 1200pF
		D, E	27pF thru 1200pF
		F	85pF thru 1200pF
DM10	500VDC	C	1pF thru 250pF
		D, E	27pF thru 250pF
		F	85pF thru 250pF
DM15	500VDC	C	1pF thru 750pF
		D, E	27pF thru 750pF
		F	85pF thru 750pF

Where space and performance are critical, more and more manufacturers are finding that El-Menco miniaturized dipped mica capacitors are the reliable solution. The single coat is available in three sizes: 1-CRH, 1-CRT and 1-CE.

The 1-CRH DM "space savers" easily meet all the requirements of MIL and EIA specifications, including moisture resistance. The 1-CE and 1-CRT units also meet the requirements of MIL and EIA specifications, except that they have less moisture protection because of their thinner coating; these capacitors, therefore, are ideally suited where potting will be used. Note: DM10 and DM15 units are still available in the standard 4-CR size.

Specify "El-Menco" and be sure . . . the capacitors with proven reliability. Send for complete data and information.

*Normally, El-Menco 39 pF capacitors will yield a failure rate of less than 0.001% per thousand hours at a 90% confidence level when operated with rated voltage and at a temperature of 85°C. Rating for specific applications depends on style, capacitance value, and operating conditions.

THE ELECTRO MOTIVE MFG. CO., INC.

WILLIMANTIC, CONNECTICUT 06226

Dipped Mica • Molded Mica • Silvered Mica Films • Mica Trimmers & Padders
Mylar-Paper Dipped • Paper Dipped • Mylar Dipped • Tubular Paper

West Coast Manufacturers contact: COLLINS & HYDE CO., 900 N. San Antonio Rd., Los Altos, California 94022
5380 Whittier Blvd., Los Angeles, California 90022

ALSO SOLD NATIONALLY THROUGH ELECTRONIC PARTS DISTRIBUTORS

The jobs that were

Once upon a time there was a design engineer who was busily working on his latest project for an industrial customer. After his small team designed the equipment, he spent nights writing terse, intelligent instructions for intelligent persons, describing how the machine operates and how to troubleshoot it. The machines were a success and, since they seldom broke down, their instruction manuals were seldom used.

Then, one day, the engineer's company got a contract to provide a similar machine for the Air Force. The hardware specifications were going to be much the same, differing only in the reinforced cabinet to meet Mil specs. He happily estimated the price and prudently added 10% to his estimate for "contingencies."

He cheerfully accompanied his sales manager to a meeting with the contracting officer, carrying with him his bullet-proof instruction manual. The contracting officer looked at it, said it was obviously well written, but it did not meet Mil Standard M-4410E, and Mil-M-38784, and Mil-M- The engineer politely asked for a copy of those standards, got them and went back to the office to spend another night looking them over.

The next day, grim-faced, he told his boss that he was afraid he could not prepare the instruction manual by himself, and that the cost of such manual could exceed the cost of the equipment, swallow up all the nice profit his company was planning to make with the Government's order, and leave them in the red to boot.

He was right. Very soon, the contracting officer suggested they either subcontract for the preparation of the manual with a specialized company, or hire a department of almost equal size to the design department, if they wanted to do it themselves. Either way, our engineer friend could foresee that his time was going to be tied up for a long while explaining the intricacies of his design to people who were completely unfamiliar with the equipment. Not only was his company going to run up a sizable bill on the manual, but it was going to lose valuable engineering man-hours.

Now, we don't pretend that the engineering "overhead"—such as writing instruction manuals, writing proposals, or keeping track of reliability figures—can be as low for military contracts as it is for industrial products. But we do contend that it is unreasonably high. "Documentation at the contract definition stage is usually wasted," says David Packard, Deputy Secretary of Defense, who is well versed in the requirements of both industry and defense. "It usually ties up people of very high technical caliber to write truckloads of paper, rather than concentrate on developing hardware." If, as Secretary Packard suggests, the ratio of hardware development and production to software in the total cost should increase, while holding the line on cost, the obvious place to save money will be in software and services. That is, the long proposals, the heavy instruction manuals, the interminable reports on reliability of components, will have to become a thing of the past. With them, will disappear many "paratechnical" jobs held now by electronic engineers who are involved with interfacing design with documentation.

What will happen to them? Will they be able to return to the mainstream of engineering devoted to product design and development? Very unlikely. Since their recent experience has led them away from design, they will not be able to compete for such jobs with many engineers who have heavy design experience and are also looking for work. Since their plight will be the hardest, their solutions will, hopefully, be the most imaginative ones. Those whose training consisted in explaining electronic products and systems to nonelectronic people will be able to find applications of electronics to areas other than defense—applications that this magazine will report in detail, in the hope of sparking new ideas to create more jobs for electronic engineers—*jobs that are, rather than were.*

Alberto Socolovsky
Editor

Take advantage of RCA's ability to supply superior SCR's and Triacs... when you need them.

Ask our solid-state specialists why RCA's broad line of industrial SCR's and triacs excel in quality, reliability, and performance. They'll tell you that RCA thyristors are subjected to some of the toughest quality assurance tests in the industry. Thus, they save design dollars by virtue of superior performance in critical applications.

Ask users of industrial thyristors why RCA is a key supplier and they'll tell you RCA services the industry! Whatever the application—area lighting to avionics, regulators to inverters, or power supplies to modulators—RCA has SCR's and triacs to meet your application requirements.

Use these SCR's and triacs in your control applications:

SCR Family	Rating		Triac Family	Rating	
	$I_T(RMS)$	V_{DROM}		$I_T(RMS)$	V_{DROM}
40740	10 A	600 V	40795	10 A	600 V
40752	20 A	600 V	40797	15 A	600 V
2N690	25 A	600 V	40671	30 A	600 V
2N3899	35 A	600 V	2N5443	40 A	600 V

NOTE: SCR ratings of 100, 200, & 400 volts and triac ratings of 200 & 400 volts are available in each family. Stud packages & isolated-stud packages are also available in each rating.

For further details and your copy of the latest thyristor catalog, THC-500, see your local RCA Representative or your RCA Distributor. Or write RCA Electronic Components, Commercial Engineering Section 59H/UR6, Harrison, N.J. 07029. International: RCA, 2-4 rue du Lièvre, 1227 Geneva, Switzerland, or Post Office Box 112, Hong Kong.

RCA
Thyristors

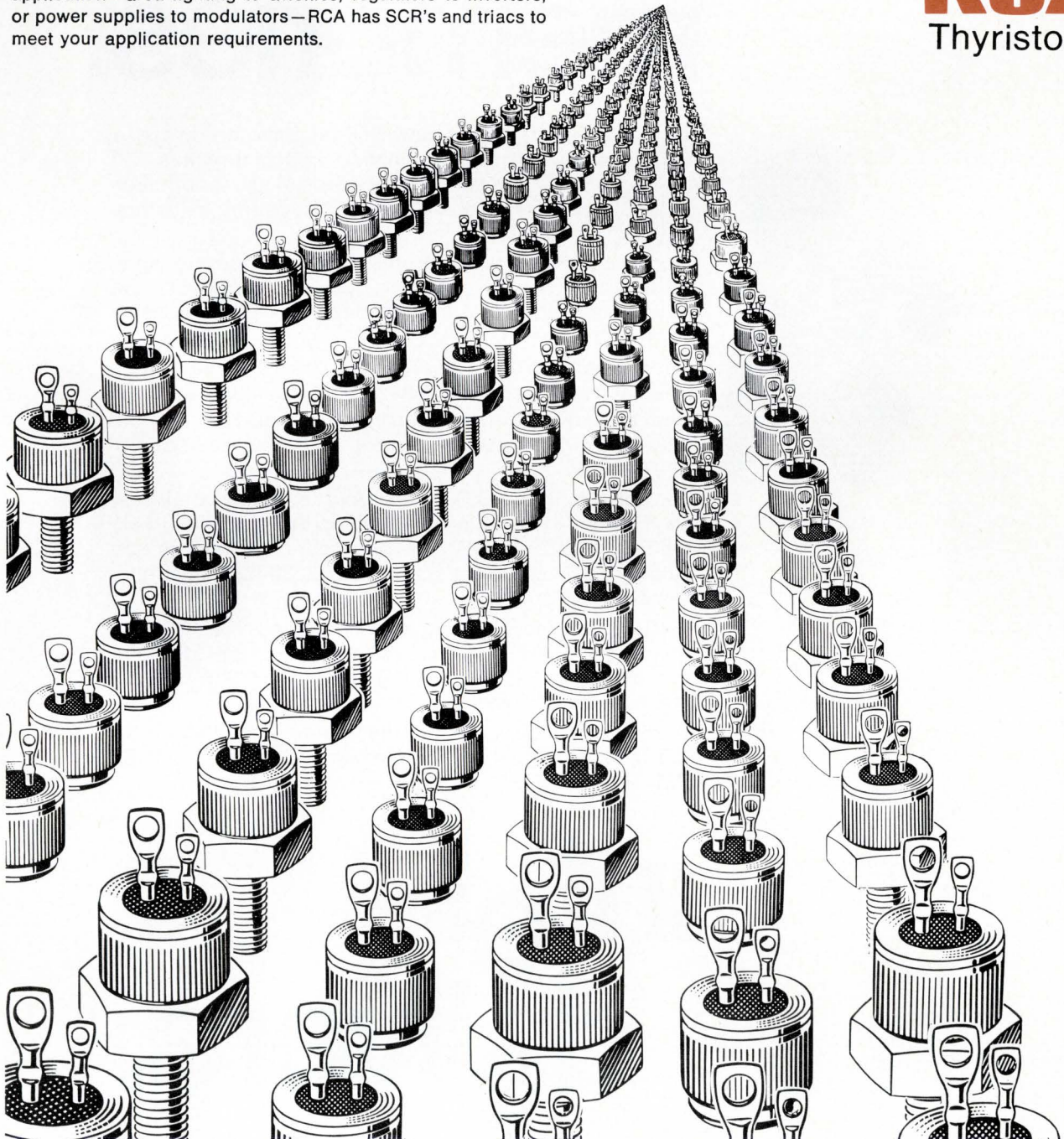

Big bipolar RAM makes fast main-frame memories.

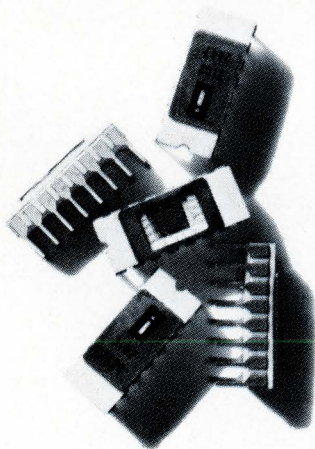

Now in stock is Intel's new 256-bit Schottky process RAM. Used with our companion decoder, it makes 120 ns memories storing up to 4096 words of any length. For example, 512 memory units plus 32 decoders will store 4096 32-bit words.

Such memories are TTL compatible and operate without need for further decoding circuitry. Moreover, low power dissipation ($1\frac{1}{2}$ mW per bit) permits high-density packing.

The memory unit, Type 3102, has a 256 x 1 organization. The decoder, Type 3202, has four chip-select inputs.

Both units draw only 0.25 ma input load current, exhibit only 40 μ a input leakage current, and are supplied in a 16-lead DIP.

For delivery in the U.S. phone your local Intel distributor: Cramer Electronics or Hamilton Electro Sales. Ask for Types 3102 and 3202. If your local distributor is not stocked, call us collect at (415) 961-8080 for immediate same-day shipment.

In Europe contact Intel at Avenue Louise 216, B 1050, Bruxelles, Belgium. Phone 492003. In Japan contact Nippon IC, Inc., Sanko-Cho Bldg., No. 53 Sanko-Cho, Shinjuku-Ku, Tokyo 160.

Intel Corporation is now in high-volume production at 365 Middlefield Rd., Mountain View, California 94040. TWX 910-379-6476.

intelTM
delivers.

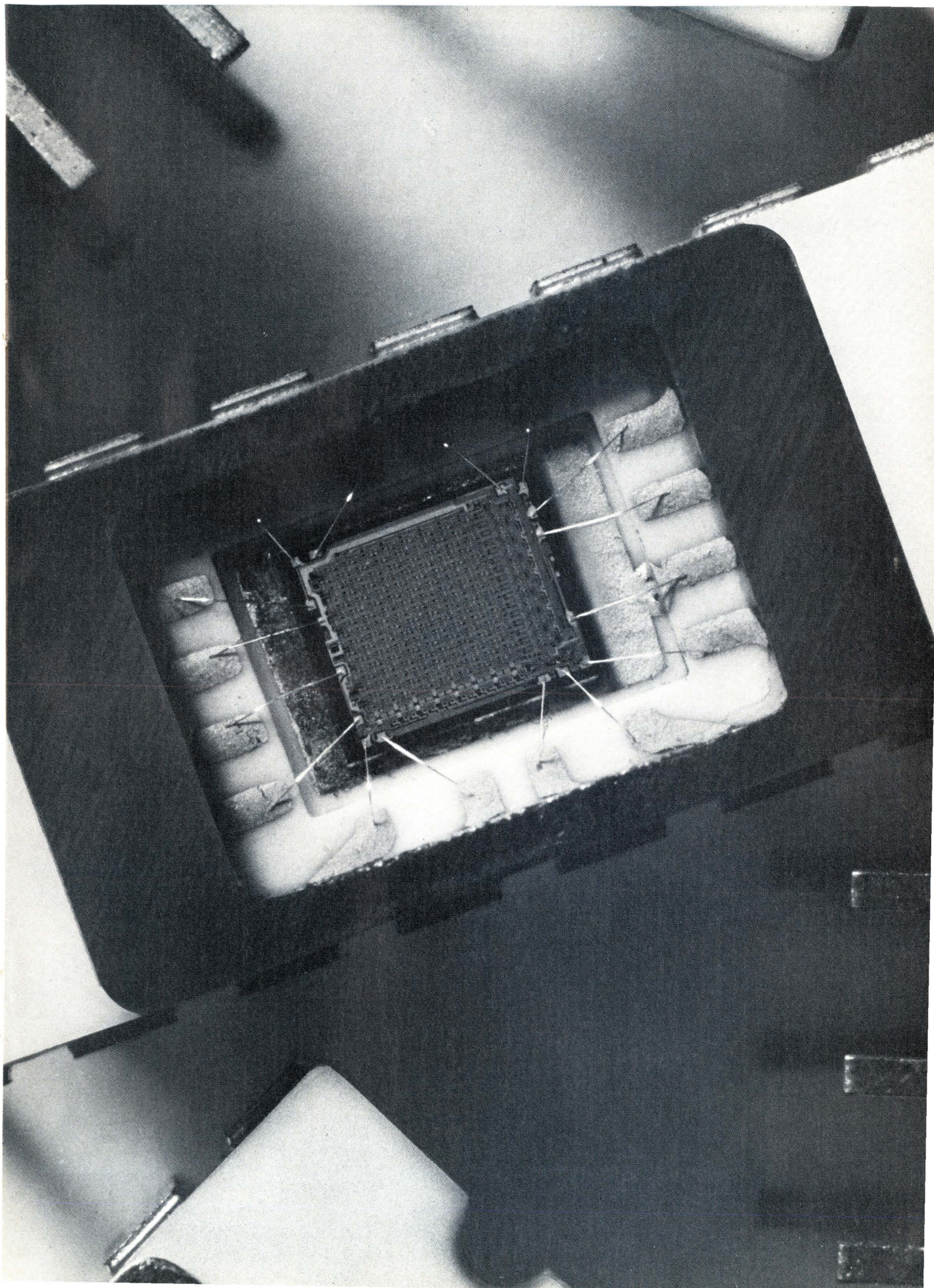

IT HAPPENED LAST MONTH . . .

The editors of THE ELECTRONIC ENGINEER have sifted through the various technical and significant happenings of the past month and selected the items that would be of the most interest or use to you.

Technological balance of payments . . . An important element of our overall international balance of payments is what is termed "technological balance of payments." This term means that we receive money for technical know-how and patent royalties, for example, from foreign countries. Apparently, the U.S. is receiving roughly ten times as much in technological payments from abroad as it pays out. According to Rocco C. Sicilano, Under Secretary of Commerce, we received about one-half billion dollars in 1961, and more than one billion dollars in 1968.

IC failures . . . What percentage of your purchased ICs fail? Semiconductor Specialists, Inc., Chicago, Ill., say they have tested several types, finding 2 to 6% failures right from the box. An English component and reliability engineer says that he has an average 3.5% failure of ICs with all manufacturers. The reasons for the failures do not seem to be well known—some component engineers believe that IC manufacturers' automatic testers might either mis-sort or mis-test devices. Others feel that the vibrations of shipping and handling are enough to break the weak bonds, and of course the human error exists forever, even with the best manufacturer. Semiconductor specialists suggest incoming testing of all ICs, either in your own home or by an independent testing service.

Laser spots wake turbulence . . . Under test at the NASA-Marshall Space Flight Center is a system that uses laser techniques to detect and measure the velocity and range of an aircraft's invisible wake. Characteristics of the wake are determined by a Doppler shift of laser light. As far as we know it is the only optical method to measure atmospheric wind velocity directly. There is much interest in the wake turbulence because the swirling motions created in the air behind an airplane can and often do cause severe disturbances to following aircraft.

Wire this combination . . . Copper clad steel wire has been with us for many years. Now, General Cable Corp. has come up with something new. It's a copper-aluminum wire, made with a copper wire bonded metallurgically to an aluminum core. And it's their answer to the critical copper shortage we're experiencing. The rod from which the wire is processed is supplied by Texas Instruments, Metallurgical Materials Division, Attleboro, Mass.

Increased foreign competition . . . Toshiba America, Inc., recently displayed 63 home entertainment products in Los Angeles, marking the inauguration of a vigorous sales drive in California. Integrated circuitry, ceramic filters, and FETs

were among the sophisticated features brought into consumer products. The first foreign-made remote-operation TV was introduced. The products are backed up by substantial advertising, an improved service network, a prepaid freight program, price protection, and other incentives to improve dealers' sales and profits.

More reliable power semiconductors? . . . Because of the extended operating life of many of today's systems, RCA plans to provide a thermal cycle rating chart for all of its semiconductor power devices. When equipment is alternately switched on and off and the devices cycle between their operating temperature and ambient temperature, unrelieved thermal stresses build up between the silicon pellet and its mounting surface. These stresses cause a gradual separation of the two, resulting in an increase in the thermal resistance of the device, and finally its failure. RCA's rating chart will show the number of thermal cycles a device will withstand over various temperature excursions. Company officials hope to have this data on all spec sheets within six months. They also plan to propose it as an industry standard.

Semiconductor group . . . Dr. William Hogle (Hogle Industries) and Frederick Kulicke (Kulicke and Soffa) are spearheading the formation of a trade organization exclusively for semiconductor-related firms. The investment in exhibits at the big shows (IEEE, WESCON, NEPCON, and so forth) is very big, but the return is very small. So a main concern of the "Semiconductor Equipment and Materials Institute," as it is called, is an annual semiconductor trade show. To bring strength to this show, an Institute member who wishes to exhibit will not be allowed to show his semiconductor-related wares elsewhere.

Cross-licensed . . . Advanced Memory Systems, Sunnyvale, Calif. and IBM have entered into a cross-licensing agreement. Although to date there have been no infringements by either party, the IC and memory area is rather delicate in this regard. IBM, of course, holds many patents in many areas. To avoid any problems, AMS approached IBM as a protective measure. And, although the Sunnyvale firm now has access to IBM patents, no definite agreement has been planned along these lines, as far as we can determine.

More automation . . . The National Association of Broadcasters has approved the organization of a subcommittee to work with manufacturers of broadcast equipment in order to develop automatic transmitters which use computer techniques.

CENTIGRID*

The Low Profile .100 Grid Relay

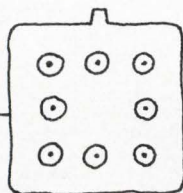

Packaging and Production Engineers please note:

CENTIGRID* Series 112 Relay's 8 leads, spaced on 0.100 centers — all on the periphery of the header — permit direct plug-in convenience on all PC boards. This relay won't be the highest component on the board. It's only .225 high, thereby minimizing board spacing. It's only .370 per side.

Design and Circuit Engineers please note: The CENTIGRID* has the same performance as our TO-5 relays. Coil voltages, in 6 choices, range from 5 to 26.5 VDC.

Using CENTIGRID* Series 112 relays permits compliance to Mil Std. 275B and Mil-P-55110A circuit board specifications without complicated lead spreading.

Space-wise Engineers please note: Ease of installation and inspection makes CENTIGRID* the perfect answer to any packaging density problem.

*TM App.

We're not complacent. We're relay innovators. We built the first relay with single or double diodes for polarity reversal protection.

The first relay with coil transients suppression, and an internal transistor driver. We added internal diode chips for built-in arc suppression, combined it with the internal transistor driver, and made it double as a transapad. That's our TO-5 relay. We built it from the leads up!

And now: CENTIGRID* . . . another big breakthrough from the "little relay people." All the problem-solving low-down is yours for the asking. Simply write or call:

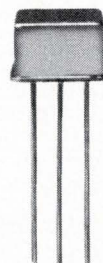

TELEDYNE RELAYS

3155 West El Segundo Boulevard, Hawthorne, California 90250 • Telephone (213) 679-2205

Is it a battery or a capacitor?

This new component fills the middle ground between capacitors and rechargeable batteries.

Stephen A. Thompson, Western Editor—Los Angeles

A new component, the energy storage device (ESD), is being marketed by Gould Ionics of Canoga Park, Calif. To give you a frame of reference, we will compare the ESD capacitors and batteries, though it is neither. The table compares its characteristics to common capacitor types.

Electrolyte is key

Based upon the highly conductive solid electrolyte, RbAg_4I_5 , ESD conductivity is due to silver ion mobility in a crystal lattice. While the ionic conductivity of $0.27(\Omega\text{-cm})^{-1}$ is comparable to that of aqueous electrolytes, (example, 30% KOH is $0.7(\Omega\text{-cm})^{-1}$, the electronic conductivity is less than $10^{-11}(\Omega\text{-cm})^{-1}$.

As a battery

Normally, the electrical conductivity of a battery's material is responsible for its self-discharge which, in turn, limits shelf life. The extremely low electronic conductivity of the ESD extends shelf life to 10 years. This suggests long term, low power applications, such as power supplies for cardiac pacemakers.

A mercury battery the same size as an ESD would have a capacity three times greater, because its conductivity is three times higher. The mercury cell would operate at 1.35 V and the ESD at 0.5 V, but after two years, the ESD would surpass the mercury cell in deliverable capacity. Because of the outstand-

ing low temperature qualities of RbAg_4I_5 , the ESD delivers 90% of its room temperature capacity at -65°F , where a mercury cell is worthless. Its full temperature range extends from -65°F to 350°F .

As a capacitor

High-capacity density and minimal leakage distinguish the ESD from standard capacitors. It can be viewed as an energy storage capacitor retaining 97% of its charge after one year. RC timing applications are possible in which the time interval extends from 10 seconds to several years and at accuracies of

(continued on page 14)

A 50-F ESD is shown above the ruler. A typical application is long term sample and hold, as illustrated by the circuit.

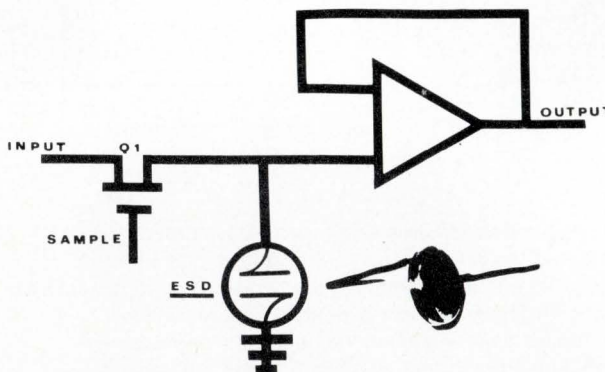

Comparison of the ESD with standard capacitor types

Capacitor Type	Rated Voltage	F/in. ³	C/in. ³	J/in. ³
ESD (single cell)	0.5	160	80	20
ESD (10 cells in series)	5	2.2	11.2	28
Aluminum	5	8.9×10^{-3}	4.4×10^{-2}	0.11
Tantalum (wet slug)	6	5.5×10^{-3}	3.3×10^{-2}	0.10
Tantalum (solid)	6	5.0×10^{-3}	3.0×10^{-2}	0.09
Ceramic	1000	1.6×10^{-6}	1.6×10^{-3}	0.8

ESC Introduces ... The Dual In-line LC Filter Series - compatible with integrated circuit boards

To meet the demand for a standard miniature filter, ESC has designed and developed the DIF[®] (Dual In-line Filter) series. DIF filters are passive, stable networks that fit any commercial dual in-line connector or hole spacing. They meet the requirements of MIL-F-18327C, grade 5, class R operating temperature range of -55°C to $+105^{\circ}\text{C}$.

In addition to the standard DIF filters shown here, other characteristics can be custom designed to your specifications in this case size e.g. linear phase, band pass, telemetering filters.

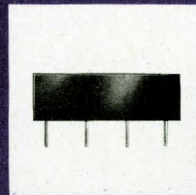

.76" L x .46" W x .25" H

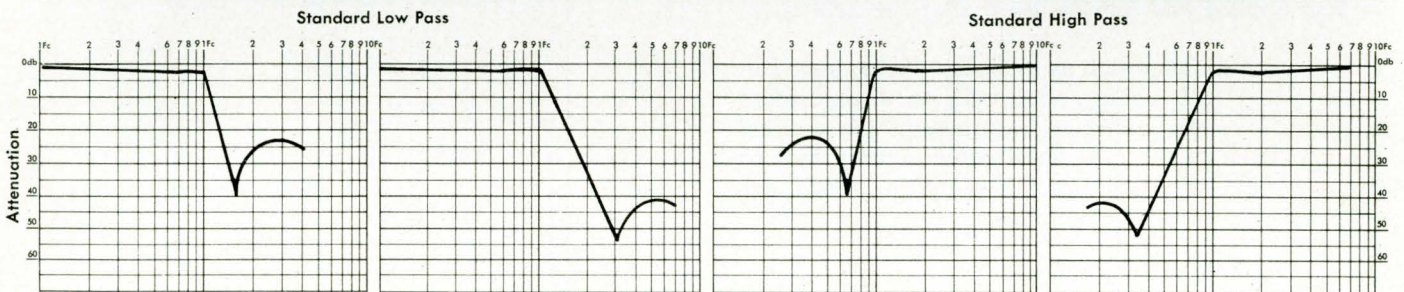

Type	DIF-L20 Series	DIF-L39 Series	DIF-H20 Series	DIF-H39 Series
Insertion Loss	.5 db maximum at .1Fc		.5 db maximum at 10Fc	
Ripple	Less than ± 1 db in passband			
Attenuation in stopband	20 db minimum at 1.4 Fc & higher	39 db minimum at 2.5 Fc & higher	20 db minimum at .715 Fc & lower	39 db minimum at .4Fc & lower

Other LC Filters designed by ESC include:

- Low Pass • High Pass • Band Pass • Single Sideband • RFI • Telephone Line Simulators
- Miniature • Printed Circuit • Audio • Mobile Communications • Telemetering
- Special Applications — all to MIL-F-18327

Write today for your copy of ESC's DIF Filter brochure.



534 Bergen Boulevard, Palisades Park, N. J. 07650 • (201) 947-0400
 World's Leading Designer and Producer of Delay Lines
 a division of General Laboratory Associates
 a Simmonds Precision subsidiary

This may be only a memory

While the prime application of the new transparent ceramic is in computer memories, the material can be used for multi-colored displays.

About three years ago, Sandia Labs. discovered that electro-optic ceramics could be used for high-density memories and in displaying rapidly changing black and white or color images. During their early development, however, those ceramic suffered from poor transparency, relatively low black-white contrast, and difficulty in producing the colors blue and violet.

A new ceramic, lead zirconate-lead titanate mixed with about 4% by weight of lanthanum, provides good black-white contrast, produces a wide range of colors at low switching voltages, and makes it possible to store ten detectable shades of grey.

A thin slice (up to 0.25 mm thick) of ceramic, with an array of electrodes vapor-deposited on its surface, is sandwiched between two crossed polarizers. By applying an electrical field between the electrodes, this structure has an optical effect on the light passing through it. For example, it can pass just one color while absorbing all others, or it can vary its brightness. This optical effect depends on the field applied and remains even after the field is removed.

To use the sandwich as a display, the ceramic can be plated with enough electrodes to display more than 500 dotted lines of information per vertical inch. Each of the 500 lines would contain 500 or more dots. For computer applications, each dot

would represent a bit of information. Or by varying the shades of grey, the dots could be coded to represent the digits 0 to 9. Although there is a certain amount of cross-talk between adjacent cells, it will probably impair memory applications only slightly because cross-talk is limited to a small area. This cross-talk apparently occurs because electrical linkages within the ceramic cause an unwanted spread of birefringence.

Color filters are one application of the transparent ferroelectric ceramic. While many colors are contained in the white light source, only one is passed through the analyzer. By a sequence of voltage pulses to the ceramic plate, the polarization of the passing light is adjusted, so the analyzer permits only the selected color to pass through and all others are blocked.

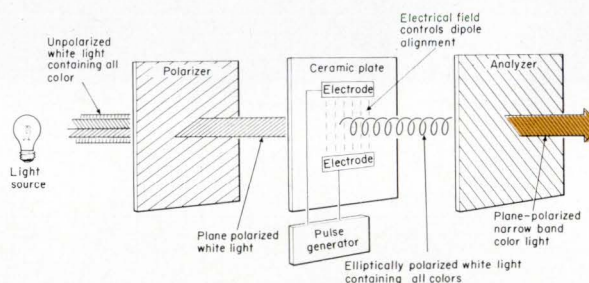

Battery or capacitor (cont'd)

(continued from page 12)

$\pm 1\%$. Other applications include extremely long term sample and hold circuits, standby computer power, and other areas requiring high energy, low power, pulse capability over a wide temperature range.

Ac applications are less attractive than dc, because of the large dispersion of the capacitance with frequency. At 20 Hz the capacity decreases about two orders of magnitude.

The ESD electrolyte can be screened on to substrates to make thick-film capacitors. A 250 mil square is about 100 μF . The drawback is its high internal resistance of about 100,000 ohms. Gould believes this can be lowered substantially, but cir-

cuits indifferent to this parameter will find it useful now.

The ESD can be made in almost any form, and devices in the range of 0.01-50 F are available. In unit quantities they cost \$30.00, and in volume the price drops to between \$1.00 and \$3.00. For more information, contact Gould Ionics Inc., P. O. Box 1377, Canoga Park, Calif. 91304 or
Circle 297 on Inquiry Card

INFORMATION RETRIEVAL

Passive components, Materials,
 Circuit design, Power supplies.

In less than one second

you've got it wired

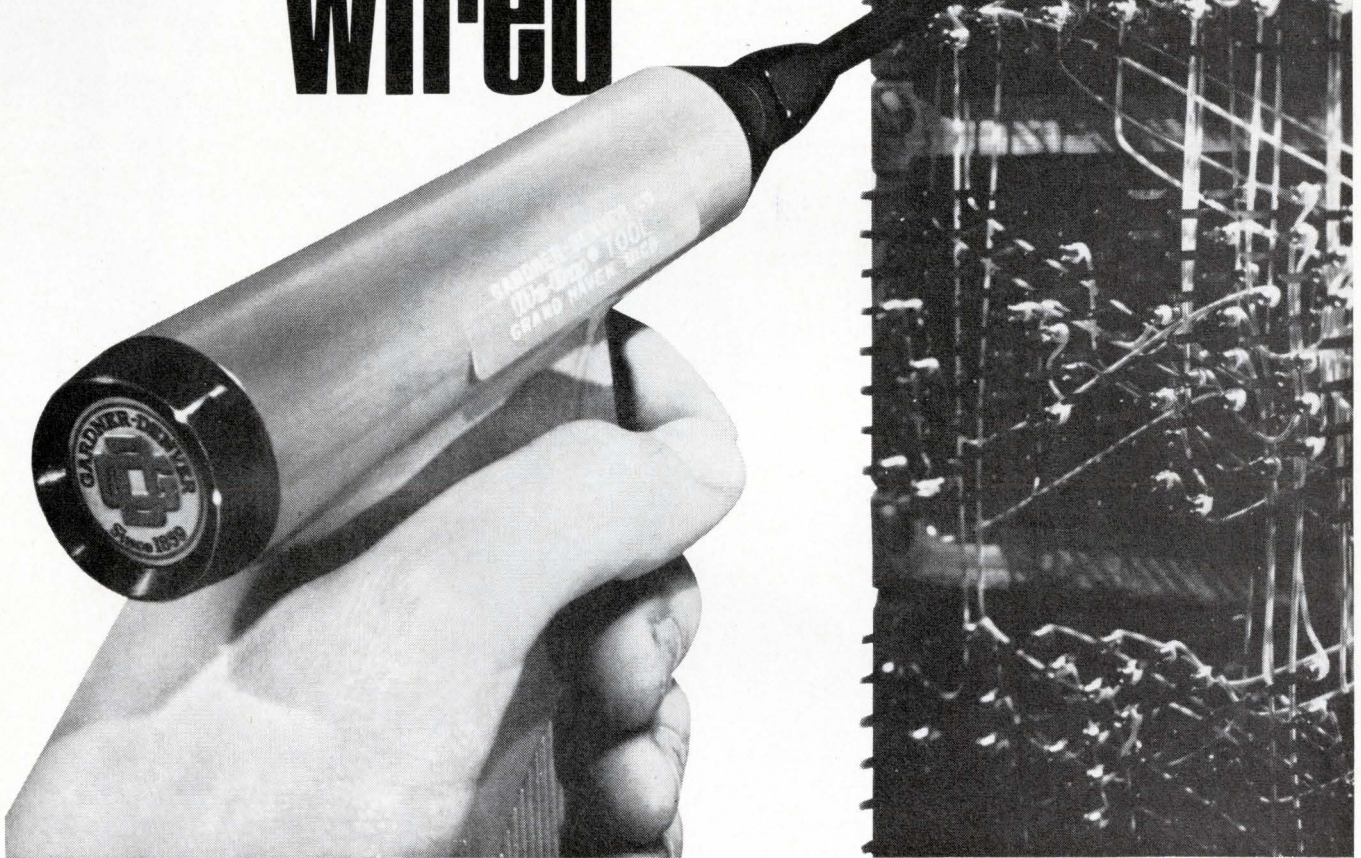

Permanent gas-tight electrical connections with Gardner-Denver *Wire-Wrap** tools

These light, quiet air tools wrap wires at a high rate of speed for solderless connections that are permanent, gas-tight, and reliable. Model 14XL1 weighs 13½ ounces, takes bits and sleeves for 20 through 32 gauge wire.

Pneumatic Wire-Wrap tools have pistol grip or

straight handles. Or you may prefer our electric-powered models. Or the model with rechargeable battery. Manual wrapping and unwrapping tools are available for service kits. Bulletin 14-1 describes them all. Write for your copy today.

GARDNER-DENVER

Gardner-Denver Company, Quincy, Illinois 62301

**Wire-Wrap* is a registered Trademark of Gardner-Denver Company



Need rugged and compact switching for your circuitry?

The CTS Answer Man offers a new Miniature Selector Switch.

CTS Series 223 Selector Switch gives you what you need: longevity and space-saving size. Designed for industrial and military control circuits, the 223 Series offers a rotational life of 100,000 cycles (through 12 positions) and return at 10 cycles per minute. Meets MIL-S-3786C (Style SR05) specs. Size? A mere 1" in diameter. Fully interchangeable. You'll like both price and delivery.

The CTS Answer Man is your man at CTS. He's more than a salesman — he'll quarterback your product requirement through the multi-resources of CTS. At his fingertips: broad production facilities, the latest technologies, plus years of switching experience. You can bet he'll come up with an answer every bit as good as our selector switch.

Trimmers. Potentiometers. Selector switches. Crystal products. Thick-film hybrid circuits. Cermet resistor modules. Loudspeakers. CTS makes them all in 10 U.S. and 8 foreign plants. And the CTS Answer Man stands ready to fit them to your application. To learn more, write:

CTS CORPORATION
Elkhart, Indiana



Circle 13 on Inquiry Card



FOREFRONT

The EE Forefront is a graphical representation of the practical state of the art. You will find here the most advanced components and instruments in their class, classified by the parameter in which they excel.

A word of caution

Keep in mind the tradeoffs, since any parameter can

be improved at the expense of others. If there is no figure-of-merit available, we either include other significant parameters of the same products, or we provide additional bar graphs for the same products.

Do not use these charts to specify. Get complete specifications first, directly from the manufacturers.

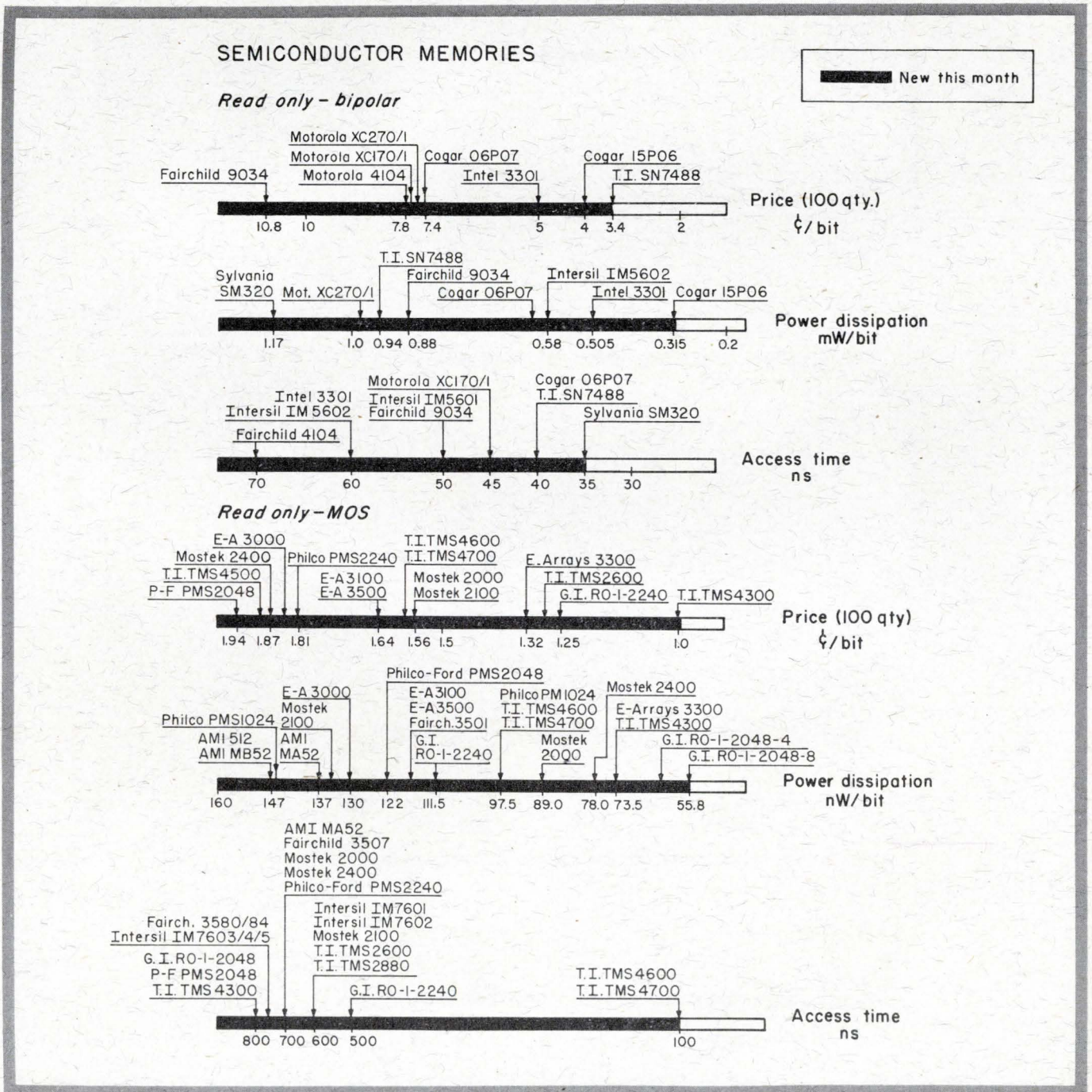

SEMICONDUCTOR MEMORIES

■ New this month

Random access - bipolar

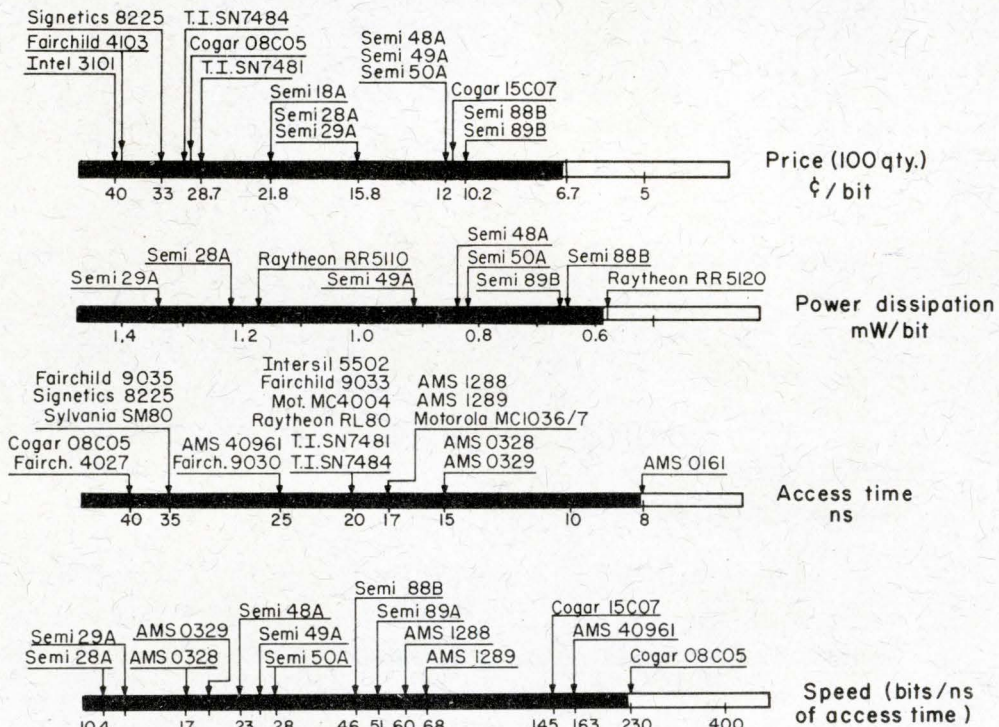

Random access - MOS

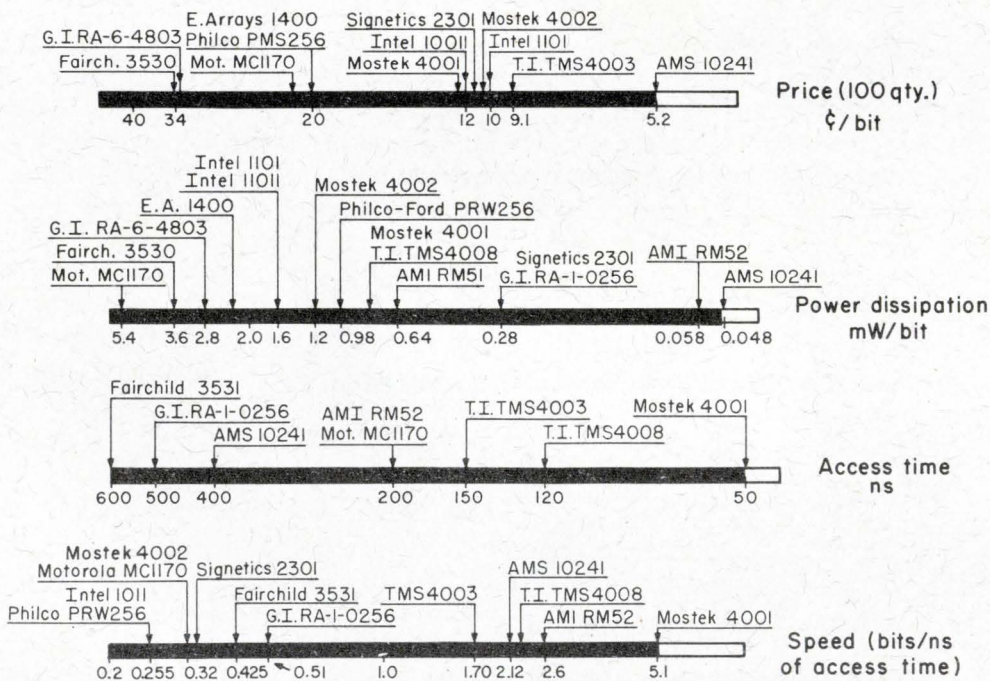



Let there be light

Optoelectronics is on the move.

In card and tape readers. In star trackers. In computer peripherals and light-actuated switching. In spectrophotometry and burglar alarms. In optical logic drives, shaft encoders and movie projectors. In test and inspection equipment. In visual displays and autos and home appliances. In just about everything.

The day is even seen when optoelectronics may give us the much-talked about picture-frame or flat-screen TV receiver where thousands of multi-colored LED's are excited by many sets of lines driven by integrated circuits.

Opto offers a degree of control not possible through other methods. It is virtually "the perfect switch." It has the speed of light. It furnishes sensitivity acute enough to detect infrared and ultraviolet luminance. It has no moving parts and life expectancy is in excess of 100 years. Its prices are down to a universally-desirable, dollar-and-less range.

You may interface with optoelectronics sooner than you think.

So you're prepared for what's coming, we've prepared a special, basic design guide containing application notes, selector and cross-reference lists, data sheets and where-to-get-it-now information. You'll find out about theory and characteristics of photodevices, static and dynamic conditions, switching parameters, geometric considerations, area sources and lens systems, fiber optics and applications, definitions (like Nits, Luxes and Candelas) plus several circuits suited to dc, low and high-frequency applications.

And, if you're looking for complete data on the best devices to evaluate and design in, complete specs on the bright new introductions on the next page, as well as Motorola's complete capability in emitters, detectors and arrays, will be included to help show you the way.

Send to Box 20912, Phoenix 85036 for our "Let There Be Light" brochure. It's a good start.

**Begin with
Motorola Optoelectronics**

Your light source... Optoelectronics from Motorola

Light Emitters

Compactness, reliability and compatibility with integrated circuits keynote light-emitting diode advantages — as well as perfect spectral-matching of IR units to

silicon detectors. Six Motorola red and infrared, fast-switching types now offer flexibility in package, performance — and price!



LED BRIGHTNESS/POWER OUTPUT vs FORWARD CURRENT

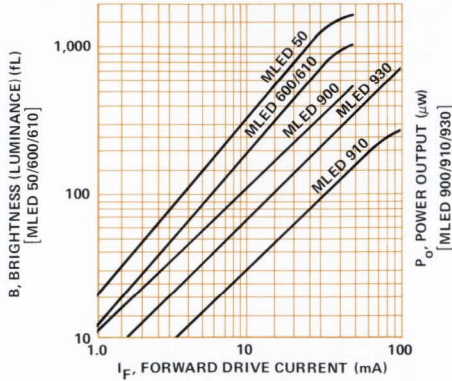

LED	Color	Application Advantage	Package	Peak Emission Wavelength λ	Brightness (typ.)	Price 100-up
MLED50	Red	Tiny, Bright, Plastic Performer	Plastic Micro-T	6,600	750 fl @ 20 mA	\$1.50
MLED610	Red	High Density Reliability	Pill	6,600	450 fl @ 20 mA	\$2.60
MLED600	Red	Fast, Low-cost, Visibility	Plastic Mini-T	6,600	450 fl @ 20 mA	\$1.95
MLED900	IR	Economical Power Output	Plastic Mini-T	9,000	550 μ w @ 50 mA	\$1.50
MLED910	IR	Direct, PC Board Matrix Assembly	Pill	9,000	150 μ w @ 50 mA	\$2.40
MLED930	IR	Rugged Match for Any Detector	TO-18	9,000	650 μ w @ 100 mA	\$3.30



Light Detectors

Control light-to-current flow with 23 different diodes, PIN's, transistors and Darlington's for optimized optical performance in dc to high-frequency designs. Sensitive, fast and rugged, Motorola detectors are 100-up-priced low as 80¢ in metal hermetic packages!

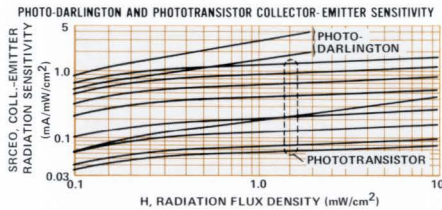

Detector	Type	Application Advantage	Package	Sensitivity mA/mW/cm²	Dark Current (max) nA	Switch Time = $t_r + t_f$ μ s	Price 100-up
MRD100	Transistor	Smooth, Clean Arrays/ Matrices	Plastic Micro-T	0.04 (min)	100	6.5	\$1.00 \$.80
MRD200	Transistor	2 Subminiature Lenses, Multiple Sensitivities	Pill	0.25 (min)	25	6.5	\$2.60
MRD210	Transistor			0.05 (min)			\$2.30
MRD250	Transistor			0.1 (min)			\$2.40
MRD600	Transistor			0.04 (min)			\$2.10
MRD300	Transistor	Control Flexibility, Annular Reliability	TO-18	0.8 (min)	25	6.5	\$7.00
MRD310	Transistor			0.2 (min)			\$3.00
MRD450	Transistor	Uniform Sensitivity through Unique Lens	Plastic Mini-T	0.2 (min)	100	6.5	\$.75
MRD500	PIN Diodes	Fast, Low-Light Reaction	TO-18	1.2 (min)†	2	1 ns (typ)	\$7.25
MRD510				0.3 (min)†			\$6.60
MRD810	Transistor	Optimum Optical Performance	TO-18	0.2 (min)	50	11	\$4.00
MRD3050	Transistor	Plastic-Priced Metal Package	TO-18	.02 (min)	100	5.5 (typ)	\$.80
MRD3051	Transistor			.04 (min)			\$.90
MRD3052	Transistor			.02 to .08			\$1.20
MRD3053	Transistor			.05 to 0.2			\$1.20
MRD3054	Transistor			.125 to 0.5			\$1.30
MRD3055	Transistor			.3 (min)			\$1.40
MRD3056	Transistor			.4 (min)			\$1.60
2N5777	Darlington Amplifiers	Ultra-High Sensitivity, 5,000 h_{FE}	Clear Plastic Unibloc	2.0 (typ)	100	400	\$.50
2N5778				2.0 (typ)			\$.55
2N5779				4.0 (typ)			\$.70
2N5780				4.0 (typ)			\$.80
MRD14B				1.0 (typ)			\$.40

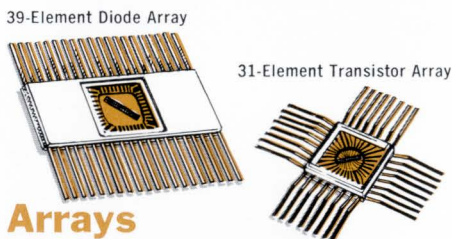

Arrays

The challenges in character recognition are rapidly being met with the introduction of the industry's first standard, 39-element monolithic diode array in a ceramic flat-pack plus a new transistor array with 5-mil spaced elements... as well as Motorola's recognized leadership in customizing individual requirements. Cost-cutting, finished packaging and optimized performance matching are the advantages when you go "the Motorola array way" for your OCR applications!

LED/DETECTOR SPECTRAL MATCHING CHARACTERISTICS

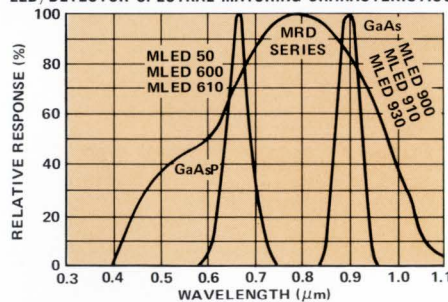

100-Element, 1.4" Custom Diode Array

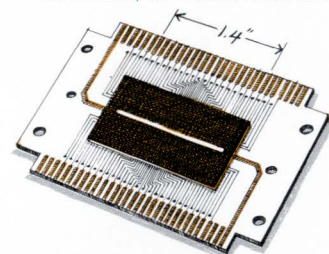

Array	Type	Application Advantage	Package	Sensitivity @ $H = 5mW/cm^2$ nA/mW/cm² (min.)	Dark Current (max) nA	Price 100-up
MRD6039D	39-Element Diode	State-Of-The-Art Resolution	(Ceramic Flat-Pack)	14	2	\$100.00
MRD6039T	39-Element Transistor	Super-Sensitivity in a Standard Package	(Ceramic Flat-Pack)	300	10	\$116.50

*Trademark Motorola Inc.

BAY SOUNDINGS

There's a new trade organization about to be born. Acting as midwives are Dr. William Hugel, president of Hugel Industries, and Frederick Kulicke, president of Kulicke & Soffa Industries.

The group is tentatively named the Semiconductor Equipment and Materials Institute—SEMI, for short. And it will be a focal point for the entire semiconductor industry, both manufacturers and users.

As you've probably noticed, the semiconductor industry people have been dropping out of the major trade shows. Their complaint is that such shows are not a cost-effective way to show their wares.

Further, they draw too large a cross-section of the electronics industry. That is, only a small portion of the typical trade show's attendees represent a good audience from the point of view of the semiconductor materials suppliers and equipment manufacturers.

For these reasons SEMI's prime goal is to have one trade show each year, alternating between the East and West Coasts. And this show would be *the* show for those of us interested in what's happening in the semiconductor industry.

Now, members of SEMI must agree not to show their semiconductor-related supplies and equipment at any other show. Further, SEMI's show exhibitors would be restricted to SEMI members. So such a show once a year would give equal time, in effect, to all semiconductor-related firms, whether large or small.

The second aim of SEMI is to foster a good relationship between the semiconductor industry and the Federal Government.

In Western Europe, the business is there, but many in the industry feel that we tend to get lost in their vast technical fairs. To combat this, SEMI hopes to have one European show each year. And in Asia, there are possibilities for a show in Japan, and another for the Hong Kong-Singapore axis.

The first meeting of SEMI—the organizational meeting—was held at the end of June. It was well attended, and the audience represented an excellent cross-section of semiconductor-related firms. At this meeting, it was announced that SEMI intends to hold its first show in the last quarter of this year, in the Bay Area.

Sheldon Edelman
Western Editor—San Francisco

If it's pulser programmability you're after, it's right here, right now.

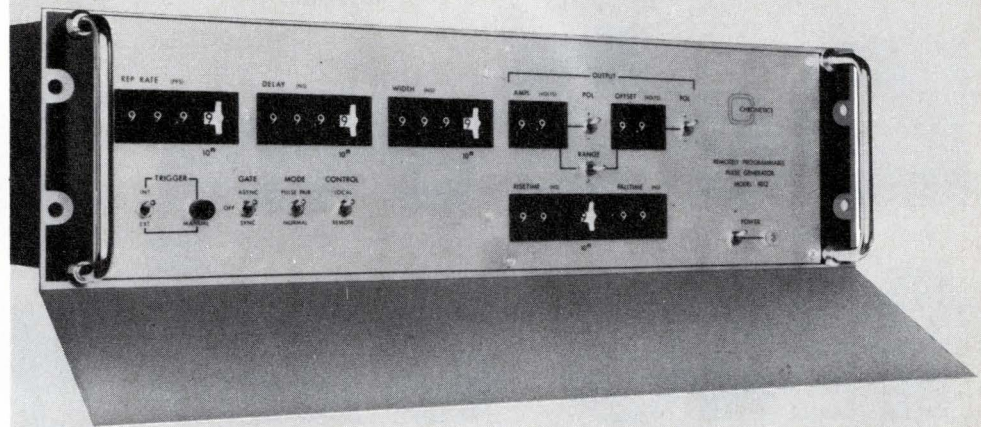

Chronetics' Model 1012. Full digital programmability. Simple current sinking DTL, TTL compatible logic. All parameters programmable. All parameters.

Rep rate to 20 MHz; Risettime 5 ns to 10 ms, typically 3.5 ns at 10 volts into 50 ohms. Amplitude $\pm 10V$ ($\pm 20V$ open circuit); option $\pm 15V$ ($\pm 30V$ into high impedance, e.g., MOS). Offset $\pm 10V$ independent of output polarity, into 50 ohms. Source impedance, 50 ohms.

In stock.

From \$3250*

Model 1012. From Chronetics. The **only** fully programmable, digitally controlled pulser now available. And its wide acceptance proves it.

You can have an evaluation pulser in your lab, at once, on request. Please request. Put it on your program.

Model 1012—only one of a very complete line of Chronetics' pulsers.

Write now for new Applications Bulletin: Automatic Dynamic Test Systems.

*Model 1012R; \$4000. with manual digital override or local control.

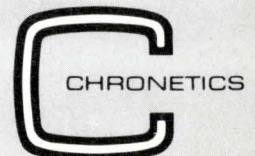

U.S.A.: 500 Nuber Avenue, Mt. Vernon, New York (914) 699-4400 TWX 710 560 0014
Europe: 39 Rue Rothschild, Geneva, Switzerland (022) 31 81 80 TELEX 22266

Circle 15 on Inquiry Card →

National TTL/MSI tha

Delivery isn' the only rea

Say good-bye to slow bus systems. National is introducing Tri-State logic. A first-of-its kind family of TTL devices specifically designed to speed up bus-organized digital systems.

Tri-State logic allows you to work with fewer packages and without external open collector gates.

Our first off-the-shelf product in this new family is the DM8551 bus or-able quad D flip-flop. A unique device that lets you connect outputs of many circuits to a common bus line.

The DM8551 is organized as four D-type flip-flops operating from a common clock. The outputs are normal low-impedance, high-drive TTL types. Up to 128 can be tied together because, unlike other TTLs, the DM8551 can be gated into a state where both the

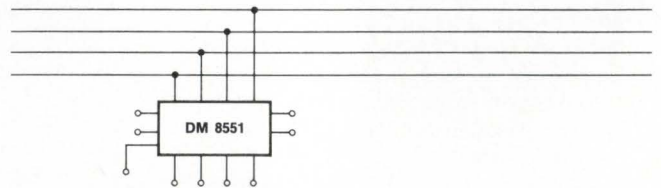

TRI-STATE BUS SYSTEM

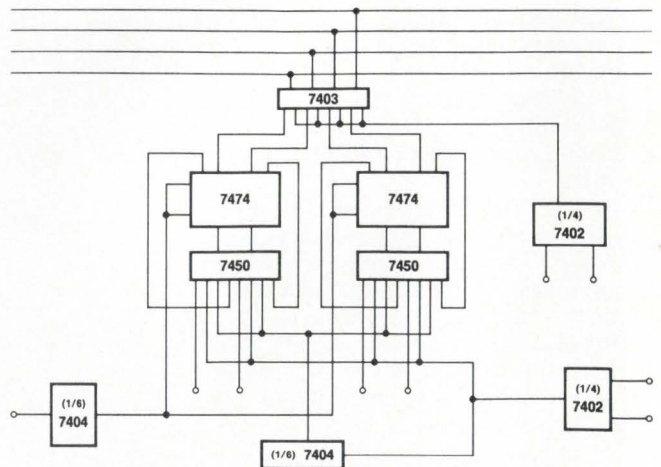

STANDARD BUS SYSTEM

sells more n Fairchild.

t son:

upper and lower output transistors are OFF. The output, therefore, appears as a high impedance. It neither delivers current nor demands significant current from the outputs to which it is connected. You get the economy of bus connection without losing output waveform integrity.

The DM8551 design eliminates the false clock-signal problem usually associated with D-type flip-flops. Internal data input disable lines feed the Q output back into the D input so there's no change of state during clocking.

Output disable lines are used for gating into the OFF state. NOR gate logic was chosen for this function since it is possible to select up to 128 DM8551s with only two BCD-to-Decimal decoders (DM8842s). You get

maximum decoding capability at minimum cost.

In addition to the DM8551, we're also introducing the DM8230 Tri-State Data Flow Gate for signal routing and the DM8831 Tri-State Party Line Driver for multiple signal driving. (They're also available off-the-shelf.)

Of course, Tri-State logic is only one reason National sells so many TTL/MSI circuits. Call any National distributor for prices and specs on twenty-seven other reasons.

National Semiconductor Corporation
2900 Semiconductor Drive, Santa Clara,
California 95051 / Phone (408) 732-5000
TWX (910) 339-9240

National

WESCON— keeping up with the times

The big West Coast show with three separate rings will have some strong technical sessions, fewer exhibitors, and more foreign acts.

Stephen A. Thompson, Western Editor—Los Angeles

Although exhibits are off about 10% from last year, WESCON keeps evolving. Some 580 exhibitors are expected to put on a 1030 booth show, and several trends are evident.

Visitors from abroad

There will be 73 foreign exhibitors: 29 from the United Kingdom, 14 each from Canada and Japan, 12 from Australia, and 4 from Finland. Notable domestic additions are AT&T, XDS, and Computer Sciences. The most significant drop-out is Hewlett-Packard, which will exhibit components but not instruments.

Reunification in 1972

This is the last split show in Los Angeles. In 1972, WESCON has been booked into the Los Angeles Convention Center, now under construction, that will handle both the technical sessions and exhibits. However, for this year the 27 technical sessions will be held in close proximity to the show. Twenty are scheduled for the Museum of Science and Industry, which is adjacent to the Sports Arena. They break down into five management, six component and manufacturing, six instrumentation and microwave, and three communications systems sessions. The seven computer sessions will be held at Hollywood Park, where the computer-oriented exhibits are located.

The WESCON sessions are listed in the table. The ones that look especially interesting are outlined in color. Two of these merit special note. Session 7, on LSI Memories, could be a hot one. Intel's silicon gate and Macrodata's design philosophy will be aired. Ion

implantation and multichip beam lead technology will also be discussed. In addition, the format includes invited speakers offering rebuttals from the floor, not to exceed five minutes. For instance, Dr. Hans Dill, who has a basic patent pending on the silicon gate manufacturing process, will defend ion-implanted MOS memories against the silicon gate. Cheers!

Session D is concerned with programmable calculators. The noteworthy point here is that several units are expected to be available at the session for engineers to play with.

Engineering goes public

A special WESCON blue-ribbon symposium on "Applying Technology to Public Problems" is being held on August 26th and 27th. It will focus on the problems, opportunities, and limitations of relating technological programs to the solution of pressing public problems.

The list of participants is impressive, even at this early filing date. The Keynote Session will feature Lester Hogan of Fairchild Camera & Instrument, Dr. Bert Klein of Cal Tech, Max Palevsky of XDS, and an unnamed speaker from the Department of Health, Education and Welfare. The transportation session, "Technology and the Mobile Population," will include James Beggs of the Department of Transportation (see CHALLENGE, *The Electronic Engineer*, May 1970, page 30), John Beckett of Hewlett-Packard, former Secretary of the Interior Stewart Udall, and Albert Hibbs of JPL.

"Communications and the Public Need" panelists are Dr. Peter Goldmark of CBS, Dr. John Pierce of Bell Labs, Paul Visher of Hughes, and Daniel Noble of Motorola. Speaking on "Technology and the Urban Society" will be Charles Miller of MIT's Draper Lab,

WESCON TECHNICAL PROGRAM Museum of Science and Industry – Exposition Park				
10 - 12:30 am	Tuesday, Aug. 25	Wednesday, Aug. 26	Thursday, Aug. 27	Friday, Aug. 28
Room I	1 Integrated Circuits for Consumer Electronics	7 LSI Memories	13 The Next Generation of Satellite Systems	19 British Progress in Telecommunications
Room II	2 Electronic Instrumentation/ Distribution Trends – 1970	8 The Integrated Circuit Overseas	14 Instrumentation for Data Acquisition and Central Systems	20 West Coast Environmental Problems
Room III	3 Millimeter Systems, Devices and Guides	9 Solutions to Problems of Low-Noise Amplification at Microwave Frequencies	15 Optoelectronic Devices and Applications	
2 - 4:30 pm Room I	4 Optimizing Selection of Vacuum Deposition Equipment	10 Active and Passive Filters and Equalizers	16 Component Manufacturing for the '70s	
Room II	5 Military User Views of Automatic Test Equipment	11 New Product Planning in a Maturing Market	17 Advances in Commercial Avionics	
Room III	6 Instrumentation Guidelines for the Study, Control of Ecology & Water Pollution	12 Medical Electronics	18 Management Control Systems (MCS), Knight or Dragon?	

Hollywood Park Computer Sessions				
10 - 12:30 am Room IV	A Managing the Development of Large Software Systems	C Minicomputers in the Process Industries	E Impact of Interactive Computing Systems on Engineering Problem Solving	G Computer-Aided Design Capability of Digital Logic Blocks
2 - 4:30 pm Room IV	B Evaluation of Proprietary Software	D Hands-on Programmable Calculators	F A Synoptic Evaluation of Timesharing Services	

WESCON SPECIAL PROGRAM "Technology and Public Problems" – L.A. Hilton Pacific Ballroom		
Pacific Ballroom (am)	Keynote Session	Communications and the Public Need
Pacific Ballroom (pm)	Technology and the Mobile Population	Technology and the Urban Society

The sessions indicated in color are recommended by **The Electronic Engineer**.

Floyd Goss from the Los Angeles Department of Water and Power, president of the Sierra Club Phillip Berry, and Frank Dimster of William Pereira and Asso. The technical world is overdue for some good ses-

sions in this area. Usually, several designers rise to the occasion by announcing such bulletins as, "What urban planning needs is a systems approach!" and that's that
(Continued on page 27)

Low energy switching problem? Leave it to our "GOLDIE"...



"Goldie"—the new Cherry gold crosspoint contact switches solve practically every low energy switching problem. They do it with a contact design innovation that helps prevent the two main causes of contact failure:

1. Formation of insulating chemical films on contacts
2. Mechanical interference of foreign particles on contacts.

Our new "Goldie" switches combine a solid layer of gold alloy (69% gold, 25% silver, 6% platinum) contact material

with a crossed knife-edge configuration. These provide interfaces inert to chemical action and virtually eliminate contact closure interference from foreign particles. Low contact resistance is maintained throughout the switch lifetime, which is measured in millions of operations. Initial insertion resistance is below 50 milliohms.

Take a closer look at our problem-solving "Goldie" switches. Send for the sample of your choice today.



Hewlett-Packard Desk Top Calculator uses 63 Cherry "Goldies"

FREE SAMPLE SWITCH



E69 Push Button
Circle Reader
Service No. 56

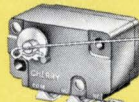

E53 Low Torque
Circle Reader
Service No. 57



E63 Subminiature
Circle Reader
Service No. 58



S31 Open Miniature
Circle Reader
Service No. 59



E21 Miniature
Circle Reader
Service No. 60

CHERRY



SEE THE NEWEST and MOST ADVANCED
ELECTRONIC KEYBOARD at the
WESCON SHOW Booth Nos. 2710-12 Sports Arena

CHERRY ELECTRICAL PRODUCTS CORP. • 1655 Old Deerfield Road, Highland Park, Illinois 60035

for urban planning. If the panels get down to business with constructive plans or suggestions, in areas of engineering interest and capability, they could provide a great service.

The winners, and new champs . . .

Some 152 products were entered in the twelfth annual Industrial Design Award program, and 26 were chosen to receive "Awards of Merit." Just prior to the Show, some of them may also receive "Awards of Excellence." All of them will be in a special display at Hollywood Park. The winners of the Award of Merit, by category, are listed below:

Category A—Instruments and Instrumentation

Beckman Instruments	IR-33 Infrared Spectrophotometer
Beckman Instruments	Flame Photometer
Chromatix	Crystal Oven and Controller
Datatrol, Inc.	Fastplot 1200
General Instrument Corp.	Thermoelectric Lab System
Xerox Corp.	100 Power Microscope
Xynetics, Inc.	Automated Drafting System

Category B—

Production Machinery & Fabrication Equipment

Apollo Lasers, Inc.	Lasertrim
International Plasma Corp.	Plasma Machine IPC 1003B
Universal Graphics, Inc.	Unigraph 22 Plotter System

Category C—

Computer & Electronic Data Processing Equipment

Computer Transmission Corp.	Optran Infrared Transceiver/Data Set
Data Products Corp.	Discfile
Data Recognition Corp.	Optical Scanner/Encoder
Honeywell, Inc.	H-2423 Card Reader—Tabletop
Honeywell, Inc.	Magnetic Tape Drive
International Plasma Corp.	Dual Image Recorder
Memorex Equipment Group	Storage Control Unit
Sperry Rand Corp.	Uniscope

Category D—Communications Equipment

Motorola, Inc.	CCTV Camera
Pacific Plantronics, Inc.	Starset Communications Headset
RCA Corp.	2000—23-in. Color Console

Category E—Components & Materials

API Instruments Co.	Analog Panel Meter
Electronic Associates, Inc.	Quadrupole rf-dc Generator
Hewlett-Packard Co.	Ac Power Line Module
Hewlett-Packard Co.	Laser Beam Bonder
Hewlett-Packard Co.	Network Analyzer Accessory Family



The cleaner/solvent that couldn't be cleaner

When you have important cleaning jobs, can you afford to take chances on solvents made with reclaimed materials? If not, rely on MS-180 Degreaser—it's formulated entirely from virgin fluorocarbons and meets Government specs for cleaning solvents.

Reclaimed materials are cheaper, but we want to solve problems, not create new ones. So, for the critical jobs use the cleaner that's 100% clean to start with—MS-180 Degreaser.

Prices: 1-11 doz. 16 oz. cans, \$2.60/can; 1 gross, \$2.00/can;
4 gross, \$1.90/can; 7 gross, \$1.80/can.
Trial order: 4 cans @ \$3.70/can



miller-stephenson chemical co.,inc.

ROUTE 7, DANBURY, CONNECTICUT 06810

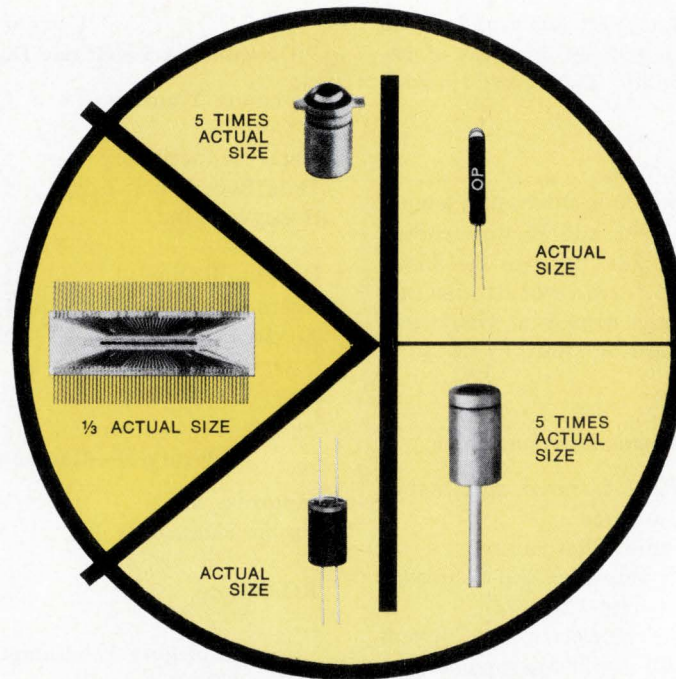

OPTRON is a "SHOPPER STOPPER!"

*OPTRON'S full line of standard optoelectronic devices/arrays
and complete custom capabilities put an end to your
"shopping around" for the best combination of
price, reliability and delivery*

Whether you're a shopper by nature or by necessity, you can now stop looking because OPTRON is your best optoelectronics source. For example, our line of off-the-shelf standard devices meet most design applications.

Here, take a look!

HERMETIC "PILL" PACKAGE (flat lens optional) mount on 0.075" centers



- OP 100** Light emitting diode — gallium arsenide energy source
- OP 300** High gain Darlington light sensor transistor
- OP 600** Light sensor transistor — industry-accepted standard for tape and card reader applications
- OP 601 Series** Light sensors—for applications requiring tight gain ranges for critical tracking requirements
- OP 620** High speed light sensor transistor — for applications requiring ultimate in switching speeds vs. sensitivity
- OP 666** Light sensor (photometric standard)
- OP 900** Light sensor diode — for applications where linearity and switching speed are primary parametric considerations

HERMETIC GLASS PACKAGE mount on 0.100" centers



- OP 400** Light sensor transistor — industry-accepted standard
- OP 420** High speed NPN silicon light sensor
- OP 490** Light sensor diode — for applications where linearity and switching speeds are primary parametric considerations
- 1N2175** Light sensor duo-diode

HERMETIC COAXIAL PACKAGE (round lens optional) mount on 0.075" centers



- OP 700** NPN silicon light sensor
- OP 790** Light sensor diode

HERMETIC PACKAGE



- Photo detectors energized by an OP 100 gallium arsenide diode:
- OP 1020** Isolator (OP 620 detector)
 - OP 1030** Isolator (OP 300 detector)
 - OP 1060** Isolator (OP 600 detector)
 - OP 1090** Isolator (OP 900 detector)

But, that's not all!

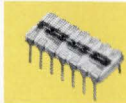

OPTRON can provide complete discrete, hybrid or monolithic optical arrays, pre-assembled and pre-tested, to your specifications.

In addition, OPTRON is experienced and capable of working on your most stringent custom requirements or interface problems. An OPTRON-assembled functional module offers you significant system-cost and performance advantages.

Write today for technical literature on our standard product line and the name of your nearest OPTRON representative.

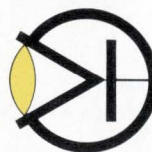

OPTRON, INC.

1201 Tappan Circle
Carrollton, Texas 75006
214/242-6571

LET THE LIGHT SHINE OUT

Light emitters range from simple flat structures to complex arrays

By Dr. Robert Haisty,
Texas Instruments Incorporated, Dallas, Tex.

Parts 2A and 2B of our Optoelectronics Course will explain the basic optoelectronic components that form the building blocks for optoelectronic systems. Fundamental to any optoelectronics system is the generation (Part 2A) and sensing (Part 2B) of light for a specific task.

While the variety of optoelectronic components is already large and growing each year, we will present the essential details you need for a basic understanding of devices.

For each component type, the materials of construction, basic theory, and features will be discussed. While specialized types of components are not mentioned, their operation can be understood after gaining a knowledge of the basic types. Since detailed information is accessible for the components presented in this course, the serious optoelectronic student should pursue the references and source material.

The nature of light emitters

When minority carriers recombine with majority carriers in a semiconductor, energy is released in the form of light, heat, or kinetic energy to other carriers. Although minority carriers can be introduced in several ways, the most effective way is carrier injection in a pn junction, the basis for semiconductor light sources.

Any pn junction, under forward bias, can emit some light, but before reasonable conversion efficiencies can be obtained, a great many factors must be optimized. For instance, light output can be drastically reduced by competing nonradiative recombination processes, as

well as by internal absorption and reflection losses. These losses can be minimized by choosing the right material in a state of high degree of purity and crystal perfection, which is properly doped, and by using geometrical structures and other methods to reduce absorption and reflection losses.

It is possible to achieve internal quantum efficiencies (photons generated per recombination event) approaching 100%. Overall power conversion efficiencies (100 X light power output ÷ electrical power input) of 25% or more have been attained.

Materials

The selection of the semiconductor material is the most important single factor. As an example, light-emitting diodes did not evolve during the early years of transistor development because germanium and silicon, both indirect gap semiconductors, are very poor light emitters.

In an indirect gap semiconductor there is a difference in momentum between the initial and final states for a band-to-band transition, which must be taken up by a phonon cooperating in the electron-hole recombination. In effect, a three-body collision is required, hence the low probability of light emission from indirect gap materials. On the other hand, vertical band-to-band radiative transitions in direct gap material, such as GaAs, have a high probability.

There are other possible radiative transitions in which the requirement to conserve momentum is relaxed. For example, the decay of bound excitons at the neutral center ZnO or N indirect gap semiconductor GaP leads to efficient red and green emission.

In selecting the semiconductor, the wavelength of light desired must be considered. To a good approxi-

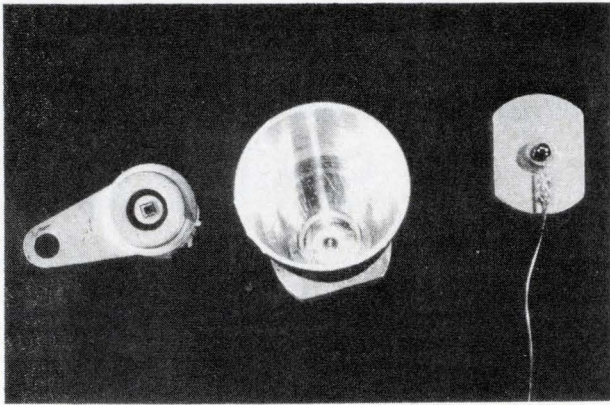

Fig. 1: Drawing of a simple flat, planar emitter shows internal reflection for angles of incidence greater than the critical angle, θ_c .

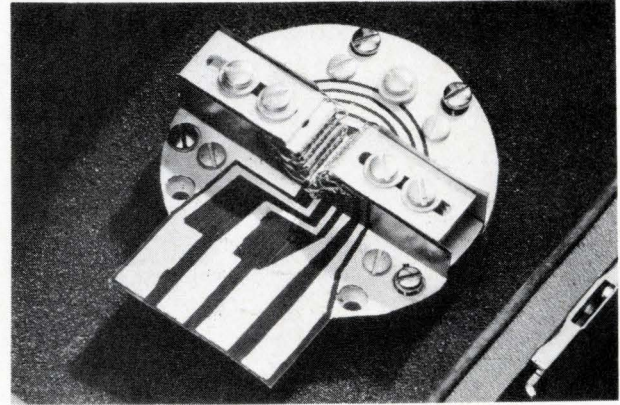

Fig. 2: A high power dome emitter, showing how internal reflection is eliminated, and a net gain factor of about 10 is achieved.

mation, the wavelength of light emitted for band-to-band or shallow acceptor (or donor) level will be that corresponding to the band gap, that is

$$E_g = h\nu = \frac{hc}{\lambda}, \text{ or } \lambda \text{ in microns} = \frac{1.24}{E_g(\text{eV})}$$

By growing single crystal mixed compounds such as Ga(AsP) and GaAlAs, we can "tailor" a material for a desired wavelength by varying the composition. In this way, for example, energy gaps from the ~ 1.4 eV of GaAs to 2.26 eV corresponding to pure GaP can be obtained. However, GaP and AlAs are indirect gap materials and in both alloy systems the cross-over is around the 50% point, so efficient light emitters have only been made down to $\sim 6500 \text{ \AA}$. Wavelengths longer than 9000 \AA are obtained in alloys of GaAs with the lower energy gap semiconductors such as InAs (0.36 eV) or GaSb (0.67 eV). A chart of III-V compounds commonly used for light emitters is given in the "Guide to Optoelectronic Devices" wall chart published in the July, 1970 issue of **The Electronic Engineer**.

Other possible light-emitting materials, especially the II-VIs (CdS, ZnTe, etc.) should be mentioned. Some of these are especially interesting because they have band gaps large enough to produce blue emission, but they tend toward self-compensation, and good pn junctions have not been obtained in the higher band gap compounds.

Another important material is silicon carbide, in which yellow, green, and blue emission has been observed. But, efficiencies have been low, and the difficulty of working with such a highly refractory material has made progress slow.

Types of emitters

Each new application for light-emitting diodes generates increased needs for power outputs ranging from a milliwatt or so, as for card readers, to many watts, as for night vision illuminators or rangefinders. In a simple planar junction in a flat device, much of the light generated is lost by internal reflection. The critical angle for total internal reflection at an interface between two media with index of refraction n_1 and n_2 is given by:

$$\sin \theta_c = \frac{n_1}{n_2}$$

For the air-GaAs interface: $n_1 = 1$, $n_2 = 3.6$, and $\theta_c = 16^\circ$.

The fraction of total light reaching the front surface that lies within the critical angle is given by:

$$F_c = (1 - \cos \theta_c).$$

For GaAs-air, this is only $1 - 0.96$, or 0.04 of the light generated. Unless an anti-reflective coating is used, an additional amount, given by

$$\left[1 - \frac{4n}{(1+n^2)} \right]$$

or 30% is also reflected within the critical angle.

A typical flat device is shown in Fig. 1. In the compound GaAs, light generation takes place almost entirely in the p-region and is of a slightly longer wavelength than the absorption edge of n-type material. Light can therefore be brought out through the n-region without excessive absorption, if it is not too thick.

To eliminate the internal reflection, and thereby in-

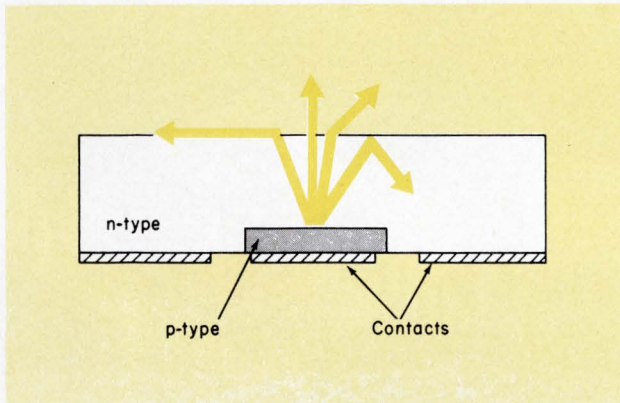

Fig. 3: These three 72-mil dome emitters can be used with or without reflector.

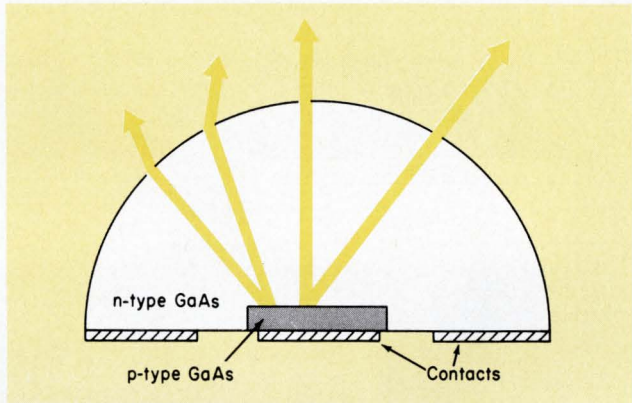

Fig. 4: Ten-watt laser output is achieved with a cooled diode array.

crease the light output by a factor of 25, a hemispherical dome can be placed over the junction. If the ratio of dome-to-junction diameter is at least as great as that of the index of refraction of GaAs to air, none of the light reaching the surface will exceed the critical angle (Fig. 2). In practice the increased absorption loss in the thicker dome reduces the output so that a net gain of about a factor of 10 is achieved. Thus, a flat GaAs emitter will have about a 0.2% to 1.5% efficiency at 25°C and the addition of a GaAs dome raises the efficiency to about 2% to 8%. Some manufacturers use epoxy domes with an index of about 1.7, which should provide an improvement about 3X over a flat emitter.

How, then, do we achieve the 25% efficiency mentioned earlier? Fortunately, in GaAs it is possible to shift the wavelength of emitted light output several hundred Å longer than the absorption edge, to greatly reduce absorption in the dome. This is done by using Si as the dopant for both the n- and p-regions.

When Group II elements are added to GaAs, they replace Ga atoms to produce p-type material; similarly, Group VI atoms replace As to form n-type material. The Group IV elements Si and Ge are amphoteric, going on both Ga and As sites, and pn junctions can be formed by changing the growth temperature to shift this ratio during epitaxial growth from Ga solutions. Light emitted from this junction ranges from 9300 Å to about 9700 Å at very high concentrations.

The behavior of Si in GaAs is not completely understood. Recent studies of the absorption bands associated with the localized vibrational mode of Si on Ga- and As-sites in GaAs indicate that there are too few

Si atoms on As-sites to account for the measured acceptor concentration. Further, the increase in overall power efficiency achieved in the solution-grown, amphotericly-doped emitters is greater than expected from reduction of absorption alone. The light generation process in this material is much more efficient than in other GaAs.

A single large dome device can provide up to 200 mW of light for 2 A drive current at 25°C. These emitters are often assembled in arrays to provide many watts of output power. Reflector packages (Fig. 3) reduce the beam angle to about 20°.

Where pulse operation with high peak power outputs is needed, as in gated night vision systems, the injection laser takes over. Necessarily operating at high current densities, a laser diode with a junction only 0.006 x 0.016 in. can provide 10 W peak power. With typical 25°C operating conditions of 200 ns pulses at 5 kHz, an average power of 10 mW is reached. Cooling the lasers greatly reduces the threshold current (approximately as T^3) so that longer pulses can be used, and even cw operation is possible below 100°K.

There are methods for packing the laser chips into very small arrays. Figure 4 shows an array designed to operate at 77° with a peak power output of 350 W, using 1 μs pulses at 30 kHz, for an average output power of 10 W. The source size is only 0.22 x 0.22 in. The beam angle from a diode laser is typically about 10° in the plane of the junction and 30° in the other. While this is large compared to ruby or Nd:YAG lasers, it is much less than the 2 π steradian pattern from noncoherent sources. Because of the small source size, the light from this array can easily be collected

Fig. 5: Schematic drawing of (a) simple injection laser; (b) close confinement, or heterostructure; (c) a laser chip mounted for series connection; and (d) a sample array assembly using chips shown in (c).

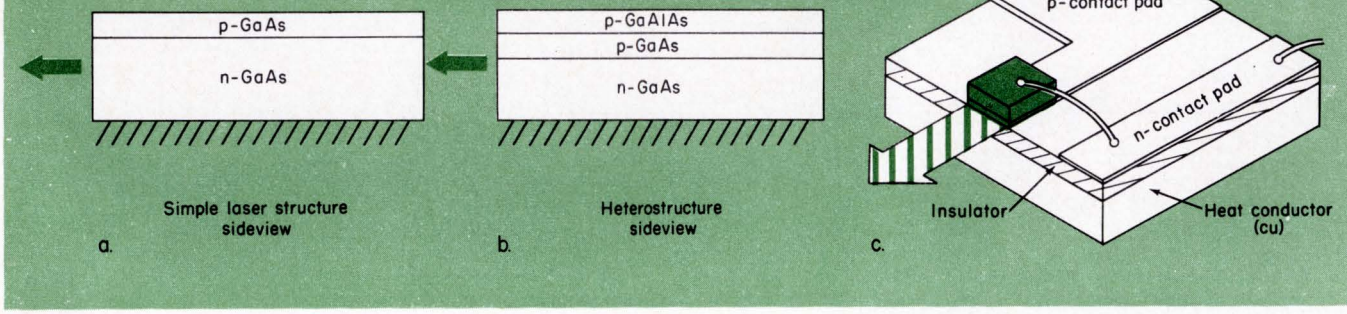

and brought into a $\frac{1}{2}^\circ$ beam by a simple $f/1.8$ lens about 8 in. in diameter.

To achieve lasing, it is necessary to produce a population inversion* and to have a net cavity gain. Although GaAs lasers have been made in a number of forms, the most practical is the Fabry-Perot structure, a resonant cavity with two parallel reflecting surfaces (Fig. 5a). When a threshold current density is reached, stimulated emission occurs from a region a few microns wide in the plane of the junction. The threshold is marked by a sharp increase in power output with current, spectral narrowing of the light output, and the appearance of coherent light. Rather than bulk absorption, the internal losses now consist of (1) cavity leakage, or diffraction losses, (2) transmission losses through the exit surface, and (3) free carrier absorption.

Photons outside the region of population inversion are lost by absorption. Similarly electrons that diffuse beyond the inverted region before recombining are lost to the lasing process. These points are essential to understanding a recent significant improvement in laser threshold current densities and efficiencies. In 1969, a "close confinement" laser structure was announced in which a reduction in threshold current density from a typical value of 5×10^4 A/cm² to 1.9×10^4 A/cm² was obtained with an increase in differential quantum efficiency from 13% to 39%.

The structure used (Fig. 5b) placed a layer of GaAlAs about 2 microns above the pn junction. The improvement was attributed mostly to the confinement of light by reflection at the GaAs-GaAlAs interface, be-

* It has been calculated that the ratio of stimulated to spontaneous emission under thermal equilibrium is only 10^{-30} .

cause of the slightly lower refractive index of the GaAlAs at the wavelength of GaAs emission.

Other studies on similar heterostructures indicate that confinement of carriers by the potential barrier at the GaAs-GaAlAs plays a major role in the improvement of density and efficiency. Very recently a three-layered heterostructure, with GaAlAs on both sides of pn junction was reported to have a threshold as low as 2000 A/cm².¹

Future developments

Probably the fastest growth in the field, at present, is solid-state displays. Going ahead with the available GaAsP technology, several companies are marketing 7-segment numeric, and 5 x 7 alphanumeric displays with matching IC logic, to produce any desired character.

The considerations in designing visible displays differ somewhat from the IR sources. Here, apparent brightness at low driving currents is of primary importance. In the wavelength range obtainable with GaAs_xP_{1-x}, the trade-off between the decreasing efficiency of the GaAsP with decreasing x to produce shorter wavelengths, and the increasing responsivity of the eye as the maximum at 5500 Å is approached, shows a rather sharp maximum in the red, at about 6550 Å.

Two approaches to green emitters and displays are being investigated intensively. For blue, only one of these is applicable. Both green and red emitters can be produced in GaP by proper doping, as discussed earlier. Efficiencies of 7.2% for red, and 0.6% for green were reported in solution growth material on GaP sub-

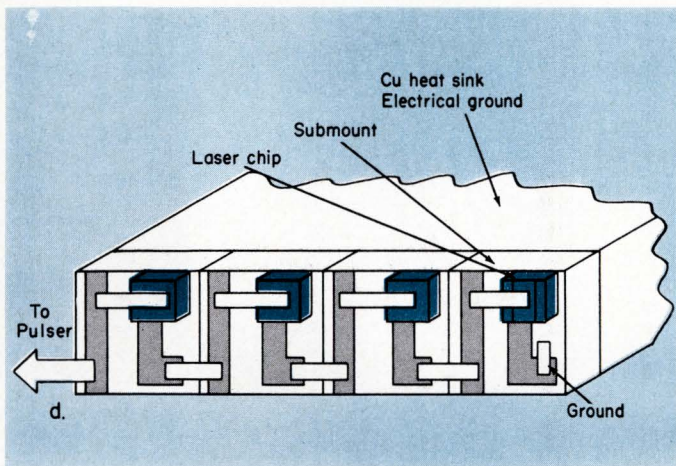

strates.² GaP is much more difficult to prepare in good single crystal form than GaAs because of the high phosphorous pressure (~ 40 atm) at the melting point. However, once the high pressure crystal puller is on hand, there is no reason for GaP to be more expensive to produce than GaAs.

The second approach by which all three colors—red, green and blue—can be produced is by pumping certain rare earth phosphors with the long wavelength (9300 Å - 9700 Å Si-doped GaAs).

Conversion efficiencies are comparable to those for GaAsP, but still well below GaP. Further improvements in purity of the phosphors better host materials can be expected. Blue phosphors capable of 60 ft-L for a diode current density of 50 A/cm² were reported recently.³

Another development that can be expected to appear within the next year or so is a compact, efficient YAG laser pumped with solid-state emitters.⁴ Because the wavelength of the emitters can be tailored to peak at a pump band around 8050 Å, a large fraction of the light is used, offering better efficiency and less heating than possible with a broad spectral pump sources.

Also, light-emitting diodes with negative resistance characteristics, although known for some time, are now attracting more interest. Diodes which can be switched by external light in tens of nanoseconds were recently described. These offer interesting possibilities for optical logic, delay and memory circuits as well as amplifiers and special purpose displays.

INFORMATION RETRIEVAL
Light-emitting diodes, Semiconductors

GLOSSARY OF TERMS

Band gap—The energy difference between the conduction band and the valence band in a material.

Conduction band—The empty energy band where electrons are the charge carriers.

Depletion region—That region where the density of charge carriers is negligible compared to the impurity concentration.

Hole-electron pair—A positive (hole) and a negative (electron) charge carrier, considered together as an entity.

Laser efficiency—There are several measures of efficiency used to evaluate laser diodes. It is important to distinguish among them carefully.

- Internal quantum efficiency: Photons generated per current carrier injected.

- Emission efficiency: Photons emitted per photon generated.

- External quantum efficiency: Photons emitted per current carrier injected. Quantum efficiency is also called "junction efficiency."

- Differential efficiency: Slope of the light output vs forward current curve, above the lasing threshold. Also called "slope efficiency" or "incremental efficiency."

- Power efficiency: Light output power divided by total input power. Also called "device efficiency," "overall efficiency," or "conversion efficiency."

Majority carriers—Charge carriers responsible for conduction under thermal equilibrium; electrons in n-type or holes in p-type material.

Minority carriers—Electrons in p-type material or holes in n-type material.

Mobility—The velocity of a charge carrier per unit of applied electric field.

Recombination—The combining of a hole and an electron.

Trapping—The capturing of a hole or an electron in an impurity or defect.

Valence band—The filled energy band from which electrons are excited into the conduction band.

References

1. M. B. Panish, I. Hayashi, and S. Sumski, *Applied Physics Letters*, Vol. 16, 1970, p. 326
2. W. Rosenzweig, paper presented at IEEE Device Conference, 1970, New York.
3. *Electronics*, May 11, 1970, p. 41.
4. R. E. Allen and S. J. Scalise, *Applied Physics Letters*, Vol. 14, 1969, p. 188
5. *Electronics*, April 27, 1970, p. 67.

Electro-optics
technology
from RCA
for your
UV/ visible/IR
needs



Working in the fascinating world of the optical spectrum, you should be using one or more of these exciting RCA products—photomultipliers, gas lasers, solid-state IR emitters, single-diode lasers and laser diode arrays. Each line is the result of technology that comes from a leader with decades of electronics experience.

RCA now has available standard products for your electro-optics applications. Even as new devices are announced, RCA stands ready to custom-design a source or detector for your special requirements.

RCA can help you in your work in the optical spectrum. With photomultipliers. With gas lasers. With solid-state IR emitters, and laser diodes and arrays. Ask about them.

RCA Photomultipliers. This line is the widest and most diverse in the industry—more than 250 established and state-of-the-art types. New photocathodes and secondary emitters provide these types with such features as: broad spectral response with high sensitivity from UV to IR, resolving capability of one, two, three, or more photoelectron events, and subnanosecond anode pulse rise time. In electro-optical applications, these RCA photomultipliers can be used in systems for optical

character recognition, Raman spectroscopy, air pollution detection, laser range finding, security surveillance, and entertainment consoles such as the new video player systems.

RCA Gas-ion Lasers. Resulting from one of the industry's most extensive laser development programs, RCA's line of gas-ion lasers ranges in size from a few milliwatts to 600 mW (air cooled), and up to 100 W CW in the optical spectrum. With an unmatched production facility, RCA can supply one unit—or 100,000 units—a year! Included are helium-cadmium, helium-neon, argon-ion, and krypton (ultraviolet, violet, blue, green and red) lasers.

RCA gas-ion lasers may be selected for specific applications to provide high intensity, coherent output in a range from 325 nm to 647.1 nm. These highly stable, long-life lasers have potential in applications for today and tomorrow in holography, data processing, ranging, Raman spectroscopy, film recording, satellite tracking, communications, and bloodless surgery.

RCA Solid-State IR Emitters, Laser Diodes and Laser Diode Arrays. Among the first to announce availability of solid-state light sources,

RCA has units that operate in the near-infrared (from 800 nm to 930 nm) region of the spectrum. Small in size... they range in outputs from 1 mW up to 1 kW of peak power... from 1 mW to 50 W of average power. The "close confinement" structure (lasers) results in power efficiencies as high as 40%. Designed for operation from room temperature to cryogenic conditions, these IR emitters, laser diodes and arrays are superior, rugged performers in such electro-optical uses as punched-card and tape readout, fog and smoke penetration, intrusion alarms, night vision, fuzing, altimeters, distance measuring and dozens of other signaling, location, and illumination applications to excite you.

If you are working in the area of laser sources and detection, why not discuss your requirements with RCA. For detailed information on any of these device areas, consult your local RCA Representative. For technical data, write: RCA, Commercial Engineering, Section 59H/ZP9, Harrison, N.J. 07029. International: RCA, 2-4 rue du Lièvre, 1227 Geneva, Switzerland, or P.O. Box 112, Hong Kong.

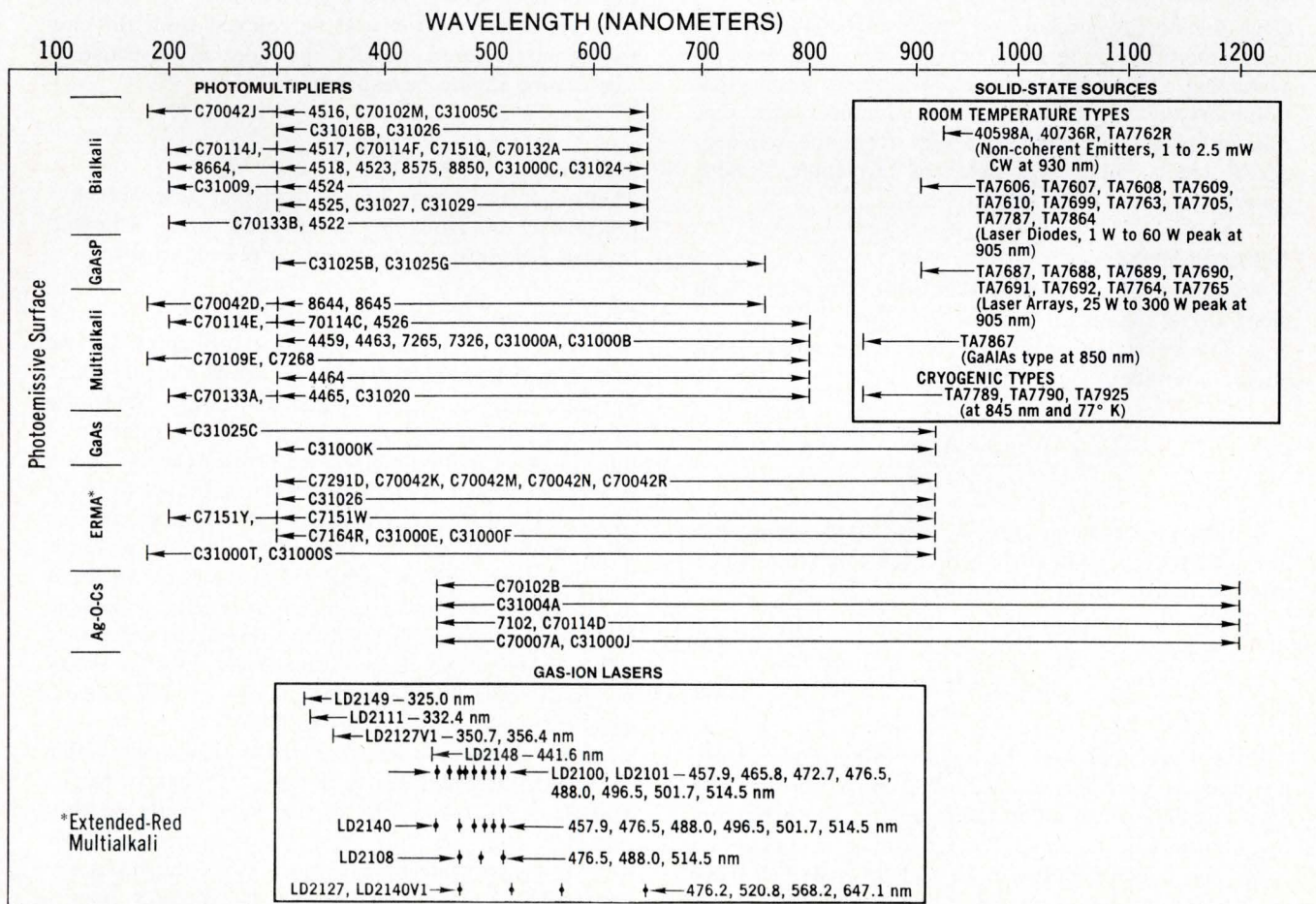

EMITTER PACKAGING AND PERFORMANCE

Brighten your application by understanding packages and basic performance parameters.

By Dr. Michael G. Coleman, Richard W. Gurtler, and Arnold London

Motorola Semiconductor Products Div., Phoenix, Ariz.

Once the doping profiles and processing methods have been determined, the next step in chip fabrication is packaging. The best technique, of course, is one that fully uses the chip's efficiency and minimizes cost. One primary packaging problem results from the semiconductor chip's rather high index of refraction, a value generally greater than 3.0.

Index of refraction

The two basic problems that arise from the high index of refraction of the LED chip are:

a. The reflection coefficient, R , at the air-semiconductor interface is quite high,

$$R = \frac{(n_{sc} - n_{air})^2}{(n_{sc} + n_{air})^2} \quad (1)$$

b. The critical angle, Θ_c , is quite small, giving rise to a rather small, solid angle within the chip from which external radiation can be obtained.

$$\sin \theta_c = \frac{n_{air}}{n_{sc}} \quad (2)$$

Rays originating near the light-emitting diode (LED) pn junction may interact with the chip's surface and leave the chip or be reflected internally. The back surface of the chip is usually coated with some reflective metal for bonding purposes. The light reflected from this surface can be specular or diffuse in nature and can

provide more radiation from the LED.

By placing a transparent material over the LED having an index of refraction greater than n_{air} and less than n_{sc} , more radiation can be coupled from the chip to the outside world. Ideally, the index of refraction of this coating should be equal to

$$\sqrt{n_{sc} n_{air}}$$

This value is normally higher than that achieved on a practical basis. Also, the use of such layers is limited by their absorption of light passing through them.

Coatings and lenses

It is common practice to coat the surface of an LED with SiO_2 (silicon dioxide) ($n \approx 1.5$) or a higher index material, SiO or Si_3N_4 (silicon nitride). With the thickness of this coating equal to an odd number of quarter wavelengths, reflectance losses can be minimized. But, the critical angle remains the same as in the semiconductor-to-air interface due to the parallelism of the two interfaces of this thin film structure. Large increases of the critical angle within the LED chip (and therefore the total solid angle of externally obtainable radiation) are made by placing transparent masses of intermediate refractive index materials, such as epoxy or plastic, over the chip. This mass is usually a hemispherical dome surrounding the chip.

At the chip-plastic interface, the critical angle within the chip is increased due to the greater index of refraction (typically 1.4 to 1.5) of the dome medium. Most rays that enter into this surrounding medium are able to leave the hemisphere, since they strike the surface at near-normal incidence. This type of geometry gives a

**TI's quiet
revolution in
optoelectronics**

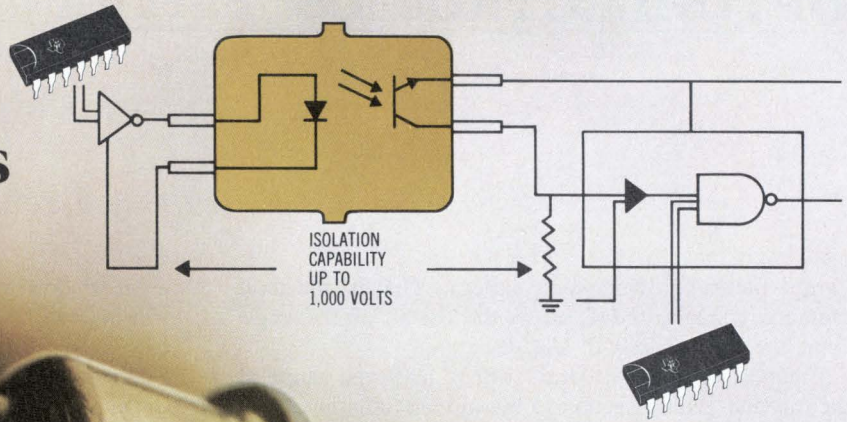

Optically-coupled isolators deliver four interface freedoms.

Freedom from noise.

Electrical isolation of the input diode and output transistor eliminates ground loops and noise signal transmission.

Freedom from voltage isolation problems.

Input/output isolation of up to 1000 volts allows for the simple interface of different voltage levels and suppresses high voltage transients.

Freedom from the cost and design problems of interfacing.

TI optically-coupled isolators (OCIs) handle the job alone. You don't need complex circuits to pass noise-free signals between input

terminals and computers and along transmission lines.

Plus, you get these important advantages over relays and pulse transformers: Response from dc to 100 kHz. High shock and vibration immunity. Bounceless action. Speeds to 5 μ sec. Wide operating temperature range. Longer life.

Freedom from space limitations.

In a tight spot? TI OCIs fit into high density situations with ease. The twin TO-18 metal can measures just 0.206" x 0.220" diameter.

And, performance is improved, too.

A more efficient emitter guaran-

tees you a 1.6 mA output for a 15 mA input. Enough to drive logic gates without additional components. Example: the TIL 107 and TIL 108 OCIs guarantee direct DTL/TTL compatibility. You cut space, weight, power and overall system costs.

Both are available now at new lower prices: TIL 107—\$6; TIL 108—\$10 (100-999). Call your TI sales office or authorized TI distributor for fast delivery.

For a data sheet, write Texas Instruments Incorporated, PO Box 5012, MS 308, Dallas, Texas 75222. Or circle number 193.



TEXAS INSTRUMENTS
INCORPORATED

Lambertian-type of emission pattern. That is, the total radiance appears to fall off as the cosine of the angle from the optical axis of the device.

Figure 1 shows a structure with a lens-type shape at the top that gives direction to the emitted radiation. Such a packaging scheme is useful when you want to transfer energy from the emitter to a small spatial area, such as that of a silicon detector. Lens-like structures improve bare-chip external efficiency by a factor of two or more.

Far greater efficiency can be obtained from a structure in which the dome, rather than plastic, is made from semiconductor material itself. This gives a Lambertian-type emitter with no critical angle losses. Only surface reflection losses occur. The domed semiconductor chip, however, is more costly than flat chips. If greater direction is desired from a device, it may be mounted in the focus of a parabolic reflector.

One way of improving the appearance of a visible LED is to increase the contrast. This is done on some red emitters by using a red (rather than clear) plastic covering. Transmission properties of the red plastic are such that it transmits the emitted wavelength and absorbs all other visible wavelengths. Thus the background observed by the viewer has less brightness than would be the case with clear plastic.

A very important LED packaging consideration is that of heat sinking. The device's efficiency decreases as temperature increases. If high reliability is a consideration, then metal packages (for heat sinking) with glass lenses may be desirable.

Another device in which packaging is quite important is the coupled pair, consisting of an LED chip and a silicon photo-detector chip mounted in the same package. The main function is to transmit an input signal to an output terminal with an extremely high degree of isolation. The packaging goal is optimum light coupling. Chip proximity, index of refraction, and reflective techniques are employed to achieve this goal.

Read-out packages

Another important device consists of arrays of LEDs for the transfer of information to a human observer or to an array of detectors (Figs. 2 and 3). The arrays in Figs. 2 and 3 are used for displaying digits. Displays can consist of many LEDs individually mounted on a substrate (e.g., metallized ceramic) and wired together or made on a single chip. With either device it is sometimes desirable to include, in the same package, a decoder-driver chip so that the display may be directly addressed by binary input signals.

In either case, the package should not be much larger than the dimensions of the digit so that the units may be stacked together to form long numbers. Dual-in-line or flat packages are ideal for these devices. Generally

a flat window will be placed over these packages so that viewing can be achieved at large angles.

Performance characteristics

Dc electrical properties normally specified for discrete LEDs are forward voltage drop and the breakdown voltage. Of primary importance is the forward voltage drop, since the devices are operated at forward bias. As the band-gap of the LED material increases, so does the required forward voltage. GaAs needs a forward drop of about 1.2 V, while GaP values are in excess of 2.0 V.

Reverse breakdown voltage is related to the magnitude of the doping levels within the semiconductor device. Typical values range from 5 to 25 V.

When using an infrared (IR) emitter, you should know the total radiant flux, P , emitted by the device for a given forward current, I_f , and also its spatial distribution. The external quantum efficiency, η_e , of a device is given by the expression:

$$\eta_e = \frac{\lambda(\text{\AA})}{12,400} \cdot \frac{P \text{ (mW)}}{I_f \text{ (mA)}}$$

Typically, infrared emitters have external quantum efficiency ratings from 0.1 to 1%, with premium devices rated higher.

The major concern with visible LEDs is the response of the human eye to the emitted radiation. These devices are usually specified in terms of brightness or luminance, measured in foot-lamberts. A rating of 50 ft-L is considered adequate for viewing under ordinary room conditions. As the wavelength moves farther away from green (to which the eye is most responsive), more efficient devices are needed to produce the same visual effects. The spatial distribution is often represented in the form of a polar plot (Fig. 4) which shows the relative radiant flux emitted by the device as a function of the angle from the optical axis.

Devices can be operated in a pulsed mode at instantaneous current values well in excess of the dc rated current, providing the duty cycle is kept sufficiently low to avoid excessive heating of the junction. Power output varies in a nearly linear fashion when forward current is more than one order of magnitude greater than the steady-state rated forward current. This fact can be useful when operating a device in conjunction with a detector that is noise limited. Pulsed operation is also used to vary the apparent brightness of visible emitters by varying pulse width rather than the absolute magnitude of the forward current.

The switching speeds of most diffused LEDs are in the <10 ns range and closely related to the radiative recombination lifetime in the material. In liquid-phase, epitaxy-formed, silicon-doped GaAs devices, longer rise

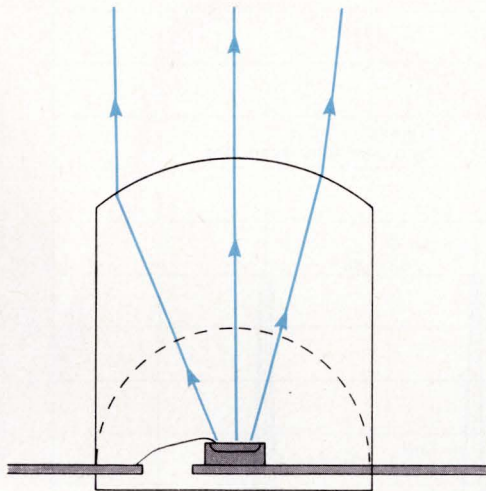

Fig. 1: A plastic-domed lens (broken line) gives emission over a large, solid angle, while a plastic shaped lens gives a more directional pattern.

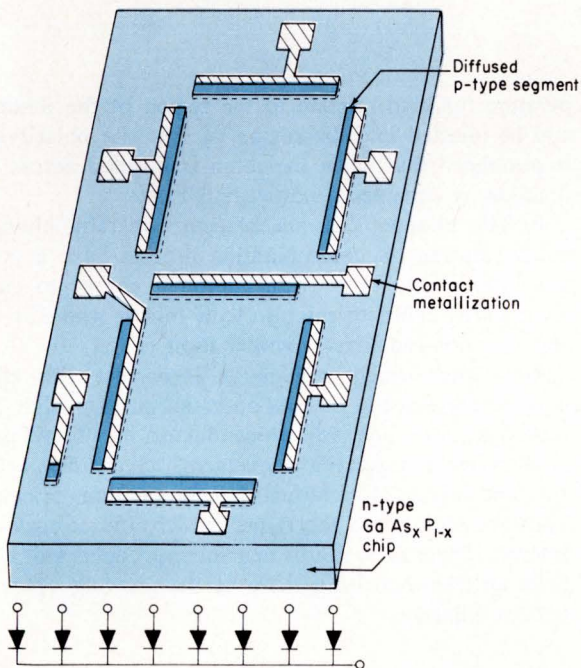

Fig. 2: Monolithic, 7-segment numeric displays are becoming more available. The display schematic shows eight diodes, with the eighth diode representing a decimal point on the display.

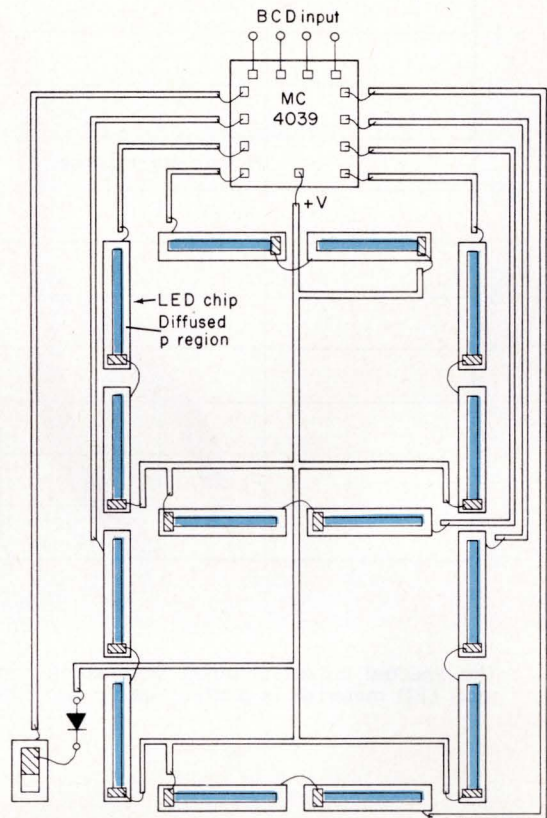

Fig. 3: Larger displays are normally made in hybrid form with discrete devices. An IC BCD chip can be incorporated in package of the readout.

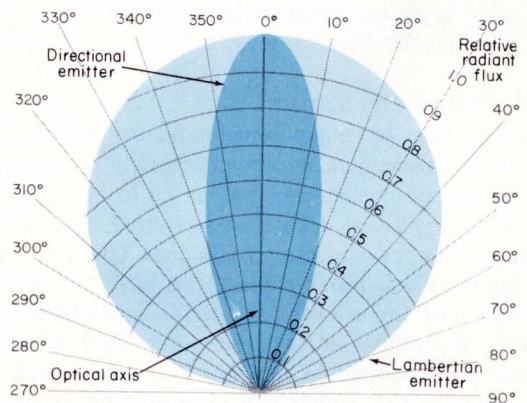
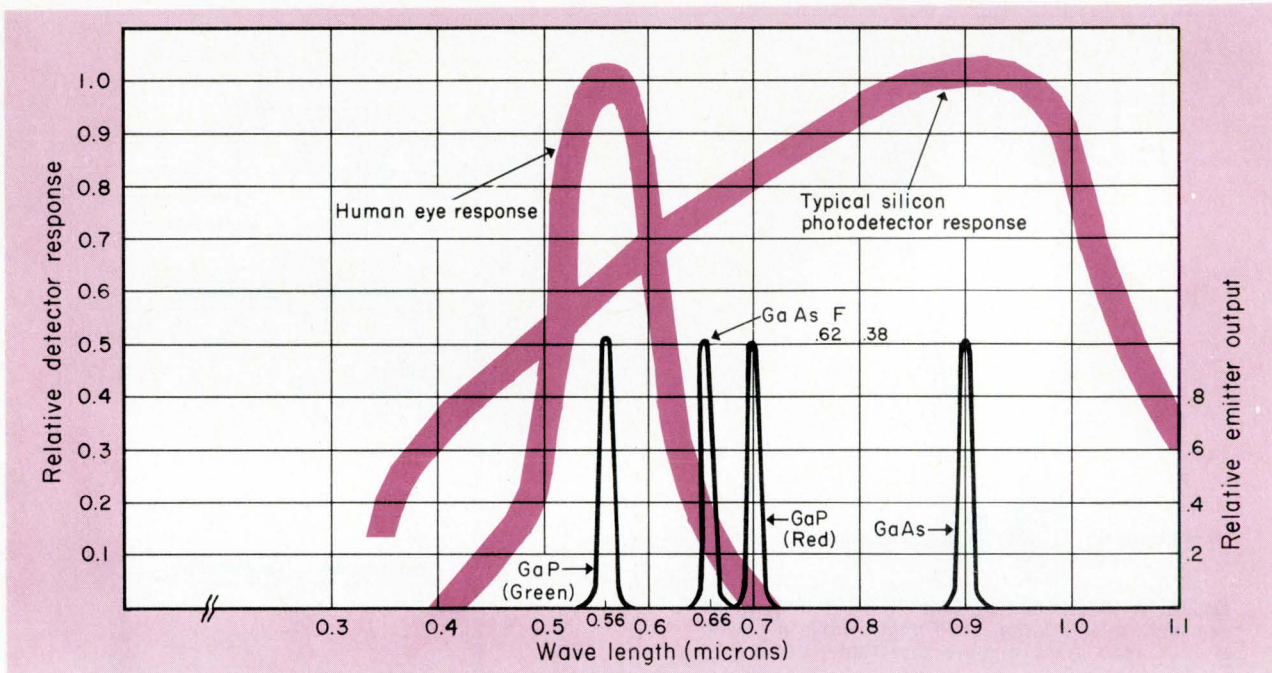

Fig. 4: The polar plot shows the spatial radiation distribution of two common LEDs lenses used.



The spectral output obtained from some common LED materials is plotted against two com-

monly used detector materials and the human eye. Note how the eye peaks around green.

and fall times, on the order of hundreds of nanoseconds, are observed. The inherently fast devices can be RC-time constant limited if the series resistance-junction capacitance product exceeds the intrinsic device speed. The junction capacitance value increases with junction area and increased doping levels in the material. Capacitance is on the order of hundreds of picofarads in most low-power discrete devices.

Undesirable mechanism

As is true of other semiconductor devices, LEDs withstand mechanical and environmental stresses quite well. The one mechanism that seems to be of concern relates to a gradual decrease of external quantum efficiency under forward bias conditions. The latest thinking on the mechanisms causing this effect is related to migration of impure atoms such as interstitial copper or zinc to positions in the lattice where they act as non-radiative recombination centers. Two mechanisms have been proposed to explain this unwanted migration:

a. The Longini mechanism whereby a charged atom is injected across the junction when forward biased in the same manner as holes and electrons, but with much lower probability. The magnitude of the atom's lattice diffusion coefficient can be high enough near room tem-

perature for it to migrate to the region of the junction and be injected into the region of opposite polarity. It is postulated that when the atom is injected across the junction, it occupies a non-radiative site.

b. The phonon kick mechanism, whereby phonons created during the recombination process have a (very low) probability of providing enough energy to cause an impurity atom to migrate to a region where it can act as a non-radiative recombination center.

No matter which explanation is correct, this effect is more prevalent in devices operating at very high current densities, such as semiconductor injection lasers.

With technological improvements constantly occurring and increased manufacturer competition, prices on LEDs are falling into the ranges which attract customer interest. There is no doubt that these products will comprise an ever-increasing share of the growing optoelectronics industry.

INFORMATION RETRIEVAL
Light-emitting diodes, semiconductors



visible light

...from the MOD line

If you need a visual indication of what is happening in your system, equipment or instrument you should be using the FLV100 or FLV101 light emitting diode. Either one will provide you with a bright red status indicator. These products feature ■ Low cost (99c in 10,000 quantities) ■ High brightness (typically 1500 foot lamberts for the FLV100) ■ Mechanical rigidity (impervious to mechanical shock and vibration) ■ Solid state reliability ■ Moisture resistance (65°C and 95% relative humidity) ■ Low power consumption (within drive capability of standard digital IC's) ■ Wide viewing angle (160 degrees for FLV101) ■ Plug in package for easy mounting

You can have either a large area, wide viewing angle indicator (the FLV101) or

a highly intense point light source (the FLV100) for the same low price. Whether you need one lamp for an ON/OFF switch or thousands for a complex panel display you should contact Fairchild MOD.

Fairchild Microwave and Optoelectronics Division (MOD), in addition to these devices, makes a complete line of optoelectronic products.

Your local Fairchild MOD distributor, listed to the right, has sensors and emitters in stock. You can order the devices you need from him or if you need detailed information he will be glad to send you data sheets.

The FLV100 and FLV101 are the latest optoelectronics devices from Number 1. Keep watching Number 1 because more new products are on the way.

FAIRCHILD MOD DISTRIBUTORS

SCHWEBER ELECTRONICS

(516) 334-7474 (617) 891-8484 (416) 925-2471 (305) 927-0511
(301) 427-4977 (205) 539-2756 (216) 336-7020

HAMILTON/AVNET SALES

(213) 870-7171 (415) 961-7000 (713) 526-4661 (602) 272-2601
(714) 279-2421 (206) 624-5930 (303) 433-8551 (503) 255-8550

COMPUTER COMPONENTS CORP

(214) 239-0271

SEMICONDUCTOR SPECIALISTS, INC.

(312) 279-1000 (313) 255-0300 (513) 278-9455 (412) 351-3611
(317) 243-8271 (612) 861-3400 (314) 423-6500

FAIRCHILD

MICROWAVE AND OPTOELECTRONICS

A DIVISION OF FAIRCHILD CAMERA AND INSTRUMENT CORPORATION

2513 Charleston Rd., Mt. View, Ca. 94040

One of these panels any capital

This one.

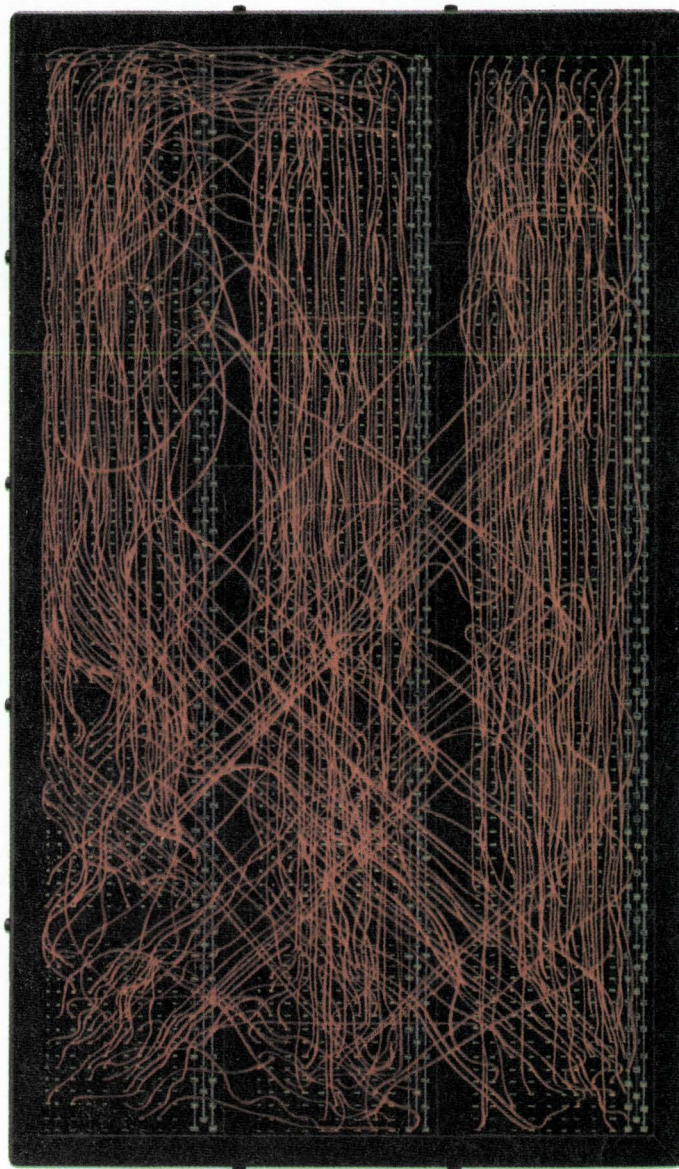
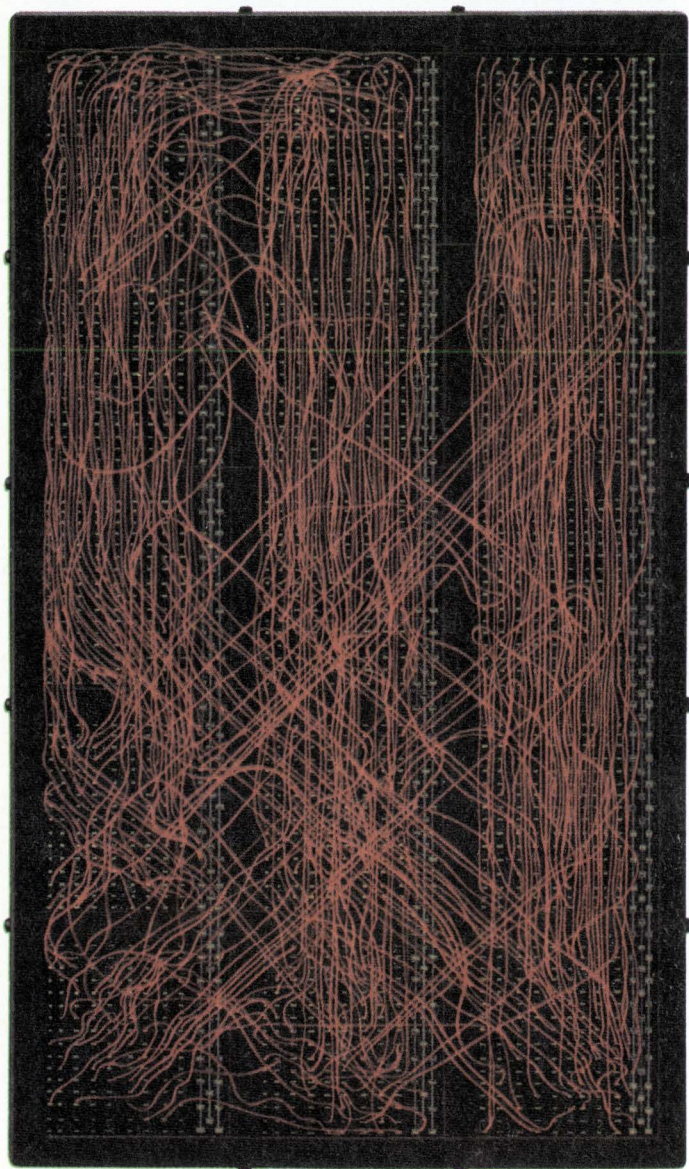

was wired without investment.

It was wired with AMP's unique TERMI-POINT★ point-to-point automatic machine wiring.

The other panel was wired with wrap-type terminations. Which required a considerable capital investment.

There's no capital investment with the AMP method because you don't have to buy any wiring machine. And the system is faster, more reliable, and easily maintainable.

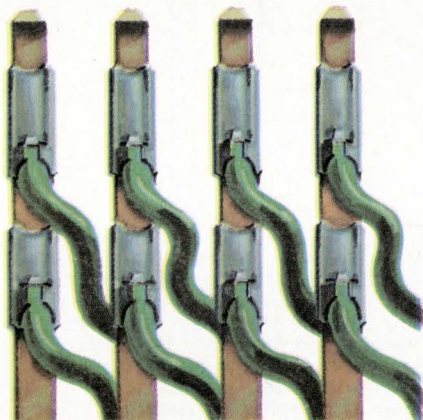

Metal clips swage the wire against the post

And the wire can be either solid or stranded. The clips are fed from one reel; the wire from another. They're applied to the post simultaneously. The clips hold with a spring action. The stored energy of this clip keeps the connection gas tight. And compensates for conductor creep. The clip keeps resistance low, too, because of the high force it exerts on the wire. In short, the clip assures greater reliability.

★Trademark of AMP Incorporated

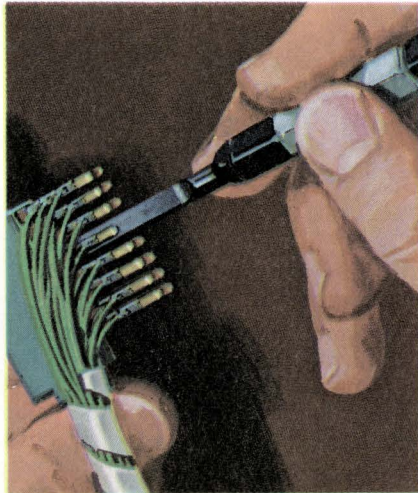

TERMI-POINT terminations are easier to test, maintain and service

The termination can be inspected visually. And the tensile strength is tested (non-destructively) using a simple spring force gauge. There can be up to three terminations per post. Yet you can remove any one without disturbing the others. A simple hand extraction tool makes it easy.

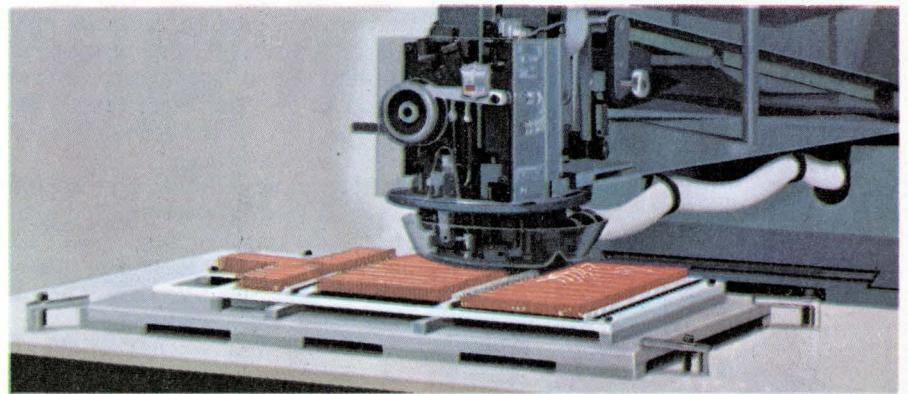

Two types of AMP application tools

One is a numerically controlled and fully automated machine. It wires panels on a pre-determined pattern by means of a programmed tape. On a grid of .001". For example, on a .156" by .188" edge connector cabled to an IO connector having .200" by .200" grid. This machine can duplicate your present wire routings and produce up to 1000 leads per hour. The other tool is a hand gun. It holds a reel of clips and operates pneumatically. It's ideal for prototype, standard production, or on-spot servicing.



You'll need to know more

If the lower costs and greater reliability of our point-to-point wiring system makes sense to you, learn more about it and its associated connectors and accessories. Write to Industrial Division, AMP Incorporated, Harrisburg, Pa. 17105.

AMP
INCORPORATED

Call on Isomet... the Leader for

Crystals

Optical
Scintillation
Piezoelectric
Electro-Optic
Acousto-Optic
X-Ray Analyzers
Laser Crystals

Electro/ Acousto-Optics

Light Modulators
Laser Q-Switches
Laser Beam Deflectors
Drivers/Amplifiers
Mode Lockers
Tunable Filters

Laser Components

Harmonic Generators
Polarizers
Brewster Windows
Mirrors
Water Optics
Laser Rods
Optical Coatings

Sonics

Acoustic Delay Lines

Isomet's applications engineering department is at your service to provide in-depth technical assistance.

Call or write to
Isomet Corporation
103 Bauer Drive
Oakland, New Jersey 07436
(201) 944-4100

ISOMET

THE WESTERN COLUMN

Ion implantation

Ion implantation (II) is slowly gaining a foothold in microcircuit processing (see *The Electronic Engineer*, January 1969, p. 68). Since January, 1970, Mostek Corp. has been quietly fabricating low threshold MOS/LSI circuits in production quantities, using a proprietary II process. Their p-channel circuits are directly DTL/TTL compatible without any external components. They have shipped more implanted (listed in the Mostek catalog simply

Ion bombardment— another cool process

At a recent meeting of the American Vacuum Society in Anaheim, Professor James Gibbons of Stanford University—a pioneer of ion implantation—described a new low-temperature process for semiconductors. He coated silicon substrates with the same dopant that would have been used for a diffused semiconductor, heated them in vacuum to about 600°C (as opposed to over 1000°C for thermal diffusion), and bombarded them with a high energy proton beam.

For beam energies above 100 eV, the bombarding protons are stopped within the substrate primarily by electron interaction. Below 100 eV, the protons undergo nuclear interactions and can form vacancy-interstitial pairs (called Frenkel defects). As a result, the protons produce vacancies in the silicon lattice at the end of their path, forming a thin layer as shown in the figure below. The depth of this layer can be controlled by controlling the energy of the beam.

The vacancies diffuse away from the layer in both directions. Those that reach the surface meet the dopant, which substitutes itself into the vacancies and begins to diffuse into the substrate. The proton-induced vacancies have the same effect on diffusion as does increased temperature. For example, Dr. Gibbons has seen diffusion rates for boron into silicon increase 1000 times at a given temperature.

The dopant diffuses toward the vacancy layer, as though the effective temperature of the substrate would increase toward this layer. Beyond this

as "full DTL/TTL compatibility") than non-implanted circuits.

The process uses the silicon substrate oriented in the $\langle 111 \rangle$ direction for high channel mobility. Since the dielectric is the conventional SiO_2 , field oxide thresholds over 30 V are achieved with device thresholds between 1.0 and 2.0 V. Device thresholds can be tailored higher or lower by this process. Mostek's process development programs and implantations are carried out at the Sprague Electric R&D Center in North Adams, Mass.

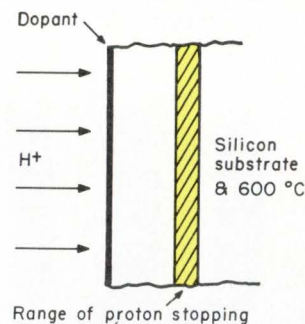

Cool diffusion. Protons bombarded at 600°C penetrate the substrate and create vacancy-interstitial pairs in a narrow layer where they come to rest. Vacancies drift toward the surface and enable the dopant to diffuse into the silicon at a rate comparable to diffusion at a higher temperature.

layer, the effective temperature decreases smoothly to the substrate temperature (600°C) within a distance of about 1000 Å. This yields graded impurity profiles for short diffusion times, and abrupt junctions for long diffusion times. The depth of an abrupt junction made this way, is completely independent of doping level over a range of 8×10^{14} to 5×10^{18} atoms/cm³.

Professor Gibbons has filed patent applications on this process and believes it "could be more significant commercially than ion implantation."

Western Editor

Where's the trend to denser p.c. packing going?

Here's one answer. Actual size.

Use Elco Series 6309 card-edge connectors and you can condense the connectors for ten pc boards into 17.1 square inches. Without paying a premium for the privilege.

That's one thousand contacts. On .100" centers. Ready for wrapping. Easy.

But that's only one answer. We have eighteen others. With contact spacings of .100", .125", .150", or .200", accommodating from 14 to 100 contacts in eight different basic configurations.

And that's not counting our Mojo™ (.150") modular connectors, which obligingly, inexpensively, change their size to suit the job at hand.

Ready to accept your boards. Ready to be mounted on metal plates, frames, and boards and with their tails wrapped for whatever little thing you're making. (We can even do that job for you.)

You'll find all our little helpers in the Elco Card-Edge Connector Guide. Call, write, wire or TWX us for a copy. Elco Corporation, Willow Grove, Pa. 19090. 215-659-7000; TWX 510-665-5573. Or Elco Pacific, 2200 Park Place, El Segundo, California 90245. 213-675-3311; TWX 910-325-6602.



ELCO Card Edge
Connectors

Circle 22 on Inquiry Card

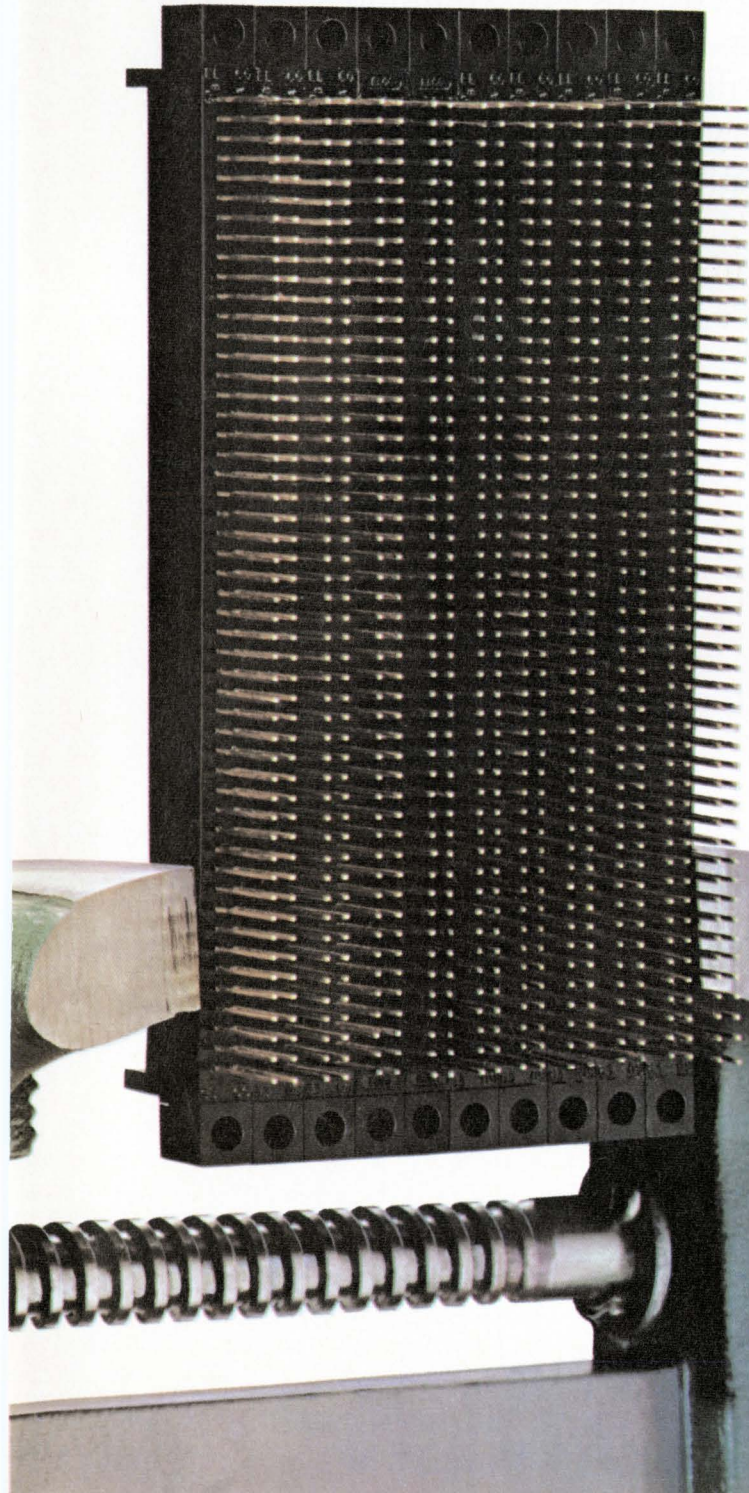

One of the nicest things about our new MSI Multiplexer

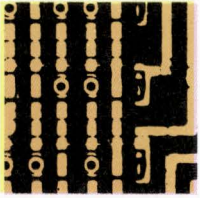

Even multiplexers can't escape the advantages of MSI family planning. (When we plan a family, we plan a *complete* family.) Here's proof: The 9322. Our third extremely versatile MSI multiplexer. A high-speed, quad two-input device that consists of four multiplexing circuits with common select and enable logic. Each circuit contains two inputs and one output.

Of course, the 9322 is ideal for moving data from a group of registers to a common output buss. But, being a very versatile device, it has many other applications. For example, it can be used to generate any four functions of two variables.

This latest addition to our MSI family gives us a well-rounded multiplexer capability. In addition to the 9322, we have the 9309 dual four-input multiplexer and the 9312 eight-input multiplexer which feature complementary outputs.

All three devices offer on-chip select logic decoding, fully buffered outputs, typical through delay of 9ns, and complete compatibility with Fairchild DT μ L, LPDT μ L, TT μ L and MSI families.

To order MSI Multiplexers, call your Fairchild Distributor and ask for:

PART NUMBER	PACKAGE	TEMPERATURE RANGE	PRICE (1-24)	PRICE (25-99)	PRICE (100-999)
U6B930951X	DIP	-55°C to +125°C	\$15.80	\$12.70	\$10.60
U6B930959X	DIP	0°C to +75°C	7.90	6.35	5.30
U4L930951X	Flat	-55°C to +125°C	17.40	14.00	11.70
U4L930959X	Flat	0°C to +75°C	8.70	7.00	5.85
U6B931251X	DIP	-55°C to +125°C	15.80	12.70	10.60
U6B931259X	DIP	0°C to +75°C	7.90	6.35	5.30
U4L931251X	Flat	-55°C to +125°C	17.40	14.00	11.70
U4L931259X	Flat	0°C to +75°C	8.70	7.00	5.85
U6B932251X	DIP	-55°C to +125°C	15.80	12.70	10.60
U6B932259X	DIP	0°C to +75°C	7.90	6.35	5.30
U4L932251X	Flat	-55°C to +125°C	17.40	14.00	11.70
U4L932259X	Flat	0°C to +75°C	8.70	7.00	5.85

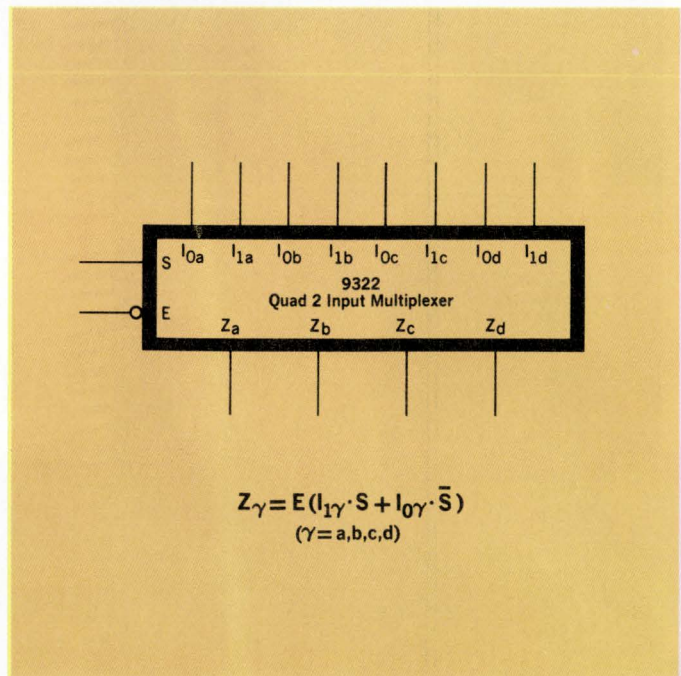

is the family it comes from.

We put together a family plan by taking systems apart. All kinds of digital systems. Thousands of them.

First we looked for functional categories. We found them. Time after time, in a clear and recurrent pattern, seven basic categories popped up: Registers. Decoders and demultiplexers. Counters. Multiplexers. Encoders. Operators. Latches.

Inside each of the seven categories, we sifted by application. We wanted to design the minimum number of devices that could do the maximum number of things. That's why, for example, Fairchild MSI registers can be used in storage, in shifting, in counting and in conversion applications. And you'll find this sort of versatility throughout our entire MSI line.

Finally, we studied ancillary logic requirements and packed, wherever possible, our MSI devices with input and output decoding, buffering and complementing functions. That's why Fairchild MSI reduces—in many cases eliminates—the need for additional logic packages.

The Fairchild MSI family plan. A new approach to MSI that's as old as the industrial revolution. It started with functional simplicity, extended through multi-use component parts, and concluded with a sharp reduction in add-ons. Simplicity. Versatility. Compatibility. Available now. In military or industrial temperature ranges. In hermetic DIPs and Flatpaks. From any Fairchild Distributor.

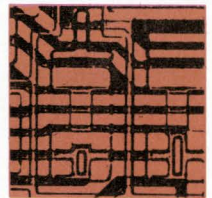

OPERATORS
9304—Dual Full Adder/Parity Generator



LATCHES
9308—Dual 4-Bit Latch
9314—Quad Latch

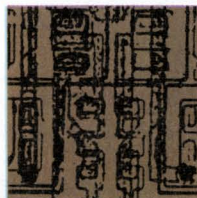

REGISTERS
9300—4-Bit Shift Register
9328—Dual 8-Bit Shift Register

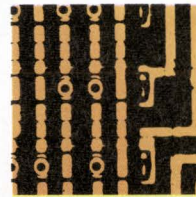

MULTIPLEXERS
9309—Dual 4 Input Digital Multiplexer
9312—8-Input Digital Multiplexer
9322—Quad 2-Input Digital Multiplexer

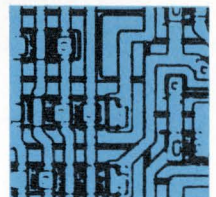

DECODERS AND DEMULTIPLEXERS
9301—One-Of-Ten Decoder
9315—One-Of-Ten Decoder/Driver
9307—Seven-Segment Decoder
9311—One-Of-16 Decoder
9317—Seven-Segment Decoder/Driver
9327—Seven-Segment Decoder/Driver

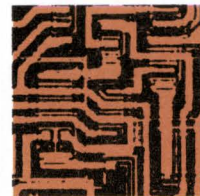

COUNTERS
9306—Decade Up/Down Counter
9310—Decade Counter
9316—Hexadecimal Counter

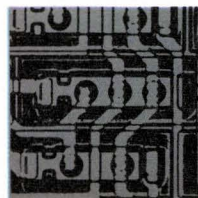

ENCODERS
9318—Priority 8-Input Encoder

FAIRCHILD
SEMICONDUCTOR

PRODUCT SEMINARS

This column lists product seminars that electronic companies offer to users of their products.

Power Supply Seminar: Aug. 26 & 27, at WESCON. The optional character of linear regulators is the subject of this seminar sponsored by Kepco to be held during the WESCON show. The readers of our magazine may receive complimentary tickets. Simply write to Mr. Art Rippeon at Windsor Dynamics, Box 5500, Sherman Oaks, Calif. 91413, and

Circle 495 on Inquiry Card

RFI/EMC Instrument Training: Sept. 7-11, Amsterdam, no charge. You'll be interested in this seminar if you're a user of signal acquisition, recording, processing and analysis equipment, and systems used in the measurement of electromagnetic interference tests and other applications. The company's Spectrum Surveillance System Model FSS-250, including computer control, will be used in training, but most of the techniques taught are applicable to any state-of-the-art surveillance system. Fairchild Electro-Metrics Corp., 88 Church St., Amsterdam, N. Y. 12011.

Circle 496 on Inquiry Card

Techniques of Designing and Implementing a Data Communication System: Sept. 14-18, Chicago. Seminar Manager, Honeywell EDP, 110 Cedar St., Wellesley, Mass. 02181.

Circle 497 on Inquiry Card

Operation, Calibration and Maintenance of SDC Instruments: Sept. 14-18, San Diego, \$200. Here is a basic, practical seminar designed for those of you with a thorough understanding of basic solid-state circuit fundamentals. You'll apply this background to the operation, calibration and maintenance of SDC instruments. Spectral Dynamics Corp. of San Diego, Box 671, San Diego, Calif. 92112.

Circle 498 on Inquiry Card

Theory and Operation of Data Acquisition Systems: Sept. 14-25, Denver, \$360. The main objectives of this seminar are to enable the operator/technician to understand and use his system to its maximum capability, and to assist the buyer/planner in the selection of the most appropriate equipment. Honeywell Inc., Test Instruments Div., Box 5227, Denver, Colo. 80217.

Circle 499 on Inquiry Card

Product Noise and Vibration Measurement: Sept. 15-17, Cleveland, \$100. Recommended for those with a basic sound or vibration background, or those who have attended an earlier basic seminar course. This seminar is

an advanced study of sound and vibration measurements, analysis techniques, practical applications for product design, and quality control criteria. B & K Instruments Inc., 5111 W. 164th St., Cleveland, Ohio 44142.

Circle 500 on Inquiry Card

The image displays several North Electric Standardized Modular Power Units (MEPs) of various sizes and configurations. Some units are shown in their original packaging boxes, which are labeled 'North Electric Standardized Modular Power Units'. The units themselves are black, rectangular boxes with a front panel featuring a label and several control points. The units are arranged in a cluster, showing different models and sizes.

MODEL	10000
HEIGHT	3.19
WIDTH	3.75
DEPTH	6.50
VDC AMPERES	
0-7.5	2.10
0-16	1.25
0-25	0.85
0-33	0.68

MODEL	11000	12000	13000	14000	15000	16000	17000	18000
HEIGHT	3.19	3.19	4.94	4.94	4.94	4.94	3.50	5.25
WIDTH	4.94	4.94	4.94	7.50	7.50	7.50	19.00	19.00
DEPTH	6.50	9.41	9.41	9.41	11.75	16.50	16.50	16.50
VDC		AMPERES						
3.7	4.0	5.6	12.0	14.0	21.0	33.2	50.0	87.0
5.0	3.9	5.3	11.3	13.0	20.0	32.5	49.0	82.0
6.0	3.5	5.0	10.5	12.8	19.0	31.0	47.0	82.0
12.0	2.8	4.2	8.0	10.5	15.0	23.0	36.0	58.0
15.0	2.4	3.7	7.5	9.5	14.0	20.5	27.0	47.0
24.0	1.5	2.8	4.2	7.0	11.0	15.0	21.0	33.0
28.0	1.4	2.4	4.0	6.3	9.0	14.0	20.0	29.0

Note: Specifications subject to change without notice.

This column welcomes new companies or new divisions in the electronics industry.

Put your memory to a test

Just a few months ago Technitrol Inc. of Philadelphia purchased the Honeywell Computer Control Division's memory test products business

and its manufacturing assets. Technitrol has established a new division to design, manufacture and distribute the test instruments and systems. They're working full force towards the development of this addition, the third

working division of the company, and already have field sales and service engineers available to serve customers on an international basis.

Richard Grossman, local sales manager for the new division, tells us that this acquisition is simply "an extension of our present business interests. We've served the memory market in the past with products such as magnetic networks, pulse transformers, delay lines and specialized test equipment. Honeywell worked with the same clientele, so we are now servicing the same customers but offering them an extended range of products."

Those responsible for the operation of the new division are William McDermott, vice president for operations at Technitrol; the division manager, John Eichert; his chief engineer, Joseph Fitzpatrick and special assistant Pat Stanley, former chief engineer of the Honeywell MTP group. Initially, the division will specialize in the design and manufacture of memory test products for core and plated wire memory stacks and planes.

Test equipment modules offered by the new division include current drivers, triggers, timing generators, difference amplifiers, discriminators, calibrators and enclosures. Among the major pieces of equipment is the Model 3601 general purpose memory exerciser that generates 65,536 addresses of up to 80-bit words with system cycle speeds as fast as 150 ns. Another memory exerciser, Model 3602, runs a memory through all its paces in various combinations of tests. And the Model 3702 is a new generation test system for development and production testing of magnetic core memory planes and stacks. Available plated wire test equipment includes on-line testers, wire handlers and accessories and digital program generators.

After having met the challenge of memory testers, Technitrol's new division will expand into other automatic test fields, such as testers for semiconductors, ICS, MSI and LSI. The new product list will also include multiplexed passive and active component testers, assembled circuit testers and continuity testers.

Circle 494 on Inquiry Card

The new standard in standardized power modules.

For 37 years North Electric has been meeting the exceptional requirements of the custom power equipment market. Now, out of this experience and the engineering skills developed by North, comes a great new line of standardized power modules . . . All designed to give you more versatility and a new high in power reliability! Send for North's new Standardized Power Catalog and start buying your custom power and standard power from one great source . . . NORTH. Call 419/468-8244 (or TWX 419/468-4860) for immediate service. Attention Product Manager, Standard Power Equipment.

*North Electric Company
Electronics Division / Galion, Ohio
A Subsidiary of
United Utilities, Incorporated*



NORTH ELECTRIC

TOMORROW many systems will use Solid State Relay Hybrids We have them TODAY

These six new devices expand dramatically your range of switching options. Now, you can conveniently interface semiconductor logic circuits with inductive loads such as motors, solenoids, or relays. Inputs as low as 5 microwatts can be used to switch 7 ampere loads, for example. Many millions of times, too.

Input/output isolation normally associated with relays is maintained. Installation is conventional, too . . . direct onto printed circuit boards or in a wide choice of sockets. These new products represent a happy melding of semiconductors and relays to enhance the qualities of both. Here is a look at tomorrow's switching devices. We have them today!

- ① **SOLID STATE/REED AC SWITCH** Our JDB Series has a height of only .275". It offers the input/output isolation of a reed relay plus the power switching capability and long life of a thyristor. Its 1 Form A contacts will switch loads of 1.7A rms at 25°C ambient for more than 10 million times.
- ② **AMPLIFIER-DRIVEN JDT RELAYS** Signals as low as 25 microwatts will operate this modified version of our low profile, Thin-line JDT Series. Two dry reed contact forms are available: 2 Form A and 4 Form A. In the 2 Form A configuration, input voltages range from 5 to 24 VDC. In the 4 Form A package, from 12 to 24 VDC. This Series—our JDA—allows for 0.5" centers for printed circuit boards.
- ③ **ALTERNATE, DIRECT-ACTION, IMPULSE RELAY** This hybrid relay is unique. The DPDT relay employs a permanent magnet in parallel with its normal, single coil, magnetic circuit. Added to this is a solid state flip flop circuit. Thus, our KUR Series has both permanent memory and alternate action features and is controlled from a single, non-polarized, DC source. Contacts are rated 5 or 10 amperes. Because the KUR is designed to transfer its contacts when it receives a specified input pulse and then hold in that mode with or without power, it is recommended for on-off operation or alternate energizing of two loads.
- ④ **AMPLIFIER-DRIVEN KUP RELAY** The KUA Series significantly expands our family of KUP general purpose relays. Its sensitivity is in the 25 microwatts range . . . and its

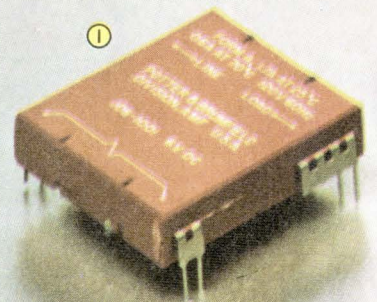

New from P&B! solid state relay/hybrids that advance the art of switching

DPDT contacts will switch 5 amperes at 28 VDC resistive or 120V 60 Hz, 80% P.F. It is designed for continuous duty and to fit the wide choice of KUP sockets and enclosures.

⑤ **SOLID STATE HYBRID RELAY** Our EBT Series is a solid state AC switch controlled by a reed relay. This device will switch 7 amperes rms, 60 Hz at 25°C ambient. It is fast (operate time is approximately 2 milliseconds), and the relay provides input/output isolation. Coil voltages range from 6 to 48 VDC. Convenient octal-type socket mounting is provided. Life greater than 10 million operations can be expected.

⑥ **SENSITIVE SOLID STATE HYBRID RELAY** Our EBA Series is similar to the EBT (above) except considerably more sensitive. It will accept a signal of only 12 microwatts. It, too, will switch a 7 ampere load in 2 milliseconds and, like the EBT, incorporates an RC network for dv/dt suppression. As semiconductors accomplish the switching, it is bounce-free.

These devices widen the dimensions of electromagnetic switching. They are engineered and tooled. They offer a ready solution to going from low power logic sources to work-performing loads. Information is available from your P&B representative or contact the factory.

Potter & Brumfield
Division of American
Machine & Foundry Company,
Princeton, Indiana 47570.
812/385-5251.

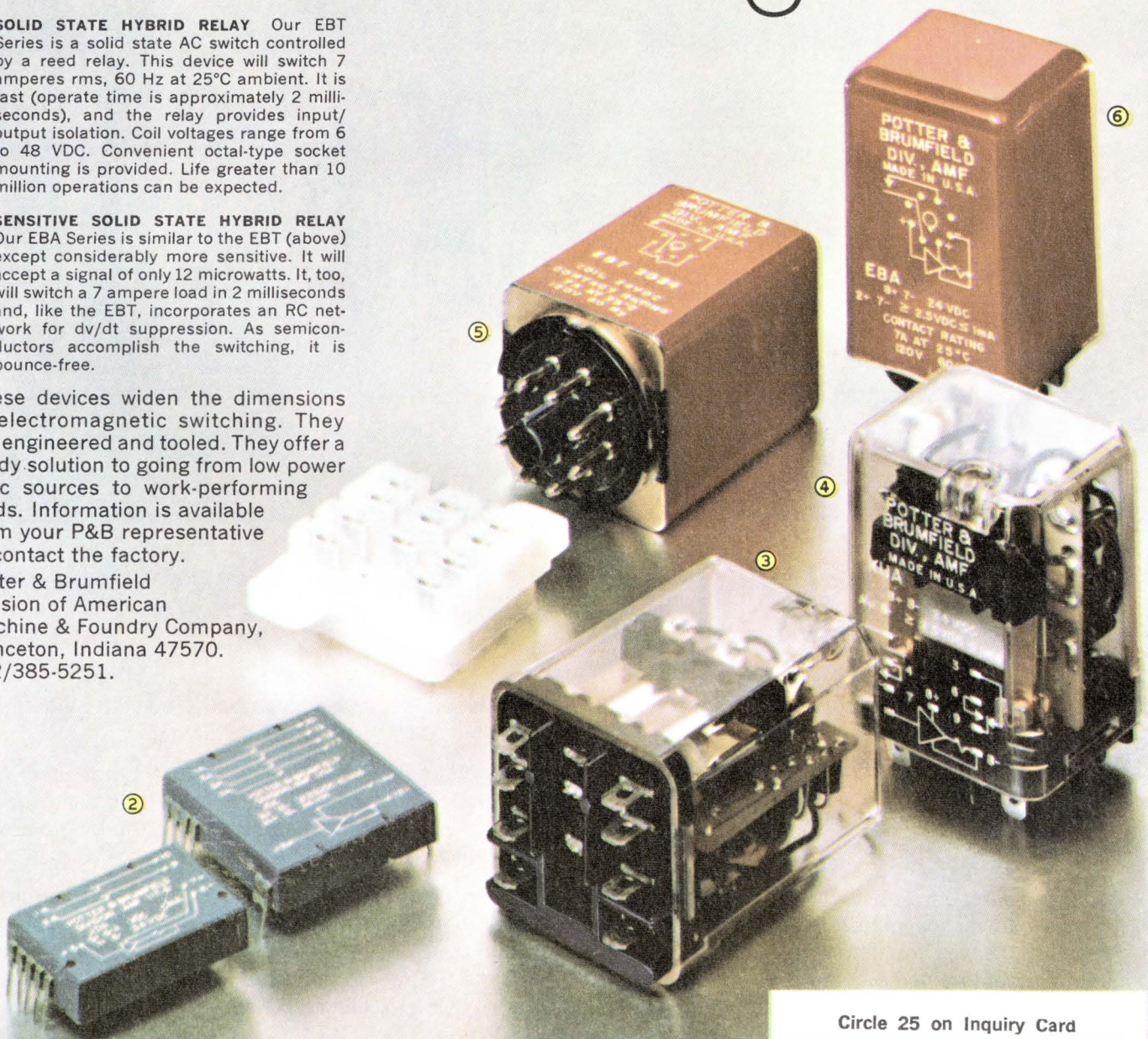

Circle 25 on Inquiry Card

The beauty of this connector...



it saves you a pretty penny.

Sure, Amphenol's new Excellite audio/electronic connector is beautiful. It's strong and light weight, too. Made from the same tough, molded ABS plastic used in pro football helmets and golf club heads. The lustrous nickel plating enhances the look and value of your product.

But where it really sparkles is on the money it saves you. First off, it costs less to buy. The savings from new, lower cost materials are passed on to you. Secondly, it saves you time in termination. Excellite cable connectors come completely assembled, not as a bag of parts. Your production people aren't

burdened with assembly or bothered with parts that don't fit or are missing. We do all that.

The Excellite line provides a full complement of distinctive 3, 4 and 5 contact connectors that are completely interchangeable and intermateable with all latch-lock type audio connectors.

For complete information on Excellite audio/electronic connectors, send for your free copy of Catalog EX-1. Amphenol Industrial Division, The Bunker-Ramo Corporation, 1830 South 54th Avenue, Chicago, Illinois 60650.

Circle 26 on Inquiry Card



AMPHENOL
THE BUNKER-RAMO CORPORATION

MOS Course—Part 5C

Associative memories

MOS associative memories p. 54

By Arthur J. Boyle,
Technical Editor

This is the third consecutive month that our MOS course has been concerned with memories (June dealt with random access and July with read-only memories). From this emphasis you should have a pretty fair idea of where MOS is getting its biggest play. This month, our course discusses associative, or content-addressable, memories (CAMs).

Associative memories have one prominent feature that sets them apart from their RAM and ROM cousins. In both a ROM and a RAM, data is stored in a specific location in the memory. When you want to retrieve this data, you must know exactly where it is stored (its address).

The CAM, however, locates and retrieves data as a function of the data itself, not as a function of an address. With a content-addressable memory, the address is an addendum to the data rather than the search criteria.

It took LSI

Associative memories are certainly not a new concept. The idea was first conceived in the early 1950s, and a paper¹ presented in 1956 proposed just such a memory that was implemented with cryotron logic and storage arrays. (Cryotron elements are 4-terminal, superconductive devices. A magnetic field, produced by an input current, controls the transition of the element between its two stable states.) Actually, cryogenic is certainly not the easiest technology to design into a computer and yet, despite this drawback, the associative memory generated a lot of interest even then. It remained, however, for the advent of large scale integration of semiconductors to make the associative memory practical. As late as 1966, a survey of these

devices laments, "The major drawback to the development of content-addressable memories is the lack of a suitable associative cell in a practical technology at an acceptable price."²

The content-addressable memory is similar to the random access memory in that it has read/write capability. But it combines this capability with the ability to perform logic functions. It can compare its contents to an external search criteria, decide if there is a match between the two, and then remember the location of each word that did match the search criteria. In a typical operation, some portion of a word is specified as the search criteria and the rest is ignored (masked). The CAM then searches through all words in memory in one pass and compares each with the search criteria.

Made to order applications for the CAM include sorting, merging and pattern recognition. A brand-new application uses them to allocate memory in time-shared computers. In conventional systems, a great deal of programming time is spent in assigning and keeping track of addresses. In certain applications, the CAM could eliminate the need for this type of book-keeping.

Despite its years, the associative memory is still at a very early stage in its development. Before practical LSI, it was no more than a curiosity and it's going to take some time for designers to get used to it. But once they do, new applications are undoubtedly going to appear. Just how big the potential market is, no one really knows. But whatever its size, right now, MOS has a head start toward grabbing the whole pie.

1. A. E. Slade and H. O. McMahon, "A Cryotron Catalog Memory Systems," *Proc. EJCC*, Vol. 10, Dec. 1966, pp. 115-120.

2. A. G. Hanlon, "Content-Addressable and Associative Memory Systems—A Survey," *IEEE Trans. on Electronic Computers*, Vol. EC-15, No. 4, 1966, pp. 509-521.

MOS course—Part 5C

MOS associative memories

Storage plus logic, that's an associative memory.

With that combination, what could be more natural than MOS/LSI.

By **Leon D. Wald***

Honeywell Inc., St. Paul, Minn.

Associative memories and associatively organized systems, which have received increasing attention in the past few years,¹ have recently come into their own through the development of LSI technology making these devices a practical reality. In explaining the principles of an associative memory, we will use as an example an associative storage cell, comprised of MOS transistors, that has been fabricated as an array of 128 cells. Organized as 16 words of 8-bits each, the array is designed as a building block for large associative systems. Each array, consisting of 1296 transistors, is on a silicon chip about 0.11 by 0.13 in. The arrays, which have a cycle time of 300 ns in a memory system environment, are capable of considerably faster operation in small memory modules.

Operation of an associative memory (AM) can be explained by comparison with a conventional random access memory (RAM). For instance, each data storage location in a RAM is assigned an address and data is stored and retrieved by specification of the corresponding address. In an associative or content addressable memory, however, data words may be assigned locations at random. Data is retrieved on the basis of some aspect of the stored information itself. For example, you can search or interrogate the memory for all words that match a specified key or argument in a specified field

within the word. All other bits or fields of the stored words are ignored during the interrogate operation (these bits are said to be masked). It is important to note that all words in memory are searched in parallel, i.e., during a single search cycle all responding words are flagged simultaneously.

The equality search described above is the simplest and most basic associative operation. Many others are possible, such as extremum (maximum, minimum), inequality (greater than, less than) and nested (combination) searches, and such non-search operations as counting, incrementing, and arithmetic processing of all words in parallel. Most of these more complex operations may be achieved as sequences of equality searches.

From this discussion of associative memory capabilities, you can see their usefulness in list processing applications. An AM is most useful in systems that require rapid access to data tables that cannot be conveniently ordered with respect to the parameter involved or that require similar processing (such as incrementing) of many words in a table. Applications of the former type arise when items are constantly being added and deleted from the stored table. This type of system is also used when table look-up must be performed variously with respect to several parameters (fields) of the stored words. Parallel processing requirements occur when you must keep track of (tag) table entries having some common property; increment or decrement a priority factor every time an entry responds to a search; or add a common constant to some field of every item in the table. Among the applications having such requirements are multiprocessor central control,² video and radar data processing, character recognition, com-

*This article has been prepared by the author from a paper given by him at the National Aerospace Electronic Conference, Dayton, Ohio, on May 19, 1970.

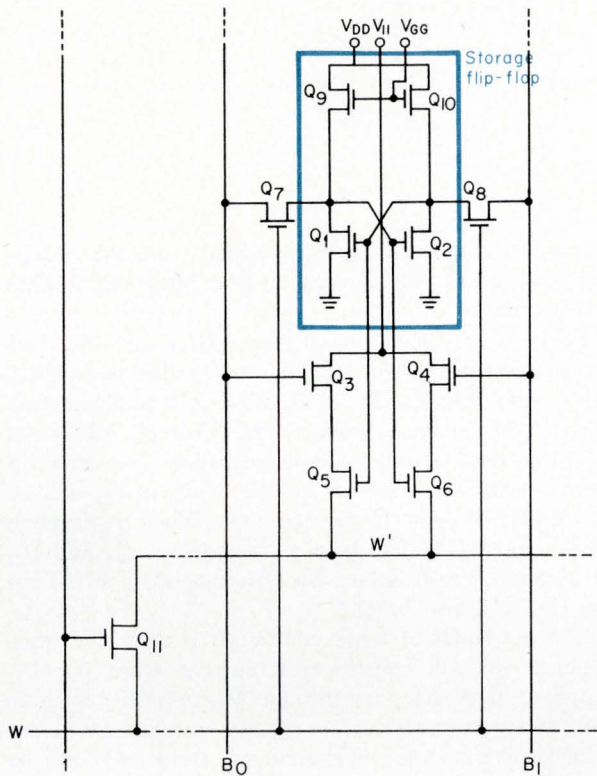

Associative memory cell circuit diagram.

A memory write/search/read sequence. The waveforms are from one word of the MOS array described in the text. The array at the time was operating with a 300-ns cycle time.

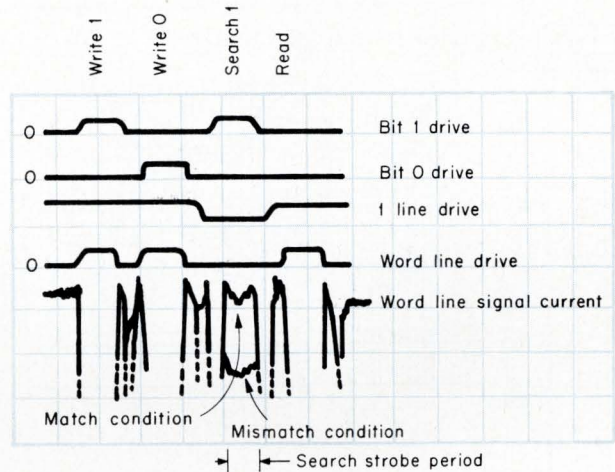

munication multiplexing, message encoding/decoding, and signal processing.

There are many possible hardware configurations for realizing the AM capabilities described above. Among the IC technologies, non-complementary MOS was selected as the best compromise for low-cost systems of moderate size, speed, and power dissipation. At the present state of the art, MOS technology permits fabrications of a greater number of bits of complexity in a given silicon area at lower cost than any other approach, and this advantage is likely to remain for some time.

The basic cell

Several MOS associative memory storage circuits have been proposed^{3, 4}. Within the limits of the non-complementary MOS technology, the described cell was designed for optimality in the following respects.

- Memory cycle time
- Power dissipation
- Number of interconnection lines
- Flexibility of operation

These objectives dictate a low impedance, complementary (dual-rail) drive configuration, and the detection of output signals as currents rather than voltages. Also, input and output signals must be multiplexed on the same lines and information stored as a capacitive charge. To achieve better cycle times, the cell uses bipolar sense/drive circuitry.

This particular design allowed little or no logic in addition to the basic cells on the chip because of a need for interconnection flexibility. The circuit diagram for the basic cell is shown in Fig. 1. Information is stored in the flip-flop consisting of Q_1 , Q_2 , Q_9 ,

and Q_{10} . The latter two transistors serve as switched load resistors. These may be normally off, but must be switched on at least a small percentage of the time to restore the flip-flop voltage lost to leakage current. The selection transistors, Q_7 and Q_8 , enable the cell to participate in "write" and "read" operations. Transistors Q_3 , Q_4 , Q_5 , and Q_6 comprise the EXCLUSIVE OR function required for the associative search. These operations will be discussed in detail later.

The cell was designed to operate with a cycle time of less than 300 ns in either write, read, or search modes. Experimental measurements have indicated faster operation in a simulated memory environment.

Since the storage cell allows pulsed operation of the basic power source through switching of the load transistors, Q_9 and Q_{10} , quiescent power dissipation can be made very small. The impedance of these transistors can be increased without affecting switching speed because cell capacitances are charged (and discharged) through much lower resistance devices. In fact, a long sequence of memory operations can be performed with no restore current required through Q_9 and Q_{10} . Power dissipation is less than 100 μ W/cell and an order magnitude lower standby dissipation is possible.

Additional power consumption due to memory operations will normally be significant only in the interrogate mode. Theoretically, the comparison transistors (Q_3 and Q_5 or Q_4 and Q_6) may be drawing current simultaneously in all cells in the memory. However, for the practical worst case with exclusively search instructions, an average of 50% of the input search word would be masked and 50% of the considered memory cells would match the search data. With these assump-

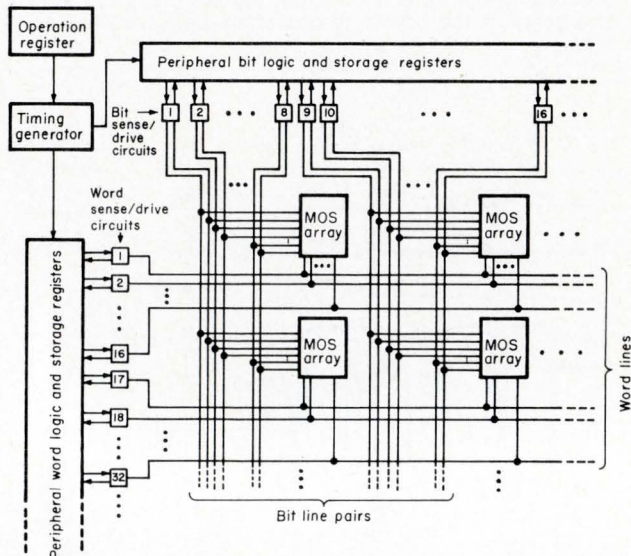

A typical associative memory organization.

tions, the average operating power, even when executing only searches, will not exceed $100 \mu\text{W}/\text{cell}$.

Operating modes

Each chip or array is essentially a small memory, which, with appropriate peripheral circuitry, has three operational modes—read, write, and interrogate (search). The write and search operations are fully maskable in arbitrary combinations of bit positions. Read and write modes may be executed simultaneously on different bits of a given word. As many as all the words in memory may simultaneously be written with the same information in a tag operation. Array cycle time, independent of mode, sequence, or data is approximately 300 ns.

In the write mode, information is supplied in complementary form to the bit lines, B_0 and B_1 . The interrogate (I) line is biased off (near ground). The word(s) to be written is selected by a negative voltage on the associated word (W) line. Transistors Q_7 and Q_8 in all cells in the word selected will be turned on (in the low-impedance state), and the corresponding storage flip-flop is forced to the state impressed on the bit lines. Simultaneous selection of several word lines will cause the specified information to be written into all selected words.

For a read operation the applied voltages are identical to those above, except that all bit lines remain negative. Again, Q_7 and Q_8 will connect the bit lines to the flip-flop nodes of the selected word. In this case, the cell is read by detecting the current that flows in the bit line associated with the low-voltage (on) node. The delay required after word selection (the time until

the sense current can be distinguished from the capacitive charge currents flowing in the lines) establishes access time.

For the interrogate (search) operation, all word lines are unselected and the interrogate (I) line is enabled. Interrogate information is supplied in complementary form to the bit lines. Thus, either Q_3 or Q_4 will be on as a function of the input information (or both off in the masked condition), and either Q_5 or Q_6 will be on, depending upon the flip-flop state. When a mismatch occurs, one of the two pairs of transistors, Q_3 and Q_5 , or Q_4 and Q_6 , will be on. All Q_{11} transistors in the entire chip will also be on.

The net result of these conditions is that each mismatched bit will contribute a current from the V_{II} supply to its W' line, and through Q_{11} to its W terminal. Only if a particular word is exactly matched in all unmasked bit positions will the current from its W pin be zero. As in the read mode, access time is dependent upon the time required to discriminate between the signal and capacitive charging currents.

Conclusions

The associative memory array described here was designed to permit wide flexibility in system organization. While optimized for this purpose, it shows the practicality of building associative memory systems using MOS LSI techniques. In general, a system would comprise a matrix (or several matrices) of MOS arrays with sets of special sense/drive circuits in both bit and word directions to provide an interface to conventional registers and peripheral logic. Corresponding bit, word, control and power pins are connected in parallel to achieve the desired memory word length and number of words within the limits imposed by the need to sense and drive these lines.

References

1. Hanlon, A. G., "Content-Addressable and Associative Memory Systems—A Survey," *IEEE Trans. on Electronic Computers*, Vol. EC-15, No. 4, 1966, pp. 509-521.
2. Gunderson, D. C., Heimerdinger, W. L., and Francis, N. P., "Associative Techniques for Control Functions in a Multi-Processor," Rome Air Development Center, Rome, N. Y., Technical Report RADC-TR-66-573, 1966.
3. Igaroshi, R., and Yaita, T., "An Integrated MOS Transistor Associative Memory System with 100 Nanosecond Cycle Time," *Proc. SJCC (AFIPS)*, Vol. 30, 1967.
4. Herlein, R. F., and Thompson, A. V., "An Integrated Associative Memory Element," *ISSCC Digest (IEEE)*, Vol. XII, 1969, pp. 42-43.

INFORMATION RETRIEVAL
Digital design, Integrated circuits,
Computers and peripherals



POLYCELL + CAD = Custom MOS

Motorola's "New Math" Formula Works Fast For Accurate, Economical Logic Design

Call it "New Math" or old fashioned common sense, Motorola's POLYCELL LSI brings you custom MOS arrays today. The design accuracy, speed, and efficiency of Motorola's POLYCELL approach are realized through the use of optimum sized "building block" cells and an advanced computer aided design facility.

Motorola's POLYCELL LSI for Custom MOS is a total system, starting with the performance specification and logic drawing, and working through design, artwork, fabrication, and testing. With a library of predesigned MOS logic cells at the heart of the system, circuit requirements are quickly and accurately reduced to working arrays. Design errors are quickly identified and corrected through the use of logic and circuit simulation programs proven over a full year of handling customer requirements. Total

design costs are only 40% to 60% of those in lengthy "hand-wrought" methods. To make the system work, Motorola has developed a flexible Customer-Motorola interface arrangement for complete, clear communications insuring full recognition of customer interests and needs — and his understanding of his responsibilities, too. A completely detailed 88 page manual, "MOS POLYCELL LSI," describes the entire POLYCELL program. You may obtain a copy by addressing a request on your company letterhead to Motorola Semiconductor Products, Inc., Technical Information Center, P. O. Box 20912, Phoenix, Arizona 85036.

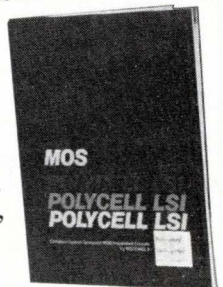

 **MOTOROLA MOS**
... LSI The POLYCELL Way!

Circle 27 on Inquiry Card

The First of the OPERATOR-ORIENTED AUTOMATIC MICROWAVE COLLECTION SYSTEMS

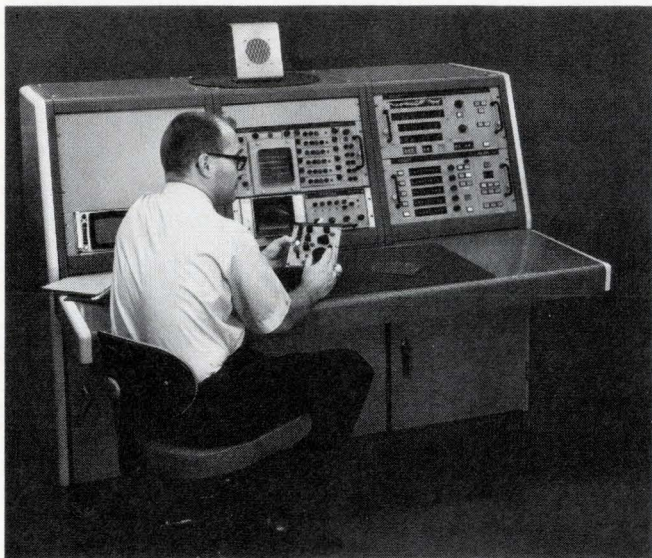

WJ-1007A is a versatile microwave electromagnetic surveillance system capable of automatically detecting, measuring and recording the parameters of all current types of electromagnetic emissions in the 0.5 to 18 GHz frequency range. It is completely modular in organization and construction, making operation as simple as possible.

Environmentally qualified for airborne, shipboard, mobile or fixed-station applications, this second-generation receiver incorporates state-of-the-art improvements in displays and receiver circuitry and components in addition to an automatic signal analysis and recording mode of operation. It instantaneously provides a frequency accuracy and resettability of 1 part in 10^5 .

***And there's more to tell!
See us at our Applications Engineering Suite
at the Century Plaza during WESCON Week.***



3333 HILLVIEW AVE., STANFORD INDUSTRIAL PARK, PALO ALTO, CALIF. 94304 • (415) 326-8830

Designing wideband amplifiers: let the computer help

Using a computer as a design tool produced a 50- to 500-MHz amplifier with high gain, low noise, and good input/output match. The technique is useful from 100 kHz to 1 GHz.

By John A. Eisenberg,

Technical Staff,
Solid State Div., Watkins-Johnson Co., Palo Alto, Calif.

Among several ways to design wideband, uhf amplifiers, are design approaches that use selective mismatching of the active devices to obtain flat gain or various combinations of local and multistage feedback.

To cover a broad bandwidth with a high degree of gain flatness you must compensate for the decrease in the transistor's forward transducer-power-gain, S_{21} , which rolls off at 6 dB/octave as frequency increases. Furthermore, if you wish to make your design compatible with hybrid ic technology, you should use a few inductors as possible. These considerations imply the use of a special class of feedback amplifiers that uses only RC feedback elements—video amplifiers.

And because you can buy inexpensive microwave transistors with 2- to 4-GHz f_T s (gain-bandwidth product) and excellent noise figures, you can get high performance video amplifiers in the uhf region—but at a price of reduced gain and a somewhat increased noise figure. However, you still retain the advantages of very-broad-band performance, good terminal vswr, high repeatability and economy due to the large amounts of feedback, and relative ease of design and fabrication.

Getting started

Before you begin a design you must set your goals. (For example, the amplifier described here was specified to have a decade bandwidth of 50-500 MHz, at least 30 dB gain with ± 1 dB variation, input vswr < 2.5 , output vswr < 2 , and a noise figure < 4 dB.) Furthermore, you must have an accurate and rapid means of

evaluating the anticipated performance of a design before it is built. So you need accurate models of the transistor used and the circuit in which it is embedded.

You also need a computer program which will print out, as a function of frequency, relevant circuit parameters such as transducer-power-gain response, phase response, terminal vswr and, as in all feedback designs, stability criteria.

Since this is to be a video-amplifier design, the basic configuration for a single stage must be chosen. A good choice is a common emitter, dc coupled, feedback pair; it's simple, yet lets you match impedances and still get a reasonable gain. You should model the circuit using

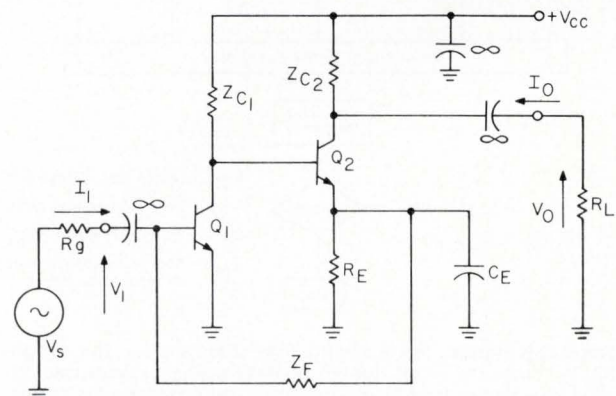

Starting point. A common-emitter pair is a good choice for the building-block of a wideband, uhf amplifier. It's simple, yet still offers a good impedance match and moderate gain. The dc feedback helps to stabilize the bias point.

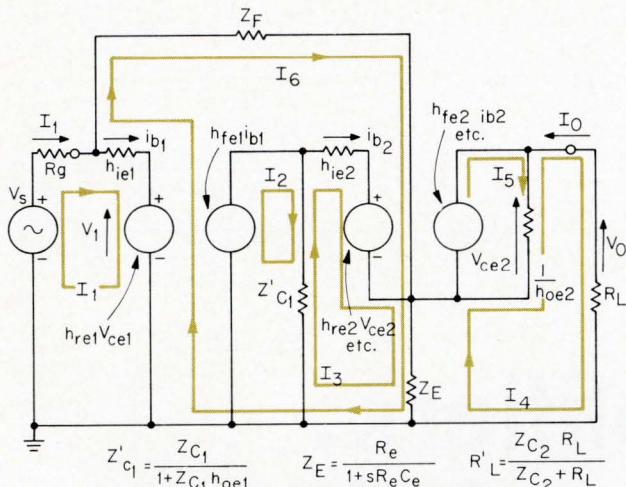

Circuit modeling. This h-parameter representation of the common-emitter pair is convenient for analysis purposes. However, h-parameters are difficult to measure at high frequencies because of the difficulty in establishing the open- and short-circuit conditions that define them. Instead, scattering parameters are measured, and converted from S to h in the computer.

h parameters. But because these parameters are difficult to measure at high frequencies, you can characterize the transistors by measuring their scattering or *S* parameters. The computer program, which tells you the circuit's performance, converts the *S* parameters to *h* parameters with little loss of accuracy.

Analysis

With *h* parameters, you can conveniently analyze the circuit model by means of loop equations. For our single-stage model, there are ten loop equations in all—six loop currents and four dependent, controlled sources defined in terms of input and output currents and voltages. These ten equations can be reduced to three independent equations of the form

$$\begin{bmatrix} A & B & C \\ D & E & F \\ G & H & I \end{bmatrix} \begin{bmatrix} I_3 \\ I_4 \\ I_6 \end{bmatrix} = \begin{bmatrix} J \\ K \\ L \end{bmatrix} V_1 \quad (1)$$

where *A* through *L* are matrix coefficients written in terms of the transistor small-signal *h* parameters and circuit elements; *I*₃, *I*₄ and *I*₆ are loop currents; and *V*₁ is the input voltage. If you solve eq. (1) by Cramer's rule for the independent loop currents *I*₃, *I*₄ and *I*₆, you can arrive at all other loop currents.

Programming the Cramer's rule solution into the computer lets it evaluate all the loop currents necessary to solve for

- Voltage gain
- Transducer power gain
- Input impedance and vswr
- Output impedance and vswr
- Phase of *V*_{out} with respect to *V*_{in}
- Impedance seen by the input transistor when embedded in the circuit
- Stability criteria

And the computer can evaluate these parameters at each frequency for which you provide transistor *S* parameters.

Computer program

Written so that you can use a commercial time-sharing service, the program fully evaluates the performance of the amplifier stage. The program has been optimized for user convenience in altering circuit element values, while retaining the ability to handle complex circuit elements.

The measured transistor *S* parameters at each frequency of interest, and the trial circuit-element values in the form of complex impedances at the lowest frequency under consideration are read into the machine as data. The computer scales the circuit-element impedances with respect to the lowest frequency to yield their correct values.

Enter the expressions for *I*₃, *I*₄ and *I*₆ (see eq. 1) into the computer program. The computer then solves these and enters the results of the calculations into the remaining dependent equations, and evaluates each of the remaining loop currents in the form of a complex variable. Now the computer can solve for any cir-

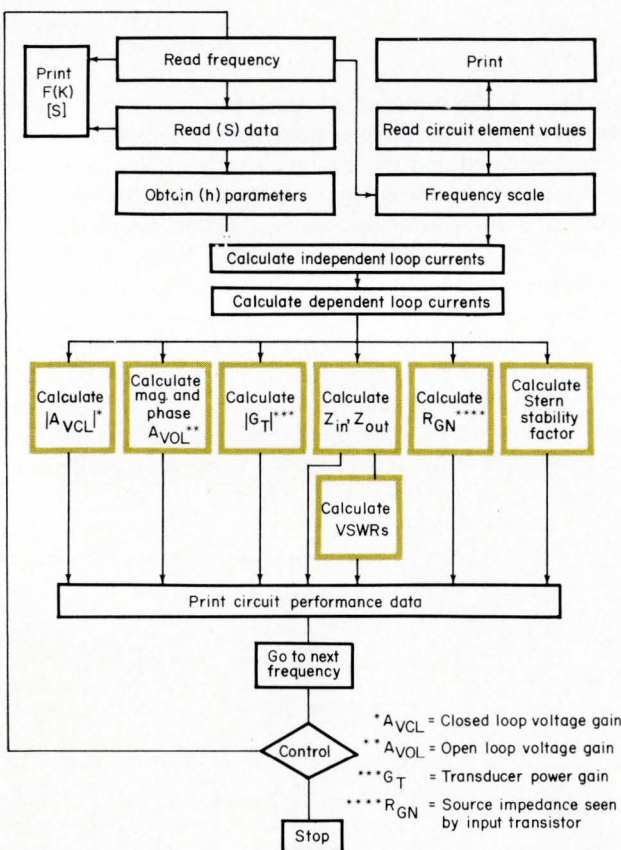

Data calculation. Here is the flow diagram for the amplifier's computer-aided design program. The program evaluates the performance of the common-emitter pair, printing out the parameters shown in the color-bordered blocks. Data inputs are *S* parameters at frequencies of interest, and assumed circuit values. Frequency scaling and circuit element modification are performed at the computer terminal.

- * *A*_{VCL} = Closed loop voltage gain
- ** *A*_{VOL} = Open loop voltage gain
- *** *G*_T = Transducer power gain
- **** *R*_{GN} = Source impedance seen by input transistor

circuit current by linear superposition of the appropriate loop currents, as a function of the transistor parameters and circuit element values. After the computer has obtained all the currents in the model, it can take your equations and solve for the desired circuit performance parameters, which are then printed out. These expressions are functions of the circuit elements, transistor h parameters, and loop currents.

For example, the computer can evaluate the magnitude of the closed-loop voltage gain from

$$A_{VCL} = 20 \log_{10} \left[\frac{R'_L I_4}{V_1} \right] \quad (2)$$

which you enter in the program, and in which A_{VCL} is the closed-loop voltage gain in dB, R'_L is the effective load impedance (including Z_{C2}), and V_1 is the signal voltage of the input terminal of the amplifier. The computer can similarly evaluate transducer power gain, input impedance, output impedance, and terminal vswr as a function of the source and load impedances.

The program also includes two types of stability information: magnitude and phase of the open-loop voltage transfer function at each data frequency, to which you may apply Nyquist's analysis, and the conventional Stern's stability criteria. This data is sufficient to predict unconditional amplifier stability.

Finally, using the loop currents, the program computes the effective source impedance seen by the input transistor when the feedback loop is closed. You can compare this information with the transistor noise figure vs source impedance contours to predict, qualitatively, changes in amplifier noise figure with changes in element values.

Stage performance

A transistor widely used in this frequency range is the Fairchild MT1061A. With the measured S parameters from 50 to 500 MHz, the computer can perform an iteration to optimize stage gain, gain flatness, and match as a video amplifier. You can then build a circuit to check the computer results. Using the above technique, the following data were found.

Freq. MHz	Gain, dB		Input vswr		Input vswr	
	Comp.	Meas.	Comp.	Meas.	Comp.	Meas.
50	13.03	13.7	1.29	1.05	1.51	1.50
100	12.97	13.7	1.56	1.37	1.53	1.50
200	12.98	13.7	1.79	1.59	1.62	1.50
300	13.15	13.8	1.83	1.44	1.47	1.45
400	13.28	13.8	2.06	1.32	1.36	1.39
500	12.02	13.4	1.91	1.44	1.21	1.26

Because of the excellent agreement between the computed and measured data, we decided to use the MT-1061A for all but the first stage of the three-stage video amplifier. (The MT1061A is unsuitable as an input transistor because of its high noise figure in video amplifier service.) Instead, we used a 2N5650 for the first stage; it has a high f_T and a very low noise figure.

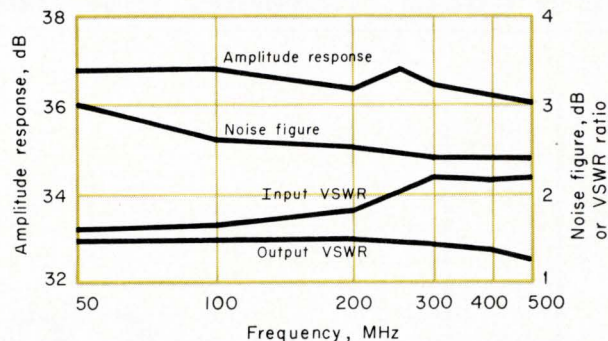

Proof positive. After iterating the parameters of the transistors to optimize gain, gain flatness, and match, you will have a stage that is easy to cascade. Here are the results of cascading three such stages: a decade-bandwidth amplifier which more than meets the original specs.

At this point, you can make a new computer run to optimize the first stage for gain and noise figure at the expense of input match. We did this, and then used a simple two-element matching network to get the required input vswr across the band. The worst-case noise figure of this stage is 3 dB at 50 MHz, where the loop gain is maximum. At 500 MHz, the measured noise figure is 2.4 dB.

Because of the excellent output match of each stage, you can cascade them with little loss of gain flatness. We cascaded three, using the low-noise first stage followed by two MT1061A stages. The result gave us an amplifier which adequately met our original specifications.

Hybrid version

We have built a hybrid ic version of this amplifier in a volume one-tenth of the original, discrete-component circuit. This hybrid uses thin-film technology and unpackaged transistor chips, and in one a one-inch-square alumina substrate. Performance of this amplifier, which is virtually identical to the discrete-component model, has the added advantages of increased manufacturing reproducibility with little or no trimming necessary after assembly.

Acknowledgements

The author would like to thank R. N. Kopeck for the guidance and technical assistance he provided throughout this program, and K. Stiffey, who did much of the prototype fabrication and made many of the microwave measurements.

INFORMATION RETRIEVAL
Microwaves and microwave products,
Amplifiers, Circuit design

The "foremost-in-film-capacitors" people
did it again...another first from Dearborn!

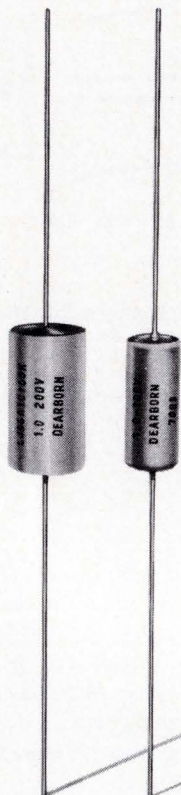

-65 C to +150 C OPERATION WITHOUT VOLTAGE DERATING

NEW! DELTAFILM® 'LJ'
METALIZED POLYSULFONE
FILM CAPACITORS.
OUTSTANDING.

Extended operating temperature range lets you use these new capacitors in applications where film capacitors could not previously qualify. Capacitance/voltage parameters equal to or better than those of metalized polycarbonate capacitors. Extended life expectancy. Improved electrical characteristics. Voltage range from 60 to 200 VDC. Available in hermetically-sealed metal cases as well as wrap-and-fill epoxy end seal construction.

For complete technical information write to:
Dearborn Electronics, Inc.
Box 530, Orlando, Fla. 32802

Dearborn Electronics, Inc.
(a subsidiary of the Sprague Electric Company)

FOREMOST IN FILM CAPACITORS

IC IDEAS

This month's Ideas	Page
No. 923: Pulse rate filter	65
No. 924: Low frequency function generator	65
No. 925: Next pulse synchronizer	68
No. 926: Digital AFSK discriminator	68

Vote for the one you like best.

Write the number of the Idea you like best in the box on the Inquiry Card, and send to us.

Send us practical, reproducible ideas that are original with you and have been implemented with linear or digital ICs.

- If we publish your idea you win a check for \$25.00.
- If our readers vote yours the best of the issue in which it appears, you have your choice of a Simpson 270 or a Triplet 600 multimeter.
- After 12 issues our readers will vote on the best

idea for all 12 issues. The winner gets his choice of either a Hewlett-Packard 1206A or a Tektronix 310A oscilloscope.

Submit your IC Ideas to:
Alberto Socolovsky
Editor
THE ELECTRONIC ENGINEER
Chestnut & 56th Sts.
Philadelphia, Pa. 19139

Here's how you voted

The winning Idea for the March 1970 issue is, "Feedback eliminates switch contact transients."

Veeikko O. Jaakkola is our prize-winning author. Mr. Jaakkola submitted his entry while employed at Teledyne Systems in El Segundo, Calif. and has since returned to his native Finland. He has chosen the Triplet Model 600 TVO as his prize.

In D/A and A/D converters, the people at Teledyne Philbrick Nexus are just beginning.

But you'd never know it.

Today we stand up to be counted.

Counted in the world of digits.

The digital converter business—in depth.

With highly accurate, price-competitive production. Like 10, 12, or 14 bits conversion. And more accuracy in a 16 bit converter on our drawing board—that's well on its way.

We even have timing circuitry that resolves "glitch" problems.

This newcomer really has something. In our case, we think you'll have to convert.

For further information, contact your nearest Teledyne Philbrick Nexus field representative or write, Teledyne Philbrick Nexus, 67 Allied Drive at Route 128, Dedham, Mass.

 **TELEDYNE
PHILBRICK NEXUS**

No. 1 should do more . . .
you expect us to.

Beginning but not beginners

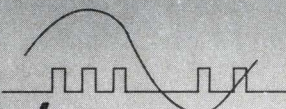
D/A Converters
A/D Converters



923 Pulse rate filter

Quon S. Chow

Northern Electric Laboratories, Ottawa, Canada

Here's a circuit that indicates whether the frequency of an input pulse train is within predetermined limits. You must select the RC combinations such that the period of MONO 1 is about 95% of the input pulse period. Also, MONO 2 must have a period that is short in comparison to that of MONO 1.

The rising edge of the input pulse triggers MONO 1 so that pin 1 goes low. At the end of its time out, the rising edge at pin 1 triggers MONO 2. If the next input pulse occurs during the time when pin 6 of MONO 2 is high, a pulse appears at the output of G_2 and turns off the light-emitting diode. If the period of the input pulse is different from that determined by the duty cycle of the two mono-

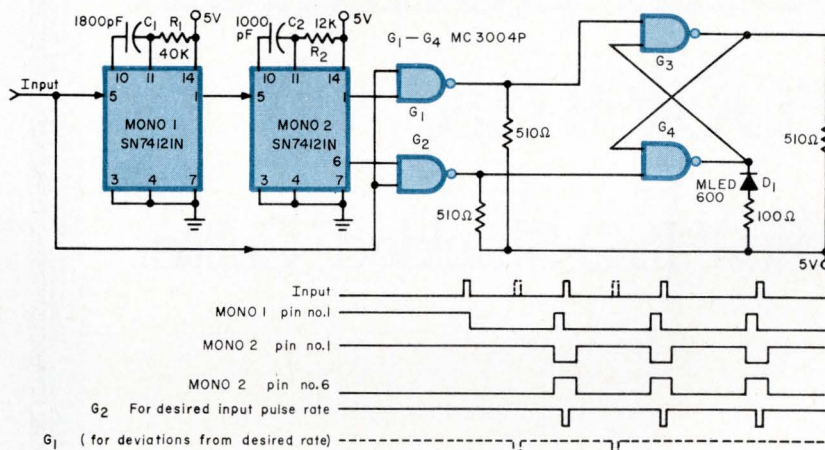

stables, a pulse appears at the output of G_1 and turns on the LED. The LED remains on as long as the input pulse rate is either above or below the desired rate.

The example shown is for a pulse rate of 19.26 kp/s with a pulse width of 260 ns. The LED is turned on for rates higher than 19.7 kp/s or lower than 18.8 kp/s.

924 Low frequency function generator

Barry Schwartz

Sperry Gyroscope, Great Neck, N.Y.

This circuit gives you two sets of waveforms, either triangular and square waves or a sawtooth and pulses. Changing a diode switches the circuit from one set to the other.

The first 741 acts as a standard integrator while the second is a unity gain inverter. The third 741 acts as a comparator with hysteresis through positive feedback.

Let's assume that the diode is not in the circuit and the output of the comparator is positive. The threshold of the comparator is one-third of its output voltage (determined by the R_1 and R_2 divider).

The integrator starts a negative-going ramp. When the comparator's threshold is reached, it switches to a negative output and the new threshold is also negative. The integrator now gives a positive

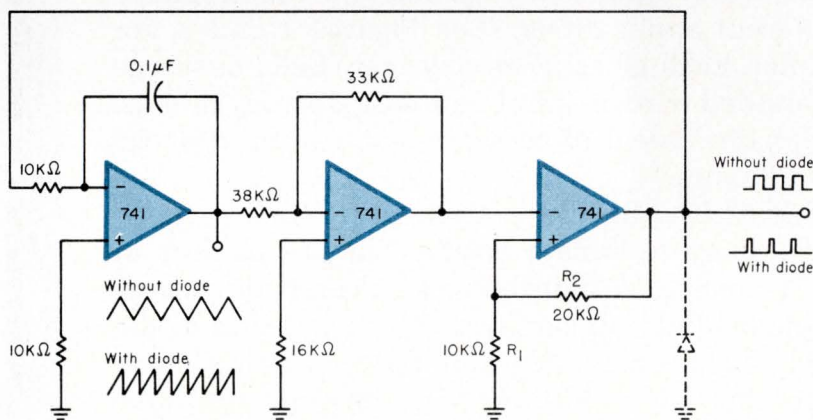

ramp until the comparator's new threshold is reached. In this mode the circuit gives you two triangular waveforms, 180° out of phase, plus a square wave.

For the other set of waveforms, a diode clamps the comparator output to ± 0.7 V. This changes the 50% duty cycle to give a sawtooth

from the triangle and pulses from the square waves.

In either mode, the frequency is determined by the integrator time constant, the power supplies and the comparator divider ratio. The frequency limit is determined by the slew rate of the op amp. In this example, the limit is 5 kHz.

end your signal pollution problems

Beldfoil® ISO-Shielded™ Cable

It's the cable with virtually perfect shielding. It's a Belden exclusive. Beldfoil ISO-Shield is like a continuous metal tube enclosing each pair of conductors in a cable. It locks out crosstalk or interference . . . whether from outside sources or between shielded elements in the cable.

Beldfoil is a layer of aluminum foil bonded to a tough polyester film (for insulation and added strength.) To form an ISO-Shield, we apply it in any one of several unique ways to meet the requirements of different applications. (See Figures 1 and 2, for example). Each gives more physical shield coverage than braided wire or spiral wrapped (served) shields. And greater shield effectiveness . . . even after repeated flexing.

Beldfoil ISO-Shielded Cables are small, lightweight. They terminate easily. They're modest in price. Your Belden Distributor stocks a wide variety of standard Beldfoil shielded cables as listed in the "Belden Electronic Wire and Cable Catalog" (ask him for the latest edition). And, should you have specifications no standard product can meet, ask him to quote on a specially engineered design. Or, if you choose, contact: Belden Corporation, P. O. Box 5070-A, Chicago, Ill. 60680. Phone (312) 378-1000.

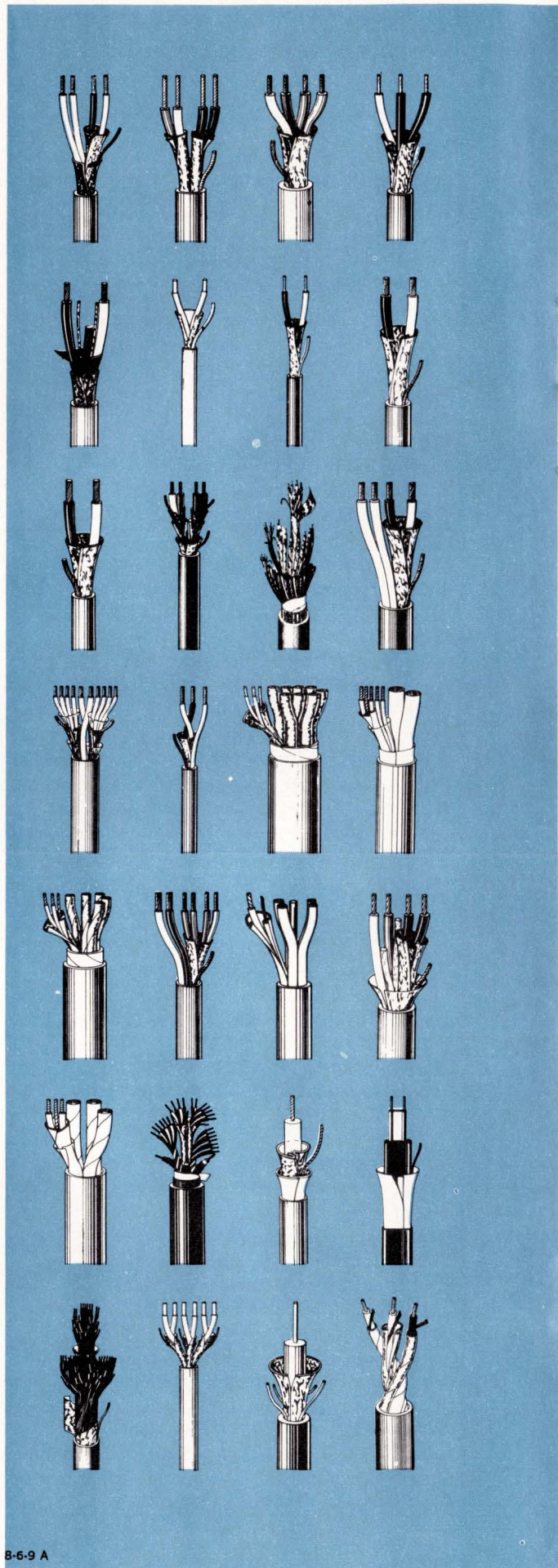

8-6-9 A



Metal (shield) foil, folded to assure metal-to-metal contact.

FIGURE 1

Polyester insulating layer folded to assure isolation between shields.

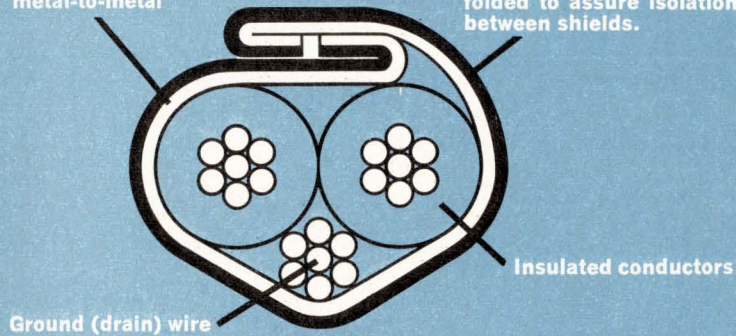

Beldfoil Multiple Pair Individually Shielded Cable

The Figure 1 cross-section shows Belden's exclusive Z-folded Beldfoil ISO-Shield. Note the metal-to-metal contact between the two edges of the aluminum foil. In essence, you have a continuous aluminum tube. And the polyester layer on the outside of the fold assures the isolation between shields so necessary for best performance in the field.

Technical Data

Nominal values for multiple pair individually shielded cables containing 3 to 27 pairs (including 8769 and 8773 through 8778 Series cables)

Suggested working voltage: 300 volts rms max.

Working voltage between adjacent shields: 50 volts rms max.

Capacitance between conductors in a pair: 30 pf per ft. nom.

Capacitance between one conductor and other conductor connected to shield: 55 pf per ft. nom.

Capacitance between shields on adjacent pairs: 115 pf per ft. nom.

Insulation resistance between shields on adjacent pairs: 100 megohms per 1000 ft. nom.

Metal (shield) foil, folded to assure metal-to-metal contact.

FIGURE 2

Polyester insulation layer folded to provide bonus insulation between conductors and shield.

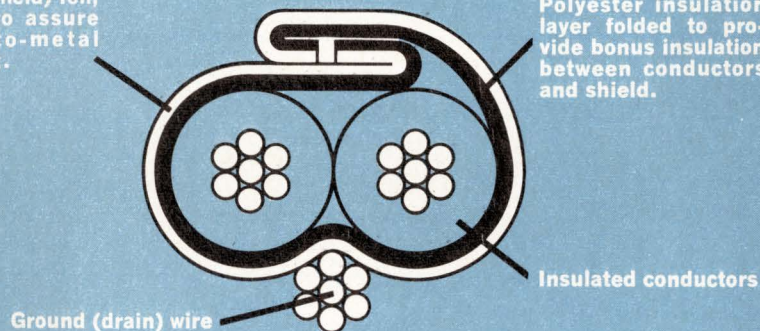

Beldfoil Shielded Single Pair Cable

The Figure 2 cross-section shows the exclusive Belden Z-fold with the polyester insulating layer inward. This makes use of the high dielectric strength of the polyester film as bonus insulation between the conductors and the shield. (The cable jacket provides the primary insulation of the shield from outside objects or adjacent cables.)

Technical Data

Nominal values for 8451 Shielded Pair Cable

Suggested working voltage: 200 volts rms max.

Capacitance between conductors: 34 pf per ft. nom.

Capacitance between one conductor and other conductor connected to shield: 67 pf per ft. nom.

BELDEN

new ideas for moving electrical energy

925 Next pulse synchronizer

Don M. Evans

Lawrence Radiation Lab, Berkeley, Calif.

Have you ever been faced with the problem of synchronizing to an incoming asynchronous gate or pulse? Frequently in an application like this, you can not afford to miss even one clock pulse. This circuit is designed to pickup the next clock pulse in just such an application. In addition, its anti-slice features assure that you get only full width pulses at the output.

With the addition of one-half of a SN7473, you can also use the circuit to synchronize asynchronous pulses to the system's clock. In this application, the level change on the gate input to the synchronizer is replaced with the pulses as shown in the lower figure.

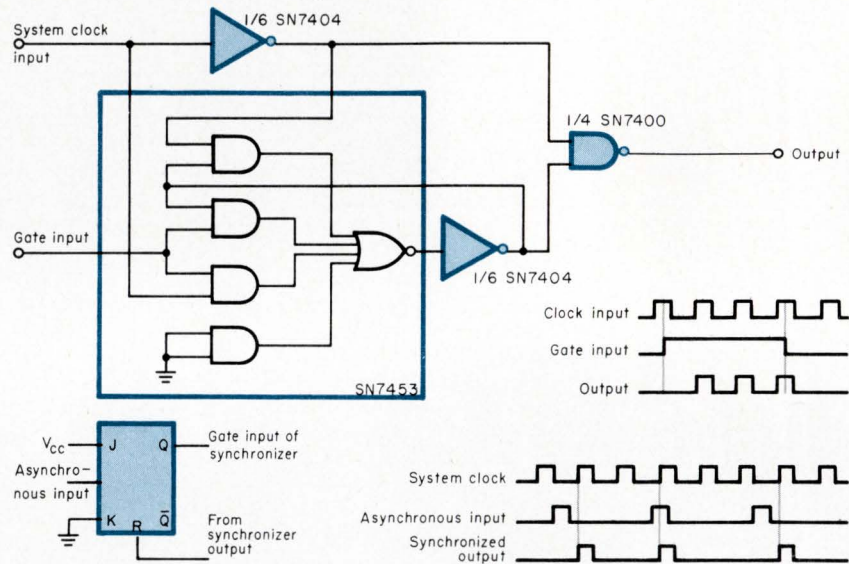

926 Digital AFSK discriminator

Arleigh B. Baker

E. F. Johnson Co., Waseca, Minn.

This AFSK discriminator will operate from 1 to 10 kHz and will detect shifts as narrow as 1%. You can select any pair of frequencies in the range to represent mark, and space by adjusting a delay circuit.

For an example, let 2750 Hz represent a space and 2920 Hz be a mark. The input section of the circuit acts as a limiter and the CA 3020 produces square waves at its differential output. The differential square waves are applied to the J and K inputs of the flip-flop.

The MC724 circuit is connected as a monostable delay network and, in this case, is adjusted for a 175- μ s delay (180° at 2835-Hz mid-frequency). At the end of 175 μ s, the delay circuit strobes the flip-flop. If the input frequency is 2920

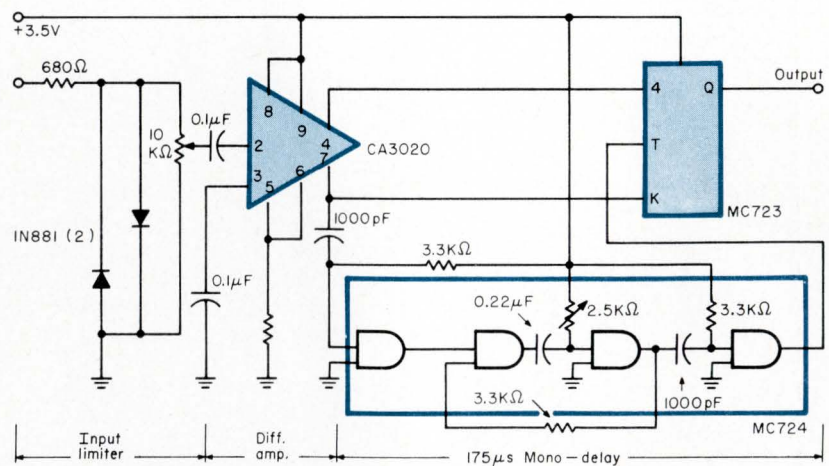

Hz, the J input to the flip-flop will be a 1 and the K input will be 0. Under these conditions, Q = 1 represents a mark.

The circuit was found to have a

resolution of 10 Hz with a mid-frequency of 2835 Hz. Calibration accuracy depends on the time constant components in the delay stage.

Teledyne Philbrick Nexus introduces its combination "Hole-in-One" Chopper Stabilized Operational Amplifiers. The 1412 "Mini-Chopper" that is hermetically sealed and the 1701 Low Cost Discrete Chopper Amplifier, both individually designed to meet your most exacting requirements. Looking for a better than par score? Read the card below.

MODEL 1412 "Mini" chopper-stabilized operational amplifier.

- Miniature Size
- Extremely Low Voltage and Current Drift
- Hermetically Sealed Package
- Low Initial Offset Voltage
- High Gain
- Wide Power Supply Range
- Input/Output Protected
- Cost (\$104 in hundreds)

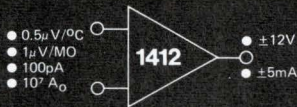

MODEL 1701 Low cost, chopper-stabilized operational amplifier.

- Very Low Voltage and Current Drift
- Low Initial Offset Voltage
- High Gain
- Wide Power Supply Range
- Input/Output Protected
- Low Flicker Noise
- Low Cost (\$49 in hundreds)

Now add up your score card and you'll find that you're a winner when you team up with Teledyne Philbrick Nexus' Analog-State-of-the-Art.

Write today for your free copy of the new 1970 Teledyne Philbrick Nexus Catalog.

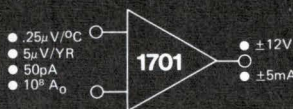

For further information, contact your local Teledyne Philbrick Nexus representative or Teledyne Philbrick Nexus, 35 Allied Drive at Route 128, Dedham, Massachusetts 02026. Telephone: (617)329-1600. Prices F.O.B. Factory U.S.A.



TELEDYNE PHILBRICK NEXUS

No. 1 should do more . . . you expect us to.

Teledyne Philbrick Nexus chopper-stabilized Op Amps reduce your handicap

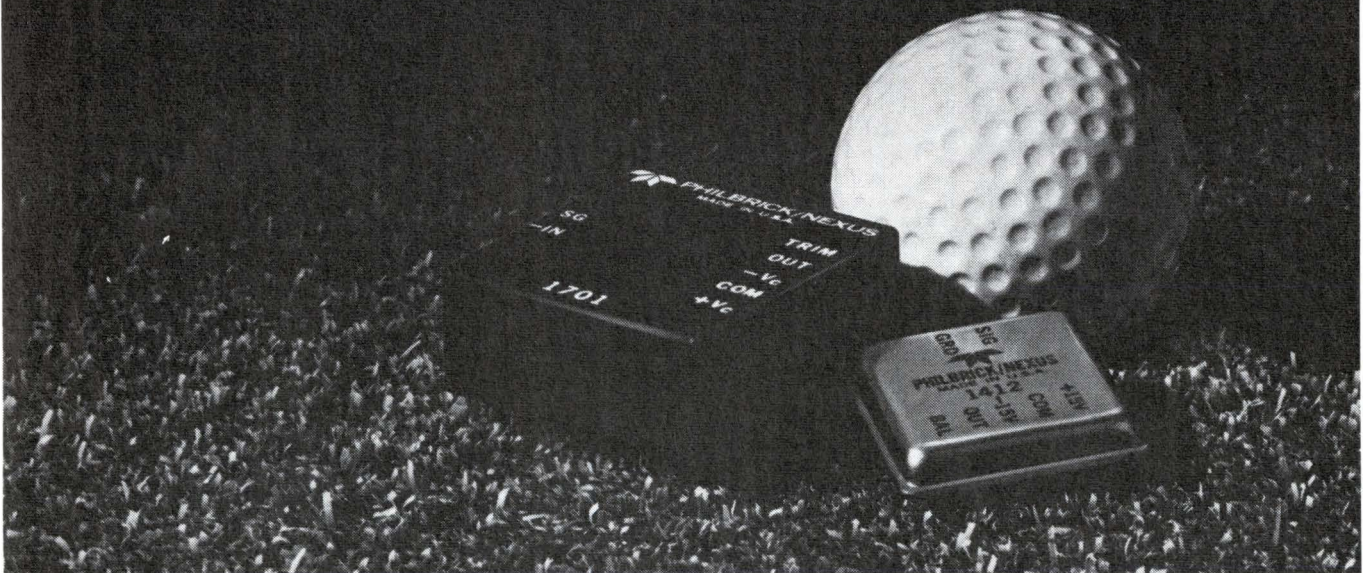

All solid-state true rms arrives

Dana Labs of Irvine, Calif., is showing its new, premium quality, 5-digit DVM at WESCON. The 5800 features a converter that measures true rms without thermocouples! That should keep the purists busy with definitions for some time.

In a manner similar to Dana's computing rms converter, a piecewise linear approximation to a square law is generated with operational rectifiers. One difference from Dana's computing rms converter is that, in the absence of other signals, the "pieces" fit the square law curve such that the true value of the input is always equal to, or greater than, the approximation.

However, a pseudo-random waveform is impressed upon the input signal, adding a correction to the piecewise approximation. The pseudo-

random signal (PRS) is given a probability distribution function such that, in effect, it fills in the error between a true square law and the approximation.

The availability of an all-electronic precision square law allows the use of active filters, and eliminates the dependence on the thermal time constant of a thermocouple. This leads to more precise control of the dynamic characteristics of the converter, making faster rms measurement speeds possible. Since any of three filter positions can be selected from the front panel, frequency response selections may be made down to 10 Hz, 50 Hz or dc coupled, depending on the measurement speed and low frequency response trade-off desired. A waveform with a crest factor of 7:1 must usually be measured at 1 kHz or



higher; the 5800 will measure such a waveform to as low as 10 Hz.

The 5800 can accommodate two ac converters, so it can be used for real-time ac/ac ratios. You can choose from an average responding ac converter. Dana's patented computing rms converter, or the all solid-state true rms converter.

The Programmer Printer Output accessory solves some problems facing users incorporating DVMS into data-acquisition systems. One is the limited lifetime of the reed relays used for crossing the guard shield. The 5800 uses light-emitting diodes and photo transistors in a unique arrangement. These units offer solid-state reliability and TTL compatibility.

The 4-wire Ohms Converter has nine ranges from 1 Ω to 100 M Ω full scale, giving a resolution 10 $\mu\Omega$ and a total measurement range of 10^{13} . It has a floating current source with its own precision zero reference, allowing accurate measurements without degradation due to lead impedance. The selectable 5-pole filters are also provided for ohms' measurements.

The basic dc accuracy of the 5800 is $\pm 0.003\%$ of reading $\pm 0.001\%$ of full scale. Temperature coefficients are 0.0003% of reading and 0.0001% of full scale per $^{\circ}\text{C}$. The three switchable filter positions are all filters out, a five-pole Bessel filter with 30 dB rejection at 60 Hz, and a 5-pole Bessel filter with 100 dB rejection at 60 Hz.

The basic instrument price of about \$3000 includes dc and dc ratio, filtering, and auto ranging. Delivery of the true rms converter is about 90 days. Delivery of the 5800 with any other option is 30 days.

For more information, contact Dana Labs, 2401 Campus Drive, Irvine, Calif.

Circle 299 on Inquiry Card

All electronic true rms. In a, the square law curve is approximated in a linear piecewise fashion. Actually, seven diode breakpoints are chosen such that spacing between them is equal. When the actual value of the input falls at a point where the approximation is exact, i.e., the midpoint of a "piece," the pseudo-random signal (PRS) has no effect because, 1.) its maximum amplitude exactly fills one span of the approximation, 2.) it is symmetrical about the input signal, spending as much time above as below, then cancelling its effect, and 3.) its lowest frequency is very high compared to the measuring time interval.

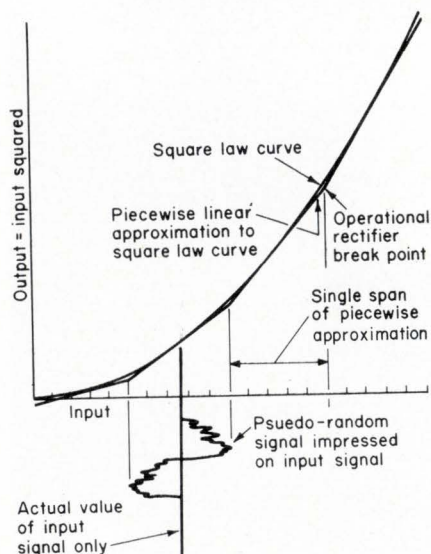

In b, the input value falls where the approximation is not exact. The portion of the PRS between the dashed lines still cancels. The portions at the ends of the PRS' "span" are weighted unequally, because of the different slopes of the portions of the approximation at which they fall. The portion to the right is weighted more heavily, thus adding to the approximate value. The further "off-exact" the input signal is, the more pronounced the effect. Dana claims that it can be shown mathematically that when the PRS is given the proper probability distribution, it will exactly compensate for the error between the approximation and the square law curve.

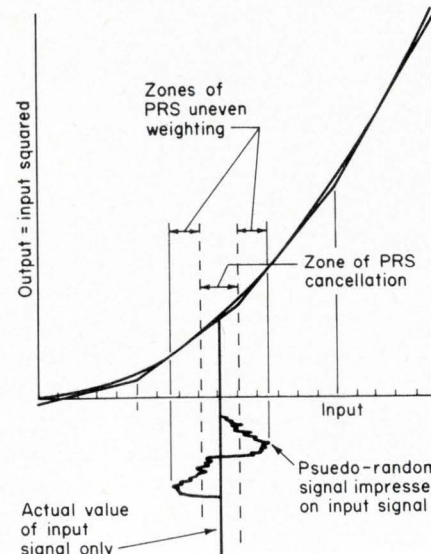

**“LMI^{T.M.}
offers an
opportunity
that is truly
unlimited”**



Copyright © SUCCESS MOTIVATION INSTITUTE, INC. 1970. ALL RIGHTS RESERVED Printed in U.S.A.

“It’s amazing what a man can accomplish when he’s doing something he really believes in. Every day I see absolutely profound effects that Leadership Motivation Institute programs have on both distributors and their customers. There is no ceiling here on a man’s potential!” – Joe DiTorrice, WISCONSIN

Joe DiTorrice is one of several hundred distributors for Leadership Motivation Institute. Joe not only enjoys independence and financial rewards, but he also provides a tremendous service in his community. As a distributor, he serves individuals, businesses and industries, and government agencies with leadership development, executive motivation, and management development programs. Among his many satisfied clients are auto and trucking firms, hospitals, schools, manufacturing companies, engineering consultants, and banks.

Let’s face it: Business has problems today. Most executive training methods simply haven’t kept pace with the dynamic progress of the business and professional world during the last twenty years. Leadership Motivation Institute offers several comprehensive training programs designed to meet today’s need for more capable and productive executives, managers, and supervisors.

This is the business of Leadership Motivation Institute. Wouldn’t you like to be a part of this challenging and rewarding field?

Inquire today! If you qualify, Leadership Motivation Institute offers you immediate opportunity to provide a most needed service and to build your own independent business.

Even if you’re not interested in the distributorship opportunity, inquire about the benefits that LMI training programs can provide for you and your business.

Send this coupon today for complete information at no obligation to you.

**Trevor Willhite – Vice President
Leadership Motivation^{T.M.} Institute
Box 7614 Waco, Texas 76710**

EE 8-0

Please provide information to:

Name _____

Address _____

Phone _____ Area Code _____

City _____ State _____ Zip _____

Check here if you want only information about LMI programs for yourself or your company’s benefit.



A Division of Success Motivation[®] Institute, Inc.
An international publicly held corporation
P.O. Box 7657 Waco, Texas 76710 817-752-9711

Micropower op amp

Solitron Devices, Inc. of San Diego has introduced a general-purpose operational amplifier that will operate over a power supply range of $\pm 1-18$ V and use as little as $20 \mu\text{W}$ of standby power. Pin compatible with the 741, the key to its improved performance is that the quiescent current, I_q , can be set independently of power supply voltage, giving the design engineer a very powerful tool.

The designer fixes I_q in the Solitron UC4250 by choosing an external resistor to connect between pin 8 (unused in the 741) and the negative supply voltage; thus, a range of I_q can be obtained at any supply voltage. By controlling I_q , the designer can optimize the amplifier for the particular characteristics he is concerned with, such as slew rate or for output buffer applications.

One traditional method for obtaining low I_q is to include a high value resistor on the chip. However, IC technology places practical limits on this approach. Another method is to use a multi-transistor internal current source. In this approach, performance at low temperatures is not reproducible, because the source relies on leakage currents to start it. In both methods, I_q is out of control of the circuit designer.

Most popular operational amplifiers are limited to $\frac{3}{4}$ V at the low end, because they use an npn emitter follower driving into a pnp on the inputs. This requires a power supply voltage to overcome the V_{be} of each of the two transistors, plus the saturation voltage, V_{sat} , of the pnp, and the V_{sat} of the current source that keeps it going. Using a V_{be} of about 0.6 V and a V_{sat} near 1 V, 3 V is about the lowest limit of supply voltage that can be achieved, and operation there is not always the best. The UC4250 uses a single transistor on each input and output, so one V_{be} is all that is required to operate the amplifier.

The UC4250 will have applications wherever batteries are used. Medical electronics, portable instruments, telemetry, monitoring, and military fusing are all potential markets. The low power requirements also permit reduced power supply size.

In medical electronics, 8 V is the maximum allowed voltage without

enclosure. This limit minimizes chances for inadvertent connection to 110 V lines and sparking in oxygen atmospheres. However, designers would like to operate within the ± 3 V range to have some margin. Long term power consumption is also critical. At Solitron, two watch batteries have been running a square wave oscillator since January. It uses approximately 100 pA of power supply current. The load characteristics show that it will operate for $2\frac{1}{2}$ years on the one set of batteries, but the shelf life is only guaranteed for about 1.3 years. The batteries will probably destruct chemically before they are used up electrically.

An example of a monitoring application is an explosive vapor monitor that activates an alarm when excess vapor is detected. The battery would be replaced after an alarm, but reliable monitoring for up to two years is possible.

UC4250 specs are difficult to com-

pare with other amplifiers, because many can be varied by the choice of I_q . Standby power as low as $20 \mu\text{W}$ is featured when $I_q = 10 \mu\text{A}$ and $V_s = \pm 1$ V.

Operating at 25°C , $V_s = \pm 6\text{V}$, and $I_q = 30 \mu\text{A}$, the guaranteed gain is 100 k into a $10 \text{ k}\Omega$ load. Solitron believes this is the highest gain for any two-stage monolithic operational amplifier. At this operating point the common mode rejection ratio is 70 dB; supply voltage rejection ratio is $150 \mu\text{V/V}$; power consumption is less than $480 \mu\text{W}$; and the slew rate is $0.16 \text{ V}/\mu\text{sec}$.

In quantities of 1000, the commercial version costs \$8.50 and full temperature units are \$23.75. Delivery is off the shelf. For further information, contact Solitron Devices, Inc., Semiconductor Division, 8808 Balboa Ave., San Diego, Calif. 92123.

Circle 298 on Inquiry Card

The quiescent current is related to the supply voltage and an external resistor according to the chart. Normally R_{set} is connected between pin 8 and V-; however it can be placed between pin 8 and ground, if one-half the value of R_{set} is used. Such things as input bias current and slew rate are dependent on quiescent current, but are independent of power supply voltage.

Input bias I vs quiescent I

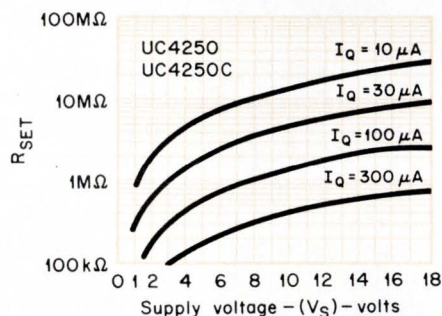

Quiescent current setting resistor (pin 8 to V)

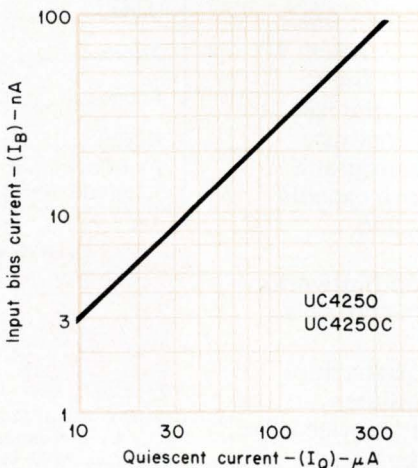

Slew rate vs quiescent I

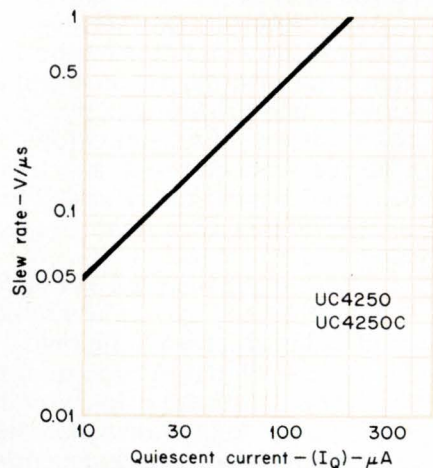

FIRST PETER...NOW IT'S THE **PAUL*** PRINCIPLE

One way to maintain professional progress is offered by the Chilton Company. A series of self-study courses has been developed in cooperation with the American Management Association (AMA) to provide you with a chance to keep up with the complex and expanding management skills demanded by the sophisticated technology of industry.

The AMA Extension Institute offers you the benefits of advanced business education *without interrupting your normal schedule*. Guided by qualified AMA instructors, the self-paced home courses employ the same case method of instruction made famous by the Harvard Business School.

MANAGEMENT AND THE COMPUTER

This fully integrated and up-to-date course is designed to provide you with a comprehensive, non-technical understanding of the use of EDP systems as aids to management . . . not substitutions for it. Employing basic concepts and realistic case examples, MANAGEMENT and THE COMPUTER will help you deal with such important questions as:

What can computers do for various types of business organizations? . . . When and how can their use be justified? . . . What human and organizational problems may arise from the introduction of EDP? . . . What are the criteria of a good computer-based information system? . . . How can computers improve management decision making?

Five study units are included in this course, each one a self-contained unit with text materials, programmed case studies and examination case materials, including marking and evaluation service:

1. Computer Basics for Management
2. EDP Feasibility Analysis
3. Managing the Human Elements in EDP
4. Management Information Systems
5. Quantitative Aids for Decision Making

You may participate in the complete course or in individual study units. Remember . . . no special knowledge or background is required . . . just a serious desire to equip yourself for the management task of tomorrow.

* Now, on the heels of the "Peter Principle" we have the "Paul Principle"! What is it? Simply: "Individuals often become incompetent at a level on which they once performed quite adequately as they become uneducated for that level."

It's brought about by that now familiar modern menace—rapid change.

Paul Armer, Director of the Stanford Univer-

sity Computation Center, evolved the concept. Notes Mr. Armer: "I've seen a number of executives who were psychologically in a bad way. They were aware they were technologically obsolete and no longer in control of the organizations they managed.

These individuals had climbed to responsible positions in large companies; they didn't lack native ability. Rather, they had become 'uneducated' for the job."

AMERICAN
MANAGEMENT
ASSOCIATION

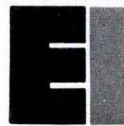

EXTENSION
INSTITUTE



Chilton

USE THE READER SERVICE CARD IN THIS ISSUE.

We'll rush an illustrated brochure to you with full details about this management course offered to ambitious, serious-minded men who want the challenge, the high income, and the prestige of a top management position.

Circle number 160 for information on MANAGEMENT AND THE COMPUTER

The same pricing advantage holds true for RCA's 2N5038—at \$6.25. (Prices of 2N5039 and its companion type are based on 1000-unit purchases. These prices go down as your volume requirements go up.) For the full story, call your local RCA Representa-

tive or your RCA Distributor. For technical data, write: RCA, Commercial Engineering, Section 59H/UT10, Harrison, New Jersey 07029. International: RCA 2-4 rue du Lièvre, 1227 Geneva, Switzerland, or P. O. Box 112, Hong Kong.

RCA

2N5039... switches off 15 A in less than 250 ns at \$4.90

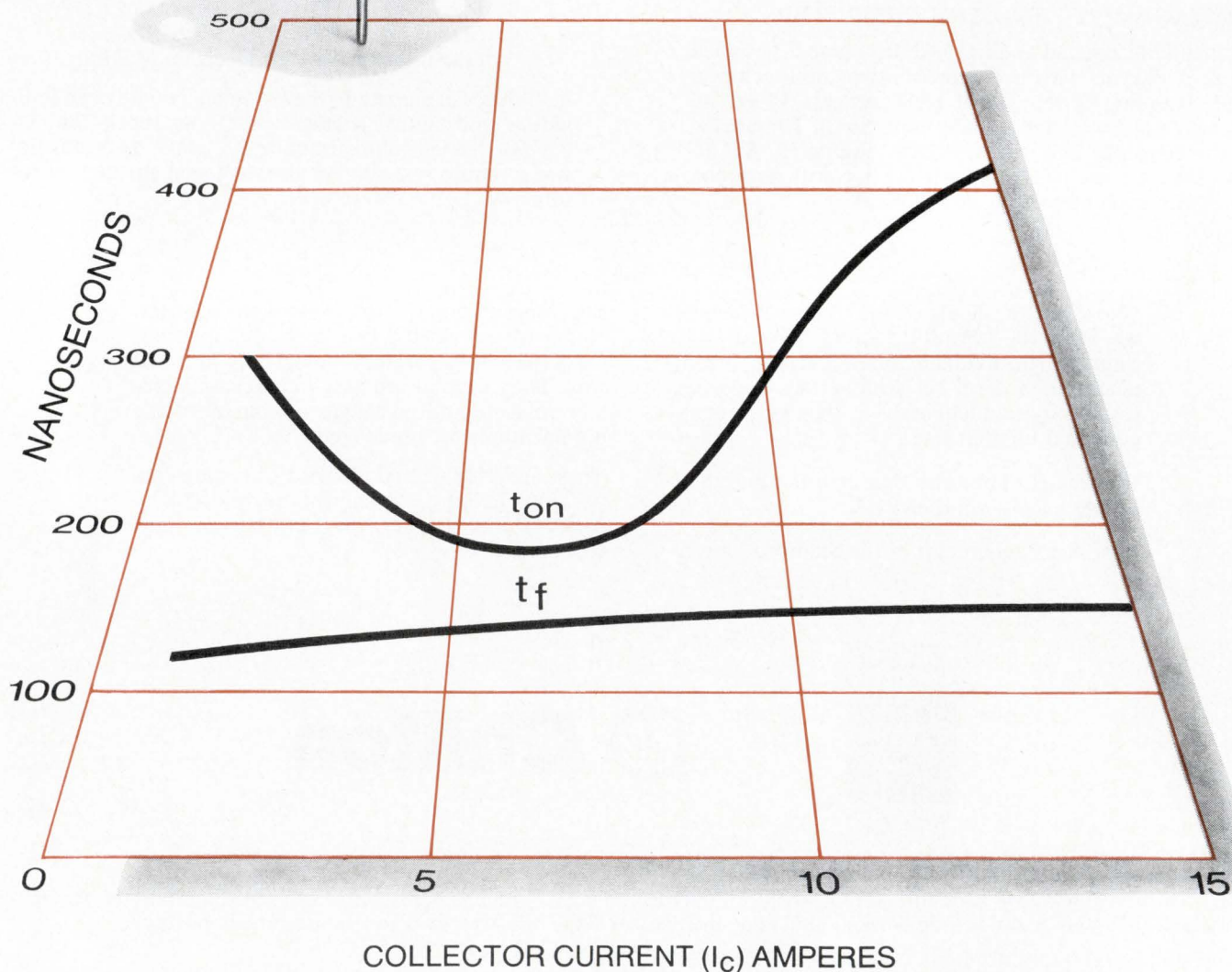

A new memory: the PROM

Electronic programming plus a monolithic bipolar read-only memory circuit adds up to PROM™, a recently introduced development of Radiation's Microelectronics Division.

The 512 bit MSI circuit can be field programmed even after the chip has been hermetically sealed. A fusible link method is used to accomplish the programming. Here's how it works: All bits in the memory matrix are set at "0." To pattern as "1" at any desired location you merely pass a 30 mA current through that circuit and the link opens. In any given word each bit is in series with the base of one of the output buffers. Thus, a bit programmed as "1," being an open circuit, would prohibit base current flow. This causes a high or logical "1" voltage to appear at the buffer's output. Conversely, bits programmed

as logical "0" would let base current flow, causing a low or logical "0" to appear at the buffer output.

With the PROM there is no need for final pattern masking—always done by the manufacturer. This lets you stock a single type of ROM for any and all applications through both breadboard and production phases of design. Automated programming procedures can then be used for volume requirements.

Total operating power is 400 mW/device at 25°C. By using the enable feature you can reduce power dissipation for a device not in use to about 250 mW. If you use power strobing, you can reduce average power dissipation even further.

The ROM 0512 has a 65 ns access time, 20 mA fan-out current, word-bit expandability, parallel input, out-

put and CHIP enable. It is compatible with DTL and TTL logic.

You address the 64 x 8 memory matrix through a 6-input decode address which accepts binary codes and allows random selections of any one of 64 words. The eight open collector output buffers will drive up to 20 mA of current into a 30 pF load at room temperature.

The military version meets the requirements of Mil-Std-883 over the range of -55°C to +125°C. A commercial version is available for 0° to +75°C operation.

The new memory costs \$61.50 (100 to 999) in the military temperature range and \$47.00 (100 to 999) in the commercial version.

Radiation Microelectronics Division, Melbourne, Fla. 32901. (305) 727-5412.

Circle 300 on Inquiry Card

Function generator modules are here

The Function Generator (FG) module is 1½ x 3 x 0.8 in. and it outputs a 2½-V, peak-to-peak square wave, triangle wave, or ramp. The ramp has adjustable rise and fall ratios up to 20:1. The FG module can serve as a function generator, sweep generator, voltage-to-frequency converter, or fixed-frequency oscillator. The maximum frequency is 50 kHz. The designer can determine the operating range by selecting the value of an ex-

ternal capacitor. Within the range, the frequency can be varied by a factor of 100:1 by varying the input bias over 0-5 V. Cost is less than \$100.

The Sine Converter module attaches to the output of the FG module and converts the triangle output to a 5-V, peak-to-peak sine wave. Cost is \$80.

The Trigger module, which costs \$50, attaches to the input of the FG module. Input impedance is 10 kΩ, and it triggers when more than 1 V is

applied to the input. The FG module puts out a single pulse or a tone burst, depending on the length of time the signal exceeds 1 V.

All three modules require ±15 V, which can be supplied by the Regulator module. The regulator module costs \$50 and operates on 18-32 Vdc. A PC card for mounting all modules is available for less than \$25.

Wavetek, 9045 Balboa Ave., San Diego, Calif. 92123.

Circle 301 on Inquiry Card

Self-illuminated switch shows its colors

Most pushbutton switches contain one or more miniature lamps to illuminate translucent plastic caps and identifying legends. Lamps add complexity, and require power and connections. High ambient light makes it difficult to determine if the lamp is "on" or "off", particularly with lighter colors of plastic.

In addition, the International Electrotechnical Committee (IEC) standards require that a switch indicate its condition under any circumstances. A toggle switch qualifies, as does a pushbutton that latches in the down position. A panel switch that

depends solely on illumination for its status is unacceptable, because bulbs fail. (Sanction by the U. S. is about four years away, but IEC standards must be met now by those selling abroad.)

The Marco-Oak Rainbow™ switch overcomes these problems by providing passive, high-contrast indications under almost any ambient lighting. In addition to latching down, switch illumination changes with the ambient light level.

The latching travel of the switch is used to change the color of the cap. A prism structure gathers light, reflects it

off a color panel, and sends it back to the operator. Lamps provide a fixed brightness, but changes in contrast proportional to ambient light are inherent in this new technique—you can read them independently of light level. By using reflected instead of transmitted light, colors retain their distinctive shades.

Two-level switches are available in almost any power rating. Frontal area is 1 x 1½ in. About \$6.00 for one and \$5.00 ea. in quantities of 1,000.

Marco-Oak Industries, 207 South Helena St., Anaheim, Calif. 92805.

Circle 302 on Inquiry Card

FOR EXCELLENCE IN TERMINATION HARDWARE SPECIFY GRAYHILL

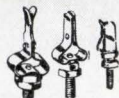

Test Clips

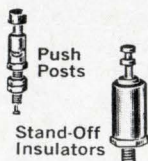

Push Posts

Stand-Off Insulators



Binding Posts

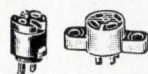

Sockets



Plastic Molded Parts

Test Clips

Adjustable tension, threaded studs or plug in bases, various sizes.

Push Posts

Plunger action lets you connect and disconnect quickly and easily, assures positive contact.

Binding Posts

Screw type or spring loaded, banana plug or stud mounting, single or multiple units, with various colors for circuit identification.

Stand-Off Insulators

High dielectric strength, low loss insulation, low moisture absorption, various mounting styles.

Sockets

Lamp or transistor, various colors, various mountings including printed circuit.

Custom Molded Parts

Tight tolerances provide you with "assembly ready" units. Thermosetting plastics to meet most specifications.

For your Grayhill Engineering Catalog offering complete technical data — contact

543 Hillgrove Avenue
LaGrange, Illinois 60525
Area Code 312, Phone 354-1040



... the Difference Between Excellent and Adequate

Circle 35 on Inquiry Card

send for this varflo sleeving sample and treat it rough

vinyl-coated fiberglass sleeving for Class 130,
Type B, Category b applications

Here's what laboratory tests performed on 3 representative sizes have shown about varflo vinyl-coated fiberglass sleeving

Property	Performance Requirement			Test Results		
	Min. A	Max. B	Min. 1A	Min. A	Max. B	Min. 1A
Dielectric Strength (V/mil)	1000	1000	1000	1000	1000	1000
Flexibility (mm)	0.001	0.001	0.001	0.001	0.001	0.001
Resistance to aging temperature (hr)	1000	1000	1000	1000	1000	1000
Heat resistance (°C)	100	100	100	100	100	100
Self-extinguishing	Yes	Yes	Yes	Yes	Yes	Yes
UL 94 V-0	Yes	Yes	Yes	Yes	Yes	Yes

Now test varflo yourself*

Put this sample through your own tests for dielectric strength, flexibility, heat- and flame-resistance. Varflo will meet the most exacting specifications, including MIL-I-21557 and MIL-I-3190/2.

Meet both Class A and Class B needs at the one low price! And save double because Varflo has long shelf life, with no deterioration.



Varflex

Varflex Corporation
W. Court Street
Rome, New York 13440
*additional samples on request

WRITE TO:

VARFLEX CORPORATION
506 W. Court Street Rome, New York 13440

NEW MICROWORLD PRODUCTS

MONOLITHIC SOLID-STATE DISPLAY

Seven-segment display is 0.1 in. high.

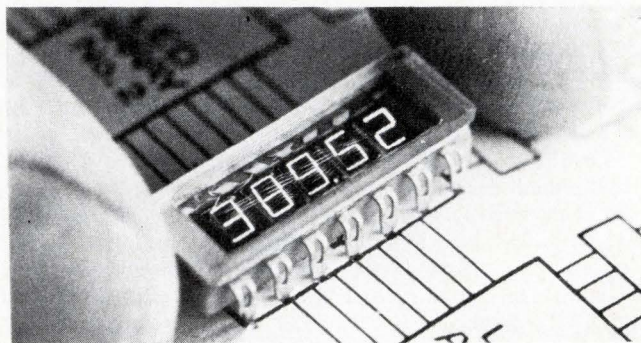

These displays come in two package types, a 14-pin dual-in-line package, (Models 5082-7210, 11, 12) and also a flat pack, (Models 5082-7215, 16, 17). You can get three, four and five characters in each package type and the packages are designed to meet Mil-STD-750 for hermetic seals. The modules are compatible with TTL and DTL and require 1.6 V at 3 mA for a 100 ft-lambert brightness. Because they are wired to be strobed, you only need 13 leads to access a 5-digit display. Price is \$11.95/digit in 1-9 digit quantities and drops to \$7.80/digit for 100-999 digits. Inquiries Manager, Hewlett-Packard Co., 1501 Page Mill Rd., Palo Alto, Calif. 94304. (415) 326-7000.

Circle 212 on Inquiry Card

NEW CAM ELEMENTS

Can operate as learning memory.

These two new content-addressable memory (CAM) elements are the 8220 for high-speed and the 8222 for low-power operation. Both units have addressing and comparison logic and eight identical memory cells organized as four words, each two bits long. Each element can be conditioned to associate, read, or write. In the associate mode, the CAM units will respond with a match or mismatch answer to each bit presented to the data inputs. Both devices are available in 16-pin dual-in-line silicone packages and the 8222 also comes in a 16-pin flat pack. Price for both is \$13.30 ea. in quan. of 100 to 999, and are available from stock. Signetics Corp., 811 E. Arques Ave., Sunnyvale, Calif. 94086. (408) 739-7700.

Circle 213 on Inquiry Card

MOS/LSI ROM

Has access time of 600 ns.

This 2048-bit static ROM is designated the TM2600JC. Two different organizations are available, either 512-words by 4 bits, or 256 words by 8 bits. Inputs are available for enabling the chip and for selecting a memory organization. Two types of output buffers are available: single-ended for driving TTL and the double-ended for driving the inputs to other MOS ICs and devices. The single-ended output has one MOS device with its drain at the output and its source at chip ground. The double-ended version has its own MOS load resistor provided internally so that no external circuitry is required. Texas Instruments Incorporated, Box 5012, M/S 308, Dallas, Tex. 75222.

Circle 214 on Inquiry Card

LSI SHIFT REGISTERS

Mos devices feature 5 MHz operation.

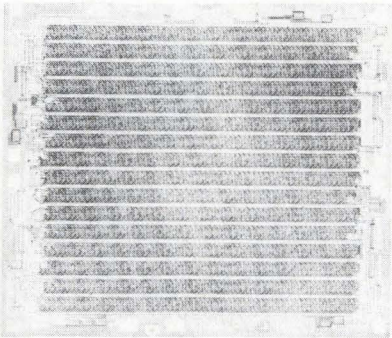

These three shift registers have a capacity of 1024 bits each. The registers are fabricated with silicon gate technology and have a total clock capacitance of 140 pF. The manufacturer claims this is one-half the capacitance/bit of other TTL compatible registers. Models available immediately are the 1402, a 16-lead dual in-line package with four 256-bit registers on one chip; Model 1403, a TO-5 package with two 512-bit registers on one chip; and Model 1404, a TO-5 with a single 1024-bit register. Price is \$25.60 for all models in 100 pc quantities. Intel Corporation, 365 Middlefield Rd., Mountain View, Calif. 94040. (415) 969-1670.

Circle 215 on Inquiry Card

MORE NEW MICROWORLD PRODUCTS

Here are some more products just announced. For more information, please use the circle number indicated.

DIGITAL CIRCUITS

Read/write memory. The CM2400 series gives you 1024 to 4096 bits. Computer Microtechnology Circle 201
BCD to seven segment decoders/drivers. Sprague adds the US54/7446, 47 and 48 to its TTL line. Circle 202
Series 7400 AND gates. The US7408A, US7409A and US7411A are now available from Sprague. Circle 203
Interface circuit. The 363 drives 12 V, 40 mA outputs from TTL/DTL. Amelco Semiconductor Circle 204
Twelve-volt hex inverter. The 332 is part of Amelco's high noise immunity logic line. Circle 205
MOS frequency divider. The PD455 is a six-stage frequency divider from General Electric. Circle 206
Seven-stage frequency divider. The SAJ110 was designed for electronic organs. IIT Semiconductor Circle 207
Character generators. Two 2240-bit mos devices (pM-S2240C5 and C7) are offered by Philco-Ford. Circle 208

LINEAR CIRCUITS

Op amps. The 741 and 741B are being offered by Precision Monolithics. \$27 and \$10.80 (100 pcs) Circle 209
Micropower op amp. Qualidyne says the QC 1735 costs about half as much as similar units. Circle 210
MOS 10-channel switch. Philco-Ford offers immediate delivery on the pL4S10C. Circle 211

DUAL LINE DRIVER AND RECEIVER

For data transmission applications.

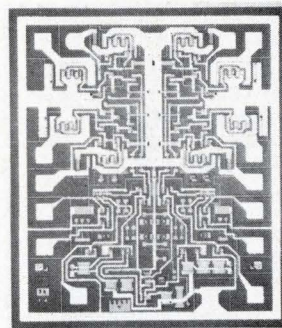

The 9614 is a dual differential line driver featuring a current sinking capability of 40 mA, while the 9615 is a dual differential line receiver that has a 15 V common mode rejection. You can use them as interface devices between complementary transistor logic and current sinking logics such as DTL and TTL. Both devices have open collector outputs that allow a ± 12 V swing and you can adapt them for wired-or applications. Shorting adjacent pins also gives you an active pull-up output. Prices (100-999 pc lots) start at \$7.50 for the 9614 and \$9.55 for the 9615. Fairchild Semiconductor, 313 Fairchild Dr., Mountain View, Calif. (415) 962-3563.

Circle 216 on Inquiry Card

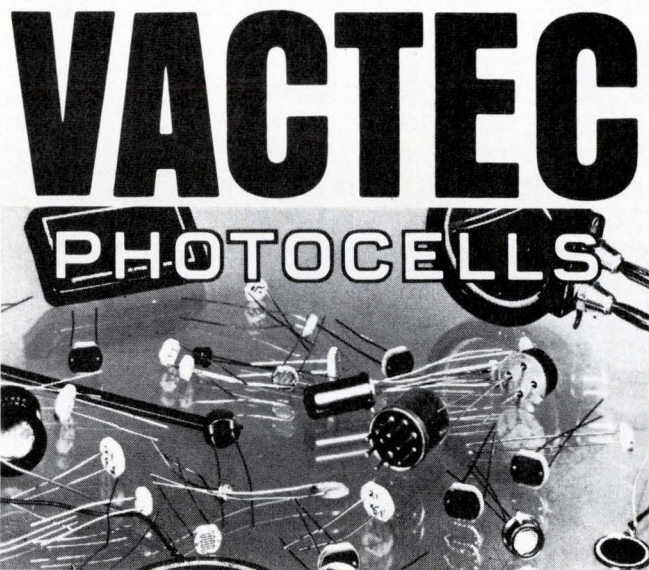

**The world's most un-diversified
company manufactures a
standard or custom size
and type for every requirement.**

VACTEC, INC.

2423 Northline Ind. Blvd. Maryland Heights, Mo. 63043
Phone (314) 872-8300

Write for Bulletin PCD-4 describing CdS and CdSe cells; for photocell lamp or LED modules request Vactrol Bulletin SPV-4A for Se types; or see EBG under "Semiconductors" or EEM Sec. 3700.

START

WITH A LENS-END LAMP

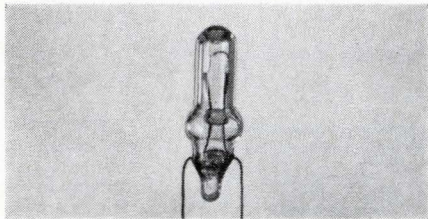

TEST

FOR SPOT SIZE AND
CANDLEPOWER

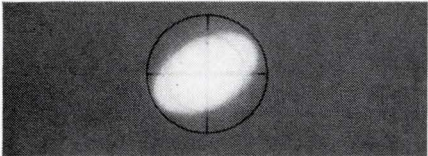

WELD

PINS TO END OF LEAD
WIRES

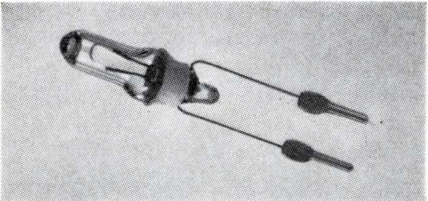

MOLD

TO MAKE A PLUG-IN LIGHT
MODULE THAT WILL ACTIVATE
PHOTO ELECTRIC SENSOR IN
A HIGH SPEED CHECK SORTER

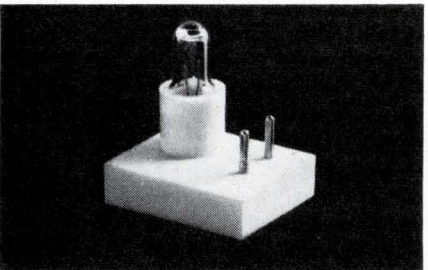

We specialize in finding practical solutions to small applications where cataloged items won't do. Write, describing your requirement. Tung-Sol Division, Wagner Electric Corporation, 630 W. Mt. Pleasant Avenue, Livingston, N.J. 07039. TWX: 710-994-4865. Phone: (201) 992-1100.

TUNG-SOL®

WHERE BIG THINGS ARE
DONE WITH SMALL LAMPS

® Reg. T.M. Wagner Electric Corporation

Circle 38 on Inquiry Card

NEW MICROWORLD PRODUCTS

CURRENT SOURCE

For D/A converters.

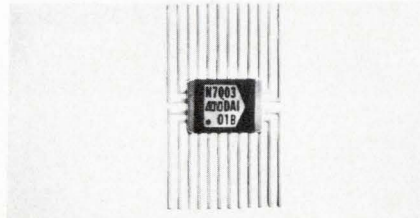

The monoDAI-01B converter is a monolithic 10-bit precision current source current summing D/A converters. You can also use it as a feedback element in successive-approximation A/D converters. It features a 150 ns settling time. Precision Monolithics, Inc., 1500 Space Park Dr., Santa Clara, Calif. 95050. (408) 246-9222

Circle 217 on Inquiry Card

OPERATIONAL AMPLIFIER

In new 'mini-DIP' package.

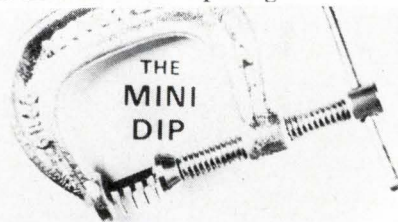

The LM301AN op amp is packaged in the manufacturer's new 8-pin DIP. This silicone molded package has a 50% size advantage over the standard 16-pin package, and two of them will fit a standard 16-pin dual-in-line socket. Price is \$4.85 ea. (1-24 pcs). National Semiconductor Corp., 2900 Semiconductor Dr., Santa Clara, Calif. 95051. (408) 732-5000.

Circle 218 on Inquiry Card

TTL SHIFT REGISTERS

Two, 8-bit MSI devices.

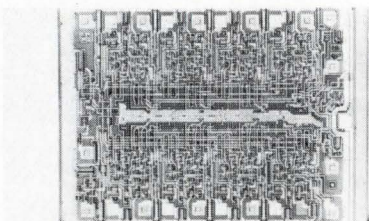

These devices are said to be the first truly universal shift registers available. One is the SN74198 parallel-access left-shift, right-shift register and the other, a parallel-access type, is designated SN74199. \$7.28 in 100-piece quantities. Texas Instruments Inc., Inquiry Answering Service, Box 5012, M/S 308, Dallas, Tex. 75222. (214) 238-3741.

Circle 219 on Inquiry Card

LOGIC CLOCK

From 187.5 kHz to 20 MHz.



This crystal controlled clock gives you complimentary Q and Q outputs. Series 7017 has a logic 0 of +0.5 V max. and can sink 5 mA in the 0 state. The logic 1 state is +3.0 V min. and will source 1 mA. Operating range is -55 to 105°C. Spectrum Technology, Box 948, Goleta, Calif. 93017. (805) 964-7791.

Circle 220 on Inquiry Card

INTERFACE CIRCUITS

For A/D and D/A applications.

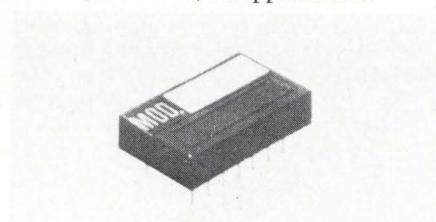

The 7400 series includes a delta modular (Model 7402); a delta digital code to analog converter (Model 7401), a 7-bit parallel binary digital to analog converter (Model 7400); and an 8-bit parallel BCD digital to analog converter (Model 7404). \$48 to \$66 ea. In single quantity. Optical Electronics, Inc., Box 11140, Tucson, Ariz. 85706. (602) 624-8358.

Circle 221 on Inquiry Card

SPEECH AMPLIFIERS

Operate from 1.5 Vdc battery.

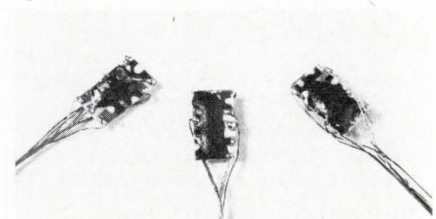

This family of hybrid devices is designed for small portable equipment operating from low voltages. To complete the amplifier you just add an external volume control. Frequency response is 250-5000 Hz with power outputs ranging from 0.1 to 0.5 mW (rms). ASC Microelectronics, Shelter Rock Lane, Danbury, Conn. 06810. (203) 744-1900.

Circle 222 on Inquiry Card

The Electronic Engineer • Aug. 1970

DECODER/DRIVER

With memory.

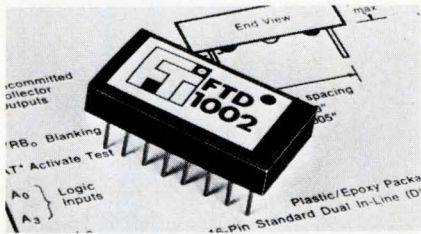

The FTD-1002 is a BCD to 7-output decoder/driver that includes a quad-latch memory. Each output can sink up to 100 mA continuously with surge currents up to 500 mA if the average power is kept below 1.1 W. Price is \$13.75 in 100 quantities. Fabri-Tek Micro-Systems, Inc., 1150 N.W. 70th St., Ft. Lauderdale, Fla. 33309.

Circle 223 on Inquiry Card

POWER SUPPLY REGULATOR

From 1 to 100 V.

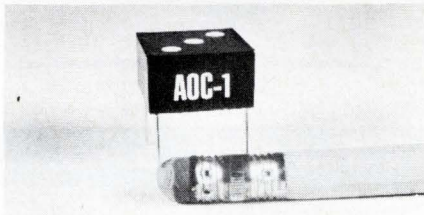

You can use the Model UR-1 for very low current applications, as well as currents in excess of 100 A (with suitable external power transistors). Specifications include regulation of better than 10 mV for zero to full load changes and 5 mV for input changes of $\pm 10\%$. \$15.00, (1-9 pcs). Space Age Microcircuits, Box 426, Chatham, N.J. 07928.

Circle 224 on Inquiry Card

LINE DRIVERS/RECEIVERS

For TTL/DTL signals.

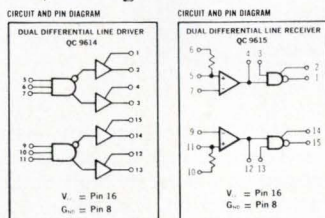

The QC9614 driver has input and output diode clamps, output short circuit protection and you can NAND or AND it. The QC9615 receiver features ± 15 V common mode voltage range, freq. response control, output gate with strobe, and uncommitted, active pull up/pull-down. Qualidyne Corp., 3699 Tahoe Way, Santa Clara, Calif. 95051. (408) 738-0120.

Circle 225 on Inquiry Card

KNOWING THAT TELEDYNE SEMICONDUCTOR MAKES ANALOG SWITCHES WILL BE HELPFUL

Characteristics

- Zero offset voltage
- Low "on" resistance
- Extremely high "off" resistance
- High switching speed with little transient
- Excellent isolation between drive signal and data signal
- High level (0-15v) and low level (0-5v) input control available

Applications

- Multiplexers
- D/A conversions
- Chopper
- Sample and hold

If you don't know about Teledyne's Analog Switch capability, mail the ad response card today and we will send you our new Analog Gate Catalog. If you do know about us, you also know that we're the largest producer of Analog Gates and have a reputation for problem solving, quality manufacturing and meeting delivery dates.

TELEDYNE SEMICONDUCTOR

1300 Terra Bella Ave.
Mountain View
Calif. 94040
Phone (415) 968-9241
TWX: (910) 379-6494



TELEDYNE FIELD SALES OFFICES: Palo Alto, California (415) 321-4681 • Hawthorne, California (213) 772-4551 • Anaheim, California (714) 635-3171 • Dallas, Texas (214) 357-0259 • DesPlaines, Illinois (312) 299-6196 • Westwood, Massachusetts (617) 326-6600 • Lutherville, Maryland (301) 825-1920 • Little Falls, New Jersey (201) 256-8557 • Wappinger Falls, New York (914) 297-4316 • Winter Park, Florida (305) 647-7813 • Dayton, Ohio (513) 298-7207 • Wiesbaden, Germany 370243

Tron Rectifier Fuses



Available in sizes from 1/2 to 1000 amps for voltages up to 1500, TRON Rectifier Fuses are ideal for protecting variable speed drives, inverters, battery chargers, plating power supplies, power controls, and any other application where fast opening and great current limitation are required.

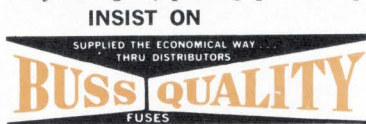

Write for BUSS Form TRFS

Bussmann Mfg. Division, McGraw-Edison Co., St. Louis, Mo. 63107

FUSES

for protection of Electronic Devices

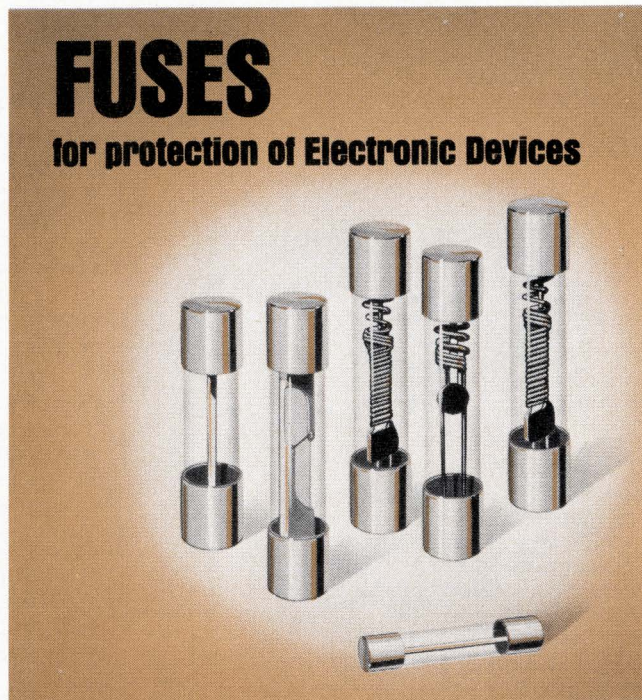

There is a complete line of BUSS Quality fuses in 1/4 x 1 inch, 1/4 x 1 1/4 inch, and miniature sizes, with standard and pigtail types available in quick-acting or dual-element slow blowing varieties.

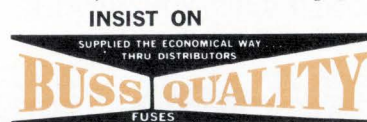

Write for BUSS Form SFB

Bussmann Mfg. Division, McGraw-Edison Co., St. Louis, Mo. 63107

BUSS: The Complete Line of Fuses and . . .

FOURIER ANALYZER

Can operate from an external reference.



Model 825A fills a void in the analysis of rotating machinery and other complex periodic data. Synchronizing itself to the base or ref. freq. derived from the item under test, it establishes an internal digitally controlled reference from which it calculates the amplitude coefficient as well as the phase relationship for the harmonics series. A built-in scanning mechanism automatically sequences it through its present range of harmonics. It is not necessary to manually advance the analysis frequency nor is ext. computer control required to step the analysis. Instrumentation Div. of Progress Electronics Co. of Oregon, 5160 N. Lagoon Ave., Portland, Ore. 97217. Booth 460.

Circle 258 on Inquiry Card

IMPEDANCE BRIDGE

With high-accuracy and portability.

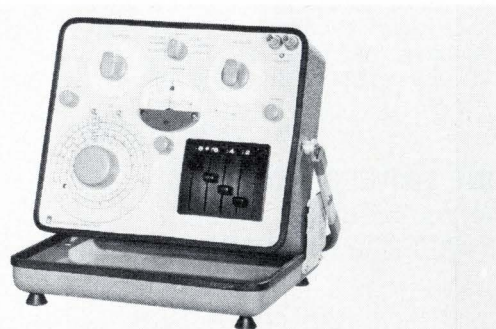

The 1656 bridge features 0.1% basic accuracy, ease of balance and low cost. It is a self-contained, battery-operated, portable bridge developed to measure high-precision components. Lever-arm switches permit fast balances and easy-to-read answers for measurements of C, L, R, and G. It also measures D and Q, using a dial-indicating method. A 1-kHz generator is included for ac measurements; a connection for an ext. oscillator and detector enables measurements from 20 Hz to 20 kHz. The sensitive detector and wide resistance and conductance ranges make the 1656 an excellent dc bridge, \$700.00. General Radio Co., 300 Baker Ave., West Concord, Mass. 01781.

Circle 259 on Inquiry Card

NEW LAB INSTRUMENTS

DIGITAL L-C METER

Four digit in-line readouts.



Model 9400 measures inductance with a resolution of 0.1 μ H and capacitance to 0.1 pF. Measurement accuracy is $\pm 1\%$ FS ± 1 digit. Full scale ranges are 100 pF to 100 μ F in 7 decade steps, and 100 μ H to 100 mH in 4 decade steps. The new meter has BCD output as standard. It can thus be used directly with printers or comparators in automatic go-no-go applications. The readout indicators are lighted display tubes, easily visible from a distance. \$550 F.O.B. Concord, Calif. Instrument Div., Syston-Donner Corp., 888 Galindo St., Concord, Calif. 94520. (415) 682-6161. Booths 521-524 and 547-550.

Circle 260 on Inquiry Card

POWER METER

Operates on the calorimeter principle.



The NRS microwave power meter indicates average power at all frequencies down to dc (response time 10 s, error about 2%; accuracy can be improved by a factor of 10 with a suitable voltmeter). The power range is divided into five subranges and can be extended up to about 60 kW by using attenuators or load resistors. Applications include: power measurements on all kinds of signal generators, and insertion loss measurements on cables, filters, matching pads and attenuators. \$1140.00. Rohde & Schwarz, 510 S. Mathilda Ave., Sunnyvale, Calif. 94086. (408) 736-1122. Booths 309-310.

Circle 261 on Inquiry Card

.. Fuseholders of Unquestioned High Quality

FUSEBLOCKS

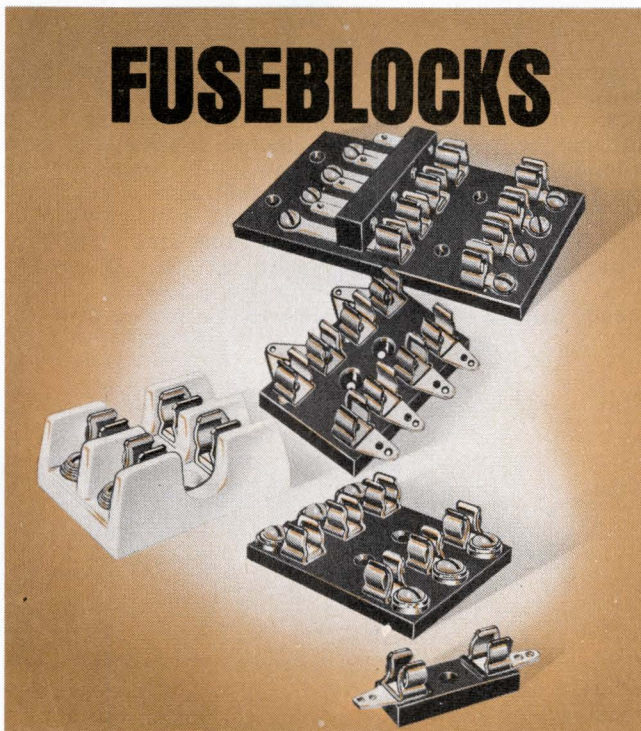

There is a full line of BUSS Quality fuseblocks in bakelite, phenolic, and porcelain, with solder, screw-type, or quick-connect terminals.

INSIST ON
SUPPLIED THE ECONOMICAL WAY
THRU DISTRIBUTORS
BUSS QUALITY
FUSES

Write for BUSS Form SFB

Bussmann Mfg. Division, McGraw-Edison Co., St. Louis, Mo. 63107

Circle 40 on Inquiry Card

FUSEHOLDERS

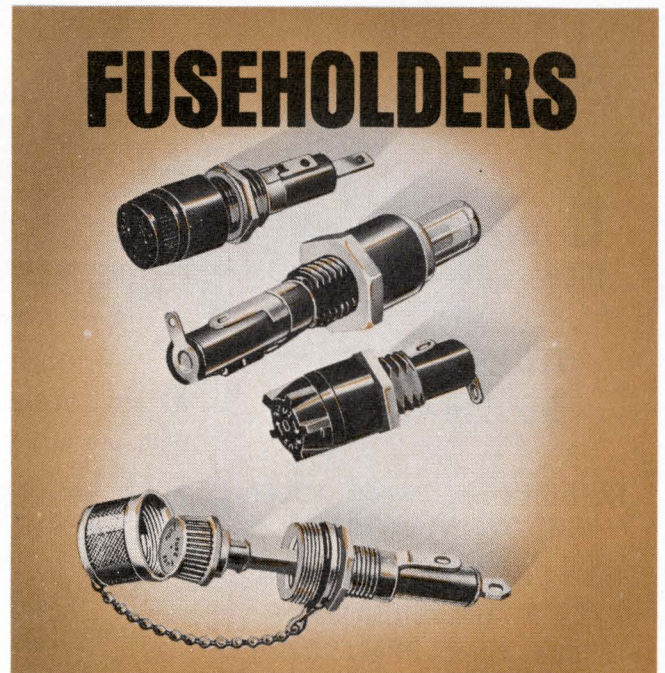

BUSS has a complete line of fuseholders to cover every application. It includes lamp indicating and alarm activating types, space-saving panel mounted types, in-line holders, RFI-shielded types, and a full line of military types. Most are available with quick-connect terminals.

INSIST ON
SUPPLIED THE ECONOMICAL WAY
THRU DISTRIBUTORS
BUSS QUALITY
FUSES

Write for BUSS Form SFB

Bussmann Mfg. Division, McGraw-Edison Co., St. Louis, Mo. 63107

Circle 40 on Inquiry Card

MUCON[®] CERAMIC CAPACITORS

NPO

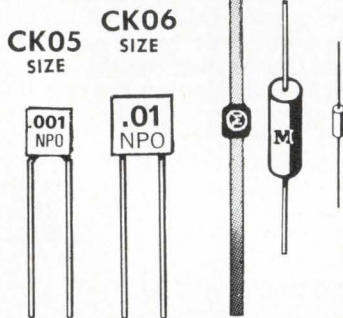

TOLERANCE to $\pm 1\%$

CAPACITANCE $\frac{1}{2}$ PF.
to 56000 PF.

Q GREATER THAN
1000... UP TO 1000 MHz

STABILITY $\pm .3\%$
-55°C to +125°C

RIBBON LEADS AVAILABLE
FOR LOW INDUCTANCE

ALSO COMPLETE RANGE OF
TEMP. COMPENSATION
thru N5600 PPM/°C

Visit booth 2511
WESCON

Mucon Subminiature Ceramic
Capacitors to meet any requirement.

REPUBLIC ELECTRONICS CORP.
176 E. 7th St. PATERSON, N. J. 07524
201-279-0300 TWX 710-988-5908

Circle 42 on Inquiry Card

NEW LAB INSTRUMENTS

RF/IF SWEEP GENERATOR

For microwave systems.

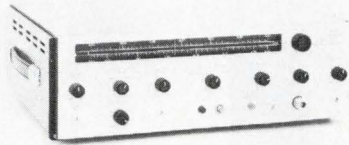

Model 613 covers 50 to 100 MHz, 3.6 to 4.3 GHz and 5.9 to 6.5 GHz. Flatness over these ranges is ± 0.01 dB from 60 to 80 MHz and $+0.02$ dB/30 MHz from 3.6 to 4.3 GHz and 5.9 to 6.5 GHz. Output power is +10 dBm at i-f and +13 dBm at rf frequencies. Wiltron Co., 930 E. Meadow Dr., Palo Alto, Calif. 94303. (415) 321-7428. Booths 554-555

Circle 249 on Inquiry Card

PULSE GENERATOR

From 10 Hz to 8 MHz.

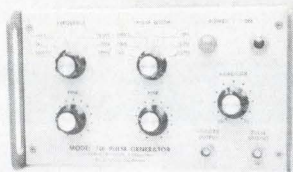

The Model 701 features rise and fall times $<$ than 3 ns. The output amplitude is variable from 0 to +5 V across a 50 Ω load and the pulse width is adjustable from 80 ns to 100 ms in six overlapping ranges. Available from stock at \$160.00 each. Dytech Research Corp., Box 162, Agnew Station, Santa Clara, Calif. 95054. (408) 241-4333.

Circle 250 on Inquiry Card

RF MILLIVOLTMETER

With programmability.



The Model 92A offers a basic accuracy of 1% of reading plus 1% of full scale. The measurement range is 100 μ V to 3 V from 10 kHz to 1.2 GHz in 8 ranges by push-button selection. The instrument is supplied with probe, probe tip and 50 Ω BNC adapter and costs \$750. Boonton Electronics Corp., Rte. 287 at Smith Rd., Parsippany, N.J. 07054.

Circle 251 on Inquiry Card

PROGRAMMABLE COUNTER

With six decades.

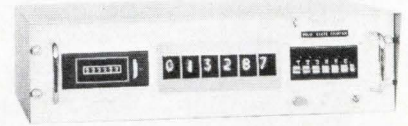

Model N-6 provides an output signal in the form of a contact opening or closure when the preset thumb-wheel setting is reached. The unit counts up to 50 kHz and has automatic and manual reset. A batch counter tabulates the number of completed programs. Numerics Corp., 540 Main St., Tewksbury, Mass. (617) 851-7296.

Circle 252 on Inquiry Card

FREQUENCY COUNTER

From 1 Hz to 25 MHz.

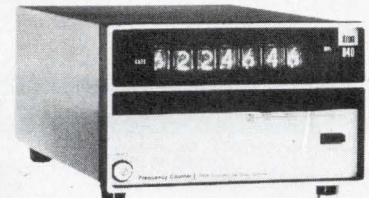

Model 640 is intended for applications where simplicity of operation is essential. Operating controls are limited to gate-time selection and power. Input sensitivity is completely automatic. The unit also eliminates the typical ± 1 count ambiguity up to 1 MHz. \$515. Itron Corp., 11675 Sorrento Valley Rd., San Diego, Calif. 92121. (714) 453-5300.

Circle 253 on Inquiry Card

DIFFERENTIAL DC AMP

Has $\pm 0.01\%$ gain accuracy.

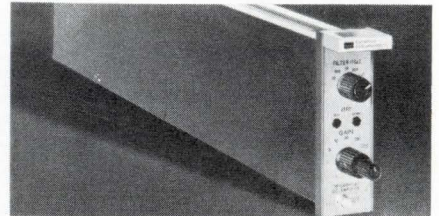

Model 7520 has 14 options to give you a wide selection of operating parameters. Input circuitry allows for inverting or non-inverting gain polarity. Key features include: fast overload recovery, self-contained power supply, and output short circuit protection. Dynamic Instrumentation Co., 583 Monterey Pass Rd., Monterey Park, Calif. 91754.

Circle 254 on Inquiry Card

The Electronic Engineer • Aug. 1970

Products with Booth Numbers
will be exhibited at WESCON

MOS CLOCK/DATA GENERATOR

For testing MOS ICs.

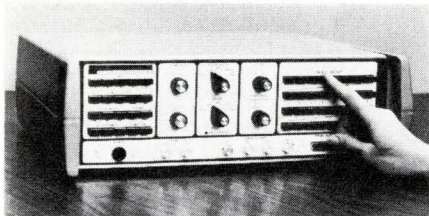

This unit provides timing signals while generating words up to 32 bits long. You can choose four 8-bit channels, two 16-bit channels, or one 16-bit and two 8-bit channels. The clock section gives you single ϕ (to 16 MHz), 2 ϕ (up to 8 MHz) or 4 ϕ (to 4 MHz). Signetics Measurement/Data, 341 Moffett Blvd., Mountain View, Calif. 94040. Booth 525.

Circle 255 on Inquiry Card

MICROWAVE SWEEP GENERATOR

From 10 to 12,400 MHz.

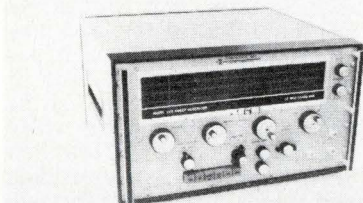

Model 103 covers its frequency range without plug-ins. The range is divided into three bands (0.01-4.2 GHz, 4.2-8 GHz, 8-12.4 GHz), selected by a front panel control. Continuous sweep is up to 4200 MHz. Price \$5500 to \$6800, depending on options. Delivery is 60 days. Space-Kom, Inc., Box 10, Goleta, Calif. 92017. (805) 967-7114.

Circle 256 on Inquiry Card

LOCK-IN AMPLIFIER

For signals from 1 mV to 500 mV.

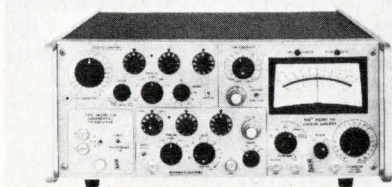

The Model 124 mixes a noisy input with a "clean" reference signal of the same frequency. After filtering and demodulation, the difference freq. provides amplitude and phase information. The active filter may be used in any five modes: flat, bandpass, notch lowpass or highpass. Princeton Applied Research Corp., Box 565, Princeton, N.J. 08540.

Circle 257 on Inquiry Card

The Electronic Engineer • Aug. 1970

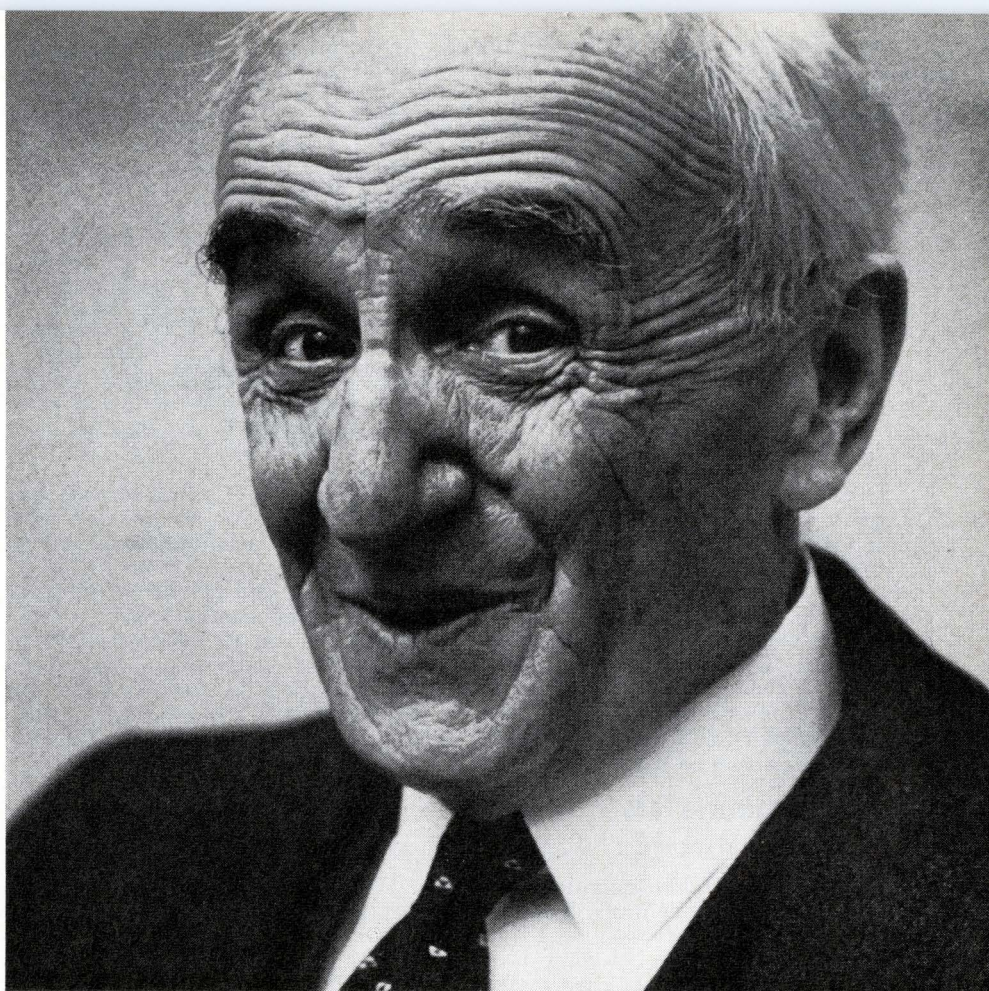

Scanbe lights my fire.

Let me tell you why. Scanbe has a new version of their DI PAK[™] packaging system. They call it the "Swinger." It has hinged panels that swing out and lock into position. And that's nice because I'm tired of breaking my fingers trying to change a wire or a DIP. What's more, each panel has up to 720 14-pin or 576 16-pin DIP color coded Wire Wrap* sockets in one vertical or horizontal drawer. That's not all. If you other young bucks would like a complete software and wire wrapping service, Scanbe can make your from/to wire lists swing too. Write for further information.

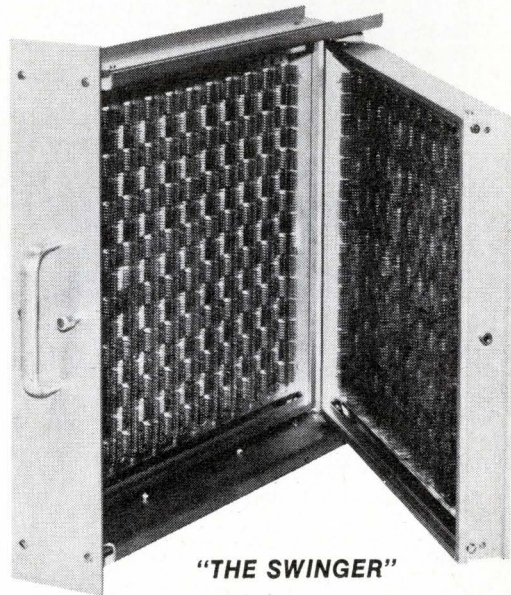

"THE SWINGER"

*Registered trademark of Gardner Denver Company



MANUFACTURING CORP.
A CANOGA COMPANY

3445 Fletcher Ave. • El Monte, CA 91731 • (213) 579-2300/686-1202 • TWX: 910-587-3437

Circle 43 on Inquiry Card

83

NEW PRODUCTS

MOLDED INDUCTOR

Film hybrid unit.

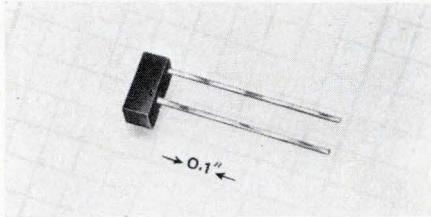

New D series inductor is for thick and thin film microcircuit applications where compactness, ruggedness, and high reliability are essential. Because of its configuration (0.060 x 0.180 in.), it permits a low profile in thin microcircuit packaging. It comes with either silver plated copper ribbon leads or solid gold ribbon leads. Piconics Inc., Cummings Rd., Tyngsboro, Mass. 01879. (617) 649-7501.

Circle 226 on Inquiry Card

DEPOSITION SYSTEM

Controls rate, thickness to 0.1%.

All-digital thin film deposition system automatically controls deposition rates and film thickness to 0.1% or better with resistance heated, E-beam and sputtering sources. Up to seven independent programmers can be used with the Series 222 automatic deposition system (ADS), permitting control of multilayer film depositions of up to seven different materials. Granville-Phillips Co., 5675 E. Arapaho Ave., Boulder, Colo. 80303. (303) 443-7660. Booth 209.

Circle 227 on Inquiry Card

SUBMINIATURE CONNECTORS

Approved to Mil-C-38999.

These compact Bantam™ connectors use rear release crimp-removable contacts for wire sizes 12 to 28 and can be ordered with inserts accommodating from 3 to 128 contacts. Nine shell styles are available in series 11A (range of -65 to 150°C) or series 11B (range of -65° to 200°C). They have bayonet type disconnect and five shell polarizations. Burndy Corp., Norwalk, Conn. 06852. (203) 838-4444. Booths 3151-53.

Circle 228 on Inquiry Card

PANEL METERS

For restricted space applications.

This special shallow barrel unit is designed for the company's 1½, 2½, 3½ and 4½ in. G-series panel meters. The 120-GS has a behind-the-panel dimension of 0.940 in. and a barrel dia. of 1.5 in.; the 220-GS measures 1.113 and 2.2 in.; and the 320-GS and 420-GS measure 1.113 in. and 2.75 in. Triplett Corp., Bluffton, Ohio 34817. (419) 358-5015. Booth 326-327.

Circle 229 on Inquiry Card

RFI/EMI FILTER

Meets Mil-F-15733 requirements.



Model 3299-003 subminiature rfi/emi filter is in a 4-40 threaded case 0.340 in. long and weighs < 1.0 g. This low pass unit is rated for 10 A at 100 WVdc and provides better than 45 dB of attenuation from 100 to 1000 MHz and 65 dB from 1000 to 10,000 MHz, under full load. Less than \$1.00 in prod. quan. U. S. Capacitor Corp., 2151 N. Lincoln St., Burbank, Calif. 91504. (213) 843-4222.

Circle 230 on Inquiry Card

VHF POWER TRANSISTORS

For communications equipment.

Three new silicon power transistors (2N5589, 2N5590 and 2N5591) have been optimized for operation at 13.6 V for fm/vhf mobile communications equipment. They provide 3.0, 10 and 25 W respectively. Tantalum nitride emitter ballasting resistors assure uniform power dissipation from the multiple emitter array. Price in quantities of 1-99: 2N5589—\$7; 2N5590—\$14; and 2N5591—\$24. Electronic Components Div. of United Aircraft, Treviso, Pa. 19047.

Circle 231 on Inquiry Card

READOUTS

Viewing angle to 120°.

Series 10-50 digital and alphanumeric readouts with directly viewed incandescent filaments can be read in direct sunlight. Features include: low voltage, 5 V and below; low current, under 20 mA; variable brightness, from 0 to full brightness; and small size, only 5/8 in. char. height with an overall depth of 0.175 in. Pinlites Inc., 1275 Bloomfield Ave., Fairfield, N.J. 07006. (201) 226-7724. Booths 2314-15.

Circle 232 on Inquiry Card

COUNT/CONTROLLER

Only 6.23 x 10.12 x 6.50 in.

Speeds to 20,000 Hz ss, integrated circuitry, long life, 7/8 in. high seven line, or BCD display are features of this industrial electronic count/controller. The precision control is available with either one or two levels of predetermining, and a variety of output timings as std. \$160.00 and up. Durant Digital Instruments, 622 N. Cass St., Milwaukee, Wis. 53201. (414) 271-9300. Booth 1303.

Circle 233 on Inquiry Card

SOCKET CONNECTOR

It's pluggable.



This connector allows replacement of faulty transistors and diodes in PC boards without resoldering. It also speeds component assembly to PC boards. Socket is a tin-plated formed tube which contains a Teflon® insert. The connector accepts 0.016 to 0.019 in. leads. Machine staking may be done with min. center-to-center spacing of 0.120 in. Berg Electronics, Inc., New Cumberland, Pa. 17070.

Circle 234 on Inquiry Card

SYNCHRONOUS MOTOR

High torque.

New 86100 series permanent magnet motor features high torque (7 oz.-in at the rotor shaft) and low rotor speed (300 rpm). Since it has fast start/stop characteristics and is electrically reversible, clutches can be eliminated in many applications where 2-way operation is needed. A selection of 11 gear trains is offered, providing a range of speeds from 1 rpm through 150 rpm. The A.W. Haydon Co., 232 N. Elm St., Waterbury, Conn. (203) 756-4481.

Circle 235 on Inquiry Card

SCR GATE DRIVE

Three-phase control.

Phasetrol® ss, SCR gate drives are for phase control of half-wave hybrid bridge circuits. VPH4000 series drives do not "snap on" when power is applied. They are hard firing with a rise time of 200 ns and signal isolation from the input power line and the SCR gates. Available as either a plug-in or with combination quick-connect and solder terminals. About \$85 (100 quan.). Vectrol, Inc., 1110 Westmore Ave., Rockville, Md. 20850.

Circle 236 on Inquiry Card

MINIATURE CHOKES

Wide range of inductance values.

Measuring only 0.155 x 0.375 in., this new molded choke comes in inductances ranging from 36 µH to 240 µH and color coded for easy value determination. The 550-3628 is the newest addition to the company's 3628 series. Cambridge Thermionic Corp., 445 Concord Ave., Cambridge, Mass. 02138. (617) 491-5400. Booth 1405.

Circle 237 on Inquiry Card

PANEL LIGHTS

Many styles available.

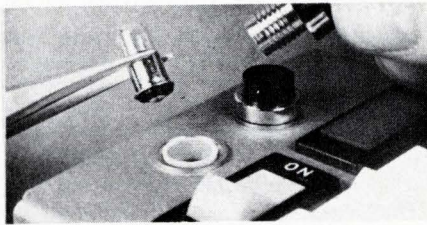

These relampable panel lights come in nine lens styles, three body styles, and 10 lens colors, plus varieties with no lens. Each has two sets of screw threads: one for panel-mounting, and one for lamp and lens-replacing. They hold T-1 $\frac{3}{4}$ midget flanged base lamps. \$1.45 to \$0.56. Chicago Switch, Inc., 2035 W. Wabansia Ave., Chicago, Ill. 60647. (312) 489-5500. Booth 1411.

Circle 238 on Inquiry Card

MILLIMETER WAVE SOURCE

Fixed-tuned, solid-state.

SYG 2040 cw wave source is for use in superheterodyne systems or as a low power transmitter. It consists of a high power avalanche oscillator driving a tripler-doubler in the 52 to 70 GHz range. Characteristics at +35°C case temp. are: aux. output freq., 26 to 35 GHz; fund. oscillator freq., 8.66 to 11.66 GHz; 20 mW min. power output without filter, and 5 mW min. with filter. Sylvania Electric Products Inc., 1100 Main St., Buffalo, N.Y. 14209.

Circle 239 on Inquiry Card

CONDUCTOR COMPOSITIONS

With excellent adhesive properties.

DP-8420, DP-8430 and DP-8440 were developed to provide major improvement in initial and aged adhesion even with high tin containing solders. They exhibit good solder wetting and resistance to solder leaching. They provide high conductivity and print resolution of 2-mil lines and spaces using metal masks. DP-8420 exhibits the best resistance to solder leaching and compatibility with thick film resistors. DP-8440 has the best wirebonding capabilities, has the highest conductivity, and offers good resistance to solder leaching. DP-8430 has intermediate properties. \$25 for DP-8420; \$22 for DP-8430; \$19 for DP-8440/troy oz. in 100 oz. quantities, f.o.b. plant at Niagara Falls, N.Y. DuPont Co., Wilmington, Del. 19898. (302) 774-8631.

Circle 240 on Inquiry Card

Products with Booth Numbers
will be exhibited at WESCON

REMNANT REED RELAY

Magnetic latching.

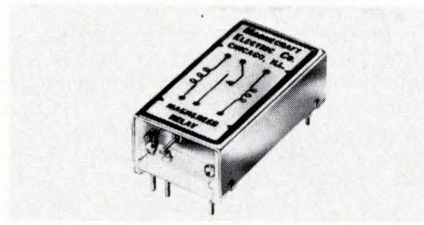

Latching function in the Class 101LMPC is done without the use of a permanent biasing magnet or standby power. It latches and stays latched. It operates on coil voltages to 48 Vdc, including sensitive ic compatible voltages, such as 3 Vdc or 5 Vdc. \$8.93 ea. Magnecraft Electric Co., 5575 N. Lynch Ave., Chicago, Ill. 60630. (312) 282-5500. Booth 1216.

Circle 241 on Inquiry Card

FET OP-AMP

Internally compensated.

Model P201-7 is for use in integrators, buffers and general purpose applications. It is particularly useful in applications requiring high input imp. (10^{12} Ω) and low bias current (5 pA). It has a 250,000 voltage gain, 10^{12} Ω dc input res., 5 pA offset current and 35 μ V/°C voltage drift. Output voltage is ± 11 V and output current is ± 5.5 mA. \$14.50 (1-9). Polytrotron Devices, Inc., 844 E. 25th St., Paterson, N.J. 07513. (201) 523-5000.

Circle 242 on Inquiry Card

BATTERY-POWERED METER

Makes portable DPM use practical.

A battery-power option for the company's digital panel meters (3300 series) makes it practical to use DPM's in portable equipment. Basic panel meters feature 200, 2000, or 4000 count capacity displays. With the battery option, they can use any dc source from 10.5 to 16 V. All meter options operate normally on battery power. Electro-Numerics Corp., 2961 Corvin Dr., Santa Clara, Calif. 95051. (408) 738-1840.

Circle 243 on Inquiry Card

POWER MULTICOUPLER

Covers 250 kHz to 110 MHz.

Model PM 40-4 is a four-way hybrid coupler with an average power rating of 40 W at 75°C case temp. Specs include: max. insertion loss, 0.4 dB; amplitude balance, 0.2 dB; vswr 1.2:1 max.; and isolation, 25 dB min. \$210.00. Electronic Navigation Industries Inc., 1337 Main St. East, Rochester, N.Y. 14609. (716) 288-2420.

Circle 244 on Inquiry Card

IC TEST SOCKETS

High temp. (250°C cont.) devices.

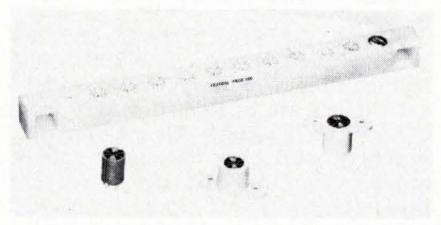

These miniature multi-lead TO-5 sockets are well suited for hand test or burn-in. Three, four, six, eight, 10, 12, and dual 6 contact arrangements are std. Tapered entry makes possible easy hand or automatic loading. Minimum lead length is 0.4 in. and std. terminations may be dipped or hand soldered. Textool Products, Inc., 1410 Pioneer Dr., Irving, Tex. 75060. (214) ME 1-5585.

Circle 245 on Inquiry Card

SPLITTER/COMBINER

Features 3 dB power division.

Model 8007 and 8008 (shown) 2-way and 4-way power splitter/combiners operate from 5 MHz to 1.5 GHz. Insertion loss is 1 dB between input and one output and impedance is 50 Ω . Isolation, 5 MHz to 100 MHz is -40 dB, 100 MHz to 500 MHz it's -30 dB, and 500 MHz to 1.5 GHz it's -20 dB, measured between two outputs. Reynolds Electronics Inc., 1915 University Ave., Palo Alto, Calif. 94303. (415) 325-7841. Booth 406.

Circle 246 on Inquiry Card

CLOCK OSCILLATORS

Crystal controlled.

The CO-230 series units operate from 5 Vdc and furnish TTL/DTL compatible output at any freq. in the 4 kHz through 50 MHz range. Stability of std. units is $\pm 0.0025\%$ over 0° to 70°C. These oscillators are for pc board use and include units as small as $\frac{1}{2}$ in.³ and profile as low as 0.3 in. Units in the 1-15 MHz range are \$75.00. Vectron Laboratories, Inc., 121 Water St., Norwalk, Conn. 06854. (203) 853-4433. Booth 1904.

Circle 247 on Inquiry Card

ULTRASONIC CLEANERS

For benchtop use.

Smallest of these cleaners is only 5 in.²; the largest, 14 x 9 x 8 $\frac{1}{2}$ in. Completely self-tuning, there are no adjustment or control knobs, only an ON/OFF switch and pilot light. All circuitry is ss, mounted on G-10 board, anchored in the base. Integral also is the lead zirconate titanate generating transducer. American Electrical Heater Co., American Beauty Div., 6110 Cass Ave., Detroit, Mich. 48202. (313) 875-2505.

Circle 248 on Inquiry Card

NEW PRODUCTS

POWER SUPPLY

Operates at 80% efficiency.

LB-720 series performs at 80% efficiency at current ratings to 300 A and voltage ranges to 300 Vdc. Six different models are offered at ranges from 0-7.5 V to 0-300 V. All are remotely programmable over the entire voltage range. An electronic ripple reducer produces low output ripple— <10 mV rms, max. Lambda Electronics Corp., 515 Broad Hollow Rd., Melville, N.Y. 11746. (516) 694-4200. Booths 1007-09.

Circle 262 on Inquiry Card

DIP SOLDERING MACHINE

Semi-automatic.

This portable machine speeds DIP soldering of PC boards and the tinning of IC leads. The portasolder adjusts to fit any size and shape PCB up to $5\frac{1}{2}$ x 11 in. More than one PCB can be accommodated at a time. Arms of the Portasolder extend away from the solder bath for easy loading and unloading. Temperature can be regulated to 650°F . Dentronix Corp., Box 327, 977a Bristol Pike, Cornwells Heights, Pa. 19020. (215) 639-6200.

Circle 263 on Inquiry Card

MINIATURE INDUCTOR

Only 0.25 in.³.

Model 4220 microinductor has a freq. range of 50 Hz to 50 kHz. It meets Mil-T-27 grade 5 requirements, with PC pin type terminals, sealed construction and laminated core for high efficiency. Maximum op. temp. is $+130^{\circ}\text{C}$, ind. range is 0.01 mH to 66 H, and insulation res. is 10,000 M Ω . It weighs 1.2 g. \$5.40 to \$7.00 ea. (10-24) Bourns Pacific Magnetics Corp., 28151 Hwy, 74, Romoland, Calif. 92380.

Circle 264 on Inquiry Card

CHIP RESISTORS

Range of 10 Ω to 5 M Ω units.

MDI cermet chip resistors are available in a variety of terminations for the most complex bonding problems. They have a TCR of ± 300 ppm/ $^{\circ}\text{C}$, ± 150 ppm/ $^{\circ}\text{C}$, or ± 50 ppm/ $^{\circ}\text{C}$. Operating temp. is -55° to $+125^{\circ}\text{C}$. Resistors measure 0.050 l x 0.040 w or 0.075 l x 0.050 in. w. Thickness is from 0.012 in. Prices start at \$0.10 ea. Monolithic Dielectrics Inc., 1114 W. Magnolia Blvd., Box 647, Burbank, Calif. 91503. (213) 848-4465.

Circle 265 on Inquiry Card

FILM CAPACITORS

Molded case offers protection.

Type 417 Filmite 'E' capacitors (PETP polyester film) are well-suited for use under high humidity conditions. They come in std. ratings of 100, 200, 400, and 600 Vdc with values from 470 pF to 0.1 μF . Rated op. temp. range is from -55° to $+85^{\circ}\text{C}$. They may, however, be operated up to $+150^{\circ}\text{C}$ when derated to 70% of the 85°C rated WV. Sprague Electric Co., Marshall St., North Adams, Mass. (413) 664-4411. Booths 1412, 1421 and Unit A.

Circle 266 on Inquiry Card

AUTOMATIC PRESS-FITTER

Up to 3,600 terminal insertions/h.

The double feed-bowl SS-DAB can insert any of three different components, selecting at the flick of a switch from left bowl automatic, right bowl automatic or manual feed. Feed-thrus, standoffs, and double standoffs may be inserted into a single chassis without down time for cleaning and refill of the component-feed system. Sealectro Corp., 225 Hoyt St., Mamaroneck, N.Y. 10543. (914) 698-5600. Booths 25-09 & 23-16 to 23-19.

Circle 267 on Inquiry Card

FET OP AMP

1.0 μs settling, 0.01% gain accuracy.

Model 3401A FET op amp will operate as a buffer (voltage follower) with gain accuracy of 0.01% and settling time of <1.0 μs . It is tolerant of capacitive loads. It has high CMR over the entire ± 10 V common mode range. Thus the max. gain error, including nonlinearity is $\pm 0.01\%$ (± 1 mV, for ± 10 V input). \$45.00. Burr-Brown Research Corp., International Airport Industrial Park, Tucson, Ariz. 85706. (602) 294-1431. Booths 1135-1136.

Circle 268 on Inquiry Card

DIE HANDLING SYSTEMS

Increase yield.

Model DS-1010 Mini-SortTM and Model DS-1021 automatic transfer system eliminate costly, time consuming, manual reorientation of dice after the break operation, and also the need for manually loading die-attach or die-bond equipments. Yield is increased because the dice never come in scrubbing contact with one another; no good dice are lost through operator spills; and the use of constant contact pressures eliminates the cosmetic and mechanical losses associated with manual handling. Teledyne TAC, 10 Forbes Rd., Woburn, Mass. 01801. (617) 935-5400. Booths 1601-02.

Circle 269 on Inquiry Card

MEASURES ONLY 1" DIAMETER BY 1" LONG OR 1" CUBE
□ WEIGHS JUST 1 OUNCE □ AIR BEARING □ AIR FLOW
REVERSIBLE □ DELIVERS 7.5 CFM AT FREE DELIVERY
□ FLANGE OR SERVO MOUNTING

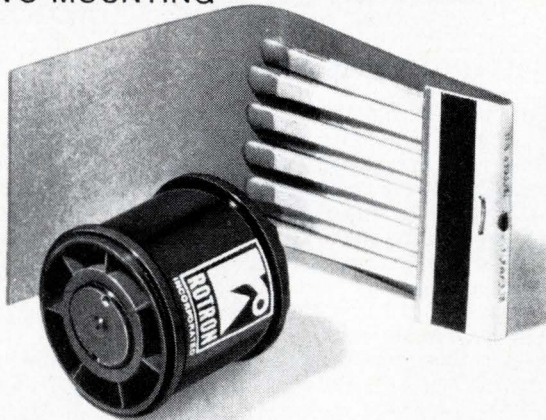

Actual size! Rotron's new Nanos[®] fan

Want to find out more about this extremely small air moving device?
Call 914-679-2401 or write to Rotron Incorporated, Woodstock, N. Y. 12498



Visit ROTRON at WESCON SHOW BOOTHS: 3051-3053

SELECTOR SWITCH

Combines popular features.

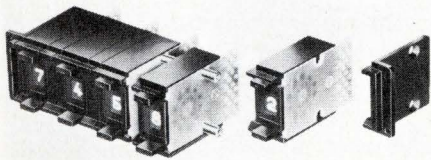

With this bi-directional switch you push one button to add, another to subtract. Good for readout or programming control, the add or subtract selector switch has full field readability and large numbers. Either panel mount or behind-the-panel mounting. Electrical readout is in either 10 position or BCD code. The 10-pos. decimal switch costs \$4.75 ea. Durant Digital Instruments, 622 N. Cass St., Milwaukee, Wis. 53201. (414) 271-9300.

Circle 270 on Inquiry Card

CERMET POTENTIOMETER

With Mil Spec immersion seal.

Model 3322 is the first cermet single-turn pot. to be listed on the DESC QPL/Mil-R-22097. Style RJ50. The Palirium® element pot is only 0.25 in. in dia. x 0.24 in. high and is sealed to withstand any wave soldering and immersion cleaning process. Operating temp. range is -65° to $+175^{\circ}$ C, and resistance range 10 Ω to 1 M Ω . It has a 0.5 W (at 85°C) pwr rating and a τ c of ± 100 ppm/ $^{\circ}$ C over entire temp. and resistance range. Trimpot Products Div., Bourns, Inc., 1200 Columbia Ave., Riverside, Calif. 92507. (714) 684-1700.

Circle 271 on Inquiry Card

POWER SUPPLY

For op amp and logic circuit designers.

You can now get plus and minus 15 Vdc at 60 mA (for op amps) and 5 Vdc at 500 mA (for logic ICs) in a single "plug-in" package from one source. Also built into the Model 299 is 40 mA of plus and minus 25 Vdc unreg. for lamp or relay driving. Specs for the ± 15 Vdc include 0.05% line and load reg. and noise and ripple < 1 mV rms. The 5 Vdc supply has 0.5% reg. and also has < 1 mV rms noise ripple. \$78 (1 to 9) and \$55.60 (100 pcs). Calif. Electronic Mfg. Co., Inc., Box 555, Alamo, Calif. 94507. (415) 932-3911.

Circle 272 on Inquiry Card

Products with Booth Numbers
will be exhibited at WESCON

CERAMIC FM FILTER

Replaces bulkier i-f cans.

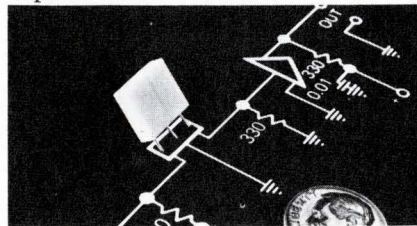

New 10.7 MHz bandpass (FM-4) filter has distortion-free performance to a stopband above 45 dB, with 3 dB bandwidth 235 kHz and 40 dB bandwidth 825 kHz. Adjacent channels 400 kHz apart are suppressed more than 35 dB with a single filter circuit. Where two filters are cascaded, stopbands above 90 dB are achieved. Ripple is < 1 dB, typ. insertion loss is 3 dB. \$0.50 (100,000). Gould Inc. Piezoelectric Div., 232 Forbes Rd., Bedford, Ohio 44146.

Circle 273 on Inquiry Card

RACK ASSEMBLY

Accepts 13 IC packaging panels.

Rack assembly accepts 13 of the 8136-R series high density IC packaging panels. Mount into std. 19 in. relay rack. Back panel is $\frac{1}{8}$ in. glass epoxy with VCC and ground planes tied into additional solderless wrap pins for easy access. Thirteen 120 contact edge connectors are mounted on back panel with solderless wrap terminations. \$150.00 to \$250.00. Augat Inc., 33 Perry Ave., Attleboro, Mass. 02703. (617) 222-2202. Booths 3180-81.

Circle 274 on Inquiry Card

VARIABLE CAPACITOR

With high-Q "chips" in parallel.

Series 505 capacitors are designed for uhf, vhf, microwave and stripline applications. They come with high Q chip capacitors soldered in parallel to provide high Q with higher current and capacitance capabilities. Working voltage is 250 Vdc and insulation res. 10^6 M Ω . Johanson Mfg. Corp., 400 Rockaway Valley Rd., Boonton, N.J. 07005. Booth 1015.

Circle 275 on Inquiry Card

MAGNETIC PICKUP

As low as \$1.95 each.

These miniature pickups are epoxy potted oil and water resistant. They are $\frac{7}{8}$ in. long by 0.187 in. in dia., come with 6 in.-long pigtailed and weigh 0.05 oz. Their temp. range is -65° to $+225^{\circ}$ F with max. output of 12 V pk-to-pk at 0.005 in. gap. Power Instruments, Inc., 7352 N. Lawndale Ave., Skokie, Ill. 60076. Booth 2602.

Circle 276 on Inquiry Card

This R10 relay
was designed to be

- COMPACT
- VERSATILE
- DEPENDABLE

it is

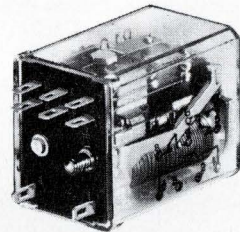

Switches up to 8
poles from dry circuit
to 10 amperes

The R10 is designed for critical applications such as computers, data processing equipment and precision instruments.

Contact arrangements up to 8 PDT (AC relays up to 4 PDT) are available. Six contact styles including bifurcated may be specified for switching currents from dry circuit to 10 amperes. Mechanical life is rated at 100 million operations with electrical life ranging from 100,000 to 100 million operations, depending on load and voltage.

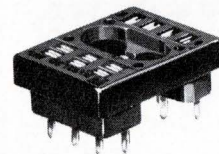

Designers are given many options of terminals and sockets for a wide variety of mountings.

For complete information about the full line of Potter & Brumfield relays, call your nearest P&B representative or write direct: Potter & Brumfield Division of AMF Incorporated, Princeton, Indiana 47570. 812 385 5251.

AMF
POTTER & BRUMFIELD

Circle 46 on Inquiry Card

AMPERITE

Thermostatic DELAY RELAYS

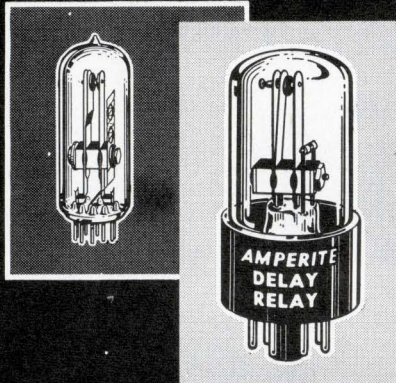

Only a glass seal
offers true hermetic sealing
... assuring maximum stability and life!

Delays: 2 to 180 seconds . . . Actuated by a heater, they operate on A.C., D.C., or Pulsating Current . . . Being hermetically sealed, they are not affected by altitude, moisture, or climate changes . . . SPST only—normally open or normally closed . . . Compensated for ambient temperature changes from -55° to $+80^{\circ}$ C. . . Heaters consume approximately 2 W, and may be operated continuously . . . The units are rugged, explosion-proof, long-lived, and—inexpensive!

TYPES: Standard Radio Octal, and 9-Pin Miniature.
List Price, \$4.00

PROBLEM? Send for Bulletin No. TR-81

AMPERITE

BALLAST REGULATORS

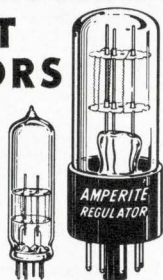
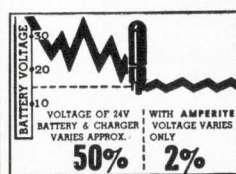

Hermetically sealed, they are not affected by changes in altitude, ambient temperature (-50° to $+70^{\circ}$ C.), or humidity . . . Rugged, light, compact, most inexpensive . . . List Price, \$3.00.

Write for 4-page Technical Bulletin No. AB-51

AMPERITE

600 PALISADE AVE., UNION CITY, N.J.
Telephone: 201 Union 4-9503
In Canada: Atlas Radio Corp., Ltd.,
50 Wingold Ave., Toronto 10

Circle 47 on Inquiry Card

NEW PRODUCTS

FIBER-OPTIC READOUT

Has "built-in" IC decoder/driver.

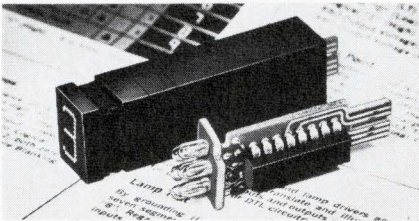

Model 901 D2-D8 readouts are compatible with TTL or DTL circuitry. Their IC decoder and lamp drivers accept four line 8-4-2-1 BCD inputs, translate them and then illuminate the proper fiber-optic readout segments. Master Specialties Co., 1640 Monrovia, Costa Mesa, Calif. 92627. (714) 642-2427. Booths 2320-2321.

Circle 277 on Inquiry Card

EMI FILTERS

Low dc resistance.

These A.V. (advanced version of Micro-Brute series) filters have ratings from 50 to 250 WVdc. One group, the special 115 Vac, 400 Hz series has no voltage deratings for temps. to 125° C and has std. ratings of from 50 mA to 10 A. A typ. industry std. case length of 0.540 in. gives 65 dB attenuation at 40 kHz under full load. The Potter Co., 500 W. Florence Ave., Inglewood, Calif. 90301. Booth 1921.

Circle 278 on Inquiry Card

FLEXIBLE TERMINAL STRIP

Conforms to curved surfaces.

Type EKS flexible 12-pole terminal strip can be easily cut with a sharp knife to the required number of terminal points. You don't have to drill mounting holes as holes to accommodate $\frac{1}{8}$ in bolts are molded into the terminal strip body. The EKS is rated for 20 A, 300 V and will accept conductors up to A.W.G. #12. Electrovert, Inc., 86 Hartford Ave., Mt. Vernon, N.Y. 10553. (914) 664-6090. Booths 1627-29.

Circle 279 on Inquiry Card

MODULAR POWER SUPPLIES

Meet military specs.

Two new series of modular power supplies meet Mil-Std-810B, Mil-E-5272C, and Mil-I-6181D. The S series includes single output models from 3 to 150 V and from 50 mA to 4 A. The H series consists of models with dual outputs ranging from 3 to 150 V and from 50 mA to 1 A. No derating is needed for operation between -20° C and $+71^{\circ}$ C. From \$80 to \$230 ea. Acopian Corp., Easton, Pa. 18042. (215) 258-5441.

Circle 280 on Inquiry Card

DIP EXTENDER BOARD

Hi-density.

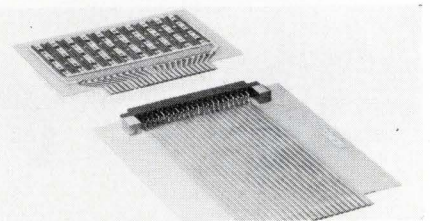

This useful tool mates with any std. "WIC" board and creates accessibility for troubleshooting by extending a wired board from a cabinet or other out-of-reach areas. The Extender Board is 7.5 in. by 5.850 in. by 1/16 in. thick. Robinson-Nugent, Inc., 800 E. 8th St., New Albany, Ind. 47150. (812) 945-0211.

Circle 281 on Inquiry Card

PUSH BUTTON

Small behind-panel dimension.

Features of the Series 46-230 and 46-430 include DPDT (break before make) circuit versatility and wiping contacts to maintain a low contact resistance during switch life. They are rated to make and break $\frac{1}{4}$ A. The 46-230 is a momentary contact, and the 46-430 is an alternate action (push-on, push-off). Grayhill, Inc., 561 Hillgrove Ave., LaGrange, Ill. 60525. (312) 354-1040. Booths 2501-02.

Circle 282 on Inquiry Card

SIGNAL CONDITIONERS

Basic 0-10 mV input sensitivity.

These 500 series units accept the output of a basic sensor and make the signal compatible with the inputs of alarms, recorders, controllers, and so forth. Inputs may be thermocouples, resistance temp. detectors, pressure transducers and the like. Outputs may be selected from either current ranges of 1 to 5, 4 to 20 and 10 to 50 or several available voltage ranges. Telmar, Inc., 810 W. Third Ave., Columbus, Ohio 43212. (614) 299-2165.

Circle 283 on Inquiry Card

X-BAND OSCILLATOR

Fixed tuned at 10.525 GHz.

The S289 transferred-electron oscillator is a ss replacement for klystrons in applications such as doppler radar systems. It is compensated over the range of -30° to $+80^{\circ}$ C. Minimum cw power output is 25 mW over this range. The TEO makes use of a differential negative resistance in the bulk of a GaAs diode. \$250.00 ea. (1-10). RCA Microwave Solid-State, Harrison, N.J. 07029. (201) 485-3900.

Circle 284 on Inquiry Card

PUSHBUTTON SWITCH

Right-angle mounting for PC boards.

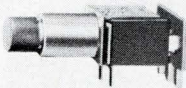

Mounting angle of this switch allows the pushbutton to be upright and clear of vertically stacked PC boards, in a position where it can easily be actuated. Switch body dimensions are 0.500 x 0.284 x 0.434 in. Absolute length, with pushbutton and bushing added to body length, is 1.046 ±0.031 in. C&K Components, Inc., 103 Morse St., Watertown, Mass. 02172 (617) 926-0800. Booth 1212.

Circle 285 on Inquiry Card

LEVEL CONVERTER

Accepts computer logic levels.

Microconverter accepts computer logic levels and converts them to drive communications equipment. Model 7202A isolates input power and ground returns from the output by optically coupling input signals through a light-emitting diode and light-sensitive resistor. Isolation between input and output is > 100 db. Less than \$100 in small quan. Tele-Dynamics, Div. of AMBAC Industries, Inc., 525 Virginia Dr., Fort Washington, Pa. 19034.

Circle 286 on Inquiry Card

METAL CAN TRIACS

Current ratings to 15 A rms.

TIC 220, 230, and 240 series will handle load currents of 6, 10, and 15 A. Each comes in voltages of 200, 400, and 500 V at max. operating temps of 125°C. They have high dv/dt ratings, typ. 500 V/μs static and 5 V/μs min. commutating. In lots of 100, prices range from \$1.70 for a 6 A, 200 V device to \$4.15 for a 15 A, 500 V isolated unit. Texas Instruments Incorporated, Box 5012, M/S 308, Dallas, Tex. 75222. (214) 238-2011.

Circle 287 on Inquiry Card

THERMISTOR PELLET

In glass diode type enclosure.

Thermistor pellets hermetically sealed in glass diode type enclosures are well suited for large volume applications. Their construction makes them rugged enough to be imbedded in coil windings, and to be mounted on PC boards. Standard resistance values (at 25°C) are 2 k, 5 k, 10 k, 20 k, 50 k, 100 k, 200 k, 500 k, and 1 M Ω Fenwal Electronics Inc., 63 Fountain St., Framingham, Mass. 01701. (617) 872-8841.

Circle 288 on Inquiry Card

HYBRID DC-DC CONVERTERS

Eliminate highly-reg. pwr. supply.

New 3 W units allow you to convert directly on your cards where needed and eliminate the need for the highly-regulated, multiple-output power supply. Standard products operate from an input of 20 Vdc with all of the popular single output voltages from 5 to 300 Vdc and dual outputs at ±12, ±15, ±18 and ±25. Technetics Inc., Boulder Industrial Park, Boulder, Colo. 80302. (303) 442-3837. Booth 1917.

Circle 289 on Inquiry Card

TYING-CLAMPING STRAP

Self-locking.

This pre-mountable cable tying strap, TY40M, performs the dual function of tying a wire bundle and clamping it into position. Positioning of the tying head is such that it can be easily raised off a flush mounting surface for tying. It will accept wire bundles from 0.187 through 1.5 in. in dia. The Thomas & Betts Co., 36 Butler St., Elizabeth, N.J. 07201. (201) 354-4321. Booths 2518-19.

Circle 290 on Inquiry Card

DIE BONDER

Automatic or semi-auto operation.

Model DB 1000 has a capacity of 7200 cycles or 6000 parts/h. It will strip-bond devices up to 1½ in. wide. Infinite strip index provides an index range from 0.050 to 1.500 in. spacings. It also has observed die pick-up, high-speed acceleration and deceleration die pick-up and deposit mechanism and adj. bonding force from 10 to 200 grams. Kasper Instruments, Inc., 983 Shulman Ave., Santa Clara, Calif. 95050. (408) 246-2696. Booths 3024-3027.

Circle 291 on Inquiry Card

HV SUPPLY

0.005% stab. and 0.001% line reg.

Model 244 is a fixed negative-polarity supply which provides accurate outputs from -200 to -2200 Vdc at up to 10 mA. Easily-read dials allow 1% accurate output selection in calibrated 20-V steps. A front panel trim pot permits interpolation between steps with better than 100 mV resolution. Keithley Instruments, Inc., 28775 Aurora Rd., Cleveland, Ohio 441349. (216) 248-0400. Booths 566-566A.

Circle 292 on Inquiry Card

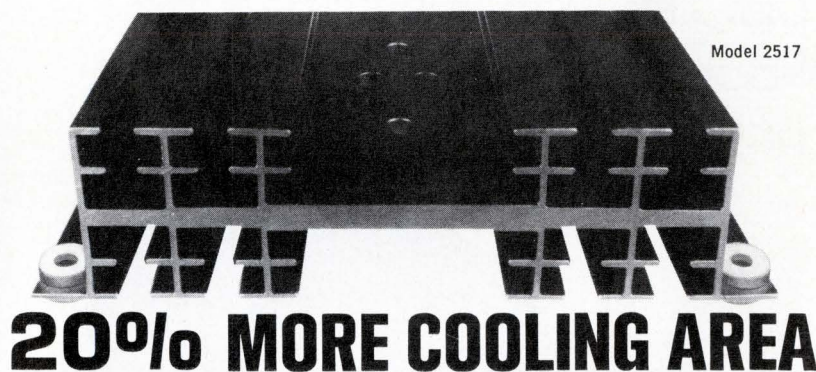

20% MORE COOLING AREA

Patented T-fin construction and balanced design permit significant improvement in natural convection heat dissipation by new Astrodyne Model 2517 heat sinks. In addition to the 20% increase in surface area over conventional units, Astrodyne's optimum heat-flow design provides ⅓ heat loss from conducting shelf to fins, ⅓ in fins and ⅓ from fins to ambient air.

Even without a blower, Model 2517

units have exceptionally low thermal resistance of 1.35°C/watt at 100 watt operation and 1.8°C/watt at 20 watts.

Standard 1½" and 3" length units are supplied with any desired mounting hole pattern, finished to order and with teflon or nylon grommets as desired.

A NEW CATALOG — NATURAL CONVECTION HEAT SINKS, plus technical data on the 2517, will be sent on request.



astrodyne, inc.

SUBSIDIARY OF ROANWELL CORP.
353 MIDDLESEX AVE, WILMINGTON, MASS. (617) 272-3850

NOW HIGH-PERFORMANCE SCRs TO MEET THE CRITICAL NEEDS OF...

- Power Inverters
- A.C. Motor Variable Speed Drives
- Induction Heaters
- Pulse Width Modulators

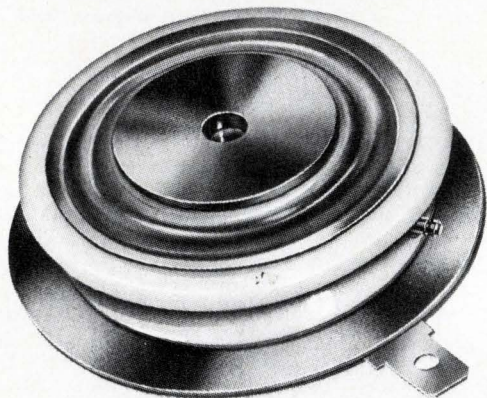

NATIONAL®
DISC PACKAGED
REGENERATIVE GATE* SCRs
provide these plus factors...

- + Voltages to 1000 V
- + dv/dt to 500 V/ μ sec.
- + Turn-off time to 15 μ sec.
- + di/dt to 800 A/ μ sec.
- + Low power gate drive
- + Operation to 20 KHz, with low switching losses
- + 175 and 380 amperes RMS
- + Also available in stud packages to 470 amperes RMS

* A NATIONAL® exclusive.
Patent No. 3,486,088

We welcome requests for detailed data and application assistance. Contact...

NATIONAL ELECTRONICS, INC.
a varian subsidiary

Geneva, Ill. 60134, phone 312-232-4300

NEW PRODUCTS

CIRCUIT ANALYSIS SYSTEM

Self-contained, manually-programmed.

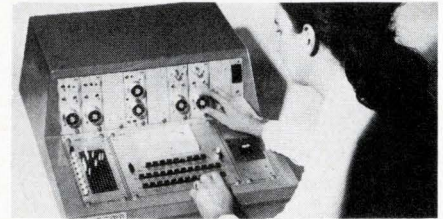

This system provides facilities for you to test and evaluate a variety of circuits without having to collect separate power supplies, signal generators, measuring instruments, and so forth. Linear and digital circuits can be evaluated on the Ceta 201 which will cover bipolar and mos ics. Ceta Electronics Ltd., 45 Richmond Rd., Poole, Dorset BH14 OBS, England. Bournemouth 28306. Booths 502-03.
Circle 293 on Inquiry Card

CRT GRAPHIC DISPLAY

With hi-speed deflection amp.

New high speed major deflection amplifier has made it possible to eliminate the usual character writing minor deflection amplifier and yoke in the Model CDO-6300 graphic display. With the CDO-6300, you can write short character strokes in <250 ns or make a full 10 in. beam excursion and settle to one spot diameter in <6 μ s using a single high speed deflection input for each axis. Optimization, Inc., 9421 Telfair Ave., Sun Valley, Calif. 91352. (213) 768-0830. Booth 556.
Circle 294 on Inquiry Card

A/D CONVERTER

With 16-bit resolution.

Model 737 uses a new design concept which makes possible 16-bit (including sign) resolution, 150,000 words/s speed, and 0.01% $\pm 1/2$ LSB accuracy. It also has a self-test feature and incandescent display. Also available with 9 and 12 bits. Electronics Div., Hi-Tek Corp., 2220 S. Anne St., Santa Ana, Calif. 92704. (714) 540-3520. Booth 432.
Circle 295 on Inquiry Card

NUMERIC CARD PRINTERS

Ribbonless printing.

New printers accept serial count, time, 10 line or BCD, in any combination. Maximum complement is 20 col. Each column can have up to 12 char. Mounting may be behind the panel or on table top for vert. or horiz. insertion of card. Operates on 12, 24 or 48 Vdc. Practical Automation, Inc., Trap Falls Rd., Shelton, Conn. 06484. (203) 929-1495. Booth 358.
Circle 296 on Inquiry Card

Feature article abstracts

Published information is vital to your job.
To save time in finding this information,
we have abstracted the important technical features
from eight electronic engineering publications.
Should any of these articles interest you, contact the magazine—
names and addresses are listed below.
Reprints of articles with an asterisk are available free.
Save this section for future reference.

Amplifiers

*Designing wideband amplifiers: let the computer help, John A. Eisenberg, Watkins-Johnson Co., "The Electronic Engineer," Vol. 29, No. 8, August 1970, pp. 59-61. The author discusses a technique, useful from 100 kHz to 1 GHz, for designing wideband amplifiers with the aid of a computer. A step-by-step exposition suggests that this is an attractive method if you know your specs, have accurate models, and have a computer program.

Charts and Nomographs

Solve op-amp slew-rate requirements, Thomas Carmody, PRD Electronics, Inc., "Electronic Design," Vol. 18, No. 13, June 21, 1970, p. 82. A nomograph is given that relates op-amp frequency, peak-to-peak output voltage, and slew rate.

Nomograms simplify design of dc-to-dc converters, Chester W. Young, Young Ocean Exploration, "EEE," Vol. 18, No. 6, June 1970, pp. 46-47. With two nomograms, one for power calculations and the other to calculate transformer characteristics, you can speed the calculation of the transformer for a dc-to-dc converter. The article includes, in addition to both nomographs, an example for a 40-W converter.

Circuit Design

Design MOS circuits on a computer, Jim Kubinec, Computer Microtechnology, Inc., "Electronic Design," Vol. 18, No. 13, June 21, 1970, pp. 68-70. A simple, limited, conversational, FOCAL program is presented that designs MOS circuits for dc and steady state solutions. Each circuit is broken into transistor pairs and the program uses equations describing the three operating modes, the triode region, the saturated region, and cutoff, to design the circuits. A four transistor flip-flop is used as an example.

Simple technique extends op amp slew rate, Don R. Kesner, Motorola Semiconductor, "EDN," Vol. 15, No. 11, June 1, 1970, pp. 46-50. Mr. Kesner shows a simple circuit-technique that results in a wide power-bandwidth. The method uses data-sheet information, and does away with elaborate compensation procedures. The author points out that error and output offset increase as loop gain decreases, and shows you how to avoid these common problems.

Build better source followers 10 ways, James S. Sherwin, Siliconix Inc., "Electronic Design," Vol. 18, No. 12, June 7, 1970, pp. 80-84. Ten source follower designs are examined, some with, and some without gate feedback. These circuits are useful for impedance transformations between FETs and bipolar transistors because of the high input impedance and low output impedance. Several graphs are presented to simplify biasing calculations.

Components

*Optoelectronic course, part 2a, "The Electronic Engineer," Vol. 29, No. 8, August 1970, pp. 29-40. The second installment of this course is comprised of two articles: "Let the light shine out," by L. Wetterau, M. Miller, and Dr. R. Haisty of Texas Instruments; and "Emitter packaging and performance," by Dr. M. G. Colemand, R. W. Gurtler, and A. London, Motorola. The first explains the generation of light with solid state devices and what types of devices are available. The second discusses device packaging in relation to application and performance. Here is your chance to learn about both of these important facets.

Computers and Peripherals

MOS memory and its application, Marcian E. Hoff, Jr., Intel Corp., "Computer Design," Vol. 9, No. 6, June 1970, pp. 83-87. The author discusses several types of MOS memories and some of the important factors to be considered in their application. The two approaches—static and dynamic—are covered. He describes in-

Magazine publishers and their addresses

Computer Design

Computer Design Publishing Corp.
Prof. Bldg., Baker Ave.
W. Concord, Mass. 01781

EDN

Cahners Publishing Company
3375 S. Bannock Street
Englewood, Colo. 80110

EEE

Mactier Publishing Co.
820 Second Avenue
New York, N. Y. 10017

Electronic Design

Hayden Publishing Co.
850 Third Avenue
New York, N. Y. 10022

Electronic Products

United Technical Publications
645 Stewart Avenue
Garden City, N. Y. 11530

Electronics

McGraw-Hill, Inc.
330 W. 42nd Street
New York, N. Y. 10036

IEEE Spectrum

Institute of Electrical & Electronics
Engineers
345 East 47th Street
New York, N. Y. 10017

The Electronic Engineer

Chilton Company
56th & Chestnut Streets
Philadelphia, Pa. 19139

*Reprints available free. Request them on your company letterhead.

ABSTRACTS

verters, shift registers, and RAMs. Much of this material duplicates that published (by the same author) in the June 1970 issues of *The Electronic Engineer*, (pp. 72-74) and "EEE" (pp. 62-69).

High-performance semiconductor memories: CML vs other approaches, Andrew R. Berding and Robert C. Lutz, *Advanced Memory Systems*, "EEE," Vol. 18, No. 6, June 1970, pp. 72-73. The article makes a case for current-mode logic memories, claiming that these memories are not only faster, but can also be cheaper and more reliable than TTL and MOS-bipolar memories. In addition, it states that they dissipate less power than TTL memories, yet still more than MOS-bipolar hybrid memories.

The writeable personalized chip, Harold Fleisher, Arnold Weinberger, and Vaughn D. Winkler, IBM, "Computer Design," Vol. 9, No. 6, June 1970, pp. 59-66. In this article the authors discuss elements and operation of the WPC, and how it offers improved use of logic arrays in data processors. They also demonstrate the capability of a controlled logic gate array to generate any combination logic function of the input variables.

Digital Design

Any code goes with IC decoder/drivers, R. L. Nelson Jr., Tracor Inc., "Electronic Design," Vol. 18, No. 13, June 21, 1970, pp. 74-75. BCD decoder/drivers can be used to drive display tubes directly from many codes if the wiring is done properly. A review of several codes and diagrams for proper connections is presented.

Integrated Circuits

***MOS associative memories**, Leon D. Wald, Honeywell Inc., "The Electronic Engineer," Vol. 29, No. 8, August 1970, pp. 53-56. Associative memories first attracted attention back in the early 1950's, but it remained for the advent of LSI to make these devices practical. In this article, Mr. Wald discusses such a memory made with MOS technology.

Ion implantation offers a bagful of benefits for MOS, John Macdougall and Ken Manchester, Sprague Electric Co., and Robert B. Palmer, Mostek Corp., "Electronics," Vol. 43, No. 13, June 22, 1970, pp. 86-90. High frequency performance, a broad range of low threshold voltages, and possible new devices are the outcome of ion implantation of MOS devices. N-channel IC fabrication is much easier with implantation. Several new low-threshold devices are now available for designers.

Low voltage offers new jobs for MOS commutators, Dale Marzek, National Semiconductor, "Electronics," Vol. 43, No. 12, June 8, 1970, pp. 82-87. Through new fabrication techniques MOS FETs can have low threshold voltages. Because of the lower threshold, switching rates to 20 MHz are possible, making these devices compatible with bipolar devices.

Try using VCOs as discriminators, P. Bruce Uhlhopp, and Larry G. Smeins, Environmental

Science Services Administration and Ball Brothers Research Corp., "Electronic Design," Vol. 18, No. 12, June 7, 1970, pp. 86-87. Phase-lock techniques can be used to make a VCO function as a discriminator. This can eliminate separate designs in systems where both VCOs and discriminators are used, and performance can be improved.

Reliability

Yes, redundancy increases reliability . . ., William H. Huber, TRW Systems, "Electronic Design," Vol. 18, No. 12, June 7, 1970, pp. 70-77. This article examines the tradeoffs between redundancy and reliability when using redundant operational amplifiers, or RAMPS. The gain available from additional amplifiers overcomes the effect of a single op amp failure, but decreases the dynamic range and output accuracy. A short primer on reliability accompanies this article.

Semiconductors

Silicon and sapphire getting together for a comeback, Staff report, "Electronics," Vol. 43, No. 12, June 8, 1970, pp. 88-94. Silicone-on-sapphire has been "promised" for several years, with out any devices available. Being able to manufacture the devices has been the holdup. Right now there are three camps: a few manufacturers say they can make the devices; some say SOS salability is questionable; while a third group sees no future for such devices. This article describes where the technology stands at this time.

Another tiny parts
FIRST from

GRC[®]

Now join 2 different plastics
in a single small part

WITH

Intermold[®]

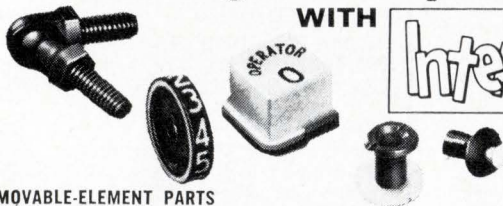

MOVABLE-ELEMENT PARTS SEPARABLE PARTS — Multi-part units that combine controlled separability with variable fit.
TWO-COLOR PARTS AND NUMBERED OR LETTERED PARTS — Make possible dual-color parts without secondary assembly costs.
COMBINATION OF MATERIALS — Join different plastics — in a single part for a combination of properties.

New molding process—"Intermold"—is GRC's exclusive patented method of producing multi-part components automatically mold-assembled in one high-speed operation. Eliminates assembly, achieves production savings and enhances performance.

Write today for "Intermold" samples and detailed bulletin

Gries Reproducer Co.

Division of Coats & Clark Inc.

165 Beechwood Ave., New Rochelle, New York 10802 • (914) 633-8600
Plants in: New Rochelle, N. Y.; Warren, R. I.; Toccoa, Ga.
In Canada: Gries Div., Dynacast Ltd. Lachine, Que.

• SPRING-LOADED CONTACTS DESIGNED TO BE PLUGGED INTO A MATING SOCKET

• PATENTED BIASING BALL CONSTRUCTION PROVIDES CONTACT BETWEEN PLUNGER AND LINING OF BARREL.

• LOW AND UNIFORM RESISTANCE

New

• ROUND, CONICAL & FLAT TIPS

REPLACEABLE

• REPLACEABLE POGOS ARE AVAILABLE FOR CENTERLINE SPACING OF .050" UPWARD

POGO Contacts

• SINGLE, BOARD MOUNTED OR COMPLETE ACTUATING SYSTEMS

• GOLD-PLATED

• LONG LIFE

Tel. (617) 222-3726

Pylon

PYLON COMPANY, INC. — 57 Newcomb St.
Attleboro, Massachusetts 02703

Ac/dc converter application

The design evolution of a precision ac/dc converter is outlined in an 8-page application note. The result is a circuit using an active 3-pole Butterworth low-pass filter with a 0.25-Hz cutoff frequency built from a

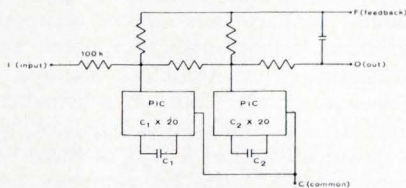

Three-pole low-pass network using PICs

standard MA-series filter network and one other chopper-stabilized op amp. The various steps in the evolution are illustrated with schematics. Testronic Development Laboratory, P. O. Drawer H, Las Cruces N.M. 88001.

Circle 361 on Inquiry Card

Microcircuit components

A comprehensive line of unencapsulated active and passive component chips for hybrid circuits and prototype development are described in this 44-page catalog. The products are divided into three sections for you—transistors and small signal diodes, zener diodes, and passive components. Discussions on chip processing and carrier packages are included, as well as necessary specs and schematics illustrating the use of these components in circuit construction. Motorola Semiconductor Products Inc., Box 20912, Phoenix, Ariz. 85036.

Circle 362 on Inquiry Card

Application notes

"Counters using MIC7400 Series TTL" and "Interfacing Circuitry for use with MIC7400 Series TTL" are available to you. The first paper describes several forms of synchronous and asynchronous circuits for counting and frequency division applications. The second discusses variable methods by which compatible interface circuits between MIC7400 series TTL and external circuits may be designed. And both are carefully illustrated with schematics. S.T.C. Semiconductors, Footscray, Sidcup, Kent, England.

Circle 363 on Inquiry Card

Electronic components

A 1970 condensed catalog of electronic components brings you 208 pages of products such as solitrons, zeners, rectifiers, power hybrid circuits, linear ICS, FETS, germanium transistors, resistors and attenuators. Outline drawings supplement many of the product descriptions, and various categories are photographically illustrated. Solitron Devices, 256 Oak Tree Rd., Tappan, N.Y. 10983.

Circle 364 on Inquiry Card

Rectifiers

Silicon-controlled rectifiers for inverter applications are the subject of this 48-page catalog. It describes the three basic methods of construction used in making SCRs with parameters required in such applications. Filled with charts and graphs illustrating performance characteristics and ratings, complete specs are provided as well as dimensional drawings. Also, there's a discussion of the various tests and parameters peculiar to inverter applications. International Rectifier, Semiconductor Div.—Dept. 781, 233 Kansas St., El Segundo, Calif. 90245.

Circle 365 on Inquiry Card

The Hall Effect

"The Hall Effect and Its Applications" is the title of a little 24-page booklet explaining the theory of the Hall Effect and its practical application through the media of Hall generators. Unlike transistors and diodes, Hall generators are completely independent of the surface effects of semiconductor material. Various configurations of Hall generators are illustrated as is the circuitry of typical applications. F. W. Bell Inc., 4949 Freeway Dr. E., Columbus, Ohio 43229.

Circle 366 on Inquiry Card

PC connector guide

The 1970 edition of this guide covers 26 series of metal-to-metal pc connectors as well as ic and test probe sockets. The connectors are available with contact spacings of 0.05, 0.075, 0.1, 0.156 and 0.2 in., and sizes range from 2 to 152 contacts. The connectors are compatible with solder, wire-wrapping, crimp, taper tab and taper pin terminating techniques. Elco Corp., Willow Grove, Pa. 19090.

Circle 367 on Inquiry Card

Computer reference manual

System design features, system organization, instruction set, memory and input/output characteristics, interrupt structure and packaging techniques are all described with reference to the cd 200 digital computer system in a 67-page manual. An asynchronous memory interface results in corresponding control of processor speed and instruction execution time and is a major feature of the system discussed in this manual. Computer Development Corp., 3001 Daimler St., Santa Ana, Calif. 92705.

Circle 368 on Inquiry Card

Panel instruments

Application data and the features of this company's ac and dc panel instruments are brought to you in a 58-page catalog. Descriptions are keyed to illustrations for easy understanding; types 20/20, foundation and conventional instruments are listed with price, style and a rating scale; and diagrams show physical dimensions. Extras include a scale selector chart of preferred wattmeter and varmeter scale markings. Westinghouse Electric Corp., Box 2278, Pittsburgh, Pa. 15230.

Circle 369 on Inquiry Card

Light-emitting semiconductors

"GaAsLITE Tips" is the title of a 48-page applications manual on light-emitting semiconductors. Diagrams and discussions describe how light-emitting diodes can serve as constant brightness light sources, how to use a photodiode coupled pair to isolate

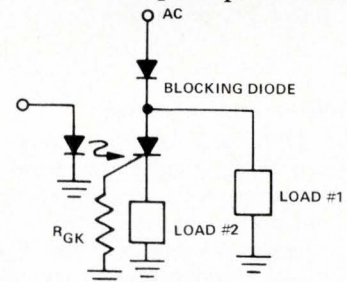

diode-transistor logic from a relay, and how to operate a number of solid-state displays with only one decoder driver. For your copy write on company letterhead to Monsanto Co., Electronic Products & Controls Div., 11636 Administration Dr., St. Louis, Mo. 63141.

Databook and rental catalog

The 1970 Instrument Databook and Rental Catalog provides a comprehensive and useful cross-reference for general purpose electronic instrumentation. It sorts products and compares pertinent specs. Other sections cross-reference manufacturers' model num-



bers and list contact phones for various geographic areas. With a spec-to-spec comparison among major manufacturers, alternate source selection is greatly simplified. Leasametric, 822 Airport Blvd., Burlingame, Calif. 94020.

Circle 370 on Inquiry Card

Product capabilities

A manufacturer of standard and custom-made rf interference filters, capacitors and high voltage power supplies describes the company's facilities and capabilities in this 12-page booklet. You receive a brief background and then read on to the capabilities of several plant locations. The custom design and field testing services are outlined, and the booklet closes with a brief description of its standard product lines. The Potter Company, 7351 Lawndale Ave., Skokie, Ill.

Circle 371 on Inquiry Card

Computer and terminal

The 4700 large scale 16-bit computer system, its standard features, optional features, software, and peripherals and options are discussed in this 8-page booklet. You'll also find a discussion of applications, including communications processing, process control, and research and engineering computation. Then a 12-page booklet describes the DCT-132 remote terminal, also providing information on all the extras and on applications. Scientific Control Corp., 1215 W. Crosby Rd., Carrollton, Tex. 75006.

Circle 372 on Inquiry Card

Conversion card

A handy digital angle conversion chart in the form of a wallet-size card is being offered by Astrosystems, Inc. Information listed includes degrees/bit, minutes/bit, seconds/bit and least significant bit as a percentage of full scale. The card can be used when working with synchro-to-digital converters, digital-to-synchro converters, and digital angle readouts. Astrosystems, Inc., 6 Nevada Drive, Lake Success, N.Y. 11040.

Circle 373 on Inquiry Card

Frequency measurements

"Precision Frequency Measurements" is the title of a 16-page application note discussing the use of the H-P 5360A Computing Counter. Examples of various frequency measurements are detailed and the counter's capabilities are compared with those of other counters. Short-term stability, precision time comparisons between frequency standards, and measurements of crystal warm-up characteristics are among the measurements included. Hewlett-Packard Co., 1501 Page Mill Rd., Palo Alto, Calif. 94304.

Circle 374 on Inquiry Card

Zener selector chart

A pocket-size chart offers voltage/power ratings for a variety of voltage regulator zener diodes. All devices listed exhibit $\pm 5\%$ tolerance, nominal voltages up to 75 V, high reliability, and are hermetically sealed or are of approved epoxy encapsulations. Tips for using the selector are included. Mullard Inc., 100 Finn Court, Farmingdale, N.Y. 11735.

Circle 375 on Inquiry Card

IC test system film

To provide you with the most complete and accurate information, Tektronix offers you a film on the S-3150 IC test system. The sequences that show the pulses on the 'scope face are very well done, as are those which show the TTY call-up of test equipment. These sequences give you a good feel for how the machine's push-buttons and dials tie in with the real world. For more information on the system, see page 100 of our March issue, then ask for the film from Mr. James W. Griffin, Tektronix Inc., Box 500, Beaverton, Ore. 97005.

Silicon semiconductors

The 1970 annual catalog of Crystalonics' silicon semiconductors and circuits is now available to our readers. We found it very thorough—with electrical data and characteristics provided for each model. Tables and graphs provide other important information. But that's not all. You'll find it goes more than one step further—it offers standard and special purpose products, quality assurance notes, application notes, technical memos, a relevant article, lots of schematics, and last (we think!) but not least, an OEM price list. For a copy of this 190-page catalog, write on company letterhead to Crystalonics, 63 Atlantic Ave., Boston, Mass. 02110.

Electric motors

You'll find information in this 32-page catalog on remote control units, actuators, and timing and control devices and systems, as well as on all kinds of motors—stepper, synchronous, asynchronous and small dc motors, to name a few. Applications are an important part of the write-ups, and you'll find a picture or diagram to illustrate every model. Polymotor International, Brussels, c/o A. W. Haydon Co., 232 N. Elm St., Waterbury, Conn.

Circle 376 on Inquiry Card

Power supplies

A new line of shelf power packages is introduced in this 12-page catalog. Seven voltage levels range from 3.6 to 28 Vdc at current ratings from 0.35 to 85 A. Each product is illus-

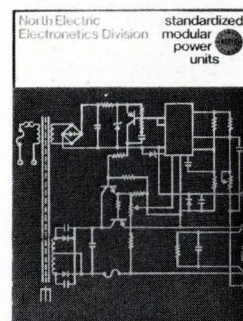

trated and diagrammed, and specs are included in each write-up. Accessories, rack adapters and additional equipment are also described. North Electric, Electronics Div., Galion, Ohio 44833.

Circle 377 on Inquiry Card

Back-and-panel connectors

The 1970 edition of this connector guide describes rectangular, miniature, modular and appliance connectors. Sizes range from 2 to 140 contacts, and current ranges from 5 to 20 A. Some models incorporate polarizing pins and sockets that prevent mismatching. An illustrated connector index shows the basic characteristics of each connector and permits immediate identification of the model best suited for your application—28 pages. Elco Corp., Willow Grove, Pa. 19090.

Circle 378 on Inquiry Card

1970 condensed catalog

Discrete semiconductors, ICs and components are the product lines listed in this 60-page catalog. One section introduces a new line of semiconductors, from TTL/MSI ICs to discrete optoelectronic devices. Electrical parameters, mechanical data, product features, application information and circuit diagrams are provided with the condensed listings. And another section devotes 7 pages to case outlines of discrete devices. Texas Instruments Inc., Box 5012, M/S 308, Dallas, Tex. 75222.

Circle 379 on Inquiry Card

Test accessories

Shielded "black boxes," patch cords, receptacle jacks, series/parallel isolation plugs, pin connector test adapters and pin tip plugs and jacks are only a few of the 420 items you'll find in this 56-page 1970 general catalog of electronic test and design accessories. Plus you get complete engineering information on all items, including photos, dimension drawings, schematics, specs, special features and operating ranges. Pomona Electronics Co. Inc., 1500 E. Ninth St., Pomona, Calif. 91766.

Circle 380 on Inquiry Card

Transformer card

A wallet-size plastic card contains tables for determining rated line amperes for single phase dry-type transformers in a variety of voltages. Transformers from 1 to 500 kVA in voltages of 120, 240, 480, and 600, and for 3-phase from 3 to 2000 kVA at 208, 240, 480 and 600 V are listed. Federal Pacific Electric Co., 50 Paris Street, Newark, N.J.

Circle 381 on Inquiry Card

It took a new generation to bridge the gap

Delevan's Micro-i® Series 155

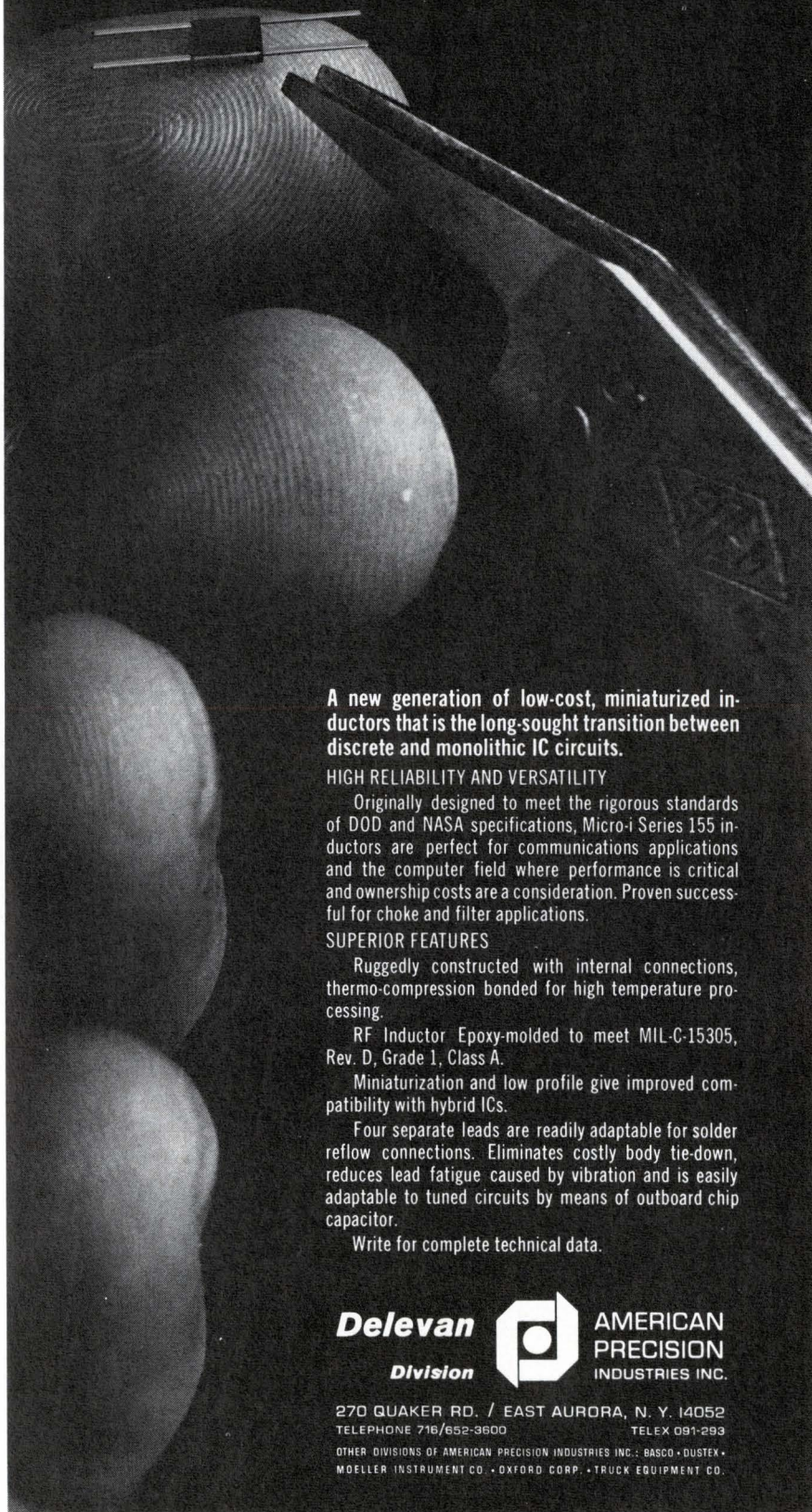

A new generation of low-cost, miniaturized inductors that is the long-sought transition between discrete and monolithic IC circuits.

HIGH RELIABILITY AND VERSATILITY

Originally designed to meet the rigorous standards of DOD and NASA specifications, Micro-i Series 155 inductors are perfect for communications applications and the computer field where performance is critical and ownership costs are a consideration. Proven successful for choke and filter applications.

SUPERIOR FEATURES

Ruggedly constructed with internal connections, thermo-compression bonded for high temperature processing.

RF Inductor Epoxy-molded to meet MIL-C-15305, Rev. D, Grade 1, Class A.

Miniaturization and low profile give improved compatibility with hybrid ICs.

Four separate leads are readily adaptable for solder reflow connections. Eliminates costly body tie-down, reduces lead fatigue caused by vibration and is easily adaptable to tuned circuits by means of outboard chip capacitor.

Write for complete technical data.

Delevan
Division



**AMERICAN
PRECISION
INDUSTRIES INC.**

270 QUAKER RD. / EAST AURORA, N. Y. 14052
TELEPHONE 716/652-3600 TELEEX 091-293

OTHER DIVISIONS OF AMERICAN PRECISION INDUSTRIES INC.: BASCO • DUSTEX •
MOELLER INSTRUMENT CO. • OXFORD CORP. • TRUCK EQUIPMENT CO.

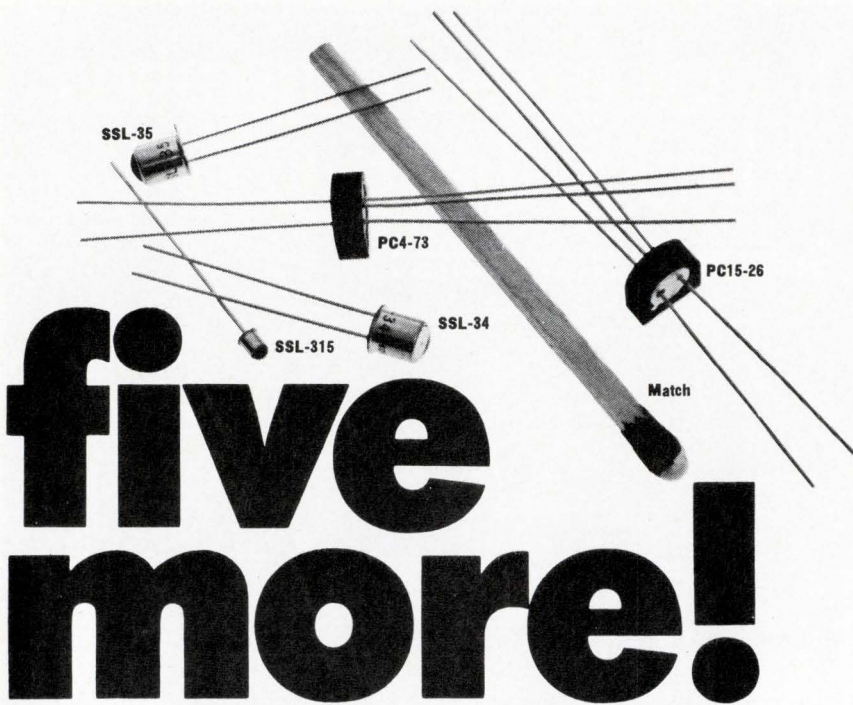

five more!

from General Electric, five new bursts in the SSL explosion.

At GE, solid state lamp technology is booming. And no wonder. For reliability, long life and fast switching speeds, no other SSL's outperform General Electric SSL's (previously known as light emitting diodes). Or withstands shock and vibration better. They practically eliminate maintenance costs. And these five new GE SSL's offer you other outstanding benefits:

- SSL-35** A gallium arsenide infrared SSL with more milliwatt output per dollar (5.5mW at 100mA) than any other SSL on the market. So you can locate it farther from the detector, or use less expensive detectors. Typical applications: intrusion alarms, safety devices and computer-related uses like BOT and EOT sensing. Price \$3.90 each in 1,000 quantity.
- SSL-315** A gallium arsenide infrared SSL, hermetically sealed, with twice the power (1mW at 20mA) of our SSL-15. High (4%) external efficiency. Less than 1/10th inch diameter. For printed circuit board applications, tape readers and other photoelectric systems. Price \$3.27 each in 1,000 quantity.
- SSL-34** Another high output gallium arsenide infrared SSL, giving up to 1/2 Watt peak power output. Permits increasing distance between lamp and detector. Applications similar to SSL-35. Price \$2.50 each in 1,000 quantity.
- PC15-26** A photon coupler consisting of a gallium arsenide SSL and an NPN planar silicon phototransistor. Has the inherent reliability of a transistor, and can withstand severe shock and vibration. Recommended for electrical isolation and high speed switching. Isolates up to 2,500 volts. Price \$7.20 each in 1,000 quantity.
- PC4-73** First of its kind. Combines a gallium arsenide SSL and an NPN planar silicon photodarlington amplifier. Has the highest transfer ratio (125%) of any coupler on the market today. Isolates up to 2,500 volts. Price \$6.50 each in 1,000 quantity.

Ask us for complete mechanical and electrical data on all five of these new GE SSL products. Or send for free detailed information on the entire General Electric SSL line — or order either of these new SSL Manuals: Theory, Characteristics and Applications, \$2.00. Applications only, \$1.00. Write: General Electric Company, Miniature Lamp Department, M-EE, Nela Park, Cleveland, Ohio 44112.

GENERAL  **ELECTRIC**

LITERATURE

Aging and burn-in systems

Semiconductor Peripherals, a new division of the Republic Corp., offers a 4-page brochure on its semiconductor aging products and burn-in systems designed for MOS/LSI. Systems are specified in five separate performance categories from bench-top units to free-standing, turnkey systems. Semiconductor Peripherals, 4820 Kearney Mesa Rd., San Diego, Calif. 92111.

Circle 382 on Inquiry Card

Fluidic die protection

A 4-page bulletin (FPD FCA-2473) discusses Corning's fluidic die-saver™ control package, a ready packaged fluidic circuit designed to sense parts, detect troubles, and halt press operation before damage occurs. Methods for using the system on progressive dies, transfer dies, and single station dies are described, and specs for the system are listed. Corning Glass Works, Corning, N.Y. 14830.

Circle 383 on Inquiry Card

Signal averaging system

A detailed description and specs for the 1070 main frame and the 19 plug-ins are given in a 44-page brochure. The plug-ins adapt the main frame to a variety of applications, including signal conditioning, A/D conversion, arithmetic operations, data display, data modification, data readout and direct, hard-wired computer interface. Fabri-Tek Instruments Inc., 5225 Verona Rd., Madison, Wis. 53711.

Circle 384 on Inquiry Card

Electronics catalog

Here's a roundup of the latest prices and product specs on lines of semiconductors, tubes, resistors, relays, switches and transformers. Other products in the field are included as well — hardware, connectors, instruments, etc. So you're sure to find just what you're looking for, the 564-page volume is indexed by product, manufacturer and new products listed for the first time. For a copy of the catalog write directly to Pioneer/Cleveland, 5403 Prospect Ave., Cleveland, Ohio 44103.

Instrumentation catalog

The company's complete line of instrumentation for low-level signals is contained in their 1970-71 catalog. Among the many lines included in the catalog are high voltage supplies, ac amplifiers, electrometer op amps, re-

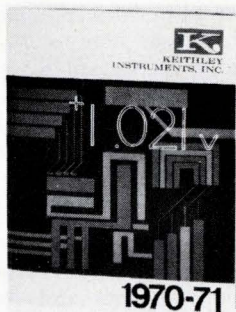

sistance measuring devices and calibration sources. Theoretical and practical limits of measurements are described, and selector charts help in choosing the right product model for a particular application. Keithley Instruments, 28775 Aurora Rd., Cleveland, Ohio 44139.

Circle 385 on Inquiry Card

Optoelectronics and relays

A 20-page distributors' stock catalog provides technical data on a line of relays, optoelectronic components, and reed switches. All products are described and dimensions for each are included. Engineering considerations intended to aid the reader in relay selection are also provided. Sigma Instruments, Inc., 170 Pearl St., Braintree, Mass. 02185.

Circle 386 on Inquiry Card

Digital printer applications

In addition to straight printout, there are at least 10 other applications for a digital printer, according to the Metricist, an applications bulletin available from Monsanto. Metricist #9 discusses the not so obvious applications for a digital printer. Time and source tagging, event monitoring, multiple limit recording, data compression and histogramming and profiling are some of the applications covered. Another article contained in this edition of the Metricist deals with ways in which near perfect pulse signals may be used to test digital equipment. Monsanto Electronic Instruments, 620 Passaic Ave., West Caldwell, N.J. 07006.

Circle 387 on Inquiry Card

Microwave tubes

A complete line of magnetrons, klystrons, crossed field amplifiers, travelling wave tubes and backward wave oscillators, operating at various frequency bands and power levels, are described in a 48-page catalog. An index is included to aid the reader in locating specific tube types. Within the various sections, tubes are listed according to operating band. Raytheon Co., Microwave and Power Tube Div., 190 Willow St., Waltham, Mass. 02154.

Circle 388 on Inquiry Card

Components catalog

Integrated circuits, discrete semiconductors and components are all discussed in this 60-page booklet. Electrical parameters, mechanical data, product features, application information and circuit diagrams sup-

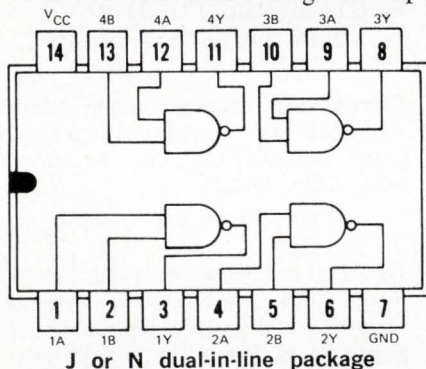

plement the product descriptions. You'll find case outlines of discrete devices and a cross-reference to military spec requirements. Texas Instruments Inc., Box 5012, M/S 308, Dallas, Tex. 75222.

Circle 389 on Inquiry Card

Interconnectors

Electronic connectors, plugs and sockets are described in a 32-page catalog providing photos, line drawings, electrical characteristics and mechanical specs for all interconnection products. New products are included in the listing, and a selection guide completes the information necessary for choosing the right component for any equipment or circuit application. Amphenol Div., Bunker-Ramo Corp., 1830 S. 54th Ave., Chicago, Ill. 60650.

Circle 390 on Inquiry Card

Optoelectronics glossary

Two freebies are being offered by Schweber Electronics. An optoelectronics newsletter, available on a monthly basis, will feature recent happenings in the optoelectronics field with specific regard to products, specs, and applications. The other "give-away" is the Schweber glossary of optoelectronics which contains up-to-date terms and definitions related to the field. The 8-pager is the first industry standardization of optoelectronic terminology. Both the glossary and the newsletter are available for the asking by writing on company letterhead to: Sam Kass, Editor, Schweber Electronics, Westbury, N.Y. 11590.

Crystal polishing kit

Techniques for cleaving and grinding crystals along with polishing methods, including the alcohol-felt technique and the aqueous solution-glass method, are covered in a 4-page manual. Necessary precautions in handling transmission materials are also discussed. Barnes Engineering Co., 30 Commerce Rd., Stamford, Conn. 06902.

Circle 391 on Inquiry Card

Communications processor

A microprogrammed minicomputer designed specifically for data communications applications is the subject of a 20-page brochure. The literature describes the Micro 812 Communications Processor's capabilities, applications, input/output operation, general

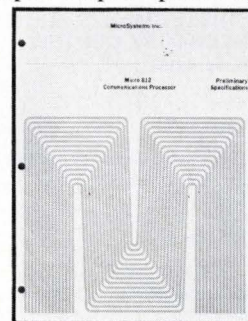

specs, instruction set and standard options. A 4k x 8 core memory, 1,024 words of preprogrammed read only storage, an option board, basic panel and power supply are included at its initial price. MicroSystems, 644 E. Young St., Santa Ana, Calif. 92705.

Circle 392 on Inquiry Card

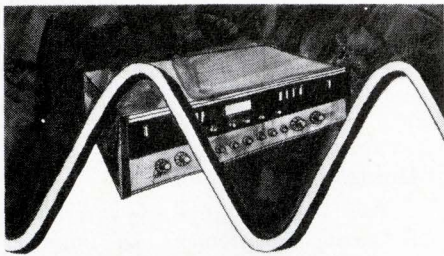

Rent-a Hz

When your laboratory needs a precision oscillator, or a pulse generator, or some other reasonably sophisticated instrument, should you buy it? Maybe not. As with a house or a car or a computer, there's a time to buy and a time to rent.

Actually there are a number of pretty good reasons for renting precision instruments any time . . . the elimination of problems like maintenance and calibration for example, or how to handle peak loads, or what to do with instruments that are obsolete or no longer needed. But let's face it, the most important reason is money. Frequently, renting instead of purchasing can save dollars, free capital for other uses, or provide financial advantages in other ways. So before you pay till it Hz, think RENTAL.

R.E.I. can give you the fastest service, the widest selection and the lowest rates of any rental firm in the country. One of our inventory centers is located near you, wherever you are, for instant delivery. Let us tell you more about the many advantages of renting vs. buying. Send today for your free copy of the new R.E.I. Instrument Rental Handbook.

Amplifiers	Filters	Power Supplies
Analyzers	Generators	Recorders
Attenuators	Meters	Sources
Bridges	Oscillators	Stroboscopes
Cameras	Oscilloscopes	Synthesizers
Counters	Plug-In Units	Test Chambers
Detectors	Generator/Synchronizer	

INSTANT INSTRUMENTS FROM THESE INVENTORY CENTERS:

Waltham, Mass. 02154

69 Hickory Drive
(617) 891-7610—Telex 923472

Anaheim, Calif. 92801

159 East Freedom Ave.
(714) 879-0561—Telex 655473

Gaithersburg, Md. 20760

16600 Oakmont Ave.
(301) 948-0620—Telex 898446

Rosemont, Ill. 60018

5607 Pearl St.
(312) 671-2464—Telex 726488

Ft. Lauderdale, Fla. 33308

4808 N.E. 10th Ave.
(305) 771-3500—Telex 51-4467

RENTAL ELECTRONICS, INC.

1341 Crampton St.
(214) 638-4180
Telex 732617

Dallas, Texas 75207

1341 Crampton St.
(214) 638-4180
Telex 732617

INSTRUMENT
RENTAL
CATALOG
1970

Dallas, Texas 75207

1341 Crampton St.
(214) 638-4180
Telex 732617

1341 Crampton St.
(214) 638-4180
Telex 732617

1341 Crampton St.
(214) 638-4180
Telex 732617

MORE INVENTORY CENTERS COMING SOON

Rental Electronics inc.

A PEPSICO LEASING COMPANY

Circle 54 on Inquiry Card

LITERATURE

Performance parameters for custom thick-film resistor and resistor-capacitor networks—4 pages. Microcircuits, 1200 Columbia Ave., Riverside, Calif. 92507.

Circle 393 on Inquiry Card

Low noise microminiature i-f amplifier with a minimum agc range of 60 dB—1 page. Scientific Research Corp., 4726 Eisenhower Blvd., Tampa, Fla. 33614.

Circle 394 on Inquiry Card

GaAs diode-silicon photodetector couplers, silicon planar Darlington light sensor and GaAs diode energy source—6 pages. Optron Inc., 1201 Tappan Circle, Carrollton, Tex. 75006.

Circle 395 on Inquiry Card

PC breadboards with tack-on pads for discrete components and with various connection availabilities—2 pages. Spectrum Dynamics Inc., Box 23699, Fort Lauderdale, Fla. 33307.

Circle 396 on Inquiry Card

Coaxial relay catalog contains detailed electrical and mechanical specs—20 pages. Dow-Key Co., Box 348, Broomfield, Colo. 80020.

Circle 397 on Inquiry Card

Drafting and production aids for PCs include new drafting shapes, connector strips and pad configurations—24 pages. W. H. Brady Co., 726 W. Glendale Ave., Milwaukee, Wis. 53201.

Circle 398 on Inquiry Card

Product assurance/MIL STD 883 explains all test sequences of the company's digital and linear ics—6 pages. Advanced Micro Devices, 901 Thompson Pl., Sunnyvale, Calif. 94086.

Circle 399 on Inquiry Card

Ku-band, solid-state source designed with minimum 100-mW output power—2 pages. Trak Microwave Corp., 4726 Eisenhower Blvd., Tampa, Fla. 33614.

Circle 400 on Inquiry Card

Decoder/power-drivers and decoder/drivers, hybrid BCD to 7-output, are TTL and DTL compatible and have uncommitted collector outputs—8 pages. Fabri-Tek Micro Systems Inc., 1150 N. W. 70th St., Fort Lauderdale, Fla. 33309.

Circle 401 on Inquiry Card

Digital data acquisition system for the processing, analysis and presentation of environmental field data—4 pages. Varian, 611 Hansen Way, Palo Alto, Calif. 94303.

Circle 402 on Inquiry Card

MOS monolithic switches—6 pages cover maximum ratings, electrical characteristics, schematic diagrams, specs and applications. Teledyne Amelco Semiconductor, 1300 Terra Bella Ave., Mountain View, Calif. 94040.

Circle 403 on Inquiry Card

Data transfer system—specific characteristics, typical applications and quality assurance procedures—6 pages. Data Graphics Corp., 8402 Speedway Dr., San Antonio, Tex. 78230.

Circle 404 on Inquiry Card

Differential video amplifiers are monolithic two-stage wideband amplifiers for applications requiring a fast linear function—4 pages. Silicon General Inc., 7382 Bolsa Ave., Westminster, Calif. 92683.

Circle 405 on Inquiry Card

WHOLESALE TO ALL

Breadboard Kits—"RF" Kits—"PC" Kits—Perf. Phenolic Board—Copper Clad Board—Cowl Type Electronic Cabinets—Heat Sinks—Solid State Hobby Kits—Solderless Connectors—Hardware Kits—Transistor Sockets and many more items. (Products approved by the Defense Supply Agency—Federal Supply Code number furnished upon request.) Send for free catalog from:

H. M. C. Sales

P. O. Box 276, Santa Susana, California 93063

Circle 55 on Inquiry Card

Advertisers—August 1970

No liability is assumed for errors or omissions.
This Index is published for a convenience.

AMF, INC., POTTER & BRUMFIELD DIV.	50-51, 87	Grant, Wright & Baker, Inc.	MILLER-STEPHENSON	27	Michel-Cather, Inc.
AMP, INC.	42, 43	Aitkin-Kynett	MOTOROLA SEMI. PRDTS., INC.	19-20, 57	Lane & Wampler Adv., Inc.
AMPERITE CO.	88	H. J. Gold Co.	NATIONAL ELECTRO-MECHANICAL SYSTEMS, INC.	4	Fred Riger Adv., Inc.
ASTRODYNE, INC.	89	Robert J. Allen	NATIONAL ELECTRONICS, INC.	90	Connor-Sager Assoc., Inc.
BELDEN CORP.	66, 67	Fensholt Adv., Inc.	NATIONAL SEMI.	22, 23	Chiat/Day, Inc.
BUNKER RAMO CORP. AMPHENOL INDUSTRIAL DIV.	52	Marsteller, Inc.	NORTH ELECTRIC CO.	48-49	Marc Assoc.
BUSSMANN MFG. DIV.	80, 81	Henderson Adv. Co.	OPTRON, INC.	28	Dean & Bain Adv., Inc.
CHERRY ELECTRICAL PRDTS. CORP.	26	Kolb/Tookey & Assoc., Inc.	POTTER & BRUMFIELD, DIV. AMF, INC.	50-51, 87	Grant, Wright & Baker, Inc.
CHRONETICS, INC.	21	i. s. Ianza & assoc.	PYLON CO., INC.	92	American Line-A-Graph Corp.
CTS CORP.	16	Reincke, Myer & Finn	QUALIDYNE CORP.	Inside Back Cover	Hal Lawrence, Inc.
DATAPAC	2	Rose Assoc.	RCA ELECTRONIC COMPONENTS	7, 34-35, 74, Back Cover	Al Paul Lefton Co., Inc.
DEARBORN ELECTRONICS, INC.	62	The Harry P. Bridge Co.	RENTAL ELECTRONICS	98	Larcom Randall Adv., Inc.
DELEVAN, DIV. API	95	Stahika, Faller & Klenk, Inc.	REPUBLIC ELECTRONICS CORP.	82	Kardonne Adv.
ELCO CORP.	45	Schaefer Advertising Inc.	ROTRON, INC.	86	Lescarbours Adv., Inc.
ELECTRO-MOTIVE CO.	5	Culver Adv., Inc.	SCANBE MFG. CORP.	83	Jansson Adv., Inc.
ESC ELECTRONICS	13	AC, Inc.	SPRAGUE ELECTRIC CO. CAPACITOR DIV.	1	The Harry P. Bridge Co.
FAIRCHILD SEMI.	46, 47	Carson/Roberts/Inc.	SUCCESS MOTIVATION INSTITUTE, INC.	71	Advertising & Marketing Assoc., Inc.
FAIRCHILD MICROWAVE	41	Tom Jones Adv.	TELEDYNE PHILBRICK NEXUS	64, 69	Renaccio Adv., Inc.
GARDNER-DENVER CO.	15	Buchen Adv., Inc.	TELEDYNE RELAYS	11	S. Michelson Adv.
GENERAL ELECTRIC	96	Batten, Barton, Durstine & Osborn, Inc.	TELEDYNE SEMI.	79	Monda Smith & Co.
GRAYHILL, INC.	76	Carr Liggett Adv., Inc.	TEXAS INSTRUMENTS, INC., COMPONENTS GROUP	37	Albert Frank-Guenther Law, Inc.
GRIES REPRODUCER CO.	92	Harold Marshall Adv. Co., Inc.	TUNG-SOL DIV.	78	Winius-Brandon Co.
HOULE MFG. CO.	98		VACTEC, INC.	77	Coleman & Assoc.
INTEL	8-9		VARFLEX CORP.	76	Barlow/Johnson, Inc.
ISOMET CORP.	44	Technical, Industrial & Scientific Marketing, Inc.	WATKINS-JOHNSON CO.	58	William C. Estler
KEPCO, INC.	Inside Front Cover	Weiss Adv.			

THE ELECTRONIC ENGINEER

DISTRICT SALES MANAGERS

EDWARD G. SHAUD BALA-CYNWYD, (Pa.) 19004 One Decker Square (Area Code 215) SHERWOOD 8 2000
JOSEPH DRUCKER NEW YORK 10017—100 East 42nd St. (Area Code 212) OXFORD 7 3400
JOHN W. BERNHARDT CHICAGO 60606—120 S. Riverside Plaza (Area Code 312) 782-1400
G. T. ALFANO NEEDHAM HEIGHTS, MASS. 02194— 570 Hillside Ave (Area Code 617) 444 0010
TERRENCE D. BUCKLEY THOMAS R. BORIS LOS ANGELES 90005 3727 W. Sixth St. #202 (Area Code 213) DUNKIRK 7 1271
RALPH PETERSEN LOS ALTOS (San Francisco) 94022 199 First St., Room 335 (Area Code 415) 941-6655
RICHARD DUTE CLEVELAND 44114—601 Rockwell Ave (Area Code 216) SUPERIOR 1-2860
NEWTON B. COLLINSON ATLANTA 30309—1776 Peachtree St. N W (Area Code 404) 872 4723
HAROLD E. MOTT WAYNE L. LOVING DALLAS 75206—Meadows Bldg Expressway at Milton (Area Code 214) EMERSON 3 6426
BRENT GILBERT Houston 77027 4151 Southwest Freeway Suite 735 (Area Code 713) 621-7550
INTERNATIONAL BUSINESS OFFICES
London, S W 1 Max F. Holsinger 67-68 Jermyrn St., St. James's Dir. European Sales TRA 6318 9 Roy V.C. Hall, A. Berg Cables WHIP LONDON S W 1
Manchester 22 D. I. Goulden Haletop, Wythenshawe Civic Centre MERCURY 3292
4 Dusseldorf-Rath E. Hillerbrand, R. Schomburg, Eitelstrasse 32 W. Heckelmann Dusseldorf 632031 Cables WHIP DUSSELDORF
Paris, 8e S. Brown-Joussard 70 Rue de Ponthieu ELYsees 65-77 Cables UIIP PARIS 16e
Tokyo C. T. Sakaguchi Room 814, Tugin Bldg. Marunouchi CPO Box No. 1572 Tel. 211-3506 3509 Cables CLARENCE SAKA TOKYO
BUSINESS STAFF
K. ROBERT BRINK <i>Publisher</i>
JOHN E. JAENISCH <i>Advertising Sales Manager</i>
DENNIS J. PERKINS <i>Promotion Manager</i>
MARK R. WERTH <i>Marketing Services Manager</i>
PAT KAUFFMAN <i>Production Manager</i>
WILLIAM M. COFFEY <i>Circulation Director</i>
JAMES F. NAGY <i>Circulation Manager</i>
JOSEPH P. BABCOCK <i>Reader Service Manager</i>
JOHN H. KOFRON <i>Chilton Research Services</i>
C. R. WILHIDE <i>Washington Vice-President</i>

Index to Product Information

Listed below are all products and new literature that appear in this issue, along with the page number they appear on and their Reader Service Numbers (RSN). For more information, see the appropriate page and circle the corresponding number on the reader service card.

Components	Page	RSN		Page	RSN		Page	RSN
capacitors, dipped mica	5	7	series 7400 AND gates	77	203	components, microcircuit	93	362
capacitors, film	86	266	seven-stage frequency divider	77	207	components catalog	97	389
capacitors, polysulfone film	1	4	shift registers, TTL	78	219	computer and terminal	94	372
capacitors, polysulfone film	62	29	solid-state display, monolithic	76	212	computer reference manual	93	368
capacitors, variable	87	275	solid state lamps	96	53	connector guide, PC	93	367
choke, miniature	84	237	transistors, VHF power	84	231	connectors, rack-and-panel	95	378
connector, audio/electronic	52	26	triacs, metal can	89	287	conversion card	94	373
connector socket	84	234	TTL/MSI circuits	22, 23	16	couplers, GaAs diode-silicon photodetector	98	395
connectors, card-edge	45	22	twelve-volt hex inverter	77	205	crystal polishing kit	97	391
connectors, subminiature	84	228	2N5039	74	34	databook and rental catalog	94	370
contacts, spring-loaded	92	51				decoder/power-drivers	98	401
crystals	44	21	Instrumentation	Page	RSN	drafting and production aids	98	398
fan	86	45	amplifier, lock-in	83	257	electronics catalog	96	none
filter, ceramic	87	273	circuit analysis system	90	293	fluidic die protection	96	383
filter, RFI/EMI	84	230	clock/data generator	83	255	frequency measurements	94	374
filters, EMI	88	278	count/controller	84	233	glossary, optoelectronics	97	none
fuses & fuseholders	81	40	Fourier analyzer	40	258	Hall effect	93	366
IC test sockets	85	245	generator, rf/i-f	82	249	IC test system film	94	none
indicator, molded	84	226	impedance bridge	40	259	instrumentation catalog	97	385
inductor, miniature	86	264	L-C meter, digital	81	260	instruments, panel	93	369
inductors, miniaturized	95	52	meter, battery-powered	85	243	interconnectors	97	390
LC filter	13	11	meters, panel	84	229	motors, electric	94	376
light, panel	85	238	power meter	81	261	optoelectronics and relays	97	386
magnetic pickup	87	276	pulsar	21	15	parameters, performance	98	393
multi-parts components	92	50	rental instruments	98	54	power supplies	94	377
optically-coupled isolators	37	193	splitter/combiner	85	246	processor, communications	97	392
photoceils	77	37	sweep generator	83	256	product assurance/Mil Std 883	98	399
potentiometer, cermet	87	271				product capabilities	94	371
pushbutton	88	282	Materials and Packaging	Page	RSN	rectifiers	93	365
readouts	84	232	cleaner/solvent	27	18	relay catalog, coaxial	98	397
relay, remnant reed	85	241	conductor compositions	85	240	semiconductors, light-emitting	93	none
relays	11	10	heat sinks	8	48	semiconductors, silicon	94	none
relays, delay	88	47	rack assembly	87	274	solid-state source, Ku-band	98	400
resistors, chip	86	265	sleeving	76	36	switches, MOS monolithic	98	403
shielded cable	66, 67	31	terminal strip, flexible	88	279	system, data transfer	98	404
switches	26	56-60	termination hardware	76	35	system, digital data acquisition	98	402
switch, miniature selector	16	13				system, signal averaging	96	383
switch, pushbutton	89	285	Modules	Page	RSN	systems, aging and burn-in	96	382
switch, selector	87	270	A/D converter	90	295	test accessories	95	380
synchronous motor	84	235	chopper stabilized op amps	69	32	transformer card	95	381
thermistor pellet	89	288	converters, D/A and A/D	64	30	tubes, microwave	97	388
tubes for SSB	back cover	None	converters, dc-dc	89	289	zener selector chart	94	375
			decoder/driver	79	223			
			HV supply	89	292	Production and Manufacturing	Page	RSN
			interface circuits	78	221	automated manufacturing	4	6
			logic clock	78	220	deposition system	84	227
			multicoupler, power	85	244	die bonder	89	291
			op-amp, FET	85	242	die handling systems	86	269
			op amp, FET	86	268	extender board, DIP	88	281
			power modules	48, 49	24	press-fitter, automatic	86	267
			power supply	86	262	soldering machine	86	263
			power supply regulator	79	224	strap, tying-clamping	89	290
			readout, fiber-optic	88	277	ultrasonic cleaners	85	248
			solid-state relay	50, 51	25	wire-wrap tools	15	2
			speech amplifiers	78	222			
						Systems Equipment	Page	RSN
			New Literature	Page	RSN	card printers, numeric	90	296
			amplifier, low noise	98	394	converters, level	89	286
			microminiature i-f	98	405	display, CRT graphic	90	294
			amplifiers, differential video	98	405	microwave collection systems	58	28
			application, ac/dc converter	93	361	millimeter wave source	85	239
			application notes	93	363	oscillator, clock	85	247
			applications, digital printer	97	387	oscillator, X-band	88	284
			breadboards, PC	98	396	power supply	ins. front cover	2
			catalog, 1970 condensed	95	379	power supply	87	272
			components, electronic	93	364	ROM	2	5
						signal conditioners	88	283

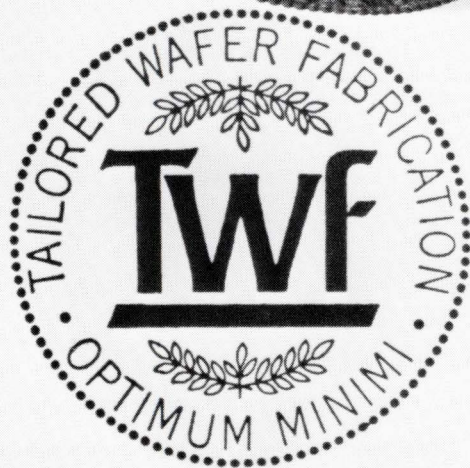
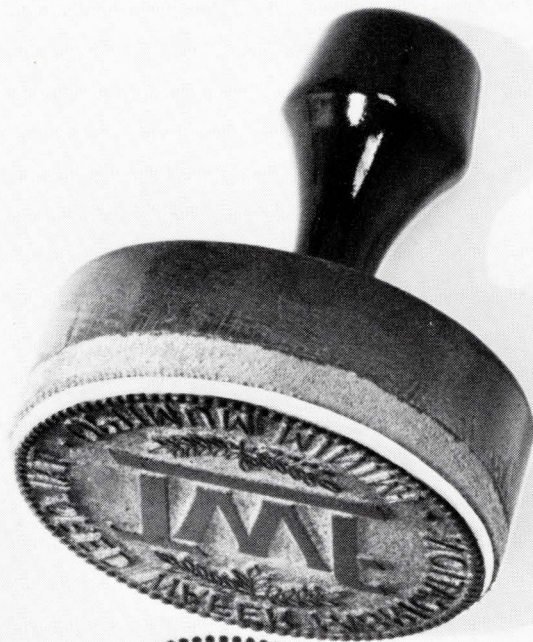

This seal is worth money.

You've never seen this symbol before.

But if you're interested in buying interface and memory components for less, yet retaining high quality manufacturing processes, you won't forget it.

This seal is the symbol for Tailored Wafer Fabrication, a unique Qualidyne innovation in semiconductor manufacturing.

This proprietary process makes possible a wafer yield nearly twice the industry average.

That in itself is only part of the story. Quality hasn't been sacrificed for price. The process lets us produce components of unusually high quality.

Hard to believe? Just for comparison's sake, see if your present dual transistors match these monolithic NPN and PNP specs and prices:

The NPN-QD-100 Series (in TO-71, 78, 78 epoxy cans) exhibit DC current gains (h_{FE}) of 200 min. from 10 μ A to 1 mA with the Base-Emitter Voltage (V_{BE1} - V_{BE2}) of 5 mV, 3 mV and 1.5 mV. The 100 piece price is \$1.00 to \$3.68, depending upon the package and model you choose.

The PNP-QD400 Series (in TO-71, 78, 78 epoxy cans) have DC current gains (h_{FE}) of 100 min. from 10 μ A to 1 mA with Base-Emitter Voltage (V_{BE1} - V_{BE2}) of 5 mV, 3 mV and 1.5 mV. The 100 piece price is \$1.10 to \$4.05, depending upon the package and model you choose.

The NPN 2N Series in TO-71 and TO-78 cans.
2N2913-2N2920—General Purpose—\$1.75 to \$5.50
2N3423-2N3424—High Frequency—\$5.00 to \$7.30
2N4044-2N4880—Dielectric Isolation—\$3.00 to \$8.00

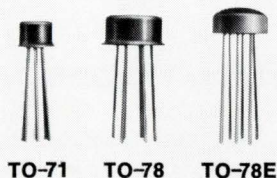

**Qualidyne
Corporation**

Demonstration, not conversation, sells Qualidyne TWF components. For information on our line of diode arrays, monolithic duals, linear ICs, drivers/receivers and custom semiconductor memories, contact your Qualidyne representative, or contact us directly.
Qualidyne Corporation, 3699 Tahoe Way, Santa Clara, Calif. 95051. (408) 738-0120.

Circle 3 on Inquiry Card

Now, RCA tubes for SSB can be "White Noise" tested

RCA is the first tube manufacturer to offer power tubes for SSB applications whose distortion characteristics have been tested by "white noise".

This means that RCA power tubes intended for multiplex service can be checked out under field use conditions before they are shipped. Thus, RCA tubes can meet conditions for distortion as it relates to noise loading procedures set forth by Mil Std 188C and Mil Std 1311.

Under these test conditions, you can forget questions of definition between peak envelope power and peak side-band power, of peaking characteristics taking on average characteristics in multiplex services, of intermodulation performance ratings and how they relate to power output. RCA power tubes for SSB when tested for "white noise" at

average power output will supply the information to fulfill your application requirements.

Whether speech, teletype, data transmission or any combination is your SSB application, see your local RCA Representative or your RCA Industrial Tube Distributor about RCA power tubes. For technical data on specific types, write: RCA, Commercial Engineering, Section 59H / ZR4, Harrison, N. J. 07029. International: RCA, 2-4 rue du Lièvre, 1227 Geneva, Switzerland, or P.O. Box 112, Hong Kong.

RCA

RCA-8792, typical of the RCA Line of SSB Tubes for RF Power.

