

ANNUAL TRADE SHOW NUMBER

Radio Retailing

The Business Magazine of the Radio Industry

A McGraw-Hill Publication

JUNE, 1930

SPARTON CELEBRATES
*its 30th anniversary year
by announcing, at the Atlantic
City Show, the magnificent new*

JUBILEE
SPARTON



[This announcement means more than it says]

REMEMBER IT

A BARE OUTLINE OF THE GREAT NEW BRUNSWICK STORY

See—

4 Brunswick models
at prices that mean substan-
tial profits and sales volume
a low boy ~ ~ ~ ~ ~
a high boy ~ ~ ~ ~ ~
a combination Radio and
Panatropé.

*and a combination with a
new automatic feature!*

cabinets even finer than ever.
all shielded and armored chassis.
absolute single control—one con-
trol, the Uni-selector turns the set
on and off, adjusts volume,
changes antenna tuning from
local to distant reception, and
tunes the set!

4 screen grid tubes ~ ~ ~ ~
resistance coupling with two '45
power tubes in parallel ~ ~ ~
10 inch dynamic speaker ~ ~

**New and greater value in
the Brunswick 1931 line!**

GET
THE FULL DETAILS
at the
ATLANTIC CITY
CONVENTION

June 2nd to 7th

Booths Section C 17, 18, 19
Demonstration Rooms 34, 35

Brunswick

LEST WE FORGET

Radio Retailing again defines its editorial policies and suggestions for industry action; formerly published in the May issue under the heading: "A Course to Steer By."

Match Production with Demand

Through a knowledge of merchandise movements.

A Factual Control of Costs

We must keep adequate records.

Aggressive Selling

Within the limits of working capital and sound business policies.

Establish a Standard of Values

Lines must have a permanent market worth.

A Radio in Every Home—Unwired as Well as Wired

Improved designing will make these objectives practical.

A Profit Every Month in the Year

Sell other home devices if need be.

A Charge for Credit, Installation and Maintenance Service

Formulate policies and keep them.

Capture the Automobile Market

The radio dealer is the logical man to satisfy this demand.

Radio Retailing

The Business Magazine of the Radio Industry

O. H. CALDWELL, Editor

RAY V. SUTLIFF, Managing Editor
W. W. MACDONALD, Technical Editor
S. J. RYAN, Merchandising Counsellor
M. E. HERRING, Publishing Director

VOL. 11
No. 6

HARRY PHILLIPS, Art Director
T. H. PURINTON, Assistant Editor
C. GRUNSKY, San Francisco
P. WOOTON, Washington

Contents for June, 1930

Copyright, 1930, by McGraw-Hill Publishing Company, Inc.

World Overproduction and the Radio Situation.....	55
Can We Budget Production to Meet Demand?.....	56
Animated Record Window.....	58
Enter, the Midgets.....	59
Handling Salesmen..... By Ray V. Sulliffe	60
The New Lines at Atlantic City.....	63
The Technical Trends..... By W. W. MacDonald	64
Automobile-Radio Is Your Market.. By Tom F. Blackburn	70
Pepping Up the Tube Business.....	72
Publicity and Sales from Beauty Contests.....	74
How the Auction Game Is Played.. By Henry H. Moore	76
Snappy Sales Stunts.....	78
Symptoms at the Socket..... By Edward Chinitz	80
Editorials, The RCA Suit.....	86
New Merchandise Described.....	88
The News of the Month, Extracted by "Detector".....	92
Jobber Appointments.....	96
Give a Thought to Broadcasting.....	102



"Mighty glad to see you here!"

Here's the kind of reception the glad-hand committee extended last year at Chicago. It will be given even more enthusiastically at Atlantic City.

McGRAW-HILL PUBLISHING COMPANY, INC., Tenth Ave. at 36th St., New York, N. Y.

Cable Address: "Machinist, N. Y."

JAMES H. MCGRAW, Chairman of the Board
MALCOLM MOIR, President
JAMES H. MCGRAW, JR., Vice-Pres. and Treas.
EDWARD J. MERRIN, Vice-President
C. H. THOMPSON, Secretary

MASON BRITTON, Vice-President
EDGAR KOBAR, Vice-President
HAROLD W. MCGRAW, Vice-President
H. C. PARMELEE, Editorial Director

NEW YORK District Office, 285 Madison Ave.
WASHINGTON, National Press Building
CHICAGO, 520 North Michigan Ave.
PHILADELPHIA, 1600 Arch Street
CLEVELAND, Guardian Building
ST. LOUIS, Bell Telephone Building

SAN FRANCISCO, 883 Mission Street
BOSTON, 1427 Statler Bldg.
GREENVILLE, S. C., 1301 Woodside Bldg.
DETROIT, 2-257 General Motors Bldg.
LOS ANGELES, 632 Chamber of Com. Bldg.
LONDON, 6 Bouverie St., London, E. C. 4

Member A.B.P. Member A.B.C. Printed in U.S.A.

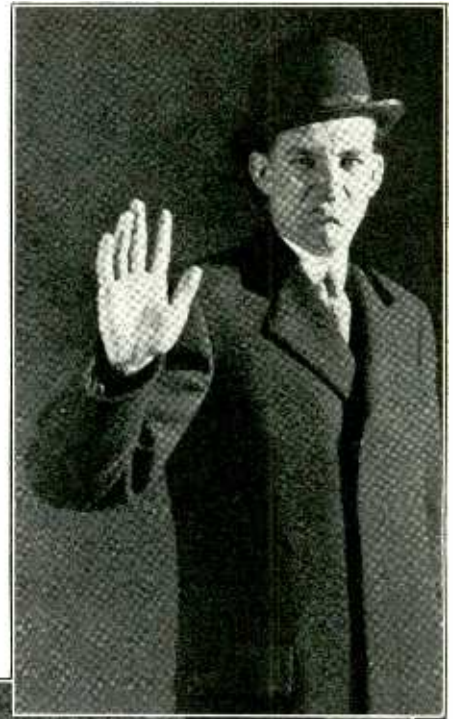

Takes more than talk to sell these men

HARD ones, all of them: the man who used to build his own, the skeptic, the cynic, the shopper. They vary as to type, but they have this in common: it takes more than talk to sell them. And the new Grebe has sold them—is selling them—*will continue to sell them*—on actual performance in every essential of radio enjoyment.

At the R. M. A. show, the SK4 line is presented with important refinements and improvements. Profit opportunities for Grebe franchise holders are further strengthened by the inclusion, in the line, of a new moderate-priced receiver which maintains the SK4 audio quality standard.

Grebe radio

SUPER-SYNCHROPHASE 

These Grebe receivers are presented without the accompaniment of high-sounding proclamations. *The superlatives have been built into the sets.*



A. H. GREBE & COMPANY, Inc., Richmond Hill, New York
Western Branch, 443 So. San Pedro Street, Los Angeles, California

The Sensation of the Show

UTAH Remote Control



See it installed in leading
nationally advertised sets ready
for the market



Two other startling developments
for Radio Engineers



Demonstrations at
Ambassador Hotel



All Divisions Represented:
THE CASWELL-RUNYON COMPANY
THE CARTER RADIO COMPANY
and the UTAH LINES

SALT LAKE CITY

NEW YORK

TORONTO, CANADA

UTAH RADIO PRODUCTS CO., 1737 S. Michigan Ave., Chicago

ANNOUNCEMENT

of the NEW Fall Stromberg-Carlsons
*— Telephone and Radio Laboratories
 combine to produce these fine instruments*

THE addition of these four distinctive new instruments so broadens the Stromberg-Carlson line as to enable you to supply every customer need in quality radio with a Stromberg-Carlson product.

Now you may concentrate upon a line which is consistently profitable for its dealers—a line which already in 1930 has increased sales 50% above last year—a line on which factory prices have always been maintained—a line backed by more than 35 years of successful telephone manufacturing.

These four models embody Stromberg-Carlson's latest gift to radio engineering—"Full Dial Efficiency," consisting of: **UNIFORMLY SHARP TUNING WITH THE SAME SUPERB TONE QUALITY ON EVERY BROADCAST CHANNEL; ALSO, THE SAME HIGH SENSITIVITY AT EVERY DIAL SETTING!** Read the physical descriptions and specifications of each individual instrument, They are NEW! Their results are NEW! They are additional evidence to prove that:

"There is Nothing Finer Than a Stromberg-Carlson"

Other standard Stromberg-Carlsons are Nos. 641, 645 (Direct Current), 652, 846 and 654, ranging in price from \$155 to \$369. Custom-built period cabinet models from \$695 to \$795. Prices, less tubes, East of Rockies.
 STROMBERG-CARLSON TELEPHONE MFG. CO., ROCHESTER, N. Y.

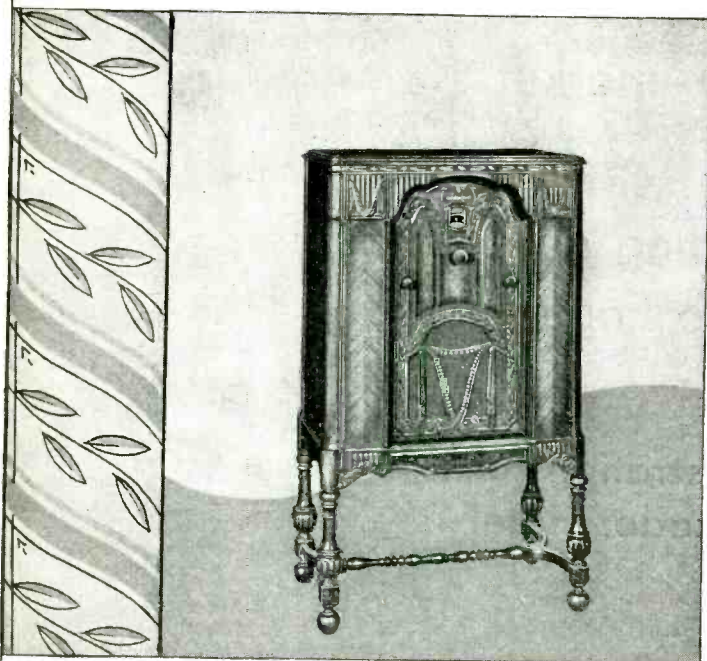

NO. 10 STROMBERG-CARLSON
 LOW CONSOLE

Designed for homes where space is limited. Uses 4 UY-224 Screen Grid, 2 UX-245 in Push-Pull and 1 UX-280 (Rectifier) Radiotrons. Five tuned stages with two Bi-resonators. Range Control. Extra-size Electro-Dynamic Speaker. Walnut finish cabinet, with side panels half-diamond center matched. Price, less tubes, East of Rockies \$259.00



NO. 11 STROMBERG-CARLSON
 "CONVERTIBLE" CONSOLE

A radio Receiver which can be converted into a Radio-Phonograph simply by installing the No. 1 Phonograph Panel Assembly. Uses 4 UY-224 Screen Grid, 2 UX-245 in Push-Pull and 1 UX-280 (Rectifier) Radiotrons. Five tuned stages with two Bi-resonators. Range Control. Extra-size Electro Dynamic Speaker. Walnut finish cabinet. Price, less tubes, East of Rockies \$285.00
 No. 1 Phonograph Panel Assembly . . . \$75.00

{
 The Stromberg-Carlson Guarantee not to reduce its list prices has been in effect since March 1925 and continues without limitation.
 }

Listen to the Stromberg-Carlson Hour Monday Evenings in a Coast-to-Coast Broadcast of the 50-piece Rochester Civic Orchestra over the N.B.C. Blue Network and Associated Stations.

NO. 12 STROMBERG-CARLSON GRAND CONSOLE

Incorporates every advancement known to radio. Uses 10 tubes, 3 UY-224 Screen Grid, 3 UY-227, 2 UX-245 in Push-Pull, 2 UX-280 (Rectifier) Radiotrons. Automatic Volume Control. Visual Tuning Meter. Silent Push Button. Five tuned stages with two Bi-resonators. Range Control. Extra-size Electro-Dynamic Speaker. Half-octagonal walnut cabinet. Proscenium Arch Lighting. Price, less tubes, East of Rockies **\$355.00**

Provision made for connecting Remote Control

NO. 14 STROMBERG-CARLSON MULTIPLE-RECORD RADIO-PHONOGRAPH

Equipped with automatic record changer. Capacity 12 records: 10 inch, 12 inch, or both together. Electrical Reproduction. Motor driven. Uses 10 tubes, 3 UY-221 Screen Grid, 3 UY-227, 2 UX-245 in Push-Pull, 2 UX-280 (Rectifier) Radiotrons. Automatic Volume Control. Visual Tuning Meter. Silent Push Button. Five tuned stages with two Bi-resonators. Range Control. Extra-size Electro-Dynamic Speaker. Attractive walnut cabinet, exceptionally compact. Proscenium Arch Lighting. Price, less tubes, East of Rockies **\$645.00**

Provision made for connecting Remote Control

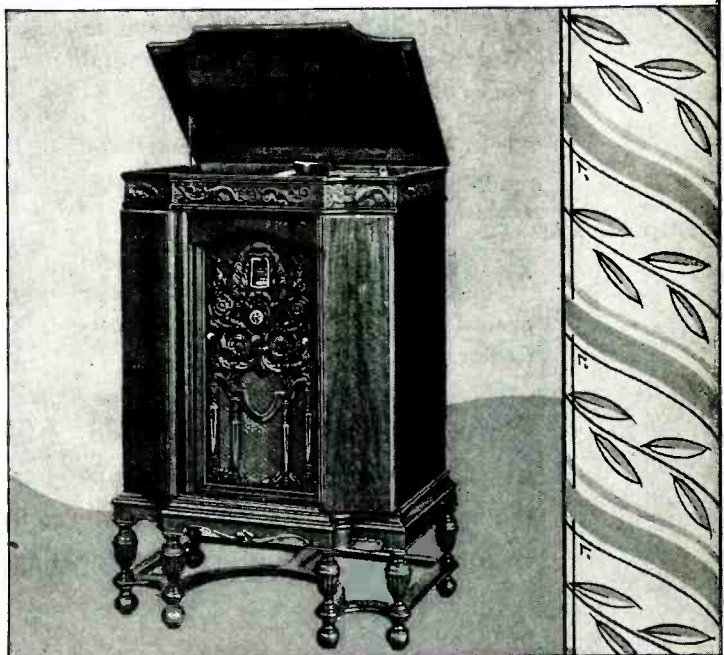

Stromberg-Carlson

MAKERS OF VOICE TRANSMISSION AND VOICE RECEPTION APPARATUS
FOR MORE THAN THIRTY-FIVE YEARS

Nine Important Facts About ASSOCIATED FACTORY DISTRIBUTORS

THE Wedge-shaped business mark of ASSOCIATED FACTORY DISTRIBUTORS, which nowatimes appears on many a shipping carton, has made many friends. Growing numbers of its champions appear among the dealers and jobbers of this industry—earnest men who have been fighting a war of independence for a long time, and are grateful for such strong reinforcements.

But because there is occasional confusion in the land—because the eager tongue of the small mind is too ready with misinformation, we here set down the essential facts.

Briefly, ASSOCIATED FACTORY DISTRIBUTORS are combined:

- 1** To provide, at twelve important points of the business compass, local representation for a limited number of manufacturers.
- 2** To locally insure to jobbers and to dealers immediate and plentiful stocks of significant merchandise.
- 3** To locally and liberally interpret the policies and guarantees of represented manufacturers.
- 4** To further the business development and profit of the legitimate dealer against his "gyp" or dishonest competitor.
- 5** To personally assist jobbers and dealers in their merchandising and general business promotional problems.
- 6** To protect wholesaler and retailer from the hazards of price fluctuations.
- 7** To bring about "on-the-ground" adjustments in matters of merchandise replacements.
- 8** To support the just claims of dealers and jobbers in manufacturer controversy.
- 9** To have at all times ample financial and physical resources to insure all of the foregoing.

On the nine points of this credo, ASSOCIATED FACTORY DISTRIBUTORS have laid the steady progress of their purpose — to increase the scope of manufacturer helpfulness that good retailers and wholesalers so long have been justified in expecting.



ASSOCIATED FACTORY DISTRIBUTORS

At Albany
WM. J. KATTREIN
1031 Broadway

At Boston
TUNG-SOL SALES
CO., INC.
221 Columbus Avenue

At Chicago
THE EKKO CO.
400 W. Madison St.

At Detroit
TUNG-SOL SALES CO.
OF MICHIGAN
4612 Woodward Avenue

At Minneapolis
A. A. HUME CO.
104 N. Third Street

At Philadelphia
A. HOPKIN, JR. CO.
235 S. 8th Street

At Baltimore
W. B. MASLAND CO.
105 East Franklin St.

At Charlotte
S. L. BAGBY
219 W. First Street

At Dallas
THE FOLSOM CO.
212 North Austin St.

At Indianapolis
H. J. ARENS CO., INC.
202-4 S. Pennsylvania St.

At New York
WIEDENBACH-BROWN
CO., INC.
118 E. 25th Street

At Rochester
ERSKINE-HEALY, INC.
420 St. Paul Street

BOSCH MOTOR CAR RADIO

RADIO for the motor car has been made just as practical as radio for the home by the makers of the famous Bosch Radio. An achievement that brings a new pleasure to motoring and a new profit source to dealers. Bosch Motor Car Radio is easily installed in any car—new or old. This newest Bosch Radio model embodies all the superior qualities of Bosch Radio so long recognized for quality performance. It is a screen-grid tube receiver—four are used with one power tube. The receiver is extremely compact

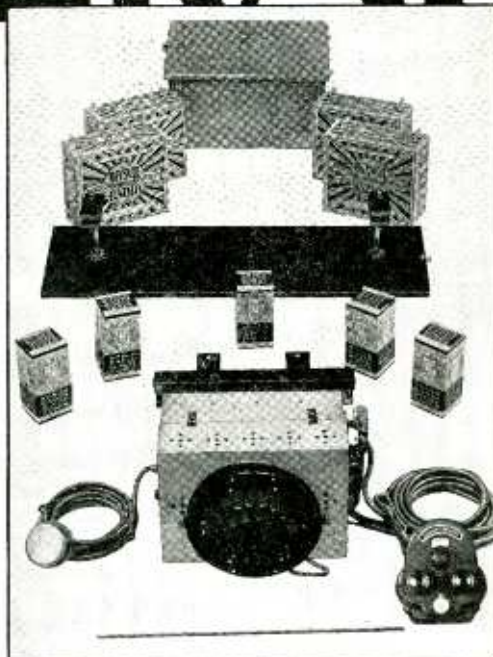

Bosch Radio is complete with receiver, station selector, five tubes, special B Batteries, battery box, cone speaker, antenna and all required shielded cables, ready to install. Price \$140.00. Western and Canadian prices slightly higher.

and requires minimum space; it has a cone type speaker, completely housed. The single dial tuning control is placed on the instrument panel without mutilation of panel or interference with instruments. No need to disturb upholstery. There is a quick, active demand for Bosch Motor Car Radio wherever it is demonstrated because it gives you the same perfection of tone regardless of varying

motor speed. It is the outstanding radio achievement of the year. Use the coupon and receive the interesting details.

Bosch Radio is manufactured under patents and applications of R.C.A., R.F.L. and Lektophone

AMERICAN BOSCH MAGNETO CORP., SPRINGFIELD, MASS.

Branches: New York · Chicago · Detroit · San Francisco

Installed without mutilation of panel

No antenna in Car Body

Cone speaker well pitched above vibration and rumble of car

Precision built by Bosch Automotive and Radio Engineers

Single tuning control

Single radio unit

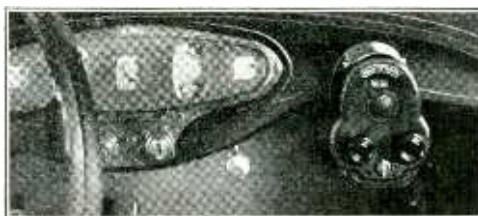

The tuning control unit is compact with illuminated dial, volume control, station selector and switch lock. It is installed without mutilation of panel.

C O U P O N

American Bosch Magneto Corp., Springfield, Mass.

Please send me details of Bosch Motor Car Radio.

Name

Firm

Address

Introducing The New

GORDON
Electric

P
I
C
K
U
P

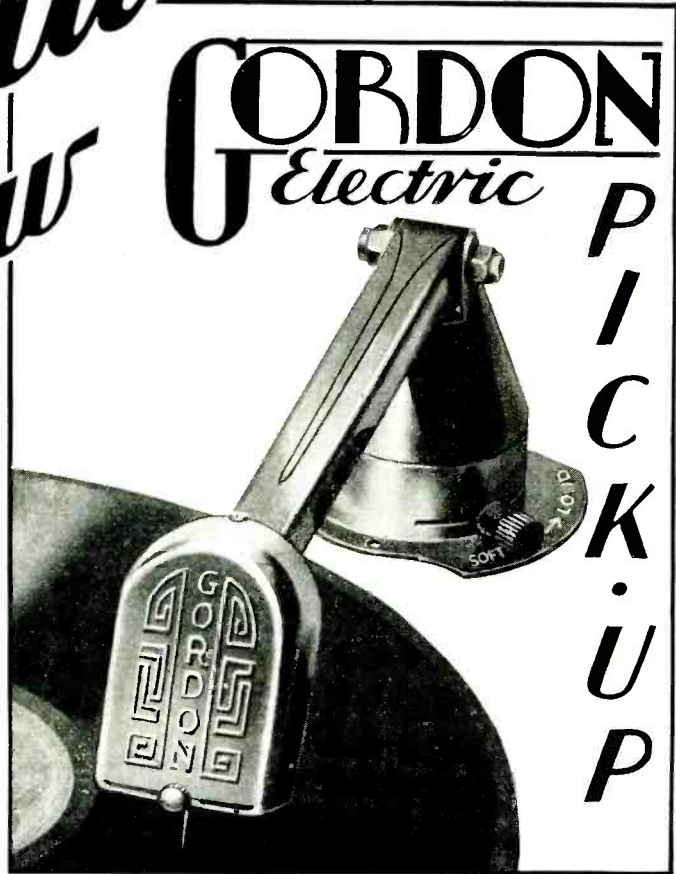

The New Gordon Electric Pickup

- produces full tone quality, rich in harmonics
- extends the range of reproduction
- and registers with surpassing fidelity
- has a special keyed construction which eliminates all need for adjustment
- provides unfailing accuracy and uniformity of performance
- is triple tested for frequency output by the finest precision instruments
- and is individually tested for tone accuracy.

Years of concentration on the design, construction and use of electric pickups and motors, plus exhaustive laboratory tests, prove there is none superior to the new Gordon electric products. And frankly, we have found none wholly equal.

The NEW Gordon electric pickup will successfully deliver all the quality that the engineer and manufac-

turer build into the radio frequency, audio, and speaker units.

Gordon's NEW Model "H" motor embodies new principles which provide extreme power and positive action with compactness, simplicity and—unusually low cost.

Our exceptional plant facilities enable us to meet your cost requirements.

L. S. GORDON COMPANY
CHICAGO, U. S. A.

GORDON MOTORS

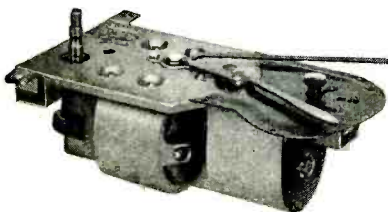

Model "G"

This established member of the Gordon family has proved itself in thousands of instruments. Quiet (because

of the Spanish felt gears), exceptionally quick starting torque, and constant speed are only three of its many features. List: \$30.00.

Model "H"

Compact; super-powered; full speed of turn-table in less than one revolution; three bearing main shaft; positive speed control; simple; silent—just a few of many outstanding features. Priced unusually low—List: \$15.00.

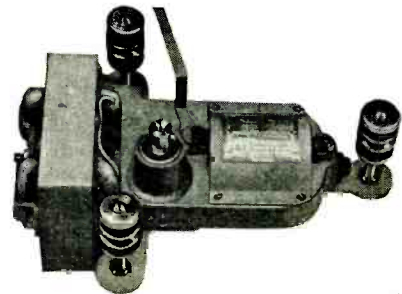

AGAIN

...THE HIGHEST QUALITY RADIO IN THE WORLD

...YEAR-IN-ADVANCE ENGINEERING DEVELOPMENTS

...FULL DEALER PROFITS *THROUGHOUT* THE SEASON

ZENITH



FOR THE SIXTEENTH SUCCESSIVE YEAR ZENITH SUBSCRIBES TO THOSE

PRINCIPLES OF QUALITY MANUFACTURE, ENGINEERING ADVANCEMENT

AND SOUND SELLING PRACTICE THAT HAVE PLACED ITS PRODUCT IN-

DISPUTABLY IN A CLASS BY ITSELF. (C) ONCE AGAIN THE BEGINNING

OF A NEW SEASON BRINGS TO ZENITH DEALERS NOT ONLY NEW MODELS



OF OUTSTANDING SUPERIORITY, BUT ALSO THE SURETY THAT SANE PRO-

DUCTION STANDARDS WILL MAINTAIN ORIGINAL VALUES AND PUBLIC

ACCEPTANCE THROUGHOUT THE SEASON. *C.* IN PRESENTING ITS NEW

70-LINE OF RADIO RECEIVERS, ZENITH HAS GONE FAR FORWARD, NOT

ONLY IN ENGINEERING DEVELOPMENT, BUT IN ARTISTRY OF APPEAR-



MODEL 71

A distinctive low-boy console of authentic Tudor motif. Woods are of selected Walnut veneers, Birch, and Redgum, with panel of Australian Maple Bilt. Advanced super screen-grid circuit. Advanced super-size electro dynamic type speaker. Entirely new degrees of sensitivity, selectivity, tonal purity and distance range. 9 tubes, with rectification. less tubes

\$185

Slightly higher in Far West.

ANCE . . . AN ENTIRELY NEW NOTE IN CABINETRY WHICH, FOR SHEER

BEAUTY AND DISTINCTION, DISMISSES ALL FORMER CONCEPTIONS OF



MODEL 72

The new Zenith 70 chassis housed in an exquisite low-boy of authentic Tudor design. Woods are of carefully selected Walnut, Birch, and Redgum, with panels of Butt Walnut. Advanced screen-grid circuit. Genuine Automatic Tuning. Super-size electro dynamic type speaker. 9 tubes, with rectification. less tubes

\$210

Slightly higher in Far West.

RADIO FURNITURE. ☉ THE PERFORMANCE OF THE CHASSIS REVEALS AN

ENTIRELY NEW PEAK IN TONE QUALITY, WITH BOTH SENSITIVITY AND

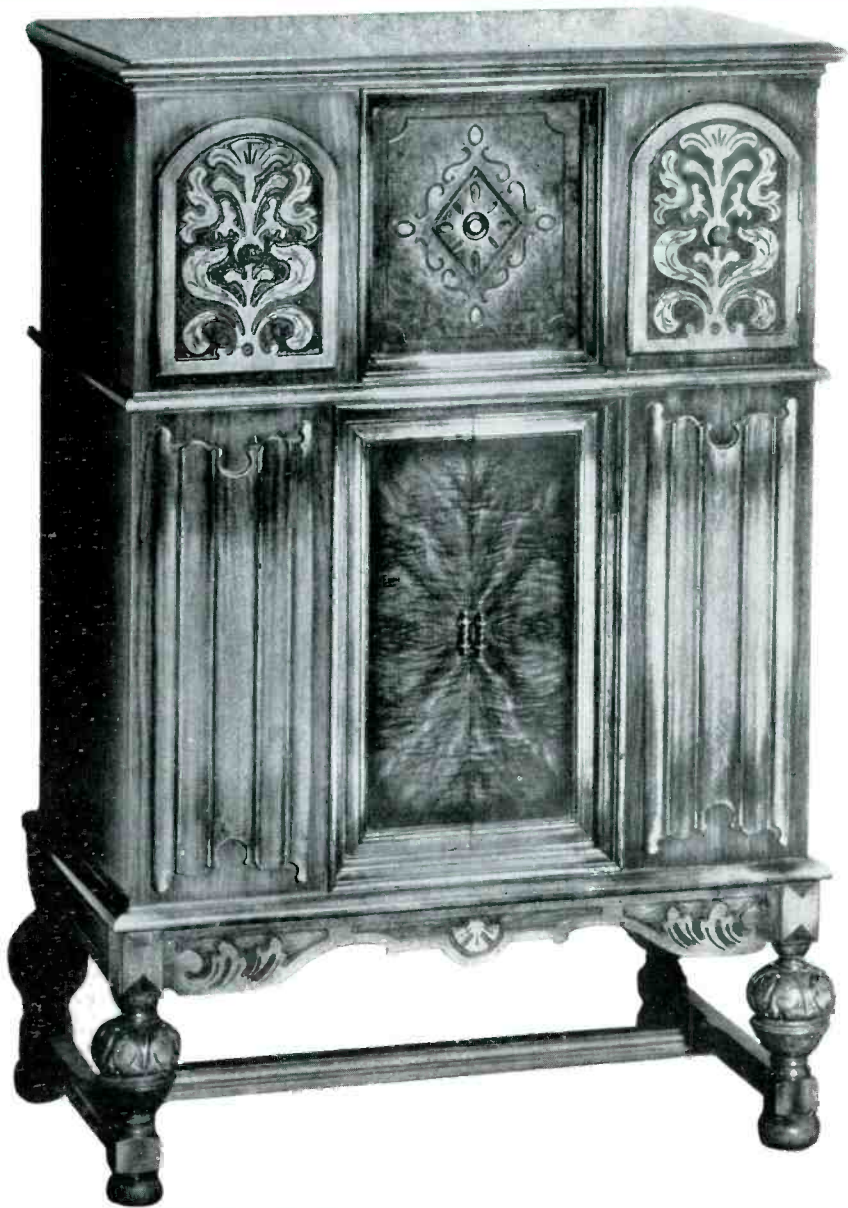

MODEL 73

An entirely new note in radio furniture craftsmanship and cabinetry is reflected in this beautiful semi-high-boy. Of authentic Tudor design to the smallest detail, built of choicest, rare woods, its appeal to the discriminating buyer is instant. Woods used are Walnut and Birch, with the upper door of Italian Olive Burl. The instrument panel is of Butt Walnut. All features of new 70-line Zenith chassis, including genuine Automatic Tuning, 9 tubes, with rectification. **\$265** less tubes

Slightly higher in Far West.

MODEL 74

Same console as Model 73 with REMOTE Automatic CONTROL. **\$315** less tubes

Slightly higher in Far West.

SELECTIVITY INCREASED TO HEIGHTS NEVER BEFORE ATTAINED. C. AND,

OF COURSE, ZENITH GENUINE AUTOMATIC TUNING HAS BECOME AN

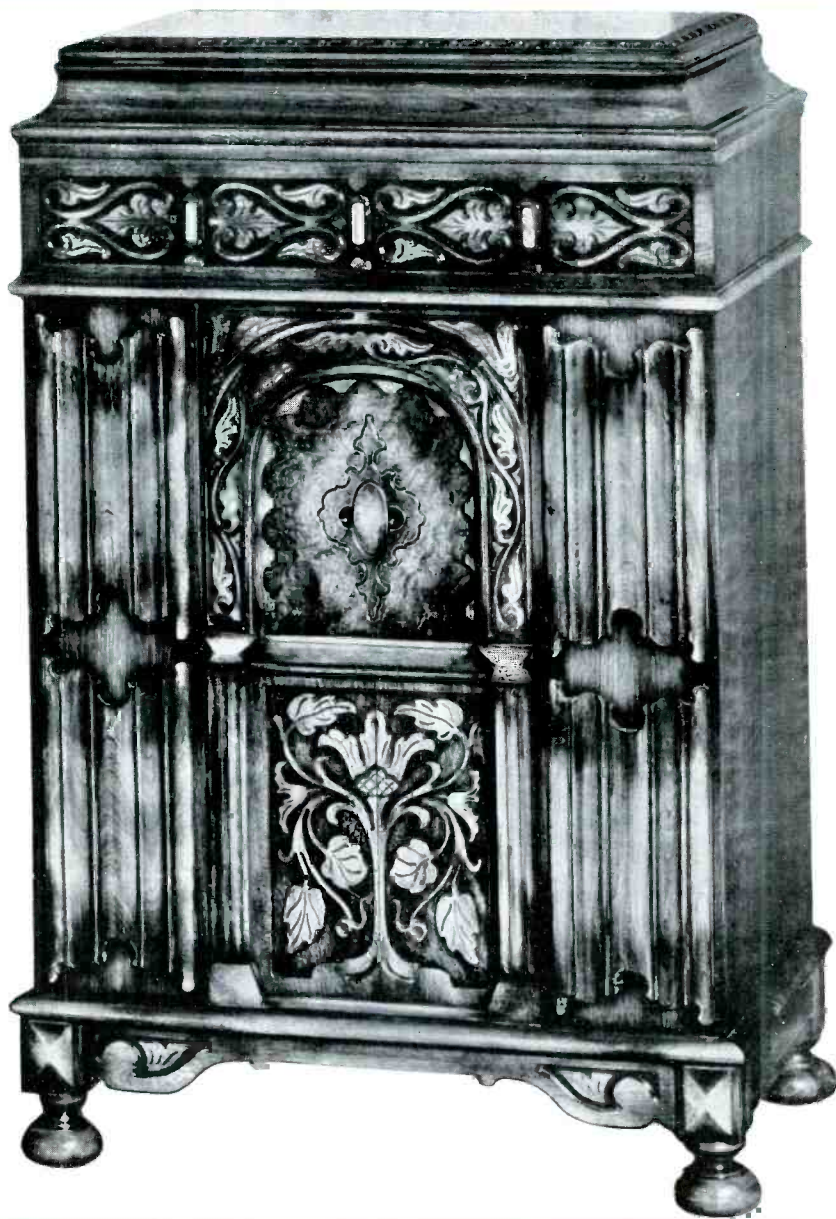

MODEL 75

A sensational advancement in radio-phonograph combinations, featuring a revolutionary Automatic Record Changer that provides thirty minutes of continuous transcription. Housed in a magnificent console of authentic Tudor period. Handsome carvings and fineness of detail enhance richly grained Walnut and Birch. The Panel is of Butt Walnut. Employs the new Zenith 70 chassis. 9 tubes, with rectification. **\$375** less tubes

Slightly higher in Far West.

OUTSTANDING, WANTED FEATURE . . . LOOKED FOR, AND FOUND ONLY,

IN ZENITH RECEIVERS . . . TO BE MORE DEMANDED THAN EVER THIS SEASON.



AND LINKED WITH THE OUTSTANDING SUPERIORITY OF THESE NEW ZENITH

RECEIVERS IS A TIME-PROVEN POLICY OF PRICE ADHERENCE THAT ASSURES

CONTINUOUS FULL PROFITS TO ZENITH DEALERS. AGAIN ZENITH OFFERS

THE RADIO DEALER THE SUREST GUARANTEE OF A SUCCESSFUL SEASON.

EXHIBITING DURING SHOW WEEK...2407 BOARDWALK, ATLANTIC CITY

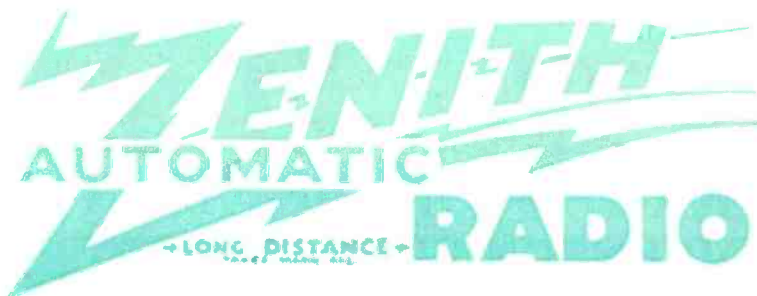

★ ZENITH RADIO CORPORATION, CHICAGO, ILL. ★

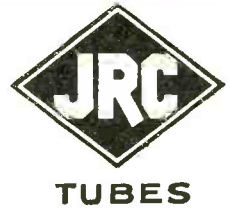
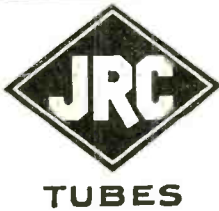

*Sealed
in Cellophane
at our factory
for your
protection*

JRC new type construction enables us to make EVERY JRC Tube a good tube. Therefore, every JRC Tube remains good when it comes to you, Mr. Dealer, and is good when you hand it to your customers.

No other tube has the improved features which characterize JRC construction. These assure quick reception and greater uniformity. No chance of shorting a JRC Tube, which means longer life and quieter operation, thus eliminating Dealer Service.



We make all types of tubes in our own factory



Chicago Office
28 E. Jackson Blvd.
New York City Office
55 W. 42nd Street

“The Standard by Which Others
The Electro-Chromatic
PICK-UP by AUDAK

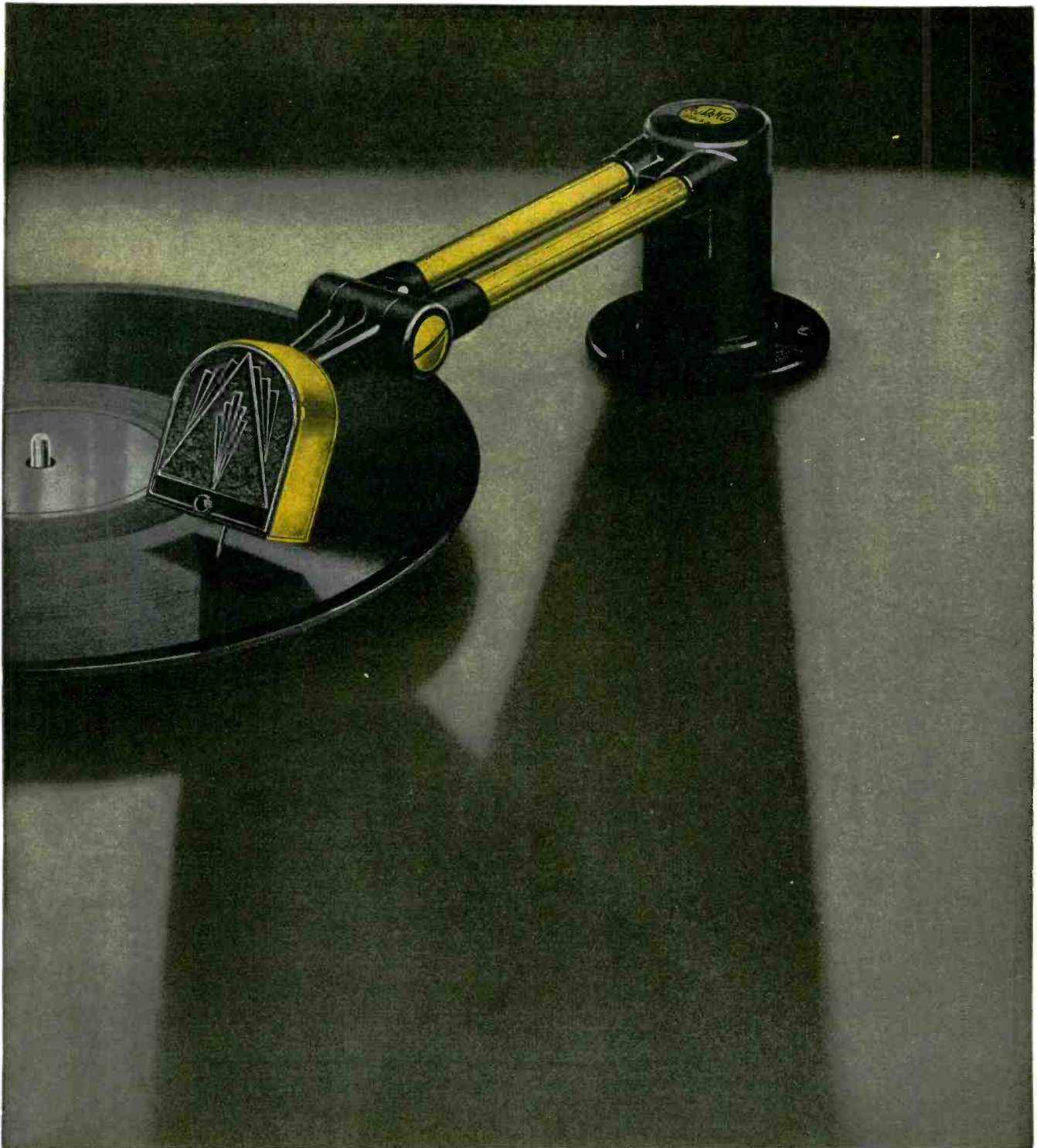

All models now available in *New* **TUNED** type
Shortly to be seen and heard on some of the best combinations made

Are Judged and Valued"



SENSATION OF THE YEAR!

The Musichrome

**Developed especially
for YOU!**

Weighing less than 14 pounds, this marvelous little cabinet of solid mahogany or walnut holds the secret of perfect home and public entertainment through the RADIO . . . via RECORDS. Identical outfit used by broadcasting stations, theaters and exclusive radio shops for electrically transcribing music. Equipped with genuine ELECTRO - CHROMATIC Pick-up (full length). Just plug in, enjoy MUSICHROME, then tuck it out of the way if you wish till needed again! What a mighty CONSTRUCTIVE force for BETTER BUSINESS! The possibilities are tremendous!

SPECIFICATIONS

Cabinet—Solid mahogany, walnut finished. Size 11 inches by 11 inches by 7 inches.

Pick-up—Genuine AUDAK Electro-Chromatic full length.

Motor—High grade splitphase induction motor, self-starting.

Switches—Switchboard wiring; best switches and jacks.

Hardware—Finest bronze-plated.

Handle—Removable leather handle.

Stroboscope—Instantaneous speed indicator.

Cover—Waterproof, rubberized zipper cover (optional).

The AUDAK COMPANY

565 Fifth Avenue, New York

"Creators of High Grade Electrical and Acoustical Apparatus Since 1915"

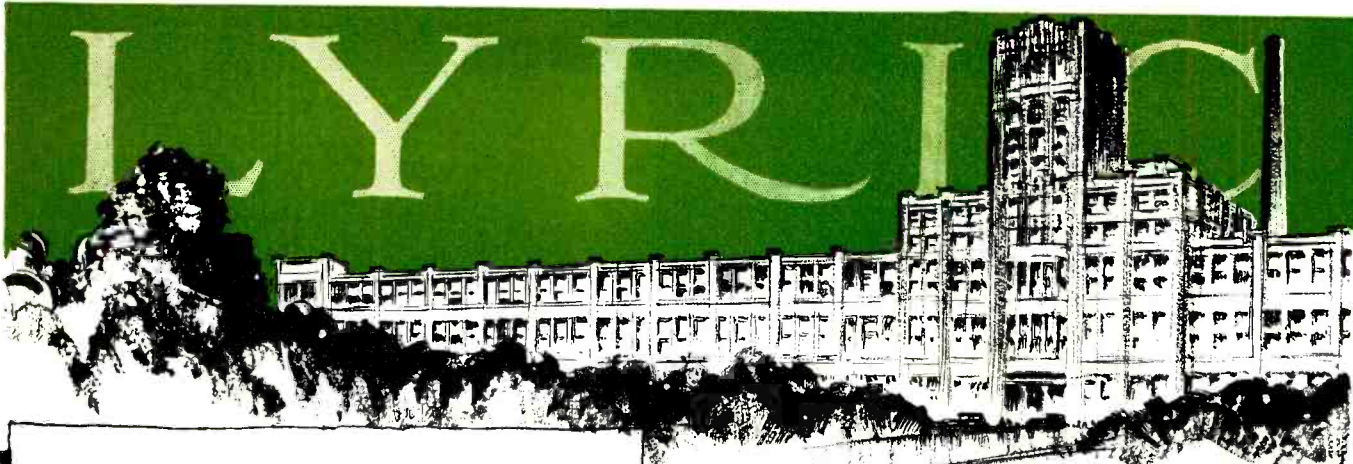

June 10 1928

My Dear Son -
 A dear letter from your
 mother tells me that
 continuing to be ^{the} ^{best}
 of your parents' ^{interest}
 As I grow older and look
 back on our work we can
 well feel proud of the progress
 made in our violin shop.
 It is the wish of my heart
 that quality and fineness
 will always be your guide in
 your future work as it has
 been while we were together.
 Your loving father,
 Harry Oswald Wurlitzer

THE admonition of an old craftsman has been through centuries . . . a guidance . . . a goal . . . a tradition . . . to be guarded and upheld. From prosperous upper New York comes a modern translation of old world fineness in the new Lyric Consoles; a complete satisfaction to one's inward longing for beauty of design.

The famous Wurlitzer organization is now one of America's industrial Titans. Being fully conscious of the responsibility assumed in the new era of American musical recreation—the wonder of Radio—it produces 93% of the completed set in the gigantic Lyric plants at North Tonawanda, N. Y. Only in this manner can a great name protect a tradition that has made it so preeminent.

To meet the demands of the 1930 Radio market, the Wurlitzer organization, at great expense, incorporated among its corps of experts one of America's leading cabinet designers.



▲ ▲ ▲ ALL-AMERICAN
 CHICAGO, ILLINOIS ▲ ▲ ▲

LYRIC RADIO
Product of **WURLITZER**

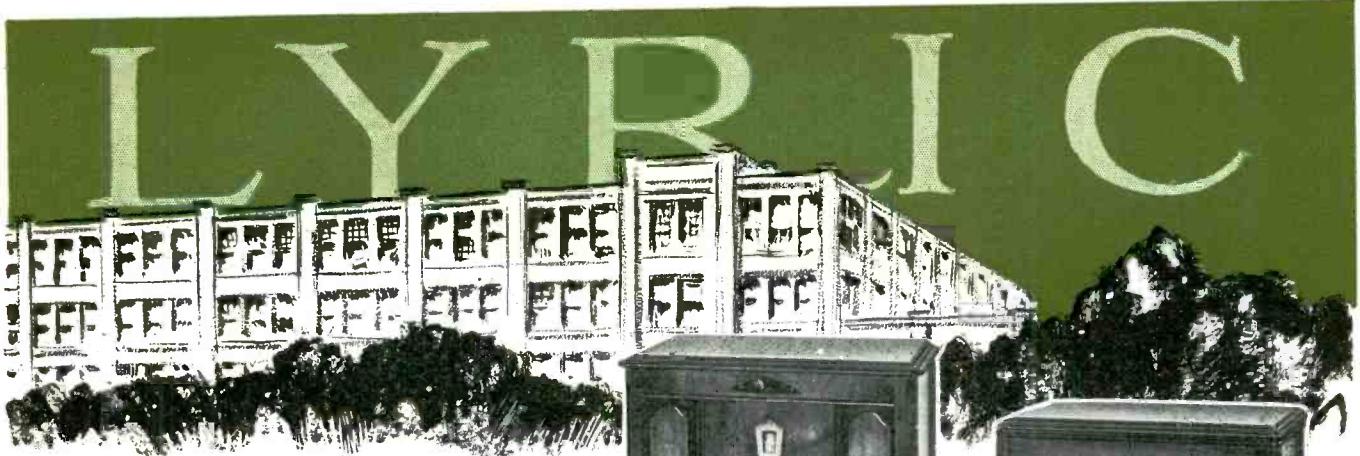

For this reason the 1930 Lyric Consoles justify their calm dignified poise which is only made possible by the background and preponderance of financial strength which supports their origin.

At the right are illustrated four beautiful models, which constitute the new Lyric line:

Modest Model 11 with its Colonial cabinet cannot for the price be matched in America today. Seven tube super-shielded screen grid chassis and super dynamic speaker.

Model 19 of Tudor design is equipped with seven tube super-shielded screen grid chassis, tone control, phonograph plug, exquisite tapestry grill and super dynamic speaker.

Model 29 is of Spanish Umbrian design with a seven tube, screen grid super-shielded chassis, tone control, phonograph plug, beautiful tapestry grill and super dynamic speaker.

Model 39, a combination radio and phonograph, has a beautifully substantial cabinet of Tuscan design with seven tube, super-shielded screen grid chassis, tone control, attractive tapestry grill and super dynamic speaker.

Lyric Radio is meeting the market with a combination of background, finance, mechanical perfection and cabinet design that will mean wider horizons for 1930 Lyric dealers.

[The new Lyric line will be on display in booths A33 and 34 at the R.M.A. show, Atlantic City Auditorium]



MODEL 11
\$99.50

less tubes



MODEL 19
\$119.00

less tubes



MODEL 29
\$139.00

less tubes



Radio Combination
MODEL 39
\$199.50

less tubes

MOHAWK CORPORATION
▲ ▲ NORTH TONAWANDA, N.Y.

LYRIC RADIO

Product of WURLITZER

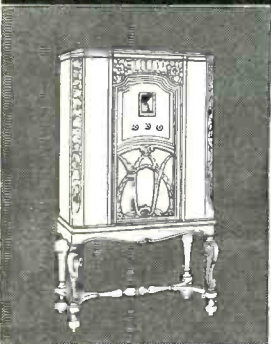

MODEL 43 CONSOLE. Equipped with automatic volume control. Price without tubes, \$248

MODEL 36 CONSOLE—the finest of woods, craftsmanship and finish; classis embodying the very latest of engineering achievements and built with utmost precision and *extraordinary margins of safety.*
 Price without tubes, \$208.

STORY & CLARK RADIO

(Built complete in the Story & Clark factories)

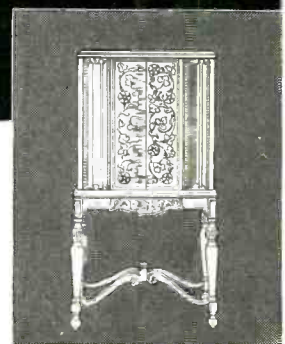

MODEL 50 CONSOLE WITH DIALS. Equipped with automatic volume control. Price without tubes, \$287

RADIO

by **STORY & CLARK**

THE House of Story & Clark, realizing how much was expected of it, has been in no haste to enter the field of radio. It knew that whatever it produced must be true to the traditions it has kept alive for nearly three-quarters of a century in the making of fine musical instruments.

The year 1930 brings to a close radio's decade of formative confusion and marks the birth of this fine musical instrument from the House of Story & Clark.

It is simple, efficient, beautiful—the radio you expect of Story & Clark—a firm whose two enthusiasms are its splendid old name and the craftsman-ideal for which that name has always stood.

STORY & CLARK RADIO

(Built complete in the Story & Clark factories)

THE STORY & CLARK RADIO CORPORATION
173 North Michigan Avenue • Chicago

*Division of the House of Story & Clark, makers
of fine musical instruments since 1857*

•
BOOTHS B27-28, R. M. A. TRADE SHOW, ATLANTIC CITY
Suite 18 to 22—Eleventh Floor, The Ritz-Carlton—Atlantic City

•
*Manufactured under Story & Clark owned Patents & Patents Pending.
Licensed under R. C. A. and Affiliated Companies. Charter Member R. M. A.*

A NEW
Farrand
 INDUCTOR
SPEAKER *is available*

It will be used as the equipment speaker of leading battery set manufacturers.

✧ ✧ ✧

Battery set tone now comparable with that of A-C receivers.

✧ ✧ ✧

No field leads—no drain on batteries—no hum—but *Full Dynamic Tone.*

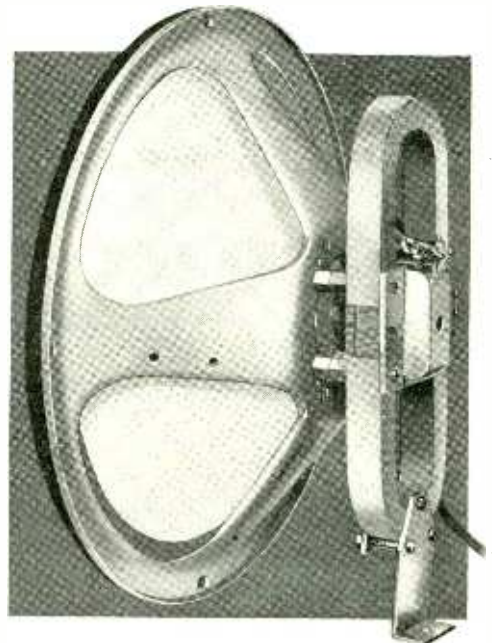

For Push Pull or Single Output
 Tube Operation

Manufactured by BRUNSWICK RADIO CORPORATION, 120 W. 42nd STREET, N. Y.

ANNOUNCING AN INTRODUCTORY SALES PLAN ON **EVEREADY RAYTHEON** **4-PILLAR TUBES** OPENING THE DOOR TO BIGGER PROFITS

YOU'LL travel long and far to find another offer as attractive as this one. In the first place, it involves the finest quality merchandise—Eveready Raytheon 4-Pillar Tubes! Tubes that have built an outstanding reputation for performance in every radio set where they've been installed. In addition, this introductory sales plan is made with no strings or reservations. It's just the same as money in the bank—or in the cash drawer. Here it is:

1 With every purchase of 25 Eveready Raytheon Tubes, either assorted types or one type, two additional type-227 tubes will be included in the shipment. No charge. You pay for 25, but you get 27 tubes.

2 With every purchase of 45 Eveready Raytheon Tubes, either assorted types or one type, 5 additional type-227 tubes will be included in the shipment. No charge. You pay for 45, but you get 50 tubes.

3 With every purchase of 200 Eveready Raytheon Tubes, either assorted types or one type, 25 additional type-227 tubes will be included in the shipment. No charge. You pay for 200, but you get 225 tubes.

In each case, the retailer may select his own assortment of tubes purchased.

AND THAT'S NOT ALL—TURN TO NEXT PAGE

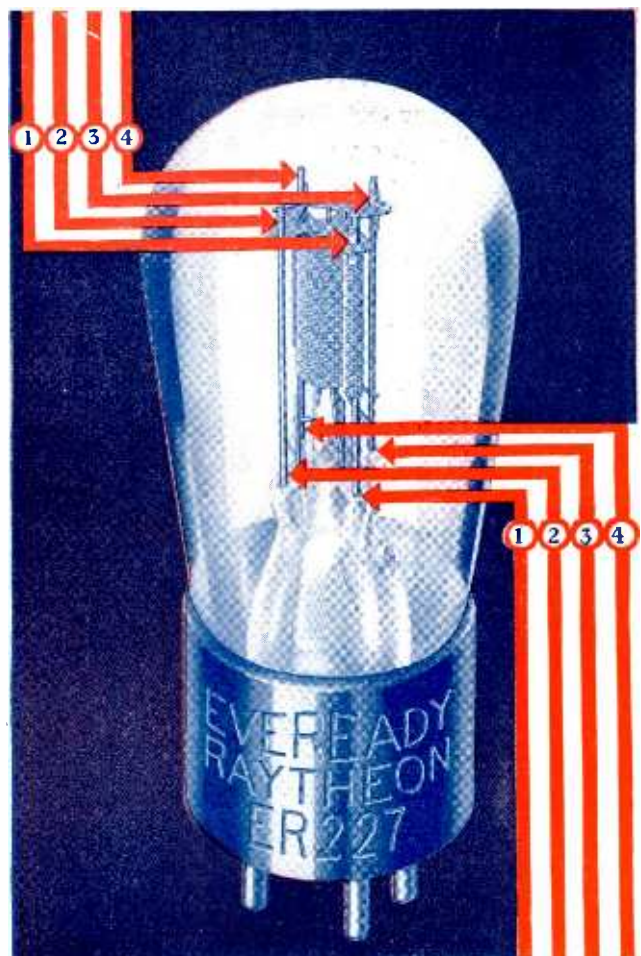

>> FREE — HANDSOME EVEREADY CABINET GIVEN YOU WITH MADE OF METAL

THIS special K-11 50-tube deal offers you outstanding profit. You get this brilliantly colored, permanent, metal tube-vending cabinet free with your purchase of 45 Eveready Raytheon Tubes in the following types and quantities:

15 - Type-224; 10 - Type-227; 10 - Type-245; 5 - Type-280; 5 - Type-226.

You will also receive five additional type-227 tubes in the shipment, *at no additional charge*. You pay for only 45 tubes in the assortment given above. AND you get 50 tubes and the metal cabinet shown on this page. The cabinet is offered to dealers in this K-11 deal only. This assortment has been tested and packed at the factory and sealed in the cabinet in which you receive it.

You pay \$86.25 for this deal. You get \$156.25 from your customers. You make \$70, which is 81% on your investment!

Look at the illustrations. They show the front and back of this strong, striking cabinet—it actually helps you sell the tubes!

The assortment of Eveready Raytheons which you get, *including your five free tubes*, comprises the most popular types! The purpose from start to finish is to help you sell the greatest number of Eveready Raytheons, and to see that you make the most money out of it. It's 100% co-operation with the trade, and there's a lot more to it than this one big bargain!



Trade-marks



RAYTHEON TUBE-VENDING

THE K-11 50-TUBE DEAL <<

—\$5 VALUE—FREE

There's national advertising—telling the public what a SOUND improvement Eveready Raytheons are. Telling them why, and pointing out the exclusive advantages of the patented Eveready Raython 4-Pillar construction.

There's the product itself—backed by National Carbon Company, Inc., a leader in the industry, with a quality reputation and a world of experience. Makers of the famous Eveready Layerbilt "B" Batteries—

an improvement as revolutionary as Eveready Raytheon 4-Pillar Tubes. With tremendous laboratory resources constantly engaged in development that will keep these tubes at the head of the league. Each Eveready Raytheon Tube meets laboratory standards of construction and performance.

There are dealer helps—counter and window displays, a muslin wall chart and tube register to tell you and your customers what you want to know about tube types, a station-log for your customers—a wealth of material to make selling Eveready Raytheons one of the easiest and most profitable things you can do. Take advantage of it—all of it—then *demonstrate* the superiority of Eveready Raytheon reception in your customers' own radios. Tell them to put a new Eveready Raytheon in each socket of their present receivers. Let them *hear the difference and see the reason.*

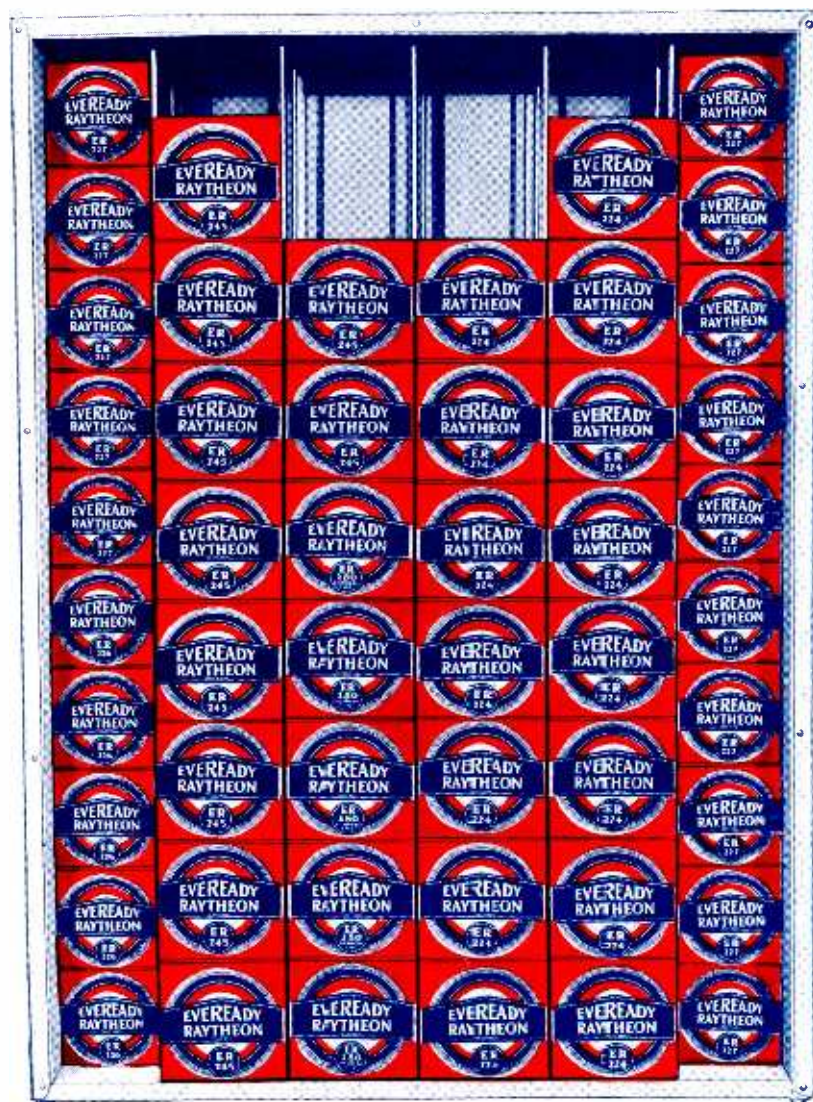

Trade-marks

>> HERE'S SOMETHING YOU CAN REALLY SELL YOUR CUSTOMERS

AS HIGH as 90% of all the radio troubles your customers have are due to faulty tubes. These customers come to you for service, and repairs . . . and *tubes*. Cut down their trouble, give them a better kind of reception than they've ever listened to from their radio sets. Sell them Eveready Raytheons! These tubes give you something to talk about.

First of all, there's the patented *4-Pillar construction*, a SOUND improvement. You can actually see it, inside an Eveready Raytheon. It means long life, strength to resist the bumps of shipment and handling which endanger the performance of ordinary tubes. And rigidity to resist vibration from dynamic speakers. Modern radios need Eveready Raytheons, with their superior strength and rigidity. These tubes are quick-acting too. For rich, full-voiced reception, with breath-taking realism, tell every customer to put a new Eveready Raytheon in each socket of his receiver.

The Eveready Hour, radio's oldest commercial feature, is broadcast every Tuesday evening at nine (New York daylight saving time) from WEA F over a nation-wide N. B. C. network of 30 stations.

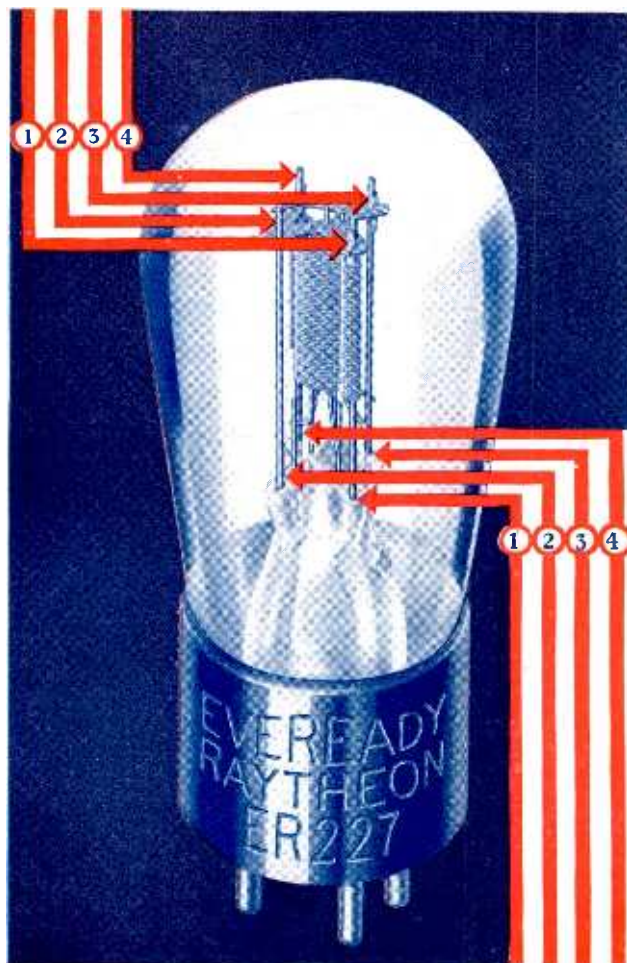

Service-men! Write for this material

Information and sales helps, designed especially for service-men's use, will gladly be sent free. Among them is a blue-print showing complete engineering data on all Eveready Raytheon Tubes. Hundreds of service-men are using this data to advantage. Write our nearest branch.



Trade-marks

NATIONAL CARBON COMPANY, INC.

General Offices: New York, N. Y.

Branches: Chicago Kansas City New York San Francisco

Unit of Union Carbide  and Carbon Corporation

YOU CAN HEAR THE DIFFERENCE AND SEE THE REASON

"dere's sho goin' to be
sum happy folks where
dis is goin', boy"



"ah's jus' hustlin'
along as fas' as
ah can!"



Westinghouse
Radio



MODEL
W.R. 6

SERIAL
HX 25177

WESTINGHOUSE ELECTRIC &
RADIO DEPARTMENT INC
NEW YORK CITY



On June 15th

On June 15th, Westinghouse representatives will start on a tour of the country to exhibit the new Westinghouse Radio sets and to explain in detail the powerful advertising

and merchandising campaign. Westinghouse distributors will announce details of these meetings at the proper time to the radio dealers in their territories.

Akron, O.
The Mook Elec. Sup. Co.
Albany, N.Y.
Westinghouse Elec. Sup. Co.
Allentown, Pa.
Westinghouse Elec. Sup. Co.
Asheville, N. C.
Carolina States Elec. Co.
Atlanta, Ga.
Gilham Electric Co.
Baltimore, Md.
Westinghouse Elec. Sup. Co.
Bangor, Me.
Wetmore-Savage Elec. Sup. Co.
Binghamton, N. Y.
Westinghouse Elec. Sup. Co.
Birmingham, Ala.
Moore-Handley Hardware Co.
Bluefield, W. Va.
Superior Supply Co.
Boston, Mass.
Wetmore-Savage Elec. Sup. Co.
Brooklyn, N. Y.
Westinghouse Elec. Sup. Co.
Buffalo, N. Y.
McCarthy Bros. & Ford
Burlington, Vt.
Wetmore-Savage Elec. Sup. Co.
Butte, Montana
Westinghouse Elec. Sup. Co.
Canton, O.
Mook Elec. Sup. Co.
Charlotte, N. C.
Westinghouse Elec. Sup. Co.
Chattanooga, Tenn.
Mills & Lupton Sup. Co.
Chicago, Ill.
Westinghouse Elec. Sup. Co.
Cincinnati, O.
The Johnson Elec. Sup. Co.
Cleveland, O.
Westinghouse Elec. Sup. Co.
Columbia, S. C.
Mann Elec. Sup. Co.
Columbus, O.
Hughes-Peters Elec. Corp.
Dallas, Texas
Westinghouse Elec. Sup. Co.

Denver, Colo.
Mine & Smelter Sup. Co.
Des Moines, Ia.
Westinghouse Elec. Sup. Co.
Detroit, Mich.
Westinghouse Elec. Sup. Co.
Duluth, Minn.
Westinghouse Elec. Sup. Co.
Elmira, N. Y.
Elmira Elec. Sup. Co.
El Paso, Texas
Mine & Smelter Sup. Co.
Erie, Penna.
Star Electrical Co.
Evansville, Ind.
Westinghouse Elec. Sup. Co.
Fargo, N. D.
Westinghouse Elec. Sup. Co.
Flint, Michigan
Westinghouse Elec. Sup. Co.
Grand Rapids, Mich.
Westinghouse Elec. Sup. Co.
Greensboro, N. C.
Westinghouse Elec. Sup. Co.
Greenville, S. C.
Mann Elec. Sup. Co.
Harlingen, Texas
Westinghouse Elec. Sup. Co.
Houston, Texas
Westinghouse Elec. Sup. Co.
Huntington, W. Va.
Banks-Miller Sup. Co.
Indianapolis, Ind.
Westinghouse Elec. Sup. Co.
Jacksonville, Fla.
Westinghouse Elec. Sup. Co.
Kansas City, Mo.
Columbian Elec. Co.
Long Beach, Calif.
Westinghouse Elec. Sup. Co.
Los Angeles, Calif.
Westinghouse Elec. Sup. Co.
Louisville, Ky.
Tafel Electric Co.
Madison, Wisc.
Westinghouse Elec. Sup. Co.
Mason City, Iowa
Westinghouse Elec. Sup. Co.

Memphis, Tenn.
Westinghouse Elec. Sup. Co.
Miami, Fla.
Westinghouse Elec. Sup. Co.
Milwaukee, Wisc.
Westinghouse Elec. Sup. Co.
Minneapolis, Minn.
Westinghouse Elec. Sup. Co.
Nashville, Tenn.
Tafel Elec. Co.
New Haven, Conn.
Hessel & Hoppen Co.
New Orleans, La.
Electrical Supply Co.
New York, N. Y.
Westinghouse Elec. Sup. Co.
New York, N. Y.
Times Appliance Co.
Newark, N. J.
Westinghouse Elec. Sup. Co.
Oakland, Calif.
Westinghouse Elec. Sup. Co.
Oklahoma City, Okla.
Westinghouse Elec. Sup. Co.
Omaha, Neb.
Westinghouse Elec. Sup. Co.
Peoria, Ill.
Westinghouse Elec. Sup. Co.
Philadelphia, Pa.
Westinghouse Elec. Sup. Co.
Phoenix, Ariz.
Westinghouse Elec. Sup. Co.
Pittsburgh, Pa.
Iron City Elec. Co.
Pocatello, Idaho
Inter-Mountain Elec. Co.
Portland, Ore.
Westinghouse Elec. Sup. Co.
Providence, R. I.
Wetmore-Savage Elec. Sup. Co.
Raleigh, N. C.
North State Elec. Sup. Co.
Reading, Penna.
Westinghouse Elec. Sup. Co.
Rochester, N. Y.
Westinghouse Elec. Sup. Co.
Salt Lake City, Utah
Inter-Mountain Elec. Co.

San Antonio, Texas
Westinghouse Elec. Sup. Co.
San Francisco, Calif.
Westinghouse Elec. Sup. Co.
Scranton, Penna.
Penn. Elec. Engr. Co.
Seattle, Wash.
Westinghouse Elec. Sup. Co.
Sioux City, Ia.
Westinghouse Elec. Sup. Co.
Spokane, Wash.
Westinghouse Elec. Sup. Co.
Springfield, Mass.
Wetmore-Savage Elec. Sup. Co.
St. Joseph, Mo.
Columbian Elec. Co.
St. Louis, Mo.
Westinghouse Elec. Sup. Co.
St. Paul, Minn.
Westinghouse Elec. Sup. Co.
Syracuse, N. Y.
Westinghouse Elec. Sup. Co.
Tampa, Fla.
Westinghouse Elec. Sup. Co.
Toledo, Ohio
Westinghouse Elec. Sup. Co.
Trenton, N. J.
Westinghouse Elec. Sup. Co.
Tulsa, Okla.
Westinghouse Elec. Sup. Co.
Utica, N. Y.
Westinghouse Elec. Sup. Co.
Washington, D. C.
Westinghouse Elec. Sup. Co.
Waterloo, Ia.
Westinghouse Elec. Sup. Co.
Wichita, Kansas
United Electric Co.
Wilmington, Del.
Westinghouse Elec. Sup. Co.
Worcester, Mass.
Wetmore-Savage Elec. Sup. Co.
York, Penna.
Westinghouse Elec. Sup. Co.
Youngstown, O.
The Mook Elec. Sup. Co.



Westinghouse Radio

Q-107

WESTINGHOUSE ELECTRIC AND MANUFACTURING COMPANY
RADIO DEPARTMENT . . . 150 BROADWAY . . . NEW YORK CITY

THREE *Tube* FACTS

1

2

3

That Help Increase Your

PROFITS



"CLICK"

"TICK"

"QUICK"

Acts in
7 SECONDS

See the ARCTURUS Exhibit
at the R.M.A. Trade Show,
Booths A-11 and 12.

A. C. TUBES
127 Detector Amplifier
124 A-C Screen Grid
126 Amplifier
145 Power Amplifier
150 Power Amplifier
071 Power Amplifier
180 Full-Wave Rectifier
181 Half-Wave Rectifier



they're

blue!

D. C. TUBES
012-A Power Amplifier
and Detector
Amplifier
101-A Detector
Amplifier
099 Detector Amplifier
122 D-C Screen Grid
071-A Power Amplifier

Prove It
BY YOUR WATCH

ARCTURUS
"Act in 7"



CHECK THESE
ARCTURUS
FACTS

In Your Own Store

1

QUICK ACTION

Hold a watch on any set equipped with Arcturus Blue Tubes. No question about QUICK ACTION . . . the program is there in seven seconds.

2

CLEAR TONE

Listen to the CLEAR TONE that is characteristic of Arcturus Tubes. There's no hum, no background noise to mar any program.

3

LONG LIFE

Put an Arcturus Tube in your meter. See how it withstands overloading. This stamina has given Arcturus Tubes the world's record for LONG LIFE.

ARCTURUS
Seconds

TUBES
for every
RADIO

ARCTURUS PERFORMANCE FACTS

will help you get more of
THIS PROFITABLE BUSINESS

1 QUICK
ACTION

2 CLEAR
TONE

3 LONG
LIFE

By the time this advertisement appears there will be 12,000,000 sets in use. Figuring an average of six tubes per set, there are 72,000,000 tubes now in service. If each set owner replaces only four tubes, we have a volume of 48,000,000 tubes, or \$120,000,000, waiting for us in the next twelve months on replacement business only.

Your share of this should be approximately one-third of your total set business—half of this volume for renewals, half for sales with new sets.

Arcturus *Blue* Tubes can help you get this business. They combine three features that interest every set owner—Quick Action, Clear Tone, and Long Life.

You can *demonstrate* every one of these Arcturus features to any buyer. And when you make an Arcturus sale you've made a satisfied customer, because Arcturus Tubes give clear, humless reproduction of any program and require the minimum amount of servicing.

Get the facts about Arcturus *Blue* Tubes and go after your share of the profitable tube market with a tube of proved superiority!

ARCTURUS RADIO TUBE COMPANY
NEWARK, N. J.

ARCTURUS

TUBES *for every* RADIO

"Act in 7 Seconds"



Now! Crosley puts Radio on Wheels

See It ▲▲▲▲▲
Hear It ▲▲▲▲▲
Drive with It! ●

An Amazing Automobile Radio Receiving Set ▲▲▲▲ at a price that everyone can afford!

Screen Grid
Neutrodyne
Power Speaker

The CROSLY
ROAMIO
AUTOMOBILE RADIO
RECEIVING SET

ONLY
\$75

Less
Accessories
Installation
Extra

Western
Price
Slightly
Higher

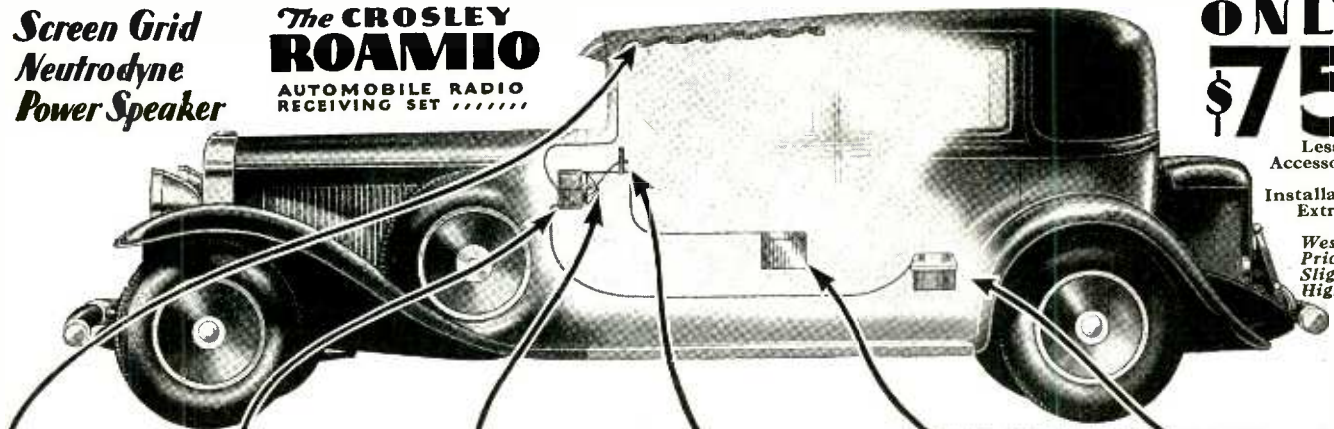

The ANTENNA

The RECEIVER

The SPEAKER

The CONTROL PANEL

CAR STORAGE
(A) BATTERY

"B" "C" and "D"
BATTERIES

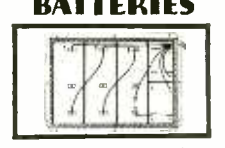
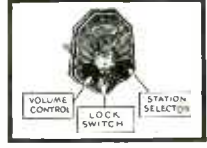
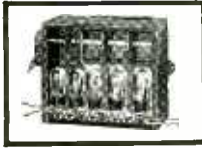
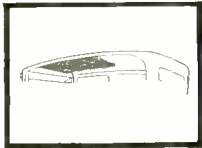

"Was surprised at how quickly and easily the ROAMIO was installed in my car."

"Driving through town could easily tune out powerful local stations and get DX."

"First evening we received 30 stations with good volume, selectivity and tone."

"There is no noticeable variation in signal strength in any part of the city."

"The ROAMIO performs as well at higher speeds as when the car is driven slowly."

"It works perfectly; gives exceptional volume with wonderful tone qualities."

Take your favorite radio entertainment with you wherever and whenever you drive with a ROAMIO

Now Crosley has put radio on wheels — and is the first to advertise automobile radio in a national way. Crosley is putting the convenience and pleasure of home radio into the automobile so that the family can take their favorite radio entertainment with them whenever and wherever they drive the car.

Radio on wheels! Think of it! Only a few short years ago it was an amazing thing to throw out an antenna, ground a wire to a water pipe, and, between them, have a radio receiving set. Today, Cros-

ley makes it possible for everyone to take radio reception with them in their cars—and at a price all can afford.

The CROSLY ROAMIO Automobile Receiving Set is less than three months of age, yet, remarkable as it may seem, thousands upon thousands of cars all over the United States are already CROSLY ROAMIO equipped and every day sees shipments from the factory increasing.

The CROSLY ROAMIO has crossed the line—it is no experiment—it is no untried unit—it is dis-

tinctly and definitely an Automobile Radio Receiving Set which the American motoring public has tried, tested and proved, and is buying as fast as the factory is able to produce it.

Where are you in this wonderful picture of exceptional opportunity for added profit? Get in touch with the Crosley distributor in your territory today. Learn from him how you can double and treble your radio sales. Be THERE with Crosley.

The Crosley Radio Corporation
Powel Crosley, Jr., President
CINCINNATI, OHIO
Home of WLW—"the Nation's Station"

The CROSLY ROAMIO is recommended for use in motor boats and cruisers.



NEW ★ MODELS ★ FEATURES ★ PRICES



Fada Headquarters at the Ritz-Carlton Hotel, Atlantic City, during the Trade Show, June 2-6. Also see Fada Booths 22-23-24-25, Section A, Atlantic City Auditorium.

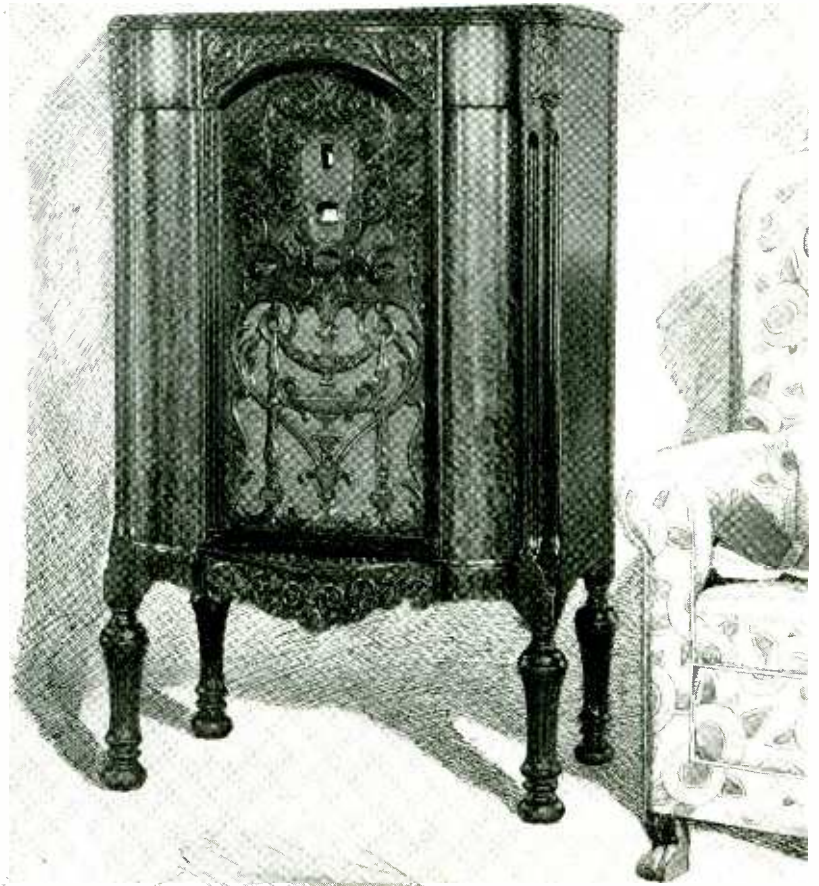

The New Fada 42—Open Face Lowboy, \$159 without tubes

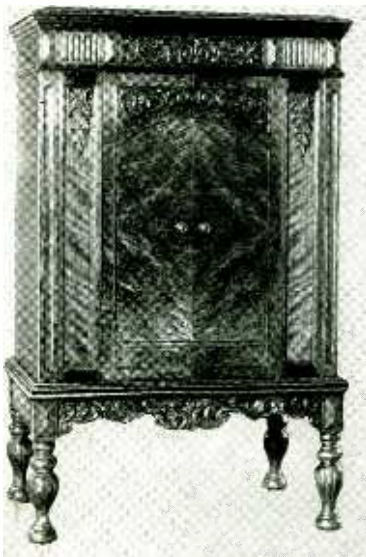

★ The New Fada 47—Radio-Phonograph Combination, \$328 without tubes.

ONLY THE NEW FADAS HAVE ALL THESE FEATURES

★ **Flashograph**... as dial is turned favorite stations are announced in lights, by name, perfectly tuned.

★ **Automatic Volume Control**... constant level detection enables Fada receivers to produce and hold a constant loud-speaker volume from any signal entering the antenna, whether it be weak or strong. Fading is eliminated, all stations within range of the set are received at volume level selected by listener.

★ **Noise Filter**... a device that eliminates or minimizes noise by cutting out high frequency disturbances, permitting pleasurable reception under adverse reception conditions.

★ **Pre-selector Tuning**... insures razor-sharp dependable selectivity and prevents cross talk or domination by powerful local stations.

★ **Double-coupled Transformers**... maintains more uniform amplification over the whole broadcast band, resulting in more uniform selectivity and sensitivity all the way across the dial.

★ **Two-element Detector**... provides straight line distortionless detection so that all parts of a program (loud or low) are detected in their original studio proportions.

★ Fada Radio receivers carry the approval of the Under-

writers Laboratories of the National Board of Fire Underwriters.

★ **Nine Tubes**... three screen grid type '24 in radio frequency stages insure maximum gain, one '27 operating as a two element detector and a four tube audio system consisting of two '27 and two '15 tubes in combination resistance and push-pull transformer coupled for finest quality, one type '80 full wave rectifier... humless operation; complete shielding; local-distance switch; remote control shaft; phonograph connection automatically controlled from tuning dial and radio volume control is also the volume control for phonograph.

1920 · SINCE

make Fada the SELF-SELLINGEST line in all Radio History - - - -



IN the new Fada models, an overwhelming array of new features that make demonstrations irresistible—note them on the opposite page. In the franchise, exclusive territorial protection; price protection; loyal, intelligent factory support; distinctive, out-of-the-ordinary sales and advertising helps.

Fada offers the famous Fada tone, in cabinets of distinguished beauty, with high performance insured and made effortless by more automatic features than any other one radio possesses—a product in tune with modern needs.

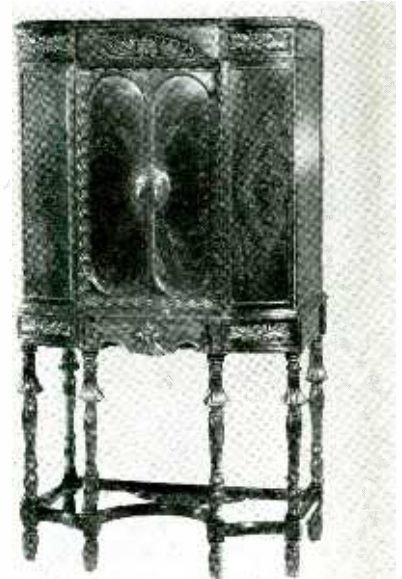

★ The Fada 46—Highboy, \$228 without tubes.

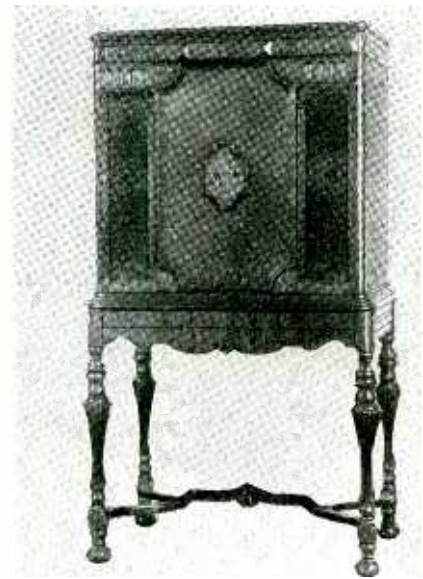

★ The new Fada 41—Highboy, \$218 without tubes



★ The New Fada 44—Sliding Door Lowboy, \$188 without tubes.

Write or wire for full information.

All sets illustrated above are A. C. electric available for either 25 or 60 cycle operation on 90–130 volt lines. 25 cycle slightly higher in price.

F. A. D. ANDREA, INC.
LONG ISLAND CITY, N. Y.

Same Prices West of the Rockies, Slightly Higher in Canada and For Export



BROADCASTING BEGAN · 1930

it would be

FATAL

to lose **CONTROL**



BARBED wire—trenches—dug-outs—
—a field set and a thin strand of wire.

The difference between control and lack of control may spell life or death to an entire brigade.

It's a far cry from No Man's Land to the comforts of your home.

But even in your radio set . . . control plays a vital part . . . and it has been the privilege of **CENTRALAB** to furnish the volume controls of millions of radio receivers.

Is your radio — **CENTRALAB** equipped?



THIS shows the exclusive rocking disc construction of Centralab volume control. "R" is the resistance. Contact disc "D" has only a rocking action on the resistance. Pressure arm "P" together with shaft and bushing is fully insulated.

[Write Dept. 140-D, 20
Keefe Ave. for free
booklet "Volume Controls,
Voltage Controls,
their uses."]

Centralab

CENTRAL RADIO  LABORATORIES

Dept. 140-D, 20 Keefe Ave., Milwaukee, Wis.

ATWATER KENT RADIO

will announce its new
1931 leadership line



The New

ATWATER KENT

RADIO

with the

Golden

Voice

◆ ◆ ◆ ◆ **AUGUST 1ST**

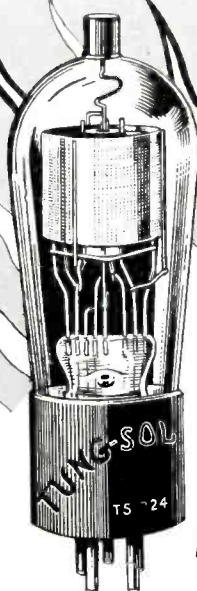

MADE WITH CARE FOR THOSE WHO CARE FOR QUALITY

A companion line to the famous automobile lamps, it is only natural that Tung-Sol Radio Tubes should possess the same perfection that has typified all Tung-Sol products. The uniform excellence of these tubes is without parallel in the radio industry.

Be sure to see our exhibit at the R. M. A.
Convention, Atlantic City, June 2nd-6th.

TUNG-SOL RADIO TUBES INC.
Main Office and Factory, Newark, N. J.
District Sales Divisions in
all principal cities.

TUNG-SOL RADIO TUBES

Licensed under patents of RCA

--- easily identified by the blue
carton with the orange stripes.

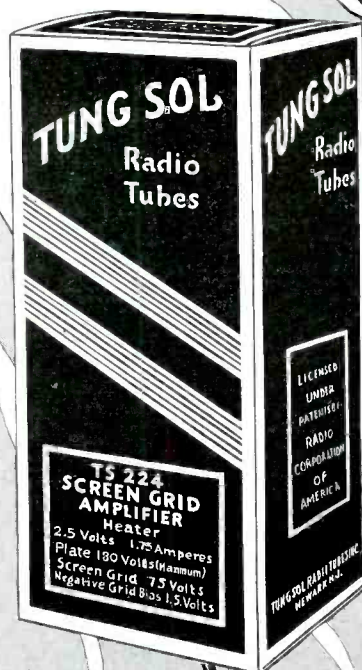

TS 224
SCREEN GRID
AMPLIFIER
Heater
2.5 Volts 1.75 Amperes
Plate 180 Volts (Maximum)
Screen Grid 7.5 Volts
Negative Grid Bias 1.2 Volts

LICENSED
UNDER
PATENTS OF
RCA
CORPORATION
OF
AMERICA

TUNG-SOL RADIO TUBES INC.
NEWARK, N. J.

Colonial...now...

The Greatest Quality Line in Colonial History

At R. M. A. Convention · Booths B36-37 · Demonstration Rooms BB2-3

Colonial's 1930-31 Sensation

Now...the QUALITY line with a wide public QUALITY reputation...the BEST Colonial has ever produced...at prices within reach of everyone...at prices which GUARANTEE volume business on a NATIONAL BASIS and give the distributor and dealer a WORKABLE PROFIT!



The PRINCESS

A charming low cabinet of harmonizing sliced and Oriental striped walnut with a simulated floral design inlay on front and apron. Artistically carved floral grille. Height 38 in. Width 24 $\frac{1}{2}$ in. Depth 17 in. Price, less tubes \$129⁵⁰

Specifications

Steel chassis with provision for Cutting Fully Automatic Remote Control...Cutting Dynamic Speaker, with 14-Watt field...Compensated Band Pass Tuning...Push Pull Power Stage...Inductive Volume Control...Mershon Condensers...Selectivity equal to six-tuned circuit set...Large Safety Factor in all condensers, resistors, etc. Tubes used are three 324's, one 327, two 245's, one 380. Models for Alternating and Direct Current.



The MAYFLOWER

An exquisite highboy executed in sliced, Oriental striped and American striped walnut. Antique bronze grille on front. The legs are turned, tapered and reeded. Height 47 in. Width 24 $\frac{1}{2}$ in. Depth 17 in. Price, less tubes \$139⁵⁰

Distributors...Write or Wire!

A Few Territories Still Open

Consider the inducements! QUALITY products... QUALITY reputation... RIGHT PRICES for profitable operation... a powerful manufacturing combine to insure stability... an ADVERTISING CAMPAIGN that will reach the millions... Write or wire for the details NOW.

COLONIAL RADIO CORPORATION

Sales Offices: 25 Wilbur Avenue, Long Island City, N. Y.

Plants: Rochester, N. Y.

\$129⁵⁰ \$139⁵⁰ \$149⁵⁰

Priced and Promoted on a Volume Business Basis

Ambassador Hotel · Demonstration Room 47 · Tenth Floor

...and the Mighty Campaign Back of It...

With outstanding IMPROVEMENTS to bring new honors to a great radio name...with STABILITY INSURED by enormous resources...with PRODUCTION already far advanced in modern plants...with IMMEDIATE deliveries of all models...with every

advantage to offer to Distributor, Dealer and Public...COLONIAL is presented for 1930-31 as one of the most progressive factors in the radio industry. 1930-31 will be Colonial's biggest year in advertising, publicity, special campaigns and constructive cooperation.

Another Triumph!

CUTTING

Fully Automatic

REMOTE CONTROL



Again the engineering genius of Dr. Fulton Cutting asserts itself. Here...perfected...is Remote Control that IS Remote Control...with outstanding EXCLUSIVE features. Noiseless tuning of any station at any volume from remote point, with automatic tuning of 10 pre-selected stations. Several control boxes may be used. Manual tuning is independent. Pilot light indicates whether set is on or off. All of attachments on back of set. Conforms to underwriters' specifications.

*Immediate Delivery
of all Models*

COLONIAL



Radio

"RADIO'S CLEAREST VOICE"

Licensed under patents of Radio Corporation of America, Westinghouse, General Electric and American Telephone and Telegraph Companies.



The WINDSOR

Sliced, Oriental striped and American striped walnut, with choice matched Butt walnut doors. Art frieze over doors and carved pendants along the sides. Height 51 in. Width 27 in. Depth 17½ in. **\$149⁵⁰**
Price, less tubes

Produced As Well As Designed By SCIENTISTS!

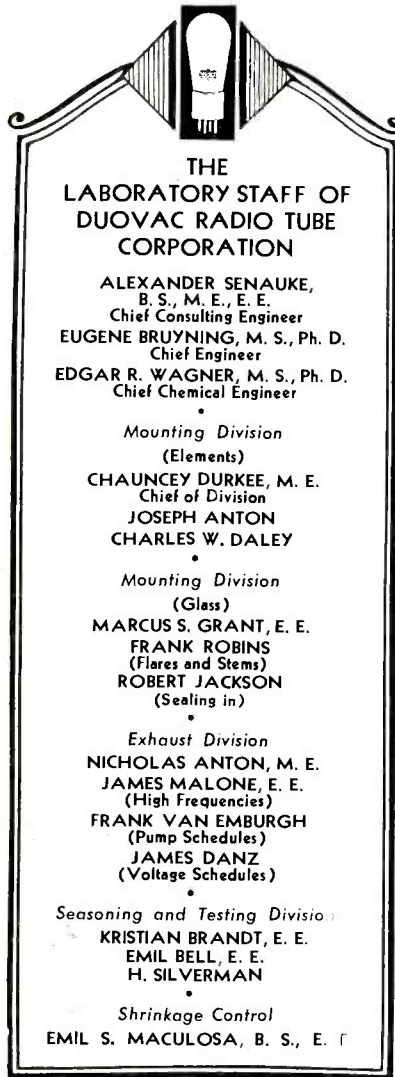

THE
LABORATORY STAFF OF
DUOVAC RADIO TUBE
CORPORATION

ALEXANDER SENAUE,
B. S., M. E., E. E.
Chief Consulting Engineer

EUGENE BRUYNING, M. S., Ph. D.
Chief Engineer

EDGAR R. WAGNER, M. S., Ph. D.
Chief Chemical Engineer

*Mounting Division
(Elements)*

CHAUNCEY DURKEE, M. E.
Chief of Division

JOSEPH ANTON
CHARLES W. DALEY

*Mounting Division
(Glass)*

MARCUS S. GRANT, E. E.
FRANK ROBINS
(Flares and Stems)

ROBERT JACKSON
(Sealing in)

Exhaust Division

NICHOLAS ANTON, M. E.
JAMES MALONE, E. E.
(High Frequencies)

FRANK VAN EMBURGH
(Pump Schedules)

JAMES DANZ
(Voltage Schedules)

Seasoning and Testing Division

KRISTIAN BRANDT, E. E.
EMIL BELL, E. E.
H. SILVERMAN

Shrinkage Control

EMIL S. MACULOSA, B. S., E. E.

DUOVAC RADIO TUBES alone carry science in tube manufacture all the way from the laboratory door to the shipping platform.

SEVENTEEN SCIENTISTS—some of them internationally famed, labor continuously not only to make DUOVAC design the highest that unceasing research and accumulated knowledge make possible, but also to make DUOVAC production just as highly scientific.

DUOVAC'S magnificent laboratory offers its eminent specialists in physics, electronics and mechanical design the very highest facilities obtainable for advancing human knowledge in the electronic field as well as in keeping DUOVACS the most up-to-date tubes scientifically.

EVERY PHASE OF DUOVAC PRODUCTION is personally supervised by some member of the DUOVAC laboratory staff.

This new relationship of design and production means a new era in the vacuum tube field—a new era of satisfaction in selling vacuum tubes and a new era of satisfaction in using them.

DUOVACS are kept within narrower tolerance limits than any other tubes now on the market.

DUOVAC

The PRECISION Radio Tube

Duovac Radio Tube Corp.

360 Furman Street
Brooklyn, N. Y.



Experts making Microscopic Observation of element characteristics in Duovac Laboratory.

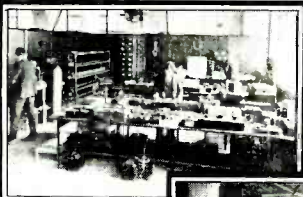

Measuring the Tolerance Limits of Duovacs—the highest standard of any tube.



Each tube must meet the exacting requirement of the Duovac Laboratory Standards.

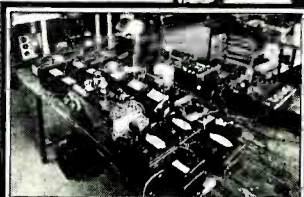

Duovacs must register their characteristics upon a dozen or more precision meters.



Nothing goes into a Duovac unless first subjected to every known test to prove its fitness.



Part of the great Duovac Laboratory Equipment of highly scientific apparatus.

See DUOVAC Exhibit, Booth D-63 at R.M.A. Show, Atlantic City

Would you like to receive a copy?
Write to The American Weekly,
9 East 40th St., New York City.



10 times as much help as the average magazine

THE average circulation of America's 100 leading magazines is 587,997 copies per issue.

The American Weekly distributes over 10 times that number—nearly 6,000,000 copies every Sunday, the largest circulation on earth.

That means an advertisement in The

American Weekly gives the retailer 10 times as much help as it would in the average magazine.

Time your displays to fit in with advertising in The American Weekly. Take advantage of the tenfold demand it creates. There's some real money in it for you!

What is The American Weekly?

The American Weekly is the magazine distributed through seventeen great Sunday newspapers from seventeen principal American cities. It concentrates and dominates in 536 of America's 812 towns and cities of 10,000 population and over.

IN EACH OF 185 CITIES IT REACHES ONE OUT OF EVERY TWO FAMILIES

IN 132 MORE CITIES, IT REACHES 40 TO 50%

IN AN ADDITIONAL 102 CITIES, IT REACHES 30 TO 40%

IN ANOTHER 117 CITIES, IT REACHES 20 TO 30%

—but that's not all. Nearly 2,000,000 additional families in thousands of other communities regularly buy The American Weekly—making the unprecedented national total of nearly 6,000,000 families who read The American Weekly.

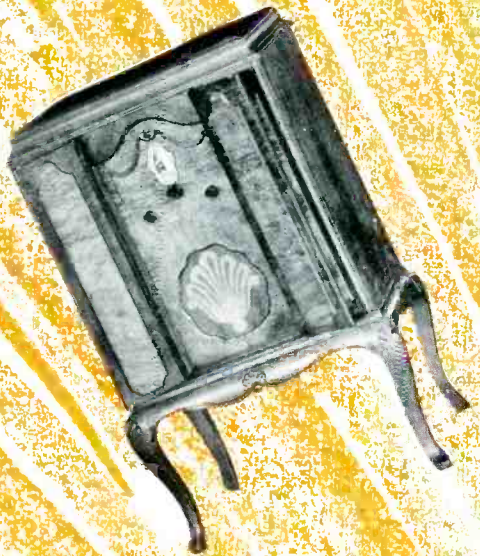

FILTERED TONE
CRYSTAL CLEAR

TONE CONTROL
ON PANEL

FOUR TUNED CIRCUITS
SUPER-SELECTIVITY

THE QUEEN ANNE SEVEN. \$160

Four-piece center-matched butt walnut top; front panel and overlays of Carpathian ash; legs of hand-carved walnut.

7 tubes: 2-24, 1-27, 2-45, 1-80

LIFETIME
DIAL

ABSOLUTELY NO A.C. HUM

FULL-RESPONSE
ELECTRO-DYNAMIC
SPEAKER

"CLOUGH-SYSTEM"
TUNED AUDIO

**MAN!
WHAT A RADIO!**



What's new in radio? Silver-Marshall answers definitely with everything that's new.

The most advertising dollars per set—spent mostly right over your name. Puts an end to next-door and next-block competition. The season's most beautiful cabinets. Prices down, in the volume-moving class, yet well out of the low-profit "cat-and-dog-fight."

Two screen-grid chassis models: a 7-tube 4-gang—and a 9-tube 5-gang,

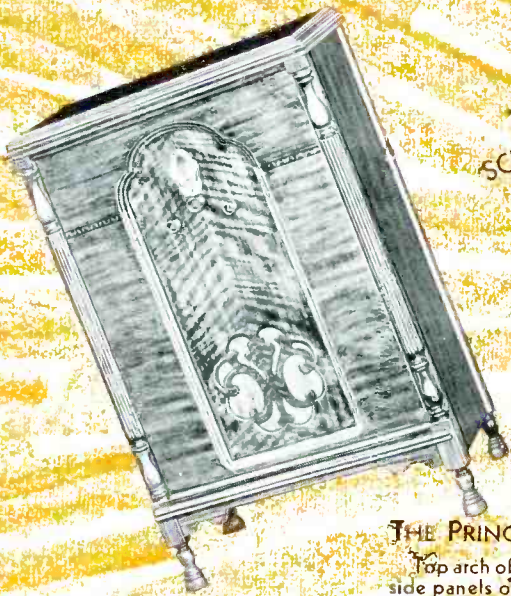

THREE
SCREEN-GRID
TUBES

THE PRINCESS. \$135

Top arch of Australian laurel; side panels of genuine African mahogany; top of four-piece center-matched walnut.

7 tubes: chassis identical with Queen Anne Seven above.

At Atlantic City:

**SILVER
MARSHALL
RADIO EX**

PROGRAMS

DX PERFORMANCE
THAT WILL KEEP
YOU UP ALL NIGHT

AUTOMATIC
VOLUME
CONTROL

REMOTE CONTROL
OPTIONAL

FIVE TUNED CIRCUITS
10 KC SELECTIVITY

FOUR
SCREEN-GRID
TUBES



THE QUEEN ANNE NINE: \$185

Four-piece center-matched
butt walnut top, front panel
and overlays of Carpathian
mahogany, legs of hand-carved walnuts.
9 tubes: 4-1A, 2-27, 2-45,
1-80.

CABINETS
THAT ARE
"WOWS"

DOUBLE-DUAL
SELECTION

100 TO 130 VOLTS
50 TO 60 CYCLE
OR 95 TO 110 CYCLE

PUSH-PULL
245⁵⁰

110 TO 120 VOLT D.C.
OR BATTERY OPERATION

with positive 10 kc. selectivity!
Lots of treble, lots of bass, and you
control the tone at will, with a knob.
Automatic volume control on the 9
—the "fading" problem solved—
you can tune through loud locals
without breaking an ear drum.

Put that in your pipe, and smoke
out the blues. The hottest line of
the season—clean protection and
profits that mean "out of the red and
into the blue"—the new SILVER-
MARSHALL "Sharpshooters" stand
out like a big silver dollar in a pocket-
ful of street-car change!

Phone your distributor or wire
us to arrange demonstration.

SILVER-MARSHALL, Inc.
6421 West 65th St., Chicago, U.S.A.

Auditorium, Sec. A, Booths 20-21,
Ambassador Hotel, 8th Floor Annex

PRE
SELECTION

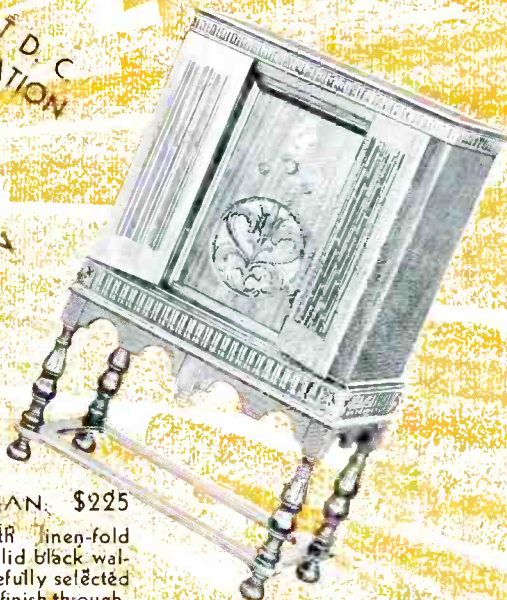

THE ELIZABETHAN: \$225

All walnut with linen-fold
overlay panels of solid black wal-
nut. All cuts are carefully selected
for color and figure; finish through-
out follows the finest practice of
furniture craftsmanship.

9 tubes: chassis identical with
Queen Anne Nine above.

All prices less tubes; applying
throughout continental United States.

SILVER- MARSHALL

EXTRAORDINARY

The World's *first* Super Pick-Up *leads the way with* **GREATER VOLUME!**



*The new Toman Super
 Pick-Up—The greatest
 advance ever made in
 the Pick-Up field.*

TREMENDOUS volume, that can be stilled to a whisper by means of the built-in volume control . . . New beauty of tone, clear and undistorted over the entire range . . . Unusually attractive design . . . These unique features of the World's first Super Pick-Up make it one of the most important recent developments in the radio-musical field!

Produced by the Toman laboratories . . . makers of the world's finest tonearms and reproducers . . . it sets new standards of Pick-Up performance. And it is reasonably priced!

Manufacturers who have seen and heard this new Super Pick-Up are specifying it for their phonographs and radio-phonograph combinations. Many Jobbers and Dealers are enjoying the new profit-opportunity it brings the trade!

A single demonstration will convince you of its superiority over all preceding pick-ups . . . of its value to you.

Write or wire for a sample. But . . . do it NOW!

E. TOMAN & COMPANY,
 2621 W. 21st Place, Chicago.

Gentlemen: You may send me a sample of the 1930 Toman Super Pick-Up — for tone tests and inspection — without obligation on my part to buy.

Name

Address

City

Executive

TOMAN
 REPRODUCERS TONEARMS
 PICK-UP ARMS PICK - UPS



E. TOMAN & COMPANY

Established 1914

2621 West 21st Place Chicago, U. S. A.

Cable — SIVAD — Chicago

Bankers: First National Bank of Chicago

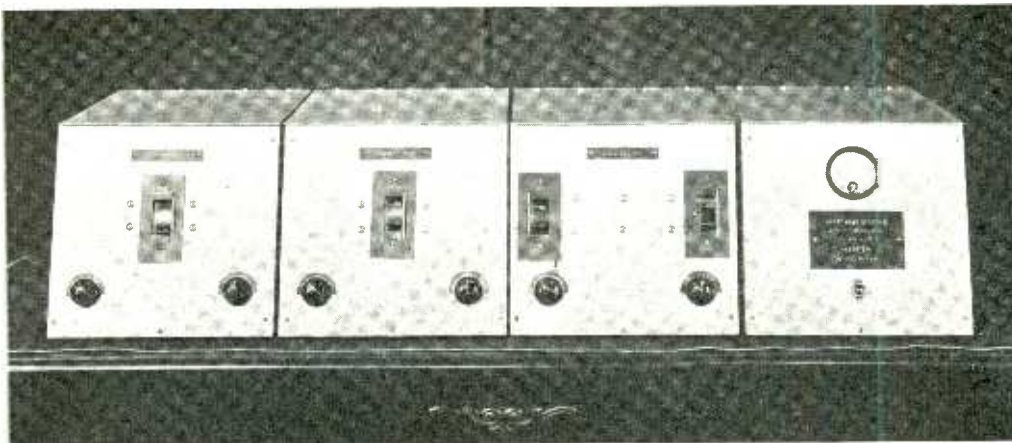

Treat your customers to a concert direct from Hawaii!

**THEN WATCH THEM BUY
THIS AMAZING SHORT-WAVE RECEIVER**

A set designed, built and sold for one purpose only—The clear, perfect reproduction of short wave transmission. So amazing is its sensitivity, that stations in remote parts of the world come in clearly and strong.

The New Leutz Short Wave Receiver is of unit construction throughout permitting the use of detector and Audio Frequency alone for local reception, with one or more stages of Radio Frequency for the reception of weak or very distant signals.

Shielding is of a new high efficiency, permitting high amplification without distortion.

Sooner or later every radio owner will be going after the short wave programs and television. Get in on the ground floor with this up-to-the-minute set.

You will want complete particulars of course. We are ready to give you the whole story. Write or wire for it now.

C. R. LEUTZ INC.

**RADIO ENGINEERS AND MANUFACTURERS
ALTOONA, PA., U. S. A.
CABLES "EXPERINFO"**

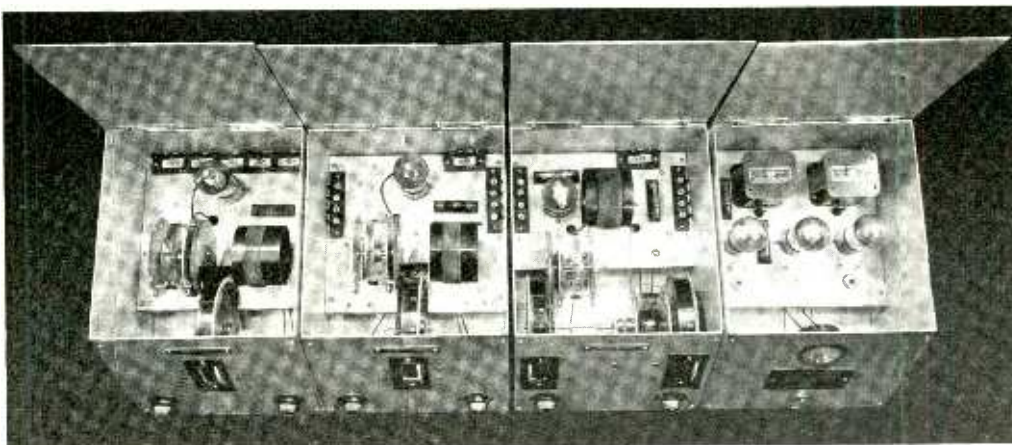

SPEAKER

OXFORD



The Oxford Chromatrope will be merchandised through the regular jobber-dealer channels. Franchises are being signed up during the R. M. A. Trade Show.

Built by Speaker Engineers, with every possible engineering aid to improve tone quality, housed in elaborate period cabinets, with great eye appeal, priced moderately for the highest class of merchandise, the Oxford Chromatrope offers an outstanding merchandising opportunity.

Built in Oxford's large new factory on large production schedules, deliveries and fine workmanship are assured.

Model 150—is a complete electric phonograph, having built-in speakers, amplifier, electric pick-up and phonograph turntable. Price \$260

Model 151—has built-in speakers and amplifier, but is without electric pick-up or phonograph turntable. It, however, has pick-up jacks for this connection. Price \$200

For Radio Reception both Model 150 and 151 have jacks for connection to your present radio set. Also the cabinet of each provides ample space so that standard table model radio sets, or standard tuners, may be inserted, making a regular built-in radio-phonograph combination of Model 150 and a complete Radio Receiver of Model 150.

See our Exhibit R. M. A. Trade Show, Booth C-3, Demonstrating Room CC-25.

NOW

The New Oxford

Manufactured by
OXFORD RADIO CORPORATION
 2035 W. Pershing Place Chicago, U. S. A.

Manufactured under the designs and patents of Frank Reichmann,
 the oldest loud speaker manufacturer in the United States.

Licensed under Lektophone patents.

by OXFORD

The Oxford Chromatrobe For Jobbers and Dealers

Oxford Engineers, in the Chromatrobe, have developed the finest possible sound reproducer. To do this it was necessary to furnish speaker, amplifier and cabinet, all engineered with the one idea of the height of perfection in sound reproduction.

The Oxford Chromatrobe has two speakers in an elaborate double baffle sound chamber, with a chromatic amplifier.

Base drums, bass instruments of all kinds are reproduced with true fidelity, intermediate ranges are all present, and clear crystal high notes, with their higher harmonics.

When you hear the Oxford Chromatrobe you will appreciate all this. Bass drums, that are real, voice that is natural, the highest violin and piccolo notes and their high overtones. In addition there is a tone balance control to match room acoustics. This gives perfect tone balance in home, auditorium, or outdoors, and also at all volumes. The Oxford Chromatrobe gives gorgeous, tremendous music at full volume and also perfect lows and tone balance at the lowest volume.

The Oxford Chromatrobe has been developed through the work of Oxford Engineers on elaborate Theatre installations where price is no object and every aid is commandeered for better performance. These same principles, we believe extended and improved, are incorporated in this great musical instrument for the home.

Now Available for Radio Set Manufacturers
Oxford's New 14-Inch Speaker
An outstanding achievement in the speaker art



Chromatrobe

YOUR
 COPY
 IS
 READY
 Send
 for it
 Now!

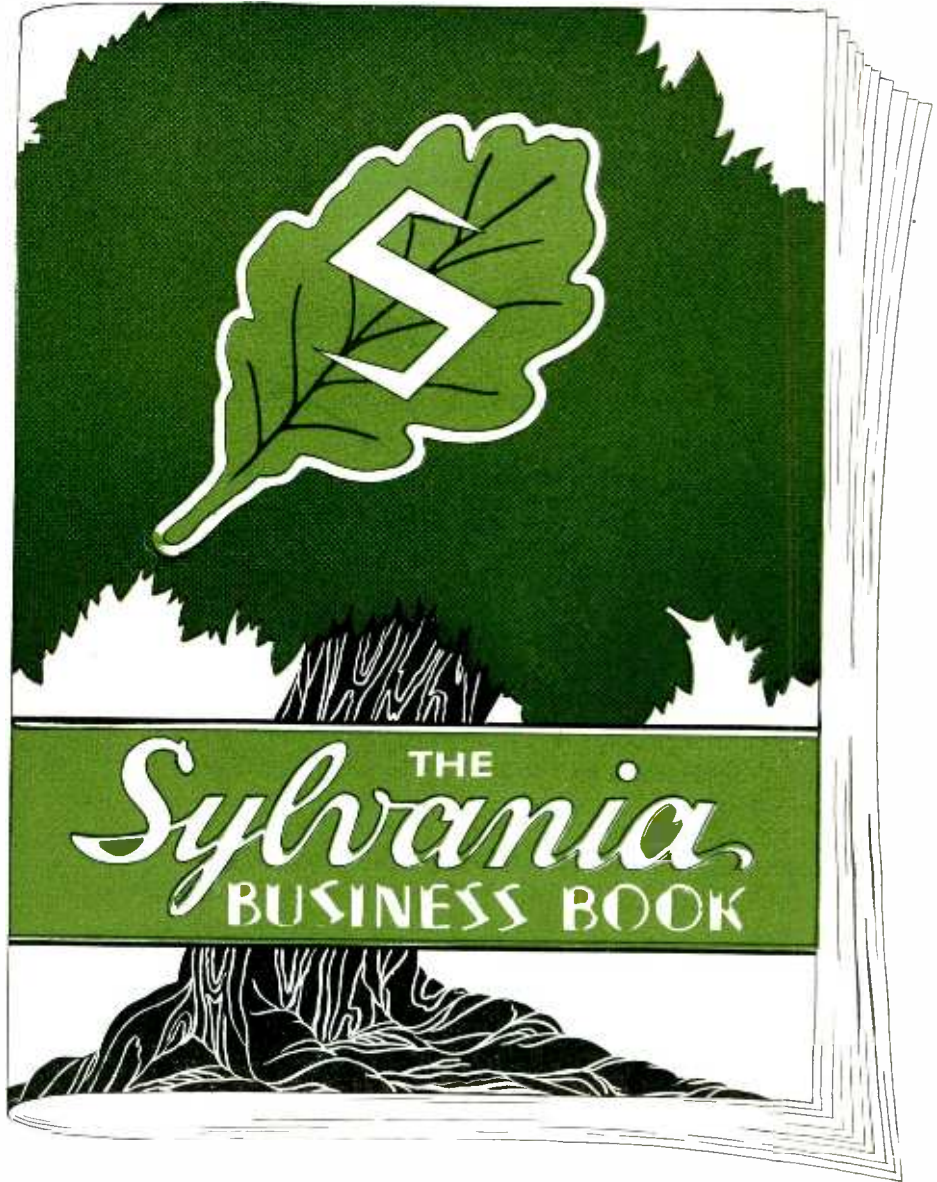

The new Sylvania Business Book is off the press today. Write your name and address in the coupon we've provided and we'll see that you get your copy. Or if you're planning on attending the R.M.A. Show in Atlantic City, be sure to visit us and let us present you with your copy. Our representatives will be in attendance at Sylvania's Booths (A52, 53, 54, Auditorium) and also at Sylvania Lodge atop the Hotel Ambassador—11th Floor. We'll be delighted to have you.

You'll want the ideas this book contains. You'll want to know all the details about Sylvania's new plans for even finer products and for letting the world know about them.

Write right now.

SYLVANIA PRODUCTS COMPANY, Emporium, Pennsylvania

The Home of the Sylvania Foresters Who Broadcast Each Week over WJZ, KDKA, KWK, KYW, WBZ, WBZA, WHAM, WREN, KFAB, WGY, WLW.

Sylvania
RADIO TUBES
Licensed Under RCA Patents



RR-6-30

Sylvania Products Company
 Emporium, Pennsylvania

Mail a copy of the new Business Book to

Name..... Address.....

City..... State.....

JUNE, 1930

Radio Retailing

The Business Magazine of the Radio Industry

O. H. CALDWELL,
Editor

A MCGRAW-HILL PUBLICATION. ESTABLISHED 1925

World

OVERPRODUCTION

and the Radio Situation

THE malady of overproduction is not confined to the radio industry although its course has been particularly virulent and its effects unusually destructive within our ranks.

Overproduction is running rampant through practically all of the nation's business affairs—in truth it has become a world-wide evil—according to no less an authority than Bernard M. Baruch.

“A supreme court of business may be necessary to check this fever,” declared this well-known economist in a forward-looking address delivered recently before the Boston Chamber of Commerce.

Because so many of Mr. Baruch's utterances are directly applicable to radio's own situation, *Radio Retailing* directs attention to the following excerpts from this speech:

“Under the stress of a world debacle there was created in this country a War Industries Board. Under this plan American industries combined to work out their vast production problems for the common good—and the Sherman Act took a temporary nap. So unusual and satisfactory was this experiment that many began to exclaim: ‘If only this were possible in peace time!’”

WITHIN the radio industry we face today a similar condition of turmoil. And we need now a common forum where our problems of material concern—particularly those of production—can be considered and acted upon constructively and with the sanction of the government.

Again quoting Mr. Baruch: “It may have been sound business policy to forbid by law anything that looked to regulation of production when the world was in fear



Bernard M. Baruch

of famine, but it is public lunacy to decree unlimited operation of a system which periodically disgorges indigestible masses of unconsumable products.”

In developing this theme Mr. Baruch proposed a tribunal invested with so much prestige and dignity as to invite the respect and co-operation of America's greatest business leaders.

“It should have no power to repress or coerce but it should have power to convoke conference, to suggest, sanction or license such common-sense co-operation among industrial units as would prevent economic blessings from becoming unbearable burdens. Its deliberations should be open and always scientific. . . Naturally one of

its obvious regulations would rule out all re-sale price discussions.”

Of course Mr. Baruch's proposals in their entirety cannot be instituted in radio nor in industry-at-large without basic changes in our federal laws. Such changes, if they come, will be approached only after long deliberations on the part of Congress.

But with attention directed to the acute situation in radio, the industry can, with entire propriety, apply the main palliations necessary. It should collectively analyze itself; and then proceed, *individually*, to “take its medicine.” Co-operative fact-finding machinery has already been set up by the RMA which will enable the radio manufacturers to attain this first step.

The whole subject of industry production statistics should be reviewed at Atlantic City. With the full facts at hand, each manufacturer will then be in a position to apply the remedy to his own operations during the next five vital months.

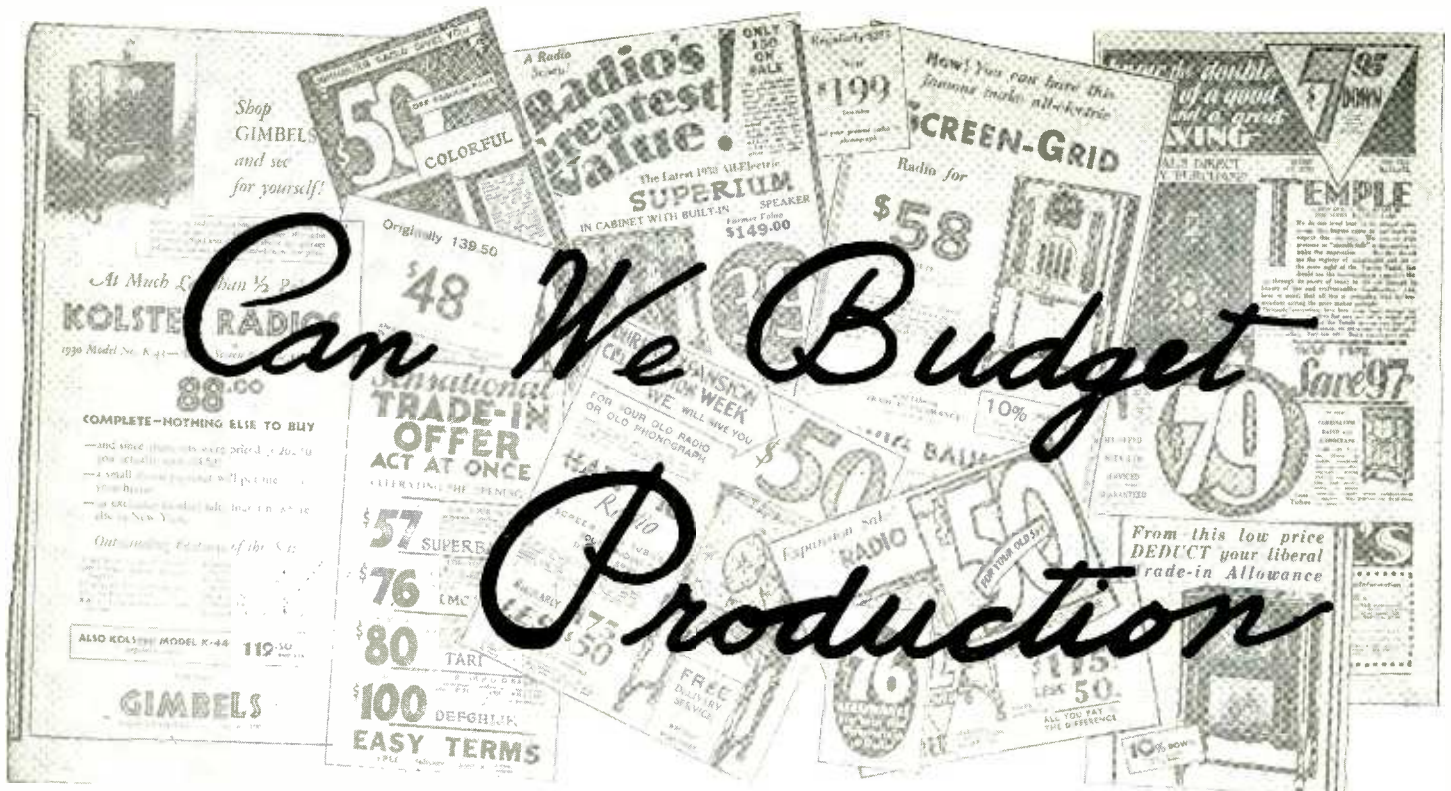

*Frank Comment on Our Most Vital Problem
by Leading Manufacturers*

NOT a pretty picture, is it? . . . This annual throwing of established values to the winds? . . . This nation-wide spectacle of radio prices, of reputations, of manufacturer, wholesaler and dealer prosperity being slaughtered to provide a Roman Holiday for the multitudes? And if we hadn't overproduced it never would have happened.

But it's June again—the Trade Show's in progress—and the time to start afresh is here!

What will the industry do this year? Will it repeat its past mistakes of failing to measure accurately its market; of failing to match manufacturing with actual demand?

Let us see what the following key authorities have to say about the outlook for the solution of this, our basic, problem:

“Capital, the cause and cure”—

RICHMOND

“NOT until it is an established fact that capital employed in the radio industry is habitually unprofitable will overproduction cease. Most new enterprises expect but a small return on their capital at first, but they do expect an ultimate adequate return when the venture becomes well established.

“The radio industry does have available statistics showing demand, but it has also had available more capital than is required to produce sets to meet that demand. Through the recognition that capital now employed in the radio receiver manufacturing business is not as profitable as that employed in many other industries, we may expect in the not too distant future a withdrawal or depletion of a sufficient amount of that capital to limit production to a point more nearly commensurate with consumption.”

H. B. RICHMOND, *President*
Radio Manufacturers Association.

“No overproduction during 1930-31”—

SPARTON

“IT IS safe to prophesy that there will be no overproduction of radio sets this coming season by any conservative, well financed radio concern.

“It has been my privilege to meet the leading manufacturers recently and I am sure most radio sets will be manufactured this coming year to conform almost entirely to specifications placed by dealers and distributors. There may be a few exceptions to this rule by companies who have not yet learned their lesson or who may think they are smarter than other companies. There is no question in my mind that business conditions are decidedly looking up.”

WILLIAM SPARKS, *President*
The Sparks-Withington Company.

to meet Demand?

- and STOP this suicidal destruction of value standards

"The industry must, if it would thrive"—

WESTINGHOUSE

"MY ANSWER is that the industry must do so if it is to thrive and develop to the fullest extent in the future. All are fully aware that radio manufacturers, with the exception of those few who have kept production and demand in step and phase in their operations, have been bled white or ruined by the losses incidental to inventory liquidation following upon overproduction.

"The alert radio dealer, I am confident, will not be caught with an overstock in the season ahead of us, nor will the jobber, and if each will co-operate with the manufacturer by providing the latter with regular reports of sales, shipments, stock and outlook, then the manufacturer can readily keep his production regulated so that a sudden decrease in demand will not involve more than a relatively short over-run which can easily be absorbed without liquidation."

M. C. RYPINSKI, *Manager Radio Department*
Westinghouse Electric & Manufacturing Company.

"It's time for checking up"—

MAJESTIC

"IT IS high time that the radio industry stand aside and take a look at itself—contemplating the events of the past year with a view to making this a more stable industry in the future. If the radio business is to have the respect of not only those in it but of the public, it is

important to keep production well within the bounds of demand.

"It should be as plain as the nose on one's face that only by constantly keeping in touch with the field—with distributors' and dealers' operations, their sales and their stock—can manufacturers hope to sense the approach of overproduction? This is a large problem and it will not be solved overnight because there can always be found those who are too optimistic and also who are too pessimistic, but if individual manufacturers would "keep their ears to the ground," reach out and give heed to public demands at all times, they can do much to put overproduction behind them and make dumping a thing of the past.

"Dumping is bad business from every angle. It is a destructive element in merchandising and involves everyone associated with it."

WILLIAM C. GRUNOW, *President*
Grigsby-Grunow Company.

"Dealer the key man"—

RCA VICTOR

"EVERYONE in the industry knows that its most serious problem is overproduction. Overproduction will be eliminated just as soon and as surely as the dealer sends his manufacturer a weekly inventory and sales report—full, accurate, regular and on time! No single group of manufacturers, wholesalers or dealers can stop overproduction, for the liquidation of even one overproduced line will demoralize the market. But the one

solution of this problem suggested above, will be adopted—for it is the only answer.

“Dealers associated with an overproduced line, as well as its manufacturer, will be left in a distinctly uncomfortable position.”

E. E. SHUMAKER, *President*
RCA Victor Company, Inc.

“Will see no extravagance”—

GULBRANSEN

“MANUFACTURERS can, and are, budgeting themselves. The coming year will see no extravagant production. After taking a careful census of all Gulbransen outlets, based on what each retailer did last year, our total set quota has been re-adjusted.”

JOHN S. GORMAN, *Sales Manager*
Gulbransen Company.

“Will be less than heretofore”—

BOSCH

“CAN we budget production to meet demand? Yes, if we base it upon the ability of our sales organization to sell. I do not say that I think this will happen, because manufacturers will continue to base production budgets on faith, factory capacity, or financial requirements, but I look for less overproduction this year than usual, because of the mortality among weak factors and lessons learned by survivors.”

MORRIS METCALF, *Vice-President*
American Bosch Magneto Corporation.

“Once burnt, twice shy”—ZENITH

“RADIO manufacturers will proceed cautiously from now on. A burnt child fears the fire and the receiver manufacturers who went through the conflagration of last autumn realize that there is such a thing as conditions getting beyond their control. Consequently each individual in the industry is already budgeting production

to meet the demand. In many recent talks with radio supply houses I have been told that receiver manufacturers, with one exception, are buying very carefully.

“Zenith’s policy is, and always has been, to have the distributors report their inventory twice a month. As a result of this rule it never has had any trouble.”

PAUL B. KLUGH, *Vice-President*
Zenith Distribution Corporation.

“We can and we will”—PHILCO

“PRODUCTION orders are issued on a week-to-week basis and are always based on data that is only a few hours old. One clause in the contract we require of every jobber specifies that he must report-by-wire every Saturday the stock on hand, by type and model, and the actual sales for the week ending the day of the report. By Monday morning they have been tabulated and we have an actual picture of the national situation.”

J. M. SKINNER, *Vice-President*
Philadelphia Storage Battery Company.

“On minimum basis”—

TRANSFORMER CORP.

“WE ARE setting up a minimum production for three months, keeping production slightly behind orders and basing production on past performance. Prices will be maintained.”

E. J. DYKSTRA, *Sales Manager*
Transformer Corporation of America.

“We can”—ATWATER KENT

“YOU ask me, is it humanly possible for the radio industry, singly and collectively, to correct the evil of overproduction? It is.

“Production in our factory is scientifically controlled, so that our dealers always have enough radios on hand to meet the public demand, and are never overstocked.”

A. ATWATER KENT, *President*
Atwater Kent Manufacturing Company.

An Animated Window Display for Record Dealers

THE attention value of a window display is in direct proportion to the degree of “action” which such a display contains.

Shalek’s Brunswick Shop, Chicago, seeking a method of popularizing phonograph records of high quality which suffered from the disproportionate publicity given other numbers, developed a live window display of extraordinary effectiveness.

In establishing and maintaining the display, the following working plan was followed: An attractive girl was hired to work from one to two hours daily, seated or standing in a window of the store which was dressed to create the atmosphere of a living room, with a phonograph combination, lamps, chairs, etc. A few of the usual record posters were displayed.

It was the young woman’s duty to change the records on the instrument, which was connected with the transom speaker. As each selection was played, she announced its name and number by turning a card on an easel.

A comparison of Shalek’s orders for a week preceding the use of the live display idea and the week during which it was used show its value. Seven records were used in the “life-interest” display. The week previous to its introduction Shalek’s

ordered 18 records from this selection; during the week it was in use they ordered 163 from the same group—over 900 per cent increase!



This window demonstration built up slow-moving record sales 900 per cent

enter—

The “MIDGETS”

Small, cheap sets give new impetus to the two-set-per-home idea, says J. S. Bietry of Southern California Music Co.

Technically Speaking—

The average “midget” set is about 17 inches high, 14 wide and 9 or 10 inches deep, weighing about 20 lb. Some use semi-dynamic cones, others dynamic. Practically all operate on 60 cycle a.c. A few use three tuned screen-grid r.f. stages with push-pull audio, while still others employ screen-grid power detection and a single '45 in the audio end.

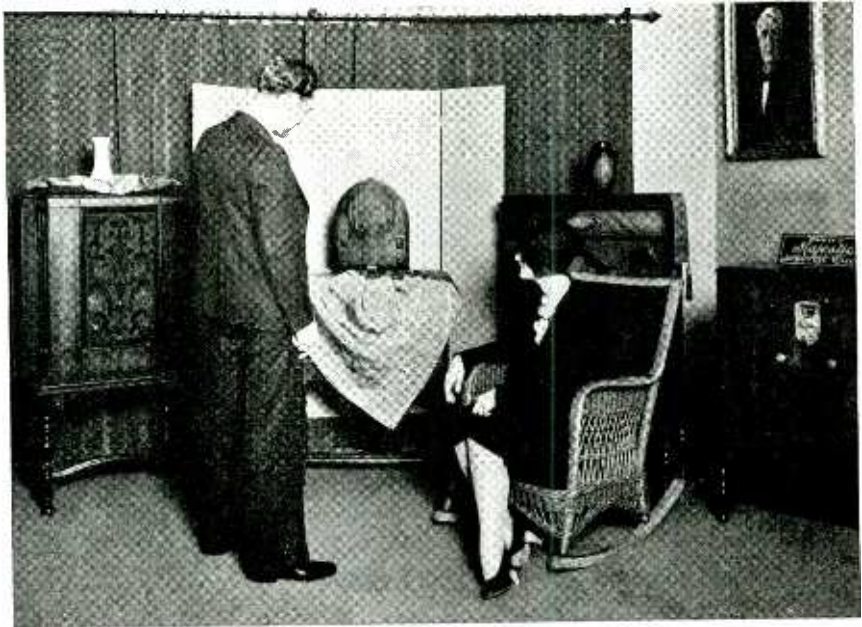

THERE is a definite place in the retail picture for the “midget” set, says J. S. Bietry of the Southern California Music Company, Los Angeles. This new set type, small in size, not unlike a portable, but operating from a.c. lines, is not only suitable for use in apartments where space is limited but is also an excellent auxiliary model, its efficiency and price giving new impetus to the two-set-per-home idea.

The name “midget” is now in general use throughout Southern California. When the miniature set made its appearance the first reaction of coast dealers was unfavorable. They apparently believed that their trade was of a higher class than the low-price level of this innovation and they did not wish to injure their market for better quality merchandise by appealing to a poorer trade. Bietry confesses that he refused to admit the set when it was first brought out.

And then he learned, as did other leading music stores, that the set was by no mean unadapted to high class trade. He discovered that his well-to-do customers would buy these little sets to fill in as *auxiliaries*. One man bought two midgets in addition to his larger model, one for the maid's room and one for the children's playroom. Another wealthy invalid bought a small set for his own personal use while the family still enjoyed the larger equipment downstairs. A woman who wished to hear the Sunday morning sermons without having to get up and dress to go into the living room found use for a midget set by her bedside. Wherever the dealer had formerly seen an opportunity to sell a second speaker, Mr. Bietry found a market for a midget set, slightly more expensive but with the advantage that the set gave opportunity for individual tuning.

The sets also appeal to those with small house space, such as apartment dwellers, and to those with small incomes. The Southern California Music Company has done very little to push the set except to place a model in their windows and to run an occasional advertisement describing it in the local papers, but already it has advanced until in numbers of sets sold it ranks first. Since the first of the year in the neighborhood of 3,000 midgets have been sold. *This does not mean that the sale of larger sets has dropped off, but that a new field has been opened. Their console business has not suffered.*

A fair proportion of the purchasers are owners of larger sets already, buying this equipment purely as an auxiliary. The remainder are purchasers who might not otherwise have come into the store. That this is good business even for a store which specializes in better class instruments, is shown by the fact that about ten per cent of this new clientele is actually sold a more expensive set in place of the smaller equipment they came in for. Of those who buy the midget set as their first adventure in radio a certain number are prospects later for a better class receiver.

Mr. Bietry is planning definitely to use this opening to build up sales.

The fact that these sets appeal to the better type of clientele as well as to the person of small income is indicated by the fact that Bietry's records show a greater ratio of cash sales since they have been carried. On Saturday nights it is not uncommon for half-a-dozen people to drop into the store, pay cash and take their sets home. Midgets, because of their size and price, often are “cash and carry” items.

OBTAINING TRAINING *and* RETAINING

By Ray V.



"I receive a degree of united, family concentration not possible in the store," says C. M. Martin, Edwards Furniture Company, Portland, Ore.

RAYMOND MARSH, one of the most brilliant sales managers the washing machine industry ever has produced, hitched his wagon to this star of promotional selling axioms: "Salesmen are hard to obtain, they are hard to train and they are hard to retain—BUT—they are the life of the electrical appliance business."

The radio dealer who hopes to expand his business will do well to admit the merit of this statement and to shape his policies accordingly.

From the wealth of "success" stories received from radio merchants on the Pacific Coast it would appear that our Western brothers truly appreciate the need for developing intensive selling methods.

THE chief reason why the Holloway Hardware and Radio Co., Los Angeles, Calif., attains all three of the above objectives is its realization that *the salesman must receive at least 50 per cent of his live leads through the efforts of the firm he represents.*

To obtain the names of worthwhile prospects Hollo-

way employs the "Use the User" plan. Booklets, post card size, are distributed to every purchaser of a radio set. The front cover reads "This Book is Worth \$30 to You." Inside are six postal cards so that the customer may readily notify the dealer in case he lines up a prospective set owner. For every lead which results in a sale the one responsible receives a check for \$5.

This plan is not new. It has been used by dealers in electrical appliances and by other radio dealers before. But because Holloway keeps in close touch with each "customer-salesman" every two weeks by mail, telephone or personal visits and because this firm follows each tip with a well-trained field representative this plan has doubled turnover.

"Another plan which adds a lot in the training and retaining of my 'contact-makers' as I term my newer men," states sales manager Thomas, "is my statement to them, when hired, that they are not expected to go out and at once make good. Rather their first job is to make friendly visits, to become acquainted with the people in their territory, to obtain names for the trained

Sutcliffe

See Inside Front Cover

This Book is Worth \$30⁰⁰ to You

HOLLOWAY HDW. & R.
1009 W. MANCHESTER
Near Vermont

Note how every exigency is provided for with these forms

Salesmen

on the Pacific Coast

salesmen to follow up, to call on the users and see that the prospect book has not been mislaid. This plan enables me to try out a large number of applicants at a half salary rate, and for both parties to decide whether or not the shoe fits before making a definite commitment.

"Further proof of the worth of this plan is seen in the fact that a recent check of radio consoles sold during a two-week period disclosed that every buyer but three had previously been contacted by one of our walking representatives."

"How many radios were sold in that period?" Mr. Thomas was asked.

"Thirty-two," he replied.

THE three best ways to obtain salesmen are as follows: The "Help Wanted" columns of the newspaper; letters to prominent citizens asking that they recommend good material; recommendations from the members of your present sales force. These suggestions come from a man of wide experience, Clarence H. Mansfield, manager of the radio department of the Fitzgerald Music Company, of Los Angeles. This concern does one of the largest music businesses in California. At the time Mr. Mansfield was interviewed he was directing the activities of 26 sales representatives.

"There is no substitute for advertising for salesmen," he declared. "Naturally this method produces a formidable proportion of 'down-and-outers' but time and judgment will eliminate this class without undue expense. Frequently worthwhile material will be found in a man experienced in other work. Character, persistence and personality are the prime requirements."

Whenever Mr. Mansfield wishes to reinforce his sales

You can earn a tidy sum each month by giving us the names of friends who are about to buy a Radio.

We will pay \$5.00 for name of any person who actually purchases a new radio. This offer is subject to the following rules:

1. Your prospect card must be received and registered at our office prior to the actual sale of the radio.
2. Prospect must be an interested party (not previously registered by some one else).
3. Sale must be made within 30 days from the filing of each prospect card.
4. It is agreed and understood that the money obtained from the use of this book will under no condition benefit the party buying a radio.

On receipt, card will be "time-stamped"—date and hour.
Only actual sales count, so be sure to choose your prospects with care.
Act now before someone else sends in the names of prospects you have in mind.

This Book and Contents good for six months from date.

This page is for your convenience in recording names and dates on the prospect cards you send us.

Name _____ Date _____

This form is for New Book Users.

I have read the foregoing rules and regulations and agree to strictli by same.

Book User's Registration Card

NAME _____

STREET ADDRESS _____

CITY _____

STATE _____

TELEPHONE NUMBER _____

For your protection
Detach and mail immediately to HOLLOWAY HDW. & RADIO CO.

Gentlemen:

The person below is interested in a RADIO.

Please file this card to my credit and have salesman call at once on this prospect.

Name of Prospect _____

Address _____ Phone _____

Now using _____ Make _____ Battery or Electric _____

Sender's Name _____

Address _____ Phone _____

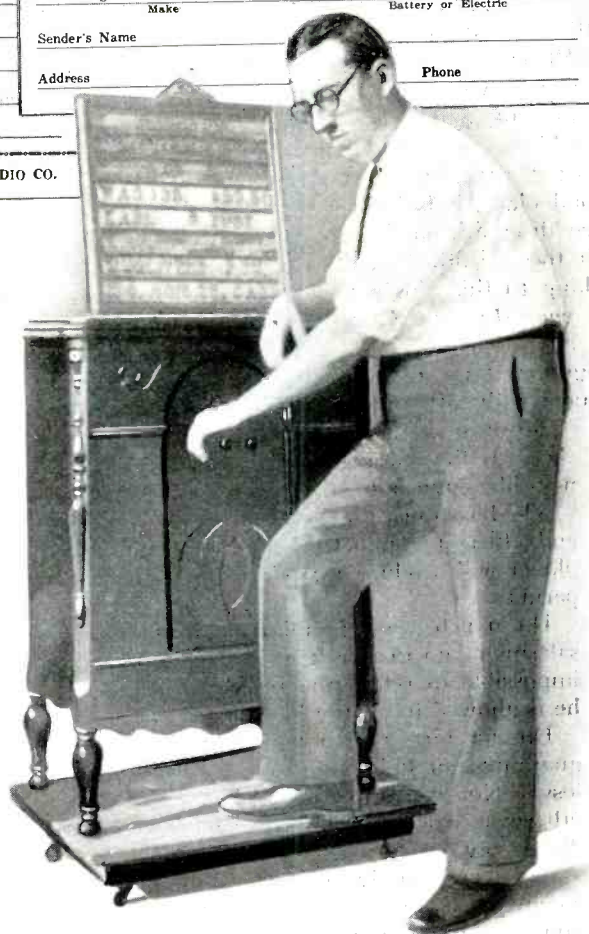

"Use the user and double turnover," declares sales manager Thomas, Holloway Hardware and Radio Co., Los Angeles

organization he also writes letters to physicians, lawyers, educators and well-known merchants of his acquaintance in which he states frankly the opportunity and the hurdles which must be overcome. The type of men just mentioned is frequently contacted by chaps who are about to enter the world of business.

But the most important source of all for good sales material, in the opinion of Mr. Mansfield, is the dealer's own sales organization. The present salesmen will bring in their friends and, if hired, they are in a position to help them get started. Their judgment as to the type of material is also sound. One young man with Fitzgerald has introduced six others, all of whom made good.

Mr. Mansfield has prepared *elaborate written instructions which each new salesman must study and master. These instructions cover the fundamentals of radio*, the characteristics of the sets being carried, the sales policies of the store, the mechanics of the sale and of the demonstration, the elements of salesmanship and practical suggestions on securing leads, approaching the customer, creating desire and closing. Sales meetings are held regularly and contests and prizes frequently given.

It is during the summer months that this gentleman devotes the greatest amount of attention to maintaining the morale of his sales force. "Keep the salesmen enthused from May to October in order that they will follow summer prospects actively rather than have the manager concentrate personally on individual sales. The sum total result will be greater."

HERE'S an interesting viewpoint, for the small dealer, written by a small dealer, located this time in the state of Washington.

"When the small radio business comes to the point where its owner must hire an assistant, special problems, not present in the case of the larger enterprise, are involved," he contends. "In the first place the little fellow does not attract the better type of salesman and, in the second place, it is harder for the one-man outfit to enforce discipline and keep his one or two salesmen on their toes. Both difficulties can be overcome, I find, by sticking to this single principle: *conduct yourself and your store on the same high level as that of the big and successful competitor down the street.*"

Summarizing the specific rules of our Washington friend for the attainment of this end we find that:

Store appearance and management must be first class—if the salesman is not surrounded with a business-like environment he will go to seed or quit.

The boss must set the example by neat appearance and efficient conduct at all times—a slovenly employer will produce a careless clerk within a ten-day period.

Do not become familiar or confidential with a salesman—no matter how likable he may be. It is impossible to retain the respect of the salesman if he is allowed too many liberties.

Do not hire a man who is in debt and do not guarantee an obligation for an employee. Heartless? Not at all, just sound business sense. To do otherwise encourages extravagance and leads to dishonesty.

An over-friendly employee will quit, to go with a competitor, just as quickly as will one who respects you as a fair-minded executive.

Better that your employee regards you as a good business man than as a good fellow.

THE scene of action moves northward to Portland, Ore. Says C. M. Martin, manager of the radio department, Edwards Furniture Company, "It's simple enough to get a contract for a radio set under the high pressure of inefficient, misleading salesmen. But will that contact lead to a chain of other contacts—each mutually profitable? It is to avoid this great danger in outside selling that I decided to *first demonstrate my own ability to sell, in the home, just the way I would expect my men to operate.* This policy is most essential to the dealer who would be a successful executive over temperamental salesmen. In my case it has worked out admirably."

Mr. Martin then reveals his own outside selling methods with the thought that his experience is applicable to the average field cultivator.

Martin specializes on giving a hundred per cent demonstration. Every salesman *must* master the technique of that vital first 15 minutes after the switch is thrown. he finds. This policy nets him a successful closing in three out of every four trial installations.

Surely there is substantial wisdom in this philosophy: "A demonstration that goes sour is worse than none at all," declares Mr. Martin. "Under the wrong conditions the best set in the world will give a poor performance. Consequently men who start out to demonstrate a radio receiver must know its technical characteristics, must have checked up on local conditions and must be sure that the antenna and ground arrangements are nearly perfect."

Martin spends as much time preparing for a demonstration as does a good photographer in setting up his camera for a picture. He carries registers to balance for high voltage, also extra tubes and extra speakers of different pitch values. Naturally he does not permit the set to be hooked up until he is present and he does not demonstrate it on other than favorable reception nights.

Here's another policy of Martin's that eases the path for the salesman. Before the set is tuned in ask the prospect just what he expects of his radio. If the prospect has exaggerated or impractical ideas clarify the matter at once. Lead him to expect that the set will not do quite as much as its actual performance will reveal.

The Credit Situation on the Pacific Coast

1. It is a growing practice for wholesalers to require from retailers operating statements, together with a statement of assets and liabilities, at frequent intervals.

2. Campaigns are being undertaken whose purpose is to educate the dealer to install an adequate system of cost accounting.

3. An analysis of dealers' operating statements show that, in general, three items are too high: advertising; administration and accounts receivable. In the second instance too much money is withdrawn by the proprietor and in the latter case the credit policy is too loose.

4. A helpful service to dealers is now available in many instances through the instrumentality of the business service department of the local associations of credit men. When a dealer's account approaches the danger line this department surveys the case; frequently calling upon interested members of the credit association to give their constructive advice. This business analysis service is given to the dealer without charge. In many instances the retailer who has revamped his business accordingly has been able to turn a loss into a profit.

The
New Lines

176 Radio Manufacturers

*are exhibiting
at the*

Trade Show



and as we go from booth to booth we see _____

Some of the New Sets Dealers



Philco 96, \$145
R.F.—three '24
Det.—one '27
A.F.—one '27, two '45 p-p

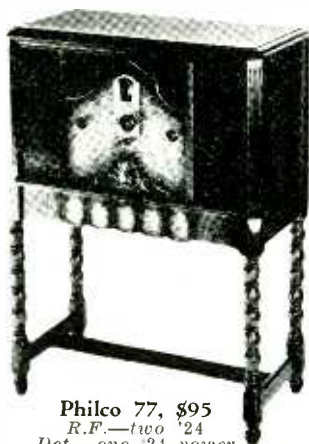

Philco 77, \$95
R.F.—two '24
Det.—one '24 power
A.F.—one '27, two '45 p-p

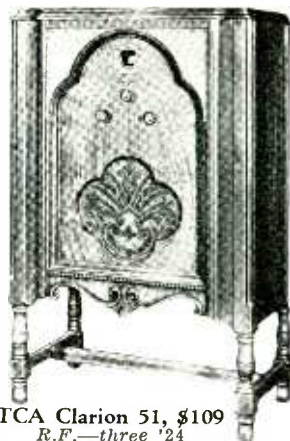

TCA Clarion 51, \$109
R.F.—three '24
Det.—one '27
A.F.—one '27, two '45 p-p



TCA Clarion 53, \$129
R.F.—three '24
Det.—one '27
A.F.—one '27, two '45 p-p

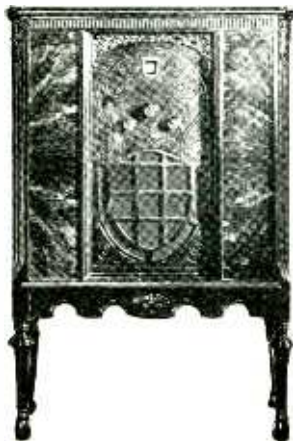

Bosch 58-A, \$144.50
R.F.—three '24
Det.—one '24 power
A.F.—one '27, two '45 p-p

Technical Trends
 By
 W. W. MacDonald
 Technical Editor

The Engineering Contingent has gone decidedly SCREEN-GRID this season—as per expectations. This will be obvious to those enterprising dealers who peer hither and yon into the murky depths of consoles at The Show, or examine the models shown on these pages. For most of the new arrivals employ the efficient tetrode in r.f. stages and many incorporate it also as a power detector.

Several interesting by-product trends have developed as a direct outgrowth of this more or less universal use of the '24. Its general adaptation has greatly influenced receiver design in other di-



Edison R-6, \$297
R.F.—three '24
Det.—one '27 two element
A.F.—two '27, two '45 p-p



Bosch 60-E, \$250
R.F.—three '24
Det.—one '24 power
A.F.—one '27, two '45 p-p
Auto. Vol. Cont.—one '27

Stromberg-Carlson 10
R.F.—three '24
Det.—one '24 power
A.F.—two '45 p-p



***Stromberg-Carlson 11**
R.F.—three '24
Det.—one '24 power
A.F.—two '45 p-p
Auto. Vol. Cont.—one '27



Edison R-7, \$268
R.F.—three '24
Det.—one '27 two element
A.F.—two '27, two '45 p-p

Will Sell this Season

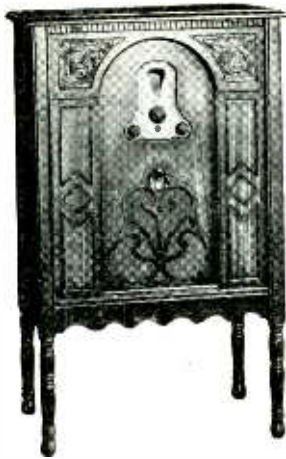

Stewart-Warner
Avon, \$99.75
R.F.—screen-grid



Stewart-Warner
Raphael, \$162.50
R.F.—screen-grid



Fada 42, \$159
R.F.—three '24
Det.—one '27 two element
A.F.—two '27, two '45 p-p
Auto. Vol. Cont.—one '27



Fada 46, \$228
R.F.—three '24
Det.—one '27, two element
A.F.—two '27, two '45 p-p
Auto. Vol. Cont.—one '27



Nathaniel Baldwin
Baldwinette, \$99.50
with tubes
R.F.—two '24
Det.—one '24 power
A.F.—two '45 p-p

rections. The following highlights are typical:

INPUT FILTERS, interposed between antenna and first r.f. stage and tuned by means of an additional unit of the gang condenser assembly, are used in several models to reduce cross-talk caused by strong locals "crashing the gate" through screen-grid amplifiers.

UNTUNED R.F. transformers, working between tuned stages usually, have again put in an appearance in a few sets. A number of manufacturers use band-pass tuners and variations of the input filter selection scheme. Three r.f. stages appears to be the average pre-detector amplification.

POWER DETECTION, made practicable by the high r.f. voltage gain afforded by screen-grid amplifiers, is the rule rather than the exception. The preference of designers



General Motors
Sheraton, \$152
R.F.—three '24
Det.—one '27 power
A.F.—one '27, two '45 p-p



Nathaniel Baldwin 70
\$129.50 with tubes
R.F.—two '24
Det.—one '24 power
A.F.—one '27, two '45 p-p

Lyric 11, \$99.50
R.F.—three '24
Det.—one '27 power
A.F.—two '45 p-p



Lyric 19, \$119
R.F.—three '24
Det.—one '27 power
A.F.—two '45 p-p



General Motors
Hepplewhite, \$136
R.F.—three '24
Det.—one '27 power
A.F.—one '27, two '45 p-p

Wide Variety of Period



Erla 36, \$170
R.F.—three '24
Det.—one '24 power
A.F.—one '27, two '45 p-p



Erla 36, \$160
R.F.—three '24
Det.—one '24 power
A.F.—one '27, two '45 p-p
Auto. Vol. Cont.—one '27

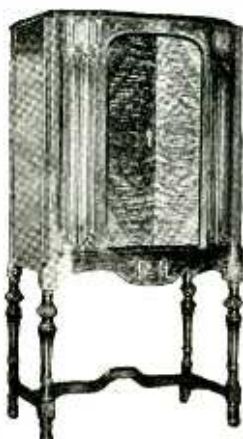

Brunswick 22
R.F.—three '24
Det.—one '24 power
A.F.—two '45 p-p



Brunswick 15
R.F.—three '24
Det.—one '24 power
A.F.—two '45 p-p



Victoreen, \$345
 (Super-Het.)
R.F.—one t.r.f., three int.

appears to be about evenly split between the '24 and the '27 tube for this purpose. One or two screen-grid models use TWO-ELEMENT DETECTION, with grid and plate of a '27 tied together to operate in a similar manner to the older diode.

A single stage of RESISTANCE-COUPLED A.F. commonly follows power detection, particularly in those sets using screen-grid tubes in the detector system. The output from such resistance-coupled amplifiers, usually a '27 type tube, is almost invariably fed to a final push-pull stage equipped with two '45s. In some models the r.f. and detector amplification is great enough to permit the use of a final PUSH-PULL stage immediately following the detector without the use of an intermediate a.f. amplifier. One set uses DOUBLE PUSH-PULL a.f., with two '27s in the



Story & Clark 36, \$208
R.F.—three '24
Det.—one '27 power
A.F.—one '27, two '45 p-p

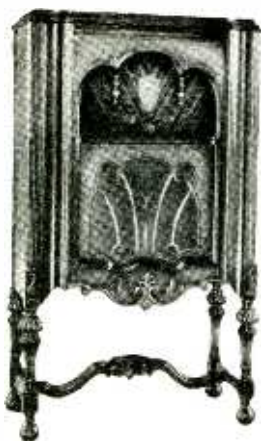

Gulbransen Champion
 \$130
R.F.—three '24
Det.—one '27 power
A.F.—one '27, two '45 p-p

Browning-Drake 69, \$129.50

R.F.—three '24
Det.—one '27 power
A.F.—one '27, two '45 p-p

Browning-Drake 70, \$159.50

R.F.—three '24
Det.—one '24 power
A.F.—one '27, two '45 p-p
Auto. Vol. Cont.—one '27

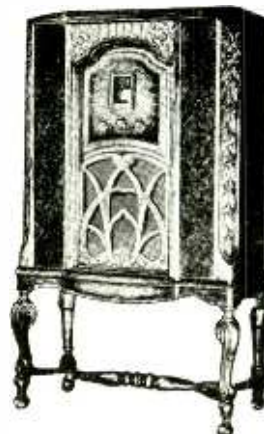

Story & Clark 43, \$248
R.F.—three '24
Det.—one '27 power
A.F.—one '27, two '45 p-p
Auto. Vol. Cont.—one '27

Designs is Cabinet Keynote



Audiola 70, \$107
R.F.—three '24
Det.—one power
A.F.—two '45 p-p



Audiola 80, \$119
R.F.—three '24
Det.—one power
A.F.—two '45 p-p



Silver-Marshall Princess \$135
R.F.—three '24
Det.—one '27 power
A.F.—two '45 Clough

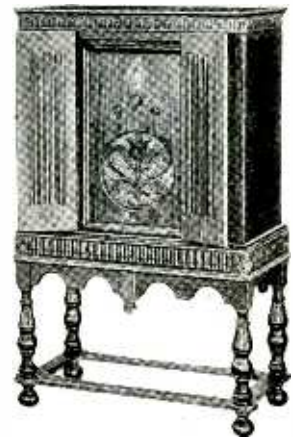

Silver-Marshall Elizabethan \$225
R.F.—four '24
Det.—one '27 power
A.F.—two '45 Clough
Auto. Vol. Cont.—one '27

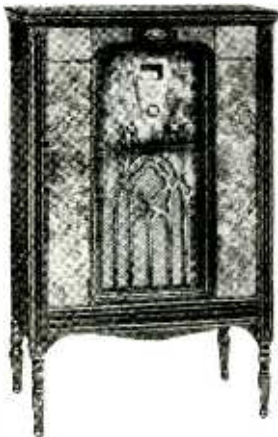

Howard Plymouth, \$165
R.F.—three '24
Det.—one '27 power
A.F.—two '45 p-p

first stage and two '45s in the final output stage.

Tone, or ACOUSTIC CONTROLS, permitting the listener to alter the low or high frequency audio output to taste, are more noticeable this year. Nearly a dozen manufacturers offer this refinement.

AUTOMATIC VOLUME CONTROL, used in only a few sets last year, are now incorporated in several of the higher priced lines. Wavelength indicating "RESONANCE" meters are included in a number of the more expensive models. Semi-automatic tuning devices by which the user may tune to the flash of a light once stations have been mechanically logged and recorded, are not uncommon. SPEAKER MUTES, which permit sets employing resonance indicating devices to be tuned with the speaker momentarily disconnected by



Colonial Princess 33 \$129.50
R.F.—three '24
Det.—one '27 power
A.F.—two '45 p-p



Howard Consolette, \$185
R.F.—three '24
Det.—one '27 power
A.F.—two '45 p-p

Sentinel 12, \$180
R.F.—two '24
Det.—one '24 power
A.F.—one '27, two '45 p-p

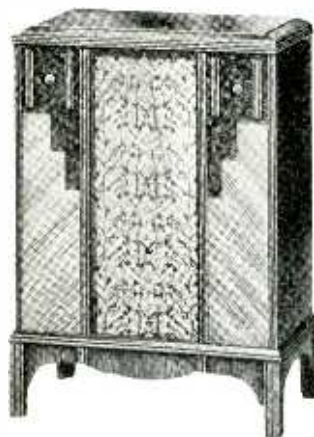

Sentinel 12, (Comb.) \$180
R.F.—two '24
Det.—one '24 power
A.F.—one '27, two '45 p-p

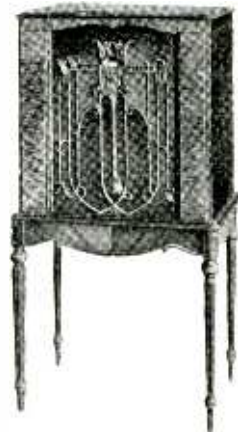

Colonial Mayflower 33 \$139.50
R.F.—three '24
Det.—one '27 power
A.F.—two '45 p-p

Most Speakers Below Chassis

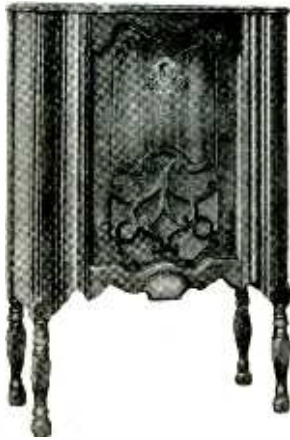

U. S. Apex 28-A, \$105
R.F.—three '24
Det.—one '27 power
A.F.—one '27, two '45 p-p

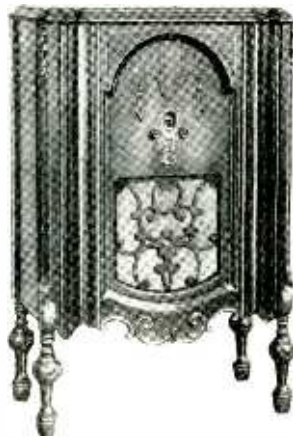

U. S. Apex 31-B, \$127.50
R.F.—three '24
Det.—one '27 power
A.F.—one '27, two '45 p-p

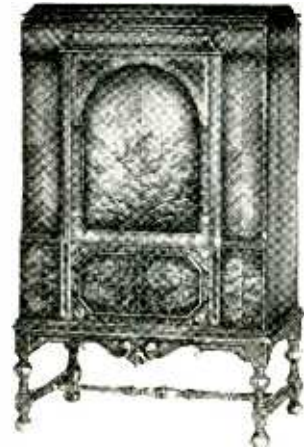

TCA Clarion AC-55
Phono. Comb., \$200
R.F.—three '24
Det.—one '27 power
A.F.—one '27, two '45 p-p

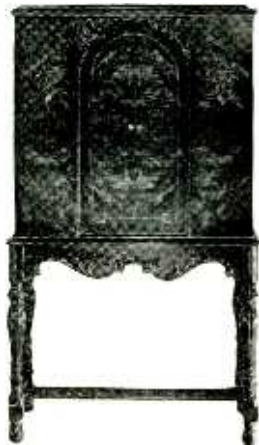

Bosch 58-B, \$159.50
R.F.—three '24
Det.—one '24 power
A.F.—one '27, two '45 p-p

means of a depressed button, are also to be seen.

REMOTE CONTROL systems are obtainable with a number of sets either as stock equipment or as "extras." Speakers have apparently changed only in minor points of design, the DYNAMIC SPEAKER retaining its leadership.

The new two-volt LOW-DRAIN D.C. TUBE series has been used to advantage in several MIDGET and portable lines. AUTO-RADIOS, using capacitor plate antennas and designed to be mounted between dash and instrument panel, occupy a prominent spot in the picture.

And last but not least it is evident that SHORT-WAVE design has not been neglected. One manufacturer plans to exhibit a new broadcast receiver which also tunes to the popular short wavebands.



Stewart-Warner
St. James, \$197.50
R.F.—three '24
Det.—one '27 power
A.F.—one '27, two '45 p-p

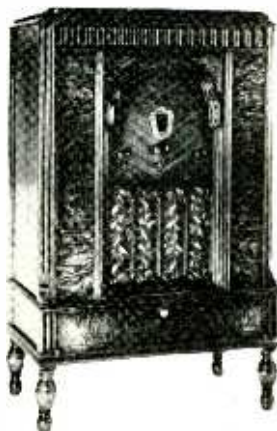

Philco 296
Phono. Comb., \$198
R.F.—three '24
Det.—one '27 power
A.F.—one '27, two '45 p-p

Oxford Chromatrope
Electric phono., amplifier.
two dynamic speakers.
space for radio chassis



Silver-Marshall
Queen Anne 7, \$160
R.F.—three '24
Det.—one '24 power
A.F.—two '45 p-p

Reproducer *Types* Exhibited



OXFORD
D. C. Dynamic

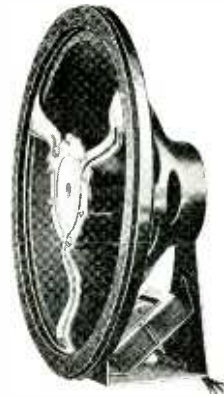

OPERADIO
Dynamic

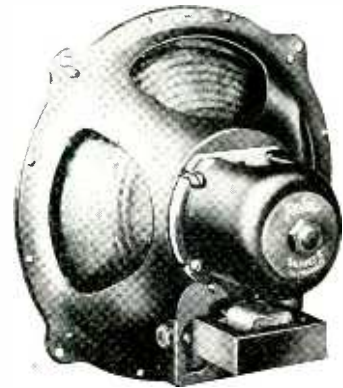

ROLA K
Dynamic



JENSEN
Concert Dynamic

Non-Exhibitors Too

Many manufacturers who are not exhibiting at Atlantic City have nevertheless brought out new lines. These are shown beginning on page 88, to which this pictorial section continues.

This issue, appearing simultaneously with the opening of the Show, presents a cross-section of the new designs offered by the entire manufacturing industry, exhibitors and non-exhibitors alike, while it is still "news."

A number of companies could not supply photographs in time to meet the closing date so these will "overflow" to July. In the June and July issues of "Radio Retailing," therefore, the trade will have as complete a picture of the new lines for 1931 as it is possible to obtain.



ROLA S
Dynamic

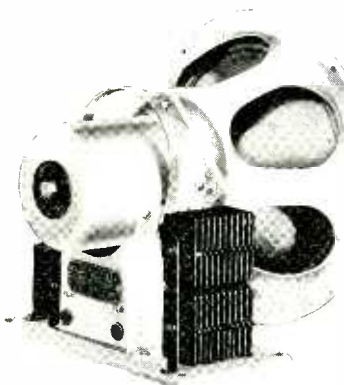

OXFORD
A. C. Theatre Dynamic

JENSEN
Auditorium Dynamic

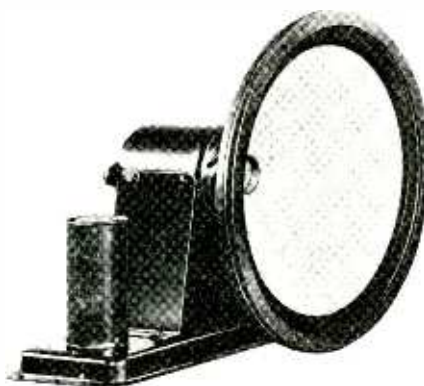

JENSEN
Auditorium, Jr., Dynamic

(Below) Installed by drilling three small holes in the instrument panel, these three radio control dials look like stock equipment.

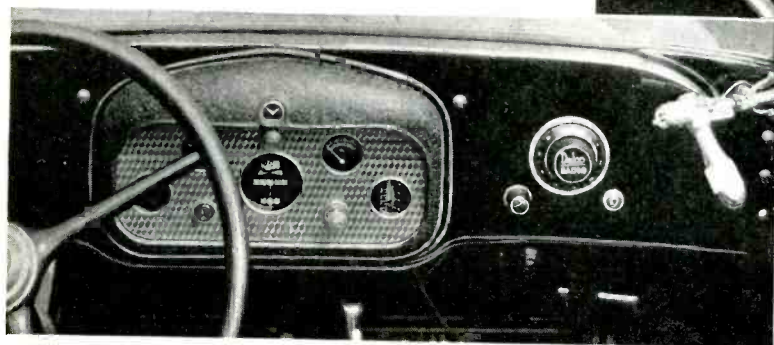

(Above) In this type of receiver the controls are encased in a neat metal box easily attached to the instrument panel.

It's Your Market—

Automobile-Radio becomes popular overnight—The why and how of it from our readers' viewpoint

By Tom F. Blackburn

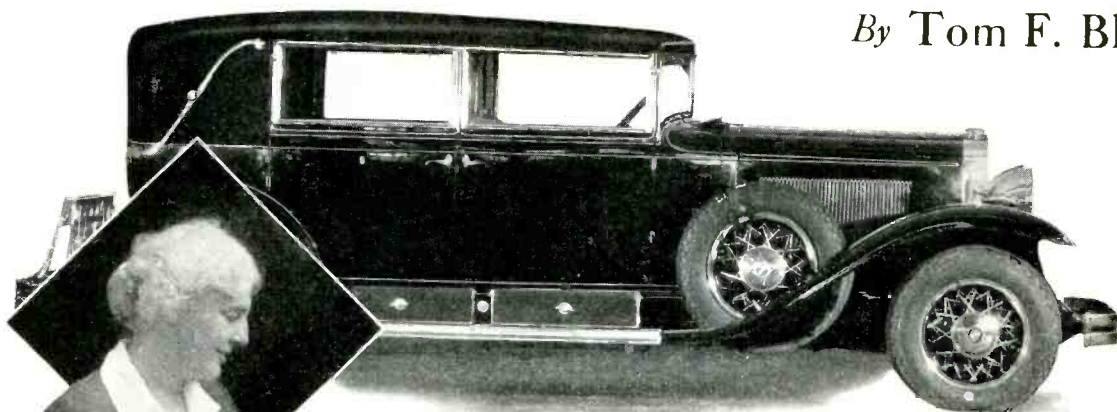

Mrs. Hoover will listen-in as she rolls down Pennsylvania Avenue. Her new car is auto-radio equipped.

THE wedding of the automobile and the radio is an accomplished fact. Old John Law muttered and mumbled about issuing a license—but the knot has been tied and showers of good wishes are the order of the day. Quantity production machinery is a-quivering and before the first autumn leaf comes swirling down thousands of auto-radio sets will have been marketed.

This device is not a howling juggernaut, shrieking a song of doom to the befuddled drivers and bringing honest folk to their windows o' nights in alarm. As a matter of fact an automobile-radio concert is not nearly so disconcerting to a car driver as a pretty face in the front seat or a friend's chit-chat, for there is no impulse to take the eyes off the road when an impersonal radio voice sings "In the Gloaming."



Mr. Radio

Tuning is as convenient as snapping on the ignition.

It takes about five hours to install an automobile radio set.

▼

Wrenches, drill and screw driver are the chief tools needed.

▼

Send the salesman down gasoline alley after orders.

▼

Automobile-radio does not disconcert the driver, nor annoy others.

▼

Sixteen million cars in active use—that's your potential market.

▼

The radio retailer has the best chance at this business—but he can't let grass grow under his feet.

▼

Dealer

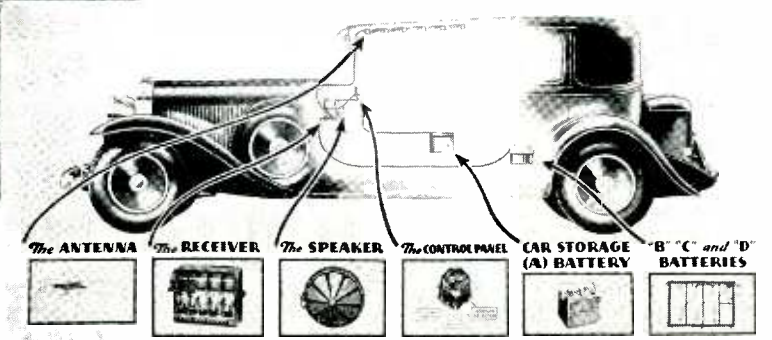

The toot of the horn of a passing car is perfectly audible and outside noises are heard as before. The automobile radio has enough volume to carry clearly to everyone in the vehicle but no further. It keeps the driver's mind alert with a fresh variety of impressions. Long trips seem shorter because of the freedom from the deadening, hypnotic hum of the motor, which has lulled so many drivers to sleep in the past.

So at least say countless persons who have thoroughly tried out radio on their cars, including the city fathers of Cincinnati, Ohio—and such was the experience of the writer a few weeks ago.

More than anything else the automobile-radio will make the dream of two receiving sets to a home come true.

Dollars Possibility for the Radio Man

Who will get this worthwhile business—the radio shop, the local garage, or the automobile dealer? Logically, and by all rights, it belongs to the radio dealer. By virtue of his experience and set-up he can sell it; by virtue of his servicing facilities he can install it and make it operate satisfactorily.

The radio retailer has the jump on the field in possessing a going organization accustomed to selling a \$150 electrical unit, and in instantly being able to merchandise

a commodity on which he enjoys public confidence. The automobile dealer has the advantage of a floor on which to give service and an intimate acquaintance with car owners, but car owners do not necessarily think of garages in connection with radio. Furthermore, state license records make lists of automobile owners easy for anyone to obtain.

On the surface it looks like a matter of putting outside men to work contacting auto owners. The radio house with a good service department can readily master its end of the proposition.

Installation Problems

With the automobile-radio there is no pretty cabinet for the ladies to enthuse about. The job comes knocked down, and a service man has to hop into unionalls and dig right into a car to install it.

Cincinnati servicers, who have been doing this work, estimate that it takes about five hours to install a set. The time varies, depending on the make of car. Fords and Chevrolets are no more difficult than other models.

Most sets are controlled from a small panel, with illuminated dial, mounted on the lower edge of the instrument board. This panel is generally attached without drilling holes, and carries a tuning knob, a volume

(Please turn to page 98)

OMAHA



DES MOINES



I DEAS *that Boosted* Tube

FRANK TINNEY, the comedian, when asked the time of day, used to take out his watch, look at it solemnly, and mutter: "Darned if it ain't!" His companion was left in the dark as to the hour. This is the status of the radio fan who brings in his tubes to be tested and, with a puzzled expression, watches the dealer as he plugs them in and notes the mysterious results.

It has been humorously suggested by radio retailers that a need exists for a tube which will blow out with a bang, like an automobile tire, when its day of usefulness is over. Certainly the business of selling tube replacements is held back by the fact that the public is obsessed with the belief that as long as a radio tube lights up it is all right.

WARD RADIO COMPANY, Omaha, Nebraska, believes in putting tubes in the window in mass display so that the public will be reminded of them. Jack Ward declares that one of his earlier mistakes lay in not carrying a sufficient stock to meet the demand.

The method used by the Sunkist orange producers lends itself to the display of radio tubes. Twenty-five years or so ago, California orange growers launched the habit of buying oranges by the dozens through imposing pyramid displays of oranges poured helter skelter out of crates. The first time this was done it was to aid a grocer who had purchased an over-supply. The public believed that a new fresh stock had arrived and responded generously to the dozen price. Window displays of tubes have much the same reaction in the public mind.

THE voice of Mrs. R. W. Bim Merle of the Marquette Radio Store, Chicago, is the chief vehicle for bringing in tube business to this firm. Old customers and even telephone numbers of people located in the neighborhood are fruitful sources of tube business, according to Mrs. Merle. Situated on a boulevard where

cars cannot park, she has overcome the handicap by use of the telephone. "What sells them," she says, "are the elements of quality and reception." She bears down on this point when calling up and it is a subject concerning which any home owner will gladly reply. Hoarseness, fading and unsatisfactory reception are made the logical reasons for a visit to the Marquette Radio Store for a tube test.

ROGER PUTNAM RADIO STORE, on Delmar Avenue, St. Louis, Mo., recently put out several men to call on homes and test tubes at no charge. It was discovered that the cost of obtaining business this way was more than offset by the profit balance on additional set sales.



Tube cabinets, designed not only for effective display but to segregate the tubes according to type, are a big help in moving and controlling the tube stock



CHICAGO

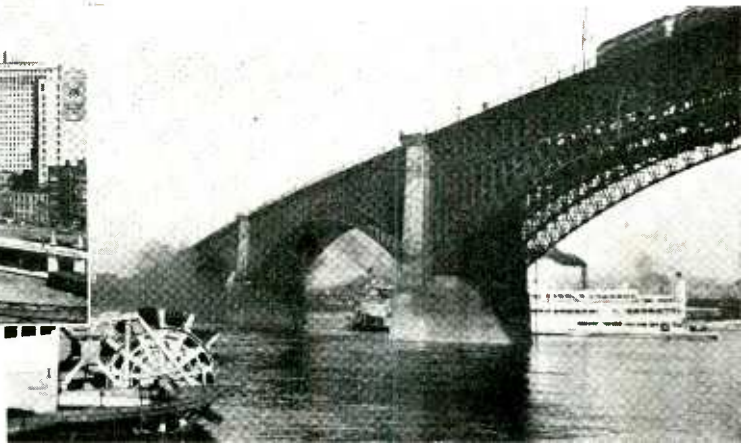

ST. LOUIS

Photos by Galloway

Business in 4 Cities



The customer does the reading in the store of the Thomas Electric Co., Des Moines, and a diagram permits the girl to explain what's wrong

THE Thomas Electric Company, Des Moines, Iowa, has prepared a chart which shows why a tube may light and yet be shorted. Customers are encouraged to slip a few tubes in their pockets each day as they come downtown to work and drop in and have them tested free of charge. A flat top desk has been altered to make a testing table, with a young woman in charge. In plain view of the customer a diagram shows what tubes should test. The attendant plugs in the tube and explains the reading to the customer. Then she tells him what the tube should read and, without debating the subject, takes a new tube out of the package, plugs it in, showing him that it actually tests that figure. Right before his eyes the customer sees proof that his own tube is not up to standard. A few words explaining what a poor tube does to the set is nearly always sufficient to sell a new one.

Radio Retailing, June, 1930

The Thomas Electric Company does one of the largest tube businesses in Des Moines, obtaining list prices and a great deal of its trade walks in the front door.

GUNNAR THULIN, of the National Radio Company, Chicago, is a believer in telephone selling when it comes to tubes. Noting that nearly every call for service was prefaced by the remark that the family was going to give a party and did not want the radio out of order, he finds that telephone calls made by him before logical party times such as Saturday night and holidays are volume producers.

"Never use technical terms in selling over the telephone," says Mr. Thulin. "If I am handling, for example, a complaint on a new radio which has only been cut two or three weeks I always tell the customer that a radio is like an automobile. A brand new automobile has four new tires and yet there is nothing to prevent them from picking up a nail and getting a puncture. There is nothing to prevent new tubes from running into trouble the same way. On cold turkey calls, a variation of this same theme is used—I simply inquire how the set is running and remind the customer that performance is dependent upon tubes and we are interested in having the receiver at its best at all times."

Empty corrugated tube boxes piled in a window, with the legend: "Free boxes—bring your radio tubes down in one of them and have them tested," has been used effectively as a replacement reminder.

THE Kaemmerer Music Shop in St. Louis stresses the necessity of having tubes tested every six months when the set is sold. By education on the point that a tube's burning out is no criterion of the length of its life, Mr. Kaemmerer acts at the very beginning to stimulate the receiver buyer into looking after this important matter.

Where Do The
IOWANS GO
When They Go Out?
The answer is in this article.



BETTY McELHINNEY
of Primghar, Iowa, winner of last year's
Tribune-Atwater Kent Bathing Beauty
Contest. Sorry, but we don't know her
address!



P ublicity and

has the affair jointly sponsored by the local newspaper as well as by his own company, it attracts state-wide interest and makes the front page for several weeks prior to the event and for two or three days thereafter.

"It brings good-will and radio sales for all of our dealers," continues Mr. Schneiderhahn. "Feminine beauty has an universal appeal. We have found that a beauty contest is assured of success, *provided it is run on a high plane*. Special pains are taken to avoid everything cheap or tawdry."

Now for the Details

The contest is known as the Tribune-Atwater Kent Bathing Beauty Contest. The first prize is an especially fine radio set. Fifty to 100 smaller prizes are usually donated by Sioux City merchants who tie in with the event—another idea for securing publicity and good-will.

The rules are simple. Any girl over 15 can enter by filling out an entrance coupon which is run daily in the *Tribune*.

As is customary in these contests the newspaper publishes photographs of new entrants and news articles covering the progress of the contest. Unbiased personages selected from city officials and including the mayors of surrounding towns, serve as the judges. This lends additional interest to the contest.

As an added attraction the girl selected as "Miss Iowa" in a national beauty contest is persuaded to grace the festivities with her presence. For the past two years the American Legion Drum Corps, led by this young lady, headed the march to the judges' stand as a preface

"ATLANTIC CITY hasn't corralled all the bathing beauties in the country—opinions of the 'visiting firemen' to the Trade Show notwithstanding," declares A. A. Schneiderhahn, a wholesaler in Sioux City, Iowa, and submits the accompanying eye-fillers to back up his contention. "A. A." should know because, for the past three years, he has been chief instigator of bathing beauty contests which, he claims, would turn Mayor Ruffu green with envy—could the latter gentleman disentangle himself from the clutches of the law long enough to view the local parade "on the beach of Tribogi, on the lake of Okabogi."

This Sioux City outfit is famous for its radio publicity methods and the annual summer bathing beauty contest is the best of all. Because Mr. Schneiderhahn enlists the co-operation of the *Sioux City Tribune* and



"Give this little girl a hand!" America's homeliest struts "hey" stuff with A. A. Schneiderhahn.

Sales from

Blushing Bathing Beauties

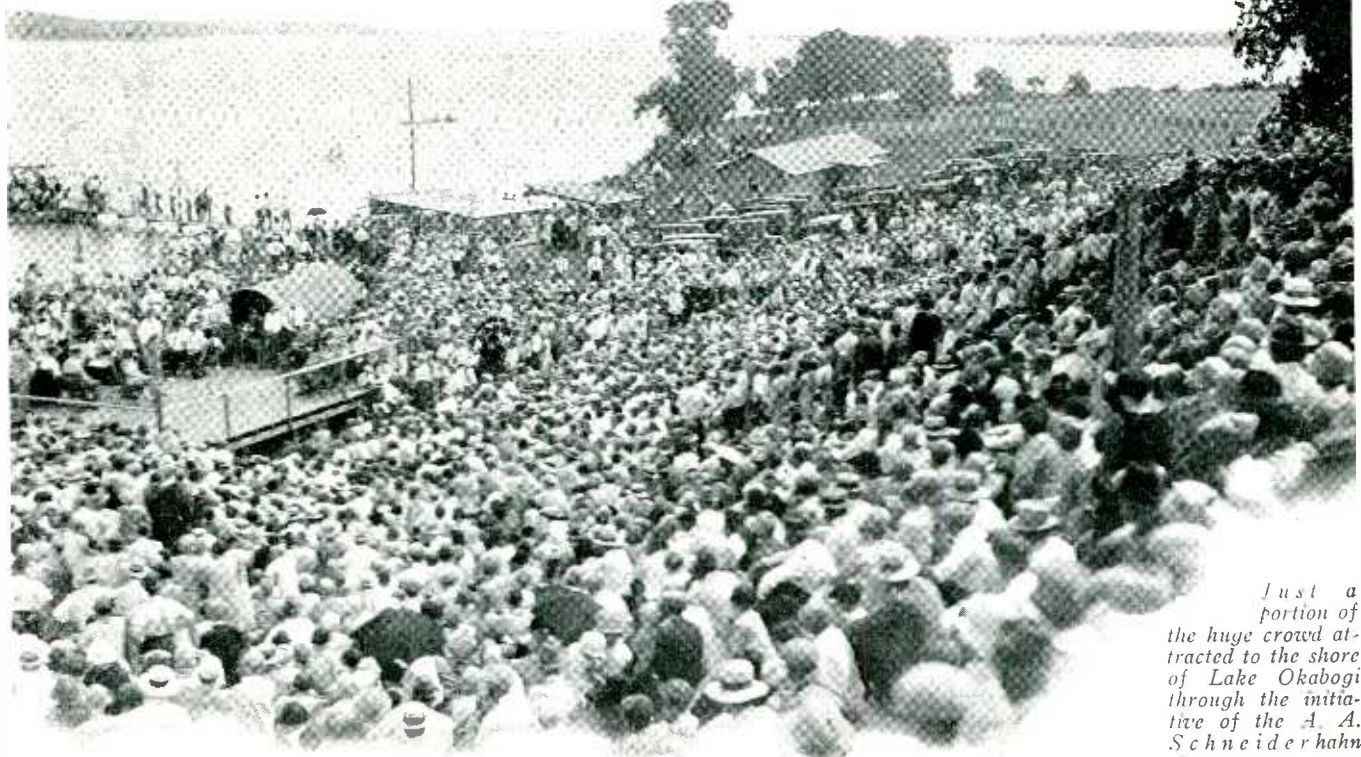

Just a portion of the huge crowd attracted to the shore of Lake Okabogi through the initiative of the A. A. Schneiderhahn Company.

Schneiderhahn

puts Sioux City on the map, and radio before the public eye

to the final ceremony. With few exceptions every town of importance in the Tall Corn State enters one or more local beauties. The citizens in these towns turn out in a body to cheer their local favorite, frequently bringing their town band.

Over 10,000 people gathered in the natural amphitheater overlooking Lake Okabogi to view the beauty parade in 1928 and 1929. Thousands make this affair the occasion for a regular field day. Father brings the family lunch basket and group picnic parties are arranged. Rest assured that this opportunity for promoting radio is not overlooked.

The Sales Angle

While it is impossible to check accurately the actual amount of publicity and the number of orders for sets which result from this promotional idea, Schneiderhahn's dealers report a marked increase in business during the time this contest is before the public. Front page space, which invariably mentions the name of the set handled by the joint sponsors of this contest, is a daily occurrence. The word of mouth advertising is tremendous.

All the dealers tie in with local displays—posters, window trims, special newspaper items and motion picture slides.

"It is an exceedingly worthwhile campaign," concludes Mr. Schneiderhahn. "Its cost, in proportion to the publicity and sales obtained, is exceptionally low. And the right side of the ledger throughout the entire summer, reflects the business value of such an affair to the tune of an increase in sales of from 25 to 40 per cent over normal."



"The gentleman on my right bids eighteen! Do I hear twenty?"

"TWO dollars I'm offered! All done? Any more? Anybody? Somebody? Nobody? I've got two—two—two—two. Last call. Where are those big butter and egg men we hear about? Why this transformer alone is worth five dollars. I'll tell you what; I'll throw in a good set of tubes. Now let's see some action. What's that? Two dollars and ten cents? Do you think this is a poker game? All right smart guy, I'll take your bid. Bang goes the hammer. I've got two-ten—two-ten. Who'll make it three?" says the radio auctioneer, as the crowds surge in and out of those red flag stores on Cortlandt street, New York City.

The experiment of conducting a permanent radio auction store was tried several years ago, successfully. "Radio Row," Manhattan, is the birthplace of the idea. There, and elsewhere, may be found those more or less permanent outlets for distress, obsolete, non-standard brands, trade-ins and overloaded inventories of radio merchandise.

They are popular for several reasons. The public is offered merchandise not regularly found in the average radio store. The prices are extremely low. The methods of auctioning furnish plenty of thrills to the listener. Once in the auction store it is difficult to leave. The urge to remain just a little longer gets in the blood. One is under the spell of the auctioneer, who furnishes plenty of comedy in his method and remarks. The

passer-by walks in with the idea of having his curiosity appeased and walks out with some relic under his arm which he considers a rare buy even though no real need exists for it.

The radio auction store is a boon to the chain stores. It is the answer to their even-present problem of unloading undesirable surpluses. It is not sufficient, however, to offer only these items to the public if successful auction results are to be obtained. The sale is pepped up with items such as wallets, umbrellas and statuary. This breaks up the monotony of the sale, which continues from morning till night.

HOW do these stores get their opening crowd? Mob psychology. One of the clerks stands out front and places several dollar bills on the sidewalk. He drops several coins. The resulting clinking sound causes nearby pedestrians to stop in their places and look about. They soon spy the "come-on" man and his roll of bills. What is he up to? The crowd gets into a huddle. "Watch closely," he exhorts.

In the meantime more people close in on the group. Standing erect, with all the money, of course, he thanks the crowd for their interest. He then calls their attention to the fact that they are blocking the sidewalk and that is necessary for them to step into the store. The crowd follows. They look like sheep being led to

By

Henry H. Moore

OLD!



the meadows—how obedient such a crowd can be.

The auctioneer takes his stand and the auction commences. The better the auctioneer the longer is he able to hold the crowd. The bigger the crowd the better the bidding. Some of these auction stores boast the fact that they do not employ "shillabers" or professional bidders to help out in a pinch. It therefore behooves these fellows to use every possible means available to keep the crowd in a bidding mood. The auctioneering is done in relays. Several hours at a stretch tires the auctioneer. He is generally assisted and relieved by several "block-boys." They, unlike the auctioneer, require no license and bond, which would be subject to forfeiture for unethical performance.

The general lay-out of most radio auction stores is similar in many respects. A high counter called the "block" is situated along a wall located so that the auctioneer can be seen by the crowds passing the doorway. A runaway is located behind the block on which the auctioneer and his assistants pace to and fro. Then we find the shelving with ample sections for displaying merchandise. Wrapping is done in the rear of the room; in some cases behind a partition. There's a purpose behind this lay-out. It would not do for the crowd to see an occasional customer reject a purchase. The rest of the store with the exception of some miscellaneous shelv-

(Please turn to page 100)

*The AUCTION GAME
How it is played—Has it legitimate
possibilities for the ethical dealer?*

SNAPPY Selling STUNTS

June Brides Like Radio

SOME years ago the electrical industry of California started a "June Bride" window display contest—an event which has become national and which has spread to many other lines of merchandising outside of the electrical industry. Last year the winning window display among California electragnists devoted one-half of its space to radio. Why not a June Bride drive among radio retailers in their own right? Every new home which is started is certainly a prospect for radio and every June wedding means hundreds, sometimes thousands of dollars spent in wedding gifts. It is not to be overlooked also that June weddings mean June wedding anniversaries.

Save your list of June brides and send out a reminder to the young husband next year that one of the best ways he can remember the event is by way of a present of a radio to his wife. That is, in case you did not sell them a set in the first place. In which case, you probably have a second loud speaker, or a motion picture machine or some musical accessory to suggest for the anniversary gift.

Sound Equipment Idea

THE Paramount Theater, one of New York's largest movie palaces, has mounted a dynamic speaker over its ticket office. The passerby hears a "ballyhoo" selling talk describing the excellence of the theater's picture for the week. The stunt is accomplished through the

▼
\$ 5 0 0

RADIO RETAILING

will pay \$5 for acceptable sales ideas sent in by dealers, or their employees.

What stunts have you used successfully to increase the sale of tubes, speakers, sets, etc.?

Send 'em in.
▲



Believe It or Not

The combination of a sign calling attention to a daily special offer and the "Believe It or Not" twist in the card presented with the special offer itself has moved practically all the sets taken in trade by the University Radio Laboratories of Berkeley, Calif., according to Herbert G. Hollis of the service department.

use of an electric turntable, a "flyer" record supplied by the film company, a record repeater and an amplifier.

This is an excellent sales idea for radio dealers to present to local theaters. If "flyer" records are not available it is possible to purchase metallic discs at many novelty stores upon which recordings may be made with an ordinary phonograph, the speaker talking into the horn while the record turns.

Trade-In Allowance Offer Produces Leads

THE various stores of the City Radio chain, on Long Island, in New York State, have mounted small, slotted boxes about a foot square outside their entrances, these boxes being labelled "Free Trade-in Estimate." A supply of cards is placed atop each box, reading as follows: "Free Estimate. No obligation to you. If you have an old model radio and would like to know its present value, fill in attached coupon, bring it in, or mail it in."

The cards are stamped and space for a description of the set to be traded in, set desired, as well as the prospect's name and address is provided.

"It is amazing," the manager of the Jamaica store tells us, "how many of these cards are removed from the box each night and how few people actually enter the store to ask for this same information. Probably they hesitate to come right in even though they want the information as they are often not ready for an immediate purchase. The card system reduces sales resistance in this direction as it is an easier way for them to check up on set values."

Saving Selling Time by Store Service Window

A GOOD many people come into the store with their service troubles instead of phoning about them. They usually wait about to talk to the man who originally made the sale, or, failing to find him, apply to some one of the other salesmen on the floor.

A service window in the back of the store at which owners apply for advice and assistance in caring for set troubles has saved a tremendous amount of selling time for the Kinney and Sipprell Music Company of Everett, Wash. Instead of waiting on the floor for the attention of a salesman, who may be busy, service applicants go direct to the rear of the store where they are handled by a clerk especially trained in service work. The salesman's time is saved and the intrusion of the "set out of order" idea is kept off the sales floor.

Ellerman Runs a Dance

THE Ellerman Furniture Company of St. Louis employs two rather unique sales ideas with unvarying success. Mr. Ellerman tells us that when his new set models are received each year he has his sales department offer a different prospect a free limousine ride to the display floor each evening to inspect radio's latest offering. Each invitation is a personal invitation from a particular salesman.

Occasionally the company runs a dance in its store, decorating it with a few Japanese lanterns, and inviting twenty or thirty young couples who have been singled out over a period of a few months as prospects. "A waxed floor and a radio out of our stock is all that is needed," says Mr. Ellerman, "and these dances, which are well attended, foster goodwill for the company in addition to attracting attention to the set supplying the music."

Reduces Home Demos

E. I. CLARK, head of the Fisher Music Company's radio department in Tucson, Ariz., has reduced home demonstrations 25 per cent without losing business by asking each store customer who requests it: "Why do you want a home demonstration?" Clark claims that most people who ask that a set be sent their home for a tryout do so either because an over-anxious salesman indirectly suggests it or because they think this is the customary way in which radio is sold.

In one out of four cases where this question is asked Clark finds that the customer immediately realizes that there is really no reason why purchase should be delayed. The set selected is standard, the house is reliable. They buy.



Kids Are Great for Publicity

Craxford Green, superintendent of the Blytheville (Arkansas) High School, accepts a new radio receiver, the gift of the Parkhurst & Marsh Radio Company, for the school auditorium while all the school children listen. W. Paul Marsh, a member of the firm, is on the platform at the right. The company writes: "We consider this the best piece of advertising we have ever done since we have been in the radio business."

A Good Tube Sales Idea

MOST servicemen testing a customer's set and suspecting tube trouble check one stage after another with an analyzer and finally succeed in finding one tube which is very bad. Upon replacing this tube with a new one the set usually operates so much better that the customer is satisfied with the improvement and buys it, though several of the other tubes may also be weak.

Not so with the North Side Radio Company of Dayton, Ohio, tube testing routine. Julius Nestor has trained his three servicemen to reverse this test procedure in order to sell the maximum instead of the minimum number of tubes. When one of Nestor's men suspects tube trouble his first step is to remove all tubes from the set, substituting new ones throughout. He then proceeds to test one old tube at a time, while the receiver is operating with an entire new set. The result of this complete changeover, naturally, is the marked difference in reception while the entire family listens. As a result it is much less difficult to convince the customer that several of the tubes, and not just one, are sub-standard.

Radio Retailing, June, 1930

Elgin Retail Radio Dealers Association

Date _____ 193__

ELGIN BUSINESS MENS ASSOCIATION

Gentlemen:

Please enter the following information on The Elgin Retail Radio Dealers register and oblige.

Name of firm reporting: _____

Name _____

Street _____

City _____

To Dealers:
Be careful to report every demonstration where sale is not made and be sure to check letter.
Your name will be known only to employees of the Elgin Business Mens Association.

A <input type="checkbox"/>	B <input type="checkbox"/>	C <input type="checkbox"/>	D <input type="checkbox"/>
One demonstration. Believed willing to buy when suited.	Believe has had many demonstrations and not intending to buy.	In our opinion this person is a buyer but ability to pay is doubtful.	Check credits very carefully and require good references.

Stops the Joyrider

THE Elgin (Illinois) Retail Radio Dealers Association has effectively stopped "joyriding" by inducing its members to fill out special forms for each demonstration, forwarding the form to the Elgin Business Men's Association offices to be entered on a register which is available to all other dealers who are members. The form is also used as a credit record.

Circular Sells Tubes

THE Kessler Radio Service, New Straitsville, Ohio, mails a small circular to its customers, worded as follows:

BAD TUBES

cause half of all radio troubles. Have your tubes tested often. Once a month is not too often as they can go bad over night. We will test them free of charge.

This circular is used as a stuffer in all tube boxes and is also used for direct mail advertising

Curiosity Attracts 'Em—And No Wonder

URBANIK'S radio store, Flint, Mich., recommends this unusual method of decorating a window. The "empties" prove that the store is selling plenty of sets, the sign implies that there is a reason for the good business and the inherent curiosity of window shoppers who can't find the window does the rest.



How Are Meters Affected?

(with respect to normal plate voltage, grid voltage, plate current)

IF

If the grid bias resistor (R1) is open?

If the grid resistor by-pass (C1) is shorted? Open?

If the input circuit (L1) is open? Shorted?

If the output circuit (L2) is open? Shorted?

If the center-tap resistor (R2) is open? Shorted?

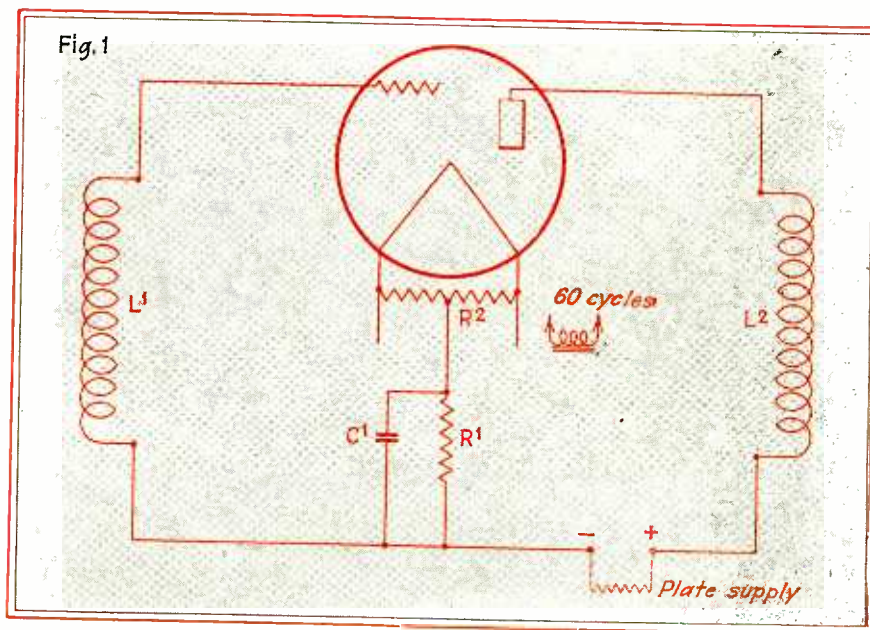

Symptoms at the Socket

By
Edward Chinitz



The author is radio service manager for the European Phonograph Co., operating two large retail stores in New York City. Seven men handle repairs under his direction and do it so well that the excellence of the company's service is a common local topic.

Concerning the reason for this reputation we quote Mr. Chinitz: "I am emphatically opposed to the idea that a radio serviceman should be '75 per cent salesman and 25 per cent common-sense mechanic.' Radio service is becoming a more highly specialized field each year and I believe a serviceman can best serve his company by making field repairs so efficiently that sets stay sold, rather than by striving to produce new business.

"Such work should be left to the sales department though, of course, close co-operation should exist at all times between the two departments."

A serviceman who is thoroughly familiar with the basic wiring which surrounds a single a.c. amplifying tube, and is well grounded in radio theory fundamentals, can accurately diagnose trouble in almost any stage of any a.c. receiver by socket test.

WHEN a serviceman is to be hired the average manager endeavors to determine the relative ability of applicants in one of three ways. A man is questioned concerning his background of experience. He is asked to answer several more or less general technical questions. Or he is turned loose in the shop to demonstrate on any defective set which happens to be in for repair. Sometimes all three tests are combined.

It has been my experience that these methods of selection do not produce uniformly satisfying results. I find, for instance, that many men with years of experience flounder hopelessly over a new receiver because of an unfamiliar arrangement of parts; that others who answer general technical questions brilliantly are familiar only with high-lights gleaned from various popular sources and have no connected picture and that still others fairly adept at locating opens and shorts by physical check of the wiring are completely at sea when it comes to analyzing symptoms at the socket with a set of test meters.

SO I prefer another method of examination.

Consider Fig. 1. This is a fundamental circuit of an amplifying stage using a single a.c. tube. It is basic in r.f. and a.f. stages of most a.c. receivers. L1, for in-

stance, may be the secondary of an r.f. transformer, an aperiodic antenna choke or resistance or an input impedance in an a.f. stage. L2 may be the primary of either an a.f. or r.f. transformer, an output choke or resistance, or the windings of a loud-speaker. The tube employed may be a power type in an output stage or a heater type with the grid return grounded and the cathode grounded through the bias resistor. If we think of Fig. 1 as the circuit of an r.f. stage a variable tuning condenser may appear shunted across L1 and additional r.f. chokes and by-pass condensers may be associated with the circuit. If we imagine that it is an a.f. stage other impedances or resistances may be incorporated.

But irrespective of variations the basic circuit remains relatively unchanged. A man who can find the source of trouble in this basic "stage" by analyzing symptoms at the socket can likewise diagnose abnormal voltages or currents in almost any stage of any manufactured receiver by applying the same reasoning. For when certain, specific shorts or opens occur in either the fundamental circuit in Fig. 1 or in an actual amplifying stage of an a.c. receiver, plate voltage, grid voltage and plate current values distort with respect to normal in an identical manner. It is necessary only to consider the trend—up or down with respect to normal—rather than actual numerical values to recognize

this similarity. Normal voltage and current values obviously differ between dissimilar amplifying stages and between different receivers, hinging upon the purpose of the stage considered, the tube, voltages and characteristics of associated apparatus employed, but abnormally negative grid bias voltage, for example, reduces plate current wherever it occurs.

One of my most important tests, therefore, is based upon questions relating to this fundamental a.c. circuit. I first draw Fig. 1 on a blackboard. Then I present a hypothetical case to each applicant for his answers:

"Consider this circuit to represent an amplifying stage in an a.c. receiver, reduced to 'bare poles.' The set is detuned. The power supply device is operating correctly on normal line voltage. All tubes are perfect. You are making a test at the socket of this stage with a perfect analyzer, plugged into the socket and its tube in the analyzer.

"What is the effect on plate voltage, grid voltage and plate current readings, with respect to normal—

- If R1 is open?
- If C1 is open? Shorted?
- If L1 is open? Shorted?
- If L2 is open? Shorted?
- If one side of R2 is open? Shorted?

My choice of a man depends largely upon the answers I receive to these questions, for obviously if an applicant can tell me how specific opens and shorts affect grid and plate readings in the fundamental circuit he can also reverse his reasoning and will recognize these same circuit troubles from abnormal meter deflection on an actual repair job.

The Answers

THE answers to these questions concerning the fundamental circuit of an a.c. stage employing a plate circuit resistor for grid bias supply are given in the following paragraphs, with semi-technical explanations where these are thought necessary.

Naturally, in order to recognize the abnormal current or voltage reading it is necessary to know approximately what the normal value should be. A chart showing average tube characteristics appears with this article and is a good general guide. The man who is fairly familiar with the average values shown by this chart for several common types of tubes will be able to recognize an abnormal condition in practically all a.c. stages.

In actual practice a serviceman may be equipped with service manuals obtained from manufacturers of sets which he is liable to encounter in the field. These manuals contain actual normal voltage and current values in the various stages. Analyzer Set manufacturers also supply leaflets with their equipment covering standard circuits and indicating normal values at each socket. No attempt is made herein to list such specific numerical values except as illustrations.

It should be noted that abnormal values may be caused not only by trouble in specific parts but also in wiring associated with these parts. The effect of opens and shorts at the five common points is noted with respect to plate voltage, grid voltage and plate current readings, in this order, as all three values are mutually dependent in this a.c. circuit, a change in any single value influencing one or both of the others to some extent.

D.C. and battery operated sets are not covered in these paragraphs nor are filament troubles mentioned, these being generally understood.

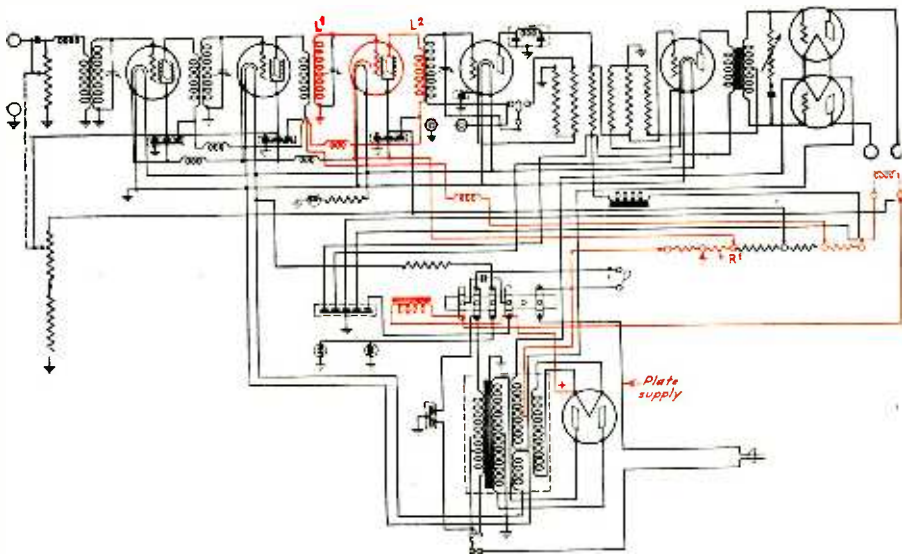

The New General Motors Set

Trace the leads shown in red in the third r.f. stage of this typical 1930 receiver and note the similarity between this wiring and the fundamental a.c. circuit of Fig. 1. The two ground symbols refer to a common ground on the metal chassis of the set which in this instance forms a connection between the low potential end of the input coil and the grid bias resistor which is, incidentally, common for all three r.f. stages.

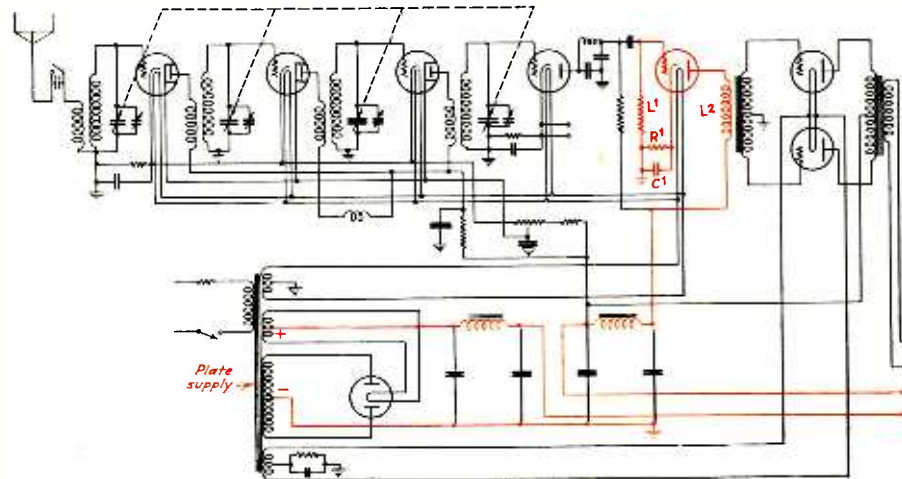

Another Example—The New TCA Clarion

The similarity between the wiring of the a.f. stage shown in red and the fundamental circuit of Fig. 1 is obvious here also. In this case L1 is a coupling resistance and R1 provides negative grid bias for this resistance coupled a.f. stage only.

Screen-grid, "power" detection and grid-leak and condenser detection, being modifications of the fundamental electrical circuit of Fig. 1, are covered in concluding paragraphs. Push-pull amplifying stages are not included in this discussion as in such stages the use of two tubes complicates matters somewhat and the following symptoms do not apply except in general.

If R1 Is Open (grid bias resistor)

PLATE VOLTAGE will be zero. R1 forms part of the plate circuit and plate current must flow through it to the tube filament in order to complete its circuit. Hence an open grid bias resistor automatically cancels both plate current and plate voltage, the filament being ungrounded.

GRID VOLTAGE will read abnormally high, but fictitiously so. The grid bias reading of a '71 in a power output stage, for example, may read as high as 100 volts negative, whereas normal is about 40 volts. The grid voltmeter, in position between the grid of the tube and the cathode (Fig. 4)

takes the place of the open bias resistor in the plate circuit, grounding the filament, and permits plate current to flow through itself, indicating plate voltage drop across its own internal resistance rather than grid bias.

PLATE CURRENT, measured at the socket, will be zero. Note: Except in those cases where an analyzer is used which permits the reading of grid voltage and plate current simultaneously, in which instances the plate milliammeter will indicate the current flowing through the grid voltmeter.

If C1 Is Shorted (grid bias resistor by-pass)

PLATE VOLTAGE will be normal or slightly below normal. In an r.f. stage the difference will probably not be noticeable while in a power output stage the voltage may fall off to a value 25 per cent or more below normal due to the "regulation" of the plate supply device incorporated in the set.

GRID VOLTAGE, or negative bias, will be zero. Shorting C1 cuts the resistor R1

Fig. 2

E_g - Control grid bias voltage
 E_p - Plate voltage
 E_s - Screen grid voltage
 I_p - Plate current
 I_s - Screen grid current

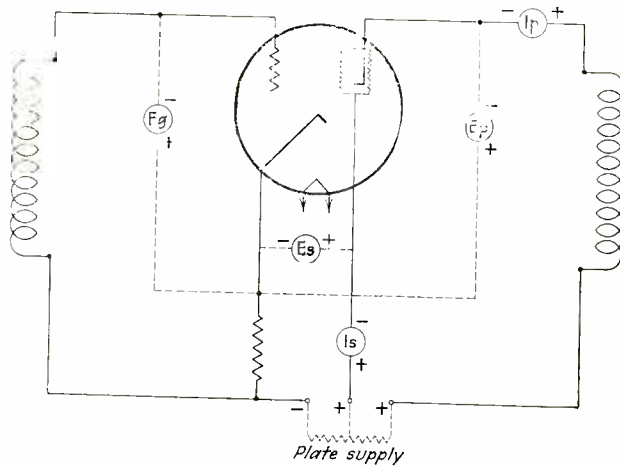

Grid and Plate Test Meters

When readings are taken at a vacuum tube socket of an a.c. radio receiver by means of a standard Analyzer Set equipped with a flexible cable and adapter, the tube of the stage under test being inserted in the Analyzer, meters are cut into the grid and plate circuits as shown. Two meters or more may be in the circuit simultaneously, depending upon the type of instrument used and the system of switching which it employs.

out of the circuit and it is the function of this resistor to keep the grid negative with respect to the filament by utilizing voltage drop across it. (See Fig. 3.) With C1 shorted the grid is connected directly to the filament or cathode through L1 and the shorted by-pass condenser and is therefore at the same potential. Removal of negative bias from the grid affects plate current and indirectly plate voltage if the current drawn is high.

PLATE CURRENT reading will be far above normal. One of the principal functions of negative grid bias is to keep plate current to a safe low value and its removal permits the tube to increase its current drain. More technically, a grid negatively charged with respect to the filament normally opposes the flow of negative electrons

which form plate current through its mesh to the positively charged plate from the heated filament. Removal of the negative charge from the opposing grid thus permits more electrons to be drawn from filament to plate.

If the stage under survey happens to be a power output stage, using a '45, for example, this increase in plate current by removal of grid bias places so much of a drain on the plate supply device that it is usually unable to supply both the current demand and the normal voltage. In Fig. 6, a graph of a typical plate supply device is shown. It will be seen upon examination of this graph that if the plate current of a power output tube is permitted to exceed its normal value by twenty or thirty milliamperes the regulation of the plate supply device reduces the voltage output from 25 to 30 per cent.

It is this excessive current drain which in some instances causes the plate voltage to be reduced as noted above.

Obtaining Grid Bias

Fig. 3

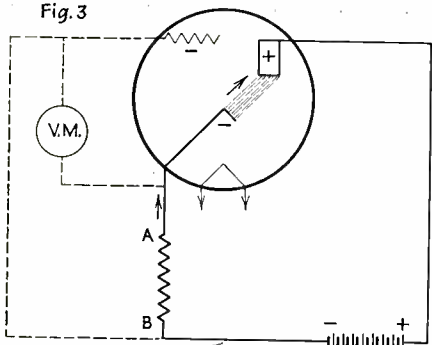

When current flows through a resistor a voltage difference exists between its respective ends. That is, some electrical energy is expended when current is forced through a resistor, producing a "voltage drop."

Thus, tracing the plate circuit in Fig. 3 from the negative terminal of the plate supply device we approach closer and closer to the positive terminal of this device, each point in the circuit becoming less negative as we proceed. Point A (connected to the cathode) is therefore less negative than point B (connected to the grid) and so the grid is negative with respect to the cathode so long as plate current flows through the resistance to produce the necessary voltage difference.

This method of obtaining negative grid bias is generally used in a.c. set design though it is also possible to utilize the voltage drop across resistors in other circuits. D.C. and battery operated sets (not covered in this article) usually employ other C bias systems.

If C1 Is Open

PLATE VOLTAGE, GRID VOLTAGE and PLATE CURRENT remain unaffected. The function of this condenser is to provide an easy path around R1 for a.c. input currents without affecting the flow of d.c. plate current through this resistor. An open in C1 in r.f. stages may produce broad tuning, weak signals or oscillation, or all three, by forcing input currents to flow through the bias resistance for grid return. If this condenser is used in an a.f. stage an open circuit sometimes affects tone quality and occasionally produces a shrill audio whistle in the amplifier.

If L1 Is Open

(input impedance, resistance, etc.)

PLATE VOLTAGE will be approximately normal.

GRID VOLTAGE will be zero or slight. While no negative bias is impressed on the grid, its connection to the bias source being broken, this control element accumulates a very high negative charge by becoming saturated with the negative electrons emanating from the filament. This charge, which is negative with respect to the filament or cathode, cannot leak off except through the resistance of the meter. This leakage current produces a misleading reading. (See Fig. 5.)

PLATE CURRENT will be below normal

and may fluctuate violently at this level. The flow is reduced by the high negative charge on the grid which opposes the passage through the tube of plate current. In most instances, however, the negative charge obtained from the filament is not sufficiently "husky" to remain constant and the grid swings rapidly from highly negative to a less negative value, causing the plate current to fluctuate correspondingly. It is interesting to note, in passing over this item, that this fluctuation of plate current when L1 is open is especially noticeable if the receiver happens to be tuned in on a signal and a break in L1 is in such a place as to permit coupling between two halves of the input coil or impedance.

If L1 Is Shorted

PLATE VOLTAGE is not affected.

GRID VOLTAGE may appear to be more negative than normal due to the elimination of a resistance in this circuit. This is especially true where L1 is the resistance of a resistance coupled amplifier, where the reduction of measured grid bias by the d.c. resistance of L1 is considerable. Where L1 is an impedance its d.c. resistance is seldom great enough to have an appreciable effect on the meter reading. Actually, the resistance of L1 does not affect the bias. No current flows through it normally, hence there can be no voltage drop.

PLATE CURRENT will be normal.

Misleading Grid Reading

Fig. 4

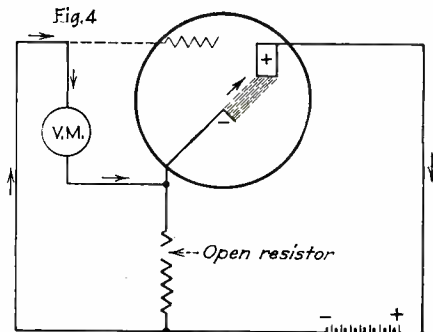

THE CIRCUIT, in which a grid voltmeter is in its normal test position between grid and cathode, indicates clearly that an open bias resistor in an a.c. set leaves no other path for plate current except through the meter itself. When this occurs the meter indicates plate voltage drop across its own internal resistance rather than grid bias. The actual grid bias is zero.

Though slightly irrelevant, it might interest servicemen to know that depending upon the amplification present in preceding stages where L1 is open a signal may or may not pass through this defective stage to be amplified by succeeding tubes.

If L2 Is Open

(output, impedance, resistance, etc.)

PLATE VOLTAGE, zero. No explanation is necessary other than Fig. 2, showing the position of the plate voltmeter.

GRID VOLTAGE will be zero. When L2 is open no current can flow in the plate circuit of the stage, hence no current flows through the bias resistance R1 which forms part of the plate circuit. Since negative grid bias is obtained by utilizing the voltage drop produced across R1 by the flow of plate current through this resistor no voltage drop is present and hence no bias is obtainable if the plate circuit is broken and current does not flow. (See Fig. 3.)

PLATE CURRENT will be nil. The reason

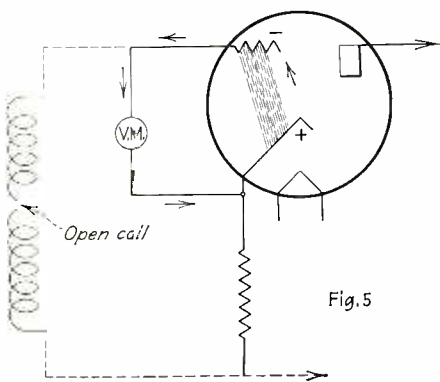

Free Grid Reading

With L1 open, the negative charge accumulating on the grid due to saturation by the negative electronic stream flowing from filament to plate through its mesh cannot leak off except through the resistance of the grid voltmeter. This leakage current causes a fictitious reading, which will be high or low depending on the emission of the tube filament.

is apparent upon examination of the position of the plate milliammeter in Fig. 2 where an Analyzer with a flexible cable is used to cut this milliammeter in series with the plate lead.

If L2 Is Shorted

PLATE VOLTAGE is increased proportionately with the reduction of d.c. resistance between the plate of the tube and the supply device. This is not great enough to greatly influence a plate voltage reading unless L2 is a resistance or an impedance with very high d.c. resistance.

GRID VOLTAGE will be practically normal except where the effect noted above increases plate current which in turn causes a greater voltage drop across R1 and consequently a more negative grid bias.

PLATE CURRENT, normal except as noted above.

Open or Short in R2 (grid return center-tap)

PLATE VOLTAGE, GRID VOLTAGE and PLATE CURRENT will be affected only if a short or open in one side of R2 affects the regulation of the filament supply transformer and hence the filament voltage. Inasmuch as this test does not concern itself with plate or filament supply except where these influence voltages and currents at the amplifying stage we will assume that the condition of R2 is not such as to influence filament voltage, in which case the three values in which we are interested, plate voltage, grid voltage and plate current, are not affected at all.

This question is asked in the nature of a "sticker," following all the others which directly influence plate and grid conditions traceable from symptoms at the socket. The correct answer is that plate and grid meters show normal values when an open or short appears in one side of R2, the trouble producing a 60 cycle hum in the speaker rather than an abnormal meter reading.

Screen-grid Stages

My test concerns itself chiefly with an applicant's knowledge of a simple three element tube amplifying circuit but it is also possible to modify it to include an examination on screen-grid r.f. circuits. To make such a test it is necessary to consider the placing of meters in connection with the

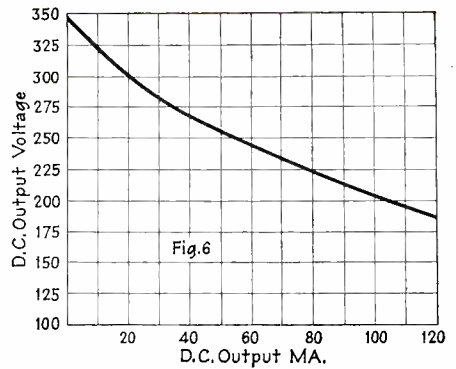

Plate Supply "Regulation"

Plate current supply devices incorporated in a.c. receivers are designed to supply predetermined current values at required voltages. As indicated by this graph showing the typical voltage-load characteristic of the plate supply unit of a well-known set an abnormal current demand reduces voltage output. This voltage drop affects plate voltages throughout the receiver and grid bias values as well.

additional or screen element as shown in Fig. 2; to keep in mind the fact that a positive potential is applied to the screen.

The screen element is positively charged with respect to the filament though not as highly as the plate, which for this reason continues to attract practically all negative electrons from the filament through the mesh of the screen. Briefly, a decrease from normal positive screen-grid voltage to a less positive value reduces plate current for the same reason that a higher negative bias on the control grid reduces plate current—greater opposition to attraction

(Please turn to page 97)

Average Characteristics of Receiving Radiotrons																			
GENERAL				FILAMENT SUPPLY				DETECTION				AMPLIFICATION							
MODEL	USE	CIRCUIT REQUIREMENTS	BASE	MAXIMUM OVERALL HEIGHT	MAXIMUM OVERALL DIAMETER	FILAMENT SUPPLY	FILAMENT CURRENT (AMPERES)	DETECTOR GRID RETURN LEAD TO	GRID LEAD VOLTAGE (MILLIAMPERES)	DETECTOR PLATE CURRENT (MILLIAMPERES)	DETECTOR PLATE VOLTAGE	AMPLIFIER PLATE CURRENT (MILLIAMPERES)	AMPLIFIER PLATE VOLTAGE	AMPLIFIER PLATE CURRENT (MILLIAMPERES)	A.C. PLATE RESISTANCE (OHMS)	METAL CONDUCTANCE (MICROHMS)	VOLTADE UNSTORIED FACTOR	MAXIMUM UNSTORIED POWER (MILLIWATTS)	
WB-11	Detector or Amplifier	Transformer Coupling	WD-1 Base	4 1/2"	1 1/2"	Dry Cell 1 1/2 V Storage 2 V	1.1	25	+	3 to 5	225 to 45	1.5	90	45	2.5	15,000	425	4.4	5
WX-11	Detector or Amplifier	Transformer Coupling	Large Standard UX Base	4 1/2"	1 1/2"	Dry Cell 1 1/2 V Storage 2 V	1.1	25	+	3 to 5	225 to 45	1.5	90	45	2.5	15,000	425	4.4	5
UX-112-A	Detector or Amplifier	Transformer Coupling	Large Standard UX Base	4 1/2"	1 1/2"	Storage 6 V	5.0	25	+	3 to 5	225 to 45	1.5	90	45	2.5	15,000	425	4.4	5
UX-119	Detector or Amplifier	Transformer Coupling	UX-99 Base	3 1/2"	1 1/2"	Dry Cell 1 1/2 V Storage 4 V	1.2	25	+	2 to 4	45	1	90	45	2.5	15,000	425	4.4	7
UX-120	Detector or Amplifier	Transformer Coupling	Small Standard UX Base	4 1/2"	1 1/2"	Dry Cell 1 1/2 V Storage 4 V	1.2	25	+	2 to 4	45	1	90	45	2.5	15,000	425	4.4	7
UX-200-A	Detector	Thermal or Resistor Coupling	Large Standard UX Base	4 1/2"	1 1/2"	Storage 6 V	5.0	25	-	1 to 3	45	1.5	90	45	2.5	15,000	425	4.4	7
UX-201-A	Detector or Amplifier	Transformer Coupling	Large Standard UX Base	4 1/2"	1 1/2"	Storage 6 V	5.0	25	+	2 to 4	45	1.5	90	45	2.5	15,000	425	4.4	7
UX-202	Radio-Freq. Amplifier	Resistor Coupling	Large Standard UX Base	4 1/2"	1 1/2"	Dry Cell 1 1/2 V Storage 4 V	1.2	142	—	—	—	—	135	150	2	150,000	300	M	—
UX-203	Radio-Freq. Amplifier	Resistor Coupling	Large Standard UX Base	4 1/2"	1 1/2"	Dry Cell 1 1/2 V Storage 4 V	1.2	112	—	—	—	—	180	150	2	150,000	400	40	—
UX-204	Radio-Freq. Amplifier	Special	Large Standard UX Base	4 1/2"	1 1/2"	Transformer 2 1/2 V	2	175	—	—	—	—	180	150	2	150,000	1,000	400	—
UX-205	Amplifier	Transformer Coupling	Large Standard UX Base	4 1/2"	1 1/2"	Transformer 2 1/2 V	1	105	—	—	—	—	180	150	2	150,000	1,000	400	—
UX-207	Detector or Amplifier	Transformer Coupling	Large Standard UX Base	4 1/2"	1 1/2"	Transformer 2 1/2 V	2.5	125	C	2 to 4	45	1	90	45	2.5	15,000	425	4.4	7
UX-208	Detector or Amplifier	Transformer Coupling	Large Standard UX Base	4 1/2"	1 1/2"	Storage 6 V	1.0	25	+	2 to 5	150	2	135	150	2	150,000	400	40	—
UX-113-A	Power Amplifier	No. L. R. C. Required	Large Standard UX Base	4 1/2"	1 1/2"	Storage 6 V Transformer 5 V	5.0	25	—	—	—	—	135	150	2	150,000	1,000	400	150
UX-114	Power Amplifier	No. L. R. C.	Large Standard UX Base	4 1/2"	1 1/2"	Dry Cell 1 1/2 V Storage 4 V	1.2	125	—	—	—	—	135	225	4.5	6,000	300	3.5	110
UX-117-A	Power Amplifier	L. R. C. Steps at 90 V.	Large Standard UX Base	4 1/2"	1 1/2"	Storage 6 V Transformer 5 V	5.0	25	—	—	—	—	90	180	10	2,500	1,200	5	150
UX-144	Power Amplifier	L. R. C.	Large Standard UX Base	4 1/2"	1 1/2"	Transformer 2 1/2 V	2.5	1.5	—	—	—	—	180	30	20	1,500	1,000	5	1,400
UX-110	Power Amplifier	L. R. C.	Large Standard UX Base	4 1/2"	1 1/2"	Transformer 2 1/2 V	2.5	1.25	—	—	—	—	180	30	20	1,500	1,000	5	1,400
UX-206	Power Amplifier	L. R. C.	Large Standard UX Base	4 1/2"	1 1/2"	Transformer 2 1/2 V	2.5	1.25	—	—	—	—	180	30	20	1,500	1,000	5	1,400

This chart gives a good general idea of what bias voltages, plate voltages and currents will be, normally, in the average a.c. receiver. A.C. tubes in most common use are marked. The actual values vary between different sets.

Now-

Stabilized Business

for the

Radiola Dealer!

CONTROL OF PRODUCTION

will link retailer,
manufacturer and public
closer than ever before!

Display the famous



RCA trademark

RCA RADIOLA

Now—through closer cooperation with the Radiola dealer, we can accurately gauge consumer demand—and meet it speedily and economically through straight line production under one roof. The great resources of the new RCA Victor Company, Inc., back up this plan of *Controlled Production* with manufacturing facilities of assured capacity.

The execution of this plan will give the Radiola dealer a higher degree of stability than has ever been known in the Radio industry. As ever, only the highest quality merchandise will be manufactured and sold under the RCA Radiola trademark. As ever, RCA Radiola, the name that means most in Radio—will continue to be the acknowledged leader!

Our Future and Yours are One

Powerful, consistent advertising in magazines, newspapers, broadcasting and window displays will make the public continue to use the name RCA Radiola as a synonym for the best in Radio. And, with our greatest assets—dealer loyalty and the strength of the RCA name with the public—the Radiola franchise will grow greater and more valuable in 1930—and in the years to come!

RADIOLA DIVISION
RCA VICTOR COMPANY, INC.

Display the famous



RCA trademark

RCA RADIOLA

Editorial Views

The Government's Suit Against the Radio Corporation

SEVERAL months ago the Senate Committee on Interstate Commerce, acting at the instance of Senator Couzens, called on the Department of Justice for a report of its activities concerning various complaints against the Radio Corporation of America. The Government suit, announced May 14 and reported in the news columns of this issue, is the Department's answer to the critics of RCA.

This action attacks the present and proposed policies of the Radio Corporation as those in which the control of the radio industry, through the medium of the improper use of patent rights, will be perpetuated.

Radio Corporation's representations to the Department of Justice are based on the contention that it has been doing nothing not authorized under the patent laws.

Lengthy litigation is in prospect. It has been several years since the government has had forces of the strength of these defendants to contend with, and the consensus of opinion in Washington is that only the opinion of the Supreme Court of the United States will conclude the court proceedings that have now been set in motion—for the case is one which permits use of every type of legal maneuver.

The case, in fact, may result in a new construction of our patent laws in their relation to the anti-monopoly acts, together with a clearer crystallization of the nature of the monopoly that was intended to be extended to patent holders by the drafters of the Constitution of the United States.

These factors make it obvious that the merger question will be secondary throughout the fight because the scope of the patentees' rights to license will be scrutinized and the way in which these rights may be exercised will be definitely at stake.

It's Real News— and It's Being Played Down

EVERY time a new play, concert or film makes its bow all the leading newspapers in the country review it—yet the former type of entertainment is seen by less than one per cent of the nation's citizens and the average movie possesses no greater educational or amusement possibilities than will be found in an evening of well selected radio programs. But broadcasters are practically neglected by the newspaper critics. This policy of silence is weakening reader interest in the daily press and hurting the radio industry.

In an article which appears in the May issue of *Good News*, the house organ published by the RCA Radiotron Company, Inc., Charlotte Geer, dean of radio critics, points out that this "step-child of the entertainment world," as newspaper editors seem to regard broadcasting, has earned an important place in the public eye.

"A program of artistic value and cultural worth passes

without comment," she declares. "While in the same paper will appear a column review of a new movie although the picture may be without beauty, of doubtful ethics and with an inane plot. . . . On the other hand the broadcasters of chain programs burn the midnight oil with the author, spending hours in trying to get his exact idea, they cast with extreme care, sometimes giving auditions to a hundred people to assemble a group of six. Hours are spent perfecting sound effects and in rehearsing the incidental music. The result of all this effort is a half hour program over a chain of 50 stations."

Worthy of Conscientious Criticism

THE fact that a broadcast, no matter how elaborate, is the program of a single evening, affords some basis for the newspaper editor's claim that it is not worth a critical review. But, although a radio program has no length of days, a *type* of program is quickly standardized—and should receive the attention of the critics. The high ethical standards of radio programs also should entitle them to special consideration.

We cannot couch the conclusion of this editorial in more effective words than those of Miss Geer: "Why must radio, the greatest of them all if the size of its audience could be computed, be the only one to suffer from neglect? This giant in swaddling clothes, who, in six short years, has over-topped every rival and who hasn't begun to realize its full stature, can neither be patronized nor ignored. It is the voice of the people; it is the molder of opinions and the weaver of dreams. It laughs and the world laughs with it, but when it weeps it does not weep alone.

"A radio producer, on all the counts there are deserves the support of constructive comments, approval or disapproval, in the daily press. The broadcasters deserve the publicity for their radio work which is accorded to their brothers of the theater. The musical artists are entitled to recognition. And the newspaper owes it to its readers to use its influence in encouraging and upholding the best efforts of this new art of radio broadcasting. Besides, the activity of the industry is legitimate *news*—news that is wanted by millions of newspaper readers."

Local Influence

THE average dealer is prone to forget that next to the manufacturer's reputation, his own reputation is of utmost importance. More and more, people are buying radio sets because they know the local dealer and have faith in him. They take his recommendation and will buy the set he recommends. National advertising by manufacturers is very valuable and a wonderful help in making the public conscious of a certain brand of set. But in the final analysis it is the local dealer who guides the prospect and places the set in the home. Therefore, it behooves every radio merchant to so build his reputation that people will know he can be depended upon after the sale. Once this is accomplished sales follow with greater ease.

on Live Issues ♦

The "Hot News" Possibilities of Radio

ANOTHER development which will heighten interest in radio is that of the growing trend to broadcast "hot news." Witness the prompt action of the Columbia Broadcasting Company when, a few weeks ago, it presented "The Deacon's" colorful description of the Ohio prison disaster through station WIAU. Here was a case of quick thinking and quick action on the part of Columbia for which the industry at large should be duly grateful.

Or take the example of NBC re-transmitting the trans-oceanic conversation of Signor Marconi, aboard his yacht in the Mediterranean Sea, with David Sarnoff, in New York City. This conversation, incidentally, was picked up by a salesman demonstrating an automobile-radio set to a prospect near Buffalo, while traveling along the countryside at 30 miles an hour. Think of it, and we haven't yet scratched the surface of the possibilities of unusual, "on the spot" news programs or of fascinating transmission ideas!

Here, then, are two more talking points for dealers to tuck away in the back of their heads.

"From Missouri"

SOME of the auxiliary lines which are suggested to radio dealers as a means of pepping up summer business have excellent possibilities while others are entirely unsuited. The difficulty is to distinguish between the good and the bad without being burnt.

A dealer with whom we are well acquainted was urged by a salesman to take on pianos. He immediately mentioned the common trade belief that pianos are particularly slow-movers. The salesman offered to send him two on consignment. Curiously enough, these practically sold themselves in the first month and our friend now plans to invest some of his own money in these instruments.

Originally he was "from Missouri." Many wary dealers, we wager, will find their auxiliary line in this selfsame manner—consignment.

Good News for the Ruralite

THREE new d.c. tubes, which draw considerably less filament current than similar types heretofore available, are on the market. Two of these, a general

purpose ('30) and a power output type ('31), resemble the '99 in external appearance though the element construction is radically different. The third is a screen-grid type ('32) with the large UX base. All three operate from two volt filament supply sources.

The immediate effect of these new tubes will probably be an increase in tube replacement business in rural districts. For with minor circuit changes—perhaps none at all if special filament batteries are used—the general purpose and power output tubes are interchangeable with the older '99 and '20 types, effecting important battery replacement savings.

Other important effects will be a general lowering in the manufacturing cost of d.c. power-pack receivers, increased interest in portables and generally greater customer satisfaction for all battery-operated sets.

The Lure of "Admit One"

THERE is a tale of how a girl courted a bashful beau by mailing him a single theater ticket, anonymously. That green pasteboard looked so valuable and irresistible that he couldn't help going, and of course met the young lady, much surprised, sitting next to him. Tickets to events have a concrete, impressive value in the mind of the public. A collection of tickets and programs to events broadcast in a year's time would make an impression on a sales prospect as profound as the instrument itself. What retailer is doing it this way?

Omar's Rubaiyat Modernized



*A Book of Verses underneath the Bough,
A Jug of (prohibition) Wine, a Loaf of Bread—and Thou
Beside me singing in the Wilderness—
Oh, Wilderness were Paradise now!*

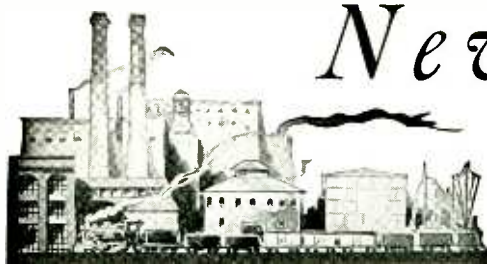

New Products for

This editorial section is prepared purely as a news service, to keep readers of "Radio Retailing" informed of new products.



Model 75 Combination

Zenith "70" Line

AUTHENTIC reproduction of period designs feature the five models in the "70" series just brought out by the Zenith Radio Corp., 3620 Iron St., Chicago, Ill. All incorporate the screen grid circuit using nine tubes. The speaker is a super-sized "Syntonic" dynamic.

Model 71 is a lowboy with full length doors, carved on both sides. The intended retail price is \$185.

Model 72, illustrated, is of semi-lowboy type equipped with automatic tuning, \$210.

Model 73, also with automatic tuning, is a semi-highboy console, listing at \$265.

Model 74 is identical in design with Model 73 but is equipped with remote control. It lists at \$315.

Model 75, illustrated, is a combination in a semi-highboy cabinet. Automatic record changing permits continuous playing of records for thirty minutes. \$375.—*Radio Retailing*, June, 1930.



Model 72

Rug Aerial

A RADIO capacity antenna pick-up in the form of a rug aerial is being marketed by the Potter Co., North Chicago, Ill.

The device is a thin condenser, shaped so that it can be concealed under a rug. The approximate dimensions (flat), are: 6 in. by 11 ft. by 1/40th of an inch, foldable to fit rugs of any shape. Complete with ground clamp, the list price is \$1.70.—*Radio Retailing*, June, 1930.

Gilfillan Models 105 and 106

GILFILLAN BROS., INC., 1815 Venice Blvd., Los Angeles, Calif., has just brought out Models 105 and 106. They both use four 224's, one 245 and one 280. The speaker is a dynamic.

Model 105, a lowboy, is finished in walnut and stands 40 in. high by 26 in. wide by 16 in. deep. The price on the Pacific Coast is \$122 complete; in the inter-mountain and eastern territories, \$132.

Model 106 is a semi-highboy with burl walnut panels and overlays. This model is 43 in. high by 26 in. wide by 14 in. deep. The intended retail price on the Coast is \$155 complete; \$10 higher in the inter-mountain and eastern territories.—*Radio Retailing*, June, 1930.



Model 106

Clarion Receivers

UNDER the trade mark, "Clarion," a highboy, a lowboy and a radio-phonograph combination have been brought out by the Transformer Corp. of America, 2309 S. Keeler Ave., Chicago, Ill. TCA has made such parts as transformers and condensers for a number of years and will produce many of the parts which go into these receivers.

Three stages of transformer coupled screen-grid amplification using three 224's are employed in these sets. The tuned input circuit, together with a device which maintains a bias potential on the 224's practically independent of the volume control setting eliminates, the maker says, cross talk and synthetic harmonics. In addition to the 224's, one 227 linear power detector, one 227 as first a.f. amplifier feeding two 245's in push-pull and a 280 rectifier are used. The speaker is a 12-in. dynamic. The power pack incorporates a triple-pi-section filter system.

Model 51 is the lowboy of swirl walnut and satinwood. The dimensions are 40 in. high by 26 1/2 in. wide by 14 1/2 in. deep. Intended retail price, \$109.

Model 53 comes in a cabinet of swirl walnut, burl elm and satinwood, standing 44 in. high by 28 in. wide by 14 1/2 in. deep. Price \$129.

Model 55 is a radio-phonograph combination in a cabinet of matched woods, \$199.—*Radio Retailing*, June, 1930.



"Queen Anne"

General Motors Line

FEATURING a "tone selector" by which either the bass or treble may be emphasized, the new General Motors radio was recently presented by the General Motors Radio Corp., Dayton, Ohio.

It is an 8-tube set composed of four tuned r.f. circuits. The tubes utilized are three 224's a 227 power detector, a 227 in the first audio stage of resistance coupled amplification, two 245's and a 280 rectifier.

The tone control consists of a fixed condenser and a variable resistor, connected in series be-



"Late Italian"

tween the grid terminals of the 245 tube sockets. This permits adjustment of the speaker pitch. A strip type dial on the panel, calibrated "bass" and "treble," shows at which pitch the device is set.

The set employs double volume control affecting the antenna circuit and the first r.f. circuit simultaneously.

The electro-dynamic speaker uses an output push-pull transformer to match the impedance of the voice coil on the speaker to the output of the power tubes. This is done by matching the impedance of the speaker coil with the audio transformer and by employing two 245 tubes in push-pull.

An advance step in radio construction is the use of ball bearings to support the four-gang variable condenser, assuring the maintenance of correct position of the plates as well as increasing ease of operation.

Five models are offered, all conforming to the traditional lines of period furniture. The

prices are as follows: Hepplewhite lowboy, \$136; Sheraton, \$152; Late Italian, \$172; Queen Anne, \$198; and the Georgian, \$270. The Queen Anne and Georgian models are combinations. The other sets have phonograph pick-up jacks.—*Radio Retailing*, June, 1930



"Mighty Midget"

Master Receivers

THE "Mighty Midget," made by the Master Radio Mfg. Co., Inc., 1682 W. 35th Place, Los Angeles, Calif., is one of the new type of receivers so popular just now. It is about the size of a table speaker, measuring but 13 in. by 16 in. Both the Magnovox dynamic speaker and the chassis are housed in a Doric walnut cabinet. As this set weighs only 28 lb. it is semi-portable. The intended retail price is \$59.50, complete.

The standard shape table model has the same chassis and a built-in speaker, \$66.50, complete.

The console is made of walnut and is of a size and design that makes it readily adaptable to most any type of home interior. Price, \$89.50, complete.—*Radio Retailing*, June, 1930.



Console Model

Polymet Transformers

POLYMET MANUFACTURING CORP., 829 E. 134th St., New York City, is exhibiting for the first time a complete line of audio transformers, power transformers for both 25 cycle and 60 cycle circuits, and choke units. They are available either in stock forms, or for manufacturer's use.—*Radio Retailing*, June, 1930.

Dealers to SELL

All announcements appearing on these pages are published without advertising considerations of any kind whatsoever.



United States Corp. Auto Radio

Automatic's Automobile Radio Set

Showing the equipment necessary for the installation of the Apex set

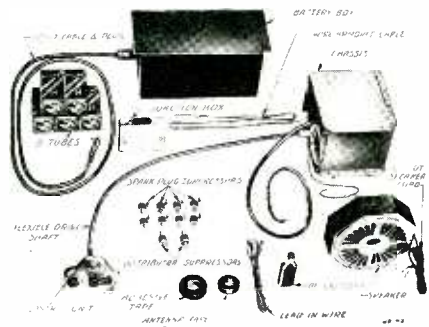

TUBES, control, junction box and lead-in wire are included in the price of \$75 for the auto radio receiver which the United States Radio and Television Corp., Marion, Ind., has just developed. The accessories needed for installation vary with the make of car and ordinarily consist of speaker, antenna, spark plug and distributor suppressors, battery cable and connector plug, contact condenser and B and C batteries.

The set employs two 224's, one 226 detector, one 201-A and one 171-A. The chassis is fully shielded against electrical dis-

turbances. The A battery power is taken from the regular automobile battery and the B batteries are a single unit cased in a steel container which is mounted beneath the floor boards.

The type of speaker and antenna used varies according to the requirements of the car owner but an electro-magnetic speaker (\$10) especially designed for the set and a tinfoil covered tape antenna, which can be laid lengthwise on the roof of the car, may be obtained from the company.—*Radio Retailing*, June, 1930.



This set mounts under the engine hood on the bulkhead

A NEW development of the Automatic Radio Manufacturing Company, 112 Canal Street, Boston, Mass., is a radio set designed for automobile, aircraft and marine use.

The receiver which is doubly shielded, consists of a tuned antenna stage, three high-gain radio frequency stages, tuned detector and two stages of transformer coupled radio. Three 224's are utilized for the R. F., a 227 for detector, a 112A for first A.F., and a 171A for the power output tube. Filament current is supplied from the car battery. The B and C batteries, for plate and bias voltage, are carried in a container.

The receiver is very compact and may be placed conveniently in a number of positions, such as under the dash or under the hood, and may be operated directly or by means of a remote control cable.

The speaker which can be sup-

plied in either a special type horn, or a cone speaker, may be mounted wherever desired. It will operate on any kind of antenna, such as a screen in the top of the car, a plate under the running board, or even the body of the car may be utilized as an antenna.

It is expected that this set will market at a retail price under \$125 completely installed and with equipment.—*Radio Retailing*, June, 1930.

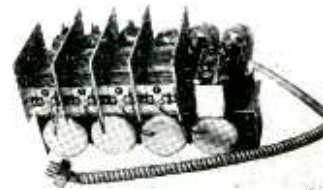

Crosley Auto Radio

THE radio receiver, control panel, battery box and Dynacone speaker, Model 321, are included in the "knock-down" kit of the "Roamio" auto-radio set as it comes from the factory of the Crosley Radio Corporation, Cincinnati, Ohio. The necessary equipment for complete installation includes, in addition to the above equipment, two 224 tubes, one 227 and two 112A's, five batteries as follows: three 45 volt B-batteries, two 22½ volt B-batteries; and material for an antenna. For eliminating interference from the automobile electrical system, the following are suggested:

Three eliminators, one each at the generator, ignition coil and starter button, for the average installation; one spark plug type suppressor for each spark plug and one distributor type suppressor for each distributor head.

The control panel is modern-



istic in design, and has a volume control knob, a station selector knob, and a lock switch on it. The set retails for \$75 with speaker but less the tubes and the batteries. Installation is extra.—*Radio Retailing*, June, 1930.

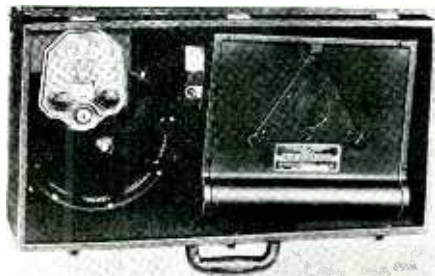

The "Roamio" comes in a carrying case, the lower part of which is shown. Tools are carried in the cover

Ray-O-Vac Autoradio B-Battery

IN motor cars equipped with receiving sets, the radio battery is subject to constant vibration and often severe jolts and as a result the radio B-battery must be built to withstand this strain. Storage battery principle is applied to the housing of the new "Autoradio" B-bat-



tery of the French Battery Co., Madison, Wis.

A sturdy case of special composition, built like the case on any starting and lighting battery, thoroughly protects the dry-cells inside. Weather, cold, heat and moisture tests have been given this battery with

successful results, says the manufacturer. It will retail at \$3.—*Radio Retailing*, June, 1930.

Master Filtered Aerial

A SMALL and compact aerial (2½ in. in diameter) now supplements the line of the Master Engineering Company, 771 Mather St., Chicago, Ill. It can be easily and quickly mounted and has a capacity equal to a 50 ft. outside aerial, the statement says.

This aerial is non-directional and non-corrosive, and comes in a polished Bakelite case. It is not a light socket aerial. The intended retail price is \$2.—*Radio Retailing*, June, 1930.



Three New D.C. Tubes

THREE new d.c. tubes have been placed on the market by the RCA Radiotron Co., Inc., Harrison, N. J., to be known as type 230, a general purpose tube; type 231 a power output tube; and type 232, a screen-grid tube. All three operate with 2 volts d.c. applied to the filament and consume considerably less filament current than battery types heretofore sold. Manufacturers' literature indicates that all three tubes are particularly sensitive to filament voltage and it is recommended that the rated value be carefully adjusted.

The general purpose and power output tubes fit small UX sockets while the screen-grid is equipped with the larger standard UX base.

Detailed specifications are as follows; these being only approximate at the present writing:

GENERAL PURPOSE TUBE ('30)

Fil. Voltage, 2.0 Volts.
Fil. Current, 0.06 Amp.
Plate Voltage (Max.), 90 Volts.
Grid Voltage (C-Bias), —4.5 V.
Plate Current, 2.0 Mils.
Plate Resistance, 12,500 Ohms.
Amplification Factor, 8.8.
Mutual Conductance, 700 Micromhos.
Approx. Direct Inter-Electrode Capacitances.
Grid to Plate, 6 Mmf.
Grid to Fil., 3.5 Mmf.
Plate to Fil., 2 Mmf.
Max. Over-all Dimensions
Length, 4½ in.
Diam., 1½ in.



Types 230 and 231 are identical in appearance.

POWER OUTPUT TUBE ('31)

Fil. Voltage, 2.0 Volts.
Fil. Current, 0.150 Amp.
Plate Voltage, Max. Recommended, 135 Volts.
Grid Voltage (C-Bias), —22.5 V.
Plate Current, 8 Mils.
Plate Resistance, 4,000 Ohms.
Amplification Factor, 3.5
Mutual Conductance 875 Micromhos.
Undistorted Power Output, 170 Milliwatts.
Approx. Direct Inter-Electrode Capacitances.
Grid to Plate, 6 Mmf.
Grid to Fil., 3.5 Mmf.
Plate to Fil., 2 Mmf.
Max. Over-all Dimensions
Length, 4½ in.
Diam., 1½ in.

SCREEN GRID TUBE ('32)

Fil. Voltage, 2.0 Volts.
Fil. Current, 0.06 Amperes.
Plate Voltage, Max. Recommended, 135 Volts.
Grid Voltage (C-Bias), —3 V.
Screen Voltage, Max., 67.5 Volts.
Screen Current, 1.5 Mils.

Screen Current, Not over ¼ of plate current.
Plate Resistance, 800,000 Ohms.
Amplification Factor, 440.
Mutual Conductance, 550 Micromhos.

Effective Grid-Plate Capacitances, 0.02 Mmf.,
Max. Dimensions
Max. Over-all Length, 5½ In.
Max. Diam., 1½ In.
Control Grid Contact Cap (Diam.), .346 In.—.369 In.
—Radio Retailing, June, 1930.

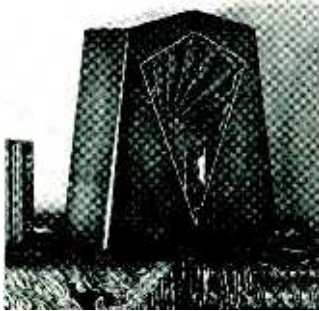

Keller-Fuller "Midget" Set

UNDER the trade name "Radiette," the Keller-Fuller Mfg. Co., 1573 W. Jefferson Ave., Los Angeles, Calif., has placed on the market a "midget" receiver. This type of receiver is a new trend which is becoming very popular. The set has three 224's, resistance coupled audio circuit, balanced volume control, power detector, 45 output, and phonograph jack. The speaker is a Rola electro-dynamic.

The "Radiette De Luxe" comes in a modernistic cabinet of walnut, 14 in. wide and 16 in. deep. The price is \$69.50.—Radio Retailing, June, 1930.

Victor Fans

DESIGNED to move air rapidly and quietly without any sudden blasts or drafts is a new table fan announced by the Cincinnati Victor Company, Cincinnati, Ohio.

It has six silver-finished airplane type blades. The patented "Victor Breezespreader" supplies an even circulation of air without draft. The motor, it is pointed out, has no brushes to interfere with radio reception. The fan has three speed control, can be used as a table or wall fan, and comes in blue, green and ebony enamel finish. Intended retail price, \$19.

A "Luminaire" floor model on an ornamental standard about 5 ft. high is also available. Artistic side lights add to its attractiveness. Price, \$39.—Radio Retailing, June, 1930.

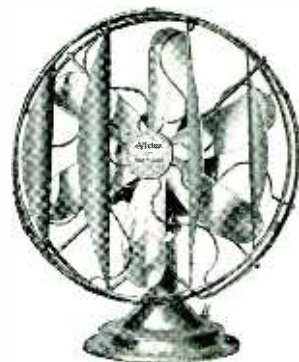

"Jam Handy" Pocket Explainer

SOCIETY for Visual Education, Inc., 327 S. La Salle St., Chicago, Ill., makes a "Jam Handy" Pocket Explainer for use by contact salesmen especially. It can be slipped into the pocket, being only 6½ in. by 4 in. by 2 in. in size and weighing but 1½ lb. The "Jam Handy" is a complete projection machine operating from the light socket. A brightly-lighted picture several feet or a few inches wide can be shown on any plain surface.

The S.V.E. "Pictural" projector manually operated is light, compact, durable, and designed for use in classrooms, Sunday schools and small assemblies. Model C, illustrated, weighs but 4½ lb. and retails at \$55.

A complete library of educational and religious films is also available.—Radio Retailing, June, 1930.



Mills Troubadour

ANY establishment not requiring more than from 60 to 100 magnetic speakers will find the Model 865 "Troubadour" made



by the Mills Manufacturing Co., 4100 Fullerton Ave., Chicago, Ill., fitted for their requirements. This outfit is self-contained and requires little space. Either radio programs or music from records is available, and a microphone for use in paging or giving special talks is attached.

A special Troubadour for use in mortuaries is also made. The cabinet can be placed in an out-of-the-way place and the table speaker installed in the chapel. Organ music, vocal selection, sacred hymns or any other type of music, are available for use during the funeral services.—Radio Retailing, June, 1930

Three Howard Sets

THE "Plymouth," the first Howard cabinet set to be priced below \$175, uses the same chassis that is placed in the higher-priced models. This receiver is built the same as the others, with the exception that the cabinet design has been simplified. Three stages of screen grid radio amplification, a power detector and two 245 power tubes, and a 280 rectifier are used.

The "Consolette," of the open face type, retails at \$185.

The "Puritan" is a highboy with swinging doors. \$210. Howard Radio Co., South Haven, Mich.—Radio Retailing, June, 1930.



The Puritan

Small Dynamic Unit

A "BABY dynamic" unit weighing only 6½ lb. and but slightly larger than a man's fist, has been developed by the Racon Electric Co., 18 Washington Place, New York City. It is 4 in. in thickness and has a maximum diameter of 5 in.

This newest and smallest addition to the Racon line of dynamic units includes many of the same features which have been incorporated in former models. It is intended for use in conjunction with exponential horns. The list price will be about \$35.—Radio Retailing, June, 1930.

Gordon Pick-Ups

L. S. GORDON COMPANY, 1800 Montrose Ave., Chicago, Ill., has brought out two new pick-ups; the CG-3 (without volume control), and the CG-4 which has a volume control mounted in the base of the tone arm.

These new pick-ups feature the reduction of weight on the needle to four ounces, while still keeping the actual pick-up head weight high enough to insure that the inertia of the head will not be overcome due to needle vibration. Smooth action of the head as it operates across the record is assured by a ball bearing rest at the swivel.—Radio Retailing, June, 1930.



Radio Retailing, June, 1930



Excello Radios and Cabinets

FOR many years the Excello Products Corp., 4820 W. 16th St., Cicero, Ill., has specialized in the manufacture of cabinets. Due to the many requests for a chassis and speaker to combine with their cabinets, they have now placed on the market a screen grid set using three 224's, two 227's, two 245's and a 280. This receiver will be available in the various Excello model cabinets, and will be distributed direct from the factory.

Six consoles of the highboy and semi-highboy types are available, the illustrated model being of Louis XV period. It is 21½ in. high by 26 in. wide by 19 in. deep. The price of the cabinet alone is \$145; with speaker and chassis assembled, \$265.

In addition to these models, eight radio-phonograph models are available. They are offered in the following combinations: cabinet only; cabinet and phonograph equipment; or, cabinet with chassis, speaker and phonograph equipment complete.—*Radio Retailing*, June, 1930.



Western Automatic Phonographs

ILLUSTRATED is Model 70 of the coin-operated automatic phonographs made by the Western Electric Piano Co., 850 Blackhawk St., Chicago, Ill. It will play up to 15 records on both sides. The coin magazine is of new construction, registering from one to 20 coins. The five ply walnut cabinet measures 49 in. high x 34 in. wide x 23 in. deep. Weight, 240 lb. Standard equipment requires 110 volt 60 cycle a.c. current but equipment for 25 cycle a.c. may be had. The list price is \$850.

Model 71 is the same as Model 70 but is not coin operated. \$815.

Model 60 is a combination radio and automatic phonograph standing 54 in. high, and 35 in. wide. Price, \$965.

Model 60A, super amplification, is similar to Model 60 but the amplifying capacity provides high volume for from 1 to 6 dynamic speakers or approximately 25 magnetics. \$1,095.—*Radio Retailing*, June, 1930.

Radio Retailing, June, 1930

Nathaniel Baldwin Sets

NATHANIEL Baldwin, Inc., 1601 S. Michigan Ave., Chicago, Ill., is now making radio receivers.

The "Consolette," Model 70, uses three 224's, one 227, two 245's and a 280 in a triple screen grid circuit with 12½ in. Baldwin dynamic speaker. The cabinet is walnut, standing 46½ in. high. A phonograph jack is furnished. The intended retail price, complete with tubes, is \$129.50. Equipped with remote control, \$159.50.

The "Baldwinette," Model 50, is a "midget" set only 18½ in. high by 15½ in. high, which make it semi-portable. The triple screen grid circuit employs three 224, one 245 and one 280. The speaker is a 9-in. Baldwin dy-



namic. Price, \$99.50, complete. With remote control, \$129.50.

The "Hydaway," as its name implies, is made to be hidden away in a bookcase, behind a davenport or in some out-of-the-way place, being tuned entirely by remote control. The chassis is the same as used in the Consolette. It lists at \$119.50, complete with remote control and tubes, but not including speaker.

The portable, Model 40, is an eight tube set, entirely self-contained, using 224's in the r.f. and push-pull amplification in the audio stage, the latter being coupled to a special push-pull magnetic speaker. It weighs but 19 lb. and when used in connection with a Baldwin step-up converter, may be operated in automobiles directly from the 6-volt storage battery. This set can also be plugged into any 110-volt current without any changes. In addition to the two 224's six 227's are employed. Price, complete with tubes, \$79.50.

A remote control kit, adaptable to any single dial radio set, is also available. The entire mechanism operates on but twenty volts, \$35.—*Radio Retailing*, June, 1930.

Brunswick 15 and 22

TWO new Brunswick models are being shown by Brunswick-Balke-Callender, 629 S. Wabash Ave., Chicago, Ill., each with the style "B" chassis and 10 in. dynamic reproducer. The circuit is an improvement over last year's screen grid circuit, and consists of three tuned screen grid stages of radio frequency amplification, a linear power detector using a screen grid tube, resistance coupled to two 245 power tubes operated in parallel, making a total of 7 tubes, including rectifier. The power unit and the tuning unit are housed in the one chassis; only two iron core transformers are used; and the fixed condensers are made in Brunswick's own plant. The variable condenser plant has been so designed that a remote tuning control can be readily attached.

Model 15 is a lowboy, approximately the same size as the present model S-14, with sloping front corner panels and slightly greater depth.

The highboy, Model 22, has French doors and fluted corner panels.—*Radio Retailing*, June, 1930.



A collapsible pole permits the pick-up loop to be extended to isolate pole transformer noises, etc.

Tobe Interference Locator With Intensity Meter

TOBE Deuschmann Corp., Canton, Mass., offers a new interference locating receiver, designed to be carried in a car, or with a shoulder strap as a portable field instrument. Four screen-grid tubes and two 112-A's are used in the set to provide a high degree of sensitivity and a vacuum tube sensitivity meter for tracing sources of noise more accurately than by earphone test alone is included.

High and low frequency switches are provided so that noise at either audio or radio frequencies may be traced. Antenna equipment consists of an inductance loop which may be used for directional work and a well insulated, collapsible extension pole. A separate container is provided for batteries. Tube filaments are lighted from a small storage battery which may be charged without being removed from the container through the use of a built-in charger. The battery carrier is equipped with meters to permit calibration of intensity control. If required, the filaments may be lighted from an automobile storage battery.

The price, less tubes and batteries, is \$255.—*Radio Retailing*, June, 1930.



Pacent "Phonovox"

PACENT ELECTRIC CO., 91 Seventh Ave., New York City, announces a new and improved electric pick-up, to be known as



the "Master Phonovox." The characteristic vertical design of the pick-up head has been eliminated, and in its place is a new contour in which the pick-up is elongated horizontally. This feature in design adds consider-

ably to the appearance, and makes it more compact through the absence of the bulky pick-up head, as well as permitting a low center of gravity, so that a counter-balanced tone arm is unnecessary.

The external volume control is discarded and a combination control and radio-record switch, both controlled by one knob, has been built into the base of the tone arm. A special adapter for a.c. sets comes with each unit. The intended retail price is \$15.—*Radio Retailing*, June, 1930.



The Selective

Crystal Sets

THREE sizes of crystal receiving sets are being made by the Philmore Manufacturing Co., 113 University Place, New York City.

The largest is known as the "Selective" model, and is built with a tapped coil matched with a .00035 mfd. variable condenser. It comes in a cabinet with a nickeloid polished front panel equipped with graduated dial for tuning, two double posts to take two pairs of headphones and a glass enclosed crystal detector. The price is \$5.

A smaller set, known as the "Supertone" is \$1.50, and the "Little Wonder" receiver lists at \$1.—*Radio Retailing*, June, 1930.



Leutz Short-Wave Receivers

C. R. LEUTZ, INC., Altoona, Pa., announces two new short-wave receivers.

Unit construction is employed, allowing maximum flexibility and permitting the use of two, three or four units together as complete receivers. The simplest arrangement is the detector stage and audio unit combined. To this combination may be added the first r.f. stage, and later the second r.f. stage. For maximum range and audibility, the complete four units are suggested.

Each unit is in its individual aluminum case, which affords double shielding between units. Each r.f. stage is in a separate compartment. The detector stage is also in a separate compartment, while the three audio stages are combined in a fourth compartment. The push-pull audio amplifier design has been eliminated because of the extra input signal required to secure full output.

A voltmeter is provided, having two scales—0-8 and 0-200 volts. The meter is not permanently connected to the receiver but has flexible leads and pick points for the purpose of taking readings of various A, B and C voltages.

Both models C and L are sold without coils. The coils may be purchased separately to cover any particular bands or any wave length ranges desired.—*Radio Retailing*, June, 1930.

Pacific Coast Will

Other Events of

JUNE, 1930

**First Affair of Its Kind for Far-Western Tradesmen—
To Be Held, William Taylor Hotel, San Francisco,
June 30-July 2—Music Merchants Convene
June 9-14—RCA Sued by Government**



By Detector

CONVENTIONS, conventions! Is there no end to these affairs? The answer, dear reader, is "No!" And more power to 'em—despite the wear and tear on the "visiting firemen"—for when we cease to get together, we cease to grow.

For the benefit of those 7,000 dealers who reside in the states fringing both sides of the Rockies and east of Waikiki and who cannot make the grade to Atlantic City, the Pacific Coast Radio Trade Asso-

ciation is staging a trade show and convention at the William Taylor Hotel, San Francisco, June 30-July 2.

Approximately 70 manufacturers will exhibit their wares. The doors to the auditorium and assembly rooms of the William Taylor Hotel will be open afternoons and evenings only; this in order to co-operate with the Western Music and Radio Trades Convention which holds its sessions at the St. Francis Hotel on the same dates. The music trades people are also taking care of the social activities. Wholehearted western hospitality assures a good time for all.

Lectures on Interference

A prominent feature of the show will be a series of lectures on radio interference, its causes and cure. The results of two years' study of this subject will be available.

Admission badges will be required just the same as at the big show, and there will be special railroad rates.

Attention is called to the fact that the dates for this affair have been changed from June 25-27 to June 30-July 2. This is in order to avoid conflict with important conventions of other natures scheduled for San Francisco the latter part of June.

The chairman of the show committee is H. R. Curtiss and the general manager, George H. Curtiss. A. L. Meyer is president of the Pacific Coast Trade Association.

Los Angeles has decided to hold a public radio show, this September, under the auspices of the Radio and Music Trades Assoc., of Southern California.

which the corporation derives patent rights and the proposed unification action are entirely within the laws of the United States.

In view of the subsequent action of the Department of Justice, as reported elsewhere in this section, the actual consummation of this unification plan will be withheld pending the outcome of the government's suit against the Radio Corporation, it is understood.

Utah Increases Stock Issue

Application for listing of 143,380 additional shares of the no par common stock of the Utah Radio Products Company, of Chicago, was announced the forepart of May. This will make a total of 393,280 shares outstanding.

The additional stock will be used to acquire all the common stock of the Caswell-Runyan Co., of Huntington, Ind., and the Carter Radio Co., of Chicago.

Audiola Now Specializing in Sets

The Audiola Radio Company, of Chicago, Ill., formerly specializing in the manufacture of chassis, is planning to center the major part of its activities during the coming season in the production of receiving sets. Set specifications and prices are announced elsewhere in this issue.

Audiola has just received from the Radio Corporation of America a license to manufacture receiving sets.

George and H. R. Curtiss



These brothers are acting as general manager of the Pacific Trade Show and chairman of the show committee respectively.

Stockholders Verify RCA-G.E. Plan

At a special meeting of the stockholders of the Radio Corporation of America, held at New York City, May 6, president David Sarnoff stated that the meeting was for the purpose of authorizing an increase of the capital stock in connection with the program of unification previously announced. This increase was voted, the number of shares in favor of the project representing a substantial majority of the outstanding preferred and common stock of the corporation.

Mr. Sarnoff further stated that Radio Corporation had been advised by counsel that both the basic agreements from

The William Taylor Hotel, San Francisco

Where the
first western
trade show
will be held,
June 30 to
July 2.



Have a Trade Show

the Month Epitomized

NEW YORK, N. Y.

Westinghouse Competes for Share of Radio Market

Set Distribution to Start Soon—Sales Policies and Territories Established

The Westinghouse Electric and Manufacturing Company is now well along in its plans for placing on the market a line of radio receivers under its own name.

The activities of the radio department will be in the charge of M. C. Rypinski, former vice-president of Brandes and Kolster from 1922 until 1928. Prior to these connections he served as manager of Westinghouse's radio activities during its early pioneer days.

C. Hart Collins will be the merchandising manager responsible for jobbing relations. He will be assisted by Ralph B. Austrian who will look after dealer relations. LeRoy W. Staunton will be in charge of advertising and sales promotion.

The western coast will be managed by John A. Duncan, formerly a top executive with the Illinois Electric Company, Chicago.

The distribution of Westinghouse radio will flow through Westinghouse agent jobbers who in turn will distribute mainly through their established Westinghouse dealer outlets. Other dealers, however, such as music merchants and radio specialty concerns, will be signed up if it appears mutually advantageous to do so.

Jobber-dealer meetings will start about the middle of June under the direction of Mr. Collins. It is of interest that Mr. Collins was the founder of the company of C. Hart Collins, Ltd., manufacturers of radio sets in Great Britain. He is one of the original group of founders of the British Broadcasting Company.

RADIOTYPES



FRED D. WILLIAMS

They say that Fred D. Williams commutes between Philadelphia and 30 E. 42nd Street, New York City.

How he is able to maintain that characteristic Williams disposition of uniform good humor under such "shipping conditions" can only be accounted for by that famous 4-Pillar construction. Fred has a good line of ——— radio tubes.

General Saltzman to Address Trade Convention

General Charles McK. Saltzman will be the speaker at the Sixth Annual Convention and Trade Show at Atlantic City.

The only other speaker on the program will be Dr. Hugh P. Baker, manager of the Trade Association Department of the Chamber of Commerce of the United States, Washington, D. C.

General Saltzman's address will be made on Wednesday morning, June 4, in the Civic Auditorium. This will be the first time General Saltzman has addressed the radio industry as a group. His message, therefore, will be extremely interesting.

Ken-Rad Loses Services of Erskine

Fifty friends of William E. Erskine were the guests of Roy Burlew at a dinner in Owensboro, Ky., given the forepart of May as a farewell to Mr. Erskine, who leaves to assume a share of the management of the Sylvania and Nilco Companies, at Emporium, Pa.

Although Kenrad and Sylvania are competitors, Roy Burlew and B. G. Erskine have always been warm personal friends—hence the plan whereby the junior Erskine served an apprenticeship away from his father's roof.

"Meet the King"

Under the slogan, "Meet the King," the line of receivers made by the King Manufacturing Corporation, Buffalo, N. Y., will be sold under the sales agency of Allan Strauss and Julian Jacobs, who will maintain offices at 122 Greenwich St., New York City.

Richard A. Graver will be the southeast district sales manager of the RCA Radiotron Co., Inc. He will make his headquarters in Atlanta, Ga.

Radio Men Who Were Active in the May News



JESS HAWLEY
(above)
Chairman
Show Comm.



M. C.
RYPINSKI
heads Radio
Westinghouse



H. T. ROBERTS
(above)
Sales Manager
Gulbransen



A. H. MEYER
(below)
President
Pacific RTA



E. J. DYKSTRA
G. S. M. of
Transformer
Corp.



HUGH P.
BAKER
will speak
at Atlantic City

Government to Test Validity of RCA Compacts

Action Begun by Mitchell at Wilmington—Young Says He Welcomes the Move—Patent Licensing Rights Involved

Following persistent demands from the Senate and from other quarters, the government instituted, on May 13, an anti-trust suit in the Federal court at Wilmington, Del., to test "the legality of the arrangement existing between the Radio Corporation of America and General Electric, Westinghouse, the American Telephone and Telegraph Co. and six other corporations." The filing of this suit under the Sherman law was announced by Attorney General Mitchell. The other companies involved, according to the Department of Justice, are the Western Electric, RCA Photophone, RCA Radiotron, RCA Victor, General Motors Radio Corporation and General Motors Corporation.

In effect the suit appears to be broader in scope than would have been the case if only the recent merger of interests by the Radio Corporation, General Electric and Westinghouse companies was involved.

The Government's Viewpoint

"The patent arrangements made among several of the defendants," the Department of Justice statement explained, "have steadily increased in number and enlarged in scope until the defendants now practically have control of the radio business and its development. This control has been brought about by a novel method of cross licensing patents.

"The suit is concerned chiefly with the legality of these patent arrangements. The petition filed alleges that the defendants, most of whom are competitors, by issuing patent licenses to one another, have created a patent combination or pool through which they exercise joint control over the radio industry and that competition among them has ceased, and that no outsider can obtain a license except on terms jointly prescribed by the chief defendants.

"The petition also alleges that the proposed reorganization recently submitted to stockholders of the Radio Corporation would have the effect of perpetuating the control already obtained by the defendants.

"The defendants, on the other hand, have earnestly contended that they are doing nothing more than they are authorized to do under the patent laws. The situation is an intricate one, and it is desirable that these vexed questions be settled in the courts."

The suit comes as a climax to repeated attacks on the Radio Corporation in the Senate. On numerous occasions the department has been criticised for its failure to proceed against the alleged radio monopoly.

Another alleged monopoly, covering the

sale of radio tubes, has been under fire before the Radio Commission, but it has been generally conceded that this case be allowed to hang fire pending action of the Department of Justice.

RCA Welcomes Suit

Following receipt of information that suit had been brought by the government against the Radio Corporation, Owen D. Young, chairman of the executive committee of the Radio Corporation of America, issued a statement, the text of which follows:

"The Radio Corporation of America welcomes the suit of the government of the United States to test the validity of its organization, which has now existed for more than ten years, and in every step of which the government has been advised.

"In 1919, when the company was organized, no one concern in the country had the necessary patents to enable it to develop the radio art and create a business. Each of several had some and each could block the other. The purpose of the organization of the Radio Corporation was to release the art by grouping patents enough in one place so as to enable sending stations to be created and receiving sets to be built. That this was accomplished is shown by the rapid development of the radio business.

"In order to promote competition in the art and in the business, and to avoid patent litigation which would have prevented development, licenses have been issued to 34 concerns to make radio receiving sets and to 14 concerns to make radio tubes. Between them, as the public knows, competition is severe.

Sees Benefits in Licenses

"These licenses provide a royalty payment which was intended to represent the fair contribution of the licensees to the expenses of the research and the cost of the original patents. It was intended to be less than the royalty payment would have been had the patents remained in scattered hands. All these licensees are licensed under all new inventions, and have the benefits of all existing research of the Radio Corporation and its associated companies in the field which the licenses cover.

"Certainly if there be anything illegal in the set-up of the Radio Corporation, its officers, directors and stockholders are more deeply interested in that question than either the government or any other group can possibly be. It is very glad, therefore, that a test case has been brought. It prefers very much to have such a question out of politics."



Guest of Honor at Music Convention

Dr. Walter Damrosch will be the guest of honor at the annual banquet, June 12, of the convention of the National Association of Music Merchants, The Hotel New Yorker, New York City, will be the scene of this year's convention to culminate in this "high light" banquet and entertainment.

Balkeit Factory Purchased by National Transformer

The National Transformer Manufacturing Company has purchased the Balkeit assets both physical and intangible. The former concern will move to North Chicago to occupy its new quarters, maintaining an office at 205 Wacker Drive, Chicago. National announces that it will produce eight private brand chassis and one bearing the trade name Balkeit. By this move National also acquires an RCA license.

Five Little Resistors



They'll be at Atlantic City, these engineers of the Clarostat Mfg. Co., Brooklyn, N. Y., to talk resistance in all its forms and phases.

Reading from vest to coat here are the Murchers of Clarostat fame: George, Jacob, Stephen, "Uncle" and John.

Federated to Publish Booklet

The National Federation of Radio Associations has been authorized by its executive committee to publish a booklet on the examination, registration and grading of radio service men. The plan of examining and registering service men has been promoted by the NFRA for the past two years and many local associations now have a very successful service men's organization as a result of this effort. The past results of the leading associations will form the basis for this booklet.

Another Market for Radio

The waiting rooms of railroad stations, bus terminals, etc., are likely prospects for radio sets. Here is a group of travelers listening to the "wild waves" in the Baltimore & Ohio station at Chicago.



Federated's Recent Activities

Plans for Advertising Standards, Examination of Servicemen, Bankruptcy Survey and National Radio Week, Well Along

The National Federation of Radio Associations will hold but one general meeting at Atlantic City during Trade Show week. This is scheduled for Monday at 10 a.m. at Convention Hall. J. Newcomb Blackman, president of NFRA, will preside.

The executive office of National Federation is making a survey of the advertising standards now in effect with local associations throughout the country. The best points of each will be considered and will be assembled into a new set of advertising standards and practices to be presented for adoption at the Atlantic City get-together. The endorsement of these standards by the newly organized Radio Press Association will be sought.

In order that radio men may have information and statistics covering the pitfalls of retailing radio apparatus, the

Tea for Two



C. W. Schafer, manager of the Chicago office, Stromberg-Carlson Company, presents George A. Scoville, vice-president in charge of sales, with a silver tea set at the Stromberg-Carlson annual sales conference at Rochester.

association has arranged with Dr. Julius Klein, of the Department of Commerce, to have a survey made among retailers and wholesalers of radio apparatus with a view to analyzing the causes for failures within the radio industry.

National Radio Week

National Radio Week, created and sponsored by the National Federation of Radio Associations for the week of September 22 to 28, has been officially endorsed and will be jointly sponsored by the RMA.

Last year National Radio Week was observed by most of the local associations that were members of the NFRA and this year plans are being formulated so that it will be of far greater benefit than ever before.

The executive committee appointed a committee to supervise the details of National Radio Week. J. Newcomb Blackman, Blackman Distributing Co., New York City; Harry Alter, Harry Alter Company, Chicago, and executive vice-president Erstrom, of the NFRA, compose this committee.

The RMA has appointed H. H. Frost, of New York City; Herbert Young, of Grigsby-Grunow Company, Chicago,

Top Off with the Music Convention

The Annual Music Convention will be held at the Hotel New Yorker, Eighth Ave., and 34th St., New York City, during the week immediately following the Atlantic City festivities. All music merchants should plan to top off the convention season by attending this affair.

Mark P. Campbell, president of the Music Industries Chamber of Commerce, declares that the program features and opportunities for advancing one's merchandising technique will be far greater than at any previous convention of this nature.

and executive vice-president Bond Geddes, of the RMA, New York City. Close co-operation between these two committees already has been established.

National Radio Banquet

The board of directors of the National Federation of Radio Associations officially endorsed and authorized the holding of a National Radio Week Banquet to be held some time during National Radio Week, September 22 to 28 at New York City. The National Radio Banquet has been endorsed and is being sponsored jointly by the RMA.

Preliminary plans for the banquet include providing entertainment of such outstanding character as to be of great value and interest to the listening public.

Young, Coit, Emmert on RMA Board

Herbert E. Young, vice president of Grigsby-Grunow Co., J. Clark Coit, president of the U. S. Radio and Television Corp., and Roger J. Emmert, president of the General Motors Radio Corp., were, on May 7, unanimously elected to fill three vacancies on the RMA board of directors.



And Jimmy Got Married This June

"Jimmy" Johnson, general manager of the Western Electric Piano Co., Chicago, joined the ranks of the harassed benedicts June 4. Among other things he manufactures automatic phonographs, both domestic and commercial, also radio-combinations.

Oh, yes! We almost forgot to state that the cute youngster in his arms belongs to his big brother.

Gulbransen Sales Headed by Roberts

The Gulbransen Co., radio and piano manufacturer, Chicago, announces the appointment of Henry T. Roberts, formerly with the U. S. Radio and Television Co., as sales manager of its radio division.

Mr. Roberts is a pioneer in the merchandising of radio, having founded the H. T. Roberts Co. in 1921. Prior to that he was an executive in the automobile and phonograph industries.

Magnavox Purchases Mershon Co.

The Magnavox Company, Oakland, Calif., and Chicago, Ill., loud speaker manufacturer, has acquired the plant and business of the Mershon Condenser Company, of Medford Hillside, Mass. The latter concern formerly was owned and operated by the Amrad Corporation. In turn this concern was controlled by Powel Crosley, Jr.

Radio Shows and Conventions

Atlantic City	June 2-8	St. Louis	Sept. 15-22
RMA Trade Show and Convention		Sixth Annual Southwest National Radio Exposition	
New York City	June 9-14	New York City	Sept. 22-27
Convention of the National Association of Music Merchants, Hotel New Yorker.		Radio World's Fair, New Madison Square Garden	
Indianapolis	June 24-26	Milwaukee	Sept. 22-28
Indianapolis Radio Trade Show, Claypool Hotel		Wisconsin Radio Exposition, Milwaukee Auditorium	
First two days, dealers only; third day, open to public		Pittsburgh	Sept. 29 - Oct. 4
San Francisco	June 30 - July 2	Pittsburgh Radio Show, Duquesne Garden	
Pacific Coast Radio Trade Show, William Taylor Hotel		Minneapolis	Sept. 29 - Oct. 4
San Francisco	June 30 - July 3	Ninth Annual Northwest Radio and Electrical Show, Minneapolis, Municipal Auditorium	
Seventh Annual Western Music and Radio Trades Convention, St. Francis Hotel		Los Angeles	Sept. 1-6
Los Angeles	Sept. 1-6	Eighth Annual Los Angeles Radio Show, Ambassador Auditorium	
Rochester	Sept. 15-20	Boston	Sept. 29 - Oct. 4
Sixth Annual Rochester Radio Show, Convention Hall		Tenth Annual Boston Radio Exposition	
		Chicago	Oct. 20-26
		Chicago Radio Show, Coliseum	

What the Wholesalers are Doing

RWA Has Valuable Data on Supplementary Lines

The Radio Wholesalers Association has recently completed an interesting survey of supplementary lines, other than radio sets or accessories, being handled by its members.

While the intimate results of this survey are for the exclusive use of the members of RWA, it may be stated that the survey revealed that outboard motors, small boats, electric clocks, electric refrigerators, electric fans and violet-ray lamps were among the favorites. Close seconds were such items as Neon signs, tube testers and testing equipment, athletic goods, toys, phonograph pick-ups, coin slot machines, golf clubs, oil burners, speedometers and washing machines.

A Texas Ranger Comes North



A. E. Emrick, manager of Dallas and Denver branches of the Edison Distributing Corp., is greeted by Edison Radio executives at Orange, N. J. Left to right are: Alfred Hand, advertising manager; A. E. Emrick; H. H. Silliman, eastern sales manager; R. R. Karch and Paul McGee, assistants to the vice-president, and Roy S. Dunn, manager of sales promotion.

Kimberly Will Distribute Brunswick Sets in Chicago

Kimberly Radio Corporation, Chicago will act as distributor for all radio and recording interests of the Brunswick-Balke-Collender Co., now controlled by Warner Bros. This announcement comes from L. T. Johnson, president and treasurer of Kimberly.

With the acquisition of the Brunswick franchise the Kimberly Radio Corporation relinquished its Zenith distributorship in Illinois, Indiana and Wisconsin.

An extensive sales staff, under the direction of G. P. Gunther, has been augmented to render still better service to Kimberly accounts. The majority of Kimberly salesmen are veterans with the organization and enjoy an extensive trade following.

Thompson Joins MacDermott

Charles E. Thompson, former president and general manager of the Thompson Engineering Company of Toledo, Ohio, has been appointed sales promotion manager for the James C. MacDermott Company, Philco distributor.

Here an' There

The Ayers-Lyon Corp., New England factory representative for Colin B. Kennedy, is now located in new display rooms at 215 Stuart St., Boston, Mass.

Wilbur D. Brill, recently connected with the U. S. Supplies Co., San Francisco, and Ervin C. Wenger, formerly sales manager for the Electric Supply Company, of Oakland, have formed a radio distribution company under the firm name of Brill-Wenger Company.

Henry F. Gardiner, formerly Pacific coast manager for Sonora, is now northern California representative of the General Motors Radio Corp.

Louis Gruen has been appointed Pacific coast representative for the Nathaniel Baldwin Co., of Salt Lake City, manufacturer of the Baldwin radio receiver.

The Bush-Caldwell Company, 121 Main St., Little Rock, Ark., has been named Arkansas distributor for American Bosch.

N. J. Clark & Co., Detroit, and Sigmond H. Cohen, Los Angeles, are two new representatives of the United Scientific Laboratories, New York City.

Richmond Hardware Co., Richmond, will handle the products of the Zenith Radio Corp. in Virginia and the eastern half of North Carolina. Other Zenith distributors are the Chapin-Owen Co., of Rochester, and the Wayne Hardware Co., of Fort Wayne.

The Boley-Oliver Co. will distribute the Story & Clark radio line in the New York area, acting as sales agent in the Story & Clark eastern branch at 33 West 57th St., New York City.

K. E. Campbell has been named manager of the Electric Corp., Seattle, Wash., and H. Hunziker manager of the radio department of the company. The Electric Corp. is distributor in the Seattle territory for American Bosch.

Coast Radio Supply Co., of San Francisco, is distributor in northern California and western Nevada for Brunswick.



Initial Order Via Air

The Ackerman Electrical Supply Co., Grand Rapids, Mich., has the honor of signing Baldwin distributor franchise No. 1. This outfit will cover the western half of Michigan and received its first shipment in its own airplane. Needless to say Ackerman will deliver sample sets to its dealers by this same plane.

From left to right: W. M. Ackerman, president; Jerry Vinkemulder, pilot, and Ernie Cantilo, sales manager.

Rice Offers Trips to Havana

A three-day trip to Havana, Cuba, will be provided for the 25 winners of a sales contest sponsored by the Rice Sales Co., Birmingham, Ala., distributor of the Stewart-Warner radio line. The contest, which will run until Dec. 31, is open to all the retail store owners and salesmen served by the Rice Co.

Bihl Bros. Baldwin Distributor

Bihl Bros., of Buffalo are distributors for Nathaniel Baldwin products in the Buffalo territory. They will not only handle Nathaniel Baldwin radio receivers but also speakers, remote control units and dynamic pick-ups.

St. Louis Soccers Stage Successful Season



The E. J. Strauss Radio Company, Sparton radio distributor in St. Louis sponsors the Sparton Radio Soccer Club, shown above, which won last year's state and municipal championships. At a recent meeting this firm inducted 99 dealers into the St. Louis Sparton Radio Dealers Club for the furtherance of mutual pleasures as well as business interests.

"Symptoms at the Socket"

(Continued from page 83)

of electrons from the filament by the plate. With this reduction of plate current by a change in screen voltage comes a reduction of control grid bias as shown in Fig. 3. A broken lead to the screen, for this reason, will greatly reduce plate current and control grid bias simultaneously.

An increase in screen-grid voltage, though this is not a usual trouble, on the other hand, increases plate current and control grid bias up to the saturation point of the tube and may introduce oscillation.

Power Detection

Detectors employing no grid-leak or condenser, using high plate voltages, as employed in many new receivers, may be tested with an Analyzer in much the same manner as an amplifying stage. It is necessary to keep in mind, however, that the plate current is much less than in an amplifying stage at normal. The grid-bias is normally highly negative with respect to the filament or cathode.

Grid-leak and condenser or "square-law detectors" as they are sometimes called, may be tested with an Analyzer if the grid-condenser is first shorted.

The Proper Method of Operating More Than One Loud Speaker from a Single Receiver

Several speakers may be operated from a single receiver. The same program may, in this way, be supplied simultaneously to a number of rooms, apartments, or houses. According to one of the sound engineers now with Fada Radio, better sound distribution can be obtained in large rooms or halls with several speakers operated at a medium volume than with one speaker operated at high volume. The number of speakers required in a given room is determined by the size and character of the room and by the type of sound distribution required. Due to the large number of variables involved, there can be no simple method of determining the best number of speakers or the best location for them. Such things are usually determined by trial.

A simple explanation of fundamentals which should prove helpful in laying out any installation is as follows: A speaker is a power absorbing device. When a given amount of power is supplied to it, a given performance can be expected. Further, if two identical speakers are connected to the same source, each will absorb half the power and each will supply half as much sound energy to the air as one alone. From this, it is evident that doubling the number of speakers connected to a receiver halves the power supplied to and by each speaker. A power amplifier tube with given plate and grid biases will supply a given amount of power.

It is common practice for a receiver to have its output impedance properly matched for one speaker. If more than one speaker is used, either in simple series or parallel connection, the resulting impedance mismatch will result in a loss of power and in extreme cases the quality may be damaged. It is, therefore, important that the proper connections be employed. There are two common methods of preserving the proper impedance match. The first makes use of

a stepdown transformer, while the second involves series parallel connection of the speakers. A table illustrating the use of a stepdown transformer such as the American type 933 output transformer follows:

No. of Speakers	Connection
1	directly on receiver output
2	series on receiver output
4	parallel on low side of 933 output transformer
8	parallel on low side of 933 output transformer
16	parallel on low side of 933 output transformer
32	parallel on low side of 933 output transformer with parallel aid connection of low impedance transformer coils.

The output transformer has two low impedance (secondary) windings. Normally, the two center secondary terminals should be strapped together and the two outside terminals connected to the loud speakers. When more than 20 speakers are used, it is desirable to connect the transformer secondaries in parallel. This is accomplished by strapping terminals 1 to 3 and 2 to 4, considering the secondary terminals as numbered left to right. The speakers are then connected in parallel across the outside terminals as before.

The second arrangement consists in connecting the speakers in series parallel according to the following table:

Total No. of Speakers	No. in Series	No. in Parallel
1	1	..
2	2	..
4	2	2
8	4	2
9	3	3
16	4	4
25	5	5
32	8	4

The speakers should be connected so that their combined impedance is equal to that of a single speaker as closely as possible. Such a condition cannot always be met, consequently it must be approximated as closely as possible.

When two or more speakers operated from a single receiver are placed close together, it is necessary that the polarity of the speakers be the same, which can be accomplished by seeing that the leads of both speakers to the receiver are reversed as needed until polarity is the same, otherwise there may be distortion at certain frequencies. The proper polarity can easily be determined by trial. Such procedure is called phasing and is necessary when two or more speakers are operated relatively close to each other.

Long leads should be avoided as much as possible and all speaker connections should be isolated from power lines and other sources of interference. When this is impractical, shielded cable should be used with the shield grounded and the cable wires should have negligible resistance compared to the total impedance of the loud speakers. In all cases of leads over 100 ft. in length, it is advisable to use a stepdown transformer out of the receiver into the cable. If the leads or cable is over 300 ft. in length, No. 18 or No. 20 wire should be employed.

Such systems are commonly used in the wiring of large apartments for centralized radio. If the number of speakers operated at remote points is great 50 watt and similar power tubes are naturally used to obtain high volume levels.

Will Service Stage a Comeback?

An Editorial

THERE is much speculation among keen observers with regard to service specialty organizations. Will these companies, which are operated to stand on their own feet, shortly assume a more important place in the retail sales picture?

Interest in this possibility is running high. A certain dealer, for example, is considering renting space adjacent to his present store for the sole purpose of developing a well equipped service and repair laboratory. This merchant has consistently made money in radio and associated side lines by closely following trends.

Obviously there always will be a very definite need for organizations equipped to handle general service and repairing efficiently. And even a casual inquiry indicates clearly that too few dealers are sufficiently well equipped to handle satisfactorily the service resulting from their own sales, let alone general work on "orphans," home-made outfits, and comparatively new equipment which, for some reason, cannot be taken back to its original retail outlet.

It is a curious fact that radio history repeats itself in regular cycles. Will the pendulum swing back to service? Many early engineering developments, which were prematurely smothered under an overwhelming influx of new ideas, have apparently laid dormant only to reappear, in slightly altered form, more impressive and important than at the time of their original debut. Consider push-pull amplification; speakers with their fields energized from an external source. Even the multi-grid tube. Are these new?

Radio Retailing's chief concern is whether or not dealers who have struggled for a place in the industry will have sufficient foresight and initiative to corral this returning business if service stages a comeback.

It's Your Market, Mr. Radio Dealer

(Continued from page 71)

control knob and a locking switch and key for the batteries. The set itself is bolted beneath the cowling.

The tubes are connected in series parallel, so as to accommodate them to the changing voltage of the automobile storage battery without danger of filament burn-outs. New tubes are not difficult to put in place.

A battery box for the B and C-batteries is mounted wherever convenient, out of reach of moisture and dirt. The antenna is placed in the roof, tacked to the cross-bows, or placed under the car chassis. The loud speaker is mounted under the cowl or on the roof of the car over the back seat, as preferred.

In addition to spark suppressors on the spark plug and coil, and by-pass condensers across the generator contacts and the starting motor, the set itself is completely shielded. Battery cables are carried in a shielding armor which prevents interference that is radiated from the ignition system on the car.

A wrench, drill and screw driver are the chief tools needed to install an automobile-radio set. There is no need to interfere with any fundamental mechanism of the car proper.

While any radio shop with parking space can do the job in front of its place of business, with downtown retailers it undoubtedly will be best to send the service man to the garage of the customer. While not absolutely necessary, it is advisable, say the manufacturers, to have at least one service man experienced in motor car mechanics. It is much easier to get this sort of talent than it is for the garage to employ a specialized radio man and keep him busy.

What of Its Future?

Further consideration, from the radio dealers' viewpoint, of this new opportunity leads to the question, "What of the permanence of this market? Here we have a brand new 'spring tonic'; will its effect be lasting?"

In the light of the millions of prospects for automobile-radio the most logical answer should be in the affirmative. Listing between \$75 and \$150, plus a worthwhile installation charge, automobile-radio offers an immediate market and one which should be contacted by the radio dealer before manufacturers of the better cars make radio standard equipment. It will be a number of years before popularly priced cars are fitted out with this accessory.

Those who have tried it agree that radio in the automobile is extremely desirable. It makes endurable the long, lonely drives and it lends color to the picnic party. From the legal standpoint any development tending to stimulate business need not fear the law makers.

The November, 1929, issue of *Radio Retailing*, for the first time in any radio magazine, published a thorough presentation of this proposition. Those who are seriously considering taking on automobile-radio should also review this preceding article.

Specific Cases of Enthusiasm

That the automobile-radio really has found favor with radio dealers and distributors is apparent from the following reports:

The Galvin Company, Chicago, co-operates with automobile dealers. The latter sees in this device an effective aid to the sale of cars.

A. G. Waite, manager of Erskine-Healy, Inc., Rochester, N. Y., is selling more sets than he can obtain from the manufacturer. Twenty-five in three weeks to be exact. So keen has been the interest of Ford owners that Mr. Waite has purchased a Ford car and equipped it with radio for the benefit of this class of prospects. *He tuned in Marconi's conversation, from his yacht in the Mediterranean, with Sarnoff, in New York—and sold a set in five minutes on the strength of this remarkable "ship-to-shore-to-auto" demonstration.*

"The installations and service are taken care of by one of our automotive ignition service stations in this city. From our experience, the practical man to install a motor car set is one who is familiar with automotive ignition problems. There is no reason why a radio service man, familiar also with automobile ignition systems, would not function equally well."

The 20th Century Radio Corp., Brooklyn, N. Y., has taken on a man to specialize in selling automobile-radio.

Walthal's, New York City, gave a special luncheon for newspaper men to enlist their interest in the cause of publicity for radio in motor cars. It is the intention of this well known concern to push automobile-radio intensively.

To obtain conclusive evidence of the thinking of dealers on this subject, *Radio Retailing* recently circularized 1,000 radio merchants. But 224 stated that they would not be interested in automobile-radio, while 572 said that they would merchandise a product of this nature if it were properly designed and when they were convinced that it would operate satisfactorily.

Telephone Tribulations

By P. C. PEUSER
Radio-Music Dealer, Scranton, Pa.

(Ding-a-ling; ding-a-ling)

Dealer:

Hello, hello! Hello, hello!

Yes, yes; don't shout.

What do I hear you say?

Come take the radio out?

Customer:

Last night I heard that funny noise,

Same as the one we had;

My husband took the set apart,

And found three tubes were bad.

He:

That noise was coming through
the air;

Last night the waves were light.

We'll send our man to check it up,

I'm sure the set's all right.

She:

Oh, no; oh, no!

Come take it out;

I'm going to try the Razzle set

I've heard so much about.

He:

You called and were so very nice,

We took you at your word;

You said you liked our Roozle set

The best you ever heard.

She:

You are mistaken, my dear man;

I never said I'd buy it;

You have contusions of the brain,

I only said I'd try it.

He: Hello, hell —; % ? / " : — !

Get this FREE SALES TRAINING

Now!

Hundreds have proved its value. It can mean extra money to you, too.

BE a sales expert. Earn more than you ever earned before. Make sure of a bigger future. It's easy to be prosperous if you know the secrets of master salesmen.

Tuition and transportation free!

Without paying one cent for tuition, you can graduate from one of the country's greatest sales schools. You can learn sales secrets direct from famous sales experts. The Majestic Sales School gives you complete training in every branch of selling. It opens the way to big success in any job—any business you ever enter.

You can have this wonderful training without interfering with your present work. It takes only one week. There is no tuition cost. Even your transportation is free, under a special offer made by your Majestic distributor.

Act now—Earn more this fall

Plan now to get this free sales training during summer months. Get set for big fall sales. Write your Majestic distributor for details of his free transportation offer.

Or address F. A. Delano, Majestic Sales School, Lake Shore Athletic Club, Chicago, for information on the training offered.



The beautiful Lake Shore Athletic Club, Chicago, where the Majestic Sales School is located. All club facilities are yours during your training.

GRIGSBY - GRUNOW COMPANY, CHICAGO, U. S. A.

Majestic

RADIO

At the Atlantic City Radio Show, drop in at Majestic headquarters—the second, third and fourth floors of the Ambassador Hotel. Visit the Majestic exhibit, Section D, Booths 16, 17, 18, 19.

Sold! (Continued from page 77)

ing is bare. Even the electric bulbs are unshielded to produce the correct auction atmosphere. The crowd is made up of people from all walks of life.

The auction is conducted along definite lines unless someone requests an item that is on view. The auctioneer starts off possibly with some back numbers of magazines on which he accepts bids then, generously, decides to hand them out gratis. He condenses the crowd by walking to the rear of the room while distributing these magazines. This permits more people to enter.

He then proceeds to warm up the crowd by offering some inexpensive novelties for sale. He delivers a fifty dollar oration on the merits of one of these items and succeeds in getting a final twenty-five cent bid. He furnishes as many as the crowd desires at this price. An old trade-in set is then put on the block. The auctioneer removes the mechanism from its cabinet by destroying the latter with his hammer. This action produces many laughs. He gets several bids and then offers to flip a coin to decide if the last bidder is to get it for nothing or double the price. The auctioneer wins the toss but nevertheless gives the last bidder the set free of charge.

The crowd now has been treated to both comedy and philanthropy. They have tasted the pleasure of getting. Now it's their turn to give and get. The auction is in full swing. More expensive accessories are offered until the point is reached when a *real expensive radio set* is put on the block. The spotlight is turned on it. Many explanations of its features are given. Apologies for all extraneous noises are made while the set is demonstrated.

After the bidding has gone to the point where no further bid can be obtained the auctioneer decides to throw in a set of tubes. This helps bidding materially. The hammer goes down for the third and last time. The set is sold. The auctioneer inquires as to who will purchase set number two at the same price. In this manner

many sets are disposed of. Then the cycle of events starts over again.

When an auctioneer fails to get a bid he sometimes resorts to what is termed "Chinese Auction." He suggests a price at which he would sell the article. If he gets no response he drops the price to successive lower figures until he gets a buyer.

Most radio auction stores conduct a retail business in other parts of the establishment. It is surprising to learn of the volume of business done in the retail department. The auctioneers make it their business in one way or another to call the crowd's attention to the existence of such a department. All sets sold at auction may be tested in the retail department. Adept salesmen are at hand to recommend higher priced sets to the customer as the test goes on.

Another point of interest might be mentioned here in passing, namely the use made of the microphone by these auction houses. The mike is suspended from the ceiling and located over the block. The auctioneer's voice is carried clearly to all parts of the store and to a speaker in front of the store. The passing throngs are attracted by the flowing verbiage permeating the atmosphere already overlaid with broadcast traffic.

With the advent of television we may some day hear and see the auctioneers in our own homes and send in our bids by radio.

So much for the methods employed by the average radio auction house. The writer leaves it to the judgment of the reader as to whether or not such methods are, strictly speaking, unethical. He also leaves it to the merchandising "sense" of the radio retailer to figure out any local application or applications to his own business, based on the psychology of the mob, as above exemplified.

There are times and circumstances when certain applications of the "radio auction" plan might seem to have merit when used in smaller communities and if staged with a degree of dignity and sincerity which is now conspicuous by its absence on Cortlandt Street, New York.

Outstanding Business of Southern Distributor Is Built on These Eight Policies

THE Braid Electric Company, Memphis and Nashville, Tenn., is reorganized as one of the largest and most successful radio distributors in the entire South. It recently prepared a promotional circular which credited eight specific policies for this attainment. This "credo" is the more interesting because it is in line with the recommendations of leading economists. Here they are:

1. **WE SELL STRICTLY AT WHOLESALE.** Competing in no sense with our dealers. No courtesy sales. Absolutely protecting the retailer.

2. **RADIO AND SPECIALTIES** a main business, not a side line. Pushing—twelve months in the year. Every salesman a merchandising specialist—not an "order taker." Limited lines. Concentrated energy. Doing our best for the manufacturers whose lines we represent.

3. **AMPLE FINANCED.** We discount our bills. Always have the merchandise because factories *want* to ship our orders.

4. **MOST COMPLETE SERVICE DEPARTMENT** in Memphis and Nashville operated by competent service

men—backing up our dealers and our manufacturers in their problems. We don't sell you and then forget you.

5. **CREATING CONSUMER ACCEPTANCE** for the products we sell—through consistent advertising and publicity. Consumers respect our guaranty of quality.

6. **BUILDING UP THE DEALER**—by working with and through a restricted number of accounts in each section. If *radio* is really a business and *not* a side line then the number of retailers should be limited. We honestly and sincerely try to help our dealers.

7. **INTENSIVE COVERAGE FOR THE MANUFACTURER.** Every town carefully covered. No open territory. Every hamlet, every home, in our territory must know of our products—must be asked to buy.

8. **MODERN MERCHANDISING.** Alert and on the watch for new items—for changes in methods that now come so fast. Our organization is flexible so we can adapt ourselves to these changes, pass them along in such a way that the ultimate consumers get the benefit and our dealers, and ourselves, the *profit*.



A Presentation of the New
GENERAL MOTORS RADIO
with Tone Selector

AT THE R. M. A. CONVENTION

Exhibit Space A 40 - 41 - 42 - 43
Demonstration Room No. CC7 at the
Atlantic City Auditorium , , , ,

ALSO AT THE PERMANENT
EXHIBIT OF GENERAL MOTORS
PRODUCTS, STEEL PIER

Executives of the General Motors Radio Corporation will be present at these exhibits to discuss features of the exclusive franchise plan with prospective dealers

GENERAL MOTORS RADIO CORPORATION, DAYTON, OHIO

S T A N D A R D O F Q U A L I T Y

Give
a
Thought
to
BROADCASTING

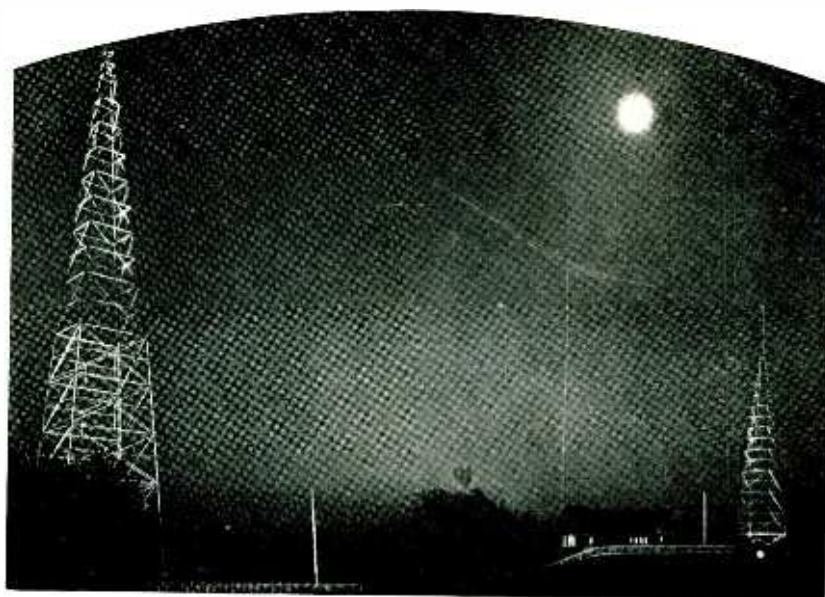

Summer plans of National and Columbia

Live News
and a Full Schedule
N. B. C.

SPECIAL TO "RADIO RETAILING"—NBC is now better equipped to handle timely broadcasts than ever before. It has created a special department for this purpose headed by William Burke Miller, Pulitzer Prize journalist.

In addition, there will be an extensive assortment of special broadcasts in connection with current events and important athletic contest descriptions.

For the first time in the history of broadcasting, commercial or sponsored broadcasts are on the increase for the summer season instead of on the wane. Available time on NBC networks is being snapped up as soon as it becomes available with the result that hot-weather programs this year will be equal, if not superior, to winter standards. High-power will mean good reception.

Practically all of the big commercial features heard weekly through NBC networks are retaining the same talent throughout the summer, so that a high standard of broadcast entertainment is guaranteed.

The grand opera season has ended in radio just as in the opera houses of the country. The orchestra and soloists, however, will continue to be heard through NBC networks in a substitute presentation called "Great Love Scenes in Music." Also, last year's features known as "In the Time of Roses" will return to the air this summer.

Give a thought to broadcasting these summer days.

Keep in touch with what's ahead in the world of worthwhile programs, and with other station news usable with radio prospects and customers.

And what a wonderful audio feast is now in the making—for set owners to enjoy during the next five months. Read what our two great broadcasting institutions have to say on this subject, in their special messages to the readers of *Radio Retailing*.

Gay Programs
for Summer Months
COLUMBIA

SPECIAL TO "RADIO RETAILING"—Gay programs to suit the mood of summer listeners will be the aim of the Columbia Broadcasting System. All the leading sporting events and important news "breaks" will be reported over general hook-ups. Out-of-door concerts will be added to Columbia's schedule of Saturday afternoon and evening events.

Radio programs are no longer seasonal as far as effort put upon them and quality maintained are concerned. Radio is no longer dependent upon the casual artist. Our staff is available year in and year out, and we start on a basis of assured material.

For the past four years the increase in summer business has gone forward with remarkable rapidity.

Plenty of dance music will be available from Columbia stations throughout the summer. Orchestras from seaside resorts and from prominent hotels will supply the major part of this entertainment.

This year there has been no appreciable summer recession from broadcasting by our advertisers and a number of new contracts have been signed. Because Columbia has added to its chain of stations WPG, at Atlantic City, station WLBZ, at Bangor, Me., and WBCM, at Bay City, Mich., summer reception will be vastly improved in these vacation areas.

To the Members of the
Radio Manufacturers Association
and to all
Visiting Jobbers, Dealers and Guests
attending the
Fourth Annual Trade Show and Sixth Annual Convention
at Atlantic City

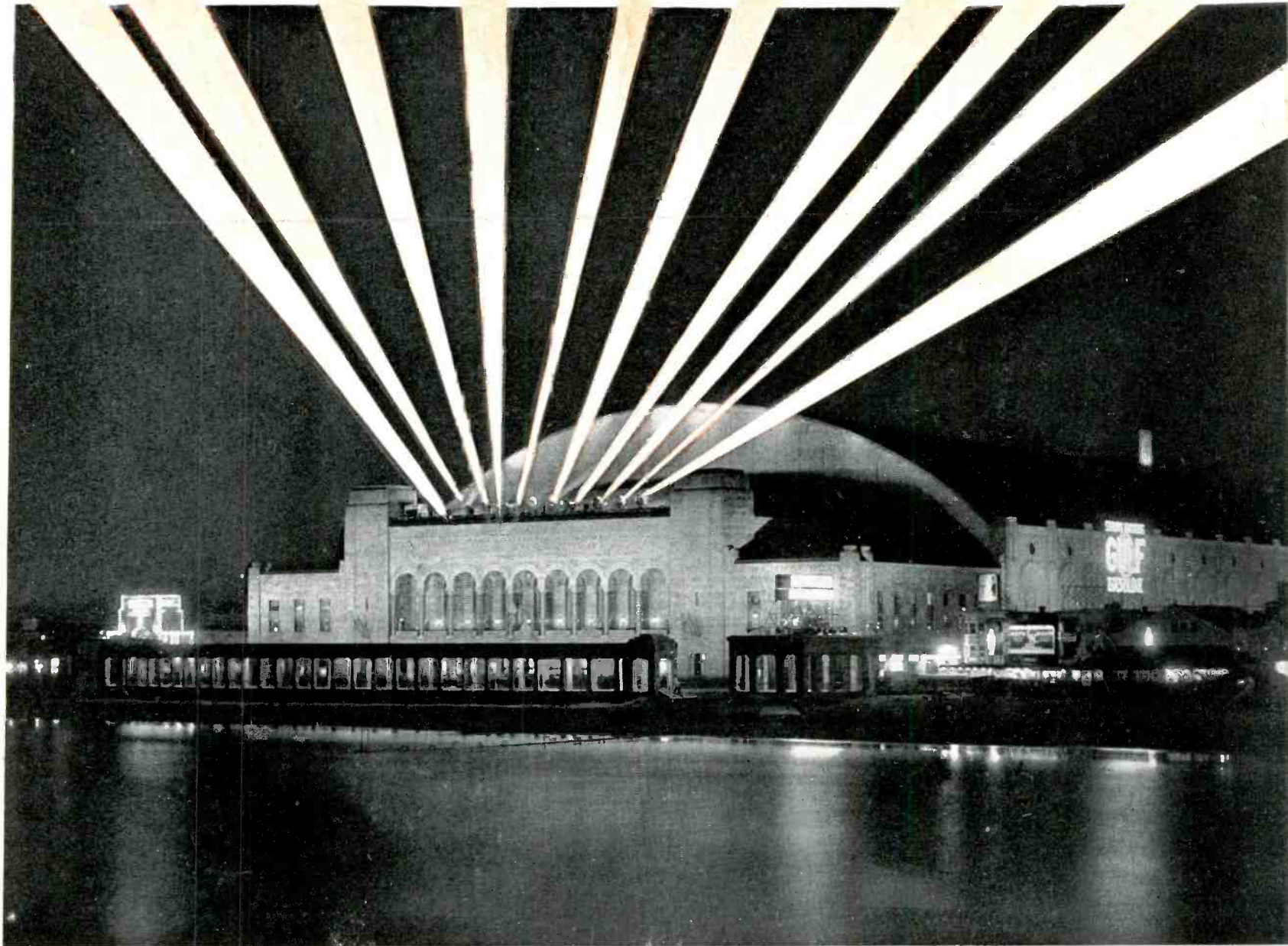

Radio Retailing
Extends Its Heartiest Greetings

New

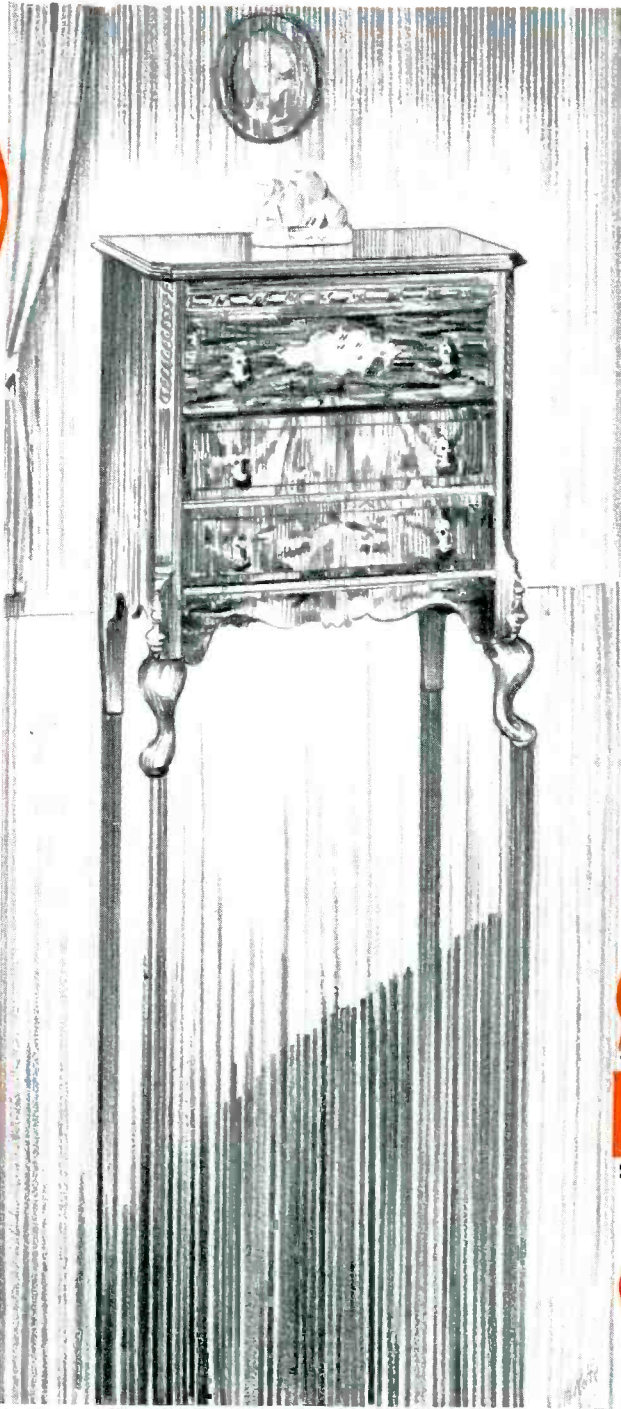

Body

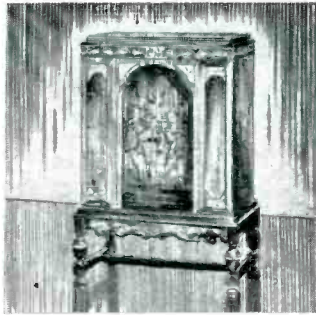

Radio Master

SOURCE OF
DISTINGUISHED
RADIO FURNITURE

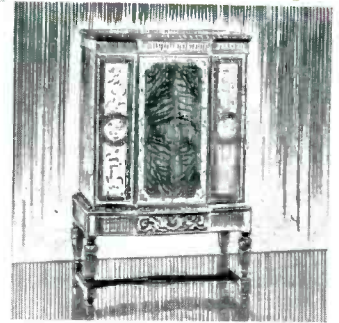

RADIO MASTER ~ THE SETTING

SEE RADIO MASTER FURNITURE OF DISTINCTION AT THE TRADE SHOW

REMEMBER the funny looking automobiles made prior to 1921?—back in the days when manufacturers looked on a body as only something to house a mechanism.

And remember the stimulus auto sales received when manufacturers made really beautiful bodies. A style element was introduced which continuously stimulated sales.

Radio is at the stage today the auto makers and sellers were in 1920. Almost all radios sound so well that it is difficult to sell one against the other.

But cabinets—that is a different story. Very few cabinets adequately distinguish the magnificent instruments they house. The eye can find little difference between the external appearance of a \$100 set and a \$500 set.

Lines

WOMEN BUYERS

Another thing—women are becoming an increasingly important factor in radio sales. And you know how women are about appearance. True, they stood for a lot, while radio was a novelty. But it is no longer a novelty, and the ladies are looking at them as furniture—sometimes askance.

It would be interesting to know how many sales have been lost because the lady of the house didn't like the looks of the set offered—many, without doubt.

All people want any furniture they buy better than that they have. And a radio, too, often isn't.

RADIO MASTER

Source of Distinguished Radio Furniture

Radio Master does not build ordinary cabinets—

But cabinets of such rare loveliness that they greatly enhance the instrument they house.

Splendid design by one of America's foremost in furniture designers—beautiful woods, some of them rare and costly—go hand in hand with cabinet work of matchless excellence.

Result—cabinets that make sets look their worth, and return enhanced profit to maker and seller.

Let us show you what can be done in beautifying sets.

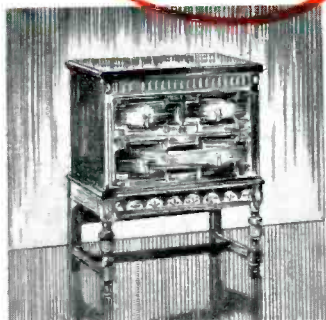

RADIO MASTER CORP., BAY CITY, MICH.

BEAUTIFUL FOR ANY RADIO

MORE RAY-O-VAC LEADERS

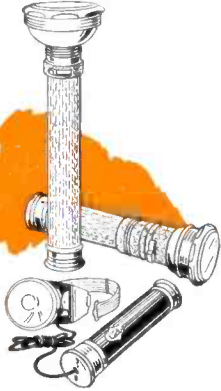

There is a Ray-O-Vac Flashlight for every conceivable flashlight need.



Ray-O-Vac Radio Batteries for all purposes. Longer life without additional cost.



Ray-O-Vac Licensed and Guaranteed Radio Tubes make good programs better.



Ray-O-Vac Telephone, Ignition, and Flashlight Batteries are leaders wherever you find them.

See the Ray-O-Vac exhibit at the R. M. A. Convention—Booth 7, Section C.



Ray-O-Vac leadership again!

Ray-O-Vac has pioneered the way in battery power for motor car radio. The new Ray-O-Vac Autoradio "B" is the acknowledged leader of the field!

Now the Ray-O-Vac Autoradio "B" Battery! Specially designed and built for this one purpose—tested and proved in the hardest, most strenuous series of experiments that engineering skill could devise—built to withstand all the shocks and strains of hard driving—

Moisture proof

Vibration proof

Weather proof

Literature on the Ray-O-Vac Autoradio "B" is ready. Ask your jobber about it.

FRENCH BATTERY COMPANY

Madison, Wisconsin

General Sales Office: 20 North Wacker Drive, Chicago

Makers also of

RAY-O-VAC

"A", "B", and "C" Radio Batteries, Aircraft, Ignition, Telephone, and Flashlight Batteries; Ray-O-Vac Standard and Rotomatic Flashlights; and Ray-O-Vac Radio Tubes.

Going Over Big!

STIKTAPE AERIAL is a scientific, low resistance alloy, being non-corrosive and very sensitive to broadcast reception. This alloy was developed in our own laboratories for this particular purpose and does not contain any tin or lead.

Coated with self-insulating, adhesive rubber, it sticks to anything, anywhere.

STIKTAPE AERIAL eliminates lightning hazard.

STIKTAPE AERIAL eliminates fire hazard.

STIKTAPE AERIAL can be easily hidden from view behind picture moulding, baseboard, or under carpet or rug without loss of efficiency. Simply hook the clip under or through aerial binding post. Unroll tape and stick in place. No trouble, no effort, and you have a real aerial—NOT A SUBSTITUTE. STIKTAPE AERIAL is no substitute, and there is no substitute for STIKTAPE AERIAL.

This modern, new aerial has done more toward taking the grief out of radio set installation than any other one item that has as yet entered the industry. STIKTAPE AERIAL positively does cut down dealer overhead expense.

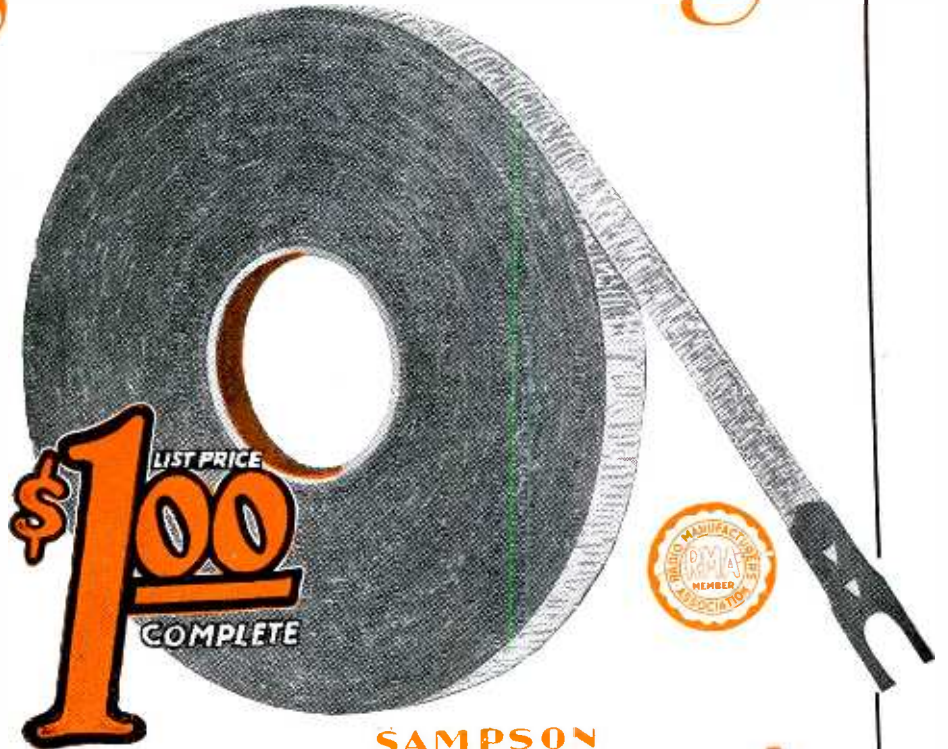

SAMPSON
STIKTAPE AERIAL
INSTANTLY INSTALLED

Five Hundred Jobbers Can't Be Wrong

Over two hundred thousand STIKTAPE AERIALS are already in use and these have been supplied to dealers throughout the United States by over 500 of the leading jobbers of the industry (all since the first of this year). Repeat orders show us that once you get used to STIKTAPE AERIAL, you will not use anything else.

STIKTAPE AERIAL overnight has been universally accepted as the standard for radio set installation and its sales volume this year will run into millions.

Find out for yourself the real merits of STIKTAPE AERIAL. Jobbers, order standard case lots, one gross, packed twelve dealer display cartons, twelve in.

MAIL COUPON TODAY



Dealers! Send check or money order for \$7.20 and we will ship you one full dealer display carton as illustrated, containing twelve complete aerials, also containing one counter

display card and descriptive literature. Your money will be refunded if you are not completely satisfied. All orders will be credited to your local jobber, so please furnish us with his name.

Sampson Industries, Inc.

9 Rutger St., St. Louis, Mo.

MEMBER—R.M.A.

Sampson Industries, Inc.,
9 Rutger Street,
St. Louis, Missouri.

Enclosed find check, or P. O. money order amounting to \$... for which send me...
STIKTAPE AERIALS.

Name

Address

Name and Address of Local Jobber.....

● CeCo Announces a Campaign that Trebles

THE REASON WHY

“75% of all radio sets in operation are not playing properly because of one or more defective tubes. Thus, a market exists today for 10,000,000 extra replacement tubes . . . providing the set owners can be induced to buy. A fair and attractive offer is necessary to open this tremendous field.

On June 16th, CeCo will stimulate this profitable market by announcing the ‘Better Or You Don’t Pay’ campaign. The sales possibilities offered by this plan are obvious. To every radio dealer, I say ‘Here’s your chance—wire or write me today.’”

FIRST AGAIN!

1926 Pioneered type “H” detector tube.

1928 Developed and introduced the A.C. screen grid tube.

1930 Pioneered and developed the A.C. Pentode and other tubes for scientific purposes.

Now—The first manufacturer to demonstrate the quality of his product by a “Money Back Guarantee.”

IN six years, CeCo has outgrown two sizable factories. During the same period, annual tube sales have jumped from 300,000 to 3,970,000 in 1929.

The CeCo million dollar factory is the largest in the world, devoted to the manufacture of radio tubes exclusively . . . it covers an area of 3½ acres and contains a \$200,000 testing laboratory. 1,000 employees and 42 expert engineers form the staff. Over 10,000,000 CeCo Tubes are in use today.



Ernest Kauer
PRESIDENT,
CECO MANUFACTURING CO., INC.
PROVIDENCE, R. I.

● CeCo Tubes are licensed under patents and applications of Radio Corporation of America, and affiliated companies.

They're Better or You Don't Pay! -

MEET US AT THE R. M. A. CONVENTION IN BOOTHS 11 AND 12,

Startling New Merchandising Radio Tube Sales . . .

. . . IT BREAKS

Monday June 16th

CeCo builds the finest tubes made . . . we intend the public shall know it . . . furthermore, radio owners shall prove it themselves by actual test. In this convincing campaign, CeCo will openly demonstrate the superiority of its 1930 line.

THIS IS CECO'S NEW PLAN . . .

First, three weeks of "teaser" advertising to stimulate interest. Then, on June 16th, broadcasting from 22 Columbia Stations and announcements on 10,000 dealers' windows will deliver this dramatic message to millions of set owners . . . CECO RADIO TUBES INSURE BETTER RECEPTION . . . They're Better . . . or You Don't Pay!



Miniature reproduction of dealer's final window announcement

DEALERS, that's the most revolutionary idea in radio merchandising . . . and the most profitable, too. The public will buy because CeCo offers a fair and square deal . . . and the dealer—he's protected, too, by CeCo's 100% replacement policy. Quality tubes make this offer possible.

Obviously, this big story cannot all be told in a single advertisement. A 12-page portfolio on the new campaign has been prepared. It tells graphically how the plan works . . . how the dealer should tie-in . . . it contains the necessary window streamers for display purposes. It's yours for the asking. Mail your request now. CeCo Mfg. Co., Inc., Providence, R. I.

CeCo

1930 RADIO TUBES

SECTION B, AUDITORIUM—CECO HEADQUARTERS, HOTEL AMBASSADOR

DAYRAD INSTRUMENTS insure greater profits in your Service Department

The visits of your service men to the homes of radio owners bring orders for new tubes, better speakers and other radio merchandise. There are many reasons why your Service Men should be equipped with DayRad Instruments for testing all makes of radio sets and tubes. We mention here the three dominant reasons why—

- (1) Because with DayRad they can make every conceivable test—
- (2) Because all DayRad Instruments are simple, accurate and up to the minute—
- (3) Because they cost less than other reliable instruments for the purpose—

Measure DayRad by the scope of service rendered, compare them in every detail with other types at higher price; the weight of evidence is all in favor of DayRad. This is true of DayRad Set Analyzers, Tube Checkers, Ohmmeters, the new DayRad Automobile Set Analyzer, the new DayRad Oscillator-Output Meter-Grid Dip Meter Unit, and the DayRad Test Panel.

ALL THESE DAYRAD INSTRUMENTS WILL BE ON VIEW AT R.M.A. TRADE SHOW, ATLANTIC CITY, JUNE 2-6

If, for any reason, you do not attend the Show, write now to Dayton, address below, for descriptive circulars.



DAYRAD AUTOMOBILE RADIO SET ANALYZER

Voltmeter resistance 5000 ohms per volt.
Six D.C. voltage scales—0-1-5-10-20-100-200.
Milliammeter scales—0-.4-10-20.
One selector switch.
Double Ohmmeter range.
Self-contained continuity tests.
All ranges available for external use.

DEALERS NET PRICE \$66.00

DAYRAD RADIO SET ANALYZER (A.C.-D.C.)

One selector switch.
Meters (Jewell or Weston).
A.C. Volts—0-4-8-160-800.
D.C. Volts—0-20-100-200-600.
Resistance 1000 ohms per volt.
D.C. Mills.—0-20-100.
Separate tests on 280 rectifier plates.
Self-contained continuity tests.
Resistance and capacity tests.
All ranges available for external use.

DEALERS NET PRICE \$58.50



THE DAYRAD GRID DIP METER

For aligning and neutralizing radio frequency circuits either individually or overall. Visual indications on out-put meter. No external batteries required. Operates from 110 volts, 60 cycle line. Light and portable.

Prices on other voltages and frequencies on request

DEALERS NET PRICE \$37.50

THE DAYRAD TUBE CHECKER, Type B

Operates from 110 volt, 60 cycle, A.C. Line.
No rheostats—no adapters.
Tests all standard radio tubes as well as Kellogg, Cardon.
Wired for pentode testing.
Indications for good, fair and poor tubes engraved on panel.
Simple—Accurate—Complete.

DEALERS NET PRICE \$22.75

Available in other frequencies and voltages.



THE DAYRAD OHMMETER

Designed especially for measurement of resistors commonly used in Radio power packs, grid suppressors, bias resistors, etc. The indicating meter is a highly sensitive galvanometer. The dial is easily readable and the resistance under test can be instantly determined. Has self-contained continuity test.

DEALERS NET PRICE \$25.00

All DayRad Instruments are equipped with D'Arsonval movement meters.



DayRad's Location at Atlantic City

Visitors to the R.M.A. Trade Show will be cordially welcomed at our two locations.

Be sure to see the complete DayRad Line of Service Instruments including Tube Checkers, Counter Checker, Set Analyzers, Ohmmeters, Grid Dip Meters, Test Panels and Portable Combinations.

BOOTH No. C-29, Demonstration Room No. 10.

THE RADIO PRODUCTS CO.

Fifth and Norwood.

Write Department R.

Dayton, Ohio



MERSHON

ELECTROLYTIC CONDENSER



Single anode,
inverted type

Self-Healing

The Pioneer

First patented in 1911. First publicly displayed for use in radio receivers in 1921—and in continuous development and production since then—the Mershon Condenser is unquestionably the pioneer practical, successful electrolytic condenser. And by virtue of the vast experience and research behind it, it is today years ahead of any other condenser in the field. It was first to provide high capacity in small space, to afford absolute freedom from puncture and to embody a service life measured in years, rather than weeks or months.

Multiple anode, up-right type



Dealers and Service Men

will find in the Mershon Condenser a new source of profitable business. They provide economical replacements in damaged power packs and trouble-free operation in custom-made receivers and transmitters. Mershon Condensers can be had in self-contained units of 8 to 72 MFD capacity—saving at least half the space and one-quarter the cost of equivalent paper capacity. They can be kept for an indefinite period without deterioration—and because of their self-healing feature they make instant appeal to amateurs, repair men and service men.

The new booklet "Puncture-Proof Filter Condensers" describes the Mershon Condenser and shows its profit-making possibilities for you.

THE
AMRAD CORPORATION
230 College Avenue
MEDFORD HILLSIDE MASS.

"We'll See You At
Atlantic City"
Auditorium Booth C-1
June 2nd to 6th

Browning-Drake
Comes Through
With Flying Colors!

Model 70—A beauty! Made of material far heavier than heretofore used in radio cabinets. Note the artistic simplicity of the dial opening. Automatic call-letter tuning. Automatic volume control. 4 screen-grid tubes. Equalized band-pass filter. Antennaless reception. \$159.50
Model 70-R—(with remote control) \$229.50



BROWNING-DRAKE **dependability** has now been proved.

The policy of the famous Browning-Drake laboratory—famous since the earliest pioneer days of radio—comes through radio's recent storm unchanged, flags flying, stronger than ever.

Quality... superior equipment... honest craftsmanship—with quantity limited so that every set can be our best.

As a practical dealer we believe you'll say: "What a difference if all radio had only followed the policy Browning-Drake has been setting since the pioneer days!"

Into the 1931 season Browning-Drake now sweeps with the finest instruments ever developed in its famous laboratory.

Again... quantity limited so that every set can be absolutely assured as our very best.

Again... superior craftsmanship—a limited number of the best jobbers, best dealers—those jobbers and dealers who prefer to attract the class of trade that appreciates the finer things of life.

See the new Browning-Drake models at Booth D-13 in the Auditorium, at the Radio Show in Atlantic City. Demonstration space at Hotel Jefferson.

BOOTH D13

The latest in modern improvements and conveniences . . . now further improved. And beauty supreme!

In the new Browning-Drake 70 series . . . automatic call-letter tuning for the unprecedented number of 125 stations!

In the same distinguished series . . . automatic volume control—an end to the annoyance of distant and semi-distant stations fading out, and from the loud blare of local stations too near. ♦ ♦ ♦ ♦ ♦

By adding a fourth screen-grid tube our laboratory now sets a new standard of leadership in tone quality, unstrained volume, and the final harnessing of distance. There is also the proved efficiency of the equalized band-pass filter; of antennaless reception from light sockets, and all the other lesser features which can now be combined to make fine radio a little finer. ♦ ♦

In models 70-R and 71-R . . . remote control, the last word in convenience and luxurious ease of operation.

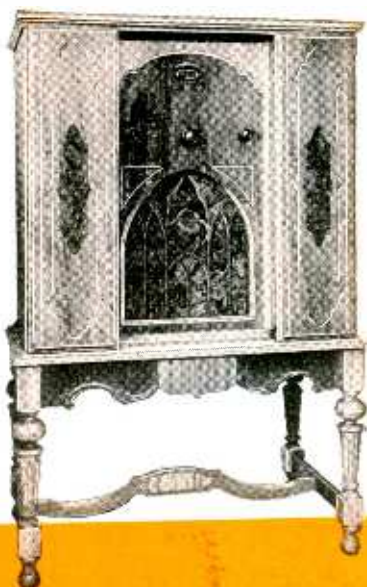

Model 71—Console De Luxe—a high-boy beautifully proportioned and constructed of the finest materials—the last word in impressive radio quality. Large-size speaker . . . \$192.50
Model 71-R—(with remote control) ♦ ♦ ♦ ♦ ♦ \$262.50

All prices listed do not include tubes.

The Browning-Drake (60 series) offers maximum radio quality at a popular price. Semi-automatic tuning (47 stations listed by name); triple screen-grid; 5 tuned circuits; push-pull audio; electrolytic trouble-proof condenser. ♦ ♦ ♦ ♦ ♦ \$129.50



For a limited number of jobbers and dealers who have learned that the set to get behind is the set which "walks away with the demonstration" and then gives service-free satisfaction . . . there's a wonderful season ahead in Browning-Drake sets! But don't wait . . . let's get in touch right now!

Table model—(Model 68) dignified striped mahogany with satin Duco finish. ♦ ♦ ♦ ♦ ♦ \$95



Send for booklet RR. BROWNING-DRAKE CORPORATION, 224 Calvary Street, Waltham, Mass.

BROWNING-DRAKE SCREEN-GRID **RADIO**

A Pioneer Manufacturer of Quality Radio Apparatus

OVER 1,500,000 PEOPLE LISTEN-IN ON BROWNING-DRAKE SETS

Demonstration Exhibit at Ambassador Hotel

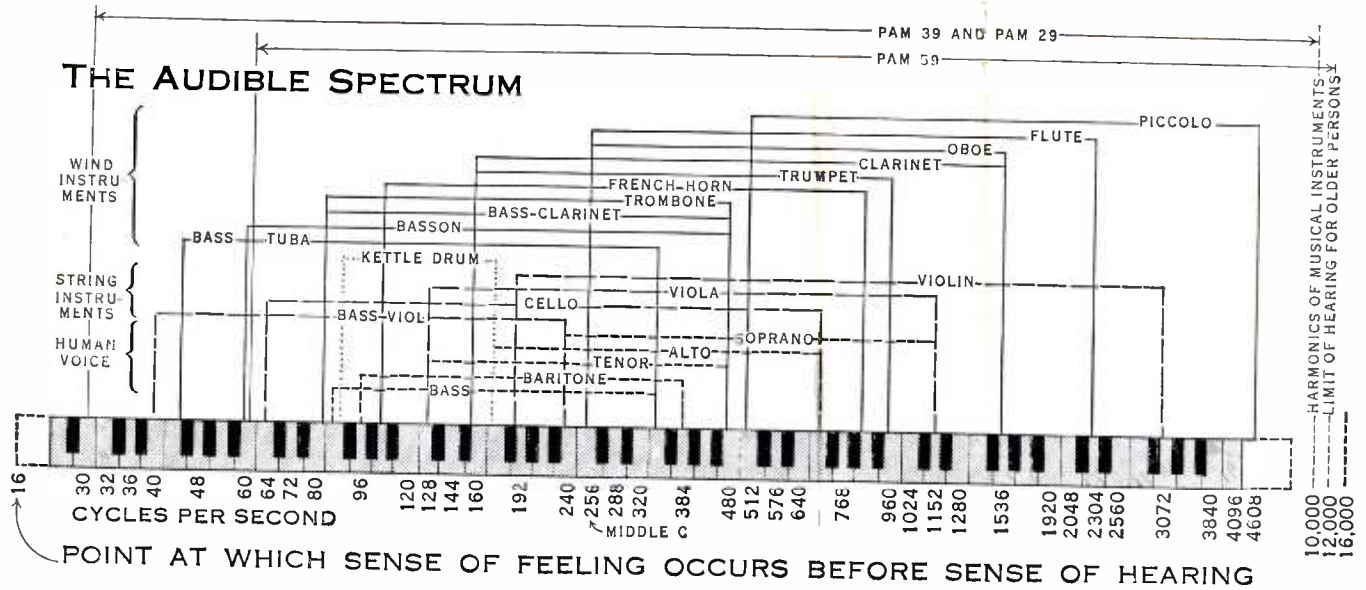

The ranges of the new PAM amplifiers are considerably greater on both ends of the audible spectrum than shown above. The ranges shown are those over which the new PAMs will amplify with discrimination noticeable to the human ear.

EQUAL Amplification over entire musical and vocal scale

You will be surprised at the new brilliance of tone due to equal amplification of harmonics as well as fundamentals. The high notes and the rich deep low ones come in as never before with perfect fidelity. Nothing is there except *undiscriminating* amplification of original signal.

Greater compactness, improved appearance, less weight, longer life, two values of output impedance, and hum voltage cut to one-fourth are but a few of the many features built into these new PAMs which are the products of a company nearly half a century old with years of experience in amplifier construction and with financial stability to insure that your PAM amplifier will not be an orphan.

The NEW Samson PAMs will be demonstrated at the Hotel Ambassador, Atlantic City, during the Radio Trade Show. Visit Booth No. B10 in the Auditorium.

For those who are not fortunate enough to hear the NEW PAMs at the Show, we have prepared an attractive folder No. RR 20, called "More Power per Dollar," descriptive of these NEW PAMs. This folder will be sent promptly on request.

Main Office:
Canton, Mass.

Samson Electric Co.

MANUFACTURERS SINCE 1882

MEMBER
RMA

Factories: Canton and
Watertown, Mass.

GOOD NEWS

**GOLD SEAL
ELECTRICAL COMPANY, INC.**
250 PARK AVENUE
NEW YORK

SOLE ADDRESS: GOSWICK
BOXES, WESTERN UNION,
BENTLEY AND A. & C.



The H. K. McCann Co
285 Madison Ave., New York City
Gentlemen:

Here is the message we would like you to put over:
What Gold Seal needs in particular, is to have the public understand that we are building a new tube - a better tube, and perhaps it would be good advertising to have them know that all our tubes are now being branded on the base and dated as well, thus assuring them of new and fresh stock at all times.

This summer it will be highly important that we sell our trade on new production, especially in view of the fact that prices in the past, and even at the present time, are cut to pieces and the public should know that the new 1930 production of Gold Seal tubes, which is branded and dated, is the highest quality product on the market today and unconditionally guaranteed for ninety days.

This should be very good news for our dealers and jobbers throughout the country.

Sincerely yours,
W. E. Duff
W. E. Duff,
Treasurer.

GOLD SEAL ELECTRICAL COMPANY, INC.

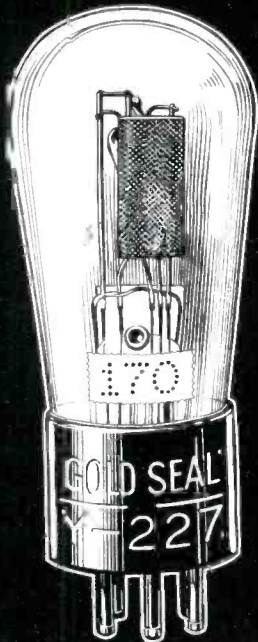

GOLD SEAL ELECTRICAL CO., Inc.
Dept. 10-A, 250 Park Ave., New York

I'm ready to be shown, if you can help me to make money in the tube business. Send me your dealer jobber proposition.

Name

Address



Beauty

This year Kennedy strikes a dominant note in furniture—expressively beautiful woods, warmly toned and voguishly fashioned in rich designs . . . The Life-Tone of Kennedy is still further enhanced by the new Kennedy SELECTONE which permits true regulation of tone timbre to please the ear of every listener . . . Ask for complete details of The Royalty of Radio.

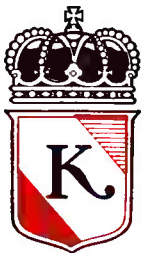

1911

1930

BE SURE

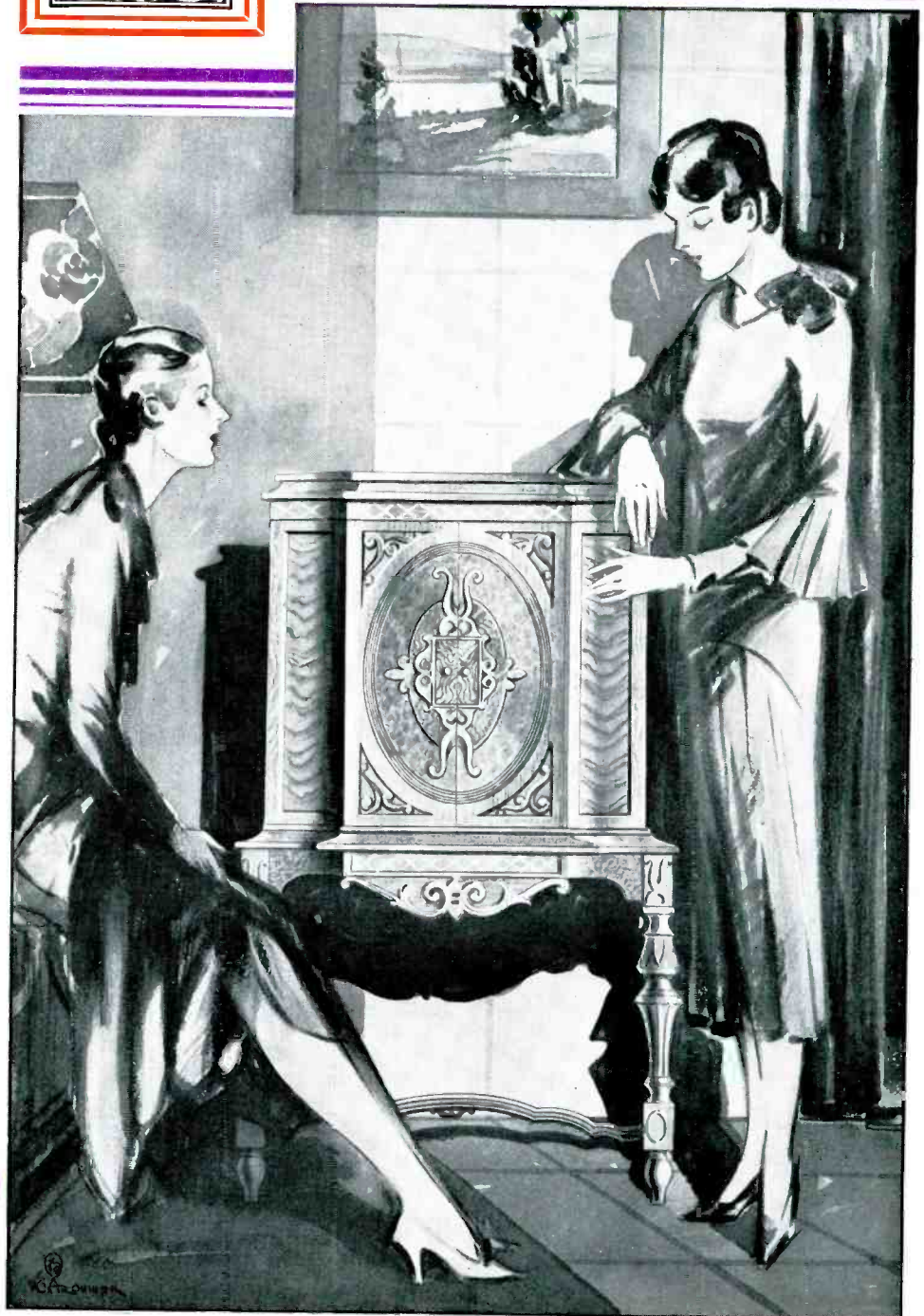

to Visit the KENNEDY Exhibit, Section B, Booths 20 and 21 . . . Demonstrations at Section AA, Room 11 and 12 . . . Special Demonstrations and Exhibits at The Royalty of Radio Headquarters, RITZ-CARLTON Hotel.

Cabinetry that Captures the Eye Life-Tone that Charms the Ear

BEAUTY! . . . A dynamic selling force, that instantly appeals to the most subtle and powerful buying influence in the world—*Woman*, purchasing agent for the American home! With one dashing stroke Kennedy this year adds a new and modish touch in furniture elegance . . . creating the positive impression that leads to greater sales!

LIFE-TONE! To describe the brilliant performance of the Royalty of Radio would merely add words to facts that already speak for themselves . . . Here, too, Kennedy leads again! Quality *added* to Quality—the Life-Tone of Radio is re-presented in all the liquid fullness of life itself!

MERCHANDISING STABILITY! Doubly secured by the financial strength and vigorous sponsorship of leaders in industry, the Kennedy-originated *Protective Merchandising Policy* is still in full force. It secures for every dealer the full reward of individual effort—the paved highway leading directly to substantial growth and profitable business.

DEALERS, DISTRIBUTORS! Look forward to this source of greater profit . . . Benefit by all the advantages that Kennedy offers — the eye appeal of modish beauty . . . the matchless brilliance of radio Life-Tone . . . prices that tempt the purse of every buyer . . . a sound protective policy forcefully carried out . . . full merchandising co-operation . . . assured stability and the vigorous sponsorship of leaders in radio and industry . . . Colin B. Kennedy Corporation, South Bend, Indiana.



KENNEDY

The Royalty of Radio

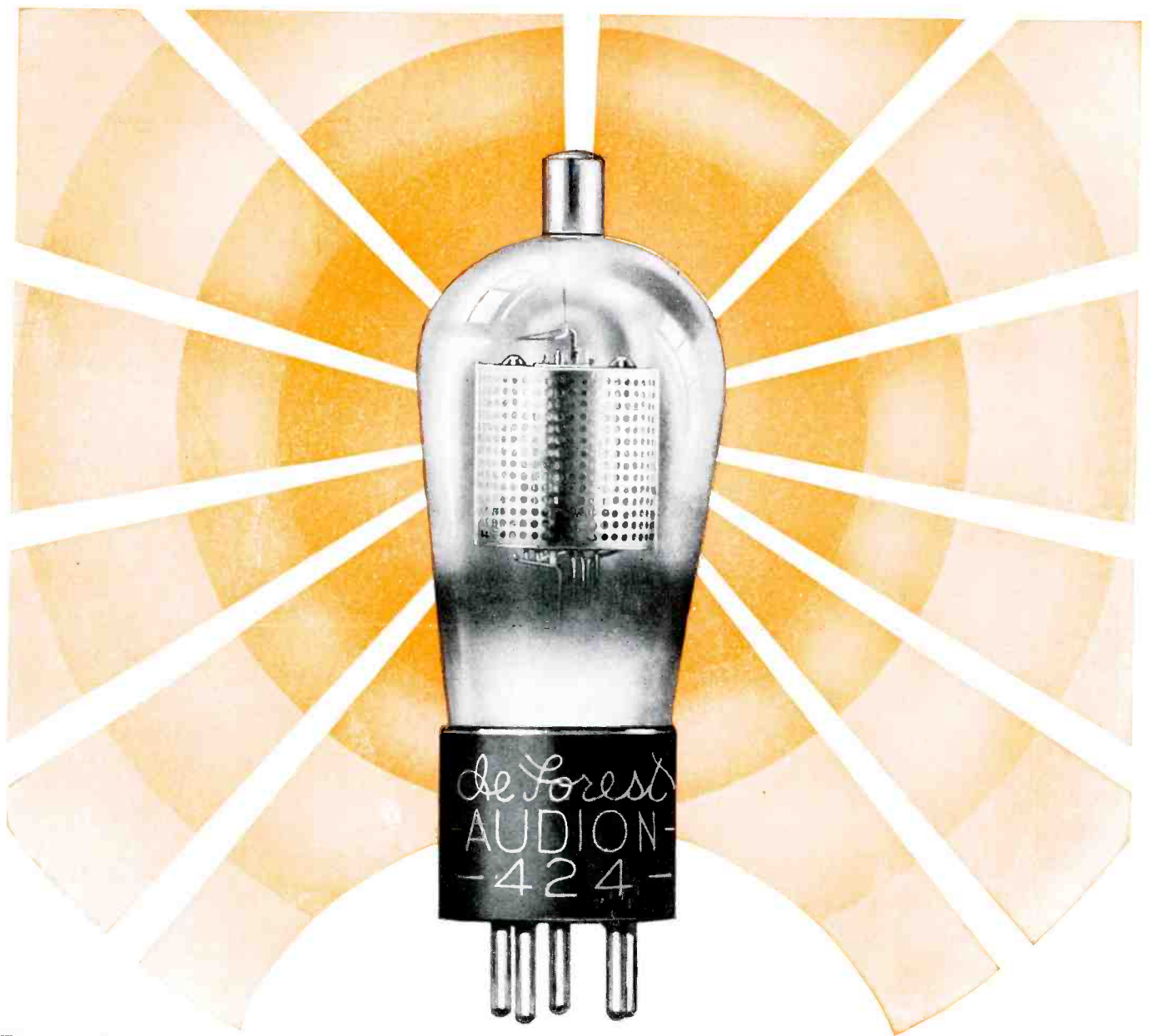

De Forest Tubes have achieved a new perfection

AUTOMATIC high-speed machinery, recently developed, assures the highest engineering standards while multiplying production and reducing the selling prices.

This season get off to a new start. Push these laboratory precision tubes. You will avoid tube troubles and have fewer service calls, more satisfied customers and correspondingly larger profits.

Visit the De Forest Exhibit at Booths B4 and B5 at the 4th Annual R. M. A. Trade Show — Atlantic City Auditorium, June 2nd to 6th. Everybody of importance in radio will be there.

DE FOREST RADIO CO.
PASSAIC, NEW JERSEY

de Forest
AUDIONS
RADIO TUBES

Radio Retailing, A McGraw-Hill Publication

Branch Offices located in:
Boston, New York, Philadelphia, Atlanta,
Pittsburgh, Chicago, Minneapolis, St. Louis,
Kansas City, Denver, Los Angeles, Seattle,
Detroit, Dallas, Cleveland

WHO'S TO BE 1930'S RADIO STAR?

EVERY so often a single manufacturer of radio emerges from the fog of competition and takes his permanent place in the sun.

Meanwhile, dozens of others flash brilliantly before the trade, then drop, extinguished, into oblivion overnight.

Look at the magnificent record of these brilliant stars—Arwater Kent—Majestic—Philco.

Then see what is back of them. Each has had a record of success in manufacture and merchandising in similar or allied lines.

Who's to be 1930's bright particular star? Clarion?

It is reasonable to think so, because quality and price are the principal factors which determine the success or failure of any product. Clarion radio is outstanding merchandise offering more value in appearance, workmanship, and performance than any other receiver on the market—a set that meets every requirement and excels all competition. Clarion will sell readily, stay sold, pay a good profit and build good will.

It is reasonable to think so, too, because TCA, the makers of Clarion, have had an experience and record of success equalled by few in the radio industry. For years TCA have fabricated the essential parts for radio receivers put out by America's leading set manufacturers and have taken a very active part in solving the engineering problems presented by every successful receiver. We have been through all the rapid developments of past seasons—have expert knowledge

of all the reasons for the successes or failures of manufacturers and the causes of service troubles. With all this experience and background we have no illusions on what the public will accept or reject.

We have perhaps the most modern radio plant in the world, equipped with the latest automatic machinery. Clarion is not an "assembled" job. We fabricate from the raw material, finish, assemble, and test every part that goes into *Clarion* from the smallest metal stamping to the complete electro-dynamic speaker—at one profit and one overhead.

This remarkable set-up enables us to produce Clarion Radio to sell for \$109.00—when others costing twice as much do not offer equal performance or appearance, and still assure a good profit to us, to the jobber, and to the dealer.

TCA's liberal but sane advertising plan will meet the approval of every radio merchant, and the TCA Commercial Credit Trust Finance Plan assures dealers of prompt and satisfactory handling of deferred payments on Clarion Radio.

Read the center pages of this announcement—examine the illustrations—study the specifications—and judge for yourself whether or not you agree that Clarion will be the bright star of radio for the coming season.

Distributors and dealers are invited to write for details. We will be happy to have you inspect Clarion Radio either at our factory or at the R. M. A. Shows at Atlantic City and San Francisco.

TRANSFORMER CORPORATION OF AMERICA, 2309 SO. KEELER AVENUE, CHICAGO

Licensed under R. C. A. and Associated Company Patents; Member R. M. A.

Clarion

THE GREATEST RADIO VALUE AT ANY PRICE



\$109⁰⁰
LESS TUBES

MODEL AC-51—An unusually attractive cabinet of swirl walnut and satinwood, 40 inches high, 26½ inches wide, and 14½ inches deep. A full sized cabinet, yet not too large for the smaller rooms. Standard chassis, electro-dynamic speaker. List price without tubes—\$109.00.

Chassis. Tuned radio frequency—three screen-grid tubes as radio frequency amplifiers—one '227 tube as power detector—one '227 tube as first stage audio frequency feeding two '245 power tubes operating electro-dynamic speaker—power supplied by a '280 rectifier tube. Line fluctuation automatically controlled by voltage regulator. Power pack entirely separate and easily accessible. Chassis, speaker, and power pack weigh 65 lbs.

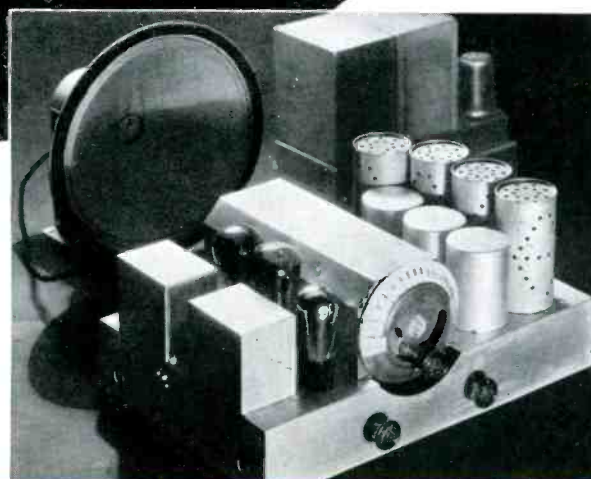

Clarion

MODEL AC-53—
*De luxe cabinet of swirl
 walnut, burlem and satin-
 wood. 44 inches high, 28
 inches wide, 14¾ inches
 deep. One of the handsom-
 est cabinets that will be
 shown this season—stand-
 ard chassis, electro-dynamic
 speaker. List price without
 tubes—\$129.00.*

\$129.00
 LESS TUBES



\$199.00
 LESS TUBES

MODEL AC-55—
*Clarion Radio-Phono-
 graph Combination—cab-
 inet of selected and beauti-
 fully finished matched
 woods—modern adapta-
 tion of the English—44
 inches high, 27 inches wide,
 17 inches deep. Standard
 Clarion chassis complete
 with electro-magnetic pick-
 up and motorized turn-
 table. List price without
 tubes, \$199.00.*

The Greatest Radio Value at any price

Put this in your pocket
 Clarion Radio RMA Show, Atlantic City.
 Booth 48-49, Section B.
 Don't miss the Clarion Show at Clarion
 Theatre, Room 32A, Exhibition Bldg.

Put this in the mail box
 Transformer Corporation of America,
 2313 So. Keeler Ave., Chicago.
 Send me full information regarding Clarion
 Dealer Distributor Proposition.
 Name _____
 Address _____

A Clarion Franchise means financial success

Every distributor and dealer—especially those who have been the victims of “dumped” merchandise, mid-season price cuts, and excessive servicing costs—is looking for a radio receiver this year that will assure substantial profits to him and complete satisfaction to his customers.

Among the leading distributors who believe in Clarion Radio and have signed up with us for 1930 are:

Wakem & Whipple <i>Chicago, Illinois</i>	Stern & Co., <i>Boston, Mass.</i>	Front Company <i>Wheeling, W. Va.</i>
E. M. Wilson & Son <i>Newark, N. J.</i>	Boetticher & Kellogg <i>Evansville, Indiana</i>	Standard Supply Co. <i>Portsmouth, Ohio</i>
Stern & Co. <i>Hartford, Conn.</i>	Bihl Brothers, <i>Buffalo, N. Y.</i>	Repass Automobile Co. <i>Waterloo, Iowa</i>
Roberts Auto & Radio Supply Co. <i>Philadelphia, Penna.</i>	Patterson Parts Co. <i>Cincinnati, Ohio</i>	Dakota Electric Supply Company <i>Fargo, N. D.</i>
McIntyre & Burrall Company <i>Green Bay, Wisconsin</i>	Rockefeller Accessory House <i>Sunbury, Penna.</i>	Stratton & Terstegge Co. <i>Louisville, Ky.</i>
	Stern & Co. <i>Portland, Me.</i>	
	Musical Products Distributing Co., <i>New York City, N. Y.</i>	

These key distributors are seasoned radio men—they know the success that has followed the selection of a winning set. They have visited our factory, met the men in our organization—studied our financial set-up—and after a most thorough and searching investigation have tied their future up with ours. This should be proof to you that a TCA franchise means a credit balance in the bank.

Read the center pages of this announcement again . . . examine the illustrations—and then if you're satisfied, as we are, that Clarion Radio will be the shining star of this season . . . write or send the coupon for full information.

TRANSFORMER CORPORATION OF AMERICA, 2309 S. KEELER AVE., CHICAGO
At the R. M. A. Show, Atlantic City, visit the Clarion Theatre, (Sound-proof Booth No. 32A) and Display Booth Sec. B-48-49
Headquarters and demonstrating rooms, Ritz-Carlton Hotel

Clarion

THE GREATEST RADIO VALUE AT ANY PRICE

A Self-Contained Ohmmeter and Circuit Tester!

Again Jewell has taken the lead, and in the Pattern 89 Self-Contained Ohmmeter provided an instrument unequalled in combined accuracy and convenience, at a comparable price, for making resistance and continuity tests on radio receivers.

A $1\frac{1}{2}$ volt cell, mounted inside the neat bakelite case of this circuit tester, makes it independent of outside sources of energy.

A screw provides convenient adjustment through a magnetic shunt to compensate for variations in cell voltage. Since this adjustment may be easily made before a series of tests, very accurate direct readings are assured.

The Jewell Direct Current Meter, used in the Pattern 89, is renowned for its ability to maintain a high degree of accuracy under severe service conditions. The compact case of molded bakelite is small, easy to handle and carry, and provides excellent protection for the meter.

The Pattern 89 is ideal for service testing in connection with data furnished in service manuals of set manufacturers. Mail the coupon for your copy of bulletin which explains its use.



The kit of every radio serviceman should contain a Jewell Pattern 89 Ohmmeter for resistance and continuity testing. The Pattern 89 is designed especially for the needs of servicemen, and combines a high degree of accuracy and convenience with light weight, easy portability, and an instrument that is famous for its reliability. Mail the coupon for data on the Pattern 89 and the complete line of Jewell Radio Instruments.

30 YEARS MAKING GOOD INSTRUMENTS
JEWELL



**Radio
Instruments**

Jewell Electrical Instrument Co.
1642-A Walnut St., Chicago, Ill.
Please mail literature on the Pattern 89
Ohmmeter and the complete line of Jewell
Radio Instruments.

Name

Address

NEW! **THE MASTER** **PHONOVOX**

Pacent Talking Picture Research, plus years of pick-up experience, brings this **NEW** Master Model Pick-up

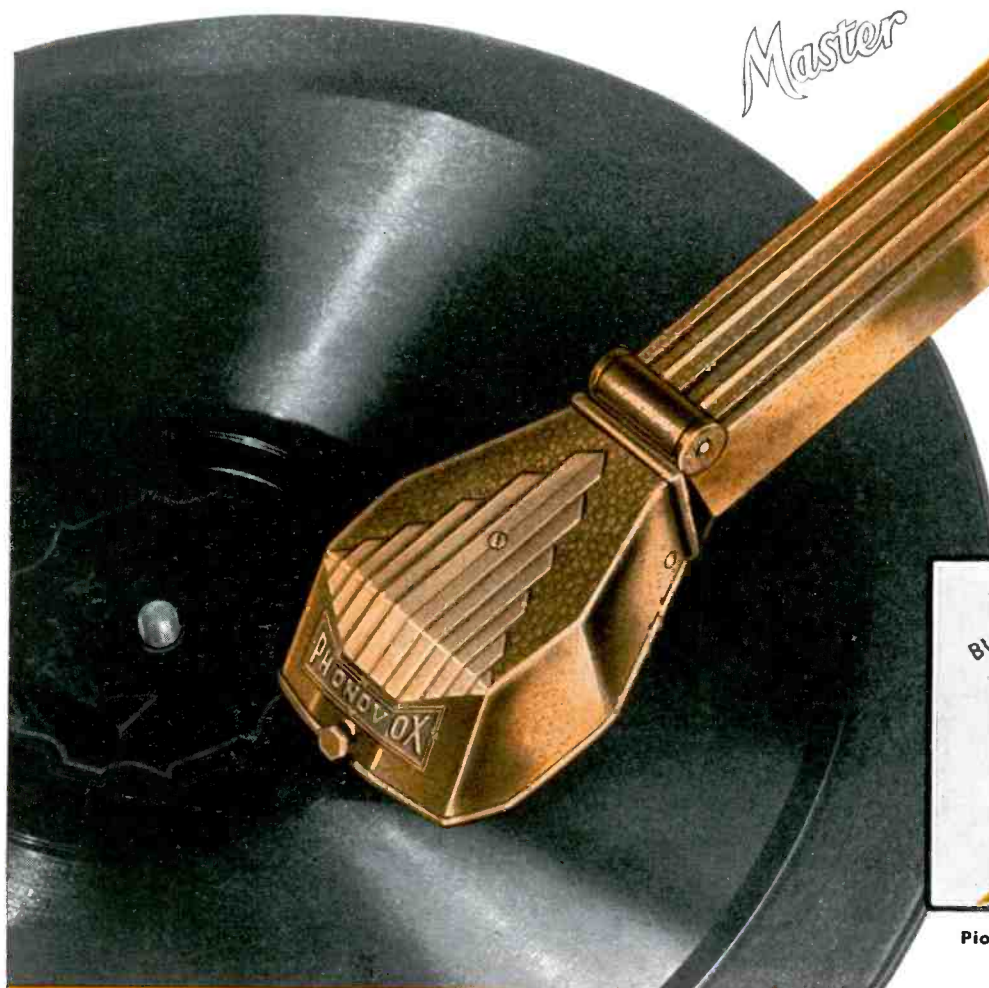

Master

Model 107

\$15.00 Complete

(Prices slightly higher West of Rockies and in Canada.)



Pioneers in Radio and Electric Reproduction for Over 20 Years.

PACENT ELECTRIC CO., Inc.

Manufacturing Licensee for Great Britain and Ireland: Igranic Electric Co., Ltd., Bedford, England

PACENT LEADS IN PHONO-RADIO ACCESSORIES

PACENT'S ever-growing leadership in the field of phono-radio accessories means greatly increased sales possibilities for you. There's money, and sure, continuous sales in Pacent Products. They are known throughout the world as leaders in their field. Cash in on this leadership now as never before!

Pacent Radio-Phonograph Chassis

Specially designed for use in producing an efficient, low-priced combination. Pacent motor, new 107 Phonovox and all accessories are mounted, ready to slip in assembly. Prices and specifications on request.

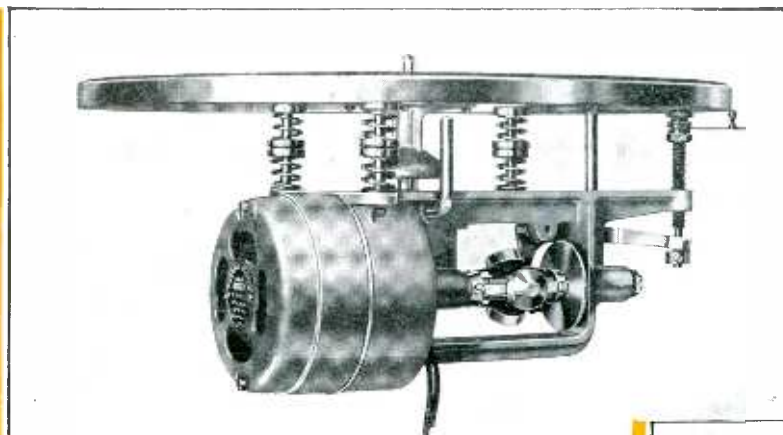

Pacent Electric Phonograph Motor

Silent induction type for 110 volts, 50 or 60 cycles A. C. Available in many special frequencies. Ideal for all radio-phonograph requirements. Sturdy, quiet, extremely economical.

List price, **\$25**



Write today for new literature on Pacent Products, the fastest sellers in the phonograph-radio field.

The New Pacent Electrovox

The Pacent Electric Motor and marvelous new 107 Master Phonovox built, with necessary accessories, in handsome cabinet. Makes a combination of any radio set. List price,

Including cabinet, **\$75**



91 SEVENTH AVE., New York, N.Y.

... *Three months ago*
us permission

**DR. R. E. MYERS**

This vacuum tube authority, formerly the Chief Engineer of the Tube Division, Westinghouse Company, has joined National Union Radio. With him he brought a picked staff of 15 Westinghouse engineers and manufacturing experts. Now he gives his emphatic endorsement to this statement at the right.

Why we engaged Dr. Myers

To produce a tube at least as good as any now on the market, we sought the finest engineering talent that the radio business could offer. We went to Westinghouse and to General Electric, who at that time were producing all the tubes for R. C. A.

After several weeks of negotiation, Dr. Ralph E. Myers, Chief Engineer of the Westinghouse Lamp Company, agreed to join us. He brought with him what he considered the pick of the Westinghouse organization — 15 able experts who, for the past six years, have

been responsible for the quality of the R. C. A. and Cunningham tubes manufactured by Westinghouse.

Naturally, we wished to make public the fact that Dr. Myers and his staff had joined us, but he flatly refused at that time to allow this.

Then he and his organization went to work. We placed unlimited funds at their disposal. They secured the equipment and concentrated on the production of the finest radio tube that science could devise.

The result is the new National Union Tube. Tests prove it lasts as long or longer than any tube on the

Dr. R.E. MYERS *refused* to print this ad!!

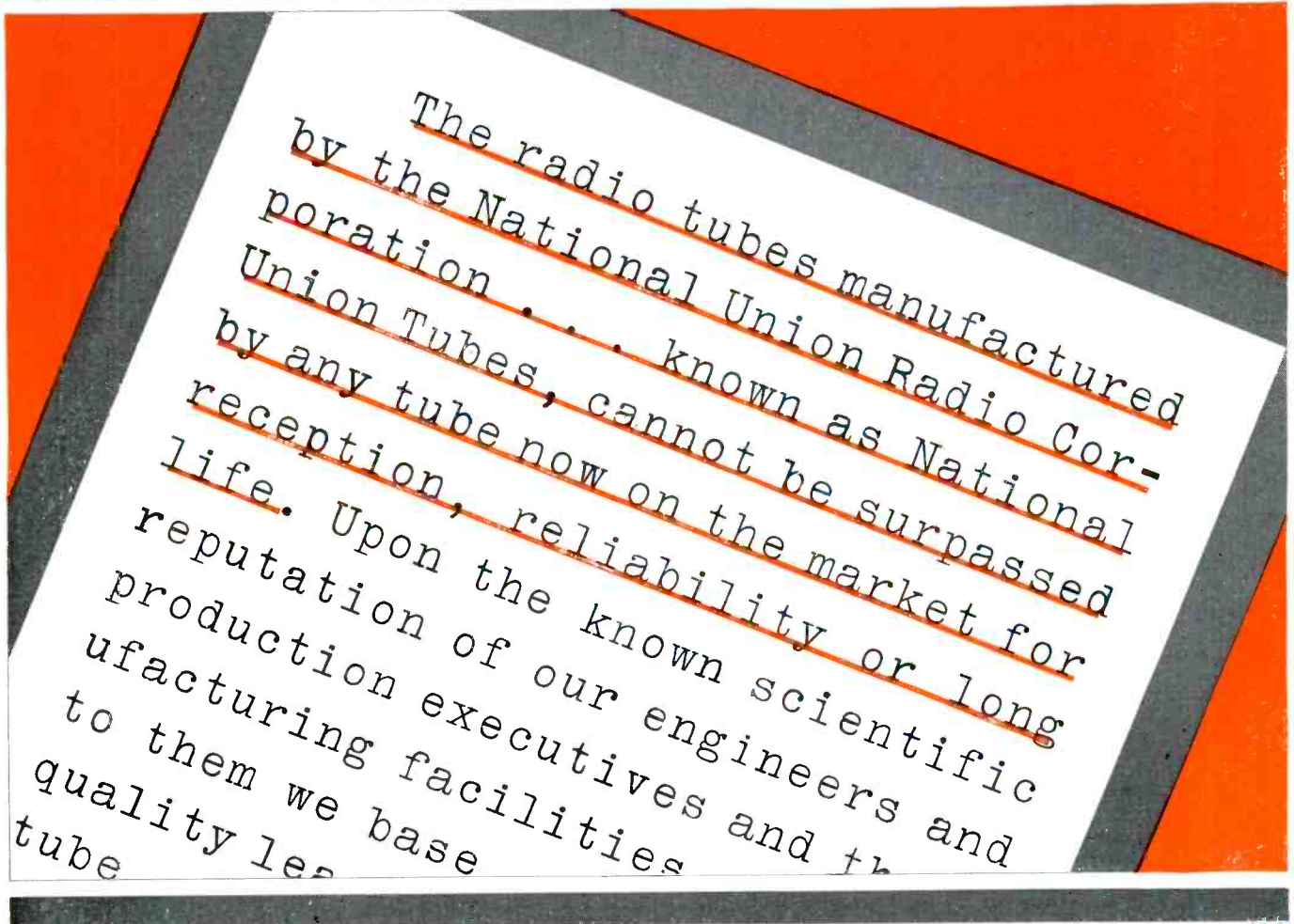

market. Musical experts and eight leading set engineers say its tone is second to none.

And most important of all, perhaps, you can count on perfect uniformity. Dr. Myers installed the "double test" system whereby each tube, in addition to passing the production inspection, must also pass a second inspection supervised by a representative of the Sales Department. This guarantees you against receiving any tubes of even slightly doubtful quality.

Dealers who have installed National Union Radio Tubes in the sets they have sold, are already beginning to report fewer service calls—and growing sales.

REMARKABLE PROFIT PLAN

The New National Union tube offers you profit possibilities that cannot be duplicated in any other tube of proved quality.

It also offers you constructive merchandising help. A card brings full details in prices, also a description of the sensational National Union display idea—the idea that puts Rudy Vallee to work on your sales staff, free!

NATIONAL UNION RADIO CORPORATION
400 MADISON AVENUE · NEW YORK CITY · N · Y

There is an INCREASING DEMAND for sound distribution systems

..... AND A VERY DESIRABLE
PROFIT FOR MEN WHO KNOW
HOW TO INSTALL THEM

TO the men or organizations who possess a knowledge of sound amplification and who have the requisite sales ability, financial responsibility and engineering facilities, the sales, installation and servicing of sound distribution systems offers a very distinct and profitable opportunity.

There is an ever-widening market in every community for the installation of sound distribution systems in—

Apartment Buildings	Playgrounds
Amusement Parks	Public Parks
Airports	Race Tracks
Base Ball Parks	Railroad Depots
Camps	Restaurants
Churches	Riding Academies
Circuses	Sanitariums
Civic Centers	Skating Rinks
Convention Halls	Schools
Dance Halls	Sporting Arenas
Factories	Stadiums
Gymnasiums	Swimming Pools
Hospitals	Yacht Clubs
Hotels	

These installations will require the use of amplifiers . . . Webster Amplifiers, the product of an institution specializing in the manufacture of delicate and precise electrical apparatus for nearly a quarter of a century, are compact, neatly designed and finely built. They will form the basis of highly efficient sound distribution systems.

WEBSTER

Webster
W Power Amplifier

Someone in your community is going to sell and install these systems. To the man whose installations include Webster Amplifiers will come the cream of the business, for these fine units are built painstakingly and perform flawlessly. You can be this man. Write us as to your facilities and capabilities and we will send you complete descriptive literature regarding Webster Amplifiers and the Company behind them.

THE NEW WEBSTER MODEL "4"

OFFERS

- Enhanced Tone Quality
- Unusual Volume Through Screen Grid Sets
- Other Webster Refinements

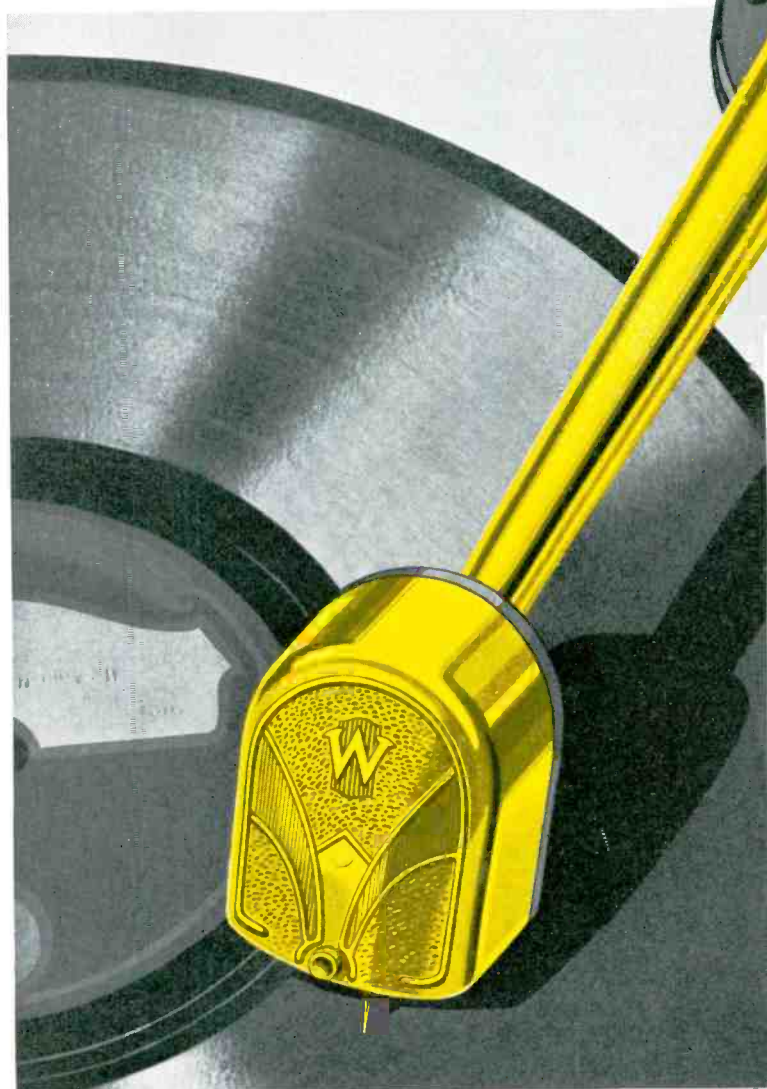

THIS year the Webster Electric Pick-up is destined to be the "talk of the show".

For, in this new model "4" you will find incorporated the accumulated knowledge of nearly a quarter of a century's experience in the designing and building of precise and delicate electrical apparatus . . . It is completely new in design; compact, neat and finely finished in a two-tone scheme of rose-gold and mahogany brown. It possesses an appearance of quiet dignity and quality that will permit its application to the finest cabinets of either mahogany or walnut.

The now famous Webster precision tone, which has become the standard of comparison, has been still further improved. To the matchless fidelity of its tone has been added a frequency response from the narrowest range of high frequency note to the wide sweep of the deepest bass. And the volume too, is unusual, permitting a solution of the problem of phonograph reproduction through screen grid receiving sets having a low gain in their audio amplifiers

From every viewpoint . . . beauty of appearance, fidelity of tone, correctness of design and quality of construction, the new Webster Model "4" Electric Pick-up will be the outstanding pick-up of the year . . . Read the list of features below. See and hear it at the R. M. A. Show. Space C-10 in the Atlantic City Auditorium or in the Webster demonstration room in the Ambassador Hotel, June 2nd to 6th. Or, better still, place an order for a sample now. As in the past, this new model will be packed in an attractive self-selling carton and attractive selling literature will be supplied.

ELECTRIC COMPANY

Webster
W Electric Pick-up

RACINE Established 1909 WISCONSIN
 WEBSTER FEATURES

1. The original Webster knife edge bearing has been improved.
2. Free and highly sensitive stylus movement.
3. 37% of Cobalt magnet.
4. Pole pieces of special high permeability alloy.
5. Counterbalancing insures correct weight on record.
6. Ball bearing base allows free swing over record.
7. Remarkable frequency response range giving uniform tone quality and volume from the lowest to the highest tone frequencies.
8. Unusual tone volume for reproduction thru screen grid receivers.



Bosch Radio is licensed under patents and applications of R. C. A., R. F. L. and Lelephone. Prices slightly higher west of Rockies and in Canada.

Model A—A delightfully pleasing open console most beautifully proportioned with highly patterned woods. It stands 39 $\frac{3}{4}$ " high, is 26" wide, and 12 $\frac{1}{2}$ " deep. Built into the cabinet is the Bosch Radio 8 tube receiver and electro-dynamic speaker. Designed for 25 or 60 cycle operation. Price, less tubes . \$144.50



Model B—The richly grained walnut woods so beautifully matched give this console a pleasing individuality. Has sliding doors, built-in electro-dynamic speaker and 8 tube receiver. Designed for 25 or 60 cycle operation. Price, less tubes . . . \$159.50

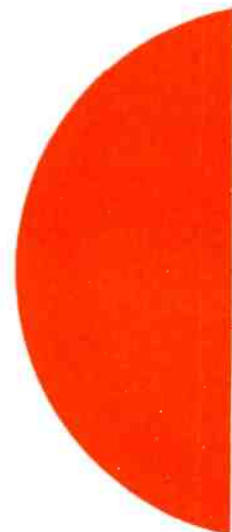

BOSCH

Each year at the Radio Trade Show, dealers turn to Bosch Radio to see progress. Each year demonstrates Bosch Engineering is advanced and sound — that precision manufacture is a fact, not a claim — that Bosch prices are attractive to the customer; profitable to the dealer. The year just passed thoroughly demonstrated Bosch Stability and that Bosch Policies safeguarded the profits of distributors and dealers alike. There were no frozen inventories. Upon this enviable background a completely new line of Bosch Radio is now presented. Embodying finer and more advanced engineering, richer cabinets, more attractive price range covering volume business models to de luxe models, Bosch Radio is by far the finest line of quality radio we have ever presented. Consider the customer appeal of these sales

AMERICAN BOSCH
SPRINGFIELD

Branches: New York · Detroit



Model D—A console so decidedly away from the usual that it expresses rare elegance and charm. It is 47 $\frac{1}{4}$ " high, 28" wide and 14 $\frac{3}{4}$ " deep. It is a 9 tube receiver, has full automatic volume control, tuning meter, tone selector, speaker mute, phonograph pick-up connection and illuminated kilocycle tuning scale. Designed for AC—26 or 60 cycle operation or AC—DC operation. Price, less tubes . . . \$195.00

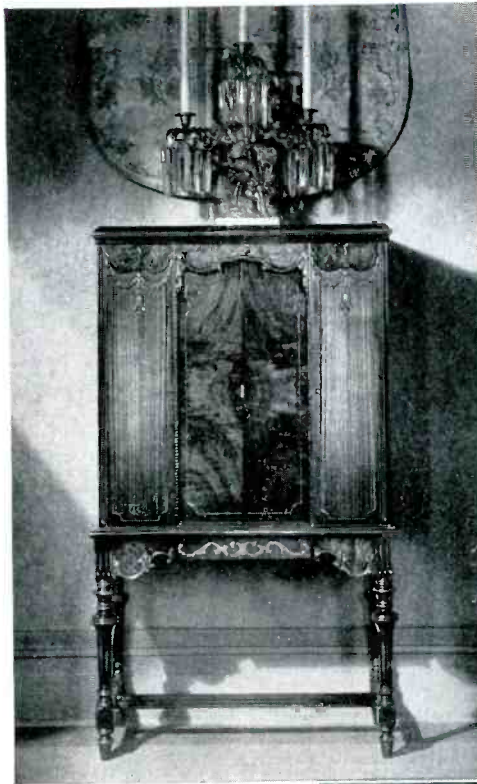

Model E—A graceful console, gorgeously designed in beautiful matched walnut woods. It is 50 $\frac{1}{4}$ " high, 28" wide and 15 $\frac{3}{4}$ " deep. It is a 9 tube receiver, has full automatic volume control, tuning meter, tone selector, speaker mute, phonograph pick-up connection and illuminated kilocycle tuning scale. Designed for AC—25 or 60 cycle operation or DC—AC operation. Price, less tubes . . . \$250.00

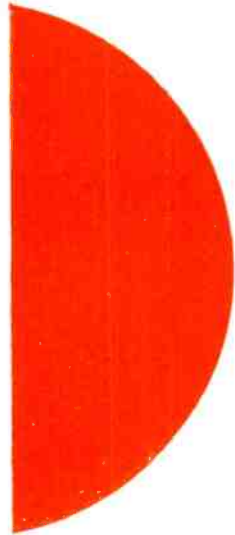

RADIO

features: Complete selectivity of both high and low wave lengths; efficient performance on antenna from 5 to 100 feet; eight tubes — four are screen-grid; push-pull amplification; five tuning condensers; single tuning control. Nine tube de luxe models to attract the upper fringe market, with five screen-grid tubes, full automatic volume control; tuning meter; speaker mute; tone control from treble to bass; local and distance antenna switch; bigger speaker. Motor Car Models — Motor Boat Models. A price range of \$144.50, \$159.50, \$195.00, \$250.00. You cannot correctly formulate your plans for the coming year until you know all Bosch Radio has to offer. See Bosch Radio at Atlantic City, Booths B-31-32 or write for the details of all Bosch has in store for the coming year.

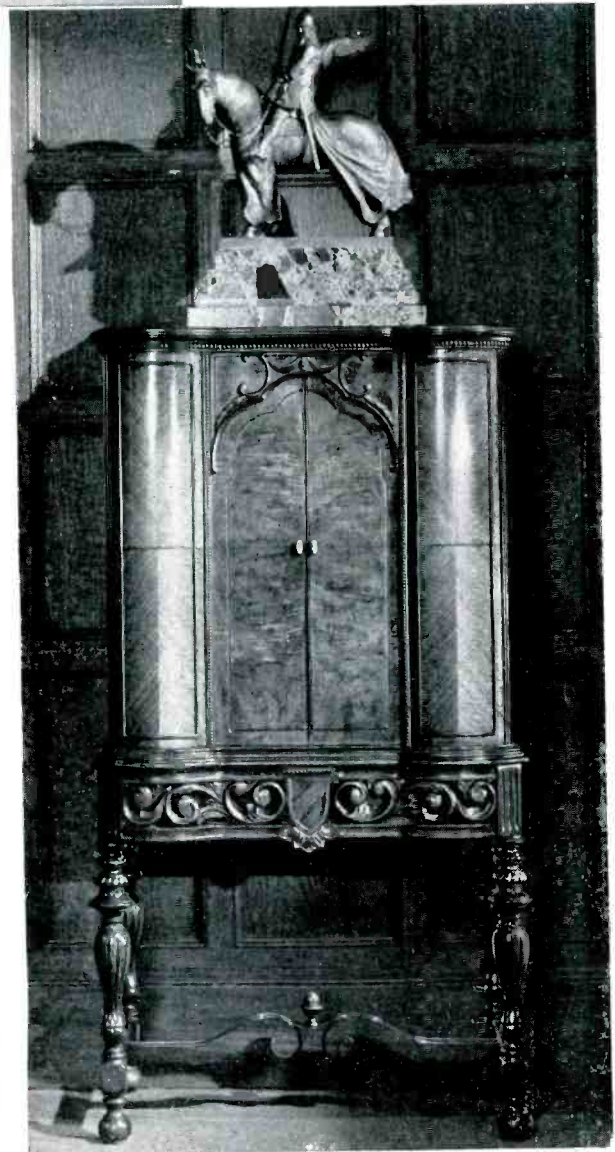

MAGNETO CORPORATION

MASSACHUSETTS

Chicago San Francisco

♦ ♦ **Just think!**

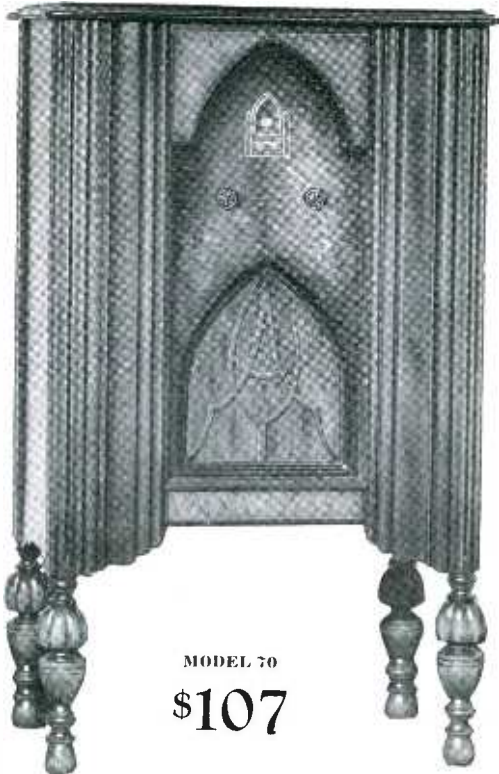

MODEL 70
\$107

what

AUDIOLA'S

8

SUCCESSFUL YEARS

mean to you!

*... in Booth B-7 at the show
and at the Ritz Carlton!*

—you will find the impressive reasons which have caused the highest type of radio jobbers to sign up for the Audiola line. You will find an amazing achievement in radio value—four tuned circuit, triple screen grid receivers, equipped with the newest dynamic speakers, and housed

in the season's most distinctive cabinets. And Audiola offers all these features at prices starting from

\$97

AUDIOLA RADIO COMPANY
430 South Green Street, Chicago, Ill.

LICENSED
under the patents of
RCA and associated
companies



MODEL 80
\$119

AUDIOLA

"Known for Its Tone"

8 Successful years Building Fine Radios

NOW.**THE NEW IMPROVED****TRIAD LINE**

See the TRIAD display at the
R. M. A. Show Booth A 46

Hotel Headquarters
Marlborough-Blenheim



TRIADS have always been known as "better" tubes. Nevertheless our engineers have been ceaselessly experimenting — searching — testing to find the BEST.

And now — this skilled research has developed for TRIAD T-24 a more rigid construction that practically eliminates microphonics and burn-outs. The same painstaking effort has discovered a new carbonizing process that renders TRIAD T-45 free from gas — has evolved Improvements that give to this tube longer life — greatly increased range and undistorted output — ability to stand materially higher plate voltages — and super-clear and amazingly realistic tonal quality.

These advantages mean — greater satisfaction for your customers — bigger sales and greater profits for YOU!

Triad Manufacturing Co., Inc. Pawtucket, R. I.

TRIADS are now manufactured under R.C.A., G.E. and Westinghouse patents — thus assuring you the best in Radio research and engineering skill.

TRIAD
RADIO TUBES

**MAGNAVOX
DYNAMIC
SPEAKERS**

UNFETTERED · REPRODUCTION

PROTECT THE THING YOU SELL:

PERFORMANCE

When all's said and done, the public has but one test for the receiver or combination you sell—"How does it perform?"

That test will be more rigid than ever in 1931.

The dealer who sells a receiver equipped with a Magnavox Dynamic Speaker faces that test with confidence. He knows that a discriminating public will hear all the fineness of the receiver—true—clear—undistorted—unfettered.

He knows, too, that the name Magnavox means something definite to his customers—that it means speaker leadership maintained through 19 years—research that means tomorrow's engineering standards achieved today. He realizes—and uses—a real selling advantage.



THE MAGNAVOX COMPANY

ESTABLISHED 1911

Factory and Sales East of the Rockies:
CHICAGO, ILLINOIS

Sales Office: 1315 S. Michigan Ave.

Factory and Pacific Sales:
OAKLAND, CALIFORNIA

SPEED

RADIO TUBES

RCA LICENSED

NOW THAT YOU'VE SEEN ALL
THE TUBE EXHIBITS—
CHECK UP WITH YOUR FELLOW
VISITORS

You'll be astonished at the number who have definitely declared themselves for **SPEED** † † After careful consideration—looking ahead to next season—if you can find a tube of higher quality—a more intensive sales program—then that's the hook-up you want. † † But we believe you'll be with **SPEED**



See the
"ARMORED BRIDGE" CONSTRUCTION
exclusively featured in

SPEED RADIO TUBES

BOOTHS C11, C12
AUDITORIUM, ATLANTIC CITY, JUNE 2-6



CABLE RADIO TUBE CORPORATION

84-90 North 9th Street

Brooklyn, N. Y.



See Our Exhibit
Space D 47
ATLANTIC CITY
JUNE 2-6

*Test every tube
you buy and sell—*



Readrite

No. 450 SHORT TESTER



Companion to the No. 400 Counter Tester, the No. 450 is used for locating "shorts" in radio tubes. Plugs into socket on No. 400 and connects to 4½ volt battery. The flash of the bulb indicates a "short" while the position of the lever switch shows instantly the part shorted. Handy — Sturdy — Complete.

*...the New Readrite Counter
Tester Makes It Easy...*

Conveniently located on the counter the new Readrite No. 400 Tube Tester permits a quick, complete check of every radio tube you sell.

There is no guessing—you know accurately for the new Readrite gives you all the factors for a complete test, instantly.

Provided with a new precision made, highly accurate milliammeter, it indicates milliamperes flow and gives mutual conductance grid change test of all tubes.

Heater type tubes can be quickly tested in quantities. Eight tube sockets are provided for testing this type, Screen-Gred, Pentode, Rectifier Tubes and others in general use.

Priced exceptionally low at \$12.00 net to dealers, the Readrite Counter Tester should be on every counter where tubes are sold.

It comes complete ready for use—size 8¼" x 3½"—housed in an attractive Baked Enamel Seamless Steel Case.

Order yours today.

Readrite

No. 400
TUBE TESTER
\$12 NET

No. 450
SHORT TESTER
\$3.50 NET

THE READRITE METER WORKS

6 COLLEGE AVE., BLUFFTON, OHIO



The **NEW** and **PROFITABLE** Way to Sell **Condensers**

EACH carton contains six standard Sprague units of 8 MFD capacity, 430 Volts, D. C.; with individual screw sockets for utmost mounting adaptability. The Sprague standard unit eliminates the confusion that occurs when different capacities are assembled in the same can.

With each unit measuring but 1 3/8" diameter x 5" height overall—you sell giant condenser capacity in midget space. And the Sprague exclusive, one-piece, round-edge anode puts the Sprague electrolytic condenser in a class by itself—years ahead of the field.

Order a standard Distributor's Package of Sprague electrolytic condensers (24—6-unit cartons), and see what real profits mean.

SPRAGUE SPECIALTIES COMPANY
QUINCY MASS.

Manufacturers also of the well-known SPRAGUE PAPER CONDENSERS

This three-color Sprague display card tells the whole Sprague story at a glance, and sells Sprague Condensers on sight.



SPRAGUE

Electrolytic

CONDENSER

THE PRICELESS ELEMENT

INTO every Perryman Tube, Time has built a "Priceless Element"; an invaluable "something" that years of honest effort, of close adherence to an ideal injects into a product and an organization.

Perryman jobbers and dealers know the value of this "Priceless Element" in action. They see it in their increasing profits, in the active cooperation of the Perryman executive personnel whose keen, sympathetic and unselfish understanding of the trade problems has assisted materially in building a substantial tube volume for many distributors.

Invariably the Perryman-distributor relationship grows intensely personal as well as commercial. It is built up by a close affinity of thought, interest, policy and objective.

Thus the position of Perryman in the industry has been won by steadfast allegiance to sound fundamental manufacturing and merchandising principles. It has been achieved *without* circus advertising, trick deals, trick tubes, trick discounts.

It has been teamwork between the distributor and the Perryman organization that has injected the "Priceless Element" into the Perryman Line.

PERRYMAN ELECTRIC CO., INC.

NORTH BERGEN, N. J.

NOW—Turn to Capehart for Profits!

CAPEHART opens to dealers the path that leads them back to sound business and substantial profits.

Today, music dealers **NEED** what the Capehart Franchise offers them.

1. An article which, by *sheer merit*, has built a great industry.
2. A virgin, untouched market, growing every day by leaps and bounds.
3. A margin of profit, *large in actual dollars*, that will repay your sales efforts with a business that runs into real money and *real profits*.

Capehart dealers are making money right now, and have been right along. They do not know the meaning of depression. If you are wondering what the future holds for you, *investigate the Capehart franchise*. Everywhere dealers are turning to Capehart. You cannot afford to ignore this new giant in the music industry.

CAPEHART LEADS in AUTOMATIC MUSIC

Priceless Tone
Plays Records on **BOTH SIDES**
No Re-Stacking

Capehart

AMPERION

THE CAPEHART CORPORATION • FORT WAYNE, IND.

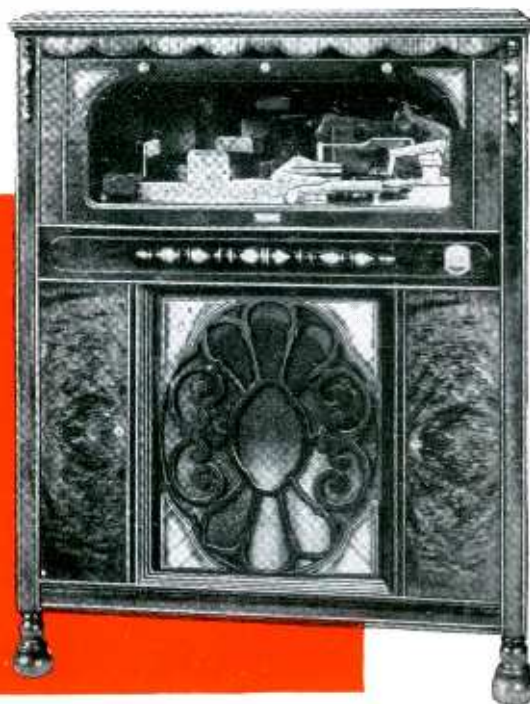

See the Capehart at the
R. M. A. TRADE SHOW
Atlantic City, June 2-6
Booths 40, 41, 42, 43. Demonstration Room 27

MAIL COUPON for Free Book

Find out about the Capehart franchise. Catalog showing all models and actual evidence of profits sent without obligation. Mail coupon.



The Capehart Corporation
Dept. A485 Fort Wayne, Ind.

Please send, without obligation, your dealer's portfolio telling full details of the Capehart Dealer's Franchise and descriptions of the full Capehart line.

Name

Address

City State



REPR *nation's*



New Model DA-9
JENSEN AUDITORIUM, JR.
Electro-Dynamic Speaker
List Prices, \$30.00 up



New Model DA-7
JENSEN AUDITORIUM
Electro-Dynamic Speaker
List Prices, \$45.00 up



New Model D-8—JENSEN CONCERT Speaker
List Prices, \$27.50 up

Write immediately for the new Jensen Folder No. 26 which gives complete information, response curves and technical data on all three of these new Jensen Electro-Dynamic Speakers.



PRODUCING a entertainment

The greatest tribute ever paid to any product of the radio industry. . . . Reproducing a nation's entertainment. . . . Approval voiced so effectively by leading engineers and critics that Jensen Electro-Dynamic Speakers are now more widely used than ever before. At the Atlantic City R. M. A. Trade Show more radio receivers will be equipped with Jensen Speakers than with any other make. These receivers are destined to be the season's best sellers for they will offer the finest possible tone quality. To the manufacturers of these receivers the cost of the speaker has been secondary. . . . Designers and engineers of talking moving picture, public address and allied apparatus have also voiced their approval, particularly of the new Jensen Auditorium, with 12-inch cone, and Auditorium, Jr., with 10-inch cone, Speakers. . . . The new model D-8 Jensen Concert Speaker, with 10-inch cone, has been designed particularly for use in radio receivers. . . . All of these new reproducers represent the culmination of Peter L. Jensen's genius and twenty years of experience. All are available for either AC or DC operation from any convenient source of power supply.

JENSEN RADIO MANUFACTURING COMPANY, 6601 SOUTH LARAMIE AVE., CHICAGO, ILL.

Jensen Patents Allowed and Pending. Licensed under Lektophone Patents.



Pioneering New Ideals in Radio Engineering

Realizing the select market offered by those who appreciate and know the possibilities of finer radio reception the Victoreen Radio Company has developed, for the 1931 season, a receiver of unusual merit. * Since its inception the Superheterodyne circuit has been acknowledged to be the most efficient in radio. In the new Victoreen this circuit has been developed to its utmost capabilities. Here is a non-harmonic Superheterodyne, possessing fine tone, knife-edged selectivity with a flat tuning curve and sensitivity to satisfy the thrill of reaching out for distant or favorite stations. * The following features, Mr. Dealer, are combined in the new Victoreen chassis to emphasize its salient characteristics. A Superheterodyne employing fourteen tubes in an extremely well balanced circuit—four screen grid tubes in the radio frequency and intermediate frequency stages—a two-part chassis, tuner and amplifier, each housed in a cast aluminum case—a dial calibrated in kilocycles uniformly graduated over the entire broadcast band—cabinets carefully selected in keeping with the quality of the chassis. * The new Victoreen naturally is priced above production type merchandise. This offers a two-fold advantage proportionately higher profit per sale and a growing clientele of satisfied users. * This is the receiver and the circuit of the future. See and hear the new Victoreen at the June Trade Show or write the factory direct for exclusive dealer proposition.



The Victoreen Radio Co.

2825 Chester Avenue

Cleveland, Ohio

Victoreen

NOW



RIBBON LABELS FOR DATING

On Every Champion Tube

Turns Your Replacement Losses Into Sale Profits

Give the SET USER Value, too

Champion

Licensed under patents of RCA and associated companies



Visit our display of Champion Radio Tubes, Booth C58-59, at the Radio Manufacturers Association Trade Show, to be held in the Auditorium at Atlantic City, N. J., June 2 to June 6, inclusive.

Set User . . . Dealer . . . or
Jobber—

profit by starting from this point
—“honest delivery of service.”

Render and deliver this service by
using Ribbon Labels for dating!

CHAMPION RADIO WORKS, INC., DANVERS, MASS.

A Year Ahead in Radio Convenience

Nathaniel
BALDWIN
RADIO
Remote Control

See Us At
the R.M.A. Show
Space C 31-32
or write for the name
of your jobber.

Nathaniel Baldwin Incorporated
1601 S. MICHIGAN AVE. CHICAGO. ILL.

BOOTH C31-32

Console Model 70 and 71



The Consolelets are of the lowboy type, yet are different than anything that the radio industry offers. These seven tube models represent the finest in engineering—the triple screen grid circuits develop the maximum in amplification made possible by the use of screen grid tubes. Push-pull amplification, in the last stage of audio, coupled with a specially developed 12½ in. dynamic speaker, results in a tone that is more than colorful—absolutely life like. Screen grid detection is employed and the chassis is equipped with phonograph jacks for record re-creation.

The cabinets are of walnut, embellished with overlays that bespeak perfection in the cabinetmaker's art. The Consolelets may be had in two models, with or without remote control. They represent the finest in engineering and design.

Consolelet Model 70, complete with tubes. Price **\$129.50**

Consolelet Model 71, equipped with remote control, in other respects identical to Model 70, complete with tubes. Price **\$159.50**

The Baldwinettes



Here are the biggest "little" Radio Sets the industry has ever seen, yet, in performance and tone, comparing favorably with the larger models. They are of the mantel type, being but 18½ in. high and 15¼ in. wide, which makes them semi-portable. They are ideal for the smaller apartments or in homes where a second radio set is desired. Triple screen grid circuits are employed. The cabinets are of walnut with artistic overlays, giving an eye-value that will appeal to all. These sets, though small employ a 9-in. dynamic speaker.

Baldwinette Model 50, complete with tubes. Price **\$99.50**

Baldwinette Model 51, same as Model 50, except that it is equipped with remote control, complete with tubes. Price **\$129.50**

The Universal Portable



One of the most outstanding items of the sensational Nathaniel Baldwin line. This is a Portable Set that can be plugged into any 110 volt line, irrespective of type of current or cycle pulsation—without any changes. It works equally as well on alternating as on direct current. Whether it is used on 25, 50 or 60 cycles makes no difference. It is an eight-tube set, entirely self-contained, weighing but nineteen pounds.

Universal Portable Model 40, complete with tubes **\$79.50**

The Hydaway

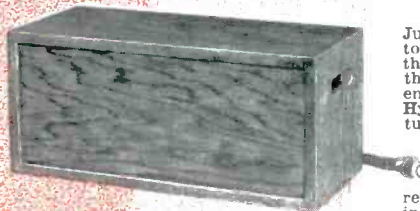

Just what its name implies. It is made to be hidden away in a bookcase, under the davenport or in some other out-of-the-way place in the home. It is tuned entirely with remote control. The Hydaway model carries the same seven-tube chassis as the Consolelets. It must be used in connection with one Model 26 Dynamic Speaker.

Hydaway Model 75, complete with remote control and tubes, not including speaker. Price **\$119.50**

Remote Control Kit



The Nathaniel Baldwin Remote Control will tune in every station on the dial just as if the set was being tuned by hand. It allows for the tuning of the set from any room or corner of the home. Nathaniel Baldwin Remote Control will bring any older model up to 1930 standards of performance.

Remote Control Kit, Model 35, complete with tuning unit, motors, transformer and connector box. Price **\$35.00**
Additional Remote Control Units, Model 15, unit only **\$15.00**

Nathaniel Baldwin Speakers



Nathaniel Baldwin Dynamic Speaker, Model 26, designed specially for the Hydaway model. It is a 9-in. dynamic and is housed in a beautiful walnut cabinet of the console type.

Baldwin Dynamic Speaker, Model 26 **\$35.00**

Baldwin Dual Magnetic Speaker, Model 25, is the outstanding speaker of the magnetic type. It is ideal for any set. Model 25 Dual Magnetic Speaker. **\$25.00**

Baldwin Dynamic Pickup

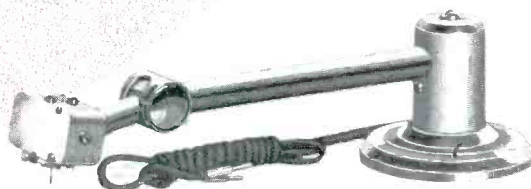

Baldwin Dynamic Pickup, Model 30, is for the re-creation of phonograph records. It is acknowledged in its field as sensational and outstanding as the dynamic speaker. It will reproduce records as you never heard them before.

Baldwin Dynamic Pickup, Model 30. **\$35.00**

Everybody
**KNOWS
THIS
FAMOUS
NAME**

NEW
I. C. A. adds a number of
new items to its famous line



Multi-Speaker Relay

This is a new compact device enabling the set owner, service man, or radio dealer to compare and operate a number of loud speakers at one time without loss of a single note, merely by turning a knob. In wide demand among homes, apartment houses, hotels, hospitals, radio dealers, laboratories, etc. Sturdily built of bakelite with brown crystalline finish. List price \$2.75.

ONCE again I. C. A., world's leading maker of radio accessories, leads the way in this important field with the introduction of a number of important additions to its already extensive line.

Successful as Resistovolt, Filtervolt and a number of other I. C. A. items have been, and still are, these new additions are being proclaimed by the trade as sure winners for the 1930-1931 radio season.

INSULTENNA

The Insultenna is an innovation—a compact antenna eliminator using the radically new I. C. A. principle of filtered aerial wire and condensers. The Insultenna may be used in place of outdoor and indoor antennas and has the capacity of 75 feet of ordinary antenna.

The Insultenna is definitely superior to any type of indoor aerial, and except in comparison with outdoor aerials of great length, has a capacity beyond that of the ordinary outside aerial equipment.

By reason of Insultenna's wonderfully efficient, compact size of 5" by 2½" by 1", its attractiveness, and popular price, it is bound to be the hit of the season for both new and old installations. List price \$2.50.



ACCURATUNER Station Selector

The Accuratuner is an advanced band pass principle station interference eliminator. An essential in this day of ten kilocycle station separation. The Accuratuner will shut out any unwanted station interfering with local reception and, in most cases, will cut through locals for distant stations.

The Accuratuner is a handsome instrument of polished bakelite. List price \$2.50.

Convenience Outlets

The new I. C. A. Convenience Outlets for easy and attractive installation of remote control for every conceivable radio requirement are unique in design and superior to any other. For new construction, or quickly installed on old construction without chopping away baseboards, walls or plaster. Screw-driver only tool necessary. In great demand by private homes, apartments, public buildings and hotels. I. C. A. Radio Convenience Outlets are of a standard, compact size, 5" by 2½" by 1" with bakelite panel, backed by metal receptacle. Made in eleven combinations with prices ranging from 90c. to \$2.65. Sold with or without receptacles. Also quotations on special designs.



FILTERVOLT and FILTERVOLT JR.

The I. C. A. line of Filtervolt is becoming more popular every day for the elimination of A.C. and D.C. line noises caused by electric signs, vacuum cleaners, washing machines, electric refrigerators, oil-burning furnaces and all other electrical appliances operated in or near

the home. Filtervolts are available in varying capacities:

Filtervolt Sr. List price \$15.

Flasher-Sign Model. List \$17.50.

Service Model. List \$7.50.

Filtervolt Jr., the popular light duty line noise eliminator. List \$3.

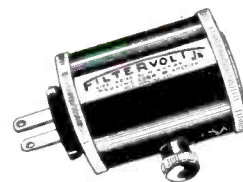

RESISTOVOLT

Since its introduction four seasons ago, Resistovolt has been saving tubes from blowing out for hundreds of thousands of radio owners and has been paying increasingly large profits to the thousands of dealers who sell this essential radio accessory. List \$1.75.

ELECTROSTATIC

The Electrostatic is more than a lightning arrester passed by the underwriters and backed by a \$100 insurance bond. It also reduces electrostatic interference with reception. At \$1 list, it is a highly popular and profitable item for new and old installations.



Don't fail to see our Television Exhibit at R.M.A. Show, June 2, 1930, Booth C-8

INSULINE CORP. of AMERICA, NEW YORK, N. Y., U. S. A.

78-80 CORTLANDT STREET—BARclay 4460



This is the Ravenswood with alarm—Retail at \$12.50

Sell the New Way of Telling Time

June Is a Gift Month Weddings—Anniversaries

THE ideal gift—an electric clock that requires no winding—no regulating—always tells exact time.

Radio dealers are finding the synchronous electric clock a fast moving profitable specialty. The public is replacing the old fashioned spring clock with the new electrical timepieces that operate from the light socket.

This is the dealer's opportunity to create additional profits—and now is a good time to start. Now, when the wedding and anniversary gift season is at its best. Hammond advertising in national magazines will feature the wedding gift idea in Hammond All-Electric clocks. The dealer who ties in will benefit. Ask for more information from your jobber or send the coupon below.



Kitchen Clocks
\$9.75



ARLINGTON MODEL \$14.50

The Hammond Clock Company, 2915 N. Western Ave., Chicago, Ill.
Gentlemen: Please send me full details.

Name _____

Address _____

City and State _____

HAMMOND

ELECTRIC CLOCKS

STEWART



The St. James Console Model

Elizabethan Period. Front of solid walnut ornamented with genuine hand carving and Redwood Burl overlays. Silent sliding doors. *One of Four New Models.*

STEWART-WARNER

WARNER

A GREAT RADIO

« « BACKED BY » »

A GREAT NAME

And the Fairest Franchise in the Industry

Whereas the former series of Stewart-Warner 7-Tube Screen-Grid Radio left little to be desired in beauty and quality of performance, the new Stewart-Warner "Century" Series, now offered, embodies an even greater degree of excellence and "sales urge."

Among the outstanding improvements of this new line are:—A new and superlative Audio System possessing a uniform tonal range extending far beyond limits hitherto possible; an improved, stable, non-oscillating *screen-grid* radio frequency circuit, with uniform maximum sensitivity and selectivity throughout the tuning range; superior trouble-free resistors; automatic voltage control; and new electro-dynamic reproducer.

All mounted on a splendid gold finished chassis. And housed in cabinets of new and exquisite beauty. In choicest matched hardwoods with *genuine* hand-carved decorations.

The Stewart-Warner Franchise is free from red tape—liberal—above-board. With it goes a *public confidence* that money cannot buy—that takes root in 27,000,000 users of Stewart-Warner products—that makes sales easy and profits sure. Details of this franchise are yours on request. If on the lookout for a new radio connection—one you can bank on for the *future* as well as for the present—here it is! Territories are closing fast. Write us today. Stewart-Warner Corporation, Chicago, Illinois.

Four Handsome Period Models—from \$99.75 to \$197.50 (less tubes)

RADIO » » » »

Belden Aerial Kits

*Sell Them
Good Aerials
at a
Profit!*

Belden Shielded Lead-in Wire



Belden Shielded Lead-in Wire is solving the problem of troublesome interference for thousands of dealers and servicemen.

Belden Shielded Lead-in Wire consists of stranded cable with Easy-Strip Rubber Insulation enclosed in a braided shield of tinned copper wire. In service the shielding is grounded, and thus protects the signal energy from interference caused by high tension lines, motors, and similar disturbances. Write for explanatory bulletin.

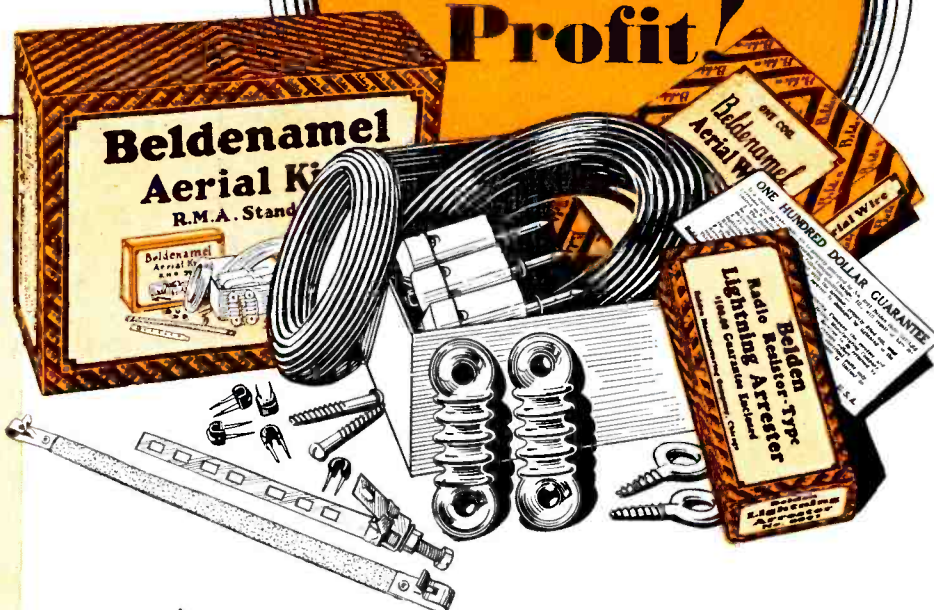

A GOOD AERIAL is just as essential to the finest reception as good tubes. One manufacturer says, "25% of our service calls are caused by faulty aerials." Belden Aerial Kits and Belden Radio Accessories provide aerial equipment that is absolutely unsurpassed.

By selling a Belden Aerial Kit with every set you provide for your receiver the best aerial equipment possible. By "throwing in" cheap aerial material you not only lose your fair profit, but you permanently handicap the receiver.

Belden Aerial Kits have full size 7x22 wire, Belden Bakelite Lightning Arresters with \$100 guarantee, Ground Wire with Easy-Strip Rubber Insulation, and other accessories essential to a high grade aerial.

Again this year Belden Aerial Kits and the complete line of Radio Accessories will be advertised in the Saturday Evening Post.

Stock the complete Belden Line; it means extra profit on every service job and on every set you sell!

BELDEN MANUFACTURING COMPANY
4667 W. Van Buren Street Chicago, Illinois

Belden

Aerial Kits and Accessories

Sentinel ▲ ▲ ▲

Dollar for Dollar ▲ ▲ ▲ Tone for Tone

*the greatest value on
the radio market today*

JUDGED as radio prospects judge radio — on the basis of *price* and *performance* — the new Sentinel is the best buy on the market. More dealers are learning this truth every day!

Everything you can ask of a radio receiver Sentinel does superlatively well. Its eight tube screen grid chassis — with *four* screen grid tubes—has power, sensitivity, selectivity—to unusual degrees. And its tone — from its nationally famous dynamic speaker — is life-like and undistorted over the whole musical range.

Yet it is popularly-priced for volume sales in the hard competitive market of 1930. And the line includes a fine combination — at a price at which you usually sell a radio alone!

Saturday Evening Post Advertising

Saturday Evening Post advertising has told the story of Sentinel's excellence at sensible prices to thousands of your prospects. National newspaper advertising now carries the same selling story to thousands more

If dollar for dollar value, as well as fine performance, is important to your prospects — Sentinel will increase your sales. Order both the radio and combination today. They will prove their value in your store. We will ship them quickly through your Sentinel Distributor.

UNITED AIR CLEANER CORPORATION

9705 Cottage Grove Avenue

Chicago, Ill.



Model 12

List Price

\$180

(less tubes)

The world's finest combination. Beautifully and compactly designed of burl and butt walnut, with panels of zebra wood. High polished finish. Tapestry in rich colorful harmony with this beautiful instrument. Same chassis as Model 10. Fully equipped with electric pick-up, electric motor, speed regulator, record compartment, and phonograph volume control.



Model 10

List Price

\$127.50

(less tubes)

This new Sentinel has all leading developments in screen grid radio. The cabinet is of burl and butt walnut, designed to a period and with modernistic effects. Panels of zebra wood give it a three toned appearance. High polished finish. Tapestry of harmonious colors gives it a strikingly rich character. Seven tubes. Three screen grid, two in two stages of tuned radio frequency amplification and resistance coupled, two 245's in push-pull, one 180 rectifier. Electro Dynamic Speaker.

*See Sentinel's Display at
the Trade Show, Atlan-
tic City—Booth A-1.*

when people want to save money sell washing machines

In times like these, take your attention off luxury goods and put your effort where it has a chance for reward.



It means something now to sell a device that saves money for the family budget every week! And the home laundry is getting more appreciation today than it has for years.

The Meadows Company offers a splendid set-up to capitalize the wave of economy that is sweeping America.

Meadows has a washing machine for every type of buyer in both rural and urban markets.

The Meadows Model V Select-A-Speed is the finest quality washer made. The electric model retails for \$165.

To reach the low price buyer, there is the Model Y, with a round porcelain enamel tub.

large, soft, black, wringer rolls, altogether an unusually sturdy washer retailing with electric motor for \$99.50.

And for the medium priced field, a great, great bargain in the Model X. A standard, oversized, square-tub, aluminum agitator machine for \$135 electrically equipped.

All Meadows products can be equipped with the new style Model L1 Briggs Stratton four-cycle gasoline engine, built to supply the demand in homes without electricity.

Each model in the line is a well-made, splendid creation, specifically built to fit a certain level of buying power.

Get the details of this great new merchandising plan. Tuned to the tempo of 1930. A specialty selling proposition for a specialty that will sell right now. Write or wire the factory for details.

THE MEADOWS MANUFACTURING CO., BLOOMINGTON, ILLINOIS

MEADOWS THE LINE THAT ALWAYS WINS



... sell the romance of far places ...



... The voice of the tropics . . . the music of strange native instruments . . . foreign tongues out of the air . . . the whisper of waves on coral beaches . . . the intangible, mysterious spell of the Orient . . . Java, Siam, Hawaii . . . Africa, the dark land of romance . . . programs from Australia . . . the bottom of the world.

... A twist of the dial . . . and there! London and the deep toned bell of Big Ben . . . another change . . . they are speaking French from the Eiffel Tower . . . here's Holland, the land of wooden shoes and canals . . . another turn—Russia, Germany, the land of storied castles.

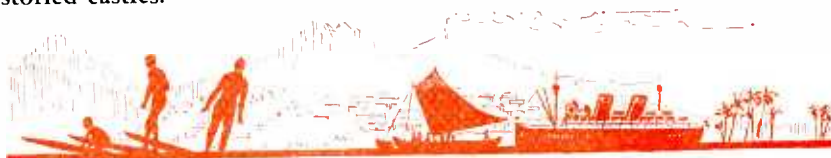

... The Norden-Hauck Super DX-5 short wave receiver is the key to the far romance that fills the air every day!

... Sell it! Sell the fascination that comes from reaching out over the world for strange, new sounds—for the voices and music of far away peoples. Sell Romance with the Norden-Hauck.

Complete all electric operation . . . entirely new R. F. amplifier . . . first commercial receiver using the new pentode tube . . . all circuits tuned with smooth vernier adjustment . . . duplex shielding wide wave length range . . . uses any type loud speaker . . . beauty of design and finish . . . sensational distance . . . extreme selectivity.

List price \$150.00

NORDEN-HAUCK, INC., ENGINEERS
MARINE BUILDING—PHILADELPHIA, PA.



SHORT WAVE
SUPER DX-5
RADIO RECEIVER

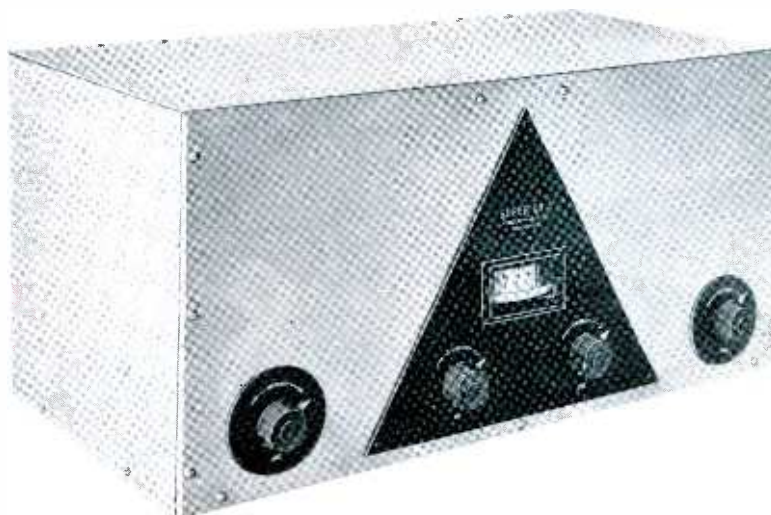

BUILDERS OF THE HIGHEST CLASS RADIO APPARATUS IN THE WORLD

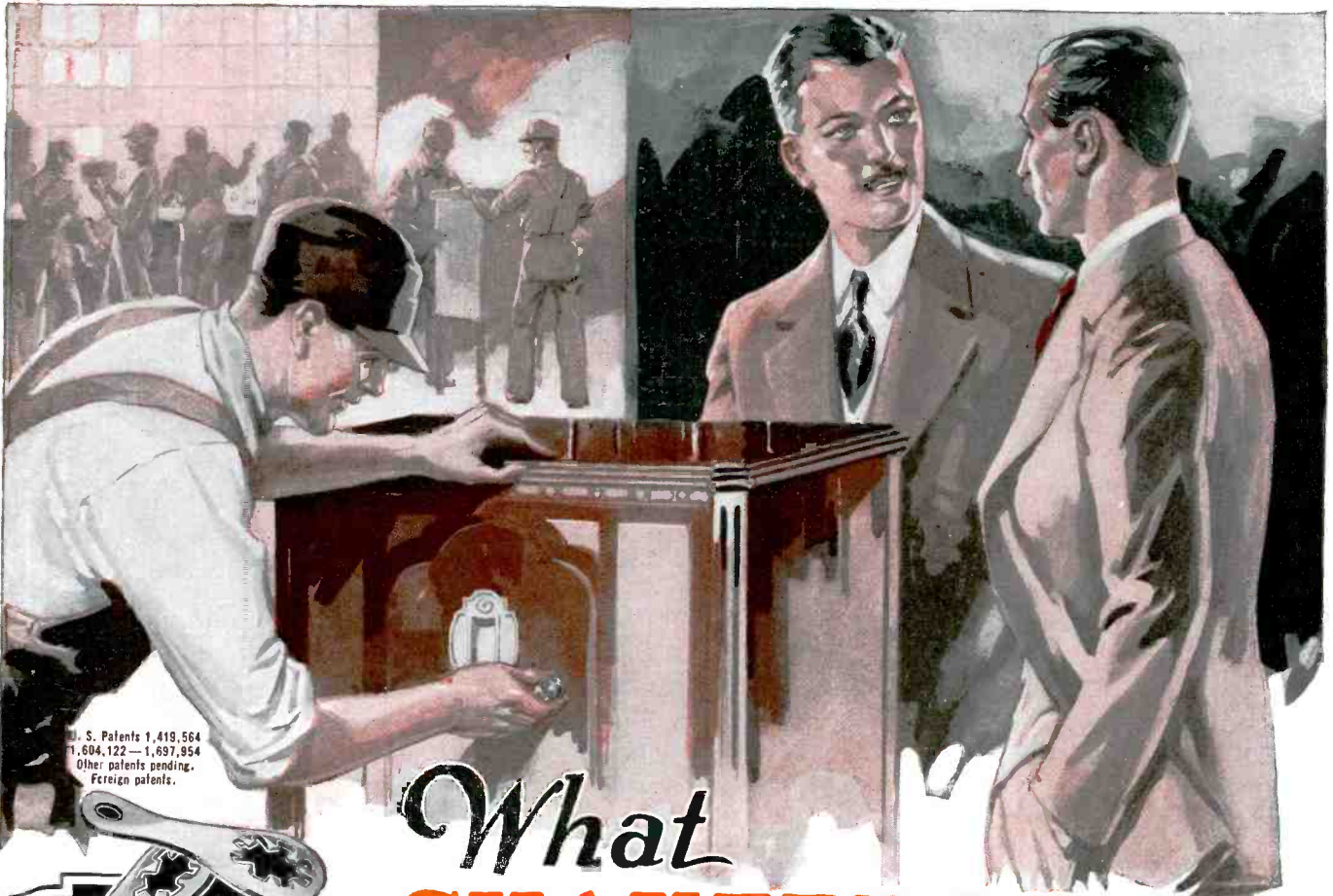

U. S. Patents 1,419,564
1,604,122 — 1,697,954
Other patents pending.
Foreign patents.

What **SHAKEPROOF**

means to the Radio Industry

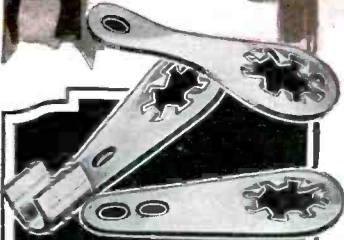

Type 20. Locking Terminals
For Radio and Electrical Work



Type 12. Internal
For S. A. E. and Standard
Machine Screws



Type 11. External
For Standard Bolts
and Nuts



Type 15. Countersunk
For all Countersunk
Screws

EVERY radio manufacturer realizes he is facing a serious situation today. The public is demanding exceptional radio performance at extremely low prices. This means costs must be lowered but it also means that quality must be improved.

That is why practically every leading radio manufacturer is using Shakeproof Locking Terminals to insure absolutely tight connections. They have found by exhaustive tests that the Shakeproof principle has no equal. The twisted teeth provide the strongest contact possible and holds the terminal absolutely rigid thus preventing short circuits or faulty connections. These terminals also cut down production costs and make possible neater assembly work, too!

Shakeproof Lock Washers are what you need under every nut and screw. A test will show that they can improve the performance of your product and reduce service requirements to a minimum. Write for samples today!



"It's the Twisted
Teeth that LOCK"

SHAKEPROOF Lock Washer Company

{Division of Illinois Tool Works}

2531 N. KEELER AVE. CHICAGO, ILLINOIS

MUSIC — The Only Universal Language

Plays the latest hits



**WESTERN
MECHANIC-DYNAMIC
PHONOGRAPH**

(Can also be had in combination with radio)

MUSIC

The life of every Club.
Popularizes the cafes,
dance pavilion and
Summer Resorts.

There are many lo-
cations in your terri-
tory waiting for a new

WESTERN

Lateral record change
—Plays from 1 to 15
records—Fast, reliable
mechanism — True
tone, faithful repro-
duction.

Dealers who heeded the call years ago have
successfully benefited by the progressiveness
of WESTERN policy. Ever alert to the pulse
of public demand, the new Mechanic-Dynamic
introduces a new era in automatic musical
instruments.

Will exhibit at Music Trades Convention, Hotel New Yorker,
New York City, June 9-12.

WESTERN ELECTRIC PIANO CO.

850 BLACKHAWK STREET
CHICAGO, ILLINOIS, U. S. A.

A F E W T E R R I T O R I E S S T I L L O P E N

Now Featured in 1930-1931 Radio-Phonograph Combinations

The NEW BODINE ELECTRIC TURNTABLE

Greater Power...Cooler Motor...Lower Price

"Engineered for Better Music"

Bodine scores another triumph in the new Model RC-12 Electric Turntable! Long experience in the application of electric drives for mechanical reproduction of music has produced this marvelous electric turntable—designed not "Down" to price, but "Up" to the highest standard of fine musical performance.

The Bodine Electric Turntable eliminates the interference and noise which is unavoidable in turntables of cheaper construction. The new unit has a motor of greater power with quicker acceleration. An oversize fan completely ventilates the stator and assures a cooler motor. The new totally-enclosed reduction gear has fewer parts and is more compact and efficient than the old unit.

The new Bodine Electric Turntable is a unit of extraordinary performance—and the new price is so attractive that no manufacturer can afford to equip his radio-phonograph combinations with an inferior unit. Write for literature and prices today. Mail the handy coupon.

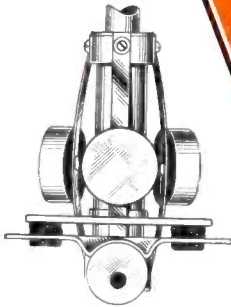

DOUBLE BRAKE GOVERNOR

The new Bodine Governor has a steel brake disk which cannot score and is silent. The governor is easily adjusted for any standard speed by turning knob. A governor shield protects the mechanism.

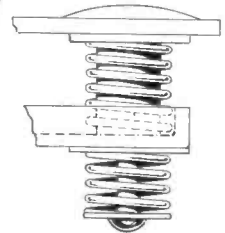

DOUBLE SPRING SUSPENSION

The motor and governor are supported by four double springs provided with dampers which prevent vibrations from traveling to cabinet. No other type of mounting has proved so effective and satisfactory.

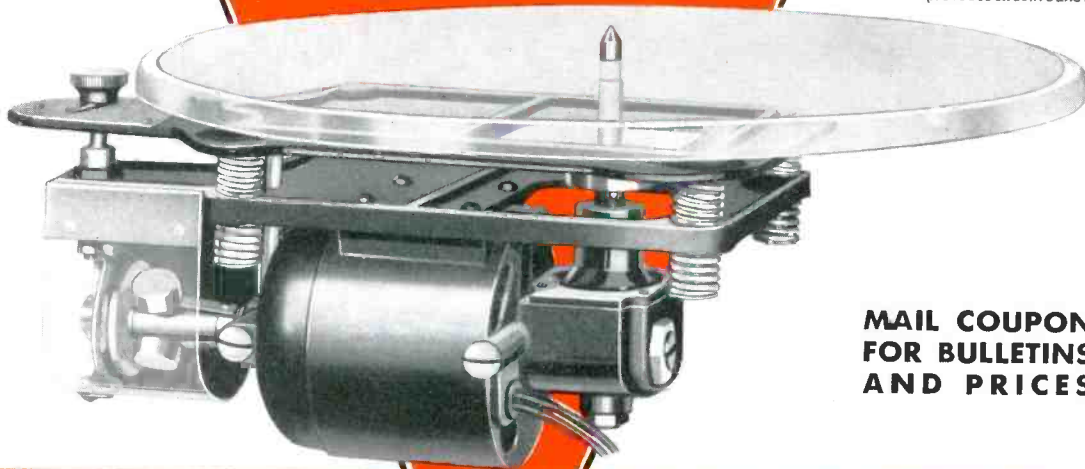

TYPE RC-12 BODINE
Electric Turntable

MAIL COUPON FOR BULLETINS AND PRICES

RADIO MOTOR-GENERATOR SET

Produces interference-free alternating current. Type 1031-R 115 V. D.C. to 110 V. 60 cycle A. C. Type 1037-R 32 V. D.C. to 110 V. 60 cycle A. C. Ideal for demonstrating sets.



SYNCHRONOUS SLOW SPEED MOTORS

1/20 to 1/12 H. P. with speed reducers giving 33-1/3, 45, 60, 78 and 180 R. P. M. Self-starting. Do not "hunt." Sizes from 1/20 to 1/4 H. P. available without speed reducers.



Bodine Electric Co.
2252 W. Ohio Street, Chicago.

Please send us literature on items checked.

- Type RC-12 Electric Turntable.
- Model 1031-R Motor Generator.
- Type SAR Synchronous Motors.

Name.....

Address.....

GET THE NEW DEAL ON THIS GREAT NEW MEADOWS LINE



MODEL X
electric
\$135

MODEL X
gas engine
\$165

MODEL Y
gas engine
\$129.50

MODEL Y
electric
\$99.50

SELECT-A-
SPEED, gas
engine, \$195

SELECT-A-
SPEED, elec-
tric, \$165

HERE'S a new day and a new deal for the washing machine dealer. Get this extra-profit proposition without delay. Write or wire the factory for details.

There is no strata of competition that can't be knocked over with the Meadows line. Different cities and different rural markets present different competitive set-ups. The Meadows line is the answer to everyone. Is your competition mail-order? Then

see how they like selling against the Model Y Briggs-Stratton Gas Engine Meadows for \$129.50. Or is your chief competition a higher-priced washer? Then see how the Meadows Select-A-Speed outperforms and outdemonstrates the whole world regardless of price.

Get the facts on this great new deal on a great new line. No obligation whatever. Write or wire.

THE MEADOWS MANUFACTURING CO., BLOOMINGTON, ILLINOIS

MEADOWS THE LINE THAT ALWAYS WINS

Ken·Rad

Fine Radio Tubes



THE story of these fine tubes is being told to the public NOW—through a new series of full pages appearing in The Saturday Evening Post. This advertising is but one of the many features of the Ken-Rad sales program. And what Ken-Rad tells you Ken-Rad does — and is doing NOW. You owe it to yourself to get all the facts.

THE KEN-RAD CORPORATION, *Incorporated, Owensboro, Kentucky*

A Division of Ken-Rad Tube & Lamp Corporation

AT R. M. A. SHOW • SPACE A-48-49 AND AMBASSADOR HOTEL.

*Marking a New Era in the Radio
Industry... an Era of Dependability
and Permanent Service.....*



RADIO

RMA SHOW ATLANTIC CITY JUNE 2-6 1930



A Message to Radio Dealers

Since the infancy of radio, General Electric has been a leading contributor to the scientific progress which has made your business the greatest in the field of electrical merchandising.

In our research laboratories, scientists have labored year in and year out, discovering and perfecting principles and devices, many of which are so fundamental that we now accept them as matters of course.

Millions of dollars have been spent in this research.

We are now about to extend our activity in the commercial field, and will soon place before the public radio receiving sets on which we are proud to place the G-E Mono-

gram. This act is an event in the life of the Company of equal importance to any of the other milestones which have marked our progress to our present position in the electrical industry.

For thirty odd years we, and those who preceded us, have given our best efforts to make General Electric successful in that which it has undertaken.

This tradition of success is the heritage of those who have been charged with the marketing of the G-E Set. We are massing our resources to the end that General Electric Radio may enjoy the same measure of success which has marked our efforts in other lines of business.

GENERAL  **ELECTRIC**

MERCHANDISE DEPARTMENT • GENERAL ELECTRIC COMPANY • BRIDGEPORT, CONNECTICUT

A sound Progressive Policy assures a PROFITABLE and PERMANENT Franchise for a selected list of DEALERS

UNPRECEDENTED PUBLIC ACCEPTANCE

The name "General Electric" and the G-E monogram enjoy national acceptance and confidence. That confidence is General Electric's password into the homes of America. It is the foundation upon which the success of General Electric Radio will be built.

PRESERVING ESTABLISHED GOOD-WILL

Each individual General Electric Radio set, every phase of the merchandising operation, will be accepted or rejected on the basis of its ability to preserve and enhance the reputation of the name "General Electric".

Because of its confidence in General Electric the public expects the unusual from G-E Radio—from the performance of the set and from those who serve it. General Electric Radio stands pledged to that "unusual" standard.

TURNING G-E GOOD-WILL INTO SALES

Public confidence in General Electric will make millions want to see and hear the G-E Radio. General Electric definitely promises its dealers that these millions will be surprised and delighted with this new product.

RELIABLE, ESTABLISHED DISTRIBUTORS

Supporting G-E Radio dealers is an organization of alert, experienced distributors. Men who know G-E products...how to merchandise them...and are pledged to a new high standard of service. They are selecting dealers desirous of doing business on a permanently profitable basis.

COMPETENT FACTORY FIELD STAFF

In addition to the distributing houses and their field organizations, General Electric has organized a radio field force. Men whose names and reputations are respected and whose abilities and records have been proven. These experienced radio merchandisers will direct the General Electric Radio program in their territories, enabling selected dealers to make the most of the great opportunity which General Electric Radio presents.

DOMINANT ADVERTISING PROGRAM

The vast experience of General Electric in advertising products for home use is back of a nationwide advertising campaign for G-E Radio.

CAREFULLY CHOSEN DEALERS

Dealers will be selected for their ability to fulfill the merchandising responsibility which is expected of them as General Electric Radio Dealers.

If you are that kind of dealer... if the prospect of a permanent, profitable franchise that will grow steadily in value and volume from year to year appeals to you—make a point of seeing your local General Electric Merchandise Distributor at once.

IF YOU WILL BE AT THE RMA SHOW AT ATLANTIC CITY—SEE NEXT PAGE

Every G-E RADIO DEALER will have the full resources of GENERAL ELECTRIC behind him!



The Men back of
GENERAL  ELECTRIC
RADIO
wish to see **YOU**
at the **RMA Show**
ATLANTIC CITY
June 2-6 1930



 *Please*
accept this as a
PERSONAL *Invitation*

Radio's Fastest Growing Business

Can't Gamble on Tubes—Can You?

All over the world users of Pilot radio products

parts and tubes are increasing tremendously month after month—The standard of excellence which Pilot parts and PILOTRON tubes must meet is not just that of bringing in stations within 5 to 500 miles but there are PILOT short wave listeners scattered over both hemispheres keeping contact with broadcasters thousands of miles away with PILOTRON Radio Tubes. To them a dud radio tube is a real tragedy—they must have the absolute tube dependability which PILOTRON tubes endorsed by professionals give.

You haven't seen Pilotrons cut and you will not

—nor have you seen PILOTRONS disguised under aliases. YOU NEVER WILL because no such thing as PILOT seconds exist. Every PILOTRON that doesn't meter up to first grade standards in every characteristic gets dumped on the ash pile—not on the Radio Market because not only PILOTRONS' but PILOT'S whole reputation is at stake.

Pilot with its International business and strong financial

resources could afford to mark time and to wait while others ruined their reputation or their product by being compelled to dump tubes on the market or go broke. The public is buying millions of dollars worth of Pilot Products a year, besides PILOTRONS, all yielding LIST PRICE PROFITS to Franchised Pilot Dealers.

The ONLY Factory-To-Dealer Franchise on tubes

as well as Auto Receivers, kits, etc. Now Pilot is ready to talk to the right kind of new dealers about selling PILOTRON, the tube which already enjoys a special demand and which you need never cut to meet competition, because PILOTRON is the only tube for which the dealer is a direct Factory representative.

Too many tube makers feature the guarantee and the

ability to make replacements because they expect replacements. PILOTRONS too are guaranteed liberally and completely but Pilotrons are made with the avowed intention that the guarantee won't be needed. Pilot is selling tube satisfaction not replacements.

Pilot Progressiveness in Product and Publicity means Profit

to progressive Dealers who can meet Pilot requirements. The recent front page stories about the history-making Bermuda flight of the airplane Pilot Radio is just one example of the scope of PILOT promotion. The dealer who is fortunate enough to secure a Pilot Franchise is assured of direct factory cooperation in all forms of advertising—a tie-up that builds both prestige and profit. There may be a Pilot Franchise open in your town—write for details.



The **AUTO PILOT**



A Full Screen Grid Broadcast Receiver Kit

Bolts on Running Board
Remote Control and Speaker Placed Anywhere
Simple to Install—No Carpentry—No Marring Car
Clear toned and powerful. Aerial attaches under car

KIT K-140 LIST Complete with aerial \$47.50
(Less Pilotrons and Speaker)
Another Money Maker for Pilot Dealers

Pilot Super-Wasp Short Wave Kits
CASH IN ON THIS
NEW THRILL IN RADIO

World Wide Short Wave Reception
Without Re-broadcasting

An entirely new field is opening up for enterprising Radio Dealers. People are discovering not only that they can hear Foreign Stations day and night but they can also hear some of the finest programs from some of the biggest stations in the U. S. A. day and night consistently which they cannot hear on any set confined to 240 to 500 meters. A short wave set is the greatest static eliminator.

Ask about Pilot's Double Duty Kits
14 to 500 Meters. LIST \$29.50 and \$34.50.

PILOT
RADIO &
TUBE CORP.

Chicago Sales Office
234 So. Wells Street

Factories at Lawrence, Mass.

323 Berry Street, Brooklyn, N. Y.

San Francisco Sales Office
1278 Mission Street

Atlantic City Show Headquarters—Hotel Ambassador

NEW-1931

BALKEIT 8-TUBE A.C.

SCREEN GRID

*The Latest Triumph in 3 Screen Grid
Radio Engineering*



\$125⁰⁰
LESS TUBES

THE-SET-WITH-INSTANT-APPEAL

You will find the Balkeit 8-tube set the greatest advance in engineering that has been accomplished in years. It uses 3 screen grid tubes, 4 gang shielded condenser and 245 push pull.

A demonstration shows a marked superiority in tone qualities—sharp tuning—clarity—power, and an entire absence from hum.

Because it is designed and engineered specifically for Screen Grid tubes and is not merely a makeshift—it brings out the full value of the Screen Grid tonal qualities. This set is outstanding in its sturdy construction, excellence of parts and operating perfection. It enables you to give your customers an outstanding value.

This set is licensed by RCA and is fully guaranteed by the factory. It is particularly noticeable for its selectivity which permits complete station separation—for its beautiful tone and *great power*.

Notice the handsomely engraved new style tuning arrangement. No knobs to control. Perfectly counter-balanced.

Cabinet beautiful, of walnut and maple. May be blended with the most costly or modestly furnished home.

Jobbers: Write for our proposition now.
Only a few available territories open.

VISIT
OUR EXHIBIT
D-40
ATLANTIC CITY
AUDITORIUM

National Transformer Mfg. Co.
205 West Wacker Dr., Dept. 12,
Chicago, Ill.
Factories at North Chicago, Illinois



*Electric
Automatic*

*Easily
Attached to Any
Make of Radio*

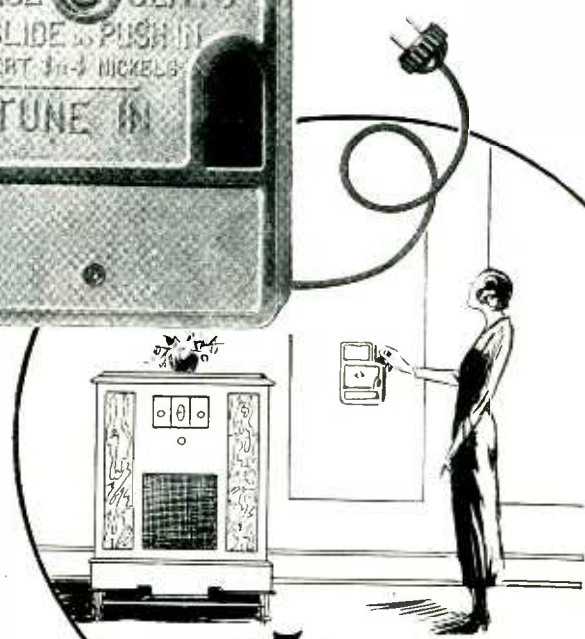

Slusser

COIN-RADIO ATTACHMENT

Every Public Place Is A Prospect

Paying as much as \$40.00 per month and quickly attachable to any radio, the Slusser Coin-Radio Attachment offers unusual sales and profit possibilities to every radio dealer.

It's automatic—needs no winding—simply plug radio into it and attachment cord into light socket. Operates only when a nickel is inserted—each nickel operates the Radio for six minutes. Rejects slugs, pennies and the like.

Every public place will want a Slusser Coin-Radio Attachment. Cash in on this new source of quick profit. Write for prices and discounts at once.

Frank E. Pierman, Manufacturer
OTTAWA, OHIO

G R A Y B A R
WILL ANNOUNCE
NEXT MONTH
A NEW AND
IMPROVED LINE
OF RADIO SETS
SEVERAL REMARK-
ABLE FEATURES
LOOK FOR IT

The experience built into FLYER Electrics

The perfection of service achieved by Flyer Electric Phonograph Motors is in no small measure due to *balanced experience*.

As a manufacturer of phonograph motors, during the last 15 years General Industries has produced as high as 600,000 spring-power motors annually, with a total output of over 5,000,000. Motors famous for their uniform speed under all conditions. Famous also for their high dependability and long service.

On the electrical side, in the same plant for a quarter century our same manufacturing organization has produced light electrical apparatus with similar success and distinction.

Just as perfection of balance in power is one of the highest essentials in phonograph motors, so also is *balanced experience* invaluable to production of the modern electric phonograph motor.

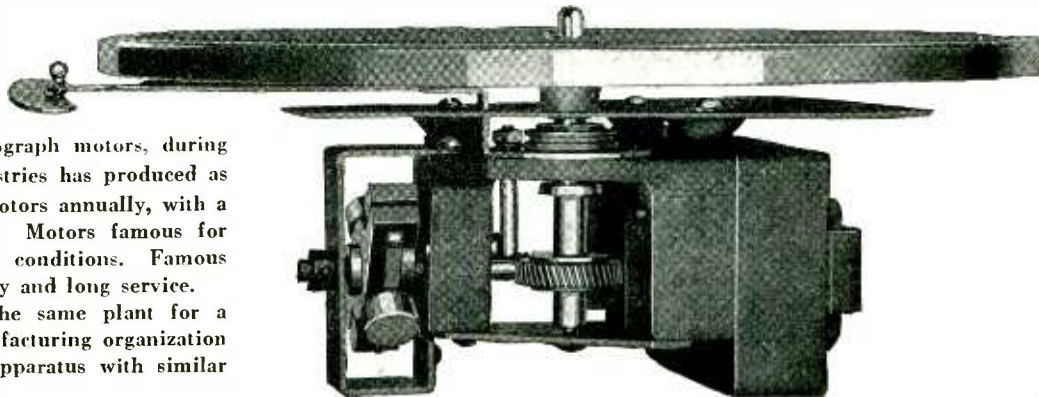

The Green Flyer Electric Phonograph motor. Small and light, yet dependably supplies uniform speed under severe variations of voltage and record drag. Specially designed for record playing. Open construc-

tion with complete ventilation; will not overheat in closed case or cabinet. Operates on all voltages and frequencies. Automatic Stop equipment is optional.

The GENERAL INDUSTRIES CO.

For clock mechanisms, our Lorraine Synchronous Electric Motor.

3043 Taylor Street, Elyria, Ohio

Responsibly Guaranteed

New literature is ready . . .

IT WAS made up for you . . . showing the Concourse line of transformers, chokes, condensers, power packs, replacement parts manufactured in our spacious, well-equipped factory for the most exacting members of the radio-electrical industry. We want to do business with you, and are sure that when you appreciate the quality of our merchandise and the fullness of our service, you will enjoy dealing with us.

Wholesalers, write us at once.

CONCOURSE
ELECTRIC COMPANY, INC.

296 East 137th Street



New York City

MANUFACTURERS

We specialize in the special transformer, condenser and coil winding needs of individual production.

Send us your specifications; our experts will recommend and quote prices.

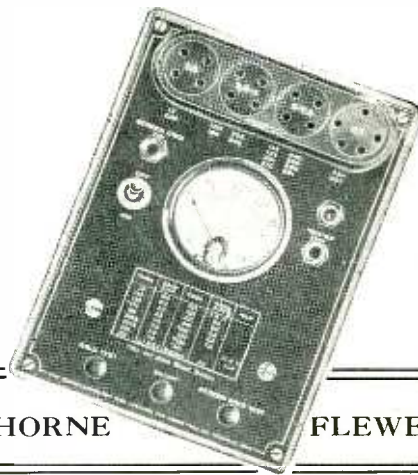

VAN HORNE

FLEWELLING

The New Improved FLEWELLING TUBE CHECKER

A New Improved model of the most popular tube checker ever sold.

Checks tubes three times as fast as other checkers. Checks any kind of tubes, screen grid, pentode, Carbon, Kellogg, etc., without adapters. All sockets in numerical order marked with voltages and tube types.

Patented shunt device protects against "shorts" in tube or imperfect contacts on push buttons.

Unconditionally Guaranteed against any and all defects.

Popularly Priced—Far less than other high quality checkers.

Most good jobbers the country over are stocking this popular new-type checker. If your jobber does not, write direct to Tube Checker Division of

VAN HORNE TUBE CO., Franklin, O.
Manufacturers of Van Horne Certified Radio Tubes

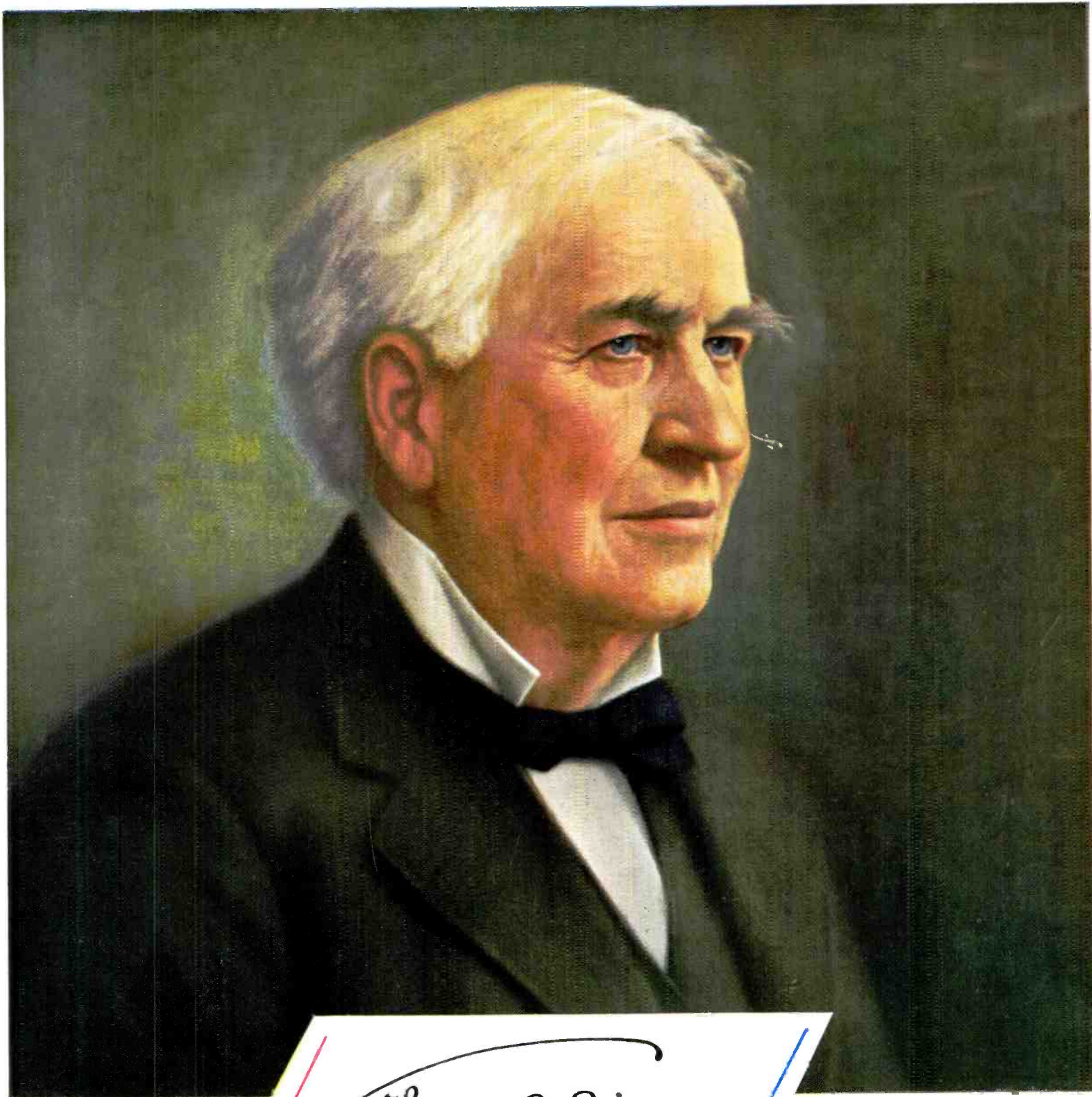

Thomas A Edison



HIS IS the man who discovered the fundamental principles on which radio and the radio tube are based—the man who built the first microphone, without which broadcasting would not have been possible ••• Now from his Laboratories comes the Edison Light-O-Matic

Radio—the *perfected* radio—the radio the world so long awaited and now so widely acclaims ••• In seeking permanency, on which to build a sound, profitable business, where else can any dealer find so great a man, so great an organization or so great a radio?

EDISON LIGHT-O-MATIC RADIO

EDISON



Model R-6. Here is the Edison triple screen-grid set, super-selective, yet super-sensitive. It employs nine tubes — three '24's, three '27's, two '45's in balanced push-pull arrangement, and one '80 rectifying tube. Automatic volume control, without sacrifice of sensitivity. Adjustment provided for acoustic requirements of individual installations. Its cabinet is a noteworthy example of superb design and craftsmanship. Beautifully finished in walnut, with panels and doors carved after a fine old linen-fold design. \$297 (less tubes). Prices slightly higher in the far West.

ADVANCED RADIO! Radio replete with the most modern developments — yet fully perfected with characteristic Edison thoroughness ● ● ● Two years ago the advent of the Edison Radio proved the high expectations of the trade and the public to be more than justified. And now, two years of success founded on sound policies and fair dealing have doubly confirmed Edison's right to leadership ● ● ● Again this year Edison leads with *truly* advanced radio. Two powerful circuits are presented in five cabinet designs — radios that in actual performance produce the results rightly expected of Edison. Both circuits, Edison-screen-grid and Edison-neutrodyne, are ready for home enjoyment — not home experiment. The Edison is the dependable modern radio that dealers everywhere are finding it profitable to sell.

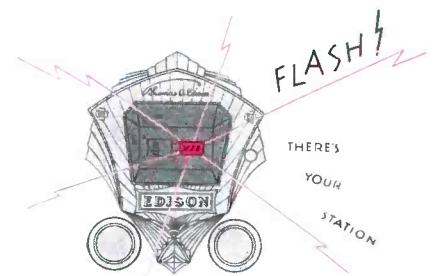

All Edison models — and only Edison — possess Light-O-Matic Tuning, which instantly, easily and accurately brings in the listener's favorite stations, announcing each arrival with a flash of light.

LIGHT-O-MATIC

RADIO

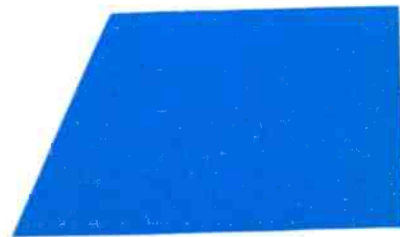

VISIT THE EDISON DISPLAY AT THE
ATLANTIC CITY SHOW
EXHIBIT — BOOTHS B 33-34 AUDITORIUM
DEMONSTRATIONS — BOOTH B-B 1 AUDITORIUM
AND AT THE AMBASSADOR HOTEL

CABINET BEAUTY! Edison Radios deserve cabinets in keeping with their perfected electrical excellence • • • All models look their part as well as play it. The beauty of their design is a result of their being creations of the Edison Laboratories. The selected woods and the master-craftsmanship reveal that Edison standards are of the same high character throughout • • • Edison dealers can be as proud of Edison cabinets as they are of the sets — and find them a great factor in promoting greater sales!



Model R-7 is identical in circuit and electrical appointments with the R-6. Played at full volume, this radio gets all that the radio performers have to give — played at a whisper, it still gets everything — every detail of treble and bass. Its cabinet work, like that of its companion model, is distinguished. It, too, is finished in walnut, with doors carved in linen-fold design and panels quarter-matched. \$268 (less tubes). Prices slightly higher in far West.

EDISON LIGHT-O-MATIC RADIO

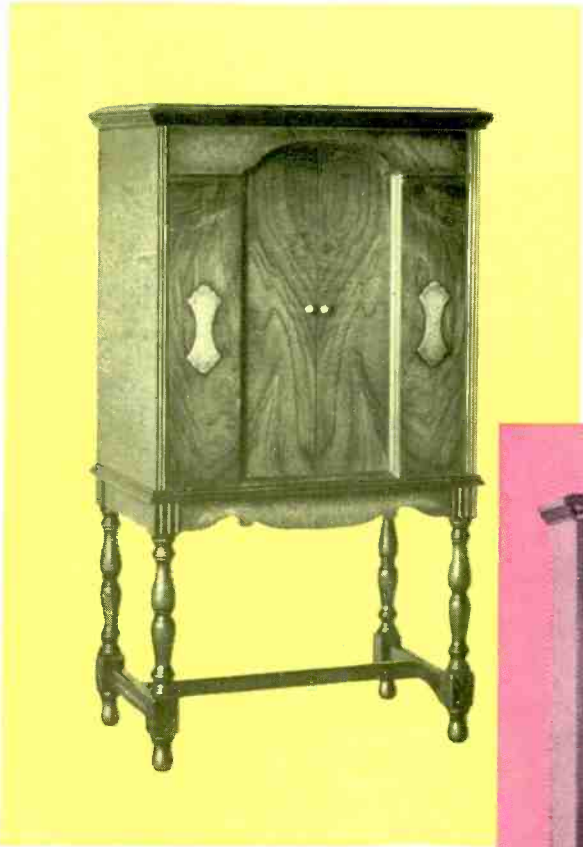

Model R-5, above. Pure in tone—and powerful. Constant gain Edison-neutrodyne circuit, employing five '27 tubes, two '45 power tubes and one '80 tube. Cabinet is finished in walnut with matched butt walnut pilasters. \$175 (less tubes). Also available for DC operation.*

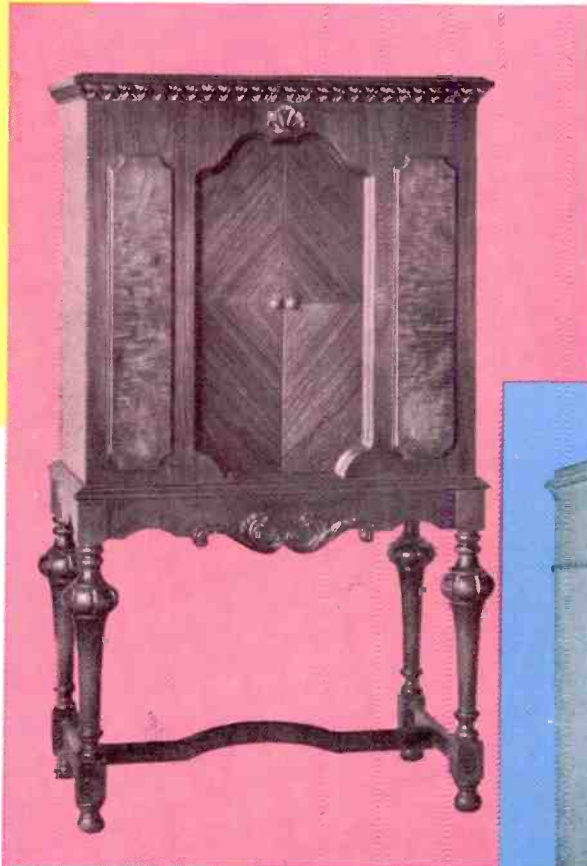

Model R-4, below. The same efficient circuit as the R-5, housed in a more massive cabinet. Blended walnut finish, with quarter-matched sliding doors and raised butt walnut panels. Appearance is enhanced by carved moldings and ornaments. \$215 (less tubes). Also available for DC operation.*



*Model C-4, below. Radio and Phonograph Combination. Plays all makes of needle records with the same radio-realism that characterizes the Edison Radio. Same radio circuit as Models R-4 and R-5. A cabinet in walnut finish of impressive beauty. \$225 (less tubes)**

TWO years of Edison Radio, backed by more than a half century of electrical and acoustic research in the Edison Laboratories! Two years that are merely an index to what the name Edison means to the radio future.

In spite of the price wars, the over-production and the general frenzied chaos with which the industry has been beset, the Edison has forged dramatically

forward. It has proved itself as great as the name it bears. It has won the confidence of the public and of the radio dealer . . . confidence built on the greatness of the Edison name...on the super-ness of the Edison Radio . . . on the stability of the Edison line. It is the kind of confidence out of which grow business and profits for radio dealers.

** Prices slightly higher in the far West.*

DESIGNED AND BUILT IN THE LABORATORIES OF *Thomas A. Edison*, ORANGE, N. J.

TUDOR—a profitable new leader for a well-established line!

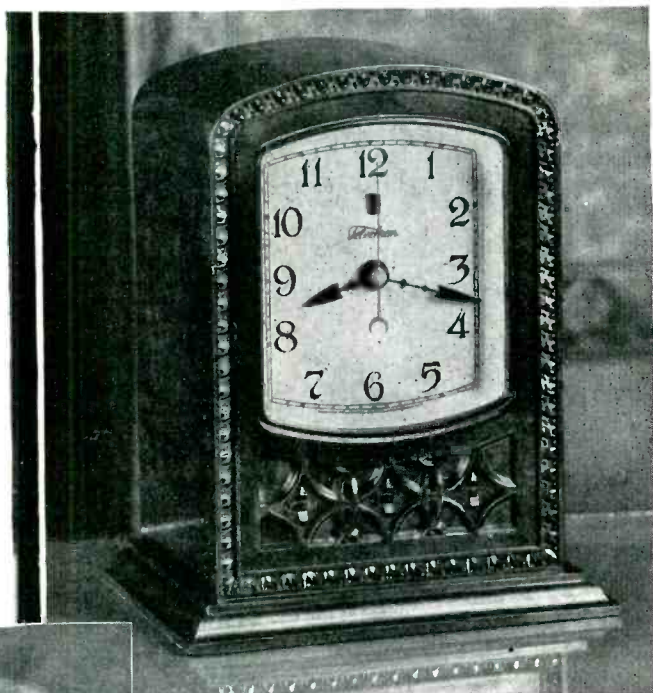

TUDOR, shown at left, is the newest member of the Telechron* clock family and already one of the most important. Its Bakelite case, mottled walnut color, its three-inch cream-colored dial, its classic design, make Tudor most attractive. It will fit almost anywhere in any home. And, by its unusually low price of \$9.75, it simplifies your selling job.

But Tudor is only one of the many other attractive designs. Designs of distinguished beauty—in rich woods and metals. Giving you by far the broadest range of styles and prices you have ever offered your customers. All of them delivering accurate electric time from the light socket—without winding, oiling, cleaning or regulating. All of them backed by a dominating advertising campaign in eleven leading national magazines.

This new model will make the Telechron franchise even more profitable than it is already. Plan to make the most of it! Get the full story today. Clip out the convenient coupon below.



CLINTON. Model No. 370. Illuminated dial. Retail price, \$20.

- TUDOR. Model No. 356. Bakelite case. Retail price, \$9.75.
- MAGNOLIA. Model No. 652. Mahogany case. Retail price, \$40.



Telechron
ELECTRIC TIMEKEEPERS

WARREN TELECHRON COMPANY
601 Main Street
Ashland, Massachusetts

Please send me information on Telechron electric timekeepers and details of your authorized dealer franchise.

Name _____

Address _____

*Telechron is the trade-mark of Warren Telechron Co., registered in U. S. Patent Office



**HOLED-TITE INTERIOR PACKING
FOR KITS OF 5 TO 12 TUBES**

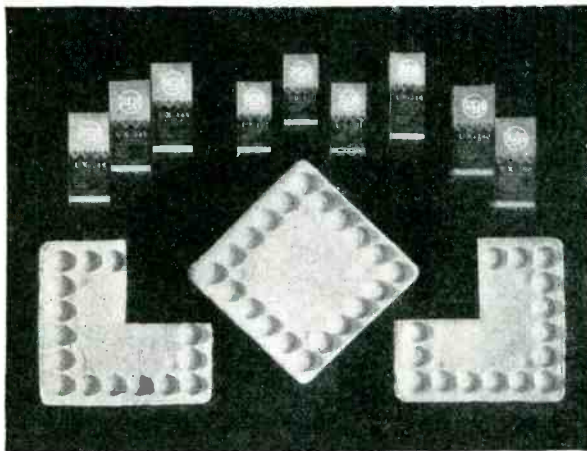

THIS IS EVERYTHING NEEDED TO PACK A 9 TUBE KIT
ready to place into corrugated carton

**TUBE KITS NOW PACKED
THE HOLED-TITE WAY**

Prevents breakage, costs less, requires smaller shipping carton. simplifies packing, *eliminates mussy excelsior.*



HOLED-TITE PACKING CORP
100 E. 42nd St., New York, N. Y.
Affiliated with International Paper Co.

Simplify your kit packing problem. Pin coupon to letter-head and

MAIL AT ONCE

"PROTECT the HEART of the RADIO"

Holed-Tite moulded pulp pads are standard in use by most large tube manufacturers.

<input type="checkbox"/>	<input type="checkbox"/>	<input type="checkbox"/>	<input type="checkbox"/>	<input type="checkbox"/>	<input type="checkbox"/>
<input type="checkbox"/>	<input type="checkbox"/>	Send us sample kit packed the Holed-Tite way.	<input type="checkbox"/>	<input type="checkbox"/>	<input type="checkbox"/>
<input type="checkbox"/>	<input type="checkbox"/>	Brand, number and quantities of tubes used in our principal kit are:	<input type="checkbox"/>	<input type="checkbox"/>	<input type="checkbox"/>
<input type="checkbox"/>	<input type="checkbox"/>	<input type="checkbox"/>	<input type="checkbox"/>	<input type="checkbox"/>
<input type="checkbox"/>	<input type="checkbox"/>	<input type="checkbox"/>	<input type="checkbox"/>	<input type="checkbox"/>
<input type="checkbox"/>	<input type="checkbox"/>	<input type="checkbox"/>	<input type="checkbox"/>	<input type="checkbox"/>	<input type="checkbox"/>
<input type="checkbox"/>	<input type="checkbox"/>	<input type="checkbox"/>	<input type="checkbox"/>	<input type="checkbox"/>	<input type="checkbox"/>

**THE
ANTENNON**

A . . .
**Perfect
Aerial
Eliminator . . .**

WHY

do jobbers continually ask for exclusive distribution of the ANTENNON? Because they have satisfactorily tested it

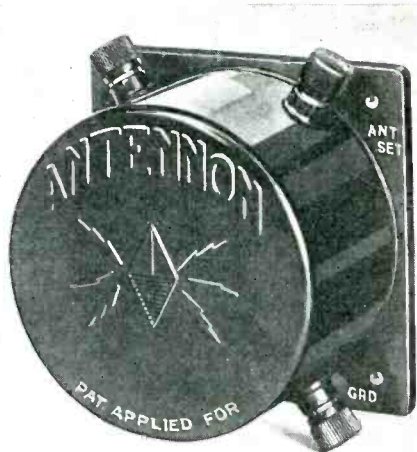

on all makes of sets and found just what they have been waiting for. Same results as a 60 ft. aerial, lasts a life time, easily installed. Takes care of the entire broadcast frequencies, and an appearance that classifies the ANTENNON with the better kind of accessory.

Your Jobber or

ANTENNON RADIO CO.
2648 MAIN ST., BUFFALO, N. Y.

DURHAM Metallized Resistances are selected by service men for the same reason they are specified by set makers—greater accuracy and longer life.

There is a DURHAM Resistance for every replacement purpose. Data sheets and prices sent promptly upon request.

DURHAM METALLIZED
RESISTORS & POWEROHMS
INTERNATIONAL RESISTANCE CO.
7006 Chestnut Street, Philadelphia, Pa.

A New Tested Line of Synchronous Motor Clocks Perfected by SESSIONS

This announcement might have been released many months ago. It wasn't. A vital Sessions policy forbids "the introduction of new lines until long periods of exacting tests have proved the product fit in every detail against conditions more severe than it will be called upon to meet."

- Electric Clocks by Sessions! A name that millions long have coupled with style and reliability in clocks within the reach of all. An unusual variety of exquisitely-grained hardwood cabinet styles, selected in the light of more than a century of making and selling nationally advertised clocks. Fitted with a hardy fool-proof synchronous motor. Every clock in the line has the popular Sessions legible raised numerals.

• Three of the Sessions electric models are shown on this page. Look them over. Note their prices and the Sessions reputation for value in clocks.

• Jobber, retailer...we invite your inquiry for detailed information and prices.

• The Sessions Clock Company, Forestville, Connecticut.

EL DORADO
Electric

A handsome 22½-inch Banjo with inlay design. Polished brass trim and sash. Convex glass. Finished in Mahogany, Rose, Green or Ivory. Retail for \$16.50



ELF Electric

Below. An all-purpose wall clock finished in Rose, Blue, Green or Ivory. Retail for \$9.75

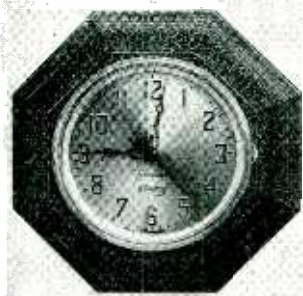

ELKINS Electric

At right. A popular 14½-inch Tambour with genuine mahogany case and inlay design. Design is a composite of public preference trends in clock style. Retail for \$15.75

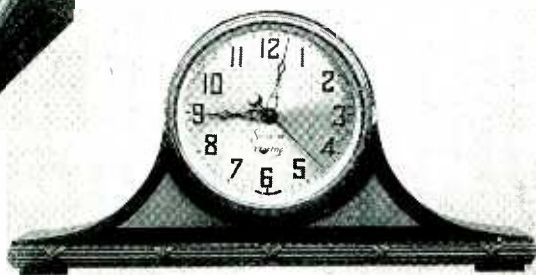

Sessions Electric Clocks

Millions Every Day Hear Sessions Broadcasting From These Radio Stations:

In the EAST, WOR, New York, WOKO Poughkeepsie, N. Y., WHEC Rochester, N. Y., WIP Philadelphia, WWVA Wheeling, W. Va., WAPI Birmingham.

In the MIDDLEWEST, WTAM Cleveland, KYW Chicago, KMOX St. Louis, KMMJ Clay Center, Nebr., WDAY Fargo, N. D.

In the WEST, KGO San Francisco, KOL Seattle.

A SENSATION IN THE TALKING MACHINE WORLD

The **CONCERT-TROPE**
 AUTOMATIC PHONOGRAPH



**A 'Sound' Investment
 See Us At the Show**

**[[Booth No. D-62, Demonstrating Room]]
 in the Ambassador Hotel**

Concert-Trope

1. Plays 64 selections continuously.
2. Changes records in 10 seconds.
3. More income per hour.
4. Highest quality units used throughout.

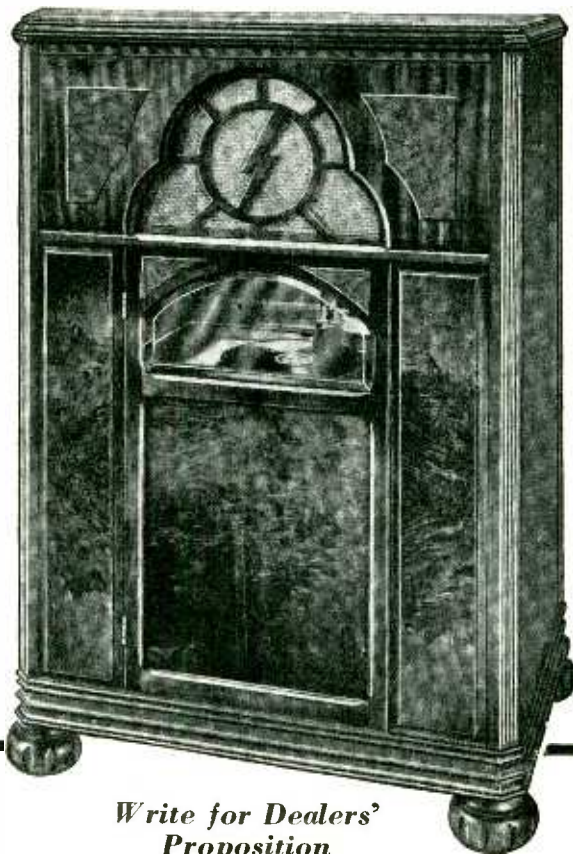

Concert-Trope

5. Finest tone qualities.
6. Positive action.
7. Extreme simplicity.
8. Few working parts.
9. Beautiful dignified design.

*Write for Dealers'
 Proposition*

**CONCERT-TROPE MANUFACTURING CORP.
 Indianapolis, Ind.**

SPEED IN CHANGING RECORDS MAKES MORE INCOME PER HOUR

The entire trade has asked
... what will PHILCO do?

Here it is!

Philco is going *ahead!* The radio dealer who concentrates on Philco *also* is going ahead!

Philco dealers have sailed right through the recent unsettled conditions *in better shape than their neighbors.* There has been no Philco "dumping" . . . no overstocking . . . no obsolete models and *no distress merchandise.*

Think this over, gentlemen, before you sign up with any *new* proposition to handle *untried radio sets* . . . take it easy until you *see* the new Philco line, and the new Philco proposition, *because we assure you that Philco dealers will again make real money in the radio business.* Here are some of the high spots in the new Philco program:

Philco Tone-Control — Radio's Newest Marvel ◻◻◻ New
Red-Hot *Complete* Line of Models ◻◻◻ Amazing Prices —
Startling Values ◻◻◻ New Combination Radio-Phonograph
—A Masterpiece ◻◻◻ Four Marvelous New Chassis — Super-
performance ◻◻◻ Station Recording Dial ◻◻◻ Gigantic National
Advertising — Local Cooperative Advertising ◻◻◻ Greater
National Broadcasting — *And* Local Broadcasting ◻◻◻ More
Philco-Paramount Picture Tie-ups ◻◻◻ Greatest Dealer
Program of Sales Helps ever staged ◻◻◻ Dealer Protection
— Philco Sets in Philco Cabinets *only* ◻◻◻ Generous
Discounts — Assured Profits ◻◻◻ *And* Balanced Units —
Philco *Undistorted Tone.*

All for the dealer who concentrates on Philco

● **TURN HERE**

Again Philco leads TONE-CONTROL, assuring

Here's the new line; backed by a program

This line will dominate the market. It is brand new; *complete*. It meets the demand for beautiful furniture *plus* amazing performance. You have only to glance at these models to see that they are *quality*. Then look at these prices and you realize at once that these are the *values* that positively will not be equalled this year. Concentration on this *complete* line will give you maximum discounts, protection against obsolete models, increased turn-over and greater *profits*. That's the way to insure your future in the radio business and Philco has planned its merchandise and its policies to *make money for the Philco dealer*.

Highest Quality · Amazing Prices · No Obsolete

Philco Announces Radio's Newest Marvel...PHILCO TONE-CONTROL

**4 different shades of tone—
"Brilliant"... "Bright"... "Mellow"... "Deep"**



Now—by simply turning the Philco Tone-Control knob, any Philco owner of the new 1930 models can instantaneously adjust his Philco to speech, symphonic music, jazz, crooning, or, if he should happen to be in a noisy location, he may cut down the noise and enjoy the program in a way never before possible. "Brilliant"—"Bright"—"Mellow"—or "Deep" shades of tone are now at his finger tips.

PHILCO Tone-Control means perfect demonstration for every ear, program or location. It costs money to make home demonstrations, but with the new Philco, you are more certain than ever of turning the demonstration into a sale.

Regardless of the type of program, regardless of the character of the broadcasting station, regardless of the location, or regardless of the prospect's idea of what tone should be, a demonstration made with Tone-Control enables the prospect to adjust his set to either "Brilliant"—"Bright"—"Mellow"—or "Deep"—and thus secure for the first time the kind of tone that he prefers.

Never again will you have to make excuses and allowances for harsh and noisy stations. Never again will you lose a sale because the prospect

thinks that the tone is not all that he personally prefers.

Philco, through its national advertising and broadcasting, is going to make the public "Tone-Control Conscious". This is the most sensational improvement in radio this year, and it is going to sweep the country like wild fire, because the public cannot help but appreciate its tremendous value from the very instant they first hear the new Philco models demonstrated with the new Tone-Control.

Don't neglect to let your prospects work the Tone-Control as much as they please. It is not a toy—they can't break it, and it will turn demonstrations into sales. "Brilliant"—"Bright"—"Mellow"—or "Deep" shades of tone will win over any reluctant purchaser in 1930.



**Philco's New 9-Tube
Radio-Phonograph
Only 198.00**

*Model 96 Radio-Phonograph—*The cabinet speaks for itself. Pillasters and record compartment door of figured, matched butt walnut. Instrument panel of V-matched, Oriental wood. Top and side panels of American walnut. **FOR THE FIRST TIME IN THIS BUSINESS** the Philco exclusive balanced-unit principle of perfect tone production AND Philco's new Tone-Control are applied to the reproduction of phonograph records. This wonderful new musical instrument uses for the first time a new and greatly improved electric pick-up. **WHAT** a drawing card!

With PHILCO TONE-CONTROL

PHILCO'S FOUR

A GAIN Philco produces the receiving sets which we confidently predict will lead the field. Here you have the new Philco Tone-Control; the Balanced Units which have made Philco *undistorted* tone famous, and the selectivity which has made people turn to "Philco" by hundreds of thousands. These four great chassis are in the new *complete* Philco line:

A. C. Screen Grid

*Model 77 Philco Screen Grid—*This 7-tube chassis has distance, power, selectivity, super-acute sensitivity and the glorious Philco tone.

This new Model also has the new Tone-Control; new Electro-Dynamic Speaker; Balanced-Unit Construction for **UNDISTORTED TONE**; Double-Tuned Input Circuit; Linear Detector Action (using a Screen Grid Tube for Detector which just about doubles amplification); high and equalized Sensitivity; Super-Selectivity anywhere on the dial; rigid drawn-steel Chassis; Armored Tuning Condenser; scientific Shielding, and a new, exclusive Station Recording Dial on which favorite stations can be logged.

A. C. Screen Grid Plus

*Model 96 Philco Screen Grid Plus—*Here is

the greatest chassis in the world. The set which out-performs any set on the market. It is for the people who want the last word in radio reception. In fact, it is **MORE RADIO** than many people need, but—**THAT'S THE KIND THEY LIKE TO BUY**. Here is super-power for distant stations; 9 tubes; Multiplex Detector Circuit; Built-in Aerial; *Philco Automatic Volume Control*, reducing blasting and blare from local stations and counteracting fading so one can not only *get* but *hold* and enjoy far away programs. In addition, Model 96 has the new Philco Tone-Control; new Electro-Dynamic Speaker, Balanced-Unit Construction for **UNDISTORTED**

The New Philcos Have Illuminated Station Recording Dial

the way with

REAL RADIO PROFITS

that makes 1930 another Philco Year

The Philco Franchise is worth more in 1930 than it was in 1929, because of Philco's wonderful new merchandise and merchandising policies—Philco sets in Philco cabinets *only*, maintained for your protection; Marvelous Values; Tremendous Profits and, what is of importance at this time, the possibility of building for the future. Consequently, the Philco Franchise is going to be increasingly difficult to obtain, and once obtained, Philco will back up their dealers with sales promotion ideas and gigantic advertising that will absolutely pay them to concentrate on the Philco line.

Models • No Overstocking • Generous Discounts



**Philco's New 9-Tube
Screen Grid Plus
Only 145.00**

Model 96 Highboy—We can practically guarantee that the trade will NOT see a job like this at this price — or ANYWHERE NEAR IT THIS YEAR. Like the Radio-Phonograph, the chassis is the great Philco 9-tube, Screen Grid Plus—the distance getter; the most highly selective set on the market; the super-radio which contributed to Philco's leadership. **AND THE CABINET**—100% matched and figured American butt walnut on pilasters and instrument panel; pencil striped American walnut apron; panels of American walnut. This is a trade-builder!

With PHILCO TONE-CONTROL



**Philco's New 7-tube
Screen Grid Lowboy
Only 110.00**

Model 77 Lowboy—Here is the set that will be sold in volume. You would never expect to find such "class" in a cabinet at such a price. The pilaster panels and arch are of figured, matched butt walnut; instrument panel V-matched Oriental wood; top and side panels American black walnut. Such a value is only made possible because Philco has attained such vast public acceptance that immense quantities of these cabinets will be made and SOLD. The Screen Grid Set in this new Lowboy is described below.

With PHILCO TONE-CONTROL



**Philco's 7-tube Screen
Grid Console
Only 95.00**

Model 77 Console—This Console at this new price is a real "leader". You can pull them into the store with this one. Sized to fit the needs of the modern small home, it is at the same time complete in every detail; with Tone-Control, Balanced Units and all the features of the new 77 Philco Chassis described below. This Console design is by America's foremost furniture creators and has the beauty of line to grace the finest home. It is finished in exquisite butt walnut and bird's-eye maple.

With PHILCO TONE-CONTROL

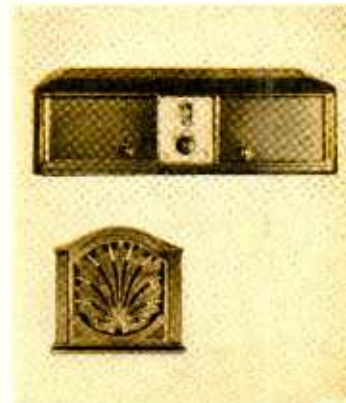

**The 7-tube Screen
Grid Table Model**

Receiver—ONLY **55.00**

Electro-Dynamic
Speaker—ONLY **25.00**

Model 77 Table Set—Many people like to have an inconspicuous set and speaker like this. Philco gives full measure. Here is every feature to be found in the new Screen Grid Line—Balanced Units, New Tone-Control, wonderful tone and selectivity—a fine, big-performing set in little space. Table Model with Screen Grid Plus Chassis No. 96. \$85. All prices less tubes.

With PHILCO TONE-CONTROL

GREAT NEW CHASSIS

TONE; Double-tuned Input Circuit; Linear Detector Action; high, equalized Sensitivity; super-Selectivity; rigid drawn-steel Chassis, Armored Tuning Condenser and Station Recording Dial.

D. C. Screen Grid

Model 41 D. C. Screen Grid—This 6-tube set is a new all-electric Screen Grid Radio for use on direct current, so that users in D. C. sections now can enjoy all the advantages of Philco Balanced-Unit Tone and reception. It is as fine a radio in every respect as the A. C. Receivers which have given Philco such wide public ac-

ceptance. Double-tuned input circuit and four-gang condenser, with advanced radio frequency coil design, give great selectivity. The detector is a Screen Grid tube. Sensitivity and selectivity are uniform over the entire dial. It has volume without distortion because of Philco Balanced Units.

Battery-Operated Screen Grid Plus

Prospects who need a battery-operated set are usually located at some distance from their nearest broadcasting station. They need a set that

will step out, get and hold far distant stations. This new Philco Battery-Operated set has super-power for distant stations, super-selectivity, and the marvelous Philco *Automatic Volume Control*, which automatically counteracts fading, thus making it easy not only to get but to hold and enjoy distant stations. This new Philco uses eight of the new 1930 high efficiency battery tubes, and is constructed in the same sturdy fashion as all Philco models, employing 4 gang armored tuning condensers, rigid drawn-steel chassis, scientific shielding, and is housed in furniture designed by America's foremost furniture creators to grace the finest home.

for Permanently Logging Favorite Stations . . . Prices slightly higher in Canada, Rocky Mountains and West

Gigantic **PHILCO** Advertising Program

Millions and Millions and Millions Circulation

1 New campaign *in colors* in the big national magazines, including the women's publications; pages and double spreads; great, sales-compelling ads EVERY WEEK, *beginning June 14.*

2 A new Philco broadcast on the Columbia Network employing Philco's own full Symphony Orchestra, giving the people "the greatest music for the greatest musical instrument"—Philco Radio. The outstanding "hour" on the air; heard by *millions*. In addition, Leopold Stokowski, the world's conducting genius, will again broadcast for Philco with the Philadelphia Orchestra.

3 A Philco Dealer's Merchandising Kit including the greatest array of sales helps, ads, neon signs, 24-sheet posters, window trims,

Sales and Service Manuals, publicity articles, cards, cut-outs, window designs, etc., ever devised.

4 A new local broadcasting service for the Philco dealer, putting the great "Philco" type of radio entertainment right on his local broadcasting station in his own territory.

5 Nation-wide newspaper publicity in the newspapers — live news matter on what Philco is doing and what the Philco dealer has to offer; read by millions everywhere.

6 Free newspaper publicity service to dealers, matching the national publicity of Philco and bringing the story of PHILCO right home to their trade.

THIS HUGE CAMPAIGN, BIGGEST EVER LAUNCHED, IS STARTING NOW

Philco Carloads Whizzing to Jobbers

Right this minute carload shipments of the wonderful new Philco Radios and Radio-Phonographs are whizzing to jobbers in every section of the country. The big sales drive has ALREADY STARTED.

YOU start now, TOO. You can get deliveries. You can tie up to this great Philco advertising and selling program and make the new 1930 sales season *a hummer.*

Don't wait—Get Started NOW

If you are a Philco dealer get in touch with your jobber NOW. Take full advantage of the sales momentum that Philco has begun for you with its national advertising, broadcasting, publicity, dealer merchandising program and wealth of profit-producing PLANS. If you are not a Philco dealer, and are

interested in MAKING REAL MONEY, send this coupon for full details. Philco is attracting the best dealers in every community. Success is catching. Send this coupon and we will tell you frankly if it is still possible for you to get a valuable Philco Franchise. If we can take care of you, we will back you up, and protect your trade and cooperate with you in the way that has made successes of Philco dealers everywhere.

This Coupon Brings Complete Profit-Plan—Send it Now.



PHILCO
Ontario and C Streets,
Philadelphia, Pa.

Gentlemen:

Please send me at once complete details regarding the new Philco Radios and Radio-Phonographs, together with outline of the Philco Dealer Merchandising Plans and Franchise.

Name

Address

City

State



EVERY SERVICE MAN KNOWS HOW DEPENDABLE IS BAKELITE INSULATION

Considering the fact that a radio receiver is an extremely sensitive electrical instrument, it is remarkable how little expert attention the modern set requires. When performance falls off, the skilled service man can usually locate and correct the fault in a few minutes.

These service men, who are familiar with the internals of radio receivers, the things that are mysteries to the average set owner, have learned through long experience that Bakelite Insulation may always be depended upon. They know that superior per-

formance is dependent upon insulation whose values are unimpaired by time, use, climatic conditions or temperature changes, and that Bakelite Insulations have met every test.

Radio engineers, manufacturers and service men, all are familiar with the prominent part that Bakelite Materials play in advanced radio receiver design. Write for a copy of booklet, "Bakelite in Radio", which clearly indicates the importance to the radio dealer of making sure that the sets which he handles are Bakelite Insulated.

BAKELITE CORPORATION, 247 Park Avenue, New York. CHICAGO OFFICE, 635 West Twenty-Second Street
BAKELITE CORPORATION OF CANADA, LIMITED, 163 Dufferin Street, Toronto, Ontario

BAKELITE

REGISTERED U. S. PAT. OFF



The registered Trade Mark and Symbol shown may be used only on products made from materials manufactured by Bakelite Corporation. Under the copyright "B" is the numerical sign for infinity, or unlimited quantity. It symbolizes the infinite number of present and future uses of Bakelite Corporation's products.

THE MATERIAL OF A THOUSAND USES

TESTS
SCREEN
GRID
SETS
AND
TUBES



EVERY
DEALER
NEEDS
THIS NEW
BEEDE
TUBE AND
SET TESTER

The small dealer who doesn't want to invest a considerable sum in testing apparatus, needs the Beede Set. The larger dealer who has a number of service men, but doesn't want to furnish an expensive set to each, needs the Beede Set. It is of inestimable value to all dealers who want to economize on testing apparatus.

It is especially helpful when used in a comparative capacity. Extremely simple to operate and tests can be quickly made.

The following tests can be made with it: ordinary tests for receiving sets, "B" tests, "C" tests, cathode volts, "A" supply, tube testing, AC line test, and tests where screen grid tubes are used.

Write for discounts and literature of Beede products.

**Beede Electrical
Instrument Co.**
Penacook, N. H.

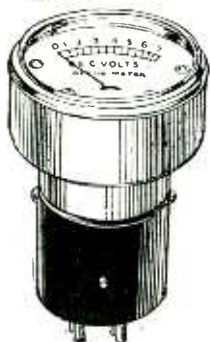

Socket Test Meter for testing the filament voltage of AC tubes.



Panel Voltmeter, Ammeter and Milliammeter.

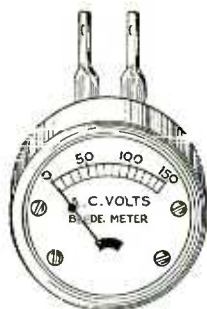

Handy Beede AC Line tester. Range 0-150 volts. Very accurate.

*Do You Know How Good
Your Condensers Are?*



YOU can test condensers accurately with this type RCT "King" Radio Condenser Tester.

Measures capacities from 1/10 to 8 Microfarads — quickly shows up poor insulation and other defects.

AS AN OHMMETER AND TRANSFORMER TESTER

Can be used as an ohmmeter to measure resistances from 150 to 30,000 ohms, also as a tester for radio transformers and as a continuity tester.

Transformers—250 milli capacity. Tube socket for type 281 tube permits use of 500 volts D.C. as well as 500 volts A.C.
NET PRICE . . . \$17.50

"KING"
INSTRUMENTS

THE ELECTRIC
HEAT CONTROL Co.

CLEVELAND, O.

*Now
Ready!*

The latest information for reference and study in your field—the valuable experience of men who are widely recognized as experts—is contained in McGraw-Hill books. You have the key to this experience in the

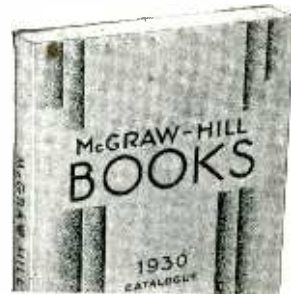

**New 1930
McGraw-Hill Catalogue
of Engineering and Business Books**

THIS catalogue describes more than 1500 books covering all branches of engineering, science and business.

Our latest publications and the newest revisions of standard works are listed. Electrical books covering all phases of engineering, design and shop practice are listed.

This catalogue describes a plan whereby you can put your book-buying on a convenient budget basis. Get the books as you need them—pay for them by the month as you use them.

*We have reserved a FREE copy for you.
Send for it—TODAY!*

McGraw-Hill Book Co., Inc., 370 Seventh Avenue, New York.
Send me the new 1930 McGraw-Hill CATALOGUE of Engineering and Business Books, to the address given below. This catalogue is to be sent entirely without cost.

Name

Address

City and State

R. R. 6-30

The Outstanding Radio Chassis for 1931

**EIGHT MODELS TO CHOOSE FROM
8 TUBES—3 SCREEN GRIDS
245 PUSH-PULL**

A.C.

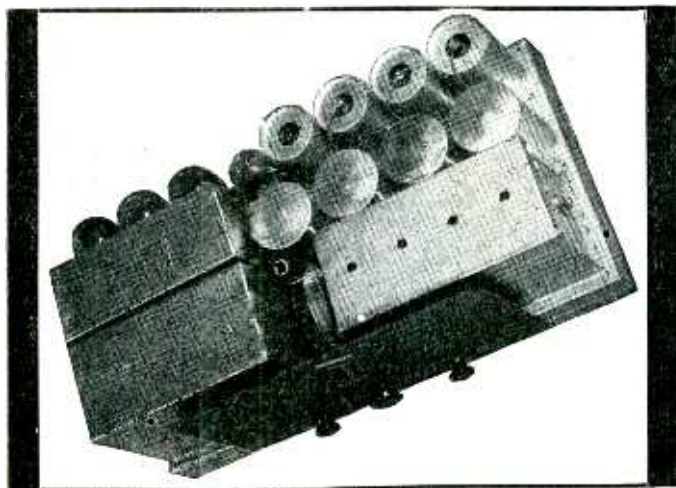

This Remarkable Private Label 8-Tube Chassis with Utah Auditorium Dynamic Speaker \$85⁰⁰_{LIST}
R. C. A. Licensed

Give your customers the most for their money—make an excellent profit for yourself. This superior chassis with its well known speaker will enable you to build a big business in radio, for it gives amazingly fine results and can be sold at an attractive price.

The extreme selectivity of this set is immediately noticeable—stations are separated perfectly. The 4 gang condenser assures tuning perfection—shielding is perfect. Its fine appearance, due to excellence of parts, construction and finish, is an important sales factor.

The sweetness of tone, the power and entire absence of hum in this set are rarely found in any set regardless of price.

A.C. 60 cycle 110 volt. An extra charge for 25 cycle.

Built with long or short shafts, either for use with regular metal panel or without for cabinets drilled. Fully cadmium plated and finished in aluminum or bronze finish.

There is a small die cost for your own Private Brand name.

Be sure to try it. Let us show you. Write to us today for discounts.

Has Jack for phonograph pick-up connections. Size—20-in. long, 10½-in. deep, 7½-in. high.

Visit Our Exhibit D40, Radio Trade Show

NATIONAL TRANSFORMER MFG. CO.
205 W. WACKER DRIVE, DEPT. 11, CHICAGO
Factories at North Chicago, Ill.



*Everyone
Is a
Prospect*



*A Small
Item That Gives You
A Big, Quick Profit*

Made of solid, sponge rubber, soft and compressible, NO-VIBES absorb vibration and shock. Specially surface treated, they look like wood.

Placed under the legs of a Radio Cabinet they improve tone quality and reception—protect the floor or floor covering.

Every radio owner—every owner of an electric refrigerator is a prospect, for NO-VIBES deaden sound and take up vibration. Where floor is uneven they eliminate “teeter.”

NO-VIBES will do the work on any vibrative appliance.

Cash in—send the coupon today.

PRICE \$1.00 PER SET.

The DALITZ MFG. CO.

570 ERIE BLDG.

CLEVELAND, OHIO

The Dalitz Manufacturing Co.
570 Erie Bldg., Cleveland, Ohio

Please send me discounts.

Name

Company

Address



The New Weston MODEL 555 Counter Tube Checker

Here is a valuable scientific instrument for dealers in radio supplies whose business prestige has been built upon selling only thoroughly inspected products. Testing radio tubes with this rapid and accurate checker insures customer satisfaction and prevents "comebacks"—profitless transactions which every dealer should seek to avoid.

Equipment of Model 555

- 1—Sockets for UX, UY and A. C. screen grid tubes.
- 2—A six-point filament voltage dial.
- 3—Four push button switches for making all the required tests.
- 4—Two 3 1/4" diameter instruments—an A. C. voltage indicator and a tube test meter.

Service Features of Model 555

Checks all tubes, A.C. and D.C., including '80 and '81 type rectifier tubes. Tests A.C. screen grid tubes and both plates of the 280 type rectifier (one at a time) without adapters. Indicates shorts between the filament and cathode.

See this new model at our Booth or in our Lecture Room at the Hotel Traymore during the R.M.A. Convention—or write to factory for full particulars.

WESTON ELECTRICAL INSTRUMENT CORP.
581 Frelinghuysen Avenue Newark, N. J.



Now you can give them music worthy of the BEST instruments . . . and make more MONEY! Don't be without this great sales aid! Samples on request!

BRILLIANTONE Steel Needle Company of America, Inc.
Pennsylvania Terminal Bldg., 7th Ave. at 30th St., New York City



ACCURACY PRODUCTION SERVICE . . .

Manufacturers of quick heating radio tubes have given instant approval to Summerill Seamless Nickel Tubing. An experience of 30 years in the Art assures them a dependable source of supply.

Write for Samples

THE SUMMERILL TUBING CO.
Founded in 1899
BRIDGEPORT, PA. (Philadelphia District)



AFTER THE SHOW

Turn To The Great Farm Market

The wise Radio dealer will take stock of where additional sales will come from in 1930. He will find that the Kato Engineering Company is reaching thousands of 32 volt light plant owners in every territory, persistently selling them on the additional advantages and new pleasures to be had from a modern A.C. Radio, operated by the Kato Konverter, direct from the light plant. Get your share of profits from this new field. For particulars, address Dept. R.

KATO ENGINEERING CO., Mankato, Minnesota

WASMUTH-GOODRICH COMPANY



Fine Radio Cabinets
fashioned by
Master Craftsmen

103 Park Ave., New York
Peru, Indiana

Eliminate Your Radio Aerial



The Unsightly Aerial Is Doomed!

For the Bud Antenna Eliminator and Selector has the same capacity as a good 50 ft. outside aerial. Think of the advantages—more selectivity, less interference, installed in two minutes, no lightning arrester necessary and will last a lifetime.

The hazards of climbing around slippery roofs or the possibilities of leaking roofs through faulty aerial installation is done away with.

Dealers are jumping at it because their installation costs are cut and complaints are less. And the price is only \$2.50.

BUD ANTENNA ELIMINATOR

now only **\$2.50**

Order from your jobber or write direct to us.

BUD RADIO Inc.

CLEVELAND, O.

MAYO

FOR

SERVICE MEN REPLACEMENT TRANSFORMERS, CONDENSERS RESISTANCES

Replace with MAYO. "They're Guaranteed"



	List	Net
CONDENSERS FOR		
MAJESTIC A.....	\$7.50	\$3.75
Kodel (3 condensers).....	10.00	5.00
Kodel (2 condensers).....	7.50	3.75
Kuprox (same as Kodel)		
Knapp (uses 3 this type)...	4.00	2.00 ea.
Elkon (replacement).....	4.00	2.00
Pkda (ABC).....	4.00	2.00 ea.
MAYO 4000 mfd. can be used as replacement in most any A eliminator...	6.00	3.00 ea.
CONDENSER BLOCKS FOR		
Majestic B.....	\$6.00	\$3.00
Majestic Special.....	6.50	3.25
Willard B.....	6.00	3.00
Zenith.....	7.00	3.50
Atwater Kent No. 37.....	10.00	5.00
Majestic Set (1928).....	10.00	5.00
TRANSFORMERS FOR		
Majestic B.....	\$5.00	\$2.50
Majestic A.....	9.00	4.50
Zenith, Mohawk, Stewart Warner and all packs made by Majestic.....	9.00	4.50
Atwater Kent.....	8.00	4.00
RESISTANCES		
A Complete Line of Wire Wound Resistances		

Send for Catalog for Complete List

Write for new catalogue sheets

MAYO LABORATORIES, Inc.
281 East 137th St., New York City

CORWICO

DON'T OVERLOOK PARTS AND ACCESSORIES

With just a little extra selling effort and a very small investment, you can increase your profits by stocking nationally known and established sellers among parts and accessories such as Corwico products. Your investment is small—the turnover is rapid—your profit is attractive.

Thousands of dealers are making money with Corwico products. You can, too. If your jobber cannot supply you, write us for complete catalog and full particulars regarding the Corwico line. We call your particular attention to these

THREE GOOD SELLERS



Corwico Vulcan Lightning Arrester
It also dissipates accumulated static charges. Backed by \$100 guarantee. Sells for a dollar. A timely item right now.



Corwico Braidite Hook-up Wire
Braidite is recognized by the trade as the best hook-up wire made. It's a year round seller. A good item.



Corwico No. 4 Antenna Kit
Includes a Corwico Vulcan Lightning Arrester. All other equipment also of the highest quality. An unequalled value for two fifty list.

OTHER CORWICO PRODUCTS

- Antenna Wire
- Antenna Kits
- Antenna Accessories
- Lightning Arresters

- Lead-in Wires
- Hook-up Wires
- Annunciator Wire
- Cables

See the Corwico Display at the R.M.A. Trade Show, Booth C-6.

CORNISH WIRE COMPANY

28 CHURCH ST., NEW YORK CITY

MAKERS OF THE FAMOUS

CORWICO

BRAIDITE HOOKUP WIRE

SEVEN YEARS EXPERIENCE IS BACK OF

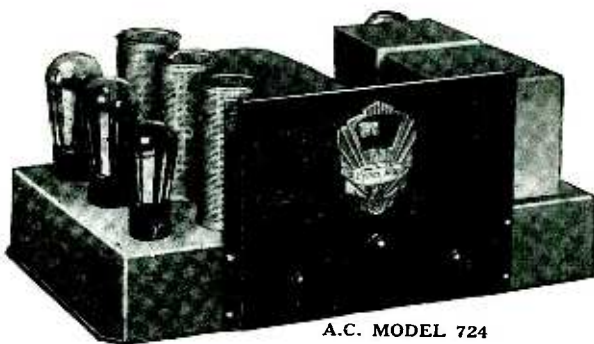

A.C. MODEL 724

THE NEW 1931
TRIPLE SCREEN GRID



POWER PLUS CHASSIS

FOR A.C. OR D.C. CURRENT—A.C. TUBES USED ON BOTH SETS

Why take chances with new and untried receivers? Our stability, standing and reputation in the radio industry is your assurance of the fulfillment of our guarantee that goes with each Pierce-Airo Receiver.

The Pierce-Airo Chassis fits all standard consoles. You buy the chassis at a net cost, put it in any console the customer

selects, set your own price, and name your own profit.

In thousands of homes throughout the country the Pierce-Airo is giving satisfactory and uninterrupted radio service. For hundreds of dealers it has increased sales and profits and cut service costs. You can't go wrong with the Pierce-Airo. Make it your leader this season.

Write or wire today for complete specifications, prices and sample chassis for test in your store.

A.C. Model 724—D.C. Model 727

See Our Display at the R.M.A. Trade Show, Atlantic City, Booth C-41

PIERCE-AIRO, Inc., 113R Fourth Ave., New York City

ACME WIRE PRODUCTS

Parvolt Filter and By-Pass Condensers
Coils—Magnet Wire Wound
Varnished Insulations

Magnet Wire - - - All Insulations

All products made to Recognized Commercial Standards, including those of:

National Electric Mfrs. Assn.
Radio Manufacturers' Assn.
American Society for Testing Materials

For 25 years manufacturers and suppliers to the largest and most discriminating users.

THE ACME WIRE CO.
NEW HAVEN, CONN.

Branch Offices

New York
52 Vanderbilt Ave.

Cleveland
Guardian Bldg.

Chicago
842 N. Michigan Ave.

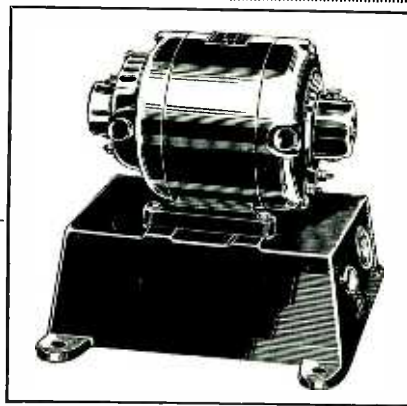

A New 32-Volt Rotary Converter by JANETTE

Get complete information on the new 32-volt JANETTE Rotary Converter. More efficient than ever before—and at prices so low that every farmer with a 32 volt lighting plant will become a live prospect for an AC radio and a JANETTE Converter.

Write for Bulletin 630-C

**JANETTE MANUFACTURING
COMPANY**

555 West Monroe Street
Chicago

Singer Bldg.
149 Broadway
New York

Real Estate
Trust Bldg.,
Philadelphia



Do think of
TRANSFORMERS

is to think of

THORDARSON

**TRANSFORMER
SPECIALISTS**
Since 1895 « «

-
- Microphone Transformers . . .
- Line to Tube, Tube to Line, Line to Line
- Mixing Transformers ● Coupling Trans-
formers ● Filter Chokes
- Audio Transformers ● Impedance
Matching Transformers ● Power
Compacts
- Speaker Coupling Transformers
- Complete Amplifiers
-

*Catalog of new Replacement Power and Audio
Transformers will be sent upon request*

Thordarson Electric Mfg. Co.
Huron, Kingsbury and Larrabee Streets, Chicago, Ill.

**BUYERS
WILL SEE**

the cabinet before they
see the set.

And radios, like auto-
mobiles, are bought most
generally on appearances.

That's why, in this matter
of cabinets

ADLER-ROYAL

places so much importance
on correct engineering and
thorough workmanship.

That's why, through highly
efficient production meth-
ods, we can supply your
cabinets squarely up to
specifications, at the time
you want them and at the
lowest consistent price.

ADLER MFG. CO., Incorporated
LOUISVILLE, KY.

**DEPENDABLE
CABINETS
NEED COST
NO MORE**

SEARCHLIGHT SECTION

EMPLOYMENT and BUSINESS OPPORTUNITIES—SURPLUS STOCKS—DISCONTINUED MODELS

UNDISPLAYED—RATE PER WORD:

Positions Wanted, 5 cents a word, *minimum* \$1.00 an insertion, payable in advance.
Positions Vacant and all other classifications, 10 cents a word, *minimum* charge \$2.00.
Proposals, 40 cents a line an insertion.

INFORMATION:

Box Numbers in care of any of our offices count 10 words additional in undisplayed ads.
Discount of 10% if one payment is made in advance for four consecutive insertions of undisplayed ads (not including proposals).

DISPLAYED—RATE PER INCH

1 inch \$7.50
 2 to 3 inches 7.50 an inch
 4 to 7 inches 7.00 an inch
 Rates for larger spaces, or yearly rates, on request.
 An *advertising inch* is measured vertically on one column, 3 columns—30 inches—to a page. Radio Retailing

BUSINESS OPPORTUNITY

Leading Music and Radio Store

For sale in central Ohio city of 20,000. Annual business forty thousand. Nationally advertised agencies. Reason, have manufacturing business requiring entire time. About \$8,500 required. BO-123, Radio Retailing, 520 No. Michigan Ave., Chicago, Ill.

MANUFACTURER'S REPRESENTATIVES

"Screen Grid" Chassis—A.C. and D.C.—of unsurpassed quality and operating efficiency which are sold mostly under "private brand" label, is the product. If your following buy chassis and demand quality first (most of them will this coming season) and you are open for a classisline, write us stating territory covered. Advertiser is responsible manufacturer of long standing and demand responsibility in their representatives. Address

Chassis Division

PREMIER ELECTRIC COMPANY
 Grace & Ravenswood, Chicago

SPECIAL NOTICE:

TO THE RADIO INDUSTRY

Advertising in connection with legitimate offers of surplus stocks and discontinued models of radio merchandise is acceptable in this section of "Radio Retailing."

Extreme care will be exercised by the publishers to prevent the use of advertising in the Searchlight Section to encourage price cutting on current models of merchandise or equipment. Nor will advertising which invites violation of the dealer's contract with the manufacturer be acceptable.

All merchandise offered in the Searchlight Section must be accurately and fully described and must be available on order.

There is a
Searchlight Section

in each McGraw-Hill paper:

- American Machinist (American Edition)
- Aviation
- Bus Transportation
- Chemical and Metallurgical Engineering
- Coal Age
- Construction Methods
- Electric Railway Journal
- Electrical Merchandising
- Electrical World
- Engineering News-Record
- Engineering and Mining Journal
- Food Industries
- Power
- Radio Retailing
- Textile World

And also in the McGraw-Shaw papers:

- Factory and Industrial Management
- Industrial Engineering

For advertising rates and other information on any or all of these publications, address

SEARCHLIGHT DEPT.
 Tenth Ave. at 36th St., New York

ATTENTION

To the Radio Manufacturers
DESMARAS AND CO., Ltd.
 Casilla 1489
 SANTIAGO, CHILE

Desire to receive offers for sale of Radio Receivers and Radio Parts in Chile.

New "SEARCHLIGHT" Advertisements

must be received by June 24 to appear in issue out the 1st of the following month.

Address copy to the Searchlight Department
Radio Retailing
 Tenth Ave. at 36th St., New York City

Surplus Radio Stocks Purchased

anywhere in the U. S., any quantity; give us the low down and we will give you the cash.

SOUTHWEST RADIO MART
 4700 So. Western Ave., Los Angeles, Calif.

WESTERN ELECTRIC No. 3. PUBLIC ADDRESS SYSTEM

BARGAIN

No. 3B Amplifier, 8—205D Tubes, 12 Projectors with units, brackets, etc. 2—373-W.E. Mikes, two mike stands, battery boxes hold 180 dry cells. Complete system cost \$1,300. Make offer.

BURT RADIO

402 Atlantic Ave., Atlantic City, N. J.

KEEP POSTED on PRICES

S. S. Jobbing House
 156 W. 26th St.
 New York City, N. Y.

Without obligation add my name to your list so that I get your Radio and Electrical Merchandising Bargains regularly.

Name

Street

City..... State.....

Important

← You cannot afford to be without our quotations on our latest Radio and Electrical Bargains.

MAIL THIS NOW

←

3500 KOLSTER-BRANDES Radio Sets—Latest 1930 Models

Purchased from the Kolster Radio Corporation by the New York Kolster Distributors and now available to dealers throughout the country at these extremely attractive prices. No more sets will be available after these are sold. Buy all you can NOW!

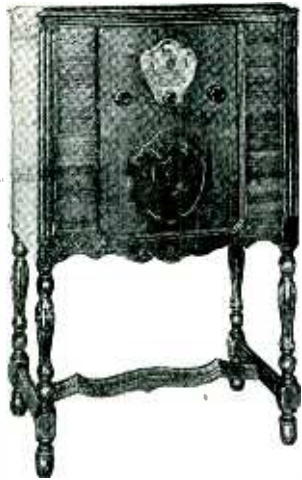

KOLSTER-BRANDES MODEL B-15

\$32.50
Less Tubes

Compact and Sturdily built genuine Walnut Console. Powerful 9½ inch Dynamic Speaker built by Kolster. Cabinet has real eye value and is 40 in. High, 24 in. Wide and 15 in. Deep. 8 tubes (5—C-327, 2—CX-345 in push-pull, 1—CX-380) 4 tuned stages. A. C. operation.

List Price \$125.50
Less Tubes

KOLSTER-BRANDES MODEL B-16

\$43.00
Less Tubes

Beautiful Walnut Highboy with full doors. Super-Dynamic 11½ inch Speaker built by Kolster and unexcelled in tone and quality. Cabinet is 50 in. High, 24 in. Wide and 15 in. Deep. 8 tubes (5—C-327, 2—CX-345 in push-pull, 1—CX-380) + tuned stages. A. C. operation.

List Price \$165
Less Tubes



RADIO WHOLESALERS CORP.

22 WEST 19th ST.

NEW YORK

TERMS:—All orders for 6 sets or less, Net Cash with order. All orders above 6 sets, Twenty (20%) Percent payment with order, balance Sight Draft attached to Bill of Lading or Express C.O.D. All sets are brand new, in original factory cases and are shipped F.O.B. from the Kolster Factory at Newark, N. J. All orders subject to prior sale and acceptance.
For references on Radio Wholesalers Corporation, you can refer to Bank of Manhattan Trust Company, Union Square Branch, New York City.

Attention:—Radio Buyers

For Buyers attending the R.M.A. Convention who are interested in a good sales promotion we have a limited quantity of Kolster models K-43 and K-44 and a large quantity of Kolster K-20 Electric Sets. See B. D. Colen or Maurice Lauday at the Hotel Shelburne, Atlantic City, during Convention week.

Mr. Manufacturer and Mr. Jobber!

We are outright cash buyers of surplus stocks of standard Radio Merchandise.

In fact we have cash resources that permit us to buy stocks of any quantity and they can't come too big.

Before disposing of your next lot be sure to get our cash bid.

Upon receipt of complete details — such as make, models and amount of stock on hand — we will promptly submit our bid.

Write, wire or phone full details today.

AMERICAN SALES CO.

19-21 WARREN ST.
NEW YORK CITY
Barclay 1496-1497

..... the Searchlight Section is looked upon as the meeting place for BUYERS and SELLERS of used or surplus new equipment.

..... the advertising rate is moderate.

..... the results are usually more than satisfactory.

Send in your advertisement today and be introduced to "Quick Action" advertising.

Address

Searchlight Department
Tenth Ave. at 36th St., N. Y.

G-35

"Opportunity" Advertising:
Think "SEARCHLIGHT" First!

0100



The CHALLENGER!

Use these three great nationally-known products as your leaders. People want and quickly buy the quality guaranteed by these great names. Radio Challenger company's buying power is second to none in the surplus radio business. Our very large, complete-lot purchases alone make these low prices possible. Your own knowledge of radio tells you they are below cost of labor and material. Here are three real money makers for summer!

"SURE-FIRE" MONEY MAKERS

The new 1930
STEWART-WARNER
Dyphonic Electro
Magnetic Speaker

The famous "Speaker with the punch" produced and backed by the 50-million-dollar Stewart-Warner Corporation. Clear, dynamic tone—volume—power—1930's sensational radio advance.

New discoveries in design give it remarkable performance. It is guaranteed. Sturdy—compactly built. Cadmium coated against rust. List \$18.50.

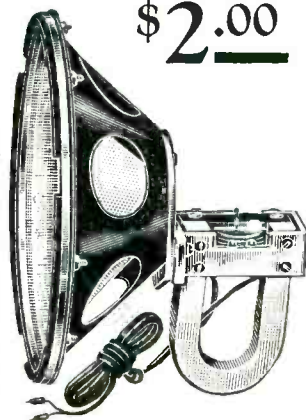

\$2.00

Dynamic Power Quality Tone

for NOW WHILE THEY LAST

Allen-Hough
RoTOR
Electric
Phonograph
Motor

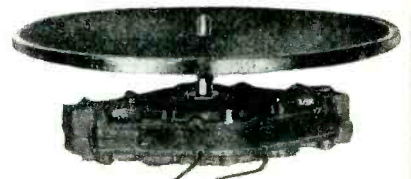

Made by the "Carryola" people—the world's largest makers of portable musical instruments. The Rotor gives perfect performance—exactly 80 smooth, silent revolutions a minute guaranteed with plenty of reserve power regardless of voltage fluctuation—just one moving part. Only 1/4 inch thick—needs little cabinet space. Highly saleable.

Everybody wants to make his radio a "combination" at this economical cost. And the Rotor enables them to throw the phonograph crank away. List \$15.00.

Every
Radio a
Combination

\$3.25

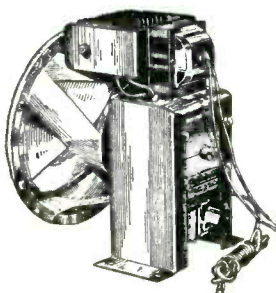

TEMPLE DYNAMIC SPEAKERS

The great Temple Super-Dynamic Speaker is noted for its clear, pure tone at every register and without a trace of rattle or blast. The Temple System of Hum Elimination overcomes also line hum, by a method under exclusive Temple control. Has two-tone switch for varying tone to suit listener's tastes. This Temple chassis has been priced at \$39.50 list. A.C. 110-volt, 60-cycle. A speaker that pleases—backed by a noted name in radio.

\$5.85

All orders have 24 hour service. Merchandise shipped in original factory sealed packing

TERMS: 20% with order, balance C.O.D. 2% discount for full remittance with order.

RADIO CHALLENGER CO.

1737 S. Michigan Avenue

Chicago, Illinois

Almost given away!

Prices smashed to a pulp! We must clean out remaining few Sets and Speakers. Order now!!



Model K-5
Height 42", width
25½", depth 19"

Genuine KOLSTER Products each Set and Speaker sealed in original factory case. All have KOLSTER Serial Number and guarantee tag.

Feature these Sets and Speakers in your summer clean-up sales. You can make at least 80% profit on each sale.

Only a few left at the prices shown below. Write or wire your order today . . . First come, first served.

Buy now!!! Our stock is very limited.



Model 6-H
Height 53", width
27", depth 18½"

K O L S T E R ELECTRO-DYNAMIC SPEAKER

Combined with 210 or 250 Power Amplifier and "B" Supply Unit

Features

1. Electro - Dynamic Speaker (10¼-in. dia.)
2. 210 or 250 Power Amplifier. Fine tone quality.
3. Supplies "B" voltage, if desired.
4. Can be used with any electric or battery set.
5. Complete A.C. Electric operation.
6. Beautiful pencil-stripped walnut cabinet.

This finely matched, rugged unit comprises a complete heavy duty Electro-Dynamic Speaker, including a 210 or 250 Power Amplifier with "B" supply unit, all self-contained in a steel frame. It weighs 45 pounds without the cabinet. The cabinet itself is of pencil-stripped walnut, beautifully designed with Cathedral grille. It is equipped with switch for control of house current to Speaker, power unit and amplifier. A pilot light indicates when the Speaker is in operation.

If desired, the 210 or 250 Power Amplifier will also supply 22, 67 and 90 volts "B" current, sufficient for any set using up to 8 tubes. An Automatic voltage regulator tube, UX-874, maintains the "B" voltage silent and steady.

This Electro-Dynamic Speaker

can be used with any battery or A.C. set, replacing the last audio stage or be used with all tubes of the set. Wherever used, it will bring out every shading and range of tone; every note is reproduced with utmost faithfulness, pure and undistorted. It will modernize any radio receiver.

The following tubes are required for its operation: 2—UX-281 (for full-wave rectification); 1—UX-210 or 250 (for super power amplification); 1—UX-874 (for voltage regulation). For use with phonograph pick-up, one additional audio stage is recommended between the pick-up and this Speaker.

A 20-ft. cable is included with each instrument. Operates direct from 50-60 cycle, 110-120 volt A.C. current.

List Price, \$175.00 (less tubes)

Going at \$ **15.00!**

K O L S T E R SIX TUBE CONSOLE RECEIVER

With Built-In Kolster
Electro-Dynamic Speaker

The entire set can be operated direct from the A.C. light socket, 50-60 cycle, 110-120-v., by simply adding any "A" supply unit and a small 4½-volt "C" battery. The built-in Electro-Dynamic Power Speaker furnishes the "B" supply current to the set. A switch snaps the receiver in or out of operation and a pilot light tells instantly when set is in operation. The single dial control makes this the simplest of receivers to operate.

Features

1. Beautiful highboy console of burlled walnut with maple overlay.
2. Kolster K-5, Electro-Dynamic Speaker, with built-in 210 or 250 power Amplifier included for fine tone quality (see opposite page).
3. Famous Kolster 6-tube T.R.F. circuit.
4. Hairline selectivity. Distance Reception.
5. Single dial control—simple to operate.

This Receiver Employs the Famous Kolster T.R.F. Circuit

It operates on either indoor or outdoor antenna using three stages of R. F., detector and two stages of A. F. The three point tap switch aerial adjuster operated from panel gives hairline selectivity. A loose coupled coil in conjunction with tap switch increases the distance getting value of the receiver. In addition, the 210 or 250 power amplifier built into the model K-5 Dynamic Speaker, achieves remarkable tone quality. In this receiver is embodied everything looked for in modern radio.

The combination Kolster Set and Electro-Dynamic Speaker is housed in a beautiful console of burlled walnut with maple overlay. Full swinging doors found only in the finest cabinets add to its beauty.

The receiver uses 6—UX-201A tubes and the Electro-Dynamic Speaker uses 2—UX-281, 1—UX-210 or 250 and 1—UX-874 tubes.

List Price \$295.00 (less tubes)

Going at \$ **28.50!**

TERMS: 20% cash with order, balance C.O.D. f.o.b., New York—2% discount for full remittance with order.

AMERICAN SALES CO., 19-21 WARREN ST. NEW YORK CITY

Replacement Parts at Big Savings

for leading commercial receivers

RCA
VICTOR
EDISON

DEALERS — SERVICEMEN

Numerous radio bargains have often been given to you. But here are the biggest that you have ever read of. All merchandise is of the finest material and manufactured by well-known set manufacturers.

FREED
A. K.
MAJESTIC

RCA Replacement Condenser
BLOCK FOR

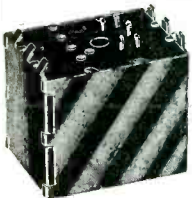

RCA

Nos. 17, 18, 33 Sets
Special,
\$1.50
each

PART No. 8333
LIST \$7.40

RCA
Double Filter
Chokes



RCA Replacement Part No. 8336 Contains Two 30 Henry 80 Mil Chokes
Special **\$1.70**
each

Each choke insulated for 1,000 volts.

GENUINE
NEW TYPE
ELKON M-16
RECTIFIER



Officially recognized by Grigsby-Grinnow as the proper replacement unit for the Majestic "A" eliminator. May be used on the following "A" eliminators: Majestic, Mayolian, Elkon, Philco, Webster, Knapp, Gen. Inst., Metro, Pada, Bernard, Sentinel, Elkon and Briggs and Stratton.

FIRST TIME AT THESE PRICES
With Base—**\$3.45**
U-20 Without Base—**\$2.35**

RCA
By-Pass Condenser
Part No. 5996



Comprising one 1/2 and three .1 mfd. condensers.
LIST \$3.00
Our Price **35c**

YAXLEY
2,000 Ohm
Volume Control
RCA Replacement
Part No. 5091



For Radiola 17, 18, 32, 42, 44 and practically all sets. Insulating strip (easily removed) for metal panels.

List price \$1.95
Each **45c.**

HART & HEGEMAN
TOGGLE SWITCH



For Battery and Electric Sets
Approved by Underwriters
20c. each—**\$2.15 per doz.**
Gen. Elec. Switch 20c.
\$2.15 per dozen

RCA
CHOKE COILS



15 HENRYS—35 MILS
Impregnated in Rosin. Ideal choke for B Eliminators and A.C. Sets.
D.C. Resistance 500 OHMS.
Special, **35c**

FROST
Twin Volume
Control



3000-3800 Ohms. Will stand up. No more burned out volume controls. Standard for Victor but can be used on all sets.

List price \$2.50
Our price 55c.
Dozen **\$5.50**

Polymet
BY-PASS TUBULAR
CONDENSER
.1 MFD.
200 VOLTS



\$1.00 Per Doz.
Can be used across Choke Terminals in Victor sets to reduce hum

VICTOR
ABC
POWER
TRANSFORMERS



Supplies Voltages for
6—224 tubes.
1—227 tube.
1—280 tube.
2—245 tubes.
Can be used in Loftin-White Circuit.
Price, **\$2.75**
As used in Victor sets

Fixed Pigtail Resistors



OHMS	500	10,000	25,000
2,000	15,000	50,000	
4,700	20,000	250,000	
		500,000	

\$1.00 Per Dozen

Polymet
HI-VOLT 1 MFD. FILTER
CONDENSER 300 VOLTS D.C.



35c Each
\$3.60 Per Doz.

VICTOR
Audio
Transformer



Our Price,
95c

BAL-RAD Replacement Blocks

All Brand New and Fully Guaranteed. Products of an old reliable Manufacturer.

A replacement block for Majestic eliminator—guaranteed for a period of one year. The condensers in this block are all composed of high-voltage condensers, and you can be assured that once this block is installed, it will last indefinitely.

For Atwater Kent Electric Set Model No. 37. This unit contains the proper chokes and high voltages. All flexible wires—colored leads identical to original. Fully guaranteed.

Net **\$4.95**
each

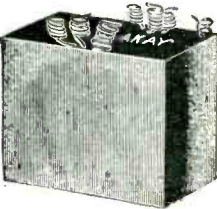



VICTOR
Push Pull
Transformers



Our Price,
\$2.50
per pair

The "BAL-RAD"
Hy-Voltage Uncased Surge-Proof Condensers



For General Repair and Power-Pack Work

1/2 mfd. 300 V. 25c	2 mfd. 600 V. 40c
1 mfd. 600 V. 30c	4 mfd. 600 V. 60c

This "Bal-Rad" Condenser is the result of many suggestions from servicemen throughout the country. It is small and compact, impregnated in pitch with long flexible leads to facilitate quick connections. Can be placed outside of Pack. We guarantee these Condensers for 100% Free Replacement. Repair men should carry a few dozen in stock. Packed in individual cartons.

Grid Suppressors
750 OHM
\$1.00 Per Doz.



SEND FOR OUR LATEST BARGAIN CATALOGUE—NO OBLIGATION, OF COURSE

MAIL ORDERS TO: **BALTIMORE RADIO CO.**
47A MURRAY ST., NEW YORK CITY

TERMS: 20% with order; balance C. O. D. 2% discount allowed for full remittance with order only.

CASH BUYS AT THE LOWEST PRICE "ALWAYS"

RADIO CIRCULAR, SCHOVERLING, DALY & GALES

BARGAIN BULLETIN

225 Varick Street, New York City

Vol. 6—No. 5

JUNE, JULY and AUGUST

Free to Dealers

SPORTS • ELECTRICAL • RADIO • CAMERA • SPORTS



HOW DO YOU FIND BUSINESS?
BY GOING AFTER IT!

SPECIAL

RADIOLA "44" SCREEN GRID
RADIOLA 100-A SPEAKER
COMPLETE SET OF TUBES

ALL FOR

\$ 35.00

Summer Sidelines at Bargain Prices

This new 128 Page Bargain Bulletin makes the selection of a good "Summer Sideline" easy.

Of course you want a copy—write for one today. Mail the handy coupon.

Every page in the Bargain Bulletin is crammed with items that just can't help but sell, especially as summer sidelines.

Don't overlook this fact either. You can obtain a generous stock by making a comparatively small investment.

Your money goes farther, buys more and earns more if this new Bargain Bulletin guides your selection of a summer sideline.

Every Item An Easy Selling Summer Profit Builder

You'll marvel at bargain prices we have placed on every page. Electric appliances—clocks, lamps, irons; sporting goods—golf clubs, tennis rackets, bathing suits, sport shoes; baseball equipment; cameras—all types; field glasses; portable phonographs; and many other money-making items.

Mail the coupon now!

Be sure to have your name put on our preferential list.

Radio Circular Company, Inc.
225 VARICK ST., N. Y. CITY



See May, 1930, Radio Retailing, page 29, for details on why and how it pays to take on a "Summer Sideline."

MAIL THIS COUPON FOR A FREE COPY

Radio Circular Co., Inc., 225 Varick St., New York City
Please send me a free copy of the new 128 Page Bargain Bulletin.
Dealer's Name
Address
City

SERVICE

After many years as engineer and head of the service department of some of the largest radio manufacturers I am in a position to help solve your radio problems.

Let me help you on your vexing problems on all A.C., D.C., and battery sets, power packs, eliminators, and special testing apparatus.

There is no charge for this service. The sale of replacement parts at prices that will compare with any quoted is my compensation. Of course there is no obligation to purchase your parts here.

Do not hesitate to write.

JACK SOLZBERG

SOME OF MY SPECIALS :

Freed-Eisemann Output Transformer for use in dynamic speakers..\$.75	Carbon Pigtail Resistors: 375, 500, 1,000, 1,500, 2,000, 10,000, 15,000, 20,000, 25,000, 50,000, 100,000, 250,000 ohms at...doz.\$1.00
Freed-Eisemann Model No. 85 Power Transformer 4.25	Toggle Switches as used in Radiolas, Freed, Freshman, Atwater Kent and Earl Receiversdoz. 1.50
2-meg. carbon pigtail Grid Leaks, doz. 1.00	Replacement Transformers 4:1..... .29
Freed-Eisemann Model No. 80 and 85 Volume Controls27	Freshman G Model Audio Transformers42
Freed-Eisemann Model No. 80 and 85 Transformers90	Power Transformers for No. 22 Earl and No. 55 Freed, unmounted... 2.05
Freed-Eisemann Model No. 85 Power Chokes60	Sets of 3 low loss spider web Coils, for use with .0035 condensers, can be used for auto radio receivers and portable setsset .18
K. K. Knobs as used on Freshman Receivers08	Centralab Volume Control, 50,000 and 3,000 ohms42
Majestic B Blocks 2.85	Dubilier Fixed Condensers, .0025, doz. .50
Stewart Warner Speaker Chassis... 2.25	Freed-Eisemann Single Jacks..... .05
Acme B Eliminator 8.00	Freed-Eisemann Model No. 70 Condenser Blocks 1.25
Soft Rubber Cushions 1x1/4x6 in. for use in support on Auto Radio... .05	
Hum Adjusters Model No. 81 and 85 Receivers40	
Mazda Pilot Lamps, 6 volt and 2 1/2 voltdoz. 1.00	
Filter Condensers 4 1/2 x 1 x 2 1/2 in. 1 Mfd., 600 volt30	
1 Mfd., 800 volt45	

I carry a complete line of replacement parts for the following sets:

Freed-Eisemann, Freed-Earl, and Freshman, also replacement parts for many other models.

Write for quotation for prices on parts wanted.

Terms:—

20% with order, balance C.O.D. All merchandise is guaranteed.

FREED RADIO SALES, 16 Hudson Street, New York City

RADIO TUBE



SONORA ARCTURUS

(RA-1) No. 28
15 Volt Amplifier Tubes

\$1.00 each

Made by Arcturus Radio Tube Co.
Newark, New Jersey

SONORA ARCTURUS

(RE-1) No. 180
Rectifier Tubes

\$1 each

TERMS: 20% cash must accompany all orders; balance C.O.D.

These tubes are in original Arcturus boxes and fully guaranteed

RALPH RUBENSTEIN, INC.

26 Thames Street, New York, N. Y.

Thousands of Radio Dealers Since 1919

have been purchasing their requirements from us. **ARE YOU on OUR mailing list?**
CROSLLEY B.B. JR. (dry cell), \$10.50.
KOLSTER 6D Sets, \$15.99.
RCA Speakers, 100A, 100B, 103, \$5.99.
VICTOR, A. K., Maj., Edison, etc. (parts).
WARD Leonard Res. 13400 Ohms., \$29.
BEST Theatre elec. pickup, \$5.35.
ACME 800 volt, 2 mfd., \$.59—12 @ \$.49.
TRAVIN Audios 33c (A.C. tubes 25c.).
AIR KING short wave incl. coils, \$5.99.
HAVLIN Mary Lou Elec. Clocks, \$4.79.
Write for hundreds of other sensational values. Every item UNCONDITIONALLY GUARANTEED.

Write for our terms.

RADIO SCHIER COMPANY
135 Liberty St., New York City.

Over
26,000
other
men
in the
Radio
Industry
will see
this page—

Then isn't this the logical place to advertise any business wants you may have of interest to men in the Radio Industry?
Employment — Business Opportunities — Surplus Stocks, etc.

RECEIVERS

SPEAKERS

Radiola 33 with Legs.....	\$27.50
Radiola 44.....	28.50
Radiola 60.....	39.00
Peerless Kyletron 653.....	45.00
Peerless 652 Dynamic Speaker.....	49.00
Peerless 21A.....	53.50
Peerless 23A.....	69.50
Apex Neutrodyne Electric Table Model..	23.50
Apex Neutrodyne Battery Operated Console Set	22.50
Browning-Drake Screen Grid 7 Tube Battery Set	19.50
A.C. Dayton 9 Tube Navigator A.C. Set (with Tubes)	34.50
Arbophone 6 Tube Battery Set with Loftin-White Tuner	12.50
Loftin-White Tuners, 227 or S. G. type.....	12.00

RCA 100A.....	\$ 4.75
RCA 100B.....	4.75
RCA 103.....	4.75
Stewart-Warner Magnetic Chassis.....	2.25
Kolster K-6 Magnetic Speaker.....	4.95
Peerless 19A Dynamic Speaker.....	14.50
Peerless 17A Dynamic Speaker.....	10.50
Farrand 2500 Ohm D.C. Chassis 11-in. ..	7.50
Peerless 2500 Ohm D.C. Chassis 11-in. ..	7.50
Stewart-Warner Gothic Speaker.....	4.75
Temple Magnetic Model 5.....	4.75
R F I Ansonia Gothic 911G.....	4.75
Farrand A.C. Dynamic Chassis... ..	7.50



TUBES

Type	Lgt	Our Price
226	\$1.75	35c.
227	2.50	35c.
171A	2.25	35c.
224	4.00	50c.
222	6.50	60c.
245	3.50	50c.
280	3.00	50c.
210	9.00	75c.
250	11.00	75c.
281	7.25	75c.
201A	1.25	45c.
112A	3.25	45c.
200A	4.00	45c.
199U.Y.	2.25	45c.
199U.X	2.25	45c.
120	3.00	45c.
Rectifier BH	4.50	1.65



Frost Twin Volume Control 30 3500 Ohm for Victor and other sets, \$3.50
Yaxley 2000 Ohm Volume Control for all RCA sets, \$4.50
Frost 500,000 ohm Control, \$3.00
Stromberg - Carlson, 20,000 ohm volume control, \$4.50
Bradley volume, all sizes, \$3.00
Frost 100,000 ohm volume control, \$3.00
Variable wire wound resistance on lava tube, 0-25,000 ohm with variable slides, \$7.50
Fixed wire wound resistances of all ohmages up to 25,000 (Ward Leonard). A 150 ohm resistor lapped resistances, grid suppressors and pig-tail carbon resistances. Complete description in our June Catalog

RESISTANCES

SEND FOR THIS

New! Radio Bargain News

If you are not one of the 20,000 dealers on our mailing list, write in now.

Federated Purchaser
18 HUDSON ST., NEW YORK CITY

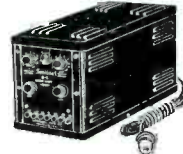
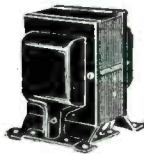

RCA Replacement Audio... \$.55
RCA Double Choke..... 1.25
Victor Audio..... .95
Edison Input..... .85
Edison Audio..... .85
Victor A B C Power Transformer..... 2.75
Federal Replacement Audio 1.45
Replacement for A. K. 1.50
We carry a complete line of replacement filament and power transformers. Our June catalog contains full descriptions. For all standard sets.

Replacement Condenser Block for Radiolas 18, 33 and 51 \$1.50
We are distributors for Dubilier and Mayo condensers and carry a complete stock of replacement condensers for all sets and eliminators.

Airline Power Amplifier & B Supply (MP'd by Brach) \$8.00
Acme 180 V. B Eliminator 7.85
Sentinel B-C Supply..... 7.50
Powerizer P210..... 9.50
Powerizer P171A 9.50
Dumont Dry A..... 9.95
Yale A 6.95
Kuprox Dry Trickle Charger..... 2.75
National Elkon Dry Trickle..... 3.75
Varion 180 V. B..... 5.75
Tobe Dry A..... 9.95
Dumont Line Noise Eliminator... 2.95
Brach Relay..... .60

ACCESSORIES

TESTING EQUIPMENT

7 strand cop. per aerial wire, 10c. coil
R.C. solid lead-in wire, 16c. coil
Glass aerial insulators, 3c.
Approved lightning arresters, 7c.
Copper ground clamps, 2 1/2 c.
Window lead-in strips, 3c.
Insulated Staples per 1000, \$1.10.
Hundreds of other items at bargain prices listed in our big catalog.



Dayrad Tube Tester, \$24.50.
Dayrad Set Analyzer, \$58.50.
Supremo Tube Tester, \$21.75.
Supremo Set Diagnostic, \$139.50.
DeVitt LaPrance Dynamometer, \$24.50.
Readrite Tube Tester, \$10.00.
Readrite Complete Test Kit, \$18.50.
Fleethim 300 V. D.C. Meter, \$3.
Fleethim 500 V. D.C. Meter, \$4.25.
Fleethim 600 V. A.C.-D.C. Meter, \$6.25.

TRANSFORMERS CONDENSERS ELIMINATORS

ALPHABETICAL INDEX TO ADVERTISEMENTS

	Page		Page
A			
Acme Wire Co.	184	Gordon Co., L. S.	8
Adler Mfg. Co.	185	Graybar Elec. Co.	165
All-American Mohawk Corp.	20-21	Grebe & Co., Inc., A. H.	2
American Bosch Magneto Co.	7-130-131	Grigsby-Grunow Co.	99
American Weekly	47	Gulbransen Co.	Inside Back Cover
Amrad Corp.	111	H	
Andrea, F. A. D.	38-39	Hammond Clock Co.	147
Antennon Radio Co.	172	Holed-Tite Packing Corp.	172
Arcturus Radio Co.	33-34-35-36	I	
Associated Factory Distr.	6	Insuline Corp. of America.....	146
Atwater Kent Mfg. Co.....	41-42	International Resistance Co.	172
Audak Co.	18-19	J	
Audiola Radio Co.	132	Janette Mfg. Co.	184
B			
Bakelite Corp.	179	Jensen Radio Mfg. Co.	140-141
Baldwin, Inc., Nathaniel	144-145	Jewell Elec. Instrument Co.....	123
Beede Elec. Instrument Co.....	180	Johnsonburg Radio Corp.	17
Belden Mfg. Co.	150	K	
Bodine Electric Co.	156	Kato Eng. Co.	182
Brilliantone Steel Needle Co.....	182	Kennedy, Inc., Colin B.....	116-117
Browning Drake Corp.	112-113	Ken-Rad Corp., Inc.	158
Brunswick-Balke-Collender Co.	Inside Front Cover	L	
Brunswick Radio Corp. (Farand) ..	24	Leutz, Inc., C. R.	51
Bud Radio, Inc.	183	M	
C			
Cable Radio Tube Corp.....	135	Magnavox Co.	134
Capehart Corp.	139	Mayo Labs.	183
Ce Co Mfg. Co.	108-109	Meadows Mfg. Co.	152-157
Central Radio Lab.	40	N	
Champion Radio Wks., Inc.	143	National Carbon Co., Raytheon Div.	25-26-27-28
Colonial Radio Corp.	44-45	National Transf. Mfg. Co.....	164-181
Concert Trope	174	National Union Radio Corp. ...	126-127
Concourse Elec. Co., Inc.	166	Norden-Hauck, Inc.	153
Cornish Wire Co.	183	O	
Crosley Radio Corp.	37	Oxford Radio Corp.	52-53
D			
Dalitz Mfg. Co., The	181	P	
DeForest Radio Co.	118	Pacent Elec. Co.	124-125
Duovac Radio Tube Corp.	46	Perryman Elec. Co.	138
E			
Edison Co., Inc., Thos. A.....	167-168-169-170	Philadelphia Storage Battery Co.	175-176-177-178
Electric Heat Control Co.	180	Pierce Airo, Inc.	184
F			
French Battery Co.	106	Pilot Radio & Tube Corp.....	163
G			
General Electric Co.	159-160-161-162	Pierman, Frank E.	164
General Industries Co.	166	R	
General Motors Radio Corp.	101	Radio Master Corp.	104-105
Gold Seal Elec. Co., Inc.	115	Radio Prod. Co.	110
		RCA Radiotron Co., Inc....	Back Cover
		RCA Victor Co., Inc., Radiola Div.	84-85
		Readrite Meter Works	136
S			
Sampson Industries, Inc.	107	T	
Samson Electric Co.	114	Thordarsron Elec. Mfg. Co.....	185
Sessions Clock Co.	173	Toman & Co., E.	50
Silver-Marshall, Inc.	48-49	Transformer Corp.	119-120-121-122
Shakeproof Lock Washer Co.	154	Triad Mfg. Co.	133
Sparks-Withington Co.....	Front Cover	Tung-Sol Radio Tubes, Inc.	43
Sprague Specialties Co.	137	U	
Stewart-Warner Corp.	148-149	United Air Cleaner Corp.....	151
Story & Clark Radio Corp.....	22-23	Utah Radio Prod. Co.....	3
Stromberg-Carlson Tel. Mfg. Co....	4-5	V	
Summerill Tubing Co.	182	Van Horne Tube Co.	166
Sylvania Prod. Co.	54	Victoreen Radio Co.	142
W			
		Warren Telechron Co.	171
		Wasmuth-Goodrich Co.	182
		Webster Elec. Co.	128-129
		Western Elec. Piano Co.....	155
		Westinghouse Elec. & Mfg. Co.	29-30-31-32
		Weston Elec. Instrument Co.....	182
Z			
		Zenith Radio Corp.	9-10-11-12-13-14-15-16

SEARCHLIGHT SECTION

Classified Advertising

EMPLOYMENT	186
BUSINESS OPPORTUNITIES.....	186
REPRESENTATION	186
RADIO STOCKS	
American Sales Co.....	187-189
Baltimore Radio Co.....	190
Burt Radio	186
Federated Purchaser	193
Freed Radio Sales Service	192
Radio Challenger Co.....	188
Radio Circular Co.....	191
Radio Schier Co.....	192
Radio Wholesalers Corp.....	187
Rubinstein, Inc., Ralph.....	192
Southwest Radio Mart	186
Svensgaard, Harry	186
S. S. Jobbing House.....	186

Here it is



The New
GULBRANSEN *Champion*



The "Champion" is the result of the complete devotion of Gulbransen's entire facilities to one brilliant performing chassis—one beautiful cabinet—one challenging value! Business-men in radio quickly appreciate the profit possibilities of the "Champion," due to quick turn-over of invested capital. Specifications—Tone-Control, four-gang condenser, push-pull, a new Stadium Type, Lektophone licensed, dynamic speaker. Eight tubes—3-224s—2-227s—2-245s—1-280. Full size cabinet 48 inches high. Beautiful rare woods—genuine carvings. Distributors' and dealers' inquiries promptly handled. GULBRANSEN COMPANY, 3232 Chicago Avenue, Chicago.

\$
130

Licensed by
RCA—
Hazeltine—
Meissner

MAKERS OF FINE MUSICAL INSTRUMENTS FOR THE HOME FOR A QUARTER OF A CENTURY

EDW C RIPPEL
1522 EAST ST
HONESDALE PA

Announcing

New RCA Radiotrons!

THESE three new RCA Radiotrons have been designed particularly for operation on dry batteries and under conditions where maximum economy of operation is necessary.

The characteristics of these new RCA Radiotrons represent a real advance in the art of designing tubes for dry battery operation. They are decidedly non-microphonic and make possible high radio frequency amplification besides permitting ample volume with battery service.



**The New General Purpose
RCA Radiotron 230**

—may be used either as detector or amplifier. Its characteristics are:

Filament Voltage	2.0 Volts
Filament Current	0.06 Amperes
Plate Voltage, Max.	90 Volts
Grid Voltage (C-Bias)	-4.5 Volts
Plate Current	2.0 Ma.
Plate Resistance	12,500 Ohms
Amplification Factor	8.8
Mutual Conductance	700 Micromhos
Effective Grid-Plate Capacitance	6 Mmf.

**The New Screen Grid
RCA Radiotron 232**

—is particularly recommended for use as a radio frequency amplifier in circuits designed especially for it. Its characteristics are:

Filament Voltage	2.0 Volts
Filament Current	0.06 Amperes
Plate Voltage, Max.	135 Volts
Grid Voltage (C-Bias)	-3 Volts
Screen Voltage, Max.	67.5 Volts
Plate Current	1.5 Ma.
Screen Current	Not over 1/3 of plate current
Plate Resistance	800,000 Ohms
Amplification Factor	440
Mutual Conductance	550 Micromhos
Effective Grid-Plate Capacitance	0.02 Mmf. Max.



**The New Power Output
RCA Radiotron 231**

—has been designed for volume output from battery operated receivers where economy of plate current is important. It is for use in the last audio stage. Its characteristics are:

Filament Voltage	2.0 Volts
Filament Current	0.150 Amperes
Plate Voltage, Max.	135 Volts
Grid Voltage (C-Bias)	-22.5 Volts
Plate Current	8 Ma.
Plate Resistance	4,000 Ohms
Amplification Factor	3.5
Mutual Conductance	875 Micromhos
Undistorted Power Output	170 Milliwatts
Effective Grid-Plate Capacitance	6 Mmf.



RCA RADIOTRON CO., INC.

HARRISON, N. J.

RCA Radiotrons

THE HEART OF YOUR RADIO SET