



## Solid Bamboo Hardwood Flooring



**Installation Guide**

(888) 788-2254  
[www.CaliFloors.com](http://www.CaliFloors.com)

## Flooring Systems



**Standard Click**  
3-3/4" Wide  
Plank Dims:  
36" L x 3-3/4" W x 7/16" H



**Standard T&G**  
3-3/4" Wide  
Plank Dims:  
72" L x 3-3/4" W x 9/16" H



**Wide Click**  
5-5/16" Wide  
Plank Dims:  
72-7/8" L x 5-5/16" W x 9/16" H



**Wide T&G**  
5-3/8" Wide  
Plank Dims:  
72" L x 5-3/8" W x 9/16" H

## Flooring Accessories

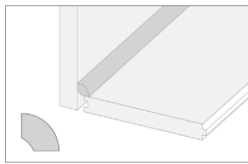

**Quarter Round**

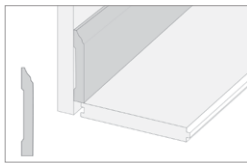

**Baseboard**

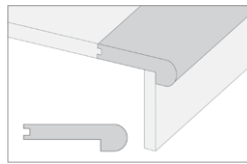

**9/16" Stair Nosing**

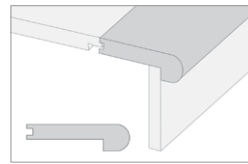

**7/16" Click Stair Nosing**

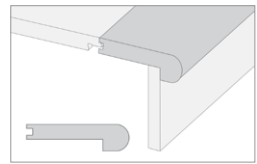

**9/16" Click Stair Nosing**



**Stair Riser**

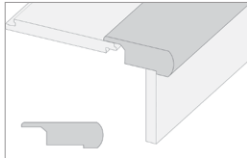

**7/16" Overlap Stair Nosing**

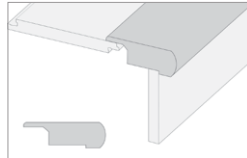

**9/16" Overlap Stair Nosing**



**Stair Tread**

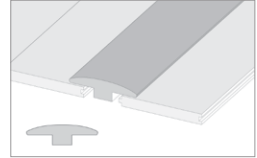

**T-Molding**

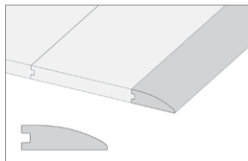

**9/16" Reducer**

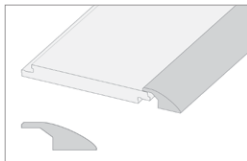

**7/16" Overlap Reducer**

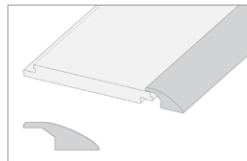

**9/16" Overlap Reducer**

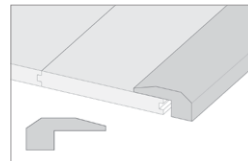

**9/16" Threshold**

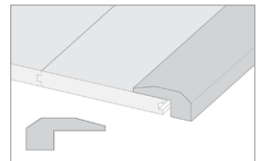

**7/16" Threshold**

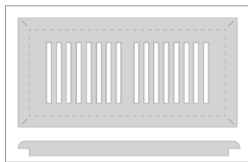

**10" Air Register**

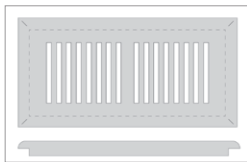

**12" Air Register**

Before you begin installation, remember to P.A.C.E. yourself with the checklist below. Full installation instructions and maintenance guidelines can also be found online at [www.CaliFloors.com](http://www.CaliFloors.com)

## P A C E PREPARE THE SUBFLOOR



**Titebond® 531+**

**Use Titebond® 531+ On Concrete**

Make sure the subfloor is flat, level, clean and free of debris. New concrete must be cured for at least 60 days. Test the subfloor moisture prior to installation and apply an appropriate moisture barrier such as Titebond® 531+ on concrete subfloors.

## P A C E ACCLIMATE FLOORING

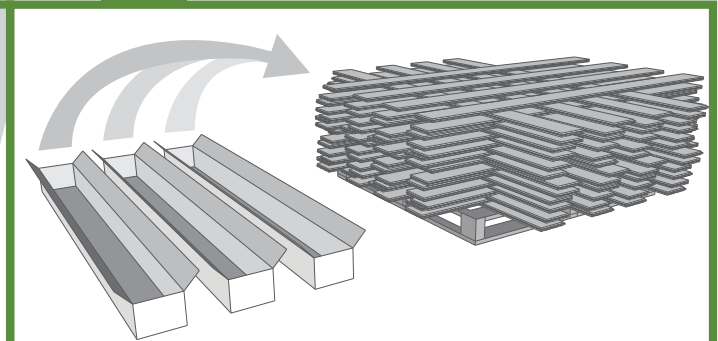

**Acclimate Your Solid Flooring For At Least 5 Days**

Cross-stack flooring on a pallet, mixing boards from each box. Acclimate your floor as close to the installation area as possible, for at least 5 days in normal living conditions. More time is necessary in extreme climates.

## P A C E CONTROL ENVIRONMENT

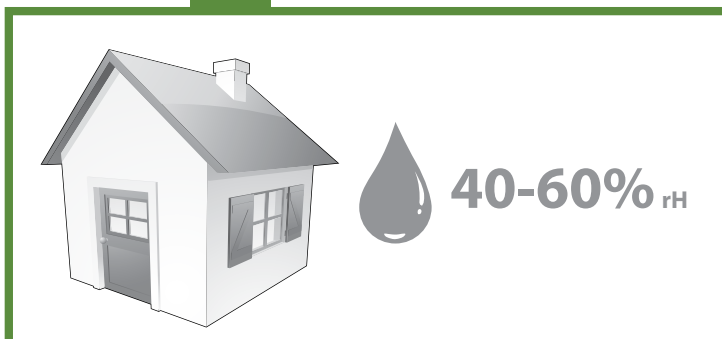

**40-60% rH**

As a general rule, the ideal indoor humidity range for hardwood is 40-60% relative humidity. **In some climates or households, the average humidity range may be higher or lower. That's okay!** In this case, simply extend the acclimation period, and maintain humidity levels at normal living conditions set during acclimation.

## P A C E EXPANSION GAPS

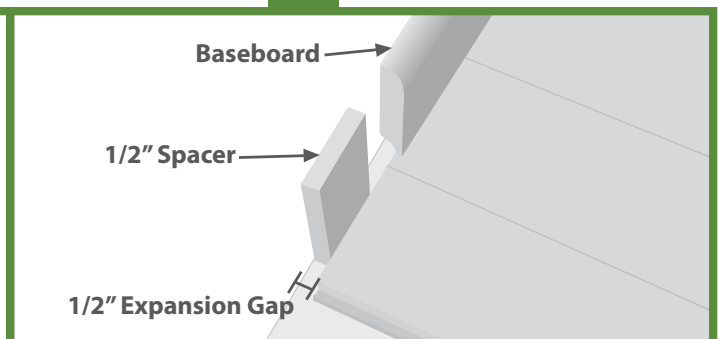

**Baseboard**

**1/2" Spacer**

**1/2" Expansion Gap**

Leave at least 1/2" expansion spaces between flooring and ALL vertical objects (walls, cabinets, pipes, etc.) Large flooring runs may require additional expansion space. **For floating floors, use transition moldings between rooms and in doorways.** Undercut door jambs and casings to provide adequate expansion space. Do not screw or nail cabinetry or other permanent fixtures to a floating floor.

## Prepare Job Site, Acclimation, Control Subfloor Moisture, Environmental Conditions

Proper installation and maintenance are key elements in achieving best flooring results. It is the responsibility of the installer/owner to follow all guidelines provided by Cali Bamboo for success. **Please read through this document completely, additional installation materials such as videos, illustrations and more can also be found at [www.CaliFloors.com](http://www.CaliFloors.com).**

### Important Pre-Installation Notes

**Note: Flooring not used for its intended purpose will not be covered under warranty.**

The following information provided by Cali Bamboo is intended to serve as a reference guide only. Please carefully read Cali Bamboo's installation, maintenance and warranty documentation prior to installation. Follow the National Wood Flooring Association (NWFA) Installation Guidelines when installing your floor.

Cali Bamboo offers in house technical support as a courtesy to our customers. Consult with one of our bamboo flooring experts to find answers to your specific installation questions unique to your application. Contact us by email: [customerservice@calibamboo.com](mailto:customerservice@calibamboo.com); or by phone: 1(877) 237-2254 ext. 2.

- Determine the best installation method that suits your application. Cali Bamboo® floors may be Floated (not secured to the subfloor), Glued, or Nailed. Follow the instructions designated for the most suitable installation method for your project.
- Upon ordering of wood floor material consider adding an additional 8% to allow for cutting waste (5%) and grading allowance (3%).
- Cali Bamboo® flooring is manufactured in accordance with accepted industry standards, which permit manufacturing, grading and natural deficiencies not to exceed 5%. If more than 5% of the material is unusable, do not install the flooring. Immediately contact the distributor/retailer from which the flooring was purchased. No claim will be accepted for materials with visible defects once they are installed. Installation of any material serves as acceptance of the material delivered.
- Installer/Owner assumes all responsibility to inspect all flooring before installation. Boards deemed unacceptable in appearance can be placed in closets, near walls or simply not be used. Pieces with glaring defects that can be seen from a standing position should be cut off or not be used as use constitutes acceptance. The use of putty, filler sticks or markers to touch-up flooring during installation is considered normal practice.
- As bamboo is a natural product, natural variations in color may occur within and between individual flooring planks. To visualize the range of colors within the flooring style you are considering, compare your samples to the photos on our web site. During installation, work from several cartons at a time to achieve a uniform appearance across the entire floor. Mix and mingle planks when dry laying the floor for maximum aesthetic appearance. Blend moldings to planks that have similar color. Natural variations in color are not covered under warranty.
- It is the responsibility of the installer/homeowner to determine if the job site conditions, environmental conditions and sub-floor are acceptable for the installation of Cali Bamboo® flooring. Prior to installation, the installer/owner must determine that the jobsite meets or exceeds all applicable National Wood Flooring Association's Installation Guidelines. Cali Bamboo does NOT warrant against failure resulting from or connected with subfloor, job site damage, or environmental deficiencies after installation.
- Cali Bamboo makes no warranty or guarantee of the quality of the chosen installer's work or of a particular installation performed by him or her. Cali Bamboo disclaims all liability for any errors or improprieties in the installation of its products by an installer. Please contact the National Wood Flooring Association (800-422-4556) to find a certified installer in your area, or for more information on installation.
- **Controlling flooring moisture content is important for success. Bamboo, like all hardwood flooring species, is hygroscopic; its size and shape changes naturally with the absorption or release of moisture. The amount of movement varies depending on the preventative steps taken at the time of installation (i.e. acclimation, moisture barrier application, etc.) and the stability home environment thereafter. Care should be taken to control fluctuating levels of moisture indoors.**

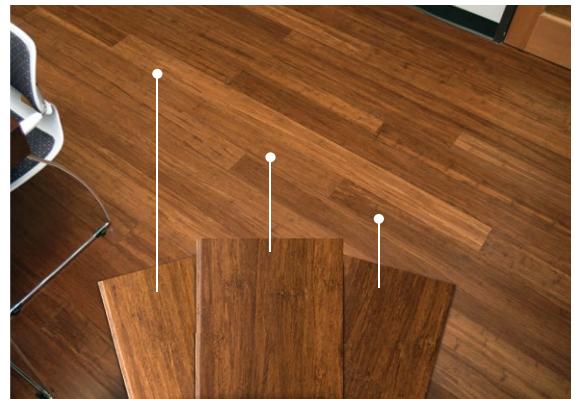

- Floor noise is normal and will vary from one installation type to the next. Occasional noise is due to structural movement and may relate to sub-floor type, flatness, deflection, and/or related to the fasteners, changes in environmental conditions, relative humidity and the amount of topside pressure applied to the flooring. For these reasons floor noise is not considered a product or manufacturer defect.
- Cali Bamboo® flooring is intended for installation on or above grade only. Flooring installed below grade is not covered under warranty.

## Prior to Installation of Cali Bamboo Flooring

### Job Site Preparation

Prior to installation, it is the installer's responsibility to determine that the jobsite, environment and subfloor conditions all meet the requirements of the National Wood Flooring Association. Do not deliver flooring to jobsite until the building has been enclosed with windows and doors, all cement, plastering, and other "wet" work has been completed, and a consistent room temperature has been reached. Confirm proper drainage exists around the structure. Lack of moisture protection can allow excessive water or moisture to penetrate basement walls, flow beneath concrete slabs, basement floors, and into crawl spaces. In crawl spaces, exposed earth must be fully covered with minimum 6-mil polyethylene sheeting. Crawl space vents must be open. A moisture retardant such as 6 mil polyethylene film must be placed in crawl spaces. Heating units or non-insulated ductwork close to the flooring or subfloor may cause "hot spots" which must be eliminated prior to installation.

During installation, it is the installer's responsibility to document all jobsite conditions and measurements including the installation date, flooring moisture content, site relative humidity, temperature, and subfloor moisture content. This information must be retained by the installer and left with the property owner as a permanent record. For a complete list of points to address prior to installation, refer to the NWFA's Jobsite Checklist.

### Subfloor Requirements

**General:** Subfloor must be structurally sound and meet all NWFA guidelines. All subfloors must be flat to a tolerance of 3/16" in a 10' radius. Use appropriate leveling products for correcting subfloor deficiencies. Subfloor surfaces must be smooth, clean, dry and free of contaminants that would interfere with an adhesive bond. All subfloors should be tested for moisture content (see "Subfloor Moisture Testing"). If high moisture readings are found, identify the moisture source and correct the problem before installation. Do not install flooring directly over floor joist without proper subflooring.

### Appropriate Wood Subfloors Materials:

- CD Exposure 1 plywood (grade stamped US PS1-95)
- OSB Exposure 1 subfloor panels
- Solid-board subflooring should be 3/4" x 5 1/2" (1" x 6" nominal), Group 1 dense softwoods, No. 2 Common, kiln dried

### Acceptable Subfloor Thickness Requirements:

Joist System Spacing (inches on center)	Minimum Thickness
12"	5/8"
12" to 16"	3/4"
16" to 19.2"	7/8"
19.3" to 24"	1-1/8"

**Concrete Subfloors:** Subfloor must meet all above requirements. Concrete must be fully cured and at least 60 days old. Concrete must be free of dirt, oil, paint, old adhesive, wax, sealers and curing agents. Concrete that is not properly leveled can cause improper adhesive transfer, hollow spots, and squeaks. Sand or grind down high spots. Level low spots with appropriate leveling material; allow extra drying time for the leveling compounds. Test subfloor moisture content. To minimize moisture transfer from the slab, apply: Titebond 531+ Moisture Control System.

### Moisture Testing Subfloor

**General:** Test the subfloor for moisture content before installation. If high moisture readings are found, identify the moisture source and correct the problem. Extend acclimation time and increase ventilation until the proper conditions have been met. Apply a moisture barrier. Please note that test results are only applicable the day of testing and will not ensure that moisture will not fluctuate with seasonal changes. Regardless of subfloor moisture content, the use of a moisture barrier is required for all installations. Cali Bamboo does not warrant against moisture related problems. If results show moisture vapor at or exceeding 12%, determine its source and correct problem before installation.



**Wood Subfloors:** Wood Subfloors: Use moisture meter to test wood subfloor moisture content. If results show moisture vapor at or exceeding 12%, determine its source and correct problem. Do not install the floor without a vapor barrier. Cali Bamboo always recommends using a moisture/vapor barrier, especially if the moisture content of the flooring and subfloor vary greater than 3%.

**Concrete Subfloors:** Concrete subfloors must be tested for moisture vapor pressure in more than one place for consistent readings. If test results show moisture vapor exceeds the minimum requirements below, do not install the floor without an impermeable vapor retarder with a perm rating of less than .13 designed to permanently block this moisture.

- Calcium Chloride Test (ASTM F 1869): Maximum vapor emissions cannot exceed 3lbs/1000SF in 24 hours
- Tramex Concrete Moisture Encounter: Moisture readings should not exceed 4% on upper scale
- In-Situ Probe Method (ASTM F 2170): Relative Humidity levels should not exceed 75%

### Moisture Testing Bamboo Floor

Use a reliable moisture meter that is acceptable for strand bamboo flooring. Examples of acceptable moisture meters include Delmhorst or a Lignomat SDM. Contact the meter manufacture to verify settings for strand bamboo. Please note that some meters require the use of a substitute setting for bamboo, and thus must have the moisture content readings converted in order to get an accurate measurement (such as Delmhorst; see table; right\*).

### Moisture Barrier Requirements

**General:** Unexpected changes to subfloor moisture content may cause dimensional changes to the floor. To ensure a lifetime of satisfaction, it is strongly recommended that Cali Bamboo® flooring be installed over a moisture barrier or vapor retarder (following manufactures guidelines) per the following specifications:

**Wood Subfloors:** For best results, use a vapor retarder with a perm rating between 0.7 and 50 when tested in accordance with ASTM E-96 Method A. Install as recommended by the manufacturer. Examples of acceptable vapor retarders for wood subfloors include: Asphalt laminated paper (UU-B-790a, Grade B, Type I, Style 1a.), Asphalt-saturated kraft paper, and Silicon Vapor Shield.

**Concrete Subfloors:** For concrete applications, a moisture barrier/vapor retarder should be chosen based on concrete moisture content. For unlimited moisture protection, use Titebond® 531+ Moisture Control System. Install as recommended by the manufacturer.

### Acclimation & Conditioning of Cali Bamboo® Flooring

The goal of acclimation is to allow the moisture content (MC) of the flooring to fully adjust to its new surroundings before installation.

- **Determine Normal Living Conditions** - Ideal interior environmental conditions vary from region to region and jobsite to jobsite. It is the installer's responsibility to know what the "ideal" climate conditions are and customize the acclimation of the floor around those conditions. For a general view of moisture content averages by region, see the map below.
- **Control Home Conditions Accordingly** - Acclimation should occur at normal living conditions. Before opening the cartons, the indoor environment should reflect the room temperature and relative humidity levels expected to be present before, during, and most importantly, after installation. Operate temperature / humidity control systems as normal. Allow normal ventilation through rooms.
- **Cross-Stacking Flooring Planks** - For maximum stability, Cali Bamboo recommends cross stacking the flooring at the installation site while it acclimates. Remove the flooring from boxes and cross stack planks at least 4" off the subfloor with even spacing between planks to allow for complete and even air-circulation around the flooring.

### \*Bamboo moisture reading conversions

**Delmhorst Moisture Meter Conversion Table for Strand-Woven Bamboo Flooring**

Meter Reading (Doug. Fir Setting)	Actual % Moisture Content
6	3
7	3.5
8	4
9	4.5
10	5
11	6
12	6.5
13	7
14	7.5
15	8
16	8.5
17	9
18	9.5
19	10
20	11
21	11.5
22	12
23	12.5
24	13
25	13.5
26	14
27	14.5
28	15.5



- **Acceptable Areas for Acclimation** - Acclimate the flooring as close to the center of the installation area as possible. Do not store flooring next to outside walls, in direct sunlight, near air vents or under conditions that don't reflect the normal home environment. Garages, and exterior patios, for example, are not acceptable areas to store wood flooring during acclimation.
- **Determine Appropriate Acclimation Time Frame** - Cali Bamboo® flooring should be allowed to acclimate on the job site for a minimum of 5 days. Extended conditioning may be necessary depending on the climate. For regions or conditions that are extremely dry, humid or highly-fluctuating, 2 or more weeks may be necessary for acclimation.

## Optimum Flooring Moisture Content (%) by U.S. Region

This map is provided by the NWFA and relates to all hardwood flooring species. For each region, the average equilibrium moisture content (EMC) for hardwood is identified for both January and July. The EMC is the MC (%) that the floor will reach once it has fully acclimated to its environment. This is also the optimum MC for installation, and will provide a general idea of what acclimation measures to take. In each pair of figures, the first number is the average EMC during January; the second is the average EMC during July.

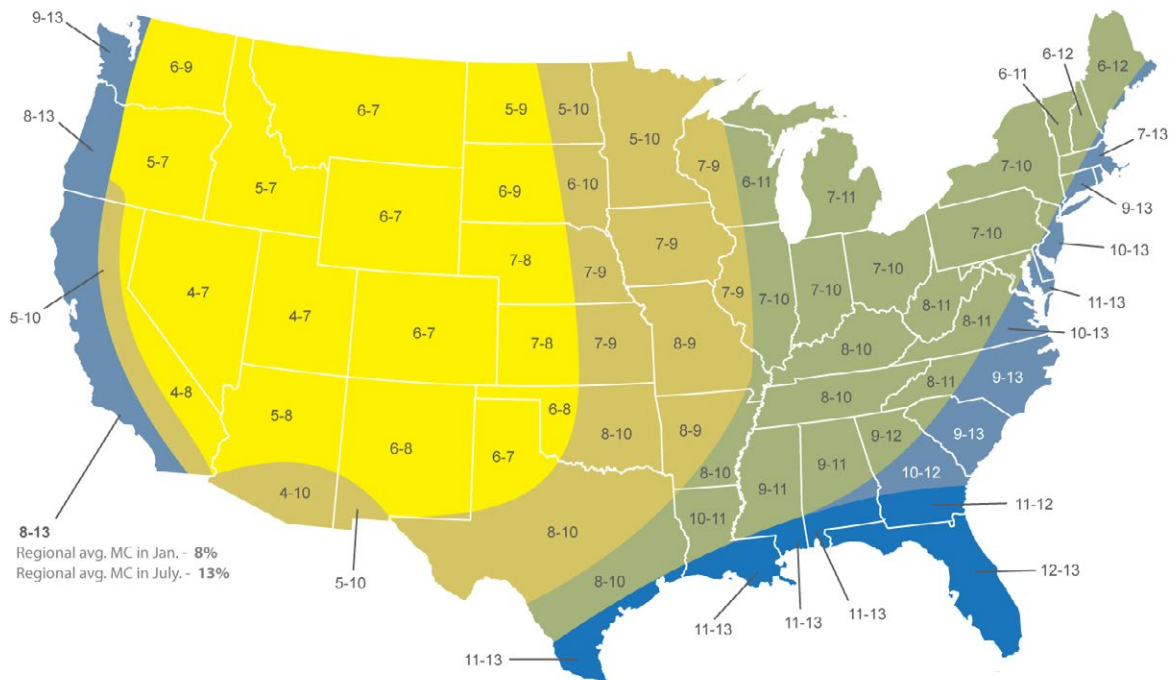

**Note:** Actual moisture content conditions in any location may differ significantly from these numbers. This map cannot be reliably used as a basis for installation. The most reliable moisture-content numbers can be obtained at the job site. Take moisture content readings of the flooring, subfloor and relative humidity to be sure.

To better understand the specific acclimation requirements for your home, refer to the chart below for correlations between relative humidity (RH), temperature, and flooring moisture content (%). Referencing the weather conditions in your area, find the combination of temperature and RH on the chart. This value represents the flooring moisture content to achieve during acclimation for best results.

Values within chart's shaded area represent environments with relative humidity (RH) and temperature capable of maintaining the delivered moisture content of 6-10%. These are optimum conditions for maximum flooring stability. For environments outside of this range, allow more time for acclimation. Depending on your local in-home conditions, the use of humidification/dehumidification equipment may be recommended to maintain proper in-home environment.

## Here is an example of how to use the chart (on the following page):

- My home is normally and currently maintained at an average temperature of: **70°F**
- My home is normally and currently maintained at an average relative humidity of: **40% RH**
- The combination of 70°F and 40%RH on the chart shows that the floor should be acclimated moisture content of: **7.7%**
- The value of **7.7%** MC falls within the **shaded area** on the chart.

Continue acclimating until the flooring has reached an equilibrium with the home environment. Testing of the flooring, subfloor and relative humidity of the job site can determine this (see Subfloor & Flooring Moisture Testing) sections. You know that equilibrium has been met when the moisture content of the flooring is no longer fluctuating.

**Note:** Not properly acclimating wood flooring may cause excessive expansion, shrinkage, dimensional distortion or structural damage. The worstcase scenario is one in which wood flooring is stored outside of the area in which the wood is to be installed. Acclimation is the responsibility of the installer/homeowner. A video tutorial is also available at [www.CaliBamboo.com](http://www.CaliBamboo.com)

## MOISTURE CONTENT OF WOOD AT VARIOUS TEMPERATURES AND RELATIVE HUMIDITY READINGS

<b>30</b>	1.4	2.6	3.7	4.6	5.5	6.3	7.1	7.9	8.7	9.5	10.4	11.3	12.4	13.5	14.9	16.5	18.5	21.0	24.3	26.0
<b>40</b>	1.4	2.6	3.7	4.6	5.5	6.3	7.1	7.9	8.7	9.5	10.4	11.3	12.4	13.5	14.9	16.5	18.5	21.0	24.3	26.0
<b>50</b>	1.4	2.6	3.7	4.6	5.5	6.3	7.1	7.9	8.7	9.5	10.4	11.3	12.4	13.5	14.9	16.5	18.5	21.0	24.3	26.0
<b>60</b>	1.3	2.5	3.6	4.6	5.4	6.2	7.0	7.8	8.6	9.4	10.2	11.1	12.1	13.3	14.6	16.2	18.2	20.7	24.1	26.8
<b>70</b>	1.3	2.5	3.5	4.5	5.4	6.2	6.0	7.7	8.5	9.2	10.1	11.0	12.0	13.1	14.4	16.0	17.9	20.5	23.9	26.6
<b>80</b>	1.3	2.4	3.5	4.4	5.3	6.1	6.8	7.6	8.3	9.1	9.9	10.8	11.7	12.0	14.2	15.7	17.7	20.2	23.6	26.3
<b>90</b>	1.2	2.3	3.4	4.3	5.1	5.9	6.7	7.4	8.1	8.9	9.7	10.5	11.5	12.6	13.9	15.4	17.3	19.8	23.3	26.0
<b>100</b>	1.2	2.3	3.3	4.2	5.0	5.8	6.5	7.2	7.9	8.7	9.5	10.3	11.2	12.3	13.6	15.1	17.0	19.5	22.9	25.6
	<b>5</b>	<b>10</b>	<b>15</b>	<b>20</b>	<b>25</b>	<b>30</b>	<b>35</b>	<b>40</b>	<b>45</b>	<b>50</b>	<b>55</b>	<b>60</b>	<b>65</b>	<b>70</b>	<b>75</b>	<b>80</b>	<b>85</b>	<b>90</b>	<b>95</b>	<b>98</b>
	<b>Relative Humidity (percent)</b>																			

Chart taken from *Wood Handbook: Wood as an Engineering Material* (Agriculture Handbook, 72). Forest Products Laboratory, U.S. Department of Agriculture

## Radiant Heat Systems

Cali Bamboo® flooring is only recommended for use over radiant heat systems if the special requirements specified by the National Wood Flooring Association are met (please refer to the NWFA's Radiant Heat Guidelines). Ensuring stable job site conditions, subfloor suitability and proper acclimation are especially important when installing over a radiant heat system. It is the responsibility of the installer to ensure that the recommended environmental conditions are met for installation. Refer to your radiant heat system manufacturer to determine its compatibility with bamboo flooring, and to learn the specific requirements for installation.

- Because of the wide variety of systems on the market (Hydronic, embedded in concrete, electrical wire/coil, heating film/mat) each with its own features and applications it is recommended that the user consult with the radiant heating provider for best practices, installation methods and proper subfloors.
- Typically the floating installation method is the most suitable for use with radiant heat systems.
- Radiant heat system must be turned on and in operation for at least 6 days before installation.
- The flooring must be acclimated per Cali Bamboo's Fossilized acclimation instruction over the radiant heat with the system turned on throughout the acclimation timeframe.
- The system must be turned down to 65°F and maintained 24 hours prior to installation.
- Once install is complete, turn system back on and slowly bring back up to normal operating temperature over a period 4-5 days.
- Floor should never be heated over 80°F. Consult with your radiant heating system manufacturer to successfully limit the maximum temperature.
- Always remember that rugs placed over radiant heated flooring can increase the surface temperature in that area by 3°-5°F degrees.
- Relative Humidity must be maintained between 40-60%. The use of a humidifier may be necessary to achieve this.
- When turning off the radiant heat system it must be turned down slowly at a rate of 1.5° degrees per day. You should never just turn the system off.
- For additional information on radiant heating systems please refer to <http://www.radiantpanelassociation.org> or the NWFA's Radiant Heat Guidelines.





## Installation of Cali Bamboo® Flooring

### General Guidelines - All Installation Types

- Follow Cali Bamboo Maintenance & Care Guidelines to keep your floor looking its best after installation
- Save extra flooring for future repairs.
- Do not install flooring under permanent or fixed cabinetry.
- Floor should be installed from several cartons at the same time to ensure good color, shade and appearance.
- Most installation failures result from jobsite moisture. Do not deliver flooring to the jobsite until problems are corrected.
- Cali Bamboo® flooring is intended for installation on or above grade only. Flooring installed below grade is not covered under warranty.
- Since bamboo expands with any increase in moisture content, we require leaving at least 1/2" expansion space between flooring and all walls and vertical objects, such as walls, cabinets, pipes, etc. If the installation flows into other rooms and continuous runs in excess of 30 feet, a greater expansion is required, approximately 1/16" for every ten (10) feet. NEVER install any floating floors against any vertical fixed object such as fireplace, columns, floor outlets, etc. Failure to follow this guideline may result in tenting or buckled floors.
- 3M blue painter tape #2080 can be used to keep rows or sections of floor boards together until the adhesive has cured. (Incorrect or aggressive tape can harm the finish, do not leave on overnight.)
- During installation, it is the installer's responsibility to document all jobsite conditions and measurements including the installation date, flooring moisture content, site relative humidity, temperature, and subfloor moisture content. This information must be retained by the installer and left with the property owner as a permanent record.
- Depending on the application, Cali Bamboo flooring can be installed over an approved underlayment to provide greater thermal insulation and sound isolation qualities. Cali Bamboo recommends using our Cali Complete™ All-in-One Underlayment, which offers several benefits that include step noise reduction, increased walking comfort, and an industry-leading moisture warranty.

### Expansion Space Is Required

- Since bamboo expands with any increase in moisture content, we require leaving at least 1/2" expansion space between flooring and all vertical objects (walls, cabinets, pipes, etc.). If the installation area exceeds 30 feet, a greater expansion space is required; approximately 1/16" for every additional ten (10) feet. If the floating installation flows into other rooms, a T-molding must be used in doorways and openings between rooms (halls, archways, etc.) to allow separate areas to move without interference less than five (5) feet.
- Note that proper expansion space depends not only on the size and flow of the installation, but also on expected seasonal changes in temperature and humidity that may cause the flooring to gain or lose moisture content over time. For example, if an installation takes place when humidity conditions are low, it's likely that the wood flooring will gain moisture and expand later during humid seasons. In those cases, incorporate additional expansion space through use of spacers or transition moldings.
- Hardwood floors must be able to expand/contract without interference. NEVER install flooring against any vertical or fixed object such as fireplace, columns, islands, door jambs, floor outlets, etc. Failure to follow this guideline may result in tenting, separation or buckled floors. Do not install cabinets or other permanent fixtures on top of the floor. Never nail or screw anything through a FLOATED floor. If you have extremely heavy furniture items, install the floor using the glue-down method or nail-down method as opposed to floating the floor.
- To cover your expansion space, Cali Bamboo carries matching bamboo flooring moldings that include reducers, t-moldings, baseboards, quarter rounds, thresholds and vent registers. Matching stair parts are also available; including stair nosing, treads and risers. Cali Bamboo also provides all the glues and adhesives you will need for to complete your project. Please visit Cali Bamboo's Flooring Accessories webpage.
- Undercut door casings and jambs. Remove any existing base, shoe mold or doorway thresholds. These items can be replaced after installation. When undercutting door casings the installer should confirm there is the recommended expansion space. The floor must have 1/16" clearance under the door casing to be able to float freely without vertical restriction. The installer should ensure that the plank can move freely under the door jamb.



## Floating Click-Lock Glueless Installation Method

### Recommended Floating Click-Lock Floor Tools

- Underlayment (see “Moisture Barrier Requirements”)
- Hammer
- Tapping block (trimmed piece of flooring)
- Tape measure
- Wood or plastic spacers (1/2”)
- Pencil
- Flat bar or pull bar
- Chalk line
- Miter saw (chop-saw) with carbide blade 80 tooth or higher
- Earplugs & safety glasses
- Undercut or jamb saw

### Installation of Cali Bamboo® Flooring

1. Before you start, ensure that the job site, subfloor and environmental conditions are acceptable for installation of Cali Bamboo® flooring. All requirements specified in Cali Bamboo’s Installation Guidelines must be met.
2. For unlimited moisture protection on concrete applications, seal concrete subfloor with Titebond® 531+ Moisture Control System prior to installation.
3. Allow at least a 1/2” space for expansion around the perimeter of the room and all vertical objects using spacers. Also see section: “Expansion Space is Required”.
4. It is recommended to install the planks parallel to the longest wall.
5. Click a few rows together before full installation to confirm your layout plan.
6. Begin by laying the first plank in a corner with the long grooved side toward the long wall.
7. Connect short side of second plank together with mating side of the first plank.
8. Cut the last plank and complete the row. Use the remaining plank to start the second row.
9. Make sure to offset the end joints of consecutive rows by a minimum of 6 inches for best appearance.
10. Begin the second row by clicking the long edge of the planks together.
11. Begin at an angle and press the plank downward to fully engage the click lock system.
12. Repeat this process for the second plank with the short end of the plank covering the mating end of the previous plank. Use a hammer and tapping block to ensure proper engagement.
13. Repeat this process for remaining rows keeping 6 inches between joints and maintaining a 1/2” expansion gap around fixed objects.
14. The last row may require rip cutting the planks to size, be sure to cut enough to maintain proper expansion gap.
15. As with the other rows, complete the last row by connecting the long edges.

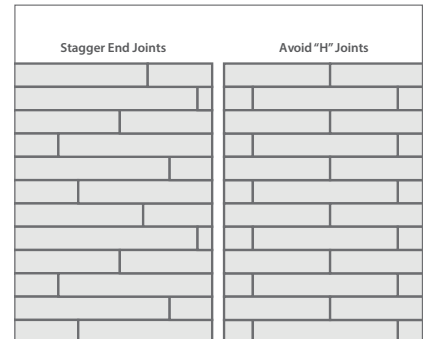
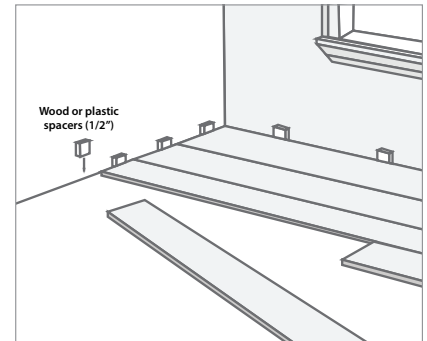
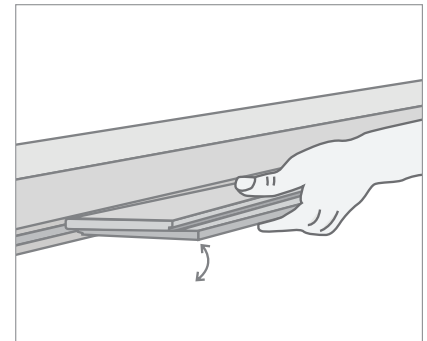
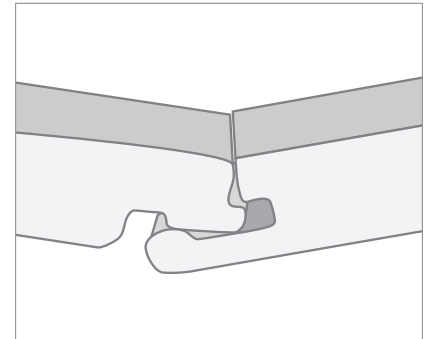

### After Installation

The newly installed floor is complete and can be walked on immediately.

## Floating T&G Installation Method

### Recommended Floating T&G Floor Tools

- Titebond® Tongue & Groove Flooring Glue
- Undercut or jamb saw
- Underlayment (see “Moisture Barrier Requirements”)
- Hammer
- Tapping block (trimmed piece of flooring)
- Tape Measure
- Wood or plastic spacers (1/2”)
- Pencil
- Flat bar or pull bar
- Chalk line
- Miter saw (chop-saw) with carbide blade 80 tooth or higher
- Earplugs & safety glasses

### Floating T&G Installation Steps

1. Use Titebond® Tongue & Groove Flooring Glue for floating applications.
2. Before you start, ensure that the job site, subfloor and environmental conditions are acceptable for installation of Cali Bamboo® flooring. All requirements specified in Cali Bamboo’s Installation Guidelines must be met.
3. Seal concrete subfloor with Titebond® 531+ Moisture Control System prior to installation.
4. Allow at least a 1/2” space for expansion around the perimeter of the room and all vertical objects using spacers. Also see section: “Expansion Space is Required”.
5. It is recommended to install the planks parallel to the longest wall.
6. Dry lay (do not glue) a few rows before installation to confirm your layout plan.
7. Begin by laying the first plank in a corner with the long grooved side toward the long wall.
8. Apply a small continuous consistent bead of Titebond™ T&G flooring glue along the bottom side of the flooring groove.
9. Connect short side of second plank together with mating side of the first plank.
10. Cut the last plank and complete the row. Use the remaining plank to start the second row.
11. Make sure to offset the end joints of consecutive rows by a minimum of 6 inches for best appearance.
12. Continue second row by connecting short edges of planks first with long edges.
13. The last row may require rip cutting the planks to size, be sure to cut enough to maintain proper expansion space.
14. As with the other rows, complete the last row by connecting the short edges first and using a pull bar to tap the long edges together.

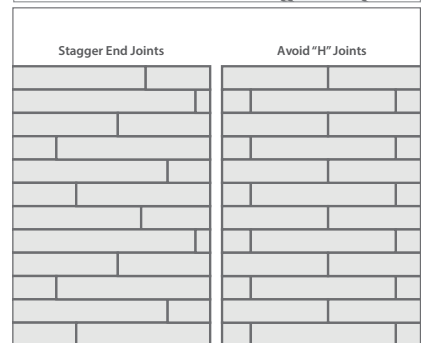
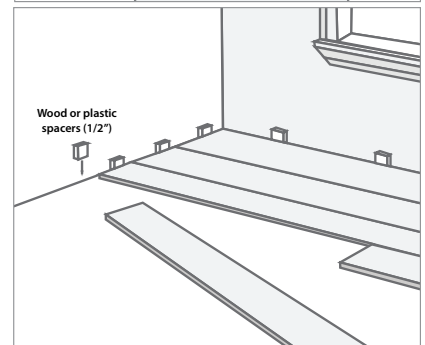
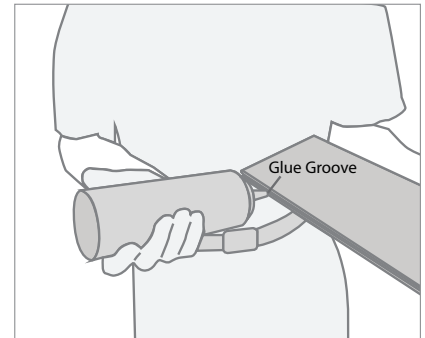

### After Installation

- Always remove any adhesive from the surface of the flooring (smudges, fingerprints, etc.) before it dries. Use Bostik’s™ Ultimate Adhesive Remover Towels to immediately remove any adhesive on flooring surface as you go.
- Allow the newly installed floor to fully cure based on adhesive recommendations before walking or moving furniture onto the floor.

## Nail-Down T&G Installation Method

The nail-down method is suitable for wood subfloors using our tongue and groove flooring only. Before you start, ensure that the job site, subfloor and environmental conditions are acceptable for installation of Cali Bamboo® flooring. All requirements specified in Cali Bamboo's Installation Guidelines must be met. Nailing down a click-lock floor will void the warranty.

### Recommended Tools

The selection and use of any nailer is at the discretion and responsibility of the installer/ homeowner. Choose a nailer model that is specifically designed for tongue and groove applications. We recommend a Pneumatic 18 Gauge Flooring Nailer (such as Powernail 50p Flex or similar). It is the installer's responsibility to determine the correct pressure for their nailer, and to ensure that the fastener is properly seated. Dimpling of the flooring face or edge is not a manufacturing defect.

- Pneumatic 18-gauge tongue-and-groove flooring nailer
- Use 1-1/2" to 2" long, 18 gauge cleats for Fossilized® flooring
- Underlayment (see "Moisture Barrier Requirements")
- Earplugs & safety glasses
- Tapping block (trimmed piece of flooring)
- Tape Measure
- Wood or plastic spacers (1/2")
- Pencil
- Flat bar or pull bar
- Chalk line
- Miter saw (chop-saw) with carbide blade 80 tooth or higher
- Hammer
- Undercut or jamb saw

### Nail-Down Installation Steps

1. Use a moisture barrier designed for wood subfloors (see "Moisture Barrier Requirements").
2. When nailing, the flooring should be always laid perpendicular to the floor joist.
3. Allow at least a 1/2" space for expansion around the perimeter of the room and all vertical objects using spacers. Also see section: "Expansion Space is Required".
4. Dry lay (do not nail) a few rows before installation to confirm your layout plan.
5. Test the air pressure and angle of your pneumatic nailer with a sample plank to check for correct air pressure before installation. If you note any surface damage (face dimpling), tongue damage (splitting), etc., adjust the air pressure/angle accordingly. Test until dimpling no longer occurs.
6. Begin installation next to an outside wall. This is the best reference for establishing a straight working line.
7. Hold starter row in place by blind nailing or gluing to avoid unsightly nail marks.
8. Connect short side of second plank together with the mating side of the first plank.
9. Cut last plank and complete row. Use the remaining plank to start the second row.
10. Be sure to offset the end joints of consecutive rows by a minimum of six (6) inches for best appearance.
11. Continue second row by connecting short plank edges first with the long edges.
12. After the first two rows are secured, start the next row by nailing directly above the tongue at a 45 degree angle.
13. Carefully monitor nailer pressure to ensure that the nail head enters the tongue only as deeply as required to allow the adjacent plank to fit properly. Ensure that the nail head rests cleanly in the "nail pocket".
14. Recommended nail spacing is 8 to 10 inches along the length of each board.
15. Avoid nailing closer than 4 inches from the end of the plank.
16. As with the other rows, connect the short edges first and use a pull bar to tap the long edges together.
17. Always check your working lines to be sure the floor is still aligned.
18. The last row may require rip cutting the planks to size.
19. The last two rows will need to be secured in the same manner as the first two.

### After Installation

- The newly installed floor is complete and can be walked on immediately.
- Use wood filler or putty to correct minor flooring damage that occurs during installation.

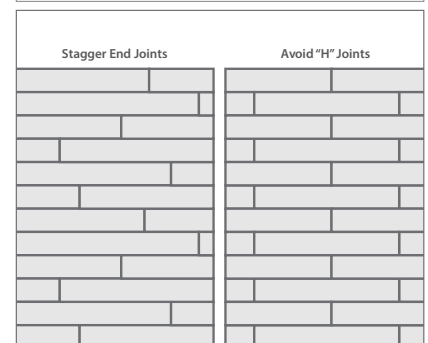
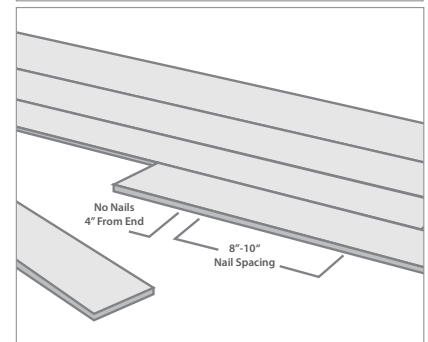
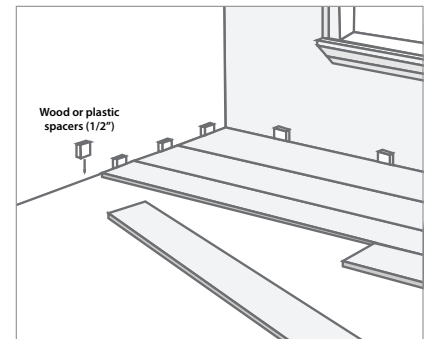

## Glue-Down Installation Method

### Recommended Adhesive Products

Cali Bamboo® recommends using Titebond® flooring adhesive and moisture barrier systems in accordance with manufactures specifications to receive Titebond's Platinum installation warranty. *Remember: Always Follow Flooring Adhesive Recommendations.* Cali Bamboo does not warrant against adhesive related problems.

### Recommended Glue-Down Floor Tools

- Flooring adhesive: Zero-VOC Adhesive by Titebond®
- Adhesive trowel as recommended by adhesive manufacturer
- Underlayment (see Moisture Barrier Requirements)
- Tapping block (trimmed piece of flooring)
- Wood or plastic spacers (1/2")
- Flat bar or pull bar
- Miter saw (chop-saw) with carbide blade 80 tooth or higher
- Undercut or jamb saw
- Hammer
- Tape measure
- Chalk line
- Carpenter square
- Earplugs and safety glasses

### Glue-Down Installation Steps

1. Before you start, ensure that the job site, subfloor and environmental conditions are acceptable for installation of Cali Bamboo® flooring. All requirements specified in Cali Bamboo's Installation Guidelines must be met.
2. Seal concrete subfloor with Titebond® 531+ Moisture Control System prior to installation.
3. Allow at least a 1/2" space for expansion around the perimeter of the room and all vertical objects using spacers. Also see section: "Expansion Space is Required".
4. Dry-lay a couple rows before starting installation to confirm your layout plan.
5. Begin installation next to an outside wall. This is the best reference for establishing a straight working line.
6. Lay the first row of flooring with groove facing the wall. Starter rows should be secured by blind nailing and gluing.
7. Connect short side of second plank together with mating side of the first plank.
8. Cut last plank and complete row. Use the remaining plank to start second row.
9. Offset end joints of consecutive rows by a minimum of 6" for best appearance.
10. With the first row in place, trowel out some adhesive and lay second row by connecting short edges of planks first. Use a pull bar to tap long edges together.
11. Always check your working lines to be sure the floor is still aligned.
12. Use tapping block to fit planks together, but be careful not to let installed floor move on the wet adhesive while you are working.
13. The last row may require rip cutting the planks to size.
14. Flooring planks on perimeter of room may require weight on them until adhesive cures enough to hold them down.

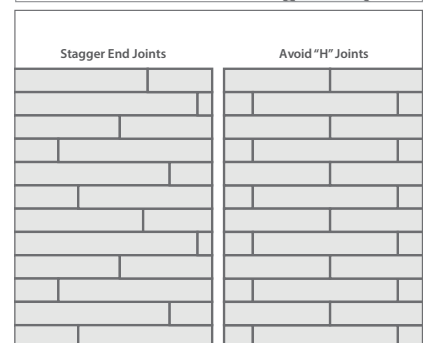
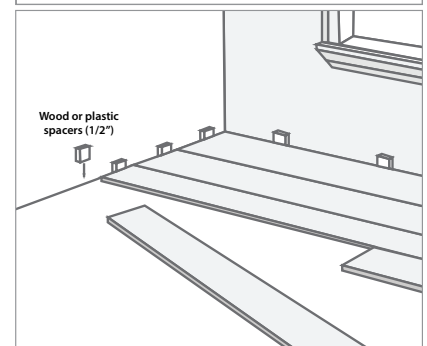
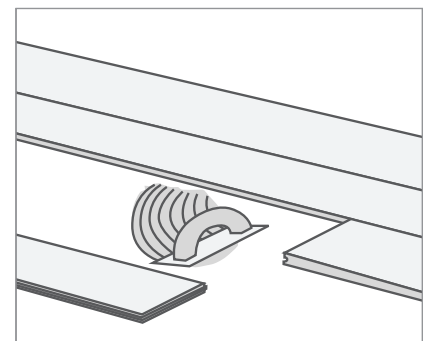

### After Installation

- Always remove any adhesive from the surface of the flooring (smudges, fingerprints, etc.) before it dries. Use Bostik's™ Ultimate Adhesive Remover Towels to immediately remove any adhesive on flooring surface as you go.
- Allow the newly installed floor to fully cure based on adhesive recommendations before walking or moving furniture onto the floor.

## Cali Bamboo Care & Maintenance Guidelines

Cali Bamboo® flooring is treated with an industry-leading scratch resistant coating, and its density and strength surpasses almost any other flooring in the world. Bamboo flooring is tough, but all hardwood flooring is pervious to dents, scratches, discoloration or other natural or man-made damage. Prevention is a big part of the care for bamboo floors.

- Cali Bamboo recommends you vacuum or sweep the floor on a regular basis or as needed to remove dirt, sand or grit.
- Soak up spills immediately using a dry towel or dry mop.
- For general cleaning, use Bona Pro Hardwood Floor Cleaner & Bona Pro Hardwood Floor Mop.
- Fit furniture legs with felt tips or protective caps. Fix rolling furniture with soft rubber casters. Pick up heavy furniture or appliances; do not slide.
- Keep pets nails trimmed to avoid excess scratching.
- Limit direct sunlight on floor by using curtains and blinds in areas that are exposed to high UV rays.
- Maintain relative humidity between 40%-60%.
- Never wet-mop a hardwood floor. Standing water may cause permanent damage.
- Never use any of the following products on your floor: ammonia-based cleaners, acrylic finishes, wax-based products, detergents, bleach, polishes, oil soap, abrasive cleaning soaps, or acidic materials such as vinegar. Never apply wax treatments to your floor.
- Use interior and exterior doormats at entrances to prevent dirt and moisture from being tracked onto the floor. Area rugs are also recommended in front of kitchen sinks and in high traffic areas. Do not use rugs with solid rubber or vinyl backings. Rugs must be made of a breathable material to prevent moisture entrapment. We recommend using a breathable rug underlay. Mesh or grid patterns are best.



### What is the best way to mop my Cali Bamboo floor?

Never wet (or damp) mop your floor. Standing water can damage the floor. You may periodically use a very slightly dampened (near dry) mop to spot-clean; however excessive moisture will dull the finish. For wood flooring in the kitchen, place an area rug in front of the kitchen sink. We recommend using Bona Pro Hardwood Floor Cleaner & Bona Pro Hardwood Floor Mop to clean your floor.

### How can I protect the finish of my bamboo floor from wear over time?

Sweep and vacuum your floor regularly using a broom or dust mop. Brush or felt vacuum heads are recommended as opposed to vacuums with beater bars or hard heads. Use throw rugs both inside and outside doorways to prevent debris from being tracked onto floors. Keep pet's claws trimmed to avoid excess scratches. Avoid contact with excess moisture. Avoid walking on your floors with cleats, sports shoes and high heels. Do not slide heavy furniture or appliances across the floor.

### What are the best environmental conditions for my flooring?

As a general rule, with geographic exceptions, flooring will perform best when the interior environment is controlled to stay within a relative humidity range of 40%-60% and a temperature range of 60° to 80° Fahrenheit. (In some climates, the ideal humidity range might be higher or lower – 25 to 45 percent in desert areas for example.) It is the owner's responsibility to maintain appropriate conditions via the use of humidifier and/or de-humidifier. In homes in which occupants are there for a short period of time (weekend home or vacation cabin), or in rooms that are closed off (not heated or air conditioned) to save energy, ventilation is a must even when the home is not occupied.

### How do I fix a scratch on my finish?

If the scratch is white, the finish has not been compromised and is repairable. Simply using a flooring cleaner, like Bona, should eliminate these blemishes. If the scratch is deeper but the raw wood is not exposed, light buffing with a white polishing pad can shine up the dull area. Often the damage becomes less obvious. When removing stains from any wood floor, always begin at the outer edge of the stain and work toward the middle.

### My wood floor was damaged through the finish. Can it be repaired?

If you have a minor chip or slight damage, this may be minimized with a colored wax. Color Rite Caulk and Mohawk Fill Sticks are wood fill products that work great to reduce the appearance of deeper blemishes. For light scratches we recommend Tibet Almond Stick. If the damage is severe enough, board replacement is typically the best option. To match your floor repairs, we suggest that you take a sample of the flooring to your local hardware store. In most cases, more than one shade may be appropriate.

### Can I refinish my Cali Bamboo® Flooring?

Major modifications are not recommended and are never a guaranteed solution; all repairs are unique. Excessive sanding is not covered under warranty. Nevertheless, the method of refinishing Cali Bamboo® Flooring is the same as any hardwood flooring. An aluminum oxide coating is advisable. Please always seek assistance from an NWFA Certified Specialist, and always test on a sample plank before you proceed.

### What changes can I expect in my flooring from season to season?

Cali Bamboo floors, like all species of hardwood flooring, are subject to changes in temperature and humidity. Seasonal fluctuations in relative humidity may cause the wood flooring to gain moisture with periods of high humidity, and lose moisture during low periods of humidity. These changes may be noticeable. During warm, humid weather, wood expands. During dry weather, wood contracts. This seasonal movement is a normal characteristic of wood flooring, and can be minimized by using a HVAC system to maintain relative humidity between 40%-60%.

### Can I put heavy furniture on floated flooring?

Heavy furniture (500+ lbs.) may obstruct the free, natural movement of a floated floor. Restricting this movement in certain areas can lead to problems such as buckling or separation when the floor experiences natural expansion and/or contraction.

### Occasional Flooring Noise

Floor noise is normal and will vary from one installation type to the next. Occasional noise is due to structural movement and may relate to sub-floor type, flatness, deflection, and/or related to the fasteners, changes in environmental conditions, relative humidity and the amount of topside pressure applied to the flooring. For these reasons floor noise is not considered a product or manufacturer defect.

