



## 2019 – 2020 Golf Products Catalog



PEBBLE BEACH  
RESORTS

Rain Bird is the Official Turf Irrigation Supplier of Pebble Beach Resorts®, Pebble Beach®, Pebble Beach Golf Links®, Pebble Beach Resorts®, The Lone Cypress™. The Heritage logo and their underlying distinctive images are trademarks, service marks and trade dress of Pebble Beach Company. Used by permission.



## TOTAL SYSTEM SOLUTIONS

# Everything You Need for Advanced Control of Your Irrigation.

As the only manufacturer committed exclusively to irrigation, Rain Bird designs fully integrated end-to-end solutions to address both new installation and system renovation challenges. This gives you total integration of components and a full system that is easier to manage and runs more efficiently than mix-and-match systems. Plus, you get a single source for service and other benefits available only from Rain Bird.

■ Golf Rotors . . . . .	4	■ Pump Stations & Filtration . . . . .	44
■ Central Control Technologies . . . . .	20	■ Valves . . . . .	52
■ IC System™ . . . . .	28	■ Landscape Solutions . . . . .	60
■ Field Controllers . . . . .	34	■ Appendix . . . . .	92



## The TRUE Benefits™ of a Rain Bird System

### **Timeless Compatibility™**

Every Rain Bird golf irrigation product is engineered for Timeless Compatibility, allowing you to have a state-of-the-art system that can be updated or changed without obsoleting your existing equipment.



### **Real-Time Response**

Rain Bird offers continuous two-way communication, allowing for automatic optimization between your Central Control and the field. By receiving data and making instant adjustments when needed, you can protect your course from unforgiving weather and unexpected challenges.



### **Unmatched Quality**

Throughout engineering, design and testing, Rain Bird's mission is to deliver industry-leading quality to our customers. Our stringent testing procedures are implemented at the first launch of every product as well as regularly throughout the year, and they replicate the world's harshest conditions.



### **Easy To Use**

All Rain Bird products are engineered with the challenges of golf professionals in mind and designed to deliver everyday ease of use. From software interfaces to rotor designs, they help you and your crew find a quicker, hassle-free path to top playability.







Rockrimmon Country Club

## Golf Rotors

### ***Engineered to Perform. Built to Last.***

Rain Bird® golf rotors are engineered for precise application and distribution uniformity, helping you get the most from your water source. With intelligent, easy-to-use features like a top-serviceable design and quick full- or part-circle adjustments, Rain Bird golf rotors help you and your crew save time every week.

Designed for Timeless Compatibility™ with every gear-driven golf rotor manufactured since 1992, these rotors give you the flexibility to update internals without having to dig up the case, saving you even more time.

#### **GBS25 Solenoid**

Delivers 25kV surge protection and built-in filtration for a second level of protection from debris. Eliminates the most common maintenance tasks that plague competing rotors.

#### **Top Serviceability**

With superior performance in a smaller footprint than competing rotors and an intelligent snap-ring design for quick access to serviceable components, Rain Bird rotors have long been the perfect choice for golf courses.





**NEW**

**551 Series: 32' to 55' (9.8 m to 16.8 m)**

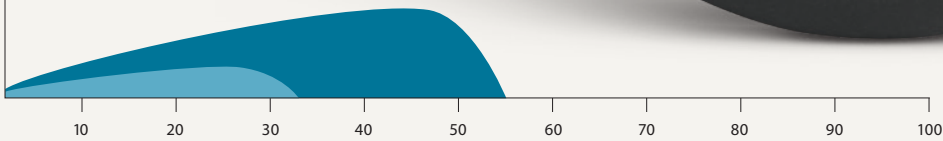

**700 Series: 57' to 79' (17.4 m to 23.5 m)**  
**751 Series: 37' to 75' (11.2 m to 22.3 m)**

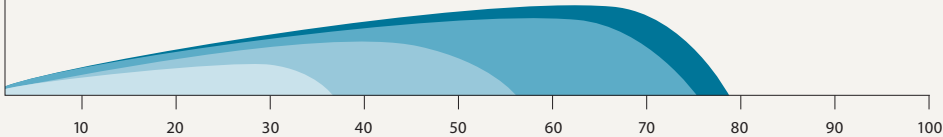

**900 Series: 63' to 97' (19.2 m to 29.6 m)**  
**950 Series: 70' to 92' (21.3 m to 28.0 m)**

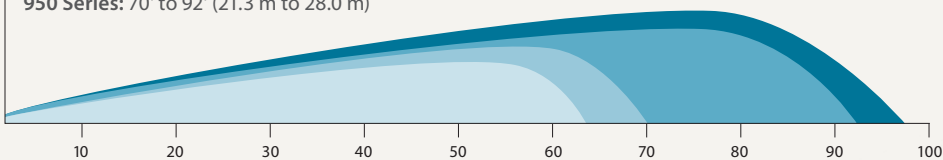



## 551 Series Rotors

### SPECIFICATIONS

**Radius:** 32' to 55' (9.8 m to 16.8 m)

**Flow Rate:** 6.83 to 13.63 gpm (0.43 to 0.86 l/s) (1.55 to 3.10 m<sup>3</sup>/h)

**Arc:** Full-circle 360°; Adjustable 30° to 345°

**Models:**

- E: Electric
- IC: Integrated Control
- SAM: Stopamatic
- B: Seal-A-Matic™ device

**Maximum Inlet Pressure:**

- Models E and IC: 150 psi (10.3 bar)
- Models SAM and B: 100 psi (6.9 bar)

**Pressure Regulation Range:** 60 to 100 psi (4.1 to 6.9 bar)

**Factory Pressure Settings:**

Models E and IC available in 70 and 80 psi (4.8 and 5.5 bar)

**Dimensions:**

**Body Height:**

- Models E, IC, SAM: 12.0" (30.5 cm)
- Model B: 9.6" (24.5 cm)

**Pop-Up Height to Mid-Nozzle:** 2.6" (6.6 cm)

**Top Diameter:**

- Models E, IC, SAM: 6.25" (15.9 cm)
- Model B: 4.25" (10.8 cm)

**Nozzle Trajectory:**

- 51 Nozzle: 12°
- 52, 53, 54 Nozzles: 25°

**Inlet Threads:**

- Models E, IC, SAM: 1.25" (3.2 cm) ACME female threaded
- Model B: 1" (2.5 cm) ACME

**Holdback:**

- Block: 10' (3.1 m) elevation
- SAM: 15' (4.6 m) elevation

**Rotation Time:** 180° in ≤ 90 seconds; 75 seconds nominally

**Maximum Stream Height:**

- 51 Nozzle: 5' (1.5 m)
- 52, 53, 54 Nozzles: 13' (4.0 m)

**Solenoid:** 24 VAC solenoid power requirement: 0.41 amp inrush current (9.8 VA);

- 60 cycle: 0.20 amp holding current (4.8 VA);
- 50 cycle: 0.23 amp holding current (5.4 VA)

**Surge Resistance:** Up to 25kV standard on electric models

**Top-Serviceable Rock Screen™ and Replaceable Valve Seat:**

On models E, IC, SAM

### Features and Benefits

Designed to provide the right coverage for areas like tee boxes and small areas, Rain Bird® 551 Series Rotors are the most efficient short-throw golf rotors on the market. As a true golf-quality rotor with valve-in-head options, the 551 Series delivers strong distribution uniformity in small, tight areas. Nozzles with a higher flow rate minimize your water window while large droplets reduce wind drift.



COMPATIBLE WITH  
Rain Bird® Sod Cup Kit  
(See page 19)



### HOW TO SPECIFY

A	551	XX	XX	XX
THREAD TYPE	MODEL	BODY/ VALVE	PRESSURE REGULATOR	NOZZLE
ACME	551	E	70 (4.8)	51
		IC	80 (5.5)	52
		SAM		53
		B		54





### Rapid-Adjust Technology Featuring MemoryArc®

Whether you're catering to grow-in or just trying to get more from a limited water supply, Rapid-Adjust Technology lets your staff make easy arc adjustments with the turn of a screw. MemoryArc retains two part-circle arc settings, so you can shift between full- and part-circle operation in seconds.

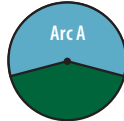

**Step 1**  
Set primary rotor arc.

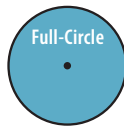

**Step 2**  
Turn the Full/Part Adjustment Screw for full-circle operation.

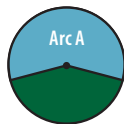

**Step 3**  
Turn the rotor to either Arc A or Arc B setting, then set to part-circle. No need to reset the arc when changing between full- and part-circle settings.

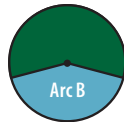

### U.S. Performance Data

CASCADE NOZZLES												
Base Pressure (psi)	50		60		70		80		90		100	
	Radius (ft)	Flow (gpm)	Radius (ft)	Flow (gpm)	Radius (ft)	Flow (gpm)	Radius (ft)	Flow (gpm)	Radius (ft)	Flow (gpm)	Radius (ft)	Flow (gpm)
#51-Blue	32	6.83	34	7.53	35	8.00	36	8.60	37	9.03	38	9.43
#52-Beige	38	6.57	39	7.17	40	7.90	40	8.73	40	8.80	40	9.33
#53-Gray	51	9.27	51	10.20	51	11.10	51	11.80	51	12.60	51	13.17
#54-Red	53	9.71	55	10.74	53	11.49	53	12.26	55	12.97	55	13.63

### Metric Performance Data

CASCADE NOZZLES																		
Base Pressure (bar)	3.4			4.1			4.8			5.5			6.2			6.9		
	Radius (m)	Flow (l/s)	Flow (m³/h)	Radius (m)	Flow (l/s)	Flow (m³/h)	Radius (m)	Flow (l/s)	Flow (m³/h)	Radius (m)	Flow (l/s)	Flow (m³/h)	Radius (m)	Flow (l/s)	Flow (m³/h)	Radius (m)	Flow (l/s)	Flow (m³/h)
#51-Blue	9.8	0.43	1.55	10.4	0.48	1.71	10.7	0.50	1.82	11.0	0.54	1.95	11.3	0.57	2.05	11.6	0.59	2.14
#52-Beige	11.6	0.41	1.49	11.9	0.45	1.63	12.2	0.50	1.79	12.2	0.55	1.98	12.2	0.56	2.00	12.2	0.59	2.12
#53-Gray	15.5	0.58	2.11	15.5	0.64	2.32	15.5	0.70	2.52	15.5	0.74	2.68	15.5	0.79	2.86	15.5	0.83	2.99
#54-Red	16.2	0.61	2.21	16.8	0.68	2.44	16.2	0.72	2.61	16.2	0.77	2.78	16.8	0.82	2.95	16.8	0.86	3.10



## 700 Series Rotors

### SPECIFICATIONS

**Radius:** 57' to 79' (17.4 m to 23.5 m)

**Flow Rate:** 16.3 to 43.8 gpm (1.03 to 2.76 l/s) (3.70 to 9.95 m<sup>3</sup>/h)

**Arc:** Full-circle 360°

**Models:**

**E:** Electric

**IC:** Integrated Control

**SAM:** Stopamatic

**B:** Seal-A-Matic™ device

**Maximum Inlet Pressure:**

**Models E and IC:** 150 psi (10.3 bar)

**Models SAM and B:** 100 psi (6.9 bar)

**Pressure Regulation Range:** 60 to 100 psi (4.1 to 6.9 bar)

**Factory Pressure Settings:** 700E/IC and available in 70 and 80 psi (4.8 and 5.5 bar)

**Dimensions:**

**Body Height:**

**Models E, IC, SAM:** 12.0" (30.5 cm)

**Model B:** 9.6" (24.5 cm)

**Pop-Up Height to Mid-Nozzle:**

**Models E, IC, SAM, B:** 2.6" (6.6 cm)

**Top Diameter:**

**Models E, IC, SAM:** 6.25" (15.9 cm)

**Model B:** 4.25" (10.8 cm)

**Nozzle Trajectory:**

**Standard:** 25°

**Wind Tolerant:** 12°

**Inlet Threads:**

**Models E, IC, SAM:** 1.25" (3.2 cm) ACME Female Threaded

**Models B:** 1" (2.5 cm) ACME Female Threaded

**Holdback:**

**Block:** 10' (3.1 m) of elevation

**SAM:** 15' (4.6 m) of elevation

**Rotation Time:** 360° in ≤ 180 seconds; 150 seconds nominally

**Maximum Stream Height:**

**Standard:** 17' (5.2 m)

**Wind Tolerant:** 10' (3.1 m)

**Solenoid:** 24 VAC solenoid power requirement: 0.41 amp inrush current (9.8 VA);

**60 cycle:** 0.20 amp holding current (4.8 VA);

**50 cycle:** 0.23 amp holding current (5.4 VA)

**Surge Resistance:** Up to 25kV standard on electric models

**Top-Serviceable Rock Screen™ and Replaceable Valve Seat:**

On models E, IC, SAM

### Features and Benefits

Featuring consistent pressure regulation and high-efficiency nozzles with large droplets that cut through harsh winds, Rain Bird® 700 Series rotors give you the even distribution you need for a healthy playing surface. With the ability to drop a new Rain Bird 700 Series internal assembly into your existing rotor cases, they save you time and money year after year.

Rain Bird golf rotors offer a low cost of ownership through a powerful combination of versatility, performance and durability.





## U.S. Performance Data

DUAL SPREADER™ NOZZLES												
Base Pressure (psi)	50		60		70		80		90		100	
	Radius (ft)	Flow (gpm)	Radius (ft)	Flow (gpm)	Radius (ft)	Flow (gpm)	Radius (ft)	Flow (gpm)	Radius (ft)	Flow (gpm)	Radius (ft)	Flow (gpm)
#28 - White	57	18.0	59	19.7	59	21.3	61	22.8	61	24.1	61	25.5
#32 - Blue	61	21.9	63	22.8	65	24.5	65	27.4	67	29.0	67	29.6
#36 - Yellow	65	23.2	65	25.5	65	27.5	67	29.5	65	31.2	67	32.9
#40 - Orange	65	25.5	67	27.8	71	29.8	71	31.9	73	33.9	73	35.6
#44 - Green	—	—	71	30.7	69	33.0	71	35.2	75	37.5	75	39.5
#48 - Black	—	—	—	—	73	37.0	77	39.4	79	41.8	77	43.8

WIND TOLERANT NOZZLES												
Base Pressure (psi)	50		60		70		80		90		100	
	Radius (ft)	Flow (gpm)	Radius (ft)	Flow (gpm)	Radius (ft)	Flow (gpm)	Radius (ft)	Flow (gpm)	Radius (ft)	Flow (gpm)	Radius (ft)	Flow (gpm)
#16 WTN - Gray	—	—	56	16.3	56	17.5	60	18.5	62	20.2	63	21.1
#18 WTN - Red	—	—	58	19.0	61	20.9	65	22.3	65	23.2	65	24.2
#22 WTN - Black	—	—	—	—	65	27.6	65	34.8	67	38.8	71	40.5

## Metric Performance Data

DUAL SPREADER™ NOZZLES																		
Base Pressure (bar)	3.4			4.1			4.8			5.5			6.2			6.9		
	Radius (m)	Flow (l/s)	Flow (m³/h)	Radius (m)	Flow (l/s)	Flow (m³/h)	Radius (m)	Flow (l/s)	Flow (m³/h)	Radius (m)	Flow (l/s)	Flow (m³/h)	Radius (m)	Flow (l/s)	Flow (m³/h)	Radius (m)	Flow (l/s)	Flow (m³/h)
#28 - White	17.4	1.14	4.09	18.0	1.24	4.47	18.0	1.34	4.84	18.6	1.44	5.18	18.6	1.52	5.47	18.6	1.61	5.79
#32 - Blue	18.6	1.38	4.97	19.2	1.44	5.18	19.8	1.55	5.56	19.8	1.73	6.22	20.4	1.83	6.59	20.4	1.87	6.72
#36 - Yellow	19.8	1.46	5.27	19.8	1.61	5.79	19.8	1.73	6.25	20.4	1.86	6.70	19.8	1.97	7.09	20.4	2.08	7.47
#40 - Orange	19.8	1.61	5.79	20.4	1.75	6.31	21.6	1.88	6.77	21.6	2.01	7.25	22.3	2.14	7.70	22.3	2.25	8.09
#44 - Green	—	—	—	21.6	1.94	6.97	21.0	2.08	7.49	21.6	2.22	7.99	22.9	2.37	8.52	22.9	2.49	8.97
#48 - Black	—	—	—	—	—	—	22.3	2.33	8.40	23.5	2.49	8.95	24.1	2.64	9.49	23.5	2.76	9.95

WIND TOLERANT NOZZLES																		
Base Pressure (bar)	3.4			4.1			4.8			5.5			6.2			6.9		
	Radius (m)	Flow (l/s)	Flow (m³/h)	Radius (m)	Flow (l/s)	Flow (m³/h)	Radius (m)	Flow (l/s)	Flow (m³/h)	Radius (m)	Flow (l/s)	Flow (m³/h)	Radius (m)	Flow (l/s)	Flow (m³/h)	Radius (m)	Flow (l/s)	Flow (m³/h)
#16 WTN - Gray	—	—	—	17.1	1.03	3.70	17.1	1.10	3.97	18.3	1.17	4.20	18.9	1.27	4.59	19.2	1.33	4.79
#18 WTN - Red	—	—	—	17.7	1.20	4.32	18.6	1.32	4.75	19.8	1.41	5.06	19.8	1.46	5.27	19.8	1.53	5.50
#22 WTN - Black	—	—	—	—	—	—	19.8	1.74	6.27	19.8	2.20	7.90	20.4	2.45	8.81	21.6	2.56	9.20

### HOW TO SPECIFY

<b>A</b>	<b>—</b>	<b>700</b>	<b>—</b>	<b>XX</b>	<b>—</b>	<b>XX</b>	<b>—</b>	<b>XX</b>
THREAD TYPE		MODEL		BODY/VALVE		PRESSURE REGULATOR		NOZZLE
ACME		700		E IC SAM B		70 (4.8) 80 (5.5)		28 32 36 40 44 48



### 751 Series Rotors

#### SPECIFICATIONS

**Radius:** 37' to 75' (11.2 m to 22.3 m)

**Flow Rate:** 7.0 to 37.7 gpm (0.44 to 2.38 l/s)  
(1.59 to 8.56 m<sup>3</sup>/h)

**Arc:** Full-circle 360°; Adjustable 30° to 345°

#### Models:

- E:** Electric
- IC:** Integrated Control
- SAM:** Stopamatic
- B:** Seal-A-Matic™ device

#### Maximum Inlet Pressure:

- Models E and IC:** 150 psi (10.3 bar)
- Models SAM and B:** 100 psi (6.9 bar)

**Pressure Regulation Range:** 60 to 100 psi  
(4.1 to 6.9 bar)

**Factory Pressure Settings:** 751E/IC available  
in 70 and 80 psi (4.8 and 5.5 bar)

#### Dimensions:

- Body Height:**
  - Models E, IC, SAM:** 12.0" (30.5 cm)
  - Model B:** 9.6" (24.5 cm)
- Pop-Up Height to Mid-Nozzle:**
  - Models E, IC, SAM, B:** 2.6" (6.6 cm)

- Top Diameter:**
  - Models E, IC, SAM:** 6.25" (15.9 cm)
  - Model B:** 4.25" (10.8 cm)

#### Nozzle Trajectory:

- Standard:** 25°
- Wind Tolerant:** 12°
- Low-Angle:** 15°

#### Inlet Threads:

- Models E, IC, SAM:** 1.25" (3.2 cm)  
ACME Female Threaded
- Model B:** 1" (2.5 cm) ACME  
Female Threaded

#### Holdback:

- Block:** 10' (3.1 m) of elevation
- SAM:** 15' (4.6 m) of elevation

**Rotation Time:** 180° in ≤ 90 seconds;  
75 seconds nominally

#### Maximum Stream Height:

- Standard:** 17' (5.2 m)
- Wind Tolerant:** 10' (3.1 m)
- Low Angle:** 12' (3.7 m)

**Solenoid:** 24 VAC solenoid power  
requirement: 0.41 amp inrush current  
(9.8 VA); **60 cycle:** 0.20 amp holding  
current (4.8 VA); **50 cycle:** 0.23 amp holding  
current (5.4 VA)

**Surge Resistance:** Up to 25kV standard  
on electric models

**Top-Serviceable Rock Screen™ and  
Replaceable Valve Seat:** On models  
E, IC, SAM



### Rapid-Adjust Technology Featuring MemoryArc®

Whether you're catering to grow-in or just trying to get more from a limited water supply, Rapid-Adjust Technology lets your staff make easy arc adjustments with the turn of a screw. MemoryArc retains two part-circle arc settings, so you can shift between full- and part-circle operation in seconds.

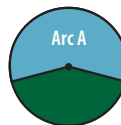

#### Step 1

Set primary rotor arc.

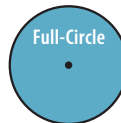

#### Step 2

Turn the Full/Part Adjustment Screw for full-circle operation.

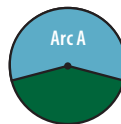

#### Step 3

Turn the rotor to either Arc A or Arc B setting, then set to part-circle. No need to reset the arc when changing between full- and part-circle settings.

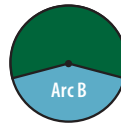

#### HOW TO SPECIFY

A	751	XX	XX	XX
THREAD TYPE	MODEL	BODY/ VALVE	PRESSURE REGULATOR	NOZZLE
ACME	751	E	70 (4.8)	20
		IC	80 (5.5)	22
		SAM		28
		B		32
				36
				40
				44
				48



COMPATIBLE WITH  
Rain Bird® Sod Cup Kit  
(See page 19)

#### NEW

### Low Angle Nozzle Housing Kit

The Rain Bird 751 Series low angle nozzle housing kit with 15° trajectory gives the user capability to optimize rotors to meet challenging field conditions such as elevation differences, wind and obstacles.

## U.S. Performance Data

DUAL SPREADER™ NOZZLES WITH STANDARD AND LOW ANGLE (LA) HOUSINGS																		
Base Pressure (psi)	50			60			70			80			90			100		
	Radius (ft)	LA (ft)	Flow (gpm)	Radius (ft)	LA (ft)	Flow (gpm)	Radius (ft)	LA (ft)	Flow (gpm)	Radius (ft)	LA (ft)	Flow (gpm)	Radius (ft)	LA (ft)	Flow (gpm)	Radius (ft)	LA (ft)	Flow (gpm)
#20 - Gray	37	32	7.0	39	32	7.8	39	32	8.4	41	34	8.9	—	—	—	—	—	—
#22 - Red	40	40	8.3	45	40	9.5	45	42	10.2	43	41	10.8	—	—	—	—	—	—
#28 - White	55	52	15.2	57	55	16.8	59	56	18.1	59	55	19.3	59	55	20.5	57	56	21.5
#32 - Blue	59	59	17.1	61	61	18.6	61	61	20.0	61	61	21.4	63	62	22.5	63	63	23.9
#36 - Yellow	61	60	19.1	63	63	20.8	65	65	22.6	67	67	24.0	69	69	25.5	69	69	26.5
#40 - Orange	63	62	21.7	67	65	23.8	69	67	25.6	71	67	27.5	71	70	28.9	71	70	30.7
#44 - Green	—	—	—	65	65	26.3	69	69	28.3	71	71	30.4	71	71	32.1	73	73	34.1
#48 - Black	—	—	—	—	—	—	69	69	31.4	73	73	33.7	75	75	35.7	73	73	37.7

WIND TOLERANT NOZZLES													
Base Pressure (psi)	50		60		70		80		90		100		
	Radius (ft)	Flow (gpm)	Radius (ft)	Flow (gpm)	Radius (ft)	Flow (gpm)	Radius (ft)	Flow (gpm)	Radius (ft)	Flow (gpm)	Radius (ft)	Flow (gpm)	
#16 WTN - Gray	—	—	60	15.7	62	16.7	62	17.8	64	18.8	66	20.4	
#18 WTN - Red	—	—	63	18.8	63	20.0	65	21.4	67	22.7	67	24.0	
#22 WTN - Black	—	—	—	—	65	27.6	65	35.8	67	37.6	71	41.1	

## Metric Performance Data

DUAL SPREADER™ NOZZLES WITH STANDARD AND LOW ANGLE (LA) HOUSINGS																								
Base Pressure (bar)	3.4				4.1				4.8				5.5				6.2				6.9			
	Radius (m)	LA (m)	Flow (l/s)	Flow (m³/h)	Radius (m)	LA (m)	Flow (l/s)	Flow (m³/h)	Radius (m)	LA (m)	Flow (l/s)	Flow (m³/h)	Radius (m)	LA (m)	Flow (l/s)	Flow (m³/h)	Radius (m)	LA (m)	Flow (l/s)	Flow (m³/h)				
#20 - Gray	11.3	9.8	0.40	1.59	11.8	9.8	0.49	1.77	11.9	9.8	0.53	1.91	12.5	10.4	0.56	2.02	—	—	—	—				
#22 - Red	12.2	12.2	0.52	1.89	13.7	12.2	0.60	2.16	13.7	12.8	0.64	2.32	13.1	12.5	0.68	2.45	—	—	—	—				
#28 - White	16.8	15.8	0.96	3.45	17.4	16.8	1.06	3.82	18.0	17.1	1.14	4.11	18.0	16.8	1.22	4.38	18.0	16.8	1.29	4.66				
#32 - Blue	18.0	18.0	1.08	3.88	18.6	18.6	1.17	4.22	18.6	18.6	1.26	4.54	18.6	18.6	1.35	4.86	19.2	18.9	1.42	5.11				
#36 - Yellow	18.6	18.3	1.21	4.34	19.2	19.2	1.31	4.72	19.8	19.8	1.43	5.13	20.4	20.4	1.51	5.45	21.0	21.0	1.61	5.79				
#40 - Orange	19.2	18.9	1.37	4.93	20.4	19.8	1.50	5.41	21.0	20.4	1.62	5.81	21.0	20.4	1.73	6.25	21.6	21.3	1.82	6.56				
#44 - Green	—	—	—	—	19.8	19.8	1.66	5.97	21.0	21.0	1.79	6.43	21.6	21.6	1.92	6.90	21.6	21.6	2.03	7.29				
#48 - Black	—	—	—	—	—	—	—	—	21.0	21.0	1.98	7.13	22.3	22.3	2.13	7.65	22.9	22.9	2.25	8.11				

  

WIND TOLERANT NOZZLES														
Base Pressure (bar)	3.4		4.1		4.8		5.5		6.2		6.9			
	Radius (m)	Flow (l/s)	Radius (m)	Flow (l/s)	Radius (m)	Flow (l/s)	Radius (m)	Flow (l/s)	Radius (m)	Flow (l/s)	Radius (m)	Flow (l/s)		
#16 WTN - Gray	—	—	18.3	0.99	3.57	18.9	1.05	3.79	18.9	1.12	4.04	19.5	1.19	4.27
#18 WTN - Red	—	—	19.2	1.19	4.27	19.2	1.26	4.54	19.8	1.35	4.86	20.4	1.43	5.16
#22 WTN - Black	—	—	—	—	—	19.8	1.74	6.27	19.8	2.26	8.13	20.4	2.37	8.54



### Typical Installation:

Watering area behind the Rain Bird 751

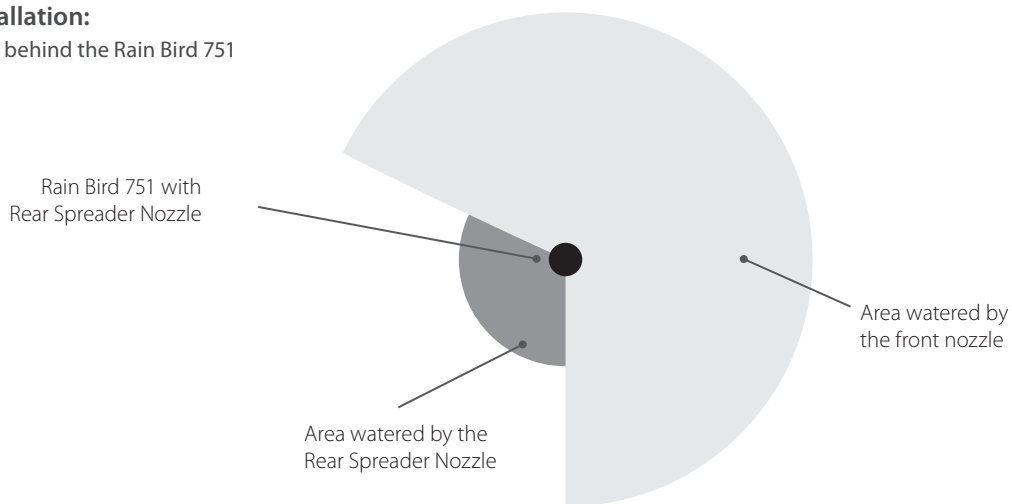

### 751 Series U.S. Performance Data

REAR SPREADER NOZZLES																		
Spreader Nozzle Color	Flow (gpm)	Nozzle Range		Flow (gpm)	Nozzle Range		Flow (gpm)	Nozzle Range		Flow (gpm)	Nozzle Range		Flow (gpm)	Nozzle Range		Flow (gpm)	Nozzle Range	
		Main (ft)	Rear (ft)		Main (ft)	Rear (ft)		Main (ft)	Rear (ft)		Main (ft)	Rear (ft)		Main (ft)	Rear (ft)		Main (ft)	Rear (ft)
<b>MAIN NOZZLE #28 – WHITE</b>									<b>MAIN NOZZLE #32 – BLUE</b>									
Pressure (psi)	<b>60</b>			<b>70</b>			<b>80</b>			<b>60</b>			<b>70</b>			<b>80</b>		
Orange	20.00	55.00	25.00	21.40	55.00	23.00	22.80	55.00	23.00	22.10	61.00	29.00	23.40	61.00	29.00	25.20	61.00	29.00
Green	22.90	51.00	47.00	24.00	53.00	45.00	25.60	51.00	47.00	24.60	57.00	47.00	26.60	59.00	45.00	28.40	59.00	45.00
Blue	22.63	50.98	44.98	24.39	50.98	44.98	25.27	52.99	44.98	24.57	58.99	42.98	26.55	58.99	44.98	28.27	60.99	44.98
Black	21.13	52.99	36.98	23.12	52.99	38.98	24.39	50.98	38.98	23.20	58.99	36.98	24.79	56.99	36.98	26.64	58.99	38.98
Red	21.90	53.00	49.00	23.60	55.00	49.00	25.10	55.00	47.00	24.10	55.00	49.00	25.00	59.00	47.00	26.50	57.00	47.00
Blue + Diffuser	20.90	57.00	33.00	21.50	55.00	33.00	22.90	55.00	33.00	23.20	61.00	31.00	24.90	61.00	31.00	26.30	61.00	31.00
Black + Diffuser	19.20	54.99	30.97	29.28	56.99	30.97	21.84	54.99	30.97	20.96	56.99	32.97	22.63	56.99	32.97	24.08	56.99	32.97
<b>MAIN NOZZLE #36 – YELLOW</b>									<b>MAIN NOZZLE #40 – ORANGE</b>									
Pressure (psi)	<b>60</b>			<b>70</b>			<b>80</b>			<b>60</b>			<b>70</b>			<b>80</b>		
Orange	23.40	61.00	29.00	25.40	63.00	29.00	27.10	63.00	27.00	27.70	69.00	29.00	29.60	69.00	29.00	31.60	71.00	29.00
Green	26.90	61.00	43.00	29.10	61.00	45.00	30.50	63.00	45.00	30.20	63.00	47.00	32.40	65.00	49.00	34.50	69.00	51.00
Blue	25.93	58.99	40.98	28.00	60.99	38.98	29.76	60.99	38.98	29.68	62.99	40.98	32.10	64.99	40.98	34.25	66.99	40.98
Black	26.42	60.99	36.98	27.78	60.99	34.97	29.54	60.99	36.98	28.97	60.99	36.98	31.22	62.99	36.98	34.20	62.99	36.98
Red	26.10	61.00	45.00	28.20	61.00	43.00	30.20	61.00	43.00	30.40	63.00	47.00	32.80	67.00	45.00	34.70	67.00	45.00
Blue + Diffuser	24.60	63.00	35.00	26.30	63.00	31.00	27.90	65.00	33.00	28.00	63.00	31.00	30.30	67.00	31.00	32.10	69.00	31.00
Black + Diffuser	24.48	64.99	34.97	25.67	64.99	34.97	27.12	64.99	34.97	27.21	62.99	30.97	29.46	64.99	30.97	31.30	66.99	30.97
<b>MAIN NOZZLE #44 – GREEN</b>									<b>MAIN NOZZLE #48 – BLACK</b>									
Pressure (psi)	<b>60</b>			<b>70</b>			<b>80</b>			<b>70</b>			<b>80</b>			<b>90</b>		
Orange	29.30	65.00	27.00	31.70	69.00	27.00	33.70	71.00	27.00	35.00	73.00	29.00	37.60	75.00	29.00	39.70	79.00	29.00
Green	32.80	65.00	47.00	35.40	67.00	43.00	37.80	69.00	43.00	38.30	71.00	45.00	40.70	77.00	45.00	42.80	77.00	47.00
Blue	32.27	64.99	38.98	35.00	66.99	38.98	37.16	69.00	38.98	37.47	71.00	40.98	39.49	75.00	38.98	42.27	75.00	38.98
Black	31.79	64.99	34.97	34.25	66.99	34.97	36.50	71.00	32.97	37.47	75.00	36.98	40.11	77.00	34.97	42.14	78.97	36.98
Red	32.30	65.00	45.00	34.90	67.00	45.00	37.10	67.00	33.00	37.80	73.00	47.00	40.40	73.00	47.00	42.80	77.00	47.00
Blue + Diffuser	30.90	67.00	33.00	33.20	73.00	31.00	35.50	73.00	33.00	36.00	77.00	31.00	38.30	77.00	31.00	40.60	77.00	31.00
Black + Diffuser	29.06	64.99	32.97	31.22	69.00	28.97	33.37	71.00	30.97	35.22	73.00	30.97	37.25	73.00	30.97	39.14	77.00	30.97



### 751 Series Metric Performance Data

REAR SPREADER NOZZLES																		
Spreader Nozzle Color	Flow (m³/h)	Nozzle Range (m)		Flow (m³/h)	Nozzle Range (m)		Flow (m³/h)	Nozzle Range (m)		Flow (m³/h)	Nozzle Range (m)		Flow (m³/h)	Nozzle Range (m)		Flow (m³/h)	Nozzle Range (m)	
<b>MAIN NOZZLE #28 – WHITE</b>									<b>MAIN NOZZLE #32 – BLUE</b>									
Pressure (bar)	4.1			4.8			5.5			4.1			4.8			5.5		
Orange	4.54	16.76	7.62	4.86	16.76	7.01	5.18	16.76	7.01	5.02	18.59	8.84	5.31	18.59	8.84	5.72	18.59	8.84
Green	5.20	15.54	14.33	5.45	16.15	13.72	5.81	15.54	14.33	5.59	17.37	14.33	6.04	17.98	13.72	6.45	17.98	13.72
Blue	5.14	15.54	13.71	5.54	15.54	13.71	5.74	16.15	13.71	5.58	17.98	13.10	6.03	17.98	13.71	6.42	18.59	13.71
Black	4.80	16.15	11.27	5.25	16.15	11.88	5.54	15.54	11.88	5.27	17.98	11.27	5.63	17.37	11.27	6.05	17.98	11.88
Red	4.97	16.15	14.94	5.36	16.76	14.94	5.70	16.76	14.33	5.47	16.76	14.94	5.68	17.37	14.33	6.02	17.37	14.33
Blue + Diffuser	4.75	17.37	10.06	4.88	16.76	10.06	5.20	16.76	10.06	5.27	18.59	9.45	5.66	18.59	9.45	5.97	18.59	9.45
Black + Diffuser	4.36	16.76	9.44	6.65	17.37	9.44	4.96	16.76	9.44	4.76	17.37	10.05	5.14	17.37	10.05	5.47	17.37	10.05
<b>MAIN NOZZLE #36 – YELLOW</b>									<b>MAIN NOZZLE #40 – ORANGE</b>									
Pressure (bar)	4.1			4.8			5.5			4.1			4.8			5.5		
Orange	5.31	18.59	8.84	5.77	19.2	8.84	6.16	19.2	8.23	6.29	21.03	8.84	6.72	21.03	8.84	7.18	21.64	8.84
Green	6.11	18.59	13.11	6.61	18.59	13.72	6.93	19.2	13.72	6.86	19.2	14.33	7.36	19.81	14.94	7.84	21.03	15.54
Blue	5.89	17.98	12.49	6.36	18.59	11.88	6.76	18.59	11.88	6.74	19.20	12.49	7.29	19.81	12.49	7.78	20.42	12.49
Black	6.00	18.59	11.27	6.31	18.59	10.66	6.71	18.59	11.27	6.58	18.59	11.27	7.09	19.20	11.27	7.77	19.20	11.27
Red	5.93	18.59	13.72	6.40	18.59	13.11	6.86	18.59	13.11	6.90	19.20	14.33	7.45	20.42	13.72	7.88	20.42	13.72
Blue + Diffuser	5.59	19.20	10.67	5.97	19.20	9.45	6.34	19.81	10.06	6.36	19.20	9.45	6.88	20.42	9.45	7.29	21.03	9.45
Black + Diffuser	5.56	19.81	10.66	5.83	19.81	10.66	6.16	19.81	10.66	6.18	19.20	9.44	6.69	19.81	9.44	7.11	20.42	9.44
<b>MAIN NOZZLE #44 – GREEN</b>									<b>MAIN NOZZLE #48 – BLACK</b>									
Pressure (bar)	4.1			4.8			5.5			4.8			5.5			6.2		
Orange	6.65	19.81	8.23	7.20	21.03	8.23	7.65	21.64	8.23	7.95	22.25	8.84	8.54	22.86	8.84	9.02	24.08	8.84
Green	7.45	19.81	14.33	8.04	20.42	13.11	8.59	21.03	13.11	8.70	21.64	13.72	9.24	23.47	13.72	9.72	23.47	14.33
Blue	7.33	19.81	11.88	7.95	20.42	11.88	8.44	21.03	11.88	8.51	21.64	12.49	8.97	22.86	11.88	9.60	22.86	11.88
Black	7.22	19.81	10.66	7.78	20.42	10.66	8.29	21.64	10.05	8.51	22.86	11.27	9.11	23.47	10.66	9.57	24.07	11.27
Red	7.34	19.81	13.72	7.93	20.42	13.72	8.43	20.42	10.06	8.59	22.25	14.33	9.18	22.25	14.33	9.72	23.47	14.33
Blue + Diffuser	7.02	20.42	10.06	7.54	22.25	9.45	8.06	22.25	10.06	8.18	23.47	9.45	8.70	23.47	9.45	9.22	23.47	9.45
Black + Diffuser	6.60	19.81	10.05	7.09	21.03	8.83	7.58	21.64	9.44	8.00	22.25	9.44	8.46	22.25	9.44	8.89	23.47	9.44



## EAGLE 900 Series Rotors

### SPECIFICATIONS

**Radius:** 63' to 97' (19.2 m to 29.6 m)

**Flow Rate:** 21.4 to 57.1 gpm  
(1.35 to 3.60 l/s) (4.85 to 12.97 m³/h)

**Arc:** Full-circle, 360°

**Models:**

**E:** Electric; **IC:** Integrated Control;  
**SAM:** Stopamatic

**Maximum Inlet Pressure:**

**Models E and IC:** 150 psi (10.3 bar)  
**Model SAM:** 100 psi (6.9 bar)

**Pressure Regulation Range:**

60 to 100 psi (4.1 to 6.9 bar)

**Factory Pressure Settings:**

Models E and IC available in 70 and 80 psi  
(4.8 and 5.5 bar)

**Dimensions:**

**Body Height:** 13.4" (34.0 cm)  
**Pop-Up Height to Mid-Nozzle:** 2.25" (5.7 cm)  
**Top Diameter:** 7" (17.8 cm)

**Nozzle Trajectory:** 25°

**Inlet Threads:** 1.5" (3.8 cm) (15/21) ACME  
Female Threaded

**Holdback:** SAM 15' (4.6 m) elevation

**Rotation Time:** 360° in ≤ 240 seconds;  
210 seconds nominally

**Maximum Stream Height:** 20' (6.1 m)

**Solenoid:** 24 VAC solenoid power  
requirement: 0.41 amp inrush current  
(9.8 VA); **60 cycle:** 0.20 amp holding  
current (4.8 VA); **50 cycle:** 0.23 amp  
holding current (5.4 VA)

**Surge Resistance:** Up to 25kV standard  
on electric models

**Top-Serviceable Rock Screen™  
and Replaceable Valve Seat:**  
All 900 models

### Features and Benefits

With up to a 97' (29.6 m) throw range, the 900 Series rotors deliver the longest throw radius coverage in a full-circle rotor. The 900 high performance nozzles allow you to reach longer distances with increased droplet size for maximum efficiency and coverage.



#### HOW TO SPECIFY

<b>A</b>	<b>-</b>	<b>900</b>	<b>-</b>	<b>X</b>	<b>-</b>	<b>XX</b>	<b>-</b>	<b>XX</b>
THREAD TYPE		MODEL		BODY/VALVE		PRESSURE REGULATOR		NOZZLE
ACME		900		E		70 (4.8)		44
				IC		80 (5.5)		48
				SAM				52
								60
								64

### U.S. Performance Data

HIGH PERFORMANCE NOZZLES												
Base Pressure (psi)	#44 Blue		#48 Yellow		#52 Orange		#56 Green		#60 Black		#64 Red	
	Radius (ft)	Flow (gpm)	Radius (ft)	Flow (gpm)	Radius (ft)	Flow (gpm)	Radius (ft)	Flow (gpm)	Radius (ft)	Flow (gpm)	Radius (ft)	Flow (gpm)
60	63	21.4	73	28.9	75	31.9	—	—	—	—	—	—
70	67	23.5	73	31.9	79	34.6	83	40.7	87	43.2	91	47.2
80	71	24.7	75	34.1	81	37.1	85	43.5	91	46.4	93	51.0
90	71	26.5	77	35.0	81	39.5	87	46.4	91	49.5	95	54.0
100	73	27.9	77	36.2	83	41.8	89	49.1	91	52.2	97	57.1

### Metric Performance Data

HIGH PERFORMANCE NOZZLES																		
Base Pressure (bar)	#44 Blue			#48 Yellow			#52 Orange			#56 Green			#60 Black			#64 Red		
	Radius (m)	Flow (l/s)	Flow (m³/h)	Radius (m)	Flow (l/s)	Flow (m³/h)	Radius (m)	Flow (l/s)	Flow (m³/h)	Radius (m)	Flow (l/s)	Flow (m³/h)	Radius (m)	Flow (l/s)	Flow (m³/h)	Radius (m)	Flow (l/s)	Flow (m³/h)
4.1	19.2	1.35	4.85	22.3	1.82	6.56	22.9	2.01	7.25	—	—	—	—	—	—	—	—	—
4.5	19.8	1.42	5.11	22.3	1.89	6.81	23.5	2.10	7.57	25.0	2.48	8.94	26.2	2.63	9.47	27.4	2.88	10.35
5.0	20.7	1.50	5.40	22.4	2.00	7.22	24.2	2.22	8.00	25.5	2.61	9.40	26.8	2.78	10.00	27.9	3.04	10.94
5.5	21.6	1.55	5.59	22.8	2.14	7.72	24.7	2.34	8.41	25.9	2.74	9.87	27.7	2.92	10.52	28.3	3.21	11.56
6.0	21.6	1.64	5.90	23.3	2.19	7.88	24.7	2.45	8.81	26.3	2.87	10.34	27.7	3.20	11.86	28.8	3.35	12.06
6.5	21.9	1.71	6.16	23.5	2.24	8.06	24.9	2.55	9.19	26.8	3.00	10.80	27.7	3.20	11.86	29.2	3.49	12.57
6.9	22.3	1.76	6.35	23.5	2.28	8.22	25.3	2.64	9.49	27.1	3.10	11.15	27.7	3.29	11.86	29.6	3.60	12.97

## EAGLE 950 Series Rotors

### SPECIFICATIONS

**Radius:** 70' to 92' (21.3 m to 28.0 m)

**Flow Rate:** 19.5 to 59.4 gpm (1.23 to 3.75 l/s)  
(4.43 to 13.49 m³/h)

**Arc:** Part-circle, 40° to 345°

**Models:**

**E:** Electric; **IC:** Integrated Control;  
**SAM:** Stopamatic

**Maximum Inlet Pressure:**

**Models E and IC:** 150 psi (10.3 bar)  
**Model SAM:** 100 psi (6.9 bar)

**Pressure Regulation Range:** 60 to 100 psi  
(4.1 to 6.9 bar)

**Factory Pressure Settings:** Models E and IC  
available in 70 and 80 psi (4.8 and 5.5 bar)

**Dimensions:**

**Body Height:** 13.4" (34.0 cm)  
**Pop-Up Height to Mid-Nozzle:** 2.25"  
(5.7 cm)  
**Top Diameter:** 7" (17.8 cm)

**Nozzle Trajectory:** 25°

**Inlet Threads:** 1.5" (3.8 cm) (15/21) ACME  
Female Threaded

**Holdback:** SAM 15' (4.6 m) elevation

**Rotation Time:** 180° in ≤ 120 seconds;  
105 seconds nominally

**Maximum Stream Height:** 20' (6.1 m)

**Solenoid:** 24 VAC solenoid power requirement:  
0.41 amp inrush current (9.8 VA);  
**60 cycle:** 0.20 amp holding current (4.8 VA);  
**50 cycle:** 0.23 amp holding current (5.4 VA)

**Surge Resistance:** Up to 25kV standard on  
electric models

**Top-Serviceable Rock Screen™ and  
Replaceable Valve Seat:** All 950 models

### Features and Benefits

With up to a 92' (28.0 m) throw range, the 950 Series rotors deliver the longest throw radius coverage in a part-circle rotor. The 950 high performance nozzles allow you to reach longer distances with increased droplet size for maximum efficiency and coverage.

HOW TO SPECIFY				
A	950	X	XX	XX
THREAD TYPE	MODEL	BODY/ VALVE	PRESSURE REGULATOR	NOZZLE
ACME	950	E	70 (4.8)	18 26
		IC	80 (5.5)	20 28
		SAM		22 30
				24 32



GOLF ROTORS

### U.S. Performance Data

DUAL SPREADER™ NOZZLES																
Base Pressure (psi)	#18 White-C		#20 Gray-C		#22 Blue-C		#24 Yellow-C		#26 Orange		#28 Green		#30 Black		#32 Brown	
	Radius (ft)	Flow (gpm)	Radius (ft)	Flow (gpm)	Radius (ft)	Flow (gpm)	Radius (ft)	Flow (gpm)	Radius (ft)	Flow (gpm)	Radius (ft)	Flow (gpm)	Radius (ft)	Flow (gpm)	Radius (ft)	Flow (gpm)
60	70	19.5	72	23.0	74	26.5	76	30.8	78	36.0	—	—	—	—	—	—
70	72	21.3	74	25.1	76	28.8	80	33.5	82	38.7	84	42.9	84	47.3	84	50.4
80	74	22.9	76	27.0	80	30.9	84	36.0	84	41.5	86	47.3	86	50.4	85	53.1
90	75	24.4	78	28.7	82	32.9	88	38.4	86	43.4	89	48.5	90	52.9	88	55.6
100	76	25.8	80	30.5	84	34.6	90	40.5	88	46.7	91	52.2	92	55.8	92	59.4

### Metric Performance Data

DUAL SPREADER™ NOZZLES																		
Base Pressure (bar)	#18 White-C		#20 Gray-C		#22 Blue-C		#24 Yellow-C		#26 Orange		#28 Green		#30 Black		#32 Brown			
	Radius (m)	Flow (l/s) (m³/h)	Radius (m)	Flow (l/s) (m³/h)	Radius (m)	Flow (l/s) (m³/h)	Radius (m)	Flow (l/s) (m³/h)	Radius (m)	Flow (l/s) (m³/h)	Radius (m)	Flow (l/s) (m³/h)	Radius (m)	Flow (l/s) (m³/h)	Radius (m)	Flow (l/s) (m³/h)		
4.1	21.3	1.23 4.43	21.9	1.45 5.22	22.6	1.67 6.06	23.2	1.94 7.00	23.8	2.27 8.18	—	—	—	—	—	—		
4.5	21.7	1.29 4.64	22.3	1.52 5.48	22.9	1.75 6.29	23.8	2.03 7.32	24.4	2.36 8.50	25.2	2.62 9.44	25.2	2.90 —	25.3	3.10 11.17		
5.0	22.1	1.37 4.93	22.7	1.61 5.81	23.5	1.85 6.66	24.7	2.15 7.75	25.1	2.49 8.95	25.8	2.78 10.00	25.8	3.03 10.92	25.7	3.22 11.60		
5.5	22.5	1.44 5.19	23.2	1.70 6.12	24.4	1.95 7.01	25.6	2.27 8.16	25.6	2.61 9.41	26.2	2.98 10.72	26.2	3.18 11.43	25.9	3.35 12.05		
6.0	22.8	1.51 5.44	23.6	1.78 6.40	24.8	2.04 7.34	26.5	2.38 8.56	26.0	2.70 9.73	26.9	3.04 10.93	27.1	3.29 11.85	26.6	3.46 12.46		
6.5	23.0	1.58 5.68	24.0	1.86 6.69	25.3	2.12 7.64	27.1	2.48 8.93	26.5	2.83 10.18	27.4	3.16 11.37	27.7	3.42 12.30	27.3	3.61 13.00		
6.9	23.2	1.63 5.86	24.4	1.92 6.93	25.6	2.18 7.86	27.4	2.56 9.20	26.8	2.95 10.61	27.7	3.29 11.86	28.0	3.52 12.67	28.0	3.75 13.49		





Features	551	700	751	900	950
<b>Radius</b>	32' to 55' (9.8 m to 16.8 m)	57' to 79' (17.4 m to 23.5 m)	37' to 75' (11.2 m to 22.3 m)	63' to 97' (19.2 m to 29.6 m)	70' to 92' (21.3 m to 28.0 m)
<b>Flow Rate</b>	6.83 to 13.63 gpm (0.43 to 0.86 l/s) (1.55 to 3.10 m <sup>3</sup> /h)	16.3 to 43.8 gpm (1.03 to 2.76 l/s) (3.70 to 9.95 m <sup>3</sup> /h)	7.0 to 37.7 gpm (0.44 to 2.38 l/s) (1.59 to 8.56 m <sup>3</sup> /h)	21.4 to 57.1 gpm (1.35 to 3.60 l/s) (4.85 to 12.97 m <sup>3</sup> /h)	19.5 to 59.4 gpm (1.23 to 3.75 l/s) (4.43 to 13.49 m <sup>3</sup> /h)
<b>Arc</b>	Full-circle 360° Adjustable 30° to 345°	Full-circle 360°	Full-circle 360° Adjustable 30° to 345°	Full-circle 360°	Adjustable 40° to 345°
<b>Models</b>	<b>Full- and Part-Circle</b> 551E: Electric 551IC: Integrated Control 551SAM: Stopamatic 551B: Seal-A-Matic™	<b>Full-Circle</b> 700E: Electric 700IC: Integrated Control 700SAM: Stopamatic 700B: Seal-A-Matic™	<b>Full- and Part-Circle</b> 751E: Electric 751IC: Integrated Control 751SAM: Stopamatic 751B: Seal-A-Matic™	<b>Full-Circle</b> 900E: Electric 900IC: Integrated Control 900SAM: Stopamatic	<b>Part-Circle</b> 950E: Electric 950IC: Integrated Control 950SAM: Stopamatic
<b>Maximum Inlet Pressure</b>	<b>Models E and IC:</b> 150 psi (10.3 bar) <b>Models SAM and B:</b> 100 psi (6.9 bar)	<b>Models E and IC:</b> 150 psi (10.3 bar) <b>Models SAM and B:</b> 100 psi (6.9 bar)	<b>Models E and IC:</b> 150 psi (10.3 bar) <b>Models SAM and B:</b> 100 psi (6.9 bar)	<b>Models E and IC:</b> 150 psi (10.3 bar) <b>Model SAM:</b> 100 psi (6.9 bar)	
<b>Pressure Regulation Range</b>	60 to 100 psi (4.1 to 6.9 bar)	60 to 100 psi (4.1 to 6.9 bar)	60 to 100 psi (4.1 to 6.9 bar)	60 to 100 psi (4.1 to 6.9 bar)	
<b>Factory Pressure Settings</b>	<b>E and IC:</b> Available in 70 and 80 psi (4.8 and 5.5 bar)	<b>E and IC:</b> Available in 70 and 80 psi (4.8 and 5.5 bar)	<b>E and IC:</b> Available in 70 and 80 psi (4.8 and 5.5 bar)	<b>E and IC:</b> Available in 70 and 80 psi (4.8 and 5.5 bar)	
<b>Body Height</b>	<b>Models E, IC, SAM:</b> 12.0" (30.5 cm) <b>Model B:</b> 9.6" (24.5 cm)	<b>Models E, IC, SAM:</b> 12.0" (30.5 cm) <b>Model B:</b> 9.6" (24.5 cm)	<b>Models E, IC, SAM:</b> 12.0" (30.5 cm) <b>Model B:</b> 9.6" (24.5 cm)	13.4" (34.0 cm)	
<b>Pop-Up Height</b>	2.6" (6.6 cm)	2.6" (6.6 cm)	2.6" (6.6 cm)	2.25" (5.7 cm)	
<b>Top Diameter</b>	<b>Models E, IC, SAM:</b> 6.25" (15.9 cm) <b>Model B:</b> 4.25" (10.8 cm)	<b>Models E, IC, SAM:</b> 6.25" (15.9 cm) <b>Model B:</b> 4.25" (10.8 cm)	<b>Models E, IC, SAM:</b> 6.25" (15.9 cm) <b>Model B:</b> 4.25" (10.8 cm)	7" (17.8 cm)	
<b>Nozzle Trajectory</b>	<b>51 Nozzle:</b> 12° <b>52, 53, 54 Nozzles:</b> 25°	<b>Standard:</b> 25° <b>Wind Tolerant:</b> 12°	<b>Standard:</b> 25° <b>Wind Tolerant:</b> 12° <b>Low-Angle:</b> 15°	25°	
<b>Inlet Threads</b>	<b>Models E, IC, SAM:</b> 1.25" (3.2 cm) ACME Female Threaded <b>Model B:</b> 1" (2.5 cm) ACME Female Threaded	<b>Models E, IC, SAM:</b> 1.25" (3.2 cm) ACME Female Threaded <b>Model B:</b> 1" (2.5 cm) ACME Female Threaded	<b>Models E, IC, SAM:</b> 1.25" (3.2 cm) ACME Female Threaded <b>Model B:</b> 1" (2.5 cm) ACME Female Threaded	1.5" (3.8 cm) (15/21) ACME Female Threaded	
<b>Holdback</b>	<b>Block:</b> 10' (3.1 m) of elevation <b>SAM:</b> 15' (4.6 m) of elevation	<b>Block:</b> 10' (3.1 m) of elevation <b>SAM:</b> 15' (4.6 m) of elevation	<b>Block:</b> 10' (3.1 m) of elevation <b>SAM:</b> 15' (4.6 m) of elevation	<b>SAM:</b> 15' (4.6 m) elevation	
<b>Rotation Time</b>	360° in ≤ 180 seconds; 150 seconds nominally	180° in ≤ 90 seconds; 75 seconds nominally	360° in ≤ 180 seconds; 150 seconds nominally	180° in ≤ 90 seconds; 75 seconds nominally	360° in ≤ 240 seconds; 210 seconds nominally
<b>Maximum Stream Height</b>	<b>51 Nozzle:</b> 5' (1.5 m) <b>52, 53, 54 Nozzles:</b> 13' (4.0 m)	<b>Standard:</b> 17' (5.2 m) <b>Wind Tolerant:</b> 10' (3.1 m)	<b>Standard:</b> 17' (5.2 m) <b>Wind Tolerant:</b> 10' (3.1 m) <b>Low-Angle:</b> 12' (3.7 m)	20' (6.1 m)	
<b>Solenoid</b>	24 VAC solenoid power requirement	24 VAC solenoid power requirement	24 VAC solenoid power requirement	24 VAC solenoid power requirement	
<b>Surge Resistance</b>	Up to 25kV standard on electric models with the GBS-25 solenoid	Up to 25kV standard on electric models	Up to 25kV standard on electric models	Up to 25kV standard on electric models	
<b>Top-Serviceable Rock Screen™ and Replaceable Valve Seat</b>	E, IC, SAM	E, IC, SAM	E, IC, SAM	E, IC, SAM	

Golf Rotor Stator Configuration

Nozzle	Pressure Settings psi (bar)				All SAM and B
	60 (4.1)	70 (4.8)	80 (5.5)	100 (6.9)	
<b>551</b>					
#51-Blue*	S-4	S-4	S-4	S-4	S-4
#52-Beige*	S-4	S-4	S-4	S-4	S-4
#53-Gray*	S-4	S-4	S-4	S-4	S-4
#54-Red*	S-8	S-8	S-8	S-8	S-8
<b>700</b>					
#28-White	SPC	SPC	SPC	SPC	SPC
#32-Blue	SPO	SPO	SPO	SPO	SPO
#36-Yellow	SPO	SPO	SPO	SPO	SPO
#40-Orange	SNP	SNP	SNP	SNP	SNP
#44-Green	SNP	SNP	SNP	SNP	SNP
#48-Black	N/R	SNP	SPR	SPR	SNP
#16 WTN	SPC	SPC	SPC	SPC	SPC
#18 WTN	SPO	SPO	SPO	SPO	SPO
#22 WTN	N/R	SNP	SNP	SNP	SNP
<b>751</b>					
#20-Gray*	S-4	S-4	S-4	S-4	S-4
#22-Red*	S-8	S-8	S-8	S-8	S-8
#28-White	SPC	SPC	SPC	SPC	SPC
#32-Blue	SPO	SPO	SPO	SPO	SPO
#36-Yellow	SPO	SPO	SPO	SPO	SPO
#40-Orange	SNP	SNP	SNP	SNP	SNP
#44-Green	SNP	SNP	SNP	SNP	SNP
#48-Black	SNP	SPR	SPR	SPR	SNP
#16 WTN	SPC	SPC	SPC	SPC	SPC
#18 WTN	SPO	SPO	SPO	SPO	SPO
#22 WTN	N/R	SNP	SNP	SNP	SNP
<b>900</b>					
#44-Blue	SPC	SPC	SPC	SPC	SPC
#48-Yellow	SPC	SPC	SPC	SPC	SPC
#52-Orange	SPC	SPO	SPO	SPO	SPO
#56-Green	N/R	SNP	SNP	SNP	SNP
#60-Black	N/R	SNP	SPR	SPR	SPR
#64-Red	N/R	SPR	SPR	SPR	SPR
<b>950</b>					
#18C-White	SPC	SPC	SPC	SPC	SPC
#20C-Gray	SPC	SPC	SPC	SPC	SPC
#22C-Blue	SPC	SPC	SPC	SPC	SPC
#24C-Yellow	SPC	SPC	SPO	SPO	SPO
#26-Orange	SPO	SPO	SPO	SPO	SPO
#28-Green	N/R	SNP	SPR	SPR	SPR
#30-Black	N/R	SNP	SPR	SPR	SPR
#32-Brown	N/R	SNP	SPR	SPR	SPR

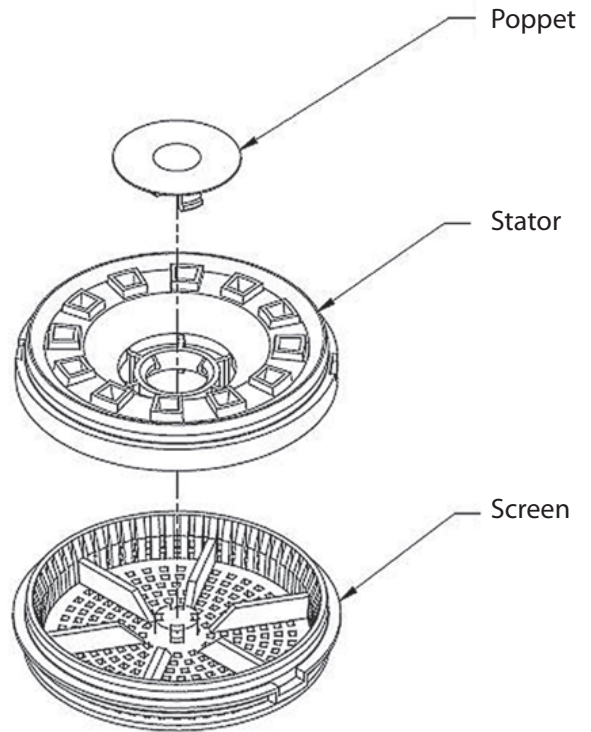

**Key:**

**SPC** = Stator Poppet Closed

**SPO** = Stator Poppet Open

**SNP** = Stator No Poppet

**SPR** = Spacer

**SO** = Screen Only

**S4** = Stator with four holes

**S8** = Stator with eight holes

**N/R** = Not a recommended pressure and nozzle combination

\* Requires low-flow valve



### Swing Joints

Featuring superior flow characteristics and excellent structural integrity, these swing joints are designed to deliver the performance you expect from Rain Bird while saving you money. They are available in a wide range of configurations. Rain Bird® Swing Joints are the perfect complement to our golf series rotors.

#### SPECIFICATIONS

**Diameter:** 1" (2.5 cm), 1 ¼" (3.2 cm) and 1 ½" (3.8 cm)

**Lay Arm Lengths:** 8" (20.3 cm), 12" (30.5 cm) and 18" (45.7 cm)

**Inlet Type:** NPT, BSP, ACME and spigot

**Outlet Thread Type:** NPT, BSP or ACME

**Enlarging NPT, BSP or ACME Outlets:** Available on 1" (2.5 cm) and 1 ¼" (3.2 cm) swing joints for connections to many rotors with 1 ¼" (3.2 cm) and 1 ½" (3.8 cm) inlet sizes respectively (no additional adapters required)

**Inlet Configurations:** Standard side or top-mount connections to lateral lines

**Outlet Configuration:** Single-top or triple-top for added rotor positioning flexibility

**Pressure Rating:** 315 psi (21.7 bar) at 73°F (22.8°C)

**Reducing ACME Inlet:** Available on 1 ¼" (3.2 cm) diameter swing joints for connection to a 1 ½" (3.8 cm) ACME service tee

**Superior Flow Characteristics.** An innovative swept elbow design reduces pressure loss by up to 50 percent over other swing joints.

**Excellent Structural Integrity.** Reduces the costs associated with fatigue-related failures.

**Double O-ring Protection.** Provides a better seal to ensure that joints are kept clean and can be repositioned easily.

**Modified ACME Outlet.** Improves safety by losing seal engagement before losing thread engagement during rotor removal.

**Color-coding and Distinct Size Markings.** Reduce costs by eliminating errors and improving installation efficiency with quick size identification at the job site.

**Oversized Threaded Inlets.** Make hand-tightening and blind installations (underwater) easier. This also reduces the risk of potential damage caused by over-tightening with a wrench.

**Extended Warranty.** When used with Rain Bird golf rotors, extends rotor and swing joint warranty to five years.

#### ALSO AVAILABLE

#### NPT and BSP ACME Adapters

If you currently have NPT or BSP swing joints, you can now enjoy the benefits of ACME-threaded rotors by utilizing a Rain Bird NPT-ACME or BSP-ACME side of the adapter. Just screw the adapter into the inlet on the ACME case, and then screw the rotor with the adapter onto the NPT or BSP swing joint until it is snug.



Available for 1", 1 ¼", and 1 ½" swing joints, the adapter adds only about 1 ⅜" to the installed height of the rotor, and is rated at the same operating pressures as Rain Bird Swing Joints.

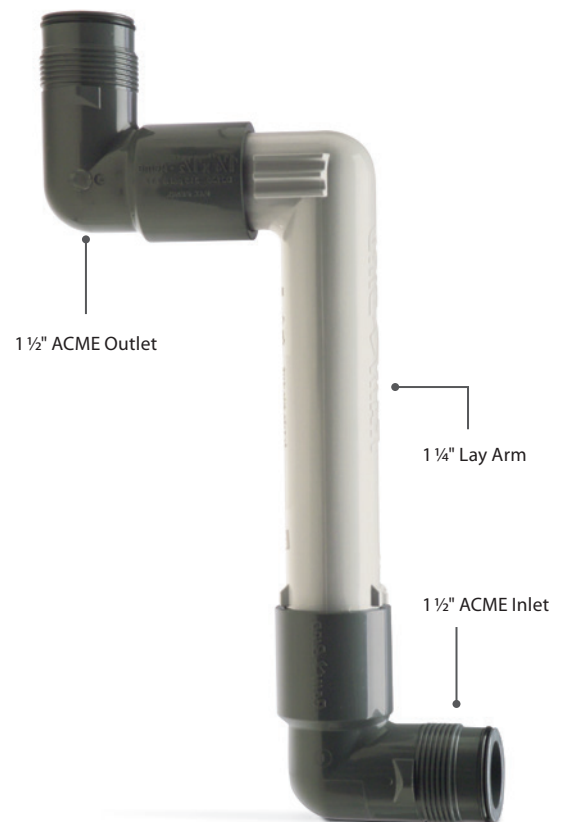

#### HOW TO SPECIFY\*

J - X	-	X	-	X - 00	-	X	-	X
LENGTH		CONFIG		CONFIG		INLET STYLE		OUTLET STYLE
	Lay Pipe Arm	0 = Standard 1 = Triple Top		0 = Standard 1 = Top Mount		1 = NPT 2 = BSP 3 = ACME 4 = Spigot R = Reducing ACME Inlet ‡		1 = NPT 2 = BSP 3 = ACME 4 = Enlarging NPT † 6 = Enlarging ACME Inlet †
A = 1" 8"								
B = 1" 12"								
C = 1" 18"								
D = 1 ¼" 8"								
E = 1 ¼" 12"								
F = 1 ¼" 18"								
G = 1 ½" 8"								
H = 1 ½" 12"								
I = 1 ½" 18"								

\*Not all configurations are available. †Enlarging outlet available only on 1" and 1 ¼" diameter models ‡Reducing inlet available on 1 ¼" diameter models

## Service Tools

Rain Bird offers a full line of quality tools for the service and maintenance of Rain Bird golf rotors. Constructed of heavy-duty metal alloys and durable plastic, these tools are lightweight and easy to use.



**D02203** – Snap-Ring Pliers 900/950/1100/1150



**Y05100** – Rotor Tool



**B41720** – Selector Service Tool/Key



**D02236** – Snap-Ring Pliers 551/700/751



**D02237** – Installation Socket for Top-Serviceable Rock Screen



**D05205** – Universal Hose Adapter



**B41730** – Valve Insertion Tool 900/950



**236571** – UF Cable Stripper



**D02215** – 7" Selector Valve Key



**B41710** – Valve Insertion Tool 551/700/751



**D02221** – 18" Selector Valve Key



### Sod Cup Kit

Enhance the playability and appearance of your course with easy-to-install sod cups. Turf growth directly on top of the rotor eliminates the need to trim around heads while keeping it easily accessible for service.







*Desert Highlands Golf Club*

## Central Control Technologies

### ***The Right Level of Control — Right Now.***

Designed to deliver real-time responses to changing conditions, Rain Bird® Central Control systems simplify irrigation management. Easy-to-use programming, advanced features like Rain Watch™, and MI Series™ mobile control helps your crew quickly create detailed programs that efficiently manage water.

Timeless Compatibility™ assures your Rain Bird software and its future updates will work with your existing Rain Bird field hardware.





### Options to Fit Any Course

Our Central Control products are compatible with all Rain Bird golf field control systems.

- Cirrus™
- Nimbus™ II
- Stratus™ II
- StratusLT™



## Cirrus™

Our most advanced option, Cirrus controls many of golf's most sophisticated irrigation systems. GPS geo-referenced images. State-of-the-art ET-based scheduling. Cirrus delivers the most innovative features in an intuitive package that lets you spend less time dealing with issues and more time achieving solutions.



## Nimbus™ II

Nimbus delivers advanced features with simple administration, ideal for saving time and effort while maintaining premier playing conditions. ET-based scheduling, precise flow management and real-time adjustments help you get the most out of every drop of water.



## Stratus™ II and StratusLT™

Offering two options, the Stratus platform is an excellent choice for simple-time or ET-based scheduling. Choose to start with the basics, or upgrade to more advanced capabilities. With either system, Rain Bird delivers the ease and convenience you want in a Central Control system, aiding superior turf and playing conditions throughout the year.

Specifications	Cirrus	Nimbus II	Stratus II	StratusLT
Map-Based Control	Up to 3 Courses (54 Holes)	Up to 3 Courses (54 Holes)	Up to 2 Courses (27 Holes)	Up to 18 Holes
Programs	Unlimited	Unlimited	500	250
Schedules	Up to 50 per Program	Up to 50 per Program	Up to 25 per Program	Up to 25 per Program
Interfaces	Up to 12	Up to 8	Up to 2	1 (Not expandable)
Satellite Stations	Up to 32,256	Up to 21,504	Up to 5,376	Up to 672
IC™ Stations	Up to 36,000	Up to 24,000	Up to 6,000	Up to 750
Pump Stations	Up to 6	Up to 6	Up to 6	Up to 2
Weather Stations	Up to 5	Up to 5	1	1 (WS-PRO LT only)
Hybrid Communication	Up to 12 Interfaces	Up to 8 Interfaces	Up to 2 Interfaces	—



	Cirrus™	Nimbus™ II	Stratus™ II	StratusLT™	
<b>Features</b>	Real-time decision making	✓	✓	✓	✓
	Radio communication option	✓	✓	✓	✓
	Works with Rain Bird Integrated Control™ System (ICS)	✓	✓	✓	✓
	Works with all Rain Bird satellites	✓	✓	✓	✓
	Works with Rain Bird decoders	✓	✓	✓	✓
	Works with Rain Bird MI Series™ Mobile Controller	✓	✓	✓	✓
	Works with The FREEDOM System™	✓	✓	✓	✓
	Maximum number of interfaces - Hybrid (same or mix)	12	8	2	1
	Number of ICS™ wire groups (paths) standard	4	4	1	1
	Maximum number of ICS™ stations	36,000*	24,000‡	6,000§	750
	Number of 2-wire satellite wire groups (paths) standard	4	4	2	1
	Maximum number of 2-wire satellite wire groups	48**	32**	8**	1
	Maximum number of 2-wire satellite stations	32,256**	21,504**	5,376**†	672
	Maximum number of wireless satellite stations	32,256**	21,504**	5,376**†	672
	Number of decoders/solenoids standard	500/1,000	500/1,000	500/1,000	200/400◊
	Maximum number of decoders/solenoids	6,000/12,000Δ	4,000/8,000Δ	700/1,400Δ	300/600 with LDI
	Number of simultaneously active decoder solenoids per interface	40/LDI	40/LDI	40/LDI	15/LDI
Maximum number of weather stations	5	5	1	1 (WS-PRO LT only)	
Maximum number of pump stations	6	6	6	2	
<b>Programming</b>	Standard/QuickIRR™/SimpleIRR™	✓	✓	✓	✓
	Number of courses	3	3	2	1
	Number of holes	54	54	27	18
	Number of Flo-Zones™	999	999	999	999
	Programs	Unlimited	Unlimited	500	250
	Schedules	50 per program	50 per program	25 per program	25 per program
	Irrigation programs - active simultaneous	50	50	20	10
	Temporary Program adjust	✓	✓	✓	✓
	Temporary Schedule adjust	✓	✓	✓	✓
	Temporary Station adjust	✓	✓	✓	✓
<b>Software Features</b>	Flo-Manager® - Dynamic Power and Hydraulic Optimization	✓	✓	✓	✓
	Flo-Guard™	✓	✓	✓	✓
	ET Management (Fully Automatic)	✓	✓	✓	✓
	ET-Based Scheduling - Irrigation by Volume	✓	✓	✓	✓
	Minimum ET Operation	✓	✓	✓	✓
	ET Spreadsheet™ Analysis	✓	✓	✓	✓
	Advanced IC™ diagnostics with pinpoint accuracy	✓	✓	✓	✓
	Wireless satellite radio diagnostics	✓	✓	✓	✓
	Comprehensive decoder diagnostics	✓	✓	✓	✓
	Real-Time Operation Log	✓	✓	✓	✓
	Report Generation	✓	✓	✓	–
	Water budgeting 0-300%	✓	✓	✓	✓
	Rain Bucket™ - accumulated rainfall allowance	✓	✓	✓	✓
	Rain Sensor	✓	✓	✓	✓
	Rain Watch™ - respond and use rain events immediately	✓	✓	✓	✓
	QuickStart™ - system setup and run irrigations in minutes	✓	✓	✓	✓
	Help Screens	✓	✓	✓	✓
	Course Monitor™	✓	✓	✓	✓
	Hole View	✓	✓	✓	✓
	DryRun™ - projected flow and runtimes	✓	✓	✓	✓
	Course View™ - map based graphical view of course	✓	✓	✓	✓
	Import GPS, CAD, and/or Aerial photos	✓	✓	✓	✓
	Virtual Monitoring and Control - area	✓	✓	✓	✓
	Virtual Monitoring and Control - individual stations	✓	✓	✓	–
	Smart Weather™ - monitoring and alarms	✓	✓	✓	–
	Precipitation Data	✓	✓	✓	✓
	Rotor Data	✓	✓	✓	✓
	Cycle + Soak™	✓	✓	✓	✓
	Smart Weather™	✓	✓	✓	✓
	Multiple Weather Stations	✓	✓	✓	–
	Hybrid - System expansion with additional interfaces (same or mix)	✓	✓	✓	–
	Station Layers - Map/Operations	✓	✓	✓	–
Rain Bird Messenger - email alerts	✓	✓	✓	✓	
Smart Pump™	✓	Keycode Module Option	Keycode Module Option	Keycode Module Option	
Additional Wire Groups (path) - expand from standard	✓	✓	Keycode Module Option	–	

CENTRAL CONTROL TECHNOLOGIES

\* With additional ICS(s) \*\* Possible with additional MIM™(s) † Possible with additional Wire Group keycodes ‡ Possible with additional ICI(s)  
Δ Possible with additional LDI(s) ◊ Possible using a LDI instead of SDI § Possible with additional ICI(s) and IC Wire Path keycodes



## MI Series™ Mobile Controllers

Remote access to your central control is now as convenient as the Internet, with mobile control. This software runs on your central control computer to provide remote irrigation control via a web-enabled device or smart phone.

Rain Bird® MI Series mobile controllers are designed to work on a smartphone or tablet with Internet connectivity and offer greater remote operation capabilities than anything else available.

When connected to the Internet, up to nine (9) remote users can simultaneously control sprinklers and programs, review system activity or directly change settings on both sprinklers and irrigation programs. All activity is logged and viewable in MI at the central control for convenient review.

MI Series mobile controllers also include the MI FREEDOM user interface. MI FREEDOM provides two smartphone interfaces for users to implement traditional FREEDOM commands: 1) Handheld radio keypad for users with handheld radio keypad experience. 2) Soft keyboard interface for use of The FREEDOM System™ commands on a standard smartphone virtual keyboard.

MI Series Mobile controllers now include the Command Console input method. Combining the speed of MI FREEDOM keypad input with the convenience of drop down action menus, Command Console is the most powerful and fastest activity control method available for manual activation, deactivation, status checks and remote programming.

### SYSTEM REQUIREMENTS

- Rain Bird Central Control.
- Requires an Internet connection to the central control.
- Requires a web-enabled smart phone or tablet with a data plan.

#### HOW TO SPECIFY

<b>MI</b>	-	<b>XXXX(X)</b>
<b>MODEL</b>		<b>CONTROL TYPE</b>
MI		ADVAN = Advanced PROF = Professional

Software license only —  
phone or tablet not included.

### Feature Comparison

Link Name	Advanced	Professional
Satellites (Areas)/Stations	X	X
Programs/Schedules	X	X
Diagnostics		X
Accessories		X
Alarm Log		X
Cancel All	X	X

### Accessories

Link Name	Advanced	Professional
Water Budget		X
Demand Flow	X	X
Smart Pump™		X
Smart Weather™		X
Activity Log	X	X
Online Users	X	X

### Available Options

	Advanced	Professional
<b>PROGRAMS</b>		
Execute	X	X
Get Status	X	X
Edit Data	X	X
<b>SCHEDULES</b>		
Execute	X	X
Get Status	X	X
Edit Data	X	X



## The FREEDOM System™

The FREEDOM System handheld provides reliable, two-way communication with your Rain Bird system. Use it to choose from command-based or schedule-based operations, making irrigation adjustments a snap. Either way, The FREEDOM System puts you in control of your irrigation management system wherever you are.

### SYSTEM FEATURES AND BENEFITS

- **Two-way Communication with Rain Bird Centrals.** Audio response at radio indicates command received by central.
- **Station- and Program-Based Commands.** Provides the flexibility to turn ON or OFF any station or an entire area with the click of a few buttons.
- **FREEDOM-Based Commands Recorded at Central.** Irrigation activity logged at the central whether stations turned ON with FREEDOM System or with central.
- **Optional Flo-Manager® Bypass.** Permits FREEDOM user to bypass Flo-Manager.
- **Optional Operating Window.** Allows user to define FREEDOM usage hours, which helps superintendents to control irrigation activity.
- **Two-Way Voice Communication.**
- **Telephone Operation.** All FREEDOM commands can be activated using a telephone connection.

### RADIO FEATURES AND BENEFITS

Weather-resistant and reliable. The NX-3320-k3 handheld radio is built to survive the drops, hard-knocks and weather environments of its users. The NX-3320-k3 meets or exceeds the demanding MIL-STD "driven rain" standard, which guarantees water-resistant performance even in wet weather.

- **LCD Display.** 4-line basic (2-line main/sub-LCD, icon & key guide) with 14 characters; 5-line text message frame (3 lines of text, icon & key guide).
- **Extra-Long Battery Life.** 1400 mAh batteries deliver more than nine (9) hours of operating time on a single charge (5-5-90 duty).
- **One-Year Warranty.**
- **MIL-STD 810 C/D/E/F Environmental Tests.** Meets or exceeds the stringent IP/54/55 dust and IP67 water intrusion standards and full range of tough MIL-STD 810 C, D, E, F and G environmental standards in categories such as vibration, shock, dust, humidity, rain, temperature, solar radiation and atmospheric pressure.



### SPECIFICATIONS

**Frequency:** 450 – 470 MHz (Narrowband)

**NOTE:** Site survey and license required

**Power:**  
**100 V/110 V:** 60 Hz

### HOW TO SPECIFY

<b>FREEDOM</b>	–	<b>SP</b>
MODEL FREEDOM		CONTROL TYPE SP



## Rain Can

A Rain Can working in tandem with our patented Rain Bird® Rain Watch™ technology responds in real time to rain events; reducing wear and tear and creating a more efficient, intelligent system.

### FEATURES AND BENEFITS

- The industry's first active rainfall monitoring and response system.
- The only system designed to automatically react to rainfall and adjust sprinkler application rates to take full advantage of natural rain, thereby eliminating over-watering.
- Saves water and electricity, while keeping the course drier and more playable, by pausing, adjusting or canceling irrigation in the event of rainfall.
- Results in reduced wear and tear on irrigation system components.
- An integral part of Rain Bird® Central Control Software versions 4.0 and higher.

### HOW RAIN WATCH MANAGES RAINFALL

- Stationed throughout the course, up to four (4) high-resolution Rain Watch rain cans collect rainfall data.
- Each irrigation program can be set to react to any one of the available rain cans.
- The central control system continuously polls each rain can.
- Rainfall data received by the system is used to make intelligent decisions based on user-defined responses:

**System Response:** For course-wide reactions

**Program Response:** For program-specific responses

**No-Action Response:** For monitoring only

**Intelligent Responses Include:**

- Pause
- Resume
- Adjust runtimes and resume
- Cancel

### AN EXAMPLE OF RAIN WATCH IN ACTION

- Your daily irrigation schedule calls for 0.20 inches (0.51 cm) of precipitation.
- A storm begins and once accumulated rainfall reaches your desired 0.04-inch (0.10 cm) threshold, Rain Watch suspends irrigation.
- The storm passes after putting down 0.11 inches (0.28 cm) of rain.
- Rain Bird software automatically adjusts remaining runtimes for active stations, as well as those stations yet to run.
- Natural precipitation is seamlessly integrated into scheduled irrigation, resulting in a water savings of 0.11 inches (0.28 cm).





## Weather Stations

Rain Bird offers two Weather Station options to help meet your course's unique irrigation management needs. Both WS-PRO2 and the WS-PRO LT provide evapotranspiration (ET) management and reporting capabilities; while only the WS-PRO2 offers optional intelligent alarm and irrigation control responses through Rain Bird's powerful Smart Weather™ software.

### FEATURES AND BENEFITS

**Superior ET Model.** Rain Bird's Central Control Systems use weather sensor input to determine ET rates based upon a field-proven proprietary equation for ET.

**Automatic ET Download/Selective Usage.** Automatically download weather data daily and calculate ET to determine irrigation times for the entire system or by specific areas, holes or stations.

**ET Override.** Allows you to easily set certain programs to ignore ET values when determining run times.

**Rain Bucket.** Allows rainfall from one day to be carried over to the following day(s) for more accurate ET calculations.

**Multiple Station Capacity.** Connect up to five (5) weather stations to one central control system for more precise ET values based upon different weather conditions and micro climates around the golf course.

**Max Rainfall.** User-defined maximum rainfall can be set to limit the amount of acceptable rainfall for specific soil types or other areas that are subject to high run-off.

**Weather Data Reports.** Generate reports to show current or past weather conditions by the hour, day, week, month or year.

**Unlimited Data Storage.** Store unlimited weather data at the central control.

**Multiple Languages.** Choose from 10 different languages (English, French, German, Italian, Japanese, Korean, Portuguese, Spanish, Swedish or Chinese).

**English or Metric Measurement Units.** Easily select between English or Metric units of measure.

The WS-PRO2 Weather Station along with Rain Bird's Smart Weather Software supports alarms when thresholds are exceeded in:

- Rain
- High or low ambient temperatures
- High winds
- Rainfall intensity

When any of these alarms exceed user-defined thresholds in a programmed time period, the system will initiate an alarm condition. The alarms will automatically reset when temperature, rain or wind conditions are again within acceptable ranges for irrigation.

**Automatic Shut Off/Turn On.** Rain Bird Central Control Systems automatically shut OFF irrigation operation for the entire system or in specific areas of the course (tee box, fairway, green, etc.) when alarm conditions are detected at the weather station. They also automatically turn ON irrigation when weather conditions return to the acceptable range for irrigation.

**Automatic Pause/Resume.** Rain Bird Central Control Systems automatically suspend irrigation to the entire system or specific areas (tee box, fairway, greens, etc.) when alarm conditions are detected. They also automatically resume irrigation when weather conditions return to the acceptable range for irrigation.

**Automatic Notification.** The WS-PRO2 Weather Station, using Rain Bird® Messenger™, can automatically notify you wherever you are — at the central control, via text messaging or e-mail — when alarm conditions exist.

HOW TO SPECIFY		
<b>WS - XXXX (XX)</b>	<b>- XX</b>	<b>- X</b>
<b>MODEL</b>	<b>CONNECTION</b>	<b>POWER</b>
PRO2 = Professional Series	SH = Short Haul	Blank = User Supplied
PRO LT = Professional Light Series		S = Solar Powered

WS-PRO LT



WS-PRO2



Atlanta Athletic Club

## IC System™

### ***A Revolutionary, Yet Simple Approach to Field Control.***

Achieving optimal playing conditions isn't so much an issue of working harder, it's working smarter. Add the Rain Bird intelligent and intuitive IC System with IC CONNECT™ and you're on your way. Communicate directly with every rotor on your course, and gain one-of-a-kind property management with IC CONNECT. With an intuitive interface operated from a computer, tablet or mobile device, the IC System puts control in your hands, anywhere.





IC SYSTEM™

### Streamlined Installation and Expansion

- Cut installation cost and time by eliminating unneeded wire, trenching and splices.
- Minimize labor costs during expansion by simply connecting new IC rotors to any existing MAXI™ Wire.

### Pinpoint Diagnostics and Control

- 45 seconds for 1000+ stations.
- Narrow in on potential problems and resolve issues quickly to prevent turf damage and unnecessary labor costs.
- Bring greater precision and water savings to areas requiring supplemental watering (hot spots, greens, grow-ins).



## IC Rotors and Valves

### SPECIFICATIONS

**System Capacity\*:** 750 ICMs per Output Wire Path, 1,500 ICMs per Output Driver Board, 3,000 ICMs per IC Interface (ICI), up to 36,000 ICMs with Cirrus™

**ICI Electrical Specifications:**

- 115 VAC:** Nominal 98-132 VAC
- 220-240 VAC:** Nominal 208-255 VAC
- 100 VAC:** Nominal 91-110 VAC

**Electrical Output:** 28.5 VAC, 1.25 AMP Per Wire Path

**Active Stations:** No electrical limit — only limited by hydraulics of pipe network and size of pump station

**ICM Current Requirements:** Varies based on wire path length — Nominal Current Draw is 0.33 mA on 5,000 feet (1,500 meters) of wire

**Grounding Requirements:** Integrated Control Surge Device (ICSD) to be grounded to 50 ohms or less every 500 feet (150 meters) or 15 ICMs, whichever is less. The central control to be grounded to 10 ohms or less of resistance

**Compliance:** CE, FCC, UL

**Environment:**

- Working Range:** 32° F to 122° F (0° C to 50° C)
- Storage Temperature:** -40° F to 150° F (-40° C to 65° C)
- Operating and Storage Humidity:** 100%

**Dimensions:**

- ICM:** 2.23" x 1.70" (57 mm x 43 mm)
- ICSD:** 2.00" x 1.41" (51 mm x 43 mm)

**Compatibility:** Rain Bird 500/550 Series Rotors, Rain Bird 551 Series Rotors, Rain Bird 700/751 Series Rotors, Rain Bird EAGLE™ 700 and 900 Series Rotors\*\*, Rain Bird 900 Series Rotors and Rain Bird PEB, PESB, PESB-R, PGA, EFB, BPE and BPES electric valves

**Maximum Wire Paths:**

- Cirrus:** 12 interfaces, 48 wire paths
- Nimbus:** 8 interfaces, 32 wire paths
- Stratus II:** 2 interfaces, 8 wire paths
- StratusLT:** 1 interface, 1 wire path

\* Specific System Capacity is dependent on the Central Control System

\*\* NOTE: EAGLE™ Rotors sold before 6/2009 will have a random orientation of the ICM relative to the Selector Housing

### HOW TO SPECIFY — ROTORS

A	XXX	IC	XX	XX
THREAD TYPE	MODEL	BODY	PRESSURE REGULATOR	NOZZLE
ACME	551	IC	70 (4.8)	See nozzle charts for each rotor model.
	700		80 (5.5)	
	751			
	900			
	950			

For exact combinations of Rotors (Nozzles and Pressure Regulator), see pages 6–15 for correct model.

### HOW TO SPECIFY — VALVES

XXX	XXX(X)
SIZE	MODEL
100	PESIC
150	PESIC-R
200	EFIC-CP
300	BPESIC

**NOTE:** IC Valve Kit must be ordered separately. See page 31.

For exact combinations of Valves (size), see pages 54–56 for correct model.



## IC Module

### FEATURES AND BENEFITS

**Timeless Compatibility.** The Integrated Control Module (ICM) is compatible with all Rain Bird golf rotors, making hardware and software updates simple and easy.

**Simple to Install.** Requires up to 90% less wire than traditional satellite control systems and 50% fewer splices than a traditional decoder system.

**Cost Savings.** Fewer splices and less wire require less time and effort to install the system.

**System Database Management.** The ICM offers a tear-off bar code for easy scanning into the central control system database. As soon as the ICM is connected to a live wire path with address entered, the station is operational.

**Reliable Control.** The IC System is a simple yet sophisticated controller. Built using Rain Bird's proven solenoid technology with on board computer redundancy.

**Easier to Design.** The IC System is easier to design – only simple calculations are required. It eliminates an array of troublesome considerations – there are no controllers to design around or conceal and no looped wires.

**Easier Maintenance.** The IC System is capable of intelligent, two-way communication with each and every ICM and IC CONNECT on the golf course.

**Dependable.** The IC System is designed to always turn off if problems occur. When the wire path is damaged or cut, or if central control communication is lost, the ICM is designed to turn off automatically with built-in redundancy.

**True "Below 30 Volt Control System".** As the IC System wire path output is 28.5 Volt, the IC System is a "true less than 30 Volt" control system. A lower than 30 Volt system is considered a low voltage system and is typically not subjected to code requirements regarding deep burial of the wire path.

**Below Ground Control.** Since the ICM is built right into the rotor or valve, the entire control system is below ground. Unlike field controller systems, the below-ground system offers protection against damage from vandalism, flooding and wildlife.

**Golf Course Aesthetics.** Since the IC System control is designed to be entirely below ground, the golf course vistas are clear of irrigation components as envisioned by the golf course designer.

**Central Control "Smart Features".** With the IC System, you have the ability to utilize all of Rain Bird's Central Control "Smart Features" including: Minimum ET,™ Smart Weather,™ Smart Pump™ mapping with custom graphics, and superior monitoring of system operation.

**Surge Resistance.** Each ICM has 20kV of onboard surge resistance standard.

### HOW TO SPECIFY — ICI

ICI	—	XXXX	—	XXX
MODEL ICI		STATION COUNT		POWER
		1500 = 1 Driver Board*		100 = 100 VAC
		3000 = 2 Driver Boards*		120 = 120 VAC
				230 = 230 VAC

\* Each driver board has two-wire paths.  
See page 23 for the number of wire paths enabled per central control system.

**IC Valve Kit** Now you can get the Integrated Control Module and valve adapter preassembled and ready for installation with the IC Valve Kit.



For information regarding the IC System Wire Path Design, see the table in the Appendix, page 100.

## IC CONNECT™

IC CONNECT allows you to feed more data into your system with IC-IN and remotely control field equipment using IC-OUT.

### FEATURES AND BENEFITS

**Simple and Elegant Design.** IC-IN can be connected to any IC System MAXI® wire path (wire path can be shared with multiple ICM, IC-OUT or IC-IN devices).

- Each IC-IN is equivalent to 15 ICMs and each IC-OUT is equivalent to 1 ICM towards the maximum 750 ICMs per MAXI wire path
- Each IC-IN and IC-OUT is equivalent to 1 ICM for determining placement of ICSD surge protection devices
- Built-in 20kV surge protection

**Hybrid Capabilities.** When connected to an ICI interface, IC-IN and IC-OUT can be used in a hybrid design configuration with Satellite field controllers and/or decoders.

### SPECIFICATIONS

**Environment:**

**Operating Temperature:** 14° F to 125° F (-10° C to 51° C)

**Storage Temperature:** -40° F to 150° F (-40° C to 65° C)

**Operating and Humidity:** 75% max at 40° F to 180° F (4° C to 42° C)

**IC System™ Field Wiring Voltage:** 26-28.5 VAC (max)

**Dimensions:**

**Excluding Wires:** 3.71" x 2.70" x 1.66" (94 mm x 69 mm x 42 mm)

**Wire Length:** 24" (61 cm)

**Sensor Types Supported:**

**Voltage:** 0-10VDC

**Current:** 4-20mA DC

**IC-IN Contact Closure:**

**Pulse Counting:** 50% duty cycle 1kHz (max)

**Pulses in 10 Seconds:** 50% duty cycle 1kHz (max)

**Pulses per Second:** 50% duty cycle 1kHz (max)

**Wiring Connections:**

**Red:** MAXI wire Red

**Black:** MAXI wire Black

**Red/White:**

**IC-IN:** Sensor (+)

**IC-OUT:** Output (+)

**Black/White:**

**IC-IN:** Sensor (-)

**IC-OUT:** Output (-)

### IC-IN

Collect information from multiple field sensors:

- Rain cans
- Flow sensors
- Lake level sensors

#### HOW TO SPECIFY

IC -	IN
MODEL	INPUT/OUTPUT
IC	IN





## Simplified Design

By eliminating up to 90% of the wire and all decoders and satellites, IC System protects the aesthetics of your course while streamlining installation, maintenance and expansion.



### IC-OUT

Centralize ON and OFF control of non-irrigation products around the facility:

- Transfer pumps
- Greens fans
- Fountains and water features
- Lighting

### HOW TO SPECIFY

IC	OUT
MODEL	INPUT / OUTPUT
IC	OUT



Medalist Golf Club

## Field Controllers

***Unparalleled Compatibility. Unmatched Quality.***

Compatible with any Rain Bird® Central Control system, Rain Bird field controllers deliver the trusted performance that golf course professionals rely on to maximize course appearance and playability. From best-in-class satellite systems to reliable field decoders, you'll get a full range of solutions that make irrigation scheduling, adjustments and maintenance easier.





## Easy to Use

From pre-coded addressing for easy installation of decoders to the modular configuration for easy expansion on PAR+ES controllers, Rain Bird field controllers are designed for easier installation, programming and expansion.

## Proven Performance

Every Rain Bird field controller is built and tested to endure decade after decade. Controllers feature premium surge protection, extensive diagnostics and a best-in-class pedestal enclosure. Decoders are no exception with industry proven surge containment and water-tight housing.



## PAR+ES Controller

The easy-to-program Rain Bird® PAR+ES Controller is compatible with any Rain Bird Central Control system and any other Rain Bird Controller. It features up to 72-Station capability, unlimited programs with central control, premium surge protection, extensive diagnostics and best-in-class pedestal enclosure.

### FEATURES AND BENEFITS

**Communication.** Standalone, two-wire and LINK™.

**Central Control Ready.** Works with any Rain Bird® Central Control system. End-users can access controller via The MI Series™ Mobile Controller\* or FREEDOM System™.

- Dynamic Flo-Manager®
- Smart Pump™
- Smart Sensor™
- Smart Weather™

**Easy to Use.** Large, raised control buttons with clear, descriptive icons and a high-contrast Liquid Crystal Display (LCD) panel make programming easy. Lights indicate active schedules and central control status, while unique copy/paste function speeds programming process. An angled keypad aids visibility as well as water drainage, and makes the PAR+ES controller extremely easy to use.

**Greater Water Precision.** The PAR+ES controller allows you to program six (6) automatic and two (2) manual schedules. It allows you to turn on a maximum of 16 solenoids at 60 Hz and 12 solenoids at 50 Hz, and features four (4) control modes — giving you ample programming and operating control.

**Modular Configuration Allows Easy Expansion.** The PAR+ES is available in any configuration and can be easily upgraded in 8-station increments. By simply plugging in an 8-station Output Station Module (OSM) you can expand your PAR+ES controller capabilities to accommodate any configuration.

**Multi Manual with Station and Program Stacking.** Perfect for syringing or putting down fertilizer, multi manual allows you to manually launch up to 16 stations at one time. Split second delayed start prevents water hammer and high inrush current.

**Multiple Schedule Operation.** No schedule limit when operated with Rain Bird Central Control systems.

**Universal Performance Simplifies Installation and Operation.** The intuitive PAR+ES Controller reduces installation and training hassles with its many universal features. For quick electrical hookups, the system automatically senses and adjusts for either a 50 or 60 Hz current; while one (1) transformer accommodates 100 V/120 V, 220 V or 230 V/240 V with the flip of a switch. The PAR+ES Controller also displays system activities and accepts user input in eight (8) different languages. The icon-driven controls and multilingual display eliminate confusion and translation problems.

**Mix and Match.** Mix and match with any other Rain Bird Controller and with any Rain Bird Central Control system.

**Enclosed Electronics.** Provides the best protection against the elements.

**16-Solenoid Simultaneous Operation.** Heavy-duty transformer permits simultaneous operation of up to 16 solenoids (12 at 50 Hz).

**Irrigation Control.** Variable or weekday programming, for weekday cycle or for irrigation every other day, every three (3) days or up to every nine (9) days.

**Water Budget.** Increase or decrease run times on a schedule in 10% increments from 0 to 200%.

**Simplified Installation.** Supplied templates make install easier.

**Front Panel Lighting.** Illumination LEDs and backlit faceplate buttons make programming easy even in poor lighting.

**Large Capacity Terminal Strip.** Accepts up to two (2) 14-gauge wires per station.

**Standard Station Lights and Switches.** OSM lights provide easy identification of active stations — turn stations on or off quickly for easy operation and troubleshooting.

**Premium Surge Protection.** Premium surge protection included in all models.

**Sensor Response.** Sensor activation cancels irrigation at controller.

**Master Valve Activation.** Activate master valve output with station activation.

**Available PAR+ES Retro Kit.** Extends the useful life of older satellites by converting to PAR+ES water-saving technology (see page 37).

**The flexible PAR+ES can be ordered in the following configurations:**

- PAR+ES standalone controller in a plastic pedestal.
- PAR+ES satellite with two-wire module in a plastic pedestal.
- PAR+ES satellite with LINK (wireless) module in a plastic pedestal.

All configurations are offered with a weather-proof and impact-resistant plastic pedestal.

Buy only the control you need today, and increase your operating capabilities or change your communication method at any time.

\*Software required

HOW TO SPECIFY			
<b>PAR ES</b>	<b>- XX</b>	<b>- X</b>	<b>S</b>
MODEL PAR ES	STATION COUNT 16 <sup>‡</sup> 24 32 <sup>‡</sup> 40 48 56 <sup>‡</sup> 64 72	CONFIGURATION Blank = Standalone 2 = Two-wire L = LINK**	OSM TYPE S = OSMs with Station Switches

**NOTE:** Expandable up to 72-Station count by adding OSMs.

\*\*LINK Radios must be ordered separately from controller.

‡ Only options available in standalone configuration.





## SPECIFICATIONS

**Station Capacity:** 72 stations, up to 16 solenoids operating simultaneously (60 Hz) (12 @ 50 Hz)

**Electrical Input:** (50/60 Hz); 117 VAC Nominal 98 to 132 VAC; 220 VAC Nominal 208 to 232 VAC; 240 VAC Nominal 225 to 255 VAC

**Electrical Output:** 26.5 VAC, 5.25 AMP

**Station Load Capacity:** Up to four (4) 24 VAC, seven (7) VA solenoids per station

### Plastic Pedestal Dimensions:

**Width:** 17" (43.2 cm)

**Height:** 34 3/4" (88 cm)

**Depth:** 21" (53.4 cm)

**Programs:** As many programs as possible with Rain Bird Central Control Systems or six (6) automatic (12 start times each) and two (2) manual in standalone mode

**Water Budget:** 0 to 200% in 10% increments



**Station Runtimes:** One (1) to 120 minutes, in one (1) minute increments

**Languages:** English, French, German, Italian, Japanese, Portuguese, Spanish and Dutch

**Grounding Requirements:** Less than 10 ohms

**Compliance:** UL & C-UL Listed, CE approved, C-Tick Compliant and FCC

## PAR+ES Retro Kit

The PAR+ES Retro Kit is the perfect controller upgrade for low budget retrofit to extend the life of your irrigation system.

### FEATURES

**Installation:** Installs in any existing Rain Bird small plastic or stainless steel pedestal.

**Versatile Configurations:** Available as standalone, hardwired<sup>1</sup> or wireless<sup>2</sup>. Hardwired and wireless configurations have real-time two-way communication with central control. In wireless mode, up to four controllers can share a single radio.

**Expandable:** 16-station configuration up to 48-station using plug-in 8-station output station modules with switches and station LED.

### SPECIFICATIONS

**Water Budget:** 0 to 200% in 10% increments

**Station Runtimes:** One (1) to 120 minutes, in one (1) minute increments

**Configurations:** Standalone, hardwired and wireless

**Programs:** No limit with Rain Bird Central Control systems. Six (6) automatic (12 start times each) and two (2) manual programs

**Schedule:** Variable day watering (up to nine (9) days), custom day-of-the-week by program

**Electrical Input:** 117 VAC ±10% (60 Hz); 220 VAC (50 Hz)

**Electrical Output:** 26.5 VAC, 3 AMP

**Station Load Capacity:** Up to four (4) 24 VAC, seven (7) VA solenoids per station

**Languages:** English, French, German, Italian, Japanese, Portuguese, Spanish and Dutch

<sup>1</sup>Requires interface module not included.

<sup>2</sup>Requires additional transformer.

## PAR+ES Sat Decoder Controller

The PAR+ES Sat Decoder combines the features and benefits of a satellite controller with those of a decoder system. The advantages include:

- Easy Installation
- Reduced Installation Costs
- Easy Expansion

### The Idea is Simple:

- Install the controller.
- Install a single two-wire path to control all the sprinklers.
- Install decoder between wire path and each sprinkler head.
  - Uses up to 80 percent fewer wires than conventional controllers
  - Built-in diagnostic tools
  - Compatible with all Rain Bird Golf Decoders (FD-101, FD-102, FD-202, FD-401 and FD-601)
  - Simply attach new decoder to the wire path
  - Operates as a standalone controller or add a Rain Bird® Central Control system for greater control
  - Operates up to 72 decoder addresses
- Program controller with decoder address.

### SPECIFICATIONS

**Station Capacity:** 72 decoder addresses, up to 16 solenoids operating simultaneously (60 Hz)

**Configurations:** Standalone, two-wire and LINK

**Electrical Input:** (50/60 Hz); 115 VAC Nominal 98 – 132 VAC; 220 VAC Nominal 208 – 232 VAC; 240 VAC Nominal 225 – 255 VAC

**Electrical Output:** 26.5 VAC, 5.25 AMP

**Station Load Capacity:** Up to two (2) 24 VAC, seven (7) VA solenoids per station depending on decoder type

#### Plastic Pedestal Dimensions:

**Width:** 17" (43.2 cm)

**Height:** 34¾" (88 cm)

**Depth:** 21" (53.4 cm)

**Programs:** As many programs as possible with Rain Bird Central Control systems or six (6) automatic (12 start times each) and two (2) manual in standalone mode

**Water Budget:** 0 – 200% in 10% increments

**Station Runtimes:** One (1) – 120 minutes, in one (1) minute increments

**Languages:** English, French, German, Italian, Japanese, Portuguese, Spanish and Dutch

**Grounding Requirements:** Less than 10 ohms

**Compliance:** UL & C-UL Listed, CE approved, C-Tick Compliant and FCC

#### Maximum Wire Length Between Controller and Decoder:

##### #12 AWG:

**Star Design:** 3.8 miles (6.1 km)

**Loop Design:** 15.2 miles (24.4 km)

##### #14 AWG

**Star Design:** 2.4 miles (3.8 km)

**Loop Design:** 9.6 miles (15.2 km)

**Maximum Wire Length Between Decoder and Rotor:** 456 ft (#14 AWG)

**Maximum Wire Paths:** Four (4), plus multiple branches per wire path

### HOW TO SPECIFY

**PAR ES-DEC - X - 72**

MODEL	CONFIGURATION
PAR ES	Blank = Standalone
	2 = Two-wire
	L = LINK*

\*LINK Radios must be ordered separately from controller.





## Decoders

A proven technology on golf courses around the world, Rain Bird decoders provide best-in-class field control on centrally controlled irrigation systems. Installed underground and featuring simple, low-cost wiring, decoders are an aesthetically pleasing, full-featured, economical option for reliable in-field control.

### FEATURES AND BENEFITS

- Improve aesthetics and reduce costs with buried in-field controls.
- Easy system expansion — simply splice into the communication line and add additional decoders.
- Installation requires up to 80 percent less wire than conventional controller systems.
- Electronic components are completely encapsulated to protect against the elements.
- Underground decoders reduce the chance of damage from wildlife, vandals or natural disasters.
- Pre-coded addressing eliminates confusion associated with switch-based addressing.
- With the addition of Rain Bird's Decoder Programming Unit (DPU), decoder addresses can be reassigned if necessary.

### A Cost-Effective Alternative

A simple wiring configuration and absence of valve boxes keeps installation and maintenance costs low. Rain Bird decoders are a "true lower than 30 Volt" system that utilize a two-wire path of 14-gauge wire connecting the central control system, decoders and valves or valve-in-head sprinklers.

### Simple, Reliable Control

If you're looking for an alternative to satellites, Rain Bird decoders may be the right solution for you. These decoders for your central control system are simple, robust and reliable. They work with your central control system just like satellites but are buried underground away from the elements.

### Sensor Capability

If you need information from analog, pulse or switch sensors to manage your irrigation, connect the sensor to the SD-210 sensor decoder and view the data at the central. Using Smart Sensor™, sensor data can even be used to control the irrigation.

### Excellent for Renovations

Thanks to advanced central control technology and simple wiring requirements, decoders are a smart choice for many golf course renovations. Using Cirrus™, Nimbus™ II, and Stratus™ II Central Control systems with Rain Bird's hybrid feature capabilities, Field Control systems and IC can be mixed and matched on one computer. This makes it easy to expand irrigation coverage using a minimal amount of wire and decoders.

\* Additional software required

### Protect Against the Elements

With all electronic components fully sealed within a water-tight enclosure and buried underground, damage from floods, frost, rodents or vandals is virtually eliminated. Rain Bird decoders are an especially good choice for flood plains.

### An Out-of-Sight Solution

Buried decoder systems leave nothing exposed to the elements. With no evidence of in-field control, this aesthetically pleasing alternative works perfectly in situations where satellites are unwanted or impractical.

### In-Field Control Options

The addition of decoders doesn't mean the elimination of in-field control. Decoders can be turned on and off in the field with The FREEDOM System™ or MI Series™ mobile controllers\*. The MI Series mobile controller allows precise control of the decoder system anywhere Internet access is available. Another alternative is The FREEDOM System. This handheld radio remote allows you to signal changes to the central control system from anywhere on the course.

### The Right Amount of Control

Select different decoders to operate one, two, four or six solenoids. Five different decoders let you choose the amount of control you need.

#### HOW TO SPECIFY

##### FD - XXX

MODEL	DECODER TYPE
101	Single Address (1 solenoid)
102	Single Address (up to 2 solenoids)
202	Dual Address (up to 4 solenoids)
401	Four Addresses (up to 4 solenoids)
601	Six addresses (up to 6 solenoids)



### Basic Data for a Decoder System

**Decoder addresses per LDI interface unit:** 500 maximum ‡

**Decoder addresses per SDI interface unit:** 200 maximum

**Active solenoids per LDI (with 20 mA current draw each):** 40 maximum

**Active solenoids per SDI (with 20 mA current draw each):** 15 maximum

**Active solenoids per two-wire path on LDI (with 20 mA current draw each):** 20 maximum

**Active solenoids per two-wire path on SDI (with 20 mA draw current each):** 15 maximum

**Maximum allowable voltage drop per two-wire path:** 9 Volts

**For LDI or SDI Lights:** 15 mA (total) ◊

**For each inactive FD-101 or FD-102 decoder:** 0.5 mA each

**For each inactive FD-401, FD-202 or FD-601 decoder:** 1.0 mA each

**Golf Black Solenoid (GBS25) coil:** 20 mA each

**LSP-1 Installation:** No more than 8 decoders between two LSP-1 surge arrestors or no more than 500 ft., whichever is less. LSP-1 ground grid resistance of 50 ohms or less is recommended.



‡ Although the LDI can handle a maximum of 500 decoder addresses total. With any number over 380, the number of active decoders you will be able to operate simultaneously may be reduced. ◊ Although the LDI and SDI can supply 1,000 mA and 500 mA respectively, allow 50 mA of safety factor (design 950 mA with a LDI and 450 mA with a SDI)



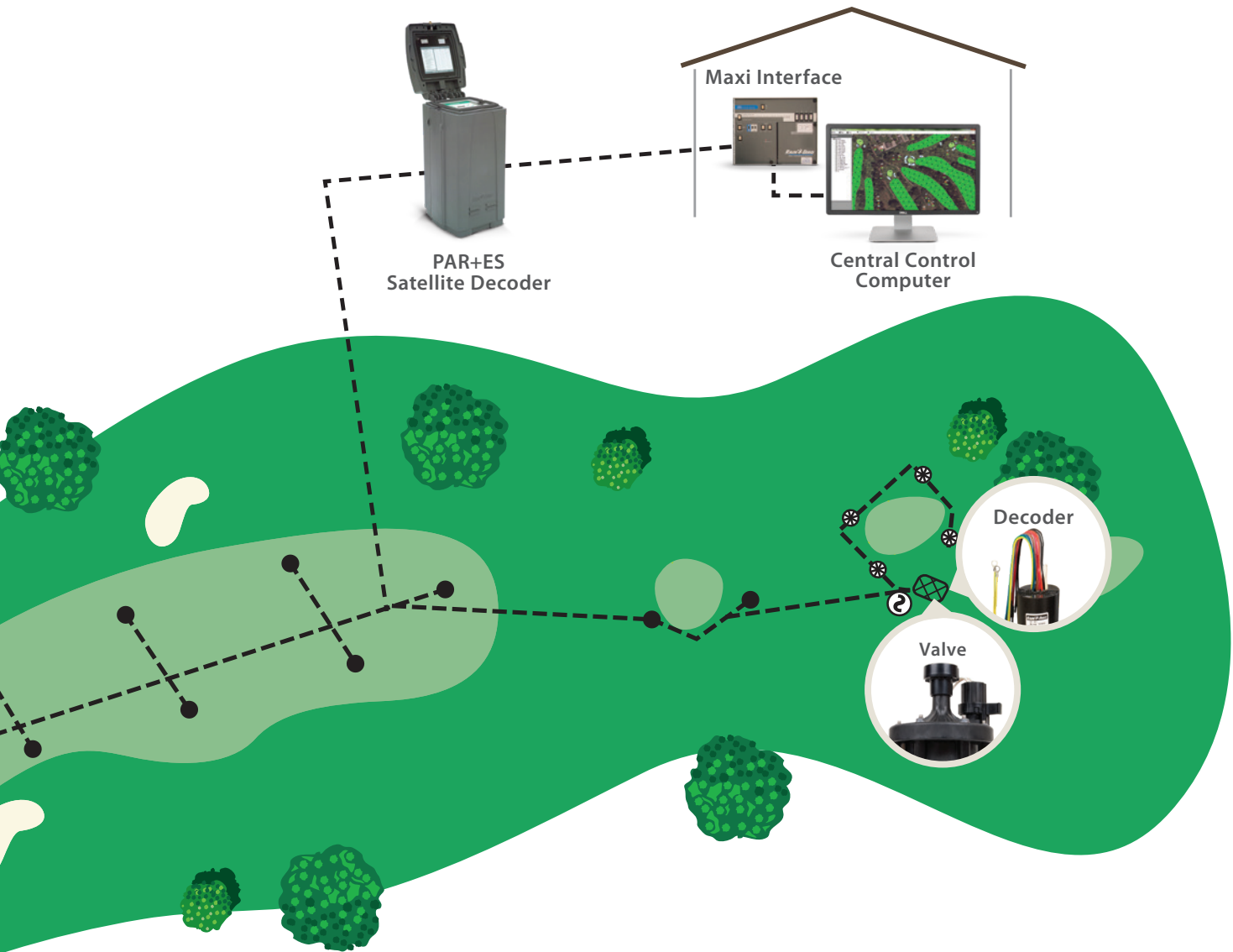

### Maximum Critical Path Lengths for Two-Wire Paths

Nominal Wire Size	ohms/1000' ohms/Km	Loop (Nominal Wire Size)		Star	
		Km	Miles	Km	Miles
2.5 mm**	15.00 ohms/Km	12.0	7.5	3.0	1.8
14 AWG	2.58 ohms/1000*	15.2	9.6	3.8	2.4
12 AWG	1.62 ohms/1000*	24.4	15.2	6.1	3.8
10 AWG	1.02 ohms/1000*	39.2	24.4	9.8	6.1

### Characteristic Table for Various Decoder Models

Decoder Model	Number of Address per Decoder	Maximum Number of Solenoids per Address	Maximum Addresses Operating at Once	Current Draw (mA at Rest per Decoder)
FD-101	1	1	1	0.5 mA
FD-102	1	2	1	0.5 mA
FD-202	2	2	2	1.0 mA
FD-401 *	4	1	4	1.0 mA
FD-601 *	6	1	4	1.0 mA

### Design Criteria

Condition	Cirrus™	Nimbus™ II	Stratus™ II	StratusLT™
Maximum resistance in critical path	33 ohms	33 ohms	33 ohms	33 ohms
Maximum number of addresses per wire path **	250	250	250	200
Maximum number of addresses per LDI	500	500	500	300
Maximum number of addresses per SDI	200	200	200	200
Maximum number of active solenoids per wire path	20	20	20	15
Recommended interface unit	LDI	LDI	LDI	SDI
Maximum number of active solenoids per recommended interface <sup>Δ</sup>	40	40	40	15
Golf Black Solenoid (GBS25)	20 mA	20 mA	20 mA	20 mA
Hybrid system max number of interfaces per system (LDI, SDI)	12	8	2	1

### Maximum Wire Lengths for Secondary Path Wire Runs

Wire Size	1.5 mm**	2.0 mm**	2.5 mm**	16.0 AWG	14.0 AWG	12.0 AWG
Meters	100	133	166	88	139	220
Feet	328	436	545	289	456	720

\* Has LSP-1 surge protection built-in. \*\* A wire path is the leg coming off the LDI, SDI or LTB. ΔThe number of decoders on a large system with long wire runs may reduce the number of active decoders that you will be able to operate at one time before the interface maximum current draw is exceeded and the interface shuts down (disconnects from the field wiring).

## WC100 Wire Connectors

### Install Faster

When your installation crew is making countless wire connections on a jobsite, why slow them down with unnecessary work steps? Use Rain Bird® Wire Connectors to get the job done faster.

### Reduce Inventory

This is the only wire connector you'll need. It is ideal for use on two-wire control systems.

- Use for standard controllers, valve boxes and soil moisture sensors.
- Wire combinations ranging from 22ga to 6ga.
- Use on connections from 24 VAC to 600 VAC.
- UL 486D certified for direct burial.

### Avoid Call Backs

Locating and repairing a corroded wire splice costs time and money. Avoid unnecessary service, due to splicing. Use Rain Bird Wire Connectors for reliable connections.

- The strain relief ensures wires are secure and won't pull apart.
- Waterproof silicone sealant protects against corrosion.
- UV-resistant material ensures product performance does not degrade even after long periods of exposure to sunlight.



### HOW TO SPECIFY

WC	-	XXX
WIRE CONNECTOR		PACK
WC		100

### FEATURES AND BENEFITS

- Direct-bury silicone-filled tube with strain relief
- UL 486D listed and 600V rated waterproof and corrosion-proof
- Patented snap-fit lid provides strain relief
- UV- and impact-resistant
- Excellent for above-ground or direct-bury applications
- Pre-filled with silicone that never hardens
- Includes Red Nut Connector
- Wire Range: Red #6 – #22
- Perfect for Two-Wire Decoder Systems, Field Controllers or Integrated Control Systems (ICS)







Atlanta Athletic Club

## Pump Stations and Filtration *System-Powering Performance and Efficiency.*

Rain Bird applies our world-leading irrigation expertise to the design and manufacture of golf pump stations and filters. As part of a fully integrated Rain Bird irrigation system, these pump stations bring real-time response to your pump, monitoring the operation of the pump and maximizing flow throughout the irrigation cycle. You'll get reduced water use, lower energy costs and less wear and tear on your pump station.



# RAIN BIRD®



PUMP STATIONS AND FILTRATION

## Designed for Durability

Rain Bird® pump stations and filters are built to the highest quality standards. Whether it's a sophisticated suppression system that reduces the risk of electronic component damage or a durable polyester powder coating that protects the appearance of your investment, these pumps and filters offer enduring performance.

## A Fit for Any Environment or Budget

Every Rain Bird pump station is custom built for the specific requirements of your course, offering a variety of options that make it easier to achieve the most efficient performance possible.

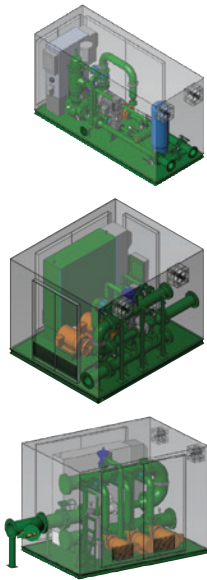

**HORIZONTAL PUMPS**

	Pump Direction and Number	Motor (with VFD)	Max psi (bar)	Max gpm (lps) (m³/h)	Enclosure	Display
<b>HES1</b>	One horizontal end suction pump	15 to 60 HP	125 psi (8.6 bar)	600 gpm (37.8 lps, 136.3 m³/h)	Aluminum	Monochrome touch-panel Optional color touch-panel
<b>HES2</b>	Two horizontal end suction pumps	15 to 60 HP	125 psi (8.6 bar)	1200 gpm (76 lps, 273 m³/h)	Aluminum	Monochrome touch-panel Optional color touch-panel
<b>HES3</b>	Three horizontal end suction pumps	20 to 60 HP	125 psi (8.6 bar)	1800 gpm (114 lps, 409 m³/h)	Aluminum	Monochrome touch-panel Optional color touch-panel

**VERTICAL PUMPS**

	Pump Direction and Number	Motor (with VFD)	Max psi (bar)	Max gpm (lps) (m³/h)	Enclosure	Display
<b>VM1</b>	One vertical multistage pump	15 to 60 HP	155 psi (10.7 bar)	500 gpm (31.5 lps, 113.6 m³/h)	Aluminum	Monochrome touch-panel Optional color touch-panel
<b>VM2</b>	Two vertical multistage pumps	15 to 60 HP	150 psi (10.3 bar)	1000 gpm (63.1 lps, 227 m³/h)	Aluminum	Monochrome touch-panel Optional color touch-panel

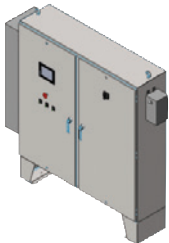

**PANEL ONLY**

	Number of Pumps	Motor Type	Additional Accessories
<b>Panel</b>	Controls 1 to 10 pumps up to 100 HP each	VFD or VPM	Flow meter and pressure transducer included

Ask about our retrofit options for existing panels.



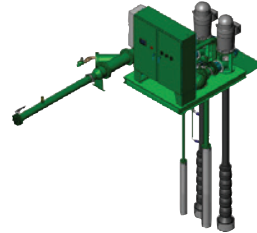
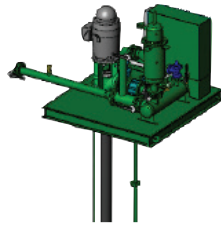

**COMPACT DECKS**

Features	VT1	VT2
Motor (with VFD)	15 to 75 HP	25 to 75 HP
Max psi (bar)	140 psi (9.7 bar)	140 psi (9.7 bar)
Max gpm (lps) (m <sup>3</sup> /h)	800 gpm (51 lps, 181 m <sup>3</sup> /h)	1600 gpm (101 lps, 363 m <sup>3</sup> /h)
Display	Color touch-panel	Color touch-panel

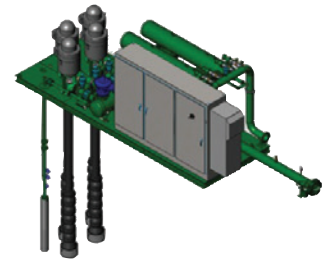
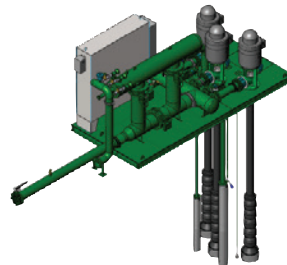
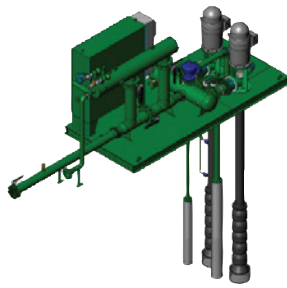

**LARGE DECKS**

Features	VT2	VT3	VT4
Integrated Filtration	Yes	Yes	Yes
Motor (with VFD)	20 to 100 HP	40 to 100 HP	40 to 100 HP
Max psi (bar)	140 psi (9.7 bar)	140 psi (9.7 bar)	140 psi (9.7 bar)
Max gpm (lps) (m <sup>3</sup> /h)	2000 gpm (126 lps, 454 m <sup>3</sup> /h)	3000 gpm (189 lps, 681 m <sup>3</sup> /h)	4000 gpm (252 lps, 908 m <sup>3</sup> /h)
Display	Color touch-panel	Color touch-panel	Color touch-panel

**VT-Custom**

- Custom-designed to meet your requirements.
- Provide us with your specifications.
- Five or more motors
- Multiple filter configurations

### Remote Pump Station Access

Rain Bird's user interface is a network ready design that allows for remote access via PC, laptop, tablet, smart phone or any web-enabled mobile device. The screen always formats properly to the remote device and allows complete control and monitoring of the golf pump station. This remote accessibility provides Rain Bird customers the confidence to control their pumping systems when they are away from the course.

### Electrical Design

Rain Bird® pump stations are UL508A listed and use the industry's best surge suppression, reducing the risk of electronic component damage that could lead to inconvenient and costly downtime. This design includes full heavy-duty circuit breaker integration providing the ultimate protection with the best serviceability.

### Backup Pressure Regulation

Every station comes with a properly sized pressure relief valve to provide automatic pressure regulation in the event of an overpressure situation.

### VFD Per Motor (VPM) Option

Rain Bird offers the industry's most comprehensive catalog of customer-focused solutions, including a VFD for each main motor on a multi-pump station. This option provides superior flow and pressure regulation, and eliminates mechanical switching components, increasing uptime. It also provides a level of efficient backup pressure regulation that a pressure relief valve or butterfly valve cannot deliver.

### Durable Polyester Powder-Coating

Rain Bird's in-house steel-grit blasting system assures all exterior surfaces of the pump station are prepared to white metal specification standards and allows for the best coating adhesion. The polyester powder-coat Rain Bird applies is far more durable than competitive solvent-based multi-layer coatings. In fact, Rain Bird's powder-coating process scores a 10 out of 10 on an ASTM corrosion test provided by Sherwin Williams. Other industry pump stations scored four (4) out of 10 on the very same test. In addition, the powder-coating process is considered very environmentally friendly.

### Engineered Pump Station Skid Design

Using 3D modeling, the channel steel skid frame is engineered for strength and rigidity. This engineered design reduces vibration and eliminates the need for raised, extra-thick steel plates under the pump heads, which can be a trip hazard. The deck is the industry's strongest and longest lasting with continuously welded smooth steel plate. In addition, Rain Bird follows industry standards and manufacturers' recommendations for station components such as the proper specifications for flow meters.

### Advanced Controls

With the industry's leading touch screens, Rain Bird continues to innovate by offering sizes up to 15". Beyond being network ready, this interface offers up to 20 years of historical memory capability and USB backup. With features such as filtration integration, water feature control, lake level control, pump lockouts, auto set point adjustment per pump, motor starts protection, and many more, Rain Bird has driven pump station innovation in the golf industry for the last decade.

### Real-Time System Integration

Rain Bird pump stations have Pump Manager 2 and Smart Pump™ technology at the central control, so you can configure your system to automatically monitor and self-adjust to changing conditions. This seamless integration by Rain Bird improves your system's overall performance by reducing watering windows and minimizing energy use.

### Pump and Motor Options

Rain Bird offers custom designed cast ductile iron discharge heads for golf irrigation pump stations. With superior flow characteristics and 12 times the required tensile strength for golf pump stations, they are the obvious choice for the application. Rain Bird utilizes G.E. motors with industry-leading warranties, efficiencies and durability. The standard Class H motor insulation provides unmatched motor life.

### Air Relief

Rain Bird provides air relief on each pump. Individual air relief valves allow for the maximum amount of air to be removed from the pump columns and not enter into the irrigation system.

### User Controls

Rain Bird pump stations have set the bar with simple, large-icon touchscreen controls in nine (9) different languages. Each pump has a lighted, three position Manual-Off-Auto switch for intuitive, safe backup control of the station.



Custom colors available.

## Pump Manager 2

Rain Bird® Pump Manager 2 is engineered for the golf course professional looking to simplify pump control, monitoring and data reporting. This powerful software application gives you full control of your pump station from your computer or central control.

### FEATURES AND BENEFITS

- Provides a direct link to the pump station touchscreen so you can view and modify pump operations from your computer or tablet as though you were standing right in front of it.
- Since all pump operation data is contained on your computer, Pump Manager 2 and its built-in reporting capabilities can keep you apprised of operations, flow, water use and other key information.
- Includes common reports for future review or regulatory reporting.
- For customized reporting, data can be exported in a file compatible with common spreadsheet applications such as Microsoft® Excel®.
- Standard with 11 different language options.
- Can be used with any computer and provide remote monitoring for any irrigation system using a competitive control system.
- Best of all, Pump Manager 2 is fully integrated with Rain Bird's exclusive central control feature, Smart Pump™.



## Smart Pump™

### FEATURES AND BENEFITS

Rain Bird's Smart Pump is a powerful central control software tool that improves pump station performance more than any comparable product on the market. It integrates your irrigation system from reservoir to rotor, constantly comparing actual flow to expected flow. By making smart, real-time decisions based on this information, it optimizes your system — saving water, conserving electricity and reducing wear and tear on your valuable pumping system.

#### Actual Flow Measurement

Unlike other irrigation central control software, Smart Pump bases its decisions on actual flow, not estimated flow. By using accurate information — in real time — Smart Pump automatically balances supply with system demand. That means greater efficiency and an end to wasted water and electricity.

#### 24-Hour Pump Supervision

With Smart Pump, you can relax knowing your system will instantly respond to actual field conditions with the right decisions. For instance, if a pipe breaks, Smart Pump will stop water flow to the pipe to prevent turf damage. Or if a pump fails, Smart Pump will make immediate water demand adjustments to keep the system from shutting down permanently. It's like having your own irrigation supervisor at every sprinkler, 24/7.

#### Integration Meets Intelligence

Smart Pump seamlessly integrates your entire irrigation system. It automatically starts waiting sprinklers or pauses active sprinklers to reduce flow or increase demand, keeping your irrigation system running at peak efficiency at all times.

Rain Bird is the only manufacturer providing both irrigation and pump station control software. This provides a level of integration that is unmatched in the industry.

#### HOW TO SPECIFY

**SMARTPUMPM**

MODEL

Smart Pump



## *I Series Hydraulic Suction Scanning Filter*

Self-cleaning line powered hydraulic water filters for turf, landscape, agriculture, greenhouse, golf course and nursery applications.

### FEATURES

- **Flow Rate:** 600 – 3,400 gpm
- **Max Temperature:** 160° F
- **Flushing Operations:** Single electric ball valve for flushing operations standard
- **Screen:** 316 L stainless steel sintered screens standard
- **Screen Opening:** 5 $\mu$  – 4000 $\mu$
- **Working Pressure:** 35 – 150 psi
- **Material:** 304 Stainless Steel
- **Configurations Available:** Filter only, or a complete assembly with bypass manifold and valves



Performance Data

Model Number Stainless Steel	Line Size (in)	Standard Flow Rate (gpm)	Sintered Screen Area (in <sup>2</sup> )	Flush Line Size (in)	Min. Inlet Pressure During Rinse Cycle (psi)
HT-I-04-PE-S	4	600	720	2.0	40
HT-I-06-PE-S	6	800	720	2.0	40
HT-I-08-PS-S	8	1400	1008	2.0	40
HT-I-08-PE-S	8	1500	1152	2.0	40
HT-I-10-PS-S	10	1700	1584	2.0	40
HT-I-10-PE-S	10	3200	1800	2.0	40
HT-I-12-PS-S	12	3400	1800	2.0	40

All models have a rinse duration of 5 to 10 seconds.

The above calculated flow rates are based on good quality water. For fair, poor or bad water contact Rain Bird at [filters@RainBird.com](mailto:filters@RainBird.com). Drawings of standard filter models are available at [rainbird.com](http://rainbird.com). Standard Rain Bird controllers: 115 or 230 VAC, 50/60 Hz (I Series filters integrated with a Rain Bird Pump station are controlled by pump station PLC). Other flow ranges available. Please contact Rain Bird at [filters@RainBird.com](mailto:filters@RainBird.com).





*Chiricahua at Desert Mountain*

## Valves

### ***Raising the Standards of Reliability.***

Rain Bird® valves are expertly engineered and manufactured to provide a level of quality and durability that's unmatched in the industry. Constructed of industrial-strength glass-filled nylon or classic brass, every model is built to stand up to the harshest environments. For decades, these valves have been delivering trouble-free performance that continues to earn the trust of golf course maintenance professionals worldwide.





### Options for Every Need

Hold every aspect of your system to the highest standard. From reclaimed water applications to integrated control (IC) configuration, Rain Bird valves are designed to meet the needs of any course.



### PESB / PESB-R Series

#### SPECIFICATIONS

##### Models:

- 100-PESB: 1" (2.5 cm) (26/34)
- 100-PESB-R: 1" (2.5 cm) (26/34)
- 150-PESB: 1 1/2" (3.8 cm) (40/49)
- 150-PESB-R: 1 1/2" (3.8 cm) (40/49)
- 200-PESB: 2" (5.1 cm) (50/60)
- 200-PESB-R: 2" (5.1 cm) (50/60)

Valve and PRS-D module must be ordered separately. See pages 58-59 for more information on the PRS-D option. For non-U.S. applications it is necessary to specify NPT or BSP thread type.

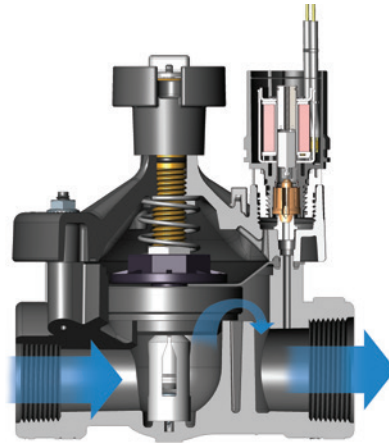

**Flow:** 0.25 to 200 gpm  
(1.2 to 757 l/m); (0.06 to 45.5 m³/h)

**Flow with PRS-D\*:** 5 to 200 gpm  
(19.2 to 757 l/m); (1.1 to 45.4 m³/h)

**Pressure:** 20 to 200 psi (1.38 to 13.8 bar)  
**Pressure with PRS-D\*:** Up to 100 psi  
(6.90 bar)

##### Electrical Specifications:

- Power:** 24 VAC 50/60 Hz (cycles/sec) solenoid
- Inrush Current:** 0.41 A (9.84 VA) at 60 Hz
- Holding Current:** 0.14 A (3.43 VA) at 60 Hz
- Coil Resistance:** 30 to 39 ohms

**Temperature:** 150°F (66°C) maximum

##### Dimensions:

**100-PESB/PESB-R (1"):**  
**Height:** 6 1/2" (16.5 cm)  
**Length:** 4" (10.2 cm)  
**Width:** 4" (10.2 cm)

**150-PESB /PESB-R (1 1/2"):**  
**Height:** 8" (20.3 cm)  
**Length:** 6" (15.2 cm)  
**Width:** 6" (15.2 cm)

**200-PESB /PESB-R (2"):**  
**Height:** 8" (20.3 cm)  
**Length:** 6" (15.2 cm)  
**Width:** 6" (15.2 cm)



#### HOW TO SPECIFY

XXX	XXXX-X	XXX-X
SIZE	MODEL	OPTIONAL FEATURE
100 = 1"	PESB	PRS-D = PRS Dial
150 = 1 1/2"	PESB-R	ICM = IC Module
200 = 2"		

**NOTE:** Valve and PRS-D or ICM must be ordered separately. See pages 30-31 on how to specify the IC configuration.

#### U.S. Data — Pressure Loss\*\* (psi)

Flow gpm	100-PESB 1"	100-PESB-R 1"	150-PESB 1 1/2"	150-PESB-R 1 1/2"	200-PESB 2"	200-PESB-R 2"
0.25	0.8	1.6	—	—	—	—
0.5	1.0	3.0	—	—	—	—
1	1.3	1.8	—	—	—	—
5	1.7	2.9	—	—	—	—
10	1.8	2.9	—	—	—	—
20	2.9	2.6	3.9	3.5	—	—
30	5.6	5.8	3.6	3.1	—	—
40	10.0	10.2	3.5	2.3	—	—
50	15.6	16.0	3.6	2.1	4.8	3.7
75	—	—	5.4	4.3	4.5	3.3
100	—	—	9.6	7.5	5.2	4.7
125	—	—	14.6	11.9	8.2	8.6
150	—	—	21.2	17.0	11.8	12.6
175	—	—	—	—	15.5	14.8
200	—	—	—	—	19.5	18.9

Rain Bird recommends flow rates in the supply line not to exceed 7 1/2 ft/sec (2.29 m/s) in order to reduce the effects of water hammer. For flows below 5 gpm (19.2 l/m, 1.14 m³/h), Rain Bird recommends use of upstream filtration to prevent debris from collecting below the diaphragm. For flows below 10 gpm (37.8 l/m, 2.27 m³/h), Rain Bird recommends that the flow control stem be turned down two full turns from the fully open position. PRS-D recommended for use in shaded area only.

#### Metric Data — Pressure Loss\*\* (bar)

Flow l/m	m³/h	100-PESB 2.5 cm	100-PESB-R 2.5 cm	150-PESB 3.8 cm	150-PESB-R 3.8 cm	200-PESB 5.1 cm	200-PESB-R 5.1 cm
1	0.06	0.06	0.11	—	—	—	—
5	0.3	0.09	0.13	—	—	—	—
10	0.6	0.10	0.15	—	—	—	—
20	1.2	0.12	0.20	—	—	—	—
50	3	0.15	0.19	—	—	—	—
100	6	0.32	0.32	0.26	0.22	—	—
150	9	0.68	0.69	0.24	0.16	—	—
200	12	—	—	0.26	0.16	0.33	0.25
250	15	—	—	0.33	0.24	0.32	0.24
300	18	—	—	0.42	0.33	0.32	0.25
350	21	—	—	0.57	0.45	0.34	0.30
400	24	—	—	0.74	0.59	0.41	0.38
450	27	—	—	0.92	0.75	0.51	0.53
500	30	—	—	1.14	0.91	0.64	0.67
550	33	—	—	1.38	1.10	0.77	0.82
600	36	—	—	—	—	0.90	0.92
650	39	—	—	—	—	1.04	1.00
700	42	—	—	—	—	1.18	1.13
757	45	—	—	—	—	1.34	1.30

\*The PRS-D option adds 2" (5.1 cm) to valve height. \*\*Loss values are with flow control fully open using the tan solenoid retainer.

## EFB-CP Series

### SPECIFICATIONS

**Models:**

- 100-EFB-CP:** 1" (2.5 cm)
- 150-EFB-CP:** 1 ½" (3.8 cm)
- 200-EFB-CP:** 2" (5.1 cm) (Brass)

Valve and PRS-D module must be ordered separately. See pages 58-59 for more information on the PRS-D option. For non-U.S. applications it is necessary to specify NPT or BSP thread type.

**Flow with or without PRS-D\*:** 5 to 200 gpm  
(19.2 to 757 l/m)

**Pressure:** 15 to 200 psi (1.0 to 13.8 bar)

**Pressure with PRS-D\*:** 15 to 100 psi (1.0 to 6.9 bar)

**Pressure Requirements using PRS-D\*:** 15 psi (1.0 bar) inlet pressure above desired outlet pressure

**Electrical Specifications:**

- Power:** 24 VAC 50/60 Hz (cycles/sec) solenoid
- Inrush current:** 0.41 A (9.84 VA) at 60 Hz
- Holding current:** 0.14 A (3.43 VA) at 60 Hz
- Coil resistance:** 30 to 39 ohms

**Dimensions:**

- |                               |                               |                               |
|-------------------------------|-------------------------------|-------------------------------|
| <b>100-EFB-CP (1"):</b>       | <b>150-EFB-CP (1 ½"):</b>     | <b>200-EFB-CP (2"):</b>       |
| <b>Height:</b> 6" (15.2 cm)   | <b>Height:</b> 6 ½" (16.5 cm) | <b>Height:</b> 7" (17.8 cm)   |
| <b>Length:</b> 4 ½" (11.4 cm) | <b>Length:</b> 5 ½" (14.0 cm) | <b>Length:</b> 6 ¾" (17.1 cm) |
| <b>Width:</b> 3 ¼" (8.3 cm)   | <b>Width:</b> 4 ¼" (11.4 cm)  | <b>Width:</b> 5 ¾" (14.6 cm)  |

**Temperature:** 150°F (66°C) maximum

### Reclaimed Water Compatible

All models feature chlorine-resistant EPDM diaphragm for applications using reclaimed water.

### U.S. Data — Pressure Loss\*\* (psi)

Flow gpm	100-EFB-CP 1"	150-EFB-CP 1 ½"	200-EFB-CP 2"
5	0.2	—	—
10	0.7	—	—
15	1.2	—	—
20	2.1	2.3	0.5
30	5.0	2.9	0.6
40	8.2	2.0	0.8
50	13.0	3.3	1.1
60	—	4.6	1.8
80	—	7.5	2.4
100	—	11.8	3.8
120	—	16.6	5.9
140	—	—	7.8
160	—	—	10.0
180	—	—	12.5
200	—	—	15.8

### Metric Data — Pressure Loss\*\* (bar)

Flow		100-EFB-CP 2.5 cm	150-EFB-CP 3.8 cm	200-EFB-CP 5.1 cm
l/m	m <sup>3</sup> /h			
19	1	0.01	—	—
50	3	0.07	—	—
100	6	0.27	0.19	0.04
150	9	0.56	0.14	0.05
200	12	—	0.25	0.09
250	15	—	0.38	0.14
300	18	—	0.51	0.16
350	21	—	0.70	0.23
400	24	—	0.91	0.30
450	27	—	1.13	0.40
500	30	—	—	0.49
550	33	—	—	0.58
600	36	—	—	0.68
650	39	—	—	0.79
700	42	—	—	0.92
757	45	—	—	1.09

Rain Bird recommends flow rates in the supply line not to exceed 7 ½ ft/sec (2.29 m/s) in order to reduce the effects of water hammer. For flows below 5 gpm (19.2 l/m, 1.14 m<sup>3</sup>/h), Rain Bird recommends use of upstream filtration to prevent debris from collecting below the diaphragm. For flows below 10 gpm (37.8 l/m, 2.27 m<sup>3</sup>/h), Rain Bird recommends that the flow control stem be turned down two full turns from the fully open position.

Purple handle cover included to designate non-potable water.



### HOW TO SPECIFY

<b>XXX</b>	—	<b>EFB-CP</b>	—	<b>XXX-X</b>
<b>SIZE</b>		<b>MODEL</b>		<b>OPTIONAL FEATURE</b>
100 = 1"		EFB-CP		PRS-D = PRS Dial
150 = 1 ½"				
200 = 2"				

**NOTE:** Valve and PRS-D or ICM must be ordered separately. See pages 30–31 on how to specify the IC configuration.



### BPES Brass Valves

#### SPECIFICATIONS

**Model:** 300-BPES: 3" (7.6 cm) (80/90)

Valve and PRS-D module must be ordered separately. See pages 58-59 for more information on the PRS-D option. For non-U.S. applications it is necessary to specify NPT or BSP thread type.

**Flow with or without PRS-D\*:** 60 to 300 gpm  
(227 to 1136 l/m); (13.6 to 68.1 m<sup>3</sup>/h)

**Pressure:** 20 to 200 psi (1.4 to 13.8 bar)

**Pressure with PRS-D\*:** Up to 100 psi (6.9 bar)

**Pressure Requirements using PRS-D\*:** 15 psi (1.04 bar) inlet pressure above desired outlet pressure

#### Dimensions:

**Height:** 13 5/8" (34.6 cm)

**Length:** 8" (20.32 cm)

**Width:** 7" (17.78 cm)

**Temperature:** 110°F (43°C) maximum

#### Electrical Specifications:

**Power:** 24 VAC 50/60 Hz (cycles/sec) solenoid

**Inrush current:** 0.41 A (9.84 VA) at 60 Hz

**Holding current:** 0.28 A (6.72 VA) at 60 Hz

**Coil resistance:** 28 ohms, nominal

#### U.S. Data — Pressure Loss\*\*

Flow gpm	Globe psi	Angle psi
60	6.6	6.8
80	5.1	5.9
100	3.2	3.5
120	1.8	1.8
140	1.8	2.1
160	2.0	2.1
180	2.2	2.0
200	2.7	2.5
250	4.0	3.4
300	4.9	4.5

#### Metric Data — Pressure Loss\*\* (bar)

Flow		Globe	Angle
l/m	m <sup>3</sup> /h	2.5 cm	3.8 cm
227	13.6	0.46	0.47
400	24	0.19	0.21
600	36	0.14	0.14
800	48	0.21	0.19
1000	60	0.29	0.26
1136	68	0.34	0.31

Rain Bird recommends flow rates in the supply line not to exceed 7 1/2 ft/sec (2.29 m/s) in order to reduce the effects of water hammer. For flows below 5 gpm (19.2 l/m, 1.14 m<sup>3</sup>/h), Rain Bird recommends use of upstream filtration to prevent debris from collecting below the diaphragm. For flows below 10 gpm (37.8 l/m, 2.27 m<sup>3</sup>/h), Rain Bird recommends that the flow control stem be turned down two full turns from the fully open position.



#### HOW TO SPECIFY

<b>XXX</b>	-	<b>BPES</b>	-	<b>XXX-X</b>
SIZE		MODEL		OPTIONAL FEATURE
300 = 3"		BPES		PRS-D = PRS Dial ICM = ICM Module

**NOTE:** Valve and PRS-D must be ordered separately. See pages 30-31 on how to specify the ICM configuration.



## Quick Coupling Valves and Valve Keys

### SPECIFICATIONS

**Models:**

- 3RC:** ¾" (1.9 cm) (20/27) Rubber cover, one-piece body
- 33DRC:** ¾" (1.9 cm) (20/27) Double track key lug, rubber cover, two-piece body
- 33DLRC:** ¾" (1.9 cm) (20/27) Double track key lug, locking rubber cover, two-piece body
- 33DNP:** ¾" (1.9 cm) (20/27) Non-potable, purple locking rubber cover, two-piece body
- 44RC:** 1" (2.5 cm) (26/34) Rubber cover, two-piece body
- 44LRC:** 1" (2.5 cm) (26/34) Locking rubber cover, two-piece body
- 44NP:** 1" (2.5 cm) (26/34) Non-potable, purple locking rubber cover, two-piece body
- 5RC:** 1" (2.5 cm) (26/34) Rubber cover, one-piece body
- 5LRC:** 1" (2.5 cm) (26/34) Locking rubber cover, one-piece body
- 5NP:** 1" (2.5 cm) (26/34) Non-potable, purple locking rubber cover, one-piece body
- 7:** 1 ½" (3.8 cm) (40/49) Metal cover, one-piece body

**Flow:**

- Models 3RC, 33DRC, 33DLRC, 33DNP, 44RC, 44LRC, 44NP, 5RC, 5LRC, 5NP, 7:** 10 to 125 gpm (37.8 to 473 l/m; 2.27 to 28.39 m³/h)
- Models 33DNP, 44NP, 5NP:** 10 to 70 gpm (37.8 to 265 l/m; 2.27 to 15.89 m³/h)

**Pressure:** 5 to 125 psi (0.4 to 8.6 bar)

**Height:**

- 3RC:** 4.3" (10.8 cm)
- 33DRC:** 4.4" (11.1 cm)
- 33DLRC:** 4.6" (11.8 cm)
- 33DNP:** 4.4" (11.1 cm)
- 44RC:** 6.0" (15.2 cm)
- 44LRC:** 6.0" (15.2 cm)
- 44NP:** 6.0" (15.2 cm)
- 5RC:** 5.5" (14.0 cm)
- 5LRC:** 5.5" (14.0 cm)
- 5NP:** 5.5" (14.0 cm)
- 7:** 5.8" (14.6 cm)



### Quick Coupling Valve Keys

**Top Pipe Threads**

Valve	Key	Male		Female	
3RC	33DK	¾"	19 mm	½"	13 mm
33DRC	33DK	¾"	19 mm	½"	13 mm
33NP	33DK	¾"	19 mm	½"	13 mm
44NP	44K	1"	25 mm	¾"	19 mm
44RC	44K	1"	25 mm	¾"	19 mm
5RC	55K-1	1"	25 mm	—	—
5NP	55K-1	1"	25 mm	—	—
7	7K	1 ½"	38 mm	—	—



### Quick Coupling Valves

**U.S. Data — Pressure Loss\* (psi)**

Flow gpm	3RC ¾"	33DRC, 33DLRC, 33DNP ¾"	44RC, 44LRC, 44NP 1"	5RC, 5LRC, 5NP 1"	7 1 ½"
10	1.8	2.0	—	—	—
15	4.7	4.3	2.2	—	—
20	7.2	7.6	4.4	—	—
30	—	—	11.5	4.1	—
40	—	—	—	7.3	—
50	—	—	—	11.0	1.7
60	—	—	—	15.7	2.5
70	—	—	—	21.5	3.6
80	—	—	—	—	4.9
90	—	—	—	—	8.4
100	—	—	—	—	14.0

**Metric Data — Pressure Loss\* (bar)**

Flow	3RC 1.9 cm		33DRC, 33DLRC, 33DNP 1.9 cm		44RC, 44LRC, 44NP 2.5 cm		5RC, 5LRC, 5NP 2.5 cm		7 3.8 cm	
	l/m	m³/h	l/m	m³/h	l/m	m³/h	l/m	m³/h	l/m	m³/h
38	2.3	0.12	0.12	—	—	—	—	—	—	—
67	4	0.41	0.42	0.23	—	—	—	—	—	—
83	5	0.57	0.62	0.40	—	—	—	—	—	—
100	6	—	—	0.62	—	—	—	—	—	—
117	7	—	—	0.83	0.30	—	—	—	—	—
133	8	—	—	—	0.40	—	—	—	—	—
150	9	—	—	—	0.50	—	—	—	—	—
167	10	—	—	—	0.61	—	—	—	—	—
200	12	—	—	—	0.85	0.13	—	—	—	—
233	14	—	—	—	1.15	0.18	—	—	—	—
267	16	—	—	—	1.50	0.25	—	—	—	—
367	22	—	—	—	—	0.54	—	—	—	—
473	28	—	—	—	—	0.97	—	—	—	—

\*Loss values are with flow control fully open using the tan solenoid retainer.



### PRS-Dial

The PRS-Dial is an excellent means of regulating outlet pressure at the valve regardless of incoming pressure fluctuations. The visible scale makes adjustment quick and easy. The regulator fits all Rain Bird® PGA, PEB, PESB, PESB-R, GB, EFB-CP and BPES series valves.

- Regulates and maintains constant outlet pressure between 15 and 100 psi (1.04 to 6.9 bar) within  $\pm 3$  psi ( $\pm 0.21$  bar).
- Adjustment knob with detents permits fine-tune setting in  $\frac{1}{3}$  psi (0.02 bar) increments. Dial cartridge makes installation and adjustment quick, easy and accurate.

#### FEATURES

- Improved spike reduction capabilities reduce water hammer.
- Ergonomic design with snap-tight cover to prevent vandalism.
- Waterproof dial cartridge eliminates fogging and binding.
- Dial cartridge retrofits into all existing PRS-D units.
- Schrader valve connects pressure hose gauge, ordered separately.
- Easy field installation — PRS-Dial threads underneath the solenoid and adapter.
- Corrosion-resistant glass-filled nylon for rugged performance.

#### SPECIFICATIONS

##### Operating Range:

**Pressure:** Up to 100 psi (6.9 bar)\*

**Regulation:** 15 to 100 psi (1.04 to 6.9 bar)

**Flow:** Refer to chart

**Model:** PRS-D

#### APPLICATION INFORMATION

- Proper operation requires inlet pressure to be a minimum of 15 psi (1.04 bar) higher than desired outlet pressure.
- For areas with very high pressure or uneven terrain, install sprinklers with PRS pressure regulating stems and/or SAM check valves.
- When inlet pressure exceeds 100 psi (6.9 bar), a pressure regulating master valve or inline pressure regulator is required.
- Rain Bird does not recommend using the pressure regulating module for applications outside the recommended flow ranges.
- To reduce the effects of water hammer, Rain Bird recommends flow rates in the supply line not to exceed  $7\frac{1}{2}$  ft/sec (2.29 m/s).
- For flows below 10 gpm (37.8 l/m, 2.27 m<sup>3</sup>/h), Rain Bird recommends the flow control stem be turned down two full turns from the fully open position.
- The PRS-D option adds an additional 2" (5.1 cm) to valve height.

\*While the PRS-Dial unit can withstand pressures up to 200 psi (13.8 bar), accurate pressure regulation can be maintained only up to 100 psi (6.9 bar).

**NOTE:** Valve and PRS-D module must be ordered separately.





U.S. Data — Valve Flow Ranges \*\*

Model	gpm
<b>PGA</b>	
100-PGA	5 – 40
150-PGA	30 – 100
200-PGA	40 – 150
<b>PEB</b>	
100-PEB	5 – 50
150-PEB	20 – 150
200-PEB	75 – 200
<b>PESB / PESB-R</b>	
100-PESB/PESB-R	5 – 50
150-PESB/PESB-R	20 – 150
200-PESB/PESB-R	75 – 200
<b>GB</b>	
100-GB	5 – 50
125-GB	20 – 80
150-GB	20 – 120
200-GB	20 – 200
<b>EFB-CP-R</b>	
100-EFB-CP-R	5 – 50
125-EFB-CP-R	20 – 80
150-EFB-CP-R	20 – 120
200-EFB-CP-R	20 – 200
<b>BPES</b>	
300-BPES	60 – 300

Metric Data — Valve Flow Ranges \*\*

Model	l/m	m <sup>3</sup> /h
<b>PGA</b>		
100-PGA	19.2 – 15.1	1.14 – 9.08
150-PGA	113 – 378	6.81 – 22.70
200-PGA	151 – 568	9.08 – 34.05
<b>PEB</b>		
100-PEB	19.2 – 189	1.14 – 11.35
150-PEB	76 – 568	4.54 – 34.05
200-PEB	284 – 757	17.03 – 45.40
<b>PESB / PESB-R</b>		
100-PESB/PESB-R	19.2 – 189	1.14 – 11.35
150-PESB/PESB-R	76 – 568	4.54 – 34.05
200-PESB/PESB-R	284 – 757	17.03 – 45.40
<b>GB</b>		
100-GB	19.2 – 189	1.14 – 11.35
125-GB	76 – 302	4.54 – 18.16
150-GB	76 – 529	4.54 – 31.78
200-GB	76 – 757	4.54 – 45.40
<b>EFB-CP-R</b>		
100-EFB-CP-R	19.2 – 189	1.14 – 11.35
125-EFB-CP-R	76 – 302	4.54 – 18.16
150-EFB-CP-R	76 – 529	4.54 – 31.78
200-EFB-CP-R	76 – 757	4.54 – 45.40
<b>BPES</b>		
300-BPES	227 – 1136	13.62 – 68.10

\*\*The PRS-Dial regulates only up to 100 psi (6.9 bar).



150-PESB with PRS-D

ICM Valve Kit

Rain Bird ICM Valve Kit includes a ready to install ICM (Integrated Control Module) and a Rain Bird valve adapter with necessary o-rings and filter. This kit is designed to convert Rain Bird PEB, PESB, BPES, EFB-CP series electric remote control valves into Integrated Control (IC) valves.



PESB with ICM Valve Kit

See pages 28–33 for more information on the IC System™.





Old Marsh Golf Club

## Landscape Solutions

### ***Specialized Solutions for Every Application.***

Rain Bird offers many landscape irrigation solutions that manage water responsibly while promoting the growth of healthy, stress-free plants and grass areas. From seals and filters that protect your system from debris to materials specially engineered to withstand harsh chemicals, these products are built to a standard the competition can't match.





**Customized Coverage for Landscapes—and More**

Offering a full range of sizes and options, Rain Bird® sprays, rotors and drip irrigation products provide a solution for every irrigation challenge. Whether you're watering flower beds or taking a precise new approach to tee boxes, Rain Bird has you covered.





## RD1800™ Series Spray Heads

### FEATURES

- Patented Triple-Blade Wiper Seal precisely balances flushing, flow-by and debris protection to optimize performance and durability at pop-up and retraction, clearing debris and ensuring positive stem retraction in all soil types.
- Unique debris pockets hold grit in place, removing it from circulation and preventing long-term damage.
- Parts resistant to corrosion for use in treated recycle water containing chlorine.

### RD1800 SAM PRS Series

Incorporates all RD1800 Series SAM and PRS features. Meets the needs of all spray areas, regardless of changing elevation or water pressures.

### RD1800 Flow-Shield™ Series

Provides low flow vertical water jet visible from +200' line of sight when a nozzle has been removed.

### RD1800 Non-Potable Water Series

Provides an alternative to clip-on caps and molded purple covers. Easy-to-read English "DO NOT DRINK" and Spanish "NO BEBA" warnings and international do not drink symbol.

### SPECIFICATIONS

#### Operating Range:

**Spacing:** 2.5' to 24' (0.8 m to 7.3 m)

**Pressure:** 15 to 100 psi (1.0 to 6.9 bar)

#### Dimensions:

**RD04 Series:** 4" (10.2 cm) pop-up height; 6" (15.0 cm) body height

**RD06 Series:** 6" (15.0 cm) pop-up height; 9 3/8" (23.8 cm) body height

**RD12 Series:** 12" (30.5 cm) pop-up height; 16" (40.6 cm) body height

**Inlet:** 1/2" (15/21) NPT female threaded

**SAM Capability:** Holds up to 14 feet (4.2 m) of head; 6 psi (0.3 bar)

#### Flow-By:

**SAM Models:** 0 at 15 psi (1.0 bar) or greater; 0.5 gpm (0.03 l/s; 0.1 m³/h) otherwise

**All Other Models:** 0 at 10 psi (0.7 bar) or greater; 0.5 gpm (0.03 l/s; 0.1 m³/h) otherwise

**Pressure Regulation:** SAM-PRS models regulate to an average 30 or 45 psi (2.1 or 3.1 bar) with inlet pressures of up to 100 psi (6.9 bar)

**Side Inlets:** SAM models only

**Warranty:** 5-year trade warranty

### Models

4"	6"	12"
RD-04	—	—
RD-04-NP	—	—
RD-04-S-P-30	RD-06-S-P-30	RD-12-S-P-30
RD-04-S-P-30-NP	RD-06-S-P-30-NP	RD-12-S-P-30-NP
RD-04-S-P-30-F	RD-06-S-P-30-F	RD-12-S-P-30-F
RD-04-S-P-30-F-NP	RD-06-S-P-30-F-NP	RD-12-S-P-30-F-NP
RD-04-S-P-45-NP	RD-06-S-P-45-NP	RD-12-S-P-45-NP
RD-04-S-P-45-F	RD-06-S-P-45-F	RD-12-S-P-45-F
RD-04-S-P-45-F-NP	RD-06-S-P-45-F-NP	RD-12-S-P-45-F-NP

### HOW TO SPECIFY

RD-XX	-	X(XX)	-	Nozzle
<b>POP-UP HEIGHT</b> 04 = 4" (10.2 cm) 06 = 6" (15.0 cm) 12 = 12" (30.5 cm)		<b>OPTIONAL FEATURES</b> S = SAM P-30 = 30 psi (2.1 bar) in-stem pressure regulation P-45 = 45 psi (3.1 bar) in-stem pressure regulation F = Flow-Shield™ technology NP = Non-potable water use indicating cover		<b>COMPATIBLE NOZZLES</b> See Rotary Nozzle, U-Series and HE-VAN Nozzle specifications for more information.

Flow-Shield™ Technology available in P30 and P45 models only. Specify sprinkler bodies and nozzles separately.



## 1800® Series Spray Heads

### FEATURES

- Co-molded wiper seal provides unmatched resistance to grit, pressures and the environment.
- Constructed of time-proven UV-resistant plastic and corrosion-resistant stainless steel parts, ensuring long product life.
- Precision-controlled flush at pop-down clears debris from unit, assuring positive stem retraction in all soil types.
- Two-piece ratchet mechanism allows easy nozzle patter alignment and provides added durability.

### 1800 PRS Series

PRS pressure regulator built into the stem maintains a constant outlet pressure of 30 psi (2.1 bar). Eliminates misting and fogging caused by high pressure.

### 1800 SAM Series

Built-in Seal-A-Matic™ (SAM) check valve eliminates the need for under-the-head check valves. Traps water in lateral pipes in elevation changes of up to 14 ft (4.2 m).

### 1800 SAM PRS Series

Incorporates all 1800 Series SAM and PRS features. Meets the needs of all spray areas, regardless of changing elevation or water pressures.

### 1800 SAM-P45 Series

Maintains a constant outlet pressure of 45 psi (3.1 bar) at varying inlet pressures. Maintains constant pressure regardless of nozzle used.

### SPECIFICATIONS

#### Operating Range:

**Spacing:** 2.5' to 24' (0.8 m to 7.3 m)\*

**Pressure:** 15 to 70 psi (1.0 to 4.8 bar)

#### Dimensions:

**1802 Series:** 2" (5.1 cm) pop-up height; 4" (10.2 cm) body height

**1804 Series:** 4" (10.2 cm) pop-up height; 6" (15.0 cm) body height

**1806 Series:** 6" (15.0 cm) pop-up height; 9 3/8" (23.8 cm) body height

**1812 Series:** 12" (30.5 cm) pop-up height; 16" (40.6 cm) body height

**Inlet:** 1/2" (15/21) NPT female threaded

**Exposed Surface Diameter:** 2 1/4" (5.7 cm)

**SAM Capability:** Holds up to 14 feet (4.2 m) of head; 6 psi (0.3 bar)

**Flow-By:** 0 gpm at 8 psi (0.6 bar) or greater; 0.10 gpm (0.36 l/m; 0.02 m³/h) otherwise

**Pressure Regulation:** SAM-PRS models regulate to an average 30 or 45 psi (2.1 or 3.1 bar) with inlet pressures of up to 70 psi (4.8 bar)

**Side Inlets:** SAM models only

**Warranty:** 5-year trade warranty

### HOW TO SPECIFY

#### 18XX

**POP-UP HEIGHT**  
02 = 2" (5.1 cm)  
04 = 4" (10.2 cm)  
06 = 6" (15.0 cm)  
12 = 12" (30.5 cm)

#### XXX

**OPTIONAL FEATURE**  
SAM = Seal-A-Matic™  
check valve  
PRS = Pressure  
regulator

#### XXX

**OPTIONAL FEATURE**  
PRS = Pressure regulator  
P45 = 45 psi pressure  
regulator





## R-VAN Rotary Nozzles

### FEATURES

- Adjust arc and radius without tools.
- Color-coded for easy identification.
- Low precipitation rate reduces run-off and erosion.
- Maintains efficient performance at high operating pressures without misting or fogging.
- Exclusive manual flush makes it easy to clear dirt and debris in seconds.
- Compatible with all models of Rain Bird spray bodies in addition to a wide variety of risers and adapters.
- Matched precipitation rates across radius and arcs simplify the design process and enable large and small turf areas to be zoned together by mixing R-VAN, R-Series and 5000 Series Rotors with the MPR nozzle set.



### SPECIFICATIONS

#### Models:

**8' to 14' (2.4 m to 4.6 m)**

**R-VAN14:** Blue top, 45° – 270° Adjustable Arc

**R-VAN14-360:** Blue top, 360° Full Circle

**13' to 18' (4.0 m to 5.5 m)**

**R-VAN18:** 45° to 270° Adjustable Arc

**R-VAN18-360:** 360° Full Circle

**17' to 24' (5.2 m to 7.3 m)**

**R-VAN24:** 45° to 270° Adjustable Arc

**R-VAN24-360:** 360° Full Circle

#### Strip Nozzles

**R-VAN-LCS:** 5' x 15' (1.5 m x 4.6 m) Left Corner Strip

**R-VAN-RCS:** 5' x 15' (1.5 m x 4.6 m) Right Corner Strip

**R-VAN-SST:** 5' x 30' (1.5 m x 9.1 m) Side Strip

**Pressure Range:** 30 to 55 psi (2.1 to 3.8 bar)

**Recommended Operating Pressure:** 45 psi (3.1 bar)\*

**Spacing:** 8' to 24' (2.4 m to 7.3 m)

**Adjustments:** Arc and radius should be adjusted while water is running

**Warranty:** 3-year trade warranty



### HOW TO SPECIFY

R-VAN	–	XX(X)-XXX
<b>MODEL</b>		<b>RADIUS RANGE / ARC</b>
R-VAN = Rotary Variable Arc Nozzle		14 = 8' to 14' (2.4 m to 4.6 m) 45° to 270° Variable Arc
		14-360 = 8' to 14' (2.4 m to 4.6 m) 360° Full Circle
		18 = 13' to 18' (4.0 m to 5.5 m) 45° to 270° Variable Arc
		18-360 = 13' to 18' (4.0 m to 5.5 m) 360° Full Circle
		24 = 17' to 24' (5.2 m to 7.3 m) 45° to 270° Variable Arc
		24-360 = 17' to 24' (5.2 m to 7.3 m) 360° Full Circle
		LCS = 5' x 15' (1.5 m x 4.6 m)
		RCS = 5' x 15' (1.5 m x 4.6 m)
		SST = 5' x 30' (1.5 m x 9.1 m)

### U.S. Performance Data

R-VAN14 ADJUSTABLE ARC NOZZLES																											
	270° Arc						210° Arc						180° Arc						90° Arc								
Pressure (psi)	30	35	40	45	50	55	30	35	40	45	50	55	30	35	40	45	50	55	30	35	40	45	50	55			
Radius (ft)	13	13	14	14	15	15	13	13	14	14	15	15	13	13	14	14	15	15	13	13	14	14	15	15			
Flow (gpm)	0.84	0.87	0.92	0.94	1.11	1.17	0.65	0.68	0.72	0.73	0.86	0.91	0.56	0.58	0.61	0.63	0.74	0.78	0.28	0.29	0.31	0.31	0.37	0.39			
■ Precipitation (in/h)	0.64	0.66	0.62	0.60	0.63	0.67	0.64	0.66	0.60	0.62	0.63	0.67	0.64	0.66	0.62	0.60	0.63	0.67	0.64	0.66	0.62	0.60	0.63	0.67			
▲ Precipitation (in/h)	0.74	0.76	0.71	0.70	0.73	0.77	0.64	0.66	0.60	0.62	0.63	0.67	0.74	0.76	0.71	0.70	0.73	0.77	0.74	0.76	0.71	0.70	0.73	0.77			

### Metric Performance Data

R-VAN14 ADJUSTABLE ARC NOZZLES																											
	270° Arc						210° Arc						180° Arc						90° Arc								
Pressure (bar)	2.1	2.4	2.8	3.1	3.4	3.8	2.1	2.4	2.8	3.1	3.4	3.8	2.1	2.4	2.8	3.1	3.4	3.8	2.1	2.4	2.8	3.1	3.4	3.8			
Radius (m)	4.0	4.0	4.3	4.3	4.6	4.6	4.0	4.0	4.3	4.3	4.6	4.6	4.0	4.0	4.3	4.3	4.6	4.6	4.0	4.0	4.3	4.3	4.6	4.6			
Flow (l/m)	3.2	3.3	3.6	3.5	4.2	4.4	2.5	2.6	2.7	2.8	3.3	3.4	2.1	2.2	2.4	2.3	2.8	3.0	1.1	1.1	1.2	1.2	1.4	1.5			
■ Precipitation (mm/h)	16	17	16	15	16	17	16	17	15	16	16	17	16	17	16	15	16	17	16	17	16	15	16	17			
▲ Precipitation (mm/h)	19	19	18	18	19	20	19	19	18	18	19	20	19	19	18	18	19	20	19	19	18	18	19	20			

### U.S. Performance Data

R-VAN14-360 FULL CIRCLE NOZZLES						
	360° Arc					
Pressure (psi)	30	35	40	45	50	55
Radius (ft)	13	13	14	14	15	15
Flow (gpm)	1.1	1.1	1.2	1.3	1.4	1.5
■ Precipitation (in/h)	0.63	0.64	0.60	0.62	0.60	0.62
▲ Precipitation (in/h)	0.72	0.74	0.69	0.72	0.70	0.72

### Metric Performance Data

R-VAN14-360 FULL CIRCLE NOZZLES						
	360° Arc					
Pressure (bar)	2.1	2.4	2.8	3.1	3.4	3.8
Radius (m)	4.0	4.0	4.3	4.3	4.6	4.6
Flow (l/m)	4.2	4.2	4.6	4.8	5.3	5.5
■ Precipitation (mm/h)	16	16	15	16	15	16
▲ Precipitation (mm/h)	18	19	18	18	18	18

8' to 14' | 2.4 m to 4.6 m



R-VAN14 | 45° - 270°

R-VAN14-360 | 360°

LANDSCAPE SOLUTIONS



## U.S. Performance Data

R-VAN18 ADJUSTABLE ARC NOZZLES																											
	270° Arc						210° Arc						180° Arc						90° Arc								
Pressure (psi)	30	35	40	45	50	55	30	35	40	45	50	55	30	35	40	45	50	55	30	35	40	45	50	55			
Radius (ft)	16	16	17	17	18	18	16	16	17	17	18	18	16	16	17	17	18	18	16	16	17	17	18	18			
Flow (gpm)	1.26	1.35	1.42	1.51	1.57	1.62	0.98	1.05	1.10	1.17	1.22	1.26	0.85	0.91	0.98	1.01	1.07	1.09	0.42	0.47	0.50	0.50	0.54	0.58			
■ Precipitation (in/h)	0.65	0.64	0.63	0.64	0.60	0.60	0.63	0.68	0.63	0.64	0.62	0.64	0.65	0.64	0.63	0.64	0.60	0.60	0.65	0.64	0.63	0.64	0.60	0.60			
▲ Precipitation (in/h)	0.75	0.74	0.73	0.73	0.69	0.69	0.73	0.78	0.73	0.77	0.72	0.74	0.75	0.74	0.73	0.73	0.69	0.69	0.75	0.74	0.73	0.73	0.69	0.69			

## Metric Performance Data

R-VAN18 ADJUSTABLE ARC NOZZLES																											
	270° Arc						210° Arc						180° Arc						90° Arc								
Pressure (bar)	2.1	2.4	2.8	3.1	3.4	3.8	2.1	2.4	2.8	3.1	3.4	3.8	2.1	2.4	2.8	3.1	3.4	3.8	2.1	2.4	2.8	3.1	3.4	3.8			
Radius (m)	4.9	4.9	5.2	5.2	5.5	5.5	4.9	4.9	5.2	5.2	5.5	5.5	4.9	4.9	5.2	5.2	5.5	5.5	4.9	4.9	5.2	5.2	5.5	5.5			
Flow (l/m)	4.77	5.11	5.38	5.72	5.94	6.13	3.71	3.97	4.16	4.43	4.62	4.77	3.22	3.44	3.71	3.82	4.05	4.13	1.59	1.78	1.89	1.89	2.04	2.20			
■ Precipitation (mm/h)	17	16	16	16	15	15	16	17	16	16	16	16	17	16	16	16	15	15	17	16	16	16	15	15			
▲ Precipitation (mm/h)	19	19	18	18	18	18	19	20	19	20	18	19	19	19	18	18	18	18	19	19	18	18	18	18			

## U.S. Performance Data

R-VAN18-360 FULL CIRCLE NOZZLES						
	360° Arc					
Pressure (psi)	30	35	40	45	50	55
Radius (ft)	16	16	17	17	18	18
Flow (gpm)	1.65	1.67	1.80	1.85	2.05	2.11
■ Precipitation (in/h)	0.62	0.63	0.60	0.62	0.61	0.63
▲ Precipitation (in/h)	0.72	0.73	0.69	0.71	0.70	0.72

## Metric Performance Data

R-VAN18-360 FULL CIRCLE NOZZLES						
	360° Arc					
Pressure (bar)	2.1	2.4	2.8	3.1	3.4	3.8
Radius (m)	4.9	4.9	5.2	5.2	5.5	5.5
Flow (l/m)	6.25	6.32	6.81	7.00	7.76	7.99
■ Precipitation (mm/h)	16	16	15	16	15	16
▲ Precipitation (mm/h)	18	19	18	18	18	18

13' to 18' | 4.0 m to 5.5 m



R-VAN18 | 45° - 270°

R-VAN18-360 | 360°

### U.S. Performance Data

R-VAN24 ADJUSTABLE ARC NOZZLES																											
	270° Arc						210° Arc						180° Arc						90° Arc								
Pressure (psi)	30	35	40	45	50	55	30	35	40	45	50	55	30	35	40	45	50	55	30	35	40	45	50	55			
Radius (ft)	16	16	17	17	18	18	16	16	17	17	18	18	16	16	17	17	18	18	16	16	17	17	18	18			
Flow (gpm)	1.26	1.35	1.42	1.51	1.57	1.62	0.98	1.05	1.10	1.17	1.22	1.26	0.85	0.91	0.98	1.01	1.07	1.09	0.42	0.47	0.50	0.50	0.54	0.58			
■ Precipitation (in/h)	0.65	0.64	0.63	0.64	0.60	0.60	0.63	0.68	0.63	0.64	0.62	0.64	0.65	0.64	0.63	0.64	0.60	0.60	0.65	0.64	0.63	0.64	0.60	0.60			
▲ Precipitation (in/h)	0.75	0.74	0.73	0.73	0.69	0.69	0.73	0.78	0.73	0.77	0.72	0.74	0.75	0.74	0.73	0.73	0.69	0.69	0.75	0.74	0.73	0.73	0.69	0.69			

### Metric Performance Data

R-VAN24 ADJUSTABLE ARC NOZZLES																											
	270° Arc						210° Arc						180° Arc						90° Arc								
Pressure (bar)	2.1	2.4	2.8	3.1	3.4	3.8	2.1	2.4	2.8	3.1	3.4	3.8	2.1	2.4	2.8	3.1	3.4	3.8	2.1	2.4	2.8	3.1	3.4	3.8			
Radius (m)	4.9	4.9	5.2	5.2	5.5	5.5	4.9	4.9	5.2	5.2	5.5	5.5	4.9	4.9	5.2	5.2	5.5	5.5	4.9	4.9	5.2	5.2	5.5	5.5			
Flow (l/m)	4.77	5.11	5.38	5.72	5.94	6.13	3.71	3.97	4.16	4.43	4.62	4.77	3.22	3.44	3.71	3.82	4.05	4.13	1.59	1.78	1.89	1.89	2.04	2.20			
■ Precipitation (mm/h)	17	16	16	16	15	15	16	17	16	16	16	16	17	16	16	16	15	15	17	16	16	16	15	15			
▲ Precipitation (mm/h)	19	19	18	18	18	18	19	20	19	20	18	19	19	19	18	18	18	18	19	19	18	18	18	18			

### U.S. Performance Data

R-VAN24-360 FULL CIRCLE NOZZLES						
	360° Arc					
Pressure (psi)	30	35	40	45	50	55
Radius (ft)	16	16	17	17	18	18
Flow (gpm)	1.65	1.67	1.80	1.85	2.05	2.11
■ Precipitation (in/h)	0.62	0.63	0.60	0.62	0.61	0.63
▲ Precipitation (in/h)	0.72	0.73	0.69	0.71	0.70	0.72

### Metric Performance Data

R-VAN24 360 FULL CIRCLE NOZZLES						
	360° Arc					
Pressure (bar)	2.1	2.4	2.8	3.1	3.4	3.8
Radius (m)	4.9	4.9	5.2	5.2	5.5	5.5
Flow (l/m)	6.25	6.32	6.81	7.00	7.76	7.99
■ Precipitation (mm/h)	16	16	15	16	15	16
▲ Precipitation (mm/h)	18	19	18	18	18	18

17' to 24' | 5.2 m to 7.3 m



R-VAN24 | 45° - 270°

R-VAN24-360 | 360°



### U.S. Performance Data

#### R-VAN-LCS LEFT CORNER STRIP / R-VAN RCS RIGHT CORNER STRIP

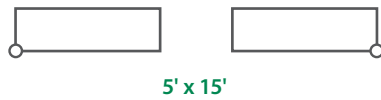

Pressure (psi)	30	35	40	45	50	55
Size (ft)	4 x 14	5 x 15	5 x 15	5 x 15	5 x 15	6 x 16
Flow (gpm)	0.18	0.22	0.23	0.24	0.25	0.28
— Precipitation (in/h)	0.62	0.56	0.59	0.62	0.64	0.56
▲ Precipitation (in/h)	0.62	0.56	0.59	0.62	0.64	0.56

### Metric Performance Data

#### R-VAN-LCS LEFT CORNER STRIP

**1.5 m x 4.6 m**

Pressure (bar)	2.1	2.4	2.8	3.1	3.4	3.8
Size (m)	1.2 x 4.3	1.5 x 4.6	1.5 x 4.6	1.5 x 4.6	1.5 x 4.6	1.8 x 4.9
Flow (l/m)	0.68	0.83	0.87	0.91	0.95	1.06
— Precipitation (mm/h)	16	14	15	16	16	14
▲ Precipitation (mm/h)	16	14	15	16	16	14

5' to 15' | 1.5 m to 4.6 m



R-VAN-LCS | Left Corner Strip

R-VAN-LCS | Left Corner Strip

### U.S. Performance Data

#### R-VAN-SST SIDE STRIP

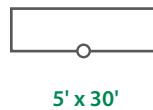

Pressure (psi)	30	35	40	45	50	55
Size (ft)	4 x 28	5 x 30	5 x 30	5 x 30	5 x 30	6 x 32
Flow (gpm)	0.36	0.44	0.46	0.48	0.50	0.56
— Precipitation (in/h)	0.62	0.56	0.59	0.62	0.64	0.56
▲ Precipitation (in/h)	0.62	0.56	0.59	0.62	0.64	0.56

### Metric Performance Data

#### R-VAN-SST SIDE STRIP

**1.5 m x 9.1 m**

Pressure (bar)	2.1	2.4	2.8	3.1	3.4	3.8
Size (m)	1.2 x 8.5	1.5 x 9.1	1.5 x 9.1	1.5 x 9.1	1.5 x 9.1	1.8 x 9.8
Flow (l/m)	1.36	1.67	1.74	1.82	1.89	2.12
— Precipitation (mm/h)	16	14	15	16	16	14
▲ Precipitation (mm/h)	16	14	15	16	16	14

5' to 30' | 1.5 m to 9.1 m



R-VAN-LCS | Left Corner Strip

## HE-VAN Series Nozzles

### FEATURES

- High-Efficiency Variable Arc (HE-VAN) nozzles have even coverage that allows you to shorten run times by up to 35%, while still maintaining a healthy lawn. HE-VAN has more than a 40% even-coverage improvement over existing variable arc nozzles.
- Low-trajectory spray and large water droplets prevent misting and airborne evaporation so the right amount of water is delivered to the right place. Gentle close-in watering eliminates dry spots around the spray head.
- Unique stream pattern that throws to the exact specified radius, delivering the cleanest edge of any VAN on the market today.
- Reduced zone run times help stay within tight watering windows, conserve water and save money.
- With full adjustability from 0° to 360°, you'll be able to efficiently water landscapes of all shapes while stocking fewer nozzles.
- Matched precipitation rates allow you to install Rain Bird® HE-VAN, MPR and U-Series nozzles on the same zone.

### SPECIFICATIONS

#### Models:

**HE-VAN-08:** Green top; 6' to 8' (1.8 m to 2.4 m)

**HE-VAN-10:** Blue top; 8' to 10' (2.4 m to 3.0 m)

**HE-VAN-12:** Brown top; 9' to 12' (2.7 m to 3.7 m)

**HE-VAN-15:** Black top; 12' to 15' (3.7 m to 4.6 m)

**Radius:** Adjustable, 0° to 360°

**Pressure Range:** 15 to 30 psi (1.0 to 2.1 bar)

**Recommended Operating Pressure:** 30 psi (2.1 bar)\*

**Spacing:** 6' to 15' (1.8 m to 2.4 m)

**Adjustment:** Tactile click keeps arc setting from drifting over time



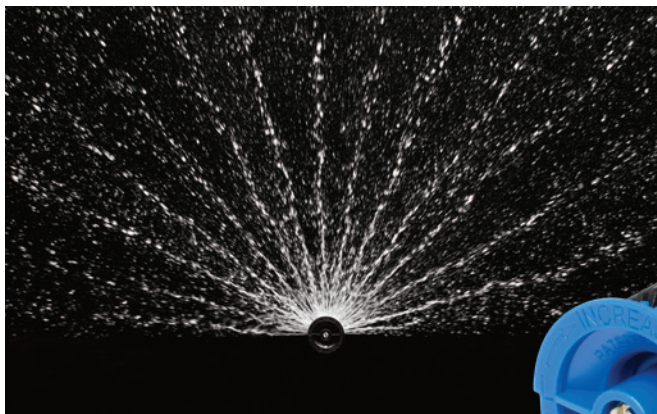

**Warranty:** 3-year trade warranty

#### HOW TO SPECIFY

HE	-	VAN	-	XX
MODEL		FEATURE		RADIUS RANGE
HE = High-Efficiency Nozzle		VAN = Variable Arc		08 = 6–8 ft (1.8–2.4 m)
				10 = 8–10 ft (2.4–3.0 m)
				12 = 9–12 ft (2.7–3.7 m)
				15 = 12–15 ft (3.7–4.6 m)







### U.S. Performance Data

8 SERIES HE-VAN — 24° TRAJECTORY																
	 360° Arc				 270° Arc				 180° Arc				 90° Arc			
Pressure (psi)	15	20	25	30	15	20	25	30	15	20	25	30	15	20	25	30
Radius (ft)	5	6	7	8	5	6	7	8	5	6	7	8	5	6	7	8
Flow (gpm)	0.83	0.96	1.07	1.17	0.62	0.72	0.80	0.88	0.41	0.48	0.53	0.59	0.21	0.24	0.27	0.29
■ Precipitation (in/h)	3.19	2.56	2.10	1.76	3.19	2.56	2.10	1.76	3.19	2.56	2.10	1.76	3.19	2.56	2.10	1.76
▲ Precipitation (in/h)	3.68	2.95	2.42	2.03	3.68	2.95	2.42	2.03	3.68	2.95	2.42	2.03	3.68	2.95	2.42	2.03

### Metric Performance Data

8 SERIES HE-VAN — 24° TRAJECTORY																
	360° Arc				270° Arc				180° Arc				90° Arc			
Pressure (bar)	1.03	1.38	1.72	2.07	1.03	1.38	1.72	2.07	1.03	1.38	1.72	2.07	1.03	1.38	1.72	2.07
Radius (m)	1.52	1.83	2.13	2.44	1.52	1.83	2.13	2.44	1.52	1.83	2.13	2.44	1.52	1.83	2.13	2.44
Flow (l/m)	3.14	3.62	4.05	4.43	2.35	2.72	3.04	3.33	1.57	1.81	2.02	2.22	0.78	0.91	1.01	1.11
Flow (m³/h)	0.19	0.22	0.25	0.27	0.14	0.16	0.18	0.20	0.10	0.11	0.12	0.13	0.05	0.05	0.06	0.07
■ Precipitation (mm/h)	82	66	54	45	82	66	54	45	82	66	54	45	82	66	54	45
▲ Precipitation (mm/h)	95	76	62	52	95	76	62	52	95	76	62	52	95	76	62	52

### U.S. Performance Data





10 SERIES HE-VAN — 27° TRAJECTORY																
	 360° Arc				 270° Arc				 180° Arc				 90° Arc			
Pressure (psi)	15	20	25	30	15	20	25	30	15	20	25	30	15	20	25	30
Radius (ft)	7	8	9	10	7	8	9	10	7	8	9	10	7	8	9	10
Flow (gpm)	1.26	1.46	1.63	1.78	0.95	1.09	1.22	1.34	0.63	0.73	0.81	0.89	0.32	0.36	0.41	0.45
■ Precipitation (in/h)	2.48	2.19	1.94	1.72	2.48	2.19	1.94	1.72	2.48	2.19	1.94	1.72	2.48	2.19	1.94	1.72
▲ Precipitation (in/h)	2.86	2.53	2.24	1.98	2.86	2.53	2.24	1.98	2.86	2.53	2.24	1.98	2.86	2.53	2.24	1.98

### Metric Performance Data

10 SERIES HE-VAN — 27° TRAJECTORY																
	360° Arc				270° Arc				180° Arc				90° Arc			
Pressure (bar)	1.03	1.38	1.72	2.07	1.03	1.38	1.72	2.07	1.03	1.38	1.72	2.07	1.03	1.38	1.72	2.07
Radius (m)	2.13	2.44	2.74	3.05	2.13	2.44	2.74	3.05	2.13	2.44	2.74	3.05	2.13	2.44	2.74	3.05
Flow (l/m)	4.78	5.52	6.17	6.76	3.59	4.14	4.63	5.07	2.39	2.76	3.09	3.38	1.20	1.38	1.54	1.69
Flow (m³/h)	0.29	0.34	0.37	0.41	0.22	0.25	0.28	0.31	0.15	0.17	0.19	0.21	0.07	0.08	0.09	0.10
■ Precipitation (mm/h)	64	56	50	44	64	56	50	44	64	56	50	44	64	56	50	44
▲ Precipitation (mm/h)	74	65	57	51	74	65	57	51	74	65	57	51	74	65	57	51







### U.S. Performance Data

12 SERIES HE-VAN — 23° TRAJECTORY																
																
	360° Arc				270° Arc				180° Arc				90° Arc			
Pressure (psi)	15	20	25	30	15	20	25	30	15	20	25	30	15	20	25	30
Radius (ft)	9	10	11	12	9	10	11	12	9	10	11	12	9	10	11	12
Flow (gpm)	1.67	1.93	2.16	2.37	1.25	1.45	1.62	1.77	0.84	0.97	1.08	1.18	0.42	0.48	0.54	0.59
■ Precipitation (in/h)	1.99	1.86	1.72	1.58	1.99	1.86	1.72	1.58	1.99	1.86	1.72	1.58	1.99	1.86	1.72	1.58
▲ Precipitation (in/h)	2.30	2.15	1.99	1.83	2.30	2.15	1.99	1.83	2.30	2.15	1.99	1.83	2.30	2.15	1.99	1.83

### Metric Performance Data

12 SERIES HE-VAN — 23° TRAJECTORY																
	360° Arc				270° Arc				180° Arc				90° Arc			
Pressure (bar)	1.0	1.4	1.7	2.1	1.0	1.4	1.7	2.1	1.0	1.4	1.7	2.1	1.0	1.4	1.7	2.1
Radius (m)	2.7	3.0	3.4	3.7	2.7	3.0	3.4	3.7	2.7	3.0	3.4	3.7	2.7	3.0	3.4	3.7
Flow (l/m)	6.33	7.31	8.18	8.96	4.75	5.48	6.16	6.72	3.17	3.66	4.09	4.48	1.58	1.83	2.04	2.24
Flow (m³/h)	0.38	0.44	0.49	0.54	0.28	0.33	0.37	0.40	0.19	0.22	0.25	0.27	0.09	0.11	0.12	0.13
■ Precipitation (mm/h)	50.5	47.3	43.7	40.2	50.5	47.3	43.7	40.2	50.5	47.3	43.7	40.2	50.5	47.3	43.7	40.2
▲ Precipitation (mm/h)	58.3	54.6	50.4	46.4	58.3	54.6	50.4	46.4	58.3	54.6	50.4	46.4	58.3	54.6	50.4	46.4

### U.S. Performance Data

15 SERIES HE-VAN — 25° TRAJECTORY																
																
	360° Arc				270° Arc				180° Arc				90° Arc			
Pressure (psi)	15	20	25	30	15	20	25	30	15	20	25	30	15	20	25	30
Radius (ft)	11	12	14	15	11	12	14	15	11	12	14	15	11	12	14	15
Flow (gpm)	2.62	3.02	3.38	3.70	1.96	2.27	2.53	2.78	1.31	1.51	1.69	1.85	0.65	0.76	0.84	0.93
■ Precipitation (in/h)	2.08	2.02	1.66	1.58	2.08	2.02	1.66	1.58	2.08	2.02	1.66	1.58	2.08	2.02	1.66	1.58
▲ Precipitation (in/h)	2.40	2.33	1.92	1.83	2.40	2.33	1.92	1.83	2.40	2.33	1.92	1.83	2.40	2.33	1.92	1.83

### Metric Performance Data

15 SERIES HE-VAN — 25° TRAJECTORY																
	360° Arc				270° Arc				180° Arc				90° Arc			
Pressure (bar)	1.0	1.4	1.7	2.1	1.0	1.4	1.7	2.1	1.0	1.4	1.7	2.1	1.0	1.4	1.7	2.1
Radius (m)	3.4	3.7	4.3	4.6	3.4	3.7	4.3	4.6	3.4	3.7	4.3	4.6	3.4	3.7	4.3	4.6
Flow (l/m)	9.91	11.44	12.79	14.01	7.43	8.58	9.59	10.51	4.95	5.72	6.39	7.00	2.48	2.86	3.20	3.50
Flow (m³/h)	0.59	0.69	0.77	0.84	0.45	0.51	0.58	0.63	0.30	0.34	0.38	0.42	0.15	0.17	0.19	0.21
■ Precipitation (mm/h)	52.9	51.3	42.2	40.2	52.9	51.3	42.2	40.2	52.9	51.3	42.2	40.2	52.9	51.3	42.2	40.2
▲ Precipitation (mm/h)	61.1	59.3	48.7	46.5	61.1	59.3	48.7	46.5	61.1	59.3	48.7	46.5	61.1	59.3	48.7	46.5

NOTE: All HE-VAN nozzles tested on 4" (10.2 cm) pop-ups. Radius reduction over 25% of the normal throw of the nozzle is not recommended.  
■ Square and ▲ triangular spacing based on 50% diameter of throw. Performance data taken in zero wind conditions.

## U-Series Nozzles

### FEATURES

- Additional orifice for close-in watering minimizes brown spots around the spray head and eliminates gaps in coverage so the entire watering area is more uniformly covered.
- Superior coverage for efficient watering. Use up to 30% less water.
- Matched precipitation rate with Rain Bird HE-VAN and MPR nozzles.

### SPECIFICATIONS

#### Operating Range:

**Spacing:** 5' to 15' (1.7 m to 4.6 m)

**Pressure:** 15 to 30 psi (1.0 to 2.1 bar)

#### Models:

**U-8:** Green top; 5' to 8' (1.7 m to 2.4 m)

**U-10:** Blue top; 7' to 10' (2.1 m to 3.0 m)

**U-12:** Brown top; 9' to 12' (2.7 m to 3.7 m)

**U-15:** Black top; 12' to 15' (3.7 m to 4.6 m)

**Warranty:** 5-year trade warranty



U-Series nozzles offer better, more uniform water distribution. Water flowing from both orifices combines to form a continuous water stream, thereby eliminating gaps for more uniform coverage throughout the entire watering area.

### HOW TO SPECIFY

U	XX	X
MODEL	RADIUS RANGE	PATTERN
U-Series Nozzle	8 = 5' to 8' (1.7 m to 2.4 m) 10 = 7' to 10' (2.1 m to 3.0 m) 12 = 9' to 12' (2.7 m to 3.7 m) 15 = 11' to 15' (3.4 m to 4.6 m)	F = Full H = Half Q = Quarter





### U.S. Performance Data

U-SERIES FULL CIRCLE PATTERN					
	Pressure (psi)	Radius (ft)	Flow (gpm)	Precipitation (in/hr) ■ ▲	
<b>U-8F</b> (10° Trajectory)	15	5	0.74	2.85	3.29
	20	6	0.86	2.30	2.66
	25	7	0.96	1.89	2.18
	30	8	1.05	1.58	1.83
<b>U-10F</b> (12° Trajectory)	15	7	1.16	2.07	2.39
	20	8	1.34	2.01	2.32
	25	9	1.50	1.62	1.87
	30	10	1.64	1.58	1.83
<b>U-12F</b> (23° Trajectory)	15	9	1.80	2.14	2.47
	20	10	2.10	2.02	2.34
	25	11	2.40	1.91	2.21
	30	12	2.60	1.74	2.01
<b>U-15F</b> (23° Trajectory)	15	11	2.60	2.07	2.39
	20	12	3.00	2.01	2.32
	25	14	3.30	1.62	1.87
	30	15	3.70	1.58	1.83

### Metric Performance Data

U-SERIES FULL CIRCLE PATTERN					
	Pressure (bar)	Radius (m)	Flow (l/m)	Flow (m³/h)	Precipitation (mm/hr) ■ ▲
<b>U-8F</b> (10° Trajectory)	1.0	1.7	2.8	0.16	72
	1.5	2.1	3.4	0.20	58
	2.0	2.4	3.9	0.23	48
	2.1	2.4	4.0	0.24	40
	4.6	3.4	9.8	0.60	44
<b>U-10F</b> (12° Trajectory)	1.0	2.1	4.4	0.226	52
	1.5	2.6	5.3	0.30	47
	2.0	3.0	6.1	0.34	41
	2.1	3.1	6.2	0.37	40
	4.6	3.7	9.8	0.60	44
<b>U-12F</b> (23° Trajectory)	1.0	2.7	6.8	0.40	55
	1.5	3.2	8.3	0.48	47
	2.0	3.6	9.7	0.59	46
	2.1	3.7	9.8	0.60	44
	4.6	4.6	14.0	0.84	40
<b>U-15F</b> (23° Trajectory)	1.0	3.4	9.8	0.60	52
	1.5	3.9	11.8	0.72	47
	2.0	4.5	13.7	0.84	41
	2.1	4.6	14.0	0.84	40
	4.6	4.6	14.0	0.84	40





U.S. Performance Data

U-SERIES HALF CIRCLE PATTERN					
	Pressure (psi)	Radius (ft)	Flow (gpm)	Precipitation (in/hr)	
				■	▲
 <b>U-8H</b> (10° Trajectory)	15	5	0.37	2.85	3.29
	20	6	0.42	2.25	2.59
	25	7	0.47	1.85	2.13
	30	8	0.52	1.58	1.83
 <b>U-10H</b> (12° Trajectory)	15	7	0.58	2.07	2.39
	20	8	0.67	2.01	2.32
	25	9	0.75	1.62	1.87
	30	10	0.82	1.58	1.83
 <b>U-12H</b> (23° Trajectory)	15	9	0.90	2.14	2.47
	20	10	1.05	2.02	2.34
	25	11	1.20	1.91	2.21
	30	12	1.30	1.74	2.01
 <b>U-15H</b> (23° Trajectory)	15	11	1.30	2.07	2.39
	20	12	1.50	2.01	2.32
	25	14	1.65	1.62	1.87
	30	15	1.85	1.58	1.83

Metric Performance Data

U-SERIES HALF CIRCLE PATTERN					
Pressure (bar)	Radius (m)	Flow (l/m)	Flow (m³/h)	Precipitation (mm/hr)	
				■	▲
1.0	1.7	1.4	0.08	72	84
1.5	2.1	1.7	0.10	57	66
2.0	2.4	1.9	0.12	47	54
2.1	2.4	2.0	0.12	40	46
1.0	2.1	2.2	0.13	52	60
1.5	2.6	2.6	0.15	47	55
2.0	3.0	3.1	0.17	41	48
2.1	3.1	3.1	0.19	40	46
1.0	2.7	3.4	0.20	55	63
1.5	3.2	4.2	0.24	47	54
2.0	3.6	4.8	0.30	46	53
2.1	3.7	4.9	0.30	44	51
1.0	3.4	4.9	0.30	52	60
1.5	3.9	5.9	0.36	47	55
2.0	4.5	6.9	0.42	41	48
2.1	4.6	7.0	0.42	40	46

U.S. Performance Data

U-SERIES QUARTER CIRCLE PATTERN					
	Pressure (psi)	Radius (ft)	Flow (gpm)	Precipitation (in/hr)	
				■	▲
 <b>U-8Q</b> (10° Trajectory)	15	5	0.18	2.77	3.20
	20	6	0.21	2.25	2.59
	25	7	0.24	1.89	2.18
	30	8	0.26	1.58	1.83
 <b>U-10Q</b> (12° Trajectory)	15	7	0.29	2.07	2.39
	20	8	0.33	2.01	2.32
	25	9	0.37	1.62	1.87
	30	10	0.41	1.58	1.83
 <b>U-12Q</b> (23° Trajectory)	15	9	0.45	2.14	2.47
	20	10	0.53	2.02	2.34
	25	11	0.60	1.91	2.21
	30	12	0.65	1.74	2.01
 <b>U-15Q</b> (23° Trajectory)	15	11	0.65	2.07	2.39
	20	12	0.75	2.01	2.32
	25	14	0.82	1.62	1.87
	30	15	0.92	1.58	1.83

Metric Performance Data

U-SERIES QUARTER CIRCLE PATTERN					
Pressure (bar)	Radius (m)	Flow (l/m)	Flow (m³/h)	Precipitation (mm/hr)	
				■	▲
1.0	1.7	0.7	0.04	70	81
1.5	2.1	0.8	0.05	57	66
2.0	2.4	1.0	0.06	48	55
2.1	2.4	1.0	0.06	40	46
1.0	2.1	1.1	0.07	52	60
1.5	2.6	1.3	0.08	47	55
2.0	3.0	1.5	0.08	41	48
2.1	3.1	1.6	0.09	40	46
1.0	2.7	1.7	0.10	55	63
1.5	3.2	2.1	0.12	47	54
2.0	3.6	2.4	0.15	46	53
2.1	3.7	2.5	0.15	44	51
1.0	3.4	2.5	0.15	52	60
1.5	3.9	2.9	0.18	47	55
2.0	4.5	3.4	0.21	41	48
2.1	4.6	3.5	0.21	40	46



## 5000 Series Rotors

### FEATURES

- Oversized wiper seal prevents leaks and protects internals from debris.
- Rain Curtain™ nozzles deliver even distribution over the entire radius including large wind resistant droplets and gentle close-in watering resulting in greener turf using less water.
- A history of proven performance and reliability tested in millions of installations.
- Self-flushing arc adjustment port that prevents buildup of debris.
- Models available in Part Circle and reversing Full Circle (PC) or non-reversing Full Circle (FC).

### SPECIFICATIONS

#### Models:

**5004:** 4" (10.2 cm) pop-up height; 7 3/8" (18.73 cm) body height

**5006:** 6" (15.2 cm) pop-up height; 9 5/8" (24.5 cm) body height

**5012:** 12" (30.5 cm) pop-up height; 16 7/8" (42.9 cm) body height

**Plus:** Flow shut-off

**Shrub:** Mounted above ground on a 3/4" fixed threaded riser

**Precipitation Rate:** 0.20 to 1.50 in/hr (5 to 38 mm/h)

**Radius:** 25' to 50' (7.6 m to 15.2 m)\*

**Pressure:** 25 to 65 psi (1.7 to 4.5 bar)

**Flow Rate:** 0.76 to 9.63 gpm (3.0 to 36.6 l/m; 0.17 to 2.19 m³/h)

**Inlet:** 3/4" (20/27) NPT female threaded

**Warranty:** 5-year trade warranty

\*Radius may be reduced up to 25% with radius reduction screw.



### HOW TO SPECIFY

50XX	-	X	-	X	-	XX	-	XXX	-	X	-	XX	-	XX
MODEL		MODEL		MODEL		ROTATION		OPTION		OPTION		OPTION		MODEL
5004: 4" pop-up		+ = Plus		S = Shrub		PC = 40° - 360°		SAM = Seal-A-Matic™		R = PRS		NP = Non-Potable Cover		SS = Stainless Steel
5006: 6" pop-up						FC = 360°								
5012: 12" pop-up														



### U.S. Performance Data

STANDARD ANGLE RAIN CURTAIN™ NOZZLE PERFORMANCE					
Pressure psi	Nozzle	Radius ft	Flow gpm	Precipitation	
				■ in/h	▲ in/h
25	1.5	33	1.12	0.20	0.23
	2.0	35	1.50	0.24	0.27
	2.5	35	1.81	0.28	0.33
	3.0	36	2.26	0.34	0.39
	4.0	36	2.91	0.43	0.49
	5.0	37	3.72	0.52	0.60
	6.0	37	4.25	0.60	0.69
	8.0	33	5.90	1.26	1.50
35	1.5	34	1.35	0.22	0.26
	2.0	36	1.81	0.27	0.31
	2.5	37	2.17	0.31	0.35
	3.0	38	2.71	0.36	0.42
	4.0	40	3.50	0.42	0.49
	5.0	41	4.47	0.51	0.59
	6.0	43	5.23	0.54	0.63
	8.0	41	7.06	0.94	1.10
45	1.5	35	1.54	0.24	0.28
	2.0	37	2.07	0.29	0.34
	2.5	37	2.51	0.35	0.41
	3.0	39	3.09	0.37	0.43
	4.0	42	4.01	0.44	0.51
	5.0	43	5.09	0.48	0.56
	6.0	44	6.01	0.59	0.69
	8.0	44	8.03	0.92	1.06
55	1.5	35	1.71	0.27	0.31
	2.0	37	2.30	0.32	0.37
	2.5	37	2.76	0.39	0.45
	3.0	40	3.47	0.42	0.48
	4.0	42	4.44	0.48	0.56
	5.0	45	5.66	0.54	0.62
	6.0	50	6.63	0.51	0.59
	8.0	47	8.86	0.80	0.93
65	1.5	34	1.86	0.31	0.36
	2.0	35	2.52	0.40	0.46
	2.5	37	3.01	0.42	0.49
	3.0	40	3.78	0.45	0.53
	4.0	42	4.83	0.53	0.61
	5.0	45	6.16	0.59	0.68
	6.0	50	7.22	0.55	0.64
	8.0	48	9.63	0.84	0.97

Precipitation based on half-circle operation.

■ Square and ▲ triangular spacing based on 50% diameter of throw.

Performance data collected in zero wind conditions.

### Metric Performance Data

STANDARD ANGLE RAIN CURTAIN™ NOZZLE PERFORMANCE						
Pressure bar	Nozzle	Radius m	Flow		Precipitation	
			l/m	m³/h	■ mm/h	▲ mm/h
2.0	1.5	10.2	4.8	0.28	5	6
	2.0	10.8	6.0	0.36	6	7
	2.5	10.9	7.2	0.44	7	9
	3.0	11.2	9.0	0.55	9	10
	4.0	11.6	12.0	0.71	11	12
	5.0	12.1	15.0	0.91	13	15
	6.0	12.4	17.4	1.05	15	17
	8.0	11.8	24.0	1.45	32	37
2.5	1.5	10.4	5.4	0.31	6	7
	2.0	11.0	6.6	0.41	7	8
	2.5	11.3	8.4	0.50	8	9
	3.0	11.2	10.2	0.62	9	11
	4.0	12.3	13.2	0.81	11	13
	5.0	12.7	17.4	1.03	13	15
	6.0	13.2	20.4	1.21	14	16
	8.0	13.3	27.0	1.63	24	28
3.0	1.5	10.6	6.0	0.34	6	7
	2.0	11.2	7.8	0.45	7	8
	2.5	11.3	9.6	0.56	9	10
	3.0	12.1	11.4	0.69	9	11
	4.0	12.7	15.0	0.89	11	13
	5.0	13.5	18.6	1.13	12	14
	6.0	13.4	22.2	1.34	13	17
	8.0	13.4	30.0	1.79	23	27
3.5	1.5	10.7	6.0	0.37	7	8
	2.0	11.3	8.4	0.49	8	9
	2.5	11.3	10.2	0.60	9	11
	3.0	12.2	12.6	0.74	10	12
	4.0	12.8	16.2	0.97	12	14
	5.0	13.7	20.4	1.23	13	15
	6.0	14.2	24.0	1.45	13	15
	8.0	14.9	32.4	1.93	20	24
4.0	1.5	10.6	6.6	0.40	7	8
	2.0	11.1	9.0	0.52	8	10
	2.5	11.3	10.8	0.64	10	12
	3.0	12.2	13.2	0.80	11	12
	4.0	12.8	17.4	1.04	13	15
	5.0	13.7	22.2	1.32	14	16
	6.0	14.9	25.8	1.55	14	16
	8.0	15.2	34.2	2.06	21	25
4.5	1.5	10.4	7.2	0.42	8	9
	2.0	10.7	9.0	0.55	10	11
	2.5	11.3	11.4	0.68	11	12
	3.0	12.2	13.8	0.84	11	13
	4.0	12.8	18.0	1.10	13	15
	5.0	13.7	23.4	1.40	15	17
	6.0	14.6	28.2	1.64	15	18
	8.0	15.2	36.6	2.19	19	22

## 5000 Series MPR Nozzles

### FEATURES

- Rain Curtain™ nozzles deliver even distribution over the entire radius including large wind resistant droplets and gentle close-in watering resulting in greener turf using less water.
- Precipitation rate is automatically matched with a uniform radius that does not require stream deflection.
- Matched 0.6"/hour precipitation rates enable large and small turf areas to be zoned together by mixing rotors and Rain Bird R-VAN or R-Series rotary nozzles.

### SPECIFICATIONS

#### Models:





**5000MPRMPK:** 5000/5000 Plus Series MPR nozzle tree multi pack. 25' (red), 30' (green) and 35' (beige) radius. Each tree contains Quarter, Third, Half and Full arcs.



#### HOW TO SPECIFY

<b>5000</b>	-	<b>MPR</b>	-	<b>XX</b>	-	<b>X</b>
<b>MODEL</b>		<b>NOZZLE</b>		<b>RADIUS RANGE</b>		<b>PATTERN</b>
Rotors		Matched		25'		Q = Quarter
		Precipitation		30'		T = Third
		Rate		35'		H = Half
						F = Full

### U.S. Performance Data





5000-MPR-25 (RED)																									
																									
	Quarter					Third					Half					Full									
Pressure (psi)	25	35	45	55	65	25	35	45	55	65	25	35	45	55	65	25	35	45	55	65					
Radius (ft)	23	24	25	25	25	23	24	25	25	25	23	24	25	25	25	23	24	25	25	25					
Flow (gpm)	0.74	0.88	1.00	1.11	1.21	1.00	1.21	1.38	1.53	1.67	1.44	1.73	1.98	2.21	2.41	2.78	3.34	3.82	4.25	4.63					
■ Precipitation (in/h)	0.54	0.59	0.62	0.68	0.75	0.55	0.61	0.64	0.71	0.77	0.52	0.58	0.61	0.68	0.74	0.51	0.56	0.59	0.65	0.71					
▲ Precipitation (in/h)	0.62	0.68	0.71	0.79	0.86	0.63	0.70	0.74	0.82	0.89	0.61	0.67	0.70	0.79	0.86	0.58	0.64	0.68	0.76	0.82					

### Metric Performance Data

5000-MPR-25 (RED)																				
	Quarter					Third					Half					Full				
Pressure (bar)	1.7	2.4	3.1	3.8	4.5	1.7	2.4	3.1	3.8	4.5	1.7	2.4	3.1	3.8	4.5	1.7	2.4	3.1	3.8	4.5
Radius (m)	7.0	7.3	7.6	7.6	7.6	7.0	7.3	7.6	7.6	7.6	7.0	7.3	7.6	7.6	7.6	7.0	7.3	7.6	7.6	7.6
Flow (l/m)	3.0	3.6	3.6	4.2	4.8	3.6	4.8	5.4	6.0	6.6	5.4	6.6	7.2	8.4	9.0	10.8	12.6	14.4	16.2	17.4
Flow (m³/h)	0.17	0.20	0.23	0.25	0.27	0.23	0.27	0.31	0.35	0.38	0.33	0.39	0.45	0.50	0.55	0.63	0.76	0.87	0.97	1.05
■ Precipitation (mm/h)	13.7	14.9	15.6	17.4	18.9	13.9	15.4	16.2	18.0	19.6	13.3	14.7	15.5	17.3	18.9	12.8	14.2	14.9	16.6	18.1
▲ Precipitation (mm/h)	15.8	17.3	18.1	20.1	21.9	16.0	17.8	18.7	20.7	22.6	15.4	17.0	17.9	20.0	21.8	14.8	16.4	17.3	19.2	20.9





### U.S. Performance Data

5000-MPR-30 (GREEN)																				
	 Quarter					 Third					 Half					 Full				
Pressure (psi)	25	35	45	55	65	25	35	45	55	65	25	35	45	55	65	25	35	45	55	65
Radius (ft)	29	30	30	30	30	29	30	30	30	30	29	30	30	30	30	29	30	30	30	30
Flow (gpm)	1.03	1.23	1.40	1.56	1.69	1.34	1.62	1.85	2.06	2.24	2.15	2.59	2.96	3.30	3.60	4.24	5.08	5.78	6.39	6.92
■ Precipitation (in/h)	0.47	0.53	0.60	0.67	0.72	0.46	0.52	0.59	0.66	0.72	0.49	0.55	0.63	0.71	0.77	0.49	0.54	0.62	0.68	0.74
▲ Precipitation (in/h)	0.54	0.61	0.69	0.77	0.83	0.53	0.60	0.69	0.76	0.83	0.57	0.64	0.73	0.82	0.89	0.56	0.63	0.71	0.79	0.85

### Metric Performance Data

5000-MPR-30 (GREEN)																				
	Quarter					Third					Half					Full				
Pressure (bar)	1.7	2.4	3.1	3.8	4.5	1.7	2.4	3.1	3.8	4.5	1.7	2.4	3.1	3.8	4.5	1.7	2.4	3.1	3.8	4.5
Radius (m)	8.8	9.1	9.1	9.1	9.1	8.8	9.1	9.1	9.1	9.1	8.8	9.1	9.1	9.1	9.1	8.8	9.1	9.1	9.1	9.1
Flow (l/m)	3.6	4.8	5.4	6.0	6.6	4.8	6.0	7.2	7.8	8.4	8.4	9.6	11.4	12.6	13.8	16.2	19.2	21.6	24.0	26.4
Flow (m³/h)	0.23	0.28	0.32	0.35	0.38	0.30	0.37	0.42	0.47	0.51	0.49	0.59	0.67	0.75	0.82	0.96	1.15	1.31	1.45	1.57
■ Precipitation (mm/h)	12.0	13.4	15.2	17.0	18.4	11.7	13.2	15.1	16.8	18.3	12.5	14.1	16.1	17.9	19.6	12.3	13.8	15.7	17.4	18.8
▲ Precipitation (mm/h)	13.8	15.4	17.6	19.6	21.2	13.5	15.2	17.4	19.4	21.1	14.4	16.2	18.6	20.7	22.6	14.2	15.9	18.1	20.0	21.7

### U.S. Performance Data

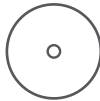
5000-MPR-35 (BEIGE)																				
	 Quarter					 Third					 Half					 Full				
Pressure (psi)	25	35	45	55	65	25	35	45	55	65	25	35	45	55	65	25	35	45	55	65
Radius (ft)	32	34	35	35	35	32	34	35	35	35	32	34	35	35	35	32	34	35	35	35
Flow (gpm)	1.40	1.67	1.92	2.13	2.31	1.77	2.15	2.46	2.74	2.99	2.75	3.33	3.81	4.23	4.62	5.36	6.62	7.58	8.43	9.18
■ Precipitation (in/h)	0.53	0.56	0.60	0.67	0.73	0.50	0.54	0.58	0.65	0.70	0.52	0.55	0.60	0.66	0.73	0.50	0.55	0.60	0.66	0.72
▲ Precipitation (in/h)	0.61	0.64	0.70	0.77	0.84	0.58	0.62	0.67	0.75	0.81	0.60	0.64	0.69	0.77	0.84	0.58	0.64	0.69	0.76	0.83

### Metric Performance Data

5000-MPR-35 (BEIGE)																				
	Quarter					Third					Half					Full				
Pressure (bar)	1.7	2.4	3.1	3.8	4.5	1.7	2.4	3.1	3.8	4.5	1.7	2.4	3.1	3.8	4.5	1.7	2.4	3.1	3.8	4.5
Radius (m)	9.8	10.4	10.7	10.7	10.7	9.8	10.4	10.7	10.7	10.7	9.8	10.4	10.7	10.7	10.7	9.8	10.4	10.7	10.7	10.7
Flow (l/m)	5.4	6.6	7.2	7.8	9.0	6.6	8.4	9.6	10.2	11.4	10.2	12.6	14.4	16.2	17.4	20.4	25.2	28.8	31.8	34.8
Flow (m³/h)	0.32	0.38	0.44	0.48	0.52	0.40	0.49	0.56	0.62	0.68	0.62	0.76	0.87	0.96	1.05	1.22	1.50	1.72	1.91	2.09
■ Precipitation (mm/h)	13.4	14.1	15.3	17.0	18.4	12.7	13.6	14.7	16.4	17.9	13.1	14.1	15.2	16.9	18.4	12.8	14.0	15.1	16.8	18.3
▲ Precipitation (mm/h)	15.4	16.3	17.7	19.6	21.3	14.6	15.8	17.0	18.9	20.7	15.2	16.3	17.6	19.5	21.3	14.8	16.2	17.5	19.4	21.2

## Root Watering System (RWS)

### FEATURES

- Subsurface aeration and irrigation prevents tree and shrub transplant shock.
- Highest efficiency solution for tree irrigation — up to 95% emission uniformity with minimal wind, evaporation or edge control losses.
- Aesthetically designs subsurface bubbler contributes to a landscape's natural appearance.
- Locking grate at grade deters vandals.
- Helps prevent shallow root growth and hardscape damage.
- Aesthetically attractive below-grade installation.
- Self-contained and factory-assembled units for assured reliability.

### SPECIFICATIONS

#### RWS

##### Dimensions:

**Length:** 36" (91.4 cm) semi-rigid mesh tube

**Top Diameter:** 4" (10.2 cm) retaining cap with vandal-resistant locking grate

**Bubbler Options:** On a factory-installed swing assembly with fixed riser

**1401:** 0.25 gpm; 0.95 l/m

**1402:** 0.5 gpm; 1.9 l/m

**1404:** 1.0 gpm; 3.8 l/m

##### Options:

**Check Valve:** Keep lines from draining

**Sand Sock:** For use in fine soils

#### RWS-Mini

##### Dimensions:

**Length:** 18" (45.7 cm) semi-rigid mesh tube

**Top Diameter:** 4" (10.2 cm) retaining cap with vandal-resistant locking grate

**Bubbler Options:** On a factory-installed ½" spiral barb elbow

**1401:** 0.25 gpm; 0.95 l/m

**1402:** 0.5 gpm; 1.9 l/m

##### Options:

**Check Valve:** Keep lines from draining

**Sand Sock:** For use in fine soils

#### RWS-Supplemental

##### Dimensions:

**Length:** 10" (25.4 cm) semi-rigid mesh tube

**Top Diameter:** 2" (5.1 cm) snap-on cap and base cap

**Bubbler Options:** On a factory-installed ½" spiral barb elbow

**PCT:** Pressure-compensating ½" FPT inlet (0.08 gpm; 0.32 l/m)

**1401:** 0.25 gpm; 0.95 l/m

##### Options:

**Check Valve:** Keep lines from draining

**Sand Sock:** For use in fine soils



RWS-Sock

Designed to fit over the outside of the unit. Ideal for use in sandy soil, it will deter fine soil from infiltrating the RWS canister.



RWS integrated collar and locking grate retainer.

### HOW TO SPECIFY

MODEL	MODEL	BUBBLER	OPTION	BUBBLER MODEL
RWS	M = Mini S = Supplemental	B = Bubbler preinstalled	C = Check Valve	PCTS = 0.08 gpm (0.32 l/m) 1401 = 0.25 gpm (0.95 l/m) 1402 = 0.50 gpm (1.9 l/m) 1404 = 1.00 gpm (3.8 l/m)

RWS Models / Specifications

Model	Bubbler	Check Valve*	Swing Assembly	Spiral Barb Elbow
<b>Root Watering System — 36" (91.4 cm) with 4" (10.2 cm) vandal-resistant locking grate</b>				
RWS	¼" drip tubing or customer-provided hardware	—	—	—
RWS-B-C-1401	0.25 gpm (0.95 l/m)	✓	✓	—
RWS-B-1401	0.25 gpm (0.95 l/m)	—	✓	—
RWS-B-X-1401	0.25 gpm (0.95 l/m)	—	✓ (18" with no elbow)	—
RWS-B-C-1402	0.50 gpm (1.9 l/m)	✓	✓	—
RWS-B-1402	0.50 gpm (1.9 l/m)	—	✓	—
RWS-B-C-1404	1.00 gpm (3.8 l/m)	✓	✓	—
<b>Root Watering System-Mini — 18" (45.7 cm) with 4" (10.2 cm) vandal-resistant locking grate</b>				
RWS-M	¼" drip tubing or customer-provided hardware	—	—	—
RWS-M-B-C-1401	0.25 gpm (0.95 l/m)	✓	—	✓
RWS-M-B-1401	0.25 gpm (0.95 l/m)	—	—	✓
RWS-M-B-C-1402	0.50 gpm (1.9 l/m)	✓	—	✓
RWS-M-B-1402	0.50 gpm (1.9 l/m)	—	—	✓
<b>Root Watering System-Supplemental — 10" (25.4 cm) with 2" (5.1 cm) pop-on cap and base</b>				
RWS-S-B-C-PCT5	0.08 gpm (0.32 l/m)	✓	—	✓
RWS-S-B-C-1401	0.25 gpm (0.95 l/m)	✓	—	✓
RWS-S-B-1401	0.25 gpm (0.95 l/m)	—	—	✓

Accessories

RWS-SOCK = Root Watering Sock

RWS-GRATE-P = Purple grate for RWS and RWS-Mini

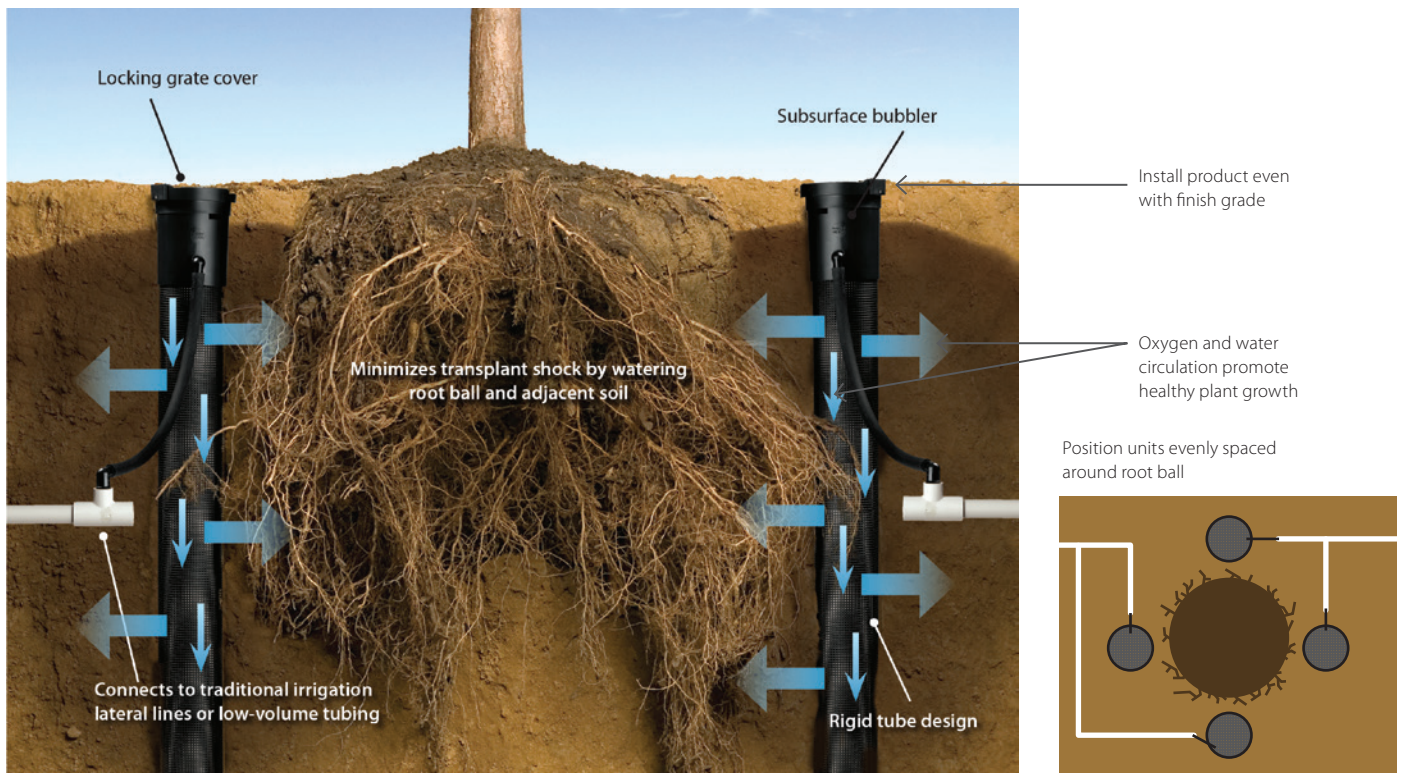



## XFS Sub-Surface Dripline with Copper Shield™ Technology

Rain Bird® XFS Sub-Surface Copper-Colored Dripline with Copper Shield Technology is the latest innovation in the Rain Bird Landscape Drip Family. Rain Bird's patent-pending Copper Shield Technology protects the emitter from root intrusion, creating a long-lasting, low maintenance sub-surface drip irrigation system for use under turf grass or shrub and groundcover areas. A proprietary tubing material makes the XFS Sub-Surface Dripline with Copper Shield the most flexible tubing in the industry, and the easiest sub-surface dripline to design with and install.

### SPECIFICATIONS

#### Dimensions:

- OD:** 0.634" (16 mm)
- ID:** 0.536" (13.6 mm)
- Thickness:** 0.049" (1.2 mm)

**Spacing:** 12" or 18" (30.5 cm or 45.7 cm)

**Coil Lengths:** 100' (30.5 m) and 500' (152.4 m)

**Coil Colors:** Copper

#### Operating Range:

- Pressure:** 8.5 to 60.0 psi (0.58 to 4.14 bar)
- Flow Rates:** 0.4, 0.6 and 0.9 gph (1.6, 2.3 and 3.5 l/hr)

#### Temperature:

- Water:** Up to 100° F (37.8° C)
- Ambient:** Up to 125° F (51.7° C)

**Required Filtration:** 120 mesh

**Compatible Fittings:** XF Dripline Insert Fittings

### HOW TO SPECIFY

XFS	-	X	-	XX	-	XX	-	XXX
MODEL		OPTIONAL		FLOW RATE		EMITTER SPACING		COIL LENGTH
Sub-Surface Dripline		P = Purple over Black		04 = 0.42 gph (1.61 l/h)		12 = 12" (30.5 cm)		100 = 100' (30.5 m)
				06 = 0.61 gph (2.3 l/h)		18 = 18" (45.7 cm)		500 = 500' (152.4 m)
				09 = 0.92 gph (3.5 l/h)		24 = 24" (61.0 cm)		



### U.S. Performance Data

MAXIMUM LATERAL LENGTH (FEET)						
	12" Spacing			18" Spacing		
	Nominal Flow (gph)			Nominal Flow (gph)		
Inlet Pressure (psi)	0.42	0.6	0.9	0.42	0.6	0.9
15	352	273.	155	374	314	250
20	399	318	169	417	353	294
30	447	360	230	481	413	350
40	488	395	255	530	465	402
50	505	417	285	610	528	420
60	573	460	290	734	596	455

FLOW (PER 100 FEET OF TUBING)						
Emitter Spacing	0.42 gph		0.6 gph		0.9 gph	
	gph	gpm	gph	gpm	gph	gpm
12"	42.0	0.70	61.0	1.02	92.0	1.53
18"	28.0	0.47	41.0	0.68	61.0	1.02

### Metric Performance Data

MAXIMUM LATERAL LENGTH (METERS)						
	30.5 cm Spacing			45.7 cm Spacing		
	Nominal Flow (l/h)			Nominal Flow (l/h)		
Inlet Pressure (bar)	1.6	2.3	3.4	1.6	2.3	3.4
1.0	107.2	83.2	47.2	114.0	95.7	76.2
1.4	121.6	96.9	51.5	127.1	107.6	89.6
2.1	136.2	109.7	70.1	146.6	125.9	106.7
2.8	148.7	120.4	77.7	161.5	141.7	122.5
3.5	153.9	127.1	86.9	185.9	160.9	128.0
4.1	174.6	140.2	88.4	223.7	181.7	138.7

FLOW (PER 100 METERS OF TUBING)						
Emitter Spacing	1.6 l/h		2.3 l/h		3.4 l/h	
	l/h	l/m	l/h	l/m	l/h	l/m
0.30 meter	531.1	8.85	757.9	12.6	1136.7	18.9
0.46 meter	351.8	5.86	502.2	8.4	741.3	12.4

## QF Dripline Header

A quick and flexible replacement for site-built header, the QF Dripline Header is a patent-pending product that is the landscape industry's first pre-fabricated header for dripline installations. Using a proprietary blend of polyethylene, similar to Rain Bird's XF Series Dripline, the QF Dripline Header allows installers to simply roll out the header and attach the dripline at a guaranteed 12" or 18" spacing — eliminating the need for measuring, cutting, gluing and taping.

### FEATURES

- Header elbows rotate 360° and incorporate a protective ring — preventing damage and ensuring a proper seal.
- Rotating barb manages trenching misalignment — move left or right to accommodate the dripline without the need to retrench.
- Elbows utilize the same design as Rain Bird's popular XFF Fitting, requiring 50% less insertion force, and are compatible with the XFF Fittings Tool.

### SPECIFICATIONS

#### ¾" QF Header

**Dimensions:**

**OD:** 0.94" (23.9 mm)

**ID:** 0.82" (20.8 mm)

**Thickness:** 0.06" (1.5 mm)

**Spacing:** 12" or 18"

(30.5 cm or 45.7 cm)

**Coil Length:** 100' (30.5 m)

**Coil Colors:** Copper or Purple

#### 1" QF Header

**Dimensions:**

**OD:** 1.20" (30.5 mm)

**ID:** 1.06" (26.9 mm)

**Thickness:** 0.07" (1.8 mm)

**Spacing:** 12" or 18"

(30.5 cm or 45.7 cm)

**Coil Length:** 100' (30.5 m)

**Coil Colors:** Copper or Purple

### Models

Coil	12" Spacing		18" Spacing	
	¾" Dripline	1" Dripline	¾" Dripline	1" Dripline
100'	XQF7512100	XQF1012100	XQF7518100	XQF1018100
100' Purple	—	XQF101210P	—	XQF101810P

### HOW TO SPECIFY

XQF	—	XX	—	XX	—	XXX
MODEL		DIAMETER		EMITTER SPACING		COIL LENGTH
XQF = Xerigation Quick Flexible		75 = ¾"		12 = 12" (30.5 cm)		100 = 100' (30.5 m)
		10 = 1"		18 = 18" (45.7 cm)		10P = 100' (30.5 m) Purple

### Compatible Fittings

See page 89 for more information.



¾" QF Header:

Twist Lock Fittings 800 Series



1" QF Header:

Twist Lock Fittings 1000 Series

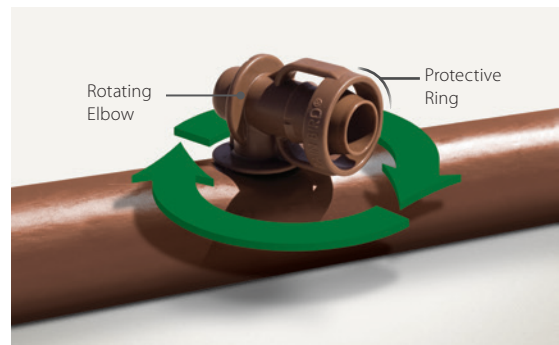



## XFD On-Surface Dripline

### FEATURES

- Extra flexible tubing for fast, easy installation.
- Dual-layered tubing (brown over black or purple over black) provides unmatched resistance to chemicals, UV damage and algae growth.
- Patent-pending emitter design provides for increased reliability.
- Longer lateral runs than the competition.
- Unique material offers significantly greater flexibility, allowing tighter turns with fewer elbows for easier installation.
- Choice of flow rates, spacing and coil lengths provides design flexibility for a variety of non-turfgrass applications.

### SPECIFICATIONS

#### Dimensions:

**OD:** 0.634" (16.1 mm)

**ID:** 0.536" (13.6 mm)

**Thickness:** 0.049" (1.2 mm)

**Spacing:** 12" or 18" (30.5 cm or 45.7 cm)

**Coil Lengths:** 100' (30.5 m), 250' (76.2 m), and 500' (152.4 m)

**Coil Colors:** Copper or Purple

#### Operating Range:

**Pressure:** 8.5 to 60 psi (0.58 to 4.1 bar)

**Flow Rates:** 0.6 and 0.9 gph (2.3 and 3.5 l/hr)

#### Temperature:

**Water:** Up to 100° F (37.8° C)

**Ambient:** Up to 125° F (51.7° C)

**Required Filtration:** 120 mesh

**Compatible Fittings:** XF Dripline Insert Fittings, Rain Bird Easy Fit Compression Fittings or Twist Lock Fittings



### HOW TO SPECIFY

XFD	-	X	-	XX	-	XX	-	XXX
MODEL		OPTIONAL		FLOW RATE		EMITTER SPACING		COIL LENGTH
XFD = Xerigation Flexible Dripline		P = Purple		06 = 0.61 gph (2.3 l/h) 09 = 0.92 gph (3.5 l/h)		12 = 12" (30.5 cm) 18 = 18" (45.7 cm)		100 = 100' (30.5 m) 250 = 250' (76.2 m) 500 = 500' (152.4 m)





## Twist Lock Fittings

- Simplify installation of QF Header, Dripline and Blank Distribution Tubing.
- Fittings provide an even tighter seal on tubing by using high quality barbs and twist locking nuts.
- Unique barb design reduces insertion force while maintaining a secure fit.

### SPECIFICATIONS

**Pressure:** 0 to 60 psi (0 to 4.1 bar)

### MODELS

#### 600 Series

- TLF-CUPL-0600:** ½" Coupler
- TLF-TEE-0600:** ½" Tee
- TLF-ELBW-0600:** ½" Elbow
- TLF-MPT6-0600:** ½" NPT to ½" Adapter
- TLF-MPT8-0600:** ¾" NPT to ½" Adapter

#### 800 Series

- TLF-CUPL-0800:** ¾" Coupler
- TLF-TEE-0800:** ¾" Tee
- TLF-ELBW-0800:** ¾" Elbow
- TLF-MPT8-0800:** ¾" NPT Adapter
- TLF-CAP-0800:** ¾" Cap

#### 1000 Series

- TLF-CUPL-1000:** 1" Coupler
- TLF-TEE-1000:** 1" Tee
- TLF-ELBW-1000:** 1" Elbow
- TLF-MPT8-1000:** 1" NPT Adapter



## XF Dripline Insert Fittings



- Complete line of 17 mm insert fittings to simplify installation of XF Series Dripline.
- Unique barb design reduces insertion force and still retain a secure fit.
- Non-obtrusive colored fittings to compliment natural earth tones.

### SPECIFICATIONS

**Pressure:** 0 to 50 psi (1.0 to 3.5 bar); If using 60 psi (4.1 bar), clamps will be required

### MODELS

- XFF-COUP:** 17 mm Barb x Barb Coupling
- XFF-ELBOW:** 17 mm Barb x Barb Elbow
- XFF-MA-050:** 17 mm Barb x ½" MPT Male Adapter
- XFF-TEE:** 17 mm Barb x Barb x Barb Tee
- XFF-TMA-050:** 17 mm Barb x ½" MPT x 17 mm Barb Tee Male Adapter
- XFF-MA-075:** 17 mm Barb x ¾" MPT Male Adapter
- XFF-FA-050:** Low-Profile Barb Elbow Female Adapter 17 mm x ½" FPT
- XFF-TFA-050:** Low-Profile Barb Tee Female Adapter 17 mm x ½" FPT x 17 mm
- XFD-CROSS:** Barb Cross 17 mm x 17 mm x 17 mm x 17 mm
- XFS-TFA-075:** Barb Tee Female Adapter 17 mm x ¾" FPT x 17 mm
- LD16STK:** 7 ¾" Barbed Tubing Plastic Stake
- FITTINGS-TOOL:** XF Fitting Insertion Tool. Compatible with XFF-COUP, XFF-ELBOW, XFF-TEE and QF Dripline Header.

## Easy Fit Compression System



- Multi-diameter compression fittings work with a wide range of 16 mm to 17 mm tubing or dripline.
- 50% less force required to connect tubing and fittings versus competitive compression fittings. Adapters swivel for easy installation.
- Patented fittings and adapters are molded from UV-resistant and durable ABS materials.
- Removable flush caps can be used to flush end of line and temporarily cap off lines for later expansion.
- Not recommended with subsurface irrigation.

### SPECIFICATIONS

**Pressure:** 0 to 60 psi (0 to 4.1 bar)

**Tubing:** Accepts tubing with an OD of 0.630" (16 mm) to 0.669" (17 mm)

### MODELS

#### Easy Fit Fittings

- MDCF-COUP:** Coupling
- MDCF-EL:** Elbow
- MDCF-TEE:** Tee

#### Easy Fit Adapters

- MDCF-50MPT:** ½" Male Pipe Thread Adapter
- MDCF-75MPT:** ¾" Male Pipe Thread Adapter
- MDCF-50FPT:** ½" Female Pipe Thread Adapter
- MDCF-75FPT:** ¾" Female Pipe Thread Adapter
- MDCF-75FHT:** ¾" Female Hose Thread Adapter
- MDCF-CAP:** Black Removable Flush Cap
- MDCF-PCAP:** Purple Removable Flush Cap

**NOTE:** Easy Fit Adapters are not barbed fittings. They are to be used only with Easy Fit Compression Fittings.

## XF Series Blank Tubing

### FEATURES

- Greater flexibility is easier to install and saves time.
- Brown color matches landscape and blends with mulch.
- Compatible with XF Series Dripline (0.634" (16.1 mm) OD x 0.536" (13.6 mm) ID).
- Accepts Rain Bird® Easy Fit Compression Fittings, XF Dripline Insert Fittings and 17 mm insert fittings. Not compatible with 16 mm fittings.

### SPECIFICATIONS

#### Dimensions:

- OD:** 0.634" (16.1 mm)
- ID:** 0.536" (13.6 mm)
- Thickness:** 0.049" (1.2 mm)

#### Models:

- XFD100:** 100' coil (30 m)
- XFD250:** 250' coil (76 m)
- XFD500:** 500' coil (152 m)



### U.S. Performance Data

FRICTION LOSS CHARACTERISTICS (PSI/100 FT)												
	Flow (gpm)											
	0.50	1.00	1.50	2.00	2.50	3.00	3.50	4.00	4.50	5.00	5.50	6.00
Velocity (fps)	0.27	1.40	2.10	2.80	3.50	4.20	4.90	5.60	6.30	7.00	7.70	8.40
Loss (psi)	0.27	0.97	2.06	3.50	5.29	7.42	9.87	12.64	15.72	19.11	22.80	26.78

### Metric Performance Data

FRICTION LOSS CHARACTERISTICS (BAR/100 M)												
	Flow (l/m)											
	1.89	3.79	5.68	7.57	9.46	11.36	13.25	15.14	17.03	18.93	20.82	22.71
Velocity (m/s)	0.21	0.43	0.64	0.85	1.07	1.28	1.49	1.71	1.92	2.13	2.35	2.56
Loss (bar)	0.06	0.22	0.46	0.79	1.20	1.68	2.23	2.86	3.56	4.32	5.16	6.06

**NOTE:** Use of tubing a flows shown in shaded area is not recommended, as velocities exceed 5 ft/sec (1.5 m/s).

## XT-700 Distribution Tubing

### FEATURES

- Thick-walled, flexible tubing resists kinks and damage caused by routine landscape maintenance activities.
- Extruded from UV-resistant polyethylene resin materials.
- Accepts Rain Bird ½" Twist Lock Fittings — 600 Series.

### SPECIFICATIONS

#### Dimensions:

- OD:** 0.70" (18 mm)
- ID:** 0.58" (15 mm)
- Thickness:** 0.06" (1.5 mm)

**Pressure:** 0 to 60 psi (0 to 4.1 bar)

#### Models:

- XT-700-100:** 100' coil (30 m)
- XT-700-500:** 500' coil (152 m)



### U.S. Performance Data

FRICTION LOSS CHARACTERISTICS (PSI/100 FT)												
	Flow (gpm)											
	0.50	1.00	1.50	2.00	2.50	3.00	3.50	4.00	4.50	5.00	5.50	6.00
Velocity (fps)	0.61	1.21	1.82	2.43	3.03	3.64	4.24	4.85	5.46	6.06	6.67	7.28
Loss (psi)	0.19	0.69	1.45	2.47	3.74	5.24	6.97	8.93	11.10	13.50	16.10	18.92

### Metric Performance Data

FRICTION LOSS CHARACTERISTICS (BAR/100 M)												
	Flow (l/m)											
	1.89	3.79	5.68	7.57	9.50	11.36	13.25	15.14	17.03	18.93	20.82	22.71
Velocity (m/s)	0.19	0.37	0.56	0.74	0.92	1.11	1.29	1.48	1.67	1.85	2.03	2.22
Loss (bar)	0.01	0.05	0.10	0.17	0.26	0.36	0.48	0.62	0.77	0.93	1.11	1.31

**NOTE:** Use of tubing a flows shown in shaded area is not recommended, as velocities exceed 5 ft/sec (1.5 m/s).

## Xeri-Bubblers™

### FEATURES

- Ideal for shrub plantings, trees, containers and flower beds.
- Adjust flow and radius by turning outer cap.
- Stream Bubbler (SXB) has wetting patterns of either half-circle, 5 stream or half-circle, 8 stream.
- Umbrella Bubbler (UXB) has a full-circle, umbrella wetting pattern.

### SPECIFICATIONS

**Pressure:** 15 to 30 psi (1.0 to 2.1 bar)

#### Flow:

**SXB Series:** 0 to 13 gph (0 to 49.21 l/h) at 30 psi (2.1 bar); 0 to 8.5 gph (0 to 30 l/h) at 15 psi (1 bar)

**UXB Series:** 0 to 35 gph (0 to 132.48 l/h) at 30 psi (2.1 bar); 0 to 26 gph (0 to 98 l/h) at 15 psi (1 bar)

#### Models:

**SXB-180:** Half-circle, 5 streams, 10-32 thread

**SXB-180-025:** Half-circle, 5 streams, ¼" barb

**SXB-180-SPYK:** Half-circle, 5 streams, 5" spike; includes barb x barb coupler

**SXB-360:** Full-circle, 8 streams, 10-32 thread

**SXB-360-025:** Full-circle, 8 streams, ¼" barb

**SXB-360-SPYK:** Full-circle, 8 streams, 5" spike; includes barb x barb coupler

**UXB-360:** Full-circle, umbrella, 10-32 thread

**UXB-360-025:** Full-circle, umbrella, ¼" barb

**UXB-360-SPYK:** Full-circle, umbrella, 5" spike; includes barb x barb coupler



### HOW TO SPECIFY

XXX	-	XXX	-	XXX(X)
MODEL		PATTERN		CONNECTION
SXB: Stream Bubbler		180 = Half-Circle		025 = ¼" Barb
UXB: Umbrella Bubbler		360 = Full-Circle		SPYK = 5" Spike

## Xeri-Bug™ Emitters

### FEATURES

- Point-source low-flow emitters Ideal for watering the root zones of shrub plantings, trees and container plants.
- Flow rates of 0.5, 1.0 and 2.0 gph (1.89, 3.79 and 7.57 l/h).
- Outlet barb securely retains ¼" distribution tubing.

### SPECIFICATIONS

#### Operating Range:

**Flow:** 0.5 to 2.0 gph (1.89 to 7.57 l/h)

**Pressure:** 15 to 50 psi (1.0 to 3.5 bar)

**Required Filtration:** 150 to 200 mesh (75 to 100 micron)

#### Barb Inlet x Barb Outlet Models:

**XB-05PC:** Blue, 0.5 gph (1.89 l/h)

**XB-10PC:** Black, 1.0 gph (3.79 l/h)

**XB-20PC:** Red, 2.0 gph (7.57 l/h)

#### 10-32 Thread Inlet x Barb Outlet Models:

**XB-05PC-1032:** Blue, 0.5 gph (1.89 l/h)

**XB-10PC-1032:** Black, 1.0 gph (3.79 l/h)

**XB-20PC-1032:** Red, 2.0 gph (7.57 l/h)

#### ½" FPT Inlet x Barb Outlet Models:

**XBT-10:** Black, 1.0 gph (3.79 l/h)

**XBT-20:** Red, 2.0 gph (7.57 l/h)



### HOW TO SPECIFY

XB	-	T	-	XX	-	PC	-	XXXX
MODEL		OPTIONAL		FLOW		FEATURE		OPTIONAL
XB = Xeri-Bug		T = ½" FPT Inlet		05 = 0.5 gph (1.89 l/h)		PC = Pressure Compensating		1032 = 10-32 Threaded Inlet
				10 = 1.0 gph (3.79 l/h)				
				20 = 2.0 gph (7.57 l/h)				



## Large-Capacity Filters

### FEATURES

- Provides extra large filtration capacity for residential, commercial and municipal applications.
- Durable filters can be easily removed for cleaning. Disc filters can decompress for easy cleaning.
- Auxiliary connection with a threaded cap can be drilled to allow draining or depressurization.

### OPERATING RANGE

#### 1" Model:

**Maximum Flow:** Up to 26 gpm (6 m<sup>3</sup>/hr)

**Disc Filtering Surface:** 28 in<sup>2</sup> (180 cm<sup>2</sup>)

#### 1.5" Model:

**Maximum Flow:** Up to 62 gpm (14 m<sup>3</sup>/hr)

**Disc Filtering Surface:** 48 in<sup>2</sup> (310 cm<sup>2</sup>)

**Screen Filtering Surface:** 42 in<sup>2</sup> (270 cm<sup>2</sup>)

#### 2" Model:

**Maximum Flow:** Up to 110 gpm (25 m<sup>3</sup>/hr)

**Disc Filtering Surface:** 81 in<sup>2</sup> (525 cm<sup>2</sup>)

**Screen Filtering Surface:** 75 in<sup>2</sup> (485 cm<sup>2</sup>)

**Maximum Pressure:** 116 psi (8 bar)

**Maximum Temperature:** 140° F (60° C)

### MODELS

**LCRBY100D:** 1" Large-Capacity Disc Filter

**LCRBY150S:** 1.5" Large-Capacity Screen Filter

**LCRBY150D:** 1.5" Large-Capacity Disc Filter

**LCRBY200S:** 2" Large-Capacity Screen Filter

**LCRBY200D:** 2" Large-Capacity Disc Filter

#### Replacement Filters:

**LGFC120MS:** 1.5" – 2" Screen Filter

**LGFC120MD:** 1.5" – 2" Disc Filter

### SPECIFICATIONS

#### Inlet/Outlet Size:

**1" Models:** 1" NPT

**1.5" Models:** 1.5" NPT

**2" Models:** 2" NPT

### FILTRATION

**Stainless Steel Screen Filter:** 120 mesh (130 micron)\*

**Plastic Filter Discs:** 120 mesh (130 micron)

\*Screen not available in 1" model.

**NOTE:** Filter should be installed downstream of valve.



### Disc Filter Pressure Loss Characteristics

Flow Rate		1" Filter		1.5" Filter		2" Filter	
gpm	l/m	psi	bar	psi	bar	psi	bar
5	18.93	0.60	0.04	0.08	0.01	0.10	0.01
11	41.67	1.16	0.08	0.18	0.01	0.10	0.01
22	83.33	2.61	0.18	0.40	0.03	0.10	0.01
33	125.00	4.35	0.30	0.73	0.05	0.24	0.02
44	166.67	—	—	1.05	0.07	0.40	0.03
55	208.33	—	—	1.50	0.10	0.60	0.04
66	250.00	—	—	2.18	0.15	0.82	0.06
77	291.67	—	—	3.10	0.21	1.10	0.08
88	333.33	—	—	3.95	0.27	1.60	0.11
99	375.00	—	—	—	—	2.03	0.14
110	416.67	—	—	—	—	2.47	0.17

### Screen Filter Pressure Loss Characteristics

Flow Rate		1" Filter		1.5" Filter		2" Filter	
gpm	l/m	psi	bar	psi	bar	psi	bar
5	18.93	0.80	0.06	0.00	0.00	0.00	0.00
11	41.67	1.74	0.12	0.00	0.00	0.00	0.00
22	83.33	2.90	0.20	0.50	0.03	0.20	0.01
33	125.00	4.06	0.28	0.95	0.07	0.25	0.02
44	166.67	—	—	1.45	0.10	0.44	0.03
55	208.33	—	—	1.89	0.13	0.60	0.04
66	250.00	—	—	2.32	0.16	0.87	0.06
77	291.67	—	—	2.76	0.19	1.16	0.08
88	333.33	—	—	3.19	0.22	1.45	0.10
99	375.00	—	—	—	—	1.89	0.13
110	416.67	—	—	—	—	2.32	0.16

**NOTE:** Filter should be installed downstream of the valve to prevent the filter from being under constant pressure.

### Filter Housing Dimensions

Model	A, B	H	W	X	D
1" (2.5 cm)	1" NPT	6.81" (17.3 cm)	7.48" (19.0 cm)	6.22" (15.8 cm)	3.27" (8.3 cm)
1.5" (3.8cm)	1.5" NPT	9.53" (24.2 cm)	10.25" (26.0 cm)	9.92" (25.2 cm)	5.67" (14.4 cm)
2" (5.1 cm)	2" NPT	9.76 (24.8 cm)	10.63" (27.0 cm)	10.51" (26.7 cm)	5.67" (14.4 cm)



#### Plastic Filter Discs:

These filters are made up of over a hundred grooved discs that allow water to pass while trapping debris. Less maintenance required due to large surface area.



#### Screen Filter:

The 120 mesh screen filters are easy to clean and provide reliable filtration.

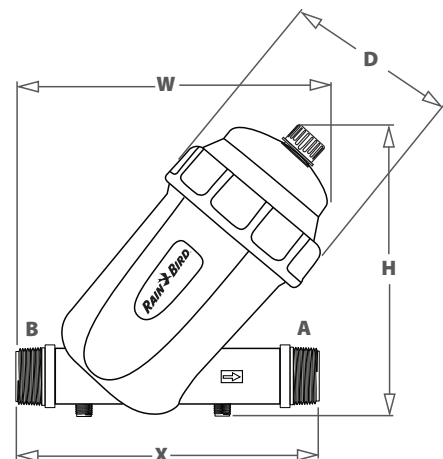

## ESP-9V Battery-Operated Controller

### FEATURES

#### Controller Features

- Waterproof case ensures long life, even when installed in a valve box.
- Common programming features are easily accessed on one screen, making programming quick and easy.
- Operates for approximately one full year using one 9-volt alkaline battery, or two years with two 9-volt alkaline batteries.
- Large LCD display with easy to navigate user interface.
- Sensor input with bypass override.
- Mast valve/pump-start circuit (multi-zone units only).
- Non-volatile (100-year) program memory.
- IP68 certified for protection against dust and water intrusion.
- Plastic controller case has outstanding resistance to weather, yellowing and aging.

#### Scheduling Features

- Dedicated manual watering button for easy operation.
- Automatic zone-stacking ensures that only one valve irrigates at the same time. ESP-9V will automatically irrigate the lower number zone first if zones are scheduled to water at the same time.
- Contractor Rapid Programming™ automatically copies the start times and watering days from zone 1 to all remaining zones at initial setup.
- Run times, start times, and watering days are customizable by zone.
- 6 start times per zone.
- 4 watering day options per zone: Custom days of the week, Cyclic, and ODD or EVEN calendar days.
- Delay watering (1 to 9 days).

### VALVE COMPATIBILITY

- Rain Bird K80920, Hunter 458200, Irritrol DCL, Toro DCLS-P

### MODELS

**ESP9V1:** 1-Zone ESP-9V Controller

**ESP9V2:** 2-Zone ESP-9V Controller

**ESP9V4:** 4-Zone ESP-9V Controller

**ESP9V6:** 6-Zone ESP-9V Controller

**ESP9V1SOL:** 1-Zone + 9V Solenoid

**ESP9VDVKIT:** 1-Zone + 1" DV Valve (SLIP)

**9VMOUNT:** Wall-mount kit

### SPECIFICATIONS

#### Dimensions:

**Width:** 5.35" (13.59 cm)

**Height:** 4.04" (10.26 cm)

**Depth:** 2.42" (6.15 cm)

**Weight:** 2.0 lbs (907 g)

#### LCD Screen Dimensions:

**Width:** 2.25" (5.72 cm)

**Height:** 1.25" (3.18 cm)

#### Optional Wall Mount Dimensions:

**Width:** 4.25" (10.76 cm)

**Height:** 6.93" (17.60 cm)

**Depth:** 1.97" (4.99 cm)

**Weight:** 3.6 oz (107 g)

### CERTIFICATIONS

- cULus, FCC, IC, CE, RCM, IP68, RoHS, WEEE



Optional Wall Mount





## TBOS-BT Battery-Operated Controller



### FEATURES

#### Controller Features

- Operates for approximately one full year using one 9-volt alkaline battery.
- Completely potted to obtain IP68 conformity.
- Independent station operation allows sequential start times (with stacking in case of overlap) restriction compliance.
- Master valve output (on TBOS-II 2, 4, and 6 Control Modules).
- No loss of irrigation program after a battery replacement.
- Backward-compatible with the TBOS-II Field Transmitter.

#### Rain Bird App Features

- Create, review and transmit irrigation programs.
- Capability to set zones or programs to manually irrigate.
- Basic programming includes 3 independent programs A,B and C, each with 8 start times per day.
- Stations can be assigned to several programs with different watering run times.
- Run time is from 1 minute to 12 hours in 1-minute increments.
- Five watering day cycle modes (Custom, even, odd, odd-31, cyclical) selectable by program for maximum flexibility and watering.
- Program and global Monthly Seasonal Adjust; 0% to 300% (1% increments).
- Built-in ID with naming capability. The control module and stations can be individually named.
- Optional passcode.
- Delay watering from 1 to 14 days.
- Permanently turn the controller off to prevent irrigation.
- Battery indicator reports the status of the control module's battery.
- Capability to clear the control module's irrigation program.

### VALVE COMPATIBILITY

- Rain Bird TBOS Potted Latching Solenoid (K80920)
  - DV, DVF, ASF, PGA, PEB, PESB, GB, EFB-CP, BPE and BPES series
- Hunter 458200, Irritrol DCL, Toro DCLS-P

### MODELS

- TBOS-BT1:** 1 Station
- TBOS-BT2:** 2 Station
- TBOS-BT4:** 4 Station
- TBOS-BT6:** 6 Station

### SPECIFICATIONS

#### Dimensions:

- Width:** 3.8" (9.5 cm)
- Height:** 5.1" (13.0 cm)
- Depth:** 2.0" (5.3 cm)
- Weight:** 17.6 oz (500 g)

**Rain Bird App (TBOS-BT):** Available for Android and IOS devices

### ACCESSORIES

- TBOS Potted Latching Solenoid
- RSD Series Rain Sensors
- The TBOS solenoid adapters will adapt the potted latching solenoid for use in retrofit applications with selected Irritrol® (Hardie/Richdel) and Buckner® valves or Champion® and Superior® valve actuators

### CERTIFICATIONS

- cULus, CE, RoHS, WEEE, FCC

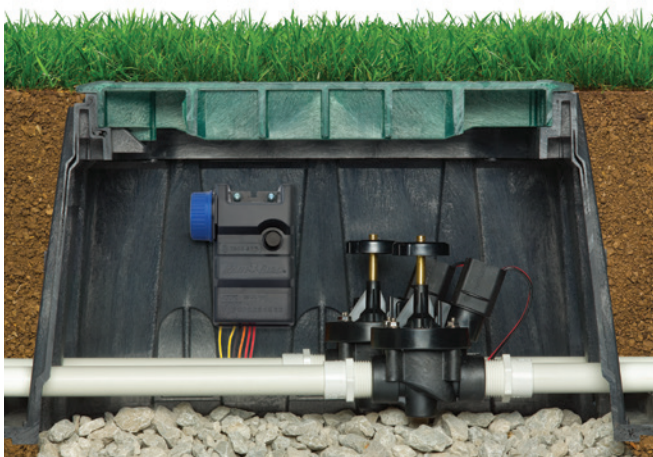

### VB Series Valve Boxes

#### FEATURES

- Commercial-grade boxes.
- Multiple sizes and shapes designed with corrugated sides and wide flange bases for maximum durability, compression strength and stability.
- Smart lid design with no holes to keep out pests and beveled edges to minimize damage potential from turf equipment with an easy-access shovel slot for lid removal.
- Interlocking stacking capabilities, extension models and pipe hole knockouts support deeper and more flexible installations.
- All black bodies and lids are made from 100% recycled materials, making them earth-friendly and LEED compliant.
- Locking systems with vandal-resistant hex or penta bolt, washers and clips.
- **Warranty:** 5-year trade warranty

#### Locking Systems:

**VB-LOCK-H:** Hex Head  $\frac{3}{8}$ " x  $2\frac{1}{4}$ " (1.0 x 5.7 cm) bolt, washer and clip

**VB-LOCK-P:** Penta Head  $\frac{3}{8}$ " x  $2\frac{1}{4}$ " (1.0 x 5.7 cm) bolt, washer and clip



LANDSCAPE SOLUTIONS



Size	7" Round	10" Round	Standard	Jumbo
Bottom Diameter	9.9" (25.1 cm)	13.7" (34.9 cm)	—	—
Length x Width	—	—	21.8" (55.4 cm) x 16.6" (42.2 cm)	26.3" (66.8 cm) x 19.8" (50.3 cm)
Height	9.0" (22.9 cm)	10.0" (25.4 cm)	12.0" (30.5 cm)	12.1" (30.7 cm)
Number of Knockouts	4	4	13	2
Specifications	Takes up to 2" (5.0 cm) pipe	Takes up to 2" (5.0 cm) pipe	2 take up to 3.5" (8.9 cm) pipe 11 take up to 2.0 (5.0 cm) pipe	Takes up to 3.5" (8.9 cm) pipe



**MODELS**

**7" Round**

Item ID	Lid Color	Model Number
G11480	Green	GVB7RNDGR
G11481	Black	GVB7RNDBLK
G11482	Purple	GVB7RNDPUR
G11483	Tan	GVB7RNDTAN

**Standard**

Item ID	Lid Color	Model Number
G11400	Green	GVBSTDGR
G11401	Black	GVBSTDBLK
G11402	Purple	GVBSTDPURP
G11403	Tan	GVBSTD TAN

**10" Round**

Item ID	Lid Color	Model Number
G11450	Green	GVB10RNDGR
G11451	Black	GVB10RNDBL
G11452	Purple	GVB10RNDPU
G11453	Tan	GVB10RNDTA

**Jumbo**

Item ID	Lid Color	Model Number
G11430	Green	GVBJMBGR
G11431	Black	GVBJMBBLK
G11432	Purple	GVBJMBPURP
G11433	Tan	GVBJMBTAN



**Areas**

6,452 sq cm	1 sq in
144 sq in	1 sq ft
9 sq ft	1 sq yd
43,560 sq ft	1 acre
1 acre	43,560 sq ft
1 acre	4,840 sq yd
1 acre	160 sq rods
1 sq rod	272.25 sq ft
1 sq rod	30.25 sq yd
640 acres	1 sq mi
640 acres	1 section
Area of a Circle	$r^2 \times 3.1416$
Area of a Square	One Side Squared
Area of a Triangle	$\frac{1}{2}$ Base x Altitude
Area of a Rectangle	Length x Width
Area of a Parallelogram	Base x Altitude

**Lineal Measurements**

1 centimeter	0.3937 inches
1 cubit	18 inches
1 meter	39.37 inches
1 rod	16.5 feet
1 rod	5.5 yards
1 chain	4 rods
1 chain	66 feet
320 rods	1 mile
5280 feet	1 mile
Circumference of Circle	Diameter x 3.1416

**Volume**

1728 cu in	1 cu ft
231 cu in	1 gallon
27 cu ft	1 cu yd
1 cu ft	7.48052 gal (U.S.)
1 cu yd	202 gallons (U.S.)
16 drams	1 ounce
32 ounces	1 quart
4 quarts	1 gallon
1 gallon	3.785 liters
1 gallon	0.00379 cu m
1 gallon	0.833 imperial gallons
27,154 gallons	1 acre inch
325,851 gallons	1 acre foot
1,000,000 gallons	3.0689 acre ft
1 acre foot	43,560 cu ft
Volume of a Cube	Area of Base x Height
Volume of a Pyramid	$\frac{1}{2}$ Area of Base x Height
Volume of a Sphere	$Diameter^3 \times 0.5236$

**Mass/Weight**

1 kg	2.204 lbs
1 lb	454 g = 7,000 grains
1 slug	14.5 kg
1 stone	14 lb

**Weights**

1 U.S. Gallon (Water)	8.3357 lbs
1 Cu Foot (Water)	62.3554 lbs
1 Imperial Gallon	10.0 lbs
1 Liter	2.2 lbs
Earth, in Place Undisturbed	100 lbs/cu ft
Earth, Dry and Loose	82-90 lbs/cu ft
Earth, Moist	75-100 lbs/cu ft
Sand, Dry	90-106 lbs/cu ft
Shale or Red Rock	162 lbs/cu ft
Limestone	160-163 lbs/cu ft
Base Gravel	12.0 lbs/sq ft/inch Thick in Place
Asphalt	12.5 lbs/sq ft/inch Thick in Place
Sack Cement	94 lbs
Concrete (Plain)	140 lbs/cu ft
Concrete (Reinforced)	150 lbs/cu ft

**Pressures**

1 atmosphere	29.921 inches of hg @ 32° F
1 atmosphere	33.94 ft of water @ 62° F
1 atmosphere	14.6963 lbs/sq in
1 lb/sq inch	2.31 feet of head
1 foot of water	0.433 lbs/sq in
1 kg/sq cm	14.22 lbs/sq in
1 foot of water	62.3554 lbs/sq ft
1 bar	14.5 lbs/sq in

**Flows**

1 gallon/min (U.S.)	0.002228 cu ft/sec
1 gallon/min (U.S.)	0.13368 cu ft/min
1 gallon/min (U.S.)	8.0208 cu ft/hr
1 gallon/min (U.S.)	0.06309 liters/sec
1 gallon/min (U.S.)	3.78533 liters/min
1 gallon/min (U.S.)	0.0044192 acre ft/24 hrs
1 gallon/min (U.S.)	0.22712 cu m/hr
1 cu ft/sec	448.83 gpm
1 liter/sec	15.85 gpm
1 cu m/min	264 gpm
1 acre in/hr	452.57 gpm
1 acre ft/day	226.3 gpm
1,000,000 gallons/day	694.4 gpm
1 cu ft/sec	0.992 acre in/hr

**Power**

1 horsepower	33,000 ft lbs/min
1 horsepower	746 watts
1 horsepower	0.746 kilowatts

**Temperature**

F	$^{\circ}\text{C} \times 9/5 + 32$
C	$(^{\circ}\text{F} - 32) \times 5/9$

Design Formulas

Precipitation Rate (in/hr)	<i>S</i> = Spacing	Run-Time	Velocity
Square = $\frac{96.3 \times \text{GPM} \times 360}{S \times S \times \text{Sprinkler Arc}}$		Run-Time = $\frac{\text{Desired Application} \times 60}{\text{Precipitation Rate}}$	$V = \frac{0.480 \times Q}{(ID)^2}$
Triangular = $\frac{96.3 \times \text{GPM} \times 360}{S \times S \times 0.866 \times \text{Sprinkler Arc}}$			Where: V = Velocity in feet per second Q = Gallons per minute ID = Inside diameter of pipe
Single Row = $\frac{96.3 \times \text{GPM}}{S \times 0.8 \text{ Diameter}}$			

Power Formulas

Horse Power	Electrical Power	Pump Laws (Affinity Laws)
1 hp = 550 foot pounds per second = 746 watts or 0.746 kW = 1 second foot of water falling 8.8'	3φ kVA = $\frac{1.732 \times \text{FLA} \times \text{Voltage}}{1000}$ 1φ kVA = $\frac{\text{FLA} \times \text{Voltage}}{1000}$	$\text{RPM}_2 / \text{RPM}_1 = \text{Flow}_2 / \text{Flow}_1$ $(\text{RPM}_2 / \text{RPM}_1)^2 = \text{Pressure}_2 / \text{Pressure}_1$ $(\text{RPM}_2 / \text{RPM}_1)^3 = \text{Power}_2 / \text{Power}_1$
Water HP = $\frac{\text{GPM} \times \text{TDH}}{3960}$ Where: GPM = Gallons per minute TDH = Total dynamic head	Ohm's Law: V = IR Where: V = Voltage in Volts I = Current in Amperes R = Resistance in ohms	Example: An irrigation pump operating at 1800 RPM and producing 600 gpm at 120 psi is switched to 3600 RPM: $\text{RPM}_2 / \text{RPM}_1 = \text{Flow}_2 / \text{Flow}_1$ $= 3600 \text{ RPM} / 1800 \text{ RPM}$ $= \text{Flow}_2 / 600 \text{ gpm} = 1200 \text{ gpm}$
Brake HP = $\frac{\text{GPM} \times \text{TDH}}{3960 \times E}$ Where: GPM = Gallons per minute TDH = Total dynamic head E = Pump efficiency	Amp Calculation Amps = Watts / Volts	$(\text{RPM}_2 / \text{RPM}_1)^2 = \text{Pressure}_2 / \text{Pressure}_1$ $= (3600 \text{ RPM} / 1800 \text{ RPM})^2$ $= \text{Pressure}_2 / 120 \text{ psi} = 480 \text{ psi}$
1 kilowatt (kW) = 1,000 watts = 1,341 HP = 735.5 foot pounds per second		$(\text{RPM}_2 / \text{RPM}_1)^3 = \text{Power}_2 / \text{Power}_1$ $= (3600 \text{ RPM} / 1800 \text{ RPM})^3$ $= \text{Power}_2 / 60 \text{ HP} = 480 \text{ HP}$

APPENDIX

Electric Formulas for Calculating Amperes, Horsepower, Kilowatts and kVA

ALTERNATING CURRENT			
To Find:	Single Phase	Two Phase-Four Phase Wire	Three Phase
Amperes when "HP" is known	$\frac{\text{HP} \times 746}{E \times \% \text{EFF} \times \text{PF}}$	$\frac{\text{HP} \times 746}{E \times \% \text{EFF} \times \text{PF} \times 2}$	$\frac{\text{HP} \times 746}{E \times \% \text{EFF} \times \text{PF} \times 1.73}$
Amperes when "kW" is known	$\frac{\text{kW} \times 1000}{E \times \text{PF}}$	$\frac{\text{kW} \times 1000}{E \times \text{PF} \times 2}$	$\frac{\text{kW} \times 1000}{E \times \text{PF} \times 1.73}$
Amperes when "kVa" is known	$\frac{\text{kVA} \times 1000}{E}$	$\frac{\text{kVA} \times 1000}{E \times 2}$	$\frac{\text{kVA} \times 1000}{E \times 1.73}$
Kilowatts	$\frac{E \times I \times \text{PF}}{1000}$	$\frac{E \times I \times \text{PF} \times 2}{1000}$	$\frac{E \times I \times \text{PF} \times 1.73}{1000}$
Kilovolt-Amperes "kVA"	$\frac{E \times I}{1000}$	$\frac{E \times I \times 2}{1000}$	$\frac{E \times I \times 1.73}{1000}$
Horsepower	$\frac{E \times I \times \% \text{EFF} \times \text{PF}}{746}$	$\frac{E \times I \times \% \text{EFF} \times \text{PF} \times 2}{746}$	$\frac{E \times I \times \% \text{EFF} \times \text{PF} \times 1.73}{746}$

**Where:**  
 Power Factor (PF) =  $\frac{\text{Power Used (Watts)}}{\text{Apparent Power}}$  or  $\frac{\text{kW}}{\text{kVA}}$   
 Power Efficiency (%EFF) =  $\frac{\text{Output (Watts)}}{\text{Input (Watts)}}$   
 E = Volts  
 I = Amperes  
 W = Watts

### Conductor Properties For Insulated Annealed Copper Direct Current Resistance

OHMS PER 1,000 FEET					
Copper Awg	Temperature				Cross Sectional Area Circular Mils
	167° F (75° C)	149° F (65° C)	77° F (25° C)	68° F (20° C)	
18 Solid	7.77	7.519	6.515	6.390	1,620
18 Stranded	7.95	7.693	6.666	6.538	1,620
16 Solid	4.89	4.732	4.100	4.021	2,580
16 Stranded	4.99	4.829	4.184	4.104	2,580
14 Solid	3.07	2.971	2.574	2.525	4,110
14 Stranded	3.14	3.039	2.633	2.582	4,110
12 Solid	1.93	1.868	1.618	1.587	6,530
12 Stranded	1.98	1.916	1.660	1.628	6,530
10 Solid	1.21	1.171	1.015	0.995	10,380
10 Stranded	1.24	1.200	1.040	1.020	10,380
8 Solid	0.764	0.739	0.641	0.628	16,510
8 Stranded	0.778	0.753	0.652	0.640	16,510
6 Stranded	0.491	0.475	0.412	0.404	26,240
4 Stranded	0.308	0.298	0.258	0.253	41,740
2 Stranded	0.194	0.188	0.163	0.160	66,360
1/0 Stranded	0.122	0.118	0.102	0.100	105,600
2/0 Stranded	0.097	0.094	0.081	0.080	133,100

Source: 2008 Edition of *National Electric Code* (NFPA 70), Chapter 9, Table 8.  
System designer must use resistance values which correlate to temperatures and applications for each specific project.

### Full Load Amperage (FLA)

Motor HP	Single Phase A-C		Three Phase A-C Induction Type Squirrel Cage & Wound Rotor		
	115 VOLTS	230 VOLTS*	230 VOLTS*	460 VOLTS	575 VOLTS
½	9.8	4.9	2.2	1.1	0.9
¾	13.8	6.9	3.2	1.6	1.3
1	16	8	4.2	2.1	1.7
1½	20	10	6.0	3.0	2.4
2	24	12	6.8	3.4	2.7
3	34	17	9.6	4.8	3.9
5	56	28	15.2	7.6	6.1
7½	80	40	22	11	9
10	100	50	28	14	11
15	—	—	42	21	17
20	—	—	54	27	22
25	—	—	68	34	27
30	—	—	80	40	32
40	—	—	104	52	41
50	—	—	130	65	52
60	—	—	154	77	62
75	—	—	192	96	77
100	—	—	240	120	96
125	—	—	296	148	118
150	—	—	350	175	140
200	—	—	456	228	182
250	—	—	558	279	223

\*For 208V applications, increase the 230V FLA by 10%.

### Horsepower to Kilowatts

Horsepower	Kilowatt
1	0.746
3	2.2
5	3.7
10	7.5
15	11.2
20	14.9
25	18.7
30	22.4
40	29.8
50	37.3
60	44.8
75	56.0



Pressure Conversion

psi	Feet	Meter	Bar	kPa
1	2.3090	0.7038	0.0689	6.8948
80	185	56	5.5	552
85	196	60	5.9	586
90	208	63	6.2	621
95	219	67	6.6	655
100	231	70	6.9	689
105	242	74	7.2	724
110	254	77	7.6	758
115	266	81	7.9	793
120	277	84	8.3	827
125	289	88	8.6	862
130	300	91	9.0	896
135	312	95	9.3	931
140	323	99	9.7	965
150	346	106	10.3	1034
160	369	113	11.0	1103
170	393	120	11.7	1172
180	416	127	12.4	1241
190	439	134	13.1	1310
200	462	141	13.8	1379

Flow Rate Conversion

gpm	ft <sup>3</sup> /s	m <sup>3</sup> /h	l/s	acre-ft/day
1	0.0022	0.2271	0.0002	0.004419
100	0.22	22.7	6.3	0.442
250	0.56	56.8	15.8	1.105
500	1.11	113.6	31.5	2.210
750	1.67	170.3	47.3	3.314
1000	2.23	227.1	63.1	4.419
1500	3.34	340.7	94.6	6.629
2000	4.46	454.2	126.2	8.838
2500	5.57	567.8	157.7	11.048
3000	6.68	681.4	189.3	13.258
3500	7.80	794.9	220.8	15.467
4000	8.91	908.5	252.4	17.677
4500	10.03	1022.1	283.9	19.886
5000	11.14	1135.6	315.5	22.096
6000	13.37	1362.7	378.5	26.515
7000	15.60	1589.9	441.6	30.934
8000	17.82	1817.0	504.7	35.353
9000	20.05	2044.1	567.8	39.773
10000	22.28	2271.2	630.9	44.192

Lake Intake Box Screen Sizing

Flow Rate In (gpm)	Box Screen Size
0 - 500	18" square
501 - 1000	24" square
1001 - 1800	30" square
1801 - 2800	36" square
2801 - 4000	42" square
4001 - 5000	48" square
5001 - 7000	54" square
7001 - 8500	60" square
8501 - 10000	66" square

Based on screen velocities of less than 0.5 feet per second.

Micron to Mesh Conversion

Micron	U.S. Mesh	Inches
2000	10	0.0787
1680	12	0.0661
1410	14	0.0555
1190	16	0.0469
1000	18	0.0394
841	20	0.0331
707	25	0.028
595	30	0.0232
500	35	0.0197
420	40	0.0165
354	45	0.0138
297	50	0.0117
250	60	0.0098
210	70	0.0083
177	80	0.007
149	100	0.0059
125	120	0.0049
105	140	0.0041
88	170	0.0035
74	200	0.0029
63	230	0.0024
53	270	0.0021
44	325	0.0017
37	400	0.0015

Wet Well Intake Pipe Sizing

Flow Rate In gpm	Length of Pipe in Feet			
	50'	100'	200'	300'
0 - 500	12"	12"	12"	14"
501 - 1000	18"	18"	18"	18"
1001 - 1500	24"	24"	24"	24"
1501 - 2000	26"	26"	26"	26"
2001 - 2500	28"	28"	28"	28"
2501 - 3000	30"	30"	30"	30"
3001 - 3500	32"	32"	32"	32"
3501 - 4000	34"	34"	34"	34"
4001 - 5000	36"	36"	36"	36"

The nominal IPS pipe diameters listed in this chart assume a total equivalent pipe length as listed for friction loss calculations. A recommended internal pipe water velocity of up to 1.5 feet per second and/or a draw down of 1 inch or less is used to develop this conservative intake sizing table. Consult a Rain Bird engineer for values ranging outside of this chart.

Wet Well Open Area Sizing

Size	Shape	Number of Pumps
36"	Round	1 – Vertical Turbine
48"	Round	1 or 2 – Vertical Turbines
60"	Round	1 or 2 – Vertical Turbines
72"	Round	1 to 3 – Vertical Turbines
84"	Round	1 to 5 – Vertical Turbines
96"	Round	1 to 6 – Vertical Turbines
6' x 8'	Rectangular	1 to 7 – Vertical Turbines

PE 4710 IPS HDPE DR 13.5 (161 psi) Pipe

VELOCITY IN FEET PER SECOND — FRICTION LOSS IN PSI PER 100 FEET (C = 150)																				
Nominal Size (ID) Flow (gpm)	2" (2.002)		3" (2.950)		4" (3.793)		6" (5.585)		8" (7.271)		10" (9.062)		12" (10.748)		14" (11.801)		16" (13.487)		18" (15.173)	
	Vel	Loss	Vel	Loss	Vel	Loss	Vel	Loss	Vel	Loss	Vel	Loss	Vel	Loss	Vel	Loss	Vel	Loss	Vel	Loss
2	0.20	0.01	0.09	0.00	0.06	0.00	0.00	0.00	0.00	0.00	0.00	0.00	0.00	0.00	0.00	0.00	0.00	0.00	0.00	0.00
4	0.41	0.02	0.19	0.00	0.11	0.00	0.00	0.00	0.00	0.00	0.00	0.00	0.00	0.00	0.00	0.00	0.00	0.00	0.00	0.00
6	0.61	0.04	0.28	0.01	0.17	0.00	0.00	0.00	0.00	0.00	0.00	0.00	0.00	0.00	0.00	0.00	0.00	0.00	0.00	0.00
8	0.81	0.07	0.38	0.01	0.23	0.00	0.00	0.00	0.00	0.00	0.00	0.00	0.00	0.00	0.00	0.00	0.00	0.00	0.00	0.00
10	1.02	0.10	0.47	0.02	0.28	0.00	0.00	0.00	0.00	0.00	0.00	0.00	0.00	0.00	0.00	0.00	0.00	0.00	0.00	0.00
12	1.22	0.14	0.56	0.02	0.34	0.01	0.00	0.00	0.00	0.00	0.00	0.00	0.00	0.00	0.00	0.00	0.00	0.00	0.00	0.00
14	1.43	0.19	0.66	0.03	0.40	0.01	0.00	0.00	0.00	0.00	0.00	0.00	0.00	0.00	0.00	0.00	0.00	0.00	0.00	0.00
16	1.63	0.25	0.75	0.04	0.45	0.01	0.00	0.00	0.00	0.00	0.00	0.00	0.00	0.00	0.00	0.00	0.00	0.00	0.00	0.00
18	1.83	0.31	0.84	0.05	0.51	0.01	0.00	0.00	0.00	0.00	0.00	0.00	0.00	0.00	0.00	0.00	0.00	0.00	0.00	0.00
20	2.04	0.37	0.94	0.06	0.57	0.02	0.00	0.00	0.00	0.00	0.00	0.00	0.00	0.00	0.00	0.00	0.00	0.00	0.00	0.00
22	2.24	0.44	1.03	0.07	0.62	0.02	0.00	0.00	0.00	0.00	0.00	0.00	0.00	0.00	0.00	0.00	0.00	0.00	0.00	0.00
24	2.44	0.52	1.13	0.08	0.68	0.02	0.00	0.00	0.00	0.00	0.00	0.00	0.00	0.00	0.00	0.00	0.00	0.00	0.00	0.00
26	2.65	0.61	1.22	0.09	0.74	0.03	0.00	0.00	0.00	0.00	0.00	0.00	0.00	0.00	0.00	0.00	0.00	0.00	0.00	0.00
28	2.85	0.70	1.31	0.11	0.79	0.03	0.00	0.00	0.00	0.00	0.00	0.00	0.00	0.00	0.00	0.00	0.00	0.00	0.00	0.00
30	3.05	0.79	1.41	0.12	0.85	0.04	0.00	0.00	0.00	0.00	0.00	0.00	0.00	0.00	0.00	0.00	0.00	0.00	0.00	0.00
35	3.56	1.05	1.64	0.16	0.99	0.05	0.00	0.00	0.00	0.00	0.00	0.00	0.00	0.00	0.00	0.00	0.00	0.00	0.00	0.00
40	4.07	1.35	1.88	0.20	1.13	0.06	0.00	0.00	0.00	0.00	0.00	0.00	0.00	0.00	0.00	0.00	0.00	0.00	0.00	0.00
45	4.58	1.67	2.11	0.25	1.28	0.07	0.00	0.00	0.00	0.00	0.00	0.00	0.00	0.00	0.00	0.00	0.00	0.00	0.00	0.00
50	5.09	2.04	2.34	0.31	1.42	0.09	0.00	0.00	0.00	0.00	0.00	0.00	0.00	0.00	0.00	0.00	0.00	0.00	0.00	0.00
55	5.60	2.43	2.58	0.37	1.56	0.11	0.00	0.00	0.00	0.00	0.00	0.00	0.00	0.00	0.00	0.00	0.00	0.00	0.00	0.00
60	6.11	2.85	2.81	0.43	1.70	0.13	0.00	0.00	0.00	0.00	0.00	0.00	0.00	0.00	0.00	0.00	0.00	0.00	0.00	0.00
65	6.62	3.31	3.05	0.50	1.84	0.15	0.00	0.00	0.00	0.00	0.00	0.00	0.00	0.00	0.00	0.00	0.00	0.00	0.00	0.00
70	7.13	3.80	3.28	0.58	1.99	0.17	0.00	0.00	0.00	0.00	0.00	0.00	0.00	0.00	0.00	0.00	0.00	0.00	0.00	0.00
75	7.63	4.31	3.52	0.65	2.13	0.19	0.00	0.00	0.00	0.00	0.00	0.00	0.00	0.00	0.00	0.00	0.00	0.00	0.00	0.00
80	8.14	4.86	3.75	0.74	2.27	0.22	0.00	0.00	0.00	0.00	0.00	0.00	0.00	0.00	0.00	0.00	0.00	0.00	0.00	0.00
85	8.65	5.44	3.99	0.82	2.41	0.24	0.00	0.00	0.00	0.00	0.00	0.00	0.00	0.00	0.00	0.00	0.00	0.00	0.00	0.00
90	9.16	6.04	4.22	0.92	2.55	0.27	0.00	0.00	0.00	0.00	0.00	0.00	0.00	0.00	0.00	0.00	0.00	0.00	0.00	0.00
100			4.69	1.11	2.84	0.33	1.31	0.05	0.77	0.01	0.50	0.00	0.35	0.00	0.00	0.00	0.00	0.00	0.00	0.00
110			5.16	1.33	3.12	0.39	1.44	0.06	0.85	0.02	0.55	0.01	0.39	0.00	0.00	0.00	0.00	0.00	0.00	0.00
120			5.63	1.56	3.40	0.46	1.57	0.07	0.93	0.02	0.60	0.01	0.42	0.00	0.00	0.00	0.00	0.00	0.00	0.00
130			6.09	1.81	3.69	0.53	1.70	0.08	1.00	0.02	0.65	0.01	0.46	0.00	0.00	0.00	0.00	0.00	0.00	0.00
140			6.56	2.08	3.97	0.61	1.83	0.09	1.08	0.03	0.70	0.01	0.49	0.00	0.00	0.00	0.00	0.00	0.00	0.00
150			7.03	2.36	4.25	0.69	1.96	0.11	1.16	0.03	0.75	0.01	0.53	0.00	0.00	0.00	0.00	0.00	0.00	0.00
160			7.50	2.66	4.54	0.78	2.09	0.12	1.23	0.03	0.79	0.01	0.57	0.00	0.00	0.00	0.00	0.00	0.00	0.00
170			7.97	2.98	4.82	0.88	2.22	0.13	1.31	0.04	0.84	0.01	0.60	0.01	0.00	0.00	0.00	0.00	0.00	0.00
180			8.44	3.31	5.10	0.97	2.35	0.15	1.39	0.04	0.89	0.01	0.64	0.01	0.00	0.00	0.00	0.00	0.00	0.00
190			8.91	3.66	5.39	1.08	2.49	0.16	1.47	0.05	0.94	0.02	0.67	0.01	0.00	0.00	0.00	0.00	0.00	0.00
200			9.38	4.02	5.67	1.18	2.62	0.18	1.54	0.05	0.99	0.02	0.71	0.01	0.00	0.00	0.00	0.00	0.00	0.00
225			10.55	5.00	6.38	1.47	2.94	0.22	1.74	0.06	1.12	0.02	0.79	0.01	0.00	0.00	0.00	0.00	0.00	0.00
250			11.72	6.08	7.09	1.79	3.27	0.27	1.93	0.08	1.24	0.03	0.88	0.01	0.00	0.00	0.00	0.00	0.00	0.00
275			12.89	7.25	7.80	2.13	3.60	0.32	2.12	0.09	1.37	0.03	0.97	0.01	0.00	0.00	0.00	0.00	0.00	0.00
300			14.06	8.52	8.51	2.51	3.92	0.38	2.32	0.11	1.49	0.04	1.06	0.02	0.00	0.00	0.00	0.00	0.00	0.00

■ Use caution at shaded velocities.

Continued on next page →

← Continued from previous page

PE 4710 IPS HDPE DR 13.5 (161 psi) Pipe

VELOCITY IN FEET PER SECOND — FRICTION LOSS IN PSI PER 100 FEET (C = 150)																				
Nominal Size (ID) Flow (gpm)	2" (2.002)		3" (2.950)		4" (3.793)		6" (5.585)		8" (7.271)		10" (9.062)		12" (10.748)		14" (11.801)		16" (13.487)		18" (15.173)	
	Vel	Loss	Vel	Loss	Vel	Loss	Vel	Loss	Vel	Loss	Vel	Loss	Vel	Loss	Vel	Loss	Vel	Loss	Vel	Loss
325			15.24	9.88	9.22	2.91	4.25	0.44	2.51	0.12	1.61	0.04	1.15	0.02	0.00	0.00	0.00	0.00	0.00	0.00
350			16.41	11.34	9.93	3.34	4.58	0.51	2.70	0.14	1.74	0.05	1.24	0.02	0.00	0.00	0.00	0.00	0.00	0.00
375				12.88	10.63	3.79	4.91	0.58	2.89	0.16	1.86	0.05	1.32	0.02	0.00	0.00	0.00	0.00	0.00	0.00
400				14.52	11.34	4.27	5.23	0.65	3.09	0.18	1.99	0.06	1.41	0.03	0.00	0.00	0.00	0.00	0.00	0.00
425				16.24	12.05	4.78	5.56	0.73	3.28	0.20	2.11	0.07	1.50	0.03	0.00	0.00	0.00	0.00	0.00	0.00
450				18.06	12.76	5.31	5.89	0.81	3.47	0.22	2.24	0.08	1.59	0.03	0.00	0.00	0.00	0.00	0.00	0.00
475				19.96	13.47	5.87	6.21	0.89	3.67	0.25	2.36	0.08	1.68	0.04	0.00	0.00	0.00	0.00	0.00	0.00
500					14.18	6.46	6.54	0.98	3.86	0.27	2.48	0.09	1.77	0.04	0.00	0.00	0.00	0.00	0.00	0.00
550					15.60	7.71	7.19	1.17	4.24	0.32	2.73	0.11	1.94	0.05	0.00	0.00	0.00	0.00	0.00	0.00
600					17.02	9.05	7.85	1.38	4.63	0.38	2.98	0.13	2.12	0.06	0.00	0.00	0.00	0.00	0.00	0.00
650					18.43	10.50	8.50	1.60	5.02	0.44	3.23	0.15	2.30	0.07	0.00	0.00	0.00	0.00	0.00	0.00
700					19.85	12.05	9.16	1.83	5.40	0.51	3.48	0.17	2.47	0.08	0.00	0.00	0.00	0.00	0.00	0.00
750					21.27	13.69	9.81	2.08	5.79	0.58	3.73	0.20	2.65	0.09	0.00	0.00	0.00	0.00	0.00	0.00
800									6.17	0.65	3.97	0.22	2.83	0.10	2.34	0.06	1.79	0.03	1.42	0.02
850									6.56	0.73	4.22	0.25	3.00	0.11	2.49	0.07	1.91	0.04	1.51	0.02
900									6.95	0.81	4.47	0.28	3.18	0.12	2.64	0.08	2.02	0.04	1.59	0.02
950									7.33	0.89	4.72	0.31	3.36	0.13	2.78	0.08	2.13	0.04	1.68	0.02
1000									7.72	0.98	4.97	0.34	3.53	0.15	2.93	0.09	2.24	0.05	1.77	0.03
1050									8.10	1.08	5.22	0.37	3.71	0.16	3.08	0.10	2.36	0.05	1.86	0.03
1100									8.49	1.17	5.47	0.40	3.89	0.18	3.22	0.11	2.47	0.06	1.95	0.03
1150									8.88	1.27	5.71	0.44	4.06	0.19	3.37	0.12	2.58	0.06	2.04	0.04
1200									9.26	1.38	5.96	0.47	4.24	0.21	3.52	0.13	2.69	0.07	2.13	0.04
1250									9.65	1.49	6.21	0.51	4.41	0.22	3.66	0.14	2.80	0.07	2.22	0.04
1300									10.03	1.60	6.46	0.55	4.59	0.24	3.81	0.15	2.92	0.08	2.30	0.04
1350									10.42	1.71	6.71	0.59	4.77	0.26	3.96	0.16	3.03	0.08	2.39	0.05
1400									10.80	1.83	6.96	0.63	4.94	0.27	4.10	0.17	3.14	0.09	2.48	0.05
1450									11.19	1.96	7.20	0.67	5.12	0.29	4.25	0.19	3.25	0.10	2.57	0.05
1500									11.58	2.08	7.45	0.71	5.30	0.31	4.39	0.20	3.36	0.10	2.66	0.06
1550											7.70	0.76	5.47	0.33	4.54	0.21	3.48	0.11	2.75	0.06
1600											7.95	0.80	5.65	0.35	4.69	0.22	3.59	0.12	2.84	0.07
1650											8.20	0.85	5.83	0.37	4.83	0.24	3.70	0.12	2.92	0.07
1700											8.45	0.90	6.00	0.39	4.98	0.25	3.81	0.13	3.01	0.07
1750											8.69	0.95	6.18	0.41	5.13	0.26	3.93	0.14	3.10	0.08
1800											8.94	1.00	6.36	0.44	5.27	0.28	4.04	0.14	3.19	0.08
1900											9.44	1.11	6.71	0.48	5.57	0.31	4.26	0.16	3.37	0.09
2000											9.94	1.22	7.06	0.53	5.86	0.34	4.49	0.18	3.54	0.10
2100											10.43	1.33	7.42	0.58	6.15	0.37	4.71	0.19	3.72	0.11
2200											10.93	1.45	7.77	0.63	6.45	0.40	4.93	0.21	3.90	0.12
2300											11.43	1.57	8.12	0.69	6.74	0.44	5.16	0.23	4.08	0.13
2400											11.92	1.70	8.48	0.74	7.03	0.47	5.38	0.25	4.25	0.14
2500											12.42	1.84	8.83	0.80	7.32	0.51	5.61	0.27	4.43	0.15

■ Use caution at shaded velocities.



SDR 21 (Class 200) PVC Pipe

VELOCITY IN FEET PER SECOND — FRICTION LOSS IN PSI PER 100 FEET (C = 150)																						
Nominal Size (ID) Flow (gpm)	1" (1.189)		1¼" (1.502)		1½" (1.720)		2" (2.149)		2½" (2.601)		3" (3.166)		4" (4.072)		6" (5.993)		8" (7.805)		10" (9.728)		12" (11.538)	
	Vel	Loss	Vel	Loss	Vel	Loss	Vel	Loss	Vel	Loss	Vel	Loss	Vel	Loss	Vel	Loss	Vel	Loss	Vel	Loss	Vel	Loss
2	0.58	0.07	0.36	0.02	0.28	0.01	0.18	0.00	0.12	0.00	0.08	0.00	0.05	0.00	0.02	0.00	0.01	0.00	0.01	0.00	0.01	0.00
4	1.15	0.24	0.72	0.08	0.55	0.04	0.35	0.01	0.24	0.01	0.16	0.00	0.10	0.00	0.05	0.00	0.03	0.00	0.02	0.00	0.01	0.00
6	1.73	0.51	1.09	0.16	0.83	0.08	0.53	0.03	0.36	0.01	0.24	0.00	0.15	0.00	0.07	0.00	0.04	0.00	0.03	0.00	0.02	0.00
8	2.31	0.86	1.45	0.28	1.10	0.14	0.71	0.05	0.48	0.02	0.33	0.01	0.20	0.00	0.09	0.00	0.05	0.00	0.03	0.00	0.02	0.00
10	2.89	1.30	1.81	0.42	1.38	0.22	0.88	0.07	0.60	0.03	0.41	0.01	0.25	0.00	0.11	0.00	0.07	0.00	0.04	0.00	0.03	0.00
12	3.46	1.83	2.17	0.59	1.65	0.30	1.06	0.10	0.72	0.04	0.49	0.02	0.30	0.00	0.14	0.00	0.08	0.00	0.05	0.00	0.04	0.00
14	4.04	2.43	2.53	0.78	1.93	0.40	1.24	0.14	0.84	0.05	0.57	0.02	0.34	0.01	0.16	0.00	0.09	0.00	0.06	0.00	0.04	0.00
16	4.62	3.11	2.89	1.00	2.21	0.52	1.41	0.17	0.96	0.07	0.65	0.03	0.39	0.01	0.18	0.00	0.11	0.00	0.07	0.00	0.05	0.00
18	5.19	3.87	3.26	1.24	2.48	0.64	1.59	0.22	1.09	0.09	0.73	0.03	0.44	0.01	0.20	0.00	0.12	0.00	0.08	0.00	0.06	0.00
20	5.77	4.71	3.62	1.51	2.76	0.78	1.77	0.26	1.21	0.10	0.81	0.04	0.49	0.01	0.23	0.00	0.13	0.00	0.09	0.00	0.06	0.00
22	6.35	5.62	3.98	1.80	3.03	0.93	1.94	0.32	1.33	0.12	0.90	0.05	0.54	0.01	0.25	0.00	0.15	0.00	0.09	0.00	0.07	0.00
24	6.93	6.60	4.34	2.12	3.31	1.09	2.12	0.37	1.45	0.15	0.98	0.06	0.59	0.02	0.27	0.00	0.16	0.00	0.10	0.00	0.07	0.00
26	7.50	7.65	4.70	2.45	3.59	1.27	2.30	0.43	1.57	0.17	1.06	0.07	0.64	0.02	0.30	0.00	0.17	0.00	0.11	0.00	0.08	0.00
28	8.08	8.78	5.06	2.82	3.86	1.46	2.47	0.49	1.69	0.19	1.14	0.07	0.69	0.02	0.32	0.00	0.19	0.00	0.12	0.00	0.09	0.00
30	8.66	9.97	5.43	3.20	4.14	1.65	2.65	0.56	1.81	0.22	1.22	0.08	0.74	0.02	0.34	0.00	0.20	0.00	0.13	0.00	0.09	0.00
35	10.10	13.27	6.33	4.26	4.83	2.20	3.09	0.74	2.11	0.29	1.42	0.11	0.86	0.03	0.40	0.01	0.23	0.00	0.15	0.00	0.11	0.00
40	11.54	16.99	7.23	5.45	5.52	2.82	3.53	0.95	2.41	0.38	1.63	0.14	0.98	0.04	0.45	0.01	0.27	0.00	0.17	0.00	0.12	0.00
45			8.14	6.78	6.21	3.51	3.98	1.19	2.71	0.47	1.83	0.18	1.11	0.05	0.51	0.01	0.30	0.00	0.19	0.00	0.14	0.00
50			9.04	8.24	6.90	4.26	4.42	1.44	3.02	0.57	2.04	0.22	1.23	0.06	0.57	0.01	0.33	0.00	0.22	0.00	0.15	0.00
55			9.95	9.83	7.59	5.08	4.86	1.72	3.32	0.68	2.24	0.26	1.35	0.08	0.62	0.01	0.37	0.00	0.24	0.00	0.17	0.00
60			10.85	11.55	8.27	5.97	5.30	2.02	3.62	0.80	2.44	0.31	1.48	0.09	0.68	0.01	0.40	0.00	0.26	0.00	0.18	0.00
65			11.76	13.39	8.96	6.93	5.74	2.34	3.92	0.93	2.65	0.36	1.60	0.10	0.74	0.02	0.44	0.00	0.28	0.00	0.20	0.00
70					9.65	7.95	6.18	2.69	4.22	1.06	2.85	0.41	1.72	0.12	0.80	0.02	0.47	0.01	0.30	0.00	0.21	0.00
75					10.34	9.03	6.63	3.05	4.52	1.21	3.05	0.46	1.85	0.14	0.85	0.02	0.50	0.01	0.32	0.00	0.23	0.00
80					11.03	10.17	7.07	3.44	4.82	1.36	3.26	0.52	1.97	0.15	0.91	0.02	0.54	0.01	0.34	0.00	0.25	0.00
85					11.72	11.38	7.51	3.85	5.13	1.52	3.46	0.58	2.09	0.17	0.97	0.03	0.57	0.01	0.37	0.00	0.26	0.00
90							7.95	4.28	5.43	1.69	3.66	0.65	2.21	0.19	1.02	0.03	0.60	0.01	0.39	0.00	0.28	0.00
100							8.83	5.20	6.03	2.06	4.07	0.79	2.46	0.23	1.14	0.04	0.67	0.01	0.43	0.00	0.31	0.00
110							9.72	6.21	6.63	2.45	4.48	0.94	2.71	0.28	1.25	0.04	0.74	0.01	0.47	0.00	0.34	0.00
120							10.60	7.30	7.24	2.88	4.88	1.11	2.95	0.33	1.36	0.05	0.80	0.01	0.52	0.00	0.37	0.00
130									7.84	3.34	5.29	1.28	3.20	0.38	1.48	0.06	0.87	0.02	0.56	0.01	0.40	0.00
140									8.44	3.83	5.70	1.47	3.44	0.43	1.59	0.07	0.94	0.02	0.60	0.01	0.43	0.00
150									9.05	4.36	6.11	1.67	3.69	0.49	1.70	0.08	1.00	0.02	0.65	0.01	0.46	0.00
160									9.65	4.91	6.51	1.89	3.94	0.55	1.82	0.08	1.07	0.02	0.69	0.01	0.49	0.00
170									10.25	5.49	6.92	2.11	4.18	0.62	1.93	0.09	1.14	0.03	0.73	0.01	0.52	0.00
180											7.33	2.35	4.43	0.69	2.04	0.11	1.21	0.03	0.78	0.01	0.55	0.00
190											7.73	2.59	4.68	0.76	2.16	0.12	1.27	0.03	0.82	0.01	0.58	0.00
200											8.14	2.85	4.92	0.84	2.27	0.13	1.34	0.04	0.86	0.01	0.61	0.01
225											9.16	3.55	5.54	1.04	2.56	0.16	1.51	0.04	0.97	0.02	0.69	0.01
250											10.18	4.31	6.15	1.27	2.84	0.19	1.67	0.05	1.08	0.02	0.77	0.01
275													6.77	1.51	3.12	0.23	1.84	0.06	1.19	0.02	0.84	0.01
300													7.38	1.78	3.41	0.27	2.01	0.07	1.29	0.03	0.92	0.01

■ Use caution at shaded velocities.

Continued on next page →

APPENDIX

← Continued from previous page

SDR 21 (Class 200) PVC Pipe

VELOCITY IN FEET PER SECOND — FRICTION LOSS IN PSI PER 100 FEET (C = 150)																						
Nominal Size (ID) Flow (gpm)	1" (1.189)		1¼" (1.502)		1½" (1.720)		2" (2.149)		2½" (2.601)		3" (3.166)		4" (4.072)		6" (5.993)		8" (7.805)		10" (9.728)		12" (11.538)	
	Vel	Loss	Vel	Loss	Vel	Loss	Vel	Loss	Vel	Loss	Vel	Loss	Vel	Loss	Vel	Loss	Vel	Loss	Vel	Loss	Vel	Loss
325													8.00	2.06	3.69	0.31	2.18	0.09	1.40	0.03	1.00	0.01
350													8.61	2.36	3.98	0.36	2.34	0.10	1.51	0.03	1.07	0.01
375													9.23	2.68	4.26	0.41	2.51	0.11	1.62	0.04	1.15	0.02
400													9.84	3.03	4.54	0.46	2.68	0.13	1.72	0.04	1.23	0.02
425													10.46	3.38	4.83	0.52	2.85	0.14	1.83	0.05	1.30	0.02
450															5.11	0.57	3.01	0.16	1.94	0.05	1.38	0.02
475															5.40	0.63	3.18	0.18	2.05	0.06	1.46	0.03
500															5.68	0.70	3.35	0.19	2.16	0.07	1.53	0.03
550															6.25	0.83	3.68	0.23	2.37	0.08	1.69	0.03
600															6.82	0.98	4.02	0.27	2.59	0.09	1.84	0.04
650															7.38	1.13	4.35	0.31	2.80	0.11	1.99	0.05
700															7.95	1.30	4.69	0.36	3.02	0.12	2.15	0.05
750															8.52	1.48	5.02	0.41	3.23	0.14	2.30	0.06
800															9.09	1.67	5.36	0.46	3.45	0.16	2.45	0.07
850															9.66	1.86	5.69	0.52	3.66	0.18	2.61	0.08
900															10.22	2.07	6.03	0.57	3.88	0.20	2.76	0.09
950																	6.36	0.63	4.10	0.22	2.91	0.09
1000																	6.70	0.70	4.31	0.24	3.06	0.10
1050																	7.03	0.76	4.53	0.26	3.22	0.11
1100																	7.37	0.83	4.74	0.28	3.37	0.12
1150																	7.70	0.90	4.96	0.31	3.52	0.13
1200																	8.04	0.98	5.17	0.33	3.68	0.15
1250																	8.37	1.05	5.39	0.36	3.83	0.16
1300																	8.71	1.13	5.60	0.39	3.98	0.17
1350																	9.04	1.21	5.82	0.42	4.14	0.18
1400																	9.38	1.30	6.04	0.44	4.29	0.19
1450																	9.71	1.39	6.25	0.47	4.44	0.21
1500																	10.05	1.48	6.47	0.51	4.60	0.22
1550																			6.68	0.54	4.75	0.23
1600																			6.90	0.57	4.90	0.25
1650																			7.11	0.60	5.06	0.26
1700																			7.33	0.64	5.21	0.28
1750																			7.54	0.67	5.36	0.29
1800																			7.76	0.71	5.52	0.31
1900																			8.19	0.78	5.82	0.34
2000																			8.62	0.86	6.13	0.38
2100																			9.05	0.94	6.44	0.41
2200																			9.48	1.03	6.74	0.45
2300																			9.92	1.11	7.05	0.49
2400																			10.35	1.21	7.36	0.53
2500																			10.78	1.30	7.66	0.57

■ Use caution at shaded velocities.

## Integrated Control System™ (ICS) Wire Path Design

### Recommended to load balance wire path.

Do not utilize the full system capacity of 750 ICMs on one wire path. Instead, leave room to expand the system and add sensing capability in the future.

### The wire distance is the “trunk length” of the wire path.

The trunk length is the “longest single run of wire” needed for accommodating the installed ICMs.

### Branches can be added to the trunk wire.

Branches do not increase the maximum number of ICMs on the wire path.

### Wire Distance in Feet (ft)

No. of Units	1,000	2,000	3,000	4,000	5,000	6,000	7,000	8,000	9,000	10,000	11,000	12,000	13,000	14,000	15,000
50	14 AWG	14 AWG	14 AWG	14 AWG	14 AWG	14 AWG	14 AWG	14 AWG	14 AWG	14 AWG	14 AWG	14 AWG	14 AWG	14 AWG	14 AWG
100	14 AWG	14 AWG	14 AWG	14 AWG	14 AWG	14 AWG	14 AWG	14 AWG	14 AWG	14 AWG	14 AWG	14 AWG	14 AWG	14 AWG	14 AWG
150	14 AWG	14 AWG	14 AWG	14 AWG	14 AWG	14 AWG	14 AWG	14 AWG	14 AWG	14 AWG	14 AWG	14 AWG	14 AWG	14 AWG	14 AWG
200	14 AWG	14 AWG	14 AWG	14 AWG	14 AWG	14 AWG	14 AWG	14 AWG	14 AWG	14 AWG	14 AWG	14 AWG	14 AWG	14 AWG	14 AWG
250	14 AWG	14 AWG	14 AWG	14 AWG	14 AWG	14 AWG	14 AWG	14 AWG	14 AWG	14 AWG	14 AWG	14 AWG	14 AWG	14 AWG	12 AWG
300	14 AWG	14 AWG	14 AWG	14 AWG	14 AWG	14 AWG	14 AWG	14 AWG	14 AWG	14 AWG	14 AWG	12 AWG	12 AWG	12 AWG	12 AWG
350	14 AWG	14 AWG	14 AWG	14 AWG	14 AWG	14 AWG	14 AWG	14 AWG	14 AWG	14 AWG	12 AWG	12 AWG	12 AWG	12 AWG	12 AWG
400	14 AWG	14 AWG	14 AWG	14 AWG	14 AWG	14 AWG	14 AWG	14 AWG	12 AWG	12 AWG	12 AWG	12 AWG	12 AWG	12 AWG	12 AWG
450	14 AWG	14 AWG	14 AWG	14 AWG	14 AWG	14 AWG	14 AWG	12 AWG	12 AWG	12 AWG	12 AWG	12 AWG	12 AWG	12 AWG	12 AWG
500	14 AWG	14 AWG	14 AWG	14 AWG	14 AWG	14 AWG	14 AWG	12 AWG	12 AWG	12 AWG	12 AWG	12 AWG	12 AWG	12 AWG	10 AWG
550	14 AWG	14 AWG	14 AWG	14 AWG	14 AWG	14 AWG	12 AWG	12 AWG	12 AWG	12 AWG	12 AWG	12 AWG	10 AWG	10 AWG	10 AWG
600	14 AWG	14 AWG	14 AWG	14 AWG	14 AWG	12 AWG	12 AWG	12 AWG	12 AWG	12 AWG	12 AWG	10 AWG	10 AWG	10 AWG	10 AWG
650	14 AWG	14 AWG	14 AWG	14 AWG	14 AWG	12 AWG	12 AWG	12 AWG	12 AWG	12 AWG	10 AWG	10 AWG	10 AWG	—	—
700	14 AWG	14 AWG	14 AWG	14 AWG	14 AWG	12 AWG	12 AWG	12 AWG	12 AWG	10 AWG	10 AWG	10 AWG	—	—	—
750	14 AWG	14 AWG	14 AWG	14 AWG	12 AWG	12 AWG	12 AWG	12 AWG	10 AWG	10 AWG	10 AWG	10 AWG	—	—	—

### Wire Distance in Meters (m)

No. of Units	1,000	1,250	1,500	1,750	2,000	2,250	2,500	2,750	3,000	3,250	3,500	3,750	4,000	4,250	4,500
50	2.5 mm <sup>2</sup>	2.5 mm <sup>2</sup>	2.5 mm <sup>2</sup>	2.5 mm <sup>2</sup>	2.5 mm <sup>2</sup>	2.5 mm <sup>2</sup>	2.5 mm <sup>2</sup>	2.5 mm <sup>2</sup>	2.5 mm <sup>2</sup>	2.5 mm <sup>2</sup>	2.5 mm <sup>2</sup>	2.5 mm <sup>2</sup>	2.5 mm <sup>2</sup>	2.5 mm <sup>2</sup>	2.5 mm <sup>2</sup>
100	2.5 mm <sup>2</sup>	2.5 mm <sup>2</sup>	2.5 mm <sup>2</sup>	2.5 mm <sup>2</sup>	2.5 mm <sup>2</sup>	2.5 mm <sup>2</sup>	2.5 mm <sup>2</sup>	2.5 mm <sup>2</sup>	2.5 mm <sup>2</sup>	2.5 mm <sup>2</sup>	2.5 mm <sup>2</sup>	2.5 mm <sup>2</sup>	2.5 mm <sup>2</sup>	2.5 mm <sup>2</sup>	2.5 mm <sup>2</sup>
150	2.5 mm <sup>2</sup>	2.5 mm <sup>2</sup>	2.5 mm <sup>2</sup>	2.5 mm <sup>2</sup>	2.5 mm <sup>2</sup>	2.5 mm <sup>2</sup>	2.5 mm <sup>2</sup>	2.5 mm <sup>2</sup>	2.5 mm <sup>2</sup>	2.5 mm <sup>2</sup>	2.5 mm <sup>2</sup>	2.5 mm <sup>2</sup>	2.5 mm <sup>2</sup>	2.5 mm <sup>2</sup>	2.5 mm <sup>2</sup>
200	2.5 mm <sup>2</sup>	2.5 mm <sup>2</sup>	2.5 mm <sup>2</sup>	2.5 mm <sup>2</sup>	2.5 mm <sup>2</sup>	2.5 mm <sup>2</sup>	2.5 mm <sup>2</sup>	2.5 mm <sup>2</sup>	2.5 mm <sup>2</sup>	2.5 mm <sup>2</sup>	2.5 mm <sup>2</sup>	2.5 mm <sup>2</sup>	2.5 mm <sup>2</sup>	2.5 mm <sup>2</sup>	2.5 mm <sup>2</sup>
250	2.5 mm <sup>2</sup>	2.5 mm <sup>2</sup>	2.5 mm <sup>2</sup>	2.5 mm <sup>2</sup>	2.5 mm <sup>2</sup>	2.5 mm <sup>2</sup>	2.5 mm <sup>2</sup>	2.5 mm <sup>2</sup>	2.5 mm <sup>2</sup>	2.5 mm <sup>2</sup>	2.5 mm <sup>2</sup>	2.5 mm <sup>2</sup>	2.5 mm <sup>2</sup>	2.5 mm <sup>2</sup>	2.5 mm <sup>2</sup>
300	2.5 mm <sup>2</sup>	2.5 mm <sup>2</sup>	2.5 mm <sup>2</sup>	2.5 mm <sup>2</sup>	2.5 mm <sup>2</sup>	2.5 mm <sup>2</sup>	2.5 mm <sup>2</sup>	2.5 mm <sup>2</sup>	2.5 mm <sup>2</sup>	2.5 mm <sup>2</sup>	2.5 mm <sup>2</sup>	2.5 mm <sup>2</sup>	2.5 mm <sup>2</sup>	4.0 mm <sup>2</sup>	4.0 mm <sup>2</sup>
350	2.5 mm <sup>2</sup>	2.5 mm <sup>2</sup>	2.5 mm <sup>2</sup>	2.5 mm <sup>2</sup>	2.5 mm <sup>2</sup>	2.5 mm <sup>2</sup>	2.5 mm <sup>2</sup>	2.5 mm <sup>2</sup>	2.5 mm <sup>2</sup>	2.5 mm <sup>2</sup>	2.5 mm <sup>2</sup>	4.0 mm <sup>2</sup>	4.0 mm <sup>2</sup>	4.0 mm <sup>2</sup>	4.0 mm <sup>2</sup>
400	2.5 mm <sup>2</sup>	2.5 mm <sup>2</sup>	2.5 mm <sup>2</sup>	2.5 mm <sup>2</sup>	2.5 mm <sup>2</sup>	2.5 mm <sup>2</sup>	2.5 mm <sup>2</sup>	2.5 mm <sup>2</sup>	2.5 mm <sup>2</sup>	4.0 mm <sup>2</sup>	4.0 mm <sup>2</sup>	4.0 mm <sup>2</sup>	4.0 mm <sup>2</sup>	4.0 mm <sup>2</sup>	4.0 mm <sup>2</sup>
450	2.5 mm <sup>2</sup>	2.5 mm <sup>2</sup>	2.5 mm <sup>2</sup>	2.5 mm <sup>2</sup>	2.5 mm <sup>2</sup>	2.5 mm <sup>2</sup>	2.5 mm <sup>2</sup>	2.5 mm <sup>2</sup>	4.0 mm <sup>2</sup>	4.0 mm <sup>2</sup>	4.0 mm <sup>2</sup>	4.0 mm <sup>2</sup>	4.0 mm <sup>2</sup>	4.0 mm <sup>2</sup>	4.0 mm <sup>2</sup>
500	2.5 mm <sup>2</sup>	2.5 mm <sup>2</sup>	2.5 mm <sup>2</sup>	2.5 mm <sup>2</sup>	2.5 mm <sup>2</sup>	2.5 mm <sup>2</sup>	4.0 mm <sup>2</sup>	4.0 mm <sup>2</sup>	4.0 mm <sup>2</sup>	4.0 mm <sup>2</sup>	4.0 mm <sup>2</sup>	4.0 mm <sup>2</sup>	4.0 mm <sup>2</sup>	4.0 mm <sup>2</sup>	4.0 mm <sup>2</sup>
550	2.5 mm <sup>2</sup>	2.5 mm <sup>2</sup>	2.5 mm <sup>2</sup>	2.5 mm <sup>2</sup>	2.5 mm <sup>2</sup>	2.5 mm <sup>2</sup>	4.0 mm <sup>2</sup>	4.0 mm <sup>2</sup>	4.0 mm <sup>2</sup>	4.0 mm <sup>2</sup>	4.0 mm <sup>2</sup>	4.0 mm <sup>2</sup>	4.0 mm <sup>2</sup>	4.0 mm <sup>2</sup>	6.0 mm <sup>2</sup>
600	2.5 mm <sup>2</sup>	2.5 mm <sup>2</sup>	2.5 mm <sup>2</sup>	2.5 mm <sup>2</sup>	2.5 mm <sup>2</sup>	4.0 mm <sup>2</sup>	4.0 mm <sup>2</sup>	4.0 mm <sup>2</sup>	4.0 mm <sup>2</sup>	4.0 mm <sup>2</sup>	4.0 mm <sup>2</sup>	4.0 mm <sup>2</sup>	4.0 mm <sup>2</sup>	6.0 mm <sup>2</sup>	6.0 mm <sup>2</sup>
650	2.5 mm <sup>2</sup>	2.5 mm <sup>2</sup>	2.5 mm <sup>2</sup>	2.5 mm <sup>2</sup>	4.0 mm <sup>2</sup>	4.0 mm <sup>2</sup>	4.0 mm <sup>2</sup>	4.0 mm <sup>2</sup>	4.0 mm <sup>2</sup>	4.0 mm <sup>2</sup>	4.0 mm <sup>2</sup>	6.0 mm <sup>2</sup>	6.0 mm <sup>2</sup>	6.0 mm <sup>2</sup>	6.0 mm <sup>2</sup>
700	2.5 mm <sup>2</sup>	2.5 mm <sup>2</sup>	2.5 mm <sup>2</sup>	2.5 mm <sup>2</sup>	4.0 mm <sup>2</sup>	4.0 mm <sup>2</sup>	4.0 mm <sup>2</sup>	4.0 mm <sup>2</sup>	4.0 mm <sup>2</sup>	4.0 mm <sup>2</sup>	6.0 mm <sup>2</sup>	6.0 mm <sup>2</sup>	6.0 mm <sup>2</sup>	6.0 mm <sup>2</sup>	—
750	2.5 mm <sup>2</sup>	2.5 mm <sup>2</sup>	2.5 mm <sup>2</sup>	2.5 mm <sup>2</sup>	4.0 mm <sup>2</sup>	4.0 mm <sup>2</sup>	4.0 mm <sup>2</sup>	4.0 mm <sup>2</sup>	4.0 mm <sup>2</sup>	6.0 mm <sup>2</sup>	6.0 mm <sup>2</sup>	6.0 mm <sup>2</sup>	6.0 mm <sup>2</sup>	—	—



Water Velocity

Flow gpm	Internal Pipe Diameter																							
	2"	4"	6"	8"	10"	12"	14"	16"	18"	20"	22"	24"	26"	28"	30"	32"	34"	36"	38"	40"	42"	44"	46"	48"
10	1.0	0.3	0.1	0.1	—	—	—	—	—	—	—	—	—	—	—	—	—	—	—	—	—	—	—	—
20	2.0	0.5	0.2	0.1	0.1	0.1	—	—	—	—	—	—	—	—	—	—	—	—	—	—	—	—	—	—
30	3.1	0.8	0.3	0.2	0.1	0.1	0.1	—	—	—	—	—	—	—	—	—	—	—	—	—	—	—	—	—
40	4.1	1.0	0.5	0.3	0.2	0.1	0.1	0.1	0.1	—	—	—	—	—	—	—	—	—	—	—	—	—	—	—
50	5.1	1.3	0.6	0.3	0.2	0.1	0.1	0.1	0.1	0.1	—	—	—	—	—	—	—	—	—	—	—	—	—	—
60	6.1	1.5	0.7	0.4	0.2	0.2	0.1	0.1	0.1	0.1	0.1	—	—	—	—	—	—	—	—	—	—	—	—	—
70	7.2	1.8	0.8	0.4	0.3	0.2	0.1	0.1	0.1	0.1	0.1	—	—	—	—	—	—	—	—	—	—	—	—	—
80	8.2	2.0	0.9	0.5	0.3	0.2	0.2	0.1	0.1	0.1	0.1	0.1	—	—	—	—	—	—	—	—	—	—	—	—
90	9.2	2.3	1.0	0.6	0.4	0.3	0.2	0.1	0.1	0.1	0.1	0.1	0.1	—	—	—	—	—	—	—	—	—	—	—
100	10.2	2.6	1.1	0.6	0.4	0.3	0.2	0.2	0.1	0.1	0.1	0.1	0.1	0.1	—	—	—	—	—	—	—	—	—	—
150	15.3	3.8	1.7	1.0	0.6	0.4	0.3	0.2	0.2	0.2	0.1	0.1	0.1	0.1	0.1	0.1	—	—	—	—	—	—	—	—
200	20.4	5.1	2.3	1.3	0.8	0.6	0.4	0.3	0.3	0.2	0.2	0.1	0.1	0.1	0.1	0.1	0.1	0.1	0.1	0.1	—	—	—	—
250	25.5	6.4	2.8	1.6	1.0	0.7	0.5	0.4	0.3	0.3	0.2	0.2	0.2	0.1	0.1	0.1	0.1	0.1	0.1	0.1	0.1	0.1	—	—
300	30.7	7.7	3.4	1.9	1.2	0.9	0.6	0.5	0.4	0.3	0.3	0.2	0.2	0.2	0.1	0.1	0.1	0.1	0.1	0.1	0.1	0.1	0.1	0.1
350	35.8	8.9	4.0	2.2	1.4	1.0	0.7	0.6	0.4	0.4	0.3	0.2	0.2	0.2	0.2	0.1	0.1	0.1	0.1	0.1	0.1	0.1	0.1	0.1
400	40.9	10.2	4.5	2.6	1.6	1.1	0.8	0.6	0.5	0.4	0.3	0.3	0.2	0.2	0.2	0.2	0.1	0.1	0.1	0.1	0.1	0.1	0.1	0.1
450	46.0	11.5	5.1	2.9	1.8	1.3	0.9	0.7	0.6	0.5	0.4	0.3	0.3	0.2	0.2	0.2	0.2	0.1	0.1	0.1	0.1	0.1	0.1	0.1
500	51.1	12.8	5.7	3.2	2.0	1.4	1.0	0.8	0.6	0.5	0.4	0.4	0.3	0.3	0.2	0.2	0.2	0.2	0.1	0.1	0.1	0.1	0.1	0.1
600	61.3	15.3	6.8	3.8	2.5	1.7	1.3	1.0	0.8	0.6	0.5	0.4	0.4	0.3	0.3	0.2	0.2	0.2	0.2	0.2	0.1	0.1	0.1	0.1
700	71.5	17.9	7.9	4.5	2.9	2.0	1.5	1.1	0.9	0.7	0.6	0.5	0.4	0.4	0.3	0.3	0.2	0.2	0.2	0.2	0.2	0.1	0.1	0.1
800	81.7	20.4	9.1	5.1	3.3	2.3	1.7	1.3	1.0	0.8	0.7	0.6	0.5	0.4	0.4	0.3	0.3	0.3	0.2	0.2	0.2	0.2	0.2	0.1
900	92.0	23.0	10.2	5.7	3.7	2.6	1.9	1.4	1.1	0.9	0.8	0.6	0.5	0.5	0.4	0.4	0.3	0.3	0.3	0.2	0.2	0.2	0.2	0.2
1000	102.2	25.5	11.4	6.4	4.1	2.8	2.1	1.6	1.3	1.0	0.8	0.7	0.6	0.5	0.5	0.4	0.4	0.3	0.3	0.3	0.2	0.2	0.2	0.2
1250	127.7	31.9	14.2	8.0	5.1	3.5	2.6	2.0	1.6	1.3	1.1	0.9	0.8	0.7	0.6	0.5	0.4	0.4	0.4	0.3	0.3	0.3	0.2	0.2
1500	153.3	38.3	17.0	9.6	6.1	4.3	3.1	2.4	1.9	1.5	1.3	1.1	0.9	0.8	0.7	0.6	0.5	0.5	0.4	0.4	0.3	0.3	0.3	0.3
1750	178.8	44.7	19.9	11.2	7.2	5.0	3.6	2.8	2.2	1.8	1.5	1.2	1.1	0.9	0.8	0.7	0.6	0.6	0.5	0.4	0.4	0.4	0.3	0.3
2000	204.4	51.1	22.7	12.8	8.2	5.7	4.2	3.2	2.5	2.0	1.7	1.4	1.2	1.0	0.9	0.8	0.7	0.6	0.6	0.5	0.5	0.4	0.4	0.4
2500	255.4	63.9	28.4	16.0	10.2	7.1	5.2	4.0	3.2	2.6	2.1	1.8	1.5	1.3	1.1	1.0	0.9	0.8	0.7	0.6	0.6	0.5	0.5	0.4
3000	306.5	76.6	34.1	19.2	12.3	8.5	6.3	4.8	3.8	3.1	2.5	2.1	1.8	1.6	1.4	1.2	1.1	0.9	0.8	0.8	0.7	0.6	0.6	0.5
3500	357.6	89.4	39.7	22.4	14.3	9.9	7.3	5.6	4.4	3.6	3.0	2.5	2.1	1.8	1.6	1.4	1.2	1.1	1.0	0.9	0.8	0.7	0.7	0.6
4000	408.7	102.2	45.4	25.5	16.3	11.4	8.3	6.4	5.0	4.1	3.4	2.8	2.4	2.1	1.8	1.6	1.4	1.3	1.1	1.0	0.9	0.8	0.8	0.7
4500	459.8	114.9	51.1	28.7	18.4	12.8	9.4	7.2	5.7	4.6	3.8	3.2	2.7	2.3	2.0	1.8	1.6	1.4	1.3	1.1	1.0	0.9	0.9	0.8
5000	510.9	127.7	56.8	31.9	20.4	14.2	10.4	8.0	6.3	5.1	4.2	3.5	3.0	2.6	2.3	2.0	1.8	1.6	1.4	1.3	1.2	1.1	1.0	0.9
5500	562.0	140.5	62.4	35.1	22.5	15.6	11.5	8.8	6.9	5.6	4.6	3.9	3.3	2.9	2.5	2.2	1.9	1.7	1.6	1.4	1.3	1.2	1.1	1.0
6000	613.1	153.3	68.1	38.3	24.5	17.0	12.5	9.6	7.6	6.1	5.1	4.3	3.6	3.1	2.7	2.4	2.1	1.9	1.7	1.5	1.4	1.3	1.2	1.1

Main line pipe diameter under standard practice is sized to achieve < 5 feet-per-second water velocity. Wet-well intake pipe diameter under standard practice is sized to achieve < 1.5 feet-per-second water velocity. Velocities listed are based on the actual internal diameter for the pipe. Verify internal diameter based on class or type of pipe being used.

### Controller Power Wiring Sizing Worksheet

	PAR+ES	PAR+ES Link with Radio	PAR+ES SAT Decoder**	PAR+ES SAT Decoder Link with Radio**
Input (VAC)	117	117	117	117
Output (VAC)	26.5	26.5	26.5	26.5
Simultaneous Rain Bird Solenoids at 60 Hz (50 Hz) per Controller†	16 (12)	16 (12)	16 (12)	16 (12)
Simultaneous Rain Bird Solenoids at 60 Hz (50 Hz) per Station	4	4	2	2
AMP Draw at Rest‡	0.15	0.17	0.235	0.250
1	0.22	0.24	0.250	0.265
2	0.30	0.32	0.258	0.273
3	0.37	0.40	0.264	0.281
4	0.45	0.47	0.272	0.289
5	0.52	0.54	0.280	0.297
6	0.60	0.62	0.288	0.305
7	0.67	0.70	0.296	0.313
8	0.75	0.77	0.304	0.321
9	0.82	0.84	0.312	0.329
10	0.90	0.92	0.320	0.337
11	0.97	0.99	0.328	0.345
12	1.05	1.07	0.336	0.353
13	1.12	1.14	0.344	0.361
14	1.20	1.22	0.352	0.369
15	1.27	1.29	0.360	0.377
16	1.35	1.37	0.368	0.385

\*Includes Master Valve. \*\*Considering 72 decoders installed. † Total AMP Draw in chart is based on 117 VAC input. For 220/240 VAC input controllers, use 50% of amp draw shown in chart.





Rain Bird will repair or replace at no charge any Rain Bird professional product that fails in normal use within the warranty period stated below. You must return it to the dealer or distributor where you bought it. Product failures due to acts of God including without limitation, lightning and flooding, are not covered by this warranty. This commitment to repair or replace is our sole and total warranty.

**Implied Warranties of Merchantability and Fitness, if Applicable, are Limited to One Year from the Date of Sale. We will not, under any circumstances be liable for incidental or consequential damages, no matter how they occur.**

## I. Landscape Irrigation Products

1800® Series Pop-Up Spray Heads, U-Series Nozzles, Brass MPR Nozzles, A-8S and PA-8S-PRS Shrub Adapters, and 1300 and 1400 Bubblers, 5000 Series Rotors, 5500 Series Rotors, 7005/8005 Rotors, Falcon® 6504 Series Rotors, PEB and PESB Plastic Valves – **5 Years**

All other Landscape Irrigation products – **3 years**

## II. Golf Products

Rain Bird Golf Rotors – **3 years**, extended to **5 years** if installed in conjunction with Rain Bird Swing Joints. Proof of concurrent installation is required.

Swing Joints – **5 years**

Brass Remote Control Valves, Valve Boxes and Brass Quick Coupling and Keys – **3 years**

Filtration system controllers – **3 years**

LINK™ Radios – **3 years**

Golf Controllers and Satellites – **1 year**

All other golf products – **1 year**

## III. Agricultural Products

LF Series Sprinklers – **5 years**

Other Impact Sprinklers – **2 years**

All other AG products – **1 year**

## IV. Pump Stations

Rain Bird guarantees that its pump station will be free of manufacturer defects for three years from the date of start-up but not beyond forty months from the date of purchase by the original customer with a copy of the seller's invoice required for coverage under this Policy. Start-up or service by anyone other than a Rain Bird authorized representative, when required, will void these terms and conditions.

Provided that all installation, start-up, operation responsibilities, and recommended maintenance procedures have been properly executed and performed by authorized Rain Bird representatives, when required, Rain Bird will replace or repair, at Rain Bird's option, any Rain Bird part found to be defective under normal recommended use during the effective period of this Policy, such evaluation to be solely determined by Rain Bird. Rain Bird's only obligation and customer's exclusive remedy under this Policy is limited to repair or replacement, at Rain Bird's option, of the parts or the products the defects of which are reported to Rain Bird within the applicable Policy period, which prove to be defective and such evaluation will be solely determined by Rain Bird.

In no case will Rain Bird cover labor costs associated with repair or replacement of parts beyond one year from date of start-up. Repairs performed and parts used at Rain Bird's expense must be authorized by Rain Bird, in writing, prior to repairs being performed. Product repairs or replacement under this Policy will not extend this Policy. Coverage for repaired or replaced product shall end when this Policy terminates. Rain Bird's sole obligation and customer's exclusive remedy under this Policy shall be limited to such repair or replacement.

Upon request, Rain Bird may provide advice on trouble-shooting a defect during the effective period of this Customer Satisfaction Policy. Repair service must be performed by a Rain Bird authorized representative regardless of whether the labor is covered by Rain Bird or is at the owner's expense during the effective period of this Policy. However, no service, replacement or repair under this Customer Satisfaction Policy will be rendered while the customer is in default of any payments due to Rain Bird.

Rain Bird will not accept responsibility for costs associated with the removal, replacement or repair of equipment in difficult-to-access locations and such evaluation will be solely determined by

Rain Bird. Difficult-to-access locations include (but are not limited to) locations where any of the following are required:

- |                               |  |
|-------------------------------|--|
| 1) Cranes larger than 15 tons | 5) Dredging  |
| 2) Divers                     | 6) Roof removal or other such construction/deconstruction requirements |
| 3) Barges                     | 7) Any other unusual means or requirements                             |
| 4) Helicopters                |  |

Such extraordinary cost associated with difficult-to-access locations shall be the sole responsibility of the customer, regardless of the reason requiring removal, repair or replacement of the equipment.

The terms and conditions of this Customer Satisfaction Policy do not cover damage, loss or injury caused by or resulting from the following:

- |   |   |
|---|---|
| 1) Misapplication, abuse, or failure to conduct routine maintenance (to include winterization/winter lay-up procedures).  | 9) Non-WYE configured power supplies such as open delta, phase converters or other forms of unbalanced three phase power supplies.  |
| 2) Pumping of liquids other than fresh water as defined by the U.S. Environmental Protection Agency, unless the pump station quoted by Rain Bird specifically lists these other liquids and their concentrations. | 10) Improper electrical grounding or exposure to incoming power lacking circuit breaker or fused protection.  |
| 3) Use of pesticides (to include insecticides, fungicides and herbicides), free chlorine or other strong biocides.  | 11) Using the control panel as a service disconnect.  |
| 4) Exposure to electrolysis, erosion, or abrasion.  | 12) Lightning, earthquake, flood, windstorm or other Acts of Nature.  |
| 5) Use or presence of destructive gases or chemicals unless these materials and their concentrations are specified in the Rain Bird quotation.  | 13) Failure of pump packing seal (unless the failure occurs on initial start-up).   |
| 6) Electrical supply voltages above or below those specified for correct pump station operation.  | 14) Any damage or loss to plants, equipment or groundwater or injury to people caused by the failure of or improper use of an injection system or improper concentration of chemicals or plant nutrients introduced into the pump station by an injection system. |
| 7) Electrical phase loss or reversal.   | 15) Any failure of nutrient or chemical storage or spill containment equipment or facilities associated with the pump station location.   |
| 8) Use of a power source other than that specified in the original quotation.   |   |

The foregoing terms and conditions constitute Rain Bird's entire pump station customer satisfaction policy. This policy is exclusive and in lieu of any other warranties whatsoever, whether express, implied, or statutory including the implied warranties of merchantability and fitness for a particular purpose, which are all hereby expressly disclaimed. The sole remedy under this policy shall be limited to the repair or replacement of the pump station or its components pursuant to the terms and conditions contained herein. In the case of any components or injection systems manufactured by others (as noted on the pump station quotation), there is no warranty provided by Rain Bird and these items are covered solely by and to the extent of the warranty if any, offered by those other manufacturers.

Rain Bird shall not be liable to the customer or any other person or entity for any liability, loss, delay or damage caused or alleged to be caused, directly or indirectly, by any use, defect, failure or malfunction of the pump station or by any injection system whether a claim for such liability, loss, delay or damages is based upon warranty, contract, tort or otherwise. Rain Bird shall not be liable for incidental, consequential, collateral or indirect damages or delay or loss of profit or loss of use or any damages related to the customer's business operations, nor for those caused by acts of nature. In no case and under no circumstances shall Rain Bird's liability exceed the Rain Bird Corporation's net sale price of the pump station.

Laws concerning customer warranties and disclaimers vary from state to state, jurisdiction to jurisdiction, province to province or country to country and therefore some of the foregoing limitations may not apply to you. The exclusions and limitations set out above are not intended to, and should not be construed so as to contravene mandatory provisions of applicable law. If any part or term of this policy is held to be illegal, unenforceable or in conflict with applicable law by a court of competent jurisdiction, the validity of the remaining portions of this policy shall not be affected, and all rights and obligations shall be construed and enforced as if this policy did not contain the particular part or term held to be invalid.

## V. All other products – 1 year

18" Selector Valve Key .....	19	IC Module .....	31	Selector Service Tool/Key .....	19
1800 Series Spray Heads.....	63	IC Rotors and Valves.....	30	Service Tools, Golf Rotors.....	19
5000 Series MPR Nozzles .....	76	IC System.....	28	Smart Pump .....	49
5000 Series Rotors .....	74	IC Valve Kit.....	31	Snap Ring Pliers (551/700/751) .....	19
551 Series Rotors.....	6	IC-IN.....	32	Snap Ring Pliers (900/950.1100/1150) .....	19
7" Selector Valve Key .....	19	IC-OUT.....	33	Sod Cup Kit .....	19
700 Series Rotors.....	8	Installation Socket .....	19	Stator Configuration, Golf Rotors .....	17
751 Series Rotors.....	10	Landscape Solutions.....	60	Stratus II Central Control.....	22
Blank Tubing.....	84	Large-Capacity Filters.....	86	StratusLT Central Control .....	22
BPES Brass Valves .....	56	MI Series Mobile Controllers.....	24	Swing Joints .....	18
Central Control – Cirrus .....	22	Nimbus II Central Control.....	22	TBOS-BT Battery-Operated Controller.....	89
Central Control – Comparison Chart .....	23	PAR+ES Controller.....	36	The FREEDOM System.....	25
Central Control – Nimbus II.....	22	PAR+ES Retro Kit .....	37	Twist Lock Fittings .....	83
Central Control – Stratus II.....	22	PAR+ES Sat Decoder Controller.....	38	U-Series Nozzles .....	72
Central Control – StratusLT .....	22	PESB / PESB-R Series Valves.....	54	UF Cable Stripper .....	19
Central Control Technology .....	20	PRS-Dial .....	58	Universal Hose Adapter .....	19
Cirrus Central Control .....	22	Pump Manager 2.....	49	Valve Insertion Tool (900/950) .....	19
Decoders.....	39	Pump Station Quick Reference Guide .....	46	Valve Insertion Tool (551/700/751) .....	19
Distribution Tubing .....	84	Pump Stations & Filtration.....	44	Valves .....	52
EAGLE 900 Series Rotors.....	14	QF Dripline Header.....	81	VB Series Valve Boxes.....	90
EAGLE 950 Series Rotors.....	15	Quick Coupling Valve Keys .....	57	Weather Stations.....	27
Easy Fit Compression System.....	83	Quick Coupling Valves .....	57	WC100 Wire Connectors.....	43
EFB-CP Series Valves .....	55	R-VAN Rotary Strip Nozzles .....	68	WS-PRO LT Weather Station .....	27
Emission Devices.....	85	R-VAN Series Rotary Nozzles.....	64	WS-PRO2 Weather Station.....	27
ESP-9V Battery Operated Controller.....	88	R-VAN14 Rotary Nozzles .....	65	Xeri-Bubblers .....	85
Field Control.....	34	R-VAN18 Rotary Nozzles .....	66	Xeri-Bug Emitters .....	85
Golf Rotors.....	4	R-VAN24 Rotary Nozzles .....	67	XF Dripline Insert Fittings .....	83
Golf Rotors, Comparison Chart .....	16	Rain Can.....	26	XF Series Blank Tubing .....	84
Golf Rotors, Service Tools .....	19	RD1800 Series Spray Heads.....	62	XFD On-Surface Dripline .....	82
HE-VAN Series Nozzles .....	69	Rear Spreader Nozzle .....	12	XFS Sub-Surface Dripline.....	80
I Series Hydraulic Suction Scanning Filter .....	50	Root Watering System (RWS) .....	78	XT-700 Distribution Tubing.....	84
IC CONNECT.....	32	Rotor Tool .....	19		

## The Intelligent Use of Water.™

LEADERSHIP • EDUCATION • PARTNERSHIPS • PRODUCTS

---

At Rain Bird, we believe it is our responsibility to develop products and technologies that use water efficiently. Our commitment also extends to education, training and services for our industry and our communities.

The need to conserve water has never been greater. We want to do even more, and with your help, we can. Visit [www.rainbird.com](http://www.rainbird.com) for more information about The Intelligent Use of Water.™



### **Rain Bird Corporation**

970 W. Sierra Madre  
Azusa, CA 91702  
Phone: (626) 812-3400  
Fax: (626) 812-3411

### **Rain Bird Technical Services**

(866) GSP-XPRT (477-9778)  
(U.S. and Canada)

### **Rain Bird Corporation**

6991 East Southpoint Road  
Tucson, AZ 85756  
Phone: (520) 741-6100  
Fax: (520) 741-6522

Follow us @RainBirdGolf 

### **Rain Bird International, Inc.**

1000 W. Sierra Madre  
Azusa, CA 91702  
Phone: (626) 963-9311  
Fax: (626) 963-4287

[rainbird.com/golf](http://rainbird.com/golf)