

# LAFAYETTE RADIO ELECTRONICS

Mail Order and Sales Center

111 Jericho Turnpike, Syosset, L. I., New York 11791

Index:  
Facing Page 24a  
Easy Pay Plan:  
Page 18  
Store Addresses:  
Opp. Page 89

## HOLIDAY CATALOG 711

SAVE 30<sup>00</sup>



**RK-200**  
Car Cassette Recorder

See Page 7

Camera Zoom Movie  
Camera



See  
Page 24 A

CUT 10<sup>00</sup>

CUT 10<sup>00</sup>



See Page 96

**PF-30 & PF-60 Police Receivers**

See Page 12

CUT 10<sup>00</sup>



**Stereo 88 8-Track Car Player**

SAVE 20<sup>00</sup>

**Star-Fire® VI**  
6 Band Portable  
Radio

See Page 32



See Page 66

SAVE 20<sup>00</sup>



**Criterion® 3x**  
Hi-Fi 3-Way  
Acoustic  
Suspension System

50th  
LRE  
anniversary

# DELUXE

## Lafayette GUARDIAN "6000" 6-Band Battery/Electric AM-FM-Police-Aircraft-Marine Portable Radio

With Radio Direction Finder

180° Rotatable Ferrite Loopstick Antenna For LW, AM, and MB Reception PLUS Direction Finding on these Bands.



Optional Mounting Bracket for Marine use so that Radio can be secured.

ONLY 3.95

Signal Strength Tuning Meter/Battery Condition Meter

### TUNES 6 BANDS

- ① LW: 180-380 kHz Beacon Band
- ② AM: 540-1600 kHz Standard Broadcast
- ③ MB: 1.6-4.0 MHz Marine Band
- ④ FM: 88-108 MHz Standard Broadcast
- ⑤ AIR: 108-136 MHz AM/VHF Aircraft
- ⑥ POLICE: 147-174 MHz FM/VHF High Band Public Service and U.S. Weather Bureau Forecasts and New VHF/FM Marine Band

Professionally designed 6-band portable radio with individually tuned circuits to provide extra sharp reception on each band. Tunes Long Wave Beacon Band, Standard AM & FM broadcast Bands, Marine Band, Aircraft Communications Band, and FM-VHF Police and Public Service High Band including the 162.55 MHz U.S. Weather Bureau Forecasts. Can be operated on 4 "C" batteries for portable use, or from 117 volt, 60 Hz AC with built-in AC line cord for home use. In addition the Guardian "6000" also has Radio Direction Finding Facilities. This will permit the boat owner to obtain bearings from marine beacon stations on the Long Wave Beacon Band, from broadcast stations on the AM Band, and small craft stations on the Marine Band. Also includes a calibrated optical sighting arrangement for visual bearings. Other features include a combined Tuning Meter/Battery Condition Indicator; adjustable telescoping whip antenna



Tunes 6 Bands

Squelch Control

79<sup>95</sup>

With Batteries and Earphone

- Individually Tuned Circuits
- Instant-on Solid State Circuitry

(plus an external antenna jack) for reception on FM, AM/VHF (Air) and FM/VHF Police Band; adjustable squelch control to eliminate background noise on the FM, Air, and Police Bands; output jacks for use with headphone or external speaker; and Automatic Gain Control to vary the sensitivity of the radio and tuning meter for direction-finding purposes. Slide Rule dial has a logging scale for precise tuning and a push-button dial light. Large 4" Speaker for exceptional tonal quality. Steel handle for ease of portability. 18 Transistors, 14 Diodes, and 2 Thermistors. Size: 11½" W x 9" H x 3" D. Imported.

- 99 T 35065W Shpg. wt., 10 lbs. No Money Down\* ..... Net 79.95  
 Mounting Bracket For Fixed Marine Use. Imported. Wt. 6 oz.  
 17 T 64000 ..... Net 3.95  
 99 T 62572 Extra "C" Batteries (4 req.) wt., 4 oz. .... Net ea. .14

## Lafayette Battery/Electric Solid-State 3-Band AM/FM/SW Portable

Tunes 3 Bands  
 AM: 530-1600 kHz  
 FM: 88-108 MHz  
 SW: 3.8-12 MHz

ONLY 29<sup>95</sup> with earphone and batteries

- Vernier Slide Rule Tuning
- Powerful Wide Range 3½" Speaker
- AFC for Drift-Free FM Reception

Enjoy the finest in drift-free reception—hear your favorite news, sports, weather and special events on AM radio. Hear symphony concerts, world renowned soloists, jazz bands on FM radio. Tune in Paris, Rome, London, Moscow and dozens of other cities on the International Shortwave band. This superb radio operates on 4 "C" batteries or on standard 117VAC house current. Comes with convenient carrying handle for effortless portability. Features AC/DC switch, logging scale for precise tuning, color-coded band indicator, and AFC for drift-free FM reception. Telescoping antenna for FM and SW. Ferrite bar antenna for AM. Instant-on solid-state circuitry, earphone jack for private listening. Black padded, simulated leatherette cabinet. Size: 8¾" W x 7¼" H x 3" D. Imported. Shpg. wt., 5 lbs. 17 T 02307L ..... Net 29.95

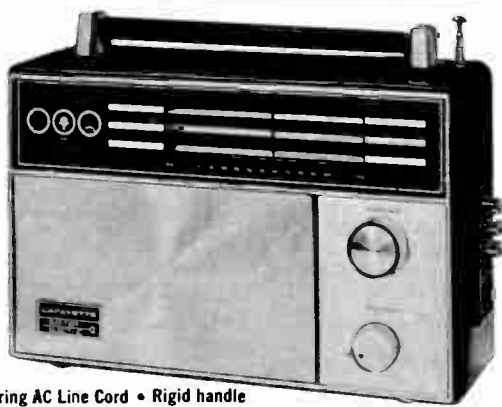

• Self Storing AC Line Cord • Rigid handle



# Deluxe Lafayette LSC-100B AM/FM Stereo Modular Hi-Fi System

# 159<sup>95</sup>

Including Tinted Plastic Dust Cover, Diamond LP Needle, and 45 RPM Spindle



Made in U.S.A.



## Magnificent Ultra-Modern Styling

- Garrard 4-Speed Automatic Record Changer with Cueing
- 40-Watt I.P.P. Solid State Stereo Amplifier
- Electronic FM Stereo Indicator Light
- Stereo Headphone Jack for Private Listening

- Two 8" 2-Way Wide Range Speaker Systems
- Guitar Microphone Input Jack
- Tape Input and Output Jacks
- Main and Remote Speaker Jacks

Our finest stereo phonograph with built-in stereo FM/AM radio is fully solid-state and features magnificent ultra-modern styling. The control center's stereo amplifier provides 40-watts I.P.P. output—and has provisions for tape input and output, guitar mike input, and stereo headphone. Also includes AC convenience outlet on rear panel. Features remote speaker output jack for hooking up an additional pair of speakers for another room. Tunes in regular FM & AM radio and receives full-dimensioned stereo FM broadcasts. 6 controls for complete flexibility: selector, balance, bass, treble, loudness and tuning. Built in AM/FM antennas. Provision for attaching external FM antenna. Calibrated slide rule tuning. AFC switch for drift-free FM reception. Garrard 2025 4-speed automatic stereo record changer with cueing lever plays 7", 10" and 12" records at 16 $\frac{1}{2}$ , 33 $\frac{1}{2}$ , 45,

and 78 rpm. Operates automatically or manually. Shuts off both changer and amplifier automatically after last record. Features tubular tone arm with Vaco TN-4 stereo turnover cartridge with diamond LP needle. Each 2-way 8" wide-range speaker system provides brilliant concert hall realism. You also get a handsome tinted plastic dust cover for the complete control unit, speaker hook-up cable and a 45 rpm spindle. The components are mounted in beautiful walnut vinyl veneer covered wood cabinets. Size: Control unit 23 $\frac{1}{2}$ Wx14Dx10 $\frac{3}{4}$ H (with dust cover). Speaker Encl.: 15 $\frac{1}{2}$ Hx 10 $\frac{1}{2}$ Wx4 $\frac{1}{2}$ D. For 110-120 VAC, 60 Hz. Shpg. wt., 45 lbs.

24 T 03251WX No Money Down\*  
24 T 03202 Replacement needle for LSC-100B

Net 199.95  
Net 2.49



# Lafayette LSC-45B Stereo Modular Hi-Fi Phono System

## Handsome Contemporary Styling

- Garrard 4-Speed Automatic Record Changer with Cueing
- 20-Watt I.P.P. Solid State Stereo Amplifier
- Two 8" Wide Range Speaker Systems
- Input For Tuner or Tape Recorders
- Stereo Headphone Jack

Luxurious 3 piece solid-state stereo hi-fi modular phono system. Two separate acoustically matched, rich sounding 8" speaker systems can be spaced apart for the utmost stereo effect. Has Aux. input jack so an AM or FM tuner or tape recorder can be played thru the powerful 20-watt I.P.P. solid state amplifier. Full complement of controls: balance, bass, treble, volume, selector, automatic shut-off switch, front panel stereo headphone jack. Garrard 2025 4-speed automatic stereo changer with cueing control plays 7", 10", and 12" records at 16 $\frac{1}{2}$ , 33 $\frac{1}{2}$ , 45, and 78 RPM. Tubular tone arm has a Vaco TN-4 stereo turnover cartridge with diamond LP needle. System includes a beautiful plastic dust cover, 45 RPM spindle, and speaker cable. The components are mounted in a beautiful walnut vinyl veneer covered wood cabinet. Size: control unit. 16x16 $\frac{1}{2}$ x7 $\frac{3}{4}$ H; speaker system: 13 $\frac{3}{4}$ x9 $\frac{3}{4}$ x5D each. Shpg. wt., 40 lbs.

24 T 03244WX Net 99.95  
Replacement needle for LSC-45B Net 2.49  
24 T 03202



# 99<sup>95</sup>

Including Plastic Dust Cover, Diamond LP Needle, and 45 RPM Spindle  
Made in U.S.A.

# Popular Priced LAFAYETTE Cassette Tape Recorders

## Complete LAFAYETTE RK-75 Solid State Portable Pushbutton Cassette Recorder Package



**29<sup>95</sup>**

### Accessories Included:



Texon Carrying Case



Remote Control Mike and Stand



Earphone



Batteries



30 min. Blank Cassette Tape

- No Tape Threading
- Automatic Record Level Control
- Ideal for Use in the Office for Dictation
- Ideal for Classroom Work for the Student

Compact, quality portable cassette recorder is just perfect for instant recording in the classroom, office, home, car or outdoors. Comes complete with all accessories. Built-in Automatic Level Control circuit assures perfect voice recording level regardless of volume control position. Remarkably easy to use—there are no reels to thread—just snap in a cassette for quick recordings of up to 2 hours. Plays back both monaural and stereo music cassettes. Piano key pushbuttons for easy selection of Play, Record, Fast Forward, Rewind, and Stop. Jacks are provided for Mike, Remote Control, Aux. input, Earphone Monitor and AC Adapter. Operates on 4 "C" batteries or 117 AC with optional AC adapter (see below). Size: 8 1/4" x 5 1/4" x 2 3/8" H. Handsome charcoal grey cabinet with metal grills. Imported.

99 T 99715M Shpg. wt., 5 lbs.	Net	29.95
99 T 35605 AC Adapter for RK-75. Shpg. wt., 6 oz.	Net	3.95
99 T 62572 Extra "C" Batteries (4 req.)	Net	14
99 T 15810 Footswitch for Remote Playback. 1/2 lb.	Net	3.95
99 T 01223 Lafayette 60 minute Tape Cassette	Net ea.	1.19

## LAFAYETTE Portable Desk Top Radio Cassette Tape Recorders



### RK-95 AM-FM Radio Cassette Recorder

**54<sup>95</sup>**

### RK-90 AM Radio Cassette Recorder

**44<sup>95</sup>**

- Complete with Remote Control Microphone with Stand, Blank 60 Minute Cassette, Earphone, Vinyl Accessory Pouch, Shoulder Strap and Batteries

**Model RK-95 AM-FM RADIO-CASSETTE RECORDER**, Sensational combination of a quality AM-FM RADIO and Cassette recorder lets you record broadcasts directly, or live with a microphone. You can permanently build your own tape library of fine music, world-wide news events as they happen, historic speeches by renowned statesmen, thrilling sports events like the World Series and the Super Bowl. Easy to use—no tape threading, push-button controls, record safety interlock button, AC bias and erase system, dynamic speaker for outstanding tonal quality, recording level and battery indicator. Can record up to 120 minutes (both tracks) on one Phillips type Cassette. External speaker output. Operates on 4 "C" batteries or 117VAC 60 Hz with optional adapter (see below). Includes Aux. input and remote control mike input. Tape speed 1 7/8 ips. Radio tunes: FM 88-108 MHz, AM 550-1600 kHz. Beautiful black case with chrome and walnut wood trim. Size: 7W x 9 1/2D x 2 1/4"H. Imported.

27 T 01126L Shpg. wt., 5 3/4 lbs. No Money Down*	Net	54.95
<b>Model RK-90 AM RADIO CASSETTE RECORDER</b> —Same deluxe features and size as the RK-95 except with AM radio instead of AM/FM radio. Imported. Wt., 5 3/4 lbs.		
27 T 01100L No Money Down*	Net	44.95

### ACCESSORIES FOR RK-90 AND RK-95

27 T 01118L AC Adapter. Shpg. wt., 1/2 lb.	Net	3.95
99 T 15810 Lafayette Foot Switch. Wt., 6 oz.	Net	3.95
28 T 01223 Lafayette 60 Minute Tape Cassette	Net	1.19
99 T 62572 Extra "C" Batteries (4-required)	Net	14

- Direct Recording From Radio to Recorder
- Instant-On Solid-State Circuitry



# LAFAYETTE'S Best Selling Cassette Recorders

## LAFAYETTE Professional RK-85 Solid State Battery/Electric Portable Cassette Transcorder®

# 39<sup>95</sup>

With Remote Control Mike  
and Stand, AC Adapter, Earphone,  
Batteries, Accessory Case,  
Hand Strap Blank Cassette Tape

- Simple To Operate
- No Tape Threading
- Pushbutton Controls
- Battery Record Level Indicator
- Record Safety Interlock Button
- Remote Control Start/Stop Mike

The RK-85 portable Cassette recorder is one of the easiest tape recorders in the world to operate—there are no reels, and therefore no tape threading. Just insert the tape cartridge, press a button and you are ready to playback or record. Tape stops automatically at the end. To record or playback on the other side, just turn the cartridge over. Beautifully styled and engineered. Capstan drive for constant 1 7/8 ips speed. Operates on 5 "C" batteries or 117VAC with AC adapter included. Perfect for "on-the-go" recordings. Records up to 120 minutes (both tracks). Separate pushbutton controls for: Fast Forward, Rewind, Stop, Play, plus safely record button. Permits perfect recordings with level meter that also checks batteries. 8-transistors. 1-diode. Includes: earphone jack, auxiliary input jack for recording from external sources such as phonograph, TV set, or Tuner, and remote control mike jack. Large 2 3/4" dynamic speaker. Size: 8 3/4 x 5 x 2 1/4" H. Imported. Shpg. wt., 6 3/4 lbs.

99 T 15794L No Money Down\*

Net 39.95



### ACCESSORIES FOR RK-85

Stock No.	Description	Shpg. wt.	Net ea.
99 T 15620	Vinyl Case with Strap	10 oz.	2.95
99 T 62572	Extra "C" Batteries...5 req.	4 oz.	.14
28 T 01223	60 minute Lafayette Cassette Cartridge	6 oz.	1.19
99 T 15810	Foot Switch for Remote Playback	6 oz.	3.95

## Deluxe LAFAYETTE RK-100 Battery/Electric Cassette Recorder

### Our Finest Solid-State Portable Monaural Cassette Recorder

# 54<sup>95</sup>

With Remote Control Mike,  
AC Line Card, Carrying  
Strap, and 60 Minute Cassette

- Semi-Slot Loading
- ALC Circuit with On/Off Switch
- Six Pushbutton Controls
- VU Meter/Battery Level Indicator
- AC Bias and Erase System

Deluxe portable cassette system provides complete ease of operation with high quality record and playback performance. There is no tape to handle, no reels to thread, no fumbling. Instant on solid-state circuitry is powered by 6 "C" batteries (not included) or standard 117VAC with built-in AC power supply, so you can enjoy the RK100 away from home—indoors, outdoors—anywhere. Six pushbuttons completely and conveniently control operations for Record, Play, Stop, Fast-forward, Rewind and cassette Eject. Recording and battery level indicator shows correct recording level for music recording, plus condition of batteries, or you can use the ALC (automatic record-level control) for perfect voice recordings everytime. Big 3 1/2" speaker delivers clear, room-filling sound. Continuous tone control. Has inputs for recording live with remote control mike, off-the-air, from records, or from reel-to-reel tapes. Output for playback thru an external speaker is provided. High impact plastic case with brushed aluminum front panel and chrome trim. Comes with remote mike and built-in AC line cord in self-storing compartment. Also includes carry strap for portable use. Size: 11 1/2 x 7 x 3 3/8". Imported. Shpg. wt., 6 3/4 lbs.

99 T 15679 No Money Down\*

Net 54.95

99 T 62572 "C" Batteries (6 required)

Net ea. .14

99 T 15810 Foot Switch Playback. Wt., 4 oz.

Net 3.95

28 T 01223 60 Minute Lafayette Cassette Tape 6 oz.

Net 1.19



# Professionally Record Your Own Cassette Stereo Tape Library

## Deluxe LAFAYETTE RK-550 Solid-State Stereo Pushbutton Cassette Deck



- Automatic Shut-Off Switch
- Records: 4 Track Stereo and 2 Track Monaural
- Plays back 4 and 2 Track Stereo and Monaural

Professionally styled and engineered to provide superb stereo and monaural cassette recording facilities. Features a full set of push-button controls for all tape modes; record, play, fast-forward, re-wind, pause, stop, cassette ejector; stereo/mono input selector switch, record safety button. Specifications: ¼ Track Record/Play narrow gap head, with 4 laminations per stack to deliver wide-band frequency response and virtually distortion-free performance; ½ Track double gapped high efficiency erase head. Response 40-12,000 Hz, S/N Ratio: better than 45 db. Wow and Flutter: Less than 0.25%. Overall Distortion: Less than 1.5% at 0 VU @ 600 ohms, Aux. Input

- Record Safety Button
- 2 Large Illuminated VU Meters
- 3 Digit Tape Counter with Reset Button

(Low) 100 mv for 0 VU @ 150 K ohms, Aux. Input (high) 500 mv for 0 VU @ 700 K ohms, Tape Speed 1 7/8 ips. Size: 15Wx5Hx9"D. Handsome brushed aluminum gold anodized extruded front panel. Attractive metal enclosure with the simulated look of rich walnut wood grain. Matches Lafayette Hi-Fi Line of Receivers, Tuners, and Amplifiers. Wt., 12 lbs. Imported. For 117VAC, 60Hz.  
 99 T 15711WX No Money Down\* ..... Net 99.95  
 Dynamic Mike for RK-550. Imported. Shpg. wt., 8 oz. .... Net ea. 5.95  
 99 T 46302 ..... Net ea. 1.19  
 26 T 01223 60 Min. Cassette Recording Tape ..... Net ea. 1.19

## Deluxe Lafayette RK-510 Solid State Stereo Cassette Tape Recorder



**149<sup>95</sup>**  
with mikes  
less speakers

- Narrow-Gap Record/Playback Heads with 4-Laminations Per Stack For Virtually Distortion-Free Performance
- 10 Watt Solid-State Stereo Amplifier
- 2-Mic. and 4-Aux. Input Jacks

Superb hi-fidelity stereo cassette tape recorder (less speakers) featuring the convenience of no tape threading. Includes the latest type narrow-gap record/playback heads with four laminations per stack to deliver wide-band frequency response and virtually distortion-free performance. Records 4-track stereo and 2-track monaural, playback 4 and 2-track stereo and monaural. 2-mike input jacks are located on the front panel for live recording. Jacks for external recording from record changer or phono, and an FM stereo tuner are provided on the rear of the recorder. Has 6-pushbut-

ton controls for all tape modes including Pause for instant editing and cueing. 3-digit tape counter with reset button. Large dual illuminated VU record level meters. Handsome brushed aluminum gold anodized extruded front panel. Attractive metal enclosure with the simulated look of rich walnut grain. Frequency Response  $\pm 2$  db 30-12,500 Hz; Wow and Flutter, less than 0.2% rms. Signal-to-Noise—better than 44 db @ 0 VU. Channel Separation—36 db. Bias Frequency—106 kHz. For 110-125 VAC., 50/60 Hz. Imported. Size: 14 1/2 Wx4 1/2 Hx8 1/2 D. Shpg. wt., 12 lbs. 99 T 15779WX No Money Down\* Net 149.95

**RK-510 Cassette  
Tape Recorder System**

Only **179<sup>95</sup>**  
No Money Down\*

**SAVE 8.50**

From Individual Catalog Prices  
When You Purchase RK-510  
With Criterion 25A Speakers  
Lafayette Model RK-510 Stereo Cassette Recorder Plus 2 Lafayette Criterion 25A Speaker Systems. See Page 64 for complete description of Criterion 25A. Shpg. wt., 30 lbs.  
99 T 99459WX ..... Net 179.95

# Outstanding Values in Cassette Players and Recorders

## LAFAYETTE "CASSETTE MATE" PORTABLE TAPE PLAYER



**SALE**

SAVE 3.00

NOW **11<sup>95</sup>**

WAS 14.95  
CATALOG 710

- Instant "On"  
Solid-State Circuitry



A great new way to listen to the vast selection of pre-recorded cassette tapes on the market today. The Lafayette "Cassette-Mate" gives you remarkably Full Range sound and unlimited convenience. Battery operated or can be played on 110 VAC house current with optional adapter. Integrated carrying handle for ease of portability. Earphone for private listening. Instant-on solid-state circuitry. Easy to use "Stop/Play Switch." Earphone/external speaker jack, Volume Control. With batteries and earphone. Size: 9 1/2"H x 5 3/4"W x 2 1/2"D. Shpg. wt., 4 lbs. Imported.

99 T15786 \_\_\_\_\_ Net 11.95  
99 T35605 AC Adapter For Cassette-Mate \_\_\_\_\_ Net 3.95  
99 T62572 Extra "C" batteries (4 req.) \_\_\_\_\_ Net ea. .14

## LAFAYETTE RK-200 SOLID STATE CAR CASSETTE STEREO TAPE SYSTEM

- Stereo Playback  
Monaural  
Record



**SALE**

SAVE 30.00

NOW **49<sup>95</sup>**

WAS 79.95  
1970 CATALOG 700

LESS SPEAKERS QUANTITIES LIMITED

Enjoy concert hall stereo sound reproduction in the comfort of your car. Lafayette's stereo cassette tape system provides 4-track stereo playback as well as 2-track monaural record. Fast-Forward and Rewind lever control allows you to choose the exact selections on a tape. Dependable solid-state circuitry. Convenient ONE-LEVER operation for Start, Stop, Fast-Forward, and Rewind. Stereo balance control adjusts stereo separation through left and right channels. Also features Record safety button, automatic stop at end of tape and plastic slide door. Includes: Remote Control Start/Stop Mike with spiral retractable cord; adjustable gimble mounting bracket and hardware that permits unit to easily mount in any car dash or console, truck, or boat; and blank 60 minute-tape cassette. For 12VDC, negative ground systems. Size: 7x8 3/4 x 4". Imported. Shpg. wt., 5 lbs.

99 T15737 \_\_\_\_\_ Net 49.95  
Set of 2 Rear Deck Matching Speaker Systems.  
99 T62994 Imported. Shpg. wt., 4 lbs. \_\_\_\_\_ Net 6.95

## LAFAYETTE PORTABLE CASSETTE TAPE PLAYER with BUILT-IN AM RADIO



**SALE**

SAVE 10.00

NOW **19<sup>95</sup>**

WAS 29.95  
CATALOG 710

- Instant "On"  
Solid-State Circuitry
- 3 Cassette Controls:  
Stop-Play-Rewind



Enjoy the pleasure of listening to wonderful pre-recorded cassette tapes with added convenience of being able to also hear music, news and sports events on the built-in AM radio. Compact, portable cassette player is pushbutton operated. Plays on 4 "C" batteries, or, 117VAC with optional adapter. Superheterodyne AM radio has a ferrite core antenna. You get excellent sound quality from a special dynamic speaker. Size: 11H x 6 3/4W x 2 3/4"D. Imported. Shpg., 5 lbs. 27 T 01134 \_\_\_\_\_ Net 19.95

27 T 01142L AC Adapter for Above. Wt., 6 oz. \_\_\_\_\_ Net 3.95  
99 T 62572 Extra "C" Batteries (4 req.) \_\_\_\_\_ Net ea. .14

## HITACHI Portable Battery/Electric 4-Track Stereo Cassette Recorder



**99<sup>95</sup>**

With batteries  
and earphone

- Operates on 6 "D" Batteries or 117VAC House Current

Compact, lightweight traveling companion, for the music lover. Easy-to-carry cassette stereo tape recorder. Plays anywhere, anytime. Operates on 117V., 60 Hz. AC, house current, or on standard "D" type flashlight batteries. Two swing-out extension cabinets each contain a 5" speaker. Provides excellent stereo sound reproduction and full dimensional stereo separation. Features "Levelmatic" (automatic record level control). Also has pushbutton control; level and tone controls for each channel; two record level VU meters and remote control jack. Frequency Response: 100 to 10,000 Hz. Speed: 1 7/8 ips. Circuitry: 16 transistors, 10 diodes, 4 thermistors. Size: 11 x 6 1/4 x 8 3/4". Imported. Shpg. wt., 14 lbs.  
27 T 23013W No Money Down" \_\_\_\_\_ Net 99.95

Extra "D" Batteries for above (6 req.) \_\_\_\_\_ Net ea. .15  
99 T 62564 \_\_\_\_\_

## LAFAYETTE STEREO CHECKOUT AND DEMONSTRATION CASSETTE TAPE

Every owner of a cassette tape system should have this tape. Tests and balances your equipment for optimum audio reproduction. The test portion of this tape includes checks for speaker phasing, channel separation and balance. Checks for Wow and Flutter. The demonstration portion of this tape demonstrates the dynamic range of your sound system and includes sound effects and excerpts from Gayne Suite by Khachaturian. In durable clear plastic box. Shpg. wt., 4 oz.



**2<sup>95</sup>**

28 T 01397 \_\_\_\_\_ Net 2.95

# Lafayette Solid State Reel-To-Reel Tape Recorders

## Big Savings on Lafayette RK-710A 7" Tape Recorder



Individual  
Volume and  
Tone Controls



Illuminated VU  
Meter for  
Record/  
Playback Level



Large 3x5"  
Speaker



Dynamic  
Mike

- ★ 3 Speeds— $7\frac{1}{2}$ , 3 $\frac{3}{4}$ , 1 $\frac{1}{2}$  ips
- ★ 2 Track Monaural Record/Playback
- ★ Vertical or Horizontal Operation
- ★ Record Safety Button
- ★ Single Tape Function Control: Rewind, Stop, Run, Pause for Editing, Fast Forward
- ★ Tape Spill Proof

**\$10.00** Now **59<sup>95</sup>**  
**Price Cut**  
 Was **69.95**  
 Includes  
 Dynamic Mike,  
 7" Empty Reel,  
 2 Rubber  
 Reel Caps

Catalog 710

Superb, self-contained, professionally styled, three speed, two-track monaural 7" tape recorder. Space age solid state circuitry permits you to start recording the instant you turn the RK-710A on. Records and plays back two-track monaural at three speeds:  $7\frac{1}{2}$ , 3 $\frac{3}{4}$ , and 1 $\frac{1}{2}$  ips. Easy to operate—offers the convenience of a single tape function control knob for five modes of operation: Rewind, Stop, Run, Pause for editing and cueing, and Fast Forward. Records directly from FM tuner, phono, TV, plus "live" using the dynamic mike. Illuminated VU meter for proper record/playback level. Record safety button guards against accidental tape erasure. Individual volume and tone controls. 4-pole induction motor.

**SPECIFICATIONS** — Response: 60-12,000 Hz. at  $7\frac{1}{2}$  ips., 60-8,000 Hz at 3 $\frac{3}{4}$  ips. Wow and Flutter: less than 0.25% RMS at  $7\frac{1}{2}$  ips. Signal-To-Noise Ratio. Better than 42 db. Bias and Erase Frequency: 60 kHz. Large 3x5" speaker. Power Output. 1.5 watts maximum. 2 Inputs: Microphone and Auxiliary. 1 Output: External Speaker. Size: 11 $\frac{1}{2}$ x12 $\frac{1}{2}$ x6 $\frac{3}{4}$ "D. Comes with low impedance dynamic microphone, 7" empty reel, and two rubber reel caps. Solid vinyl cabinet has built-in accessory compartment and carrying handle. For 117 VAC 60 Hz. Imported. 99 T 15646WX Shpg. wt., 18 lbs. Net 59.95

7" Reel of 1800' Lafayette Mylar Recording Tape. Net 2.14  
 20 T 01066 Shpg. wt., 1 $\frac{1}{4}$  lbs. Net 2.14

## Professional Lafayette Model RK-960 Solid State Automatic Reversing Stereophonic Tape Recorder



**"COMPUTER-MATIC"<sup>TM</sup> Reversing System Operates on 4-Modes In Either Record or Playback**

1) Manual      3) Single Reverse  
 2) Automatic    4) Continuous Reverse

The Model 960 features "Full Automatic Reversing" in both record and playback modes. Makes professional quality recordings from AM, FM, FM Stereo broadcasts, or a record changer (direct from magnetic or ceramic phono cartridge). With microphones you can record "live" any program material you desire. Two self-contained 5x7" wide-range hi-fi speakers provide optimum stereo separation. Two 4-pole induction capstan drive motors assure ultra-smooth, quiet drive. Feather-touch, pushbutton operated solenoids control all tape motion modes. Front Panel Stereo Headphone jack. Specifications—Record/Play Frequency Response: 30-22,000 Hz  $\pm$  3 db at  $7\frac{1}{2}$  ips.; 40-10,000 Hz  $\pm$  3 db at 3 $\frac{3}{4}$  ips. S/N Ratio: 50 db or better. Bias/Erase Freq. 96 kHz. Equalization:  $7\frac{1}{2}$  ips, NAB; 3 $\frac{3}{4}$  ips, RIAA. Input Imped.: Mic., 10K ohms; Mag., 45K ohms; Aux., 500K ohms. Output Imped.: Ext. Spkr., 8-ohms; Headphones, 8-ohms. Heads: Two  $\frac{1}{4}$ -track lamination type stereo record/playback; two  $\frac{1}{4}$ -track double-gapped high efficiency erase heads. 2-external outputs. Housed in a handsome black leatherette covered wood cabinet with silver metal trim. Dimensions: 22x15 $\frac{1}{2}$ x8 $\frac{1}{4}$ "D. For 110-120 VAC, 60 Hz. Imported. Shpg. wt., 55 lbs. 99 T 15489WX No Money Down\* Net 229.95

Optional Dynamic Mike. Shpg. wt., 1 lb. Net 4.95  
 99 T 45882 Net ea. 14.95  
 7" reel of 1800 ft. Mylar Recording Tape with reversing sensing tools. Shpg. wt., 13 oz. Net 2.09  
 20 T 01181

**229<sup>95</sup>**

With 7" Take Up Reel and 2 Rubber Reel Caps

Optional Dynamic Mikes 14.95 ea.

- ★ Sound-on-Sound, Sound-with-Sound, and Sound Monitoring
- ★ 4-Track Stereophonic or Monaural Record/Playback
- ★ 3-Digit Tape Counter with Reset Button
- ★ 3-Speeds: 1 $\frac{1}{2}$ , 3 $\frac{3}{4}$ ,  $7\frac{1}{2}$  ips
- ★ 2 Large Illuminated VU Meters



# Popular-Priced Solid State Reel-to-Reel Stereo Tape Decks

**Panasonic Model RS 765US 4-Track Stereo Record/Playback Tape Deck**



**99<sup>95</sup>** With 4 Connecting Cables, 7" Empty Reel, Splicing Tape and 2 Reel Holders.

Walnut Wood Base

Handsome stereo record and playback tape deck that plugs into your present hi-fi amplifier or receiver. 3 tape speeds: 17 $\frac{1}{2}$ , 3 $\frac{3}{4}$  and 7 $\frac{1}{2}$  IPS. Constant speed, 4-pole induction motor. Two VU meters offer immediate indication of recording level on both channels. Single lever control for play, stop, fast forward and rewind. Separate left and right channel volume controls. Digital Tape Counter. Pause control for editing. A special internal circuit automatically turns off the recorder when the tape is finished. Headphone jack for private stereo listening. Comes complete with 7" empty reel, 4 connecting cords, splicing tape and 2 reel holders. Specifications: Takes reels up to 7"; Freq. Response: 30 to 18,000 Hz, Wow and flutter: less than 0.10% @ 7 $\frac{1}{2}$  IPS, 2 mike inputs (600 ohms), 2 aux inputs. Size: 13 $\frac{3}{4}$ " x 11" x 5 $\frac{1}{2}$ ". For 117 VAC 60 Hz. Imported. Shpg. wt., 19 lbs. 27 T 12206W No Money Down\* Net 99.95

**Sony/Superscope 252-D Stereo Record/Playback Tape Deck**



**139<sup>95</sup>** With Two Patch Cords

Walnut Wood Base

Fine performing stereo tape deck. With self contained solid-state stereo preamplifiers for the recording and playback of 4-track stereo and 4-track mono thru your home hi-fi system. Two speeds: 7 $\frac{1}{2}$  or 3 $\frac{3}{4}$  IPS. Vertical or horizontal operation. Features: sound with sound mixing, dual VU recording level meters, 3 digit tape counter, vibration free motor, stereo headphone monitor jack, single knob control, automatic tape lifter, scrape flutter filter, record interlock, non-magnetizing record head and automatic shut off. Specifications: Takes reels up to 7". Freq. res.: 30-18,000 Hz @ 7 $\frac{1}{2}$  IPS, 40-13,000 Hz @ 3 $\frac{3}{4}$  IPS, Wow/flutter 0.12% @ 7 $\frac{1}{2}$  IPS, 0.15% @ 3 $\frac{3}{4}$  IPS. Signal-to-Noise ratio: 52 db. Size 15 $\frac{1}{4}$ " x 7 $\frac{1}{2}$ " x 13 $\frac{1}{4}$ ". For 117 VAC 60 Hz. Imported. Shpg. wt., 18 lbs 27 T 60569W No Money Down\* Net 139.95

27 T 60379—F98 Mike for 252-D. Shpg. wt., 1 lb. Net 13.50

## LAFAYETTE POPULAR RECORDING ACCESSORIES

### LAFAYETTE BULK TAPE ERASERS

#### PROFESSIONAL MODEL

- Completely Erases Tape
- Two Erasing Coils
- Erases up to 1" Tapes
- Erases 1/4" Tapes in One Operation—No Reversing
- For 3", 5", 7" or 10 $\frac{1}{2}$ " Reels

**11<sup>95</sup>** Deluxe Model  
**26<sup>95</sup>** Professional Model



A carefully designed and precisely manufactured tape "degausser" for complete erasing of tapes. Just place the tape reel on spindle of demagnetizer, slowly rotate 2 or 3 turns, take off, and that's all. Reduce tape hiss to the level of new "virgin" tape. Two completely separate coils are used for doubly-effective erasures, even of large, 10 $\frac{1}{2}$ " reels. Will erase 1" wide tape. An extra powerful unit for heavy duty use—draws over 9 amperes. Can be used to demagnetize tape, magnetically stripped film, plus tools and watches. Has a heavy, custom finished case, a rugged non-magnetic top, heavy duty on-off switch and power cord. Has built-in fuse. Pilot light prevents accidentally leaving it turned on. Size 6 $\frac{1}{4}$ " x 7 $\frac{1}{2}$ " x 3 $\frac{1}{2}$ ". 105-125V, 60 Hz. Imported. Shpg. wt., 12 $\frac{3}{4}$  lbs. 99 T 15166 Professional Model Net 26.95

#### Deluxe Model

Similar to professional model for all size reels but handles only standard size 1/4" tapes or smaller and reel must be turned over once. Has separate spindle positions for 10 $\frac{1}{2}$ " and 3, 5, and 7" reels; non-magnetic bakelite plate for reel rest. One powerful coil consumes 5 amps. Metal case 7 $\frac{1}{4}$ " x 4 $\frac{1}{4}$ " x 3 $\frac{1}{2}$ ". Imported. Shpg. wt., 4 $\frac{3}{4}$  lbs. 99 T 15182 Net 11.95

### HAND HELD BULK ERASER

- Utmost Versatility—Demagnetizes Cassettes, Cartridges All Size Reels and Equipment

**10<sup>95</sup>**

Easily erases tapes or sound films regardless of reel size. Convenient, comfortable hand held design. Also demagnetizes capstans, tape guides, etc. Lowers background noise better than new tape. Safe, durable plastic case and control switch. High intensity field with low power consumption. 28 T 30016 Shpg. wt., 2 $\frac{3}{4}$  lbs. Net 10.95



### TELEPHONE PICKUP FOR CRADLE OR UPRIGHT PHONES

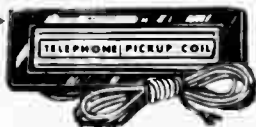

**1<sup>49</sup>**

Induction telephone pickup for cradle or upright phones. Simply place base on pickup and connect leads to high impedance input of an audio amplifier or directly to a tape recorder. Imported. Shpg. wt., 5 oz. 99 T 10340 Net 1.49

### LAFAYETTE REEL RECORDER CHECK OUT AND DEMONSTRATION TAPE

STEREO CHECK OUT AND DEMONSTRATION TAPE



- Tests and Balances Your Stereo Equipment
- Excerpts From Outstanding Recordings

Every owner of a reel-to-reel tape system should have this tape. Tests and balances your equipment for optimum audio reproduction. Test portion of tape includes speaker phasing, channel separation and balance checks, wow and flutter. Demonstration portion of tape demonstrates the dynamic range of your sound system and includes sound effects and excerpts from Gayne Suite by Khachatourian. On 7" reel. 28 T 01389 Shpg. wt., 10 oz Net 2.95

\*See Page 18 for Full Credit Details on Easy Pay Plan

# LAFAYETTE Finest 8-Track Stereo Tape Players



## LAFAYETTE RK-850 20-WATT SOLID-STATE 8-TRACK STEREO AMPLIFIER/PLAYER



with  
**EXCLUSIVE  
"REMOVE  
TAPE  
INDICATOR"**

Insures That You Do  
Not Damage The  
Tape Head and  
Your Cartridges

**79<sup>95</sup>**  
Less  
Speakers

Less  
Speakers

**109<sup>95</sup>**  
With 2-Criterion 25A  
Speaker Systems

With 2-Criterion 25A  
Speaker Systems

No Money Down\*

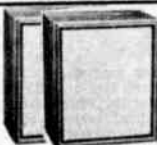

**SAVE \$10.00**

From Individual  
Catalog Prices When  
You Purchase RK-850  
with Criterion 25A  
Speakers

- 20-Watts  $\pm 1$  db of Stereo Power
- Inputs For Phono, Tuner, Tape
- Tape Outputs • Stereo Headphone Jack

- Main and Remote Speaker Switch
- Individual Illuminated Track Indicator Lights
- Pushbutton Track Selector

The RK-850 combines a complete 8-track stereo playback system with a powerful 20-watt full feature stereo amplifier on one integrated chassis. Advanced solid-state circuitry (16 transistors, 3-diodes, and 2-thermistors) provides instant-on play with superb high fidelity performance and reliability. The RK-850's exclusive "Remove Tape" indicator light will provide years of trouble-free 8-track performance . . . no longer will you have to worry about damaging the playback head by leaving a tape inserted in the player after you have turned the power off; a "Remove Tape" bulb illuminates with the power turned off and a tape cartridge left fully inserted in the player. This feature will also preserve the life of your cartridges. Convenient operating features include: Pushbutton Track Selector; 4-Illuminated Track Indicator lights; Selector Switch for choice of inputs: Phono (with ceramic cartridge), Tuner, and Auxiliary; plus tape output for external tape recorder. Push-

button Switches for: Main and Remote speakers; Loudness; Stereo/Mono mode; Power on/off with Pilot Lamp. Separate controls for Volume/Balance, Treble, Bass. Stereo headphone jack for private listening. SPECIFICATIONS: Tape Section—Response: 30 Hz to 10 kHz; S/N: 50 db; Wow and Flutter: 0.3% rms. Amplifier Section—Frequency Response: 20 Hz to 20 kHz; Separation: 60db; H/D: 0.2%; Input Sensitivity (Aux., Tuner, Phono CER.): 250 mV; Hum and Noise (Aux., Tuner, Phono CER.): 70 db. Distinctive styling features a black front panel accented by brushed gold anodized aluminum trim and simulated walnut grain case. For 105/120 VAC., 60 Hz. Imported. Size: 12W x 3 3/4H x 9 1/4"D.  
99 T 15836WX Shpg. wt., 13 lbs. . . . . Net 79.95  
RK-850 plus 2-Criterion 25A speakers (See page 64 for description of speakers). Shpg. wt., 38 lbs.  
99 T 82396WXM No Money Down\* . . . . . Net 109.95

## DELUXE LAFAYETTE RK-800 8-TRACK STEREO CARTRIDGE PLAYBACK DECK



ONLY

**54<sup>95</sup>**

No Money Down\*

Update Your Home Stereo System to Play  
Brilliant 8-Track Stereo Tape Cartridges

- Built-in Solid-State Stereo Playback Preamplifier
- Pushbutton Track Selector
- Individual Illuminated Track Indicator Lights
- Spill-Proof Capstan Mechanism

Get True Hi-Fidelity performance from Lafayette's professional 8-track stereo tape deck. Designed to complement the finest stereo systems. Unique capstan bearing assembly insures long-life operation without damage to your tapes. Spill-proof mechanism stops tape from wrapping around capstan. Built-in solid-state stereo playback pre-amplifiers. Connects to your stereo amplifier or receiver tape input. Tape plays continuously. Four indicator lights tell you which track is playing at any given time. In sequence you may switch tracks by depressing the pushbutton track selector button. Power Output: 1-volt. S/N Ratio; better than 38 db. Wow & Flutter: less than 0.3% rms. Tape Speed: 3 1/2 ips. 4-pole AC condenser motor. Walnut grain finished metal case. Brushed aluminum front panel. Size: 9Wx4 1/2Hx9 1/4"D. For 117VAC., 60 Hz. Imp. Shpg. wt., 10 1/4 lbs.  
99 T 15905W . . . . . Net 54.95

# 8-Track Stereo Tape Cartridge Recorders and Decks

## NEW!

## LAFAYETTE RK-890 Solid-State Stereo 8-Track Cartridge Recorder/Player Tape Deck



With Pushbutton Fast Forward

Record 8-Track Cartridges thru your Stereo Amplifier or Receiver, or live with Microphones using the RK-890

# 119<sup>95</sup>

less miles

### RECORD FEATURES

- ★ Stop after each Channel and Automatic Eject, or Stop after Channel 1 thru 4 and Eject
- ★ Sound with Sound Mixing
- ★ Pushbutton Manual Eject
- ★ Pushbutton Fast-Forward
- ★ Front Panel Left and Right Channel Microphone Input Jacks
- ★ Record Safety Interlock Button
- ★ Illuminated Track Indicator Lights
- ★ Dual Recording VU Level Meter
- ★ Separate Dual Concentric Microphone and Aux. Volume Controls

### PLAYBACK FEATURES

- ★ Continuous Play
- ★ Pre-Select and Play any 1 Channel and Stop and Automatic Eject
- ★ Pushbutton Track Selector
- ★ Illuminated Track Indicator Lights
- ★ Pushbutton Fast Forward
- ★ Pushbutton Manual Eject

### EXCLUSIVE FEATURES

- ★ Automatic Cartridge Ejector—Insures you do not damage the tape head and your cartridge
- ★ Specially Designed Built-In Lafayette Solid-State Stereo Record/Playback Pre-Amplifiers

Certain to be one of our most exciting new recorders, as well as one of our best sellers of the year. Offers unsurpassed 8 Track cartridge record and playback facilities. You can enjoy hours of listening pleasure from your own pre-recorded stereo cartridges. The RK-890 will become the ideal companion to your present high fidelity system. Exclusive Automatic Cartridge Ejector will provide years of trouble-free 8-Track performance—no longer will you damage the heads of your recorder or the roller of any cartridge by leaving a tape inserted after you have turned the power off. The fast forward feature permits quick selection of tape sections. And, most important, you can automatically record 4 tracks continuously and stop, or record each track individually and stop. Specifications: 2 Mike

Input, (Sensitivity 1 MV) 2 Aux. input, (Sensitivity 100MV) BIAS Freq.: 60 kHz. AC erasing system. Freq. response: 30 Hz to 12 kHz, Wow and Flutter: less than .25%. Channel Separation—more than 40db, output level 1 volt Max., 300MV average. 13 Transistors, 12 diodes, Walnut metal wrap around case. Brush gold anodized aluminum trim. AC Power Fuse, For 117VAC 60 Hz Size: 12" x 3 3/4" x 9 1/4" D. Imported. No Money Down\*

99 T 15844W Shpg. wt., 12 lbs.	Net 119.95
Microphone for RK890. Imported. Shpg. wt., 8 oz.	
99 T 46161	Net 5.95
Lafayette 60 Min. 8 Tr. Mylar Recording Tape	
24 T 01348	Net ea. 1.95



## NEW! VIKING 814S SOLID STATE 8-TRACK AM/FM STEREO RECORD/PLAYBACK SYSTEM

# 349<sup>95</sup>

- With 2 Separate Acoustic Suspension Bookshelf Systems Each Containing a 6 1/2" Speaker

Superb 8-Track home entertainment center. The control unit consists of a 100 watt (Peak Music Power) solid state stereo integrated amplifier, a sensitive FET Solid State AM-FM stereo tuner, and 8-Track Tape Cartridge Recorder/Player. Amplifier/Tuner Features: Black out dial with slide rule indicator; FM stereo beacon, Tuning meter for signal strength, AFC on/off slide switch, built-in ferrite AM loop stick antenna, and provisions for external FM antenna. 8-Track Recorder Features: Manual channel Selector, illuminated track indicator lights, pause control, eject lever, and 2 VU level record meters. Handsome walnut wood cabinet. Size: 18"W x 6"H x 11"D, Each Speaker 8"W x 12"H x 7"D. Shpg. wt., 36 lbs. UL listed. For 117 VAC 60 Hz.

27 T 68133WX No Money Down*	Net 349.95
New Model 812S 8-Track Record/Playback System: Same as above but less AM/FM stereo Tuner. Provisions are provided for plugging in an external Tuner or Phono. Shpg. wt., 35 lbs.	
27 T 68141WX No Money Down*	Net 299.95

\*See Page 16 for Full Credit Details on Easy Pay Plan

Lafayette Cal. No. 711 11

# LAFAYETTE Stereo 8-Track Listening in the Car

Deluxe LAFAYETTE "Stereo 88" Solid-State 8-Track Cartridge Car Tape Player



## SALE

SAVE \$10.00

NOW **49<sup>95</sup>** Complete with Adjustable Mounting Bracket, and all Mounting Hardware. Less Speakers.  
 WAS 59.95

Sale Price in Effect thru 12/31/70

### Features: Built-in Burglar Alarm



- Instant-On Space Age Solid-State Circuitry
- Individual Illuminated Track Indicator Lights

Beautifully designed stereo car tape system superbly engineered to provide high quality stereo sound playback of 8-Track Stereo Pre-Recorded Tape Cartridges. Features a built-in Burglar Alarm System to prevent theft. The "Stereo 88" measures only 2 3/4" H x 7 W x 7 3/4" D, and can be easily mounted under the dash of your car with attached adjustable mounting bracket. Fully automatic—just slip in an 8-track tape cartridge and the "Stereo 88" plays instantly. Removal of cartridge automatically switches player off. Illuminated

- Pushbutton Track Selector
- Power Output: 12 Watts
- Volume, Balance, and Tone Controls
- For 12 Volt Negative Ground System

track indicator shows track that is playing. Tracks change automatically after end of each program or instantly by operating the selector button. Frequency Response: 50 to 10,000 Hz; Signal-To-Noise Ratio: more than 40 db. Wow and Flutter: less than 0.3%. 12-transistors, 1-diode, 4-thermistors; Output Impedance: 4-ohms. For 12 volt negative ground systems. With mounting bracket and hardware. Imported. Shpg. wt., 10 lbs. Less Speakers..... Net 49.95  
 99 T 15521W No Money Down\*

## LAFAYETTE Speakers for 8-Track and Cassette Car Stereo Tape Players

### "VARY-MOUNT" FLUSH MOUNTING SPEAKER



**3<sup>95</sup>**

Deluxe flush-mounting speaker with beautiful chrome grill. Ideal for use as an auto speaker or anywhere shallow depth is required. Full range speaker has heavy magnet and offers outstanding sound quality. Can also be used as a ceiling or wall mount speaker in your home. Imp., 8 ohms. Overall dia.: 6 1/4". Imported. Shpg. wt., 3 lbs. 99 T 01794 Net 3.95

### PAIR OF 3 x 5 UNDER-DASH MATCHING SPEAKER SYSTEMS

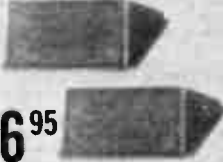

**6<sup>95</sup>**

- Full Range Response

Two—3 x 5" wide-range ceramic speakers mounted in plastic housing will mount under dash, under seats, on kick panels, doors, or rear package shelf. Includes all necessary cables and mounting hardware. Imported. Shpg. wt., 3 lbs. 99 T 62994 Net 6.95

### CUSTOM INDOOR SET OF FOUR SPEAKERS & MATCHING GRILLES



**8<sup>95</sup>**

Ready for quick installation. Improves the sound and performance of any car tape player. Kit includes: Four 4 3/4" extended range 8-ohm PM speakers; four round custom mount plastic speaker grilles; all necessary hook-up wire with solderless connectors; mounting hardware and easy-to-follow instructions. Imported. Shpg. wt., 3 lbs. 99 T 62861 Net 8.95

### DELUXE PAIR OF REAR DECK MATCHING SPEAKER SYSTEMS



**9<sup>95</sup>**

• 5 Watts Peak Handling Power  
 Set of two powerful 4" speakers mounted in handsome ebony plastic cabinets with silver trim. Specially designed to mount on car's rear deck. Can also be surface mounted anywhere. Provides outstanding sound reproduction. Includes all necessary cables and mounting hardware. 99 T 62966 Wt., 4 lbs. Net 9.95

## Pair of Trusonic Die-Cast Stereo Hi-Fi Speakers For the Car



**29<sup>95</sup>** Pair

With Grills and Mounting Hardware

- Frequency Response: 50-18,000 Hz

• For Door or Rear Deck Mounting • Power Handling: 12-Watts  
 The ultimate in auto speaker design. Powerful 5" full-range speaker delivers brilliant clean highs to 18,000 Hz and deep solid bass down to 50 Hz. Features rigid die-cast frame, free cone suspension, 2 lb. magnet structure and 1" edge-wound wire ribbon voice coil. Handles 12 full watts of power. Custom mounts in door panels or on rear deck. 99 T 49489 2-Speaker Kit Shpg. wt., 8 lbs. Net 29.95



# 1c BONUS

Pair of Deluxe LAFAYETTE Rear Deck Matching Speaker Systems  
For Only 1¢ with Purchase of a Ranger Car Player Listed Below  
**SAVE 9.94** Bonus Offer Expires on Dec. 31, 1970

## RANGER 4 and 8 Track Solid-State Stereo Car Tape Player

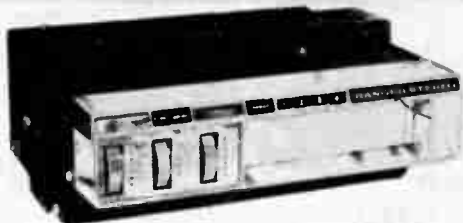

**79<sup>95</sup>**

Less Speakers

- Built-In Burglar Alarm
- Pushbutton Track Selector
- Individual Track Lights
- Fine Tuning
- Thumbwheel Control Knobs
- For 12 Volt Neg. Ground

A fully automatic 4- and 8-track stereo tape player with fine tuning control and built-in burglar alarm. Mounts easily under the dash of your car with attached universal bracket. Fully automatic—no switches or lever to select choice of cartridge. Either a 4 or 8-track cartridge slips in easily and plays instantly. Removal of cartridge automatically switches player off. Illuminated channel indicator shows channel that is playing. Channel changes automatically after each program. Separate thumbwheel Volume, Balance, and Tone controls. Size: 2 7/8" x 7 7/8" x 8". For 12 volt neg./pos. ground. Less speakers. Imported. Shpg. wt., 8 lbs.

17 T 74496W No Money Down\* Net 79.95

Ranger 4 and 8-Track Player plus Pair of Deluxe Speakers. Net 79.96

17 T 74611WM Shpg. wt., 12 lbs. No Money Down\* Net 79.96

Pair of Deluxe Matching Car Speaker Systems Only. Net 9.95

99 T 62966 Shpg. wt., 4 lbs. Net 9.95

## RANGER RR-62MPX Solid-State 8-Track Car Stereo Tape Player With FM Stereo Radio



**119<sup>95</sup>**

Less Speakers

- Built in Burglar Alarm
- Fine Tuning
- FM Stereo Indicator Light
- Pushbutton Track Selector
- Thumbwheel Control Knobs
- For 12 Volt Neg. Ground

Hide-Away tape cartridge opening with a functional, illuminated dial glass. When the cartridge is out, this unit looks and performs as an FM stereo radio producing crisp, clear, static-free reception. Insertion of the 8-Track Cartridge through the dial glass opening instantly converts the unit into a tape player. Built in burglar alarm. Fine tuning control. Channel changes automatically after each program or by manually operating the selector bar. Size: 3 1/4" x 8" x 9" D. 20 watts peak output. For 12 volt neg. ground. Less speakers. Imported. Shpg. wt., 12 lbs.

17 T 74595WX No Money Down\* Net 119.95

Ranger RR-62MPX Plus Pair of Deluxe Speakers. Net 119.96

17 T 74603WXM Shpg. wt., 16 lbs. No Money Down\* Net 119.96

Pair of Deluxe Lafayette Matching Car Speaker Systems only. Net 9.95

99 T 82966 Shpg. wt., 4 lbs. Net 9.95

## UNIVERSAL Lock Mount For Car Tape Players

Prevents Theft



**9.99**

- Remove Your Tape Player When Your Car is Unprotected

Prevent the theft of your car stereo tape player. Makes your player removable. Takes minutes to install. Adjustable mount adapts to car stereo tape players or CB transceivers. Once installed, no screws or wires are needed to disconnect player from mount. Plugs-in and locks. For 6 or 12 V. neg or positive ground. Dim.: 6 1/4" x 7 1/8" x 1 1/4".

17 T 63010 Shpg. wt., 1 lbs. Net 9.99

## UNIVERSAL FM Stereo Tuner Cartridge

Converts Stereo 8-Track and 4-Track Car Tape Players Into an FM Stereo Radio

**SPECIAL PURCHASE**  
For  
**50<sup>th</sup>**  
**Anniversary**

Only **29<sup>95</sup>** with Auto-Y antenna

Listen to full dimensional FM stereo radio broadcasts in your car. Inserts into your car tape player just like a regular tape cartridge. Requires a 9-volt battery (not included). Features instant-on solid-state circuitry, FM stereo indicator light, built-in AFC to prevent station drift, roll-bar FM tuning, and an auto-Y antenna. Size: 7 1/2" x 3 1/4" x 7/8" D. Imported.

17 T 43053 Shpg. wt., 1 lb. Net 29.95

99 T 60212 9V Battery for above Net .21



- FM Stereo Indicator Light
- Built-in AFC

\*See Page 18 for Full Credit Details on Easy Pay Plan

# 8-Track Stereo Tape Cartridge Players and Accessories

**NEW**

## Belair 323 Portable Stereo 8-Track Tape Cartridge Player



**69<sup>95</sup>**  
No Money Down\*  
With Batteries

Plays Anywhere

- (1) Portable—on 8 "D" Batteries
- (2) Home—on 110-120 VAC 60 Hz
- (3) Car—thru Cigarette Lighter

Listen to stereo 8-track tape cartridges wherever you go. Each detachable enclosure contains a high compliance 4-inch speaker for wide range hi-fi sound. Plays with each enclosure separated up to 8 ft. for maximum stereo separation, or in closed position with speakers snapped together for "walk-along" portability. Recessed handle for installation in book shelves. Instant-on solid state circuitry. Automatic or manual track selection. Built-in battery charger. Includes batteries and AC line cord. Color: Brown and beige. Size: 6¾" x 9½" x 9¼" H. Imported.

17 T 73001W Shpg. wt., 10 lbs. Net **69.95**  
Model BPR333—Same as above but with built-in AM/FM radio. Imported. Shpg. wt., 11 lbs. Net **94.95**  
17 T 73019W Car Cigarette Lighter Adapter Cord. Shpg. wt., 1/2 lb. Net **1.95**  
17 T 73027

**NEW**

## Belair 412 Portable Stereo 8-Track Tape Cartridge Player With Built-In AM/FM/FM Stereo Radio

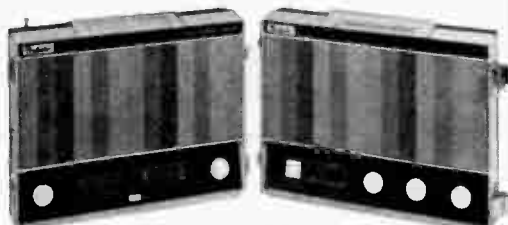

**139<sup>95</sup>**  
With Batteries, Car Adapter

Plays Anywhere

- (1) Portable—on 8 "D" Batteries
- (2) Home—on 110-120 VAC 60 Hz
- (3) Car—thru Cigarette Lighter

Handsome High Fidelity 8-Track Stereo Tape Cartridge player with a precision engineered AM, FM, FM Stereo Radio in "mod" styled portable design. Each detachable speaker contains a powerful 6 inch speaker for superb full frequency sound. Can be separated up to 8 ft. Includes cigarette lighter cord for car or boat, 8 "D" batteries for portable use, and an AC line cord for 110-120 VAC 60 Hz home use. Radio features AFC on FM to prevent drift, and a telescopic FM antenna. 8 track player has automatic or manual track selection. Built-in battery charger. Color: Brown and beige with decorative grill cloth. Size: 12¾" x 6¾" x 9¾" H. Imported. Shpg. wt., 12 lbs.

17 T 73035W No Money Down\* Net **139.95**  
Model BP410—Same as above but less AM/FM/FM Stereo Radio. Imported. Shpg. wt., 11 lbs. Net **99.95**  
17 T 73043W No Money Down\* Net **99.95**

## Qatron Automatic 8-Track Stereo Tape Player/Changer

- Plays Up To 12 Cartridges
- Instant-on Solid State Circuitry
- Just Hook-up 2 External Speakers for Complete Playback Systems

**299<sup>95</sup>**  
With Dust Cover

Up to 12 hours of continuous play. Automatically switches and selects 12 8-track tape cartridges in an easily removable rotary magazine. 4 Modes of operation—(1) Plays all channels of all tapes in sequence, (2) Plays random selection of tapes, (3) Plays individual tracks of each tape, (4) Repeat-play same cartridges. Aux. Inputs for AM/FM stereo tuner. Power output—30 watts (15 per channel). Requires set of 2 external speakers for complete playback system. Has Pre-Amp output for use with existing home stereo system. Separate tone and balance controls. For 117 VAC 60 Hz. Size: 18¼" x 9" x 16¼" D. Walnut vinyl finish base. Shpg. wt., 32 lbs.

27 T 28004WX No Money Down\* Net **299.95**



## Lafayette 8 Track Equipment Check Out and Demo Tape



**NEW**  
**2<sup>95</sup>**

- Tests And Balances Your Equipment
- Excerpts From Gayne Suite

Every owner of an 8-track tape system should have this tape. Tests and balances your equipment for optimum performance. Test part of tape includes: Speaker phasing, channel separation check, balance check, wow and flutter check. Demo part of tape includes organ and piano music plus excerpts from Gayne Suite by Khachaturian. Shpg. wt., 8 oz.

28 T 01371 Net **2.95**

## Deluxe 4 and 8 Track Tape Cartridge Storage Rack

**10<sup>95</sup>**

- Holds Up To 48 Tapes
- Lazy Susan Type Base

Easy access to your 4 and 8-track tape cartridges. No more misplaced tapes. Attractively styled wood and masonite storage rack with simulated walnut vinyl finish. Has "Lazy Susan" type base. Holds up to 48 tapes. Size: 9½" x 9½" x 12½" H.

28 T 78048W Shpg. wt., 8 lbs. Net **10.95**

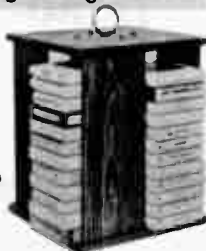

## Deluxe Carrying Case for 8-Track Tape Cartridges



- Holds Up To 24 Cartridges

Deluxe Lafayette all wood carrying case. Measures 17½" x 6½" x 7½" D. Black simulated alligator vinyl covering. Felt inserts, brass fasteners, and handle. Shpg. wt., 4 lbs.

28 T 78064W Net **7.95**

# Pre-Recorded 8-Track and Cassette Stereo Tapes



**POPULAR  
SERIES**  
**344**  
each

**Deluxe "Lafayette" Premier  
8-Track Pre-Recorded  
Stereo Tape Cartridges**

**CLASSICAL  
1 HR. SERIES**  
**398**  
each



**28 T 04088 THIS IS BROADWAY—My Fair Lady Overture, Wouldn't It Be Lovely, The Rain in Spain, I Could Have Danced All Night, plus many more.**

**28 T 04094 MUSIC FROM WEST SIDE STORY:** Hollywood Radio City Orchestra & Singers, London Pops Orchestra, Hollywood Light Opera, Al Goodman Orchestra.

**28 T 04102 MUSIC FROM CAMELOT:** Hollywood Radio City Orchestra & Singers, London Pops Orchestra, Hollywood Light Opera, Al Goodman Orchestra.

**28 T 04110 MUSIC FROM SOUND OF MUSIC:** Hollywood Radio City Orchestra & Singers, London Pops Orchestra, Hollywood Light Opera, Al Goodman Orchestra.

**28 T 04128 BIG BAND ERA—**Charlie Barnet, Woody Herman, Tito Puente, Bobo Valdez, Ernie Wilkins; Stardust, Canadian Sunset, Southern Fried, Serenade to May, and others.

**28 T 04136 IT HAPPENED IN MONTEREY (JAZZ) VOL. I—**Duke Ellington: Take The A Train, Solitude, others.

**28 T 04144 IT HAPPENED IN MONTEREY (JAZZ) VOL. II—**Miles Davis, Art Pepper, Bob Cooper: Blue Bird, Moment's Notice, Stable Mates, and others.

**28 T 04151 SILK, SATIN, AND STRINGS:** Velvet Strings Orchestra—Jalousie, Sleepy Lagoon, Holiday for Strings, and others.

**28 T 04180 DANCING AND DREAMING VOL. I—**Velvet Strings Orchestra: Somebody Loves Me, The Way You Look Tonight, The Breeze and I, plus others.

## VIVID SOUNDS—Those Were The Days Pre-recorded 8-Track Stereo Tapes

Columbia Orch. and Chorus

Those Were The Days, This Guy's in Love With You, Mrs. Robinson, MacArthur Park, What the World Needs Now, Love Is Blue, Walk On By, plus more.  
**28 T 17082 Shpg. wt., 10 oz. Net 2.98**

Only  
**2.98**



## VIVID SOUNDS—Country & Western Pre-recorded 8-Track Stereo Tapes

New Orleans—Anthony Armstrong, J. Jones Take A Letter Maria, Ruby Don't Take Your Love To Town, Everybody's Talking (Midnight Cowboy), One For The Road, and many more.

**28 T 17070 Shpg. 10 oz. Net 2.98**

Jeanie C. In Good Company—Jeanie C. Riley/Bonnie Guitar/Dori Heims Leave the Weeping to the Willow Tree, Faded Ribbons, I Don't Love Anymore, Neglected, and many more.

**28-T 17088 Shpg. wt., 10 oz. Net 2.98**



## Big Name Pre-Recorded Long Play 8-Track Stereo Tape Cartridges

**ONLY 3.95**  
EACH



**28 T 44066** Dean Martin—Young & Foolish.  
**28 T 44074** Dean Martin—I Can't Give You Anything But Love.

**28 T 44116** Glen Campbell—A Satisfied Mind.

**28 T 44181** Patsy Cline—I Can't Forget You.

**28 T 44025** Frank Sinatra—Nevertheless I'm In Love with You.

**28 T 44033** Sergio Mendes—So Nice.

**28 T 44264** The Music and Songs from "Hair."

**24 T 44009** Today's Pop's #1—Hey Jude, Those Were The Days, Abraham, Martin and John.

**28 T 44231** Today's Pops #2—Midnight Cowboy; Raindrops Keep Falling, Jean, plus others.

**28 T 44256** Today's Pops #4—Leaving on a Jet Plane, I'll Never Fall In Love Again, Money Come Back, plus others.

**28 T 04177 DANCING AND DREAMING VOL. II—**Velvet Strings Orchestra: Just One of Those Things, Last Time I Saw Paris, plus others.

**28 T 04003 BEETHOVEN SYMPHONY NO. 9 "CHORAL,"** London Symphony Orchestra, Joseph Krips, Conductor.

**28 T 04011 BEETHOVEN SYMPHONY NO. 1 AND BEETHOVEN SYMPHONY NO. 5,** London Symphony Orchestra, Joseph Krips, Conductor.

**28 T 04029 DVORAK: NEW WORLD SYMPHONY NO. 5,** London Symphony Orchestra, Leopold Ludwig, Conductor, STRAUSS—TILL EULENSPIEGEL'S MERRY PRANKS, Stadium Symphony Orchestra of N.Y., Leopold Stokowski, Conductor.

**28 T 04037 SMETANA: The Moldau—**Austrian Symphony Orchestra, TCHAIKOVSKY — THE NUTCRACKER SUITE — London Symphony Orchestra.

**28 T 04045 MUSSORGSKY: PICTURES AT AN EXHIBITION and RESPIGI: PINES OF ROMÉ.** London Symphony Orchestra, Malcolm Sargent, Conductor.

**28 T 04052 MOZART: EINE KLEINE NACHTMUSIK—**Viennese Chamber Orchestra and BARTOK: CONCERTO FOR ORCHESTRA—Houston Symphony Orchestra, Leopold Stokowski, Conductor.

**28 T 04060 RESPIGI: FOUNTAINS OF ROME —**London Symphony Orchestra, M. Sargent—Conductor. STRAUSS, DON JUAN—Stadium Symphony Orchestra, of N.Y. Stokowski—Cond., DEBUSSY: IBERIA, Rochester Philharmonic Orch., WAGNER: GOOD FRIDAY SPELL, Houston Symphony Orchestra.

**28 T 04078 RIMSKY-KORSAKOV—SCHEHERAZADE** London Symphony Orchestra—Gessen, Conductor and KHACHATURIAN: GAYNE SUITE, London Symphony Orchestra, M. Sargent—Conductor.

## LAFAYETTE Pre-Recorded Stereo Cassette Tapes

**YOUR CHOICE 2.95**  
each

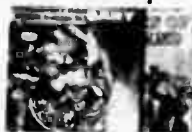

• Playable On Stereo or Monaural Equipment  
• Includes Sides A and B  
Shpg. wt., 5 oz. ea.

**28 T 41229L** Great Movie Themes—London Pops Orchestra—Exodus, Around the World in 80 Days, Picnic, Moulin Rouge, Merry Widow. Playing Time\* 28:51.

**28 T 41260L** Hits from Fiddler On The Roof, West Side Story, Pal Joey—Hollywood Radio City Orchestra and Chorus and London Pops Orchestra. Playing Time\* 27:53.

**28 T 41088L** Gershwin's Rhapsody in Blue—American in Paris—London Pops Orchestra. Playing Time\* 30:79.

**28 T 41096L** Hits from: My Fair Lady—Camelot—GiGi—Sound of Music—Hollywood Radio City Orchestra and Chorus. Playing Time\* 26:35.

**28 T 41104L** Hits from Oklahoma—South Pacific—King & I—Flower Drum Song—Hollywood Radio City Orchestra and Chorus. Playing Time\* 26:06.

**28 T 41112L** Hits from Music Man—Can Can—Porgy & Bess—Showboat—Hollywood Radio City Orchestra and Chorus. Playing Time\* 26:36.

**28 T 41187L** Andre Previn Plays: I've Got A Feeling I'm Falling, Black and Blue, Gypsy Dance, Money Suckle Rose plus other selections. Playing Time\* 25:54.

**28 T 41013L** 1812 Overture/Russian Eastern Overture/Polovetsian Dances/A Night On Bald Mountain—Vienna Symphony Orchestra. Playing Time\* 55:36.

**28 T 41021L** Bolero/Espana Rapsodie/The Sorcerer's Apprentice/Afternoon of the Faun—Vienna Symphony Orchestra. Playing Time\* 44:28.

**28 T 41054L** Rachmaninoff: Piano Concerto #2—Tchaikovsky: Piano Concerto #1—Felicja Blumental Solist, Orchester Der Wiener Musikgesellschaft, Playing Time\* 61:35.

## Free LAFAYETTE Pre-Recorded Stereo Tape Brochure

Complete Listing of all Lafayette Pre-Recorded Stereo Cassette, 8-Track, and Reel-to-Reel Tapes.

**28 T 03005** ..... No Charge

# Accessories For Cassette Players and Recorders

## DELUXE CASSETTE TAPE STORAGE CABINET



14<sup>95</sup>

- Holds Up to 32 Cassettes
- Store in Bookcase or on Wall, on Top of Desk, or Stereo Cabinet

Contemporary styling to fit every home. Beautiful Brazilian grained walnut finish. Attractive burgundy styrene sliding doors. Individual tape compartments. Size: 21 x 4 x 7 1/2" D. Shpg. wt., 5 1/2 lbs.

28 T 79098W

Net 14.95

## SOLID STATE CASSETTE AM & FM RADIO TUNERS



AM RADIO TUNER

FM RADIO TUNER

6<sup>95</sup>

12<sup>95</sup>

- Converts Most Cassette Tape Recorders and Players into a Sensitive Radio

Miniaturized, solid-state radio tuner circuit with self-contained battery (included). Same size as any standard blank or prerecorded cassette. Take it anywhere, play it anywhere. Plays directly through the amplifier and speaker system of your cassette player or recorder. High-impact break resistant case. Size 4x2 1/2 x 3 3/8". Imported. Wt. 1/2 lb.  
28 T 43019L AM Radio Tuner ..... Net 6.95  
28 T 43027L FM Radio Tuner ..... Net 12.95

## CASSETTE HEAD CLEANER AND TEST TAPE



149

### 3-in-1 Cassette

- 1) Tests for Proper Head Alignment
- 2) Tests for Stereo Balance
- 3) Cleans Tape Head

Keep your cassette player sounding like new with this professionally calibrated test tape. Cleans tape heads to restore full richness of tone. Checks for proper alignment of heads to eliminate crosstalk. Checks for proper balance and equalization of channels. Shpg. wt., 6 oz.

28 T 92024

Net 1.49

16 Lafayette Cat. No. 711

## CASSETTE TAPE CARTRIDGE STORAGE RACK

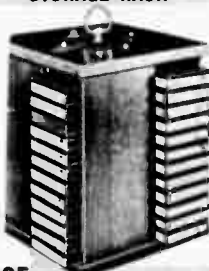

10<sup>95</sup>

- Holds Up To 48 Tapes
- Lazy Susan Type Base

Attractively styled wood and masonite cassette cartridge storage rack with simulated walnut vinyl finish. Has "Lazy Susan" type base for easy access to your cassettes. Size: 7 7/8 x 7 7/8 x 10" H. Shpg. wt., 3 3/4 lbs.

28 T 78056W

Net 10.95

## CASSETTE TEST STROBE

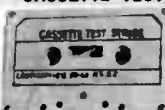

3<sup>90</sup>

Checks your cassette recorder/player for proper speed. Too fast causes flutter; too slow creates tape drag or wow. Strobe tape and light built into standard cassette. For 110 VAC 50/60 Hz. Shpg. wt., 5 oz.

28 T 72414

Net 3.90

## LAFAYETTE FOOT SWITCH



3<sup>95</sup>

Ideal for Stenographic Transcribing

Gives your cassette recorder the versatility of a dictating machine. Plays when the foot switch is depressed, stops when released. Simply plugs into "remote" jack, 5 ft. cable with micro-miniature plug. Imported. Shpg. wt. 1 lb

99 T 15810

Net 3.95

## CASSETTE TAPE HEAD MAINTENANCE KIT



Only

1<sup>95</sup>

Keeps heads in top operating condition. Contains cleaner, lubricant, applicators, brushes and convenient storage case.

28 T 78015

Shpg. wt., 1/2 lb. Net 1.95

## TAPE HEAD CLEANER



Only

99<sup>c</sup>

Use in any cassette recorder, removes coating deposits from tape heads, restores both volume and high frequency response. Can be reused many times. Shpg. wt., 6 oz.

28 T 16015

Net .99

## DELUXE CASSETTE TAPE CARRYING CASE



Only

7<sup>95</sup>

- Holds up to 30 Cassettes

Solid wood construction. Durable black alligator vinyl covering with attractive red plush interior. Horizontal storing of cassettes permits immediate visibility of all titles. Equipped with lock and key and handle.

28 T 78072

Shpg. wt., 3 1/2 lbs. Net 7.95

## NEW CASSETTE "CARRY-ALL" PORTABLE CASE



7<sup>95</sup>

Holds up to 6 Cassettes and Most Portable Cassette Recorders

Carry your cassette recorder, tapes and accessories in one handy case. Rich leather textured vinyl with sturdy compartments in a suede-like finished interior.

28 T 78114

Shpg. wt., 2 lbs. Net 7.95

## UNIVERSAL CARRYING CASE FOR PORTABLE CASSETTE RECORDERS



2<sup>95</sup>

- Measures 9 1/2" Dx 5 3/4" Wx 2 1/2" Ht

Durable black texon carrying case for most portable cassette recorders. Double adjustable strap. Shpg. wt., 1 lb.

28 T 72020

Dimensions of Case. Net 2.95

## CASSETTE CARRYING CASE



1<sup>95</sup>

Holds 12 Cassettes

Black vinyl with chrome trim, shoulder strap, and spring snap lock. Dim: 6 1/2 x 5 1/2 x 3 1/2" D.

28 T 27012

Shpg. wt., 1 lb. Net 1.95

Lafayette Stocks A Complete Line Of Tape Accessories



# LAFAYETTE RECORDING TAPES

## LAFAYETTE'S GUARANTEE—YOU BE THE JUDGE!



Lafayette's tape is made by outstanding nationally known manufacturers. It is first quality, splice free, red oxide coated, with full frequency response, uniform output and no "drop-outs." Resistant to moisture, heat,

cold and abrasion. If for any reason you are dissatisfied return the tape within 30 days and we will refund your money less only transportation charges. You are the sole judge.



### LAFAYETTE ACETATE RECORDING TAPE

Stock No.	Feet	Reel	Mils	Wt. lbs.	Net Per Reel		
					1-4	5-24	25 Up
28 T 01025	600	5"	1 1/2	1/2	.99	.99	.88
28 T 01033	900	5"	1	3/4	1.29	1.10	.99
28 T 01017	1200	7"	1 1/2	1	1.99	1.49	1.35
28 T 01041	1890	7"	1	1 1/4	1.99	1.89	1.79

### LAFAYETTE MYLAR® RECORDING TAPE

Stock No.	Feet	Reel	Mils	Wt. lbs.	Net Per Reel		
					1-4	5-24	25 Up
28 T 01056	1200	5"	1	3/4	1.75	1.59	1.42
28 T 01068	1800	7"	1 1/2	1 1/4	2.14	1.83	1.75
28 T 01074	2400	7"	1 1/2	1 1/4	3.10	2.79	2.81

\*Mylar is the registered DuPont trademark for its polyester film

### CRITERION® DELUXE BLANK TAPE CASSETTES



- Head Cleaning Tape on Each Cassette
- Super-Calendered Tape to Minimize Wear and Improve Frequency Response

- Sensing Foils to Actuate Machines with Reversing Mechanisms
- With Plastic Album Storage Box

Lafayette's best recording tape cassettes manufactured to our specifications, with extra deluxe features. Deep lubricated, super-calendered tape in an improved black plastic cassette, minimizes tape head wear and provides better low and high frequency response. Head cleaning tape at one end removes accumulated material from recorder heads. Sensing foils at each end actuate recorders having automatic reversing capabilities, but may also be used on all cassette recorders. Comes in hard plastic album storage box. Imported. Shpg. wt., 5 oz.

Stock No.	Model No.	Playing Time	NET EACH		
			1-9	10 up	10 up
28 T 01296	C-30	30 Minutes	1.23	1.11	
28 T 01306	C-60	60 Minutes	1.50	1.35	
28 T 01314	C-90	90 Minutes	2.40	2.16	
28 T 01322	C-120	120 Minutes	3.18	2.86	

### LAFAYETTE 8-TRACK CARTRIDGE

#### MYLAR RECORDING TAPE

As Low As **1.29**



Continuous loop 8-track cartridges well lubricated to preserve tape life. Fits all standard 8-track recorders and players. With UNI-tension pressure pads, precision molded tape guide. Shpg. wt., 6 oz.

Stock No.	Record Time	1-5	Net Ea.	
			6-11	12 up
28 T 01330	30 Min.	1.69	1.49	1.29
28 T 01348	60 Min.	1.95	1.79	1.49
28 T 01355	80 Min.	2.29	2.05	1.85

### SHAMROCK RECORDING TAPE



- Made by Leading U.S.A. Manufacturer
- Factory Boxed

POLYESTER TAPE ON 7 INCH REELS

1200 FT. 1 1/2 MIL	1800 FT. 1 MIL
AS LOW <b>99¢</b> of AS	AS LOW <b>1.29</b> of AS
AS 12	AS 12

1200 Ft. 1 1/2 MIL Shpg. wt., 1 lb.  
 28 T 19001 1-4 ea. 1.09 12 up .99  
 5-11 ea. 1.09 12 up .99  
 1800 Ft. 1 MIL Shpg. wt., 1 lb.  
 28 T 19010 1-4 ea. 1.59  
 5-11 ea. 1.49 12 up 1.29

### LAFAYETTE TENSILIZED MYLAR® TAPES

Stock No.	Feet	Reel	Mils	Wt. lbs.	Net Per Reel		
					1-4	5-24	25 Up
28 T 01090	300	3"	1/2	1/4	.89	.83	.59
28 T 01108	600	3 1/4"	1/2	1/2	.99	.90	.81
28 T 01116	1200	5"	1/2	1	2.25	2.03	1.83
28 T 01082	2400	7"	1/2	1 1/4	3.49	3.14	2.86
28 T 01231	3600	7"	1/2	1 3/4	4.99	4.49	3.99

### LAFAYETTE TAPE FOR AUTOMATIC REVERSING TAPE RECORDERS

Stock No.	Feet	Reel	Description	Net Per Reel		
				1-4	5-24	25 Up
28 T 01165	1200	5"	1/2 mil mylar	1.99	1.84	1.87
28 T 01173	1200	7"	1/2 mil acetate	1.84	1.73	1.82
28 T 01181	1800	7"	1 mil mylar	2.99	2.69	2.43
28 T 01199	2400	7"	1/2 mil teqs mylar	3.99	3.74	3.52

### LAFAYETTE ECONOMY BLANK TAPE CASSETTES



As Low As **69¢**

High quality tape assures full fidelity recording. Records and plays 2-tracks at 1 1/2 ips. Super strong polyester base. Proper lubrication for longer tape life. Protects heads. Imported. Shpg. wt., 4 oz.

Stock No.	Model No.	Playing Time	NET EACH		
			1-2	3-8	10 Up
28 T 01280	C-30	30 Minutes	.99	.79	.69
28 T 01223	C-60	60 Minutes	1.19	.99	.89
28 T 01207	C-90	90 Minutes	1.99	1.79	1.59
28 T 01215	C-120	120 Minutes	2.49	2.19	1.99

### CRITERION® C-60UD HI-FI CASSETTE



As Low As **2.20** in Lots of 25

- Wide Dynamic Range—30-20,000 Hz Response
- Super-Calendering Minimizes Wear and Improves Frequency Response
- Head Cleaning Tape on Each Cassette
- Sensing Foils to Actuate Machines with Reversing Mechanisms
- Low Noise—High Output

This Lafayette 60 minute ultra-dynamic hi-fi cassette is the only one having all of these deluxe features and represents the peak of cassette excellence. Advanced oxide formulation provides a wide dynamic range with a frequency response of 30-20,000 Hz. The low noise, distortion-free high output results in the highest performance that can be expected of a cassette tape. Each tape has a section of head cleaner at one end and sensing foils at each end to actuate equipment having automatic reversing capabilities, but may be used on all cassette recorders. In hard clear plastic hinged album storage box. Imported. Shpg. wt., 5 oz.

28 T 15851 1-11 Net ea. 2.89  
 12-24 Net ea. 2.59 25 or more 2.29

### PLASTIC CASSETTE STORAGE BOX



5 For **99¢**

Snap-open plastic box for individual cassettes. Clear hinged cover for instant identification. Built-in stops prevent tape slack and unwinding. Shpg. wt., 3 oz.  
 28 T 17054 Net ea., .25 Lot of 5 .99

# OPEN AN EASY-PAY CREDIT ACCOUNT TODAY

**EXTENDED  
PLAN**

**TAKE UP TO  
2 Years To Pay**

# 2

# EASY PAY CREDIT PLANS

**STANDARD  
PLAN**

**TAKE UP TO  
16 Months To Pay**

**TO SUIT YOUR INDIVIDUAL NEEDS**

Pay balance in 30 days and save the entire FINANCE CHARGE.\*

# NO MONEY DOWN

\* It's easy to open a credit account. Simply fill in application on back of order blank when you send your order.

\* Add-on any time you like. No money down and usually at no increase in monthly payment.

## EASY PAY PAYMENT SCHEDULE

\$250.01 to \$300.00		STANDARD PLAN		EXTENDED PLAN	
If Unpaid Balance (Amount Financed) Is From	To	Add for FINANCE CHARGE	Monthly Payment Is	Add for FINANCE CHARGE	Monthly Payment Is
\$490.01	\$500.00	\$64.75	\$35.00	\$98.00	\$25.00
480.01	490.00	63.50	34.50	96.00	24.50
470.01	480.00	62.25	33.50	94.00	24.00
460.01	470.00	61.00	33.00	92.00	23.50
450.01	460.00	59.50	32.50	90.00	23.00
440.01	450.00	58.25	31.50	88.00	22.50
430.01	440.00	57.00	31.00	86.00	22.00
420.01	430.00	55.75	30.00	84.00	21.50
410.01	420.00	54.25	29.50	82.00	21.00
400.01	410.00	53.00	29.00	80.00	20.50
390.01	400.00	51.75	28.00	78.00	20.00
380.01	390.00	50.50	27.50	76.00	19.50
370.01	380.00	49.00	26.50	74.00	19.00
360.01	370.00	47.75	26.00	72.00	18.50
350.01	360.00	46.50	25.00	70.00	18.00
340.01	350.00	45.25	24.50	68.00	17.50
330.01	340.00	43.75	24.00	66.00	17.00
320.01	330.00	42.50	23.00	64.00	16.50
310.01	320.00	41.25	22.50	62.00	16.00
300.01	310.00	40.00	22.00	60.00	15.50
290.01	300.00	38.50	21.00	58.00	14.50
280.01	290.00	37.25	20.00	56.00	14.00
270.01	280.00	36.00	19.50	54.00	13.50
260.01	270.00	34.50	19.00	52.00	13.00
250.01	260.00	33.25	18.00	50.00	12.50

\$100.01 to \$250.00		STANDARD PLAN		EXTENDED PLAN	
If Unpaid Balance (Amount Financed) Is From	To	Add for FINANCE CHARGE	Monthly Payment Is	Add for FINANCE CHARGE	Monthly Payment Is
\$240.01	\$250.00	\$32.00	\$17.50	\$48.00	\$12.00
230.01	240.00	30.50	17.00	46.00	11.50
220.01	230.00	29.25	16.00	44.00	11.00
210.01	220.00	28.00	15.50	42.00	10.50
200.01	210.00	26.50	15.00	40.00	10.00
195.01	200.00	25.75	14.50	39.00	9.75
190.01	195.00	25.25	14.00	38.00	9.50
185.01	190.00	24.50	13.75	37.00	9.25
180.01	185.00	23.75	13.50	36.00	9.00
175.01	180.00	23.25	13.00	35.00	8.75
170.01	175.00	22.50	12.50	34.00	8.50
165.01	170.00	22.00	12.00	33.00	8.25
160.01	165.00	21.25	11.50	32.00	8.00
155.01	160.00	20.50	11.00	31.00	7.75
150.01	155.00	20.00	10.75	30.00	7.50
145.01	150.00	19.25	10.50	29.00	7.25
140.01	145.00	18.50	10.50	28.00	7.00
135.01	140.00	16.75	10.50	27.00	6.75
130.01	135.00	16.25	10.25	26.00	6.50
125.01	130.00	14.50	10.25	24.00	6.50
120.01	125.00	14.00	10.00	23.00	6.25
115.01	120.00	12.50	10.00	21.00	6.25
110.01	115.00	12.00	10.00	20.00	6.00
105.01	110.00	10.50	10.00	18.35	6.00
100.01	105.00	9.25	10.00	17.50	5.75

The ANNUAL PERCENTAGE RATE of each FINANCE CHARGE set forth in the above tables is 17.75%. The number of payments will be the Total of Payments (Amount Financed plus the FINANCE CHARGES) divided by the amount of one monthly payment.

\$90.01 to \$100.00		STANDARD PLAN			EXTENDED PLAN		
If Unpaid Balance (Amount Financed) Is From	To	Add for FINANCE CHARGE	Monthly Payment Is	ANNUAL PERCENTAGE RATE	Add for FINANCE CHARGE	Monthly Payment Is	ANNUAL PERCENTAGE RATE
\$95.01	\$100.00	\$9.25	\$10.00	18.50%	\$15.65	\$5.50	17.50%
90.01	95.00	9.25	9.75	19.50	14.85	5.50	17.50
85.01	90.00	9.25	9.50	22.50	13.45	5.25	17.75
80.01	85.00	9.25	9.25	23.75	12.00	5.25	17.75
75.01	80.00	9.00	9.00	24.50	10.70	5.00	17.75
70.01	75.00	8.40	8.00	24.50	10.00	5.00	18.75
65.01	70.00	7.80	7.50	24.50	10.00	5.00	21.25
60.01	65.00	7.20	7.00	24.50	10.00	5.00	24.50
55.01	60.00	6.65	6.50	24.50	8.55	5.00	24.50
50.01	55.00	6.10	6.00	24.50	7.25	5.00	24.50

\$20.00 to \$50.00		STANDARD PLAN			
If Unpaid Balance (Amount Financed) Is From	To	Add for FINANCE CHARGE	Monthly Payment Is	ANNUAL PERCENTAGE RATE	
\$45.01	\$50.00	\$6.00	\$5.00	24.50%	
40.01	45.00	5.25	4.75	28.00	
35.01	40.00	4.75	4.25	26.75	
30.01	35.00	4.50	3.70	29.25	
25.01	30.00	3.50	3.35	30.00	
20.00	25.00	3.00	2.70	32.00	

OVER \$300.00. Please write for terms for amounts to be financed over \$300.00.

minimum ORDER—\$30  
minimum "ADD-ON"—\$20

Number of payments will be Total of Payments (Amount Financed plus the FINANCE CHARGE) divided by the amount of one monthly payment.

# 50<sup>th</sup> Anniversary 33<sup>1</sup>/<sub>3</sub> Stereo LP Album

made by Columbia Records Exclusively for Lafayette



Sensationally Priced!

Only **\$1.98**

## Let Us Entertain You

We Have Assembled 10 of the Most Outstanding Recording Artists to Help Celebrate Our 50 Years in the Electronics Business

The Ray Conniff Orch. and Chorus—Scarborough Fair.

Gary Puckett and The Union Gap—By The Time I Get To Phoenix.

Peter Nero—Aquarius.

Brothers Four—Abraham, Martin, & John.

Charlie Byrd—Those Were The Days.

Chicago—Wake Up Sunshine.

Aretha Franklin—If Ever I Would Leave You.

Leave You.

Percy Faith—Fool On The Hill.

Laura Nyro—Stone Soul Picnic.

Robert Goulet—For Once In My Life.

28 T 01405 Lafayette 50th Anniversary Stereo Album Shpg. wt., 1 lb. Net 1.98



## Panasonic SG-719 Battery/AC 2 Speed AM/FM Portable Radio Phono

## Lafayette 4-Speed Solid-State Phono with Built-in Color Lights



Instant-On Solid State Circuitry

**4.95**

2 Speeds—33<sup>1</sup>/<sub>3</sub> and 45 RPM  
Large 4" Wide Range Speaker  
Separate Tone and Volume Control

Handsome combination portable FM/AM radio and 2-speed manual phonograph. Sensitive FM/AM radio features; roll bar tuning dial, FM telescoping antenna, AM ferrite core antenna. Operates on 6 "D" batteries (incl.) or 117VAC 60 Hz. Two-Tone black and white. Size: 11<sup>3</sup>/<sub>4</sub> x 3<sup>3</sup>/<sub>4</sub> x 10<sup>3</sup>/<sub>4</sub>". Imported. Shpg. wt., 6<sup>3</sup>/<sub>4</sub> lbs. Net 49.95  
24 T 41184W "No Money Down"  
99 T 62564 Extra "D" batteries (6 req.) Net ea. .15

**Sale**  
**24.95**

WAS ~~29.95~~

Save 5.00

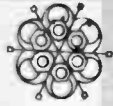

Become the center of attraction, the hit of the party with your psychedelic phonograph. Beautiful array of color lights are activated when a record is playing. Large, 3x5" front mounted speaker provides fine tonal quality. Plays all size monaural and stereo records at 16<sup>2</sup>/<sub>3</sub>, 33<sup>1</sup>/<sub>3</sub>, 45 and 78 RPM. A single lever selects any speed. 2 controls: On-Off/Volume (light intensity) and tone. Built-in 45 RPM adapter disc. Dual turnover cartridge with 2 synthetic needles. Case colors: bottom section—psychedelic blue, white, and orange; top section—blue; white portable carrying strap. Size: 12<sup>1</sup>/<sub>2</sub>Wx7<sup>1</sup>/<sub>2</sub>Hx 11"D. Shpg. wt., 10 lbs. Net 24.95  
24 T 02915W

## Lafayette LSC-50 Stereo Modular Hi-Fidelity Phono System featuring Two 360° Omni-Directional Speakers



  
Diamond Needle

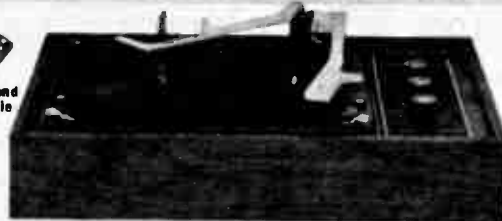

★ Instant-On Solid State Circuitry ★ Stereo Headphone Jack for Private Listening  
★ BSR 4-Speed Automatic Stereo Record Changer ★ 10 Watt Stereo Amplifier

**69.95**

with Dust Cover

Thrill to breathtaking hi-fi sound from our unique 3-piece modular hi-fi phono system featuring 2 omni-directional speaker systems with 360° sound dispersion. Solid state stereo amplifier has 3 controls: Volume Left, Volume Right, Continuous Tone (Bass/Treble), plus a stereo headphone jack. BSR 4-speed stereo automatic "Mini-Changer" features automatic shut-off after last record has been played. Plays all size records: 7", 10" and 12"; and all speeds: 16<sup>2</sup>/<sub>3</sub>, 33<sup>1</sup>/<sub>3</sub>, 45, and 78 RPM. Inter-mixes 12" and 10" records of the same speed. Tone arm

is equipped with a stereo turnover cartridge with diamond LP needle. Attractive wood cabinetry is covered with simulated walnut vinyl. Includes plastic dust cover, and speaker hook-up cable. Size: Amplifier/Changer Control Section—17<sup>1</sup>/<sub>2</sub>L x 10<sup>1</sup>/<sub>2</sub>D x 7"H (with tinted plastic dust cover); Speaker Systems (each): 9W x 9D x 12<sup>1</sup>/<sub>2</sub>"H. For 117 VAC, 60 Hz. Shpg. wt., 25 lbs.

24 T 03160WX No Money Down<sup>o</sup> Net 69.95  
24 T 02568 45 RPM Spindle 1.49

See Page 18 for Full Credit Details on Easy Pay Plan

Lafayette Cat. No. 711 19

# LAFAYETTE'S FINEST PORTABLE HI-FI PHONOGRAPHS

## A DELUXE SOLID STATE 4-SPEED AUTOMATIC STEREO PHONOGRAPH

with Detachable Speaker Enclosures



MODEL T33C

Made in U.S.A.

Only **99<sup>95</sup>**



Diamond Needle

No Money Down\*

- Garrard 4-Speed Automatic Intermix Changer with Diamond LP Needle
- 10 Watt Solid State Stereo Amplifier with 8 Transistors, 2 Diodes, and 2 Silicon Rectifiers
- 4 Speakers: Two 6" Heavy Duty Woofers—Two 3½" Tweeters Provide Dazzling Tone
- Stereo Headphone Jack plus 4 Controls: Loudness, Balance, Bass, Treble

Deluxe, solid state self-contained 4-speed automatic stereo phonograph in stylish "Swing-Down" design. Equipped with detachable speaker enclosures with built-in, 6' extension cords for wall-to-wall full dimensional sound realism. Each enclosure contains a heavy-duty 8" woofer and a 3½" tweeter for magnificent hi-fi sound reproduction. Powerful 10 watt solid state stereo amplifier has 12 semiconductor devices; features a stereo headphone jack for private listening plus 4 controls: Loudness, Balance, Bass, Treble. Quality Garrard 1000 4-speed automatic record changer plays all record sizes and speeds—7", 10" and 12" records at 16½, 33½, 45 and 78 RPM. Intermixes all size records of the same speed. Changer automatically shuts off after last record has been played and is equipped with a stereo turnover cartridge with diamond LP needle. Decorator designed wood cabinet is covered with simulated walnut and black washable vinyl material. Size: 21¼x12½x14¾". For 110-120 VAC 60 Hz. Shpg. wt., 33½ lbs.

24 T 02741WX ..... Net 99.95  
 24 T 02543 Replacement Needle for T33C ..... Net 2.49  
 24 T 02170 45 RPM Spindle for T33C ..... Net 3.00

## B LIGHTWEIGHT PORTABLE SOLID STATE 4-SPEED AUTOMATIC STEREO PHONOGRAPH

with Detachable Speaker Enclosures

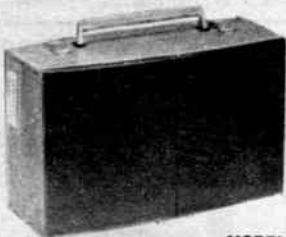

MODEL T60

Made in U.S.A.

Only **64<sup>95</sup>**



Diamond Needle

No Money Down\*

- Ultra Modern Cabinet Designed with Curved Top and Bottom
- BSR 4-Speed Automatic "Mini" Stereo Record Changer
- Each Detachable Enclosure Contains a Wide Range High Compliance 4" Air Suspension Speaker
- Built-in Stereo Headphone Jack with Private Listening Switch on Front Panel
- Solid State Stereo Amplifier with 8 Silicon Transistors and 3 Diodes

Take this portable stereo phonograph with you as often as you like, anywhere you like. Handsomely styled, it will give you years of dependable stereo listening. Two detachable lid-type speaker enclosures each contain a 4" high-compliance, acoustically matched, wide-range hi-fidelity speaker, and a 6 ft. extension cord enabling you to separate the speakers up to 12 ft. for magnificent full dimensional sound. Quality BSR record changer plays all size records at 16½, 33½, 45, and 78 RPM. Intermixes 12" and 10" records of the same speed. Instant-on solid state stereo amplifier employs 8 silicon transistors plus 3 silicon diodes. 3 Controls: separate volume for each channel plus tone. Built-in stereo headphone jack with private listening switch on front panel. Equipped with stereo turnover cartridge with diamond LP needle. Bold modern styling—curved top and bottom cabinet is covered with simulated walnut and black vinyl material. Size: 19½Wx12Dx 8¼"H. For 110-120 VAC, 60 Hz. Shpg. wt., 19 lbs.

24 T 02233WX ..... Net 64.95  
 24 T 02388 45 RPM Spindle for T60 ..... Net 1.49  
 24 T 02386 Replacement Dual Needle for T60 ..... Net 2.49

## C SLIM LINE 4-SPEED AUTOMATIC STEREO PHONOGRAPH

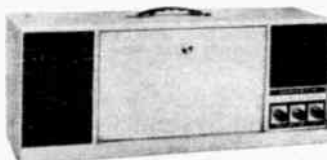

MODEL MS24C

Made in U.S.A.

Only **49<sup>95</sup>**



Diamond Needle

No Money Down\*

- Deluxe BSR 4-Speed Automatic "Mini" Stereo Record Changer
- 4 Transistors and 2 IC's • Two 4" Wide Range Speakers
- Stereo Headphone Jack plus 3 Controls

A truly outstanding performing stereo phono in a sleek cabinet of compact proportions. Designed with a drop-down hide away record changer compartment which folds away for maximum space saving efficiency. Features BSR 4-speed stereo automatic "Mini changer," with automatic shut-off. Plays all size records at 16½, 33½, 45 and 78 RPM. Intermixes 12" and 10" records of the same speed. Two separate 4" wide range speakers are acoustically balanced and spaced for true stereophonic full-dimensional sound. Powerful solid-state stereo amplifier with 4 transistors and 2 IC's provides instant-on operation—no warm up. 3 controls: volume left, volume right, and tone. Includes stereo headphone jack for private listening. Equipped with stereo turnover cartridge with diamond LP needle. Attractive, washable bright textured yellow sandalwood covering. For 110-120 VAC, 60 Hz. Measures 27½x10¼x6½"D. Shpg. wt., 16½ lbs.

24 T 03194WX ..... Net 49.95  
 24 T 02388 45 RPM Spindle for MS24C ..... Net 1.49  
 24 T 02386 Replacement Dual Needle for MS24C ..... Net 2.49

## D LOW COST 4-SPEED MANUAL PHONO

**14<sup>95</sup>**

Made in U.S.A.

- Instant-On Solid State Circuitry
- 4-Speeds: 16½, 33½, 45, 78 RPM
- Built-in 45 RPM Record Adapter

Ideal phono for the youngster in your family. Plays up to 12" monaural and stereo records at 16½, 33½, 45 or 78 RPM. A single lever selects any speed. "Feather-light" retractable tone arm is equipped with a single crystal cartridge. Volume control with on-off switch. Built-in 45 RPM record adapter. Fine quality 4" speaker. Attractive blue and white leatherette covered case. For 110-120 Volts, 60 Hz. Size: 12Wx9½Dx5"H. Shpg. wt., 6 lbs.

24 T 02725W ..... Net 14.95

## E DELUXE 4-SPEED MANUAL PHONOGRAPH

**19<sup>95</sup>**

Made in U.S.A.

- Speaker Front-Mounted for Full-Tone Sound Dispersion
- Front Mounted Controls for Convenience
- Built-in 45 RPM Adapter Disc
- Instantaneous ON Solid-State Circuitry

Plays stereo and monaural records of all speeds . . . 16½, 33½, 45, and 78 RPM . . . all sizes 12" 10", 7", 4" wide range speaker is set in front grill for full-tone sound dispersion. 2 front mounted controls—on/off volume and tone. Tone arm has dual turnover cartridge. Attractive blue washable plexin coated fabric with silver metal grill cloth. Size: 13½Wx6½Hx10¼"D. For 110-120 VAC, 60 Hz. Built-in 45 RPM record adapter.

24 T 02089W Shpg. wt., 7¼ lbs. ..... Net 19.95



A



**DELUXE  
4-SPEED STEREO  
PHONOGRAPH**  
with Detachable  
Speaker  
Enclosures  
MODEL T33C

Only **99<sup>95</sup>**  
No Money  
Down\*

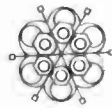

B

**LIGHTWEIGHT PORTABLE  
4-SPEED STEREO  
PHONOGRAPH**  
with Detachable  
Speaker Enclosures

**64<sup>95</sup>**

No Money Down\*



MODEL T60



C

**SLIM LINE  
4-SPEED STEREO  
MINI PHONO**

**49<sup>95</sup>**

No Money  
Down\*



MODEL MS24C  
2 IC's and  
4 Transistors



M5B

D

**4-SPEED  
MANUAL PHONO**

**14<sup>95</sup>**

Made in U.S.A.



M10C

E

**DELUXE 4-SPEED  
MANUAL PHONO**

**19<sup>95</sup>**

Made in U.S.A.

\*See Page 18 for Full Credit Details on Easy Pay Plan

# Fabulous LAFAYETTE 8-Track Stereo Phono Systems

## DELUXE Lafayette LSC-8000 SOLID-STATE 3-PIECE MODULAR AM/FM STEREO PHONO and 8-TRACK STEREO TAPE PLAYBACK SYSTEM

Plays Stereo Records, Stereo FM, AM/FM Radio Broadcasts and 8-Track Stereo Tape Cartridges



**229<sup>95</sup>**

With Tinted Plastic Dust Cover and 45 RPM Spindle

Two 3-Speaker Acoustic Suspension Speaker Systems

- 100 watt I.P.P. Stereo Amplifier
- FM Stereo Indicator Light and Tuning Meter
- Garrard 4-Speed Automatic Record Changer with Cueing

The ultimate in a 3 piece Modular stereo phono system. Start with a handsome Control Center containing a powerful solid state 100 watt, I.P.P. AM/FM stereo Tuner/Amplifier. Add to the Control Center: (1) A famous professional Garrard 4 speed Automatic stereo record changer with anti-skating and cueing devices, (2) a deluxe 8 Track stereo Cartridge Player with an AC hysteresis motor. Take the two perfectly balanced full range 3 Speaker Acoustic Suspension Systems and plug them into the control center (cable is included). You now have a magnificent performing system that permits you to enjoy the finest in hi-fidelity music listening. **Specifications:** Garrard changer: 4 speeds—16 $\frac{1}{2}$ , 33 $\frac{1}{2}$ , 45, 78 RPM. Intermixes records of the same speed. Tone arm has VACO TN-4 turnover stereo ceramic cartridge with Diamond LP needle. 8 Track Stereo Tape

- Stereo Headphone and Remote Speaker Outputs
- Individual Illuminated Track Indicator Lights
- Pushbutton Track Selector

**Cartridge Player:** Individual Illuminated Track Indicators, Pushbutton Track Selector—100 watt Solid state I.P.P. AM/FM Stereo Tuner Amplifier: 6 Controls—selector, balance, treble, bass, volume, tuning; FM Tuning meter; FM stereo indicator light, stereo Headphone jack, Main and remote speaker output jacks, Guitar mike input; Tape Input jacks; AC Convenience outlet. Each Acoustic Suspension Speaker System contains one 6 $\frac{1}{2}$  woofer, and two 3 $\frac{1}{2}$  tweeters. Freq. response 50-19,000 Hz. Beautiful walnut vinyl wood cabinetry. Includes tinted plastic dust cover and 45 RPM Spindle. Size: Control Center: 23 $\frac{1}{2}$ "W x 9 $\frac{3}{4}$ "H x 15"D, Speaker System 14 $\frac{7}{8}$ "H x 11 $\frac{1}{4}$ "W x 6 $\frac{1}{2}$ "D. For 110-120 VAC, 60 Hz. 24 T 83289WX Shpg. wt., 63 lbs. No Money Down\* Net 229.95 24 T 83292 Replacement needle for LSC8000 Net 2.49

## Lafayette LSC-888 SOLID-STATE 3 PIECE MODULAR STEREO PHONOGRAPH and 8-TRACK STEREO TAPE SYSTEM



Diamond Needle



Tinted Plastic Dust Cover

**149<sup>95</sup>**

With Tinted Plastic Dust Cover and 45 RPM Spindle

Magnificent Low-Line Silhouette Styling

- Garrard 4-Speed Automatic Record Changer with Cueing
- 20 Watt Solid-State Stereo Amplifier
- Stereo Headphone Jack
- Input For Tuner or Tape Recorder
- Individual Illuminated Track Indicator Lights
- Pushbutton Track Selector
- Each Speaker Enclosure Contains An 8" Woofer and a 4" Tweeter

Deluxe 3-piece stereo music system plays both stereo phonograph records and stereo 8-track tape cartridges. You get superb hi-fi performance and versatility. The magnificent vinyl walnut and ebony low-line silhouette styling of the control center will blend into any decor. Each brilliant-sounding, 2-way 8" Speaker System contains a powerful 8" woofer and a 3 $\frac{1}{2}$ " super tweeter housed in a handsome vinyl walnut covered wood enclosure. The professional Garrard Stereo Record Changer with tubular tone arm, cueing, and diamond stylus plays 12", 10" and 7" records at 16 $\frac{1}{2}$ , 33 $\frac{1}{2}$ , and 45 and 78 rpm. Operates manually or automatically. The 8-Track Stereo Cartridge

Tape Player features individually illuminated track indicators and a pushbutton track selector switch. The All Transistor 20 Watt Stereo Amplifier has six controls: Treble, Bass, Balance, Volume, On/Off switch, Phono/Aux selector switch as well as inputs for stereo tuner or tape recorder and a front panel stereo headphone jack. Also includes a tinted plastic dust cover and 45 rpm spindle. Size: Control Center—23 $\frac{1}{2}$ " x 4H x 14"D; each speaker system—15H x 10W x 4 $\frac{7}{8}$ "D. For 110-120 VAC., 60 Hz. Shpg. wt., 50 lbs. 24 T 8328WX No Money Down\* Net 149.95 24 T 83292 Replacement needle for LSC 888 Net 2.49

# DELUXE LAFAYETTE LRC-60T

## 75-Watt Solid-State AM/FM Stereo Receiver/Turntable Control Center



AAM Guarantee  
See Page 15.

- Powerful 75 Watt AM/FM Stereo Receiver
- Famous BSR McDonald 500 Stereo Automatic Turntable
- Pickering V15/AC-3 Dustomatic™ Stereo Cartridge with Diamond Needle
- Superbly Crafted Oiled Walnut Wood Cabinetry

Lafayette's finest AM/FM stereo compact control center is engineered to reproduce brilliant sound from a specially designed chassis of minimum size. The superb LRC-60T consists of a 75 watt AM/FM stereo receiver with FET front-end and 4 IC's, plus the famous BSR McDonald 500 4-speed automatic stereo turntable with a Pickering V15/AC-3 dustomatic stereo cartridge, all mounted in a superbly crafted and styled oiled walnut wood cabinet. You get a stunning blend of beauty and performance from a truly space saving compact control unit. With the superb Lafayette Criterion 50A speaker system listed below you have a magnificent component Hi-Fi system. The receiver section uses an FET (Field Effect-Transistor) FM tuner, and 4-Integrated Circuits (IC's): An IC is a complete circuit in miniature, in which all components: transistors, diodes, resistors, etc. are etched into a silicon wafer. The IC provides significantly better front-end performance and greater sensitivity enabling you to hear more stations with less noise and interference. Deluxe McDonald 500 turntable features a low mass tubular tone arm, micrometer stylus pressure adjustment, dynamic anti-skate control, and a cueing and pause control. Plays 7, 10, or 12" records at



### \$1.00 Bonus

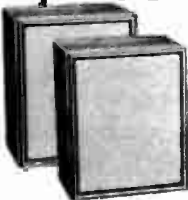

### SAVE 39.90

Buy 2-Criterion 25A Speaker Systems For Only \$1.00 with The Purchase of LRC-60T

## 229<sup>95</sup>

Less Speakers

## 230<sup>95</sup>

with 2 Criterion  
25A Speaker Systems

16 $\frac{2}{3}$ , 33 $\frac{1}{3}$ , 45, and 78 rpm. Amplifier delivers wide-range response of 20-20,000 Hz  $\pm$ 1db, plus full 75 watts  $\pm$ 1db, 60 watts IHF power. Impedance: 8-16 ohms. FM Sensitivity: 1.8 $\mu$ v IHF. 11-audio controls, plus precision D'Arsonval tuning meter, automatic FM stereo/mono switching, stereo FM indicator light, stereo headphone jack, tape recorder jacks, and precision vernier dial drive for accurate, effortless tuning. The rich oiled walnut cabinetry with slanted brushed aluminum front panel and controls will harmonize with any home decor. Control Center: 16 $\frac{3}{8}$ "W x 7" H x 15 $\frac{3}{8}$ "D. Imported. Shpg. wt., 49 lbs.

99 T 01893WX LRC-60T No Money Down\*

Net 229.95

SAVE 38.90 LRC-60T plus 2-Criterion 25A Air Suspension Speaker Systems. See Page 64 for description of Criterion 25A's. 99 T 99764WXM No Money down\* Shpg. Wt. 28 lbs. Net 230.95

TINTED PLEXIGLAS DUST COVER for LRC-60T. Size 15 $\frac{3}{8}$ "x13 $\frac{3}{8}$ "x4 $\frac{1}{2}$ ". 24 T 09050W Shpg. wt., 1 lb. Net 8.95

## Lafayette LSC-25 Solid-State 3-Piece Stereo Modular Hi-Fi Phono System

# 49<sup>95</sup>



Includes  
Tinted Plastic Dust Cover

- Two 4" Wide-Range Acoustically Matched Speaker Systems
- Ultra-Modern Low Profile Styling
- Stereo Headphone Jack for Private Listening
- Famous BSR 4-Speed Automatic "Mini" Record Changer

Component inspired design. Now a stereo hi-fidelity phonograph with the advantages of separate components. Our handsome 3-piece modular hi-fi phono system features a control unit containing a 10-watt I.P.P. solid-state stereo amplifier and a BSR 4 speed automatic "mini-changer" mounted in a simulated high-impact black leather plastic base with walnut vinyl trim. Each magnificent sounding matching speaker system can be ideally spaced for proper stereo separation. They can be placed on a bookshelf, hung on a wall, or set on end-tables. The amplifier has a stereo headphone jack for private listening and 3 controls: volume left, volume right and tone. BSR 4-speed automatic "mini-changer" features automatic shutoff



Diamond Needle

after last record has been played. Plays all size records—7" 10", 12" and all speeds—16 $\frac{2}{3}$ , 33 $\frac{1}{3}$ , 45, and 78 RPM. Intermixes 12" and 10" records of the same speed. Tone arm is equipped with a stereo turnover cartridge with a diamond LP needle. Includes a tinted plastic dust cover for the control unit. Size: Control Unit—10 $\frac{1}{4}$ "Wx16 $\frac{1}{2}$ "Lx 6 $\frac{1}{2}$ "H. Speaker—7 $\frac{3}{8}$ "Wx9 $\frac{1}{2}$ "Lx4"D. For 110 VAC, 60 Hz. 24 T 03236W Shpg. wt., 18 lbs. Net 49.95

ACCESSORIES for LSC-25

24 T 02386 Replacement Needle for LSC-25. Wt., 3 oz. Net 2.49  
24 T 02568 45 RPM Spindle for LSC-25 Net 1.49

\*See Page 18 for Full Credit Details on Easy Pay Plan

# Electronic Audio Color Organs

**Deluxe**

**Lafayette 4 Channel Frequency Synchronized Sound Actuated Color Lights**

**3-Sided Prismatic Color Audio Lites**



Only **79<sup>95</sup>**

- Giant 28½" by 13½" Screen
- 4 Adjustable Color Controls
- Continuously Flowing Color Images
- Instant-on Solid State Circuitry

A sophisticated electronics system that provides true synchronization of color and sound. See every tone, each note, and every combination of instruments create its own vivid color pattern. The system includes 4 color channels: red, blue, green and yellow that are everchanging, interweaving, and blending to produce fantastic, spontaneous, frequency synchronized multi-color patterns to the music reproduced by your speakers. Connects in seconds to your Hi-Fi system or guitar amplifier without any loss in sound quality or volume. All solid state integrated circuitry. 4 adjustable color controls and a sensitivity control. Handsome walnut vinyl covered wood cabinet. Size: 30 x 15 x 11". For 117 VAC 60 Hz. Shpg. wt., 31½ lbs.  
21 T 03000WX No Money Down\* ... Net 79.95



- Sound Actuated
- 18 x 11 x 7"

**26<sup>95</sup>**

Color Lights priced to fit your budget. One piece 3 sided prismatic lens produces a panorama of colors that have a 3 dimensional effect. Solid state electronic control transposes music sound impulses into multi-color flashing light patterns. Hooks up to speaker leads of any sound source. For 117 VAC 60 Hz. Size 18x11x7". Walnut vinyl grained wood cabinet. Shpg. wt., 8 lbs.  
13 T 75526W ..... Net 26.95

**Eico 4 Color Sound Actuated Color Lights**

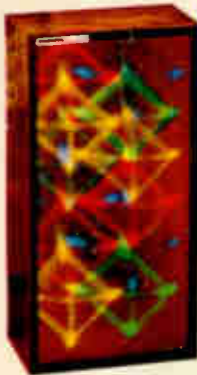

**39<sup>95</sup>** • Easily Connects to Speaker Leads  
• No Loss in Speaker Volume

Low cost, 4-color, solid-state sound actuated color organ. You can actually see every note and tone converted to a brilliantly moving panorama of colored, dancing images with each note and tone produced by the music. Flashing red, blue, green and yellow colors create an entertaining display of multi-color, 3-dimensional spontaneity which varies to the amplitude of the sound source. Hi-/low inputs allows you to adjust for music power levels; exclusive 4-in-1 color control. Housed in walnut wood grained cabinet. For 110 VAC 60 Hz. Size: 24x12x10". Shpg wt., 10 lbs. No Money Down\*  
21 T 25904W ..... Net 39.95



**"Color Column" Audio Lites**

**44<sup>95</sup>**

- 21"H x 7"D
- Full Spectrum of Abstract Color Lighting

Handsome table-top color columns only 21"H x 7"D. Magnificent abstract color images in everchanging motion. These unique color cylinders make flashing patterns of colored lights pulsating to the rhythm of your music. Hooks up to the speaker leads of your Hi-Fi system, tape recorder, or guitar amplifier. Column is constructed of unbreakable polycarbonate plastic with "Brite" chrome base. For 117 VAC. Shpg. wt., 7 lbs. No Money Down\*  
13 T 75534W ..... Net 44.95

**Eico Strobe Lights**

**Kit or Factory Wired**



Kit **24<sup>95</sup>**

Wired **39<sup>95</sup>**

Model 3470 Solid State Electronic Strobe Lite. Solid state single head strobe lite with speed control that can be adjusted to the music beat. Ideal for the preferred lighting effects now in use by combo groups, discoteques, etc. For 117 VAC, 60 Hz. Size: 6½" x 9½" x 5½"  
21 T 25839 Model 3470 Kit Shpg. wt., 5 lbs. .... Net 24.95  
21 T 25847 Model 3470 Wired. No Money Down\* ..... Net 39.95

**3-Channel Color Lights**

**With Built-In Speaker**



**New 49<sup>95</sup>**

Unique combination sound actuated color lights with built-in wide range 5½" high compliance speaker. As you enjoy listening to your favorite music watch a dynamic sweep of endless shifting color patterns responding to changes in the intensity and tempo of the music. 3-way switch permits use as a speaker only, color lights only, or both together. Sensitivity control. Walnut vinyl grain finish. Size: 12 x 24 x 5". Shpg. wt., 10 lbs. No Money Down\*  
13 T 51501W ..... Net 49.95



50th anniversary

# 50<sup>TH</sup> ANNIVERSARY CLEARANCE SALE

Some Quantities Limited—Buy Now—Sale Ends Dec. 31, 1970

## LAFAYETTE POLARIS 2.4" EQUATORIAL REFRACTOR TELESCOPE

NOW **49<sup>50</sup>**

WAS 59.95  
1970 Cat. 701

**\$10.00  
PRICE  
CUT**

- 320X With Barlow Lens

Eyeieces for 160x, 88x, 40x. Barlow Lens gives 320x, 176x, 80x, 800mm focal length. 62mm objective. Micromotion adjustments on both axes. Coated optics throughout. Equatorial mount. Accessories include sunglass, star diagonal, erecting prism, sun projection screen, field tripod, wooden case. Rack-and-pinion focusing. Imported. Shpg. wt., 30 lbs.  
99 T 70328WX No Money Down\* Net 49.50



(Available Syosset Only)

## LAFAYETTE CRITERION IV SOLID STATE PROFESSIONAL FM RADIO FEATURING 5" ACOUSTIC SUSPENSION SPEAKER

**\$10.00 PRICE CUT**

NOW **39<sup>95</sup>** WAS 49.95  
1970 Cat. 704

(Available Syosset Only)



- Magnificent Sound Quality from a Special Self-Contained 5" High Compliance Acoustic Suspension Speaker System

Genuine oiled walnut veneer cabinet. Tuned RF FM stage. Tape recorder input and output. Instant-on 17 transistor 5 diode solid state circuitry. Main-remote speaker switch. External speaker jack. Built-in FM antenna. For 110-120 VAC 50/60 Hz. Imported. Shpg. wt., 12½ lbs.  
99 T 35255W No Money Down\* Net 39.95

### LAFAYETTE BINOCULAR MAGNIFIER

**NEW  
LOW  
PRICE  
2<sup>49</sup>**



(Available Syosset Only)

- Leaves Hands Free
- Reduces Eyestrain

3 x 4½" working distance. Ideal for technicians, inspectors and hobbyists. Precision ground and polished lenses for very close work without eyestrain. Headband adjusts to any head size. Lenses can be changed with pushbutton ease for three magnifying powers. Flip up viewer may be worn over eyeglasses. Imported. Shpg. wt., 7 ozs.  
99 T 72050 Net 2.49

### LAFAYETTE TIE-CLIP SUBMINIATURE MICROPHONE

**NEW  
LOW PRICE 1<sup>49</sup>**



- Only 1½" x ½" x ⅝"

Decorative microphone is only 1½ x ½ x ⅝", mounted on a 1½" clasp. Frequency range, 200 to 5,000 cycles—more than adequate for perfect speech intelligibility. Impedance, Approx. 1600 ohms. With cord and miniature plug. Imported. Wt., 3 oz.  
99 T 45676 Net 1.49

### LAFAYETTE MIKE FOR HOME RECORDING

**NEW  
LOW  
PRICE  
1<sup>49</sup>**



An outstanding Lafayette microphone for home use. Frequency response: 100-10,000 Hz ±10 db. Output level: —57 db at 1000 Hz. Impedance: 50,000 ohms. Complete with 5' shielded cable. Size 2" W x 3" H x 7/8" D. Imported. Shpg. wt., 8 oz.  
99 T 45023 Net 1.49



50th  
anniversary

# 50<sup>TH</sup> ANNIVERSARY CLEARANCE SALE

Some Quantities Limited—Buy Now— Sale Ends Dec. 31, 1970

## TRUTEST® 150 SOLID STATE RECORDER



**\$5.00 PRICE CUT** NOW **9<sup>95</sup>**

WAS 14.95 CAT. 710

Includes:  
Remote Control Mike,  
3" Reel of Recording Tape,  
Take-up Reel, Earphone,  
Carrying Strap, and Batteries

Operates from batteries or 117 VAC with optional adapter. Dynamic microphone has its own remote control on/off switch for taping "letters." Jam-proof piano style pushbuttons simplify operation. Convenient earphone for monitoring recordings, or, for private listening. Uses 2—1.5V., and 1—9V battery. Reel size: 3 1/4". Size: 8 3/4 x 3 1/4 x 6 1/2"D. Imported. Shpg. wt., 2 1/4 lbs. (with batteries).

99 T 15562L

Net 9.95

### ACCESSORIES FOR TRUTEST® 150

99 T 35370 117V AC Adapter	6 oz.	3.95
99 T 60212 Extra 9V Bat. (1 req.)	2 oz.	.21
99 T 62572 Extra "C" Cell (2 req.)	2 oz.	.14

## LAFAYETTE SUPER 8 REFLEX ZOOM MOVIE CAMERA



**BELOW COST**

NOW **29<sup>95</sup>**

WAS 39.95 1970 CAT. 701

- f/1.8 Zoom Lens
- Automatic Thru-The-Lens CdS Electric Eye

Automatic thru-the-lens CdS electric eye exposure. Fast f/1.8 zoom lens from 12 to 30mm, for wide angle, normal, and telephoto shots. Focuses from 5 ft. to inf. Battery-powered motor drive, built-in type A filter, footage counter, film transport signal, and adjustable eye piece. Imported. Shpg. wt., 2 1/2 lbs.

99 T 72167L	Net 29.95
15 T 16103 Camera Case for above	Net 3.95
99 T 62580 Batteries (4 req.)	Net ea. .10

## LAFAYETTE PORTABLE "ROCKBEAT" RHYTHMER

**\$10.00 PRICE CUT** NOW **29<sup>95</sup>**

WAS 39.95 1970 CAT. 704

Completely automatic. Select any one of six rhythms: swing trot, down beat, jazz rock, rock beat, 4 beat, and slow ballad. Rhythm can be changed even while the "Rockbeat" is in operation. Use Solo or in a group. Tempo control varies beat. Separate pushbutton permits add-lib solo drum beat. Plugs directly into amplifier. Separate jacks for foot-pedal operation. Size: 7 1/2 x 7 1/2 x 1 3/8". Operates on a 9V transistor battery or with the optional AC adapter. Imported.

99 T 90102 No Money Down\* Shpg. wt., 3 lbs.  
AC adapter. Shpg. wt., 1/2 lb.

Net 29.95

Net 2.59

## PANASONIC RC-7148 SOLID-STATE AM/FM DIGITAL CLOCK RADIO

- 30 Minute Sleep Timer
- Full-Range 4" Speaker

The RC-7148 features a digital clock and a superb solid-state AM/FM radio in an attractively styled modern cabinet, designed to complement the most exacting home decor or executive suite. Digital clock wakes you up to music or by a buzzer alarm. A 30 minute sleep timer tells you to sleep with music, then shuts off automatically. AM/FM radio features convenient slide-rule tuning. AFC on FM, and built-in AM/FM antennas. Size: 9 1/2" x 4 1/2" x 8 1/2" D. Imported. Shpg. wt., 5 lbs. 17 T 30993 No Money Down\* Net 34.95

**\$15.00 PRICE CUT**

NOW **34<sup>95</sup>**

(Available Syosset Only)

WAS 49.95



See Page 18 for Full Credit Details on Easy Pay Plan

Lafayette Cat. No. 711 24B

# Deluxe LAFAYETTE LR-20 Solid State AM/FM Stereo System With Two Separate Matching Oiled Walnut Speakers

**20.00** Price Cut  
NOW **79.95** No Money Down\*  
WAS **99.95**  
Catalog 710



**LAFAYETTE MC22 4-Speed "Mini" Stereo Record Changer**

Only **34.95** Ideal For LR-20 System

Comes pre-mounted on simulated black leather base with walnut vinyl trim, tinted plastic dust cover and diamond LP needs. Dimensions: 14 1/2 x 5 x 10". Shpg. wt., 10 lbs. 21 T 01032W Net 34.95  
See page 68 for full description of MC22.

- 26 Transistors, 18 Diodes, and 4 Thermistors For 12 Watts of Music Power To Drive The Two Full Range 6 1/2" Speaker Systems
- Automatic FM Stereo Switching
- Stereo Headphone Input Jack
- Tape Input and Output Jacks

Provides brilliant and rewarding AM/FM Stereo performance. Includes many of the deluxe features normally found only in more expensive hi-fi stereo music systems. The LR-20 employs the latest solid-state devices, and because of the amazing reliability of these devices, you are assured of superior performance for years to come. Two separate 6 1/2" rich sounding, wide range, matching oiled walnut wood speaker systems permit you to enjoy true stereo separation. The LR-20 features a Stereo Indicator light; Automatic FM Stereo Switching; Full complement of controls; Function Selector for AM, FM, FM AFC; Phono-Aux; Volume/Balance; continuous tone (Balance/Treble); mode switch

(Stereo/Mono); Loudness compensator switch; stereo headphone jack; tape recorder input and output jacks; phono input jack. Ferrite AM antenna and FM line cord antenna, as well as connection for external FM antenna. FM RF section features a 3-gang variable tuning capacitor and connection for external 300-ohm antenna. Overall FM Sensitivity: 7  $\mu$ v. Stereo Separation: 30 db at 400 Hz. Amplifier Output: 12-watts. Control unit is housed in a handsome simulated walnut metal enclosure. For 117VAC, 50/60 Hz. Size: Control Unit—15Wx4 1/4Hx10 1/4"D; Speakers—7 1/2Wx9 3/4Hx5 3/4"D. Imported.

99 T 35495W Shpg. wt., 29 lbs. — Net 79.95

## Deluxe LAFAYETTE Full Feature Walnut Wood AM/FM Digital Clock Radio

**49.95**

With Earphone For Private Listening

**Big Full Feature Illuminated 24 Hour Leaf-Type Digital Clock**



- Prismatically Illuminated Precision Slide Rule Tuning Dial with Logging Scale
- 60 Minute Automatic Shut-Off Timer
- Separate Digital Control For Waking You Up At a Preset Time to Radio, or Alarm and Radio
- Continuous Tone Control • AFC to Prevent Drift on FM logging scale. Wide-range 3 1/2" speaker baffled in a wood cabinet provides rich, brilliant sound. Continuous tone and volume controls AFC for drift-free FM performance. Highly Sensitive FM AC line cord antenna. Ferrite core AM antenna. Earphone for private listening. Size: 4 1/4" x 12" x 5 3/4". Shpg. wt., 4 1/2 lbs. Imported. For 117VAC 60Hz.

17 T 01135W No Money Down\* Net 49.95

\*See Page 18 for Full Credit Details on Easy Pay Plan

# Popular Priced Table and Clock Radios.

## LAFAYETTE "MAGIC CUBE" FULL FEATURE SOLID STATE AM/FM CLOCK RADIO

- 60 Minute Sleep Switch
- 10 Minute Snooze Button
- Soft-Glow Electro-Luminescent Panel

**27<sup>95</sup>**

With Earphone for Private Listening

Compact and futuristic in styling and design. Only 4½"W x 4½"D x 5¾"H including pedestal. Will add to the decor of any bedroom, den or kitchen. Full-feature Telechron clock with alarm, sleep switch and snooze button. Wake up to beautiful music from the super sensitive solid-state AM/FM radio. Handsome walnut grain plastic cabinet. Features a large 3" speaker for full-bodied tone and AFC circuitry to prevent drift on FM. Built-in ferrite core AM antenna. Line-cord FM antenna. For 117 VAC, 60 Hz. Imported. Shpg. wt., 3 lbs. Net 27.95  
17 T 01879

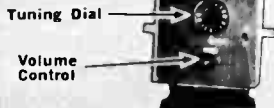

Tuning Dial

Volume Control



## PANASONIC RE6137 SOLID-STATE FM-AM TABLE RADIO

**24<sup>95</sup>**

- AFC For Drift-Free FM Performance

Fine performing FM/AM radio features rich tonal quality from its large 4" full range dynamic speaker. Its smart, functional low profile styling will be a pleasing addition to the decor of any home or apartment. Dependable and reliable solid-state semiconductor circuitry. Precision sidetune tuning. AFC for drift-free performance on FM. With FM line cord antenna and built in ferrite core antenna. Handsome high impact antique white plastic case. Size: 12"x5¼"x4¼". Imported. For 110-120 VAC 60 Hz. Net 24.95  
17 T 30803W Shpg. wt., 4 lbs.

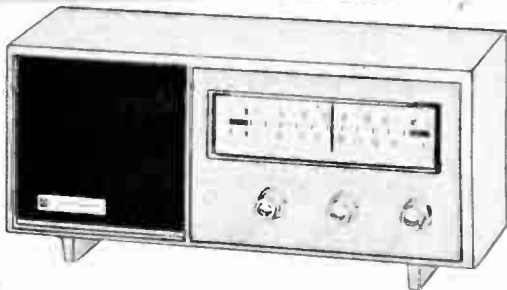

## "MINI" SOLID-STATE FM-AM TABLE RADIO

**14<sup>95</sup>**

- Distinctive Low Profile Styling

Sleek, new look design—Only 4½"H x 8½"L x 2¾"W in size, but a giant in performance. Handsome, low profile walnut grain plastic cabinet. All transistor solid-state circuitry for instant-on play. Large 3" speaker for full, rich tone. Built-in AM/FM antenna system. Direct rotary tuning. AM/FM selector switch. For 117 VAC 60Hz. Imported. Net 14.95  
17 T 69439W Shpg. wt., 4 lbs.



## SOLID STATE AM CLOCK RADIO

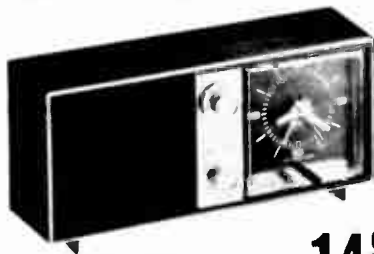

- Precision Automatic Clock
- Big 3" Speaker • Compact Styling

**14<sup>95</sup>**

Wake up to beautiful music or news at a pre-set time. Compact, low profile, decorator design. Ideal for bedside, table, bookshelf, or desk. The full size clock makes for easy, accurate time telling. Only 4¼" x 8¾" x 3". Attractive walnut-grained plastic cabinet. You will enjoy sensitive AM reception on all your favorite stations. Features powerful 3" speaker for fine tonal quality. Automatic gain control circuitry, and built-in AM antenna. Solid state circuitry for instant-on play. No warm-up. For 110 VAC 60 Hz. Imported. Net 14.95  
17 T 69454 Shpg. wt., 2½ lbs.

## SOLID STATE AM RADIO MAKE-UP MIRROR

**24<sup>95</sup>**

With Stand and Bulbs

Perfect Gift

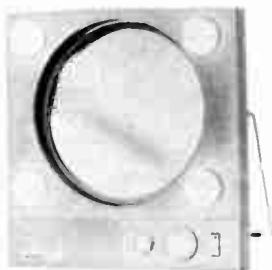

- Swivel Mirror is Magnified On One Side

The radio that permits a gal to make-up to music, or touch up to talk shows. The man of the house may even shave while listening to news. Instant-on solid state circuitry and automatic Gain Control (AGC) assures highly sensitive AM radio reception. Ferrite bar AM antenna; 4 make-up lamps. Operates on 117 VAC., 60 Hz. Rich sound reproduction from dynamic speaker. Size: 11¾"Wx11¾"Hx2¼"D. Shpg. wt., 4 lbs. Imported. UL Listed. Net 24.95  
17 T 53151L

# LAFAYETTE'S Finest Hi-Fi AM/FM Table Radios

## Deluxe LAFAYETTE Solid-State Twin Speaker Stereo AM/FM Walnut Wood Table Radio



*Brilliant Stereo Sound Reproduction from Two Perfectly Matched 4" Wide Range High Compliance Speakers*

- FM Stereo Indicator Light
- 22 Transistors, 21 Diodes
- Separate Bass and Treble Controls
- AFC For Drift-Free FM
- Automatic Loudness Compensator
- Tape Recorder Output Jacks
- Phono Input Jacks
- Provisions For External Antenna
- External Stereo Speaker Jacks
- Stereo Headphone Jack

ONLY **69<sup>95</sup>**

Luxurious instant-on solid state AM/FM stereo table radio with many of the deluxe features normally found only in expensive stereo hi-fidelity receivers. Its compact size, makes it ideal for use on a bookshelf or table top. Its walnut wood cabinet will enhance the decor of your home or office. Equipped with built-in AM and FM antenna systems—all you have to do is connect this radio to a standard 117 VAC outlet to immediately enjoy standard AM, FM, or full dimensional FM stereo broadcasts. A special indicator light will enable you to readily identify FM Stations broadcasting in stereo. In addition, the radio is equipped with a phono input to permit playing

of a stereo record changer (with ceramic/crystal cartridge) thru the radio. Stereo tape recorder outputs have been provided to let you record all stereo programs reproduced through the radio. You get magnificent tone from two matched 4" high compliance speakers. Built-in automatic loudness circuit compensates for normal loss of bass experienced at low level volume. External output jack for headphones or stereo speakers. Tuned FM RF for extremely high sensitivity and selectivity. Illuminated sliderule tuning dial. For 117 VAC, 60 Hz. Size: 20 3/4 x 7 1/4 x 6 3/4"D. Imported. Shpg. wt., 11 lbs. 99 T 35073W No Money Down" Net 69.95

## Deluxe LAFAYETTE Solid-State AM/FM Walnut Wood Table Radio



**39<sup>95</sup>**

- Tuned RF FM and 4 IF Stages
- Tape Recorder Output Jack
- 12-Transistors and 14-Diodes
- External Speaker Output Jack

A deluxe high-fidelity AM/FM radio employing an advanced solid-state circuit with 12-transistors and 12-diodes. However, it is more than just an AM/FM radio, it combines a super-sensitive AM and FM receiving section with a tuned RF FM stage and 4 IF's, a high-fidelity amplifier, and a full-range acoustic suspension loudspeaker in one compact and handsomely designed 3/8" walnut wood enclosure. Equipped with a built-in AM and FM antenna system, this outstanding radio need only be connected to a standard 117 VAC outlet to place it in operation. Separate Band Selector, Continuous Tone control, and Volume control. AFC for drift-free FM. Jack at the rear of the radio marked REC may be used to plug in a tape recorder to record any programs heard on radio. Also includes provisions for hooking up an external 8-ohm speaker as well as external FM or AM antenna. Beautiful oiled walnut wood cabinet with woven tan grill. For 105-120V., 50/60 Hz AC. Size: 13 1/2 x 5 7/8 x 8 3/4"H. Imported. Shpg. wt., 8 1/2 lbs. 99 T 35644W No Money Down" Net 39.95

*Magnificent Hi-Fidelity Sound Reproduction from a Powerful 5" Acoustic Suspension Speaker*



# Dynamic New Concepts in TV Viewing for 1971

## Panasonic AN-409TA Portable TV with Full Feature Digital Clock



- 9 Inch Picture—Measured Diagonally
- 3½ Hour Shut-Off Timer
- Channel Coverage: VHF 2-13, UHF 14-83
- Detachable Tinted Screen

**99<sup>95</sup>**

Tomorrow's look featuring built-in digital clock. Up to 3½ hour sleep timer with automatic shut-off. 38 square inch viewing area. 90° deflection aluminumized picture tube plus 10-tube 8-solid-state component circuitry delivers sharp "black and white" pictures. Instant On with "one touch" On/Off power switch. Sliding vertical controls for contrast, brightness and pre-set volume. VHF-UHF antennas. 3" up-front speaker. With earphone and retractable handle. Charcoal grey, ivory trim. For 117 VAC., 60 Hz. 9¼ x 15 x 11"D. Shpg. wt., 14 lbs. Imported.

17 T 31884W No Money Down\*

Net 99.95

## Panasonic TR-425R Portable "Pop-up" TV with AM-FM Radio



Battery or AC operated

- 5 Inch Picture—Measured Diagonally
- Hide-away Screen Pops Up for Viewing
- Channel Coverage: VHF 2-13, UHF 14-83
- Built-in Rechargeable Panaloid Batteries

**149<sup>95</sup>**

"The solid-state TV that lives in a radio." With the screen down, the set turns "off" automatically and you have a smart attach-styled FM/AM radio. Pop-up the screen and it becomes a TV. Plays on Panaloid rechargeable batteries (included). With the AC adapter (included) you can recharge the batteries as well as operate the set at home. Telescopic monopole/bowtie antennas. Front-mounted dynamic speaker provides rich, resonant sound. Slide rule VHF and radio tuning. With sun shield and an earphone for private listening. Pop-up chrome handle for easy handling. Size: 5½ x 11 x 12". Imported.

17 T 31892WX Shpg. wt., 15 lbs. No Money Down\*

Net 149.95

## Personal Portable UHF/VHF TV Set



UL Listed  
9 Inch Picture  
Measured Diagonally

**69<sup>95</sup>**

With Earphone  
Private Listening

- 82 Channel UHF/VHF Reception

Styled in a modern mood, off-white and ebony with accents of silver. Transistorized circuitry. 44 square inch, 90° deflection, aluminumized picture tube. Front-mounted 3" speaker for fine sound. Front-mounted controls for greater convenience. Separate UHF and VHF tuning knobs. With "Split-Second Start" for instant picture... instant sound. Telescopic VHF and loop UHF antenna. Earphone and jack for personal listening. Size: 9¾x13¾x9¾"D. For 117 VAC, 60 Hz. Imported. Shpg. wt., 18 lbs.

17 T 53163WX No Money Down\* Net 69.95

## Slimline Personal Portable UHF/VHF TV Set



UL Listed  
12 Inch Picture  
Measured Diagonally

**79<sup>95</sup>**

With Earphone for  
Private Listening

- 82 Channel UHF/VHF Reception

Big 82-channel reception lets you enjoy all stations, present and future. Split-second start—instant picture, instant sound. 110° aluminumized picture tube produces rich black and white, and brilliant high-lights. UHF slide rule tuning dial. Rotary VHF tuning dial 3¾" dynamic oval speaker, VHF telescopic unidipole antenna, and a rear mounted UHF loop antenna. Earphone for private listening. Walnut grain finish. For 117VAC., 60 Hz. Imported. UL listed. 13¾ x 13¾ x 10¾"D. Shpg. wt. 19¼ lbs.

17 T 93177WX No Money Down\* Net 79.95

## Sony "Trinitron" KV-1200U Single Gun Color TV Set



12 Inch Picture  
Measured Diagonally

**299<sup>95</sup>**

- Earphone for Private Viewing
- VHF: 2-13
- UHF: 14-83

Sony's color system, Trinitron, is the industry's newest idea in color TV design and engineering. The Trinitron system is entirely different from conventional color tubes. A newly designed single color gun was combined with a color defining mechanism called an APERTURE GRILLE to deliver magnificent true-to-life color TV. Solid state circuitry assures great reliability. Hue, color, brightness, and contrast controls. VHF dipole antenna and UHF loop antenna. Front mounted speaker. For 117VAC 60 Hz. Imported. Shpg. wt. 38 lbs.

17 T 32908WX No Money Down\* Net 299.95



# PERSONAL Portable Radios Make IDEAL GIFTS

## NEW

### LAFAYETTE BATTERY/ELECTRIC SOLID-STATE AM/FM PORTABLE RADIO

only **17<sup>95</sup>**  
with earphones  
and batteries



Full Size: 9"Wx5"Hx3"D

- Plugs into any AC Outlet or Plays Anywhere on 4 "C" Batteries
- Powerful 3" Speaker

Handsome, full-sized personal AM/FM portable. Smartly styled leatherette cabinet with beige and chrome trim. Provides excellent FM as well as AM reception. Comes gift packed with earphone and batteries included. Features precision slide rule dial, and wide range 3" dynamic speaker for clear, crisp tonal quality. Telescopic FM antenna and ferrite core AM antenna. Leatherette carrying handle. Size: 9"Wx5"Hx3"D. Imported. Shpg. wt. 3¾ lbs.  
17 T 01903L Net 17.95  
99 T 62572 Extra "C" bat. (4 req.) Net. ea. .14

### DELUXE LAFAYETTE BATTERY/ELECTRIC SOLID-STATE AM/FM PORTABLE RADIO

ONLY **22<sup>95</sup>**  
with earphone  
and batteries

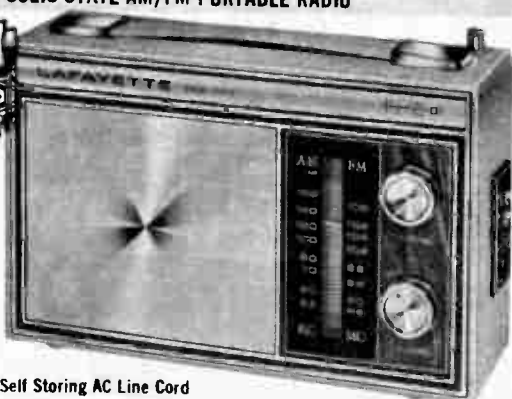

• Self Storing AC Line Cord

- AFC for Drift-Free FM Reception
- Precision Vernier Slide Rule Tuning
- Superb Tone with Wide Range 3½" Speaker

Supersensitive AM/FM portable radio in a deluxe cabinet with a big 3½" wide range speaker for magnificent tone. Features one RF and three IF stages for extremely high sensitivity and selectivity, enabling the listener to hear more stations. Operates on 4 "C" batteries or 117 VAC with built-in line cord. Precision Vernier slide rule dial with logging scale. AFC on FM to prevent drift. Pushbutton control for FM or AM. Telescoping FM and ferrite core AM antennas. 10 transistors and 5 diodes. AC/DC switch. Attractive metal front panel with chrome trim. Rugged, black leatherette case. With earphone and 4 "C" batteries. Size: 5½"x9x2½". Imported. Shpg. Wt., 4 lbs.  
17 T 01788L Net 22.95  
99 T 62572 Extra "C" bat. (4 req.) Net. ea. .14

### NEW Low Cost Solid State AM Pocket Radio

### Deluxe Lafayette Solid State AM Pocket Portable Radio

### Deluxe Lafayette Solid State AM/FM Pocket Portable Radio

ONLY **4<sup>98</sup>**

with Batteries, Earphone, Carrying Case



ONLY **7<sup>95</sup>**

with Carrying Case, Earphone and Battery



SALE **12<sup>95</sup>**

WAS 14.95  
with Carrying Strap, Earphone, and Battery



Low priced Instant-on solid state AM Radio provides fine tone from a 2¼" speaker. Attractively styled with separate unique volume and tuning indicators. Earphone is provided for private listening. Built in AM antenna. Operates on one inexpensive 9-volt battery. Black case. Size: 4½"Hx 2½"Wx1¼"D. Shpg. wt., ½ lbs. Imported.  
17 T 22032 Net 4.98  
99 T 60212 Extra 9-Volt Battery Net .21

Beautifully styled instant play AM pocket radio. Powerful 1¼" speaker provides clean, crisp tone. Features professional vernier slide rule tuning dial, and 3 IF transformers for superb sensitivity for reception on stations both near and far. Built-in ferrite antenna. Operates on only one inexpensive 9-volt battery. Includes vinyl carrying case, batteries and earphone. Color: Black with chrome trim. Size: 4½"Hx2½"Wx1¼"D. Imported. Shpg. wt., 1¾ lbs.  
17 T 01762L Net 7.95  
99 T 60212 Extra 9-volt Battery Net .21

Supersensitive, power-packed beauty provides sparkling performance on both FM and AM and measures only 2½"Wx4¼"Hx1½"D. Built-in AFC circuitry to prevent drift on FM. Features slide rule dial and logging scale for precise tuning. Large 2¼" dynamic speaker reproduces voice and music with fine tonal balance. Ferrite core antenna for AM, telescoping antenna for FM. Powered by single 9-volt battery. Includes earphone for private listening, battery, and handy carrying strap. Imported. Wt., 1½ lbs.  
99 T 35248L Net 12.95  
99 T 60212 Extra 9-volt Battery Net .21



# Deluxe Lafayette "Air Master 400" 4-Band 17 Transistor FM/AM/Police/Aircraft Portable Radio



**tunes 4 exciting bands!**



**High Band  
Police and FM/VHF**  
147-174MHz



**Aircraft Band**  
108-136 MHz AM/VHF



**FM Broadcast**  
88-108 MHz



**AM Broadcast**  
540-1600 kHz

**ONLY 44<sup>95</sup>** With Batteries and Earphone  
No Money Down\*

- Variable Squelch Control for Tuning FM, AIR and Police Bands
- Record Output Jack
- Operates on 4 "D" Batteries or 117 VAC
- Large 4" Speaker for Magnificent Tonal Quality
- Precision Slide Rule Tuning Dial
- Tunes U.S. Weather Broadcasts on 162.55 KHz

## Guardian II 2-Band Solid-State FM-VHF and AM Police Radios



**HIGH BAND**

**LOW BAND**

**FM-VHF — 147-174 MHz** **FM-VHF — 30-50 MHz**  
**AM — 540-1600 kHz** **AM — 540-1600 kHz**

**21<sup>95</sup>** with earphones and batteries

**21<sup>95</sup>** with earphones and batteries

**HIGH BAND FM-VHF POLICE AND AM RADIO.** Listen to the drama of everyday life with this exciting radio. Monitor local and state police, as well as fire departments. 162-55 MHz. U.S. Weather Bureau stations, civil defense, and emergency public services. Includes standard AM band. Loaded with these outstanding features: 2 RF stages, 4 IF stages, slide rule logging scale for precise tuning, ferrite rod AM antenna, telescoping VHF antenna, large 3" speaker for superb fidelity. Handsome black case with silver trim. Earphone jack for private listening. Operates on 4 "AA" type batteries (included) or 117 VAC with optional AC adapter. 11 transistors, 4 diodes, 1 thermistor. 7W x 4 1/4" H x 2 1/4" D. Imported.

99T35222L Shpg. wt., 2 1/4 lbs. Net 21.95

**LOW BAND FM VHF POLICE AND AM RADIO.** Same deluxe features and specifications as above Police radio but tunes low band 30-50 MHz instead of High Band. Imported. Shpg. wt., 2 1/4 lbs.

99T35347L Net 21.95

### ACCESSORIES FOR GUARDIAN II POLICE RADIOS

Stock No.	Description	Shpg. Wt.	Net Ea.
99T35362	AC Adapter	12 oz.	3.95
99T62580	Extra "AA" Batteries (4 required)	3 oz.	.10

The "Air Master 400" is a professionally designed portable radio that tunes Standard AM Broadcasts, Standard FM Broadcasts, FM-VHF High Band Police Calls, AM-VHF Aircraft Band (monitor planes in flight awaiting instructions from the control tower), and U.S. Weather Bureau forecasts. Individually tuned front end circuits for each band provides higher sensitivity—assuring sharp response with exceptional stability. Variable Squelch control while tuning Police and Aircraft Bands—also serves as interstation muting on FM Broadcast Band. Self-Storing AC line cord for 117 VAC house current. Also operates on 4 "D" cell batteries. Telescoping antenna for FM, Police and Aircraft; built-in loopstick antenna for AM. 17 transistors, 11 diodes; 2 thermistors. Jack for Ext. Ant. Phone; Record output. Padded black Vinyl case with handle. Size: 11 1/4 x 7 1/2 x 3 1/2" D. 99T35578W Imported. Shpg. wt., 7 lbs. Net 44.95  
99T62564 Extra "D" bat. 4 req. Shpg. wt., 5 oz. Net ea. .15

## "Guardian 300" 3 Band Battery Electric Solid-State FM-VHF/FM/AM Police Radios

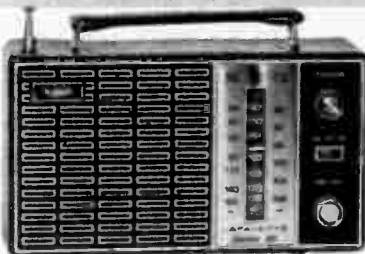

**HIGH BAND**

**LOW BAND**

**FM-VHF — 147-174 MHz** **FM-VHF — 30-50 MHz**  
**AM — 540-1600 kHz** **AM — 540-1600 kHz**  
**FM — 88-108 MHz** **FM — 88-108 MHz**

**29<sup>95</sup>** with earphones and batteries

**29<sup>95</sup>** with earphones and batteries

**HIGH BAND FM-VHF POLICE AND AM/FM RADIO.** Listen to Police and fire calls... ANYWHERE—ANYPLACE. Deluxe 3-band radio operates on 4 "C" batteries or 117 VAC 60 Hz by means of a self-storing AC line cord. Powerful space age solid-state circuitry with 12 transistors, 6 diodes, and 2 thermistors. Variable 6-gang capacitor tuning for extremely high sensitivity and selectivity enables you to pull in even the weakest stations. Complete coverage includes high-band FM-VHF 147-174 MHz and standard AM and FM broadcast bands. Slide rule dial for precise tuning. Ferrite rod antenna for AM, telescoping antenna for FM-VHF and FM bands, and an external antenna input jack. Padded black leatherette case with silver trim. Includes batteries, earphone and self-storing AC line cord. Size: 8 3/4" W x 4 5/8" H x 2 7/8" D. Imported. Shpg. wt. 3 1/4 lbs.

99T35461L Net 29.95

**LOW BAND FM-VHF POLICE AND AM/FM RADIO.** Same deluxe features and specifications as above but tunes low band FM-VHF 30-50 MHz instead of High Band. Imported. Shpg. wt., 3 1/4 lbs.

99T35479L Net 29.95

99T62572 Extra "C" bat. for above radios—4 req. Net ea. .14

local weather bureau concerning reception in your area.

# Super Deluxe LAFAYETTE "Guardian 5000" 5-Band Solid-State AC and Battery-Operated AM/FM/SW/FM-VHF Public Service Radio

## Tunes 5 Exciting Bands!

BAND	FOR	FREQUENCY
Low Band FM-VHF	30-50 MHz	 Police and Fire
High Band FM-VHF	147-174 MHz	 Police, Fire, Weather
International Shortwave	4-12 MHz	London Vatican Moscow  Voice of America
Standard AM Broadcasts	540-1600 kHz	 Sports and News
Standard FM Broadcasts	88-108 MHz	World Famous Symphonic Orchestras 

- Two Separate Front-End RF Tuning Sections For Both High and Low Police FM-VHF Bands
- Variable Squelch Control While Tuning FM-VHF Bands... Also Serves As Interstation Muting on Standard FM Band

# 59<sup>95</sup>

With Batteries, Earphone, and AC Adapter



Monitor the airwaves of the world! Listen to Police, Fire, Civil Defense, 2-Way Business and U.S. Weather forecast on BOTH THE HIGH (147-174 MHz) and LOW (30-50 MHz) FM-VHF band. Tune the 4-12 MHz International Shortwave Bands. Enjoy outstanding music on the standard FM band (88-108 MHz), as well as news, weather and sports on the standard AM band (540-1600 kHz). Advanced space age solid-state circuitry permits instant operation—no loss of precious time due to warmup—permits immediate response to emergency situations. Two separate 4 gang tuning capacitor front ends for both high and low FM-VHF Police bands for greater sensitivity and more dependable selectivity—weak stations can be heard clearly—while outside noise and interference are drastically reduced. Operates on

4 "C" batteries or 117 VAC household current with AC adapter (included). Excellent quality of tone from large 3½" speaker makes this a true hi-fidelity portable radio. Telescoping antenna for FM, FM-VHF, and SW bands. Built-in ferrite core antenna for AM band. Accessory jack for use of separate external antenna. Slide rule logging scale for precise tuning. AFC circuitry prevents drift on FM. Beautiful walnut wood grain molded case with metal grill, gold trim, and handle. Includes 4 "C" batteries, earphone, and AC adapter. Dim.: 8¾Hx6Wx2¾"D. (Metal handle 3½"). Imported. Shpg. wt., 6 lbs. 99 T 35438L No Money Down\* ..... Net 59.95  
Extra "C" batteries—4 required  
99 T 62572 ..... Net ea. .14

## LAFAYETTE 4-Band TV-FM-FM/VHF Police Portable Radio

### TUNES

- TV Low: Channels 2 thru 6
- TV High: Channels 7 thru 13
- Standard FM Broadcasts: 88-108 MHz
- FM-VHF High band Police: 146-175 MHz

A unique and truly different concept in the design of a radio. Allows you to tune TV channels 2 thru 13. Listen to the many outstanding sporting events, variety shows and special normally transmitted only on TV. At night, use your TV for the picture but control the sound from the radio—earphone lets you listen without disturbing others. Monitor Police and Fire emergency calls. Listen to U.S. Weather Bureau forecasts on 162.55 MHz. Also receives standard FM broadcasts. Operates on 4 "C" batteries or 110 VAC with optional adapter. Super-sensitive, instant-on solid-state circuitry. Precision sliderule tuning dial. Built-in telescoping antenna, external antenna jack, leatherette carrying handle, earphones, and batteries. Black plastic cabinet. Size: 9 x 5¼ x 2¾"D. Imported.

99 T 35636L Shpg. wt., 4 lbs. .... Net 39.95  
99 T 62572 Extra "C" batteries, 4 req. .... Net ea. .14  
99 T 35382 110 VAC Adapter. Wt. 10 oz. .... Net 3.95

\*See Page 18 for Full Credit Details on Easy Pay Plan

# 39<sup>95</sup>

No Money Down\*  
With Batteries and Earphone



- Listen to TV Privately Without Disturbing Others
- Listen to TV Anywhere Without Viewing

# Sale

## LAFAYETTE "Star-Fire" VI" 6-Band 18-Transistor AM/FM/SW/FM-VHF Police Portable Radio

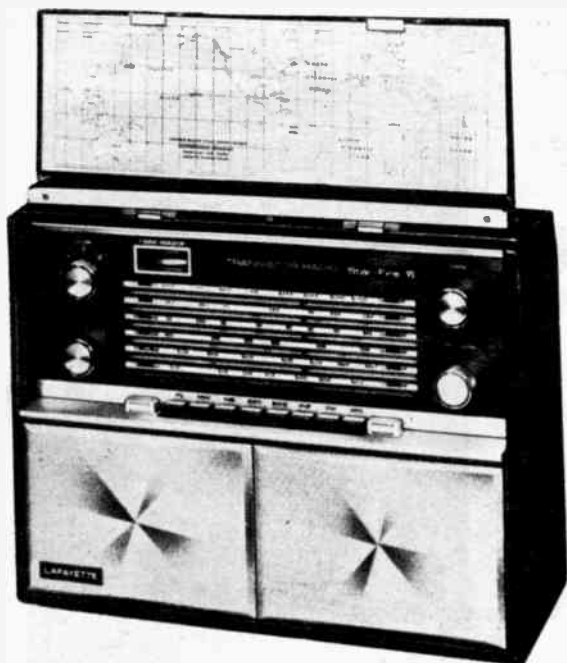

- ★ Tuning/Battery Strength Meter
- ★ Electronic Bandspread Fine Tuning Control
- ★ Operates on 4 "D" Type Batteries or 117VAC with Optional AC Adapter
- ★ Two 4" Wide-Range Speakers for Magnificent Sound Reproduction

**50th Anniversary Special**

**20.00 Price Cut**

**NOW 59<sup>95</sup> WAS 79<sup>95</sup>**

Cat. 710  
Sale Ends 12/31/70

### Tunes:

- FM VHF Police and Fire Broadcasts 147-174 MHz
- Low Band Marine Weather: 1.6 to 4.5 MHz
- International Shortwave I: 4-10 MHz
- International Shortwave II: 10-23 MHz
- Standard AM: 535-1605 KHz
- Standard FM: 88-108 MHz
- Weather Bureau Forecasts—162.55 MHz

Deluxe Star-Fire VI speaks all the languages of the world. Powerful 18-transistor and 7-diode solid-state circuitry provides extremely high sensitivity. Cover has worldwide shortwave time zone chart. Monitor exciting police radio calls on the 147-174MHz VHF band. Also features: AFC to eliminate drift on FM, push-button controls, tone control, dial light, tuning/battery strength meter, built-in compass-point indicator, black leather cabinet with die-cast front, telescoping antenna for FM, SW and VHF reception. Supplied with earphones, 4 "D" type batteries and booklet of worldwide shortwave stations. 12 x 9½ x 4½"D. Imported. Shpg. wt., 18 lbs. **99 T 35263W** Net **99.95**  
 Extra "D" Batteries (4-required). Shpg. wt., 4 oz. **99 T 62964** Net ea. **.15**  
 AC Adapter for Star-Fire VI. Shpg. wt. 6 oz. **99 T 35412** Net **4.95**

## Lafayette Battery/Electric 4-Band Solid-State AM/FM/SW Marine Portable

### TUNES 4 BANDS

AM: 530-1600 kHz      FM: 88-108 MHz  
 MB: 2.5-6.5 MHz      SW: 9-18 MHz



Includes These Accessories

**SALE! Save 5.00**

**NOW 34<sup>95</sup> Was 39<sup>95</sup>**

Catalog 710

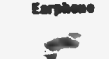

- ★ Precision Slide Rule Tuning Dial with Logging Scale
- ★ Self-storing AC Line Cord

Superb performing 4-band portable radio for all around use. Use it to travel the world with international shortwave. Use it to listen to the Marine band: ship-to-shore, and up to the minute weather forecasts. Use it for listening to FM and AM broadcasts. Separate AC/DC switch permits you to play this fine portable on 117 VAC 60 Hz or with 4 economical "C" batteries. Large 3½" full range dynamic speaker for outstanding tonal quality. Built-in ferrite core antenna for AM and SW bands. Handsome black padded, simulated leatherette cabinet with die-cast frame and chrome grill: 9¾x6x3½" Imported. Shpg. wt. 7 lbs.  
**17 T 01785L** No Money Down\* Net **34.95**  
 Extra "C" batteries for above. 4 required. **99 T 02572** Shpg. Wt., 4 oz. Net ea. **.14**

# Big Selection of Solid-State Car Radios

## MANUAL AM CAR RADIO



ONLY **19<sup>95</sup>**

- For 12 Volt Negative Ground Systems
- Built-in Speaker
- Removable Face Plate
- Tone Control Switch

Universal Solid State AM radio that is easy to install under the dash. Offers fine sound reproduction. Features built-in speaker and tone control slide switch, 7 transistors, 2 diodes, RF stage, AVC. Removable face plate. For 12 volt negative ground system. Size: 2x4 $\frac{3}{4}$ x6 $\frac{1}{2}$ ". Imported, Shpg. wt., 3 lbs. 17 T 74256 Net 19.95

## PUSHBUTTON AM/FM CAR RADIO

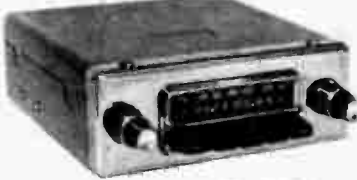

**54<sup>95</sup>**

- Includes Free Antenna
- Large 5 x 7" External Speaker
- For 12 Volt Neg./Pos. Ground Systems

All solid state circuitry. 11 transistors, 8 diodes, 2 thermistors. Push-pull Hi-Fi output. AFC for FM drift-free performance. High sensitivity for long distance reception on both AM and FM. Four I.F. stages on F.M. for maximum noise limiting. Large 5x7" external speaker. Radio mounts neatly under dash. Overall size: 6 $\frac{1}{2}$ x2 $\frac{3}{4}$ x6 $\frac{3}{8}$ "D. Imported. Shpg. wt., 6 lbs. 17 T 74124 No Money Down\* Net 54.95

## FM STEREO CAR RADIO

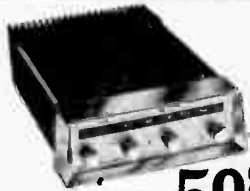

**59<sup>95</sup>**

- AFC "Drift Lock" Tuning
- Stereo Indicator Light

Deluxe FM stereo car radio features stereo indicator light. Has 4-controls: On-Off/Volume, Tone, Balance, and Tuning. AFC "drift lock" pinpoints and holds even the weakest FM station. Power Output 6 watts per channel. FM Sensitivity 3uv. For 12V, negative ground system. Comes with mounting bracket. Size: 7 $\frac{1}{2}$ x2 $\frac{3}{4}$ x9 $\frac{1}{2}$ "D. Imported. Shpg. wt., 8 lbs.

17 T 58002 No Money Down\* Net 59.95  
Set of two rear deck speakers.  
99 T 62994 Shpg. wt., 3 lbs. Net 6.95

## Sharp FX28A Solid-State FM-AM Car/Portable Radio



Complete with Car Bracket, Lock and Key, Batteries, AC Line Cord, Earphone

**39<sup>95</sup>**

- Install In Any 6 or 12 Volt Car or Boat System
- Use As A Portable, or On 117VAC 60 Hz. With Built-in AC Line Cord

Versatile "multi-purpose" AM/FM solid-state radio designed to provide outstanding reception anywhere. Used as an AM/FM car radio, it locks into its specially designed under-the-dash bracket and operates thru the car's electrical system (6 or 12 volts pos./neg. ground). Slips easily out of bracket for use outdoors—and plays on 3 "C" Batteries (included). For indoor use, it operates on regular 117VAC household current with the AC line cord provided. Pushbutton switches for tone, AFC, and Car antenna. 3-Controls: Tuning, On/Off-Volume, and Band Switching. AFC for drift free FM reception. Ferrite bar AM antenna, telescoping FM antenna. Wide range 4 x 2 $\frac{3}{4}$ " oval speaker. Wood grain finish front panel. 2Hx7 $\frac{7}{8}$ x5 $\frac{1}{8}$ "D. Imported. Shpg. wt., 5 $\frac{1}{4}$  lbs.

17 T 53110 No Money Down\* Net 39.95  
99 T 62572 Extra "C" cells (3 required) Net ea. .14  
Sharp Model FYP-30 3-Band AM/FM/POLICE Car Portable Radio — Same features and specifications as above but includes high band FM/VHF Police and Weather Band—150-170 MHz. Imported. Net 49.95  
17 T 53060 Shpg. wt., 6 lbs.

## Custom Deluxe Solid State Radios For Volkswagen Cars

### Pushbutton AM Car Radio



**34<sup>95</sup>**

- For All Standard Models from 1957-1970
- Complete with 5" Diameter External Speaker and All Mounting Hardware

Just a snap to install. Custom designed to snap into instrument panel on the dash board from the front. Mounts in a matter of minutes. Features all-transistor circuit of advanced design which gives a full 3-watts of superb audio power. Automatic volume control provides constant, even comfort-level listening. Continuously variable tone control. Five quick-set pushbuttons permit finger-to station tuning. Seven tuned circuits including RF stage, give maximum sensitivity. For 6/12 volts D.C., negative ground. Imported. Shpg. wt., 6 lbs. 17 T 26405 No Money Down\* Net 34.95

### Deluxe Pushbutton FM-AM Car Radio



**69<sup>95</sup>**

- For 1967 Thru 1970 1300 Series Models
- 6-Inch External Speaker
- 11-Transistors, 2-Diodes
- Snap-in Front Mount for Easy Installation

Deluxe solid-state custom AM-FM radio for all standard Volkswagen 1967-1970 models. Matches decor of car's interior. All solid-state circuitry with hi-fi features. 11-transistors, 2-diodes. AFC on FM for drift-free performance. Push-pull output. High sensitivity for long distance reception on both AM & FM. 4-IF stages on FM. Continuous variable tone control. Snap-in front mount for easy installation. Large 6" external speaker. Imported. Shpg. wt., 6 lbs. 17 T 74405 For 1967-1970 Volkswagens Net 69.95

\*See Page 18 for Full Credit Details on Easy Pay Plan



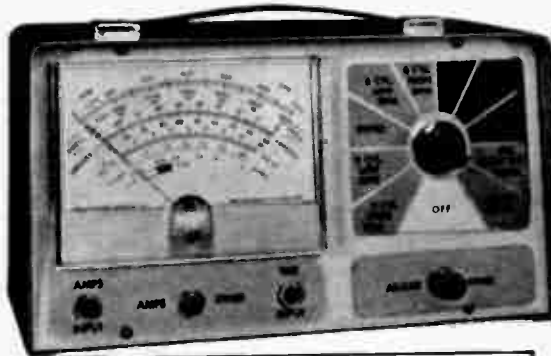

### Solid-State Engine Analyzer Will Test:

- Dwell or Cam Angle
- Measure Engine Speed
- Adjust Carburetors
- Adjust Points
- Check Condensers
- Check Coil Resistance
- Measure Carbon Suppressor Spark Plug Cables
- Check Batteries
- Test Alternators, Generators & Regulators
- Check Shorts & Opens in Wiring
- Checks All Lamps, Fuses, Relays & Switches
- Check Diodes



### 6½" DWELL TACHOMETER

**28<sup>95</sup>**

- Tunes up Electronically, Any Car Ever Made
- Three Dwell Scales
- Giant 6½" Easy-to-Read Scale
- Use to Adjust Carburetors
- Use to Adjust Points

Made in U.S.A.

A complete ready-to-use Dwell Meter and Tachometer which will operate on any car ever made. Tests cam Dwell angle and engine RPM on 4, 6 or 8 cylinder cars, 6 or 12 volt right on the engine. Giant 6½" easy-to-read meter makes it simple for anyone to adjust points and carburetors to insure maximum gas economy and quiet engine running. RPM readings are also essential to properly service automatic transmissions. Three dwell angle scales are provided: 0 to 45 degrees, 0-60 degrees, and 0 to 90 degrees. This instrument is suitable for dwell angle adjustment on all foreign and domestic cars. Dual range tachometer 0 to 1000 rpm for precise carburetor adjustments. 0 to 5000 rpm, suitable for making all other tests at high engine speeds. Complete with instruction manual. Shpg. wt., 3½ lbs.

11 T 01013W

Net 28.95

## COMPLETE SOLID-STATE ENGINE ANALYZER

For All Electrical Systems 6, 12, 24 or 32 Volt  
—Regular, Transistorized or Magneto Ignition,  
8, 6 or 4 Cylinder 4 or 2 Cycle Engines.

ONLY

**49<sup>95</sup>**

No Money Down\*

- Large 6" D'Arsonval Double Jeweled Meter
- Do-It-Yourself Instruction Book

Performs "FIFTEEN" authoritative tests under actual operating conditions; Tests output voltages in three separate ranges: 0-3.2, 0-16, 0-32 VDC. Determines the condition of batteries, battery cables, spark plug wires, coil wire, solenoids and starter motors. Permits precise setting of distributor points (cam-dwell angle) and test centrifugal advance mechanism on three scales: 0-45° for 8-cylinder, 0-60° for 6-cylinder, and 0-90° for 4 cylinder. RPM scales allow precise setting of carburetor air/fuel mixture and engine RPM in four separate scales: 8 or 6-cylinder (low) 0-1,200, (high) 0-6000; 4-cylinder (low) 0-2400, (high) 0-12,000. Measures amps from -5 to +90. Resistance scale from 0-100,000 ohms. Operates on single "D" cell battery. Complete simple operating instructions. Detailed information supplied by make and model. Rugged steel case finished in baked enamel. Rear storage compartment holds 5½" leads, clamps, plug jacks and connectors. Size: 12 x 6½" x 6". Shpg. wt., 10 lbs.

11 T 24502

Net 49.95

99 T 62564 Battery For Above

Net .15

### 3½" DWELL TACHOMETER

**16<sup>95</sup>**



- Tune Up Electronically Any Car Ever Made
- 3½" Double Jeweled D'Arsonval Meter
- For 4, 6 or 8 Cylinder Engines
- For 6 or 12 Volt Systems
- Point Resistance Check

Made in U.S.A.

Electronically tune your car! This Dwell-Tachometer permits setting the carburetor for maximum efficiency, gas economy and greater power; indicates the correct point gap setting electrically (even if the points are pitted or corroded); permits setting points with the distributor cap off and engine cranking, and permits setting points on "Window" distributors with engine running. It also locates defective spark plugs; permits correct engine RPM setting for automatic transmission adjustments, throttle linkage and idle adjustment. RPM scale: 0-3000; 8-cylinder dwell: 5-45°; 6 cylinder dwell: 20°-60°. 4 cylinder reading obtained by doubling 8 cylinder scale reading. Two-color scale. Small and compact—measures only 6¼x3¾x2". Complete with instruction manual. Shpg. wt., 1¼ lbs.

11 T 01054

Net 16.95

## PROFESSIONAL AC OR DC—POWER TIMING LIGHTS

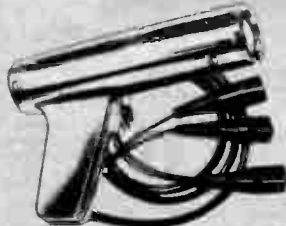

- Ultra-Brite Zenon Strobe Tube

As Low As

**12<sup>95</sup>**

### DC POWER TIMING LIGHT

Chrome finished DC-power timing light. The ultimate in a mechanic's light. Ultra-brilliant blue white zenon strobe tube gives bright light for day or night use. Rugged case; designed for operator to reach inaccessible timing marks. Simple replacement of zenon bulb. For 6 and 12 volt battery. On/Off Switch. Shpg. wt., 1¼ lbs.

11 T 42405

Net 22.95

### AC POWER TIMING LIGHT

Deluxe 110 volt AC power timing light. Uses ultra-brilliant white zenon strobe tube. For day or night use. Plugs into any 110 volt AC line, insures maximum light regardless of condition of vehicle's battery. Rugged black case with power cord and On/Off switch. Shpg. wt., 1½ lbs.

11 T 42397

Net 12.95

# Auto Accessories You Can Install



**DELTA**  
CAPACITIVE DISCHARGE  
IGNITION SYSTEM  
With Silicon Controlled Rectifier

**SALE**  
**34<sup>95</sup>**  
SAVE 5.00  
SALE ENDS  
DEC. 31, 1970

- Quick, Easy Installation
- Constant Spark to 10,000 RPM
- Extremely Low Input Power—Less Load On The Engine

Combines all the advantages of capacitive discharge with those of solid state circuitry. Eliminates point bounce problems and positively fires plugs regardless of point condition. Fast rise time spark prevents fouling from three to ten times. Point contacts last indefinitely. Eliminates mis-firing, reduces oil contaminants, prolongs engine life. Provides smoother and more efficient operation at all speeds; constant spark up to 10,000 RPM; with dramatically improved acceleration and economy. Provides faster, easier starting in all weather. Unit operates with all commercial and original tachometers. Installs immediately with two simple connections to the existing coil, leaving the standard system intact. No temperature limitations—mounts anywhere. Requires only a very small amount of input power—reduces load on engine and electrical load. For 12 volt negative ground system only. Shpg. wt., 2½ lbs.

11 T 84866 No Money Down\* ..... Net 34.95

## ELECTRONIC SPEED CONTROL



- Maintains Any Selected Highway Speed
- Does Not Affect Braking or Instant Acceleration
- Helps Adhere To Posted Speed Limits
- Sets Fast Idle for Quick Cold-Weather Warm-up

ONLY  
**21<sup>50</sup>**

An Electronic Cruise Control which enables you to drive at a constant speed by automatically holding the throttle steady. Eliminates the need to keep a foot glued on accelerator on long trips. Once you reach desired speed, simply pull out knob and the Speed Control will automatically hold that speed. Allows instant acceleration for passing but takes over again when the foot is taken off the gas pedal. Ceases to function the moment the brake is depressed and completely disengages in the event of any malfunction. Designed to fit all cars and trucks. Shpg. wt., 2 lbs.

11 T 59011 ..... Net 21.90

## AUTO/MARINE BATTERY CLOCK

**11<sup>95</sup>**

Attractively styled chrome bezel; with bright easy-to-read white face, has black markings and features a second pacing sweep hand. Fiber mesh fastening arrangements on base. Can be positioned on any metal, wood, plastic surface, including padded dashboards and yet is readily removable. 3¼" x 3¼" x 2½" gray plastic case. Wt. 1 lb.

11 T 17366 ..... Net 11.95  
99 T 82572 Battery for above ..... Net .14

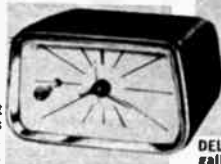

OPERATES UP TO  
1 YR. ON SINGLE  
"C" CELL.

## ¾" SLIMLINE TRANSISTORIZED TACHOMETER

**16<sup>95</sup>**

- Shift Set Needle
- 0-8,000 RPM
- For 4, 6, or 8 Cylinder



An attractive ¾" illuminated black and white face tachometer with precision 0-8,000 RPM scale, 200 RPM divisions, and adjustable shift indicator. Factory calibrated transistorized circuitry with precision D'Arsonval meter assures steady, accurate readings throughout the entire range. Can be used with transistor ignition systems. Has 360° universal mount 1½" depth slim line case with hooded bezel for easy dash mounting on compacts or on steering wheel column. Complete with installation kit. Heavy chrome and black wrinkle construction. For 6 and 12 V positive or negative ground.

11 T 42408 Shpg. wt., 1¼ lbs. Net 16.95

## DELUXE ¾" GAUGE AMMETER -WATER-OIL PRESSURE

**19<sup>95</sup>**

- All Electric—No Tubing

End guess work and space problems with this beautiful three-in-one gauge. Illuminated dial face gives accurate individual readings of oil pressure, amperage, and water temperature. Amp. gauge reads -60 to +60, oil pressure registers 0 to 80 lbs., and water temperature is indicated from 100° to 220°. Fits all 12 volt negative or positive ground alternator or generator electrical systems. Handy 360° universal mount and durable chrome zinc die cast case. Supplied with wire, adjustable mounting ring, and senders.

11 T 42633 Shpg. wt., 2½ lbs. Net 19.95  
OIL AND AMMETER GAUGE—Similar to above, less water temp. gauge.  
11 T 42641 Shpg. wt., 2 lbs. Net 19.95



## GAS SAVER VACUUM GAUGE

Only  
**12<sup>95</sup>**

- Automatically Shows Miles Per Gallon
- Chrome Die Cast Case

DELUXE ¾" TWIN VACUUM GAUGE. Automatically shows miles per gallon. Saves up to 40% of your gasoline dollars by showing you how to drive for the best economy or power. Checks your engine constantly by measuring its manifold pressure on a clear, four color illuminated dial. With 360° universal mounting, zinc die cast case, T-connector, 6 ft. vacuum tubing, steering column mount ring and instructions. Fits any car.

11 T 42658 Shpg. wt., 1¼ lbs. Net 12.95



\*See Page 18 for Full Credit Details on Easy Pay Plan

# Automotive Accessories & Specialties



**DELUXE  
REVOLVING  
BEACON**

**6<sup>95</sup>**

- Plugs Into Cigarette Lighter Outlet

- Rotates Like a Lighthouse Beacon

A red warning light that rotates 360 degrees and flashes in all directions. Suction mount holds the beacon firmly in place. Signals for help for miles around, creates a safety zone during a traffic emergency. For use on autos, boats, trucks, docks, etc. For 12 volt use, complete with cigarette lighter adapter plug. Shpg. wt., 1 1/4 lbs. 11 T 13042 Net 6.95

## "FIAMM" ELECTRO COMPRESSOR AIR HORNS

- Chrome Plated Brass Trumpet
- Range of 1/2 Mile
- Loud—Clear—Continental Tone



As Low As  
**16<sup>95</sup>**

Model 32. Custom quality chromed trumpets with loud clear, piercing, continental tone. Range up to 1/2 mile. Ideal for use on trucks, sports cars, emergency vehicles, buses, boats, etc. Compressor pumps air to trumpets instantly when horn is pressed—there's no waiting for pressure to build up. Supplied with Town and Country Selector Switch which enables use of original horns for city driving. Complete with: 2 horns (7" & 9"), compressor, fittings, horn relay, and all necessary hardware. For 12 volts only. From Italy. 11 T 82300 Shpg. wt., 5 lbs. Net 21.50  
Model 22. Same as above but trumpets are enameled die-cast metal. 11 T 82510 Net 16.95



**AH-000-GAH!  
HORN**

As Low As **11<sup>95</sup>**

- Chrome Plated Bell
- With Horn Button

A real joy for the sports car enthusiast. An authentic motor driven horn approved as an exact reproduction in sound and appearance by members of antique car, hot rod, and horseless carriage clubs the world over. Chrome plated bell with black wrinkle painted housing. With horn button, wire, bracket and instructions. Shpg. wt., 4 1/4 lbs. 11 T 30052 6-volt Net 11.95  
11 T 30020 12-volt Net 11.95  
For Compact and Sports Cars 11 T 30079 12-volt Net 11.95  
11 T 30087 6-volt Net 11.95

## RADAR ALERT

- Warns of Traffic Zones!

**KIT  
23<sup>95</sup>**

**WIRED  
29<sup>95</sup>**

- Miniature and Completely Transistorized
- Rugged Printed Circuit
- Complete With Long Life Mercury Batteries

- Clips Easily on Sunvisor
- Gives Advance Warning

Radar alert wired—miniature electronic detector gives an audible warning whenever it intercepts a radar beam. Dual-Band circuit detects all commonly used police radar speed meters and traffic control devices, both vertically and horizontally polarized, to promote safer driving. Miniaturized and completely transistorized. Top quality components: printed wiring; 8 transistors; two 1,000 hour mercury cell, self-testing batteries (equivalent to 35,000 miles of driving at 35 M.P.H.) Magnesium case eliminates radio, TV and other interference. Weighs only 13 ozs., measures 3 1/4" x 2 1/4" x 3 1/4" D; clips to sunvisor. Complete with batteries, sunvisor clip, instructions included. Shpg. wt., 1 1/2 lbs. 11 T 42017 Net 29.95

**RADAR ALERT KIT.** Same as above in kit form. 11 T 42482 Net 23.95

This item not intended for resale in States where its use is forbidden in motor vehicles by public regulation.

## ON-GUARD PROFESSIONAL SIREN-OPERATED BURGLAR ALARM



**27<sup>88</sup>**

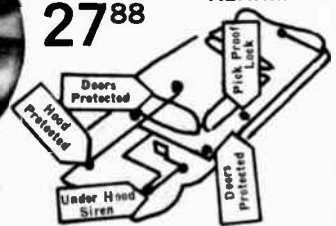

- Loud, Police-type Siren Gives 3-Way Protection—All Doors, Trunk and Hood
- Complete—Easy To Install
- Pick-Proof On-Off Key Lock Mounts on Outside of Auto

Get 24-hour protection on your car, station wagon or truck with this complete burglar alarm system. The sharp penetration sound of the police-type siren will scare thieves away. The siren blasts off when anyone opens a door, the hood or trunk. Th alarm can be shut off only with the alarm key. Complete system includes deluxe spun-aluminum siren with trumpet, 4 door switches, hood switch, trunk switch, 2 brackets, electrical lock with 2 keys, wire, mounting hardware, instructions and 2 warning decals. For 12-volt cars only. 11 T 62015 Shpg. wt., 6 3/4 lbs. Net 27.88

*Bon Airé*

## SUPER POWER AUTO VACUUM CLEANER

**SALE**  
**8<sup>95</sup> cut 10%**  
SALE ENDS DEC. 31, 1970



- Super Power Suction
- Plugs Into Cigarette Lighter Socket

A smart portable accessory for every car owner. Super power suction cleans in seconds. Specially designed nozzle gives easy access to hard to get at places such as under seats, ash trays, and in crevices. Its lightweight, and durable rust and dent proof construction make this fine unit ideal for boats, planes, trailers, and tents also. Easy to handle and well balanced. Operates off standard 12V DC car battery. Plugs right into the cigarette lighter socket. Size: 17" long x 4" wide. Shpg. wt., 2 3/4 lbs. 11 T 22506 Net 8.95

# Auto Aids and Specialties



## SURE-FIRE 3-AMP BATTERY CHARGER

10<sup>95</sup>

- For Both 6 & 12 Volts
- Built-in Meter
- Automatic Reset Breaker

Full 3-amp battery charger for quick starts in all weather. Edge view colored meter shows actual battery condition. Reset circuit breaker gives automatic overload protection. Has 6 and 12 volt selector switch. Delivers tapering charge. Vented steel case; may be wall mounted. 6 ft. battery leads with 50 amp clips. Size: 6 x 4 1/2 x 5 3/4". For operation from 105-125 Volt. 60 Hz AC. UL Listed.

11 T 76049 Shpg. wt., 5 lbs.

Net 10.95

## TRIPP LITE 150-WATT TRANSISTORIZED INVERTER

39<sup>95</sup>

NO MONEY DOWN\*

- Delivers 150 Watts Continuously
- Provides Household Current Anywhere
- Fused to Protect Battery

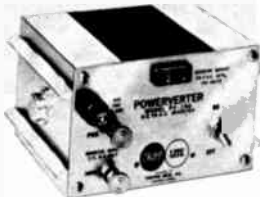

Model PV-150

A low-cost transistorized inverter which changes 12-volt DC to 115-volt 60 Hz AC. Delivers 150-watts continuously; 175-watts intermittently for shavers, recorders, radios, TV and many other appliances. Has on-off switch and replaceable fuse. Rugged construction. Size: 5 x 5 x 3 1/2". Shpg. wt., 5 1/2 lbs.

11 T 89505

Net 39.95

## DELUXE PLUG-IN SPOTLIGHT

- 12 Volt GE Sealed Beam
- 10-Foot Cord with Plug
- All Chrome, Zinc Cast Housing

4<sup>95</sup>

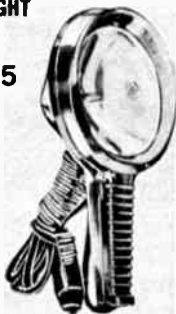

Plug-in portable spotlight is a real "life-saver" in emergencies—provides dependable, instant, powerful light for safety in every night-driving need. Finger-grip handle permits easy direction of light beam. Flexible 10-foot cord; GE sealed beam; convenient hang-up hook; rich chrome plate on die-cast metal. Fits most cigarette lighter sockets.

11 T 16250 Shpg. wt., 2 1/4 lbs. Net 4.95



## QUARTZ-IODINE FOG AND DRIVING LAMPS

- 260,000 Candle Power
- Die-cast, Slim-Line Body

High power, long life lamp gives life saving illumination in poor weather, makes night driving safer and less tiring. Wide angle, sharp cut-off fog lamp beam penetrates heavy fog. Driving lamp has concentrated narrow beam for reaching far ahead of normal high beams. Chrome plated body. Sealed lens and reflector keeps out dirt and moisture. Fully adjustable mounting bracket. For 12 volt use. 5 3/4" diameter, 2 1/2" deep. Shpg. wt., 2 1/4 lbs.

11 T 26515 Fog Lamp, yellow Net 12.95

11 T 26523 Driving Lamp, clear Net 12.95

11 T 26531 Replacement Bulb Net 4.95



12<sup>95</sup>

## LAFAYETTE BOOSTER CHARGER



SALE  
26<sup>95</sup>  
Cut 3.00  
Sale Ends Dec. 31, 1970

- 50 Amp. Battery Boost Power
- 10 Amp. Battery Charger

Starts cars fast in the coldest weather with automatic 50 amp. boost. Perfect for 6, 8, or 12 volt batteries used in trucks, cars, boats, tractors and other vehicles. Operates as a booster and as a 10 amp. charger. Features include: color coded meter indicates battery condition, charging and booster rate, and correct polarity. Full wave charging circuit, triple density selenium rectifiers, isolated and fully impregnated transformer, and an auto-reset circuit breaker; heavy duty 8" input cord, and heavy duty 6" cables with soldered clamps for full output; acid resistant front panel and baked enamel back and sides. All internal components are plated for protection against corrosion. UL listed. Size: 8Hx5 3/4Wx6 5/8D. 11 T 01062 Shpg. wt., 12 lbs. Net 26.95

## REAR WINDOW DEFROSTER/DEFOGGER KIT

ONLY  
16<sup>95</sup>



- Enjoy The Convenience and Safety of Clear Rear Vision
- Adjustable Louvers Direct Air Where Needed

Rear window defrosting kit with giant defrosting capacity — 50 cu. feet of warm air per minute quickly defrosts and defogs rear window regardless of weather. Unit is easily installed in trunk; does not interfere with spare tire or luggage space. Adjustable louvers to direct flow of air are recessed; will not interfere with vision or rear deck space. Dash switch controls defroster operation. Improves heating and air conditioning operation of car by increasing air circulation. Kit includes heavy duty motor, defroster hoses, adjustable louvers, switch, wiring, templates, and installation instructions. Fits all cars, (except station wagons, convertibles, and rear engine cars) for 12 volt electrical system. Shpg. wt., 3 lbs.

11 T 12507

Net 16.95

## WINDSHIELD DE-ICER

- Heavy Duty—Just Heat and Scrape

ONLY 10<sup>95</sup>



Heavy duty, fast acting de-icer with high capacity blower. Clears up iced windows long before your car's own heating system has a chance to take effect. No more frozen windshields to block or distort vision. Heavy gauge, 16 ft. cord is long enough to reach all windows. Plugs into cigarette lighter. Break-resistant, cyclocac housing. With mounting bracket and in-line fuse. Shpg. wt., 2 1/4 lbs. 11 T 22514 Net 10.95

\*See Page 18 for Full Credit Details on Easy Pay Plan

# Car Radio Accessories—Garage Door Openers

## LAFAYETTE SOLID-STATE CAR REVERBERATION AMPLIFIER

Recreates Concert Hall Listening In Your Car



# SALE!

NOW **9<sup>95</sup>** WAS 11.95

Including Mounting Bracket  
Less Speaker

• Can Be Used With Any 12-Volt  
Negative Ground Car Radio—AM or FM

NOW—listen to the most dramatic sound of music you have ever heard in a car with the Lafayette solid state Automobile Reverberation amplifier. When used with your present 12-volt negative ground AM or FM car radio, the Lafayette Reverb amplifier creates a second set of reflected sound waves reproduced through a rear seat speaker (not included). These reflected sound waves provide this exciting new dimension in sound reproduction. Features a push/pull Fader/Balance control. Balances regular car radio speaker and reverb speaker. Also controls amount of reverberation—from 0 to maximum. Separate isolation transformer for ultimate matching conditions. For underdash mounting. Dim.: 7½" D x 3½" W x 1¾" H. Includes mounting bracket. Imported. Shpg. wt., 4 lbs.

99 T 85193

Net 9.95

## SOLID-STATE FM CONVERTER FOR AM CAR RADIOS



• For 12 Volt Negative Ground System

Only  
**29<sup>95</sup>**

Includes: Mounting Bracket for Under-Dash Installation, Fastener for Top of Dash or Console Installation, Antenna and Patch Cords.

Operates with no alterations to your present AM car radio by tuning to 1500 KHz and then turning on the FM converter. Tunes standard FM broadcasts from 88-108 MHz. Volume and tone are controlled from the AM radio. Features 8 transistors, 7 diodes and a built-in noise filter for fine FM reception. Also includes vernier slide rule tuning dial with luminous scale and dial pointer. AFC for drift free reception and local/distance switch for optimum reception. Slim-line design allows converter to be placed on or beneath dashboard with equal convenience. With all mounting hardware. Size: 1¾" H x 4¼" D x 5½" W. Imported. Shpg. wt., 2 lbs.

17 T 41000

Net 29.95

## CUSTOM 2-WAY CAR REAR SEAT SPEAKER KIT

This two-way 6 x 9" auto speaker was specially designed to satisfy the demand for the finer tone quality available from modern FM car radios and tape players. Enjoy full quality reception in the rear seat of your car. It has a co-axially mounted 3" tweeter for high frequencies, and matches 8, 10, 20, or 40 ohm outputs for universal use. 6-oz. ceramic magnet with power handling capacity of 10 watts. Complete with chrome grille, fader control, hardware, wire and illustrated instructions. Wt. 3¾ lbs.

32 T 49448

Net 11.95

**11<sup>95</sup>**



# Chambron



- Opens—Closes—Securely Locks Garage Door
- Automatically Controls Garage Door and Lights from Inside Your Car
- Fully Transistorized Transmitter and Receiver with Private Tone Coding
- Operates 1-Piece or Sectional Doors
- 1/3 HP Motor—For Doors Up To 22 ft.

## Liftmaster<sup>T.M.</sup> Garage Door Openers

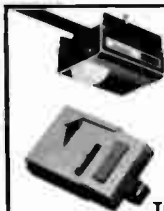

Motor Control

NOW ONLY

**SALE**  
**149<sup>95</sup>** SAVE 10.00

No Money Down\*

SALE ENDS DEC. 31, 1970

Transmitter

Receiver



Deluxe garage door operating system. Easily handles any residential, track guided garage door; metal, fiberglass or wood doors up to 22 ft. wide and 8 ft. high. Only your tone coded transmitter can open the door. Gear-head chain drive motor exerts 200 lbs. of push-pull force. Needs only 1½" of headroom space between high arc of door and ceiling. Fully automatic. Built-in light goes on as soon as door starts to open and stays

on for approximately two minutes after door closes. If door hits obstruction, it stops automatically. Safety clutch prevents damage. When started again, it will reverse itself. Transmitter can be carried in pocket, kept in glove compartment, clipped to sun visor or mounted under dash. Motor operates on 117 VAC, 60 Hz. UL listed. Shpg. wt., 65 lbs.

13 T 82183WXX

Net 149.95

See Listing of Accessories Below.

ABOVE GARAGE DOOR OPENERS SHIPPED F.O.B. CHICAGO, ILLINOIS. NO C.O.D. SHIPPING CHARGES ARE COLLECTED ON DELIVERY. SEND FULL REMITTANCE OR USE LAFAYETTE'S EASY PAY PLAN.

### ACCESSORIES

Extra transmitter for second car.  
13 T 82159 Shpg. wt., ¾ lb.  
Key Switch for outdoor operation, with 2 keys.  
13 T 82043 Shpg. wt., ½ lb.

Outside quick release lock. Used to open door from outside when electricity fails. Shpg. wt., ¼ lb.  
13 T 82134 Net 19.95  
13 T 82142 16 oz. Dry Spray Silicone Spray Lube Net 4.95  
Net 2.30

# Arcturus

## ARCTURUS 4½" D. EQUATORIAL REFLECTOR

- 450X with Barlow Lens



## Meteor 4" Reflector

- 264X with Optional Barlow Lens

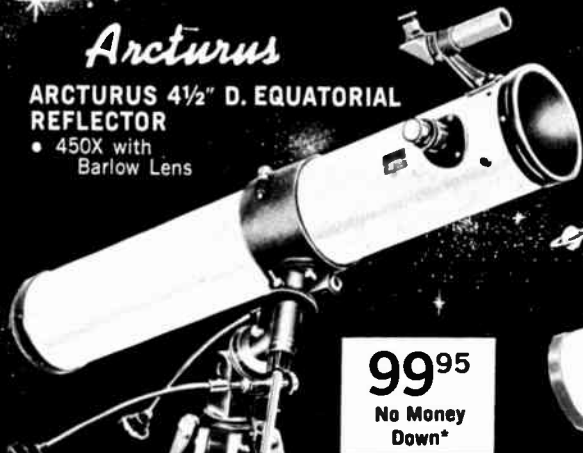

**99<sup>95</sup>**

No Money Down\*



**34<sup>95</sup>**

No Money Down\*

• Eyepieces and Barlow Lens For 450X, 300X, 225X, 150X, 90X and 45X • 900mm Focal Length • Micrometion Controls For Horizontal, Polar, Declination • 4½" (114mm) F/8 Spherical Aluminized Quartz Mirror • Barlow Lens Included

- Eyepieces for 132, 64X and 32X
- 4" (100mm) f/8
- Aluminized First Surface Secondary Mirror

4½" spherical, aluminized quartz mirror gives wide, flat field of view and outstanding color definition. Three coated eyepieces provide magnifications of 45X, 150X, 225X; (with Barlow lens 90X, 300X and 450X). Fast resolving power of 1.5 seconds and 900mm focal length permits detailed viewing up to twelfth magnitude. 5X24mm right-angle, prismatic finder scope with cross hairs easily locates objects to be viewed. Micro-motion controls and equatorial mount with hour and declination circles provides complete control for tracking. Heavy-duty hardwood tripod with accessory tray adjusts from 33 to 60". Complete with lenses. Sun glass, Moon glass, Barlow lens. Scope size: 4½" Dia., 36" long. Imported. Shpg. wt., 29¼ lbs. 99 T 72183W Net 99.95

A fine, compact professionally designed 4" reflecting telescope with carefully aluminized optics for exceptionally low light loss. Primary mirror is aluminized and quartz overlaid. Highly achromatic optical system features very low chromatic aberration. Adjustable wooden 48" tripod with tray brace and convenient optical sight permit easy field use on uneven surfaces. Rack and pinion drive assures smooth focusing. Lightweight aluminum body has white baked enameloid finish: Specs.: Mirror Dia.: 4"(100mm). Focal Length: 800 mm. Eyepieces: 6; 12.5; and 25 mm Huygenian. Resolving Power: 1.4 seconds. Supplied with stand, sun filter and three eyepieces. Imported. 99 T 72126W Shpg. wt., 10 lbs. Net 34.95 99 T 70542 Barlow lens for double power. Wt., 8 oz. Net 3.95

## LAFAYETTE 8x24 MINI-SCOPE

- Includes 6x Super Wide-Angle (11°) Objective
- Fits in Palm of Hand
- Use as Close-up Magnifying Glasses

Only **12<sup>95</sup>**



Versatile, precision pocket telescope provides powerful 8-power optics, yet slips into your pocket. Ideal for travel, hiking or nature study. For a larger field, quick-change to the 6x extra-wide view 18mm lens. Pulls in the action at football, hockey, and shows. 24mm coated lens provides 435 ft. viewing area at 1000 yds., 18mm coated lens gives 575 ft. viewing area. With soft zippered case, wrist strap. Imported. Shog. wt., 1 lb. 99 T 72159 Net 12.95

## LAFAYETTE 8-25X 30-mm ZOOM SPOTTING SCOPE



8-25X

**15<sup>95</sup>**

13-40X

**21<sup>95</sup>**

## 10X30mm TELESCOPE with TRIPOD



**8<sup>95</sup>**

- Full 10 Power
- Portable-Compact-Lightweight

A 10 power, 30mm internal (front) focus telescope that is compact, lightweight and portable—ideal for taking it everywhere you go. Features coated achromatic lenses. Has built-in camera tripod socket. Sturdy tripod supplied with rubber-tipped legs. Minimum focusing distance 14 ft. 15 T 64046 Shpg. wt., 2 lbs. Net 8.95

- Zoom Any Power From 8X to 25X
- Quick Focusing With Table Top Tripod

An outstanding varipower spotting scope that is ideal for any "spotting" need in field or general use . . . shooters, bird watchers, etc. Features 30mm coated lens for brilliant viewing. Fingertip controls for quick zooming and focusing. Has a built-in camera tripod socket. Includes a table-top tripod with rubber-tipped legs that prevent scratching of furniture. Compact, lightweight and portable . . . ideal for taking it everywhere you go. Complete with black, zippered carrying case with convenient belt loop. Overall length of scope is 12". Imported. Shpg. wt., 3 lbs. 99 T 71920 Net 15.95

## DELUXE 13-40X 40-mm ZOOM SPOTTING SCOPE

- Zoom From 13x to 40x Power • 40 mm Objective
- Same unique design as above but with extra power and larger 40-mm objective. With tripod less case. Overall Length 16". 15 T 64038 Shpg. wt., 4¼ lbs. Net 21.95

\*See Page 18 for Full Credit Details on Easy Pay Plan





# LAFAYETTE For BEGINNERS & INTERMEDIATE STUDENTS

## Microscopes

### 900X "ZOOM" STUDENT LABORATORY

Complete Outfit  
For Only **21<sup>95</sup>**

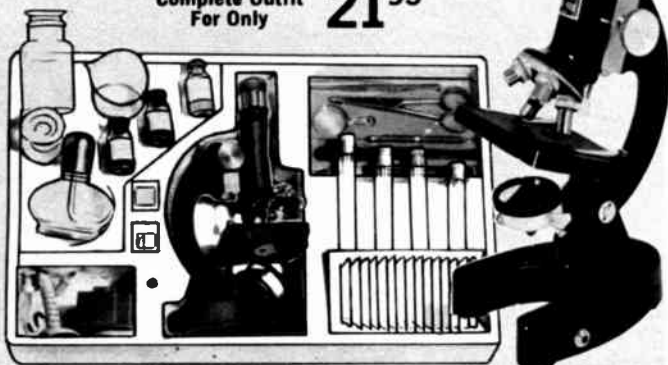

- Zoom from 100 to 900 Power
- All Metal Construction
- All Dissecting and Mounting Materials
- Includes AC/DC Substage Illuminator
- Prepared and Blank Slides

A complete microscope laboratory for the student and enthusiast. Provides all necessary material to explore the interesting field of microscopic research. The 900X microscope offers various combinations of magnification from 100X to 900X with four objective lenses (10X, 20X, 40X, 60X). Combined with the fine ocular which "zooms" from 10X to 15X, the scope provides clear sharp images. Tube movement governed by adjustable downstop with a locking screw prevents costly slide breakage. The 900X features an optical condenser piano mirror and built-in 3-volt light using the AC adapter included, or 2 night light batteries. Laboratory includes a dissecting kit with hand lens, blunt-end scissors, scalpel and probe; glassware (test tubes, specimen bottles, alcohol burner). There are several prepared slides, blank slides, cover glasses, mounting balsam. Methylene Blue and Rhodamine stains. Less batteries. Imported. Shpg. wt., 5 lbs.

99 T 71053 ..... Net 21.95  
99 T 71060 Replacement bulb ..... Net .19  
99 T 82580 Battery (2 req.) ..... Net ea. .10

### DELUXE 1200X RESEARCHER MICROSCOPE SET

**44<sup>95</sup>**

No Money  
Down\*

- 25X to 1200X in 12 Ranges
- Full Range Fine Focus Adjustment
- Integral Mechanical Stage
- Rotating Diaphragm
- All Metal Construction

Closely parallels the "Society" grade microscope. Four Huygenian eyepieces: 5X, 10X, 15X P20X combine with four achromatic objectives: 5X, 10X, 40X, 60X to yield 12 combinations: 25X, 50X, 75X, 100X, 150X, 200X, 300X, 400X, 600X, 800X, 900X, 1200X. Dual knob rack and pinion coarse focusing with tension adjustment for slow motion. Micro-motion fine focusing adjustment. Spring loaded to prevent objective from driving through slide. 85mm x 85mm stage can be moved in any direction, with slide, by 2 knurled screws while looking through the eyepiece. Sub-stage has rotating, 5-position diaphragm and 35mm piano/concave reflecting mirror. Stable horseshoe base. Complete with set of 5 basic dissecting instruments, 10 slides, pack of cover slips, tube of mounting fluid. All in a dovetailed wooden carrying case with handle and four rubber feet. Imported. Shpg. wt., 7 lbs.

99 T 70410 ..... Net 44.95

### 80X TO 1200X ZOOM MICROSCOPE SET

**27<sup>95</sup>**

- 80X-1200X Magnification
- 3-Way Substage Mirror
- 4 Achromatic Objectives
- All Metal Construction

Constantly variable magnification of 80, 100, 160, 200, 400, 600, 800 and 1200 times. Zoom eyepiece for less specimen adjustment and controlled detail magnification. Excellent dual knob coarse and fine focus control. Stage includes optical condenser and aperture diaphragm. Spring loaded rack prevents damaging objective. Substance illuminator-mirror combination for direct, incandescent, or reflected illumination. Includes 2 prepared slides, 4 blank slides, spatula, scalpel, probe, scissors, tweezers, and magnifying glass. Wooden case with carrying handle. Illuminator operates on night cells or house current, by means of a transformer. Less batteries. Imported. Shpg. wt., 6 lbs.

99 T 71489 Zoom Microscope ..... Net 27.95  
99 T 71060 Battery (2 required) ..... Net ea. .19  
TRANSFORMER—Permits use of house current for illumination  
99 T 71182 Shpg. wt., 8 oz. ..... Net 1.89

### 600X MICROSCOPE SET

**7<sup>95</sup>**

- With Sub-Stage Light
- 75X-300X-600X
- Triple Revolving Turret

For the student—hobbyists—or budding scientist! Features built-in sub-stage light and three achromatic objective lenses giving magnification of 75X, 300X and 600X. Complete with 3-glass slides, 5-piece dissecting set and hardwood cabinet. All metal. Less batteries. Imported. Shpg. wt., 2½ lbs.  
19 T 84020 ..... Net 7.95  
99 T 82580 Battery (2-req'd.) ..... Net ea. .10

### 750X "ZOOM" MICROSCOPE SET

**13<sup>95</sup>**

- 50X to 750X
- All Metal Construction
- Built-in Substage Illuminator

Features advanced zoom type micro-optics. Zoom action permits smooth, vibration-free, variable magnification without disturbing stage or specimen. Three hard coated objectives set in a revolving "click stop" turret give magnifications of 50X, 75X, 200X, 300X, 500X and 750X. Zoom action permits choosing multiple magnifications without changing eyepiece of objectives. The eyepiece zooms smoothly from 10X to 15X. Illuminator operates with batteries or on ordinary house current with transformer supplied. Round hole disc diaphragm controls illumination. Includes instructions, sample slides, 5 piece dissecting kit and wooden carrying case. Less batteries. Imported.  
19 T 84095 Shpg. wt., 3¼ lbs. ..... Net 13.95  
99 T 71060 Replacement bulb ..... Net .19  
99 T 82580 Battery (2-Required) ..... Net .10

# The "Micro-Standard Mark II

## DELUXE 1500X SOCIETY STANDARD MICROSCOPE

- 25X to 1500X in 12 Ranges • 4 Achromatic objectives in rotating turret • Variable substage condenser with iris diaphragm • Standard society optics, both objectives and eyepieces • Par focal within 0.1mm

An unusually fine optical instrument designed especially for precision viewing requiring high magnification with an oil immersion lens. The outstanding features of great range and engineered versatility, optimum clarity and great magnification are usually found in microscopes costing much more.

**OPTICAL SPECIFICATIONS:** Three Huygenian eyepieces—5x, 10x, 15x. Four achromatic objectives—5x, 10x, 40x, 100x (oil immersion). **FOCAL LENGTH:** 170 mm. **Monocular.** **FOCUSING:** Coarse focus with adjustable tension. Fine focus vernier adjustment. Par-Focal within 1/2 rotation of fine focus control (0.1 mm.). Spring loaded safety device prevents objective going through slide. **STAGE:** Square stage: 95 mm x 95mm. Integral mechanical stage, adjustable in any direction. **Stage chps.** **SUBSTAGE:** Focusing condenser with variable Iris, diaphragm, 41 mm plano/concave mirror. **Tilting Base.** Overall 12" high, 6 1/2" deep, 4 1/2" wide. Imported. Shpg. wt., 11 1/2 lbs.

99 T 71342W

Net 99.95

CLINICAL AND  
ADVANCED  
ACADEMIC MODEL

99<sup>95</sup>

No Money  
Down\*

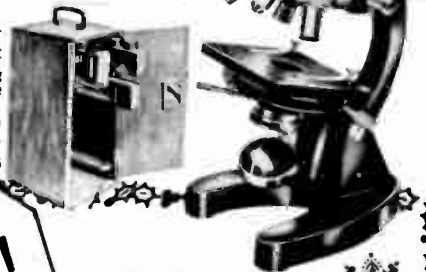

## LAFAYETTE EXTRA WIDE ANGLE BINOCULARS

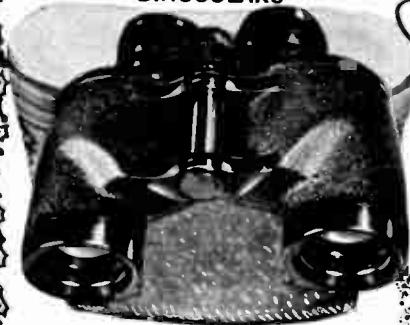

**SALE!**  
SAVE \$4.00  
was 28.95

24<sup>95</sup>

No Money Down\*

SALE ENDS  
DEC. 31, 1970

- Doubles The Field Of Ordinary Binoculars
- 580 Ft. Field Of View at 1000 Yards
- Oversize Oculars • Exceptional Quality

A multi-purpose, precise 7x35mm binocular that is particularly adept for field studies. Wide-angle hard coated prisms permit brilliant and close-up details of sporting events, without sacrificing the image, as is the case with regular narrow angle binoculars. Field of view at 1000 yards is 578 feet! Center focus and right eye adjustment insure perfect focus. All optics are sealed against moisture and are properly collimated and aligned. Hard lined case for protective storage when not in use. Complete with neck strap. Imported. Shpg. wt., 4 lbs.

99 T 70195

Net 24.95

## LAFAYETTE VERSATILE BINOCULARS



As Low As  
18<sup>95</sup>

Precise design—quality material—and expert workmanship. All lenses are hard coated—prisms clamped in lightweight alloy frame and body—sealed against dust and moisture—properly collimated and aligned. All are center focus with adjustable right eyepiece. Hard lined case and neckstraps included.

**7x35 POPULAR, VERSATILE, ALL PURPOSE BINOCULARS.** For the sportsmen—hunter—bird watcher—vacationer. High luminosity. Compact design. Imported. Shpg. wt., 3 lbs.

99 T 70187

Net 18.95

**7x50 NAVY STYLE NIGHT GLASSES.** Favored for marine use. The choice of professionals because of exceptionally high light gathering power. Superior image brightness.

99 T 70181 Shpg. wt., 3 3/4 lbs. Imported.

Net 22.95

**20x50 KING OF THE LONG RANGE.** Hunters, mountain climbers, plane spotters, forest rangers—any long distance viewing and observation requirement. Imported. Shpg. wt., 4 1/2 lbs.

99 T 70203

Net 27.95

## LAFAYETTE TRU-ZOOM™ WIDE-ANGLE BINOCULARS

- Not a "Vari-Power"
- One Control Zooms Both Barrels
- 7X to 12X—or any Power in Between
- Center Focus—Right Eye Adjust—Plus Single Synchronous' Zoom Control!

49<sup>95</sup>

No Money Down\*

Sensational Zoom action holds even fast-moving subjects in perfect view. Sight in any subject at 7-power—then Zoom up to 12-power (or any power in between) for closeup viewing. Full 40mm, objective lenses, hard coated achromats. Field of view is 323 feet at 1000 yds., at 7 power. Prisms clamped in shock-resistant mounts. Lightweight alloy frame and body. Sealed against dust and moisture. Includes plush-lined, hard case and straps. Imported

99 T 71006 Shpg. wt., 5 lbs.

Net 49.95

\*See Page 18 for Full Credit Details on Easy Pay Plan

# CORDLESS ELECTRIC DECORATOR CLOCKS

## AMERICAN TRADITIONAL CORDLESS ELECTRIC PENDULUM CLOCK

Only **16<sup>95</sup>**



Charming replica of an old favorite expertly reproduced in Timewood and carefully accented in walnut tones. Mottled parchment dial is in striking contrast to the large Roman Numerals. The graceful motion of its swinging pendulum completes the authenticity of this ageless favorite. Runs up to one year on a single "0" cell. Size: 14"H x 9"W x 2"D. Shpg. wt., 3 lbs. 13 T 30547 — Net 16.95  
Battery for above  
99 T 62564 — Net .15

## "GRANDFATHER" CORDLESS ELECTRIC PENDULUM CLOCK

Only **29<sup>95</sup>**

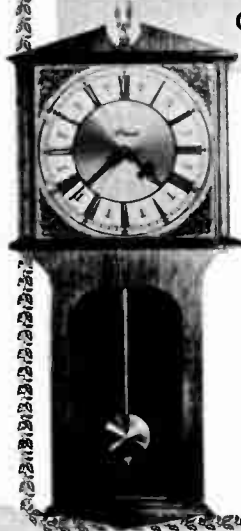

Warm walnut American styling for a charming blend of accuracy and handsome traditional design. Beautifully accented handsome spun gold and ivory dial with smoked antique Federal mirror complements the graceful motion of the golden swinging pendulum. Carved walnut raised trim is crowned with an eagle to complete this elegant timepiece. Runs up to one year on a single "0" cell. Size: 25"H x 11"W. Shpg. wt., 6 lbs. 13 T 30521W — Net 29.95  
Battery for above.  
99 T 62564 — Net .15

## DIGITAL TV LAMP CLOCK



**12<sup>95</sup>**

- Take Guesswork Out of Telling Time
- Relieves TV Eye Strain

Ideal for use on a TV cabinet, in the kitchen or baby's room. Provides soft illumination and precise time. Attractive sturdy plastic case with gold trim. Size: 4x7x3 7/8" Deep. Shpg. wt., 2 3/4 lbs. UL listed. 110V. 60 Hz. AC. 14 T 60013 Walnut  
14 T 60021 White

Net 12.95  
Net 12.95

## DIGITAL CALENDAR WRIST WATCH

**50th Anniversary SALE**  
**12<sup>95</sup>**  
**CUT 2.00**  
SALE ENDS DEC. 31, 1970



- Swiss Precision Crafted

- Gives You The Hour, Minute And Date At A Glance
- Sweep Second Hand

Digital read-out watch shows hour and minute and date in large, easy-to-read red and blue numerals. Great for anyone who must account for time at a glance . . . pilots, rally drivers, etc. Ideal for the visually handicapped. Striking dial features sweep second calendar which digitally indicates hand and incorporates an automatic the day of the month. Precision anti-magnetic Swiss movement has unbreakable mainspring. Beautiful gold tone finish case with genuine lizard strap. Imported. Shpg. wt., 8 oz. 13 T 31362L — Net 12.95

## ELECTRIC CALENDAR WRIST WATCH

**36<sup>95</sup>**

- Never Needs Winding
- See The Date At a Glance
- Precision 13-Jewel Movement



Electric battery operating watch with precision crafted, anti-magnetic 13 jewel movement. This fine quality watch features an unbreakable mainspring, automatic changing calendar, sunbrush dial, gilt-raised figures, and sweep second hand. Runs on tiny energy cell for never-wind convenience. Gleaming 10 micron gold-filled case with stainless steel back and genuine lizard strap. Comes in deluxe presentation box. Energy Cell: Standard, long-lasting 12 to 18 month. Imported. Shpg. wt., 8 oz. No Money Down\*. 13 T 31368L — Net 36.95

## LAFAYETTE TECHNI-TIMER

**7<sup>95</sup>**

- Handles Up To 1875 Watts
- Turn Lights & Appliances On & Off Automatically

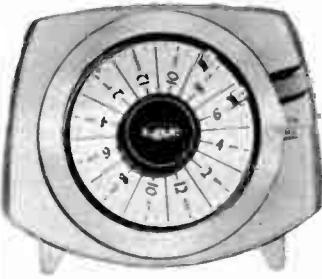

For radios, refrigerators, electric blankets, fans . . . turns your lights On and Off while you're away. Repeats cycle every 24 hours without resetting. Minimum On time 15 minutes; maximum On time 23 hours; minimum Off time 1 hour; maximum Off time 23 hours 45 minutes. Can be set to "skip-a-day" operation, or manually controlled. No special wiring—just plug into 117V. 60 Hz AC line. Includes 6 ft. cord with plug and receptacle for equipment to be controlled. Capacity 1875 watts. UL/CSA listed. Size: 5 1/4 x 2 1/2 "D. 13 T 01407 Shpg. wt., 2 lbs. Net 7.95

\*See Page 18 for Full Credit Details on Easy Pay Plan



**SELF WINDING 17 JEWEL DAY AND DATE CALENDAR WATCH**

Deluxe Swiss watch is self winding, and automatically changes the day and the date. Precision made 17 jewel movement is water resistant, antimagnetic, and features an unbreakable mainspring. Handsomely styled 10 micron gold filled case with a stainless steel back and a matching expansion band. Easy-to-read dial features the date in red and the day of the week in black, raised gilt numerals on an attractive white dial face and a sweep second hand. Shpg. wt., 8 oz.

13 T 31289L Net 36.95

**17 JEWEL CALENDAR WRIST ALARM WATCH**

Swiss made wrist alarm serves as an automatic reminder anytime—any place. Features automatic daily calendar. 17 jewel movement is water resistant, antimagnetic and features an unbreakable mainspring. And radium dial case is 10 micron gold-filled with stainless back or all stainless steel. Both with genuine lizard band. Dial has raised gilt numerals on a white face with a sweep second hand. Shpg. wt., 8 oz. No Money Down\*

Stainless Steel Case Net 39.95  
13 T 31396L  
Gold Tone Case Net 39.95  
13 T 31404L

**DELUXE SPORTSMAN'S WATCH WITH WORLD TIMER**



**An Automatic Underwater Watch That Indicates Elapsed Diving Time**

- Swiss Precision Crafted
- Automatic Day-N-Date Calendar
- Stainless Steel Band
- Tells Time in 26 World Cities

Designed for the active sportsman! Tell the time, day and the date at a glance. Revolving bezel lets you know the time in 26 cities around the world, and also operates as a 60 min. elapsed timer. Features a telemeter scale, a sweep second hand and luminous hands and dial markers. Rugged, precision timepiece is water-resistant, anti-magnetic and has an unbreakable mainspring. Hermetically sealed pressurized case provides protection to 5 atmospheres. Case is finished in bright chrome with a stainless steel back and a matching stainless steel band. Shpg. wt., 9 oz.

13 T 31271L Net 15.95



**17 JEWEL DOUBLE-BUTTON CHRONOGRAPH WATCH**

Precision made 17 jewel Swiss chronograph is ideally suited for accurate elapsed timing of sporting events, scientific experiments, etc. Features a tachometer for measuring speed, a telemeter for measuring the distance of sound and a stop watch with a 30 minute register and a sweep second hand. Accurate, dependable movement features an unbreakable mainspring. Water resistant, dustproof and antimagnetic. Bright chrome case with a stainless steel back, raised numerals, and a genuine leather strap. No Money Down\* Shpg. wt., 13 oz.

13 T 31131L Net 37.95

**SPORTSMAN'S CALENDAR WATCH SWISS PRECISION CRAFTED**

**An Automatic Underwater Watch That Indicates Elapsed Diving Time**

- As Low As **11.95**
- Also Available In Lady's Model
  - Pressurized Water-Resistant Case
  - Automatic Daily Calendar
  - Parking Meter Time
  - Luminous Marker and Hands



Handsome wristwatch especially designed for the sportsman who is apt to get his watch wet—fishermen, hunters, or skin divers. Hermetically sealed pressurized case provides maximum protection to 5 atmospheres. Movable outer bezel permits easy timing of events, parking meter time, or elapsed submerged time. Swiss crafted antimagnetic movement features automatic daily calendar, unbreakable mainspring, and sweep second hand. Luminous hour markers and hands for high visibility. Polished chrome case, stainless back, and comfortable waterproof strap. Imported. Shpg. wt., 7 oz.

13 T 31180L Mens' Net 11.95

Ladies' Model—Similar to above  
13 T 31263L Shpg. wt., 6 oz. Net 13.50

Same as above mens' watch but with 17 jewel Swiss movement.  
13 T 31198L Shpg. wt., 14 oz. Net 22.95



As Low As **11.50**



**PRECISION-SWISS STOP WATCHES**

**A 1/10 SECOND TIMER**

Designed for close timing. Large hand registers 1/10 of a second, up to 30 seconds; small hand reads minutes, up to 15. Start, stop, and continue from crown; instant zero, 7 jewel movement. Chromium plated case. Shpg. wt., 8 oz. Imported.

13 T 31032L Net 12.95

Same as 13 T 31032 (above) except 1 jewel.  
13 T 31024L Net 11.50

**B 1/5 SECOND TIMER**

Second hand registers 1/5 of a second and completes turn in 60 seconds. Small hand indicates up to 30 minutes. Side slide starts and stops hands. Fast resetting dependable 7-jewel movement. Shpg. wt., 8 oz. Imported.

13 T 31040L Net 12.95

Same as 13 T 31040 (above) except 1 jewel.  
13 T 31057L Net 11.50

\*See Page 18 for Full Credit Details on Easy Pay Plan

# LAFAYETTE 150-in-1 ELECTRONIC EXPERIMENTERS KIT

*Assemble 150 Interesting  
Electronic Projects*

- 100% Reusable Components
- No High Voltage or Soldering
- Sturdy Compact Wooden Case
- Detailed Instruction Manual

Lafayette's 150-in-1 IC Electronic Experimenter's Kit supplies a variety of exciting projects dealing with measurement, radio broadcasting and receiving, communications, sound and musical instruments, physics, chemistry, amusement, and convenient living. Its quality components are attractively displayed in a functional, sturdy wooden storage case for ease in experimentation and long lasting protection. The enlarged visualized integrated circuit clearly shows the various devices that form a typical IC. Each experiment is wired using easy to connect spring tension terminals. This feature permits 100% reuse of all components and eliminates the bother and danger of soldering. Power is supplied from three standard low voltage batteries, thus eliminating the possibility of shock hazard. Simplified manual portrays each experiment in both visual and written forms. The visual representation permits convenient theoretical circuit reasoning and the instructions provide a short cut for speedy wiring. Geared to be educationally stimulating for youngsters as well as adults. Supplied with all components including batteries. Size: 3½"H x 15½"W x 8½"D. Shpg. wt., 3¾ lbs.

Net 24.95  
 99 T 35107 ..... Net ea. .14  
 99 T 82572 Extra 1½ volt "C" Cell (2 required) ..... Net .21  
 99 T 60212 Extra 9 volt battery ..... Net .21

## NEW!

### Only

# 24<sup>95</sup>

**Featuring An  
Enlarged Visualized  
Integrated Circuit**

Vivid enlarged representation clearly shows the functional components of a typical integrated circuit. Incorporates a capacitor, resistors, transistor, and diode to form a remarkable educational unit.



**EDUCATIONAL—CREATIVE—NO TECHNICAL  
KNOWLEDGE NECESSARY! LEARN WHILE YOU BUILD!**

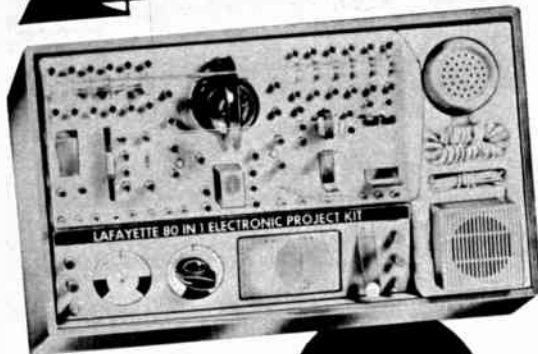

### Only

# 16<sup>95</sup>

# LAFAYETTE 80-in-1 ELECTRONIC PROJECT KIT

## BUILD 80 SAFE BATTERY OPERATED ELECTRONIC PROJECTS

- All Solid-State Circuitry • No Soldering Required

The ideal introduction to the world of electronics for young or old experimenters. Build over 80 safe, battery operated, useful solid-state projects with this one kit. No soldering or tools required. Detailed, simplified instruction manual provides easy-to-follow instructions for each project. Point-to-point wiring between numbered parts using spring type connectors completely eliminates soldering. Each project can be assembled and disassembled in just minutes. This "breadboard" type kit is ideally suited to the design of as many additional circuit projects as your ingenuity and creativity can produce. Nothing else needed—kit includes all parts for these projects—galvanometer, solar cell, transistors, relay, baffled speaker, earphone, microphone, relay transformer, tuning capacitor, volume control, telegraph key, antenna, diode, resistors, capacitors, batteries and connecting wires—all packed in a fitted hardwood case. Size: 15x8¾x4". Imported. Shpg. wt., 3 lbs.

Net 16.95  
 99 T 35016 Complete 80-in-1 Kit ..... Net ea. .10  
 99 T 62580 1½V Replacement Battery (2-required) ..... Net .21  
 99 T 60212 9V Replacement Battery (1-required) ..... Net .21

### SOME OF THE PROJECTS YOU CAN BUILD

The 80 fascinating projects which can be assembled with this Lafayette kit cover a wide range of subjects such as home entertainment, wireless communications, telephony and telegraphy, music, public address, alarms and warning systems, electrical measurement, digital circuitry, physiology, weather, etc. You can build a dozen different radio receivers, including a solar powered transistor radio. Also included are projects concerning computer type "AND" and "OR" circuits, many varieties of light and sound code

signal communications using Morse Code, several transistorized amplifiers and a public address system, continuity checkers and signal tracer, wireless microphone, metronomes, electric harmonica, photoelectric relay and burglar alarms. Some unusual projects include an electro-stethoscope, sensitive photometer, light wave transmitter, rain alarm, direction finder, auto headlight dimmer, cat sound simulator, muscle simulator, water level warning system and many others guaranteed to provide fun for the entire family.



# Exciting Kits for the Experimenter

## LAFAYETTE "EXPLOR-AIR"™ 4-BAND RECEIVER KIT TUNE IN THE WORLD!

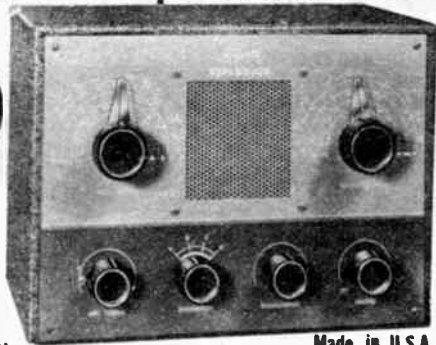

**22<sup>95</sup>**  
Less Cabinet

Made in U.S.A.

- Covers 10, 15, 20, 40, 80, 160 Meter Amateur Bands
- Tunes International Broadcast, Citizens Band, Maritime, Aeronautical and WWV Time Signals
- Covers Standard AM Broadcast Band
- Complete Band Switching from Front Panel
- Bandsread Tuning
- Built-in 4" Speaker

Lafayette's sensational shortwave receiver kit is a complete shortwave and standard broadcast set which covers the entire region from 550 kHz to 30 MHz. Four whole bands of fascinating programming. Perfect for language students and shortwave listeners. Only a regenerative circuit can offer such amazing performance and yet be so simple to build. Building this fine kit is an absolute pleasure—it's so well designed you can't go wrong. Kit includes all the parts you need and the detailed step-by-step instruction book with its giant pictorial drawings shows you just how to put them together. One front panel knob does all the bandswitching, immediately taking you from band to band. All coils are prewound for greater accuracy. Complete 4 band coverage of broadcast stations, international broadcast bands, amateur, maritime, and WWV time

signals. Big 4" speaker and sensitive circuit with 50C5 output stage and 12AT7 regenerative detector and amplifier stages give you all the volume you want. Phone jack for privacy automatically disconnects speaker. All controls are on the front panel: On-Off Volume, Main Tuning, Band Spread, Bandswitch, Antenna Tuning, and Regeneration. 110 volt 50-60 Hz AC-DC power supply. Size 10x7x5".

10 T 09050 (Less Cabinet) wt., 5 lbs. Net 22.95

Shortwave antenna kit for above. Shpg. wt., 1¼ lbs. Net 2.35

32 T 30984 Net 2.35

Leatherette covered Wooden Cabinet for above. 1 lb. Net 3.40

## LAFAYETTE 20-in-1 ELECTRONIC PROJECT KIT

- ★ Absolutely Safe . . . No High Voltage or Soldering
- ★ Detailed Simplified Instruction Manuals
- Build 20 Interesting Electronic Projects
- Easy to Wire Spring Tension Terminals
- Pre-assembled Educational Wiring Blocks

Educationally stimulating kit utilizes separate building units that connect to form 20 interesting electronic devices. Spring tension terminals simplify wiring and eliminate the bother and danger of soldering. Incorporates one transistor, a tuner, diode, key, transformer, galvanometer, solar battery, two resistors, and three capacitors. Battery provides safe low voltage power. Projects are easily assembled in minutes. Attractively packaged in a convenient storage case. Supplied with all components including battery. Shpg. wt., 2 lbs.

99 T 38214 Net 9.95

99 T 62580 Extra 1½ volt "AA" battery Net .10

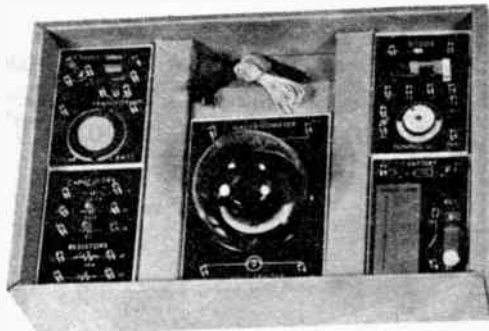

**NEW Only 9<sup>95</sup>**

## LAFAYETTE 10-in-1 ELECTRONIC PROJECT KIT



- ★ Absolutely Safe . . . No High Voltage or Soldering
- ★ No Technical Knowledge Necessary
- ★ Detailed Simplified Instruction Manuals
- Build 10 Educationally Stimulating Projects
- Enlarged Visualized Integrated Circuit

Lafayette's electronic project kit features an enlarged visualized integrated circuit which clearly shows the typical placement of a condenser, two resistors, transistor and diode in an IC. All connections are facilitated by spring tension terminals for easy wiring without soldering. Projects include circuit testers and communication sets. All components are reusable and mounted on an attractive wood molded panel. Supplied complete with manual and batteries. Size 11Wx1¼Hx8"D. Shpg. wt., 1¼ lbs.

99 T 35099 Net 7.95

99 T 60212 Extra 9 volt battery Net .21

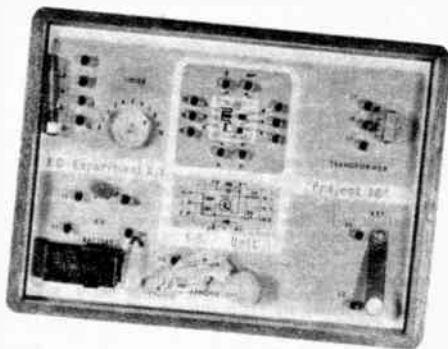

**NEW Only 7<sup>95</sup>**

# FLY THE BIG SKYHAWK BY REMOTE CONTROL

**COMPLETE OUTFIT:**  
Plane, Receiver, Transmitter,  
Batteries and Charger



TESTOR'S R/C SKYHAWK



only **79<sup>95</sup>**  
No Money Down\*

- Easy to Fly — Ideal for Beginners
- One Mile Range of Control
- Rechargeable Batteries with Charger
- Big 44" Wingspan — Length 27"
- Internal Combustion .049 Engine

Simple snap in wing and ready to fly radio controlled plane which incorporates true (pulse) proportional control for smoother, more realistic flight control. This plane is so easy to fly that it is recommended for beginners—no electronic or mechanical skill is required. Aircraft fuselage constructed of virtually indestructible super-impact styrene. Wings and horizontal stabilizer are of super light styrofoam. Tricycle landing gear assures simple landings. High torque .049 cubic inch internal combustion engine has gas tank attached for 4 minutes of powered flight. Super sensitive 9 transistor superhet receiver combines with a powerful dual coil, twin magnet actuator

for superior reliability. 8 transistor 250 milliwatt transmitter provides up to one mile range control. Simple guidance controls include finger tip trim for basic in-flight stabilization. Heavy duty rechargeable batteries are easily charged with convenient charger (included). Complete with R/C plane, transmitter, battery charger, and illustrated flying instruction book. Shpg. wt., 6¾ lbs.

42 T 73017WX for 27.145 MHz.	Net 79.95
42 T 73058WX for 26.995 MHz	Net 79.95
42 T73090WX for 27.195 MHz	Net 79.95

### SKYHAWK SPECIFICATIONS

Length: Fuselage 27", Wing 44". Flying Weight: 23 ounces (approximately). Speed: 30 MPH True. Fuel Capacity: 4 Minutes powered

flight. Transmitter: Single Tone AM Modulated Relayless Pulse. Receiver: Superheterodyne With Pulse Width Rate Decoders.

### REMOTE CONTROL MUSTANG GT OUTFIT



**COMPLETE OUTFIT:**  
MUSTANG, Receiver,  
Transmitter, Batteries  
and Charger

**79<sup>95</sup>**  
No Money Down\*

- Completely Assembled—Ready To Use
- Twin High Torque Drive Motors
- Rechargeable Batteries with Charger
- Electronic "Relay-less" Drive Control

Authentic 1/11th scale model R/C Mustang GT. Fully-assembled. Car body of glossy polystyrene. Durable chassis is tempered aluminum. Twin high torque drive motors are coupled to rear wheels through an electronically controlled 4 transistor rear end... achieves true differential action! True (pulse) proportional circuitry permits feather-touch control. Guidance controls include steering (left-center-right), drive motor (start-stop) and speed (high-low). Super sensitive 9 transistor receiver combines with powerful dual coil, twin magnet actuator for superior reliability. 8 transistor 100 milliwatt transmitter provides convenient control board. Heavy duty rechargeable batteries are easily charged with convenient charger (included). Complete with R/C model, transmitter, and battery charger. Shpg. wt., 7¼ lbs.

42 T 73033WX for 27.095 MHz	Net 79.95
42 T 73108WX for 26.995 MHz	Net 79.95
42 T 73124WX for 27.195 MHz	Net 79.95

### MUSTANG GT SPECIFICATIONS

Length: 16 inches. Width: 6 inches. Height: 4 inches. Weight: 2 lbs., 8 ounces. Speed: 100 MPH Scale. Turning Radius: 3 feet. Transmitter: Single Tone AM Modulated Relayless Pulse. Receiver: Superheterodyne With Pulse Width Rate Decoders.

46 Lafayette Cat. No. 711

### MEDIUM RANGE R/C SYSTEM MRC-FUTABA F-66

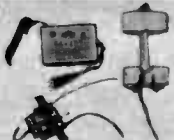

only  
**34<sup>95</sup>**

- SINGLE CHANNEL — 27.145MHz

Complete, ready-to-operate (except for batteries) single channel Radio Control system. Ideal for medium range (up to 800 feet) operation of small planes, cars and boats. All transistorized circuitry for dependable operation on 27.145MHz. Compact, lightweight (1½ oz.) relayless receiver has tuning lamp to adjust for maximum efficiency. Transmitter has 7-section retractable antenna. Compound escapement actuated by receiver batteries. Complete installation diagram and instructions are provided. Transmitter 4¾x2¾x1¾"; Receiver 1½x1¼x¾". Complete system less penlite cells not supplied. Imported.

42 T 76002 Shpg. wt., ¾ lb	Net 34.95
99 T 62580 AA Batteries (10 required)	10 for .59

### LOUDSPEAKER TELEPHONE INTERCOMS



BELOW COST  
CLOSEOUT SALE

**795**

Quantities Limited

This fascinating set consists of two standard telephone handsets and intercom "squawk boxes." Push a button and they operate as regular telephones; push another button and the voice at the other end of the wire comes through the intercom speaker so that anyone in the room can hear. Fun for everyone! Grownups use it too. Complete with connecting wires, the Loudspeaker Telephone Intercom may be operated from room to room, upstairs and down, house to house or patio to house. Uses 4 "D" batteries (not included). Each phone unit measures: 11¼x8¼x3¼". Shpg. wt., 5½ lbs. Available at Sysost Only

19 T 31062 Less Batteries.	Net 79.95
98 T 62563 1½V "D" battery (4 required)	Net ea. .15

\*See Page 18 for Full Credit Details on Easy Pay Plan

# Computer Kits and Builder's Modules

## GENIAC® COMPUTER KITS



### DOUBLE GENIAC

The newest kit in famous Geniac series! The "Double" Geniac contains over 800 parts. Two of everything in the Standard model. Offers the advanced experimenter a far wider range of activities. Perfect for school demonstration. Multiple setup is ideal for Science Fair projects—submit one or more designs. Build "electric brains" that test intelligence—code and decode—add, subtract, multiply and divide—solve puzzles

For Schools,  
For Science Fairs,  
For  
Advanced Experimenters

- Over 800 Parts
- Computes, Reasons, Plays Games
- Composes Music, Forecasts Weather
- Design Your Own Computers

—play games—forecast weather—reason in syllogisms—information and logic circuits. No soldering required. Easily assembled and operated. 64 page guide and reference book, beginners manual, wiring diagrams and many extra pamphlets outlining projects and methods. Complete with mounting rack and batteries. Shpg. wt., 8½ lbs.

19 T 38034

Net 18.95

### STANDARD GENIAC

You build up to 125 exciting "electric brain" machines. Has special circuits for forecasting weather. No soldering required. Comes complete with extra pamphlets including 64-page "Simple Electronic Brains and How To Make Them," "Symbolic Analysis of Relay

and Switching Circuits," "Beginner's Manual," "Machine to Compose Music," wiring diagrams, etc. Complete with battery. 16½ x 11¾". Shpg. wt., 4¼ lbs.

19 T 38042

Net 11.95

## 20 WATT STEREO SOLID-STATE AMPLIFIER MODULE

22<sup>95</sup>

Now With Integrated Circuits

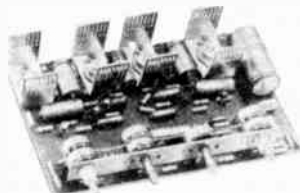

This especially fine transistor stereo amplifier delivers 10 watts per channel continuous power (RMS) into any 8 ohm speaker. Has 2-IC's and 8-transistors. The separate bass and treble controls allow 20 db adjustment at 100 Hz and 10 kHz. The dual volume control allows simultaneous increase in volume of both channels, while the balance control allows compensation for program variations. The low noise preamp stage provides a sensitivity of 0.5 volts for use with circuit gives a Hi-Fi frequency response of 30 Hz to 40 kHz @-3 db. Includes the power supply components except a power transformer. Size: 7¾" x 1¾" x 4¾".

gram variations. The low noise preamp stage provides a sensitivity of 0.5 volts for use with circuit gives a Hi-Fi frequency response of 30 Hz to 40 kHz @-3 db. Includes the power supply components except a power transformer. Size: 7¾" x 1¾" x 4¾".

19 T 09159

Net 22.95

19 T 09167

Net 22.95

19 T 09175

Net 2.95

## 8-WATT STEREO SOLID-STATE AMPLIFIER MODULE

15<sup>95</sup>

Now With Integrated Circuits

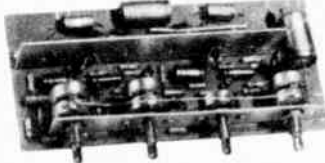

A complete 4-control stereo amplifier with 2-IC's and 6-transistors which provides 4 watts RMS per channel; 8 watts continuous power total output! The four controls allow separate volume, balance bass and treble adjustments. The direct couple complementary symmetry circuit gives a true Hi-Fi response of 45 Hz to 20kHz @-3 db. 1 Meg input impedance allows this amp to be used with a wide range stereo crystal cartridge, FM tuner or other 1.5 volt source. Use with 8 ohm speakers to give top performance. The amplifier includes power supply components (2 diodes, 1 filter capacitor) except the power transformer. Dimensions: 7½" x 1½" x 3½" D. Shpg. wt., 1¼ lbs.

19 T 09142

Net 15.95

19 T 09183

Net 2.95

## ANALOG COMPUTER KIT



14<sup>95</sup>

- Ideal Introduction to Basic Elements of Analog Computers
- Work Over 50 Experiments with Screwdriver and Pliers
- Learn the Way to Sound Scientific Knowledge

Analog Computer Kit offering a basic introduction to computer theory—gives accurate answers to practical problems. Perform over 50 experiments—multiplication, division, powers, square roots, rocketry, interest, radioactive decay, light, kinetic energy, etc. Level of accuracy better than 5%. The computer consists of a masonite, solid instrument panel, kits, potentiometers, meter specially calibrated scales, guide and operating booklet. Easy-to-assemble.

19 T 38059 Shpg. wt., 4¼ lbs. Net 14.95

## LAFAYETTE CONVERTER MODULES



LISTEN TO POLICE, FIRE, AIRCRAFT, AND SHORTWAVE ON YOUR PRESENT AM SET

Now you can have the thrill of listening to the exciting police broadcasts, the fire department calls, communications between planes and ground stations as well as international shortwave bands. Simple to connect to your present AM broadcast radio. Size: 1¾ x 3/4 x 1". Control extends 1½". Shpg. wt., 4 oz.

**VHF POLICE AND FIRE CONVERTER MODULE**  
Permits reception of police and fire calls in the 30-50 MHz band on your standard broadcast band AM radio. Requires 9V transistor battery and wire.

19 T 55205

Net 5.00

**FM VHF POLICE AND WEATHER CONVERTER MODULE**

Permits reception of 150-164 MHz FM-VHF police, fire, emergency, marine and weather transmissions on a standard FM radio. Requires 9V transistor battery, 5K potentiometer and knob, and wire.

19 T 55368

Net 5.00

**AIRCRAFT CONVERTER MODULE**

Same as above but for reception of 118 to 128 MHz. Band. Requires 9 volt battery D.

19 T 55293

Net 5.00

**SHORTWAVE CONVERTER MODULE**

Same as above but tunes 25, 31, and 41 meter bands (7-12 MHz.). Requires 9 volt battery and wire.

19 T 55301

Net 5.00

## ACCESSORIES FOR MODULES

99 T 60212	9V Battery	.21
99 T 62879	Battery clips for above	.29
32 T 31909	Wire	.49
32 T 22510	5K Potentiometer	.67
32 T 24052	Knob, miniature	.15

# EDUCATIONAL SCIENCE KITS

## RAYTHEON-LECTRON EDUCATIONAL SETS

### ELECTRORAFT MASTER ELECTRIC BUILD-IT SET



An advanced but completely safe educational kit in the field of electricity that enables the student to make any one of over 30 projects including motor driven hot rod, motor driven dune buggy, lamp, flashlight, electro-magnet, telegraph set, traffic signal, electric crane and many others. All projects are battery operated. Easy-to-read, illustrated 76-page instruction manual. Size: 21½x13½x2¼". Shpg. wt., 2½ lbs.  
 19 T 84030 Less Batteries ..... Net 8.95  
 Batteries For Above  
 99 T 82564 "D" 2 required ..... Net ea. .15  
 99 T 82580 "AA" 2 required ..... Net ea. .10

- Space-Age Magnetic Blocks Make Electronics Child's Play
- No wiring • No tools • No Electronics Knowledge Needed
- Match magnetic blocks with a schematic diagram in guidebook
- Series 2 Set Builds 43 Projects
- Series 3 Set Builds 56 Fascinating Projects

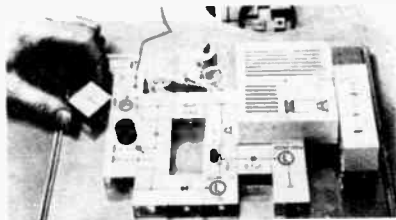

Set consists of domino-like see-thru magnetic connecting plastic blocks each self-contained with a transistor, capacitor, or other electronic component, etc., inside and the electronic symbol therefor engraved on the top; an 8" x 11" metal ground plate and an 80 page instruction manual. When a project is complete, circuit symbols on the blocks form a schematic diagram. Manual covers basic theory principles of the components and project diagrams and explanation. Easy! And Fun!

**SERIES 2 LECTRON SET**—make 43 working projects including transistor radio, electronic organ, rain moisture indicator, audio amplifiers, light modulated detector, Morse code transmitter, metronome, burglar alarm and more, plus your own ingenuity. Shpg. wt., 3 lbs.  
 19 T 18051 ..... Net 17.95

**SERIES 3 LECTRON SET**—make a solid state radio with speaker in 2 minutes and 55 more projects—all of Series 2 plus intercom, voice transmitter, public address and telephone amplifier, automatic night light, etc. Shpg. wt., 5 lbs.  
 19 T 18044 ..... Net 24.95

### MAGIC-GLO BLACK LIGHT



- Learn Invisible Detection
- Write Secret Messages
- Educational—Scientific
- Enjoyable—Interesting

The Black Light Kit enables you to see the invisible. Guaranteed completely safe and harmless. This kit allows children to study the phenomena of fluorescence and phosphorescence. Set contains black light, socket and cord, laboratory lamp stand, 4 jars of fluorescent paint, invisible ink, invisible crayon, tracer powder, 3 fluorescent mineral specimens, phosphorogram, optical bleach, brushes and pen, and a pkg. of fluorescent materials. Enables the student to perform endless numbers of fascinating experiments. The amply illustrated 48 page booklet "The Story of Black Light—The Unseen World Around Us," explains the use of black light in fields such as mineralogy, electronics, crime detection, medicine, stamp collecting, and many others. Shpg. wt., 2½ lbs.

19 T 13811 ..... Net 12.85  
 19 T 13820 Replacement U.V. Bulb for above ..... Net 3.95



### TRANSISTOR RADIO AND BROADCAST KIT

- Use It Either As An AM Wireless Broadcaster or AM Radio Receiver

9<sup>95</sup>

Transmit your own radio program with this safe, battery-operated transistorized broadcaster or receive AM radio programs. Includes headphone, broadcast microphone for home broadcasts, Alnico loud-speaker, antenna, plus all other required parts. Big 18" plastic cabinet. Easy to assemble with instructions provided. Operates on 3 inexpensive "C" cells (not included). Shpg. wt., 5 lbs.  
 19 T 31896W Less batteries ..... Net 8.95  
 99 T 82572 C Batteries (3 required) ..... Net ea. .14

### PHILMORE DUAL BAND BROADCAST SHORTWAVE RADIO KIT

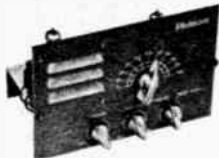

• 2 Bands  
 550-1650 kHz. 3-13 MHz

This radio covers the standard broadcast band from 550 to 1650 kHz and a shortwave band from 3 to 13 MHz. Modern circuitry with enough audio to drive a built-in 3½ inch speaker. Be rewarded with the satisfaction of having built a radio which will actually pull in standard broadcast, amateur and other shortwave stations. Includes punched chassis, gray hammerstone panel, 3½" speaker, pictorial and schematic diagrams, and easy-to-follow instructions. Complete with all hardware: less solder, wire and tubes. Tubes required: 1—50C5, 1—12AU6 plus 1—35W4 rectifier. For 105-125 volts, AC or DC. Shpg. wt., 4 lbs.  
 19 T 56018 MODEL 7001CR ..... Net 14.50

Shortwave antenna kit for above  
 32 T 30884 Shpg. wt., 1¼ lbs. .... Net 2.35

### SHORTWAVE AND SUPERHET BROADCAST RADIO KIT

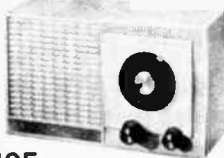

17<sup>95</sup>

2 bands cover both standard broadcast 540-1620 kHz and shortwave 5.8-18 MHz which includes international broadcast, 40 and 20-meter ham bands and some of the aeronautical and marine bands. Superheterodyne circuit has high gain IF's, built-in broadcast band loop antenna. Comes complete with ivory cabinet 4" PM speaker, tubes (12BE6, 12BA6, 12AV6, 50C5, plus 35W4 Rectifier) and all parts. Easy to follow step-by-step instructions. Shortwave band requires external antenna (not supplied). Size: 8¼x4 5/8x5¼"D. For 110V AC or DC.  
 19 T 40071 Shpg. wt., 4¾ lbs. .... Net 17.95

Shortwave antenna kit for above  
 32 T 30884 Shpg. wt., 1¼ lbs. .... Net 2.35

### PORTER COMMUNICRAFT LAB KIT

- Build 12 Projects  
 In Sound Communications



11<sup>95</sup>

All the necessary components to explore the wonders of sound. Includes control panel, electronic parts, transistor, speaker to build such projects as radio receivers, code oscillators, voice transmitter and more. Manual explains electronics in simple terms, includes easy to follow diagrams. Powered by 2 "D" cells (not supplied). Shpg. wt., 3 lbs.  
 19 T 34086 Kit less batteries. .... Net 11.95  
 1.5 v "D" battery (2 Req.) ..... Net ea. .15  
 19 T 82564 ..... Net ea. .15

# Educational Science Specialties

## PORTER DELUXE MINERALOGY SENIOR LAB OUTFIT

9<sup>95</sup>

- Alcohol Lamp With Blowtorch
- 24 Mineral Specimens
- Geologist's Hammer



The ideal mineralogy lab kit for the junior geologist to determine the various mineral types. In addition to 24 selected mineral specimens, the set includes the necessary scientific instruments. Contains a geologist's hammer for dislodging specimens, an alcohol lamp with blow torch attachment, magnifier for examining surface and crystalline structure of minerals, tweezers, chemicals and test papers, test tube rack, charcoal block, streak plate and detailed instruction manual. Wall size identification chart lists nearly 200 minerals. Three-panel metal cabinet. Shpg. wt., 7 lbs.

19 T 34017

Net 9.95

## PORTER WEATHERCRAFT FORECASTING LAB

- Build and Use Barometer, Wind Vane, Psychrometer and Rain Gauge
- Forecast Weather Accurately

11<sup>88</sup>

Be your own meteorologist and simply forecast the weather. This deluxe weather laboratory kit contains every instrument necessary for extremely accurate weather prediction. Includes: a wind vane to show wind direction and an anemometer to give its speed; a compensated aneroid barometer provides barometric pressure; a psychrometer determines relative humidity; a set of graphs for charting air pressure and temperature; a detailed weather map and cloud chart. A gauge measures rainfall to 1/100th inch, and a detailed manual shows how to make accurate forecasts. Three-panel metal cabinet. Requires 2 "C" batteries, not supplied. Shpg. wt., 6 lbs.

19 T 34009 Less batteries.

99 T 62572 1.5v C battery (2 required)

Net 11.88  
Net ea. .14



### NOVATRON

A SCIENTIFIC INSTRUMENT FOR THE EXPERIMENTER

- Miniature Atom Smasher
- Produces 75,000 Volts
- Absolutely Safe

Completely Wired (Not A Kit)

A scientific instrument capable of producing 75,000 volts—makes sparks up to 2" long—yet it is absolutely safe because the current is infinitesimal. The science-teacher—science lover or hobbyist can perform experiments to astound students—friends—family. Makes smoke disappear—defy gravity—turns propellers at a distance—transforms atomic energy into light—makes artificial lightning—smashes atoms—demonstrates ionic space ship drive—and many other experiments. Includes an experimental kit and illustrated experiment manual. A fine research tool that will give years of beneficial service. 110 VAC. Imported. Assembled.

99 T 90086 Shpg. wt., 4 lbs. Net 13.95

### GILBERT LIFE SCIENCE MICRO-BIOLOGY LAB KIT



9<sup>95</sup>

- With Microscope

Features die-cast metal 75X microscope for proper magnification of specimens in home or field study. Materials supplied to grow and observe live protozoa and brine shrimp. Includes preserved specimens of frog, crayfish, earthworm, grasshopper and fish. 5 prepared specimen slides provided. Kit also includes dissecting instruments (scissors, scalpel, etc.), materials for slide preparation and study manual. Shpg. wt., 5 lbs.

19 T 34041

Net 9.95

### ATOMIC ENERGY LAB

8<sup>95</sup>

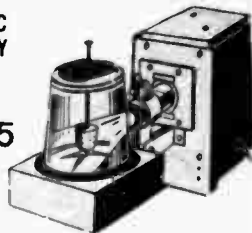

Ingenuous kit for studying some basic nuclear physics by experimentation. See the vapor trails of alpha and beta particles, and of cosmic rays. Shows exploding atoms. Instruction book covers such experiments as detecting radioactivity with a cloud chamber, with a spinthariscopes, and with radiographs; checking radioactivity with an electroscopes, detecting ionization and others. Kit includes radioactive materials. Shpg. wt., 3 1/4 lbs.

19 T 30015

Net 8.95

### MINERAL TEKNIKIT SET 1

as  
low  
as

2<sup>50</sup>



Contains 48 specimens of ore, organics, fossils, elements, plutonics, oxides, volcanics, hypabyssals, effusive crystals, common and uncommon minerals. Each specimen is tagged with name and classification. An excellent introduction to rock and mineral identification. Imported. Shpg. wt., 1 1/2 lbs.

99 T 71557 Net 2.90

SET II Includes additional specimens of some of above plus carbonates, tantalite, phosphates, and gemstones. 48 specimens. Imported. Shpg. wt., 1 1/2 lbs.

99 T 71565 Net 2.95

Special Combination. Buy both sets and save. You get all 96 specimens. Shpg. wt., 3 lbs.

99 T 71573M Net 4.30



9<sup>95</sup>

### WEATHER STATION KIT

Fun to erect and fascinating to use, this weather station kit operates with flashing neon lights to show wind speed and direction on indoor indicator board. Includes a sensitive air tank barometer with 4-ft. indicator column, a sling psychrometer to measure relative humidity, rain gauge with scale calibrated to measure 1/100th of an inch rainfall, cloud chart, weather map and forecasting manual. 150 ft. wire supplied, enough for a 2-story house. Safety power cord. All connections safe to touch. Shpg. wt., 3 1/4 lbs.

19 T 30023

Net 8.95

### SKY ROVER CRYSTAL RADIO KIT

2<sup>75</sup>



Easy to assemble, brings in loud, clear reception. Precision wound tuning coil, super-sensitive crystal, bakelite cabinet. No batteries or electricity required. Complete with earphone with plastic ear-holder, antenna lead-in wire, and hardware. Requires external antenna (not supplied). Shpg. wt., 1 lb.

19 T 58024

Net 2.75  
32 T 30984 Antenna kit. Wt., 1/4 lb. Net 2.35

Your Order Receives Prompt, Efficient Service at Lafayette



# Rock Polishers & Specialty Items



## GEM STONE TUMBLING AND JEWELRY MAKING KIT

- Grinds and Polishes Rocks and Gem Stones
- Complete Outfit, Nothing Else to Buy

Only  
**23<sup>95</sup>**

## THUMLERS TUMBLER

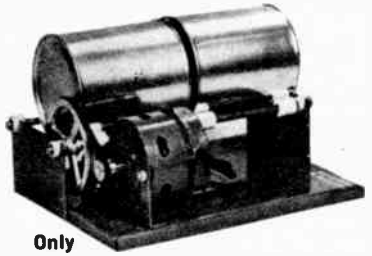

Only  
**18<sup>95</sup>**

- Grinds and Polishes Rocks, and Gem Stones

Here is your opportunity to enjoy the fascinating craft of gem polishing. Kit includes Mini-Tumbler, 2½ lb. load capacity drum and liner, 3 grades of abrasive grits plus polishing medium, assorted jewelry mountings (tie clasp, earrings, etc.), jewelry glue, and assortment of rough, exotic and aztec stones. Motor operates on 115 VAC, with built-in circuit protection. UL listed. Everything you need to go from "rocks" to "jewelry".  
15 T 58006 Shpg. wt., 13¾ lbs. Net 23.95

A fascinating hobby-craft. You can polish all rocks to a sleek, gleaming gem-like finish. Use them for decoration, put in settings, etc. Tumbling machine has two side by side barrels with a total capacity of approx. 6 lbs. of stones. This is not a knock-down kit, but a completely assembled unit ready to run with powerful continuous duty motor that operates on standard 110 VAC current. Size: 7"x9"x11". Complete with cans, but less grit and can liner. See listing on left for additional accessories. Shpg. wt., 7¼ lbs.  
15 T 44014 Net 10.95

## ACCESSORIES FOR TUMBLERS

Stones. 1 lb. pkg. of Oregon Beach Agate and Jasper. Shpg. wt., 1½ lbs.  
15 T 44030 Net 1.89

Deluxe Rough Stone Assortment. Approximately 200 agate and rose quartz, tiger eye, jasper, etc. Exotic colored rock is from all over the world; will polish to a jewelry like finish.  
15 T 58014 Shpg. wt., 3 lbs. Net 5.95

Grit and Polish Assortment Kit. Provides everything needed to polish rocks. Packed in resealable plastic container. Each kit contains graded silicon carbide grit and fine polish compound for fast grinding and fine finishes. Each set will process 14 lbs. of rock.  
15 T 58022 For Smooth Rocks, 3 step. Shpg. wt., 3½ lbs. Net 2.50  
15 T 58030 For Rough Rocks, 4 step. Shpg. wt., 5 lbs. Net 3.95

Accessory pack. Ass't. of coarse and fine grits, pre-polish and polish, and liners for above drums. Shpg. wt., 2½ lbs.  
15 T 44022 Net 2.95

Extra Cans For Above Tumbler.  
15 T 44048 Shpg. wt., 8 oz. Net ea. .39  
Extra Rubber Liners For Above. (Pkg. of 2).  
15 T 44055 Shpg. wt., 8 oz. Net .89

## PROFESSIONAL 12 POUND HEXAGONAL TUMBLER



- Heavy Duty Motor With Overload Protection
- Nylon Bearings For Smooth Operation And Long Life
- Vinyl Covered Rollers For Quiet Rotation
- UL Listed

**44<sup>95</sup>** No Money Down\*

This professional rock tumbler is ruggedly designed for long, hard wear. The heavy gauge steel hexagonal drum has a 12 pound (9 pints) capacity. Features an overload protected, continuous duty fan cooled motor... runs over 50° cooler. Shuts off automatically when motor overheats. Prevents burnt-out motor should power fail or circuits overload. Neoprene gasket and rubber double seal prevents leakage and gas build-up. Sturdy wood grained steel base covers protect motor from dirt and grit. Easy to clean. Shpg. wt., 23 lbs.  
15 T 58055 No Money Down\* Net 44.95

## JEWELRY MAKING KIT



**4<sup>95</sup>**

This high quality Hamilton gold plated 38 piece jewelry finding assortment enables you to mount your semi-precious stones that have been polished. Makes earrings, tie clasps, bracelets, cuff links, key ring, tie clasps, necklaces, adjustable finger ring, etc. from these commercial findings. Kit also contains jump rings, bell caps and a tube of jewelers on-off cement—everything you need. Shpg. wt., 7 oz.  
15 T 58063 Net 4.95

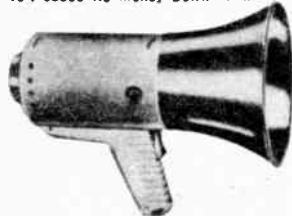

## ALL-TRANSISTOR BULL HORN

Made in U.S.A.  
Only **8<sup>95</sup>**  
NOT A KIT  
COMPLETELY PREASSEMBLED

- Range up to 400 feet • Weighs only 2½ lbs.
- For Hunting, Camping, Boating, Sports

A fully transistorized directional megaphone at Lafayette's low price. Lightweight, it carries your voice over 100 yards or above noise. Just press the trigger and talk. Features variable volume control and carrying strap. Uses 4-standard "D" cells (not supplied with unit).  
11" long. Shpg. wt., 2 lbs.  
44 T 15087 Net 8.95  
1½-volt D batteries, 4 required. Imported. Shpg. wt., 4 oz. Net ea. .15  
99 T 62564

## NORELCO MECHANICAL ENGINEER KIT



Only  
**29<sup>95</sup>**

- Over 600 Parts
- Over 30 Projects
- For Age 9 up

Consisting of over 600 components, this kit promotes understanding of fundamentals of sources of energy such as mechanical, water pressure, air pressure, gravity, and electro-mechanical. Builds any one of 32 educational operating models including electrical windmill, water turbine with dynamo, compressed air motor with pump, crane, electric pile driver, water pump clocks, etc. Absolutely safe, powered by inexpensive 1.5V batteries. Components are unbreakable, easily identifiable, machined plastic parts, includes 136 page illustrated instruction manual. Size: 21¼x10¾x1¼". Imported. Shpg. wt., 6 lbs.  
15 T 63024 Less Batteries Net 29.95  
99 T 62580 Battery for above (6 required) Net ea. .10

# Hobby Kits & Specialties

## RENWAL VISIBLE V-8 ENGINE KIT



9<sup>95</sup>

Looks And Performs Like The Real Thing

The Visible V-8 is a superb guide to the study of the internal combustion engine. Precise 1/4 scale "see-thru" model engine that simulates the power plant of V-8 autos. Parts molded in 4 colors, including "clear", so that functioning pistons, connecting rods, rocker arms and properly timed spark plugs can be observed. Powerful permag motor activates over 100 moving parts. Powered by two "C" batteries (not supplied). Complete with polystyrene cement, hardware, screwdriver, and illustrated instruction manual which details how an auto engine works. Shpg. wt., 5 lbs.

19 T 69085 Complete Kit Less Batteries ..... Net 9.95  
 99 T 62572 1.5V "C" battery, (2 required) ..... Net ea. .14

## GILBERT DELUXE GRADUATE CHEMISTRY MODULAR KIT



- Full Range of Chemicals and Supplies
- File Cards for Over 700 Experiments
- Six Modular Laboratory Storage Racks

14<sup>95</sup>

Ideal deluxe chemistry lab kit for experimenters, hobbyists, students. Conduct over 700 experiments in chemical gardening, analytical testing, thermal chemistry, chromatography, chemical magic and many more. Six modular storage racks hold complete set of chemicals and supplies. Advanced equipment includes precision lab scale, mortar and pestle, hydroponics tray, alcohol lamp, test tubes, etc. Project file cards provide detailed instructions and operating procedures. Shpg. wt., 9 3/4 lbs.

19 T 24058 ..... Net 14.95

## PHOTOGRAPHY DARKROOM LAB WITH ENLARGER

13<sup>95</sup>



- Complete Darkroom Outfit
- Photo Enlarger, Contact Printer, 35mm Projector — All In One Kit

Photography lab kit enables you to print and develop your own photos, enlarge 35mm shots up to 8 x 10", and project your 35mm negatives. Kit includes developing chemicals, printing and enlarging paper, 3 trays, thermometer, neon safelight, print frame taking negatives up to 3 1/2 x 4 1/4", twin condensing lenses and G.E. projection lamp. A complete photo lab in one kit. Shpg. wt., 4 lbs.

19 T 30631 ..... Net 13.95

## VASHON ROCKET AND ROCKET PLANE KITS

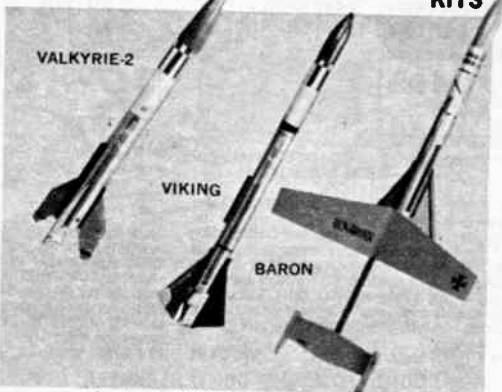

- As Low As 9<sup>95</sup>
- Looks And Performs Like The Real Thing
- Safe, Non-Flammable Non-Toxic Propellant
- Altitude Capability Over 1000 Feet
- Reusable With Parachute Recovery

### VALKYRIE-2 ROCKET KIT

- Launched Mechanically or Electrically

Here is an authentic, educational and yet entirely safe rocket kit for modelers and hobbyists which demonstrates the principles of rocket propulsion. The propellant releases no heat, is non-flammable, non-toxic and non-explosive. The 18 1/2 inch long Valkyrie-2 which blasts off to 1000 feet, can be safely held in hand. Uses durable polished aluminum rocket, engine and parts, with real working valves, separator and parachute. At liftoff, the rocket starts slowly at 4 "G's," with acceleration at burnout about 10 "G's." A timer assures deployment of the parachute which returns the rocket for another launch. May be either mechanically or electrically launched with a battery (not supplied). Complete kit includes rocket, engine, timer, separator, parachute, balsa nose cone, fins, loading valve and hose, electric firing assembly, launch stand, one can of propellant, accessories and instructions. Size: 18 1/2" long x 1" dia.

19 T 75010 Complete rocket kit. Shpg. wt. 2 3/4 lbs. .... Net 12.95  
 15 oz. can of propellant, sufficient for 3 launchings.  
 19 T 75020 Shpg. wt. 1 1/2 lbs. .... Net 2.00  
 6-Volt battery for electrical launching.  
 32 T 48104 Shpg. wt. 1 1/4 lbs. .... Net 1.13  
 Replacement ignitor wire for electrical launching.  
 19 T 75036 Shpg. wt., 3 oz. .... Net .38

### VIKING TWO STAGE ROCKET KIT

The Viking is a complete, high performance, functioning two stage rocket with staging mechanism for in-flight separation. The first stage boosts the rocket to about 75 feet where a "burn-out" signal triggers the second stage engine. This accelerates to a velocity of 300 feet per second (200 miles per hour) while the first stage drops away. This velocity carries the second stage well over 1000 feet, where a parachute is automatically deployed to return it. All parts are recovered for future flights. Both engines are the same—reloadable, highly polished aluminum construction, pre-assembled, and factory tested, each using 2 ounces of propellant per flight. The kit is complete including launcher, 15 ounce can of propellant, clear, concise instructions and a booklet on the principles of multi-staged rockets. Size 20" long x 1" dia.

19 T 75051 Complete Kit. Shpg. wt., 3 1/4 lbs. .... Net 14.95  
 15 oz. can of propellant sufficient for 3 launchings.  
 19 T 75020 Shpg. wt., 1 1/2 lbs. .... Net 2.00

### BARON ROCKET PLANE KIT

The bright red Baron Rocket Plane is a combination of a rocket and a plane. The rocket carries the plane up hundreds of feet, then catapults the plane free, at the height of its flight. While the Baron glides high in the sky, the booster rocket parachutes to earth. The aluminum booster rocket engine uses a non-flammable, non-explosive aerosol propellant and may be launched alone. The kit is complete with factory assembled and tested engine, fins, nose cone, parachute, 7 oz. can of propellant, decals, etc. and clear illustrated instructions. Size: 22 1/2" long x 1" dia. Shpg. wt., 2 1/2 lbs.

19 T 75069 Complete rocket plane kit ..... Net 9.95  
 15 oz. can of propellant.  
 19 T 75020 Shpg. wt., 1 1/2 lbs. .... Net 2.00

To Speed Your Mail Order—Please Give Your Zip Code Number

# PSYCHEDELIC LIGHT KITS & SPECIALTY ITEMS

## MOD-U-KIT PSYCHEDELIC LIGHT KITS

### FREQUENCY CONTROLLED 3-CHANNEL PSYCHEDELIC CONTROL CENTER KIT

**24<sup>95</sup>**



- Frequency Controlled 500 Watts Per Channel—1500 Watts Total

A 3-channel sound to light control center providing frequency separation of the incoming sound into 3 parts: low frequencies-60 Hz to 1 kHz, medium frequencies-1 kHz to 3 kHz, high frequencies-3 kHz to 15 kHz. Uses triacs to control 500 watts of light per channel for a total of 1500 watts. Each channel has its own sensitivity control and an AC outlet. On/off neon panel indicator. Size: 5x4½x2½".

19 T 70185 Shpg. wt., 2 lbs. Net 24.95

### 3-CHANNEL PSYCHEDELIC CONTROL CENTER KIT

**12<sup>95</sup>**



- Responds to Intensity of Sound
- Provides 500 Watts Per Channel — 1500 Watts Total

Converts audio signals to 1500 watts of available external psychedelic lighting. The audio input signal is directly applied to 3 separate SCR's. Has 3 individual sensitivity controls for 3 separate channels each capable of accommodating 500 watts of external light. Housed in walnut finish aluminum case. Size 5x4x2½".

19 T 70169 Shpg. wt., 1½ lbs. Net 12.95

### 2-CHANNEL STEREO PSYCHEDELIC COLOR CONTROL KIT

**24<sup>95</sup>**



- Converts Each Channel to 500 Watts of Psychedelic Light — 1000 Watts Total

A stereo sound to light converter kit in one unit. Has two individual channels separately responsive to the intensity of the sound in each channel of the stereo sound source. Uses triacs to provide 500 watts of controlled lights from each channel for a total of 1000 watts. Has separate intensity controls and separate in/out and output receptacles. Has neon on/off panel light and is fused internally. Size: 5x4½x2½".

19 T 70193 Shpg. wt., 2 lbs. Net 24.95

### SOUND TO LIGHT CONVERTER KIT

- Supplies 100 Watts Of Psychedelic Lighting!

**5<sup>95</sup>**

Accepts sound from any radio, hi-fi, phono, or any amplifier and changes these direct audio signals to light keying signals. In addition to 4 colored pilot light indicators plugged into the unit, an AC socket supplies 100 watts of external psychedelic lighting which varies with the sound. Shpg. wt., 1 lb. 19 T 70151 Net 5.95

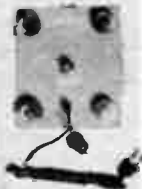

**9<sup>95</sup>**

### ELECTRONIC STROBE KIT

100 Watt Incandescent Lamp Strobe

This electronic strobe converts a 100 watt incandescent bulb into a strobe type lighting unit which gives eerie stopmotion and light-burst effects for light shows. An adjustable frequency audio oscillator and SCR circuit controls the lamp. The pulsations can be varied from fast to a one pulse per second slow rate. Powered by a 9 volt internal battery (not supplied).

19 T 70177 Wt., 1 lb. Net 9.95  
99 T 60212 9V battery Net .21



### EICOCRAFT MINI COLOR ORGAN KIT

**14<sup>95</sup>**

- Watch Colors Dance To Your Favorite Beat

EC-3800. Converts your favorite music to an entertaining display of multi-color red, blue and green 3 dimensional patterns varying to the amplitude of the sound source. Molded plastic cabinet has 8 x 8" viewing screen. For 115 VAC 60 Hz. Shpg. wt., 1½ lbs.

19 T 66183 Net 14.95



### MOO-U-KIT 5-WATT UNIVERSAL AMPLIFIER KIT

**5<sup>95</sup>**

- Compact Solid-State Circuitry

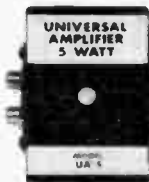

Excellent as a portable amplifier, guitar amplifier, etc. Complete with all parts, case, volume control, and instructions. Works on a 6-volt battery or power supply. Will accept almost any type of pickup device, i.e., phono cartridge, tuner, etc.; will work with any 3-ohm to 16-ohm PM speakers. 3" x 2" x 1½". 19 T 70011 Shpg. wt., 1 lb. Net 5.95

### PROJECT-A-SCOPE

- Projects Giant Pictures in Color or Black and White
- Films or Negatives Not Needed

**5<sup>95</sup>**

Handsome projector molded of heat and abuse resistant, hi-impact plastic for long life. Casts sharp, giant-size enlargements on any white wall or screen in brilliant color or black and white. Simple to operate. Can be used by students, artists, lecturers and demonstrators. Children can project comic or story books to amuse themselves and their friends. Uses ordinary household bulbs. U/L listed. 110 volts, AC-DC. Shpg. wt., 2 lbs. 15 T 50011 Net 5.95



### SOLID-STATE TREASURE/METAL LOCATOR

- New Design Using Integrated Circuit

- Gives Positive Variable Audible Signal Indicating The Presence Of Buried Coins And Metal Objects
- Locates Both Ferrous Metals (Iron, Steel, Tin) And Non-Ferrous Metals (Gold, Silver, Copper)

Pays for itself many times over... opens up a new world of excitement and adventure. Electronically detects metal objects as small as a half-dollar up to 6 inches beneath the ground: gold, silver, coins, anything metallic. No meters or dials to check; solid-state integrated circuit gives positive audible low frequency beat heard through a built-in 2½" speaker whenever a metal object is approached. Audible signal intensity increases when the treasure/metal locator draws nearer the object. Practical for home and public utilities (gas and telephone servicemen) too. Helps locate plumbing inside walls, or, find pipes in yard or garden before digging. Epoxied super-sensitive 6½" coil is shock, heat and water resistant. Special shield increases sensitivity, prevents false indications. Lightweight and easy to use. 36" handle collapses to 20" for easy storage. Not a kit—electronics completely factory wired and tested—merely requires attachment of loop and handle. Uses single 9V., transistor battery (not supplied). Overall length: 40"; housing 4x5x2¾". Shpg. wt., 3 lbs.

19 T 67017 Treasure/Metal Locator—less battery No Money Down\* Net 34.95  
99 T 60212 9V Battery. Shpg. wt., 3 oz. Net .21

Not A Kit—  
Factory Wired

**34<sup>95</sup>**

**NEW!**



Find Buried  
Coins and Metals

Locate Pipes Inside

**SAVE \$15<sup>00</sup>**

On Eico  
Color  
Lights

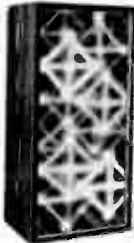

Only  
**24<sup>95</sup>**

Reg.  
39.95

With Purchase of LRK-1600  
or LRK 1600 System.  
See Page 54 for details  
Offer ends 12/31/70

# Lafayette LRK-1600 100-Watt Solid-State AM/FM Stereo Cassette/Receiver



4-IC's, 4-FET's, 24-Transistors, 25-Diodes

Expertly Crafted For Years of  
Concert Quality Performance

Only  
**279<sup>95</sup>** No  
Money  
Down\*

IT'S

**A Deluxe Lafayette 100 Watt  
AM/FM Stereo Receiver**

### RECEIVER SECTION

- 100 Watts  $\pm$ 1db of Exemplary Stereo Power
- 4 Gang FM Tuning Condenser
- Automatic FM Stereo Switching and Stereo Indicator Light
- Special Fused Circuitry Protects Output Transistors
- Front Panel Stereo Headphone Jack
- Push-button Switches for Loudness, Stereo-Mono, Tape Monitor, High Filters
- Illuminated AM and FM Tuning Meter
- Speaker Mode Switch: Main, Remote, Main and Remote
- Complete Tuning panel is illuminated when Power is turned on

The LRK-1600 adds the complete recording and playback facilities of a professional stereo cassette recorder with a superb 100 watt AM/FM stereo receiver. Add a pair of speakers and you have a complete, versatile, ready-to-play home music system. Build a great stereo cassette library: just connect a turntable and put your favorite records on tape; record AM, FM or FM stereo directly from the tuner section; connect a reel-to-reel tape recorder and convert ordinary tapes into compact cassettes; connect a pair of stereo microphones (2 mike input jacks are located on the front panel) and record your own music live, or most important—make sound-with-sound recordings (record live with a mike simultaneously while recording an external source such as broadcast, records, tape). Exceptional quality and performance are assured by the use of 4-Integrated Circuits (IC's), 4-Field-Effect-Transistors (FET's), 24-transistors, and 25-diodes. You'll hear more stations, as well as brilliant FM stereo reception with amazing noise-free clarity. Outstanding features and specifications: Receiver section—Power Out-

IT'S

**A Deluxe Performing Lafayette  
Stereo Cassette Recorder**

### CASSETTE SECTION

- 7 Pushbutton Tape Functions Including Pause for Instant Editing and Cueing
- 4 Pole Hysteresis Synchronous AC Motor
- Large Dual Channel VU Level Recording Meter
- Semi-Slot Tape Loading for Complete Ease of Operation
- Cassette Ejector Button • Visual Record Indicator Light
- 2 Mike Inputs for Left and Right Channel on Front Panel
- 3 Digit-Tape Counter with Reset Button
- Records 4 Track Stereo and 2 Track Monaural Playback 4 and 2 Track Stereo on Monaural

put 100 watts  $\pm$ 1 db; FM Tuner: 4 gang condenser, IHF Sensitivity 1.7  $\mu$ v; Stereo multiplex separation: 40db (400Hz); front panel stereo headphones jack; illuminated AM and FM tuning meter. Pushbutton switches for Loudness, Stereo-Mono, Tape Monitor, High Filters, Black-face tuning dial, Cassette Section: 4-pole Hysteresis Synchronous AC motor; dual channel VU recording meter; record indicator light; Cassette Ejector Button; 3-Digit Counter with Reset Button. Records 4-track stereo and 2-track mono, playback 4 and 2-track stereo and mono. Wow-Flutter, Less than 3% RMS; Mic. Input Sens., 1mV for 0 VU @ 10K ohms; High Level Input, 80mV for 0 VU @ 100K ohms; Frequency Response, 45 to 10,000 Hz: S/M Ratio, Better than 35db; Overall Distortion, Less than 3% @ 0 VU recording; Channel Separation, 30 db; Bias & Erase Frequency, 95 kHz. Low profile enclosure with walnut side panels. Size: 21 1/2" x 5 3/4" x 14" D. For 105-120VAC, 60 Hz. Imported.  
99 T 02172WX Shpg. wt., 40 lbs. Net 279.95  
99 T 46161 Dynamic Mike. Imported. Wt., 1 lb. Net ea. 5.95

## Deluxe 100-Watt AM/FM Stereo Cassette/Phono Hi-Fi System Featuring LRK-1600



Garrard 40B

SP55 Stereo  
Headphone



Complete System **356<sup>95</sup>** No  
Money  
Down\*

**YOU SAVE 69.80** From Individual  
Catalog Prices

Magnificent 100-watt component Hi-Fi system featuring the LRK-1600 Cassette/Receiver, Garrard 40B 3-speed automatic record changer with base, Pickering P/ATE-1 elliptical stereo cartridge, Lafayette SP55 Stereo Headphone for private listening, and 2-Lafayette Criterion 50A's 2-way bookshelf Speaker Systems with beautiful oiled walnut wood cabinets. Includes all connecting cables. (See pg. 64 for description of the Crit. 50A's). Shpg. wt., 90 lbs.  
99 T 99731WXM LRK-1600 System with Headphone Net 356.95

\*See Page 18 for Full Credit Details on Easy Pay Plan

**bonus special!**

**SAVE  
15.00**

On

**EICO**

4-COLOR AUDIO LIGHTS

Regularly  
**39.95** each

**A Panorama of Living Music  
in Colored Lights!**

**NOW  
ONLY 24.95** each

With Purchase of Any Stereo Receiver, Amplifier,  
Tuner, or Systems on Pages 53 through 63

**OFFER EXPIRES December 31, 1970**

Lafayette's Special Audio Light Bonus offer makes it easy for you to purchase this dazzling 4-color sound actuated light system as a visual complement for your favorite audio reproductions at the same time you purchase your hi-fi stereo component or system. You get this best-selling Eico 4-color audio light system at the special price of 24.95, a saving of \$15.00 over the regular catalog price, when you buy any of the Lafayette stereo receivers, amplifiers, tuners, or systems shown on pages 53 through 63. Shpg. wt., 10 lbs. When Purchased with Lafayette Components or Systems on Pages 53 through 63 Order.

21 T 25946WX ..... Net 24.95  
21 T 25904WX Purchased Separately ..... Net 39.95  
See Page 24 for full description of Eico 4-color light system above.

**Lafayette AWARD-WINNING LR-1500TA**  
**240 Watt Deluxe Solid State AM/FM Stereo Receiver**



With  
**ACRITUNE**

Precision Tuning Indicator

ONLY

**299<sup>95</sup>** with case

**AAA 2 YEAR GUARANTEE**

See Page 55 for Terms

With

**COMPUTOR-MATIC<sup>T.M.</sup>**

Automatic Overload Protection.

**4 IC's + 5 FET's + 39 Transistors + 35 Diodes + 2 Thermistors**

- 240 Watts  $\pm 1$  db, 190 Watts IFH Output Power
- IHF FM Sensitivity 1.5 $\mu$ v
- Automatic Stereo FM Switching
- Adjustable Automatic FM Interstation Muting
- Center Channel Monaural Output

Lafayette's latest and better than ever deluxe solid state AM/FM stereo receiver in the acclaimed and award winning LR-1500 series! The LR-1500TA 240-watt stereo receiver is expressly engineered to blend the ultimate in high fidelity sound with superb performance, long life, and space-age reliability. In addition to its complement of fine quality transistors the LR-1500TA includes 4 Integrated Circuits (IC's) and 5 high-performance Field Effect Transistors to provide truly sterling FM stereo reception and audio reproduction. You'll hear more stations—the weak as well as the strong, with amazing, noise-free clarity and tonal purity! Features patent pending computer designed protective circuitry for virtually foolproof protection against burnout or failure of audio driver and power output transistors, and "ACRITUNE" circuitry for foolproof visual tuning accuracy. Utilizes a complete set of automatic and manual controls such as: Automatic FM stereo/mono switching; sharp, adjustable Muting circuit to silence the receiver when tuning between stations; dual system speaker switch which permits enjoyment of stereo in one or two rooms separately or simul-

- Built-in AM and FM Antennas
- Illuminated Selector Function Indicator Jewels
- Exclusive Front and Rear Panel Tape Output Jacks
- Massive, Regulated Power Transformer Insures Proper Tuner/Amplifier Operation

taneously; direct tape monitor switch and tape monitor jeweled indicator light for tape monitoring without changing cable connections; a front panel stereo headphone jack for enjoyable private stereo listening; and a center channel low level output for monaural amplifier and speaker. Separate input jacks provide for switchable high, low and medium magnetic phono and ceramic/crystal cartridge inputs. AM rf section has a separate 3-gang tuning condenser and rf stage to accommodate the full sound potential of standard AM broadcasting. Incorporates built-in FM and AM antennas plus connections for external local and distant FM and AM antennas. Distinctively styled to enhance any decor. Features a handsome gold anodized extruded aluminum front panel with matching knobs and includes an attractive vinyl-clad metal enclosure finished with the simulated look of rich walnut wood-grain. For 117v., 50/60 Hz AC. Imported. Size 16 $\frac{1}{2}$  x 4 $\frac{3}{4}$  x 14 $\frac{1}{2}$ "D. Shpg. wt., 38 $\frac{1}{2}$ lbs.

**99 T 01950WUX** ..... Net 299.95  
Attractive Oiled Walnut Wood Cabinet for LR-1500TA.  
**21 T 01582W** Shpg. wt., 0 lbs. .... Net 19.95



# LAFAYETTE 240-Watt AM/FM Stereo Systems with LR-1500TA Receiver



Garrard  
SL55B

**A**

Choice of Stereo Cartridge

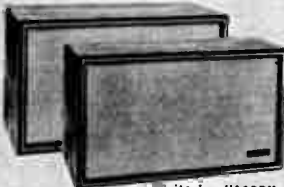

Criterion "100B"

**SAVE \$15.00 on**  
**Color Audio Lights**  
**BONUS SPECIAL!**

See Page 54 For Details

SYSTEM PRICE

**424<sup>95</sup>**

**SAVE 69.85**

From Individual  
Catalog Price



LR-1500TA

## **A** SELECTED 240-WATT AM-FM STEREO SYSTEMS

This expertly matched stereo system includes our finest receiver, the award-winning Lafayette LR-1500TA 240-Watt Solid-State AM-FM Stereo Receiver which features advanced solid-state circuitry with 4 Integrated Circuits, 5 F.E.T.'s, 39 discrete transistors, Computer-Matic® protective circuitry and ACRITUNE precision visual tuning for extraordinary performance; Garrard Synchro-Lab Model SL55B 4-Speed Automatic Turntable with attractive matching base; Pickering V-15/ACE-3 Elliptical Stereo Cartridge with high compliance diamond stylus; and 2 Lafayette Criterion 100B 3-way speaker systems with 10" woofer, 3½" mid-range, 1½" super tweeter, loaded sonic port and high frequency brilliance control in attractive oiled-walnut finished enclosures. Complete with speaker cable. Shpg. wt., 113½ lbs.

21 T 93050WXM No Money Down\* ..... Net 424.95  
Same as above but with Shure M55E elliptical stereo cartridge.  
21 T 93241WXM Shpg. wt., 113½ lbs. .... Net 424.95  
21 T 40287W Dust Cover for SL55B and SL65B. Shpg. wt., 3 lbs. .... Net 3.50

SYSTEM PRICE

**516<sup>95</sup>**

**SAVE 77.85**

From Individual  
Catalog Price



Garrard  
SL65B

**B**

Choice of Stereo Cartridge



Criterion "VI"

## **B** DELUXE 240-WATT AM-FM STEREO SYSTEMS

A deluxe stereo system that features the renowned Lafayette LR-1500TA 240-Watt Solid State AM/FM Stereo Receiver with meticulously engineered solid-state circuitry that includes 4 Integrated Circuits, 5 Field Effect Transistors and 39 discrete transistors, Computer-Matic® protective circuitry for the audio power stages and ACRITUNE precision visual tuning resulting in extraordinary performance; Garrard Model SL65B Synchro-Lab 4 Speed Automatic Turntable with adjustable anti-skating control, viscous damped cueing, etc.; Matching Base for turntable; Pickering V-15/ACE-3 Elliptical Stereo Cartridge with high compliance diamond stylus; and 2 new Lafayette Criterion VI deluxe 4-way, 6-speaker systems with 12" woofer, 5" mid-range, two 3" tweeters, two 1½" super tweeters, and Brilliance and Presence controls in a handsome oiled-walnut finished enclosure. With cable.

21 T 93092WXM Shpg. wt., 139½ lbs. .... Net 516.95  
Same system as above except with Shure M55E elliptical stereo cartridge.  
21 T 93217WXM Shpg. wt., 139½ lbs. .... Net 516.95

See pages 54, 64, 65, and 69 for full descriptions of components in above systems.

### LAFAYETTE AAA GUARANTY

LAFAYETTE HIGH FIDELITY SPEAKERS = 5 YEARS  
LAFAYETTE HIGH FIDELITY RECEIVERS = 2 YEARS  
LAFAYETTE HIGH FIDELITY TUNERS = 2 YEARS  
LAFAYETTE HIGH FIDELITY AMPLIFIERS = 2 YEARS

All Lafayette high fidelity components identified as covered by Lafayette's AAA guaranty are guaranteed to be free of defects in material or workmanship from the date of sale for the time period shown above. During that period we will repair (or at our option replace) them without charge for either material or labor. Material must be returned prepaid to us for our inspection. This guaranty does not apply to items which have been subjected to misuse, abuse, alteration, repair without our authorization or used in violation of operating instructions, nor to normal wear and tear. The speaker guaranty does not cover external parts such as

cabinets, grille cloth etc. Serial number must not be defaced. Guaranty is not transferrable.

### LAFAYETTE AAM GUARANTY

This guaranty covers Lafayette items so indicated in our catalog which contain several integrated sections in a single unit such as compacts and integrated entertainment centers. The time period for each section is as follows:

SPEAKERS	5 YRS.
RECEIVER OR TUNER SECTION	2 YRS.
AMPLIFIER SECTION	2 YRS.
RECORDER SECTION	3 MOS.
CHANGER SECTION	3 MOS.

The terms and conditions of this guaranty are otherwise identical to the AAA Guaranty.

### OTHER GUARANTEES

All merchandise not covered either by the special guarantees on this page or by other specific guarantees in the catalog are covered by a 90 day repair or replacement guarantee (at our option) against defects in material or workmanship.

### SATISFACTION GUARANTEED

If for any reason you are not satisfied with your purchase return it to us within 30 days in the original factory carton and we will exchange it or return your money (less transportation charges). Merchandise returned must be in good condition and not soldered or abused—no holes drilled or changes made in any other way. This policy does not apply to kits, nor to pre-recorded tape, records, books or merchandise not regularly stocked that has been ordered especially for you.

## (A) LAFAYETTE 150-WATT SOLID-STATE AM/FM STEREO RECEIVER



ACCLAIMED BY THE PROFESSIONAL CRITICS

4 IC's + 36 Transistors  
+ 2 FET's + 31 Diodes

Only **239<sup>95</sup>** With Case

LR-1000TA

AAA 2-YEAR GUARANTEE

See Page 53 For Terms

**COMPUTOR-MATIC™** PAT. PEND.  
Protective Circuitry For Audio Power Stages

## (B) LAFAYETTE 100-WATT SOLID-STATE AM/FM STEREO RECEIVER

4 IC's + 24 Transistors  
+ 4 FET's + 25 Diodes

Only **199<sup>95</sup>** With Case

AAA 2-YEAR GUARANTEE

See Page 53 For Terms



LR-775

### (A) DELUXE 150-WATT SOLID STATE AM/FM STEREO RECEIVER

- 150 Watts  $\pm 1$  db., 120 Watts IHF Output Power
- IHF Sensitivity 1.65 $\mu$ V
- Interstation Muting Control
- Automatic FM Stereo Switching
- Center Channel Output
- Built-in FM Antenna Plus Flexible Swivel-Mount AM Antenna
- High/Low Phono Sensitivity Switch
- Exclusive Front and Rear Tape Output Jacks

Every performance feature that you'd expect to find along with many extras to obtain the superb character of brilliant sound. The LR-1000TA features the new space age miracle, Integrated Circuits (IC's) plus FET's in the tuner front end to assure outstanding selectivity, stability, and superior capture ratio. Ingenious COMPUTOR-MATIC™ circuitry (patent pending) provides protection of audio driver and power output transistors. Advanced circuitry is complemented by all the controls you need to adjust the sound to your particular taste. Fine features include special high and low frequency switchable noise filters, front panel headphone output jack, tape output jack for direct tape recording, tape monitor plus tape monitor illuminated jewel indicator, loudness switch, signal strength tuning meter for normal or center scale tuning, colored function lights, and automatic FM stereo indicator light. Complete input and output facilities designed for easy installation and connection to any program source or external component. With 1 switched and 1 unswitched AC receptacle. The LR-1000TA's professional styling is enhanced by a brushed gold anodized extruded aluminum front panel and a simulated walnut grain metal case. For 105-120 VAC, 50/60 Hz. Size: 15 $\frac{1}{2}$ x5x13 $\frac{1}{2}$ " (incl. rear projections). Imported.

99 T 02081WUX No Money Down\* Shpg. wt., 32 lbs. Net 239.95  
Attractive Oiled Walnut Wood Cabinet for LR-1000TA  
21 T 01574WX Shpg. wt., 8 lbs. Net 19.95

### (B) LAFAYETTE 100-WATT SOLID STATE AM/FM STEREO RECEIVER

- 100-Watts  $\pm 1$  db, 80-Watts IHF Stereo Power
- IHF Sensitivity 1.7 $\mu$ V
- Fused Output Transistors
- 4-Gang FM Tuning Condenser
- Automatic FM Stereo Switching and Stereo Indicator Light
- Front and Rear Panel Tape Output Jacks

This 100-watt stereo receiver is one of Lafayette's finest with its distinctive styling and advanced solid state circuitry, truly a thing of beauty with top-notch stereo performance. In addition to many striking styling innovations, it features aluminum and black knobs which contrast nicely with the gold anodized brushed aluminum panel trim. The LR-775's sensitive FM Stereo circuitry will receive even the weakest signals while maintaining excellent fidelity and freedom from distortion. The AM tuner section offers very good selectivity plus a built-in, flexible-mount ferrite loopstick antenna for optimum sensitivity. A meticulously designed amplifier section gives faithful reproduction with more than adequate volume from any program source. Output transistors are fused for full overload protection. In addition to the illustrated selected features the LR-775 also has a selector switch for Aux, Phono, FM MPX Filter, and AM; front and rear panel jacks for tape outputs; Rear panel stereo inputs for magnetic and ceramic phono, Aux, Tape Record, and Tape Play; and one switched plus one unswitched AC convenience outlets. Complete with built-in FM antenna and provision for external AM and FM antennas. Power requirements: 105-120 VAC, 50/60 Hz. Size: 14 $\frac{1}{2}$ x4x10 $\frac{1}{4}$ "0. Imported. Shpg. wt., 16 $\frac{1}{2}$  lbs.

99 T 02150WUX No Money Down\* Net 199.95  
Oiled Walnut Wood Cabinet for LR-775. Wt., 8 lbs.  
21 T 01681W Net 19.95

See Page 50 for Systems With Above Receivers

**BONUS SPECIAL!**

**SAVE \$15.00**

Good Only Until  
December 31, 1970

When You Purchase Popular Eico Audio Color Light System With Any Receiver Above  
See Page 54 for Bonus Particulars

## (C) LAFAYETTE 50-WATT SOLID-STATE AM/FM STEREO RECEIVER

33 Transistors + 25 Diodes  
2 Thermistors

Only **139<sup>95</sup>**  
with case

AAA 2-YEAR GUARANTEE

See Page 55 For Terms



LR-100

## (D) LAFAYETTE 25-WATT SOLID-STATE AM/FM STEREO RECEIVER



LR-75

AMAZING  
LOW PRICE

**109<sup>95</sup>**  
with case

AAA 2-YEAR GUARANTEE

See Page 55 For Terms

### (C) 50-WATT SOLID STATE AM/FM STEREO RECEIVER LR-100

- 50 Watts  $\pm 1$ db, 40 Watts IHF Stereo Output
- 4-gang FM Tuning Condenser for Sensitivity of 2.5  $\mu$ v
- Illuminated Signal Strength Tuning Meter
- Built-in FM plus Flexible-Mount AM Antenna
- Front and Rear Panel Tape Output Jacks
- Front Panel Stereo Headphone Jack
- High Frequency Filter
- Automatic FM Stereo Switching and Stereo Indicator Light

An outstanding hi-fi value, the Lafayette LR-100 features deluxe decorator-designed styling plus full-range, full-fidelity sound from thrilling stereo or mono FM broadcasts, AM broadcasts, as well as phono or tape. A full complement of front panel (tone controls (Bass, Treble, Volume/Balance) and push-button switches (Loudness, Stereo/Mono, High Filter) enable the LR-100 to be tailored to the acoustical characteristics of any room, and to match the sound characteristics of virtually any phono cartridge, tape player or speaker system—performance features normally included only on much more expensive hi-fi components. Excellent sensitivity, selectivity, and capture ratio are inherent in the technologically advanced and long-life circuitry of the LR-100. You will be delighted with the clear reception of the weak as well as the stronger stations! The amplifier section has power to spare . . . 50 watts will drive main and remote stereo speakers, and will easily fill any room with clean, wall-to-wall sound. Some additional fine features of the LR-100 are: automatic stereo switching; signal-strength tuning meter for more accurate tuning; MPX filter; FM stereo indicator light; front and rear panel tape outputs for easier tape recording; stereo headphone output for enjoyable private listening; fused speaker outputs; distinctively styled front panel and attractive simulated walnut grain vinyl-clad metal case. Size: 14½Wx4½Hx10½"D. For 117 VAC 50/60 Hz. Imported. Shpg. wt., 21 lbs.

99 T 02214WUX No Money Down\* . . . Net 139.95

See Page 59 for Systems With Above Receivers

### (D) 25-WATT SOLID-STATE AM/FM STEREO RECEIVER LR-75

- 25-Watts  $\pm 1$  db, 20 Watts IHF Stereo Output
- IHF Sensitivity 3.5  $\mu$ v
- Automatic FM Stereo Indicator
- Automatic Station Lock-In
- Built-In FM plus Flexible-Mount AM Antennas
- Front Stereo Headphone Jack
- Front Panel Tape Output Jack
- Main-Remote Speaker Switches

NOW AT A SENSATIONALLY LOW PRICE . . . for the music-lovers who want the "very best" but must consider their budgets, the LR-75 is the modern solution to big AM/FM stereo sound at a low price! All solid-state circuitry (24 transistors, 21 diodes) delivers clean, crisp stereo realism with a maximum degree of freedom from unwanted interference and noise. Among the many convenience features there are AUTOMATIC STEREO/MONO SWITCHING and a simultaneous STEREO INDICATOR LIGHT that automatically signals the presence of an FM stereo broadcast. The LR-75 features the following desirable controls: PROGRAM SELECTOR (Auxiliary, Phono, CER., FM, MPX Filter, and AM); BASS and TREBLE controls; dual concentric VOLUME/BALANCE; and TUNING. In addition there are see-saw rocker switches for POWER on/off, LOUDNESS contour, LOCK automatic frequency control, STEREO/MONO mode, and switches for two separate speaker system selection. (Lets you turn on or off both MAIN and REMOTE speakers.) It also includes a front panel tape output jack and stereo headphone jack; plus unswitched AC convenience outlet on rear panel. The unit comes in a handsome, vinyl clad, heavy gauge metal enclosure, with the simulated look of rich walnut wood grain. Front panel and knobs are matching brushed gold anodized extruded aluminum. For 105/120 VAC, 50/60 Hz. 13Wx9½Dx4½H. Imported. 99 T 02362WUX Wt., 16½ lbs. No Money Down\* . . . Net 109.95

**BONUS  
SPECIAL!**

**SAVE \$15.00**

Good Only Until  
December 31, 1970

When You Purchase Popular Eico Audio Color  
Light System With Any Receiver Above  
See Page 54 for Bonus Particulars

\*See Page 18 for Full Credit Details on Easy Pay Plan



LR-1000TA



Garrard 40B

Choice of Elliptical Stereo Cartridge

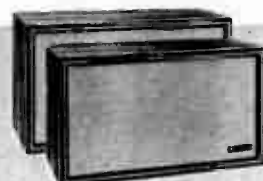

Criterion 100B

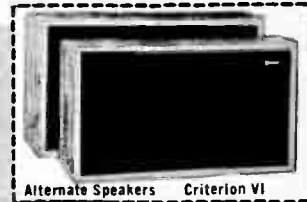

Alternate Speakers Criterion VI

## LAFAYETTE 150-Watt Stereo Systems with LR-1000TA Stereo Receiver

**SAVE 58.85**  
From Individual Catalog Prices

ONLY SYSTEM PRICE **355<sup>95</sup>**

No Money Down\*

This fine 150-watt stereo system features the Lafayette LR-1000TA 150-Watt Solid State AM-FM Stereo Receiver cited by audio critics for its outstanding performance characteristics and fine circuitry innovations; the Garrard Model 40B 3-Speed Automatic Turntable; matching base for turntable; Pickering P/ATE-1 Elliptical Stereo Cartridge with high compliance diamond stylus; and 2 Lafayette Criterion 100B 3-way loaded sonic speaker systems with 10" woofer, 3 1/2" midrange, 1 1/2" super tweeter and brilliance control in an attractively styled oiled-walnut finished enclosure. With speaker cable.  
 21 T 92920WXM Shpg. wt., 106 1/2 lbs. Net 355.95  
 As above except with Shure M44E elliptical stereo cartridge. Net 355.95  
 21 T 93274WXM Shpg. wt., 106 1/2 lbs. Net 355.95  
 Same as 21 T 92920WXM except with Empire 90EE/X elliptical stereo cartridge.  
 21 T 93282WXM Shpg. wt., 106 1/2 lbs. Net 355.95

Same system as 21 T 92920WXM except with two Lafayette Deluxe Criterion VI 6-speaker, 4-way systems that feature a 12" woofer with 4 1/2 lb. magnet structure, 5" midrange in sealed sub-enclosure, two 3" cone tweeters, two 1 1/2" aluminum cone super tweeters, and tuned "sonic tube" in oiled walnut finish enclosure. Instead of Criterion 100B speakers. Shpg. wt., 132 1/2 lbs. Net 427.95  
 21 T 93787WXM No Money Down\* Net 427.95  
 You Save \$66.85 From Individual Catalog Prices!  
 Same system as 21 T 93787WXM except with Shure M44E elliptical stereo cartridge. Shpg. wt., 132 1/2 lbs. Net 427.95  
 21 T 93795WXM No Money Down\* Net 427.95  
 Same system as 21 T 93787WXM except with Empire 90EE/X elliptical stereo cartridge. Shpg. wt., 132 1/2 lbs. Net 427.95  
 21 T 93803WXM No Money Down\* Net 427.95

## BONUS SPECIAL.....SAVE \$15.00

on Popular EICO Stereo Color Lights  
When Purchased with any System on This Page.

See Page 54 for Full Details



LR-775



Garrard 40B

Choice of Elliptical Stereo Cartridge

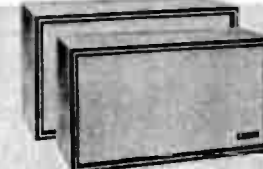

Criterion 50A



Alternate Speakers Criterion "OMNI-1"

## LAFAYETTE 100-Watt Stereo Systems with LR-775 AM/FM Stereo Receiver

**SAVE 50.85**  
From Individual Catalog Prices

ONLY SYSTEM PRICE **283<sup>95</sup>**

No Money Down\*

This complete versatile stereo system consists of Lafayette LR-775 100-Watt Solid State AM-FM Stereo Receiver with advanced solid state stereo circuitry; Garrard Model 40B 3-Speed Automatic Turntable; Matching base for turntable; Pickering P/ATE-1 Elliptical Stereo Cartridge with high-compliance diamond stylus; and 2 famous Lafayette Criterion 50A 2-way bass reflex ducted port speaker systems with 8" woofer and 3 1/2" direct radiator tweeter in oiled walnut finish enclosure for horizontal or vertical placement. With cable. Shpg. wt., 73 lbs.  
 21 T 93381WXM Net 283.95  
 Same as above but with Shure M44E elliptical stereo cartridge. Shpg. wt., 73 lbs. Net 283.95  
 21 T 93399WXM Net 283.95  
 Same as above but with Empire 90EE/X elliptical stereo cartridge.

Shpg. wt., 73 lbs. Net 283.95  
 21 T 93407WXM Net 283.95  
 Same system as 21 T 93381WXM except with 2 Lafayette Criterion "Omni-1" omnidirectional 5 speaker thin-line speaker systems that include 8" woofer plus four 3 1/2" close-back tweeters with 360° acoustic deflector in attractive oiled walnut enclosure. Net 301.95  
 21 T 92078WXM Shpg. wt., 85 lbs. Net 301.95  
 You Save \$52.85 From Individual Catalog Prices!  
 Same system as 21 T 92078WXM except with Shure M44E elliptical stereo cartridge. Shpg. wt., 85 lbs. Net 301.95  
 21 T 92060WXM No Money Down\* Net 301.95  
 Same system as 21 T 92078WXM except with Empire 90EE/X elliptical stereo cartridge. Shpg. wt., 85 lbs. Net 301.95  
 21 T 93423WXM No Money Down\* Net 301.95



LR-100



Garrard 40B

Choice of  
Elliptical  
Stereo Cartridge



Criterion 25A

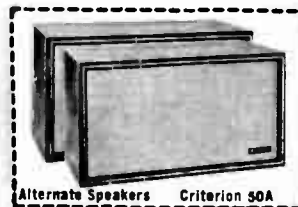

Alternate Speakers Criterion 50A

## LAFAYETTE 50-Watt Stereo Systems with LR-100 AM/FM Stereo Receiver

**SAVE**  
**42.85**  
From Individual  
Catalog Prices

ONLY

SYSTEM PRICE

**211<sup>95</sup>**

No Money Down\*

Extraordinary value in a complete 50-watt stereo system! Features the Lafayette LR-100 50-Watt Solid State AM-FM Stereo Receiver which offers full-feature stereo versatility with controls and inputs from every source, handsomely styled in black and gold anodized front panel and with simulated walnut vinyl clad metal case; Garrard Model 40B 3-speed Automatic Turntable with viscous damped, single lever cueing, complete with Matching base; Pickering P/ATE-1 Elliptical Stereo Cartridge with high compliance diamond stylus; 2 Lafayette Criterion 25A 25-Watt 2-Way speaker systems, each featuring an extra-efficient 8" woofer and 2½" tweeter. Speakers are housed in attractive enclosures with hand-rubbed oiled walnut finish. Complete with speaker cable. Shpg. wt., 56 lbs.

21 T 94769WXM Net 211.95  
Same system as above except with Shure M44E elliptical stereo cartridge. Shpg. wt., 56 lbs.  
21 T 94777WXM Net 211.95

Same system as above except with Empire 90EE/X elliptical stereo cartridge. Shpg. wt., 56 lbs.  
21 T 93464WXM Net 211.95

Same system as 21 T 94769WXM except with 2 Lafayette Criterion 50A 30-Watt 2-way bass reflex ducted port speaker systems with 8" heavy duty woofer and 3½" tweeter in oiled-walnut finish enclosure instead of Criterion 25A speakers.  
21 T 93472WXM Shpg. wt., 87¼ lbs. Net 229.95

YOU SAVE \$44.85 From Individual Catalog Prices!

21 T 93472WXM system except with Shure M44E Elliptical Cartridge. 8" heavy duty woofer and 3½" tweeter in oiled-walnut finish enclosure instead of Criterion 25A speakers. Shpg. wt., 87¼ lbs. Net 229.95  
21 T 93472WXM system except with Empire 90EE/X Elliptical Cartridge. Shpg. wt., 87¼ lbs. Net 229.95

**BONUS SPECIAL.....SAVE \$15.00**

on Popular EICO Stereo Color Lights  
When Purchased with any System on This Page.

See Page 54 for Full Details

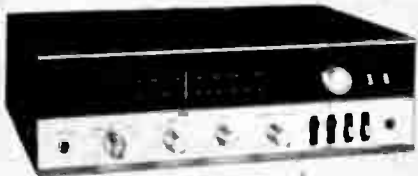

LR-75



Garrard 30



Criterion 2X



Alternate Speakers

Criterion 50A

## LAFAYETTE 25-Watt Stereo Systems with LR-75 AM/FM Stereo Receiver

**SAVE**  
**17.90**  
From Individual  
Catalog Prices

ONLY

SYSTEM PRICE

**166<sup>95</sup>**

No Money Down

A truly exciting value in a complete 25-watt stereo system package! Matched for performance as well as economy, this stereo system features the Lafayette LR-75 25-watt Solid State AM-FM Stereo Receiver with full stereo performance capability and with pleasing complementary styling; Garrard Model 30 4-Speed Automatic turntable with oversized turntable, efficient ceramic stereo cartridge and long-life diamond stylus; Attractive Matching Turntable base for Model 30; and 2 Lafayette Criterion 2X neatly styled, highly efficient 2-way oiled walnut finish bookshelf speaker systems with fine performing 6" woofer and 3½" cone-type tweeter. Shpg. wt., 45 lbs.  
21 T 93522WXM Net 166.95

Same system as above except with 2 popular, best-selling Lafayette Criterion 50A 2-way bass-reflex, ducted port speaker systems with heavy-duty 8" woofer and 3½" direct radiator tweeter in attractive oiled-walnut finish enclosure for horizontal or vertical placement instead of Criterion 2X speakers.  
21 T 93530WXM Shpg. wt., 71 lbs. Net 193.95

YOU SAVE \$20.90 From Individual Catalog Prices!

See Pages 57, 64, 68 and 69 for Full Description of Components in Above Systems.



**LAFAYETTE**  
AM/FM Stereo Tuners

DESIGNED FOR PERFORMANCE...  
STYLED FOR DISTINCTION!



4 IC's, 18 Transistors  
2 FET's, 21 Diodes

ONLY

**99<sup>95</sup>**  
No Money Down\*

**AAA 2-YEAR GUARANTEE**

See Page 55 for Terms

## LAFAYETTE Solid-State AM/FM Stereo Tuner Model LT-725

- 1.7 $\mu$ V IHF Sensitivity
- 4 Gang Tuning Condenser
- Front Panel Tape Output Jack
- Illuminated Signal-Strength Tuning Meter For Normal and Center Scale Tuning
- Automatic Stereo Switching and Stereo Indicator Light
- Internal FM Antenna plus Flexible Mount AM Loopstick Antenna
- Beautifully Styled Dial That Illuminates with "Power-On"
- 40db Stereo Separation
- 1.5db Capture Ratio

The Lafayette LT-725 establishes pace-setting standards for excellence in performance, flexibility of controls, ease of operation, and convenience. Its distinctive styling will compliment any home decor. Yet with all these features it is priced within the budget of the music lover who seeks superior performance and design at a moderate cost. In addition to high performance and unique circuit design, the LT-725 boasts an ultra-modern exterior with space-age styling. The most striking of these is the elegant ebony face-plate with gold embossed lettering; equally impressive when the unit is "On", the logging scale, tuning meter and stereo indicator are illuminated into a soft, rich blend from behind the face-plate. The front panel also features a row of push-buttons for the functions of Stereo/Mono mode, MPX Filter, FM/AM reception, and tuning meter for center channel tuning and signal strength indication. There are tape output jacks at the rear and front panels; and rear inputs for external FM and AM antennas. Complete with built-in FM and AM antennas, AC fuse holder and grounding post. Output suitable for any quality stereo amplifier. Size: 12W x 3 $\frac{1}{2}$ H x 9 $\frac{1}{2}$ "D. Imported. Shpg. wt., 12 $\frac{1}{2}$  lbs.

99 T 02164WUX ..... Net 99.95



Amazing Low Price

ONLY

**69<sup>95</sup>**  
No Money Down\*

**AAA 2-YEAR GUARANTEE**

See Page 55 for Terms

## LAFAYETTE Solid State AM/FM Stereo Tuner Model LT-670

Enjoy the full measure of high priced AM/FM stereo reception at an "Amazingly" low price. Solid-state circuitry combines advanced design and electronic principles to provide a level of performance that far exceeds the cost! Included are AUTOMATIC MULTIPLEX CIRCUITRY which instantly-switches the tuner to stereo operation when stereo is being broadcast. A "STEREO" INDICATOR LIGHT gives instantaneous visual indication of stereo broadcasts. Every control feature for outstanding performance has been included: switchable (On/Off) MPX FILTER for reduction of external interference on FM stereo; AUTO LOCK (AFC) assures drift-free reception. Other features include a MODE selector (Mono or Stereo); and a SELECTOR for AM or FM reception. There are even tape output jacks on front and rear for recording directly to a tape recorder. Has built in FM antenna and Ferrite bar for AM; plus terminals for adding a FM external antenna and anodized brush aluminum front panel and knobs. For 105/120 VAC., 50/60 Hz. Size: 10 $\frac{1}{2}$ Wx3 $\frac{1}{2}$ Hx8 $\frac{3}{4}$ "D. Shpg. wt., 12 lbs.

99 T 02313WUX ..... Net 69.95

- Automatic Stereo Switching and Stereo Indicator Light
- Front Panel Tape Output Jack
- Automatic FM Station Lock
- 3.5 $\mu$ V IHF Sensitivity
- 30 db Stereo Separation
- Multiplex Filter
- 14 Transistors plus 16 Diodes
- Internal FM Antenna plus Flexible—Mount AM Antenna
- Attractively Styled To Blend With All Decors

*Lafayette*

"Stereo 25" 20-Watt Solid-State Stereo Amplifier



Only  
**39<sup>95</sup>**  
With Case

No Money Down\*

Criterion 2X

- 20 Watts  $\pm$  1 db† of Stereo Power at 4 or 8 Ohms
- 20-20,000 Hz  $\pm$  1 db Frequency Response
- Main/Remote Speaker Switch
- Front Panel Stereo Headphone Jack

The Stereo 25 faithfully reproduces the full spectrum of audio sound with adequate volume and very low distortion. Solid state design assures top-notch performance. Convenient operating features include front panel rocker switches for activation of source (tuner, phono or auxiliary), selection of stereo or mono output, selection of remote or main speakers, and power on/off. A full complement of controls is supplied for best stereo effects and permits you to "tailor" the sound to suit your taste! Front panel controls include separate bass, treble, concentric volume/balance and stereo headphone jack for private listening. Stereo outputs are available for 4-16 ohm main speakers and for remote speakers in the den, dining room or patio area. Attractive, modern styling with a matte black and satin gold front panel is complemented by a handsome walnut grained vinyl clad metal enclosure. Fused AC line and separately fused speaker outputs prevent damage to output transistors. Operates on 105-120 VAC, 50/60 Hz. Size: 10 $\frac{1}{2}$ "Wx3 $\frac{1}{2}$ "Hx6 $\frac{1}{4}$ "D. Imported. †Rating standard used by major audio HI-FI mfrs. Shpg. wt., 10 lbs.

99 T 02271WX

Net 39.95



Garrard 30

20 WATT STEREO PHONO SYSTEM with "STEREO 25"

This value packed stereo system includes the Lafayette "Stereo 25" 20-Watt Solid State Stereo Amplifier; Garrard Model 30 4-Speed Automatic Turntable with oversized turntable, ceramic stereo cartridge and long-life diamond stylus; Matching turntable base; and 2 Lafayette Criterion 2X oiled-walnut 2-way bookshelf speaker systems with 6" woofer and 3 $\frac{1}{2}$ " direct radiator cone tweeter. With speaker cable. Shpg. wt. 40 lbs.

21 T 93340WXM

Net 103.95

THE COMPLETE SYSTEM

**103<sup>95</sup>**

with case

BONUS SPECIAL . . . SAVE \$15.00

on Eico 4 Color Audio Lights with purchase of any amplifier or system on this page. See Page 54 for details.



ONLY

**75<sup>95</sup>**

No Money Down\*

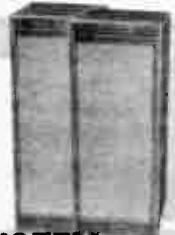

STEREO 10A HI-FI STEREO PHONO MUSIC SYSTEM

- LAFAYETTE STEREO 10A SOLIO-STATE STEREO AMPLIFIER
- LAFAYETTE MODEL AC50 4-SPEED AUTOMATIC PUSH-BUTTON STEREO RECORD CHANGER WITH STEREO TURNOVER CERAMIC CARTRIDGE AND DIAMOND LP NEEOLE

- MATCHING WALNUT BASE FOR RECORD CHANGER
- TWO LAFAYETTE MINUETTE® MARK II DECORATOR STYLED 2-WAY OILED WALNUT SPEAKER SYSTEMS WITH BRILLIANCE CONTROL

Complete Stereo 10A Stereo system above with speaker connecting cable. Shpg. wt., 33 lbs.

21 T 92912WXM

Net 75.95

LAFAYETTE STEREO 10A SOLID STATE STEREO AMPLIFIER

Attractive, neat styling, compact size, big performance! Ideal amplifier for the hi-fi beginner or use it as a second system for the living room, den, bedroom, or business. Perfect for limited space installations, bookshelf or end of table. For use with record players, AM, FM, and FM Stereo tuners. Completely transistorized to provide clean sound and cool operation. Output stages couple directly to the speakers for smooth frequency response and low distortion. Provides excellent low frequency response with high impedance crystal or ceramic phono cartridges. Front panel features: Separate volume controls for Left/Right channels; Tone control for Bass and Treble;

Rotary selector switch for Phono, Tuner and Auxiliary; Individual slide switches for Mono/Stereo Mode, Power-On/Off and Speakers-Main/Remote; Stereo headphone jack for private listening; Power On/Off indicator light. Rear panel features: Left/Right channel inputs for phono, tuner and auxiliary; Left/Right channel outputs for main and remote speakers; switched AC convenience outlet. Beautifully finished brushed aluminum front panel with complementary metal knobs and attractive metal case. Size: 9Wx3 $\frac{1}{2}$ Hx6 $\frac{1}{2}$ "D. For 105-125 VAC, 50/60 Hz. Imported. Shpg. wt., 7 lbs.

99 T 02289

Net 27.95

\*See Page 18 for Full Credit Details on Easy Pay Plan

# LAFAYETTE Stereo Amplifiers Make Ideal Gifts



LA-125TA

**COMPUTOR-MATIC™ (Pat. Pend.) Protective Circuitry For Audio Power Stages**

- 160 Watts  $\pm 1$  db, 125 Watts IHF Output Power
- 20 Transistors, 4 Diodes
- Front Panel Microphone/Musical Instrument Jack
- Main-Remote Speaker Mode Switch
- High Gain plus Low Gain Magnetic Phono Inputs
- High Gain plus Low Gain Tuner Inputs
- Front and Rear Tape Output Jacks
- Low and High Frequency Filters
- Front Panel Stereo Headphone Jack

Produces a full 160 watts of audio power from 20-20,000 Hz with virtually no faltering at either end of the response range. Concentric Balance/Volume, Treble, Bass controls provide easy adjustment on both channels. Four rocker switches are provided for Low Filter, High Filter, Loudness for tonal balance at low volume levels, and Tape Monitor for monitoring while recording and playing back tape through amplifier. The rear panel provides 6 stereo inputs and a stereo output for tape recording through amplifier. The stereo inputs include: Magnetic (high, low); Ceramic phono cartridge; Tuner (high, low), Auxiliary; and Tape Input for connection of a tape deck. Left and right speaker connections permit the use of 4, 8 and 16 ohm speakers. Special remote speaker terminals are provided for remote placement of speakers anywhere in your home. 2 AC convenience outlets (1 switched) on rear panel. For 117 VAC, 50/60 Hz. 99 T 02073W Shpg. wt., 18 $\frac{1}{2}$  lbs. Net 129.95



**160-WATT SOLID STATE STEREO AMPLIFIER**

**129<sup>95</sup>** WITH CASE  
No Money Down\*

AAA 2-YEAR GUARANTEE

See Page 55 for Terms



LA-750

- 100-Watts  $\pm 1$  db, 80-Watts IHF Stereo Power
- Fused Output Transistors
- 2 FET's, 16 Transistors, 6 Diodes, 2 Thermistors
- Main-Remote Separate/Simultaneous Speaker Switch
- Front Panel Stereo Headphone Jack
- High Frequency Noise Filter
- Front and Rear Tape Output Jacks
- Decorator Styling of Distinction

All solid-state for utmost in dependable service with such advanced features as Push On/Push Off switches for Main Power Loudness, Stereo/Mono, Tape Monitor, and High Filter, plus separate Bass, Treble, and Volume/Balance controls. Speaker Mode switch selects Main, Main plus Remote, Remote speakers, or Stereo Headphones. There are convenient tape output jacks on front and rear panels. Rear panel includes stereo jacks for Aux., Tuner, Phono, Tape Play, and Tape Record. Has fused right and left channels for protection against shorts and overloads; Remote and main speaker outputs for stereo sound anywhere in your home; 1-switched and 1-unswitched AC outlet; AC power fuse. For 105-120 VAC., 50/60 Hz. Size: 12W x 3 $\frac{3}{4}$ H x 9 $\frac{1}{2}$ "D. Imported. 99 T 02149W Shpg. wt., 13 $\frac{1}{2}$  lbs. Net 79.95



**100 WATT SOLID STATE STEREO AMPLIFIER**

**79<sup>95</sup>** WITH CASE  
No Money Down\*

AAA 2-YEAR GUARANTEE

See Page 55 for Terms



LA-324A

- 50-Watts  $\pm 1$  db, 40-Watts IHF Output Power
- Frequency Response: 20-20,000 Hz  $\pm 1.5$  db
- 18 Transistors, 4 diodes, 2 Thermistors
- Main-Remote Speaker Switch
- Front Panel Stereo Headphone Jack
- Attractive Front Panel Plus Simulated Walnut Case

See Page 54 For BONUS SPECIAL on Audie Color Lights When Purchased With Any of Above Amplifiers

The LA-324A will drive most speaker systems to maximum volume while maintaining very good frequency response and low distortion. The LA-324A features fused output transistors for protection against overloads, and front panel controls which include concentric volume/Balance, Treble and Bass, Input Selector for Aux., Tuner, Mag Phono, and Ceramic Phono. Also included are rocker switches for Mono/Stereo mode, Remote/Main Speakers and Power On/Off. Rear panel features stereo inputs for Aux. Tuner and Phono; 2 AC convenience outlets; Tape Output Jack; and Main and Remote Speaker terminals for 4, 8, 16 ohm speakers. Its attractive design (only 10 $\frac{1}{2}$ W x 3 $\frac{1}{2}$ H x 8 $\frac{3}{4}$ "D) will complement any home decor. For 105-120VAC., 50/60 Hz with AC power Fuse. Imported. 99 T 02339W Shpg. wt., 10 $\frac{3}{4}$  lbs. Net 59.95



**50 WATT SOLID-STATE STEREO AMPLIFIER**

**59<sup>95</sup>** WITH CASE  
No Money Down\*

AAA 2-YEAR GUARANTEE

See Page 55 for Terms

# LAFAYETTE STEREO HI-FI SYSTEMS



FOR LASTING JOY

Criterion 100B

**256<sup>95</sup> SAVE 47.85**

No Money Down\*

From Individual Catalog Prices

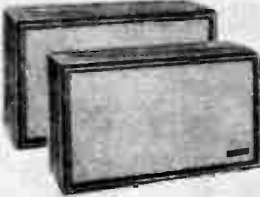

LA-125TA



Garrard 40B

Choice of Stereo Cartridge

## 160-WATT STEREO SYSTEMS with LA-125TA

Packed with satisfaction-giving audio features, this stereo system consists of the Lafayette LA-125TA 160-Watt, Solid-State Stereo Amplifier with Computor-Matic™ protective circuitry in its audio power stages for unexcelled stereophonic sound reproduction; the Garrard Model 40B 3-speed Automatic Turntable with outstanding turntable features; matching base for turntable; Pickering P/ATE-1 Elliptical Stereo Cartridge with high compliance diamond stylus; and 2 fine Lafayette Criterion 100B 3-speaker systems with 10" woofer, 3½" midrange, 1½" super tweeter, loaded sonic port and brilliance control in a handsomely styled oiled walnut finished enclosure. With speaker cable. Shpg. wt., 93 lbs.

21 T 93035WXM

Net 256.95

21 T 93555WXM Above but with Shure M44E elliptical cartridge.

Net 256.95

21 T 93563WXM Above but with Empire 90EE/X elliptical cartridge.

Net 256.95

Same as 21 T 93035WXM except with 2 Lafayette Criterion 4X 4-speaker systems with 12" woofer, 5" midrange, 3" tweeter and 1½" super tweeter in ducted port oiled-walnut finished enclosure. Shpg. wt., 111 lbs.

21 T 93571WXM No Money Down\*

Net 292.95



Alternate Speakers

Criterion 4X



Criterion 50A

**175<sup>95</sup> SAVE 38.85**

No Money Down\*

From Individual Catalog Prices



LA-750

Choice of Stereo Cartridge



Garrard 40B

## 100-WATT STEREO SYSTEMS with LA-750

A 100-watt stereo phono system that features the Lafayette LA-750 100-watt Solid State Stereo Amplifier; Garrard Model 40B 3-Speed Automatic Turntable with attractive matching base; Pickering P/ATE-1 Elliptical Cartridge with high compliance diamond stylus; plus 2 Lafayette Criterion 50A popular 2-way bass reflex ducted-port speaker systems with heavy duty 8" woofer and 3½" cone type direct radiator tweeter in decorative oiled-walnut finished enclosures. Complete with speaker cable. Shpg. wt., 70 lbs.

21 T 93621WXM

Net 175.95

21 T 93639WXM Above but with Shure M44E elliptical stereo cartridge.

Net 175.95

21 T 93647WXM Above but with Empire 90EE/X elliptical stereo cartridge.

Net 175.95

Same as 21 T 93621WXM except with 2 Lafayette Criterion "Omni-I" 5-speaker thin line systems each with 8" woofer, four 3½" closed back tweeters and 360° acoustic deflector in oiled-walnut finished enclosure.

21 T 92359WXM Shpg. wt., 82 lbs.

Net 193.95



Alternate Speakers

Criterion "Omni-I"

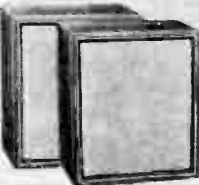

Criterion 29A

**139<sup>95</sup> SAVE 34.85**

No Money Down\*

From Individual Catalog Prices



LA-324A

Choice of Stereo Cartridge



Garrard 40B

## 50-WATT STEREO SYSTEMS with LA-324A

A budget-priced system with high performance, this Lafayette matched stereo system consists of the new Lafayette LA-324A 50-Watt Solid State Stereo Amplifier; Garrard Model 40B 3-Speed Automatic Turntable with neatly designed matching base; Pickering P/ATE-1 Elliptical Stereo Cartridge with high compliance diamond stylus; and 2 Lafayette Criterion 29A efficient 25-Watt 2-Way air-suspension speaker systems with 8" woofer, and 2½" tweeter in decorative hand-rubbed oiled-walnut finished enclosure. With cable.

21 T 93696WXM Shpg. wt., 47¼ lbs.

Net 139.95

21 T 93704WXM Above except with Shure M44E elliptical stereo cartridge.

Net 139.95

21 T 93712WXM Above except with Empire 90EE/X elliptical cartridge.

Net 139.95

Same as 21 T 93696WXM except with 2 famous Lafayette Criterion 50A 30-watt 2-way speaker systems with 8" woofer and 3½" tweeter in ducted port oiled-walnut finish enclosure.

21 T 93720WXM Shpg. wt., 67¼ lbs.

Net 157.95

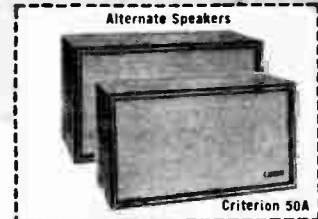

Alternate Speakers

Criterion 50A

**BONUS SPECIAL!**

**SAVE \$15.00**

Offer Good Only to December 31, 1970

When You Purchase Eico Audio Color Lights with Any of Above Systems. See Page 54 for Full Details.

# LAFAYETTE "Criterion"® Hi-Fi Speaker Systems

## CRITERION "2X" 2-SPEAKER 2-WAY ACOUSTIC SUSPENSION SYSTEM



- Truly Compact, Measures only 11"W x 7"D x 8 1/4"H
- Power Handling 20 Watts

**14<sup>95</sup>**

- 5" Acoustic Suspension Woofer with 7/8" voice coil and 1 lb. magnet structure
- 3 1/2" Cone-Type Tweeter
- 60-19,000 Hz overall response

A low-cost, ultra-compact 2-way speaker system that offers astonishing music reproduction for its size. Perfect for use as main speakers with low-powered stereo amplifiers or receivers... as remote or extension speakers in any existing stereo hi-fi system—even as replacement speakers to upgrade sound quality in modular compact phono systems. Fine sound quality results from the use of techniques employed in high-priced hi-fi speaker systems. 5" woofer in a sealed cabinet uses the well-known acoustic suspension principle to produce substantial bass from a system this size. A 3 1/2" tweeter provides smooth, crystal-clear sound up to 19,000 Hz—enclosure is fiberglass-loaded to reduce unpleasant resonances. Finished on four sides in rich oiled walnut-veneer. Crossover frequency 4000 Hz. Impedance 8 ohms. Imported. Shpg. wt., 9 lbs. Net 14.95  
99 T 02388W

## CRITERION "25A" 2-SPEAKER 2-WAY AIR SUSPENSION 8" SYSTEM

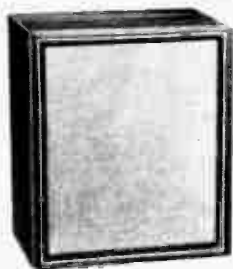

**19<sup>95</sup>**  
5 Yr.-AAA  
Guarantee  
See Page 55

- 25 Watts Power Handling Capacity
- 8" Woofer, 2 1/2" Tweeter
- Frequency Response: 55-18,500 Hz.
- Rich, Hand Rubbed Oiled Walnut Finish

**FULL SIZE PERFORMANCE**... achieves a purity of sound and music quality that is astounding for a speaker system measuring only 12 1/2"x10 1/4"x7"D. Perfect for use anywhere in your home or office. System consists of a powerful 8" woofer which provides smooth bass sound reproduction down to 55 Hz, and a 2 1/2" cone tweeter that gives you sparkling clean high frequency response. Built-in 8,000 Hz. electrical crossover network. Power handling capacity of 25 watts makes it compatible for use with most amplifiers and receivers. Interior of cabinet is designed to damp out standing waves and other spurious vibrations. Voice Coil Impedance: 8 ohms. Woofer: 8" high compliance with 32.6 oz. magnet structure; rolled edge suspension. Tweeter: 2 1/2" cone type with 2.4 oz. magnet structure. Imported. Shpg. wt., 9 lbs. Net 19.95  
99 T 02295W

## CRITERION "50A" 2-SPEAKER 2-WAY BOOKSHELF SYSTEM

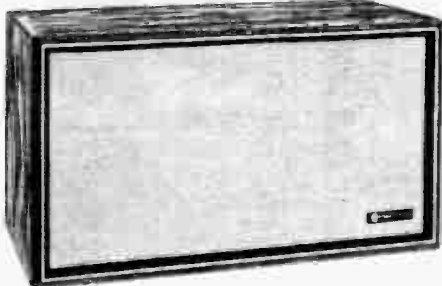

**29<sup>95</sup>**  
5 Yr. AAA  
Guarantee  
See Page 55

- 30-Watts Power Handling Capability
- Powerful 8" Woofer with 1" Aluminum Voice Coil
- 3 1/2" Cone-Type Radiator Tweeter
- Frequency Response: 55-19,000 Hz

Improved version of our best selling Criterion 50. Provides impressive hi-fi-sound, yet measures only 19"W x 8 3/4"D x 10 1/4"H. Contains two separate speakers—you get an 8-inch woofer with a 32.6 oz. magnet structure and 1" aluminum voice coil acoustically matched with a 3 1/2" cone-type Radiator Tweeter. Provides superb wide-range response from 55-19,000 Hz. An acoustically "tuned" enclosure, fully lined, assures smooth resonant-free sound output with extended bass response. The enclosure is finished on all four sides in a rich, hand-rubbed oiled walnut veneer and tastefully framed in an ebony and gold picture frame moulding with white and gold acoustic grill material. Truly, an outstanding buy at this low price. Designed for vertical or horizontal placement. Built-in electrical crossover at 7,000 Hz. Nominal Impedance: 8 ohms. Imported. 99 T 02131WX Shpg. wt., 22 lbs. Net 29.95

## CRITERION "77" 3-SPEAKER 3-WAY ACOUSTIC SUSPENSION BOOKSHELF SYSTEM



**39<sup>95</sup>**  
5-Year AAA  
Guarantee  
See Page 55

- 30-Watts Power Handling Capability
- 8 1/2" Woofer with 1 3/4 Lb. Magnet Structure and 1" Voice Coil
- 3 1/2" Mid-Range Speaker with 1/2" Voice Coil
- 1 1/2" Direct-Radiator Type Tweeter

Expert combining of components for outstanding performance at an unbelievable low price! Heavy-duty 8 1/2" woofer in a sealed fiberglass-filled enclosure uses the well-known acoustic suspension principle to extend response down to a low 40 Hz, assuring deep, natural bass with outstanding clarity and impact. Reliable 3 1/2" cone-type mid-range speaker reproduces clean, full bodied sound throughout the important middle frequency range. Sharply detailed high frequency reproduction is accomplished with a 1 1/2" direct radiator type tweeter. Electrical crossover network at 3,000 and 10,000 Hz. High frequency level control (on rear) permits you to tailor the sound to your specific room acoustics. Handsome walnut finish on four sides. Overall response: 40 Hz to 19,000 Hz. Impedance: 8 ohms. Imported. Size: 19 1/2"W x 10 1/4"H x 8 1/4"D. Wt., 21 lbs. 99 T 02321WX No Money Down Net 39.95

# LAFAYETTE "Criterion"® Hi-Fi Speaker Systems

## LAFAYETTE CRITERION® 100B 3-SPEAKER 3-WAY BOOKSHELF SYSTEM

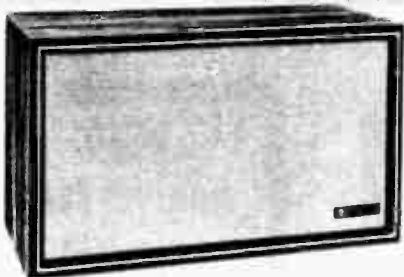

**49<sup>95</sup>**

5 YEAR AAA Guarantee. See Page 55

- Power Handling Capacity 40 Watts
- Powerful 10" Woofer with 5½ lb. Magnet Structure and 2" Diameter Voice Coil
- 3½" Mid-Range Speaker
- 1½" Direct Radiator Super Tweeter

Top quality, moderately priced 3-speaker 3-way system that delivers really "big" sound. A powerful 10 inch woofer with a 5½ lb. magnet structure and 2" pure copper wire voice coil provides smooth bass response down to 30 Hz. A 3½" mid-range and a direct radiator type super tweeter provides reproduction of the mid-range and high frequencies. All 3 speakers are acoustically matched and employ a 12 db/octave L/C crossover network at 3,500 Hz and 10,000 Hz. System also features a high frequency brilliance control. Enclosure is a bass-reflex type using a "sonic tube" to provide proper acoustic tuning and has a beautiful walnut finish on 4 sides. Dimensions are 21½"W x 11¾"H x 9¾"D. Overall frequency response: 30-19,000 Hz; nominal impedance: 8-ohms; power handling capacity: 40 watts program material. Imported. Wt., 31 lbs.

99 T 02115WX No Money Down\* Net 49.95

## CRITERION "VI" 50 WATT 6-SPEAKER 4-WAY SYSTEM

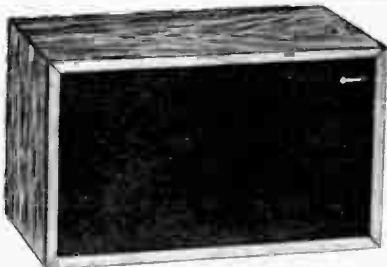

**89<sup>95</sup>**

5 YEAR AAA Guarantee. See Page 55

- Enclosure Uses "Sonic Tube" for Deep, Reinforced Bass
- 12" Woofer with 4½ lb. Magnet Structure and Large 2" Voice Coil
- 5" Midrange Speaker Housed in a Sealed Fiberglass Filled Sub-Enclosure
- Frequency Response: 20-20,000 Hz

Here's a bookshelf system with the big, multi-dimensional sound that only multiple speakers can produce... and at an unbeatable price too! Every musical instrument is reproduced with brilliant realism because there are 6 speakers covering four portions of the entire audio spectrum. There's a big 12" speaker for the lows, a 5" unit for the midrange, two 3" tweeters for the highs and two 1½" super-tweeters for the ultra high frequencies. Enclosure is of 3/4" construction and is fiberglass-filled. Tastefully styled with a fine furniture finish of oiled walnut on four sides. Overall Response: 20-20,000 Hz. Impedance: 8 ohms. Crossover Frequencies: 800 and 5,000 Hz (6 db/octave LC network), 12,000 Hz (mechanical). Controls: Continuously Variable Midrange and High frequency. Dimensions: 24 x 14½ x 12"D. Imported. Shpg. wt., 45 lbs.

99 T 02263WX No Money Down\* Net 89.95

## CRITERION "4X" 12" 4-WAY 4-SPEAKER 50-WATT SPEAKER SYSTEM

**69<sup>95</sup>**

5-Year AAA Guarantee See Page 55

- 12" Woofer with 4½ lb. Magnet Structure and Large 2" Voice Coil
- 5" Midrange Driver
- 3" Hi-Frequency Tweeter
- 1½" Super-High Frequency Tweeter



Specially engineered 4-speaker system with a full 4-way electrical crossover, housed in a deluxe oiled walnut enclosure. 4 separate speakers, each a brilliant performer over its assigned range, work in harmony to provide superb overall sound. A big 12" woofer operating in a rigid fiberglass-filled enclosure with a tube-ported duct (sonic tube), provides deep, enhanced bass. A 5" mid-range speaker housed in its own fiberglass-filled chamber and acoustically isolated from the main bass enclosure, assures smooth, peak-free reproduction in the important mid-range. Two high frequency units cover the upper musical ranges—a 3" speaker from 5,000 to 10,000 Hz, and a 1½" super tweeter from 10,000 to 20,000 Hz. Specifications—Overall Response: 25 to 20,000 Hz. Crossover Network: 4-way LC (coil-capacitor) at 800, 5,000 and 10,000 Hz. Impedance: 8-ohms. Also has high frequency and mid-range controls. Dimensions: 22 x 14¼ x 11¾"D. Imported. Shpg. wt., 40 lbs.

99 T 02370WUX No Money Down\* Net 69.95

## DELUXE CRITERION® "5XB" 75-WATT 12" 4-WAY ACOUSTIC SUSPENSION SYSTEM

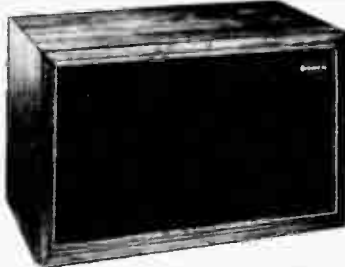

**129<sup>95</sup>**

5 YEAR AAA Guarantee. See Page 55

- 12" Woofer Features a 6 lb. 2 oz. Magnet Structure
- 6½" Acoustically Isolated Mid-Range Speaker
- 3" Aluminum Cone Type Tweeter
- 1½" Aluminum Cone Super Tweeter

Employing the acoustic suspension principle, the Criterion 5XB provides astonishing overall range and clarity, with a deep, solid bass response that makes a stunning impact on the listener. Four outstanding speakers are used to cover the full spectrum of sound. A 12" acoustic suspension woofer with 6 lb. 2 oz. magnet structure produces remarkably low bass response—undistorted even at high power levels. An acoustically isolated 6½" midrange speaker with 12.4 oz. magnet structure provides flawless reproduction of the mid-range—free of annoying peaks, yet adding true "presence" to the system. Extending response to beyond audibility are 3" and 1½" tweeters. Separate, continuously variable mid and treble range controls. Enclosure has a fine furniture finish in oiled walnut on all four sides. Specifications—Overall Response: 18 to 25,000 Hz. Impedance: 8-ohms. Size: 23¾ x 14¾ x 11¾"D. Shpg. wt., 46 lbs.

99 T 02230WUX No Money Down\* Net 129.95



# Lafayette *Smashes* Hi-Fi Speaker Prices

## Lafayette Criterion "3x" 12" 3-Way Acoustic Suspension Systems

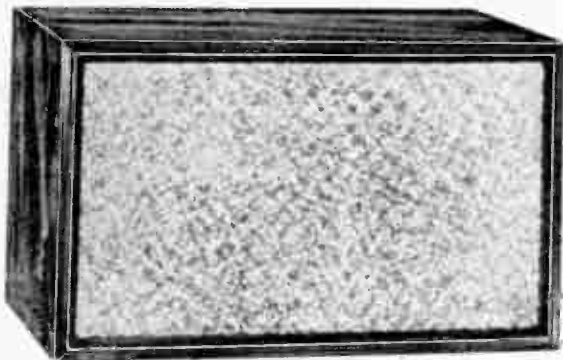

- ★ Power Handling Capacity: 60 Watts
- ★ 12" Woofer with 6 lb. 2 oz. Magnet Structure and Heavy Ribbon Shaped Copper Wire Edge-Wound Voice Coil on an Aluminum Form
- ★ Overall Response: 20-25,000 Hz.
- ★ Separate Midrange and High Frequency Controls

now  
**69<sup>95</sup>**  
was ~~89.95~~

**50th  
Anniversary  
Special  
20<sup>00</sup>  
Price  
Cut**

5 Yr AAA Guarantee—See Page 55

This brilliant performing 3-way speaker system gives you the deep, powerful bass that is so necessary to proper musical enjoyment. Heart of the system is a special 12" high compliance woofer with a 6 lb. 2 oz. magnet structure. Midrange frequencies are flawlessly reproduced by a 6½" cone driver with a 12 oz. magnet structure. A 3" metallic, dome-type tweeter with a 10.6 oz. magnet structure extends high frequency response to beyond audibility to provide

brilliant, peak-free reproduction of the highs. Electrical LC network ensures smooth crossovers at 1200 and 6000 Hz. between speaker units. Fully air-tight enclosure is solid 3/4" construction and finished on all four sides in rich, hand-rubbed oiled walnut veneer. Impedance: 8 ohms. Size: 23x13½x11¾"D. Imported. Shpg. wt., 32 lbs. **99 T 01760WX No Money Down\*** Net 69.95

## Quality Utah HF 12PC-H 12" 3-Way Co-Axial Speaker



**SAVE 38<sup>95</sup>**

**Buy 1 Speaker at Regular Price  
Buy 2nd Speaker For Only \$1**

One Speaker	Two Speakers
<b>39<sup>95</sup></b>	<b>40<sup>95</sup></b>

Special Offer Expires on December 31, 1970

### Model HF 12PC-H Features:

- ★ Power Handling Capacity—45 Watts
- ★ Frequency Response—23-20,000 Hz
- ★ Co-Axially Mounted Compression Tweeter
- ★ Magnet Structure 4 lbs. —Voice Coil 1½"

Quality 12" 3-way Co-Axial High Fidelity Speaker. Rigid, die-cast frame. Features: Cloth rolls to enhance bass performance, and newly designed co-axially mounted compression tweeter. Spring loaded finger-tip terminals are color coded for easy phasing in stereo systems. Magnet structure: 4 lbs. Voice coil: 1½". Peak power handling capacity: 45 watts. Resonance: 25 Hz. Response: 23-20,000 Hz. Imp.: 8 ohms. Overall depth, 5¾". Shpg. wt., 13 lbs. **21 T 47304W No Money Down\*** Net 39.95  
2 for 40.95

# LAFAYETTE Stereo Headphones For Magnificent Private Listening

## Low Cost SP22 Stereo Phones

Only  
**5<sup>95</sup>**

with 6 ft. cord

- Frequency Response: 35-12,000 Hz
- Lightweight, Only 10 oz.
- Adjustable Headband



Quality, private listening stereo headphones at a price everyone can afford. Perfect for stereo or mono. Designed for use with low priced stereo receivers, amplifiers, and phonographs. Adjustable headband and comfortable foam-filled vinyl ear pads. Large, 2 1/4" diameter transducers for full-range response. Impedance: 8-ohms. With 6-foot of cord and standard stereo phone plug. Imported. Shpg. wt., 1 lb.  
99 T 02123 Net 5.95

## Model 8X Stereo Headphones

with 5 ft. cord

**7<sup>95</sup>**

- Soft Rubber Cushion Earcups
- Frequency Response: 35-15,000 Hz

Wonderfully comfortable—soft rubber cushion earcups keeps out most external noise. Lightweight vinyl covered headband adjusts to fit easily. The big 2" transducers in each earcup bring to your ears smooth, full fidelity sound and complete stereo separation. Frequency response: 35 to 15,000 Hz. Output: 100 mw. Matches 8 or 16-ohm impedance. Supplied complete with 5-ft. coiled cord and standard 1/4" phone plug. Imported. Shpg. wt., 1 1/2 lbs.  
99 T 01802 Net 7.95



## Model SP55 Stereo Headphones

**11<sup>95</sup>**  
with 5 ft. cord

**Our Best Seller!**

- Two 2 1/2" Wide Range Transducers
- Frequency Response: 30-15,000 Hz



Provides outstanding full-fidelity private stereo listening. Extremely comfortable air-cushioned headband. Soft foam rubber air pads keep out external noise and provide maximum bass response. Two specially designed full range 2 1/2" transducers are precisely matched to each ear cup. Complete with attached stereo phone plug, overload cylindrical junction box for connection of the headphones to equipment which does not have stereo phone jacks, and 5' cord. Impedance: 8 ohms. Imported. Shpg. wt., 1 1/2 lbs.  
99 T 01935 Net 11.95

## Model F-880 Stereo Headphones

**17<sup>95</sup>**

with 5" cord

- Soft Rubber Cushion Ear Pads
- Actually Two 2 1/2" HI-FI Speakers
- Frequency Response: 25 to 15,000 Hz



Comfort-oriented design makes music listening a real pleasure. The F-880 stereo headphones are actually two 2 1/2" high fidelity dynamic speakers with a frequency response range of 25 to 15,000 Hz and are rated at 1/2 watt maximum input; impedance, 8 ohms per phone. The soft rubber air-cushioned ear pads provide extremely comfortable listening, help to keep out noise and maintain an excellent bass response. With 5 ft. cord and standard 1/4" phone plug. Imported. Shpg. wt., 2 lbs.  
99 T 02040 Net 17.95

## Model F-990 Stereo Headphones

**29<sup>95</sup>**

**Our Best Headphone!**

- Two Large 3 1/2" Wide Range Transducers
- Frequency Response: 20-20,000 Hz



Now the listener in his home can own a pair of professional stereo headphones similar to the one used in laboratories, recording studios and broadcast stations. Superbly engineered to provide brilliant, full-dimensional stereo sound. Two large 3 1/2" transducers provide complete full-range coverage from 20-20,000 Hz. A comfortably soft, but air-tight seal to the ear is provided by foam filled earphone cushions. Fully adjustable, cushioned vinyl headband. Comes with 6 1/2 ft. cord and standard stereo phone plug. Impedance: 8 ohms. Imported. Shpg. wt., 2 1/2 lbs.  
99 T 02099 Net 29.95

## Accessories For LAFAYETTE Headphones

Remote Control Box

25 Ft. Extension Cord

Remote Control Box. Designed to connect 1 or 2 stereo headphones to an existing system without the need of continually disconnecting speakers. Separate volume controls are provided for each side of the headsets. Speaker muting switch permits using stereo headphones and speakers together, or stereo phones only. Impedance: 4-16 ohms. Size: 4 1/4" W x 1 1/4" H x 1 1/4" D. Imported. Shpg. wt., 1 1/4 lbs.  
99 T 00366 Net 4.95

25 Ft. Extension Cord. Listen to stereo anywhere in the room. Flexible 3-conductor coiled cable. With a 1/4" 3-circuit plug on one end, a 3-circuit jack on the other end. Imported. Shpg. wt., 1 lb.  
99 T 01108 Net 2.95

## LAFAYETTE Criterion® "Omni-1" 5-Speaker Thin-Line System

**39<sup>95</sup>**

5 Year AAA Guarantee  
See Page 55

- Power Handling Capacity 30 Watts
- 8" High-Compliance Woofer
- Four 3 1/2" Tweeters

Deluxe omni-directional 5-speaker system in a convenient thin-line configuration. A new concept features a horizontal line source of four 3 1/2" diameter tweeters mounted with a textured acoustic deflector to give 360° radiation and a listening illusion that is free, open and expansive. As sound is radiated from both, front and back, the Omni-1 is perfect for use as part of a room divider—or it may be situated close to a wall. The ultra-slim enclosure is only 5 1/2" deep, and is finished in a rich, hand rubbed oiled walnut veneer. A luxurious brown/black decorator grille cloth covers the front, back and top surfaces. The extended bass is produced by a high compliance 8" diameter woofer with a four layer voice coil and ultra low free air resonance. Dimensions: 22" high x 17 1/4" wide x 5 1/2" deep. Frequency Response: 40 Hz to 18,000 Hz. Power Handling Capacity: 30 watts program material. Nominal Impedance: 8 ohms. Wt., 30 lbs.

21 T 0162WX No Money Down\* Net 39.95

Featuring Deflector for 360° Radiation



Made in U.S.A.

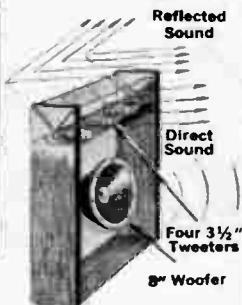

Reflected Sound

Direct Sound

Four 3 1/2" Tweeters

8" Woofer

# DELUXE

## LAFAYETTE AC-50 4-SPEED Automatic Pushbutton Stereo Record Changer



Diamond Needle



Chrome Plated Plug-in Head

# 24<sup>95</sup>

With Stereo Turnover Ceramic Cartridge and Diamond LP Needle

- 4-Speeds: 16, 33 $\frac{1}{3}$ , 45, 78 RPM
- Pushbutton Operation for Automatic Play, Manual Play, Stop
- Automatic Shut-Off After Last Record

A superb 4-speed automatic record changer — handsomely styled and engineered to provide the highest standard of performance and dependability. Ideal for playing both stereo and monaural 12", 10" and 7" records. Can play up to 7 records automatically. Features oversized turntable with ribbed record mat; one piece low mass square cast aluminum tone arm; 4-position speed selector slide switch; two spindles, one for manual play and a center drop for automatic play. All controls are always perfectly accessible, even with 12" records on the turntable. Main-plate has beautiful leather-like finish with black rubber turntable platter, and chrome trim. For 117 VAC., 60 Hz. Size: 13 $\frac{1}{4}$ "x11"D. Requires 3 $\frac{3}{4}$ " above and 3" below motor board. Imported.

21 T 01640W Shpg. wt., 8 lbs.	Net 24.95
21 T 01657W Walnut Wood Base for AC-50	Net 4.95
24 T 09043W Dust Cover for AC-50	Net 4.50
21 T 01673 45 RPM Spindle for AC-50	Net 1.95
21 T 01665 Replacement Cartridge for AC-50	Net 4.95

★ Intermixes Records of the same speed

### LAFAYETTE "Mini 4-Speed Automatic Stereo Record Changer Ensemble

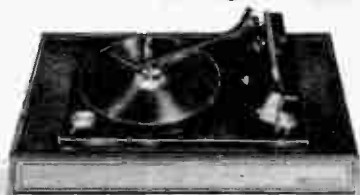

# 34<sup>95</sup>

Pre-Mounted on a Simulated Black Leather Base with Walnut Vinyl Trim, Heavy Gauge Tinted Plastic Dust Cover, and Diamond Needle Cartridge.

Completely ready to plug into your audio equipment. 4 Speeds: 16, 33 $\frac{1}{3}$ , 45, and 78 RPM. Features low-mass tubular aluminum tone arm, high quality ceramic turnover stereo cartridge with diamond LP needle, detachable spindle, vibration-free dynamically balanced 2-pole motor. Handles stack of 6-records automatically. Intermixes 10" or 12" records of the same speed. UL listed. Size (Includes Base): 14 $\frac{3}{8}$ " x 5" x 10". Shpg. wt., 7 lbs. For 110-130 volts AC, 60 Hz. Made in England.

21 T 01632W No Money Down\* Net 34.95

### GARRARD 30 4-Speed Automatic Stereo Turntable

# 39<sup>50</sup>

With Diamond Needle Ceramic Cartridge, Less Base



Garrard 4-speed automatic stereo turntable designed especially for use in low priced hi-fi systems. Features oversized, weighted turntable, one piece cast aluminum tone arm, ultra compact size. Plays 16 $\frac{2}{3}$ , 33 $\frac{1}{3}$ , 45 and 78 RPM records. Intermix automatic operation when desired. Two spindles— short for manual, center drop for automatic play. With ceramic cartridge, diamond stylus. All connecting cables. Dim.: 14 $\frac{1}{4}$ " x 12 $\frac{3}{4}$ ", above motor board 4 $\frac{3}{4}$ ", below 2 $\frac{1}{4}$ ". For 110-130 VAC, 60 Hz. Less base. Imported. Wt., 10 lbs.

21 T 37925W No Money Down\* Net 39.50

Accessories For Garrard 30

24 T 03335 Replacement Diamond Needle 2 oz.	Net 2.49
21 T 40226W Walnut Plastic Base 2 lbs.	Net 5.50
21 T 40267W Plastic Dust Cover 2 lbs.	Net 5.50

### GARRARD Model 40B 3-Speed Automatic Stereo Turntable

Only 1¢ More

# 44<sup>50</sup>

Less Cartridge and Base

# 44<sup>51</sup>

Less Bass With Elliptical Cartridge

# 49<sup>50</sup>

Less Base With Quality Elliptical Cartridge

Only \$5 More



Pickering P/ATE-1

Pickering V15/ACE-3

Plays 33 $\frac{1}{3}$ , 45 and 78 RPM records. Full viscous damped, single lever cueing. Low mass tubular aluminum tone arm with fixed, isolated counterweight. Easy to adjust stylus pressure control with visible scale. Two interchangeable spindles. Oversize turntable with handsome safety mat. Size: 14 $\frac{3}{8}$ "W x 12 $\frac{1}{2}$ "L. Requires 4 $\frac{5}{8}$ " above and 3" below motor board. With all connecting cables. Less base. For 110-130 VAC, 60 Hz. Imported Shpg. wt., 10 lbs.

21 T 40499W Model 40B only. No Money Down*	Net 44.50
Model 40B and Pickering P/ATE-1 Ellip. Cartridge.	
21 T 40556W No Money Down*	Net 44.51
Model 40B and Pickering V15/ACE-3 Ellip. Cartridge.	
21 T 40580W No Money Down*	Net 49.50

# Garrard Synchro-Lab Automatic Turntables



## MODEL SL55B 3-SPEED STEREO AUTOMATIC TURNTABLE

Plays 33 $\frac{1}{3}$ , 45, and 78 RPM Records. Lightweight, tubular aluminum tonearm with fixed-position damped counterweight and slide-in cartridge clip. Built-in stylus force adjustment and optical scale. Viscous damped, single-lever cueing. Fully adjustable anti-skating. Oversized turntable with all connecting cables. For 110-130V 60 Hz. AC. Size: 14 $\frac{1}{2}$ "x12 $\frac{1}{2}$ "L; above motor board 4 $\frac{3}{4}$ ", below 2 $\frac{1}{2}$ ". Imported. Wt., 12 lbs. less base.

21 T 40481WM No Money Down\* Net 59.50

## 3-SPEED STEREO AUTOMATIC TURNTABLE

Plays 3 Speeds: 33 $\frac{1}{3}$ , 45, and 78 RPM. Features: Synchro-Lab Motor, and low-mass tubular aluminum tonearm dynamically balanced with adjustable counterweight, adjustable anti-skating control, viscous damped single lever cueing. Precision stylus pressure gauge with optical scale. Automatic and manual spindles. Connecting cables. For 110-130V, 60 Hz. AC. Size: 15"x13 $\frac{1}{2}$ "L; above motor board 4 $\frac{3}{4}$ ", below 3". Imported. Wt., 12 lbs. less base.

21 T 40473WM No Money Down\* Net 79.50

## MODEL SL72B STEREO AUTOMATIC TRANSCRIPTION TURNTABLE

Plays 33 $\frac{1}{3}$ , 45 and 78 RPM Records. Viscous damped setdown of tone arm in automatic play. Adjustable anti-skating controls. Calibrated stylus pressure gauge with visible scale. Fingertip tab-controls. All connecting cables. Size: 15"x14 $\frac{1}{4}$ "L; above motor board 4 $\frac{3}{4}$ ", below 2 $\frac{1}{2}$ ". Imported. Shpg. wt., 13 lbs. less base.

21 T 40465WM No Money Down\* Net 89.50

## MODEL SL95B STEREO PROFESSIONAL AUTOMATIC TURNTABLE

Garrard's finest 3-speed automatic stereo turntable. Plays 33 $\frac{1}{3}$ , 45, and 78 RPM records. Advanced, ultra-low mass, one-piece tonearm of lightweight aluminum with Afrormosia wood insert is gyroscopically gimbal mounted. Features viscous damped setdown in automatic play. With all connecting cables. For 110-130 VAC, 60 Hz. Dim: 15 $\frac{1}{2}$ "x14 $\frac{1}{4}$ "x4 $\frac{3}{4}$ " above motor board and 3" below. Imported. Shpg. wt., 13 lbs. (less base).

21 T 40444WM No Money Down\* Net 129.50

Your Choice of  
Elliptical Stereo Cartridge  
For As Low As 1c or 5<sup>00</sup> more  
with the Purchase of a Garrard Automatic Turntable

Listed on This Page

**SAVE** up to **44<sup>95</sup>**

From Individual Catalog Prices



Pickering  
Phase IV/AME  
49.95



Pickering  
V15/ATE-3  
39.95



Pickering  
V15/ACE-3  
29.95



Shure M91E  
49.95



Shure M93  
39.95



Shure M55E  
29.95

## TURNTABLE AND ELLIPTICAL CARTRIDGE COMBINATIONS

21 T 40606WM	SL55B and Pick. V15/ACE-3	Net 59.51
21 T 40614WM	SL55B and Shure M55E	Net 59.51
21 T 40622WM	SL55B and Pick. V15/ATE-3	Net 64.50
21 T 40945WM	SL55B and Shure M93E	Net 64.50
21 T 40648WM	SL65B plus Pick. V15/ACE-3	Net 79.51
21 T 40655WM	SL65B plus Shure M55E	Net 79.51
21 T 40663WM	SL65B plus Pick. V15/ATE-3	Net 84.50
21 T 40952WM	SL65B and Shure M93E	Net 84.50
21 T 40689WM	SL72B plus Pick. V15/ATE-3	Net 89.51
21 T 40960WM	SL72B and Shure M93E	Net 89.51
21 T 40978WM	SL72B and Pick. Phase/IV AME	Net 94.50
21 T 40986WM	SL72B and Shure M91E	Net 94.50
21 T 40762WM	SL95B plus Pick. V15/ATE-3	Net 129.51
21 T 40911WM	SL95B and Shure M93E	Net 129.51
21 T 40937WM	SL95B and Pick. Phase/IV AME	Net 134.50
21 T 40929WM	SL95B and Shure M91E	Net 134.50

## Accessories for Garrard Turntables

Stock No.	Description	For	Shpg. wt.	Net ea.
21 T 40226W	Base	SL65B, 55B, 40B, 30	2 lbs.	5.50
21 T 40234W	Base	SL95B, 75B, 72B	2 lbs.	6.50
21 T 40267W	Dust Cover	SL65B, 55B, 40B, 30	3 lbs.	5.50
21 T 40275W	Dust Cover	SL95B, 75B, 72B	3 lbs.	6.50
21 T 40531	45 Spindle	SL65B, 55B, 40B, 30	6 oz.	1.95
21 T 37974	45 Spindle	SL95B, 75B, 72B	6 oz.	3.80

## LOW, LOW PRICES on Quality Famous Name Stereo Magnetic Cartridges

### Pickering V-15/AC-2 Diamond Needle Stereo Cartridge

Only **7<sup>95</sup>**

Micro-magnetic cartridge with exclusive Pickering "Floating Stylus". Response: 20-20,000 Hz. Shpg. wt., 3 oz.

21 T 53617L Net 7.95



### Pickering V-15/ATE-2 Elliptical Diamond Needle Stereo Cartridge

Only **11<sup>95</sup>**

Deluxe cartridge with bi-radial .009 x .004 elliptical stylus. Response: 20-20,000 Hz. Shpg. wt., 3 oz.

21 T 53625L Net 11.95



### Shure M7/N21-D Diamond Needle Stereo Cartridge

Only **9<sup>95</sup>**

Frequency response: 20 to 20,000 Hz. Tracks perfectly in all record changer arms. With .7 mil conical diamond stylus. Shpg. wt., 5 oz.

21 T 62063L Net 9.95



### Grado FTE Elliptical Diamond Needle Stereo Cartridge

Only **19<sup>95</sup>**

Frequency response 10 to 35,000 Hz, channel separation: 25 db. Output: 4 mv @ 3.54 CMV. Recommend tracking force 1/2 to 3/2 grams. Shpg. wt., 4 oz.

21 T 41364L Net 19.95



\*See Page 18 for Full Credit Details on Easy Pay Plan

Lafayette Cat. No. 711 69

# SOLID & HOLLOW BODY ELECTRIC BASSES

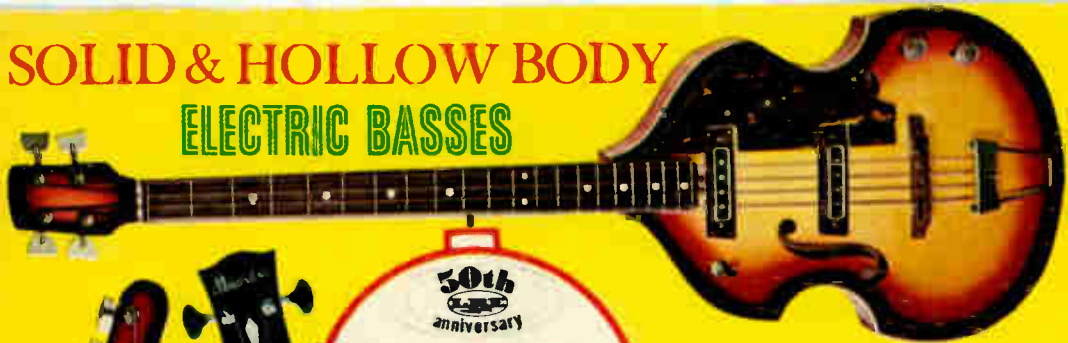

50th  
anniversary

## SALE!

54<sup>00</sup>

Save 10%

Sale Ends  
Dec. 31, 1970

**B**  
2 PICK-UP  
SOLID BODY  
ELECTRIC BASS

49<sup>95</sup>

**C**  
DELUXE 2 PICK-UP  
HOLLOW BODY  
ELECTRIC BASS

89<sup>95</sup>

**(A) VIOLIN SHAPED  
2-PICK-UP ELECTRIC BASS**

Classic violin shape produce brilliant electric bass tones, with the rich accent of an acoustic guitar. Three position switch accentuates the highs, lows and mid-range. Delicately arched hollow body bound in decorative celluloid trim, features a 4-piece laminated, fully adjustable, steel reinforced neck; bound rosewood fingerboard with heavy nickel silver frets and inlaid position markers; chrome plated trapeze tailpiece; adjustable bridge; fully enclosed tuning machines; sparkling sunburst finish with a celluloid pick guard, and mahogany finger rest, cord. 44 $\frac{1}{2}$ x13x2 $\frac{1}{4}$ ". Imported. 13 T 24532W Shpg. wt., 12 lbs. Net 94.00  
Sturdy case for above. Shpg. wt., 7 $\frac{1}{2}$  lbs. Net 9.95  
13 T 24540W

**(B) 2 PICK-UP SOLID  
BODY ELECTRIC BASS**

Long neck, slimline electric bass guitar of selected woods for excellent speed and response and easy fingering. Hand rubbed, shaded sunburst body finished in durable acrylic lacquer, 46" steel reinforced adjustable neck has celluloid bound oval rosewood fingerboard, 20 frets, 8 pearl inlaid position markers, and large machines for fast accurate tuning. Sensitive pick-ups have adjustable pole pieces for precise balancing of individual strings. Two, feather-touch rocker standby switches for instant control of each pick-up. Includes separate volume and tone controls and compensation adjustable bridge. With cord. Imported. Size: 46L x 13 $\frac{1}{2}$ W x 1"D.  
13 T 24615W Shpg. wt., 12 lbs. Net 49.95  
Sturdy Case for above. Shpg. wt., 7 $\frac{1}{2}$  lbs. Net 9.95  
13 T 24623W

**(C) DELUXE 2 PICK-UP  
HOLLOW BODY ELECTRIC BASS**

Produces deep bass tones with brilliant cadence! Features adjustable muting control; 2 perfectly balanced adjustable pick-ups; individual tone and volume controls for each pick-up; 3 position toggle switch for solo/rhythm; fully adjustable compensating bridge; individual chrome covered precision machines; and custom designed tailpiece. Hard maple, steel reinforced adjustable neck with a 20 feet, oval rosewood fingerboard. 9 mother-of-pearl inlaid position blocks, side position markers and triple bound edges. The beautiful, flame grained thin-line, double cutaway hardwood body is celluloid bound and protected by a pick guard. With cord. Imported. Size: 46H x 16W x 2"D. Shpg. wt., 13 lbs. Net 89.95  
13 T 66047W  
Sturdy case with plush lining for above. 13 T 66095W Shpg. wt., 11 lbs. Net 13.95

**Complete Electric Bass Outfits — Save Up To \$27.00**

from Individual Catalog Prices

Each Electric Bass Guitar Outfit consists of a Electric Bass, Amplifier, Case, Neck Strap, Pick-up Cord plus "Modern Electric Bass Guitar Method" book. See Page 104 and 105 for Amplifiers.

Outfit No.  
13 T 91192WXM  
13 T 91135WXM  
13 T 91242WXM

Elect. Bass  
13 T 24615W  
13 T 24532W  
13 T 66047W

Amplifier  
13 T 01540WX  
13 T 01540WX  
13 T 01654WX

Watts Shpg. Wt.  
50 68 lbs.  
60 68 lbs.  
170 100 lbs.

Net  
154.95  
159.95  
249.80



# RICH TONE

# ACOUSTIC GUITARS

CLASSIC GUITARS  
AS LOW AS

24<sup>95</sup>

FOLK GUITAR

34<sup>95</sup>

JUMBO COUNTRY  
& WESTERN

69<sup>95</sup>



A



B



C

## A GRAND CONCERT SIZE CLASSICAL GUITAR

Beautiful detailed concert classical guitar with white spruce top and mahogany sides and back. Features a steel reinforced rosewood neck with 19 fret fingerboard and the finest quality fan braced top. Front and back of the large, handsome body are individually shaped and contoured for ultimate performance. Has rosewood pinless bridge, 6 side position markers, heavy duty machine heads with rollers and an open headpiece. Highly polished, grained sides and back. With nylon strings. Sizes: 39L x 14<sup>3</sup>/<sub>4</sub>W x 3<sup>3</sup>/<sub>4</sub>"D. Imported. Shpg. wt., 10 lbs.

13 T 66152WX See Case Below Net 34.95

### CONCERT SIZE CLASSICAL GUITAR

Similar to above. Size: 38<sup>3</sup>/<sub>4</sub>L x 14<sup>1</sup>/<sub>2</sub>W x 3<sup>3</sup>/<sub>4</sub>"D. Imported. 13 T 66137WX Shpg. wt., 10 lbs. Net 24.95

Sturdy Case for Above Guitars. Shpg. wt., 4 lbs. Net 8.95

## B GRAND CONCERT SIZE FOLK GUITARS

Grand concert size folk guitar is made of beautiful, carefully selected natural white spruce top, mahogany sides, and highly polished light mahogany color back. Features adjustable thin neck reinforced double truss rod; all white celluloid-bound edges of neck, top, and back of body; mosaic inlay around soundhole; moderate celluloid guard-plate; rosewood pin bridge and solid oval rosewood fingerboard. 6 inlaid square type larger position markers for easier finger placement. Matching heads have white buttons. Size: 39<sup>3</sup>/<sub>4</sub>L x 14<sup>3</sup>/<sub>4</sub>W x 3<sup>3</sup>/<sub>4</sub>"D. Imported. 13 T 24654W Shpg. wt., 10 lbs. Net 34.95

Sturdy Lined Case for Above Guitar. Net 8.95

## C JUMBO COUNTRY AND WESTERN GUITAR

Rich deep bass and clear treble tones are built-in this jumbo size model. Made of carefully selected woods—resonant hand rubbed maple back and sides, and close grained, antique colored spruce top. Genuine "Nato" wood adjustable neck with celluloid bound rosewood fingerboard; inlaid pearl position markers; 20 nickel silver frets. Rosewood adjustable bridge, black pickguard with flowered design, individual tuning pegs. 40<sup>1</sup>/<sub>4</sub>L x 16<sup>1</sup>/<sub>2</sub>W x 4<sup>1</sup>/<sub>4</sub>"D. Steel Strings. Imported. Shpg. wt., 13 lbs. Net 69.95

13 T 52814W Net 69.95

Jumbo Country & Western 12-String Guitar similar to above. Except with Stationary Bridge and Tailpiece. 13 T 52822WX Shpg. wt., 13 lbs. Net 74.95

Sturdy Lined Case for above guitars. Shpg. wt., 4 lbs. Net 12.95

13 T 52830W Net 12.95

**SALE**  
**19<sup>95</sup>**  
**Complete Outfit**  
**CUT 20%**

SALE ENDS  
DEC. 31, 1970

**7 PIECE "BEGINNERS OUTFIT"**

• Everything You Need Including  
Beginners Record Course and Book

Nicely finished with open headpiece and pinless bridge. Can be used either as nylon string classic or steel string Folk guitar. Steel reinforced neck. Guitar has hardwood body with blonde top. Highly polished finish with design around sound hole. Comes complete with Nylon and extra set of steel strings. Vinyl zippered carrying bag, neck cord, pick, instruction book and record course. Size: 36<sup>1</sup>/<sub>4</sub> x 13W x 13<sup>1</sup>/<sub>2</sub>"D. Imported. Shpg. wt., 9 lbs. Net 19.95

13 T 66129WX Net 19.95

\* See Page 18 for Full Credit Details on Easy Pay Plan

**SOLID****ELECTRIC GUITARS****SAVE UP TO \$15.50****WHEN YOU BUY AN OUTFIT****(B) 4-Pick-Up  
ONLY****BODY****(A) 2 PICK-UP CUTAWAY  
SOLID BODY ELECTRIC GUITAR**

- With Tremolo Tailpiece
- Steel Reinforced Adjustable Neck
- Volume and Tone Controls

Electric solid body, double-cutaway guitar. Steel reinforced neck features fast fingering over rosewood fingerboard. 23 frets with 9 white inlaid position markers. Adjustable steel bridge guides strings over dual pickups, each with individual on/off switch and volume control; master tone control provided. Compression tremolo, mounted to slimline body, has large flat bar for convenient use. Black pickguard is beautifully inlaid with gold floral patterns. Lacquered, highly polished, body is finished in radiant yellow sunburst effect. 40½" H x 13½" W x 2" O. Imported.

13 T 24656W Shpg. wt., 12 lbs. Net 34.95

Sturdy Lined Case for Above.

13 T 13261W Shpg. wt., 11½ lbs. Net 8.95

**(B) DELUXE 4 PICK-UP SOLID BODY  
ELECTRIC GUITAR**

- With Tremolo Tailpiece
- Modern, Double Cutaway Design
- Adjustable, Steel Reinforced Neck

Thin body, double cutaway design features a fast, slimline neck. An instrument with great flair that can be played with pride by all guitarists. Features a steel reinforced adjustable neck with variable string guides and an adjustable metal bridge. Includes tremolo with a large, flat bar for convenient use. Has attractive oval rosewood fingerboard and 20 new flat-type frets providing faster fingering. Separate on/off switch and volume control for each pick-up plus a master tone control. Richly designed, ebony pick guard with gold floral inlay. 9 mother-of-pearl inlaid position markers. Highly polished green sunburst finish. Imported. Shpg. wt., 12 lbs.

13 T 24599W Net 44.95

Sturdy lined case for above. Shpg. wt., 11½ lbs.

13 T 13261W Net 8.95

**(A) 2-Pick-Up  
ONLY****34<sup>95</sup>****44<sup>95</sup>****MONEY SAVING GUITAR OUTFITS**

All outfits include a guitar, guitar case, amplifier, remote foot switch, plus neck strap, pickup cord, extra set of strings, pitch pipe, 6 picks, instruction book and record.

**2 Pick-Up Solid Body Guitar Outfit**

Includes: 13-24656W Guitar, 99-92074W 10 watt Reverb/Tremolo Amplifier (see page 77), plus all of above accessories. Shpg. wt., 42 lbs.

13 T 91218WXM Net 94.95

**4 Pick-Up Solid Body Guitar Outfit**

Includes: 13-24599W Guitar, 99-92074W 10 watt Reverb/Tremolo Amplifier (see page 77), plus all of above accessories. Shpg. wt., 42 lbs.

13 T 91220WXM Net 103.95

**Deluxe 4 Pick-Up Solid Body Guitar Outfit**

Includes: 13-24599W Guitar, 40 watt Reverb/Tremolo twin speaker amplifier (see page 77), plus all of above accessories. Shpg. wt., 51 lbs.

13 T 91234WXM Net 129.73

FOR **B I G**

**DYNAMIC SOUND!**

*deluxe hollow body*

**(C)**  
ONLY  
**59<sup>95</sup>**

**(D)**  
ONLY  
**79<sup>95</sup>**

**ELECTRIC  
GUITARS**

**(E)**  
ONLY  
**89<sup>95</sup>**

No Money Down\*



**(C) "ULTRA-SLIM" 2 PICK-UP  
HOLLOW BODY ELECTRIC GUITAR**

- "Hi-Response" True Vibrato Tailpiece
- Steel Reinforced, Adjustable Neck
- Adjustable Bridge—Adjustable Pick-Ups

Handsomely styled double cut-away electric guitar with dual pickups for solo or rhythm work. Narrow celluloid bound high speed adjustable neck is steel reinforced for extra strength and features a 21 fret rosewood fingerboard with white inlaid position markers. Also has sturdy tremolo tailpiece, laminated arched top and back, volume and tone controls plus 3-position selector switch for choice of pickup. Individual precision machine heads. Hand rubbed shaded red finish. 16Wx41 $\frac{1}{4}$ Hx13 $\frac{3}{4}$ "D. Imported. Wt., 14 lbs. No Money Down\*  
13 T 66186W \_\_\_\_\_ Net 59.95  
Sturdy Case For Above Guitar. Shpg. wt., 8 lbs.  
13 T 66012W \_\_\_\_\_ Net 9.95

**(D) DELUXE 2 PICK-UP "SLIMLINE"  
HOLLOW BODY ELECTRIC GUITAR**

- "Laminated" — Steel Reinforced Adjustable Neck
- Individual Volume and Tone Controls
- Custom Designed Tremolo Tailpiece

Custom crafted, professional quality instrument! Features 21 fret, oval rosewood fingerboard with mother-of-pearl inlaid position markers and triple bound edges. Has two ultra-sensitive, hum-free pick-ups with individual pole adjustments, height adjustments, and individual volume and tone controls. 3-position lever switch selects bridge pickup for solo, and forward pickup for rhythm work; or, permits use of both pickups simultaneously. Large handsome celluloid bound body is shaped and contoured for optimum sound response. Beautifully flamed high-gloss polyester finish. 16Wx44 $\frac{1}{2}$ "D. Imported. Shpg. wt., 15 lbs.  
13 T 66020W \_\_\_\_\_ Net 79.95  
Sturdy Case With Plush Lining For Above.  
13 T 66030W Shpg. wt., 8 lbs. \_\_\_\_\_ Net 11.95

**(E) DELUXE 12-STRING 2 PICK-UP  
HOLLOW BODY ELECTRIC GUITAR**

- Fully Adjustable Compensating Bridge
- Steel Reinforced Adjustable Neck
- 4-Controls plus Switch for Exciting Musical Sounds and Effects

Ultra sleek, double cutaway, thin-line instrument for the professional guitarist. Two ultra-sensitive hum-free pick-ups with individual pole and height adjustment. Separate volume and tone controls for individual pickups; 3-position selector switch for Solo/Rhythm and Super Bass sounds. The body is of selected flame grained woods and contoured both front and back for perfect body comfort. Slim fast-action neck is steel reinforced and features a 21-fret oval rosewood fingerboard with mother-of-pearl inlaid position blocks plus side position markers and triple bound edges. Also has Universally adjustable bridge; custom designed tailpiece. Beautifully flamed high-gloss polyester finish, imported. With cord. Shpg. wt., 15 lbs.  
13 T 66046W \_\_\_\_\_ Net 89.95  
Sturdy Case With Plush Lining For Above.  
13 T 66053W Shpg. wt., 11 $\frac{1}{2}$  lbs. Net 13.95

\*See Page 18 for Full Credit Details on Easy Pay Plan





**PORTABLE  
TRANSISTORIZED  
ELECTRONIC ORGAN**  
With Built-In  
Amplifier  
and Speakers

- Easy to Carry—Packs Like a Suitcase
- Perfect for Combo or Home Use

**319<sup>95</sup>**

Portable organ has a built-in fully transistorized 10-watt amplifier and two oval speakers. Ready to play anywhere... Suitable for any entertainer, at home or school, 49-key keyboard spans 4 full octaves and produces a wide range of tonal variations. Three 16' voice tabs — bass bourdon; bourdon; and strings. Four 8' voice tabs — flute; diapason; strings; and trumpet. Trumpet tab simulates 4' effects to give an even wider variety of sounds. On-Off tab vibrato with rotary speed and intensity controls. Volume/On-Off switch with pilot light and separate volume control for bass octave. Photo-cell type expression pedal. Can also be played through an external amplifier. Comes in red and black trim. Size: 31" keyboard; height 32"; 18" deep. Operate on 117 VAC. Imported from Italy. Shpg. wt., 62 lbs.  
13 T 66343WX No Money Down\* Net 319.95



**Estey DUAL MANUAL & CHORD ORGAN**

- Lifetime Stainless Steel Reeds
- 37 Key Upper—32 Key Lower  
Keyboard 40 Chord Buttons

**ONLY 199<sup>95</sup>**

Play music in 60 seconds. Features dual manual keyboard with full size waterfall keys in a 37 note upper and 32 note lower keyboard with 40 chord buttons. Includes major, minor, seventh, diminished and bass. Magnificent console cabinet is finished in mar, burn, and stain resistant walnut tone. Hand tuned stainless steel reeds. Built-in tone chamber gives more mellow sound. Foot pedal volume control. On/Off switch with pilot light. With instructions/song book and chord chart. Operates on 117 VAC. Size: 36½Wx19Dx34¼"H.

12 T 58573WX Shpg. wt., 158 lbs. Net 199.95

Storage Compartment Bench. Burnproof, mar-resistant walnut finish. Shpg. wt., 16 lbs.

12 T 58581WX Net 24.95



**Estey  
40  
CHORD  
ORGAN**



**SALE 119<sup>95</sup>**

**SAVE  
OVER 10%**

**SALE ENDS  
DEC. 31, 1970**

- 37 Keys—Foot Volume Control
- Permanently Tuned Stainless Steel Reeds

40 chord electric organ features 37 Ivory white keys; 40 chords—8 bass, 8 major, 8 minor, 8 sevenths, and 8 diminished. Convenient on/off switch, foot pedal volume control for playing with expression. Grained walnut finish is burn, stain and scratch resistant. Matching music rack. With instruction book. Size: 33Lx17Dx31"H. For 117 VAC. Less bench. Shpg. wt., 73 lbs.

12 T 58524WX No Money Down\* Net 119.95  
Non-lift Bench. Burn proof, mar-resistant walnut finish. Wt. 9 lbs.  
12 T 58532W Net 14.95



**Estey  
18  
CHORD  
ORGAN**



**SALE 88<sup>88</sup>**

**SAVE  
OVER 10%**

**SALE ENDS  
DEC. 31, 1970**

- 37 Keys—Hand Volume Control
- Stainless Steel Reeds

18 chord electric organ with 37 full size, white numbered keys. 18 chords include 6 major, 6 minor, and 6 sevenths. Features lifetime hand tuned stainless steel reeds. Modern style console cabinet with music rack has burn proof, mar-resistant walnut finish. Complete with vinyl covered bench and 5 music books. Convenient on/off switch and volume control. With easy-to-play A-B-C and 1-2-3 instruction book. Size: 30½Hx29½Wx15"D. For 117 VAC, 60 Hz. Shpg. wt., 66 lbs.

12 T 58607WX No Money Down\* Net 88.88

# BIG SOUND Drums

OPTIONAL  
16"x16" Floor Tom Tom



ONLY  
**119<sup>95</sup>**

No Money  
Down\*



ONLY **199<sup>95</sup>** No Money  
Down\*

## 9-PC. "COMBO" DRUM OUTFIT

- 9-Ply Construction Thru-Out
- Double Lug—Separate Tension
- Chrome Plated Steel Rims

A quality 9-piece drum outfit for the beginner or advanced musician. Duffit contains an 8"x12" Tom Tom, a 14"x20" bass drum, both with double lug separate tension rods, and a 5 1/2"x14" separate tension snare drum. Bass drum features a fully adjustable "fast" action pedal, die-cast chrome plated steel rims, streamlined hardware, and chrome plated cow bell. All drums have plastic heads, feature triple flanged rims and chrome plated hardware. Other items include a 14" cymbal with fully adjustable cymbal holder that will adjust to any height or angle, disappearing spurs, sticks, and stick holder, a flat base snare drum stand, and a universal adjustable roll mount console for "ride" of Tom Tom. Bright finish. Imported. Shpg. wt., 58 1/2 lbs.

13 T 24508WX Bright Blue Net 119.95  
13 T 24569WX Bright Silver Net 119.95

16"x16" FLOOR TOM TOM FOR ABOVE  
13 T 24573WX Net 34.95  
Bright Blue. Shpg. wt., 19 lbs.  
13 T 24581WX Net 34.95  
Bright Silver. Shpg. wt., 19 lbs.

### A DRUMMERS THRONE

Drummer's throne, chrome plated. Padded seat, 11" dia. Adjustable height from 20" to 27". Folds easily. Shpg. wt., 7 lbs.  
13 T 66293W Net 12.50

### B HIGH HAT OUTFIT

Two 14" Swiss brass cymbals on an adjustable, chrome plated flat base. Features a fast action foot pedal for added speed and comfort in playing. Base adjusts from 24" to 31". Shpg. wt., 7 1/2 lbs.  
13 T 66285W Net 29.95

### C SNARE DRUM SET

An exciting 14"x5 1/2" separate tension, 6 ply snare drum with metal snares, tone modulator, speedy throw-off, flanged hoops, rolled chrome plated rims, plastic head, and nickel plated hardware. Attractive celluloid sparkle finish. Complete with deluxe flat base chrome stand, 10" cymbal, sticks, brushes, and instruction book. Imported. Shpg. wt., 13 1/2 lbs.  
13 T 87059W Net 29.95



12<sup>95</sup>

29<sup>95</sup>

29<sup>95</sup>

• Complete with  
Stand,  
10" Cymbal,  
Brushes,  
Sticks

## PROFESSIONAL 15-PC. DRUM OUTFIT

- 9-Ply Construction Thru-Out
- Double Lug—Double Tension
- Chrome Plated Triple Flange Hoops

Deluxe, professional quality drum outfit with all the most wanted accessories. Meets the demand for quality and sound in every way. Each drum has completely adjustable tension rods for quick and easy tuning. Set consists of 14"x20" Bass Drum with 8-separate beaver-tail tension lugs, spurs, cymbal holder, console to tom tom mount, internal muffler and inlaid chromed hoops. 5 1/2"x14" Snare Drum—8-tension, speedy throw-off, and internal muffler. 16"x16" Floor Tom Tom—8-tension with internal muffler. One 8"x12" and one 9"x13" Tom Tom—6-tension with muffler. Drums have coated plastic heads, celluloid covered for bright finish. Includes deluxe, flat-base snare stand, floor cymbal stand, and a super deluxe, direct-action Hi-Mat stand with fast action pedal. Set also contains a 16" Ride Cymbal, a pair of 14" Hi-Mat Cymbals, and deluxe bass drum pedal, drum sticks and brushes, cowbell, woodblock and holder. Imported. Shpg. wt., 94 lbs.  
13 T 66251WX Bright Red Net 199.95  
13 T 66269WX Bright Blue Net 199.95

5-Piece Vinyl Drum Cover Case  
13 T 66277W Shpg. wt., 10 lbs. Net 34.95

\*See Page 18 for Full Credit Details on Easy Pay Plan



# LAFAYETTE Deluxe Musical

## 140 Watt Solid State "Piggy Back" Amplifier with Reverb-Tremolo, 3-Speakers, 2-Channels

- For Guitar, Organ and Vocal Use
- Hammond Reverberation Unit • Variable Tremolo
- 2-12" Special Design Heavy Duty Speakers plus High-Frequency Horn • Extruded Aluminum Panel

Piggy back amplifier with 14 silicon transistors plus silicon rectifier and heavy-duty power and driver transformers provides 140 watts peak music power! Closed back speaker designed to project low end response. Two 12" Heavy-Duty speakers plus a high frequency horn results in tremendous reproduction of brilliant highs, deep lows and solid midrange. Excellent for lead or rhythm guitars, deep lows and solid midrange. Excellent for lead or rhythm guitars. Two channels with high and low level inputs. Separate volume and tone controls for each channel. Depth control for reverb. Intensity control for tremolo circuit. Footswitch jacks for reverb and tremolo activation. Pilot light, fuse, and on-off switch. Sturdy wood cabinets covered in black textured scuff-resistant vinyl with metal corner protectors and heavy duty handles. Amplifier size: 7H x 22½L x 10¾"D. Speaker cabinet size: 27H x 23½ x 11½"D. For 117 VAC 50/60 Hz.

13 T 01647WX Shpg. wt., 70 lbs. Net 199.95  
 Dual Foot Switch for Remote Control of Tremolo and Reverb.  
 13 T 01506 Shpg. wt., 1½ lbs. Net 4.95  
 13 T 01498W Dolly for above Amplifier. Wt., 6½ lbs. Net 11.95

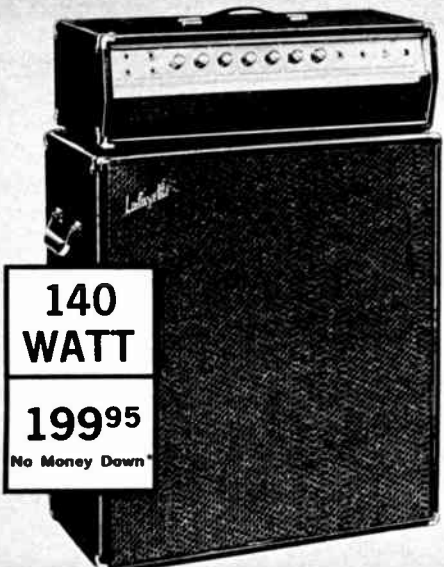

**140  
WATT**  
**199<sup>95</sup>**  
No Money Down\*



170-Watt  
"Piggy  
Back"  
Bass  
Amplifier

**170  
WATT**  
**169<sup>95</sup>**  
No Money Down\*

- Two Powerful 12" Special Design Heavy-Duty Speakers With 20 Ounce Alnico Magnets
- For Use With Bass, Accordion and Combo-Organ

A real powerhouse! Fabulous, full bass sound with a minimum of distortion. Two powerful 12" speakers have a wide-range response. The amplifier features three inputs with deep and sharp selector switches, treble, bass, and volume controls and neon pilot lamps. Fuse and 3-position switch for power off/standby/on. Super 170-watt peak music power chassis uses 5 tubes, 2 dual purpose tubes for 7 tube performance, and all solid state rectifier power supply circuit. Heavy duty transformers provide greater output. Two units: Rugged acoustic wood amplifier/speaker cabinet, and a "piggy back" amplifier which sits neatly on top of speaker cabinet. Cabinets have attractive gray and silver acoustical cloth. Ribbed vinyl carrying handle. Speaker cabinet size: 30H x 22½W x 13½"D; Amplifier cabinet size: 9½H x 22½W x 11"D. For 117VAC 50-60 Hz. Shpg. wt., 75 lbs.  
 13 T 01654WX Net 169.95

**Big Bass  
Sound**



**60  
WATT**  
**109<sup>95</sup>**  
No Money Down\*

## 60-Watt Solid State "Piggy Back" Bass Amplifier

- Heavy Duty 15" Special Design Speaker
- For Use With Electric Bass, Regular Guitar, Accordion and Combo-Organ • 2-Instrument Inputs

Gives full bass and vibrant sound with a minimum of distortion. Powerful 60 watt peak music power amplifier is ideal for use with electric bass or standard guitars, and combo organs. All solid state circuitry (5-transistors and 4-silicon rectifiers) provides excellent sound. Features a specially designed 15" speaker with a wide range response. High and low gain inputs separate volume and tone controls allow complete operating flexibility. Has On-Off switch plus pilot light and fuse. Two units; speaker and amplifier in matching black vinyl covered wood enclosures with handles. Size: Amp. 4¾H x 14W x 8"D; Speaker, 22¾H x 18W x 11"D. For 117V 50/60 Hz AC.

13 T 01548WX Shpg. wt., 47 lbs. Net 109.95

# Instrument Amplifiers

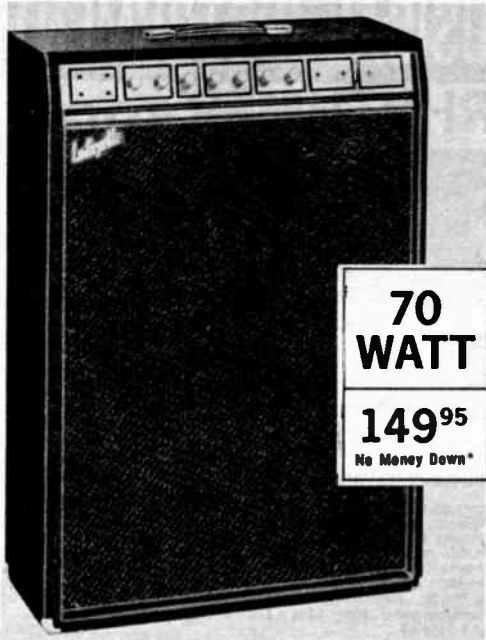

**70  
WATT**

**149<sup>95</sup>**

No Money Down\*

## 70 Watt "Reverb" "Tremolo" Twin-Speaker 2 Channel Amplifier

- Hammond "Reverb" Unit For Echo-Like Effect
- 2-12" Heavy Duty Special Design
- Pulsating "Tremolo" For "Go-Go" Effect

Get faithful reproduction of every note. Excellent for guitar, organ and vocal use. Has special heavy-duty speakers. AC chassis utilizes 6 tubes, 4 dual purpose tubes provide 10 tube performance. 4 instrument inputs provide outstanding versatility. Two channel 70 watt peak music power amplifier. Has 2 volume and 2 tone controls. Features remote control foot switch jacks for colorful tremolo and reverb operation, plus 2 tremolo controls—speed and intensity; reverb "depth" control; on/off/standby switch; pilot light and carrying handle. Sturdy wood case covered in shimmering black vinyl. "T" nut provision for dolly. Size: 32H x 23L x 10"D. For 117V., 50/60 Hz AC. Shpg. wt., 46 lbs.

13 T 01563WX Net 149.95

Dual Foot Switch for remote control of tremolo and reverb.

13 T 01506 Shpg. wt., 1½ lbs. Net 4.95

13 T 01498W Dolly for above amplifier. Shpg. wt., 6½ lbs. Net 11.95

## 5-WATT STUDENT AMPLIFIER

**22<sup>95</sup>**

Great for the student or beginner! Features rugged, solid state circuitry for cool, instantaneous amplification and trouble-free operation. Provides 5-watts peak music power into a heavy-duty specially designed 6" speaker with excellent clarity and tonal response. Smartly styled control panel has Tone and Volume control; two instrument inputs; On/Off switch. Attractively designed lock plywood construction covered in water repellent, scuff resistant black vinyl. With carrying handle. Size: 15¾"Hx 13¼"Wx6"D. For 117V., 60 Hz AC operation. Shpg. wt., 13 lbs.

13 T 01639W Net 22.95

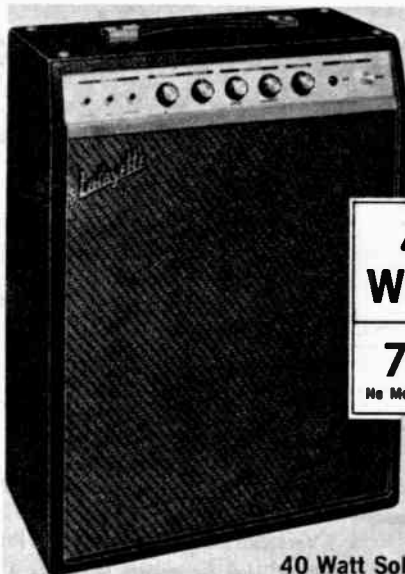

**40  
WATT**

**79<sup>95</sup>**

No Money Down\*

## 40 Watt Solid-State "Reverb-Tremolo" Amplifier

- "Reverb" For Echo-Like Effect
- Tremolo For Pulsating Sound
- 12" Special Design Speaker

Features a built-in heavy duty 12" speaker for clean reproduction of every musical note. Excellent for guitar, microphone, and accordion use. Three instrument inputs. Five controls: two for volume and tone; two for speed and intensity of tremolo, and one for "reverb" depth control. Footswitch jacks for remote control of tremolo and reverb. 40 watt peak, music power AC amplifier chassis utilizes 5 dual tubes equivalent to an 8 tube circuit, plus solid state rectifiers for reliable operation. Also has pilot light, on/off switch and fuse. Sturdy wood cabinet covered in black vinyl. Size: 22H x 17W x 8½"D. For 117 VAC 50-60 Hz.

13 T 01662W Shpg. wt., 25 lbs. Net 79.95

Dual Foot Switch for remote control of tremolo and reverb.

13 T 01506 Shpg. wt., 1½ lbs. Net 4.95



**20 Watt  
Solid-State  
"Reverb  
Tremolo"  
Amplifier**

**20  
WATT**

**49<sup>95</sup>**

No Money Down\*

- Tremolo Speed/Depth Reverb Controls
- Heavy-Duty 10" Speaker

Impressive, 20-watt solid state peak music power reverb and tremolo amplifier with self-contained 10" heavy-duty speaker. Slanted, front-mounted control panel features "easy-to-reach" controls for Volume, Tone, Reverb, Tremolo speed, Tremolo depth; two instrument inputs; reverb and tremolo foot switch input jack; bright-glow pilot light. Housed in an attractive sturdy vinyl covered wood cabinet with carry handle and grill cloth. Size: 19"Hx15"Wx6½"D. For 117V, 60 Hz AC. Imported. Shpg. wt., 16 lbs.

99 T 92074W Net 49.95

Dual Foot switch for remote control of tremolo and reverb. Shpg. wt., 1½ lbs.

13 T 01506 Net 4.95



# MUSICAL INSTRUMENT

## AUTOMATIC RHYTHMER 129<sup>95</sup>

No Money Down\*

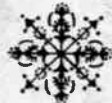
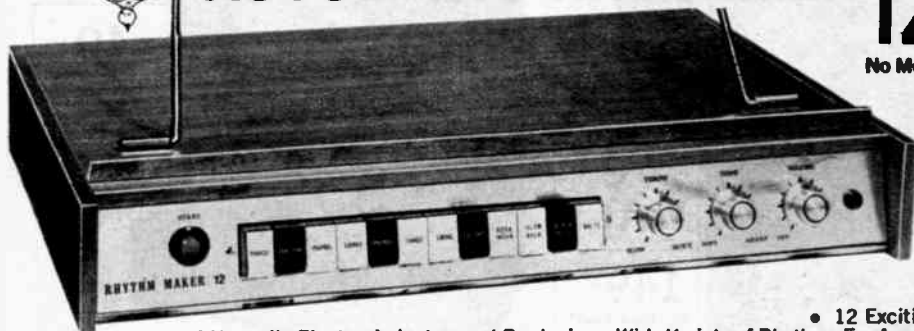

- 12 Exciting Rhythms
- A Versatile Electronic Instrument Producing a Wide Variety of Rhythms For Accompaniment

Solid-state portable rhythmmer. Ideal for teachers to produce a wide variety of rhythms and a steady beat for the students to follow. For students—a complete rhythm section to play along with. For single performers—bring along your own rhythm section! Works with any amplifier to produce 12 distinctive rhythm selections plus an infinite variety of accompaniments by mixing two or more rhythms. Variable tempo control can be set for accompaniment to a Waltz, Fox Trot, Rhumba, Samba, Mambo, Slow Rock, Fast Rock, Swing, Bossa Nova, Cha-Cha, Tango, or a March. Each rhythm is

made up of a variety of percussion sounds: Bass Drum, Snare Drum, High Hat, Cow Bell, Bass Conga, Tenor Conga, and Cymbal. Additional features include: Master Volume and On/Off control, Tone control, On/Off rocker switch for instant control or rhythmmer plus On/Off Remote Control Foot switch, pilot light and 12 pushbutton rhythm selectors. Circuitry: 32 transistors, 95 diodes. For 100-117 VAC, 50/60 Hz. Handsomely styled walnut finish case with brushed aluminum panel. Size: 17 3/4 x 4 1/4 x 9 1/2". Shpg. wt., 10 lbs. 13 T 24857W Net 129.95

### LAFAYETTE SOLID-STATE "ECHO-VERB" REVERBERATION UNIT



**SALE**  
19<sup>75</sup>  
SAVE  
10%  
SALE ENDS  
DEC. 31, 1970

- "Add-on" Reverb Unit for any Musical Instrument Amplifier or P.A. System

Simulates the full sound top artists get! Compact, lightweight, transistorized reverb unit creates a new dimension in audibility to overcome dull, flat ordinary sound. Can be used with any instrument amplifier, or P.A. system. Minutes to connect, the "Echo-Verb" may be used for sound effects. Has inputs for mike and/or instrument—plus a foot switch input to cut reverb in or out from a remote location, pilot light and a reverb mix control that lets you select whatever intensity of reverb you desire. With reverb mix control in the "Off" position, standard sound will be heard from the amplifier. With on/off switch. For 117v., 50/60 Hz. AC. Size 3 3/4 H x 11 1/2 W x 6 1/2 D. Imported. Shpg. wt., 4 lbs. 98 T 92023W Net 19.75

Foot Switch for Remote Control of "Echo-Verb." Shpg. wt., 1/2 lb. 13 T 01514 Net 2.99



**SALE**  
19<sup>95</sup> SAVE  
5.00  
SALE ENDS DEC. 31, 1970

- Fantastic Color Frequency of Light with Sound
- The Louder the Sound, the Brighter the Light!

Now, without complicated and costly stage production equipment, lighting can be as wild as voice or music! Connected to any amplifier, tape recorder, or record player, its brilliance changes from note-to-note, projecting fantastically fast and precise variations of lighting to match the intensity of sound. Use multiple units in a group with varied light colors in each unit to get sensational color blending with sound. Control unit can be placed virtually anywhere for remote operation of light sensitivity, or to turn lights on and off. System can also be used as a constant light source. Uses 2-75W flood lamps. Operates on 110-125V., 60 Hz AC. Includes lamps, 10' AC line cord. Shpg. wt., 4 lbs. 13 T 17780 Net 19.95

### 3 CHANNEL COLOR LIGHT ORGAN CONTROL CENTER



Only 39<sup>95</sup>

- True Frequency Division
- Easily Connects to Any Speaker

- 500 Watts Per Channel (1500 Watts Total)

Transform a large room into a total light-sound environment! Translates musical patterns into dynamic patterns of throbbing, flashing lights precisely synchronized to the music. Provides 500 watts per channel (1500 watts total). Audio spectrum is divided into 3 ranges, low, medium and high, by 3 separate, transistorized frequency selective amplifiers. Accepts nine 150 watt or eighteen 75 watt lights at once; on/off switch; 3 intensity adjustments; on/off pilot light and three channel indicator lights. For 110-120 VAC, 15 amps. max. 13 T 40002 Shpg. wt., 3 lbs. Net 39.95

# ACCESSORIES

PRODUCE THE ROTATING  
SPEAKER EFFECT AND  
VIBRATO WITH YOUR  
OWN AMPLIFIER —  
ELECTRONICALLY!

WAH WAH SOUND  
and VOLUME CONTROL

## ROTO-VIBE

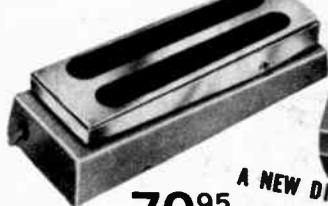

Only **29<sup>95</sup>**

**79<sup>95</sup>**

A NEW DIMENSION IN SOUND

Finally an electronic instrument that can truly simulate the rotating speaker effect through any musical instrument amplifier! Not only produces the Fast or Slow rotating effect but, by the use of the remote speed control pedal, can vary the speed at any rate you desire. Enables the player to produce the various modern effects which are being used on the stage, in the studio, and with theater organs. Can be used with any of the following instruments: organ, bass guitar, rhythm and lead guitar, electric piano, accordion, & other electronic band instruments. Plus: Voice for vocal effects now being used by the top recording groups around the country. Easily connects between instrument and amplifier. Foot pedal has cancel switch to instantly cancel effect being produced. Also features a rocker switch for selecting either the rotating speaker effect or a true vibrato effect. Other controls include Volume, Chorus/Vibrato, Intensity, On/Off power switch, fuse, pilot light, inputs for 2 instruments, and an output for the amplifier. Unit is AC operated, fully transistorized, and has a rugged metal construction. Compact, only 10"Wx6½"Dx3"H. Can be placed in any conveniently reached location. Imported. Shpg. wt., 6 lbs.

13 T 66400 No Money Down\*

Net 79.95

• Produce A Wide Variety of Special Sound Effects

• Use With Any Electric Guitar or Bass

Produce the Wah-Wah effect of a trumpet or trombone with your guitar or bass, electronically. Add extra instruments to your combo by creating the effect of synthesized tones identical to those of a trombone or trumpet when muted by hand or derby. No reaching down for controls. Large 8½" footpedal gives you the full range of Wah-Wah sounds plus operates as a volume control by depressing a built-in switch under the heel of the footpedal. Input jack contains a switch to turn the unit on or off. Operates on 3 "C" cells. Fully transistorized, rugged construction. Imported. Size: 10x3¼x3".

13 T 66301 Shpg. wt., 3¼ lbs. Net 29.95

99 T 62572 Battery for above, 3 req. Net ea. .14

## SUPER-DRIVE FOOT PEDAL CONTROL

**37<sup>95</sup>**

- Use on P.A., Guitar, Bass, Organ, Electric Piano, Etc.
- Built-In Volume Control Pedal
- 6-Step Calibrated Input Boost
- Volume "Leakage" Control
- Full Die-Cast Casing
- 100 Times Amplification Factor

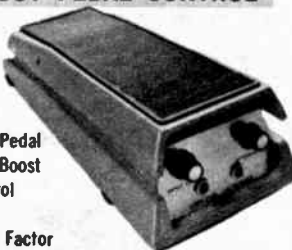

Fully solid state Super Drive offers a new dimension in completely controlled sound. Set your amplifier for the tonal range desired and let Super Drive provide the volume you wish to play. This eliminates amplifier playing at full volume. Contains a calibrated attenuator which provides 6 ranges of boost, plus a built-in volume pedal which varies the boost selected. Super Drive provides "clean distortion", rich harmonics and is capable of feedback. In addition, Super Drive also contains a volume "leakage" control which will adjust the volume pedal to hold a desired leakage when the control is in the off position. Battery powered. Frequency Range: 20-30 kHz. Size: 11¾Lx5¼Wx3¼"H. Shpg. wt., 6 lbs.

13 T 66517 No Money Down\* Net 37.95

99 T 60212 9V Battery Net ea. .21

## LAFAYETTE "FUZZ SOUND"



• Make your guitar or bass produce the harmony of several wind instruments!

Add more instruments to your small combo with the "Fuzz" Sound! Create a wide variety of synthesized tones such as those produced by a baritone, or bass saxophone. Battery powered, it easily connects between your guitar, or bass and the amplifier and is operated by an On Off foot switch. Has two variable control knobs: one for regulating the "fuzz" effect and one for volume and intensity. A supplementary On Off switch is combined with the volume control to conserve battery life. Fully transistorized, the unit is built for heavy duty use and operates on a single penlight battery. A rugged metal case protects inside circuitry. Overall size: 5½Lx3¼Wx2¼"H. Imported. Shpg. wt., 1¾ lbs.

99 T 91993 Net 11.95

99 T 62580 Battery for above Net .10

## DELUXE AC SUPER FUZZ

- Remote Control Foot Switch for Ease of Operation

**39<sup>95</sup>**

No Money Down\*



AC operated super fuzz. No more batteries to fuss with as in conventional units. No more bending to adjust controls; control unit is separate from foot switch. Can be placed on amplifier or speaker within easy reach of the performer. Controls include Balance, Expander, and Tone control for a complete, controlled range of sustained fuzz effects. Electronically creates an harmonic producing sustained sound, now being used by top recording artists. Connects easily between your guitar or bass and the amplifier. Includes remote control foot switch. Long-lasting, solid-state circuitry combined with rugged metal construction. Size: 7¾"Wx5"Dx2"H. For 117 VAC, 60 Hz. Imported. Shpg. wt., 2¼ lbs.

13 T 66418 Net 39.95

## SUPER FUZZ Today's "In-Sound"

Only **27<sup>95</sup>**

- Super Fuzz Can Produce an Expanded Dimension in Sound
- Full Control of Fuzz Sustain Effects
- Heavy Metal Casting For Long Life and Appearance

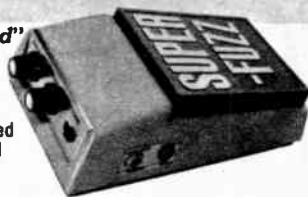

Solid-state Super Fuzz provides a complete range of controlled new sustained harmonic effects. Produces the wild new In-Sound widely used by the top recording groups. Balance control enables perfect blend of fuzz and normal tones. Expander control provides unlimited range of sustained fuzz effects. Tone switch permits choice of conventional fuzz or new harmonic sustained effects. Master foot control switches instantly to normal guitar operation. Rugged die-cast metal construction. Size: 6½x3x1¾". With cord and battery. Imported. Shpg. wt., 2½ lbs.

13 T 66525 Net 27.95

99 T 60212 Battery for Above Net .21

\*See Page 18 for Full Credit Details on Easy Pay Plan

Lafayette Cat. No. 711 79

# DELUXE SUPER 8 REFLEX AUTO POWER ZOOM MOVIE CAMERA

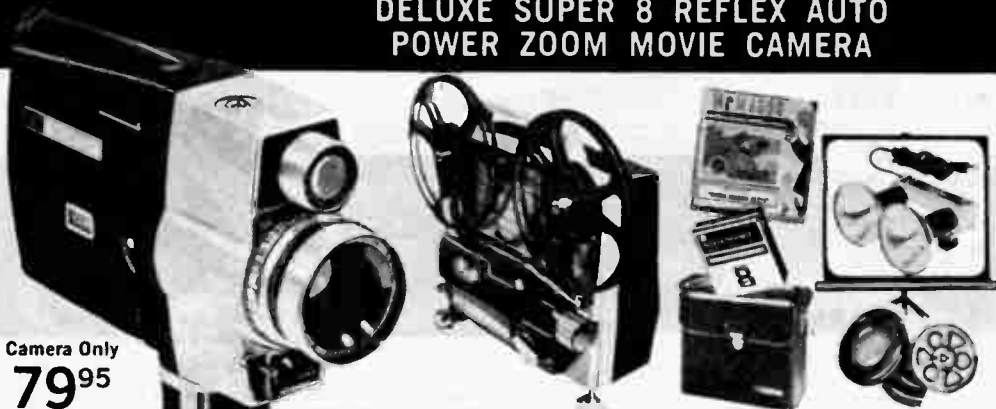

Camera Only  
**79<sup>95</sup>**

SAVE When You  
Buy  
Complete Outfit  
**159<sup>95</sup>**  
No Money Down\*

- Thru-The-Lens CdS Electric Eye
- 3.5 To 1 Power Zoom
- Two-Speed Operation
- Fast f/1.8 Lens

Take sharper, better exposed movies with this deluxe super 8 power zoom reflex camera. Features a thru-the-lens CdS electric eye that automatically controls the lens opening according to light conditions and drop-in, instant cartridge loading. Shoots 50 ft. with a single cartridge. Meter system automatically adjusts for film speeds from 10-400 ASA. Electric film drive motor does away with bothersome hand winding. Offers a choice of two filming speeds: 18 and 24 fps. Super fast f/1.8 Clnetor 3.5 to 1 zoom lens may be manually or automatically operated. Warning signal shows in viewfinder under insufficient light conditions. Exceptional features include automatic resetting footage counter, built-in type "A" filter, battery tester, focusing eyepiece, full range film speed, safety lock, light bar re-

ceptacle, cable release socket, pistol grip, and die-cast aluminum body with hinged doors. Focuses from 6 ft. to inf. Imported. Shpg. wt., 3 lbs.  
15 T 78079L ..... Net **79.95**  
15 T 18103 Camera Case for Above. Shpg. wt., 1 lb. .... Net **3.95**  
99 T 63703 Batteries for above (4 req.) ..... Net ea. **.15**

### COMPLETE POWER ZOOM MOVIE CAMERA OUTFIT

Everything you need for movie making and showing fun! Matched components consists of Power Zoom Super 8 1/8 camera—fully automatic 500W brilliance projector with F/1.6 Zoom Lens, automatic Reel-to-Reel threading thru gate, single knob control for Forward, Reverse, Still and Automatic Rapid Rewind. 400 ft. capacity. Projector includes self contained case—outfit also includes: 1-camera case; 1-roll GAF Ansochrome® II film with free processing; extra 400 ft. reel and can; Mr. "Magoo" cartoon; 1-30x40 inch folding tripod screen; 4-batteries for camera; 1 Light Bar, 2 Bulbs. Shpg. wt., 23 lbs.  
15 T 90173WXM ..... Net **159.95**  
Auto Zoom Projector Only  
Full feature, forward, still and reverse. Shpg. wt., 10 lbs.  
15 T 78087WY ..... Net **74.95**

## YASHICA SUPER 8-60E 6-1 POWER



Only  
**159<sup>95</sup>**  
No Money Down\*

- 8-48mm f/1.8 Automatic Zoom Lens
- Motorized—3-Speeds
- With Ultra-Modern Servomatic CdS Thru-the-Lens Exposure Control
- Reflex Viewing

Deluxe electric drive Super 60 Electronic reflex camera with fast electric f/1.8 lens zooms from 8 to 48 mm. Automatic CdS thru-the-lens exposure system and micro-split focusing. Super 8 drop in cartridge loading, no threading. Shoot 50 ft. without rewinding. Other features include film type indicator window, parallax free reflex viewing, shutter trigger with continuous run button, spotlight and backlight lighting control, automatic film ASA speed selector, insufficient light indicator, remote control, single frame, adjustable eyepiece, and cable release sockets. 85A filter, battery checker, footage counter, and movie light slot. ASA Speeds: 25-400. Film Speeds: 12, 18, 24 fps. Imported. Shpg. wt., 3 lbs.  
15 T 36408L ..... Net **159.95**  
99 T 63703 Batteries for above. (4 req.) ..... Net ea. **.15**

## DeDUER ELECTRA 300 3-1 POWER ZOOM



**SALE**  
**99<sup>95</sup>**  
SAVE \$10.00  
SALE ENDS  
Dec. 31, 1970

- Slow Motion
- Single Frame Exposure
- Fully Automatic Thru-the-Lens Exposure System

Super 8 reflex automatic movie camera with f/1.8, 10.5-32 mm power zoom. Sensitive CdS thru-the-lens meter assures correct exposures for proper colors. Reflex thru-the-lens viewing and focusing for accurate framing and sharp pictures. Features convenient fade-in, fade-out control and single frame exposure. Simple, drop-in cartridge loading. 50 ft. of shooting. Switch on trigger selects slow motion for slowing down fast action or standard speed for normal shooting. F/stop and over/under exposure signal is clearly visible thru view-finder. Also includes battery indicator, footage indicator, built-in type A filter, lens hood and eyepiece hood, and carrying strap. Rugged die-cast aluminum housing. Imported.  
15 T 52124L Shpg. wt., 6 lbs. .... Net **99.95**  
99 T 63703 Batteries for above (4 required) ..... Net ea. **.15**



# Movie, Slide Projectors, and Accessories



**AIREQUIPT**  
REMOTE CONTROL  
SLIDE PROJECTOR

**SALE**

**54<sup>95</sup>**

SAVE 5.00  
SALE ENDS  
DEC. 31, 1970

- Remote Control-Forward/Reverse and Micro Focus
- With Circular Magazine For 100 Slides

Model 135. Fully remote controlled, jam-proof projector with a sharp, 4" color-corrected lens and a 500-watt lamp for brilliant screen viewing. Features a highly efficient blower for cool, quiet operation, slide pre-heat to insure immediate focus, elevation control, 3-way on/off switch, panel focus control, remote control for forward/reverse and micro-focus. Smartly designed, self-contained, unbreakable case. Complete with circular slide magazine. Wt., 10 lbs.

15 T 36473W No Money Down\* ..... Net 54.95  
15 T 36481 100-Slide Circular Magazine. Wt., 1 lb. .... Net 2.79  
15 T 36499 36-Slide Metal Magazine. Wt., 1/2 lb. .... Net 1.99

## ATLAS-WARNER DUAL 8 EDITOR



For  
Both  
Standard  
and  
Super 8

**24<sup>95</sup>**

- Over 17 Sq. In. Viewing Screen
- Die-cast Construction

Large screen editor with over 17 sq. in. of viewing area. Film slips in place in seconds; notches in exact frame that is being viewed. Takes reels up to 400 ft. Smooth and rapid rewind operates without scratching film. Adjustment knob for critical focusing. Foldaway arms for convenient storage. Die cast construction, with dry splicer and splicing tape. Size: 9 1/2 x 7 x 6 1/2". UL listed. 15 T 84093 Shpg. wt., 9 lbs. .... Net 24.95

## DELUXE LENTICULAR SCREEN

- Automatic Lever-Type Handle Permits Smooth Easy Adjustment

Specialty-designed, optically-correct lenticular screen is free of glare, sheen and hot spots. Amazing sharpness and color rendition. Durable vinyl fabric resists fire and fungus. Sturdy, secure tripod legs. Screen is 40 x 40". Shpg. wt., 10 lbs.

15 T 90052W ..... Net 11.95  
Same as above. EXTRA Large 50" x 50" Super Screen—ideal for New Super 8 Movies. Shpg. wt., 12 1/4 lbs.

AS LOW  
AS  
**11<sup>95</sup>**

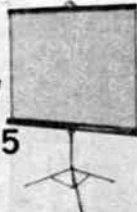

15 T 90219W ..... Net 16.95

**GLASS BEADED SCREEN**  
Fine grain glass beading for extra brilliance excellent viewing. Heavy-duty folding tripod adjustable to various heights. Large 30"x40" size. Shpg. wt., 10 lbs.

15 T 90037W ..... Net 7.95

## TABLE TOP SCREEN

22"x30" Lenticular. Shpg. wt., 2 1/4 lbs. .... Net 2.95  
15 T 87021W

\*See Page 18 for Full Credit Details on Easy Pay Plan

## DeJUR<sup>5</sup> DUAL PROJECTOR FOR BOTH SUPER AND STANDARD 8

AS LOW AS

**74<sup>95</sup>**

No Money Down\*

- A Movie Projector That Thinks It's A Slide Projector
- Self-Enclosed Case

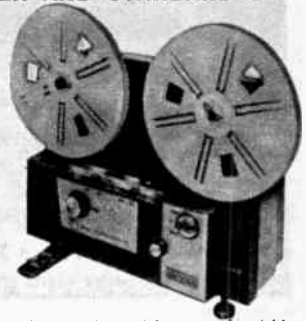

Elderade 86Z movie projector with the advanced features of variable speed control, true slow motion and forward or reverse projection. 100% illumination for extended "still" projection, ultra-bright, long-life quartz Halogen lamp and cool, quiet operation. With sturdy diecast aluminum case. 400 ft. reel capacity, built-in automatic room light receptacle, automatic reel-to-reel threading, fast rewind, built-in film trimmer, lifetime lubrication and a self enclosed carrying case with handle. Sharp f/1.5 zoom lens for excellent sharpness. For 117 VAC, 60 Hz.

15 T 82140WX Shpg. wt., 14 lbs. No Money Down\* ..... Net 109.95  
Elderade 84-Z. Similar to above but less slow motion, variable speed control, reverse projection and automatic room light illumination. 15 T 82132WX No Money Down\*. Shpg. wt., 15 lbs. .... Net 74.95



## DUAL PROJECTOR FOR BOTH SUPER AND STANDARD 8

- Instant Switch from Standard to Super 8 MM Film

- Automatic Reel-to-Reel Threading

**SALE**

**49<sup>95</sup>**

SAVE 5.00  
SALE ENDS  
DEC. 31, 1970



Model 388. Standard/super 8 mm projector combines 500-watt brilliance and a fast f/1.6 color-corrected, coated lens for vivid screen viewing. Automatic threading design features Adjusto-Matic control for proper feed onto take-up reel. Accepts reels to 400 ft. capacity. Quiet, cool operation. Automatic rewind, framing control, elevation adjustment, focus control, film trimmer and automatic tensioning. Handsome, self-contained carrying case with handle. Supplied with 400 ft. empty film reel. For 117 VAC, 60 Hz. Shpg. wt., 15 lbs.

15 T 78202W ..... Net 49.95

## SEALED-BEAM MOVIE LIGHT

- Head Tilts for Bounce Lighting

Compact, powerful 650 watt tungsten sealed beam will provide sparkling, bright indoor movies. Features top mounting and convenient on-off switch. Will fit all new super 8mm cameras plus all standard 8mm cameras with tripod socket on top, with 6 ft. cord and exposure guide.

15 T 80013 Shpg. wt., 3 lbs. .... Net 6.95



**6<sup>95</sup>**



**219<sup>95</sup>** with case  
No Money Down\*



**169<sup>95</sup>** with case  
No Money Down\*

**MIRANDA "SENSOREX" 35MM SLR      MIRANDA "SENSOMAT" 35MM SLR**

- Behind-The-Lens CdS Meter      • Variable Delay Self-Timer
- Shutter Speeds to 1/1000th
- Thru-The-Lens CdS Meter      • Sharp 50 MM F/1.8 Lens

Fully automated SLR camera utilizes cross-coupled behind-the-lens CdS meter (ASA range 25-1600 and EV 3-18) and ultrasharp Auto Miranda lens. Illumination is measured with the lens wide open. Built-in shoe provided for wide range of accessories. Multi-split-grid resolves into perfect clarity when pin point focus is achieved. Features interchangeable lens mount, built-in self timer, instant return mirror, interchangeable viewfinder, and rapid advance geared 150° cocking lever. Complete with built-in variable delay self-timer. Includes case and strap. Specifications: 50mm f/1.8 lens. Speeds: B, 1-1/1000th sec. FP & X Synch. Imported.

"Sensomat" is a truly versatile 35 mm SLR featuring a thru-the-lens CdS metering system with a narrow angle of acceptance for easier, more perfect picture taking. Match needle in the viewfinder can be centered for proper exposure by rotating the diaphragm and/or the shutter speed dial. ASA range: 25-1600. Other features include fully interchangeable finder and lens systems, shutter speeds of 1-1/1000th plus B, FP & X synch., automatic reset film counter with a magnifying lens, and a front and top shutter release for greater convenience. Focus from 17". Camera includes 50 mm f/1.8 auto lens, case and strap. Imported. Shpg. wt., 4 lbs.

"SENSOREX" 35 MM f/1.4. As above with super fast lens. Net 219.95  
15 T 37453L Shpg. wt., 3 lbs. Net 259.95

"SENSOMAT" 35 MM f/1.4. As above but with fast lens. Net 169.95  
15 T 37224L Net 199.95  
15 T 37232L No Money Down\*



**YASHICA**  
**ELECTRO-35**  
**35MM**  
**99<sup>95</sup>**  
with case  
No Money Down\*

- Sensitive CdS Sensor
- Electronic Exposure Control: 30 Sec. to 1/500 Sec.

Advanced 35 mm rangefinder camera with the "electronic brain". Sensitive solid-state circuit reads the existing lighting conditions and automatically sets the proper shutter speed at a preselected aperture. Continuously variable range of shutter speeds from 30 sec. to 1/500 sec. For maximum reliability when shooting flash, contacts are finished in gold providing very low resistance and long life. Also features coupled range/viewfinder focusing with automatic parallax correction, built-in self timer, shutter release lock, accessory shoe for flash or other accessories, battery checker. ASA: 12-500. X sync. Sharp f/1.7, 45 mm lens. Imported.



**VICEROY**  
**35 MM RANGEFINDER**  
**CAMERA**  
**59<sup>95</sup>**  
No Money Down\*

- CdS Electric Eye
- Fast 45 MM F/1.8 Lens
- Aperture Readings Are Visible In The Viewfinder

Model 503. Just focus and shoot! Perfect exposure is assured by the fully automatic cross coupled CdS exposure meter. Camera functions automatically with a manual override. Features shutter speeds from 1-1/500th and B, flash synch. at all speeds, self-timer, ASA to 400, combination range/viewfinder with parallax correction marks, f-stop and warning signal appear in finder, rapid film advance, and an auto-reset film counter. Includes 45 mm f/1.8 5-element lens case and strap. Imported.

**LAFAYETTE ELECTRONIC STROBE FLASH**

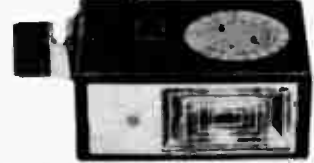

**11<sup>95</sup>**  
• Fully Transistorized  
• Recycles in 7-10 Seconds

- Use Horizontally or Vertically

Lightweight strobe weighs under 7 oz. with batteries for easy carrying on the camera at all times. Small size: 3 1/4 x 2 3/8 x 1 3/8". Hot shoe adapter allows vertical or horizontal use for best flash coverage. Recycles in 7-10 seconds on 2 easily replaceable penlight batteries. Kodachrome II (ASA 25) guide no. of 28. Flash duration: 1/2000 sec. Color temperature: 6000 K. On/Off switch to prolong battery life. Neon lamp signals when strobe is ready to fire. Built-in PC cord prevents loss. Imported. Shpg. wt., 1 lb.



**HI-BEAM II ELECTRONIC**  
**STROBE FLASH**  
**26<sup>95</sup>**

- With Built-in Rechargeable Nickel Cadmium Batteries and Charger

Compact, powerful flash no larger than a cigarette pack and weighing only 2 1/2 oz. gives you light where and when you need it. Guide No. 40 for ASA 25 films. 1/3000-sec. flash duration. Operates on 110 VAC with built-in cord or its self-contained rechargeable nickel cadmium batteries. Shoot every 10 seconds with up to 60 flashes per charge. Reflector coverage is 55°; color temperature is balanced for all daylight and B & W and/or color films. Size: 3 1/4 x 2 1/4 x 1 1/4". Imported. Shpg. wt., 1 1/4 lbs.

# Polaroid®

## MODEL 360 with Electronic Flash

- Built-In Electronic Flash with Automatic Recharger
- Built-In Electronic Timer

**179<sup>95</sup>**  
No Money Down\*

Advanced Colorpack camera with clip-on electronic flash which eliminates the bother of carrying extra flashbulbs. Have finished color pictures in a minute, black and white in seconds. Features built-in timer, two exposure ranges for color and two for black and white, lighten-darken control, and transistorized electronic shutter. Accurate Zeiss Ikon range and viewfinder. Triplet lens and electric eye exposure control for superior pictures. Shutter lock prevents accidental exposure. Automatic recharger for electronic flash operates on house current. Deluxe, brushed chrome construction. 15 T 30203L Shpg. wt., 3 lbs. Net 179.95

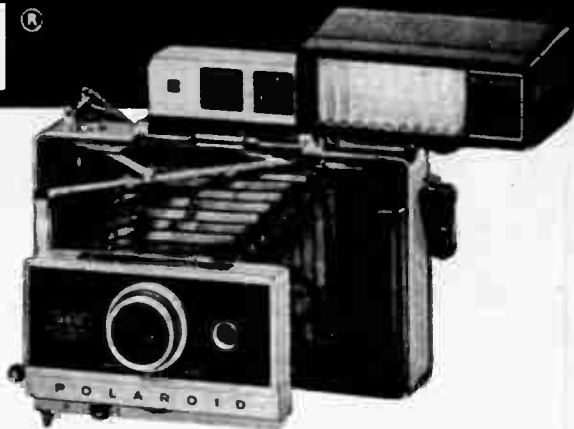

## FILM AND ACCESSORIES

Carry Case for Model 360		
15 T 16137 Shpg. wt., 2 lbs.		Net 4.95
Carry Case for Colorpack II		
15 T 16145 Shpg. wt., 2 lbs.		Net 2.95
Type 107 B & W Film Pack, 8 exp.		
15 T 30211L Shpg. wt., 8 oz.		Net 2.50
Type 108 Color Film Pack, 8 exp.		
15 T 30161L Shpg. wt., 8 oz.		Net 4.69
Flashcubes. Pkg. of 3 takes 12 shots.		
15 T 26326L Shpg. wt., 6 oz.		Net 1.49

## PHOTO COPIER FOR POLAROID CAMERAS

Want copies of your Polaroid snapshots? Make them yourself on the spot in as little as 15 seconds using your present Polaroid. It's easy! Imported. Shpg. wt., 2 lbs.

For Polaroid Color Pack Cameras.

15 T 49500	Net 7.95
FOR POLAROID COLOR PACK CAMERA	
15 T 49559	Net 7.95
FOR POLAROID SWINGER 20	
15 T 49518	Net 5.95
FOR BIG SWINGER	
15 T 49526	Net 7.95



## COLORPACK II

**29<sup>95</sup>**



- Produces Color Pictures in a Minute, Black and White in Seconds

Easy loading, no threading or winding. Sensitive electric-eye measures the light of the subject and combines with the transistorized electronic shutter to set exposures automatically. Three element lens produces sharp pictures. Flash is built-in, simply snap on a flashcube for indoor pictures... no special exposure setting necessary. Distance settings are visible in the viewfinder. T-bar insures accurate tab pulling. Lighten-Darken control. Shutter lock prevents accidental exposures. Shpg. wt., 3 lbs.

15 T 30179L Net 29.95

## Minolta

**34<sup>95</sup>**  
No Money Down\*



## "16 II" SUBMINIATURE CAMERA

An extremely easy-to-operate, palm-size camera. Sliding camera in and out of built-in case advances film, cocks, shutter, counts exposure and prevents double exposure—all automatically. 6 shutter speeds from 1/30 to 1/500 sec. plus "B". Takes B & W pictures, color prints or color slides that fit any 35mm projector. Direct viewfinder shows picture exactly as it will appear on film. Lens opening of f/2.8 to f/16. With Case. Imported. Shpg. wt., 1 lb.

15 T 34163L	Net 34.95
MINOLTA 16 II Accessories. AV. Shpg. wt., 6 oz.	
15 T 34213 Duo Fit Flash Gun	Net 7.95
15 T 34221 Bracket for Flash and Tripod Mtg.	Net 1.95
15 T 34239 Aux. Lens Set—2 closeup, 1 distance, 1 Y filter	Net 4.95
15 T 34247 Color Filter Set—1 ea. 1A, 80A, 81B	Net 4.95
FILM FOR "16 II"—All are 20-exposure magazines. Shpg. wt., 3 oz.	
15 T 34171L Kodak Plus-X ASA 100	Net 1.19
15 T 34197L Kodachrome II ASA 25	Net 1.49
15 T 34189L Kodak Double-X ASA 250	Net 1.19
15 T 34502L Ektacolor Negative (color prints) ASA 80	Net 1.00

## KODAK

## INSTAMATIC CAMERA COLOR OUTFITS



As Low As

**19<sup>95</sup>**



- Uses Pop-on Magicubes

Model AX-15R Outfit. Simple-to-operate camera with Lumenized f/11 pre-focused lens for quality pictures. Bright, large viewfinder for realistic viewing. Quick film advance. Uses self-powered Magicube flashcube which requires no batteries. Automatically adjusts for outdoor or flash shooting. "Used Lamp" shows in viewfinder when new Magicube required. Outfit: camera with wriststrap, Kodacolor-X film cartridge, Magicube, and instructions. 15 T 26375L Shpg. wt., 1 1/2 lbs. Net 19.95

Model AX-25R Outfit. Features automatic film advance for up to 12 pictures in 12 sec. Uses self-powered Magicube flashcube which requires no batteries. "Used Lamp" shows in viewfinder when new Magicube required. Bright, large viewfinder for true-to-life viewing. f/11 Lumenized pre-focused lens. Automatically adjusts for flash or outdoor operation. Outfit: camera with wriststrap, Kodacolor-X film cartridge, Magicube, and instructions. 15 T 26383L Shpg. wt., 1 1/2 lbs. Net 29.95

\*See Page 18 for Full Credit Details on Easy Pay Plan



# COPYMATE

## DRY COPIERS

- Copy Letters, Photographs, Pages Bound in Books
- Makes Crisp, Black on White Copies
- Easy to Use—Two Simple Steps
- No Messy Liquids, Powders, Sprays or Inks

As low as **29<sup>95</sup>**



### DELUXE COPYMATE II

Makes copies faster, more conveniently at home or in the office. Make permanent, 8 x 10" non-fading copies of bills, news articles, letters or receipts. Exposure time is cut to 10-15 seconds, complete copies in 30 seconds. Warm-up time only 5 minutes, faster than original Copymate. Can be left on all day. New hold-down latch lets you leave machine during exposure cycle. Built-in automatic timer controls exposure for light or dark copies. Contrast is changed by varying developing time. No liquids or powders to refill. No spilling of inks. A completely dry process. Attractive front panel has automatic timer, pilot light, and power switch. Unit is compact and portable, only 22 1/4 x 17 1/2 x 6 3/4" H and weighs only 8 lbs. High-impact green plastic case with built-in carrying handle and cord storage compartment. Complete with cover. Operates on 110-120 VAC. 60 Hz. U.L. Listed. Shpg. wt., 10 lbs. See COPYMATE paper to right.

**15 T 46035W No Money Down\***

### ORIGINAL COPYMATE

Makes 8x10" dry copies in less than a minute without using messy chemicals or inks. Front panel has pilot light and automatic exposure timer. Power switch on line cord. Handsome brown and gold case with built-in carrying handle. Compact, only 22 1/4 x 17 1/2 x 6 3/4" H. Weighs 7 1/2 lbs. Operates on 110-120 VAC, 60 Hz U. L. listed.

**15 T 46019W** Shpg. wt., 10 lbs. ... **Net 29.95**  
**COPYMATE Paper.** 8x10" white bond. 33 sheets per pkg. Shpg. wt., 12 oz.  
**15 T 46027** ... **Net 29.95**

### AUTOMATIC ELECTRIC PENCIL SHARPENER

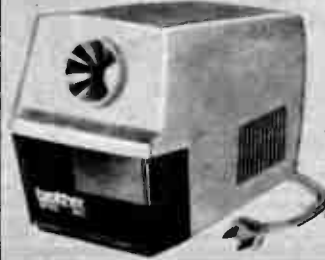

**12<sup>95</sup>**

- Automatic Stopper When Pencil is Sharpened
- Heavy Duty Electric Motor

Model 660—Ideal for student, artist, draftsman, business firms... gives a needle point instantly. Unit even sharpens charcoal and pastel pencils. Sensitive micro switch automatically stops motor when pencil is sharpened. Carefully machined precision ground cutters last indefinitely. Easy cleaning with convenient push out receptacle drawer. Safe for even a child to use. Sturdy die cast metal with heavy duty 115 volt AC motor. UL Listed. Imported.

**15 T 17091** Shpg. wt., 3 1/2 lbs. **Net 12.95**

### 13 1/4" VECTORLOG® SLIDE RULE



**16<sup>95</sup>**

- Laminated Bamboo Construction

The Lafayette VECTORLOG Slide Rule provides a new concept in scientific calculation, incorporating scales and arrangement designed for quick-easy manipulation. Twenty-seven (27) scales incorporate the many problems encountered in Electrical Engineering and Physics. The unique P, P', and Q scales allow direct right angle vector addition. No longer are several settings required to obtain right angle vector sums—these scales work in the same manner as the C and D for multiplication. The two Hyperbolic Sine and one Hyperbolic Tangent Scale, the voltage db scale, and the five Log Log scales, provide maximum coverage of these dynamic fields. VECTORLOG is the result of extensive tests for ease of manipulation. Several of these features are: C and D scales on both the front and back of the rule; Sine scales in both degrees and radians, removing the necessity of bothersome conversion of units: a problem-tested location of scales; and adjusted screws to allow variable tension on the slide. Scales include: (FRONT) Tr-1, Tr-2, P', P, Q, ST, S-1, S-O, C, D, LL01, LL02, LL03, LL1'; (REAR) Sh-1, Sh-2, DF, A, B, C1, CF, Th, C, D, LL3, LL2, db. With instruction book, leather carrying case, and belt carrying loop. Imported. Shpg. wt., 1 1/4 lbs.

**99 T 71029** ... **Net 16.95**

### draftette PORTABLE DRAFTING MACHINE

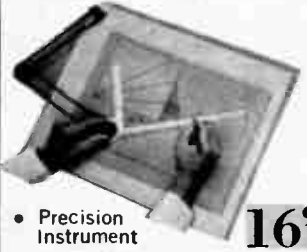

**16<sup>95</sup>**

- Precision Instrument

Model 9-B—sketch draft, design, draw diagrams and schematics like a professional. A new DRAFTETTE which gives you all the advantages of a T-square, triangle and protractor in a compact, easy to operate portable drafting machine. Constructed of anodized aluminum, features tubular arms, 360° protractor, one-piece 6"x9" scale calibrated in 16ths-1/8-1/4. Mounted on a 16"x21" drawing board, completely assembled ready to use. Shpg. wt., 5 1/2 lbs.

**15 T 174011** ... **Net 16.95**

### TACRO TACROGRAPH SET



**5<sup>95</sup>**

Drawing pen for all lettering and drawing work. Uses both India and drawing inks. Precision point for constant flow lines. Slim, easy to hold pen comes with 3 color coded nibs. Fine (Size 0, Grey nib), Light Medium (Size 1, Yellow nib), Very Broad (Size 3, Blue nib). Shpg. wt., 4 oz.

**15 T 80026** ... **Net 5.95**

Deluxe Tacrograph Set—Similar to above with 7-precision crafted points. Pigskin Case. Nibs: White-00-very fine; grey-0-fine; yellow-1-light med.; beige-2-heavy med.; green-2 1/2-broad; blue-3-very broad; red-4-extra broad. Shpg. wt., 8 oz.

**15 T 80034** ... **Net 11.50**

### TECHNICAL DRAFTING SET



**10<sup>95</sup>**

- Made in W/Germany of Nickel Plated Brass

Contains 6 1/4" self-centering compass, one leg knuckle joint with divider, pencil, pen parts and lengthening bar; 6 1/4" self-centering divider; spring bow divider 4 1/4"; center wheel adjustment with interchangeable needle points; spring bow pencil and spring bow pen, both 4 1/4" with center wheel adjustment and interchangeable needle point; two 5 3/8" ruling pens; extra handle for pen and pencil parts; adjustment tool; lead case and leads; and spare parts kit, all in fitted lined case. Shpg. wt., 1 1/2 lbs.

**99 T 70039** ... **10.95**

# SMITH-CORONA "FIGUREMATIC" PORTABLE ELECTRIC ADDING MACHINE

**SALE 69.95**  
**CUT 5.50**  
 Sale Ends Dec. 31, 1970

- Totals 8 columns to \$999,999.99



A fast-figuring electric portable that adds, subtracts and multiplies. Full-featured construction with 10 keys. Add-Subtotal, Subtract-Total, and Repeat. "Clear" and digital indicator are combined. Lists 7 columns of figures. New, easy-load ribbon cartridge gives thousands of extra prints. Easy to carry—the cord tucks in, stylish dust cover snaps on, built-in retractable carrying handle comes out, and away it goes. Ideal for everyone who figures—at work, home, in-between. Overall 7x9x13". For 110-115 volts, 60 Hz. AC. Shpg. wt., 10½ lbs. **15 T 40079W No Money Down\* Net 69.95**  
 Adding tape for above 2½" wide. Net 69.95  
**15 T 40061 Shpg. wt., 10 oz. Net ea. .39**

## ROYAL APOLLO 10 ELECTRIC PORTABLE TYPEWRITER



**99.95**  
 No Money Down\*

- Full-Size 88 Character Keyboard
- Pre-Set Tab Has 7 Stops

Features fast-action tab pre-set every 10 spaces. Automatic/manual ribbon reverse; touch-set margin control; 1, 1½, 2 line spacing. Chrome-plated paper support; paper ball with carriage scales; dual shift keys. Release lever frees jammed type keys. Ribbon selector lever for red or black ribbon or stencil. Top cover zips off for cleaning keys or changing ribbon. Finger-formed double-molded plastic keys. Accepts standard # 10 business envelopes, paper 9½" wide. Molded hi-impact plastic case. Pica type 110-120 V 60 Hz. AC. UL Listed. Shpg. wt., 20 lbs. **15 T 31045W Net 99.95**

## brother HOME/OFFICE TYPEWRITER

- With Key Set Tabulator
- All Steel Ultra/Deluxe

**74.95**  
 No Money Down\*

Echelon 91 full 88 character keyboard features pushbutton key set tabulator and pushbutton 2 color ribbon. Finger comfort sloped keyboard provides typing ease. In addition, typewriter has automatic repeat space key, jam release key, convenient eraser table, paper support arm, segment shift, synchronized measuring scale, card holder, automatic/manual ribbon reverse, and line finder. Comes with ultra-deluxe molded carrying key lock case. Pica type. Size: 16¾x18x7¾". Shpg. wt., 23 lbs. **15 T 17135W Net 74.95**



## brother PORTABLE TYPEWRITER



## brother DELUXE PORTABLE TYPEWRITER

**39.95**  
 No Money Down\*



- All Steel/with Case

**SALE 49.95**  
 SAVE 5.00  
 Sale Ends Dec. 31, 1970



- With Tabulator/Auto Repeat Space Key

Charger II standard, full-size 84 character portable gives solid performance and dependability in a lightweight, compact design. Features instant margins, paper bale scale, jam release key, measuring scale, card holder, half-space ratchet and two-color ribbon with stencil position. With console type case cover. Pica type. Size: 14½x15x5½". Shpg. wt., 13½ lbs. **15 T 17119W Net 39.95**

Echelon 79 all-steel typewriter with tabulator and full 88 character keyboard features +, = 1, all characters — four more than standard! Has automatic repeat space key, stencil selector, variable line spacer, jam release key, half-size ratchet, convenient eraser table and paper support arm. With attractive, luggage-type carrying case. Pica type. Size: 14½x15x6¾". Shpg. wt., 15 lbs. **15 T 17127W No Money Down\* Net 49.95**



# Desk Lamps for Home & Office

## DIAL-A-LITE HIGH INTENSITY LAMP

**SALE!**  
SAVE 2.00 **9<sup>95</sup>**

SALE ENDS DEC. 31, 1970

- Dials Any Degree of Light From Night Light to Bright Light.

Now you can vary your light continuously from a soft glow that is dimmer than a night light to a brilliant, glare-free, white light equivalent to 150 watts of illumination. Slide switch turns light on or off without disturbing dial setting. Telescoping arm extends to 15"; shade swivels 360°. The lamp can be hung on a wall by using keyhole slot on base. Unit folds down to only 3 1/2 x 9 1/4". Sand finish. For 120v. 60 Hz. AC. Uses GE No. 1129 bulb (included). 117V. 60 Hz. Shpg. wt., 2 1/2 lbs.  
13 T 81310 Net 9.95  
Replacement Bulb 32 T 66475 Net .36

## LAFAYETTE 5-WAY HIGH INTENSITY LAMP

- Hi-Lo-Off Selector Switch
- Adjustable Telescoping Arm

**5<sup>95</sup>**

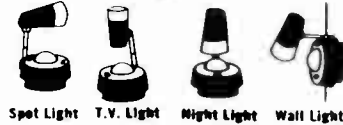

Spot Light T.V. Light Night Light Wall Light

Beautifully designed, transformer powered, telescoping Hi-Intensity lamp featuring HIGH and LDW switch. Telescopes from 3 1/2" to 11 1/2". May be used as a desk and wall light, spot and TV lamp. Use as a night light when closed. Shade swivels 360° with an arc of 180°. Shade and base are richly finished in black. Uses #93 bulb, supplied. Overall height 13". 117V, 60 Hz. Imported.  
99 T 91985 Shpg. wt., 2 lbs. Net 5.95  
Replacement Bulbs (pkg. of 2) 12 T 75502 Net .99

## HIGH INTENSITY LAMP



- Hi-Low-Off Selector Switch
- Rugged Construction

**3<sup>95</sup>**

Ideal for desk or wall mounting. Lamp shade turns in any direction, giving an ample uniform non-glare beam of light. Sturdy hinged arm extends to 14 inches, folds flat against a hi-impact base. Hi-Lo-Off switch plus 6 ft. cord. Gold finish lamp shade and arms; ivory base. Uses #93 bulb, supplied. 117 volts, 60 Hz. Shpg. wt., 2 lbs.  
12 T 25507 Net 3.95  
Replacement Bulb (pkg. of 2) 12 T 75502 Net .59

## LAFAYETTE CLAMP-TYPE "DRAFTING LAMP"



**9<sup>95</sup>**

- Spring Controlled Swivel Joints
- Extends To 30 Inches
- Perfect Illumination Anywhere

A deluxe lamp from Lafayette for perfect illumination wherever you require it. Ideal for benches, tables, and drafting boards. Clamps securely to any surface up to 3" thick. Spring controlled swivel joints and double arm action moves light in any direction. Arm extends to 30". Neutral color. For 110-125V, 60 cycles AC, less bulb. Imported. Shpg. wt., 4 lbs.  
99 T 90771 Net 9.95

## FLUORESCENT DESK LAMP

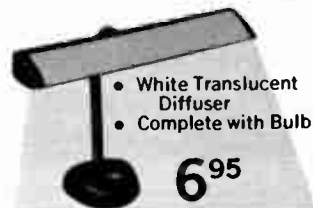

- White Translucent Diffuser
- Complete with Bulb

**6<sup>95</sup>**

An attractive all metal fluorescent lamp with combination solid/gooseneck support finished in chrome. Brown metal base with push button light control . . . perfect for study, office or den. Translucent white plastic diffuser for maximum light dispersal. Includes 14-watt, 15", cool fluorescent bulb. Streamline design complements any room decor, 14 inches high by 5 inches wide. Provides illumination anywhere on your work or reading surface. 117V, 60 Hz. Imported. Shpg. wt., 5 3/4 lbs.  
12 T 16027 Net 6.95

## ALL PURPOSE LAMP



**19<sup>95</sup>**

- Universal Joints
- Light at Any Angle
- Extends to 36"

Ideal for factory benches, tables and drafting boards. Two bolts clamp base securely to any surface up to 3" thick. Spring-controlled swivel joints and double arm action give you light in any desired position. Arm extends 36". Uses two T8, 15-W lamps. For 110-125V., 60 Hz. AC. Bronze finish. Shpg. wt., 9 1/2 lbs.  
12 T 10012W Less lamps. Shpg. wt., 9 1/2 lbs. Net 19.95  
T8. 15-watt, cool white lamp. Shpg. wt., 5 oz. 12 T 10020 Net ea. 1.35

## FLUORESCENT MAGNIFYING LAMP



As Low As  
**22<sup>95</sup>**

Designed for precision work, features a 5" diameter magnifying glass with a powerful 13" focus, surrounded by a 22 watt shadow-free fluorescent tube. A custom-engineered arm permits complete directional mobility—special adjustment knobs insure the proper tension and steadiness for any desired position. 45" arm reach. Ideal for assembly, laboratory, quality control and other detail work. In kit or assembled form. Shpg. wt., 6 lbs.  
12 T 69521W Kit, less lamp Net 22.95  
12 T 69539W Assembled less lamp Net 25.95  
T8. 22-watt, cool white lamp. Shpg. wt., 11 oz. 12 T 75015 Net ea. 3.49

# Electrical Accessories—Weather Instruments

## WHISTLE SWITCH

Only **11<sup>95</sup>**

- The Amazing Electro-Sonic Switch That Turns Anything Electrical On or Off With a Whistle

Let Sound Command do the work. Turns radios, televisions, Hi-Fi, Lamps, outdoor light, On or Off while you relax in your chair or bed. No need to walk in darkness . . . turn on lights in a different room before you get there. Just blow the whistle and appliance immediately goes On or Off. WHISTLE SWITCH is plugged into any standard household outlet, then electrical appliance is plugged into WHISTLE SWITCH. Nothing further is required. 350-watt capacity. For 110 v 60 Hz AC.

12 T 78506 Shpg. wt., 10 oz. . . . . Net 11.95  
Extra Whistle for above  
12 T 78514 . . . . . Net .50



## LAFAYETTE Wireless Remote Control

For Lamps, T.V., Hi-Fi, Household Appliances

Only **14<sup>95</sup>**

- Turns Lights and Appliances On and Off From Anywhere In Your Home—By Remote Control!
- A Lafayette Exclusive! • Simply Plug In and Operate!

Now you may turn on or off any electrical device from anywhere in your home or shop. The Lafayette wireless remote control requires no additional wires. Simply plug in your transmitter wherever you choose in the house, and the appliance, TV, hi-fi system or lights that are plugged in to the receiver will be turned off or on by pressing the button on the transmitter. Perfect for viewing TV or listening to hi-fi in bed. When you get sleepy press the switch and turn everything off. Safe! Simple remote switch of lights, lamps, radios, TV and appliances. Transmitter and Receiver operate on ordinary house current receiver accepts any 105 to 120 volt device up to 300 watts. Imported. Shpg. wt., 2 3/4 lbs.

99 T 91183 Complete Transmitter & Receiving Unit . . . . . Net 14.95  
99 T 91707 Extra Transmitter. Shpg. wt., 1 1/4 lbs. . . . . Net 3.95



## AUTOMATIC OUTDOOR LIGHT CONTROL

- Turns Lights On At Dusk/Off At Dawn Automatically
- Easily Screws Into Fixture Socket

Helps prevent burglary . . . vandalism . . . accident by turning on all your outdoor lights at home, store, office, factory, signs, etc. Screws into any standard or floodlight socket. Compact, requires only 1 7/8" of additional clearance in fixture. Weather resistant. 300 watts. U.L. listed. Shpg. wt., 1 lb. 12 T 28527 . . . . . Net 3.95



## AUTOMATIC PHOTO-ELECTRIC LIGHT CONTROL

Only **3<sup>95</sup>**

- Turns Lights On At Sunset Off At Sunrise



Automatically turns lights on at dusk and off at dawn. Helps to prevent burglary, vandalism, and accidents. Just attach to lamp cord and plug into wall socket for automatic light control. Responsive only to daylight . . . car lights, flashlights, or lightning will not operate unit. For 117V AC. 300 Watts. UL Listed. Shpg. wt., 9 oz. 12 T 28519 . . . . . Net 3.95

## FUSED POWER CONVENIENCE CENTER

Lafayette's power control center adds six, fused convenient outlets anywhere you choose. Designed to mount on walls, floor, benches, counter tops or for portable use. On/Off rocker switches and panel mounted On/Off indicator light. Built-in fused holder with replaceable 15 amp. fuse. Heavy duty 8-foot line cord. For 120 volts AC, 1500 watts. 15 amps. With Fuse. Imported. 99 T 92090 Shpg. wt., 1 lb. . . . . Net 3.95

Pkg. of 5 fuses for above . . . . . Net .81  
13 T 11679 . . . . .



## 600 WATT LIGHT DIMMER CONTROL

**4<sup>95</sup>**

- Full Range: Total Darkness to Maximum Brightness
- Replaces Any Ordinary Switch in Minutes

Convenient push-on, push-off control stays set at any lighting level. Pleasing lighting for any room in your home. Soft lighting for TV viewing and relaxing, bright light for reading and working. Easy to install in any standard wall box without complicated rewiring. Operates incandescent lamps to 600-watt capacity. Ivory plastic knob with brass finish insert. For 115 VAC. 60 Hz. Shpg. wt., 1 lb. 12 T 26505 Less wall plate . . . . . Net 4.95



## HOME WEATHER STATION

Only **11<sup>95</sup>**

- Thermometer—Barometer—Humidity Meter
- Mounted on Beautiful Wall-Panel

Three accurate dial-type instruments report barometric pressure, temperature and humidity. Finely etched precision calibrated 2 1/2" spun metal dials for easy reading. Heavy metalized finish has the warm glow of polished brass. Mounted on walnut grained panel in an ebony-grained and gold accented frame with a brass antiqued metal finial 17" x 7". For horizontal or vertical mounting. Shpg. wt., 2 1/2 lbs. 13 T 40041 . . . . . Net 11.95

Weather Station Base: Similar to above, only thermometer and humidity meter. Size: 12 1/2" x 7". Shpg. wt., 2 lbs. 13 T 40050 . . . . . Net 6.95



## DELUXE HOME WEATHER STATION

Only **15<sup>95</sup>**

- Deep Luster, Hand-Rubbed Finish
- Large, Easy to Read Dials

Beautiful three instrument home weather station incorporates a precise and sharply calibrated thermometer, barometer and humidity meter. Rich hand-rubbed, wood-grained finished case houses instruments and beautifully sets off spun golden, extra large, easy-to-read dials. Calibrations and markings are etched in black to stand out clearly. 20" tall case may be mounted vertically or horizontally. Elegantly styled instrument panel enhances any decor. Mounts simple to any wall in your home. Shpg. wt., 4 lbs. 13 T 40066 . . . . . Net 15.95

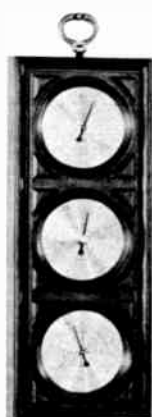

# Telephone Recorders, Intercoms & Dictating Machines

## CROWN 4400 Solid-State Telephone Answering and Recording Machine

featuring Built-in Cassette  
Tape Recorder



**199<sup>95</sup>**

No Money Down\*

With Dynamic Mils, Phone Cradle 60 Min Tape Cassette

- Requires No External Recorder
- Records Up To 45 Second Individual Incoming Messages
- Can Take Up To 50 Messages On A 90 Minute Tape Cassette
- Can Also Be Used As Outgoing Message Repeater



Optional RC-4 Direct  
Line Adapter — 19.95

Deluxe, complete self-contained telephone answering and recording machine with built-in cassette recorder and phone cradle. Answers your phone with a 20 sec. prerecorded message and automatically receives a message from the caller. Model 4400 can take up to 50 messages on a 90 minute tape. Features simple pushbutton controls. When a message is finished communication is cut off and another message can be received. With an optional RC-4 line adapter (see below), the 4400 can be plugged directly into the phone line, bypassing the phone itself. The 4100 can also be used as a message repeater or as a separate Tape Recorder. Comes housed in a fine-grained walnut wood cabinet. Size: 12 1/4" x 10 1/2" x 3 3/4". Uses Standard Cassette cartridges. Comes with 60 min. cassette microphone, and phone cradle. Imported. For 117VAC 60 Hz.  
27 T 72135WN Shpg. wt., 11 lbs. Net 199.95  
27 T 72150 Model RC-4 In-Line Adapter. Shpg. wt., 1 lb. Net 19.95

Accessory Cassette Recording Tapes for Model 4400

28 T 81223 Lafayette 60 Min. Cassette. Imported Net 1.18  
28 T 81267 Lafayette 90 Min. Cassette. Imported Net 1.98

## Security Intercoms and Viewers

### PROTECTO-COM SOLID STATE DOOR ANSWERING INTERCOM SYSTEM

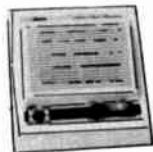

Complete  
System

**27<sup>95</sup>**

Includes:

- 1 Master Amplifier Control Station
- 1 Door Station
- 1 16 Volt Transformer
- 50 Ft. of 2 Conductor Cable

All Hardware Necessary For Installation

- Provides Protection—Identify Callers Without Opening Doors

A complete door answering intercom system designed for installation in new or existing homes. Easy-to-use "talk-listen" switch on master. Protects residents from unwanted callers. Inexpensive and easily installed. Comes complete with Master station, door station, transformer, 50 ft. of 2-conductor cable, and all hardware necessary for installation. Shpg. wt., 4 lbs.

44 T 37859 Net 27.95

32 T 38521 Extra 100 ft. coil of wire. Wt. 1/2 lb. Net 1.49

### ONE WAY DOOR VIEWER

Permits thru-the-door identification without being observed. One way viewing only—you can look out, no one can see in. Provides wide-angle view—you can see anyone standing or crouching even at the side of the door. Installs quickly with a simple hand drill. Requires 1/2" in diameter. Length adjusts to fit any standard door thickness up to 1 3/4" thick. Cannot be removed from the outside. Rust-proof. Zinc die cast. Wt. 4 oz.  
14 T 85829 Net .99



**99<sup>c</sup>**

## CROWN 4100 TELEPHONE RECORDER

Records Incoming Messages  
Up To 1 Minute in Duration  
With Any Tape Recorder with  
a Remote Control Mils Input

**79<sup>95</sup>**

No Money Down\*



Can be plugged directly into phone line using optional RC-4 Direct Line Adapter. Answers phone callers with up to 60 second prerecorded message. Incoming phone calls with optional recorder attached are recorded for up to 1-minute in duration. Can be played back at a later time at your leisure. Can also be used as a message repeater. With AC/DC remote control terminal, recording switch, and built-in mils. For 110VAC, 60 Hz. Imported.

27 T 72143W Shpg. wt., 6 lbs. Net 79.95

27 T 72150 Model RC-4 In-Line Adapter. Shpg. wt., 1 lb. Net 19.95

27 T 72181 1-Minute Message Tape For -4100 Net 4.95

Lafayette RR-65 Cassette Tape Recorder. Imported.

98 T 15826L Shpg. wt., 4 lbs. Net 19.95

## CROWNSCRIBER CASSETTE DICTATING/TRANSCRIBING MACHINE

**199<sup>95</sup>**

- Seven Second Repeat Feature

Solid State Cassette dictating/transcribing machine with a 7 second repeat feature. Patented foot pedal control starts and stops the "Crownscriber." In stop position, the transcriber can repeat the last 7 seconds of the message. Pushbutton controls for record, rewind, forward, fast forward, stop. Uses standard size 30, 60, and 90 minute cassette tapes. For dictating, a remote control start/stop mike controls the Crownscriber. Size: 11" x 11" x 5 1/4". Shpg. wt., 8 lbs. For 117 VAC 6 volts. Imported.  
27 T 72178WN No Money Down\* Net 199.95



# it's easy to shop at LAFAYETTE

## BY MAIL

Fill in any Lafayette order blank, enclose check and mail. Your order will be shipped direct to your home. See parcel post and express charts below to figure shipping charges.

## BY PHONE

Dial 516 921-7500 and a trained personal service shopper will help you. Your order will soon be on its way to your home.

## IN PERSON

Visit any of our conveniently located stores. Specially trained sales personnel will assist you. See opposite page for store nearest you.

## Take Advantage of Lafayette's EASY-PAY PLAN NO MONEY DOWN — UP TO 2 YEARS TO PAY

See Page 13 for Full Credit Details on Easy Pay Plan

## SHIPPING AND DELIVERY INFORMATION

Use our Order Blank . . . To assure fast delivery fill in all information requested (Please Print). Always give your Zip Code! We'll send you new order blanks each time you order.

**Cash Orders** . . . Please remit full amount, including amount you calculate for shipping charges, tax, handling charge or insurance. We refund any excess.

**COD Orders** . . . Ordering by COD is more expensive for you. You pay an extra fee (see COD Chart). For COD orders you

must send a deposit and pay the balance when your package arrives. No COD's under \$10.00.

**Easy Pay Orders** . . . Indicate on the order blank whether a "new" or "add-on" Easy Pay order and fill in all information requested on back of the order blank.

**Shipping Weights** . . . All weights shown in this catalog are as accurate as we can determine. Use these weights and rate charts to determine shipping charges.

### PARCEL POST SHIPMENT

Parcel Post Rate Chart Items Keyed "WUX" or "WX" are not shippable Parcel Post (Example = 18-0182WX). Figure Parcel Post Charges only for items not keyed WX or WUX. (See REA Express information.)

WEIGHT 1 Lb. & Not Exceeding	Parcel Post Rate Chart Items Keyed "WUX" or "WX" are not shippable Parcel Post (Example = 18-0182WX). Figure Parcel Post Charges only for items not keyed WX or WUX. (See REA Express information.)							
	Local	1st & 2nd Zone up to 150 mi.	3rd Zone 150 to 300 mi.	4th Zone 300 to 600 mi.	5th Zone 600 to 1000 mi.	6th Zone 1000 to 1400 mi.	7th Zone 1400 to 1800 mi.	8th Zone Over 1800 mi.
2	\$0.60	\$0.65	\$0.70	\$0.75	\$0.80	\$0.90	\$1.00	\$1.05
3	.60	.75	.80	.85	.95	1.10	1.30	1.35
4	.65	.80	.85	.95	1.10	1.30	1.40	1.60
5	.70	.85	.90	1.05	1.20	1.45	1.65	1.90
6	.70	.95	1.00	1.15	1.35	1.60	1.85	2.10
7	.75	1.05	1.10	1.25	1.50	1.75	2.10	2.35
8	.75	1.10	1.15	1.35	1.60	1.90	2.30	2.60
9	.80	1.15	1.20	1.45	1.75	2.05	2.45	2.85
10	.80	1.20	1.30	1.55	1.90	2.20	2.65	3.10
11	.80	1.25	1.35	1.60	2.00	2.30	2.85	3.35
12	.85	1.30	1.45	1.70	2.10	2.45	3.05	3.55
13	.85	1.35	1.55	1.80	2.20	2.60	3.25	3.80
14	.90	1.40	1.60	1.90	2.35	2.75	3.45	4.00
15	.90	1.45	1.65	2.00	2.45	2.85	3.60	4.20
16	.95	1.55	1.75	2.05	2.55	2.95	3.80	4.40
17	1.00	1.60	1.80	2.15	2.65	3.10	3.95	4.60
18	1.00	1.65	1.90	2.20	2.75	3.20	4.15	4.80
19	1.05	1.70	2.00	2.30	2.85	3.35	4.30	5.00
20	1.05	1.75	2.05	2.40	2.95	3.50	4.50	5.20
For Each Extra Lb.	Add 5c	Add 5c	Add 5c	Add 5c	Add 10c	Add 10c	Add 15c	Add 15c

### RATES EFFECTIVE NOV. 14, 1970

A Above rates effective Nov. 14, 1970—Use previous catalog or consult local postmaster for old rates. Any excess money refunded.

### REA EXPRESS INFORMATION

Items not shippable Parcel Post or UPS are sent Railway Express. The Letters WX or WUX identify these items. DO NOT SEND MONEY for express charges with your order. Express charges are collected upon delivery at no extra cost to you. Insurance is included in your express rates. Be sure to specify your nearest Express Office if there is no agent in your town.

### APPROXIMATE REA EXPRESS CHARGES

Zone	1 & 2	3	4	5	6	7	8
	0-150 Miles	151-300 Miles	301-600 Miles	601-1000 Miles	1001-1400 Miles	1401-1800 Miles	1801 & up Miles
Pounds	Local	\$6.85	\$7.85	\$8.75	\$9.75	\$10.90	\$12.00
1-25	\$6.05	\$6.85	\$7.85	\$8.75	\$9.75	\$10.90	\$12.00
26-50	6.55	7.75	9.25	10.55	12.10	13.85	15.45
51-75	7.05	8.60	10.70	12.40	14.40	16.70	18.90
76-100	7.55	9.45	12.00	14.15	16.65	19.50	22.30
over 100 lbs.							
Add per lb.	.08c	.10c	.12c	.14c	.17c	.20c	.22c

### AIR PARCEL POST SHIPMENTS

We will ship your order via Air Parcel Post upon your request. Rates are given in the table, below. Size and weight limits: 70 lbs. and 100 in. (length plus girth).

10c per ounce, up to 7 ounces							
ZONES 1, 2 & 3 4 5 6 7 8							
1st Lb.	.80	.80	.80	.80	.80	.80	.80
For Each Extra Lb.	Add 48c	Add 50c	Add 56c	Add 64c	Add 72c	Add 80c	Add 80c
U.S. Territories, Possessions and APO & FPO Addresses, 80c per lb.							

### MINIMUM ORDER CHARGE

ORDERS UNDER	\$5.00	.50
PARCEL POST	\$5.00 to 15.00	20c
HANDLING	15.01 to 50.00	30c
CHARGE	50.01 to 100.00	40c
	100.01 to 150.00	50c
	151.01 to 200.00	60c

### UNITED PARCEL DELIVERY

If your area is serviced by UPS and the service or rates are to your benefit, we will route your order via United Parcel Service. This fast, economical service is available from New York to most of the eastern states for parcels up to 50 lbs. and 108 inches in length and girth.

# MAIL ORDER and Sales Center

All Departments 516 921-7700  
Open Mon., Thurs.,

111 Jericho Turnpike  
(west of So. Oyster Bay Rd.)  
**Syosset, L. I., N. Y. 11791**

C.O.D. Orders Only 516 921-7500  
Fri. 'til 9:30 P.M.

Our modern Mail Order Headquarters, located on over 8 acres of land, includes expanded warehouse facilities plus the most modern handling equipment to give you quicker service. Within 24 hours after receipt, most orders are processed, picked, wrapped and shipped.

## 40 Convenient Locations

Visit the Lafayette Store nearest you for fast personalized service. See the catalog "came to life" and many other exciting displays of the latest products just released. Associate Stores From Coast To Coast. Watch for New Grand Openings.

### NEW YORK

**BROOKLYN 11226**  
2265 Bedford Ave. (cor. Snyder Ave.)  
Phone: 212 469-8900

**BUFFALO (Amherst) 14226**  
Sheridan Shopping Center  
(3600 Sheridan Dr.)  
Phone: 716 833-2826

**HEMPSTEAD 11550**  
120 N. Franklin St.  
Phone: 516 538-6464

**JAMAICA 11433**  
165-08 Liberty Ave.  
(Off Merrick Rd.)  
Phone: 212 291-7000

**LAKE GROVE 11755**  
2848 Middle Country Rd.  
(Rt. 25—1/4 mile E. of Smithhaven Mall)  
Phone: 516 585-3600

**LYNBROOK, L. I., N. Y. 11563**  
381 Sunrise Highway  
(2 miles East of Green Acres)  
Phone: 516 887-9800

**NEW ROCHELLE 10801**  
218 North Ave. (opp. Macy's Mall)  
Phone: 914 235-5101

### MASSACHUSETTS

**BOSTON 02215**  
584 Commonwealth Ave.  
(1/2 block above Kenmore Sq.)  
Phone: 617 267-8900

**NATICK 01760**  
1400 Worcester St.  
(Rt. 9 opp. Shopper's World)  
Phone: 617 875-6146

**SAUGUS 01906**  
Saugus Plaza Shopping Center  
(Rt. 1 & Walnut St.)  
Phone: 617 233-6710

**WEST ROXBURY 02132**  
1530 V.F.W. Parkway  
(1 mile north of Dedham Mall)  
Phone: 327-0300

**N.Y.C. - 45th STREET 10036**  
49 West 45 St.  
(between 5th-6th Aves.)  
Phone: 212 757-3121

**N.Y.C. - UNION SQUARE 10003**  
17 Union Square West (cor. 15th St.)  
Phone: 212 924-4433

**N.Y.C. - WARREN ST. 10007**  
45 Warren Street  
(between Church and W. Broadway)  
Phone: 212 964-0334

**ROCHESTER-IRONDEQUOIT 14621**  
999 Ridge Road East  
(Carter St. exit of Keeler Expressway)  
Phone: 716 467-1310

**ROCHESTER - PITTSFORD 14618**  
(Opposite Pittsford Plaza)  
3330 Monroe Av. (Adjoining Arlan's)  
Phone: 716 586-6331

**SCARSDALE 10583**  
691 Central Ave.  
(1/2 mile north of Ardsley Rd.)  
Phone: 914 472-2700

**SYOSSET 11791**  
111 Jericho Turnpike  
(west of So. Oyster Bay Rd.)  
Phone: 516 921-7700

### CONNECTICUT

**HAMDEN 06514**  
Hamden Plaza  
(2100 Dixwell Ave., adjoining Pagnataro's)  
Phone: 203 248-2182

**WEST HARTFORD 06117**  
Bishop's Corner Shopping Center  
(357 North Main St. cor. Albany Ave.)  
Phone: 203 236-0693

**COLUMBUS 43213**  
Great Eastern Shopping Center  
(Hamilton Rd. & Main St.)  
Phone: 614 861-8660

**COLUMBUS 43224**  
(Northern Lights Shopping Center)  
3395 Cleveland Avenue  
Phone: 614 267-3106

### MARYLAND

**CATONSVILLE 21228**  
(Rolling Rds. & Route 40)  
Baltimore  
Spring 1971

**TOWSON 21204**  
815 Taylor Avenue  
(Loch Raven Plaza)  
Phone: 301 825-7750

### PENNSYLVANIA

**KING OF PRUSSIA 19406**  
King of Prussia Shopping Center  
(Routes 202 and 23)  
Phone: 215 265-3300

**LANCASTER 17603**  
2152 Lincoln Plaza  
(Adjoining Two Guys)  
Phone: 717 397-3681

**MONROEVILLE 15146**  
Monroe Plaza Shopping Center  
4045 William Penn Highway  
Phone: 412 373-0060

**PHILADELPHIA 19095**  
Wyncote (Cheltenham Township)  
8156 Ogontz Ave.  
Phone 215 885-2140

**PITTSBURGH 15237**  
North Hills Village Shopping Ctr.  
4801 McKnight Road  
Phone: 412 366-0810

**BRIDGEVILLE 15017**  
(Great Southern Shopping Center)  
Phone: 412 221-7888

### GEORGIA

**DECATUR 30032**  
4610 Memorial Drive  
(Grant City Shopping Center)  
Phone: 404 292-3474

**SMYRNA 30080**  
Spring 1971

### NEW JERSEY

**NEWARK 07102**  
24 Central Ave. (west of Broad St.)  
Phone: 201 622-1661

**PARAMUS 07652**  
182 Route 17  
(1 mile north of Garden State Plaza)  
Phone: 201 261-8800

**PLAINFIELD 07060**  
139 W. 2nd St.  
(1 block east of Front St.)  
Phone: 201 756-5100

**TOTOWA 07512**  
410 Route 46  
Phone: 201 785-1763

### VIRGINIA

**FALLS CHURCH 22044**  
Plaza 7 Shopping Center  
(cor. Wilson & Roosevelt Blvd.)  
(across from 7 corners)  
Phone: 703 534-5772

### OHIO

**TOLEDO 43613**  
Miracle Mile Shopping Center

**PARMA HEIGHTS 44130**  
6425 Pearl Road  
Fall 1970

**MT. RAINIER/HYATTSVILLE 20822**  
3191 Queens Chapel Rd. (Rt. 500)  
(Queenstown Shopping Center)  
Phone: 301 779-7020

For Store Hours — Check The Store In Your Location



# Telephone and Accessories for Private Systems

## DIAL PHONE



**9<sup>95</sup>**

Popular modern dial phone. Can be used to make complete private systems or add to your present system. Equipment taken from service, reconditioned and ready to work. Simple 3-wire hook-up. Complete with handset, dial bell, induction coil and connecting cable. General appearance may vary slightly from catalog illustration. Shpg. wt., 6 lbs.  
44 T 18018 Net 9.95

## "PRINCESS-DUTCHESS" TYPE DIAL TELEPHONE

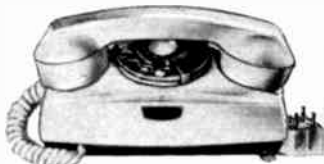

**34<sup>95</sup>**

With 6 Ft. Coiled Cord and Plug

Add a touch of elegance to your decor with the "Princess-Dutchess" type-dial phone. Can be used to make complete private systems or add to your present system. Comes complete with built-in ringer, metropolitan dial (bells and numbers), ear piece, transmitter, and 6 ft. coiled cord with plug. Beautiful pearl white finish. Imported. Shpg. wt., 5 lbs.  
44 T 17010 No Money Down\* Net 34.95

## "BONNIE & CLYDE" EXTENSION TELEPHONE

**44<sup>95</sup>**  
No Money Down\*



With 4 1/2 Ft. Cord and Plug

- Handsome Styling in Black With Gold Trim
- Equipped With Electronic Components Compatible To Telephone Co. Systems

Magnificent reproduction of the early phones used in the twenties and thirties. Complete with dial, ringer, induction coil, 4 1/2 ft. cord & plug. Size: 12"H. Diameter of Base 6".  
44 T 24009 Shpg. wt., 8 lbs. Net 44.95  
Deluxe All-Brass Bonnie & Clyde Phone. Same as above, but all brass.  
44 T 24016 Shpg. wt., 8 lbs. Net 49.95

## FRENCH CRADLE PHONE



**44<sup>95</sup>**

With 5 Ft. Cord and Plug

An exquisite reproduction of the classic turn-of-the-century French Cradle Phone. Adds a touch of continental charm to your home—your phone will become a conversation piece. Simple hook-up. Ready to use . . . equipped with bell ringer, induction coil, dial, horn, mouthpiece handset, 5-ft. cord and plug. Finished in beautiful ivory with gold trim. Imported. Shpg. wt., 9 lbs.  
99 T 46328 No Money Down\* Net 44.95

## ERICA PHONE

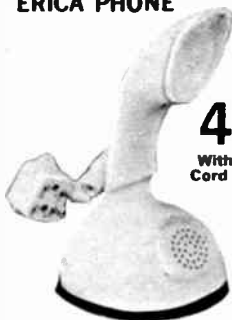

**49<sup>95</sup>**

With 4 1/2 Ft. Cord and Plug

One of the most modern of all phones in use today. Add to your present phone system. Comes complete with dial, buzzer, induction coil, and 4 1/2 ft. cord and plug. Beautiful pearl white finish. Size: 8 1/2"Hx5 1/2"Lx4 1/4"W. Imported. Shpg. wt., 5 lbs.  
44 T 24040 No Money Down\* Net 49.95

## Deluxe LAFAYETTE EASY-PHONE TELEPHONE AMPLIFIER

**12<sup>95</sup>**  
with batteries



- 4-Transistors
- No Warm-up, Instant Operation
- No Pick-ups To Connect
- Amplifies Telephone To Room Volume

The Easy-Phone amplifier is ideal for group conversation with one telephone in the room. Easy to operate, simply place the telephone on the amplifier, adjust the volume and everyone can listen through the separate matching speaker system, leaving both hands free for writing or typing. The Easy-Phone utilizes a 4-transistor battery powered amplifier and inductive pick-up, in an attractive plastic case. Features separate 3" speaker, volume control, on/off switch. Imported.  
Dimensions — Amplifier Section: 8Wx3 1/2Hx 3 1/2"D. Speaker Section: 3 1/2Wx2 1/2Hx4 1/8"D. Supplied with batteries. Shpg. wt., 3 lbs.  
99 T 92068 Net 12.95  
Replacement "AA" Type Batteries (4 req.) 99 T 62580 Net .10

## 30 FT. TELEPHONE EXTENSION CORD

**2<sup>49</sup>**



Add flexibility to your telephone intercom. Now be able to move your telephone intercom from room to room. 30 feet of telephone extension cord with standard 4-pin plug and jack. Color coded cord to match screw terminals on plug and socket. Imported. Wt., 1 1/2 lbs.  
99 T 45395 Net 2.49

## TELEPHONE PLUGS AND JACKS

44 T 60036 Phone Plug 2 oz. Net .49  
44 T 60028 Phone Jack 2 oz. Net .49

## MINIATURE "SNAP-ON" TELEPHONE AMPLIFIER AND HEARING AID

**6<sup>95</sup>**

- Ideal For Hard of Hearing



Can be carried in a pocket or purse. Designed to fit any modern telephone. Attaches to the receiver of the phone you are using. 4-transistors, 2" dynamic speaker. Size: 2 3/8" round, 1" depth. With battery and snap-around band. Imported.  
99 T 92082 Shpg. wt., 1 lb. Net 6.95

# LAFAYETTE Intercoms for Home or Business



## 2-STATION SOLID-STATE INTERCOM SYSTEM

**895**

With Battery

- Battery Operated
- Inter-Unit Tone Calling
- Simple Plug-In Connecting Cord

Battery operated solid-state 2-station intercom system. Especially useful where AC outlets are not readily available. Complete system includes 1-Master unit, 1-Remote unit, and 70' of interconnecting cable with molded plugs for easy installation. Master unit features On/Off/Volume control plus a Listen/Talk switch. "Beep" tone signaling from either Master or Remote operates even when Master is "Off". Has simple provision for stationary wall mounting. Or, can be conveniently placed on desk top. 9-volt battery included. Size: 2H x 3 1/2"W x 5"D. Shpg. wt., 1 1/2 lbs. Imported.

99 T 46245 2-Station System ..... Net 8.95  
99 T 60212 Extra 9-Volt Battery ..... Net .21



## 4-STATION SOLID-STATE INTERCOM SYSTEM

**1895**

Includes 1 Master Control Unit, 3-60 Ft. lengths of hook-up wire, 3 Remote units, 1-9 volt battery

4-station intercom system with 1 Master and 3 Remotes. All interstation calling is accomplished with one 4-way selector switch. Push-button listen-call on all units. Call signal operates even when master switch is "off". Simple coded interruption of buzzer signal lets master operator know which remote is calling. Master unit has its own volume control with "on-off" switch Easy hook-up is facilitated by inclusion of three 60 foot lengths of 2-conductor wire with jacks at each end. Additional wire is available at extra cost. See below. Size: Master: 4 1/2"W x 3 1/2"D; Remotes: 2"W x 4"D. Imported. Shpg. wt., 2 1/2 lbs.

Complete 4-station System  
99 T 45551 ..... Net 18.95  
Replacement 9-volt Battery (1 Req.)  
99 T 60212 ..... Net .21  
Additional wire. 100 Ft. Coil  
32 T 30521 ..... Net 1.49

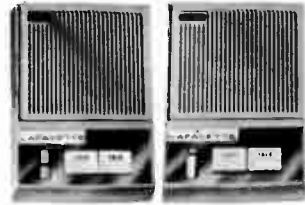

## 2-STATION SOLID-STATE WIRELESS INTERCOM SYSTEM

• No Installation Required—Just Plug In and Talk

**1995**

- Instant-On Operation—No Warm-Up
- Operates from any 117V AC/Outlet

A highly efficient wireless intercom system that simply plugs into standard 110V 60Hz AC outlets. Your voice is transmitted thru this electric power line. Talk-Lock button for monitoring baby's room or long time talking. Solid state circuitry for instant-on communication. Highly efficient speaker-microphone. Operates on very low voltage for pennies a week. Each unit is a master so you can use as many intercoms as you need. High impact styrene cabinet. On/off switch—volume control. Pilot light. Size: 3 7/8"W x 5 1/2"D x 1 3/4"H. Imported. For 110VAC, 60 Hz.  
99 T 46278 Shpg. wt., 3 lbs. .... Net 19.95

## LAFAYETTE 2-Station Telephone Intercom System



**SAVE 5.00**

**NOW 12<sup>95</sup>**

WAS 17.95  
1970 Cat. 704

Solid state circuitry transmits your voice over amazingly long distances. Operates on 4 "D" batteries. Separate call button and push-to-talk button. Buzzer indicates when you are being called. Requires 2 conductor cable for hook-up with batteries. Size: each phone 9L x 2 3/4"H x 3 1/4"D. Imported.  
99 T 46211 Shpg. wt., 2 lbs. .... Net 12.95  
100' 2 conductor cable. Shpg. wt., 2 lbs.  
32 T 30521 ..... Net 1.49

4 Station System—Same as above but with 4 phones. Imported. Shpg. wt., 8 lbs.  
99 T 46229 ..... Net 19.95  
Belden 8742 Cable for 4 Sta. System.  
32 T 15803 ..... Net 6.12

90 Lafayette Cat. No. 711

## Deluxe Wireless Intercom System

**SALE**  
**SAVE 5.00**  
**NOW 27<sup>95</sup>**



WAS 32.95 1970 Cat. 700

- Operates from any 117V AC/DC Outlet
- No Wires to Connect

- Ideal for Home or Office
- Add as Many Extra Stations as Desired

Handsomely styled, these units offer quality performance for home or business use. Each unit features a 3-position bar-control lever: Dictate (for use as "baby sitter," lengthy talking), Talk (has spring return to Listen position), and Listen. No wires to connect—simply plug into any 117V AC/DC outlet. Front panel volume control and pilot light; adjustable squelch control at rear reduces interference during quiet periods. Dependable 3" speaker. Add as many remotes as needed. Imported. Shpg. wt., 10 lbs.  
99 T 45478M 2-Station Intercom System ..... Net 27.95  
Extra Station. Imported. Shpg. wt., 5 lbs.  
99 T 45445 ..... Net 14.95

Take Advantage of Lafayette's Low PA Prices

# Quality LAFAYETTE Test Instruments

LAFAYETTE "SUPER MINI" AC/DC VOM

**6<sup>95</sup>**

- Only 3½Hx2¼Wx1¾"D.
- Reads AC/DC Volts To 1200 Volts
- 8-Input Ranges
- 4-Reading Scales
- Separate Red Scale For Low AC Reading

Highly accurate, low cost multimeter: Handy to use anywhere by technicians, hobbyist or home owners for trouble shooting electronic circuits and testing appliances. Ranges: AC/DC voltage, 0-12, 0-120; and 0-1200; DC current, 0-1mA and 0-120mA. Reads resistances from 0 to 200,000 ohms. Easy to read red scale for low AC readings. 1% resistors offer precise readings. Sensitivity: 1000 ohms per volt. Zero ohms adjust. Operates on 1.5 volt "Z" cell. Complete with test leads and battery.

99 T 50791 Imported, Shpg. wt., 10 oz.

Net 6.95

99 T 50809 Pigskin Carrying Case for above. Shpg. wt., 5 oz. Net 1.49



LAFAYETTE 20,000 OHMS PER VOLT  
MULTITESTER WITH MIRROR SCALE

Only **10<sup>95</sup>**

- 20,000 Ohms/Volt DC, 10,000 Ohms/Volt AC
- 1% Precision Resistors
- Low Voltage Scale For Transistors
- Built-in Overload Protective Circuitry



40 µA, D'Arsonval meter movement permits a high input resistance on all ranges. Features a Mirror Scale. Rugged high impact plastic case. Ranges (DC Volts): 0-3, 30, 60, 300, 600, 3,000V; AC Volts: 0-6, 60, 120, 1200V. DC Current: 0-60, µA, 0-12, 0-300 ma. Resistance: 0-60K, 0-6 megohms. Decibels: -20 to +63 db. Audio output jack. Easy-To-Read 3" Meter with test leads and 1½V battery. Size: 3¼x4½x1". Imported, Shpg. wt., 1 lb.

99 T 50726

Net 10.95

Net 1.95

QUALITY LAFAYETTE TUBE AND  
TRANSISTOR CHECKER

Kit  
**29<sup>95</sup>**

Wired  
**39<sup>95</sup>**

- Checks Tubes For Shorts, Leakage, Intermittants, and Quality
- Checks Transistors For AC Current Amplification

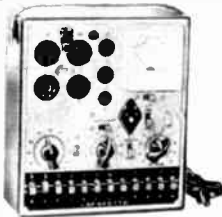

Easy, step-by-step wiring and assembly instructions. Enjoy big dollar savings when you build this fine tube and transistor tester kit. Tube section features testing of compactrons, novistors, novars, and 10-pin tubes in addition to 7- and 9-pin miniatures, octals, and loctal types. Quality is indicated directly on an easily read, 3-color meter scale. Each section of multi-purpose tubes is checked separately. Obsolete part: Unique switching arrangement allows new tubes to be tested as they become available. Checks transistors: PNP and NPN, high or low power, for AC amplification. High impact bakelite case with carrying strap. Supplied with batteries full instructions, and ring bound manual of tube charts. For 110 VAC 60 Hz. Size: 8½ x 7½ x 4". Shpg. wt., 5 lbs.

38 T 01123W

Net 29.95

As above wired and tested.

38 T 01131W

Net 39.95

DELUXE LAFAYETTE 30,000 OHMS  
PER VOLT MULTITESTER  
WITH MIRROR SCALE

Only **18<sup>95</sup>**

- 30,000 Ohms Per Volt DC, 15,000 Ohms per Volt AC
- Low Voltage Scale For Transistors
- 1% Precision Resistors
- Unique "Buzzer" for Fast Short Tests
- Built-in Overload Protective Circuitry
- 27 Meter Ranges



A deluxe portable VOM with a Mirror Scale. Provides wide voltage, current, resistance and db ranges clearly visible on a large 4" meter with 2-color calibrations. Sensitive 33 microamp meter provides full scale readings down to ¼ volt on DC and 0.05 milliamperes. Ranges: DC volts 0-25, 1, 2.5, 10, 25, 100, 250, 500, 1000; AC volts 0-2.5, 10, 25, 100, 250, 500, 1000. DC Current: 0-0.05, 5, 50, 500 ma; 0-12 amps. Ohmmeter: 0-60K, 6 Meg., 60 Meg. Db's: -20 to +56db. Controls: Range Switch, Ohms Adjust. Audio output jack with DC blocking capacitor, built-in overload protective circuitry. With leads, batteries, 4¾x6¼xHx2"D. Imported, Shpg. wt., 2 lbs.

99 T 50718

Net 18.95

38 T 01081 Pigskin Carrying Case for above

Net 1.95

## Deluxe LAFAYETTE 100,000 Ohms Per Volt VOM

**SALE**

**29<sup>95</sup>**

WAS **34<sup>95</sup>**

1970 Cat. 702

- 100,000 Ohms Per Volt DC
- Giant Easy-to-Read 6½" Scale
- 2% Accuracy on DC; 3% on AC
- Low Voltage Range for Transistor Testing
- Built-in Meter Protection on All Ranges

Deluxe laboratory-type volt-ohm milliammeter with performance that satisfies virtually any lab or shop requirement. Unique yellow function selector visually indicates exact range being used—thus eliminating chance or error. Completely self-contained, advanced circuitry features ½% precision resistors and 100,000 ohms-per-volt input resistance on DC. Measures voltage in sensitive circuits with precise accuracy. Large, easy-to-read 6½" 2-color meter has a 90° arc for greater legibility and accuracy plus built-in protection against burnout and bent pointers. Provides full coverage with thirty-three ranges for optimum flexibility. Case has carrying strap. Size: 8W x 6¾H x 3¾"D. With batteries and test leads. Imported, Shpg. wt., 4½ lbs.

99 T 50650 No Money Down\*

Net 29.95

38 T 01099 Carrying Case for above

Net 4.95

### SPECIFICATIONS

Sensitivity: 100K ohms/volt DC, 5k ohms/volt AC. Ranges: DC 0-5-2.5-10-50-250-500-1000 v. AC 0-3-10-50-250-500 1000 v. DB: -10 to +49.4 in 4 ranges. DC Current: 0-10-100 µA, 0-10-100-500 ma, 0-2.5-10 amps. Resistance: 0-1k-10k-100k-10M-100 meg-ohms ± 2%. Meter Movement Sensitivity: 9µA for full scale deflection. Output: to 250 v with built-in series capacitor.



**Save \$5.00**

\*See Page 18 for Full Credit Details on Easy Pay Plan

**RAM**

**1/4" DRILL**

*fury*



**SALE 8<sup>95</sup>**  
**SAVE 10%**  
SALE ENDS DEC. 31, 1970

- 2.5-Amp UL Listed Motor
- Jacobs Geared Chuck & Key
- Multiple Thrust Bearings

Model F-11 popular drill or all-around home and hobby use. 1/4" geared chuck drill rated at full 2.5 amps. UL listed. 1/4" capacity in steel, 1/2" in hardwood. 1200 RPM speed under full load; 2000 RPM no-load speed. Precision anti-friction bearings. Automatic trigger switch. Specially designed gear train for maximum torque transfer. For 115 volts. AC/DC. Shpg. wt., 3 1/2 lbs.

13 T 71012

Net 8.95



**McGRAW EDISON**

**HUSKY 3/8" DRILL 11<sup>95</sup>**

- 3 AMP UL Listed
- Auxiliary Left or Right Handle
- Double Reduction of Gears

A rugged, powerful 3/8" drill for tough drilling jobs around the house and shop. Features double reduction gears for maximum torque. No load speed 1000 rpm. Capacity 3/8" in steel, 1" in wood. Ball thrust bearing takes the full drilling load. Welded commutator leads prevent motor burnout. Geared key chuck, 3-conductor power cord. Bright finish. For 120 VAC, 50-60 Hz. Shpg. wt., 4 1/2 lbs.

13 T 36551

Net 11.95



**SKIL**

**3/8" Drive-R Drill**

- With Adjustable Trigger Speed Control
- Pre-set Maximum Speed You Desire  
—Forward or Reverse
- Drill Locks At Any Speed From  
0-1000 RPM

**29<sup>99</sup>**

Model 457 double insulated Drive-R-Drill for safety—Two-prong plug eliminates the need for any adapter. Squeeze the trigger for more speed and torque. Lock it for any desired constant speed without pressure. Powerful, 3 amp, super burnout protected motor; large Chuck capacity for drilling, driving, and removing applications. Double reduction high torque helical gears give extra torque, steady power. Removable side handle. Heavy duty geared chuck with key. 6 ft. 2-wire cord and plug. For 115 VAC, 60 Hz. UL listed.

13 T 69396

Shpg. wt., 4 1/2 lbs. Net 29.99

**RAM** *fury*

## 50 Piece Power Workshop

WITH 3/8" VARIABLE TRIGGER SPEED CONTROL DRILL

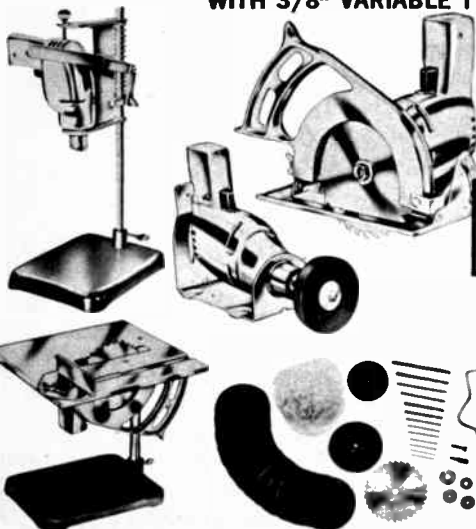

**Complete Kit Only**

**29<sup>95</sup>**

Powerful! Efficient! Flexible! Rugged 3/8" variable speed power drill with 3/8 HP 3 Amp universal motor is capable of performing most any job around workshop and home. Squeeze the trigger for any speed you desire from 0 to 1,000 RPM. Complete assortment of attachments includes: Jacobs geared chuck and key, tilting top saw attachment, crosscut and rip saw blade, horizontal bench stand, lambswool polishing bonnet, 13 pc. drill kit, rubber backing pad, steel paint mixer, grinding wheel, 6 pc. adapter set, steel saw table with protractor and mounting post, drill press with mounting post and stand, and 15 pc. sanding disc set (5 fine, 5 med., 5 coarse). Drill features multiple thrust bearings and locking button on handle for constant speed without holding trigger. Bright mirror finish with pistol grip handle for easy handling. With instruction book. Drill UL listed. For 115 volts AC, 60 Hz. Shpg. wt., 12 lbs.

13 T 71293W

Net 29.95

13 T 71244Y Drill Only. Shpg. wt., 3 1/2 lbs. Net 15.95

## 7 1/4" BUILDERS' SAW

- 1 1/2 HP Burnout Protected Motor
- 5200 RPM No Load Speed 10 Amp Motor
- UL Listed

Model 574 Tackle the "big" jobs, with this dependable 7 1/4" builders' saw. Reinforced die-cast housing that really stands up. Cuts 2x4's with ease, at 45° angle. Easy set bevel and depth adjustments. Safe non-binding blade guard with vari-torque safety clutch. Sawdust ejector keeps your work clean, lets you see what you are doing. 7 1/4" combination blade and blade wrench. Powerful 1 1/2 HP motor is designed to be trouble free. Cutting depth: 90° 2 3/4", 45° 1 7/8", 10 amps. UL listed. 115 volts AC, 3 wire cord and plug. Shpg. wt., 11 1/2 lbs. See rip fence below.

13 T 69263 ..... Net 29.99

13 T 69123 Rip Fence ..... Net 1.99

Carrying Case for Above Saw

13 T 69370 Shpg. wt., 4 lbs. .... Net 9.95

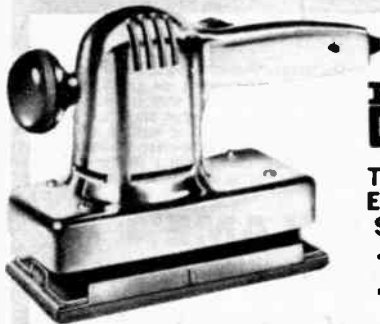

### RAM GO

#### TWO-WAY ELECTRIC SANDER

## 19<sup>95</sup>

- Orbital or Straight Line

Heavy-duty electric sander with 3/16" orbital or straight line stroke. Features 3.5 amp. universal series wound motor. Heavy-duty ball bearing and self-lubricating sleeve bearings. Pad size: 3" x 7 1/4"; sand-paper size: 3" x 9". Assorted grit paper included. Industrial mirror finish. 6 ft. 3-cond cord. For 115 V 60 Hz. AC-DC. UL listed: 13 T 71020 Shpg. wt., 5 1/2 lbs. .... Net 18.95

## HEAVY DUTY HANDYMAN SPRAYER

## 34<sup>95</sup>



- Integral Compressor Motor
- Spray Oils, Paints, Insecticides, Liquid Wax

Economy priced portable sprayer designed for the homeowner and hobbyist. Precision engineered throughout to give professional results. Compact, lightweight, versatile...perfect for those dozens of small jobs around the house, wherever and whenever spraying is needed. The spray gun easily handles paint and other types of sprayable material. Sprayer unit features an internal mix spray gun, adjustable spray pattern, quart aluminum canister with a delrin thread insert to prevent fouling and 8' air hose. Easy to operate, just plug in any 115 v. outlet. Air delivery 1.5-2 CFM at 15-20 PSI. 7 ft. power cord. Shpg. wt., 16 lbs.

14 T 67939 No Money Down" ..... Net 34.95

## "JIFFY" VARIABLE MOTOR SPEED CONTROL

- Varies Speed on AC-DC Motors From 0 RPM To Full Speed
- Ideal For Electric Drills, Saws, Polishers

## 9<sup>95</sup>

Dependable motor speed control ideal for workshop power tools using universal AC-DC and series DC motors. Assures constant speed variation from zero rpm to maximum speed. Has built-in circuit breaker. 5 amps load rating. Input: 120 volts 50-60 Hz AC. 3-wire receptacle and line cord. 3x2 1/2x1 1/4"D. Shpg. wt., 1 lb.

13 T 27006 ..... Net 9.95

\*See Page 18 for Full Credit Details on Easy Pay Plan

# SKIL

## 29<sup>99</sup>

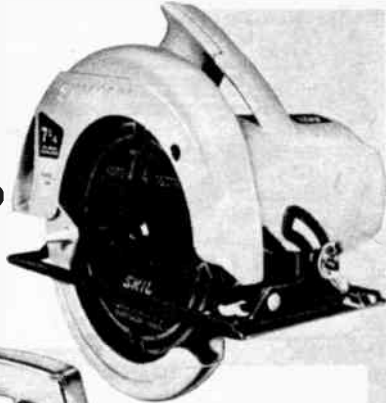

## 29<sup>95</sup>

### HEAVY-DUTY VARIABLE SPEED SABRE SAW

#### POWERED BY GENERAL ELECTRIC MOTOR

- "Dial Control" Any Speed From 0-4800 S.P.M.
- Cuts Thru 6x6 Lumber

Electronic dial variable speed control lets you use this one tool for any cutting job. Cuts through 6" logs, 6 x 6" lumber, metal pipe, masonite—practically any material. Makes its own starting hole. Low speed for steel and plastics, medium for non-ferrous metals, high for rip or cross-cut. Bevel cuts to 45°. Features a 5 amp. 1/2 HP General Electric motor. With 6' 3-cond. cord. 5 assorted blades and rip gauge. For 115 VAC. 25-60 Hz. UL listed. Shpg. wt., 6 1/4 lbs.

14 T 48089 ..... Net 29.95

## DYNAMIC

## PORTABLE ELECTRIC ARC WELDER

MARK

35

## 19<sup>95</sup>

Complete ready  
to use

- Weld-Brize-Solder-Cut
- Produces 11,000° Heat Operation on 110 Volt Line

Dependable unit that produces professional welding—Save time, money by making your own repairs. Cuts and welds up to 1/4" metals with 1/8" welding rods and 1/4" carbon. Completely portable. Simple instructions explain how to make spot repairs. Weld-braze-solder-cut on most metals. Ideal for use around home-shop-farm—even repair auto bodies. Includes welding and carbon rods. Protective mask, holders, 10 ft. H.D. cables, ground clamp, brazing rods, flux, solder and instruction manual. For 115V AC or DC. Fused for 30 amps. Shpg. wt., 7 1/4" lbs.

13 T 20540 ..... Net 18.95

## BVI ELECTRIC PENCIL

- 6<sup>50</sup> • Writes On Metal  
—Wood—Plastic
- No Heat—Vibrating Point
- Engraves Keys—Tools—  
Toys—Jewelry



Handy, useful . . . mark, identify and engrave names, design decorator effects on luggage tags, toys, sporting goods, tools and kitchenware. Automatic built-in mercury switch. Pick it up—it turns on. Put it down and it turns off. Marks won't erase, smear or rub off. Hardened steel point vibrates 7200 strokes a minute. Lightweight. 7x3x 2". 110 VAC, 50/60 Hz motor.

13 T 80542 Shpg. wt., 1 1/4 lbs. .... Net 6.50



## 48 DRAWER PARTS CABINET



- Heavy Gauge Welded Steel Frame

Extra large cabinet 21 $\frac{1}{2}$ "x12 $\frac{1}{2}$ "x6 $\frac{1}{4}$ "D. holds hundreds of items. Modular construction permits arrangement on single or multiple units, on walls, workbenches, shelves, or shop floors. Rigid steel frame and full metal shelf support any load in drawers. Plastic feet prevent scratches when standing, and secure multiple stacking. Inside drawer size: 1 $\frac{1}{2}$ "x2 $\frac{1}{2}$ "x5 $\frac{1}{8}$ ". Crystal-clear drawers. Feature safety stop and safe-grip-handle comes with 1 divider per drawer and index cards. Baked enamel finish. Imported. Shpg. wt., 12 lbs. **13 T 39159** Net ea. 7.35 **13 T 37506W** Net 8.50



**SALE! 7.35**

SALE ENDS, DEC. 31, 1970

### 100/140 WATT "EXPERT" SOLDERING KIT

**MODEL 8200-PK.** Ideal for the novice or professional. Compact design and built-in light eliminate maneuvering difficulties. Weller Soldering Kit features the 8200 gun with exclusive tip Grip which assures constant heat. Dual heat feature gives choice of 100 or 140 watts with the pull of the trigger. Accessories include 3 durable soldering-tips, tip changing wrench nylon flux brush, soldering aid for difficult connections and all purpose solder. Packed in a high impact plastic case. UL listed. Shpg. wt., 4 $\frac{1}{4}$  lbs.

**13 T 39159**

Net ea. 7.35

Model 8200 Gun Only. Shpg. wt., 3 lbs.

**13 T 37514Z**

Net 5.99

### TINY TIGER "HUSH TONE" PORTABLE GENERATOR

**114.95**

- Economical Gas Driven Motor
- 115 A.C. 350 Watts Electric Power 12V D.C. 12 Amps.
- Only 12 lbs.
- Automatic Overload Relief—for Tools, Appliances, Boats
- 12V D.C. for Battery Charging
- 1 H.P. Motor



**Model 67**—Lightweight, rugged metal construction! Features a 1 hp, 2 cycle Ohlsson & Rice air cooled engine with a high capacity magneto ignition. 6 pint, premixed (24 parts gas—1 part oil) fuel capacity allows operation at full power (6,300 rpm) for 2 $\frac{1}{2}$  hours. Also features built-in quietness with a larger "Hush Tone" spark arrester muffler. Dual voltage, direct drive Tiny Tiger generator produces up to 350 watts of 115V. AC, and 12 amps of 12V. DC simultaneously for charging auto batteries or starting cars, boats and trucks. Constant voltage within 110-120 volts with an automatic overload relief system. Light enough to carry anywhere (14 lbs.)... small enough to carry in one hand (8 $\frac{1}{2}$ "H x 8 $\frac{1}{2}$ "W x 10 $\frac{1}{4}$ "L.) Shpg. wt., 15 lbs. to carry in one hand (8 $\frac{1}{2}$ "H x 8 $\frac{1}{2}$ "W x 10 $\frac{1}{4}$ "L.) Shpg. wt., 16 $\frac{1}{2}$  lbs. **12 T 35822** No Money Down" Net 114.95

**HANDY CARRYING CASE**

**12 T 35514** Shpg. wt., 6 lbs.

Net 10.95

## MICROFLAME®

### GAS WELDING TORCH SET

**Completely Self-Contained Torch Produces 5000°F Pin-Point Flame**

WELDS, BRAZES, CUTS MOST METALS.



**17.95**

Miniature gas welding torch for precision welding, brazing and cutting jobs. Pin-point flame produces high heat in a very selective area. Many uses in printed circuit repair, jewelry repair, shop, dental lab, tool and model making. Hand-held, lightweight torch has self-contained oxygen and LP cylinders which are easily replaced. Up to 20 minutes of continuous heat. Cylinders last indefinitely when not in use. Complete torch with 3 tip sizes, 1 cylinder butane, 1 cylinder oxygen, gaskets and instructions. Overall size: 5 $\frac{1}{4}$ Lx2Wx1 $\frac{1}{4}$ " thick. **14 T 42508** Shpg. wt., 1 lb. Net 17.95  
**14 T 42516** Butane Cylinder (Pk. of 2) Net .89  
**14 T 42524** Oxygen Cylinder (Pk. of 2) Net 1.39

## Sabre-Lathe Multi-Purpose Shop Tool

## 3 Drawer Tool Chest

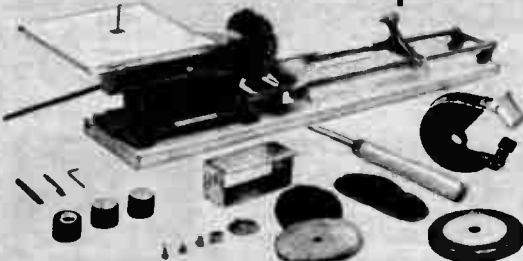

It's a . . .

Wood Turning Lathe  
Sabre Jig Saw  
Bench Grinder  
Disc or Drum Sander  
Buffing or Polishing  
Horizontal Drill

**31.95**

Only

**14.95**



An all purpose ruggedly constructed 3 drawer carrying type chest. Drawers may be locked in place even if cover is closed. Features electrically welded heavy gauge steel and baked enamel silicone treated finish. Dimensions: Box — 8 $\frac{1}{2}$ "Dx10 $\frac{1}{4}$ "Hx20" long; 3 drawers — 7 $\frac{1}{2}$ Dx1 $\frac{1}{2}$ Hx18 $\frac{1}{4}$ "L. Shpg. wt., 8 $\frac{1}{2}$  lbs.

**13 T 19508W**

Net 14.95

A home shop tool that will excite the interest of every home craftsman! Powerful, 3-speed motor provides plenty of drive for every operation . . . unit changes for any purpose in just seconds. Complete with wood turning chisel, sanding discs, sanding drum discs, 3 sabre saw blades, 45° adjustable sanding table. Entire unit is mounted on wooden base for easy portability and stability. Lathe has 18" bed, 4" throat, can be used for spindle or face plate turning. 115 volt, approximately  $\frac{1}{2}$  h.p. motor, AC only. Output speeds 3,700, 3,300 and 3,100 rpm. With illustrated instruction booklet. Mounted on 32"x6" board. Shpg. wt., 17 $\frac{1}{4}$  lbs.

**13 T 36502W** No Money Down"

Net 31.95



# MARK VI LABEL MAKER KIT

Embosses Both  $\frac{3}{16}$ " and  $\frac{1}{4}$ " Tape

**Sale 6<sup>88</sup>**  
**CUT 3.00** SALE ENDS DEC. 31, 1970

- You Get - Tool - 2 Wheels For Large and Small Characters, Case and 5-12' Rolls of Tape
- Convenient Tape Cut-off Lever

Low-Cost typewriter kit for home, office, store or workshop. Makes raised-letter labels that are self-adhesive, permanent and waterproof. Set dial to letter, number, or symbol and squeeze the handle. When label is completed, squeeze trigger to snap off tape. Kit includes: High-impact plastic embossing tool, two wheels, three  $\frac{3}{16}$ " and two  $\frac{1}{4}$ " rolls of tape plus carrying case. Shpg. wt., 1 1/2 lbs.

14 T 41404

Net 6.88

## SHOP-VAC<sup>®</sup> ALL PURPOSE VACUUM CLEANERS



- Heavy Steel Drum
- Powerful 1 HP Motor, 6 ft. 2 1/2" Dia. Hose

As Low As  
**29<sup>95</sup>**

Deluxe Shop-Vac 10 Gallon Vacuum Cleaner outfit. Excellent for picking up pebbles, wood chips, sawdust and other debris. Also attaches to woodworking machines for chip and sawdust removal. Reversible air flow—use it as a blower too. Perfect for winter oil burner cleaning. Complete with two-way 4-wheel dollie, 6 ft. 2 1/2" dia. hose, 6" nozzle, 2 1/2" to 1 1/4" adapter, 2-pc. 45" extension wand, right angle elbow, cloth filter bag and pkg. of 5 paper filters. UL listed. Shpg. wt., 20 lbs.

13 T 35652WX No Money Down\* Net 34.95

5 Gallon Shop-Vac Vacuum Cleaner. Same as above, including all accessories, except for 5 gallon vacuum capacity. UL listed. Shpg. wt., 17 lbs.

13 T 35702W Net 29.95

Paper Filter Bags: For extra dirty jobs, slips over cloth bag.

13 T 35561 Pkg. of 5. Shpg. wt., 4 oz. Net .99

13 T 35579 Replacement Cloth Bag. Wt., 4 oz. Net 1.49

## HEAVY DUTY 18" BENDING AND FORMING BRAKE



- Handles Up To 18" Width In Up To 16" Gauge Thickness

- For Experimenters—Servicemen—Shops
- Clean Smooth Bends
- Forms Up To 90°

**11<sup>95</sup>**

Rugged heavy duty all steel construction and unique design permits forming chassis, boxes, covers, trays, etc. by means of 1" deep slots in brake-bar which allows corners to fold in. Provides flange edges up to 1" high. Easy to adjust for thickness, accuracy, angle of bend. Features built-in clamps. Imported. Shpg. wt., 17 lbs.

99 T 80640WX Net 11.95

\*See Page 18 for Full Credit Details on Easy Pay Plan

## DREMEL MOTO-TOOL KITS



As Low  
 As

**29<sup>95</sup>**

- Grinds—Polishes—Engraves—Sands—Drills
- Precision High-Speed Steel Cutters and Wheel Points

Model 261—Kit. Rugged, compact machine shop with an assortment of fine accessories in a molded polyethylene case. 30,000 rpm for peak performance with small, abrasive wheel points and both high-speed and carbide cutters. Kit contains: Mo. 260 Moto-Tool with high speed steel cutters, grinding wheels, wire and bristle brushes, rubber polishing tip, sanding discs, drum sander and sanding bands, mandrels, dressing stone, finger grip extension, collet wrench,  $\frac{1}{8}$ ",  $\frac{3}{16}$ ",  $\frac{1}{4}$ " and  $\frac{1}{2}$ " collets, 117 VAC, .5 amp motor. UL listed.

14 T 43043 Shpg. wt., 2 3/4 lbs. Net 29.95

Model 260 Moto-Tool only—

14 T 43126 Shpg. wt., 1 1/2 lbs. Net 22.95

Model 271—Heavy Duty Moto-Tool Kit. Similar to above but with heavy duty .8 amp. No. 270 Moto-Tool.

14 T 43050 Shpg. wt., 4 lbs. Net 33.95

Model 270 Heavy-Duty Moto-Tool only—

14 T 43134 Shpg. wt., 1 1/2 lbs. Net 26.95

## 21 PIECE $\frac{3}{16}$ " DRIVE SOCKET SET

- DROP-FORGED STEEL
- CHROME PLATED

**14<sup>95</sup>**



Precision quality socket set. Contains: 12 Pt. socket sizes:  $\frac{5}{16}$ ",  $\frac{3}{8}$ ",  $\frac{1}{2}$ ",  $\frac{5}{8}$ ",  $\frac{3}{4}$ ",  $\frac{7}{8}$ ",  $1\frac{1}{8}$ ",  $1\frac{1}{4}$ ",  $1\frac{1}{2}$ ",  $1\frac{3}{4}$ ",  $2$ ". 12 Pt. deep socket sizes:  $\frac{3}{8}$ ",  $\frac{1}{2}$ ",  $\frac{5}{8}$ ",  $\frac{3}{4}$ ",  $1$ ". Plus 3" extension, 9" flex handle, 8" crossbar, universal joint, 8" reversible ratchet. Packed in heavy gauge red lacquered metal box with handle. Imported. Shpg. wt., 6 1/2 lbs.

13 T 55650 Net 14.95

Lafayette Cat. No. 711 95

## POLICE AND FIRE DUAL BAND SOLID STATE FM RECEIVER

# 4



+ 17 TRANSISTORS  
 + 10 DIODES  
 For Super Sensitivity  
 and Selectivity

# 2 RECEIVERS IN 1!



**2 Bands:**  
 30-50 MHz  
 +  
 152-174 MHz

Only  
**89<sup>95</sup>**

No Money Down\*

- Operates on 117VAC and 12VDC
- Sensitivity 0.7 $\mu$ V Low Band, 1 $\mu$ V High Band
- 4 IF Stages with IC'S
- Tape Recorder Output Jack.

### CRYSTAL CONTROL PLUS TUNEABLE RECEPTION

Model PF-175

*Listen to U.S. Weather Forecasts and Disaster Warnings!*

An advanced FM receiver that is outstanding in performance and features. Covers two VHF communications bands with super-sensitivity—fully tuneable or can be crystal controlled for reception on a single frequency in either band. Also tunes to 162.55 MHz and 163.275 MHz U.S. Weather Bureau reports and disaster alarms in many parts of the country. Superheterodyne circuit includes tuned RF and mixer stages. Four IF stages, each using an advanced space-age Integrated Circuit (IC). 100% solid state design offers top reliability too! "Instant-on" transistor circuit permits immediate response to emergencies! Built-in universal power supply assures continuous monitoring under any conditions—the unit also operates from a 12VDC battery supply for field use or as an emergency portable if AC power fails. Front panel controls include a 4-position

selector for choice of Xtal or Tuneable reception on either of the two VHF bands. Variable squelch control lets you silence the receiver during no-signal conditions to reduce monitoring fatigue. Also equipped with illuminated slide-rule dial, plus handy on-off volume control. Has a handsomely styled vinyl-clad steel cabinet in a simulated walnut wood-grain finish, and equipped with built-in 4" front-mounted speaker and external phone jack. Size: 13 $\frac{1}{4}$ "W x 7 $\frac{1}{2}$ "D x 6"H. Imported. Shpg. wt., 17 lbs.  
 99 T 2592WUX Less Crystals, see below for Crystals. Net 89.95  
 Ground Plane Antennas. Shpg. wt., 4 lbs.  
 40 T 01178W 30-50 MHz Net 8.95  
 40 T 01160W 130-174 MHz Net 7.50  
 40 T 13017W Window antenna for 30-50 MHz. Wt., 2 lbs. Net 7.95

## POLICE AND FIRE SINGLE BAND SOLID STATE FM RECEIVERS

# 4



+13 TRANSISTORS  
 + 9 DIODES  
 + 2 THERMISTORS

# SALE

Model PF-30  
 30-50 MHz

Model PF-60  
 152-174 MHz

Save \$10.00

NOW ONLY

# 69<sup>95</sup>

No Money Down\*

- 4 IC'S Plus 12 Transistors for PF 30
- 117 VAC and 12 VDC Operation
- Tape Recorder Output Jack

### CRYSTAL CONTROL PLUS TUNEABLE RECEPTION

Same super-sensitive solid-state FM receivers as Model PF-175 except that these are single band models covering the high or low bands. Advanced IC's included in the IF stages, plus tuned RF and Mixer stages. Also feature same rugged design for trouble-free operation and have universal power supply for either normal 117 VAC operation or 12 VDC battery operation for field use or during emergencies. Model PF-60 can tune to 162.55 MHz and 163.275 MHz U.S. Weather Bureau reports and disaster alarms in many parts of

the country. Controls: Variable Squelch, On-Off Volume, Tuning and Selector (Tune-Xtal), Less Crystal. Size: 13 $\frac{1}{4}$ "W x 7 $\frac{1}{2}$ "D x 6"H. Imported.  
 99 T 25900W UX Model PF-60 152-174 MHz Shpg. wt., 16 lbs. Net 69.95  
 99 T 25918W UX Model PF-30 30-50 MHz Shpg. wt., 16 $\frac{1}{4}$  lbs. Net 69.95  
 40 T 01160W Ground Plane Antenna for 130-174 MHz. 1 lb. Net 7.50  
 40 T 13017W Window Antenna for 30-50 MHz. Wt. 2 lbs. Net 7.95  
 40 T 01178W Ground Plane Antenna for 30-50 MHz. 4 lbs. Net 8.95

### CRYSTAL CERTIFICATE FOR PF-175, PF-60, AND PF-30

Send filled-out certificate, one for each crystal, to manufacturer. Manufacturer ships crystal directly to you, postage prepaid, within a maximum of 30 days.

40 T 82103Y CERTIFICATE Specify Exact Operating Frequency. No C.O.D. Net 5.95

# MONITOR

Business Service  
Taxicabs  
Railroads  
Auto Emergencies

Police Department  
Fire Department  
Special Emergency  
Local Government



# LAFAYETTE

VHF Monitor Receivers

## POLICE AND FIRE SOLID STATE MOBILE MONITOR RECEIVERS



**ONLY  
1 3/4"  
HIGH**

**MICRO P-100 (148-174 MHz)  
MICRO P-50 (30-50 MHz)**



**AMAZING  
LOW PRICE!**  
**ONLY 69<sup>95</sup>** No Money Down\*

### TUNEABLE PLUS 2 CRYSTAL POSITIONS

- Hear U. S. Weather Bureau Forecasts on MICROP-100†
- 1 FET plus 14 Transistors plus 9 Diodes

Self-Contained 117 VAC and 12 VDC Supply

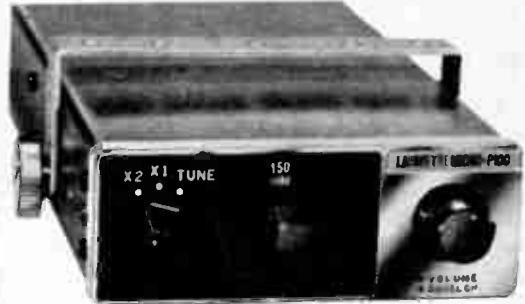

Mobile: For Car, Truck, Boat, etc.



Base: For Home, Office, etc.



Portable

Discover the everyday heroics in your community! Listen and thrill to the excitement of urgent police broadcasts and of fire squads in action! Hear industrial, public safety, ambulance, transportation and other public service radio communications. Monitor the U.S. Weather Bureau forecasts and disaster warnings on the MICRO P-100. Hear all this and more on Lafayette's MICRO P-100 and MICRO P-50 miniature solid state monitor receivers. Their compact size (1 3/4" H x 4 3/4" W x 7 3/4" D) permits convenient mobile and base operation. Exceptional features include tuneable plus 2 crystal receive positions, better than 1 µV sensitivity for 20db S/N, 3 ceramic IF filters for exceptional selectivity, variable squelch, built-in fused AC and DC power supplies, 2 watt audio output, 50-239 antenna jack, and space-age styling with attractive illuminated dial. Supplied with AC and DC cables plus mobile mounting-base station stand bracket. For 117 VAC, 60 Hz or 12 VDC (Negative Ground). Easy, portable operation with optional battery operated portable power pack. Imported, Shpg. wt., 5 lbs.

99 T 26122W MICRO P-100 (148-174 MHz) Net **69.95**  
99 T 26064W MICRO P-50 (30-50 MHz) Net **69.95**  
HB-509A Portable Battery Pack with shoulder strap, battery strength indicator and antenna. Less batteries. Shpg. wt., 3 1/2 lbs. Net **19.95**  
99 T 32260 Net **19.95**

Alkaline Batteries for HB-509A. (8 req.) Shpg. wt., 4 oz. ea. Net **.44**  
99 T 63802 Net **.44**

CRYSTAL CERTIFICATE FOR MICRO P-100 and MICRO P-50. Send filled-out certificate, one for each crystal, to manufacturer. Mfr. will ship crystal directly to you, postage prepaid, within a maximum of 30 days.

Certificate. Specify Exact Monitoring Frequency. No C.O.D. Net ea. **5.95**  
40 T 621037

†Consult your local weather bureau concerning reception in your area.

## LAFAYETTE Hand-Held FM/VHF Police and Fire Monitor Radios



- Listen To Police and Fire Calls
- Monitor Civil Defense and Public Services
- Receive Regional U.S. Weather Bureau Forecasts on 162.55 MHz†

Only an alert and informed citizen can keep up with the electrifying happenings of our everyday life. Two superb Lafayette FM/VHF receivers bring you live coverage of your city or town's daily drama on either 146-175 MHz or 27-50 MHz police and fire bands. Has a built-in 2 1/2" speaker plus an external earphone jack for convenient private listening. Rugged construction and sleek styling combine to give a clear professional type appearance. Operates on 4 penlight batteries (included with set). This ultra-compact unit also features a built-in swivel telescoping antenna and provision for an external antenna. With batteries and carrying strap. Size: 6x2x1 3/4". Imported Shpg. wt., 1 1/4 lbs. In many parts of the country.

99 T 35313L 146-175 MHz FM VHF Receiver Net **17.95**  
99 T 35339L 27-50 MHz FM VHF Receiver Net **17.95**  
99 T 35362 117 VAC Adapter 12 oz. Net **3.95**  
99 T 62580 Extra "AA" Batteries (4 required) 3 oz. Net **.10**  
40 T 79018 Earphone for Private Listening 2 oz. Net **.59**

**HIGH BAND**  
146-175 MHz  
**17<sup>95</sup>**  
with batteries and carrying strap

**LOW BAND**  
27-50 MHz  
**17<sup>95</sup>**  
with batteries and carrying strap



\*See Page 18 for Full Credit Details on Easy Pay Plan

# The World at Your Fingertips!



ONLY  
**79<sup>95</sup>**  
No Money Down\*

## Lafayette EXPLOR-AIR MARK VI Professional FM-AM-SW & Weather Receiver

- ★ Thrill To Live Broadcasts of World-Shaking Events!
- ★ Relax With The Magnificent Sound of FM Hi-Fi Music!
- ★ Hear Latest Weather & Marine Reports!
- ★ Enjoy Popular AM Local News, Sports and Weather

Hear exciting International news from: Prague, Berne, Berlin, BBC London, Havana, Moscow, Japan, Bucharest, Mexico, France, Athens, etc.

The Lafayette Explor-Air Mark VI features individually tuned circuits for each band, automatic volume control, 455kHz ceramic filter for superior selectivity, tuned RF stage for outstanding sensitivity, and a "Shock-free" transformer-operated power supply. Seven full dial bands offer extra-wide station separation; illuminated wide-view slide rule dial is labeled with clearly visible names of primary cities and countries. The back panel has terminals for external AM and FM antennas; tape recorder output jack; 8-ohm extension speaker jack; speaker fuse and 24 volt DC input connection. Attractive styling includes brushed aluminum trim and control panel, and oiled walnut wood sides. Two built-in 4" PM speakers. FM Sensitivity: 2µv or less. Size: 14 1/2 x 6 1/2 x 9 3/4" D. Imported. Shpg. wt., 17 lbs.  
99 T 26015WX Net 79.95

7 BANDS		Hi-Fi FM-AM Broadcast— Shortwave—Weather—Marine
Band 1	Weather/Marine	150-400kHz
Band 2	AM Broadcast	550-1600kHz
Band 3	FM Broadcast	88-108MHz
Band 4	Shortwave	5.9-6.25MHz
Band 5	Shortwave	9.45-9.85MHz
Band 6	Shortwave	11.85-12.05MHz
Band 7	Shortwave	15.05-15.55MHz

- 17 Transistors, 6 Diodes, 2 Thermistors
- Attractive Front Panel with Large Illuminated Slide-Rule Dial
- Illuminated Jewel Band Indicators
- Private Listening Headphone Jack
- Built-in FM and AM Antennas
- Tape Record Output Jack
- 105-125VAC/50-60 Hz; 24VDC

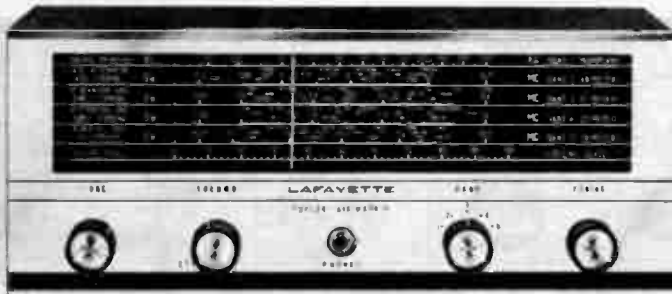

Lafayette  
**EXPLOR-AIR MARK V  
SHORTWAVE + AM  
BROADCAST RECEIVER**

**54<sup>95</sup>**  
No Money Down\*

**5  
BANDS**

**Broadcast + 4 Exciting  
International Shortwave Bands**  
• 550 to 1600 kHz • 9.45 to 9.8 MHz  
• 5.9 to 6.25 MHz • 11.45 to 12 MHz  
• 15.05 to 15.5 MHz

**BRING HISTORY-MAKING NEWS  
INTO YOUR HOME!**

**SUPERHETERODYNE— Not Super-Regenerative!**

**NOT A KIT— COMPLETELY WIRED**

Hear the actual broadcasts from the major news centers around the world in English and foreign languages; BBC London, Radio Moscow and many others.

gested bands each shortwave band has been extended to cover the entire width of the 0 to 100 logging scale. Operating features on the receiver include a self-contained 4" dynamic speaker, built-in loopstick antenna, large illuminated slide-rule dial calibrated in frequency and indicating place names, a front panel headphone jack for optional silent listening, controls for Volume Off/On, Tone and Band Selection, plus rear panel connection for external shortwave antenna. Receiver is AC transformer powered with efficient superheterodyne circuitry. Complete with beautiful walnut grained metal cabinet. For 105-125V., 50/60 Hz AC. Size: 14W x 8D x 6"H. Imported. Shpg. wt., 13 1/2 lbs.  
99 T 25850WX Net 54.95



# 5 BAND AM/CW/SSB SOLID STATE AMATEUR AND SW RECEIVER



## PRODUCT DETECTOR FOR SSB/CW

Only  
**99<sup>95</sup>**  
No Money Down\*



### 5 BANDS

BAND A	150 kHz to 400 kHz
BAND B	550 kHz to 1600 kHz
BAND C	1.6 MHz to 4.8 MHz
BAND D	4.8 MHz to 14.6 MHz
BAND E	10.5 MHz to 30 MHz

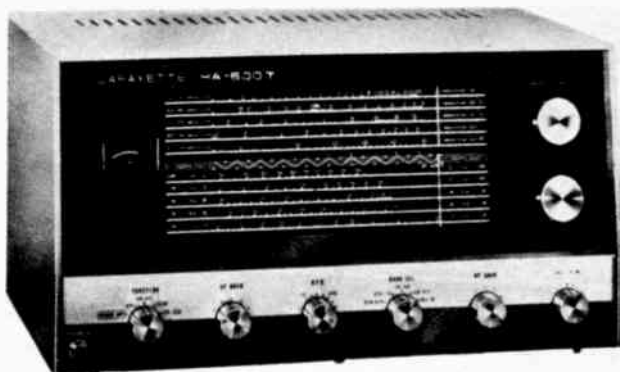

HA-600A

### SHORTWAVE - AMATEUR - AM BROADCAST - WEATHER & MARINE BANDS

- 10 Transistors, 2 FET's, 7 Diodes, and 1 Zener Diode
- Mechanical Filter for Exceptional Selectivity
- Huge Edge-Illuminated Slide Rule Dial with "S" Meter
- Automatic Series Gate Noise Limiter with AVC on AM
- Full 24½ Inches of Bandspread On 10-80 Meter Bands
- 117-Volts AC and 12-Volts DC Negative Ground Operation
- Front Panel Headphone Jack For Private Listening
- Sensitivity: 1 µV. at 10 db S/N

The HA-600A general coverage receiver combines the latest solid state electronics with sleek, modern appearance to achieve a superb blend of performance and style. Advanced circuitry utilizes two Field Effect Transistors in the front end RF stages to assure high sensitivity with lowest noise factor. 10 high performance transistors and 8 diodes compliment the FET's to provide sharp response with exceptional stability. Series-Gate noise limiter and automatic volume control circuitry provide efficient noise and audio blasting suppression on AM. Built-in variable BFO permits clear reception of code and single sideband signals. 455 kHz mechanical filter assures superior selectivity. Receiver's operation is virtually undisturbed by harmonics or

noise from antenna to speaker. Rear panel accessory socket provides convenient connection for audio output. 12 VDC. ground and AVC line, along with receiver muting connections. Huge flywheel operated slide rule dial has easy-to-read illuminated main tuning, logging and bandspread scales. Electrical bandspread features wide calibration for easier tuning of crowded ham bands. Operates from 117 VAC 60 Hz or 12 VDC (negative ground only) . . . perfect for emergency use! Imported. Shpg. wt., 25¾ lbs.

99 T 25901WUX ..... Net 99.95

Matching 3 x 1/2-inch speaker in handsome cabinet.  
99 T 09058 ..... Net 8.95

## 6-80 Meter SSB/AM/CW Solid-State Amateur Receiver

6 AMATEUR BANDS  
INCLUDING 6 METERS

SENSATIONAL LOW PRICE!

**129<sup>95</sup>**

- ★Product Detector for SSB/CW
  - ★Built-in 100 kHz Crystal Calibrator
  - ★Operates on 117 VAC or 12 VDC
- 14-TRANSISTORS + 7-DIODES + 3-FET's

- Two 455 kHz Mechanical Filters For Sharp Selectivity
- FET's For Automatic RF Overload Protection
- Zener Voltage Regulated Power Supply
- Series Gate Automatic Noise Limiting

The Lafayette Model HA-800 receiver covers the 80 through 6 meter amateur bands with outstanding reception of CW, AM, and SSB signals. Tuned RF and 1st mixer stages combine with an FET to provide high front end selectivity and sensitivity of .5 µV on 15 and 10 meters, less than 1 µV on 80, 40 and 20 meters, and 2.5 µV on 6 meters. Product detector and BFO assure crisp CW and clear SSB. Built-in 100 kHz frequency calibrator provides accurate pre-selection (supplied less crystal). Rear panel accessory socket provides convenient con-



MODEL HA-800

### Instantaneous Cool Performance

- Illuminated Calibrated "S" Meter
- Dual Conversion On All Bands
- Huge Edge-Illuminated Slide Rule Dial

nection for audio output, 12 volts DC, ground, and receiver muting. Front panel earphone and rear panel tape output jacks. Operates from 117 VAC 50/60 Hz. or 12 volts DC. Imported. Size: 15Wx9¼Dx8¼H.  
99 T 25942WUX Shpg. wt., 24¾ lbs. .... Net 129.95  
Model HE-400 3x5" Matching 8 ohm Speaker  
40 T 09058 Shpg. wt., 4 lbs. .... Net 8.95  
100 kHz. Calibrator Crystal for HA-800 Receiver  
40 T 09013L ..... Net 4.95

\*See Page 18 for Full Credit Details on Easy Pay Plan

Lafayette Cat. No. 711 99



# 6 Meter Amateur Transceiver



ONLY  
**129<sup>95</sup>**

**Model HA-460  
50-52 MHz.**

## WITH BUILT-IN VFO

- Dual Conversion with Crystal Controlled 2nd Converter
- Built-in Solid State 12 V.D.C. and 117 V.A.C. Power Supplies
- Built-in Low Pass TVI Filter
- Tuned Nuvistor Front End
- 20 Watt DC Input—2E26 Final
- Air Variable Antenna Load and Plate Tuning
- Illuminated "S" and RF Output Meter
- Front Panel Speaker
- Front Panel Crystal Socket
- Frequency Spotting Switch

Exciting 6-meter transceiver features a powerful plate modulated 20 watt DC input transmitter and stable VFO with its own frequency control knob. Tune up is fast and efficient with broad-banded driver and multiplier stages. Shielded low pass filter minimizes TVI problems. Dual conversion receiver utilizes a crystal controlled 2nd converter. Nuvistor RF amplifier's sensitivity is less than 1  $\mu$ V. for 10 db signal to noise ratio. Selectivity at 8 kHz is 35 db. Effective automatic noise limiter eliminates most types of QRM. Other features include spotting switch, use of standard 8 MHz crystals with front panel crystal socket; illuminated meter that reads S units on receive and RELATIVE RF output on transmit; plug-in encapsulated dust free relay switching; front panel earphone jack; push-pull audio amplifier; and rugged push-to-talk ceramic mike with coiled cord and plug. Going mobile? the HA-460 comes with both 117 V.A.C. and 12 V.D.C. (positive or negative ground) built-in solid state power supplies. Sup-

plied with AC + DC power cords, mike and mobile mounting bracket. Size: 12 $\frac{1}{2}$ "x5 $\frac{1}{2}$ "x3 $\frac{3}{4}$ "D. Imported. Wt., 24 lbs. 4 oz. Lafayette Model HA-460—6 Meter Amateur Transceiver for 50.0-52.0 MHz. No Money Down\*  
99 T 25793WUX Net 129.95

**CRYSTAL CERTIFICATE.** Send filled-out certificate, one for each crystal, to crystal manufacturer. Manufacturer will ship crystal directly to you, postage prepaid, within a maximum of 30 days. Specify Fundamental Frequency.  
40 T 54037Y No C.O.D.'s Net 2.95  
Lafayette 6-Meter "Rapid-Grip" Mobile Trunk Antenna. Less Cable. Net 11.95  
40 T 01095 Shpg. wt., 2 lbs.  
20 Ft. RG-58/U Cable Assembly. Net 2.95  
42 T 70021

## 100-WATT MOBILE LINEAR AMPLIFIER Model HA-250

**SMALL, COMPACT... ONLY 2 INCHES HIGH!**  
**Convert Flea Power To Real Power!**



- Covers 20-54 MHz... 6, 10, 11 and 15 Meters (Not Permitted on 11 Meters Class D (CB) Operation in U.S.A.)
- No External Switching Required
- Will Work On Any Signal of 1 to 10 Watts — AM, FM, SSB or DSB, and CW
- Completely Self-Contained 12 Volt Power Supply



**89<sup>95</sup>**  
No Money  
Down\*



Boost flea power to real high power for extended range and better readability. Provides up to 100 watts PEP (50 Watts DC) input into a 50 ohm load (with 8 watts RF drive). Unique RF sensing circuit automatically switches in linear when transmitter is activated. Absolutely no external switching is necessary. Built-in relay directly connects antenna to input SO-239 coaxial socket when receiving. No internal connections are required to your existing equipment. Simply insert the unit in series with your transmitter (or transceiver) and antenna and you're on the air with a real punch. Circuitry is broadbanded so only one tune-up is usually necessary on any band, illuminated front panel meter indicates relative RF strength of linear's output signal when linear is on, or exciter's relative RF signal strength when linear is off. Self-contained power

supply utilizes a high efficiency toroid power transformer. Ruggedly designed chassis with oversized heat sinks assures sturdy and cool operation. Supplied with comprehensive manual, fused DC power cables and mounting bracket. Size: 7"D x 9"W x 2"H. Made in U.S.A. Shpg. wt., 5 $\frac{1}{2}$  lbs. 12 Volt DC Negative Ground Only.  
40 T 01061WUX Net 89.95

**SPECIFICATIONS:** Frequency Coverage: 20-54 MHz. Plate Power Input: 50 Watts (100 Watts PEP). Minimum RF Drive: 1 Watt. Maximum RF Drive: 10 Watts. Input Impedance: 50 Ohms. Output Impedance: 40-600 Ohms (50 Ohms Nominal). Amplification Modes: AM, FM, SSB or DSB, CW. Power Requirement: 11.5-14.5 Volts DC (Neg. Ground only).

# WALKIE-TALKIES by LAFAYETTE

## LEADER IN 2-WAY CB RADIOS

### 1 Watt 3 Channel WALKIE-TALKIE

Great for Industry, Farm, Boats, Sports!

#### LAFAYETTE HA-310

# 32.95

 Each

- 3 Switchable Crystal Channels
- Jack for Internal Charging
- Superhet Receiver with Less than 1 $\mu$ V Sensitivity
- Battery Condition Indicator
- Push-Pull Modulator with "Range-Boost"
- Jacks for External Battery Eliminator, Earphone and Antenna

Lafayette's HA-310 is a lightweight powerful walkie-talkie that features 3-channel operation and 1-watt transmitter input for flexible and dependable communications. The efficient superhet receiver incorporates an RF amplifier for extra sensitivity. It's 13-transistor, 4-diode circuit features a built-in battery indicator, a high level push-pull modulator with RANGE-BOOST for greater range, variable squelch and automatic noise limiting for quiet-communications, and 117 VAC operation with optional battery eliminator/charger. Complete with telescoping antenna, battery holder (less batteries), set of crystals for channel 10, FCC License Form 505 and attractive case with hand strap. Size: 8 $\frac{1}{4}$ "H (less antenna) x 3W x 1 $\frac{3}{8}$ "D. Imported. Shpg. wt., 2 $\frac{3}{4}$  lbs. Net ea. 32.95

Alkaline Batteries. (8 required.)  
 99 T 63828 Shpg. wt., Ea. 2 oz. Net ea. .35  
 117 Volt AC Battery Eliminator and Battery Charger. Shpg. wt., 3 $\frac{1}{2}$  lbs.  
 99 T 35081 Net 14.95  
 99 T 25413 Earphone for HA 310 Net 1.29  
 46 T 15 $\dagger$  Transmit Crystal Net 2.25  
 46 T 10 $\dagger$  Receive Crystal Net 2.25  
 †See Page 103 on "How To Order Crystals."



### Popular LAFAYETTE Walkie-Talkies

No License Required, FCC Regulations Part 15

#### (A) "ASTRO COMMANDER" CB WALKIE-TALKIE HA-70C

- Not a Kit—Completely Wired
  - Interstage Transformer for More Sound
- Compact 3-transistor walkie-talkie features a sensitive superregenerative receiver for minimum noise pick-up when voice signal is being received. Crystal controlled transmitter provides range up to  $\frac{1}{4}$  mile. Has push-to-talk button, off-on volume control, and efficient speaker/mike. Supplied with telescoping antenna, crystal, and battery. Size 5 $\frac{1}{2}$ x2 $\frac{1}{4}$ ". Imported. Shpg. wt., 1 $\frac{1}{4}$  lb. Net ea. 5.99
- 99 T 30801L HA-70C Net .21  
 99 T 60212 Replacement Battery Net .21  
 Optional 9-volt Lead-Acid Battery plus Charger. Net 2.69  
 99 T 90169 Imported. Shpg. wt., 6 oz.

#### (B) 2 CHANNEL 7-TRANSISTOR SUPERHET CB WALKIE-TALKIE HA-73A

- Powerful Push-Pull Audio
- Built-in Call Alert

Power boost reflex sensitivity circuit utilizes 7 transistors to achieve higher sensitivity for extended range. 2-channel operation permits greater flexibility. Call alert system sends or receives a pleasant alerting tone for convenient calling. Case features beautiful die-cast chrome highlighted front panel. Supplied with carrying strap, telescoping antenna, battery, and plug-in crystals for channel 9. Size: 5 $\frac{7}{8}$ x1 $\frac{1}{4}$ x2 $\frac{3}{4}$ ". Imported. Net ea. 15.95

99 T 31452L HA-73A. Shpg. wt., 1 $\frac{1}{4}$  lbs. Net ea. 15.95  
 46 T 15 Extra Transmit Crystal (Specify Channel!) Net 2.25  
 46 T 10 Extra Receive Crystal (Specify Channel!) Net 2.25  
 †See Page 103 on "How To Order Crystals."  
 99 T 60212 Replacement Battery Net .21  
 Optional 9 volt Lead-Acid Battery plus Charger. Net 2.69  
 99 T 90169 Imported. Shpg. wt., 6 oz.

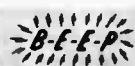

(B) HA-73A



HA-70C  
 (A) "ASTRO COMMANDER"

# 5

## Watts of Power You Can Hold in Your Hand!

### 3 Channels

Lafayette  
**DYNA-COM 5a** **79<sup>95</sup>** No Money Down\*

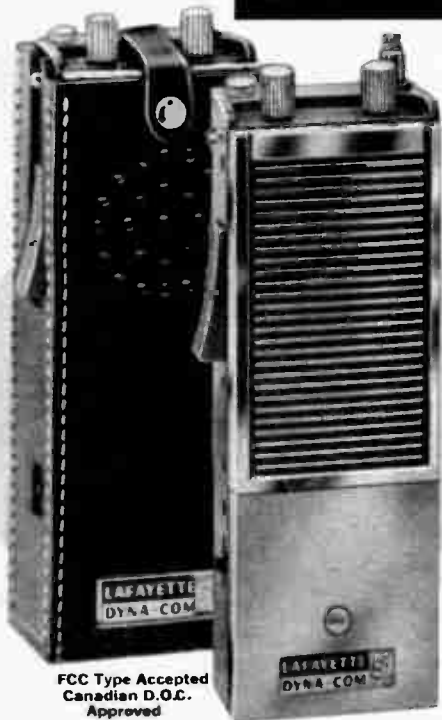

FCC Type Accepted  
Canadian D.O.C.  
Approved

- ★ 5 Watt FCC Maximum Input . . . With Power Equal to the Most Powerful CB Transceivers!
- ★ 3 Switchable Crystal Controlled Channels
- ★ 7-Stage Transmitter for Extra Transmit Sock!
- ★ Operate Mobile in Your Car with Optional Cigarette Lighter Plug-in Adapter
- ★ Superheterodyne Receiver with Less Than 1 Micro-volt Sensitivity for 10 db S+N/N Ratio
- ★ Mechanical Filter for Superior Selectivity
- ★ Automatic Range Boost for High Talk Power

- Variable Squelch and Automatic Noise Limiting
- Battery Condition and RF Power Output Indicator
- External Mobile and Base Antenna Jack
- Provision for External Battery Pack, Mobile Battery, Charger and Eliminator
- T.V.I. Trap Minimizes TV Interference
- Push-Pull Audio Modulator Circuit

The Dyna-Com 5a is small in size—BIG in performance and versatility. A Lafayette exclusive, this amazing 2-way radio has every feature you have ever wanted in a compact walkie-talkie. The unique, removable battery pack facilitates charging ni-cad batteries on or off the walkie-talkie. You always have a fresh supply of batteries on hand. In addition, an optional portable dry cell power pack keeps reserve power on tap when you need it. The unit may be connected to your auto, boat or tractor battery and external antenna for the ultimate in portable convenience. Attractive die-cast brushed aluminum case with shoulder carrying strap. Measures only 3¼xWx10¼x 2¼"D. Supplied with transmit and receive crystals for channel 10, telescoping whip antenna and FCC license application Form per regulation 95. Imported. Shpg. wt., 5 lbs.

99 T 32096L (Less Batteries)	Net ea. 79.95
46 T 15 Extra Transmit Crystal	Net 2.25
46 T 10 Extra Receive Crystal	Net 2.25
99 T 32245YL Dyna-Com 5a modified for 26.620 MHz	Net 89.95
99 T 32254YL Dyna-Com 5a for 27.575 and 27.585 MHz	Net 99.95

\*See Page 103 for "How To Order Crystals."

## Lafayette SUPER POWER LONG RANGE Walkie Talkie

### 3-WATTS 3-CHANNELS Dyna-Com® 3a

- Range Boost For Higher Talk Power
- 12 Transistors, 6 Diodes ● 455 kHz Ceramic Filter ● T.V.I. Trap ● RF Surge Protection
- Jacks for External Antenna & Battery Eliminator
- Variable Squelch and Automatic Noise Limiting
- Battery Condition and RF Power Output Indicator
- 1 μV Sensitivity ● 6 Stage Transmitter

Lafayette's Dyna-Com 3a walkie talkie is a hand-held powerhouse featuring 3 full watts of power with added flexibility of 3 crystal-controlled switchable transmit and receive channels. 12-transistor, 6-diode circuitry incorporates a sensitive superhet receiver which utilizes an RF amplification stage with lightning surge protection, and a highly selective ceramic filter for super reception. Automatic gain control, automatic noise limiter, and variable squelch combine to achieve truly quiet operation. 6-stage transmitter uses Range Boost modulation to increase the sideband modulation and thus provide far greater talk power. Includes TVI trap for minimum TV interference. Meter indicates battery level on receive and RF power output on transmit. Jacks are provided for earphone, external antenna, and external power. Operates on batteries or any other 12 volt DC supply. Complete with telescoping antenna, battery holder with batteries, one set of crystals for channel 10, shoulder strap, and FCC Form 505. Imported. Size: 3½xHx3¼xWx1¼"D. Shpg. wt., 4¼ lbs.

99 T 31940L No Money Down*	Net 57.95
46 T 11 Extra Transmit Crystal†	Net 2.25
46 T 10 Extra Receive Crystal†	Net 2.25
99 T 31981YL Dyna-Com 3a for 26.620 MHz	Net 67.95
99 T 31999YL Dyna-Com 3a for 25.575 MHz	Net 67.95
99 T 32302YL Dyna-Com 3a for 27.575 and 27.585 MHz	Net 77.95

102 Lafayette Cat. No. 711



\*See Page 103 for "How To Order Crystals."

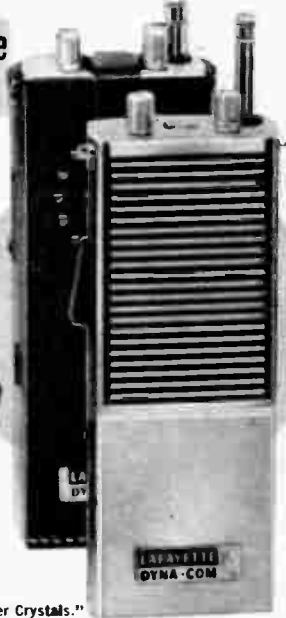

\*See Page 18 for Full Credit Details on Easy Pay Plan

# FIVE plus TWELVE!

**5 WATTS**  
Hand-Held Power

Plus

**12 CHANNELS**  
SWITCHABLE  
CRYSTAL CONTROLLED

Lafayette  
**DYNA-COM 12**

ONLY

**99<sup>95</sup>** Each  
No Money  
Down\*

- ★ 12 Switchable Crystal Controlled Transmit and Receive Channel Positions
- ★ 5-Watts FCC Maximum Permitted Input Power In The Palm of your hand!
- ★ 14 Transistors, 6 Diodes, 1 Posistor
- ★ Superheterodyne Receiver plus RF Stage with 0.7 $\mu$ V. Sensitivity
- ★ Automatic Compressor Range Boost for Consistently High Talk Power and Greater Range
- ★ Use It In Your Car with Optional Cigarette Lighter Plug-in Adapter
- ★ Public Address External Speaker Jack with PA Switch

- Mechanical Filter for Superior Selectivity
- Variable Squelch plus Automatic Noise Limiter for Minimum Noise
- Battery Condition and Automatic Relative RF Power Output Indicator
- External Antenna Jack Permits Use with Base Station and Mobile Antennas
- Provision for External Battery Pack, Mobile Battery and Battery Charger/Eliminator
- Push-pull Audio/Modulator Circuit for More Powerful Speech Transmission and High Quality Reception
- TVI Trap To Minimize Television Interference

Another 5 watt 2-way radio first by Lafayette, the Dyna-Com 12 pioneers the walkie talkie feature of 12 switchable crystal controlled transmit and receive channel positions for extra utility and flexibility. In addition to its superb engineering resulting in excellent sensitivity, selectivity, adjacent channel rejection, and RF protection, the Dyna-Com 12 incorporates all the features you would ever expect to find in a high power hand-held walkie talkie. The removable battery pack makes it simple to charge the nicad batteries on or off the walkie-talkie. The Dyna-Com 12 may be connected to your auto, boat, or tractor 12 volt battery and to an external antenna for efficient mobile communications. It can also be used on 110 volt 60 Hz AC with the optional battery eliminator/

charger and with a base station antenna for reliable base station communications. Features a professionally designed attractive die-cast case with shoulder carrying strap and crystals for channel 10. Size: 3 $\frac{1}{4}$ x10 $\frac{1}{2}$ x2 $\frac{3}{4}$ " D. Imported. Shpg. wt., 4 $\frac{3}{4}$  lbs.

FCC  
Type  
Accepted

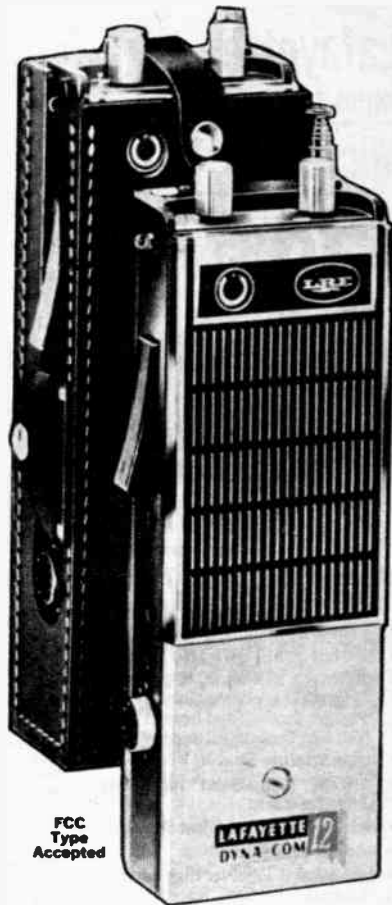

99 T 32013L (Less Batteries) No Money Down*	Net 99.95
46 T 15 Extra Transmit Crystals	Net 2.23
46 T 10 Extra Receive Crystals	Net 2.23
99 T 29413 Earphone for Dyna-Com 12	Net 1.20
99 T 32104YL Dyna-Com 12 Modified for 26.620 MHz	Net 109.95
99 T 32200YL Dyna-Com 12 for 27.575 and 27.585 MHz	Net 119.95

† SEE "HOW TO ORDER CRYSTALS" BELOW

## DYNA-COM OPTIONAL ACCESSORIES †

**Battery Eliminator/Charger.** Plugs into 117 VAC outlet to permit base station operation. Charges up to 12 nickel cadmium batteries internally and externally in Dyna-Com 5, 5a, 6, and 12; charges batteries of Dyna-Com 2, 2a, 3, and 3a in holder externally with adapter (supplied). Negative ground only. Has fused AC line. Size: 7 $\frac{3}{4}$ "H x 5 $\frac{3}{4}$ "D (at bottom) x 3 $\frac{1}{4}$ "W. Imported. Wt., 6 $\frac{1}{4}$  lbs.  
99 T 31478 Net 22.95

**Extra Battery Pack for Dyna-Com 5, 5a, 6 and 12.** Extra removable back of walkie-talkie plus battery holder. Enables charging of complete battery pack outside of walkie talkie while another pack is in use. Imported. Shpg. wt., 2 lbs.  
99 T 32203 Net 8.95

**Nicad Rechargeable Batteries for Pack 32 T 47400 12 required** Net ea. 1.63

**Mobile Cigarette Lighter Cable Assembly.** Permits operation of Dyna-Com from car 12 volt DC cigarette lighter. Shpg. wt., 8 oz.  
99 T 46054 Net 2.95

**Cases: Genuine Top Grain Leather.** Shpg. wt., 12 oz.  
42 T 28011 For Dyna-Com 2a, 3a Net 4.95  
42 T 28029 For Dyna-Com 5, 5a Net 5.95  
42 T 28045 For Dyna-Com 6, 12 Net 5.95

**Dyna-Pack External Battery Pack with 10 "D" batteries.** Plugs into Dynacoms to assure reserve power when required in the field. Imported. 3 x 3 $\frac{1}{4}$  x 7 $\frac{1}{2}$ ". Shpg. wt., 3 $\frac{1}{4}$  lbs.  
99 T 31015 Net 5.95

**Extra 10-Cell Battery Holder for Dyna-Pack.**  
99 T 31312 Net 1.95

**Antenna Adapter Cable.** Connects PL-259 plug of external antennas to Dyna-Com's antenna jack. Shpg. wt., 8 oz.  
42 T 08201 Net 2.95

**Nicad Rechargeable Batteries.** 12 required for Dyna-Com 5, 5a, 6 and 12; 10 for Dyna-Com 2, 2a, 3 and 3a. Shpg. wt., 1 oz.  
32 T 47400 Net ea. 1.63

**Alternate Heavy-Duty Alkaline Batteries.** 12 required for Dyna-Com 5, 5a, 6 and 12; 10 for Dyna-Com 2, 2a, 3 and 3a. Shpg. wt., 2 oz.  
99 T 63828 Net ea. .35

**Miniature Top Loaded Antenna.** Highly efficient coil loaded 18" antenna which mounts on top of collapsed telescopic antenna. Imported. Shpg. wt., 1 lb.  
99 T 31437 Net 4.50

**Dyna-Charge.** Charges from 8 to 15 nicad "Z" size cells. Plugs directly into Dyna-Com 5, 5a, 6 and 12 charge jacks and into jack of Extra Back Battery Pack. Charge batteries of Dyna-Com 2, 2a, 3 and 3a externally in holder with use of adapter (supplied). Size: 3 $\frac{3}{4}$ " x 2 $\frac{3}{4}$ " x 2". Imported. Shpg. wt., 2 lbs.  
99 T 31007 Net 9.95

†HOW TO ORDER CRYSTALS. Add 2 digits representing the Channel No. to the listed stock no. Sample: 46 T 10 for channel 9 is 46 T 1009; for Channel 23 is 46 T 1023.

\*Applicable to Dyna-Com 2, 2a, 3, 3a, 5, 5a, 6 and 12 unless otherwise Specified.

\*See Page 18 for Full Credit Details on Easy Pay Plan

Lafayette Cat. No. 711 103



# Lafayette

## MINI-MOBILE

### Micro-12

ONLY  
**79<sup>95</sup>**

No Money Down\*



**WORLD'S SMALLEST**  
**5-Watt 12 Channel**  
**Mobile CB 2-Way Radio**

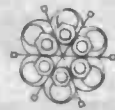

**1 3/4" HIGH!**



**FCC Type Accepted**  
D.O.C. APPROVED

**Ideal For: Car, Truck, Traller, Boat, Plane, Snowmobile, Cycle, Etc.**

- ★ 5 Watt Maximum FCC Legal Input Power
- ★ 12 Channel Crystal Controlled
- ★ Miniature Size: 1 3/4"H x 5W x 7 1/2"D.
- ★ Operates on 12 Volts DC Negative Ground (Easily Convertible to Positive Ground) and from 117 VAC with Optional AC Supply
- Highly Sensitive Receiver with RF Stage
- Full-Time "Range-Boost" for Greater Effective Range
- Variable Squelch for Silent Standby
- Automatic Noise Limiting
- Mechanical IF Filter for High Adjacent Channel Rejection
- Accepts Priva-Com IIIB for Selective Interference-Free Standby

The Lafayette Micro-12 miniature trail blazer embodies exceptional versatility and flexibility. Its compactness and size make it ideal for mobile and portable communications. The Micro-12 also includes a 3-stage transmit circuit with up to 100% modulation capability, an antenna matching adjustment for maximum radiated power, and a highly sensitive receiver with RF stage for 1  $\mu$ v. sensitivity at 10db S/N. The Micro-12 also features superior zener diode voltage regulation, very low current drain that permits continuous mobile operation, a TVI trap for minimizing TV interference, an illuminated channel indicator dial, and an 8-16 ohm external earphone/speaker jack for private or remote listening. Supplied complete with push-to-talk dynamic microphone with retractile cord, "quick-release" mobile mounting bracket, channel 10 crystals, DC power lead, and FCC Form 505. Size: 5W x 1 3/4"H x 7 1/2"D. Shpg. wt., 5 lbs.  
**99 T 31957WX** ..... Net 79.95

**EXTRA CRYSTALS FOR MICRO-12** † See Page 103 for "How to order Crystals."  
46 T 15† Transmit Crystal ..... Net ea. 2.25  
46 T 10† Receiver Crystal ..... Net ea. 2.25  
Micro-12 Modified for 26.620 MHz.  
99 T 32310WUX ..... Net 89.95  
Micro-12 for 27.575 plus 27.585 MHz.  
99 T 32328WUX ..... Net 99.95  
**HB-509A Portable Battery Pack.** Attaches to Micro-12 for conversion to portable operation. Supplied with telescoping whip antenna, battery condition meter, microphone clip and shoulder strap. Less batteries.  
99 T 32260 Shpg. wt., 2 lbs. .... Net 19.95  
**Alkaline Battery for HB-509A (8 req.)**  
99 T 63802 Shpg. wt., 3 oz. .... Net ea. .44  
**Alternate Nicad Battery for HB-509A (10 req.)**  
32 T 48887 Shpg. wt., 5 oz. .... Net ea. 3.90  
**HB-512 AC Power Supply.** Permits 117 VAC operation of Micro-12 and charges optional nicad batteries used in HB-509A.  
99 T 32278 Shpg. wt., 5 lbs. .... Net 19.95



**5-Watt Solid State CB**  
**Citizen Band 2-Way Radio**  
**Model HE-20T**

ONLY  
**89<sup>95</sup>**

**FCC Type Accepted**

- 12 Channel Crystal Controlled Transmit and Receive
- 23 Channel Tuneable Receive
- 455kHz Mechanical Filter
- Priva-Com Private Tone Caller Socket
- For 117VAC Base Station and For 12 VDC (Negative or Positive) Mobile Operation
- Also a PA Amplifier with External Speaker
- TVI Trap
- Spotting Switch for Accurate Reception
- With RF Overload Protection (Pat. Pend.)

Newest addition to the popular HE-20 series of CB transceivers. This 13 transistor, 10 diode Solid State transceiver is ideal for fixed and mobile communications. Solid-state circuitry features low battery drain and provides instant operation; full 5-watt transmitter input with efficient push-pull audio modulator; and an extra-sensitive superheterodyne receiver with sensitivity of .7 $\mu$ V for 10db signal-to-noise ratio. Fine selectivity and adjacent channel rejection is obtained through a 455 kHz mechanical filter. Receiver also incorporates automatic floating series-gate noise limiter and variable squelch control resulting in virtually no background noise between calls. Other features: dust-free transmit/receive relay, earphone jack for headphones or external extension speaker for CB/PA application, illuminated "S" and relative

power output meter, mobile mounting bracket and front panel-mounted 4" speaker. Also features Priva-Com private tone caller socket. Complete with fused DC line cord for negative ground battery, push-to-talk mike and set of crystals for channel 9. Includes FCC license application form 505. Size 8 1/4"W x 4 3/8"H x 1 13/16"D. Imported. Shpg. wt., 13 1/2 lbs.  
**99 T 30884WUX** ..... Net 89.95

**OPTIONAL ACCESSORIES**

99 T 31064 Positive ground fused 12 VDC cord. Wt., 4 oz. Net 1.50  
46 T 65 Extra transmit crystal (specify channel)† ..... Net 2.25  
46 T 10 Extra receive crystal (specify channel)† ..... Net 2.25

† See Page 103 for "How To Order Crystals."

**\* 2 MORE CHANNELS WITH EACH ADDED PLUG-IN CRYSTAL! \***

- 15 Transistors, 8 Diodes, Plus IC
- With RF Overload Protection (Pat. Pending)
- 455 kHz Mechanical Filter
- Dual Conversion Superheterodyne Receiver
- Variable Squelch Plus Automatic Noise Limiting
- Large 5 x 3 Inch Speaker For Superior Audio
- 12 Volts DC Negative or Positive Ground
- 117 VAC With Optional AC Power Supply
- Portable Operation With Optional Battery Pack



**LAFAYETTE HB-23**

FCC Type Accepted • DOC Approved

Only **99<sup>95</sup>** with Crystals For Operation on Channels 9, 13, 19  
No Money Down\*

**23 CHANNEL CRYSTAL CONTROLLED MOBILE 2-WAY RADIO**

Solid-state ultra compact crystal synthesis CB transceiver incorporates 15 transistors and one integrated circuit stage to achieve superior sensitivity, greatly increased dependability, and lower current drain. Synthesis type frequency control section utilizes a maximum of sixteen crystals for full 23 channel operation. Provides economical addition of 2 channels with each additional plug-in crystal. Carefully tuned 455 kHz mechanical filter assures razor sharp selectivity with excellent adjacent channel rejection. Dual conversion receiver features 0.7  $\mu$ v sensitivity, AM, variable squelch, and push-pull audio amplifier. Transmitter provides full 5 watt legal limit input. Illuminated front panel meter monitors "S" units on receive and PRF output during transmit. PA Speaker/Earphone jack for silent listening or public address operation. Complete with dynamic push-to-talk microphone, power cable, mounting bracket, fixed crystals for channels 9, 13, and 19, and FCC application Form 505. Size 5 $\frac{1}{2}$ "x 7 $\frac{1}{2}$ "x 2 $\frac{1}{4}$ "H. Imported.

99 T 31494WUX Shpg. wt., 6 $\frac{1}{4}$  lbs. Net **99.95**

Package of 10 Plug-In Crystals. Converts HB-23 to full 23 channel operation.

99 T 31742 Shpg. wt., 1 lb. Net **25.00**

HB-502B Solid State 117VAC Power Supply/Charger. Enables operation of HB-23 as a table top 117 VAC base station, also charges nickel cadmium batteries used in the HB-507.

99 T 32088W Net **19.95**

Model HB-507 Portable Battery Pack. Adapts HB-23 for convenient portable operation with shoulder strap. Less "C" batteries.

99 T 31951 Shpg. wt., 4 lbs. Net **19.95**

"C" Alkaline Battery for HB-507 (8 req.)

99 T 83802 Shpg. wt., ea. 5 oz. Net ea. **.44**

Alternate Nickel Cadmium Battery. Shpg. wt., ea. 5 oz. (10 req.)

32 T 48887 Net ea. **3.90**

See Page 464 Catalog #710 For Optional Individual Plug-In Crystals Each Crystal Adds 2 Operating Channels.



**LAFAYETTE**  
**Comstat 23**  
**Mark VI**  
Only  
**109<sup>95</sup>**  
No Money Down\*  
FCC Type Accepted

**ALL CRYSTALS SUPPLIED!**

**23 CHANNEL CRYSTAL CONTROLLED TWO-WAY RADIO**

- Dual Conversion with 8/10  $\mu$ v. Sensitivity
- Pi-Network and Low Pass Filter
- Range Boost for Greater Average Talk Power
- Built-in 117 Volt AC Power Supply
- 14 Tube Performance with 9 Tubes, and 9 Diodes

- Variable Squelch Control with Standby Switch
- Illuminated "S"/"PRF" Meter
- Tape Record Output Jack (Rear)
- CB/Public Address Switch
- Headphone/External Speaker Jack

The Comstat 23 Mark VI deluxe 5-watt CB transceiver incorporates a sensitive .8  $\mu$ v receiver with selective dual conversion superheterodyne circuitry. Variable squelch control quiets receiver during "no signal" conditions. Features include a full-time automatic noise limiter, 4-watt audio output into a built-in 3 $\frac{1}{2}$ " in. speaker, and a tape recorder output jack on the rear panel. RF output is coupled through a highly effective pi-network and low-pass filter for maximum energy transfer to the antenna. Includes standby switch for low current drain and instant operation and facilities for PA with external speaker or phones of 4-8 ohm impedance. Matches antennas from 50-75 ohms. For operation on 105-120 volts AC, 50/60 Hz or operates mobile with

the use of the optional 12 volt power supply. Size 12Wx8 $\frac{1}{2}$ Dx5"H. Imported. Shpg. wt., 20 lbs.

99 T 32237WUX Net **109.95**

**OPTIONAL ACCESSORIES**

HA-19 DC POWER SUPPLY. Permits 12-volt mobile operation with Negative or Positive Battery Ground. 6Wx4Hx4 $\frac{1}{2}$ "D.

42 T 47045W Shpg. wt., 4 lbs. Net **14.95**

MOBILE MOUNTING BRACKET. Facilitates under-dash mounting. Imported. Shpg. wt., 2 lbs.

99 T 31874 Net **2.95**

\*See Page 18 for Full Credit Details on Easy Pay Plan

# 23 Crystal Controlled Channels . . . ALL CRYSTALS SUPPLIED!

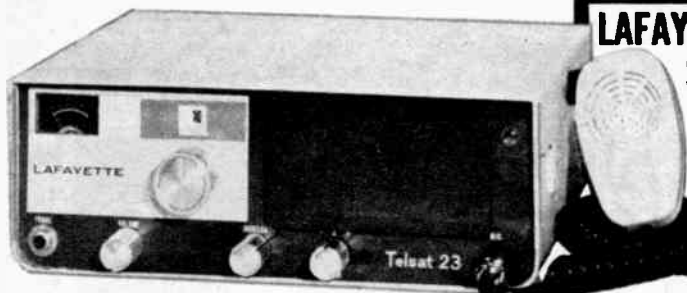

**LAFAYETTE Telsat™ 23 Deluxe  
Solid-State 2-Way Radio**

ONLY **129<sup>95</sup>**

No Money Down\*

FCC Type Accepted

- 1 IC, 18 Transistors, 10 Diodes
- With RF Overload Protection (Pat. Pend.)
- Double Conversion Superhet Receiver
- Mechanical Filter Plus IC for Super Selectivity
- Excellent Sensitivity of Less than 1 μV
- Range Boost Circuitry for Added Talk Power
- Full Public Address Amplifier Provisions

- Accepts Priva-Com® Plug-In Private Tone Caller
- Operates on 117 Volts AC or 12 Volts DC
- Illuminated Automatic S/Prf Meter
- Variable Squelch Plus Noise Limiting
- Automatic Transmit Indicator Light
- 3-Position ±1.4 kHz Crystal Delta Fine Tune
- TVI Trap Minimizes TV Interference

An exciting feature packed deluxe 23 channel 2-way radio ready to serve as either a 117 volt AC base or 12 volt DC mobile station. Use of revolutionary space age integrated circuitry assures greater sensitivity and selectivity with high efficiency and low power drain. Receiver's superior selectivity is attained by using carefully tuned IF stages coupled with a hand crafted mechanical filter. Delta tune permits copy of "off channel" stations. Full legal power transmitter uses Range Boost modulation for far greater talk power. Front panel light indicates presence of RF energy at antenna socket. Illuminated S/Prf meter reads signal strength on receive and RF output on trans-

mit. Built-in public address provisions include audio input for tape recorder, tuner, etc. and tape output jack for recording. Phone jack for private listening. Accepts Lafayette Priva-Com III series plug-in private tone caller for selective interference-free standby. Supplied with PTT dynamic microphone, mobile mounting bracket, DC cable, and FCC License Form 505. Size: 4 1/2" x 11 1/4" x 3 1/2" D. Imported. Shpg. wt., 15 lbs.  
 99 T 31577WXX ..... Net 129.95  
 DC Cable for positive ground vehicles. Shpg. wt., 8 oz.  
 99 T 31064 ..... Net 1.50

**LAFAYETTE HB-525D  
MOBILE TWO-WAY RADIO**

Only  
**149<sup>95</sup>**  
 No Money Down\*

**23 Crystal Controlled Channels . . .  
All Crystals Supplied!**



**Popular Solid State  
Mobile Favorite!**

FCC Type Accepted  
D.O.C. Approved †

**FEATURES**

- Dual Conversion for High Selectivity
- 1 IC, 18 Transistors, 9 Diodes, 1 Thermistor
- Advanced RF Overload Protection (Pat. Pend.)
- 3-Position Crystal Delta Tune
- Mechanical 455 kHz Filter
- Range Boost™ Circuitry For Added Talk Power
- Variable Squelch plus Automatic Noise Limiting
- Automatic Large Illuminated S/Prf Meter
- Receive and Transmit Indicator Lights
- PA Amplifier with External Speaker
- Simulated Leather Front Panel
- 12-Volt DC Operation (Neg. or Pos. Ground)

Lafayette's most advanced model of the famous HB-525 series of CB Transceivers. Now with all the great features plus revolutionary Integrated Circuitry. Dual conversion receiver incorporates 455 kHz mechanical filter and an integrated circuit for high selectivity, superior adjacent channel rejection, and extra long life. Variable squelch quiets receiver when no signal is being received. 3-position crystal delta tune permits easy copy of off-frequency stations. Large, easy-to-read illuminated automatic S/PRF meter indicates signal strength on receive and RF output in transmit. Full public address provisions include audio input jack for tape recorder, tuner, etc. Also features indicator lights for transmit and receive modes. Supplied with PTT dynamic mike, DC cable, mobile mounting bracket, and FCC license form 505. Size: 2 3/4" x 6 1/4" x 3 1/2" D. Imported. Shpg. wt., 7 lbs.  
 99 T 31750WXX ..... Net 149.95  
**MODEL HB-562B AC POWER SUPPLY/CHARGER.** For 115 VAC operation and for charging HB-506 Nicad batteries.  
 99 T 32000W Shpg. wt., 5 lbs. .... Net 19.95  
**MODEL HB-806 PORTABLE DC POWER PACK** attaches to HB-525D for convenient portable operation. Shpg. wt., 2 lbs.  
 99 T 31544W Less Batteries ..... Net 19.95  
 99 T 63062 "C" Alkaline Battery for HB-506 (8 req.) ea. Net .44  
 32 T 40007 Alternate Nicad Batteries (10 req.) ea. Net 3.90

†Canada Permits Legal Operation On 19 Channels Only in 27.00 mHz thru 27.30 mHz Range.

## Famous 23 Channel

### CB Best Seller...

#### LAFAYETTE COMSTAT 25B

Only

# 149<sup>95</sup>

No Money Down\*



### ALL CRYSTALS SUPPLIED!

- Standby Switch for Low Current Instant Operation
- 17 Tube Performance with 11 Tubes, 2 Transistors and 11 Diodes
- Built-in 117 VAC, 12 VDC Solid-State Power Supply
- Dual Conversion Receiver Features 8/10  $\mu$ V Sensitivity

The pace-setting Lafayette Comstat 25B, with its high performance circuitry for excellent mobile and base station operation, features a handsome midnight-black and contrasting brushed aluminum front panel with complementary multi-colored illuminated "S-PRF" meter and attractive control knobs. A 2.5 kHz total spread fine tuning vernier facilitates accurate reception. Highly selective circuits greatly suppress adjacent channel interference (-45db). Variable squelch quiets receiver between calls. Crystal frequency synthesizer enables operation on all 23 CB channels with crystals supplied. No extra crystals are necessary! Built-in dual purpose power supply al-

- Range Boost Circuitry for Added Talk Power
- PiNetwork and Low Pass Filter for Maximum Power Output
- Vari-tilt Mounting Bracket
- Modulation Indicator
- TVI Trap

lows 12-VDC mobile and 115-VAC base station operation. Front panel switch converts transceiver to a handy 4.5 watt public address amplifier. A convenient front panel jack for headphones or external extension speakers for CB/PA is provided. Comstat 25B also features push-to-talk relay switching and plug-in ceramic microphone with coiled cord. Complete with vari-tilt mounting bracket which facilitates both easy mounting and optimum positioning of set as well as serving as an adjustable table top base. With FCC License Application Form 505. Size: 12Wx8 $\frac{1}{2}$ Dx5"H. Imported. Shpg. wt., 16 lbs.

99 T 32148WUX

Net 149.95

## 23 Crystal Controlled Channels

### All Crystals Supplied!



## Lafayette Deluxe HB-625 Solid-State Mobile 2-Way Radio

ONLY **189<sup>95</sup>**

No Money Down\*

FCC Type Accepted

## 3-Integrated Circuits + 3-Stage RF

- 18 Transistors + 3 IC's + 11 Diodes
- With RF Overload Protection (Pat. Pend.)
- Selective Dual Conversion Superhet Receiver
- 3-Position Delta Tune for Accurate Tuning
- Mechanical Filter for Superior Selectivity

The HB-625 incorporates a highly selective 455 kHz mechanical filter to virtually eliminate adjacent channel splatter. It utilizes a 3-stage RF noise silencer including a 10-transistor, 8-diode integrated circuit to keep ignition noise interference from getting into the receiver's audio without cutting the incoming signal strength. Range Boost audio system uses revolutionary new IC microcircuits for increased effective talk power. Variable squelch and standard ANL combine with noise silencer to provide quiet, pleasurable reception. Other quality features include built-in public address amplifier facilities with rear panel jack for hi-fi tuner or tape recorder input. Operates instantaneously from 12-volts DC positive or negative ground with low battery drain or on 117 volts AC with optional power supply. Supplied with mounting bracket, power cord, PTT dynamic micro-

- Front Panel Transmit Mode Indicator Light
- Range Boost™ Circuitry for Added Talk Power
- Built-in Public Address Amplifier Facilities
- 12-Volt Portable or Mobile DC Operation

phone with coiled cord, and FCC Form 505 CB License Application. Size: 2 $\frac{3}{8}$ H x 6 $\frac{1}{4}$ W x 6"D. Imported. Shpg. wt., 7 lbs., 8 oz. 31406WX Net 189.95

Model HB-302B AC Power Supply for base station operation and Nicad Battery Charger. 99 T 32085W Shpg. wt., 5 lbs. Net 19.95

Model HB-308 Portable DC Power Pack. Attaches to HB-625 to permit portable DC operation. Includes battery pack (less batteries), telescoping antenna, and shoulder strap. Shpg. wt., 2 lbs. 99 T 31844W Net 19.95

Batteries for HB-308 Portable Pack. "C" Alkaline (8-required). 99 T 63602 Shpg. wt., 4 oz. ea. Net ea. .44

\*See Page 18 for Full Credit Details on Easy Pay Plan

Lafayette Cat. No. 711 107

# A CB 2-WAY RADIO PLUS A POLICE and FIRE RECEIVER

MONITOR 150-174 MHz Or 30-50 MHz And  
COMMUNICATE ON 23 CB CHANNELS

2 SOLID STATE  
UNITS IN... 1

TELSAT 150  
CB + 150-174MHz

TELSAT 50  
CB + 30-50MHz

ONLY **199<sup>95</sup>**  
No Money Down\*

- For Car and Home
- 12 VDC Neg. Ground
- 117 VAC with HB-502B

1-Integrated Circuit + 1-FET + 25 Transistors + 9 Diodes

## CB TWO-WAY RADIO

- 5-Watt FCC Max. Rating
- Dual Conversion • 0.7  $\mu$ V Sensitivity
- 23 Crystal Controlled Channels... ALL Crystals Supplied!

This exciting Lafayette innovation in the field of communications permits you to become an alert and informed citizen in your community! Now you can monitor the police and/or fire frequencies and immediately communicate with your family and with members of your volunteer fire or auxiliary police squad. The Lafayette Telsat 150 and Telsat 50 are unique compact combinations of a 5-Watt 23 channel solid-state CB transceiver (all crystals supplied) and a VHF police/fire or industrial monitor receiver. These units are expertly engineered for outstanding CB and VHF performance in a car, truck, and boat as well as in an office or home (with optional AC power supply). Complete with mobile mounting bracket and FCC license application form 505. Less crystals. Size: 2 1/2" H x

## VHF FM MONITOR RECEIVER

Tunable Receive Plus 2 Crystal Positions

- Monitors 150 thru 174 MHz or 30 thru 50 MHz
- Manual Tuning Plus Two Switchable Crystal Positions for Optional Crystals
- Less than 1  $\mu$ V Sensitivity

6 1/2" W x 8 L. Imported. † in certain areas of the country. Shpg. Wt., 7 1/2 lbs.  
 6 1/2" W x 8 L. Imported. † in certain areas of the country. Shpg. Wt., 7 1/2 lbs.  
 99 T 32153WUX Telsat 150 (150-174MHz) Net 199.95  
 99 T 32178WUX Telsat 50 (30-50 MHz) Net 199.95  
 Model HB-502B AC Power Supply For Operation in the Home or Office.  
 99 T 32080W Shpg. wt., 5 lbs. Net 19.95  
 Monitoring Crystal Certificates. Send filled-out certificate, one for each crystal, to manufacturer. Mfr. will ship crystal to you postpaid, within a maximum of 30 days.  
 Certificate: Specify Exact Operating Frequency. NO C.O.D.  
 40 T 82103Y Net 5.95  
 See page 452 Catalog 710 for VHF Antennas for above.

# BUSINESS and CB SOLID-STATE 2-WAY RADIO Model HB-600



## 23 Crystal Controlled CB Channels All CB Crystals Supplied

- PLUS Choice From 5 Business Band Frequencies
- RANGE BOOST For Greater "Talk-power"
  - SQUELCH/PA "Quiets" the Receiver Between Calls
  - PHONE JACK For Headphones or Speakers
  - NOISE LIMITER provides Choice of Noise Reduction Circuits—(A) Audio Noise Limiter, (B) Audio Noise Limiter plus RF Noise Silencer
  - 21 Transistors, 13 Diodes—Draws 1 Ampere Maximum On Full Transmit

The "CB Commander" offers every feature you'll ever want in a 2-way CB radio—PLUS provision for Business Band\* operation! You get 23 crystal-controlled CB channels plus 2 extra Business Band channels for optional crystals—lets you choose from 5 Business Band frequencies—27.235, 27.245, 27.255, 27.265, or 27.275 MHz. Range Boost circuit increases average modulation and lets your voice cut through noise to reach further! A dual conversion receiver provides high sensitivity—pulls in even the weak signals! A unique 5-stage RF ignition Noise Silencer (Pat. Pend.) provides excellent ignition noise reduction, literally "chops out" ignition noise—even really weak signals become perfectly intelligible under severe ignition noise conditions—you learn what quiet operation really means! Other top

### \* BUSINESS BAND CRYSTALS (Optional)

(A separate license is required for CB and Business Radio) The same crystal has both transmit and receive functions. Only one crystal required for each frequency listed. Choice of One:  
 42 T 42550 27.235 MHz Net 3.95

- Mechanical Filter for Ultra Selectivity
- 0.5  $\mu$ V Dual Conversion Receiver with 3-crystal "Delta" Fine Tuning
- Pi-Network Output with Low Pass Filter
- Plug-in Facilities for Lafayette Selective Call Unit
- Operates As a PA Amplifier with External PA Speaker
- Built-in Solid-State 117 Volt AC and 12 Volt DC Power Supply

features include a mechanical filter for razor-sharp selectivity, Delta tuning, Variable Squelch, effective Automatic Noise Limiter, Push-Pull audio, plus provision for Public Address operation with external speaker. Built-in solid-state AC and DC power supply permits low drain operation on 117V AC or 12V DC (Neg. or Pos. Gnd.). Supplied with push-to-talk dynamic microphone with coiled cord, AC and DC power cables, "quick-release" mounting bracket and hardware, microphone bracket. Dimensions: 4 1/4" high, 11 1/4" wide, 8" deep. Shpg. wt., 15 lbs. †limited to 19 channels in Canada from 27.00 MHz to 27.230 MHz. Imported.

99 T 30710WUX	Net 219.95
42 T 42564 27.245 MHz	Net 3.95
42 T 42574 27.255 MHz	Net 3.95
42 T 42582 27.265 MHz	Net 3.95
42 T 42590 27.275 MHz	Net 3.95

Only  
**219<sup>95</sup>**  
 No Money Down\*  
 FCC Type Accepted Part 91  
 Canadian D.O.C. Approved!

## 5-Stage RF Ignition Noise Silencer! With RF Overload Protection!



# Deluxe LAFAYETTE CB Antennas And Accessories

## LAFAYETTE RANGEBOOST II DELUXE BASE STATION CB ANTENNA



**19<sup>95</sup>**

Made in U.S.A.

- Heavy Duty Mounting Bracket
- Static Clover Leaf Ball Design Reduces Receiver Noise
- 3.75 db True Omni-Directional Gain
- VSWR-1.17-1
- Signal to Noise Improvement of 6-20 db

Best selling 1/2 wave Base Station Antenna. Specially designed anti-static cloverleaf ball drastically reduces receiver noise by continuous dissipation of static discharge. Weatherproof phasing transformer, three 54" radials provide proper transmission line decoupling. Heavy duty mounting bracket. Direct ground lightning protection. 50 ohm match. 17'6" over-all length. Accepts up to 1 1/2" masts, and PL-259 cable connector. (Less mast and coax). Wt. 6 lbs. 42 T 01448WX Net 19.95

## DELUXE LAFAYETTE 4 ELEMENT BASE STATION GROUND PLANE ANTENNA



**12<sup>95</sup>**

Made in U.S.A.

4 heavy duty solid aluminum 108" heat-treated radials and radiator. Elements supplied in two 54" lengths joined by threaded coupling nuts. Radial droop for 50 ohm match. Accepts 1 1/4" tubing, RG-58/U cable and PL-259 connector. Less mast and coax. Wt. 4 lbs. 42 T 01562W Net 12.95

## BEST-SELLING LAFAYETTE MOBILE CB ANTENNA

- 102" Stainless Steel Whip For Optimum 11-Meter Performance
- Heavy-Duty Cadmium Plated Steel Spring
- Aluminum Swivel Ball Jointed Mount Base

**8<sup>95</sup>**

Made in U.S.A.

Aluminum swivel mount base designed to be mounted on any surface. Plated steel spring holds rod in properly adjusted position and prevents rod damage from shocks and blows. Stainless steel whip for resiliency and strength. Less cable. Shpg. wt. 4 lbs. 42 T 01554WX Net 8.95

## LAFAYETTE CB BUMPER MOUNT ANTENNA WITH STAINLESS STEEL STRAP

**10<sup>95</sup>**

Made in U.S.A.

- Cadmium Plated Bumper Mount with Plated Steel Strap
- 102" Stainless Steel Whip
- Heavy-Duty Cadmium Spring

An outstanding Lafayette CB antenna. Features a full-size 102" stainless steel whip, and a fully adjustable steel plated mount with a steel plated strap designed to fit most cars. Heavy duty plated steel spring is built for extremely rugged mobile use. Less cable. Shpg. wt. 3 lbs. 42 T 01596WX Net 10.95



## NEW LAFAYETTE CB PHONE PATCH

**15<sup>95</sup>**  
**NEW**

- Ideal for Emergency Phone Calls using your CB Transceiver



Talk anywhere in the world from your car or truck. Simple installation allows your telephone to be connected to your CB communications system. For use with 3-16 ohm speakers and high impedance microphone inputs. Modulation gain control to compensate for varying line levels. On-off switch disconnects patch when not in use. Dimensions: 4 1/4" Wx1 7/8" Hx2" D. Shpg. wt. 2 lbs. 42 T 01638 Net 15.95

## DELUXE LAFAYETTE SUPER RANGE-ROOST/II™ OMNI-DIRECTIONAL BASE STATION CB ANTENNA



**29<sup>95</sup>**

Made in U.S.A.

- End Fed 1/2 Wave
- Hi-Q Phasing Coil
- VSWR 1.4 to 1 or less
- 4 db Gain Delivers 13 Watts E.R.P.
- Loaded Ground Radials For Optimum Performance

Our best base station CB antenna. Huge loading coil will safely handle 50 to 75 times normal CB power. Rubber covered, Hi-Q phasing coil optimizes impedance match. VSWR less than 1.4-1. Three ground radials (54") are base loaded. Constructed of seamless aircraft tubing and corrosion-proof steel. Rated to withstand 100 mph winds. Four element static ball passes off perceptible static smoothly and reduces receiver noise. Direct ground lightning protection. Over all height 18 ft. Stainless steel mounting hardware will accommodate up to 1 1/2" mounting mast. Less mast and coax. Shpg. wt. 10 lbs. 42 T 01604W Net 29.95

## ANTENNA SPECIALISTS M317 FIBER GLASS CB BASE STATION ANTENNA

**NEW 59<sup>95</sup>**

Gleaming white fiber-glass CB base station antenna for the 27 MHz band. Provides 4 db omni-direction gain and 1.5:1 VSWR. Features four "Power-tip"™ ground radials and super loading coil. 1000 watt power handling capability insures against burn-outs due to power surges or high level static buildups. Entire radiator encapsulated in "Armor-weave"™ fiberglass; construction is impervious to all corrosive elements. 115 mph wind rating. 17' overall height. 50-ohm input impedance. Accepts PL-259 cable connector. Includes mounting hardware for 1 1/2" mast. Shpg. wt. 5 1/2 lbs. 42 T 10621W Net 59.95

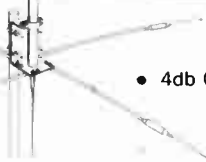

- 4db GAIN

## ANTENNA CABLE ASSEMBLIES POLYFOAM COAX CABLE ASSEMBLY FOR BASE STATIONS



As Low As

**8<sup>50</sup>**

Complete transmission line packages designed for better CB operating efficiency. The polyfoam dielectric insures low line loss important in getting the most from your base station. Ready to use. PL-259 connectors on both ends.

Stock No.	Type	Length wt.	ft.	lbs.	Net
42 T 09102	RG8/U-50 ohms	50	7	8.50	
42 T 09110	RG8/U-50 ohms	100	11	14.95	

## 20 FT. MOBILE COAXIAL CABLE ASSEMBLIES

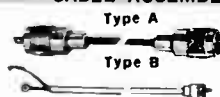

Type A

Type B

As Low As

**2<sup>95</sup>**

TYPE A—Consists of 20 ft. RG-58/U cable with PL-259 plus UG-175/U on both ends. 42 T 70013 Shpg. wt., 8 oz. Net 3.25  
TYPE B—Same as Type A except one end is terminated with PL-259 plus UG-175/U and other end with universal ring type terminal lugs. Shpg. wt., 8 oz. 42 T 70021 Net 2.95

# STEREO 8 for the home

## LAFAYETTE LR-818 FM/AM/FM STEREO 3 Piece 8 TRACK PLAYBACK SYSTEM

Only

**119<sup>95</sup>**

No Money Down\*

With 2 Separate 8" Duo-Cone  
Acoustic Suspension Speakers  
For Magnificent Sound Quality



- Illuminated Track Indicator Lights
- Pushbutton Track Selector
- FM Stereo Indicator Light

Enjoy the pleasure and ease of listening to pre-recorded 8-Track stereo tape cartridges. Tune in brilliant FM stereo plus standard FM, and AM radio broadcasts. Input jacks are provided for plugging in a record changer with ceramic cartridge so you can listen to your favorite records. You can also plug in a stereo reel-to-reel or cassette tape deck. The 8-Track stereo tape player features a pushbutton track selector, and separate illuminated channel indicator lights. Desir-

- Instant On Solid-State Circuitry
- Inputs For Phono, or Tape Recorder
- Tape Recorder Output Jacks
- Front Panel Stereo Headphone Jack

able features are: separate controls for volume, balance, and tone; illuminated slide rule tuning, built in FM and AM antennas, provisions for external FM antenna, and AC convenience outlet on the rear panel. Power Output: 120 watts 1PP. FM sensitivity: 5µv. Stereo separation: 25 db. Walnut grained finished cabinet. Size: Control Unit: 4 x 11 x 18", Speakers: 6 x 14½ x 10". For 117 VAC 60 Hz. Imported. 17 T 0229WX Shpg. wt., 36 lbs. Net 119.95

# STEREO 8 for the car

## NEW LAFAYETTE "Micro 8" STEREO 8 TRACK CAR TAPE PLAYER

At A Price  
Everyone Can Afford

**39<sup>95</sup>**

with mounting  
bracket, less  
speakers

No Money Down\*

- Compact Size—For Easy Installation
- Individual Illuminated Channel Lights
- Pushbutton Channel Selector Button
- "Instant-on" Solid State Circuitry

Listen to beautiful 8 track stereo track cartridges in your car. Compact design permits simple installation—even where space is at a premium. Player is only 7½"D x 5½"W x 2¾"H in size. Fully automatic operation—turns on when a tape is inserted, changes tracks automatically at the end of each program. A selector button permits you to instantly change tracks. Individual illuminated lights tells you which track is playing. Balance control to adjust for proper stereo channel separation. Separate volume and tone controls. Power output 10 watts. Freq. Response 30-10,000 Hz. For 12 volt neg. ground systems. Adjustable mounting bracket. Imported. 17 T 01143W Shpg. wt., 5 lbs. Net 39.95

Pair of Two 3 x 5" matching speaker systems Net 6.95  
99 T 62994 Shpg. wt., 3 lbs.



# IDEAL GIFTS For Every Member of the Family



## Deluxe LAFAYETTE RK-160 Solid-State AC/Battery Portable AM/FM Radio Cassette Tape Recorder

Sensationally  
Priced  
At

**69<sup>95</sup>**

No Money Down\*

- Includes Remote Control Mike with Stand, Earphone, Built-in AC Line Cord, Batteries, Blank 60-Minute Cassette, and Integrated Carrying Handle For Ease Of Portability.

Magnificent Lafayette full-feature AM/FM Cassette Radio-Recorder is an entertainment center in itself. Easy to use—no tape threading. 8 Piano Key type pushbutton controls. Plays back or records on a cassette tape for up to two hours. Records AM or FM programs directly "Off the Air" while monitoring through the speaker. Versatile and handsome simulated plastic walnut grain case with metal trim. Operates on 4 "D" batteries or 117 VAC with built-in self-storing AC Line cord. Superb AM/FM radio section features a precision slide-rule tuning dial, bass/treble control. 4" acoustically matched Hi-Fi speaker provides rich, full-frequency sound reproduction. Telescopic FM antenna and ferrite core AM antennas. External speaker or earphone jack. Speaker on/off Switch, Aux. input for phono or another recorder for tape duplicating. 8 pushbutton Tape Functions: Eject, Record, Play, Rewind, Fast-Forward, Stop, Cassette/Radio, AM/FM radio. Record safety interlock prevents accidental erasures. Also includes self-storage compartment for microphone and accessories. SPECIFICATIONS: Professional AC bias recording system; Power output 1 watt. Size: 3¼x11½x11¾" H. Imported. Shpg. wt., 9 lbs. 99 T 15471W RK-160 Net 69.95

12 VDC CAR ADAPTER — Imported Wt., 2 lbs.

99 T 31528 Net 3.95

99 T 62564 Extra "D" Batteries (4 req.) Net ea. .15

28 T 01223 Lafayette 60 Minute Tape Cassette Net 1.19



- Direct Recording From AM or FM Radio
- Instant-On Solid-State Circuitry
- 4" Acoustically Matched Hi-Fi Speaker

- Semi-Slot Tape Loading
- Battery Condition—Record Level Meter
- 8 Pushbutton Tape Function Controls

## LAFAYETTE Low Profile Full Feature Solid-State AM/FM Clock Radio



**29<sup>95</sup>**

With Earphone for Private Listening

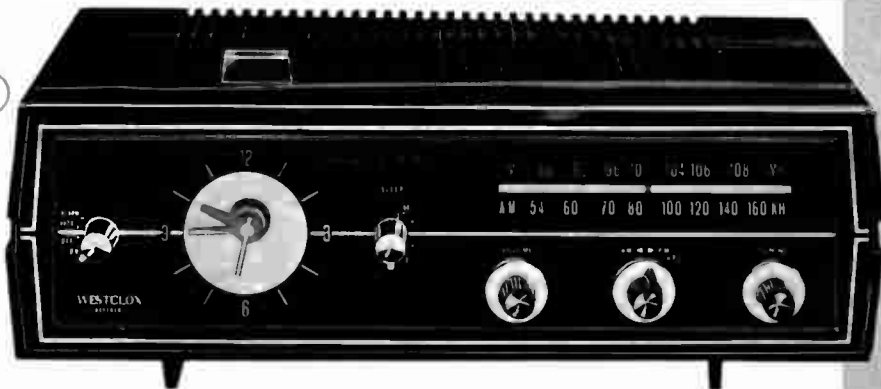

- 60 Minute Sleep Switch
- 10 Minute Snooze Button
- Full Feature Westclox Clock Movement
- Soft Glow Electro-Luminescent Night Light
- Precision Slide Rule Dial
- Large 3½" Speaker

Combines a fully automatic full feature Westclox clock with Soft Glow Electro-Luminescent Night Light and a superb FM/AM radio in a handsome low profile styled walnut grained plastic cabinet with black and silver trim. Handy sleep-switch permits you to slowly drift-off to dreamland while the radio automatically shuts itself off (up to 60 minutes). Beautiful FM or AM music will awaken you at a preset time. Even includes a snooze button so that the Radio can again be turned off to permit you an extra 10 minutes of sleep.

FM-AM radio features a slide rule dial for precise tuning, and a large 3½" wide range speaker for luxurious tonal quality. All solid state circuitry with 10 transistors, 4 diodes and 1 thermistor provides high sensitivity and selectivity enabling you to pull in stations crystal clear, both near and far. Size: 9½x5¼x3¼" D. For 117V AC, 60 Hz. Imported. Shpg. wt., 4 lbs.

17 T 01895W Net 29.95

\*See Page 18 for Full Credit Details on Easy Pay Plan

Lafayette Cat. No. 711 111

# 50<sup>th</sup> Anniversary Celebration

**39<sup>95</sup>**

with earphone  
for private  
listening



## LAFAYETTE Full Feature Solid-State AM/FM Digital Clock Radio

*Illuminated Digital Clock Face Tells  
Time By The Numbers-Not the Hands*

- Separate Digital Control Setting for Waking you up at a Preset Time to Music, Alarm or both
- 60 Minute Sleep Switch
- Large Prismatic Illuminated Station Selector Dial For Precise Tuning
- Handsomely Styled Swivel Pedestal

Sensational concept in the design and performance of a clock radio. Will become a quality addition to your home, office or den. This luxurious AM/FM radio features an easy-to-read, illuminated clock face that provides accurate, large digital indication of hours and minutes as well as seconds. Separate visual digital control setting allows you to wake-up at a preset time to music, an alarm, or both. You can also have the radio lull you to sleep with up to 60 minutes of music or your favorite program—then automatically shut-off. Large prismatically lit station selector for precise tuning. Built-in AFC prevents station drift on FM. Top mounted wide-range 3½" speaker provides fine tone. Earphone for private listening. Built-in AM ferrite core antenna. Highly sensitive FM line cord antenna. Attractive walnut grain and black matte, silver trimmed plastic cabinet is 9½"x5½"x2½" mounted on 1½ inch swivel pedestal. For 117 VAC 60 Hz. Imported. Shpg. wt., 3 lbs. **17 T 01887**

Net 39.95

## LAFAYETTE RK-65 Solid-State Portable Cassette Recorder

**19<sup>95</sup>**

with start-stop remote  
control mike, &  
integrated carrying handle

- Record Safety Button
- Single Tape Function Control For Record, Stop, Play, Fast Forward

So easy to use! Just snap in a cassette and you are ready to record or play. No tape to thread. Operates on 4 "C" batteries (not included) or 117 VAC with optional adapter. Big 2¾" speaker for excellent sound. Input for earphone or extension speaker. Size: 9Lx5½Wx2½"H. Imported.

99 T 15828L Shpg. wt., 4 lbs. Net 19.95  
99 T 35115 AC Adapter. Shpg. wt., 6 oz. Net 3.95  
99 T 01223 Lafayette 60 min. cassette, 2 oz. Net 1.19  
99 T 62572 "C" Batteries, 4 required Net ea. .14



## LAFAYETTE RADIO ELECTRONICS

111 JERICHO TURNPIKE SYDSET, L.I., N.Y. 11791

070085212 E  
R. SLOKOSKY  
RT 5  
SIDNEY OH 45365

**BULK RATE**  
U.S. Postage  
**PAID**  
**LAFAYETTE**  
Radio Electronics

POSTMASTER: If Undeliverable Handle In  
Accordance To Sec. 158.5 Of Postal Manual.