

LOW VOLTAGE AC DRIVES

ABB industrial drives

ACS880, single drives

0.55 to 6000 kW



—

**Uncompromised productivity.
ACS880 series.**

ABB industrial drives

ACS880 single drives

04 – 17	THE ALL-COMPATIBLE ACS880 DRIVE SERIES
06 – 07	SIMPLIFY YOUR WORLD WITHOUT LIMITING YOUR POSSIBILITIES
08	EASY TO USE
09	SIMPLE TO SELECT AND INSTALL
10	VIRTUAL COMMISSIONING
11	SMARTER SOLUTIONS WITH DRIVE-BASED FUNCTIONAL SAFETY
12	COMPREHENSIVE CONNECTIVITY
13	MINIMIZED DOWNTIME
14	GLOBAL COMPATIBILITY WITH VARIOUS DEMANDS
15	PREMIUM CONTROL AND PROGRAMMABILITY
16 – 17	APPLICATION- AND INDUSTRY-SPECIFIC SOLUTIONS
18	HOW TO SELECT A DRIVE
19	TECHNICAL DATA
20 – 23	WALL-MOUNTED DRIVES, ACS880-01
24 – 27	CABINET-BUILT DRIVES, ACS880-07
28 – 33	REGENERATIVE DRIVES, ACS880-11, ACS880-17
34 – 39	ULTRA-LOW HARMONIC DRIVES, ACS880-31, ACS880-37
40 – 46	LIQUID-COOLED DRIVES, ACS880-07LC, ACS880-07CLC, ACS880-17LC, ACS880-37LC
47 – 49	DIMENSIONS
50 – 51	STANDARD INTERFACE AND EXTENSIONS FOR PLUG-IN CONNECTIVITY
52 – 77	OPTIONS
52	CONTROL PANEL OPTIONS
53	ABB ABILITY™ SMARTPHONE APPS
54	CONNECTIVITY TO AUTOMATION SYSTEMS
55	FEEDBACK INTERFACE AND DDCS COMMUNICATION OPTIONS
56	REMOTE MONITORING OPTIONS
57	PC TOOL OPTIONS
58 – 59	SAFETY OPTIONS
60 – 61	EMC – ELECTROMAGNETIC COMPATIBILITY
62 – 67	SINE FILTERS
68 – 75	BRAKE OPTIONS
76 – 77	DU/DT FILTERS
79	ABB AUTOMATION PRODUCTS
80 – 81	CHOOSE THE RIGHT MOTOR FOR YOUR APPLICATION
82 – 85	ABB DRIVE SERVICES
82 – 83	KEEP YOUR PROCESS RUNNING
84 – 85	ABB ABILITY™ DIGITAL POWERTRAIN
86 – 93	SUMMARY OF FEATURES AND OPTIONS

ACS880 DRIVE SERIES
04 – 17

HOW TO SELECT A DRIVE
18

TECHNICAL DATA
19

WALL-MOUNTED DRIVES
20 – 23

CABINET-BUILT DRIVES
24 – 27

REGENERATIVE DRIVES
28 – 33

ULTRA-LOW HARMONIC DRIVES
34 – 39

LIQUID-COOLED DRIVES
40 – 46

DIMENSIONS
47 – 49

STANDARD INTERFACE AND EXTENSIONS
50 – 51

OPTIONS
52 – 77

ABB AUTOMATION PRODUCTS
79

MOTORS
80 – 81

ABB DRIVE SERVICES
82 – 85

SUMMARY OF FEATURES AND OPTIONS
86 – 93

A

B

C

D

E

F

G

H

I

J

K

L

M

N

O

The all-compatible ACS880 series

Uncompromized productivity

The ACS880 is an all-compatible ABB industrial drive, offered in a range of wall-mounted drives, drive modules and cabinet-built drives.

ABB's all-compatible drives are designed to provide customers across industries and applications with unprecedented levels of compatibility and flexibility. Our ACS880 single drives are standalone drives. They are customized to meet the particular needs of specific industries, such as oil and gas, mining, metals, chemicals, cement, power plants, material handling, pulp and paper, sawmills, marine, water and wastewater, food and beverage, and automotive. They can control a wide range of applications, including cranes, extruders, winches, winders, conveyors, mixers, compressors, centrifuges, test benches, elevators, extruders, pumps and fans.

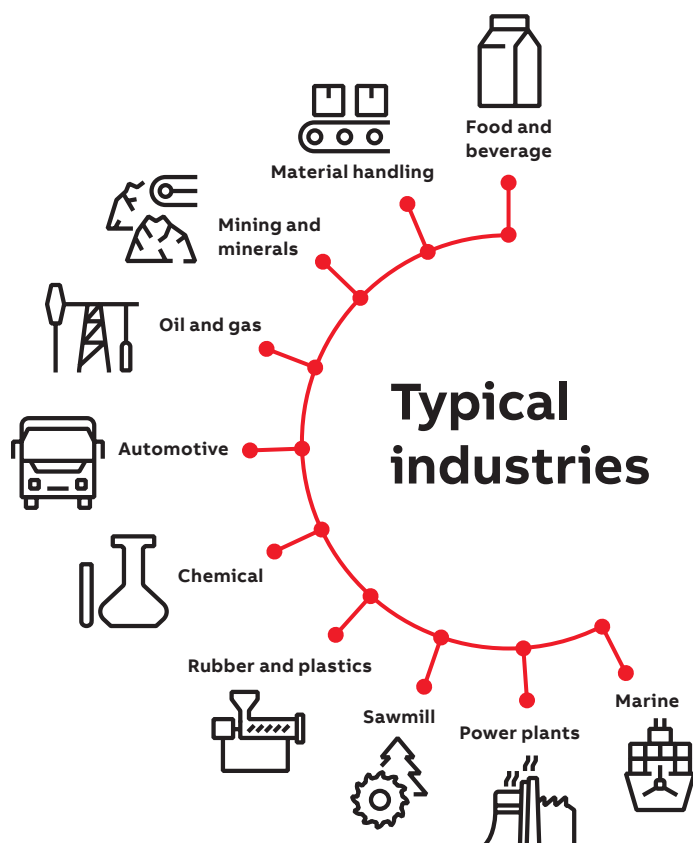

High quality

Reliability and consistent high quality

ACS880 drives are designed for customers who value high quality and robustness in their applications. They have features such as coated boards and high enclosure classes, making the ACS880 suitable for harsh conditions. Additionally, every ACS880 drive is factory-tested at full load to ensure maximum reliability. The tests include performance and all protective functions.

High performance, safety and configurability

The ACS880 offers the highest level of performance. The drives are equipped with ABB's signature direct torque control (DTC), which provides precise speed and torque control for all applications and supports virtually any type of motor.

Extensive ACS880 offering includes wall-mounted drives, drive modules and cabinet-built drives, as well as low harmonic and regenerative variants.

The ACS880 has all the essential features built-in reducing the time required for engineering, installation and commissioning. A wide range of options are also available to optimize the drive for different requirements, including certified, integrated safety features.



Simplify your world without limiting your possibilities

The ACS880 industrial drive is equipped with built-in features that simplify ordering and delivery, and reduce commissioning costs, since everything is provided in a single, compact and ready-to-use package.



Easy to use

- All-compatible ACS880 drives share the same easy-to-use user interface.
- Multilingual control panel with clear display
- Graphical PC tools for engineering, commissioning and maintenance

See page 08



Simple to select and install

- All the essential features built-in for simple drive selection, installation and use
- Flexible product configurations
- Enclosure classes for different environments, up to IP55
- Possibility for flange mounting

See page 09



Virtual commissioning

- Virtual design and test environment for drive applications

See page 10



Smarter solutions with drive-based functional safety

- Safe torque off built-in as standard
- Optional safety modules for extended safety functions
- Encoderless safe speed detection
- Highest level of machinery safety, SIL 3 / PL e
- TÜV certified

See page 11



Comprehensive connectivity

- Communication with all major automation networks
- Remote monitoring
- Mobile connectivity
- Integration tools for various PLCs

See page 12





Nine-year maintenance interval

Minimized downtime

- Robust, long lifetime design for maximum reliability
- Coated circuit boards for harsh conditions
- Removable memory unit for fast drive replacement
- Each drive factory-tested at full load
- Nine-year maintenance interval
- Worldwide service and support
- Advanced features for analyzing and resolving issues

See page 13



Global compatibility with various demands

- Global product approvals, e.g. CE, UL, cUL, CSA, marine certifications, ATEX
- Support for various motor types
- Low harmonic content
- Possibility for regeneration

See page 14



Premium control and programmability

- Direct torque control (DTC) for precise control
- Speed, torque and position control as well as synchronizing
- Adaptive programming as standard
- Drive-based PLC programmability (IEC 61131-3) for fully customized solutions

See page 15



Application- and industry-specific solutions

- Ready-made optimized solutions for various applications and industries

See page 16

Easy to use

All-compatible user interface saves commissioning and learning time

The ACS880 is part of ABB's all-compatible drives portfolio. Other drives in this portfolio are the ACS380, ACS480 and ACS580.

These drives share the same easy-to-use PC tools and multilingual control panels. To further enhance the user experience, they also have the same parameter structure, which saves time on commissioning and learning.

The drives also share the same communication options, simplifying the use of drives and spare parts handling.

Simplicity at your fingertips as standard

The control panel's assistants help you to set up the drive quickly and effectively. The intuitive, high-contrast, high-resolution display offers easy navigation in multiple languages.

The PC tool for commissioning and configuration provides extensive drive monitoring capabilities and quick access to drive settings, as well as features like a graphical interface for configuring safety functions, visual control diagrams, and direct links to user manuals.

The ACS880, part of the all-compatible drives portfolio



Simple to select and install

Built-in features simplify ordering and installation

All ACS880 drives have a choke for harmonic filtering, a Modbus RTU fieldbus interface, and safe torque off functionality as standard. Other built-in features, standard or optional, include EMC filters, brake choppers, low harmonic or regenerative functionality and various I/O extensions, communication protocol adapters, and functional safety modules.

All essential features built-in

The built-in features make drive configuration simple – the number of external components is minimized and there is no need for extra enclosures. This cuts the engineering time, and reduces commissioning costs and the risk of errors. Built-in features simplify ordering and make installation fast and easy. As result, the whole drive system is more compact.

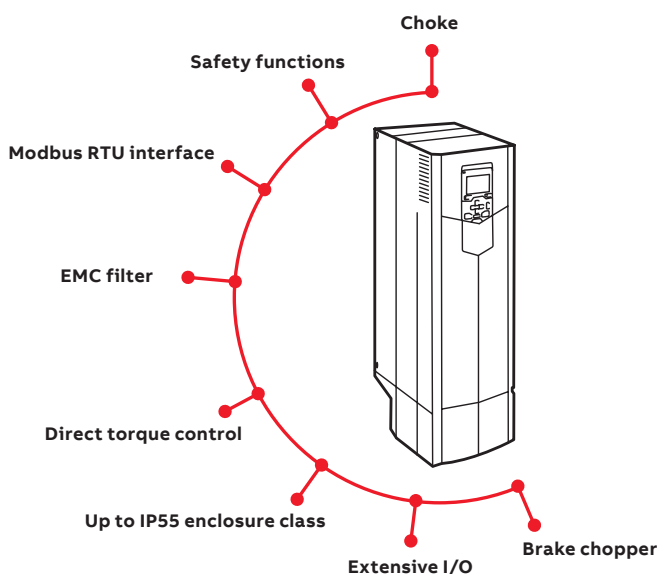

Different installation solutions

ACS880 offering has optimized variants for cabinet-building, wall-mounting and modules for cabinet assembly.

ACS880 offering also includes complete and compact solutions for dusty and wet environments with up to IP55 enclosure class.

Engineering support

ABB provides an extensive selection of support material and tools to help in engineering, such as:

- Dimensioning tools, e.g. DriveSize
- E-learning
- Safety circuit design tools
- EPLAN P8 macros
- A selection tool for choosing external components, e.g. fuses and circuit breakers
- Dimensional and electrical drawings
- Application guides
- Drive installation and configuration videos

These tools and support from our experts ensure that the drive system can be set up easily and reliably.

DriveSize dimensioning tool for selecting the optimal drive

DriveSize is designed to help select the optimal drive, motor and transformer for the application. Based on data supplied by the user, the tool calculates and suggests which drive and motors to use.

DriveSize is a free software and can be used either online or downloaded for PC from <https://new.abb.com/drives/software-tools/drivesize>.

Virtual commissioning

Virtual engineering and commissioning allow machine builders and system integrators to develop and simulate entire industrial processing lines and machines, including ABB drives, without actually running the hardware. This gives valuable benefits in the phases of designing, commissioning and operating machines.



Design safely and efficiently

Engineers can start configuring and programming drives well before receiving them from ABB production line, since the same software tools like Drive Composer pro can be used with virtual and real drives. Virtualization can also cover the kinematical and physical behavior of the machine and the overriding automation. Virtual drives can also be used with the

ABB Robot Studio tool and ABB Automation Builder programming tools to build more complete virtual machines and processing lines.

After deploying the virtual machine in use on-site, any future improvements can be virtually tested before implementing them in the process. This all supports safety and quality in the engineering process.

- Find and solve potential problems earlier
- Save time and money due to faster drive commissioning
- Assist the dimensioning and energy optimization of electromechanical drive systems

Benefits

Throughout the value chain from sales, marketing, and training to field engineering and product development, virtual commissioning makes drive applications more easily understood and helps to:

- Design, test and learn drive applications virtually with the same software tools as for the actual hardware
- Train users and engineers with application simulation
- Tune up drive parameters easily off-site before going into more demanding on-site testing

—
Save time, reduce risk, and increase engineering productivity

Smarter solutions with drive-based functional safety

Maximized safety and conformity

The safe torque off (STO) safety function comes integrated into ACS880 drives. Optional safety functions modules provide an easy way to extend safety functions. These plug-in modules are installed and cabled inside the drive, enabling safety functions and diagnostics in one compact and reliable module. The safety functions are certified by TÜV Nord and comply with the highest performance requirements in machinery safety – SIL 3 / PL e *).

Increased productivity by doing things smarter

Safety functions help to minimize unnecessary downtime by keeping the application in control at all times. Safely-limited speed (SLS), for example, keeps the process running at a safe speed instead of stopping it.

Flexibility and ease of use

The safety functionality can be scaled to your needs. From STO wired to an emergency stop push button, to a complete safety system with PROFIsafe and a safety PLC, e.g. the AC500-S.

Configuring the safety functions module is easy thanks to the graphical user interface of the Drive Composer pro PC tool.

Available safety functionality

The following safety functions are supported:

- Safe torque off (STO)
- Safe stop 1 (SS1-t and SS1-r)
- Safe stop emergency (SSE)
- Safe brake control (SBC)
- Safely-limited speed (SLS)
- Safe maximum speed (SMS)
- Prevention of unexpected startup (POUS)
- Safe direction (SDI)
- Safe speed monitor (SSM)
- Safe motor temperature (SMT)

Integrated safety simplifies configuration

Safety for explosive atmospheres

ACS880 and ABB Ex motors have been certified as a package providing a safe, proven solution for explosive atmospheres. ACS880 safety options for ATEX environments:

- ATEX-approved thermistor protection module
- ATEX-approved safe torque off

TÜV-certified safety design tool

The FSDT-01 functional safety design tool can be used to design complete safety circuits. With this tool it is possible to define required safety integrity (SIL) / performance level (PL) for safety functions, verify achieved safety level and generate design reports.

*) SIL 2 / PL c for SMT (Safe motor temperature)



Comprehensive connectivity

Communication with all major automation networks

ACS880 drives come with Modbus RTU fieldbus interface and drive-to-drive communication link as standard.

Plug-in connectivity adapters enable communication with all major industrial automation networks.

The drives support advanced communication features:

- Redundant communication
- PROFIsafe
- Functional safety over fieldbus
- Support for multiple protocols simultaneously
- Shared Ethernet connection for automation communication and Drive Composer pro PC tool – all communication via the same cable

To minimize connectivity-related risks, cybersecurity is a built-in, integral part of the ACS880.

To simplify ACS880's connectivity to automation systems, ABB offers support tools for seamless integration with PLCs from ABB and several other manufacturers.

Remote monitoring

With a built-in web server and standalone data logger, the NETA-21 remote monitoring tool enables secure worldwide access to your drives.

Drive data can also be collected via a 3G mobile connection with the RMDE reliability monitoring device.

Better connectivity and user experience



Mobile connectivity

The drive has a Bluetooth panel enabling easy connection to mobile devices.

ABB offers several smartphone applications, like Drivetune and Drivebase, to ease and enhance the use of ABB drives. These tools provide a user-friendly and easy-to-use approach for commissioning, servicing and using ABB drives.

Drive mobile apps

- Full access to parameters
- Backup and restore functionality
- Access to drive data and service history
- Possibility to share configuration files via e-mail or Bluetooth
- Easy support package creation for faster remote support

Minimized downtime

Robust, long life time design

The ACS880 is designed to last for a long time, even in harsh conditions. The benefits include a nine-year maintenance interval and good tolerance for vibrations and contamination.

Several design features make the ACS880 a safe choice:

- Coated circuit boards
- Minimized airflow through the control board section
- High IP class variants
- Designed for ambient temperatures up to 55 °C
- Advanced protections – e.g. faster and more accurate IGBT protection using a thermal model

Each ACS880 drive unit is tested in the factory at full load to ensure maximum reliability. Continuous quality improvements are made based on the results of accelerated lifetime tests.

Removable memory unit

The memory unit stores the drive software and settings, including motor data. This unit can be switched from one drive to another, allowing simple and rapid drive replacement without any special equipment, software loading, parameter settings, or other adjustments in the drive or automation system. It also eliminates the risk of software incompatibility. The new drive is ready to run as soon as the memory unit is plugged in.

Nine-year maintenance interval

Advanced features for analyzing and resolving issues

The ACS880 has timers and counters that can be configured to remind you when the drive or process equipment needs maintenance.



Accurate and reliable diagnostic information is available for warning and fault messages. Help texts give detailed information about the warning or fault. Data loggers store critical values before and during an event, such as a fault. The real-time clock allows you to see the exact times of events.

For faster remote support, all relevant drive data and changed parameters can be saved in a single file package that you can easily create with the Drive Composer or by creating a QR code with the control panel.

Global support

For true global coverage, ABB offers worldwide support via its extensive pre- and after-sales network, structured to make sure that you have the experts you need close by, locally and globally. See pages 82-85.

Global compatibility with various demands

Global product approvals

The ACS880 is a global product and has all the major global approvals, such as CE, UL, cUL, EAC, RCM and TÜV. Industry-specific approval, like different kinds of marine approval, ATEX and SEMI F47 are available either as standard or as an option.

Support for different motor types

The ACS880 provides reliable control for various motors, such as squirrel cage, high-torque or servo-type permanent magnet, synchronous reluctance (SynRM), submersible and high-speed motors. Practically any encoder type is supported.

Regardless of the motor type, drive commissioning is easy, with no need for laborious manual tuning.

Low harmonic content

All ACS880 drives have a choke for harmonic reduction. If lower harmonic content is needed, an ultra-low harmonic variant is available. It produces exceptionally low harmonic content and meets the requirements of harmonics recommendations like IEEE519, IEC61000-3-12 and G5/4.

Regeneration of energy

The ACS880 offers a number of solutions for applications where electrical braking is needed. As standard, ACS880 drives have a flux braking feature that provides greater deceleration by increasing the motor flux. If this is not sufficient, the internal brake chopper can be used together with a brake resistor.

The most advanced solution is the ACS880 regenerative drive variant, which allows, continuous braking, providing the possibility for remarkable energy savings.

ACS880 also supports common DC bus configurations, where the braking energy from one load can be utilized by other loads.



Premium control and programmability

Direct torque control (DTC)

ABB's state of the art motor control technology provides precise speed and torque control, with or without an encoder, even close to zero speed. DTC provides reliable starts and rapid reactions to load or network changes, and ensures smooth and continuous operation. DTC provides optimal control, even with sine filters.

The energy optimizer feature maximizes motor efficiency by ensuring maximum torque per ampere, reducing the power drawn from the supply.

Position control and synchronizing

Position control allows to meet motion systems demands without the need of an external position controller. The ready-made motion functions can be easily configured by parameters. For optimized solution for your application, the functions can be modified and extended by IEC 61131 programming using PLCopen motion blocks.

Additional features, such as built-in synchronized drive to drive link and possibility for encoderless positioning, make ACS880 position control ideal for any axis.

Drive programming

To meet your specific application needs, you can customize your ACS880 with an extensive range of user-definable software settings (parameters) and adaptive programming. This makes fine-tuning the ready-made application control program functionalities easy. For further customization, drive application programming based on IEC 61131 standard is available for full PLC programmability. IEC programming uses the same programming environment as ABB PLCs. It is also easy to integrate the ACS880 with other components, such as PLCs and HMIs.

Adaptive programming

is an easy to use dynamic programming which allows flexible adjustments to the ACS880 software.

IEC programming

based on IEC 61131 standard for full scale PLC programmability is available as an option.

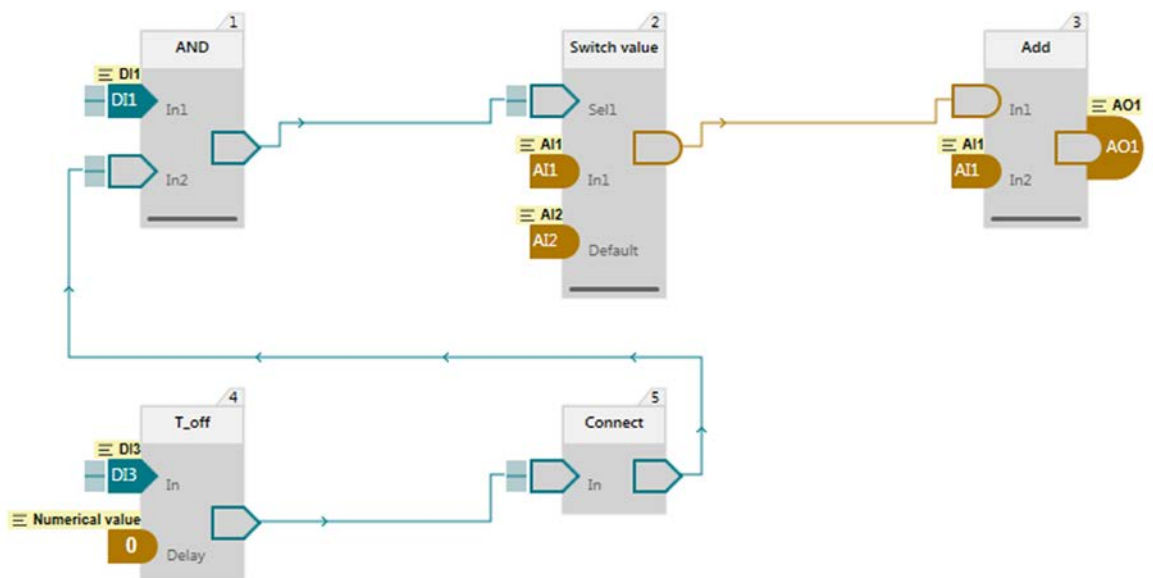

Application- and industry-specific solutions

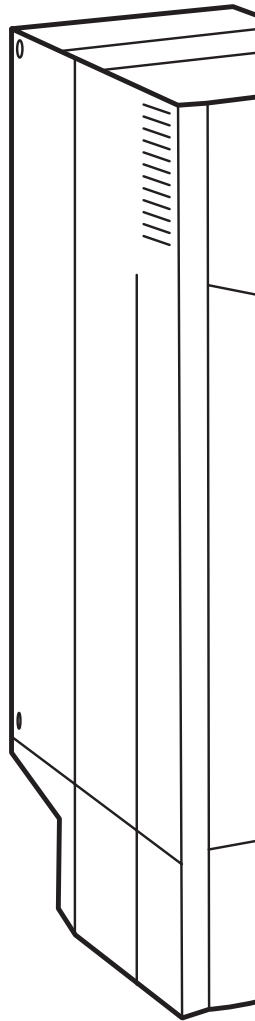
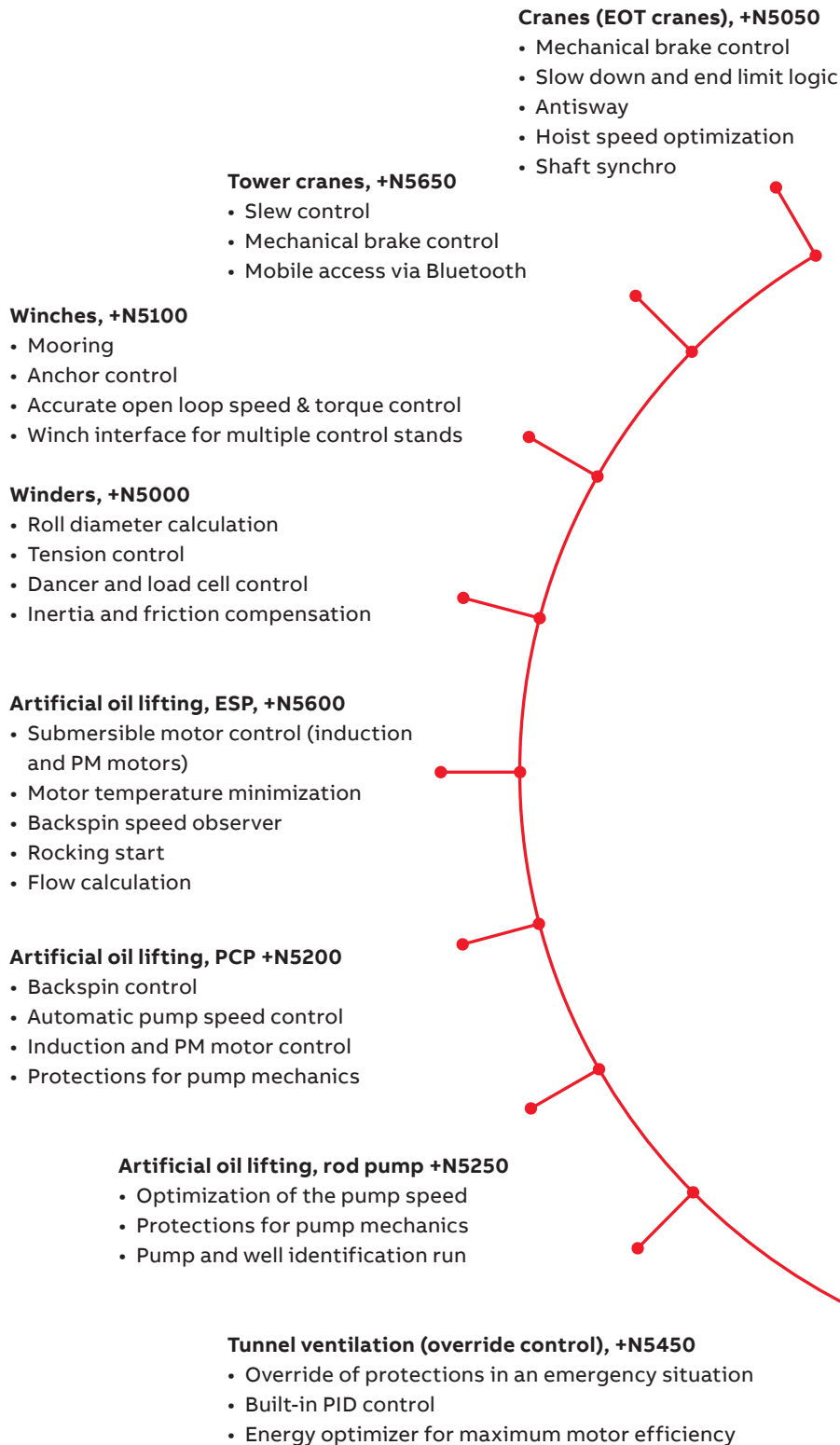

By working closely with customers over many years, ABB has developed application control programs and specific software features for specific applications and industries. This results in programs and features that include lessons learned from many customers, and that are designed to give you the flexibility to adapt the programs to your specific needs.

Advantages:

- Enhanced application usability
- Lower energy consumption
- Increased safety
- Reduced need for PLCs
- Protected machinery
- Optimized application productivity
- Optimized time usage and lower operational costs

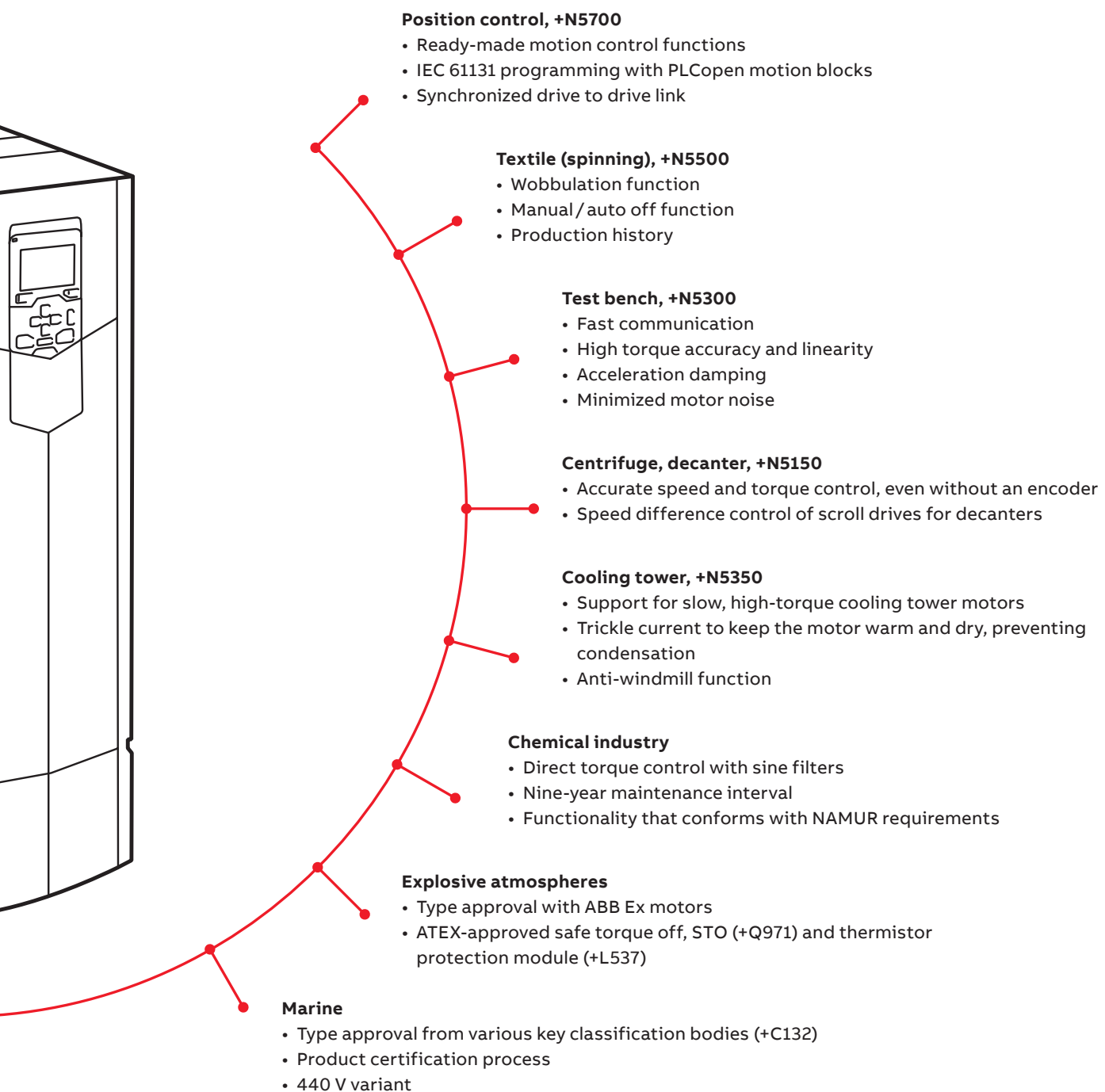

How to select a drive

The right drive is extremely easy to select. The following instructions show you how to order the right drive for your application.

Start by identifying your supply voltage and select the related rating table. Or use ABB's DriveSize dimensioning tool.

Select your drive's order code (drive type) from the rating table based on the load current, or, if it is unknown, select the drive based on your motor's power and current ratings.

Ratings, types and voltages
Wall-mounted drives, ACS880-01

U_N 230 V (range 230 to 240 V). The power ratings are valid at nominal voltage 230 V (0.95 to 1.05 UN).

Drive type	Frame size	Rated current I _N (A)	Rated power P _N (kW)	Light overload I _{150%} (A)	Heavy-duty I _{150%} (A)	Max. heat dissipation (W)	Air flow (m ³ /h)
ACS880-01-00A4-2	80	6.4	4.2	9.6	1.8	0.28	30
ACS880-01-00A6-2	81	6.4	7.8	1.1	6.3	1.1	44
ACS880-01-00A8-2	81	7.5	11.2	1.5	7.1	1.1	50
ACS880-01-00B2-2	81	10.6	15.8	2.2	10.1	2.2	55
ACS880-01-00B4-2	82	18.8	18.0	4.0	18.0	2.2	59
ACS880-01-00B6-2	82	28.8	28.8	5.5	28.8	4.0	69
ACS880-01-00B8-2	83	31.0	41	7.5	29.3	5.5	69
ACS880-01-00C4-2	84	45	64	11	44	7.5	64
ACS880-01-00C6-2	84	61	76	15	58	11	64
ACS880-01-00C8-2	85	75	88	18.5	71	14	64
ACS880-01-00D2-2	85	87	132	27	83	20	18.5
ACS880-01-00D4-2	86	115	168	39	109	30	27
ACS880-01-00D6-2	86	165	178	57	138	37	30
ACS880-01-00D8-2	87	170	287	85	185	37	67
ACS880-01-00E4-2	87	206	287	115	205	38	67
ACS880-01-00E6-2	88	278	362	150	273	55	69

U_N 480 V (range 480 to 480 V). The power ratings are valid at nominal voltage 480 V (0.95 to 1.05 UN).

Drive type	Frame size	Rated current I _N (A)	Rated power P _N (kW)	Light overload I _{150%} (A)	Heavy-duty I _{150%} (A)	Max. heat dissipation (W)	Air flow (m ³ /h)
ACS880-01-00A3-2	81	2.8	2.1	4.2	0.3	0.25	20
ACS880-01-00A1-2	81	3.5	4.1	1.1	3.1	2.8	30
ACS880-01-00A5-2	81	4.0	5.8	1.5	3.8	1.1	30
ACS880-01-00A7-2	81	5.6	8.8	2.2	5.2	4.0	35
ACS880-01-00B3-2	81	8.0	9.5	3	7.8	3	50
ACS880-01-00A2-2	81	10	12.2	4	8.5	3	50
ACS880-01-00B1-2	81	12.8	16	5.5	12	4	60
ACS880-01-00B3-2	82	17	21	7.5	16	5.5	59
ACS880-01-00B5-2	82	25	29	11	24	11	57
ACS880-01-00B7-2	83	32	42	15	31	11	60
ACS880-01-00C1-2	83	38	48	21	38	14	64
ACS880-01-00C3-2	84	45	64	27	45	18.5	64
ACS880-01-00C5-2	84	61	76	39	58	27	64
ACS880-01-00D1-2	85	72	88	57	62	30	64
ACS880-01-00D3-2	85	87	132	85	83	37	64
ACS880-01-00D5-2	86	100	180	120	101	38	120
ACS880-01-00D7-2	86	145	178	178	138	55	68
ACS880-01-00E1-2	87	169	287	240	161	75	67
ACS880-01-00E3-2	87	206	287	330	208	78	69
ACS880-01-00E5-2	88	280	360	450	280	100	78
ACS880-01-00E7-2	88	303	418	500	306	130	68
ACS880-01-00E9-2	88	363	498	600	365	200	70
ACS880-01-00F1-2	89	450	581	750	460	250	70

RATING TYPES AND VOLTAGES: CABINET-BUILT DRIVE ACS880-01

U_N 480 V (range 480 to 480 V). The power ratings are valid at nominal voltage 480 V (0.95 to 1.05 UN).

Drive type	Frame size	Rated current I _N (A)	Rated power P _N (kW)	Light overload I _{150%} (A)	Heavy-duty I _{150%} (A)	Max. heat dissipation (W)	Air flow (m ³ /h)
ACS880-01-00A4-2	80	6.4	4.2	9.6	1.8	0.28	30
ACS880-01-00A6-2	81	6.4	7.8	1.1	6.3	1.1	44
ACS880-01-00A8-2	81	7.5	11.2	1.5	7.1	1.1	50
ACS880-01-00B2-2	81	10.6	15.8	2.2	10.1	2.2	55
ACS880-01-00B4-2	82	18.8	18.0	4.0	18.0	2.2	59
ACS880-01-00B6-2	82	28.8	28.8	5.5	28.8	4.0	69
ACS880-01-00B8-2	83	31.0	41	7.5	29.3	5.5	69
ACS880-01-00C4-2	84	45	64	11	44	7.5	64
ACS880-01-00C6-2	84	61	76	15	58	11	64
ACS880-01-00C8-2	85	75	88	18.5	71	14	64
ACS880-01-00D2-2	85	87	132	27	83	20	18.5
ACS880-01-00D4-2	86	115	168	39	109	30	27
ACS880-01-00D6-2	86	165	178	57	138	37	30
ACS880-01-00D8-2	87	170	287	85	185	37	67
ACS880-01-00E4-2	87	206	287	115	205	38	67
ACS880-01-00E6-2	88	278	362	150	273	55	69

Choose your options and add the option codes to the drive's order code. Remember to use a "+" mark before each option code.

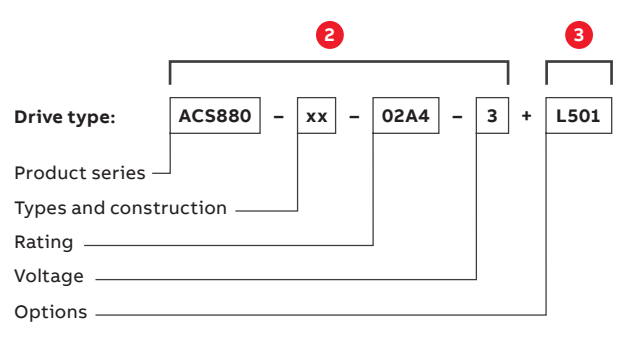

Control panel options

Standard Bluetooth assistant control panel, ACS-AP-W and industrial control panel, ACS-AP-I

Assistant control panel with clear multilingual graphical display can be used for parameter setting and back-up, drive monitoring and operation. Built-in Wi-Fi and a USB for PC tool. There are two different assistant control panels - with ACS-AP-W or without (ACS-AP-I) Bluetooth. The panels can be mounted either on the drive or on the door of the enclosure and they are compatible with any ABB A1-compatible drive.

Control panel mounting platform, DPMW-01

Control panel mounting platform, DPMW-02

Control panel mounting platform, DPMW-04

The Bluetooth connection enables the use of mobile apps like DriveTune. This app is available for free on the Google Play and the Apple App Store. DriveTune features include commissioning, troubleshooting, monitoring and controlling the drive remotely. DriveTune also has full parameter access and back-up and restore functionality.

Control panel mounting platform, DPMW-01, is for flush mounting and has IP54/UL Type 12 protection class (IP20, when control panel is not mounted). Supports daily charging of the control panel.

Control panel mounting platform, DPMW-02, is for surface mounting and has IP54/UL Type 12 protection class (IP20, when control panel is not mounted).

Control panel mounting platform, DPMW-04, is a lockable door mounting platform for drive control panels in outdoor installations or harsh environments.

Control panel options

Bluetooth Assistant control panel ACS-AP-W is included as standard in the delivery. (Class A, CE, FCC, EMC, RoHS, REACH, WEEE)

Ordering code	Description	Type
01000	No control panel	
3A000000000000000000	Bluetooth Assistant control panel, included as standard	ACS-AP-W
3A000000000000000000	Industrial assistant control panel without Bluetooth connection	ACS-AP-I
3A000000000000000000	Control panel mounting platform, flush mounted, IP54/UL Type 12 (Class A, CE, EMC, RoHS, REACH, WEEE)	DPMW-01
3A000000000000000000	Control panel mounting platform, surface mounted, IP54/UL Type 12 (Class A, CE, EMC, RoHS, REACH, WEEE)	DPMW-02
3A000000000000000000	Control panel mounting platform, lockable door, IP54/UL Type 12 protection class (IP20, when control panel is not mounted)	DPMW-04
3A000000000000000000	Control panel mounting platform, lockable door, IP54/UL Type 12 protection class (IP20, when control panel is not mounted)	DPMW-04

Technical data

Mains connection	
Voltage and power range	3-phase, U_{N2} 208 to 240 V, +10%/-15% (-01) 3-phase, U_{N3} 380 to 415 V, +10%/-15% (-01, -11, -31), ±10% (-07,-17-37) 3-phase, U_{N5} 380 to 500 V, +10%/-15% (-01, -11, -31), ±10% (-07,-17-37) 3-phase, U_{N7} 525 to 690 V, +10%/-15% (-01), ±10% (-07,-17,-37, -07CLC, -17/37LC) 0.55 to 250 kW (-01) 2.2 to 110 kW (-11, -31) 45 to 2800 kW (-07) 45 to 3200 kW (-17, -37) 250 to 6000 kW (-07CLC, -17/37LC)
Frequency	50/60 Hz ±5%
Power factor	
ACS880-01, -07, -07CLC	$\cos\phi = 0.98$ (fundamental) $\cos\phi = 0.93$ to 0.95 (total)
ACS880-11, -31, -17, -37, -17/37LC	$\cos\phi = 1$ (fundamental)
Efficiency (at nominal power)	ACS880-01, -07, -07CLC, -17/37LC: 98% ACS880-11, -31, -17, -37: 97%
Motor connection	
Voltage	3-phase output voltage 0 to $U_{N2}/U_{N3}/U_{N5}/U_{N7}$
Frequency	0 to ±598 Hz ^{1) 2)}
Motor control	Direct torque control (DTC)
Torque control	Torque step rise time: Open loop <5 ms with nominal torque Closed loop <5 ms with nominal torque Non-linearity: Open loop ± 4% with nominal torque Closed loop ± 3% with nominal torque
Speed control	Static accuracy: Open loop 10% of motor nominal slip Closed loop 0.01% of nominal speed Dynamic accuracy: Open loop 0.3 to 0.4% seconds with 100% torque step Closed loop 0.1 to 0.2% seconds with 100% torque step
Product compliance	
CE Low Voltage Directive 2014/35/EU according to EN 61800-5-1:2007 Machinery Directive 2006/42/EC EMC Directive 2014/30/EU ATEX Directive 2014/34/EU, EN 50495 Quality assurance system ISO 9001 and Environmental system ISO 14001 RoHS 2011/65/EU and Delegated Directive (EU) 2015/836 RCM, EAC ⁴⁾ TÜV Nord certification for functional safety ³⁾ ATEX-certified safe disconnection function and thermistor and PT100 protection functions, Ex II (2) GD ^{2) 7)} Marine type approvals for -01: ABS, Bureau veritas, CCS, DNV GL, KR, Lloyd's, NK, RINA, RMRS. For other drives, see https://new.abb.com/drives/segments/marine/marine-type-approvals UL, CSA: -01: cULus listed according to UL 508C and CSA C22.2 No. 274, CSA certified according to CSA C22.2 No. 274. -11, -31: cULus listed according to UL 61800-5-1 and CSA C22.2 No. 274 -07, -17, -37: cULus listed according to UL 508A and CSA C22.2 No. 14, CSA certified according to CSA C22.2 No. 14. -07CLC, -17/37LC: UL and CSA pending.	
EMC according to EN 61800-3: 2004 + A1: 2012. See page 61.	
Category C3 and C2 with internal option or as standard.	

Environmental limits	
Ambient temperature	
Transport	-40 to +70 °C
Storage	-40 to +70 °C
Operation area (air-cooled)	-15 to +40 °C as standard (-01, -11, -31) 0 to +40 °C as standard (-07, -17, -37) +40 to +55 °C with derating of 1%/1 °C (-01, -11, -31) +40 to +50 °C with derating of 1%/1 °C (-07,-17,-37)
(liquid-cooled)	0 to +45 °C as standard (-07CLC, -17/37LC) +45 to 55 °C with derating of 0.5%/1 °C (-07CLC, -17/37LC)
Cooling method	
Air-cooled	Dry clean air
Liquid-cooled -07CLC, -17/37LC	Direct liquid-cooling, Antifrogen® L
Without liquid-cooling unit	Incoming coolant temperature 0 to +40 °C as standard +40 to +45 °C with derating of 2%/1 °C +45 to +50 °C with derating of 2%/1 °C or 6%/1 °C ⁵⁾
With liquid-cooling unit	Incoming coolant temperature 0 to +36 °C as standard +36 to +46 °C with derating of 2%/1 °C
Altitude	
0 to 1,000 m	Without derating
1,000 to 4,000 m	With derating of 1% / 100 m ⁶⁾
Relative humidity	5 to 95%, no condensation allowed
Degree of protection	
IP20	Option (-01, -11, -31)
IP21	Standard (-01, -11, -31)
IP22	Standard (-07, -17, -37)
IP42	Standard (-07CLC, -17/37LC). Option (-07, -17, -37)
IP54	Option (-07, -17, -37, -07CLC, -17/37LC)
IP55	Option (-01, -11, -31)
Paint color	RAL 9017/9002 (-01, -11, -31), RAL 9017/7035 (-07, -17, -37, -07CLC, -17/37LC)
Pollution degree	PD 2
Contamination levels	No conductive dust allowed
Storage	IEC 60721-3-1:1997, IEC 60721-3-1, Class 1C2 (chemical gases), Class 1S2 (solid particles) [*]
Operation	IEC 60721-3-3:2002, IEC 60721-3-3, Class 3C2 (chemical gases), Class 3S2 (solid particles) [*]
Transportation	IEC 60721-3-2:1997, IEC 60721-3-2, Class 2C2 (chemical gases), Class 2S2 (solid particles) [*]
Built-in functional safety. See pages 58 - 59.	
For safe torque off (STO) and safety functions modules	EN/IEC 61800-5-2, IEC 61508: SIL 3, IEC 61511: SIL 3, EN/IEC 62061: SIL CL 3, EN ISO 13849-1: PL e - TÜV Nord certified
Safety over fieldbus	PROFIsafe over PROFINET, certified

^{*}) C = Chemically active substances. S = Mechanically active substances.

¹⁾ Operation above 120 Hz might require type-specific derating. For higher output frequencies, please contact your local ABB office. Output filters may limit the output frequency. See product specific hardware manual for details.

²⁾ Safe disconnection function (+Q971), Thermistor protection function (+L537+Q971) PTC/PT100 thermal motor protection for -07/17/37/17LC/37LC (+L513/L514+Q971)

³⁾ For available certificates, see <http://new.abb.com/drives/functional-safety>

⁴⁾ EAC directives: TR CU 020/2011 (EMC directive); TR CU 004/2011 (low voltage directive)
EAC has replaced GOST R

⁵⁾ See product specific hardware manual for detailed derating rules

⁶⁾ Derating reduced by lower than 40 °C ambient temperature

⁷⁾ Not applicable for -07CLC

Wall-mounted single drives

ACS880-01

—
01
ACS880-01
frame size R1, IP21
—
02
ACS880-01
frame size R5, IP55



01



02

Compact package for simple installation

The ACS880-01 comes in one compact package for easy installation and commissioning. The drive supports wall-mounting as standard and cabinet mounting as an option. The drive offering includes enclosure classes up to IP55, making it suitable for most environments and installations.

ACS880-01 drives have all the essential features built-in. These features include as standard a choke for harmonic filtering as well as options like a brake chopper, EMC filter and communication protocol adapter, functional safety and I/O extension modules. The extensive range of options also includes external output filters and brake resistors.

The ACS880-01 is also available with marine type approval from various key classification bodies.

Wall-mounted ACS880-01 drives

- Power ratings: 0.55 to 250 kW
- Enclosure classes: IP20 for cabinet mounting, IP21 (as standard) for wall-mounting and IP55 for dusty and wet environments

Main options:

- C2 and C3 EMC filters, see page 61
- Brake chopper (as standard in frames R1 to R4), see page 68
- Brake resistor, see page 68
- Marine type approval from various key classification bodies
- I/O extension modules, see page 54
- Communication protocol adapters, see page 54
- Speed feedback interfaces, see page 55
- Functional safety modules, see page 58
- Remote monitoring tool, see page 56
- Application specific software, see page 16
- Du/dt filters, see page 76
- Sine filters, see page 62
- Flange (push through) mounting

The drives have an extensive selection of built-in features and options. See page 86.

Highlights

- Wide power range supporting wall-mounting, 0.55 to 250 kW
- Enclosure classes up to IP55
- Compact, single package with all the essential features built-in
- Easy installation for different environments
- Robust and reliable design
- Optional marine type approved version

Ratings, types and voltages

Wall-mounted drives, ACS880-01

$U_N = 230\text{ V}$ (range 208 to 240 V). The power ratings are valid at nominal voltage 230 V (0.55 to 75 kW).

Drive type	Frame size	Nominal ratings			Light overload use		Heavy-duty use		Noise level (dB(A))	Heat dissipation (W)	Air flow (m ³ /h)
		I_N (A)	I_{MAX} (A)	P_N (kW)	I_{Ld} (A)	P_{Ld} (kW)	I_{Hd} (A)	P_{Hd} (kW)			
ACS880-01-04A6-2	R1	4.6	6.3	0.75	4.4	0.75	3.7	0.55	50	73	44
ACS880-01-06A6-2	R1	6.6	7.8	1.1	6.3	1.1	4.6	0.75	50	94	44
ACS880-01-07A5-2	R1	7.5	11.2	1.5	7.1	1.5	6.6	1.1	50	122	44
ACS880-01-10A6-2	R1	10.6	12.8	2.2	10.1	2.2	7.5	1.5	50	172	44
ACS880-01-16A8-2	R2	16.8	18.0	4.0	16.0	4.0	10.6	2.2	59	232	88
ACS880-01-24A3-2	R2	24.3	28.6	5.5	23.1	5.5	16.8	4	59	337	88
ACS880-01-031A-2	R3	31.0	41	7.5	29.3	7.5	24.3	5.5	60	457	134
ACS880-01-046A-2	R4	46	64	11	44	11	38	7.5	64	500	134
ACS880-01-061A-2	R4	61	76	15	58	15	45	11	64	630	280
ACS880-01-075A-2	R5	75	104	18.5	71	18.5	61	15	64	680	280
ACS880-01-087A-2	R5	87	122	22	83	22	72	18.5	64	730	280
ACS880-01-115A-2	R6	115	148	30	109	30	87	22	68	840	435
ACS880-01-145A-2	R6	145	178	37	138	37	105	30	68	940	435
ACS880-01-170A-2	R7	170	247	45	162	45	145	37	67	1260	450
ACS880-01-206A-2	R7	206	287	55	196	55	169	45	67	1500	450
ACS880-01-274A-2	R8 ³⁾	274	362	75	260	75	213	55	68	2100	550

$U_N = 400\text{ V}$ (range 380 to 415 V). The power ratings are valid at nominal voltage 400 V (0.55 to 250 kW).

Drive type	Frame size	Nominal ratings			Light overload use		Heavy-duty use		Noise level (dB(A))	Heat dissipation (W)	Air flow (m ³ /h)
		I_N (A)	I_{MAX} (A)	P_N (kW)	I_{Ld} (A)	P_{Ld} (kW)	I_{Hd} (A)	P_{Hd} (kW)			
ACS880-01-02A4-3	R1	2.4	3.1	0.75	2.3	0.75	1.8	0.55	50	30	44
ACS880-01-03A3-3	R1	3.3	4.1	1.1	3.1	1.1	2.4	0.75	50	40	44
ACS880-01-04A0-3	R1	4.0	5.6	1.5	3.8	1.5	3.3	1.1	50	52	44
ACS880-01-05A6-3	R1	5.6	6.8	2.2	5.3	2.2	4.0	1.5	50	73	44
ACS880-01-07A2-3	R1	8.0	9.5	3	7.6	3	5.6	2.2	50	94	44
ACS880-01-09A4-3	R1	10	12.2	4	9.5	4	8.0	3	50	122	44
ACS880-01-12A6-3	R1	12.9	16	5.5	12	5.5	10	4	50	172	44
ACS880-01-017A-3	R2	17	21	7.5	16	7.5	12.6	5.5	59	232	88
ACS880-01-025A-3	R2	25	29	11	24	11	17	7.5	59	337	88
ACS880-01-032A-3	R3	32	42	15	30	15	25	11	60	457	134
ACS880-01-038A-3	R3	38	54	18.5	36	18.5	32	15	60	562	134
ACS880-01-045A-3	R4	45	64	22	43	22	38	18.5	64	667	134
ACS880-01-061A-3	R4	61	76	30	58	30	45	22	64	907	280
ACS880-01-072A-3	R5	72	104	37	68	37	61	30	64	1117	280
ACS880-01-087A-3	R5	87	122	45	83	45	72	37	64	1120	280
ACS880-01-105A-3	R6	105	148	55	100	55	87	45	68	1295	435
ACS880-01-145A-3	R6	145	178	75	138	75	105	55	68	1440	435
ACS880-01-169A-3	R7	169	247	90	161	90	145	75	67	1940	450
ACS880-01-206A-3	R7	206	287	110	196	110	169	90	67	2310	450
ACS880-01-246A-3	R8	246	350	132	234	132	206	110	68	3300	550
ACS880-01-293A-3	R8 ³⁾	293	418	160	278	160	246 ¹⁾	132	68	3900	550
ACS880-01-363A-3	R9 ⁶⁾	363	498	200	345	200	293	160	70	4800	1150
ACS880-01-430A-3	R9 ⁵⁾	430	545	250	400	200	363 ²⁾	200	70	6000	1150

$U_N = 500\text{ V}$ (range 380 to 500 V). The power ratings are valid at nominal voltage 500 V (0.55 to 250 kW).

Drive type	Frame size	Nominal ratings			Light overload use		Heavy-duty use		Noise level (dB(A))	Heat dissipation (W)	Air flow (m ³ /h)
		I_N (A)	I_{MAX} (A)	P_N (kW)	I_{Ld} (A)	P_{Ld} (kW)	I_{Hd} (A)	P_{Hd} (kW)			
ACS880-01-02A1-5	R1	2.1	3.1	0.75	2.0	0.75	1.7	0.55	50	30	44
ACS880-01-03A0-5	R1	3.0	4.1	1.1	2.8	1.1	2.1	0.75	50	40	44
ACS880-01-03A4-5	R1	3.4	5.6	1.5	3.2	1.5	3.0	1.1	50	52	44
ACS880-01-04A8-5	R1	4.8	6.8	2.2	4.6	2.2	3.4	1.5	50	73	44
ACS880-01-05A2-5	R1	5.2	9.5	3	4.9	3	4.8	2.2	50	94	44
ACS880-01-07A6-5	R1	7.6	12.2	4	7.2	4	5.2	3	50	122	44
ACS880-01-11A0-5	R1	11	16	5.5	10.4	5.5	7.6	4	50	172	44
ACS880-01-014A-5	R2	14	21	7.5	13	7.5	11	5.5	59	232	88
ACS880-01-021A-5	R2	21	29	11	19	11	14	7.5	59	337	88
ACS880-01-027A-5	R3	27	42	15	26	15	21	11	60	457	134
ACS880-01-034A-5	R3	34	54	18.5	32	18.5	27	15	60	562	134
ACS880-01-040A-5	R4	40	64	22	38	22	34	19	64	667	134
ACS880-01-052A-5	R4	52	76	30	49	30	40	22	64	907	280
ACS880-01-065A-5	R5	65	104	37	62	37	52	30	64	1117	280
ACS880-01-077A-5	R5	77	122	45	73	45	65	37	64	1120	280
ACS880-01-096A-5	R6	96	148	55	91	55	77	45	68	1295	435
ACS880-01-124A-5	R6	124	178	75	118	75	96	55	68	1440	435
ACS880-01-156A-5	R7	156	247	90	148	90	124	75	67	1940	450
ACS880-01-180A-5	R7	180	287	110	171	110	156	90	67	2310	450
ACS880-01-240A-5	R8 ⁴⁾	240	350	132	228	132	180	110	68	3300	550
ACS880-01-260A-5	R8 ³⁾	260	418	160	247	160	240 ¹⁾	132	68	3900	550
ACS880-01-361A-5	R9 ⁶⁾	361	542	200	343	200	302	200	70	4800	1150
ACS880-01-414A-5	R9 ⁵⁾	414	542	250	393	250	361 ²⁾	200	70	6000	1150

$U_N = 690\text{ V}$ (range 525 to 690 V). The power ratings are valid at nominal voltage 690 V (4 to 250 kW).

Drive type	Frame size	Nominal ratings			Light overload use		Heavy-duty use		Noise level (dB(A))	Heat dissipation (W)	Air flow (m ³ /h)
		I_N (A)	I_{MAX} (A)	P_N (kW)	I_{Ld} (A)	P_{Ld} (kW)	I_{Hd} (A)	P_{Hd} (kW)			
ACS880-01-07A4-7	R3	7.4	12.2	5.5	7.0	5.5	5.6	4	60	114	134
ACS880-01-09A9-7	R3	9.9	18	7.5	9.4	7.5	7.4	5.5	60	143	134
ACS880-01-14A3-7	R3	14.3	22	11	13.6	11	9.9	7.5	60	207	134
ACS880-01-019A-7	R3	19	28.9	15	18.1	15	14.3	11	60	274	134
ACS880-01-023A-7	R3	23	38	18.5	21.9	18.5	19	15	60	329	134
ACS880-01-027A-7	R3	27	46	22	25.7	22	23	18.5	60	405	134
ACS880-01-035A-7	R5	35	64	30	33	30	26	22	64	864	280
ACS880-01-042A-7	R5	42	70	37	40	37	35	30	64	998	280
ACS880-01-049A-7	R5	49	71	45	47	45	42	37	64	1120	280
ACS880-01-061A-7	R6	61	104	55	58	55	49	45	68	1295	435
ACS880-01-084A-7	R6	84	124	75	80	75	61	55	68	1440	435
ACS880-01-098A-7	R7	98	168	90	93	90	84	75	67	1940	450
ACS880-01-119A-7	R7	119	198	110	113	110	98	90	67	2310	450
ACS880-01-142A-7	R8	142	250	132	135	132	119	110	68	3300	550
ACS880-01-174A-7	R8 ³⁾	174	274	160	165	160	142	132	68	3900	550
ACS880-01-210A-7	R9 ⁷⁾	210	384	200	200	200	174	160	70	4200	1150
ACS880-01-271A-7	R9 ⁵⁾	271	411	250	257	250	210	200	70	4800	1150

Nominal ratings

I_N	Rated current available continuously without overloadability at 40 °C.
P_N	Typical motor power in no-overload use.

Maximum output current

I_{max}	Maximum output current. Available for 10 seconds at start, then as long as allowed by drive temperature.
-----------	----------------------------------------------------------------------------------------------------------

Light-overload use

I_{Ld}	Continuous current allowing 110% I_{Ld} for 1 minute every 5 minutes at 40 °C.
P_{Ld}	Typical motor power in light-overload use.

Heavy-duty use

I_{Hd}	Continuous current allowing 150% I_{Hd} for 1 minute every 5 minutes at 40 °C.
P_{Hd}	Typical motor power in heavy-duty use.

The ratings apply at 40 °C ambient temperature. At higher temperatures (up to 55 °C) the derating is 1%/1 °C.

¹⁾ 130% overload

²⁾ 125% overload

³⁾ For drives with enclosure class IP55 the ratings apply at 40 °C ambient temperature .

At higher temperature the derating is from 40 to 45 °C 1%/1 °C and 45 to 55 °C 2.5%/1 °C.

⁴⁾ For drives with enclosure class IP55 the ratings apply at 40 °C ambient temperature.

At higher temperature the derating is from 40 to 50 °C 1%/1 °C and 50 to 55 °C 2.5%/1 °C.

⁵⁾ For drives with enclosure class IP55 the maximum ambient temperature is 35 °C

⁶⁾ For drives with enclosure class IP55 the ratings apply at 40 °C ambient temperature.

At higher temperatures the derating is from 40 to 45 °C.

1%/1 °C and 45 to 50 °C 2.5%/1 °C and 50 to 55 °C 5%/1 °C.

⁷⁾ For drives with IP55 enclosure class the ratings apply at 40 °C ambient temperature.

At higher temperatures the derating is from 40 to 45 °C 3.5%/1 °C.

Note: Maximum ambient temperature is 45 °C.

⁸⁾ 135% overload

Cabinet-built single drives

ACS880-07

—
01
ACS880-07
frame size R6 to R8, IP22

—
02
ACS880-07
frame size R9, IP22



—
01

Our cabinet-built single drives are built to order, meeting your needs regardless of the technical challenges. The drive configuration includes a rectifier, DC link, inverter, fuses, line choke and a main switch, all built into a compact cabinet for easy assembly and commissioning.

The ACS880-07 offers a wide variety of standardized configurations for different application requirements, from line contactors, to preventing unexpected motor starts. If the application requires more, ABB's Order-Based Engineering services can add special features to the standard product, such as an additional cabinet for customer-specific devices.

Drives up to frame size R11 are based on a compact single module including rectifier and inverter. Larger drives consist of separate rectifier and inverter modules, providing redundancy with parallel connected units. If one module needs to be disconnected, the drive can continue running at reduced power.

The robust design and enclosures up to IP54 make the ACS880-07 suitable for even very harsh environments.

The drives have an extensive selection of built-in features and options. See page 86.

Highlights

- Compact package for easy assembly and commissioning
- Available as an engineered, customer-specific solution
- All essential features built-in
- Robust design verified by various standards



—
02

Cabinet-built ACS880-07 drives

- Power ratings: 45 to 2800 kW
- Enclosure classes IP22 (as standard), IP42 and IP54 for different environments, with option for air intake through the bottom of the cabinet and channeled air outlet on the top of the cabinet

Main options:

- Cabling solutions for bottom and top entry and exit
- Functional safety modules, see page 58
- I/O extension modules, see page 54
- Communication protocol adapters, see page 54
- Speed feedback interfaces, see page 55
- Brake option inside the module or cabinet, see page 68
- C2 and C3 EMC filters, see page 61
- Du/dt and common mode filter options for motor protection, see page 76
- Marine construction option
- Cabinet light and heater option

Ratings, types and voltages

Cabinet-built drives, ACS880-07

$U_N = 400\text{ V}$ (range 380 to 415 V). The power ratings are valid at nominal voltage 400 V (45 to 1400 kW).

Drive type	Frame size	Nominal ratings			Light overload use		Heavy-duty use		Noise level (dB(A))	Heat dissipation (W)	Air flow (m ³ /h)
		I_N (A)	I_{MAX} (A)	P_N (kW)	I_{Ld} (A)	P_{Ld} (kW)	I_{Hd} (A)	P_{Hd} (kW)			
6-pulse diode											
ACS880-07-0105A-3	R6	105	148	55	100	55	87	45	67	1795	1750
ACS880-07-0145A-3	R6	145	178	75	138	75	105	55	67	1940	1750
ACS880-07-0169A-3	R7	169	247	90	161	90	145	75	67	2440	1750
ACS880-07-0206A-3	R7	206	287	110	196	110	169	90	67	2810	1750
ACS880-07-0246A-3	R8	246	350	132	234	132	206	110	65	3800	1750
ACS880-07-0293A-3	R8	293	418	160	278	160	246 ¹⁾	132	65	4400	1750
ACS880-07-0363A-3	R9	363	498	200	345	200	293	160	68	5300	1150
ACS880-07-0430A-3	R9	430	545	250	400	200	363 ²⁾	200	68	6500	1150
ACS880-07-0505A-3	R10	505	560	250	485	250	361	200	72	6102	2950
ACS880-07-0585A-3	R10	585	730	315	575	315	429	250	72	6909	2950
ACS880-07-0650A-3	R10	650	730	355	634	355	477	250	72	8622	2950
ACS880-07-0725A-3	R11	725	1020	400	715	400	566	315	72	9264	2950
ACS880-07-0820A-3	R11	820	1020	450	810	450	625	355	72	10362	2950
ACS880-07-0880A-3	R11	880	1100	500	865	500	725 ³⁾	400	71	11078	3170
ACS880-07-1140A-3	D8T+2×R8i	1140	1490	630	1072	560	787	450	73	18000	4290
ACS880-07-1250A-3	2×D8T+2×R8i	1250	1630	710	1200	630	935	500	74	21000	5720
ACS880-07-1480A-3	2×D8T+2×R8i	1480	1930	800	1421	800	1107	630	74	25000	5720
ACS880-07-1760A-3	2×D8T+2×R8i	1760	2120	1000	1690	900	1316	710	74	29000	5720
ACS880-07-2210A-3	3×D8T+3×R8i	2210	2880	1200	2122	1200	1653	900	76	37000	8580
ACS880-07-2610A-3	3×D8T+3×R8i	2610	3140	1400	2506	1400	1952	1000	76	44000	8580
12-pulse diode											
ACS880-07-0990A-3+A004	2×D7T+2×R8i	990	1290	560	950	500	741	400	73	15000	5720
ACS880-07-1140A-3+A004	2×D8T+2×R8i	1140	1490	630	1094	560	853	450	74	19000	5720
ACS880-07-1250A-3+A004	2×D8T+2×R8i	1250	1630	710	1200	630	935	500	74	21000	5720
ACS880-07-1480A-3+A004	2×D8T+2×R8i	1480	1930	800	1421	800	1107	630	74	25000	5720
ACS880-07-1760A-3+A004	2×D8T+2×R8i	1760	2120	1000	1690	900	1316	710	74	29000	5720
ACS880-07-2210A-3+A004	4×D8T+3×R8i	2210	2880	1200	2122	1200	1653	900	76	35000	10010
ACS880-07-2610A-3+A004	4×D8T+3×R8i	2610	3140	1400	2506	1400	1952	1000	76	44000	10010

¹⁾ = 130% overload

²⁾ = 125% overload

³⁾ = 140% overload

$U_N = 500$ V (range 380 to 500 V). The power ratings are valid at nominal voltage 500 V (45 to 1400 kW).

Drive type	Frame size	Nominal ratings			Light overload use		Heavy-duty use		Noise level (dB(A))	Heat dissipation (W)	Air flow (m ³ /h)
		I_N (A)	I_{MAX} (A)	P_N (kW)	I_{Ld} (A)	P_{Ld} (kW)	I_{Hd} (A)	P_{Hd} (kW)			
6-pulse diode											
ACS880-07-0096A-5	R6	96	148	55	91	55	77	45	67	1795	1750
ACS880-07-0124A-5	R6	124	178	75	118	75	96	55	67	1940	1750
ACS880-07-0156A-5	R7	156	247	90	148	90	124	75	67	2440	1750
ACS880-07-0180A-5	R7	180	287	110	171	110	156	90	67	2810	1750
ACS880-07-0240A-5	R8	240	350	132	228	132	180	110	65	3800	1750
ACS880-07-0260A-5	R8	260	418	160	247	160	240 ¹⁾	132	65	4400	1750
ACS880-07-0361A-5	R9	361	542	200	343	200	302	200	68	5300	1150
ACS880-07-0414A-5	R9	414	542	250	393	250	361 ²⁾	200	68	6500	1150
ACS880-07-0460A-5	R10	460	560	315	450	315	330	200	72	4903	2950
ACS880-07-0503A-5	R10	503	560	355	483	315	361	250	72	6102	2950
ACS880-07-0583A-5	R10	583	730	400	573	400	414	250	72	6909	2950
ACS880-07-0635A-5	R10	635	730	450	623	450	477	315	72	8622	2950
ACS880-07-0715A-5	R11	715	850	500	705	500	566	400	72	9264	2950
ACS880-07-0820A-5	R11	820	1020	560	807	560	625	450	71	10362	2950
ACS880-07-0880A-5	R11	880	1100	630	857	560	697	500	71	11078	2950
ACS880-07-1070A-5	D8T+2×R8i	1070	1400	710	1027	710	800	560	73	18000	4290
ACS880-07-1320A-5	2×D8T+2×R8i	1320	1720	900	1267	900	987	710	74	22000	5720
ACS880-07-1450A-5	2×D8T+2×R8i	1450	1890	1000	1392	900	1085	710	74	25800	5720
ACS880-07-1580A-5	2×D8T+2×R8i	1580	2060	1100	1517	1000	1182	800	74	27000	5720
ACS880-07-1800A-5	2×D8T+3×R8i	1800	2340	1250	1728	1200	1346	900	75	32000	7150
ACS880-07-1980A-5	2×D8T+3×R8i	1980	2580	1400	1901	1300	1481	1000	75	36000	7150
12-pulse diode											
ACS880-07-0990A-5+A004	2×D7T+2×R8i	990	1290	710	950	630	741	500	73	16000	5720
ACS880-07-1320A-5+A004	2×D8T+2×R8i	1320	1720	900	1267	900	987	710	74	22000	5720
ACS880-07-1450A-5+A004	2×D8T+2×R8i	1450	1890	1000	1392	900	1085	710	74	25000	5720
ACS880-07-1580A-5+A004	2×D8T+2×R8i	1580	2060	1100	1517	1000	1182	800	74	27000	5720
ACS880-07-1800A-5+A004	2×D8T+3×R8i	1800	2340	1250	1728	1200	1346	900	75	32000	7150
ACS880-07-1980A-5+A004	2×D8T+3×R8i	1980	2580	1400	1901	1300	1481	1000	75	36000	7150

¹⁾ =130% overload

²⁾ = 125% overload

$U_N = 690$ V (range 525 to 690 V). The power ratings are valid at nominal voltage 690 V (45 to 2800 kW).

Drive type	Frame size	Nominal ratings			Light overload use		Heavy-duty use		Noise level (dB(A))	Heat dissipation (W)	Air flow (m ³ /h)
		I_N (A)	I_{MAX} (A)	P_N (kW)	I_{Ld} (A)	P_{Ld} (kW)	I_{Hd} (A)	P_{Hd} (kW)			
6-pulse diode											
ACS880-07-0061A-7	R6	61	104	55	58	55	49	45	67	1795	1750
ACS880-07-0084A-7	R6	84	124	75	80	75	61	55	67	1940	1750
ACS880-07-0098A-7	R7	98	168	90	93	90	84	75	67	2440	1750
ACS880-07-0119A-7	R7	119	198	110	113	110	98	90	67	2810	1750
ACS880-07-0142A-7	R8	142	250	132	135	132	119	110	65	3800	1750
ACS880-07-0174A-7	R8	174	274	160	165	160	142	132	65	4400	1750
ACS880-07-0210A-7	R9	210	384	200	200	200	174	160	68	4700	1150
ACS880-07-0271A-7	R9	271	411	250	257	250	210	200	68	5300	1150
ACS880-07-0330A-7	R10	330	480	315	320	315	255	250	72	5640	2950
ACS880-07-0370A-7	R10	370	520	355	360	355	325	315	72	6371	2950
ACS880-07-0430A-7	R10	430	520	400	420	400	360 ⁴⁾	355	72	7570	2950
ACS880-07-0470A-7	R11	470	655	450	455	450	415	400	72	6611	2950
ACS880-07-0522A-7	R11	522	655	500	505	500	455	450	72	7388	2950
ACS880-07-0590A-7	R11	590	800	560	571	560	505	500	71	8971	2950
ACS880-07-0650A-7	R11	650	820	630	630	630	571 ⁴⁾	560	71	9980	3170
ACS880-07-0721A-7	R11	721	820	710	705	630	571 ⁴⁾	560	71	11177	3170
ACS880-07-0800A-7	D8T+2×R8i	800	1200	800	768	710	598	560	73	16000	4290
ACS880-07-0900A-7	D8T+2×R8i	900	1350	900	864	800	673	630	74	20000	4290
ACS880-07-1160A-7	2×D8T+2×R8i	1160	1740	1100	1114	1100	868	800	74	26000	5720
ACS880-07-1450A-7	2×D8T+3×R8i	1450	2180	1400	1392	1250	1085	1000	75	32000	7150
ACS880-07-1650A-7	2×D8T+3×R8i	1650	2480	1600	1584	1500	1234	1200	75	36500	7150
ACS880-07-1950A-7	3×D8T+4×R8i	1950	2930	1900	1872	1800	1459	1400	76	44000	10010
ACS880-07-2300A-7	3×D8T+4×R8i	2300	3450	2200	2208	2000	1720	1600	76	52000	10010
ACS880-07-2600A-7	4×D8T+5×R8i	2600	3900	2500	2496	2400	1945	1900	78	58000	12870
ACS880-07-2860A-7	4×D8T+5×R8i	2860	4290	2800	2746	2600	2139	2000	78	65000	12870
12-pulse diode											
ACS880-07-0800A-7+A004	2×D7T+2×R8i	800	1200	800	768	710	598	560	73	16000	5720
ACS880-07-0950A-7+A004	2×D8T+2×R8i	950	1430	900	912	800	711	630	74	20000	5720
ACS880-07-1160A-7+A004	2×D8T+2×R8i	1160	1740	1100	1114	1100	868	800	74	26000	5720
ACS880-07-1450A-7+A004	2×D8T+3×R8i	1450	2180	1400	1392	1250	1085	1000	75	32000	7150
ACS880-07-1650A-7+A004	2×D8T+3×R8i	1650	2480	1600	1584	1500	1234	1200	75	36500	7150
ACS880-07-1950A-7+A004	4×D8T+4×R8i	1950	2930	1900	1872	1800	1459	1400	77	44000	11440
ACS880-07-2300A-7+A004	4×D8T+4×R8i	2300	3450	2200	2208	2000	1720	1600	77	52000	11440
ACS880-07-2600A-7+A004	4×D8T+5×R8i	2600	3900	2500	2496	2400	1945	1900	78	58000	12870
ACS880-07-2860A-7+A004	4×D8T+5×R8i	2860	4290	2800	2746	2600	2139	2000	78	65000	12870

⁴⁾ = 144% overload

Nominal ratings

I_N Rated current available continuously without overloadability at 40 °C.

P_N Typical motor power in no-overload use.

Maximum output current

I_{max} Maximum output current. Available for 10 seconds at start, then as long as allowed by drive temperature.

Light-overload use

I_{Ld} Continuous current allowing 110% I_{Ld} for 1 minute every 5 minutes at 40 °C.

P_{Ld} Typical motor power in light-overload use.

Heavy-duty use

I_{Hd} Continuous current allowing 150% I_{Hd} for 1 minute every 5 minutes at 40 °C.

P_{Hd} Typical motor power in heavy-duty use.

The ratings apply at 40 °C ambient temperature. At higher temperatures (up to 50 °C), the derating is 1%/1 °C. Operation above 150 Hz might require type specific derating.

Regenerative drives

ACS880-11 and ACS880-17

—
01 Speed and
power curves in
cyclic operation

Energy savings

The ACS880-11/17 is a compact and complete regenerative drive solution with everything you need for regenerative operation in cyclic or continuous braking applications. With regenerative functionality, the braking energy of the motor is returned to the drive and distributed to the supply network so that it can be utilized by other equipment. Compared to mechanical or resistor braking, where braking energy is wasted as heat, regenerative drive operation offers significant savings in energy consumption and cooling.

The drive reaches a unity power factor. This high power factor indicates that electrical energy is used to its full potential.

—

Possibility to regenerate
100% of power continuously

Minimized downtime

Regenerative drive offers immunity to network disturbances. The drive will not interrupt the process or affect its quality in unstable supply network conditions. Drive's active supply unit is able to boost output voltage, enabling full motor voltage even when the supply voltage is below nominal. The drive can even compensate for rapid variations in supply voltage, ensuring reliable operation during network fluctuations. Voltage boost capability can also be utilized to overcome a voltage drop caused by long supply or motor cables or output filters.

Optimized cost and space

Everything needed for regenerative operation, such as an active supply unit and low harmonic line filter are integrated into the drive, and no external braking devices are needed.

Advantages:

- Quick, easy drive installation
- Small installation footprint
- No need to add cooling to handle the heat generated by mechanical or resistor braking
- Simplified wiring
- Less spare parts needed

The “all inside” design helps to cut engineering and assembly time, as well as to reduce equipment costs and the risk of errors.

The drive's voltage boost capability can be an advantage in motor dimensioning. With a higher motor voltage, the same power is achieved with less current, which may allow a smaller motor to be used.

The drive offers a possibility for network power factor correction to compensate for low power factors of equipment connected to the same network. It reduces the need for additional power factor correction equipment, such as filters and large capacitor banks. It can also help to avoid penalty charges from electrical utilities for poor power factors.

Maximized motor performance and efficiency

The drive is able to provide full motor voltage in all conditions. Regeneration can occur for as long as necessary and as often as needed.

The drive features direct torque control (DTC) as standard, making it suitable also for very demanding applications. DTC provides precise speed and torque control for maximum motor performance and motor efficiency.

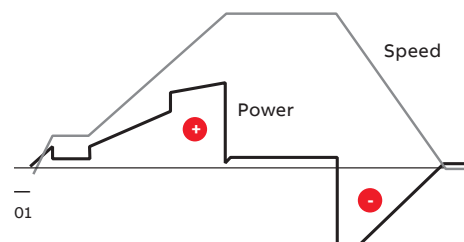

Low harmonic content

The drive produces exceptionally low harmonic content and exceeds the requirements of even the most stringent harmonic recommendations, like IEEE 519, IEC 61000-3-2, IEC 61000-3-12 and G5/4. Compared to conventional drives, the harmonic content is up to 97% lower. The total harmonic current distortion is typically <3% in nominal situation and undistorted network.

For more information, visit <https://new.abb.com/drives/regenerativedrives>.



Wall-mounted regenerative drives, ACS880-11

- Power ratings: 2.2 to 110 kW
- Enclosure classes: IP20 for cabinet mounting, IP21 (as standard) for wall-mounting and IP55 for dusty and wet environments

Main options:

- Flange (push through) mounting
- C2 and C3 EMC filters, see page 61
- I/O extension modules, see page 54
- Communication protocol adapters, see page 54
- Speed feedback interfaces, see page 55
- Functional safety modules, see page 58
- Remote monitoring tool, see page 56
- Application specific software, see page 76
- Du/dt filters, see page 76
- Sine filters, see page 62



Cabinet-built regenerative drives, ACS880-17

- Power ratings: 45 to 3200 kW
- Enclosure classes: IP22 (as standard), IP42 and IP54 for different environments, with option for air intake through bottom of the cabinet and channeled air outlet on the top of the cabinet

Main options:

- EMC filters, see page 61 (as standard for nxR8i)
- Cabling solutions for bottom and top entry and exit
- Functional safety modules, see page 58
- I/O extension modules, see page 54
- Communication protocol adapters, see page 54
- Speed feedback interfaces, see page 55
- Du/dt and common mode filter options for motor protection, see page 76
- Marine construction option
- Cabinet light and heater option

The drives have an extensive selection of built-in features and options. See page 86.

Highlights

- Everything for regenerative operation in one compact package. Designed for easy installation
- Possibility to regenerate 100% of the power continuously
- The total harmonic current distortion is typically <3% in nominal situation and undistorted network
- Clear energy savings compared to other braking methods
- Reduced cost of ownership
- Unity power factor. Possibility also for network power factor correction
- Stable output voltage in all load conditions, even with fluctuating supply voltage



Ratings, types and voltages

Wall-mounted regenerative drives, ACS880-11

$U_N = 400\text{ V}$ (range 380 to 415 V). The power ratings are valid at nominal voltage 400 V (3 to 110 kW).

Drive type	Frame size	Nominal ratings			Light overload use		Heavy-duty use		Noise level (dB(A))	Heat dissipation (W)	Air flow (m ³ /h)
		I_N (A)	I_{MAX} (A)	P_N (kW)	I_{Ld} (A)	P_{Ld} (kW)	I_{Hd} (A)	P_{Hd} (kW)			
ACS880-11-09A4-3	R3	10	13.6	4	9.5	4	8	3	57	226	361
ACS880-11-12A6-3	R3	12.9	17	5.5	12	5.5	10	4	57	329	361
ACS880-11-017A-3	R3	17	21.9	7.5	16	7.5	12.9	5.4	57	395	361
ACS880-11-025A-3	R3	25	28.8	11	24	11	17	7.5	57	579	361
ACS880-11-032A-3	R6	32	42.5	15	30	15	25	11	71	625	550
ACS880-11-038A-3	R6	38	54.4	18.5	36	18.5	32	15	71	751	550
ACS880-11-045A-3	R6	45	64.6	22	43	22	38	18.5	71	912	550
ACS880-11-061A-3	R6	61	76.5	30	58	30	45	22	71	1088	550
ACS880-11-072A-3	R6	72	103.7	37	68	37	61	30	71	1502	550
ACS880-11-087A-3	R6	87	122.4	45	83	45	72	37	71	1904	550
ACS880-11-105A-3	R8	105	148	55	100	55	87	45	68	1877	700
ACS880-11-145A-3	R8	145	178	75	138	75	105	55	68	2963	700
ACS880-11-169A-3	R8	169	247	90	161	90	145	75	68	3168	700
ACS880-11-206A-3	R8	206	287	110	196	110	169	90	68	3990	805

$U_N = 500\text{ V}$ (range 380 to 500 V). The power ratings are valid at nominal voltage 500 V (2.2 to 110 kW).

Drive type	Frame size	Nominal ratings			Light overload use		Heavy-duty use		Noise level (dB(A))	Heat dissipation (W)	Air flow (m ³ /h)
		I_N (A)	I_{MAX} (A)	P_N (kW)	I_{Ld} (A)	P_{Ld} (kW)	I_{Hd} (A)	P_{Hd} (kW)			
ACS880-11-07A6-5	R3	7.6	9.5	4	7.2	4	5.2	2.2	57	219	361
ACS880-11-11A0-5	R3	11	13.8	5.5	10.4	5.5	7.6	4	57	278	361
ACS880-11-014A-5	R3	14	18.7	7.5	13	7.5	11	5.5	57	321	361
ACS880-11-021A-5	R3	21	26.3	11	19	11	14	7.5	57	473	361
ACS880-11-027A-5	R6	27	35.7	15	26	15	21	11	71	625	550
ACS880-11-034A-5	R6	34	45.9	18.5	32	18.5	27	15	71	711	550
ACS880-11-040A-5	R6	40	57.8	22	38	22	34	18.5	71	807	550
ACS880-11-052A-5	R6	52	68	30	49	30	40	22	71	960	550
ACS880-11-065A-5	R6	65	88.4	37	62	37	52	30	71	1223	550
ACS880-11-077A-5	R6	77	110.5	45	73	45	65	37	71	1560	550
ACS880-11-101A-5	R8	101	148	55	91	55	77	45	68	1995	700
ACS880-11-124A-5	R8	124	178	75	118	75	96	55	68	2800	700
ACS880-11-156A-5	R8	156	247	90	148	90	124	75	68	3168	700
ACS880-11-180A-5	R8	180	287	110	171	110	156	90	68	3872	805

Nominal ratings

I_N Rated current available continuously without overloadability at 40 °C.

P_N Typical motor power in no-overload use.

Maximum output current

I_{max} Maximum output current. Available for 10 seconds at start, then as long as allowed by drive temperature.

Light-overload use

I_{Ld} Continuous current allowing 110% I_{Ld} for 1 minute every 5 minutes at 40 °C.

P_{Ld} Typical motor power in light-overload use.

Heavy-duty use

I_{Hd} Continuous current allowing 150% I_{Hd} for 1 minute every 5 minutes at 40 °C.

P_{Hd} Typical motor power in heavy-duty use.

The ratings apply at 40 °C ambient temperature.

At higher temperatures (up to 55 °C) the derating is 1%/1 °C.

Ratings, types and voltages

Cabinet-built regenerative drives, ACS880-17

$U_N = 400\text{ V}$ (range 380 to 415 V). The power ratings are valid at nominal voltage 400 V (45 to 1400 kW).

Drive type	Frame size	Nominal ratings			Light overload use		Heavy-duty use		Noise level (dB(A))	Heat dissipation (W)	Air flow (m ³ /h)
		I_N (A)	I_{MAX} (A)	P_N (kW)	I_{Ld} (A)	P_{Ld} (kW)	I_{Hd} (A)	P_{Hd} (kW)			
ACS880-17-0105A-3	R8	105	148	55	100	55	87	45	70	2200	700
ACS880-17-0145A-3	R8	145	178	75	138	75	105	55	70	3300	700
ACS880-17-0169A-3	R8	169	247	90	161	90	145	75	70	3570	700
ACS880-17-0206A-3	R8	206	287	110	196	110	169	90	70	4440	805
ACS880-17-0293A-3	R11	293	418	160	278	160	246	132	77	6900	2100
ACS880-17-0363A-3	R11	363	498	200	345	200	293	160	77	8500	2100
ACS880-17-0442A-3	R11	442	621	250	420	250	363	200	77	10500	2100
ACS880-17-0505A-3	R11	505	631	250	480	250	363	200	77	10600	2100
ACS880-17-0585A-3	R11	585	751	315	556	315	442	250	77	13200	2100
ACS880-17-0650A-3	R11	650	859	355	618	355	505	250	77	14800	2100
ACS880-17-0450A-3	1xR8i+1xR8i	450	590	250	432	200	337	160	75	11000	3760
ACS880-17-0620A-3	1xR8i+1xR8i	620	810	355	595	315	464	250	75	16000	3760
ACS880-17-0870A-3	1xR8i+1xR8i	870	1050	500	835	450	651	355	75	23000	3760
ACS880-17-1110A-3	2xR8i+2xR8i	1110	1450	630	1066	560	830	450	77	27000	7220
ACS880-17-1210A-3	2xR8i+2xR8i	1210	1580	710	1162	630	905	500	77	29000	7220
ACS880-17-1430A-3	2xR8i+2xR8i	1430	1860	800	1373	710	1070	560	77	34000	7220
ACS880-17-1700A-3	2xR8i+2xR8i	1700	2040	1000	1632	900	1272	710	77	45000	7220
ACS880-17-2060A-3	3xR8i+3xR8i	2060	2680	1200	1978	1100	1541	800	78	56000	11580
ACS880-17-2530A-3	3xR8i+3xR8i	2530	3040	1400	2429	1200	1892	1000	78	68000	11580

$U_N = 500\text{ V}$ (range 380 to 500 V). The power ratings are valid at nominal voltage 500 V (45 to 1600 kW).

Drive type	Frame size	Nominal ratings			Light overload use		Heavy-duty use		Noise level (dB(A))	Heat dissipation (W)	Air flow (m ³ /h)
		I_N (A)	I_{MAX} (A)	P_N (kW)	I_{Ld} (A)	P_{Ld} (kW)	I_{Hd} (A)	P_{Hd} (kW)			
ACS880-17-0101A-5	R8	101	148	55	91	55	77	45	70	2300	700
ACS880-17-0124A-5	R8	124	178	75	118	75	96	55	70	3100	700
ACS880-17-0156A-5	R8	156	247	90	148	90	124	75	70	3500	700
ACS880-17-0180A-5	R8	180	287	110	171	110	156	90	70	4300	805
ACS880-17-0260A-5	R11	260	418	160	247	160	240	132	77	6900	2100
ACS880-17-0361A-5	R11	361	542	200	343	200	260	160	77	8500	2100
ACS880-17-0414A-5	R11	414	614	250	393	250	361	200	77	10500	2100
ACS880-17-0460A-5	R11	460	660	315	450	315	414	250	77	13100	2100
ACS880-17-0503A-5	R11	503	725	355	492	355	460	315	77	14800	2100
ACS880-17-0420A-5	1xR8i+1xR8i	420	550	250	403	250	314	200	75	11000	3760
ACS880-17-0570A-5	1xR8i+1xR8i	570	750	400	547	355	426	250	75	15000	3760
ACS880-17-0780A-5	1xR8i+1xR8i	780	1020	560	749	500	583	400	75	21000	3760
ACS880-17-1010A-5	2xR8i+2xR8i	1010	1320	710	970	630	755	500	77	27000	7220
ACS880-17-1110A-5	2xR8i+2xR8i	1110	1450	800	1066	710	830	560	77	28000	7220
ACS880-17-1530A-5	2xR8i+2xR8i	1530	1990	1100	1469	1000	1144	800	77	41000	7220
ACS880-17-1980A-5	3xR8i+3xR8i	1980	2580	1400	1901	1300	1481	1000	78	51000	11580
ACS880-17-2270A-5	3xR8i+3xR8i	2270	2960	1600	2179	1500	1698	1200	78	60000	11580

$U_N = 690$ V (range 525 to 690 V). The power ratings are valid at nominal voltage 690 V (132 to 3200 kW).

Drive type	Frame size	Nominal ratings			Light overload use		Heavy-duty use		Noise level (dB(A))	Heat dissipation (W)	Air flow (m ³ /h)
		I_N (A)	I_{MAX} (A)	P_N (kW)	I_{Ld} (A)	P_{Ld} (kW)	I_{Hd} (A)	P_{Hd} (kW)			
ACS880-17-0174A-7	R11	174	274	160	165	160	142	132	77	6900	2100
ACS880-17-0210A-7	R11	210	384	200	200	200	174	160	77	8500	2100
ACS880-17-0271A-7	R11	271	411	250	257	250	210	200	77	10500	2100
ACS880-17-0330A-7	R11	330	480	315	320	315	271	250	77	13000	2100
ACS880-17-0370A-7	R11	370	520	355	360	355	330	315	77	14700	2100
ACS880-17-0430A-7	R11	430	520	400	420	400	370	355	77	16500	2100
ACS880-17-0320A-7	1xR8i+1xR8i	320	480	315	307	250	239	200	75	13000	3760
ACS880-17-0390A-7	1xR8i+1xR8i	390	590	355	374	355	292	250	75	16000	3760
ACS880-17-0580A-7	1xR8i+1xR8i	580	870	560	557	500	434	400	75	23000	3760
ACS880-17-0660A-7	2xR8i+2xR8i	660	990	630	634	560	494	450	77	26000	7220
ACS880-17-0770A-7	2xR8i+2xR8i	770	1160	710	739	710	576	560	77	29000	7220
ACS880-17-0950A-7	2xR8i+2xR8i	950	1430	900	912	800	711	710	77	38000	7220
ACS880-17-1130A-7	2xR8i+2xR8i	1130	1700	1100	1085	1000	845	800	77	44000	7220
ACS880-17-1450A-7	3xR8i+3xR8i	1450	2180	1400	1392	1300	1085	1000	78	54000	11580
ACS880-17-1680A-7	3xR8i+3xR8i	1680	2520	1600	1613	1500	1257	1200	78	64000	11580
ACS880-17-1950A-7	4xR8i+4xR8i	1950	2930	1900	1872	1800	1459	1400	79	80000	14440
ACS880-17-2230A-7	4xR8i+4xR8i	2230	3350	2200	2141	2000	1668	1600	79	88000	14440
ACS880-17-2770A-7	6xR8i+5xR8i	2770	4160	2700	2659	2600	2072	2000	79	113000	18800
ACS880-17-3310A-7	6xR8i+6xR8i	3310	4970	3200	3178	3000	2476	2400	79	132000	21660

Nominal ratings

I_N	Rated current available continuously without overloadability at 40 °C.
P_N	Typical motor power in no-overload use.

Maximum output current

I_{max}	Maximum output current. Available for 10 seconds at start, then as long as allowed by drive temperature.
-----------	----------------------------------------------------------------------------------------------------------

Light-overload use

I_{Ld}	Continuous current allowing 110% I_{Ld} for 1 minute every 5 minutes at 40 °C.
P_{Ld}	Typical motor power in light-overload use.

Heavy-duty use

I_{Hd}	Continuous current allowing 150% I_{Hd} for 1 minute every 5 minutes at 40 °C.
P_{Hd}	Typical motor power in heavy-duty use.

The ratings apply at 40 °C ambient temperature.

At higher temperatures (up to 50 °C) the derating is 1%/1 °C. Operation above 150 Hz might require type-specific derating.

Ultra-low harmonic drives

ACS880-31 and ACS880-37

Harmonic distortions can disturb or even damage sensitive equipment connected in the same environment. Harmonics also cause additional losses in the network.

Clean supply network

Our ultra-low harmonic drive produces exceptionally low harmonic content and exceeds the requirements of harmonic recommendations like IEEE 519 and G5/4. Compared to a conventional drive, the harmonic content is reduced by up to 97%. The total harmonic current distortion is typically <3% in nominal situation and undistorted network.

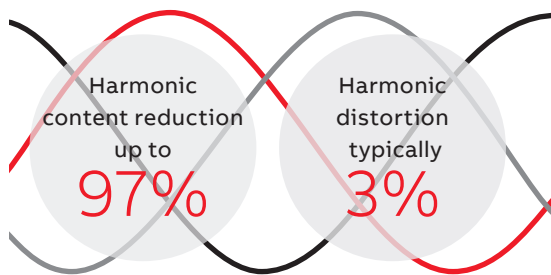

Keeps the network clean

Minimized downtime

ABB's ultra-low harmonic drive offers immunity to network disturbances. The drive will not interrupt the process or affect its quality in unstable supply network conditions. Drives' active supply unit is able to boost the output voltage to enable full motor voltage even when the supply voltage is below nominal. This ensures reliable operation in weak networks. This voltage boost capability can also be utilized to overcome voltage drops caused by long supply or motor cables.

The possibility to stabilize the output voltage of the drive is an advantage compared to alternative low harmonic solutions where voltage cannot be boosted.

Optimized cost and space

The compact drive has harmonics mitigation built-in. This includes an active supply unit and integrated low harmonic line filter.

The "all Inside" design means there is no need for external filters, multi-pulse arrangements or special transformers. The simple installation offers significant savings in space, time and cost.

As the risk of overheating is lower with lower harmonic currents, there is no need to over-dimension equipment, such as transformers and cables.

The drive's voltage boost capability can be an advantage in motor dimensioning. With a higher motor voltage, the same power is achieved with less current, which improves motor efficiency and may allow a smaller motor to be used.

Maximized motor performance and efficiency

The drive is able to provide full motor voltage even if the supply voltage fluctuates. It features direct torque control (DTC) as standard, making it suitable also for very demanding applications. DTC provides precise speed and torque control for maximum motor performance and motor efficiency.

Reduces the total cost of ownership

Efficient energy utilization

Ultra-low harmonic drives achieve a unity power factor. This high power factor indicates that electrical energy is used efficiently.

The drive offers the possibility for network power factor correction to compensate for low power factors of equipment connected to the same network. It can help to avoid penalty charges set by electrical utilities for poor power factors.

Lower harmonics and full motor voltage at all times means reduced system losses and better overall system efficiency.

For more information, visit <http://new.abb.com/drives/harmonics>.



Wall-mounted ultra-low harmonic drives, ACS880-31

- Power ratings: 2.2 to 110 kW
- Enclosure classes: IP20 for cabinet mounting, IP21 (as standard) for wall-mounting and IP55 for dusty and wet environments

Main options:

- Flange mounting
- C2 and C3 EMC filters, see page 61
- I/O extension modules, see page 54
- Communication protocol adapters, see page 54
- Speed feedback interfaces, see page 55
- Functional safety modules, see page 58
- Remote monitoring tool, see page 56
- Application-specific software, see page 16
- Du/dt filters, see page 76
- Sine filters, see page 62



Cabinet-built ultra-low harmonic drives, ACS880-37

- Power ratings: 45 to 3200 kW
- Enclosure classes: IP22 (as standard), IP42 and IP54 for different environments, with option for air intake through bottom of the cabinet and channeled air outlet on the top of the cabinet

Main options:

- EMC filters, see page 61 (as standard for nxR8i)
- Cabling solutions for bottom and top entry and exit
- Functional safety modules, see page 58
- I/O extension modules, see page 54
- Communication protocol adapters, see page 54
- Speed feedback interfaces, see page 55
- Du/dt and common mode filter options for motor protection, see page 76
- Marine construction option
- Cabinet light and heater option

The drives have an extensive selection of built-in features and options. See page 86.

Highlights

- The total harmonic current distortion is typically <3% in nominal situation and undistorted network. Low harmonic content also at partial loads
- “All inside” design: no need for external filters, multi-pulse arrangements or special transformers
- Simple and cost-effective installation
- Unity power factor. Possibility for network power factor correction
- Small installation footprint
- Output voltage stabilization secures operation in weak networks



Local ACSB80 1400.0 Rpm
Save money
Save energy
Save nerves
Save all
Exit
Select

Stop

Loc/Rem

Start



?

Ratings, types and voltages

Wall-mounted ultra-low harmonic drives, ACS880-31

$U_N = 400$ V (range 380 to 415 V). The power ratings are valid at nominal voltage 400 V (3 to 110 kW).

Drive type	Frame size	Nominal ratings			Light overload use		Heavy-duty use		Noise level (dB(A))	Heat dissipation (W)	Air flow (m ³ /h)
		I_N (A)	I_{MAX} (A)	P_N (kW)	I_{Ld} (A)	P_{Ld} (kW)	I_{Hd} (A)	P_{Hd} (kW)			
ACS880-31-09A4-3	R3	10	13.6	4	9.5	4	8	3	57	226	361
ACS880-31-12A6-3	R3	12.9	17	5.5	12	5.5	10	4	57	329	361
ACS880-31-017A-3	R3	17	21.9	7.5	16	7.5	12.9	5.4	57	395	361
ACS880-31-025A-3	R3	25	28.8	11	24	11	17	7.5	57	579	361
ACS880-31-032A-3	R6	32	42.5	15	30	15	25	11	71	625	550
ACS880-31-038A-3	R6	38	54.4	18.5	36	18.5	32	15	71	751	550
ACS880-31-045A-3	R6	45	64.6	22	43	22	38	18.5	71	912	550
ACS880-31-061A-3	R6	61	76.5	30	58	30	45	22	71	1088	550
ACS880-31-072A-3	R6	72	103.7	37	68	37	61	30	71	1502	550
ACS880-31-087A-3	R6	87	122.4	45	83	45	72	37	71	1904	550
ACS880-31-105A-3	R8	105	148	55	100	55	87	45	68	1877	700
ACS880-31-145A-3	R8	145	178.3	75	138	75	105	55	68	2963	700
ACS880-31-169A-3	R8	169	246.5	90	161	90	145	75	68	3168	700
ACS880-31-206A-3	R8	206	287.3	110	196	110	169	90	68	3990	805

$U_N = 500$ V (range 380 to 500 V). The power ratings are valid at nominal voltage 500 V (2.2 to 110 kW).

Drive type	Frame size	Nominal ratings			Light overload use		Heavy-duty use		Noise level (dB(A))	Heat dissipation (W)	Air flow (m ³ /h)
		I_N (A)	I_{MAX} (A)	P_N (kW)	I_{Ld} (A)	P_{Ld} (kW)	I_{Hd} (A)	P_{Hd} (kW)			
ACS880-31-07A6-5	R3	7.6	9.5	4	7.2	4	5.2	2.2	57	219	361
ACS880-31-11A0-5	R3	11	13.8	5.5	10.4	5.5	7.6	4	57	278	361
ACS880-31-014A-5	R3	14	18.7	7.5	13	7.5	11	5.5	57	321	361
ACS880-31-021A-5	R3	21	26.3	11	19	11	14	7.5	57	473	361
ACS880-31-027A-5	R6	27	35.7	15	26	15	21	11	71	625	550
ACS880-31-034A-5	R6	34	45.9	18.5	32	18.5	27	15	71	711	550
ACS880-31-040A-5	R6	40	57.8	22	38	22	34	18.5	71	807	550
ACS880-31-052A-5	R6	52	68	30	49	30	40	22	71	960	550
ACS880-31-065A-5	R6	65	88.4	37	62	37	52	30	71	1223	550
ACS880-31-077A-5	R6	77	110.5	45	73	45	65	37	71	1560	550
ACS880-31-101A-5	R8	101	148	55	91	55	77	45	68	1995	700
ACS880-31-124A-5	R8	124	178	75	118	75	96	55	68	2800	700
ACS880-31-156A-5	R8	156	247	90	148	90	124	75	68	3168	700
ACS880-31-180A-5	R8	180	287	110	171	110	156	90	68	3872	805

Nominal ratings

I_N Rated current available continuously without overloadability at 40 °C.

P_N Typical motor power in no-overload use.

Maximum output current

I_{max} Maximum output current. Available for 10 seconds at start, then as long as allowed by drive temperature.

Light-overload use

I_{Ld} Continuous current allowing 110% I_{Ld} for 1 minute every 5 minutes at 40 °C.

P_{Ld} Typical motor power in light-overload use.

Heavy-duty use

I_{Hd} Continuous current allowing 150% I_{Hd} for 1 minute every 5 minutes at 40 °C.

P_{Hd} Typical motor power in heavy-duty use.

The ratings apply at 40 °C ambient temperature.

At higher temperatures (up to 55 °C) the derating is 1%/1 °C.

Ratings, types and voltages

Cabinet-built ultra-low harmonic drives, ACS880-37

$U_N = 400\text{ V}$ (range 380 to 415 V). The power ratings are valid at nominal voltage 400 V (45 to 1400 kW).

Drive type	Frame size	Nominal ratings			Light overload use		Heavy-duty use		Noise level (dB(A))	Heat dissipation (W)	Air flow (m ³ /h)
		I_N (A)	I_{MAX} (A)	P_N (kW)	I_{Ld} (A)	P_{Ld} (kW)	I_{Hd} (A)	P_{Hd} (kW)			
ACS880-37-0105A-3	R8	105	148	55	100	55	87	45	70	2200	700
ACS880-37-0145A-3	R8	145	178	75	138	75	105	55	70	3300	700
ACS880-37-0169A-3	R8	169	247	90	161	90	145	75	70	3570	700
ACS880-37-0206A-3	R8	206	287	110	196	110	169	90	70	4440	805
ACS880-37-0293A-3	R11	293	418	160	278	160	246	132	77	6900	2100
ACS880-37-0363A-3	R11	363	498	200	345	200	293	160	77	8500	2100
ACS880-37-0442A-3	R11	442	621	250	420	250	363	200	77	10500	2100
ACS880-37-0505A-3	R11	505	631	250	480	250	363	200	77	10600	2100
ACS880-37-0585A-3	R11	585	751	315	556	315	442	250	77	13200	2100
ACS880-37-0650A-3	R11	650	859	355	618	355	505	250	77	14800	2100
ACS880-37-0450A-3	1xR8i+1xR8i	450	590	250	432	200	337	160	75	11000	3760
ACS880-37-0620A-3	1xR8i+1xR8i	620	810	355	595	315	464	250	75	16000	3760
ACS880-37-0870A-3	1xR8i+1xR8i	870	1050	500	835	450	651	355	75	23000	3760
ACS880-37-1110A-3	2xR8i+2xR8i	1110	1450	630	1066	560	830	450	77	27000	7220
ACS880-37-1210A-3	2xR8i+2xR8i	1210	1580	710	1162	630	905	500	77	29000	7220
ACS880-37-1430A-3	2xR8i+2xR8i	1430	1860	800	1373	710	1070	560	77	34000	7220
ACS880-37-1700A-3	2xR8i+2xR8i	1700	2040	1000	1632	900	1272	710	77	45000	7220
ACS880-37-2060A-3	3xR8i+3xR8i	2060	2680	1200	1978	1100	1541	800	78	56000	11580
ACS880-37-2530A-3	3xR8i+3xR8i	2530	3040	1400	2429	1200	1892	1000	78	68000	11580

$U_N = 500\text{ V}$ (range 380 to 500 V). The power ratings are valid at nominal voltage 500 V (45 to 1600 kW).

Drive type	Frame size	Nominal ratings			Light overload use		Heavy-duty use		Noise level (dB(A))	Heat dissipation (W)	Air flow (m ³ /h)
		I_N (A)	I_{MAX} (A)	P_N (kW)	I_{Ld} (A)	P_{Ld} (kW)	I_{Hd} (A)	P_{Hd} (kW)			
ACS880-37-0101A-5	R8	101	148	55	91	55	77	45	70	2300	700
ACS880-37-0124A-5	R8	124	178	75	118	75	96	55	70	3100	700
ACS880-37-0156A-5	R8	156	247	90	148	90	124	75	70	3500	700
ACS880-37-0180A-5	R8	180	287	110	171	110	156	90	70	4300	805
ACS880-37-0260A-5	R11	260	418	160	247	160	240	132	77	6900	2100
ACS880-37-0361A-5	R11	361	542	200	343	200	260	160	77	8500	2100
ACS880-37-0414A-5	R11	414	614	250	393	250	361	200	77	10500	2100
ACS880-37-0460A-5	R11	460	660	315	450	315	414	250	77	13100	2100
ACS880-37-0503A-5	R11	503	725	355	492	355	460	315	77	14800	2100
ACS880-37-0420A-5	1xR8i+1xR8i	420	550	250	403	250	314	200	75	11000	3760
ACS880-37-0570A-5	1xR8i+1xR8i	570	750	400	547	355	426	250	75	15000	3760
ACS880-37-0780A-5	1xR8i+1xR8i	780	1020	560	749	500	583	400	75	21000	3760
ACS880-37-1010A-5	2xR8i+2xR8i	1010	1320	710	970	630	755	500	77	27000	7220
ACS880-37-1110A-5	2xR8i+2xR8i	1110	1450	800	1066	710	830	560	77	28000	7220
ACS880-37-1530A-5	2xR8i+2xR8i	1530	1990	1100	1469	1000	1144	800	77	41000	7220
ACS880-37-1980A-5	3xR8i+3xR8i	1980	2580	1400	1901	1300	1481	1000	78	51000	11580
ACS880-37-2270A-5	3xR8i+3xR8i	2270	2960	1600	2179	1500	1698	1200	78	60000	11580

$U_N = 690$ V (range 525 to 690 V). The power ratings are valid at nominal voltage 690 V (132 to 3200 kW).

Drive type	Frame size	Nominal ratings			Light overload use		Heavy-duty use		Noise level (dB(A))	Heat dissipation (W)	Air flow (m ³ /h)
		I_N (A)	I_{MAX} (A)	P_N (kW)	I_{Ld} (A)	P_{Ld} (kW)	I_{Hd} (A)	P_{Hd} (kW)			
ACS880-37-0174A-7	R11	174	274	160	165	160	142	132	77	6900	2100
ACS880-37-0210A-7	R11	210	384	200	200	200	174	160	77	8500	2100
ACS880-37-0271A-7	R11	271	411	250	257	250	210	200	77	10500	2100
ACS880-37-0330A-7	R11	330	480	315	320	315	271	250	77	13000	2100
ACS880-37-0370A-7	R11	370	520	355	360	355	330	315	77	14700	2100
ACS880-37-0430A-7	R11	430	520	400	420	400	370	355	77	16500	2100
ACS880-37-0320A-7	1xR8i+1xR8i	320	480	315	307	250	239	200	75	13000	3760
ACS880-37-0390A-7	1xR8i+1xR8i	390	590	355	374	355	292	250	75	16000	3760
ACS880-37-0580A-7	1xR8i+1xR8i	580	870	560	557	500	434	400	75	23000	3760
ACS880-37-0660A-7	2xR8i+2xR8i	660	990	630	634	560	494	450	77	26000	7220
ACS880-37-0770A-7	2xR8i+2xR8i	770	1160	710	739	710	576	560	77	29000	7220
ACS880-37-0950A-7	2xR8i+2xR8i	950	1430	900	912	800	711	710	77	38000	7220
ACS880-37-1130A-7	2xR8i+2xR8i	1130	1700	1100	1085	1000	845	800	77	44000	7220
ACS880-37-1450A-7	3xR8i+3xR8i	1450	2180	1400	1392	1300	1085	1000	78	54000	11580
ACS880-37-1680A-7	3xR8i+3xR8i	1680	2520	1600	1613	1500	1257	1200	78	64000	11580
ACS880-37-1950A-7	4xR8i+4xR8i	1950	2930	1900	1872	1800	1459	1400	79	80000	14440
ACS880-37-2230A-7	4xR8i+4xR8i	2230	3350	2200	2141	2000	1668	1600	79	88000	14440
ACS880-37-2770A-7	6xR8i+5xR8i	2770	4160	2700	2659	2600	2072	2000	79	113000	18800
ACS880-37-3310A-7	6xR8i+6xR8i	3310	4970	3200	3178	3000	2476	2400	79	132000	21660

Nominal ratings

I_N Rated current available continuously without overloadability at 40 °C.

P_N Typical motor power in no-overload use.

Maximum output current

I_{max} Maximum output current. Available for 10 seconds at start, then as long as allowed by drive temperature.

Light-overload use

I_{Ld} Continuous current allowing 110% I_{Ld} for 1 minute every 5 minutes at 40 °C.

P_{Ld} Typical motor power in light-overload use.

Heavy-duty use

I_{Hd} Continuous current allowing 150% I_{Hd} for 1 minute every 5 minutes at 40 °C.

P_{Hd} Typical motor power in heavy-duty use.

The ratings apply at 40 °C ambient temperature.

At higher temperatures (up to 50 °C) the derating is 1%/1 °C. Operation above 150 Hz might require type-specific derating.

¹⁾ Values to be confirmed upon full sales release of the product. Please contact ABB for further information.

Liquid-cooled drives

ACS880-07LC, ACS880-07CLC,
ACS880-17LC, ACS880-37LC

The compact and robust liquid-cooled cabinet drives are an ultimate solution for various applications where space savings, silent operation or durability in harsh environments is a must.

The Single drives with diode supply unit consists of extremely compact diode supply and inverter units with parallel connected modules. The small footprint enables significant space and weight reduction.

Addition single drives with diode supply units the extensive ACS880 liquid-cooled offering includes low harmonic and regenerative variants.

Built-in redundancy through parallel connected modules enables higher drive availability and greater process uptime. If one of the modules is not operating or is being maintained, the drive will continue to operate at partial load.

Advanced liquid cooling and optimal design

Direct liquid cooling offers easy heat transfer without air filtering problems. Since the coolant takes care of 98% of the heat losses, no additional filtered air cooling is needed. This increases the total efficiency of the drive installation.

—
For harsh environmental conditions

Robust solution for different environments

Totally enclosed cabinet structure makes the ACS880 liquid-cooled drives perfect for harsh environmental conditions.

The offering fulfills marine and offshore requirements and the drives have marine type approvals from various key classification bodies.

As the direct liquid cooling enables silent operation, the ACS880 liquid-cooled drives are suitable for applications where noise levels are an important environmental factor.

—
Robust, reliable and compact

Simple and cost-efficient installation

The high-efficient liquid cooling removes the need for air-conditioning in the installation rooms, bringing the installation and operation costs down. As there is no need for additional air conditioning devices or air ducts, the installation is significantly simplified.

The used coolant type is Antifrogen® L, by Clariant International Ltd, cooling liquid with glycol and inhibitor. It is a ready-made, commercially available mix, which enables easy commissioning and maximized process uptime.



Liquid-cooled ACS880-07LC and ACS880-07CLC drives

- Power ratings: 250 to 6000 kW
- Enclosure classes: IP42 (as standard) and IP54

Main options:

- Optional liquid cooling unit (LCU) for single, redundant and tandem pump versions
- I/O extension modules, see page 54
- Communication protocol adapters, see page 54
- Emergency stop category 0 with opening main contactor/breaker
- Earth fault monitoring, unearthed mains (IT)

ACS880-07LC:

- Designed for industrial use
- 6- or 12-pulse solution
- Internal charging circuit for the drive

ACS880-07CLC:

- Extremely compact design focused on marine use
- 6-, 12- or 24-pulse solution



Liquid-cooled regenerative ACS880-17LC and ultra-low-harmonic ACS880-37LC drives

- Power ratings: 250 to 6000 kW
- Enclosure classes: IP42 (as standard) and IP54

Main options:

- Optional liquid cooling unit (LCU) for single, redundant and tandem pump versions
- Cabling solutions for bottom and top entry and exit
- I/O extension modules, see page 54
- Communication protocol adapters, see page 54

For more information on regenerative functionality see page 28 and on harmonics see page 34.

The drives have an extensive selection of built-in features and options. See page 86.

Highlights

- Advanced liquid cooling which reduces the need for air cooling in installation rooms
- High power density with compact and robust design
- Commercially available coolant mix, Antifrogen L
- Redundancy through parallel connected modules prevents unwanted process interruptions
- Low harmonic and regenerative variants
- Silent operation
- Suitable for harsh environments
- Marine approvals from various key classification bodies.

Ratings, types and voltages

Liquid-cooled drives, ACS880-07LC

$U_N = 690$ V (range 525 to 690 V). The power ratings are valid at nominal voltage 690 V (366 to 5446 kVA).

Drive type	Frame size	Nominal ratings			Light overload use		Heavy-duty use		Noise level (dB(A))	Coolant heat dissipation P_{loss} (kW)	Coolant volume (l)	Coolant flow rate (l/min)
		I_N (A)	I_{MAX} (A)	P_N (kW)	I_{Ld} (A)	P_{Ld} (kW)	I_{Hd} (A)	P_{Hd} (kW)				
Liquid-cooled diode supply units (DSU), ACS880-304LC												
6-pulse diode												
ACS880-07LC-0390A-7	1xD8T + 1xR8i	390	585	355	374	355	292	250	67	10	15	52
ACS880-07LC-0430A-7	1xD8T + 1xR8i	430	645	400	413	355	322	250	67	11	15	52
ACS880-07LC-0480A-7	1xD8T + 1xR8i	480	720	450	461	400	359	315	67	12	15	52
ACS880-07LC-0530A-7	1xD8T + 1xR8i	530	795	500	509	450	396	355	67	13	15	52
ACS880-07LC-0600A-7	1xD8T + 1xR8i	600	900	560	576	560	449	400	67	14	15	52
ACS880-07LC-0670A-7	1xD8T + 1xR8i	670	1005	630	643	630	501	450	67	16	15	52
ACS880-07LC-0750A-7	1xD8T + 1xR8i	750	1125	710	720	710	561	500	67	18	15	52
ACS880-07LC-0850A-7	1xD8T + 1xR8i	850	1275	800	816	800	636	560	67	20	15	52
ACS880-07LC-1030A-7	1xD8T + 2xR8i	1030	1545	1000	989	900	770	710	69	23	18	68
ACS880-07LC-1170A-7	1xD8T + 2xR8i	1170	1755	1100	1123	1100	875	800	69	27	18	68
ACS880-07LC-1310A-7	2xD8T + 2xR8i	1310	1965	1200	1258	1200	980	900	69	30	19	82
ACS880-07LC-1470A-7	2xD8T + 2xR8i	1470	2205	1400	1411	1200	1100	1000	69	34	19	82
ACS880-07LC-1660A-7	2xD8T + 2xR8i	1660	2490	1600	1594	1400	1242	1200	69	39	19	82
ACS880-07LC-1940A-7	2xD8T + 3xR8i	1940	2910	1800	1862	1800	1451	1400	71	43	22	98
ACS880-07LC-2180A-7	2xD8T + 3xR8i	2180	3270	2000	2093	2000	1631	1400	71	49	22	98
ACS880-07LC-2470A-7	3xD8T + 3xR8i	2470	3705	2300	2371	2300	1848	1800	71	56	26	118
ACS880-07LC-2880A-7	3xD8T + 4xR8i	2880	4320	2700	2765	2700	2154	2000	72	65	29	134
ACS880-07LC-3260A-7	3xD8T + 4xR8i	3260	4890	3000	3130	3000	2438	2300	72	75	29	134
ACS880-07LC-3580A-7	4xD8T + 5xR8i	3580	5370	3400	3437	3200	2678	2600	73	81	37	172
ACS880-07LC-4050A-7	4xD8T + 5xR8i	4050	6075	3800	3888	3800	3029	2800	74	94	37	172
ACS880-07LC-4840A-7	5xD8T + 6xR8i	4840	7260	4400	4646	4400	3620	3500	74	115	44	208
ACS880-07LC-5650A-7	6xD8T + 7xR8i	5650	8475	5200	5424	5200	4226	4000	75	129	49	238
ACS880-07LC-6460A-7	6xD8T + 8xR8i	6460	9690	6000	6202	6000	4832	4700	75	147	52	254
12-pulse diode¹⁾												
ACS880-07LC-0530A-7+A004	2xD8T + 1xR8i	530	795	500	509	450	474	355	67	13	19	74
ACS880-07LC-0600A-7+A004	2xD8T + 1xR8i	600	900	560	576	560	536	400	67	15	19	74
ACS880-07LC-0670A-7+A004	2xD8T + 1xR8i	670	1005	630	643	630	599	450	67	16	19	74
ACS880-07LC-0750A-7+A004	2xD8T + 1xR8i	750	1125	710	720	710	670	500	67	19	19	74
ACS880-07LC-0850A-7+A004	2xD8T + 1xR8i	850	1275	800	816	800	760	560	67	21	19	74
ACS880-07LC-1030A-7+A004	2xD8T + 2xR8i	1030	1545	1000	989	900	921	710	69	23	23	90
ACS880-07LC-1170A-7+A004	2xD8T + 2xR8i	1170	1755	1100	1123	1100	1046	800	69	26	23	90
ACS880-07LC-1310A-7+A004	2xD8T + 2xR8i	1310	1965	1200	1258	1200	1171	900	69	30	23	90
ACS880-07LC-1470A-7+A004	2xD8T + 2xR8i	1470	2205	1400	1411	1200	1314	1000	69	34	23	90
ACS880-07LC-1660A-7+A004	2xD8T + 2xR8i	1660	2490	1600	1594	1400	1484	1200	69	39	23	90
ACS880-07LC-1940A-7+A004	2xD8T + 3xR8i	1940	2910	1800	1862	1800	1734	1400	71	43	26	106
ACS880-07LC-2180A-7+A004	2xD8T + 3xR8i	2180	3270	2000	2093	2000	1949	1400	71	49	26	106
ACS880-07LC-2470A-7+A004	4xD8T + 3xR8i	2470	3705	2300	2371	2300	2208	1800	71	57	30	140
ACS880-07LC-2880A-7+A004	4xD8T + 4xR8i	2880	4320	2700	2765	2700	2575	2000	72	65	34	156
ACS880-07LC-3260A-7+A004	4xD8T + 4xR8i	3260	4890	3000	3130	3000	2914	2300	72	76	34	156
ACS880-07LC-3580A-7+A004	4xD8T + 5xR8i	3580	5370	3400	3437	3200	3200	2600	73	81	37	172
ACS880-07LC-4050A-7+A004	4xD8T + 5xR8i	4050	6075	3800	3888	3800	3620	2800	74	94	37	172
ACS880-07LC-4840A-7+A004	6xD8T + 6xR8i	4840	7260	4400	4646	4400	4327	3500	74	111	45	222
ACS880-07LC-5650A-7+A004	6xD8T + 7xR8i	5650	8475	5200	5424	5200	5051	4000	75	129	49	238
ACS880-07LC-6460A-7+A004	6xD8T + 8xR8i	6460	9690	6000	6202	6000	5775	4700	75	147	52	254

¹⁾ +A004 is option code for 12-pulse half controlled rectifier bridge

Ratings, types and voltages

Liquid-cooled drives, ACS880-07CLC

$U_N = 690$ V (range 525 to 690 V). The power ratings are valid at nominal voltage 690 V (250 to 6000 kW).

Drive type	Frame size	Nominal ratings			Light overload use		Heavy-duty use		Noise level (dB(A))	Coolant heat dissipation P_{loss} (kW)	Coolant volume (l)	Coolant flow rate (l/min)
		I_N (A)	I_{MAX} (A)	P_N (kW)	I_{Ld} (A)	P_{Ld} (kW)	I_{Hd} (A)	P_{Hd} (kW)				
6-pulse diode												
ACS880-07CLC-0390A-7	1xD8D + 1xR8i	390	585	355	374	355	292	250	66	9.7	7.1	28
ACS880-07CLC-0430A-7	1xD8D + 1xR8i	430	645	400	413	355	322	250	66	10	7.1	28
ACS880-07CLC-0480A-7	1xD8D + 1xR8i	480	720	450	461	400	359	315	66	12	7.1	28
ACS880-07CLC-0530A-7	1xD8D + 1xR8i	530	795	500	509	450	396	355	66	13	7.1	28
ACS880-07CLC-0600A-7	1xD8D + 1xR8i	600	900	560	576	560	449	400	66	14	7.1	28
ACS880-07CLC-0670A-7	1xD8D + 1xR8i	670	1005	630	643	630	501	450	66	16	7.1	28
ACS880-07CLC-0750A-7	1xD8D + 1xR8i	750	1125	710	720	710	561	500	66	17	7.1	28
ACS880-07CLC-0850A-7	1xD8D + 1xR8i	850	1275	800	816	800	636	560	66	20	7.1	28
ACS880-07CLC-1030A-7	2xD8D + 2xR8i	1030	1545	1000	989	900	770	710	68	25	10.8	54
ACS880-07CLC-1170A-7	2xD8D + 2xR8i	1170	1755	1100	1123	1100	875	800	68	27	10.8	54
ACS880-07CLC-1310A-7	2xD8D + 2xR8i	1310	1965	1200	1258	1200	980	900	68	31	10.8	54
ACS880-07CLC-1470A-7	2xD8D + 2xR8i	1470	2205	1400	1411	1200	1100	1000	68	34	10.8	54
ACS880-07CLC-1660A-7	2xD8D + 2xR8i	1660	2490	1600	1594	1400	1242	1200	68	39	10.8	54
ACS880-07CLC-1940A-7	3xD8D + 3xR8i	1940	2910	1800	1862	1800	1451	1400	69	45	14.6	72
ACS880-07CLC-2180A-7	3xD8D + 3xR8i	2180	3270	2000	2093	2000	1631	1400	69	51	14.6	72
ACS880-07CLC-2470A-7	3xD8D + 3xR8i	2470	3705	2300	2371	2300	1848	1800	69	58	14.6	72
ACS880-07CLC-2880A-7	4xD8D + 4xR8i	2880	4320	2700	2765	2700	2154	2000	70	67	22.5	98
ACS880-07CLC-3260A-7	4xD8D + 4xR8i	3260	4890	3000	3130	3000	2438	2300	70	77	22.5	98
12-pulse diode												
ACS880-07CLC-0530A-7+A004	2xD8D + 1xR8i	530	795	500	509	450	396	355	66	13	7.6	38
ACS880-07CLC-0600A-7+A004	2xD8D + 1xR8i	600	900	560	576	560	449	400	66	14	7.6	38
ACS880-07CLC-0670A-7+A004	2xD8D + 1xR8i	670	1005	630	643	630	501	450	66	16	7.6	38
ACS880-07CLC-0750A-7+A004	2xD8D + 1xR8i	750	1125	710	720	710	561	500	66	17	7.6	38
ACS880-07CLC-0850A-7+A004	2xD8D + 1xR8i	850	1275	800	816	800	636	560	66	20	7.6	38
ACS880-07CLC-1030A-7+A004	2xD8D + 2xR8i	1030	1545	1000	989	900	770	710	68	25	10.8	54
ACS880-07CLC-1170A-7+A004	2xD8D + 2xR8i	1170	1755	1100	1123	1100	875	800	68	27	10.8	54
ACS880-07CLC-1310A-7+A004	2xD8D + 2xR8i	1310	1965	1200	1258	1200	980	900	68	31	10.8	54
ACS880-07CLC-1470A-7+A004	2xD8D + 2xR8i	1470	2205	1400	1411	1200	1100	1000	68	34	10.8	54
ACS880-07CLC-1660A-7+A004	2xD8D + 2xR8i	1660	2490	1600	1594	1400	1242	1200	68	39	10.8	54
ACS880-07CLC-1940A-7+A004	4xD8D + 3xR8i	1940	2910	1800	1862	1800	1451	1400	69	45	15.0	82
ACS880-07CLC-2180A-7+A004	4xD8D + 3xR8i	2180	3270	2000	2093	2000	1631	1400	69	51	15.0	82
ACS880-07CLC-2470A-7+A004	4xD8D + 3xR8i	2470	3705	2300	2371	2300	1848	1800	69	58	15.0	82
ACS880-07CLC-2880A-7+A004	4xD8D + 4xR8i	2880	4320	2700	2765	2700	2154	2000	70	67	22.5	98
ACS880-07CLC-3260A-7+A004	4xD8D + 4xR8i	3260	4890	3000	3130	3000	2438	2300	70	77	22.5	98
ACS880-07CLC-3580A-7+A004	6xD8D + 5xR8i	3580	5370	3400	3437	3200	2678	2600	72	84	25.8	126
ACS880-07CLC-4050A-7+A004	6xD8D + 5xR8i	4050	6075	3800	3888	3800	3029	2800	72	95	25.8	126
ACS880-07CLC-4840A-7+A004	6xD8D + 6xR8i	4840	7260	4400	4646	4400	3620	3500	72	114	29.1	142
ACS880-07CLC-5650A-7+A004	8xD8D + 7xR8i	5650	8475	5200	5424	5200	4226	4000	73	133	33.9	170
ACS880-07CLC-6460A-7+A004	8xD8D + 8xR8i	6460	9690	6000	6202	6000	4832	4700	73	152	37.2	186
24-pulse diode												
ACS880-07CLC-2470A-7+A006	4xD8D + 3xR8i	2470	3705	2300	2371	2300	1848	1800	69	58	15.0	82
ACS880-07CLC-3260A-7+A006	4xD8D + 4xR8i	3260	4890	3000	3130	3000	2438	2300	70	77	22.5	98
ACS880-07CLC-4840A-7+A006	8xD8D + 6xR8i	4840	7260	4400	4646	4400	3620	3500	72	114	30.0	154
ACS880-07CLC-5650A-7+A006	8xD8D + 7xR8i	5650	8475	5200	5424	5200	4226	4000	73	133	33.9	170
ACS880-07CLC-6460A-7+A006	8xD8D + 8xR8i	6460	9690	6000	6202	6000	4832	4700	73	152	37.2	186

Ratings, types and voltages

Liquid-cooled regenerative drives, ACS880-17LC

$U_N = 690$ V (range 525 to 690 V). The power ratings are valid at nominal voltage 690 V (250 to 6000 kW).

Drive type	Frame size	Nominal ratings			Light overload use		Heavy-duty use		Noise level (dB(A))	$P_{\text{loss coolant}}$ (kW)	Coolant volume (l)	Coolant flow rate (l/min)
		I_N (A)	I_{MAX} (A)	P_N (kW)	I_{Ld} (A)	P_{Ld} (kW)	I_{Hd} (A)	P_{Hd} (kW)				
ACS880-17LC-0390A-7	1xR8i + 1xR8i	390	590	355	374	355	292	250	68	15	12	68
ACS880-17LC-0430A-7	1xR8i + 1xR8i	430	650	400	413	355	322	250	68	17	12	68
ACS880-17LC-0480A-7	1xR8i + 1xR8i	480	720	450	461	400	359	315	68	19	12	68
ACS880-17LC-0520A-7	1xR8i + 1xR8i	520	780	500	499	450	389	355	68	21	12	68
ACS880-17LC-0600A-7	1xR8i + 1xR8i	600	900	560	576	500	449	400	68	24	12	68
ACS880-17LC-0670A-7	1xR8i + 1xR8i	670	1010	630	643	560	501	450	68	27	12	68
ACS880-17LC-0750A-7	1xR8i + 1xR8i	750	1130	710	720	630	561	500	68	31	12	68
ACS880-17LC-0830A-7	1xR8i + 1xR8i	830	1250	800	797	710	621	560	68	35	12	68
ACS880-17LC-1000A-7	2xR8i + 2xR8i	1000	1500	1000	960	900	748	710	70	38	19	120
ACS880-17LC-1170A-7	2xR8i + 2xR8i	1170	1760	1100	1123	1000	875	800	70	44	19	120
ACS880-17LC-1270A-7	2xR8i + 2xR8i	1270	1910	1200	1219	1200	950	900	70	50	19	120
ACS880-17LC-1470A-7	2xR8i + 2xR8i	1470	2210	1400	1411	1200	1100	1000	70	55	19	120
ACS880-17LC-1620A-7	2xR8i + 2xR8i	1620	2430	1600	1555	1400	1212	1200	70	63	19	120
ACS880-17LC-1940A-7	3xR8i + 3xR8i	1940	2910	1800	1862	1800	1451	1400	72	70	29	192
ACS880-17LC-2180A-7	3xR8i + 3xR8i	2180	3270	2000	2093	2000	1631	1600	72	81	29	192
ACS880-17LC-2390A-7	3xR8i + 3xR8i	2390	3590	2300	2294	2200	1788	1800	72	93	29	192
ACS880-17LC-2880A-7	4xR8i + 4xR8i	2880	4320	2700	2765	2600	2154	2000	73	105	38	224
ACS880-17LC-3160A-7	4xR8i + 4xR8i	3160	4740	3000	3034	2900	2364	2300	73	121	38	224
ACS880-17LC-3580A-7	5xR8i + 5xR8i	3580	5370	3400	3437	3200	2678	2500	74	132	48	296
ACS880-17LC-4050A-7	6xR8i + 5xR8i	4050	6080	3800	3888	3600	3029	2800	75	151	52	360
ACS880-17LC-4700A-7	6xR8i + 6xR8i	4700	7050	4400	4512	4400	3516	3400	75	182	58	376
ACS880-17LC-5650A-7	8xR8i + 7xR8i	5650	8480	5200	5424	5000	4226	4000	76	208	68	424
ACS880-17LC-6260A-7	8xR8i + 8xR8i	6260	9390	6000	6010	6000	4682	4500	76	286	75	504

Ratings, types and voltages

Liquid-cooled ultra-low harmonic drives, ACS880-37LC

$U_N = 690$ V (range 525 to 690 V). The power ratings are valid at nominal voltage 690 V (250 to 6000 kW).

Drive type	Frame size	Nominal ratings			Light overload use		Heavy-duty use		Noise level (dB(A))	$P_{\text{loss coolant}}$ (kW)	Coolant volume (l)	Coolant flow rate (l/min)
		I_N (A)	I_{MAX} (A)	P_N (kW)	I_{Ld} (A)	P_{Ld} (kW)	I_{Hd} (A)	P_{Hd} (kW)				
ACS880-37LC-0390A-7	1xR8i + 1xR8i	390	590	355	374	355	292	250	68	15	12	68
ACS880-37LC-0430A-7	1xR8i + 1xR8i	430	650	400	413	355	322	250	68	17	12	68
ACS880-37LC-0480A-7	1xR8i + 1xR8i	480	720	450	461	400	359	315	68	19	12	68
ACS880-37LC-0520A-7	1xR8i + 1xR8i	520	780	500	499	450	389	355	68	21	12	68
ACS880-37LC-0600A-7	1xR8i + 1xR8i	600	900	560	576	500	449	400	68	24	12	68
ACS880-37LC-0670A-7	1xR8i + 1xR8i	670	1010	630	643	560	501	450	68	27	12	68
ACS880-37LC-0750A-7	1xR8i + 1xR8i	750	1130	710	720	630	561	500	68	31	12	68
ACS880-37LC-0830A-7	1xR8i + 1xR8i	830	1250	800	797	710	621	560	68	35	12	68
ACS880-37LC-1000A-7	2xR8i + 2xR8i	1000	1500	1000	960	900	748	710	70	38	19	120
ACS880-37LC-1170A-7	2xR8i + 2xR8i	1170	1760	1100	1123	1000	875	800	70	44	19	120
ACS880-37LC-1270A-7	2xR8i + 2xR8i	1270	1910	1200	1219	1200	950	900	70	50	19	120
ACS880-37LC-1470A-7	2xR8i + 2xR8i	1470	2210	1400	1411	1200	1100	1000	70	55	19	120
ACS880-37LC-1620A-7	2xR8i + 2xR8i	1620	2430	1600	1555	1400	1212	1200	70	63	19	120
ACS880-37LC-1940A-7	3xR8i + 3xR8i	1940	2910	1800	1862	1800	1451	1400	72	70	29	192
ACS880-37LC-2180A-7	3xR8i + 3xR8i	2180	3270	2000	2093	2000	1631	1600	72	81	29	192
ACS880-37LC-2390A-7	3xR8i + 3xR8i	2390	3590	2300	2294	2200	1788	1800	72	93	29	192
ACS880-37LC-2880A-7	4xR8i + 4xR8i	2880	4320	2700	2765	2600	2154	2000	73	105	38	224
ACS880-37LC-3160A-7	4xR8i + 4xR8i	3160	4740	3000	3034	2900	2364	2300	73	121	38	224
ACS880-37LC-3580A-7	5xR8i + 5xR8i	3580	5370	3400	3437	3200	2678	2500	74	132	48	296
ACS880-37LC-4050A-7	6xR8i + 5xR8i	4050	6080	3800	3888	3600	3029	2800	75	151	52	360
ACS880-37LC-4700A-7	6xR8i + 6xR8i	4700	7050	4400	4512	4400	3516	3400	75	182	58	376
ACS880-37LC-5650A-7	8xR8i + 7xR8i	5650	8480	5200	5424	5000	4226	4000	76	208	68	424
ACS880-37LC-6260A-7	8xR8i + 8xR8i	6260	9390	6000	6010	6000	4682	4500	76	286	75	504

Nominal ratings

I_N	Rated current available continuously without overloadability at 45 °C.
P_N	Typical motor power in no-overload use.
P_{max}	Maximum nominal cooling power.
Internal flow	Nominal coolant flow rate from the liquid cooling unit to the drive modules.
External flow	Nominal coolant flow rate to the liquid cooling unit from an external cooling circuit.

Maximum output current

I_{max}	Maximum output current. Available for 10 seconds at start, then as long as allowed by drive temperature.
------------------	----------------------------------------------------------------------------------------------------------

Light-overload use

I_{Ld}	Continuous current allowing 110% I_{Ld} for 1 minute every 5 minutes at 45 °C.
P_{Ld}	Typical motor power in light-overload use.

Heavy-duty use

I_{Hd}	Continuous current allowing 150% I_{Hd} for 1 minute every 5 minutes at 45 °C.
P_{Hd}	Typical motor power in heavy-duty use.

Losses

$P_{\text{loss total}}$	Power loss conducted to coolant and emitted to air.
$P_{\text{loss coolant}}$	Power loss conducted to coolant.
$P_{\text{loss air}}$	Power loss emitted to air (ambient room).
P_{drop}	Pressure loss in external cooling circuit.

The ratings apply at 45 °C ambient temperature. At higher temperatures (up to 55 °C) the derating is 1%/1 °C. Operation above 150 Hz might require type-specific derating.

Ratings, types and voltages

Liquid-cooling unit, ACS880-1007LC

Range 380 to 690 V										
Liquid cooling unit type	Nominal ratings			Noise level (dB(A))	Losses				Internal flow ¹⁾ (l/min)	External flow ²⁾ (l/min)
	P_{max} (kW)	Internal coolant volume (l)	External coolant volume (l)		$P_{loss\ total}$ (kW)	$P_{loss\ coolant}$ (kW)	$P_{loss\ air}$ (kW)	P_{drop} (kPa)		
ACS880-1007LC-0070 ³⁾	70	17	3	55	0.4	0.3	0.1	150	81/107	120
ACS880-1007LC-0195+C140 ^{3)/C141⁴⁾}	195	31/35	8	55	1.3	1.0	0.3	150	270/355	467
ACS880-1007LC-0195+C213 ⁵⁾	195	35	8	57	2.1	1.8	0.3	150	310/415	467

¹⁾ 120 kPa, Antifrogen® L 25%, 40 °C, 50/60 Hz

²⁾ 36 °C water

³⁾ Single pump

⁴⁾ Redundant, one pump running

⁵⁾ Two pumps running

Dimensions

ACS880

ACS880-01, IP21

Frame size	Height		Width (mm)	Depth (mm)	Weight (kg)
	H1 (mm)	H2 (mm)			
R1	409	370	155	226	7
R2	409	370	155	249	8.4
R3	475	420	172	261	10.8
R4	576	490	203	274	18.6
R5	730	596	203	274	22.8
R6	726	569	251	357	42.2
R7	880	600	284	365	53
R8	963	681	300	386	68
R9	955	680	380	413	95

H1 = Height with cable entry box. H2 = Height without cable entry box.
Width and depth with cable entry box.

Dimensions of the IP20 version are in the ACS880 drive modules catalog.

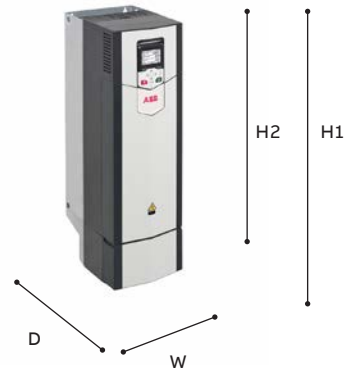

ACS880-01, IP55

Frame size	Height (mm)	Width (mm)	Depth (mm)	Weight (kg)
R1	450	162	292	8.1
R2	450	162	315	9.5
R3	525	180	327	12
R4	576	203	344	19.1
R5	730	203	344	23.4
R6	726	251	421	42.9
R7	880	284	423	54
R8	963	300	452	74
R9	955	380	477	102

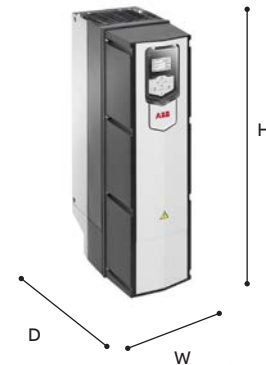

ACS880-11/31, IP21

Frame size	Height		Width (mm)	Depth (mm)	Weight (kg)
	H1 (mm)	H2 (mm)			
R3	495	490	203	356	21.3
R6	771	771	252	382	61
R8	965	965	300	430	103/118 ¹⁾

H1 = Height with cable entry box. H2 = Height without cable entry box.
Width and depth with cable entry box.

¹⁾ For types -105A-3, 145A-3, -101A-5, -124A-5: 103 kg

For types -169A-3, 206A-3, -156A-5, -180A-5: 118 kg

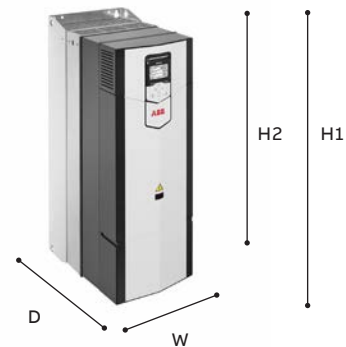

ACS880-11/31, IP55

Frame size	Height (mm)	Width (mm)	Depth (mm)	Weight (kg)
R3	495	203	360	23.3
R6	771	252	445	63
R8	966	300	496	109/124 ¹⁾

¹⁾ For types -105A-3, 145A-3, -101A-5, -124A-5: 109 kg

For types -169A-3, 206A-3, -156A-5, -180A-5: 124 kg

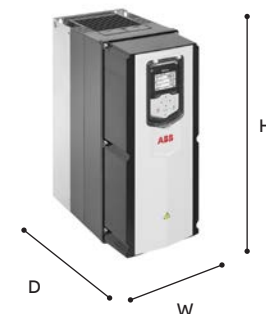

ACS880-07, IP22/42/54^{*)}

Frame size	Height		Width (mm)	Depth (mm)	Weight (kg)
	IP22/42 (mm)	IP54 (mm)			
R6	2145	2315	430	673/698 ¹⁾	240
R7	2145	2315	430	673/698 ¹⁾	250
R8	2145	2315	430	673/698 ¹⁾	265
R9	2145	2315	830	698	375
R10	2145	2315	830	698	530
R11	2145	2315	830	698	580

¹⁾ 698 mm for IP54

**ACS880-07, IP22/42/54^{*)}**

Frame size	Height		Width		Depth (mm)	Weight	
	IP22/42 (mm)	IP54 (mm)	6-pulse (mm)	12-pulse (mm)		6-pulse (kg)	12-pulse (kg)
D8T+2xR8i	2145	2315	1830	–	698	1470	–
2xD7T+2xR8i	2145	2315	–	2030	698	–	1710
2xD8T+2xR8i ¹⁾	2145	2315	2030	–	698	1650	–
2xD8T+2xR8i	2145	2315	2230	2230	698	1770	1870
2xD8T+3xR8i	2145	2315	2430	2430	698	1920	2020
3xD8T+3xR8i	2145	2315	2630	–	698	2230	–
3xD8T+4xR8i	2145	2315	3030	–	698	2590	–
4xD8T+3xR8i	2145	2315	–	3030	698	–	2600
4xD8T+4xR8i	2145	2315	–	3430	698	–	2960
4xD8T+5xR8i	2145	2315	3630	3630	698	3030	3110

¹⁾ ACS880-07-1160A-7

ACS880-17/37, IP22/42/54^{*)}

Frame size	Height		Width (mm)	Depth (mm)	Weight (kg)
	IP22/42 (mm)	IP54 (mm)			
R8	2145	2315	430	673/698 ¹⁾	320
R11	2145	2315	1230	698	750
R8i+R8i	2145	2315	1230	698	1180
2xR8i+2xR8i	2145	2315	2230/2430 ²⁾	698	1970/2090 ²⁾
3xR8i+3xR8i	2145	2315	3230	698/738 ³⁾	2730/2930 ³⁾
4xR8i+4xR8i	2145	2315	3830	738	3700
6xR8i+5xR8i	2145	2315	5030	738	4830
6xR8i+6xR8i	2145	2315	5330	738	4980

¹⁾ 698 mm for IP54

²⁾ 2430mm/2090 kg for -1210A-3, -1430A-3, -1700A-3, -1530A-5.

³⁾ 738mm/2930kg for -2060A-3, -2530A-3, -1980A-5, -2270A-5.



*) Dimensions are for standard configuration including measures for door installed components.

Plus code options can affect dimensions. For more information, please see dimensional drawings in hardware manual.

ACS880-07LC, IP42/54

Frame size	Height (mm)	Width		Depth (mm)	Weight	
		6-pulse (mm)	12-pulse (mm)		6-pulse (kg)	12-pulse (kg)
1xD8T + 1xR8i	2002	1700	-	644	1480	-
1xD8T + 2xR8i	2002	1900	-	644	1610	-
2xD8T + 1xR8i	2002	-	2300	644	-	2230
2xD8T + 2xR8i	2002	1900	2500	644	1760	2360
2xD8T + 3xR8i	2002	2100	2700	644	1930	2530
3xD8T + 3xR8i	2002	2500	-	644	2230	-
3xD8T + 4xR8i	2002	2800	-	644	2490	-
4xD8T + 3xR8i	2002	-	3240	644	-	2980
4xD8T + 4xR8i	2002	-	3400	644	-	3240
4xD8T + 5xR8i	2002	3600	3600	644	3410	3410
5xD8T + 6xR8i	2002	4500	-	644	3410	-
6xD8T + 6xR8i	2002	-	4200	644	-	4030
6xD8T + 7xR8i	2002	4800	4800	644	4470	4470
6xD8T + 8xR8i	2002	5000	5000	644	4640	4640



ACS880-07CLC, IP42/54

Frame size	Height (mm)	Width (mm)	Depth (mm)	Weight (kg)
1xD8D+1xR8i	2002	700	636	580
2xD8D+1xR8i	2002	700	636	580
2xD8D+2xR8i	2002	900	636	710
3xD8D+3xR8i	2002	1200	636	1030
4xD8D+3xR8i	2002	1200	636	1030
4xD8D+4xR8i	2002	1500	636	1290
6xD8D+5xR8i	2002	2200	636	1890
6xD8D+6xR8i	2002	2400	636	2060
8xD8D+7xR8i	2002	2700	636	2290
8xD8D+12xR8i	2002	2900	636	2520



ACS880-1007LC, liquid-cooling unit

Unit type	Height (mm)	Width ¹⁾ (mm)	Depth (mm)	Weight (kg)
ACS880-1007LC-0070	2002	300/330	636	200
ACS880-1007LC-0195+C140	2002	600/630	636	310
ACS880-1007LC-0195+C141	2002	600/630	636	366
ACS880-1007LC-0195+C213	2002	600/630	636	373

¹⁾ The first values are for line-up connected unit and the latter values for standalone unit.

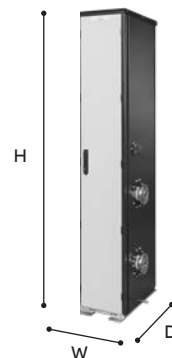

ACS880-17/37LC, IP42/54

Frame size	Height (mm)	Width (mm)	Depth (mm)	Weight (kg)
1xR8i+1xR8i	2002	2000	644	2040
2xR8i+2xR8i	2002	2400/2500 ¹⁾	644	5070/5400 ²⁾
3xR8i+3xR8i	2002	3200	644	7250
4xR8i+4xR8i	2002	4000	644	9060
5xR8i+5xR8i	2002	4600	644	10470
6xR8i+5xR8i	2002	5800	644	13600
6xR8i+6xR8i	2002	6000	644	13980
8xR8i+7xR8i	2002	7300	644	17020
8xR8i+12xR8i	2002	7600	644	17590

¹⁾ 2400 mm for -1000A-7, -1170A-7 and -1270A-7. 2500 mm for -1470A-7 and -1620A-7.

²⁾ 5070 kg for -1000A-7, -1170A-7 and -1270A-7. 5400 kg for -1470A-7 and -1620A-7.



Standard interface and extensions for plug-in connectivity

—
01
Control unit ZCU
—
02
Example of a typical single drives input/output connection diagram. Variations may be possible. For further information, please see the ACS880 user manual.

ACS880 drives offer a wide range of standard interfaces including extensive selection of I/O connections, Safe Torque Off (STO) and a galvanically isolated RS485 link that can be configured as either Modbus RTU or high speed drive-to-drive link.

In addition, they offer three option slots that can be used for extensions, including communication protocol adapters, input/output extension modules, feedback modules, and a safety functions module. For I/O extensions, see page 54.



—
01

Control connections	Description
2 analog inputs (XAI)	Current input: -20 to 20 mA, R_{in} : 100 ohm Voltage input: -10 to 10 V, $R_{in} > 200$ kohm Resolution: 11 bit + sign bit
2 analog outputs (XAO)	0 to 20 mA, $R_{load} < 500$ ohm Frequency range: 0 to 300 Hz Resolution: 11 bit + sign bit
6 digital inputs (XDI)	Input type: NPN/PNP (DI1 to DI5), NPN (DI6) DI6 (XDI:6) can alternatively be used as an input for a PTC thermistor.
Digital input interlock (DIIL)	Input type: NPN/PNP
2 digital inputs/outputs (XDIO)	As input: 24 V logic levels: "0" < 5 V, "1" > 15 V R_{in} : 2.0 kohm Filtering: 0.25 ms As output: Total output current from 24 V DC is limited to 200 mA Can be set as pulse train input and output
3 relay outputs (XRO1, XRO2, XRO3)	250 V AC/30 V DC, 2 A
Safe torque off (XSTO)	For the drive to start, both connections must be closed
Drive-to-drive link (XD2D)	Physical layer: EIA-485
Built-in Modbus	EIA-485
Assistant control panel/PC tool connection	Connector: RJ-45

02

XPOW		External power input	
1	+24VI		
2	GND		24 V DC, 2 A

XAI		Reference voltage and analog inputs	
1	+VREF		10 V DC, R_L 1 to 10 kohm
2	-VREF		-10 V DC, R_L 1 to 10 kohm
3	AGND		Ground
4	AI1+		Speed reference
5	AI1-		0(2) to 10 V, R_{in} > 200 kohm
6	AI2+		By default not in use.
7	AI2-		0(4) to 20 mA, R_{in} > 100 ohm
J1	J1		AI1 current/voltage selection jumper
J2	J2		AI2 current/voltage selection jumper

XAO		Analog outputs	
1	AO1		Motor speed rpm 0 to 20 mA, R_L < 500 ohm
2	AGND		
3	AO2		Motor current 0 to 20 mA, R_L < 500 ohm
4	AGND		

XD2D		Drive-to-drive link	
1	B		
2	A		Drive-to-drive link or built-in Modbus
3	BGND		
J3	J3		Drive-to-drive link termination switch

XRO1, XRO2, XRO3		Relay outputs	
11	NC		Ready
12	COM		250 V AC/30 V DC
13	NO		2 A
21	NC		Running
22	COM		250 V AC/30 V DC
23	NO		2 A
31	NC		Faulted (-1)
32	COM		250 V AC/30 V DC
33	NO		2 A

XD24		Digital interlock	
1	DIIL		Digital interlock
2	+24VD		+24 V DC 200 mA
3	DICOM		Digital input ground
4	+24VD		+24 V DC 200 mA
5	DIOGND		Digital input/output ground
J6	J6		Ground selection switch

XDIO		Digital input/outputs	
1	DIO1		Output: Ready
2	DIO2		Output: Running

XDI		Digital inputs	
1	DI1		Stop (0)/Start (1)
2	DI2		Forward (0)/Reverse (1)
3	DI3		Reset
4	DI4		Acceleration and deceleration select
5	DI5		Constant speed 1 (1=On)
6	DI6		Not in use by default

XSTO		Safe torque off	
1	OUT1		
2	SGND		Safe torque off. Both circuits must be closed for the drive to start.
3	IN1		
4	IN2		

X12		Safety functions module connection	
X13		Control panel connection	
X205		Memory unit connection	

Control panel options

- 01 Bluetooth assistant control panel, ACS-AP-W
- 02 Industrial assistant control panel without Bluetooth, ACS-AP-I
- 03 Control panel mounting platform DPMP-01
- 04 Control panel mounting platform DPMP-02

Standard Bluetooth assistant control panel, ACS-AP-W and Industrial assistant control panel, ACS-AP-I

Assistant control panel with clear multilingual graphical display can be used for parameter setting and back-up, drive monitoring and operation, fault tracing and as a USB link for a PC tool. There are two different assistant control panels – with (ACS-AP-W) or without (ACS-AP-I) Bluetooth. The panels can be mounted either on the drive or on the door of the enclosure and they are compatible with any ABB all-compatible drive.

Control panel helps you to set up the essential settings quickly and get the drive into action. Also diagnostics is easy due to event history, clear text messages and real-time stamps.

The Bluetooth connection enables the use of mobile apps like Drivetune. This app is available

for free on the Google Play and the Apple App store. Drivetune features include: commissioning, troubleshooting, monitoring and controlling the drive remotely. Drivetune also has full parameter access and backup and restore functionality.

Control panel mounting platform, DPMP-01, is for flush mountings and has IP54/UL Type 12 protection class (IP20, when control panel is not mounted). Supports daisy chaining of the control panel link.

Control panel mounting platform, DPMP-02, is for surface mounting and has IP65 / UL Type 12 protection class (IP20, when control panel not mounted).

Control panel mounting platform, DPMP-04, is a lockable door mounting platform for drive control panels in outdoor installations or harsh environments.



Control panel options

Bluetooth Assistant control panel ACS-AP-W is included as standard in the delivery. ACS-AP-W (+J400) can be replaced by +J options below.

Option code	Ordering code for loose item	Description	Type
+0J400	—	No control panel	—
—	3AXD50000025965	Bluetooth Assistant control panel. Included as standard.	ACS-AP-W
+J425	3AUA0000088311	Industrial assistant control panel without Bluetooth connection	ACS-AP-I
+J410	3AUA0000108878	Control panel mounting platform, flush mounted, IP54 / UL Type 12 (does not include control panel)	DPMP-01
+J413	3AXD50000009374	Control panel mounting platform, surface mounted, IP65 / UL Type 12 (does not include control panel)	DPMP-02
—	3AXD50000217717	Control panel mounting platform for outdoor and harsh environments, IP66, UV resistance, IK07 impact protection rating (does not include control panel)	DPMP-04

ABB Ability™ smartphone apps

Better connectivity and user experience with Drivetune

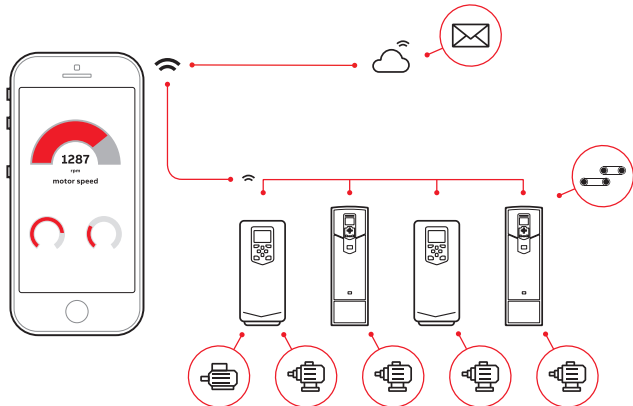

Easy and fast access to product information and support



Start-up, commission and tune your drive and application



Instantly access drive status and configuration with a simplified user guidance



Optimize performance via drive troubleshooting features



Create and share backups and support packages

Services and support on the go with Drivebase

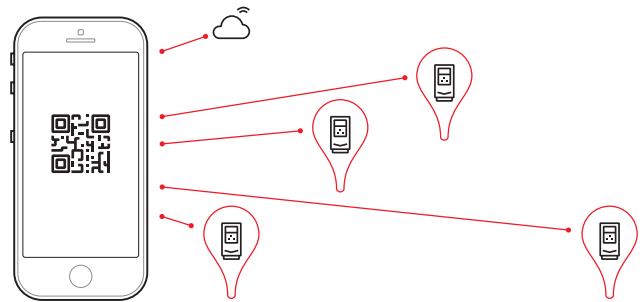

Search for support documents and contacts



Access your product and service information in the cloud from anywhere



View your drives installed base and plan service activities



Use dynamic QR code to troubleshoot your drive



Report service events

Access information anywhere

Download the apps using the QR codes below or directly from the app stores



Drivetune for commissioning and managing drives



Drivebase for ensured reliability and reduced downtime on production sites

Connectivity to automation systems

—
01
ACS880 is
compatible with
many communication
protocols
—
02
Input/output
extension modules

Communication protocol adapters

ACS880 industrial drives are compatible with a wide range of communication protocols. The drive comes with a Modbus RTU fieldbus interface as standard.

The ACS880 supports two different communication connections simultaneously and offers the possibility for redundant communication. PROFIsafe (functional safety over PROFINET) is also supported.

Communication protocol adapters

Option code	Ordering code for loose item	Communication protocol	Adapter
+K451	68469341	DeviceNet™	FDNA-01
+K454	68469325	PROFIBUS DP, DPV0/DPV1	FPBA-01
+K457	68469376	CANopen®	FCAN-01
+K458	3AUA0000031336	Modbus RTU	FSCA-01
+K462	3AUA0000094512	ControlNet	FCNA-01
+K469	3AUA0000072069	EtherCAT®	FECA-01
+K470	3AXD5000019239	POWERLINK	FEPL-02
+K491	3AXD50000049964	Modbus/TCP	FMBT-21
+K492	3AXD50000192779	PROFINET IO	FPNO-21
+K490	3AXD50000192786	EtherNet/IP	FEIP-21
+Q986	3AXD50000112821	PROFIsafe safety functions module	FSPS-21

¹⁾ For the PROFIsafe to work the PROFINET adapter module (FPNO-21) and the safety functions module FSO-12 (+Q973) or FSO-21 (+Q972) are required.



01



02

Input/output extension modules

Standard input and output can be extended by using optional analog and digital input/output extension modules. The modules are easily installed in the extension slots located on the drive.

If there are not enough I/O extension slots in the drive, the FEA-03 module can increase the number of slots. The FEA-03 has two option slots for digital I/O extensions and speed feedback interface modules. The connection to the control unit is via an optical fiber link, and the adapter can be mounted on a DIN rail (35 × 7.5 mm).

Analog and digital input/output extension modules

Option code	Ordering code for loose item	Description	I/O module
+L501	68805368	4×DI/O, 2×RO	FIO-01
+L500	68805384	3×AI (mA/V), 1×AO (mA), 2×DI/O	FIO-11
+L515	3AUA0000108669	2×F-type option extension slots	FEA-03
+L525	3AUA0000141436	2×AI (mA/V), 2×AO (mA)	FAIO-01
+L526	3AUA0000141438	3×DI (up to 250 V DC or 230 V AC), 2×RO	FDIO-01

Feedback interface and DDCS communication options

—
03
FEN-01 TTL encoder interface module
—
04
FDCO-01 DDCS communication module

Speed feedback interfaces for precise process control

ACS880 drives can be connected to various feedback devices, such as HTL pulse encoders, TTL pulse encoders, absolute encoders and resolvers. The optional feedback module is installed in the option slot on the drive. It is possible to use two feedback modules at the same time, either of the same type or different types *).

*) Excluding FSE-31.



—
03

Feedback interface modules

Option code	Ordering code for loose item	Description	Feedback module
+L517	68805422	2 inputs (TTL pulse encoder), 1 output	FEN-01
+L518	68805830	2 inputs (SinCos absolute, TTL pulse encoder), 1 output	FEN-11
+L516	68805848	2 inputs (Resolver, TTL pulse encoder), 1 output	FEN-21
+L502	68978955	1 input (HTL pulse encoder), 1 output	FEN-31
+L521	3AXD50000023272	Pulse encoder interface for functional safety (for more details see section "Safety options")	FSE-31

DDCS communication option modules

The FDCO-0X optical DDCS communication options are add-on modules on the ACS880 industrial drives control unit. The modules include connectors for two fiber optic DDCS channels. The FDCO-0X modules make it possible to perform master-follower and AC800 M communication. Alternative way for drive to drive communication is to use the standard RS485 connection.



—
04

Optical communication modules

Option code	Ordering code for loose item	Description	Module
+L503	3AUA0000107392	Optical DDCS (10 Mbd/10 Mbd)	FDCO-01
+L508	3AUA0000107393	Optical DDCS (5 Mbd/10 Mbd)	FDCO-02

K

Remote monitoring options

- 01 Remote monitoring tool NETA-21
- 02 RMDE reliability monitoring device

Remote monitoring access worldwide

The NETA-21 remote monitoring tool gives easy access to the drive via the Internet or a local Ethernet network. NETA-21 comes with a built-in web server. Compatible with standard web browsers, it ensures easy access to a web-based user interface. Through the web interface, the user can configure drive parameters, and monitor drive log data, load levels, runtime, energy consumption, I/O data, and the bearing temperatures of the motor connected to the drive. One NETA-21 supports up to 10 ABB single drives.



01

Remote monitoring option

Ordering code	Description	Type
3AUA0000094517	2 x panel bus interface max. 10 drives 2 x Ethernet interface SD memory card USB port for WLAN/3G	NETA-21



02

RMDE reliability monitoring device

The RMDE reliability monitoring device collects drive performance and event data so that it can be stored remotely and utilized for service, maintenance and troubleshooting. RMDE consists of the NETA-21 remote monitoring tool, a modem, and environmental sensors that enable collection of measured ambient temperature and humidity values. The device comes in a compact IP54 enclosure, making it suitable even for harsh environments.

RMDE reliability monitoring device

Ordering code	Description	Type
RMDE-01-1-1 Configurable product	RMDE reliability monitoring device	RMDE-01

PC tool options

—
03
Drive Composer pro
PC tool

—
04
Drive Application
Builder

PC tools

The **Drive Composer pro** PC tool offers fast and harmonized setup, commissioning and monitoring for ABB's all-compatible drives. The free version of the tool, **Drive Composer Entry**, provides startup and maintenance capabilities, and includes support for adaptive programming. It also gathers all drive information, such as parameter loggers, faults, backups and event lists, into a support diagnostics file.

Drive Composer pro provides additional features, such as

- graphical reference and control chain diagrams
- possibility to connect to several drives simultaneously over Ethernet or panel bus
- graphical interface for configuring functional safety features.

Drive Application Builder is a common tool for several ABB automation products, such as drives, PLCs, HMIs and robots.

For customized solutions, drive application programming based on IEC61131 standard is available for full PLC programmability with the **Drive Application Builder** tool.



—
03

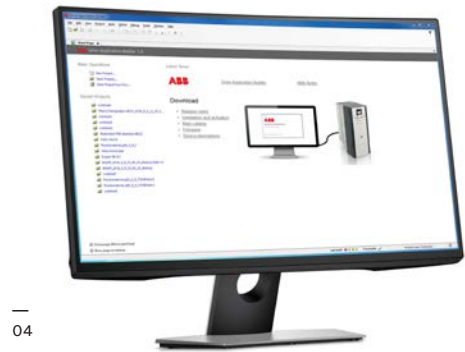

—
04

PC tools

Ordering code	Description	PC tool
3AUA0000108087	PC tool for setup, commissioning and monitoring of drives	Drive Composer pro
3AXD50000342389	Standard version of the Drive Application Builder for IEC 61131-3 programming, DABS-STANDARD	licenses for Drive Application Builder ¹⁾
3AXD50000342402	Premium version of the Drive Application Builder for IEC 61131-3 programming, DABP-PREMIUM	
3AXD50000343027	Software development productivity add-ons for Drive Application Builder, version control and static analysis extensions for improve software engineering productivity, single workstation, DABX-PRODUCTIVITY-ADD-ONS	
1SAS010000R0102	Automation Builder 2.x Standard (2). Integrated engineering for PLC, drives, motion, SCADA and panels.	Automation Builder
1SAS010002R0102	Automation Builder 2.x Premium (5). Integrated Engineering and features for engineering productivity and collaboration.	Automation Builder
+N8010	License key for drive application programming based on IEC 61131-3 using Drive Application Builder	IEC programming

¹⁾ For IEC programming license key is needed for the ACS880 drive (+N8010)

Safety options

—
01
ACS880 drive with
FSO-21, FSE-31
and FENA-21

Integrated safety

Integrated safety reduces the need for external safety components, simplifying configuration and reducing installation space. The safety functionality is a built-in feature of the ACS880, with safe torque off (STO) as standard. The STO function corresponds to an uncontrolled stop in accordance with stop category 0 of EN 60204-1. Additional safety functions can be commissioned with the optional and compact safety functions module. ACS880 drives offer functional safety with or without encoder. The drive's functional safety is designed in accordance with EN/IEC 61800-5-2 and complies with the requirements of the European Union Machinery Directive (2006/42/EC).

The safety functions are certified by TÜV Nord and comply with the highest performance requirements (SIL 3/PL e) in machinery safety.¹⁾

The safety functions module can also be ordered separately and installed afterwards to the drive.

PROFIsafe safety functions module, FSPS-21, with integrated PROFIsafe, and PROFINET IO connection supports STO and SS1-t safety functions. Since the functions are automatically configured, no additional safety settings are required in the drive.

Safety functions modules, FSO-12 and FSO-21, support a wide range of safety functions. Configuration of the functions is done with the Drive Composer pro PC tool, which provides an easy-to-use graphical user interface. Larger safety systems can be built using PROFIsafe over PROFINET connection between a safety PLC (such as AC500-S) and the ACS880 drive.



—
01

The connection is achieved by adding a PROFINET adapter, FPNO-21/FENA-21, to the drive.

Supported safety functions:

- Encoderless: SS1-t, SS1-r, SLS, SBC, SMS, SSE, POUS, STO
- With encoder (requires FSO-21 + FSE-31): SDI, SSM, SS1-t, SS1-r, SLS, SBC, SMS, SSE, POUS, STO

Pulse encoder interface module, FSE-31, provides safe encoder data to the safety functions module, and can simultaneously be used as a feedback device for the drive. FSE-31 requires an FSO-21 safety functions module and supports HTL encoders.

Thermistor protection modules, FPTC-01 and FPTC-02



Safe temperature monitoring (STM) can be achieved by using FPTC thermistor protection modules.¹⁾

Safety function modules

Option code	Ordering code for loose item	Description	Safety module
+Q973	3AXD50000016771	Safety functions module FSO-12	FSO-12
+Q972+L521	3AXD50000023987 + 3AXD50000023272	Safety functions module FSO-21 and encoder FSE-31	FSO-21+FSE-31
+Q971	—	ATEX-certified safe disconnection function, EX II (2) GD	
+Q982	—	PROFIsafe safety communication to be used together with FSO-12 or FSO-21: forces to select a functional safety module and PROFINET adapter, FPNO-21	FSO-12 or FSO-21 +FPNO-21
+Q986 ²⁾	3AXD50000112821	PROFIsafe safety functions module FSPS-21	FSPS-21
+L536	3AXD50000024934	Thermistor protection module FPTC-01	FPTC-01
+L537+Q971	3AXD50000024924	ATEX-certified thermistor protection module FPTC-02, Ex II (2) GD	FPTC-02

¹⁾ Thermistor modules comply with SIL 2 / PL c.

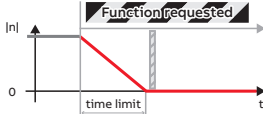
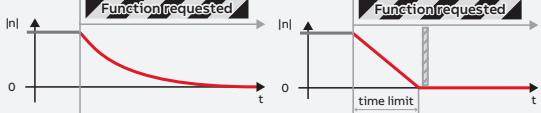
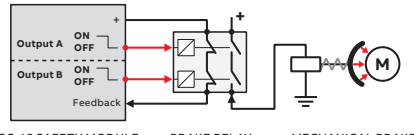
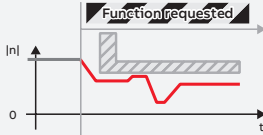
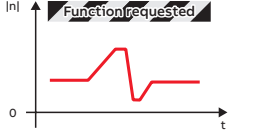
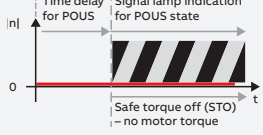
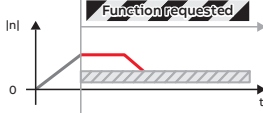
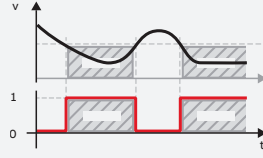
²⁾ Please contact your local ABB office to check availability.

Safety function	Description	Supported functions			
		FSPS-21 (SS1-t)	FSO-12 without encoder (SS1-t) (SS1-r)	FSO-21 + FSE-31 + HTL encoder (SS1-t) (SS1-r)	
Safe stop 1 SS1-t SS1-r	Brings the machine to a stop using a monitored deceleration ramp. It is typically used in applications where the machinery motion needs to be brought to a stop (stop category 1) in a controlled way before switching over to the no-torque (STO) state	x	x	x	
Safe stop emergency SSE	Can be configured to, upon request, either activate STO instantly (category 0 stop), or first initiate motor deceleration and then, once the motor has stopped, activate the STO (category 1 stop).		x	x	
Safe brake control SBC	Provides a safe output for controlling the motor's external (mechanical) brakes, together with STO.		x	x	 FSO-12 SAFETY MODULE BRAKE RELAY MECHANICAL BRAKE
Safely-limited speed SLS	Ensures that the specified speed limit of the motor is not exceeded. This allows machine interaction to be performed at slow speed without stopping the drive. The safety function module comes with four individual SLS settings for speed monitoring.		x	x	
Safe maximum speed SMS	Monitors that the speed of the motor does not exceed the configured maximum speed limit.		x	x	
Prevention of unexpected start-up POUS	Ensures that the machine remains stopped when people are in the danger area.		x	x	
Safe direction SDI	Ensures that rotation is allowed only in the selected direction (available only with FSO-21 and FSE-31).			x	
Safe speed monitor SSM	Provides a safe output signal to indicate whether the motor speed is between user-defined limits (available only with FSO-21).			x	
Safe torque off STO	Brings the drive safely to a no-torque state, i.e. switches off the drive output to the motor, motor speed then coasts to a stop. ACS880 has safe torque off as standard.	x	x	x	

K

EMC – electromagnetic compatibility

—
01 Immunity and
emission compatibility

Each ACS880 model can be equipped with a built-in filter to reduce high-frequency emissions.

EMC standards

The EMC product standard (EN 61800-3) covers the specific EMC requirements for drives (tested with motor and motor cable) within the EU. EMC standards such as EN 55011 or EN 61000-6-3/4 are applicable to industrial and domestic equipment and systems, including the components inside the drive. Drive units compliant with EN 61800-3 are also compliant with comparable categories in EN 55011 and EN 61000-6-3/4, but not necessarily vice versa. EN 55011 and EN 61000-6-3/4 do not specify cable length or require a motor to be connected as a load. The emission limits are comparable to EMC standards according to the table on the next page.

Domestic environments versus public low voltage networks

The first environment includes domestic premises. It also includes establishments directly connected without an intermediate transformer to a low voltage power supply network that supplies buildings used for domestic purposes.

The second environment includes all establishments other than those directly connected to a low voltage power supply network that supplies buildings used for domestic purposes.

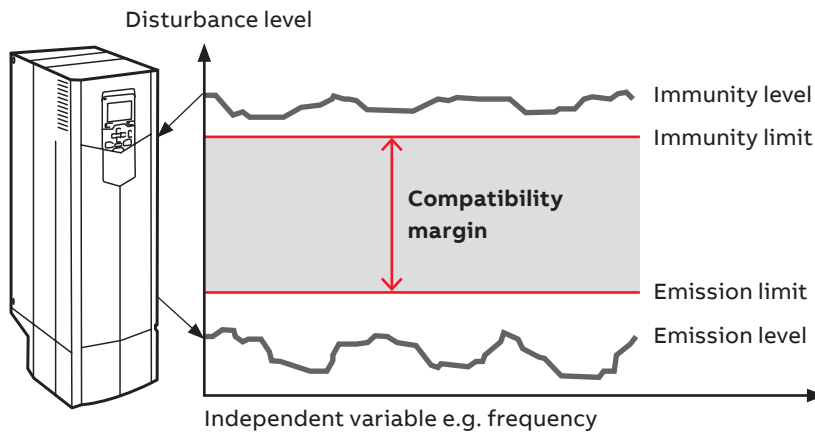

—
01

K

EMC standards				
EMC according to EN 61800-3:2004 + A1:2012 product standard	EN 61800-3 product standard	EN 55011, product family standard for industrial, scientific and medical (ISM) equipment	EN 61000-6-4, generic emission standard for industrial environments	EN 61000-6-3, generic emission standard for residential, commercial and light-industrial environment
1 st environment, unrestricted distribution	Category C1	Group 1. Class B	Not applicable	Applicable
1 st environment, restricted distribution	Category C2	Group 1. Class A	Applicable	Not applicable
2 nd environment, unrestricted distribution	Category C3	Group 2. Class A	Not applicable	Not applicable
2 nd environment, restricted distribution	Category C4	Not applicable	Not applicable	Not applicable

Selecting an EMC filter

Drive type	Voltage (V)	Frame sizes	1st environment, restricted distribution, C2, grounded network (TN) Option code	2nd environment, C3, grounded network (TN) Option code	2nd environment, C3, ungrounded network (IT) Option code	2nd environment, C4, grounded network (TN)²⁾
ACS880-01	380 to 500	R1 to R9	+E202	+E200	+E201 ¹⁾	As standard
ACS880-01	525 to 690	R3 to R9	–	+E200	+E201 ¹⁾	As standard
ACS880-11	380 to 500	R3 to R8	+E202 ⁵⁾	+E200	+E201	As standard
ACS880-31	380 to 500	R3 to R8	+E202 ⁵⁾	+E200	+E201	As standard
ACS880-07	380 to 500	R6 to R9	+E202	+E200	+E201	As standard
ACS880-07	525 to 690	R6 to R9	–	+E200	+E201 ¹⁾	As standard
ACS880-07	380 to 500	R10 to R11	+E202	+E200	+E201	As standard
ACS880-07	525 to 690	R10 to R11	–	+E200	+E201	As standard
ACS880-07	380 to 690	n×R8i	+E202 (only for 1140A-3 and 1070A-5)	As standard	As standard	–
ACS880-17	380 to 500	R8	+E202	+E200	+E201	As standard
ACS880-17	380 to 690	R11	+E202 (not for 690 V)	As standard	As standard ³⁾	–
ACS880-17	380 to 690	n×R8i	+E202 (not for 690 V, only for 1xR8i)	As standard	As standard	–
ACS880-37	380 to 500	R8	+E202	+E200	+E201	As standard
ACS880-37	380 to 690	R11	+E202 (not for 690 V)	As standard	As standard ³⁾	–
ACS880-37	380 to 690	n×R8i	+E202 (not for 690 V, only for 1xR8i)	As standard	As standard	–
ACS880-07CLC	525 to 690	n×R8i	–	As standard ⁴⁾	As standard ⁴⁾	As standard
ACS880-17LC	525 to 690	n×R8i	–	As standard ⁴⁾	As standard ⁴⁾	As standard
ACS880-37LC	525 to 690	n×R8i	–	As standard ⁴⁾	As standard ⁴⁾	As standard

¹⁾ 2nd environment, C4: ACS880-01, 380 to 500 V, frame sizes R1 to R5. ACS880-01, 690 V, frame sizes R3 to R6. ACS880-07, 690 V, frame size R6.

²⁾ EMC plan required.

³⁾ Please contact your local ABB.

⁴⁾ Radiated emission and immunity (cabinet construction).

⁵⁾ Not available for R6.

Sine filters

Together with a sine filter, ACS880 drives offer smooth motor operation in both DTC and scalar modes. The sine filter suppresses the high-frequency components of the motors output voltage, creating almost a sinusoidal voltage wave form for the motor. The filter offers an optimized LC design that takes into account the switching frequency, voltage drop and filtering characteristics.

The ACS880 inverter and sine filter solution can be used together with a variety of requirements for products and components:

- For motors without adequate insulation for the role
- Where the total motor cable length is long as a result of a number of parallel motors
- For step-up applications, e.g. where a medium voltage motor needs to be driven
- For submersible pumps with long motor cables, e.g. in the oil industry
- When the motor noise needs to be reduced
- When there are industry-specific requirements for peak voltage level and voltage rise time

Sine filter for wall-mounted single drives, ACS880-01

$U_N = 400\text{ V}$ (range 380 to 415 V). The power ratings are valid at nominal voltage 400 V.

I_N (A)	P_N ¹⁾ (kW)	Noise level ²⁾ (dB)	Heat dissipation ²⁾ (W)	Drive type	Filter type	Degree of protection	Filter width		Filter depth		Filter height		Filter weight		Frame size
							IP00 (mm)	IP21 (mm)	IP00 (mm)	IP21 (mm)	IP00 (mm)	IP21 (mm)	IP00 (kg)	IP21 (kg)	
2.3	0.75	72	60	ACS880-01-02A4-3	B84143V0004R229	IP00/IP21	235	384	95	152	200	246	5	14.4	R1
3.1	1.1	72	60	ACS880-01-03A3-3	B84143V0004R229	IP00/IP21	235	384	95	152	200	246	5	14.4	R1
3.8	1.5	72	60	ACS880-01-04A0-3	B84143V0004R229	IP00/IP21	235	384	95	152	200	246	5	14.4	R1
5.3	2.2	72	100	ACS880-01-05A6-3	B84143V0006R229	IP00/IP21	235	384	95	152	200	246	5	14.4	R1
7.2	3	72	90	ACS880-01-07A2-3	B84143V0011R229	IP00/IP21	235	384	110	152	200	246	7	14.4	R1
9.2	4	72	90	ACS880-01-09A4-3	B84143V0011R229	IP00/IP21	235	384	110	152	200	246	7	14.4	R1
12.1	5.5	72	80	ACS880-01-12A6-3	B84143V0016R229	IP00/IP21	275	420	122	200	235	290	12	24.4	R1
16	7.5	75	140	ACS880-01-017A-3	B84143V0025R229	IP00/IP21	355	500	120	200	285	360	20	36	R2
24	11	75	140	ACS880-01-025A-3	B84143V0025R229	IP00/IP21	355	500	120	200	285	360	20	36	R2
31	15	75	160	ACS880-01-032A-3	B84143V0033R229	IP00/IP21	355	500	120	200	285	360	24	36	R3
37	18.5	78	220	ACS880-01-038A-3	B84143V0050R229	IP00/IP21	400	650	140	350	360	460	41	90.3	R3
43	22	78	220	ACS880-01-045A-3	B84143V0050R229	IP00/IP21	400	650	140	350	360	460	41	90.3	R4
58	30	78	250	ACS880-01-061A-3	B84143V0066R229	IP00/IP21	400	650	147	350	360	460	43	90.3	R4
64	30	79	310	ACS880-01-072A-3	B84143V0075R229	IP00/IP21	400	650	173	350	360	460	62	90.3	R5
77	37	79	400	ACS880-01-087A-3	B84143V0095R229	IP00/IP21	440	700	164	350	500	580	70	132	R5
91	45	80	600	ACS880-01-105A-3	B84143V0130S230	IP00/IP21	560	850	300	480	420	500	110	192	R6
126	55	80	550	ACS880-01-145A-3	B84143V0162S229	IP00/IP21	500	730	300	400	380	430	112	129.9	R6
153	75	80	550	ACS880-01-169A-3	B84143V0162S229	IP00/IP21	500	730	300	400	380	430	112	129.9	R7
187	90	80	900	ACS880-01-206A-3	B84143V0230S229	IP00/IP21	570	850	285	480	430	500	120	192	R7
209	110	80	900	ACS880-01-246A-3	B84143V0230S229	IP00/IP21	570	850	285	480	430	500	120	192	R8
249	132	80	1570	ACS880-01-293A-3	B84143V0390S229	IP00/IP21	555	850	328	550	580	610	212	268.4	R8
297	160	80	1570	ACS880-01-363A-3	B84143V0390S229	IP00/IP21	555	850	328	550	580	610	212	268.4	R9
352	160	80	1570	ACS880-01-430A-3	B84143V0390S229	IP00/IP21	555	850	328	550	580	610	212	268.4	R9

Nominal ratings

I_N	Rated current of the drive-filter combination available continuously without overload at 40 °C.
P_N	Typical motor power

¹⁾ Please note that sine filters cause a voltage drop, reducing the available shaft power from the motor.

²⁾ Noise level is a combined value for the drive and the filter. Heat dissipation is a value for the filter.

For further information, please contact your local ABB office.

$U_N = 500$ V (range 380 to 500 V). The power ratings are valid at nominal voltage 500 V.

I_N (A)	$P_N^{1)}$ (kW)	Noise level ²⁾ (dB)	Heat dissi- pation ²⁾ (W)	Drive type	Filter type	Degree of protection	Filter width		Filter depth		Filter height		Filter weight		Frame size
							IP00 (mm)	IP21 (mm)	IP00 (mm)	IP21 (mm)	IP00 (mm)	IP21 (mm)	IP00 (kg)	IP21 (kg)	
1.9	0.8	72	60	ACS880-01-02A1-5	B84143V0004R229	IP00/IP21	235	384	95	152	200	246	5	14.4	R1
2.8	1.1	72	60	ACS880-01-03A0-5	B84143V0004R229	IP00/IP21	235	384	95	152	200	246	5	14.4	R1
3.1	1.5	72	60	ACS880-01-03A4-5	B84143V0004R229	IP00/IP21	235	384	95	152	200	246	5	14.4	R1
4.4	2.2	72	100	ACS880-01-04A8-5	B84143V0006R229	IP00/IP21	235	384	95	152	200	246	5	14.4	R1
4.8	3	72	100	ACS880-01-05A2-5	B84143V0006R229	IP00/IP21	235	384	95	152	200	246	5	14.4	R1
7	4	72	90	ACS880-01-07A6-5	B84143V0011R229	IP00/IP21	235	384	110	152	200	246	7	14.4	R1
10.2	5.5	72	90	ACS880-01-11A0-5	B84143V0011R229	IP00/IP21	235	384	110	152	200	246	7	14.4	R1
13	7.5	70	80	ACS880-01-014A-5	B84143V0016R229	IP00/IP21	275	420	122	200	235	290	12	24.4	R2
20	11	75	140	ACS880-01-021A-5	B84143V0025R229	IP00/IP21	355	500	120	200	285	360	20	36	R2
25	15	75	160	ACS880-01-027A-5	B84143V0033R229	IP00/IP21	355	500	120	200	285	360	24	36	R3
32	18.5	78	220	ACS880-01-034A-5	B84143V0050R229	IP00/IP21	400	650	140	350	360	460	41	90.3	R3
35	22	78	220	ACS880-01-040A-5	B84143V0050R229	IP00/IP21	400	650	140	350	360	460	41	90.3	R4
44	30	78	250	ACS880-01-052A-5	B84143V0066R229	IP00/IP21	400	650	147	350	360	460	43	90.3	R4
52	37	78	250	ACS880-01-065A-5	B84143V0066R229	IP00/IP21	400	650	147	350	360	460	43	90.3	R5
61	37	78	310	ACS880-01-077A-5	B84143V0075R229	IP00/IP21	400	650	173	350	360	460	62	132	R5
80	55	80	630	ACS880-01-096A-5	B84143V0130S230	IP00/IP21	565	850	300	480	420	500	110	192	R6
104	55	80	630	ACS880-01-124A-5	B84143V0130S230	IP00/IP21	565	850	300	480	420	500	110	192	R6
140	90	80	550	ACS880-01-156A-5	B84143V0162S229	IP00/IP21	500	730	300	400	380	430	112	129.9	R7
161	110	80	550	ACS880-01-180A-5	B84143V0162S229	IP00/IP21	500	730	300	400	380	430	112	129.9	R7
205	132	80	900	ACS880-01-240A-5	B84143V0230S229	IP00/IP21	570	850	285	480	430	500	120	192	R8
221	132	80	900	ACS880-01-260A-5	B84143V0230S229	IP00/IP21	570	850	285	480	430	500	120	192	R8
289	200	80	1570	ACS880-01-361A-5	B84143V0390S229	IP00/IP21	555	850	328	550	580	610	212	268.4	R9
332	200	80	1570	ACS880-01-414A-5	B84143V0390S229	IP00/IP21	555	850	328	550	580	610	212	268.4	R9

$U_N = 690$ V (range 525 to 690 V). The power ratings are valid at nominal voltage 690 V.

I_N (A)	$P_N^{1)}$ (kW)	Noise level ²⁾ (dB)	Heat dissi- pation ²⁾ (W)	Drive type	Filter type	Degree of protection	Filter width		Filter depth		Filter height		Filter weight		Frame size
							IP00 (mm)	IP21 (mm)	IP00 (mm)	IP21 (mm)	IP00 (mm)	IP21 (mm)	IP00 (kg)	IP21 (kg)	
7.3	5.5	72	90	ACS880-01-07A4-7	B84143V0010R230	IP00/IP21	380	500	110	200	290	360	15	36	R3
9.3	7.5	72	90	ACS880-01-09A9-7	B84143V0010R230	IP00/IP21	380	500	110	200	290	360	15	36	R3
13.5	11	72	130	ACS880-01-14A3-7	B84143V0018R230	IP00/IP21	380	500	121	200	290	360	19	36	R3
17.1	15	72	130	ACS880-01-019A-7	B84143V0018R230	IP00/IP21	380	500	121	200	290	360	19	36	R3
21	18.5	72	160	ACS880-01-023A-7	B84143V0026R230	IP00/IP21	380	500	141	200	290	360	30	68	R3
25	22	72	160	ACS880-01-027A-7	B84143V0026R230	IP00/IP21	380	500	141	200	290	360	30	68	R3
33	30	75	250	ACS880-01-035A-7	B84143V0040R230	IP00/IP21	440	650	147	350	355	430	49	90.3	R5
40	37	75	250	ACS880-01-042A-7	B84143V0040R230	IP00/IP21	440	650	147	350	355	430	49	90.3	R5
48	45	78	290	ACS880-01-049A-7	B84143V0056R230	IP00/IP21	440	650	162	350	355	430	52	90.3	R5
56	55	78	290	ACS880-01-061A-7	B84143V0056R230	IP00/IP21	440	600	162	350	355	430	52	90.3	R6
78	75	79	610	ACS880-01-084A-7	B84143V0092R230	IP00/IP21	500	700	193	350	490	580	85	132	R6
92	90	79	610	ACS880-01-098A-7	B84143V0092R230	IP00/IP21	500	700	193	350	490	580	85	132	R7
112	110	80	630	ACS880-01-119A-7	B84143V0130S230	IP00/IP21	565	850	300	480	420	500	110	192	R7
112	110	80	630	ACS880-01-142A-7	B84143V0130S230	IP00/IP21	560	850	230	480	569	500	110	192	R8
138	132	80	930	ACS880-01-174A-7	B84143V0207S230	IP00/IP21	560	850	279	550	570	610	185	268.4	R8
161	132	80	930	ACS880-01-210A-7	B84143V0207S230	IP00/IP21	560	850	279	550	570	610	185	268.4	R9
208	200	80	930	ACS880-01-271A-7	B84143V0207S230	IP00/IP21	560	850	279	550	570	610	185	268.4	R9

Sine filters for wall-mounted regenerative and ultra-low harmonic drives, ACS880-11 and ACS880-31

$U_N = 400\text{ V}$ (range 380 to 415 V). The power ratings are valid at nominal voltage 400 V.

I_N (A)	$P_N^{1)}$ (kW)	Noise level ²⁾ (dB)	Heat dissipation ²⁾ (W)	Drive type	Filter type	Degree of protection	Filter width		Filter depth		Filter height		Filter weight		Frame size
							IP00 (mm)	IP21 (mm)	IP00 (mm)	IP21 (mm)	IP00 (mm)	IP21 (mm)	IP00 (kg)	IP21 (kg)	
9.2	4	72	90	ACS880-11/31-09A4-3	B84143V0011R229	IP00/IP21	235	384	110	152	200	246	5.2	14.4	R3
12.1	5.5	72	80	ACS880-11/31-12A6-3	B84143V0016R229	IP00/IP21	275	420	122	200	235	290	7.9	24.4	R3
16	7.5	75	140	ACS880-11/31-017A-3	B84143V0025R229	IP00/IP21	355	500	120	200	285	360	12.1	36	R3
24	11	75	140	ACS880-11/31-025A-3	B84143V0025R229	IP00/IP21	355	500	120	200	285	360	12.1	36	R3
31	15	75	160	ACS880-11/31-032A-3	B84143V0033R229	IP00/IP21	355	500	120	200	285	360	12.1	36	R6
37	18.5	78	220	ACS880-11/31-038A-3	B84143V0050R229	IP00/IP21	400	650	140	350	360	460	20.2	104.7	R6
43	22	78	220	ACS880-11/31-045A-3	B84143V0050R229	IP00/IP21	400	650	140	350	360	460	20.2	104.7	R6
58	30	78	250	ACS880-11/31-061A-3	B84143V0066R229	IP00/IP21	400	650	147	350	360	460	21.2	104.7	R6
64	37	79	310	ACS880-11/31-072A-3	B84143V0075R229	IP00/IP21	400	650	173	350	360	460	24.9	104.7	R6
77	45	79	400	ACS880-11/31-087A-3	B84143V0095R229	IP00/IP21	440	700	164	350	500	580	36.1	142.1	R6
91	55	80	600	ACS880-11/31-105A-3	B84143V0130S230	IP00/IP21	565	850	300	480	420	500	71.2	204	R8
126	75	80	550	ACS880-11/31-145A-3	B84143V0162S229	IP00/IP21	500	730	300	400	380	430	57	125.6	R8
153	90	80	550	ACS880-11/31-169A-3	B84143V0162S229	IP00/IP21	500	730	300	400	380	430	57	125.6	R8
187	110	80	900	ACS880-11/31-206A-3	B84143V0230S229	IP00/IP21	570	850	285	480	430	500	69.9	204	R8

$U_N = 500\text{ V}$ (range 380 to 500 V). The power ratings are valid at nominal voltage 500 V.

I_N (A)	$P_N^{1)}$ (kW)	Noise level ²⁾ (dB)	Heat dissipation ²⁾ (W)	Drive type	Filter type	Degree of protection	Filter width		Filter depth		Filter height		Filter weight		Frame size
							IP00 (mm)	IP21 (mm)	IP00 (mm)	IP21 (mm)	IP00 (mm)	IP21 (mm)	IP00 (kg)	IP21 (kg)	
7	4	72	90	ACS880-11/31-07A6-5	B84143V0011R229	IP00/IP21	235	384	110	152	200	246	5.2	14.4	R3
10.2	5.5	72	90	ACS880-11/31-11A0-5	B84143V0011R229	IP00/IP21	235	384	110	152	200	246	5.2	14.4	R3
13	7.5	70	80	ACS880-11/31-014A-5	B84143V0016R229	IP00/IP21	275	420	122	200	235	290	7.9	24.4	R3
20	11	75	140	ACS880-11/31-021A-5	B84143V0025R229	IP00/IP21	355	500	120	200	285	360	12.1	36	R3
25	15	75	160	ACS880-11/31-027A-5	B84143V0033R229	IP00/IP21	355	500	120	200	285	360	12.1	36	R6
32	18.5	78	220	ACS880-11/31-034A-5	B84143V0050R229	IP00/IP21	400	650	140	350	360	460	20.2	104.7	R6
35	22	78	220	ACS880-11/31-040A-5	B84143V0050R229	IP00/IP21	400	650	140	350	360	460	20.2	104.7	R6
44	30	78	250	ACS880-11/31-052A-5	B84143V0066R229	IP00/IP21	400	650	147	350	360	460	21.2	104.7	R6
52	37	78	250	ACS880-11/31-065A-5	B84143V0066R229	IP00/IP21	400	650	147	350	360	460	21.2	104.7	R6
61	37	78	310	ACS880-11/31-077A-5	B84143V0075R229	IP00/IP21	400	650	173	350	360	460	24.9	104.7	R6
80	55	80	630	ACS880-11/31-096A-5	B84143V0130S230	IP00/IP21	565	850	300	480	420	500	71.2	204	R8
104	55	80	630	ACS880-11/31-124A-5	B84143V0130S230	IP00/IP21	565	850	300	480	420	500	71.2	204	R8
140	90	80	550	ACS880-11/31-156A-5	B84143V0162S229	IP00/IP21	500	730	300	400	380	430	57	125.6	R8
161	110	80	550	ACS880-11/31-180A-5	B84143V0162S229	IP00/IP21	500	730	300	400	380	430	57	125.6	R8

Nominal ratings

I_N	Rated current of the drive-filter combination available continuously without overload at 40 °C.
P_N	Typical motor power

¹⁾ Please note that sine filters cause a voltage drop, reducing the available shaft power from the motor.

²⁾ Noise level is a combined value for the drive and the filter. Heat dissipation is a value for the filter.

For further information please contact your local ABB office.

Sine filters for cabinet-built single drives, ACS880-07

$U_N = 400\text{ V}$ (range 380 to 415 V). The power ratings are valid at nominal voltage 400 V. ³⁾

I_N	$P_N^{1)}$	Noise level ²⁾	Heat dissipation ²⁾	Air flow	Drive type	Filter type	Degree of protection	Filter height	Filter width	Filter depth	Filter weight	Frame size
(A)	(kW)	(dB)	(kW)	(m ³ /h)				mm	mm	mm	kg	
6-pulse diode												
91	45	80	2.4	1750	ACS880-07-0105A-3	B84143V0130S229	IP22	2145	600	646	330	R6
126	55	80	2.5	1750	ACS880-07-0145A-3	B84143V0162S229	IP22	2145	600	646	330	R6
153	75	80	3	1750	ACS880-07-0169A-3	B84143V0162S229	IP22	2145	600	646	330	R7
187	90	80	3.7	1750	ACS880-07-0206A-3	B84143V0230S229	IP22	2145	600	646	340	R7
209	110	80	4.7	1750	ACS880-07-0246A-3	B84143V0230S229	IP22	2145	600	646	340	R8
249	132	80	6	1750	ACS880-07-0293A-3	B84143V0390S229	IP22	2145	600	646	430	R8
297	160	80	6.9	1150	ACS880-07-0363A-3	B84143V0390S229	IP22	2145	600	646	430	R9
352	160	80	8.1	1150	ACS880-07-0430A-3	B84143V0390S229	IP22	2145	600	646	430	R9
470	250	80	11.1	4950	ACS880-07-0505A-3	NSIN0900-6	IP22	2145	1000	646	840	R10
540	250	80	11.9	4950	ACS880-07-0585A-3	NSIN0900-6	IP22	2145	1000	646	840	R10
600	315	80	13.6	4950	ACS880-07-0650A-3	NSIN0900-6	IP22	2145	1000	646	840	R10
647	355	80	14.3	4950	ACS880-07-0725A-3	NSIN0900-6	IP22	2145	1000	646	840	R11
731	400	80	15.4	4950	ACS880-07-0820A-3	NSIN0900-6	IP22	2145	1000	646	840	R11
785	450	80	16.1	5170	ACS880-07-0880A-3	NSIN0900-6	IP22	2145	1000	646	840	R11
1140	630	81	25	6290	ACS880-07-1140A-3	NSIN1380-6	IP22	2145	1000	646	960	D8T+2×R8i
12-pulse diode												
990	560	81	22	7720	ACS880-07-0990A-3+A004	NSIN1380-6	IP22	2145	1000	646	960	2×D7T+2×R8i
1140	630	81	26	7720	ACS880-07-1140A-3+A004	NSIN1380-6	IP22	2145	1000	646	960	2×D8T+2×R8i

$U_N = 500\text{ V}$ (range 380 to 500 V). The power ratings are valid at nominal voltage 500 V. ³⁾

I_N	$P_N^{1)}$	Noise level ²⁾	Heat dissipation ²⁾	Air flow	Drive type	Filter type	Degree of protection	Filter height	Filter width	Filter depth	Filter weight	Frame size
(A)	(kW)	(dB)	(kW)	(m ³ /h)				mm	mm	mm	kg	
6-pulse diode												
80	55	80	2.4	1750	ACS880-07-0096A-5	B84143V0130S229	IP22	2145	600	646	330	R6
104	55	80	2.6	1750	ACS880-07-0124A-5	B84143V0130S229	IP22	2145	600	646	330	R6
140	90	80	3	1750	ACS880-07-0156A-5	B84143V0162S229	IP22	2145	600	646	330	R7
162	110	80	3.4	1750	ACS880-07-0180A-5	B84143V0162S229	IP22	2145	600	646	330	R7
205	132	80	4.7	1750	ACS880-07-0240A-5	B84143V0230S229	IP22	2145	600	646	340	R8
221	132	80	5.3	1750	ACS880-07-0260A-5	B84143V0230S229	IP22	2145	600	646	340	R8
289	200	80	6.9	1150	ACS880-07-0361A-5	B84143V0390S229	IP22	2145	600	646	430	R9
332	200	80	8.1	1150	ACS880-07-0414A-5	B84143V0390S229	IP22	2145	600	646	430	R9
430	250	80	7.4	3650	ACS880-07-0460A-5	NSIN0485-6	IP22	2145	400	646	340	R10
470	315	80	12.1	4950	ACS880-07-0503A-5	NSIN0900-6	IP22	2145	1000	646	840	R10
514	355	80	12.9	4950	ACS880-07-0583A-5	NSIN0900-6	IP22	2145	1000	646	840	R10
560	400	80	14.6	4950	ACS880-07-0635A-5	NSIN0900-6	IP22	2145	1000	646	840	R10
637	450	80	15.3	4950	ACS880-07-0715A-5	NSIN0900-6	IP22	2145	1000	646	840	R11
730	500	80	16.4	4950	ACS880-07-0820A-5	NSIN0900-6	IP22	2145	1000	646	840	R11
730	500	80	17.1	4950	ACS880-07-0880A-5	NSIN0900-6	IP22	2145	1000	646	840	R11
1170	710	81	26	6290	ACS880-07-1070A-5	NSIN1380-6	IP22	2145	1000	646	960	D8T+2×R8i
12-pulse diode												
990	710	81	24	7720	ACS880-07-0990A-5+A004	NSIN1380-6	IP22	2145	1000	646	960	2×D7T+2×R8i

$U_N = 690 \text{ V}$ (range 525 to 690 V). The power ratings are valid at nominal voltage 690 V.³⁾

I_N	P_N ¹⁾	Noise level ²⁾	Heat dissipation ²⁾	Air flow	Drive type	Filter type	Degree of protection	Filter height	Filter width	Filter depth	Filter weight	Frame size
(A)	(kW)	(dB)	(kW)	(m ³ /h)				(mm)	(mm)	(mm)	(kg)	
6-pulse diode												
56	55	78	2.1	1750	ACS880-07-0061A-7	B84143V0056R230	IP22	2145	600	646	280	R6
78	75	79	2.6	1750	ACS880-07-0084A-7	B84143V0092R230	IP22	2145	600	646	310	R6
92	90	79	3.1	1750	ACS880-07-0098A-7	B84143V0092R230	IP22	2145	600	646	310	R7
112	110	80	3.4	1750	ACS880-07-0119A-7	B84143V0130S230	IP22	2145	600	646	330	R7
112	110	80	4.4	1750	ACS880-07-0142A-7	B84143V0130S230	IP22	2145	600	646	330	R8
138	132	80	5.3	1750	ACS880-07-0174A-7	B84143V0207S230	IP22	2145	600	646	410	R8
161	132	80	5.6	1150	ACS880-07-0210A-7	B84143V0207S230	IP22	2145	600	646	410	R9
208	200	80	6.2	1150	ACS880-07-0271A-7	B84143V0207S230	IP22	2145	600	646	410	R9
303	250	80	7.9	3650	ACS880-07-0330A-7	NSIN0485-6	IP22	2145	400	646	340	R10
340	315	80	9.1	3650	ACS880-07-0370A-7	NSIN0485-6	IP22	2145	400	646	340	R10
356	351	80	9.9	3650	ACS880-07-0430A-7	NSIN0485-6	IP22	2145	400	646	340	R10
360	355	80	11.6	3650	ACS880-07-0470A-7	NSIN0485-6	IP22	2145	400	646	340	R11
400	355	80	12.3	3650	ACS880-07-0522A-7	NSIN0485-6	IP22	2145	400	646	340	R11
450	400	80	17.4	4950	ACS880-07-0590A-7	NSIN0900-6	IP22	2145	1000	646	840	R11
550	500	80	18.1	5170	ACS880-07-0650A-7	NSIN0900-6	IP22	2145	1000	646	840	R11
550	500	80	18.1	5170	ACS880-07-0721A-7	NSIN0900-6	IP22	2145	1000	646	840	R11
800	800	80	23	6290	ACS880-07-0800A-7	NSIN0900-6	IP22	2145	1000	646	840	D8T+2×R8i
900	900	81	29	6290	ACS880-07-0900A-7	NSIN1380-6	IP22	2145	1000	646	960	D8T+2×R8i
1160	1100	81	35	7720	ACS880-07-1160A-7	NSIN1380-6	IP22	2145	1000	646	960	2×D8T+2×R8i
12-pulse diode												
800	800	80	23	7720	ACS880-07-0800A-7+A004	NSIN0900-6	IP22	2145	1000	646	840	2×D7T+2×R8i
950	900	81	29	7720	ACS880-07-0950A-7+A004	NSIN1380-6	IP22	2145	1000	646	960	2×D8T+2×R8i
1160	1100	81	35	7720	ACS880-07-1160A-7+A004	NSIN1380-6	IP22	2145	1000	646	960	2×D8T+2×R8i

¹⁾ Please note that sine filters cause a voltage drop, reducing the available shaft power from the motor.

²⁾ Heat dissipation and noise level are combined values for the drive and the filter.

³⁾ Higher powers available as application engineered (+P902).

For further information please contact your local ABB office.

Sine filters for cabinet-built regenerative and ultra-low harmonic drives, ACS880-17 and ACS880-37

$U_N = 400 \text{ V}$ (range 380 to 415 V). The power ratings are valid at nominal voltage 400 V.⁴⁾

I_N	P_N ¹⁾	Noise level ²⁾	Heat dissipation ³⁾	Air flow	Drive type	Filter type	Degree of protection	Filter height	Filter width	Filter depth	Filter weight	Frame size
(A)	(kW)	(dB)	(kW)	(m ³ /h)				(mm)	(mm)	(mm)	(kg)	
91	55	70	0.6	700	ACS880-17/37-0105A-3	B84143V0130R230	IP22	2145	600	646	330	R8
126	75	70	0.55	700	ACS880-17/37-0145A-3	B84143V0162S229	IP22	2145	600	646	330	R8
153	90	70	0.55	700	ACS880-17/37-0169A-3	B84143V0162S229	IP22	2145	600	646	330	R8
187	110	70	0.9	805	ACS880-17/37-0206A-3	B84143V0230S229	IP22	2145	600	646	330	R8
264	160	77	1.6	2100	ACS880-17/37-0293A-3	B84143V0390S229	IP22	2145	600	646	430	R11
327	200	77	1.6	2100	ACS880-17/37-0363A-3	B84143V0390S229	IP22	2145	600	646	430	R11
398	250	77	1.7	2100	ACS880-17/37-0442A-3	B84143V0390S229	IP22	2145	600	646	430	R11
455	250	80	3.0	2000	ACS880-17/37-0505A-3	NSIN0900-6	IP22	2145	1000	646	840	R11
527	315	80	3.4	2000	ACS880-17/37-0585A-3	NSIN0900-6	IP22	2145	1000	646	840	R11
585	355	80	3.8	2000	ACS880-17/37-0650A-3	NSIN0900-6	IP22	2145	1000	646	840	R11
450	250	80	16	700	ACS880-17/37-0450A-3	NSIN0485-6	IP22	2145	400	636	340	1×R8i+1×R8i
620	355	80	22	2000	ACS880-17/37-0620A-3	NSIN0900-6	IP22	2145	1000	636	840	1×R8i+1×R8i
870	500	81	32	2000	ACS880-17/37-0870A-3	NSIN1380-6	IP22	2145	1000	636	960	1×R8i+1×R8i
1110	630	81	38	2000	ACS880-17/37-1110A-3	NSIN1380-6	IP22	2145	1000	636	960	2×R8i+2×R8i
1210	710	81	41	2000	ACS880-17/37-1210A-3	NSIN1380-6	IP22	2145	1000	636	960	2×R8i+2×R8i

$U_N = 500 \text{ V}$ (range 380 to 500 V). The power ratings are valid at nominal voltage 500 V.⁴⁾

I_N	P_N ¹⁾	Noise level ²⁾	Heat dissipation ³⁾	Air flow	Drive type	Filter type	Degree of protection	Filter height	Filter width	Filter depth	Filter weight	Frame size
(A)	(kW)	(dB)	(kW)	(m ³ /h)				(mm)	(mm)	(mm)	(kg)	
80	45	70	0.6	700	ACS880-17/37-0101A-5	B84143V0130S230	IP22	2145	600	646	330	R8
104	55	70	0.6	700	ACS880-17/37-0124A-5	B84143V0130S230	IP22	2145	600	646	330	R8
140	75	70	0.6	700	ACS880-17/37-0156A-5	B84143V0162S229	IP22	2145	600	646	330	R8
161	90	70	0.6	805	ACS880-17/37-0180A-5	B84143V0162S229	IP22	2145	600	646	330	R8
234	160	77	0.9	2100	ACS880-17/37-0260A-5	B84143V0230S229	IP22	2145	600	646	340	R11
325	200	77	1.6	2100	ACS880-17/37-0361A-5	B84143V0390S229	IP22	2145	600	646	430	R11
373	250	77	1.6	2100	ACS880-17/37-0414A-5	B84143V0390S229	IP22	2145	600	646	430	R11
414	315	80	3.3	2000	ACS880-17/37-0460A-5	NSIN0900-6	IP22	2145	1000	646	840	R11
453	355	80	3.6	2000	ACS880-17/37-0503A-5	NSIN0900-6	IP22	2145	1000	646	840	R11
420	250	80	15	700	ACS880-17/37-0420A-5	NSIN0485-6	IP22	2145	400	636	340	1×R8i+1×R8i
570	400	80	21	2000	ACS880-17/37-0570A-5	NSIN0900-6	IP22	2145	1000	636	840	1×R8i+1×R8i
780	560	80	30	2000	ACS880-17/37-0780A-5	NSIN0900-6	IP22	2145	1000	636	840	1×R8i+1×R8i
1010	710	81	39	2000	ACS880-17/37-1010A-5	NSIN1380-6	IP22	2145	1000	636	960	2×R8i+2×R8i
1110	800	81	40	2000	ACS880-17/37-1110A-5	NSIN1380-6	IP22	2145	1000	636	960	2×R8i+2×R8i

$U_N = 690 \text{ V}$ (range 525 to 690 V). The power ratings are valid at nominal voltage 690 V.⁴⁾

I_N	P_N ¹⁾	Noise level ²⁾	Heat dissipation ³⁾	Air flow	Drive type	Filter type	Degree of protection	Filter height	Filter width	Filter depth	Filter weight	Frame size
(A)	(kW)	(dB)	(kW)	(m ³ /h)				(mm)	(mm)	(mm)	(kg)	
157	160	77	0.9	2100	ACS880-17/37-0174A-7	B84143V0207S230	IP22	2145	600	646	410	R11
189	200	77	0.9	2100	ACS880-17/37-0210A-7	B84143V0207S230	IP22	2145	600	646	410	R11
244	250	77	0.9	2100	ACS880-17/37-0271A-7	B84143V0207S230	IP22	2145	600	646	410	R11
297	315	80	2.2	700	ACS880-17/37-0330A-7	NSIN0485-6	IP22	2145	400	646	340	R11
333	355	80	2.3	700	ACS880-17/37-0370A-7	NSIN0485-6	IP22	2145	400	646	340	R11
387	400	80	2.4	700	ACS880-17/37-0430A-7	NSIN0485-6	IP22	2145	400	646	340	R11
320	315	80	18	700	ACS880-17/37-0320A-7	NSIN0485-6	IP22	2145	400	636	340	1×R8i+1×R8i
390	355	80	21	700	ACS880-17/37-0390A-7	NSIN0485-6	IP22	2145	400	636	340	1×R8i+1×R8i
580	560	80	30	2000	ACS880-17/37-0580A-7	NSIN0900-6	IP22	2145	1000	636	840	1×R8i+1×R8i
660	630	80	35	2000	ACS880-17/37-0660A-7	NSIN0900-6	IP22	2145	1000	636	840	2×R8i+2×R8i
770	710	80	41	2000	ACS880-17/37-0770A-7	NSIN0900-6	IP22	2145	1000	636	840	2×R8i+2×R8i
950	900	81	47	2000	ACS880-17/37-0950A-7	NSIN1380-6	IP22	2145	1000	636	960	2×R8i+2×R8i
1130	1100	81	57	2000	ACS880-17/37-1130A-7	NSIN1380-6	IP22	2145	1000	636	960	2×R8i+2×R8i

¹⁾ Please note that sine filters cause a voltage drop, reducing the available shaft power from the motor.

²⁾ Noise level is a combined value for the drive and the filter.

³⁾ Heat dissipation is a combined value for the drive and the filter, except for frame sizes R8 and R11 the heat dissipation value is for the filter only.

⁴⁾ Higher powers available as application engineered (+P902).

Sine filters for larger types are available as customized option.

For further information please contact your local ABB office.

Brake options

—
01 Brake resistor,
SACE15RE13

Brake chopper

The brake chopper is built-in as standard for ACS880-01 frame sizes R1 to R4. For other constructions and frames, a brake chopper is a selectable internal option (except for the ACS880-11 and ACS880-31, where the chopper is an external option^{*)}. Braking control is integrated into ACS880 single drives. It not only controls braking, but also supervises system status and detects failures such as brake resistor and resistor cable short-circuits, chopper short-circuits, and calculated resistor overtemperature.

^{*)} For more information, please contact your local ABB office.



—
01

Brake resistor

The brake resistors are separately available for the ACS880-x1 and built in for the cabinet-built ACS880-x7. Resistors other than the standard option resistors may be used, provided that the specified resistance value is not decreased and that the heat dissipation capacity of the resistor is sufficient for the drive application. No separate fuses in the brake circuit are required if e.g. the mains cable is protected with fuses and no mains cable/fuse overrating takes place.

Brake resistor	Height mm	Width mm	Depth mm	Weight kg
JBR-03	124	340	77	0.8
SACE08RE44	365	290	131	6.1
SACE15RE22	365	290	131	6.1
SACE15RE13	365	290	131	6.8
SAFUR80F500	600	300	345	14
SAFUR90F575	600	300	345	12
SAFUR125F500	1320	300	345	25
SAFUR200F500	1320	300	345	30

Brake options, ACS880-01

$U_N = 230 \text{ V}$ (range 208 to 240 V)

Braking power		Brake resistor(s)			Drive type	Frame size	
P_{brcont} (kW)	R_{min} (ohm)	Type	R (ohm)	E_r (kJ)			
0.75	65	JBR-03	80	40	0.14	ACS880-01-04A6-2	R1
1.1	65	JBR-03	80	40	0.14	ACS880-01-06A6-2	R1
1.5	65	JBR-03	80	40	0.14	ACS880-01-07A5-2	R1
2.2	65	JBR-03	80	40	0.14	ACS880-01-10A6-2	R1
4	18	SACE15RE22	22	420	2	ACS880-01-16A8-2	R2
5.5	18	SACE15RE22	22	420	2	ACS880-01-24A3-2	R2
7.5	13	SACE15RE13	13	435	2	ACS880-01-031A-2	R3
11	12	SACE15RE13	13	435	2	ACS880-01-046A-2	R4
11	12	SACE15RE13	13	435	2	ACS880-01-061A-2	R4
18.5	6	SAFUR90F575	8	1800	4.5	ACS880-01-075A-2+D150	R5
22	6	SAFUR90F575	8	1800	4.5	ACS880-01-087A-2+D150	R5
30	3.5	SAFUR125F500	4	3600	9	ACS880-01-115A-2+D150	R6
37	3.5	SAFUR125F500	4	3600	9	ACS880-01-145A-2+D150	R6
45	2.4	SAFUR200F500	2.7	5400	13.5	ACS880-01-170A-2+D150	R7
55	2.4	SAFUR200F500	2.7	5400	13.5	ACS880-01-206A-2+D150	R7
75	1.8	SAFUR200F500	2.7	5400	13.5	ACS880-01-274A-2+D150	R8

$U_N = 400\text{ V}$ (range 380 to 415 V)								
Braking power		Brake resistor(s)				Drive type	Frame size	
P_{brcont} (kW)	R_{min} (ohm)	Type	R (ohm)	E_f (kJ)	P_{rcont} (kW)			
0.75	78	JBR-03	80	40	0.14	ACS880-01-02A4-3	R1	
1.1	78	JBR-03	80	40	0.14	ACS880-01-03A3-3	R1	
1.5	78	JBR-03	80	40	0.14	ACS880-01-04A0-3	R1	
2.2	78	JBR-03	80	40	0.14	ACS880-01-05A6-3	R1	
3	78	JBR-03	80	40	0.14	ACS880-01-07A2-3	R1	
4	78	JBR-03	80	40	0.14	ACS880-01-09A4-3	R1	
5.5	78	JBR-03	80	40	0.14	ACS880-01-12A6-3	R1	
7.5	39	SACE08RE44	44	210	1	ACS880-01-017A-3	R2	
11	39	SACE08RE44	44	210	1	ACS880-01-025A-3	R2	
15	19	SACE15RE22	22	420	2	ACS880-01-032A-3	R3	
18.5	19	SACE15RE22	22	420	2	ACS880-01-038A-3	R3	
22	13	SACE15RE13	13	435	2	ACS880-01-045A-3	R4	
22	13	SACE15RE13	13	435	2	ACS880-01-061A-3	R4	
37	8	SAFUR90F575	8	1800	4.5	ACS880-01-072A-3+D150	R5	
45	8	SAFUR90F575	8	1800	4.5	ACS880-01-087A-3+D150	R5	
55	5.4	SAFUR80F500	6	2400	6	ACS880-01-105A-3+D150	R6	
75	5.4	SAFUR80F500	6	2400	6	ACS880-01-145A-3+D150	R6	
90	3.3	SAFUR125F500	4	3600	9	ACS880-01-169A-3+D150	R7	
110	3.3	SAFUR125F500	4	3600	9	ACS880-01-206A-3+D150	R7	
132	2.3	SAFUR200F500	2.7	5400	13.5	ACS880-01-246A-3+D150	R8	
132	2.3	SAFUR200F500	2.7	5400	13.5	ACS880-01-293A-3+D150	R8	
160	2	SAFUR200F500	2.7	5400	13.5	ACS880-01-363A-3+D150	R9	
160	2	SAFUR200F500	2.7	5400	13.5	ACS880-01-430A-3+D150	R9	

$U_N = 500\text{ V}$ (range 380 to 500 V)								
Braking power		Brake resistor(s)				Drive type	Frame size	
P_{brcont} (kW)	R_{min} (ohm)	Type	R (ohm)	E_f (kJ)	P_{rcont} (kW)			
0.75	78	JBR-03	80	40	0.14	ACS880-01-02A1-5	R1	
1.1	78	JBR-03	80	40	0.14	ACS880-01-03A0-5	R1	
1.5	78	JBR-03	80	40	0.14	ACS880-01-03A4-5	R1	
2.2	78	JBR-03	80	40	0.14	ACS880-01-04A8-5	R1	
3	78	JBR-03	80	40	0.14	ACS880-01-05A2-5	R1	
4	78	JBR-03	80	40	0.14	ACS880-01-07A6-5	R1	
5.5	78	JBR-03	80	40	0.14	ACS880-01-11A0-5	R1	
7.5	39	SACE08RE44	44	210	1	ACS880-01-014A-5	R2	
11	39	SACE08RE44	44	210	1	ACS880-01-021A-5	R2	
15	19	SACE15RE22	22	420	2	ACS880-01-027A-5	R3	
18.5	19	SACE15RE22	22	420	2	ACS880-01-034A-5	R3	
22	13	SACE15RE13	13	435	2	ACS880-01-040A-5	R4	
22	13	SACE15RE13	13	435	2	ACS880-01-052A-5	R4	
37	8	SAFUR90F575	8	1800	4.5	ACS880-01-065A-5+D150	R5	
45	8	SAFUR90F575	8	1800	4.5	ACS880-01-077A-5+D150	R5	
55	5.4	SAFUR80F500	6	2400	6	ACS880-01-096A-5+D150	R6	
75	5.4	SAFUR80F500	6	2400	6	ACS880-01-124A-5+D150	R6	
90	3.3	SAFUR125F500	4	3600	9	ACS880-01-156A-5+D150	R7	
110	3.3	SAFUR125F500	4	3600	9	ACS880-01-180A-5+D150	R7	
132	2.3	SAFUR200F500	2.7	5400	13.5	ACS880-01-240A-5+D150	R8	
132	2.3	SAFUR200F500	2.7	5400	13.5	ACS880-01-260A-5+D150	R8	
160	2.3	SAFUR200F500	2.7	5400	13.5	ACS880-01-361A-5+D150	R9	
160	2.3	SAFUR200F500	2.7	5400	13.5	ACS880-01-414A-5+D150	R9	
200	2.3	SAFUR200F500	2.7	5400	13.5	ACS880-01-441A-5+D150	R9	

$U_N = 690 \text{ V}$ (range 525 to 690 V)								
Braking power			Brake resistor(s)			Drive type	Frame size	
P_{brcont} (kW)	R_{min} (ohm)	Type	R (ohm)	E_r (kJ)	P_{rcont} (kW)			
5.5	44	SACE08RE44	44	210	1	ACS880-01-07A4-7	R3	
7.5	44	SACE08RE44	44	210	1	ACS880-01-09A9-7	R3	
11	44	SACE08RE44	44	210	1	ACS880-01-14A3-7	R3	
15	44	SACE08RE44	44	210	1	ACS880-01-019A-7	R3	
18.5	44	SACE08RE44	44	210	1	ACS880-01-023A-7	R3	
22	44	SACE08RE44	44	210	1	ACS880-01-027A-7	R3	
33	18	SACE15RE22	22	420	2	ACS880-01-035A-7+D150	R5	
45	18	SACE15RE22	22	420	2	ACS880-01-042A-7+D150	R5	
45	18	SACE15RE22	22	420	2	ACS880-01-049A-7+D150	R5	
55	13	SACE15RE13	13	435	2	ACS880-01-061A-7+D150	R6	
65	13	SACE15RE13	13	435	2	ACS880-01-084A-7+D150	R6	
90	8	SAFUR90F575	8	1800	4.5	ACS880-01-098A-7+D150	R7	
110	8	SAFUR90F575	8	1800	4.5	ACS880-01-119A-7+D150	R7	
132	6	SAFUR80F500	6	2400	6	ACS880-01-142A-7+D150	R8	
160	6	SAFUR80F500	6	2400	6	ACS880-01-174A-7+D150	R8	
200	4	SAFUR125F500	4	3600	9	ACS880-01-210A-7+D150	R9	
200	4	SAFUR125F500	4	3600	9	ACS880-01-271A-7+D150	R9	

All brake resistors are to be installed outside the converter module. The JBR brake resistors are built-in to an IP20 metal housing. The SACE brake resistors are built-in to an IP21 metal housing. The SAFUR brake resistors are built-in to an IP00 metal frame.

Ratings

P_{brcont}	Continuous brake chopper power. The value applies to the minimum resistance value. With a higher resistance value, the P_{brcont} may increase in some ACS880 units.
R	Resistance value for the listed resistor type.
R_{min}	Minimum allowable resistance value for the brake resistor.
E_r	Energy pulse that the resistor assembly will withstand (400 s duty cycle). This energy will heat the resistor element from 40 °C to the maximum allowable temperature.
P_{rcont}	Continuous power (heat) dissipation of the resistor when placed correctly. Energy E_r dissipates in 400 seconds.

Brake options, ACS880-07

$U_N = 400$ V (range 380 to 415 V)

Braking power			Brake resistor(s)				Drive type	Frame size
P_{brmax} (kW)	R_{min} (ohm)	Type	R (ohm)	E_r (kJ)	P_{rcont} (kW)			
55	5.4	SAFUR80F500	6	2400	6	ACS880-07-0105A-3+D150 ²⁾	R6	
75	5.4	SAFUR80F500	6	2400	6	ACS880-07-0145A-3+D150 ²⁾	R6	
90	3.3	SAFUR125F500	4	3600	9	ACS880-07-0169A-3+D150 ²⁾	R7	
110	3.3	SAFUR125F500	4	3600	9	ACS880-07-0206A-3+D150 ²⁾	R7	
132	2.3	SAFUR200F500	2.7	5400	13.5	ACS880-07-0246A-3+D150 ²⁾	R8	
132	2.3	SAFUR200F500	2.7	5400	13.5	ACS880-07-0293A-3+D150 ²⁾	R8	
160	2	SAFUR200F500	2.7	5400	13.5	ACS880-07-0363A-3+D150 ²⁾	R9	
160	2	SAFUR200F500	2.7	5400	13.5	ACS880-07-0430A-3+D150 ²⁾	R9	
250	2	2×SAFUR125F500	2	7200	18	ACS880-07-0505A-3+D150 ²⁾	R10	
315	1.3	2×SAFUR200F500	1.35	10800	27	ACS880-07-0585A-3+D150 ²⁾	R10	
315	1.3	2×SAFUR200F500	1.35	10800	27	ACS880-07-0650A-3+D150 ²⁾	R10	
400	0.7	3×SAFUR200F500	0.9	16200	40	ACS880-07-0725A-3+D150 ²⁾	R11	
400	0.7	3×SAFUR200F500	0.9	16200	40	ACS880-07-0820A-3+D150 ²⁾	R11	
400	0.7	3×SAFUR200F500	0.9	16200	40	ACS880-07-0880A-3+D150 ²⁾	R11	

$U_N = 400$ V (range 380 to 415 V)

Nominal ratings		Duty cycle (1min/5min)		Duty cycle (10s/60s)		Brake chopper type	Brake resistor type		Drive type	Frame size			
P_{brmax} (kW)	R (ohm)	I_{max} (A)	I_{rms} (A)	P_{cont} (kW)	P_{br} (kW)		I_{rms} (A)	P_{br} (kW)			I_{rms} (A)	E_r (kJ)	
6-pulse diode													
706	0.6	1090	168	108	333	514	575	888	2×NBRA659	2 x (2 x SAFUR180F460)	24000	ACS880-07-1140A-3+D150 ²⁾	D8T+2×R8i
1058	0.4	1635	252	162	500	771	862	1332	3×NBRA659	3 x (2 x SAFUR180F460)	36000	ACS880-07-1250A-3+D150 ²⁾	2×D8T+2×R8i
1058	0.4	1635	252	162	500	771	862	1332	3×NBRA659	3 x (2 x SAFUR180F460)	36000	ACS880-07-1480A-3+D150 ²⁾	2×D8T+2×R8i
1058	0.4	1635	252	162	500	771	862	1332	3×NBRA659	3 x (2 x SAFUR180F460)	36000	ACS880-07-1760A-3+D150 ²⁾	2×D8T+2×R8i
12-pulse diode													
706	0.6	1090	168	108	333	514	575	888	2×NBRA659	2 x (2 x SAFUR180F460)	24000	ACS880-07-0990A-3+A004+D150 ²⁾	2×D7T+2×R8i
706	0.6	1090	168	108	333	514	575	888	2×NBRA659	2 x (2 x SAFUR180F460)	24000	ACS880-07-1140A-3+A004+D150 ²⁾	2×D8T+2×R8i
1058	0.4	1635	252	162	500	771	862	1332	3×NBRA659	3 x (2 x SAFUR180F460)	36000	ACS880-07-1250A-3+A004+D150 ²⁾	2×D8T+2×R8i
1058	0.4	1635	252	162	500	771	862	1332	3×NBRA659	3 x (2 x SAFUR180F460)	36000	ACS880-07-1480A-3+A004+D150 ²⁾	2×D8T+2×R8i
1058	0.4	1635	251	162	500	771	862	1332	3×NBRA659	3 x (2 x SAFUR180F460)	36000	ACS880-07-1760A-3+A004+D150 ²⁾	2×D8T+2×R8i

$U_N = 500 \text{ V}$ (range 380 to 500 V)								
Braking power			Brake resistor(s)			Drive type	Frame size	
P_{brmax} (kW)	R_{min} (ohm)	Type	R (ohm)	E_r (kJ)	P_{rcont} (kW)			
55	5.4	SAFUR80F500	6	2400	6	ACS880-07-0096A-5+D150 ²⁾	R6	
75	5.4	SAFUR80F500	6	2400	6	ACS880-07-0124A-5+D150 ²⁾	R6	
90	3.3	SAFUR125F500	4	3600	9	ACS880-07-0156A-5+D150 ²⁾	R7	
110	3.3	SAFUR125F500	4	3600	9	ACS880-07-0180A-5+D150 ²⁾	R7	
132	2.3	SAFUR200F500	2.7	5400	13.5	ACS880-07-0240A-5+D150 ²⁾	R8	
132	2.3	SAFUR200F500	2.7	5400	13.5	ACS880-07-0260A-5+D150 ²⁾	R8	
160	2.3	SAFUR200F500	2.7	5400	13.5	ACS880-07-0361A-5+D150 ²⁾	R9	
160	2.3	SAFUR200F500	2.7	5400	13.5	ACS880-07-0414A-5+D150 ²⁾	R9	
250	2	2×SAFUR125F500	2	7200	18	ACS880-07-0460A-5+D150 ²⁾	R10	
250	2	2×SAFUR125F500	2	7200	18	ACS880-07-0503A-5+D150 ²⁾	R10	
315	1.3	2×SAFUR200F500	1.35	10800	27	ACS880-07-0583A-5+D150 ²⁾	R10	
315	1.3	2×SAFUR200F500	1.35	10800	27	ACS880-07-0635A-5+D150 ²⁾	R10	
400	0.7	3×SAFUR200F500	0.9	16200	40	ACS880-07-0715A-5+D150 ²⁾	R11	
400	0.7	3×SAFUR200F500	0.9	16200	40	ACS880-07-0820A-5+D150 ²⁾	R11	
400	0.7	3×SAFUR200F500	0.9	16200	40	ACS880-07-0880A-5+D150 ²⁾	R11	

$U_N = 500 \text{ V}$ (range 380 to 500 V)													
Nominal ratings					Duty cycle (1min/ 5min)	Duty cycle (10s/ 60s)	Brake chopper type	Brake resistor type		Drive type	Frame size		
P_{brcont} (kW)	R (ohm)	I_{max} (A)	I_{rms} (A)	P_{cont} (kW)	P_{br} (kW)	I_{rms} (A)	P_{br} (kW)	I_{rms} (A)	E_r (kJ)				
6-pulse diode													
806	0.68	1210	134	108	333	412	575	710	2xNBRA-659	2 x (2 x SAFUR200F500)	21600	ACS880-07-1070A-5+D150 ²⁾	D8T+2×R8i
1208	0.45	1815	201	162	500	618	862	1065	3xNBRA-659	3 x (2 x SAFUR200F500)	32400	ACS880-07-1320A-5+D150 ²⁾	2×D8T+2×R8i
1208	0.45	1815	201	162	500	618	862	1065	3xNBRA-659	3 x (2 x SAFUR180F460)	32400	ACS880-07-1450A-5+D150 ²⁾	2×D8T+2×R8i
1208	0.45	1815	201	162	500	618	862	1065	3xNBRA-659	3 x (2 x SAFUR200F500)	32400	ACS880-07-1580A-5+D150 ²⁾	2×D8T+2×R8i
12-pulse diode													
806	0.68	1210	134	108	333	412	575	710	2xNBRA-659	2 x (2 x SAFUR200F500)	21600	ACS880-07-0990A-5+A004+D150 ²⁾	2×D7T+2×R8i
1208	0.45	1815	201	162	500	618	862	1065	3xNBRA-659	3 x (2 x SAFUR200F500)	32400	ACS880-07-1320A-5+A004+D150 ²⁾	2×D8T+2×R8i
1208	0.45	1815	201	162	500	618	862	1065	3xNBRA-659	3 x (2 x SAFUR180F460)	32400	ACS880-07-1450A-5+A004+D150 ²⁾	2×D8T+2×R8i
1208	0.45	1815	201	162	500	618	862	1065	3xNBRA-659	3 x (2 x SAFUR200F500)	32400	ACS880-07-1580A-5+A004+D150 ²⁾	2×D8T+2×R8i

$U_N = 690$ V (range 525 to 690 V)

Braking power			Brake resistor(s)				Drive type	
P_{brmax} (kW)	R_{min} (ohm)	Type	R (ohm)	E_r (kJ)	P_{rcont} (kW)			
55	13	SACE15RE13	13	435	2	ACS880-07-0061A-7+D150 ²⁾	R6	
65	13	SACE15RE13	13	435	2	ACS880-07-0084A-7+D150 ²⁾	R6	
90	8	SAFUR90F575	8	1800	4,5	ACS880-07-0098A-7+D150 ²⁾	R7	
110	8	SAFUR90F575	8	1800	4,5	ACS880-07-0119A-7+D150 ²⁾	R7	
132	6	SAFUR80F500	6	2400	6	ACS880-07-0142A-7+D150 ²⁾	R8	
160	6	SAFUR80F500	6	2400	6	ACS880-07-0174A-7+D150 ²⁾	R8	
200	4	SAFUR125F500	4	3600	9	ACS880-07-0210A-7+D150 ²⁾	R9	
200	4	SAFUR125F500	4	3600	9	ACS880-07-0271A-7+D150 ²⁾	R9	
285	2.2	SAFUR200F500	2.7	3600	13	ACS880-07-0330A-7+D150 ²⁾	R10	
285	2.2	SAFUR200F500	2.7	3600	13	ACS880-07-0370A-7+D150 ²⁾	R10	
285	2.2	SAFUR200F500	2.7	3600	13	ACS880-07-0430A-7+D150 ²⁾	R10	
350	2	2xSAFUR125F500	2	7200	18	ACS880-07-0470A-7+D150 ²⁾	R11	
350	2	2xSAFUR125F500	2	7200	18	ACS880-07-0522A-7+D150 ²⁾	R11	
400	1.8	2xSAFUR125F500	2	7200	18	ACS880-07-0590A-7+D150 ²⁾	R11	
400	1.8	2xSAFUR125F500	2	7200	18	ACS880-07-0650A-7+D150 ²⁾	R11	
400	1.8	2xSAFUR125F500	2	7200	18	ACS880-07-0721A-7+D150 ²⁾	R11	

²⁾ = +D150+D151 if resistor is ordered

 $U_N = 690$ V (range 525 to 690 V)

Nominal ratings			Duty cycle (1min/5min)	Duty cycle (10s/60s)	Brake chopper type	Brake resistor type	E_r (kJ)	Drive type	Frame size
P_{brmax} (kW)	R (ohm)	I_{max} (A)	I_{rms} (A)	P_{cont} (kW)	P_{br} (kW)	I_{rms} (A)	P_{br} (kW)	I_{rms} (A)	
6-pulse diode									
1211	0.45	2505	291	162	500	447	862	771	3xNBRA-669 3 x (2 x SAFUR200F500) 32400 ACS880-07-0800A-7+D150 ²⁾ D8T+2xR8i
1211	0.45	2505	291	162	500	447	862	771	3xNBRA-669 3 x (2 x SAFUR200F500) 32400 ACS880-07-0900A-7+D150 ²⁾ D8T+2xR8i
1211	0.45	2505	291	162	500	447	862	771	3xNBRA-669 3 x (2 x SAFUR200F500) 32400 ACS880-07-1160A-7+D150 ²⁾ 2xD8T+2xR8i
12-pulse diode									
1211	0.45	2505	291	162	500	447	862	771	3xNBRA-669 3 x (2 x SAFUR200F500) 32400 ACS880-07-0800A-7+A004+D150 ²⁾ 2xD7T+2xR8i
1211	0.45	2505	291	162	500	447	862	771	3xNBRA-669 3 x (2 x SAFUR200F500) 32400 ACS880-07-0950A-7+A004+D150 ²⁾ 2xD8T+2xR8i
1211	0.45	2505	291	162	500	447	862	771	3xNBRA-669 3 x (2 x SAFUR200F500) 32400 ACS880-07-1160A-7+A004+D150 ²⁾ 2xD8T+2xR8i

Brake choppers and resistors for larger types are available as customized option.

Ratings

P_{brmax}	Maximum braking power of the ACS880 equipped with the standard chopper and resistor.
R	Resistance value for the listed resistor type.
R_{min}	Minimum allowable resistance value for the brake resistor.
E_r	Energy pulse that the resistor assembly will withstand (400 s duty cycle). This energy will heat the resistor element from 40 °C to the maximum allowable temperature.
P_{cont}	Maximum continuous braking power
I_{max}	Maximum peak current during braking. Current is achieved with recommended resistor resistance.
I_{rms}	Corresponding rms current during load cycle.
P_{rcont}	Continuous power (heat) dissipation of the resistor when placed correctly. Energy E_r dissipates in 400 seconds.

Additional width for ACS880-07

Brake quantity	Width (mm)
1xSAFUR	400
2xSAFUR	800

Brake options, ACS880-37

$U_N = 400\text{ V}$ (range 380 to 415 V)

Nominal ratings				Duty cycle (1min/5min)		Duty cycle (10s/60s)		Brake chopper type	Brake resistor type	E_r (kJ)	Drive type	Frame size	
P_{brmax} (kW)	R (ohm)	I_{max} (A)	I_{rms} (A)	P_{cont} (kW)	P_{br} (kW)	I_{rms} (A)	P_{br} (kW)						I_{rms} (A)
230	1.7	345	65	42	130	195	224	336	NBRA658	2 x SAFUR210F575	16800	ACS880-37-0105A-3+D150 ²⁾	R8
230	1.7	345	65	42	130	195	224	336	NBRA658	2 x SAFUR210F575	16800	ACS880-37-0145A-3+D150 ²⁾	R8
230	1.7	345	65	42	130	195	224	336	NBRA658	2 x SAFUR210F575	16800	ACS880-37-0169A-3+D150 ²⁾	R8
230	1.7	345	65	42	130	195	224	336	NBRA658	2 x SAFUR210F575	16800	ACS880-37-0206A-3+D150 ²⁾	R8
355	1.2	532	84	60	167	250	287	430	NBRA659	2 x SAFUR180F460	24000	ACS880-37-0293A-3+D150 ²⁾	R11
355	1.2	532	84	60	167	250	287	430	NBRA659	2 x SAFUR180F460	24000	ACS880-37-0363A-3+D150 ²⁾	R11
355	1.2	532	84	60	167	250	287	430	NBRA659	2 x SAFUR180F460	24000	ACS880-37-0442A-3+D150 ²⁾	R11
355	1.2	532	84	60	167	250	287	430	NBRA659	2 x SAFUR180F460	24000	ACS880-37-0505A-3+D150 ²⁾	R11
355	1.2	532	84	60	167	250	287	430	NBRA659	2 x SAFUR180F460	24000	ACS880-37-0585A-3+D150 ²⁾	R11
355	1.2	532	84	60	167	250	287	430	NBRA659	2 x SAFUR180F460	24000	ACS880-37-0650A-3+D150 ²⁾	R11
353	1.2	545	84	54	167	444	287	444	NBRA659	2 x SAFUR180F460	12000	ACS880-37-0450A-3+D150 ²⁾	R8i+R8i
353	1.2	545	84	54	167	444	287	444	NBRA659	2 x SAFUR180F460	12000	ACS880-37-0620A-3+D150 ²⁾	R8i+R8i
706	0.6	1090	168	108	333	514	575	888	2xNBRA659	2 x (2 x SAFUR180F460)	24000	ACS880-37-0870A-3+D150 ²⁾	R8i+R8i
706	0.6	1090	168	108	333	514	575	888	2xNBRA659	2 x (2 x SAFUR180F460)	24000	ACS880-37-1110A-3+D150 ²⁾	2xR8i+2xR8i
706	0.6	1090	168	108	333	514	575	888	2xNBRA659	2 x (2 x SAFUR180F460)	24000	ACS880-37-1210A-3+D150 ²⁾	2xR8i+2xR8i
1058	0.4	1635	252	162	500	771	862	1332	3xNBRA659	3 x (2 x SAFUR180F460)	36000	ACS880-37-1430A-3+D150 ²⁾	2xR8i+2xR8i
1058	0.4	1635	252	162	500	771	862	1332	3xNBRA659	3 x (2 x SAFUR180F460)	36000	ACS880-37-1700A-3+D150 ²⁾	2xR8i+2xR8i

$U_N = 500\text{ V}$ (range 380 to 500 V)

Nominal ratings				Duty cycle (1min/5min)		Duty cycle (10s/60s)		Brake chopper type	Brake resistor type	E_r (kJ)	Drive type	Frame size	
P_{brmax} (kW)	R (ohm)	I_{max} (A)	I_{rms} (A)	P_{cont} (kW)	P_{br} (kW)	I_{rms} (A)	P_{br} (kW)						I_{rms} (A)
268	2	334	45	36	111	138	192	239	NBRA658	2 x SAFUR125F500	14400	ACS880-37-0101A-5+D150 ²⁾	R8
268	2	334	45	36	111	138	192	239	NBRA658	2 x SAFUR125F500	14400	ACS880-37-0124A-5+D150 ²⁾	R8
268	2	334	45	36	111	138	192	239	NBRA658	2 x SAFUR125F500	14400	ACS880-37-0156A-5+D150 ²⁾	R8
268	2	334	45	36	111	138	192	239	NBRA658	2 x SAFUR125F500	14400	ACS880-37-0180A-5+D150 ²⁾	R8
403	1.35	502	67	54	167	208	287	357	NBRA659	2 x SAFUR200F500	21600	ACS880-37-0260A-5+D150 ²⁾	R11
403	1.35	502	67	54	167	208	287	357	NBRA659	2 x SAFUR200F500	21600	ACS880-37-0361A-5+D150 ²⁾	R11
403	1.35	502	67	54	167	208	287	357	NBRA659	2 x SAFUR200F500	21600	ACS880-37-0414A-5+D150 ²⁾	R11
403	1.35	502	67	54	167	208	287	357	NBRA659	2 x SAFUR200F500	21600	ACS880-37-0460A-5+D150 ²⁾	R11
403	1.35	502	67	54	167	208	287	357	NBRA659	2 x SAFUR200F500	21600	ACS880-37-0503A-5+D150 ²⁾	R11
403	1.35	605	67	54	167	206	287	355	NBRA659	2 x SAFUR200F500	10800	ACS880-37-0420A-5+D150 ²⁾	R8i+R8i
403	1.35	605	67	54	167	206	287	355	NBRA659	2 x SAFUR200F500	10800	ACS880-37-0570A-5+D150 ²⁾	R8i+R8i
806	0.68	1210	134	108	333	412	575	710	2xNBRA659	2 x (2 x SAFUR200F500)	21600	ACS880-37-0780A-5+D150 ²⁾	R8i+R8i
806	0.68	1210	134	108	333	412	575	710	2xNBRA659	2 x (2 x SAFUR180F460)	21600	ACS880-37-1010A-5+D150 ²⁾	2xR8i+2xR8i
806	0.68	1210	134	108	333	412	575	710	2xNBRA659	2 x (2 x SAFUR200F500)	21600	ACS880-37-1110A-5+D150 ²⁾	2xR8i+2xR8i
1208	0.45	2815	201	162	500	618	862	1065	3xNBRA659	3 x (2 x SAFUR200F500)	32400	ACS880-37-1530A-5+D150 ²⁾	2xR8i+2xR8i

$U_N = 690 \text{ V}$ (range 525 to 690 V)													
Nominal ratings				Duty cycle (1min/5min)		Duty cycle (10s/60s)		Brake chopper type	Brake resistor type	E_r (kJ)	Drive type	Frame size	
P_{brmax} (kW)	R (ohm)	I_{max} (A)	I_{rms} (A)	P_{cont} (kW)	P_{br} (kW)	I_{rms} (A)	P_{br} (kW)						I_{rms} (A)
403	1.35	364	97	54	167	151	287	259	NBRA669	2 x SAFUR200F500	ACS880-37-0174A-7+D150 ²⁾	R11	
403	1.35	364	97	54	167	151	287	259	NBRA669	2 x SAFUR200F500	ACS880-37-0210A-7+D150 ²⁾	R11	
403	1.35	364	97	54	167	151	287	259	NBRA669	2 x SAFUR200F500	ACS880-37-0271A-7+D150 ²⁾	R11	
403	1.35	364	97	54	167	151	287	259	NBRA669	2 x SAFUR200F500	ACS880-37-0330A-7+D150 ²⁾	R11	
403	1.35	364	97	54	167	151	287	259	NBRA669	2 x SAFUR200F500	ACS880-37-0370A-7+D150 ²⁾	R11	
403	1.35	364	97	54	167	151	287	259	NBRA669	2 x SAFUR200F500	ACS880-37-0430A-7+D150 ²⁾	R11	
404	1.35	835	97	54	167	149	287	257	NBRA669	2 x SAFUR200F500	10800 ACS880-37-0320A-7+D150 ²⁾	R8i+R8i	
404	1.35	835	97	54	167	149	287	257	NBRA669	2 x SAFUR200F500	10800 ACS880-37-0390A-7+D150 ²⁾	R8i+R8i	
807	0.68	1670	194	108	333	298	575	514	2xNBRA669	2 x (2 x SAFUR200F500)	21600 ACS880-37-0580A-7+D150 ²⁾	R8i+R8i	
807	0.68	1670	194	108	333	298	575	514	2xNBRA669	2 x (2 x SAFUR200F500)	21600 ACS880-37-0660A-7+D150 ²⁾	2xR8i+2xR8i	
1211	0.45	2505	291	162	500	447	862	771	3xNBRA-669	3 x (2 x SAFUR200F500)	32400 ACS880-37-0770A-7+D150 ²⁾	2xR8i+2xR8i	
1211	0.45	2505	291	162	500	447	862	771	3xNBRA-669	3 x (2 x SAFUR200F500)	32400 ACS880-37-0950A-7+D150 ²⁾	2xR8i+2xR8i	
1211	0.45	2505	291	162	500	447	862	771	3xNBRA-669	3 x (2 x SAFUR200F500)	32400 ACS880-37-1130A-7+D150 ²⁾	2xR8i+2xR8i	

Brake choppers and resistors for larger types are available as customized option.

²⁾ = +D150+D151 if resistor is ordered

Ratings

P_{brmax}	Maximum braking power of the ACS880 equipped with the standard chopper and resistor.
R	Resistance value for the listed resistor type.
R_{min}	Minimum allowable resistance value for the brake resistor.
E_r	Energy pulse that the resistor assembly will withstand (400 s duty cycle). This energy will heat the resistor element from 40 °C to the maximum allowable temperature.
P_{cont}	Maximum continuous braking power
I_{max}	Maximum peak current during braking. Current is achieved with recommended resistor resistance.
I_{rms}	Corresponding rms current during load cycle.
P_{rcont}	Continuous power (heat) dissipation of the resistor when placed correctly. Energy E_r dissipates in 400 seconds.

Brake options, ACS880-07CLC, ACS880-17LC and ACS880-37LC

For liquid-cooled cabinet drives, ACS880-07CLC, -17LC and -37LC, brake options are available as engineered variants.

Du/dt filters

Du/dt filtering suppresses inverter output voltage spikes and rapid voltage changes that stress motor insulation. Additionally, du/dt filtering reduces capacitive leakage currents and high-frequency emissions from the motor cable, as well as high-frequency losses and bearing currents in the motor. The need for du/dt filtering depends on the motor insulation. For information on the construction of the motor insulation, consult the manufacturer.

If the motor does not meet the following requirements, the lifetime of the motor might decrease. Insulated N-end (non-driven end) bearings and/or common mode filters are also required for motor bearing currents with motors bigger than 100 kW. For more information, please see the ACS880 hardware manuals.

Please see below for information about how to select a filter according to the motor.

Filter selection table for ACS880

Motor type	Nominal AC supply voltage	Motor insulation system	Requirements for		
			ABB du/dt and common mode filters, insulated N-end motor bearings		
			$P_N < 100$ kW and frame size < IEC 315	100 kW $\leq P_N < 350$ kW or IEC 315 \leq frame size < IEC 400	$P_N \geq 350$ kW or frame size \geq IEC 400
			$P_N < 134$ hp and frame size < NEMA 500	134 hp $\leq P_N < 469$ hp or NEMA 500 \leq frame size \leq NEMA 580	$P_N \geq 469$ hp or frame size \geq NEMA 580
ABB motors					
Random-wound M2__, M3__ and M4__	$U_N \leq 500$ V	Standard	–	+ N	+ N + CMF
	500 V < $U_N \leq 600$ V	Standard	+ du/dt	+ du/dt + N	+ du/dt + N + CMF
		Reinforced	–	+ N	+ N + CMF
	600 V < $U_N \leq 690$ V (cable length ≤ 150 m)	Reinforced	+ du/dt	+ du/dt + N	+ du/dt + N + CMF
Reinforced		–	+ N	+ N + CMF	
Form-wound HX__ and AM__	380 V < $U_N \leq 690$ V	Standard	n/a	+ N + CMF	$P_N < 500$ kW: + N + CMF $P_N \geq 500$ kW: + du/dt + N + CMF
Old ¹⁾ form-wound HX__ and modular	380 V < $U_N \leq 690$ V	Check with the motor manufacturer	+ du/dt with voltages over 500 V + N + CMF	+ du/dt with voltages over 500 V + N + CMF	+ du/dt with voltages over 500 V + N + CMF
Random-wound HX__ and AM__ ²⁾	0 V < $U_N \leq 500$ V	Enamelled wire with fiber glass taping	+ N + CMF	+ N + CMF	+ N + CMF
	500 V < $U_N \leq 690$ V		+ du/dt + N + CMF	+ du/dt + N + CMF	+ du/dt + N + CMF
HPD	Consult the motor manufacturer.				

¹⁾ Manufactured before 1.1.1998.

²⁾ For motors manufactured before 1.1.1998, check for additional instructions with the motor manufacturer.

Non-ABB motors

Random-wound and form-wound	$U_N \leq 420$ V	Standard: $\hat{U}_{LL} = 1300$ V	–	+ N or CMF	+ N + CMF
	420 V < $U_N \leq 500$ V	Standard: $\hat{U}_{LL} = 1300$ V	+ du/dt	+ du/dt + N or + du/dt + CMF	+ du/dt + N + CMF
		Reinforced: $\hat{U}_{LL} = 1600$ V, 0.2 microsecond rise time	–	+ N or CMF	+ N + CMF
	500 V < $U_N \leq 600$ V	Reinforced: $\hat{U}_{LL} = 1600$ V	+ du/dt	+ du/dt + N or + du/dt + CMF	+ du/dt + N + CMF
		Reinforced: $\hat{U}_{LL} = 1800$ V	–	+ N or CMF	+ N + CMF
	600 V < $U_N \leq 690$ V	Reinforced: $\hat{U}_{LL} = 1800$ V	+ du/dt	+ du/dt + N	+ du/dt + N + CMF
Reinforced: $\hat{U}_{LL} = 2000$ V, 0.3 microsecond rise time ³⁾		–	+ N + CMF	+ N + CMF	

³⁾ If the intermediate DC circuit voltage of the drive is increased from the nominal level due to long term resistor braking cycles, check with the motor manufacturer if additional output filters are needed in the applied drive operation range.

The abbreviations used in the table are defined below

Abbr.	Definition
U_N	Nominal AC line voltage.
\hat{U}_{LL}	Peak line-to-line voltage at motor terminals which the motor insulation must withstand.
P_N	Motor nominal power.
du/dt	du/dt filter at the output of the drive. Available from ABB as an optional add-on kit.
CMF	Common mode filter. Depending on the drive type, CMF is available from ABB as a factory-installed option (+208) or as an optional add-on kit.
N	N-end bearing: insulated motor non-drive end bearing.
n/a	Motors of this power range are not available as standard units. Consult the motor manufacturer.



NOCH0016-60



NOCH0016-62



NOCH0016-65



FOCH0610-70

External du/dt filter for ACS880-01, ACS880-11 and ACS880-31

			du/dt filter type																
			*) 3 filters included, dimensions apply to one filter.																
			Unprotected (IP00)			Protected to IP22				Protected to IP54									
400 V	500 V	690 V	NOCH0016-60	NOCH0030-60	NOCH0070-60	NOCH0120-60*)	FOCH0260-70	FOCH0320-50	NOCH0016-62	NOCH0030-62	NOCH0070-62	NOCH0120-62	FOCH0260-72	FOCH0320-52	NOCH0016-65	NOCH0030-65	NOCH0070-65	NOCH0120-65	
02A4-3	02A1-5		x						x						x				
03A3-3	03A0-5		x						x						x				
	03A4-5		x						x						x				
04A0-3	04A8-5		x						x						x				
05A6-3	05A2-5	07A4-7	x						x						x				
07A2-3	07A6-5		x						x						x				
09A4-3		09A9-7	x						x						x				
12A6-3	11A0-5		x						x						x				
		14A3-7	x						x						x				
	014A-5			x						x							x		
017A-3		019A-7		x						x							x		
	021A-5			x						x							x		
		023A-7		x						x							x		
025A-3				x						x							x		
		027A-7		x						x							x		
	027A-5				x						x							x	
032A-3	034A-5	035A-7		x						x								x	
038A-3	040A-5	042A-7		x						x								x	
045A-3	052A-5	049A-7		x						x								x	
061A-3				x						x								x	
	065A-5	061A-7			x						x								x
072A-3	077A-5				x						x								x
087A-3		084A-7			x						x								x
105A-3	096A-5	098A-7			x						x								x
	124A-5	119A-7				x						x							
145A-3	156A-5	142A-7				x						x							
169A-3	180A-5	174A-7				x						x							
206A-3	240A-5	210A-7				x						x							
246A-3	260A-5	271A-7				x						x							
293A-3						x						x							
363A-3	361A-5								x						x				
430A-3	414A-5								x						x				

Applicability

Separate du/dt filters are available for the ACS880- 01, -11 and -31. Unprotected IP00 filters must be placed in an enclosure that provides an adequate degree of protection.

Factory-installed du/dt filters are available for the ACS880-07. They are installed inside the drive cabinet.

Dimensions and weights of the du/dt filters

du/dt filter	Height (mm)	Width (mm)	Depth (mm)	Weight (kg)
NOCH0016-60	195	140	115	2.4
NOCH0016-62/65	323	199	154	6
NOCH0030-60	215	165	130	4.7
NOCH0030-62/65	348	249	172	9
NOCH0070-60	261	180	150	9.5
NOCH0070-62/65	433	279	202	15.5
NOCH0120-60*	200	154	106	7
NOCH0120-62/65	765	308	256	45
FOCH0260-70	382	340	254	47
FOCH0260-72	900	314	384	73
FOCH0320-50	662	319	293	65
FOCH0320-52	1092	396	413	100
FOCH0610-70	662	319	293	65



ACS880 drives are compatible with the wide ABB product offering



Programmable Logic Controllers PLCs

The AC500, AC500-eCo, AC500-S and AC500-XC scalable PLC ranges provide solutions for small, medium and high-end applications. Our AC500 PLC platform offers different performance levels and is the ideal choice for high availability, extreme environments, condition monitoring, motion control or safety solutions.



All-compatible drives portfolio

The all-compatible drives share the same architecture; software platform, tools, user interfaces and options. Yet, there is an optimal drive from the smallest water pump to the biggest cement kiln, and everything in between.



AC motors

ABB's low voltage AC motors are designed to save energy, reduce operating costs and minimize unscheduled downtime. General performance motors ensure convenience, while process performance motors provide a broad set of motors for the process industries and heavy-duty applications.



Automation Builder Engineering suite

ABB Automation Builder is the software for machine builders and system integrators wanting to automate their machines and systems in a unified and efficient way. Automation Builder connects the engineering tools for PLC, safety, control panels, SCADA, drives, motion and robots.



Control panels

CP600-eCo, CP600 and CP600-Pro control panels offer a wide range of features and functionalities for maximum operability. ABB control panels are distinguished by their robustness and easy usability, providing all the relevant information from production plants and machines at one single touch.



Jokab safety products

ABB Jokab Safety is helping machine builders to create production-friendly and safe work environments for operators. We deliver machine safety solutions for single machines or entire production lines. Our long experience of helping customers making solutions for demanding environments has made us experts in combining production demands with safety demands for production-friendly solutions.

Choose the right motor for your application

Induction motors and the ACS880: a reliable combination

Induction motors are used throughout industry in applications that demand robust and high enclosure motor and drive solutions. ACS880 drives fit perfectly together with this type of motor by providing comprehensive functionality, yet simple operation. The drives are ideal for environments that require a high degree of protection and small footprint. ACS880 drives come with DTC as standard, ensuring high-speed accuracy. Our motors and drives provide the perfect foundation for energy efficiency, while delivering capabilities such as exceeding the nominal motor speed when maximum power is needed.

Our low voltage motors for explosive atmospheres and low voltage industrial drives have been tested and certified to verify that, when correctly dimensioned, they are safe to use in explosive atmospheres. ABB drives can also be used with non-ABB Ex motors with ATEX-certified thermistor protection. If this protection is not used, the motor and drive combination must be either type-tested or combined-tested for potentially explosive atmospheres by the customer, motor manufacturer or a third party. It is also important to verify that the motor can be used with ABB variable speed drives.

Permanent magnet motors and the ACS880: smooth operation

Permanent magnet technology is used for improved motor characteristics in terms of energy efficiency and compactness. This technology is particularly well-suited for low-speed control applications, as in some cases it eliminates the need to use gearboxes. The actual characteristics of different permanent magnet motors can vary considerably. Even without speed or rotor position sensors, ACS880 drives with DTC can control most types of permanent magnet motors.

IE4 synchronous reluctance motors and the ACS880: optimized energy efficiency

Combining the ACS880's control technology with our synchronous reluctance (SynRM) motors provides an IE4 motor and drive package that ensures high energy efficiency, reduces motor temperatures and provides a significant reduction in motor noise. Lower temperature results in better motor reliability and longer motor life.

ABB has tested our SynRM motor and drive packages and produced manufacturer's statements providing verified system (drive and motor) efficiency.



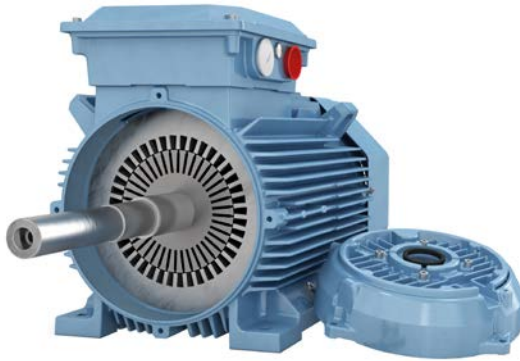

Traditional IE2 induction motor



IE4 synchronous reluctance motor SynRM

Losses

Induction motor	I^2R Stator	Other	I^2R Rotor	100%
SynRM	I^2R Stator	Other		60%

The idea is simple. Take a conventional, proven stator technology and a totally new, innovative rotor design. Then combine them with a drive loaded with new, application-specific software. Finally, optimize the whole package for applications such as pumps, fans, compressors, extruders, conveyors and mixers.

Synchronous reluctance technology combines the performance of a permanent magnet motor with the simplicity and service-friendliness of an induction motor. The new rotor has neither magnets nor windings and suffers virtually no

power losses. Because the footprints are identical, it is easy to replace an induction motor with a SynRM motor.

IE4 synchronous reluctance motors have very low winding temperatures, which increases the reliability and life of the winding. More importantly, the cooler synchronous reluctance rotor means significantly lower bearing temperatures – an important factor, because bearing failures cause about 70% of unplanned motor outages.



Keep your process running

From spare parts and technical support to cloud-based remote monitoring solutions, ABB offers the most extensive service offering to fit your needs. The global ABB service units complemented by external authorized value providers form a service network on your doorstep. Maximize performance, uptime and efficiency throughout the life cycle of your assets.

We can help you more by knowing where you are, register your drive at www.abb.com/drivereg.

Option code	Description
+P904	Extension of warranty to 24 months from commissioning or 30 months from delivery
+P909	Extension of warranty to 36 months from commissioning or 42 months from delivery
+P911	Extension of warranty to 66 months from delivery

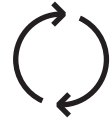

Replacements
Fast and efficient replacement services to minimize production downtime.



End-of-life services
Responsible dismantling, recycling and reusing of products, according to local laws and industrial standards.



Maintenance
Systematic and organized maintenance and support over the life cycle of your assets.



Z



ABB Ability™ Digital Powertrain

1 Intelligent powertrain

The powertrain is equipped with sensors and cloud connectivity and can comprise motors, drives, mechanical components including bearings, couplings and gearboxes – and also pumps. You can choose yourself what assets you want to monitor.

2 Turning data into valuable information

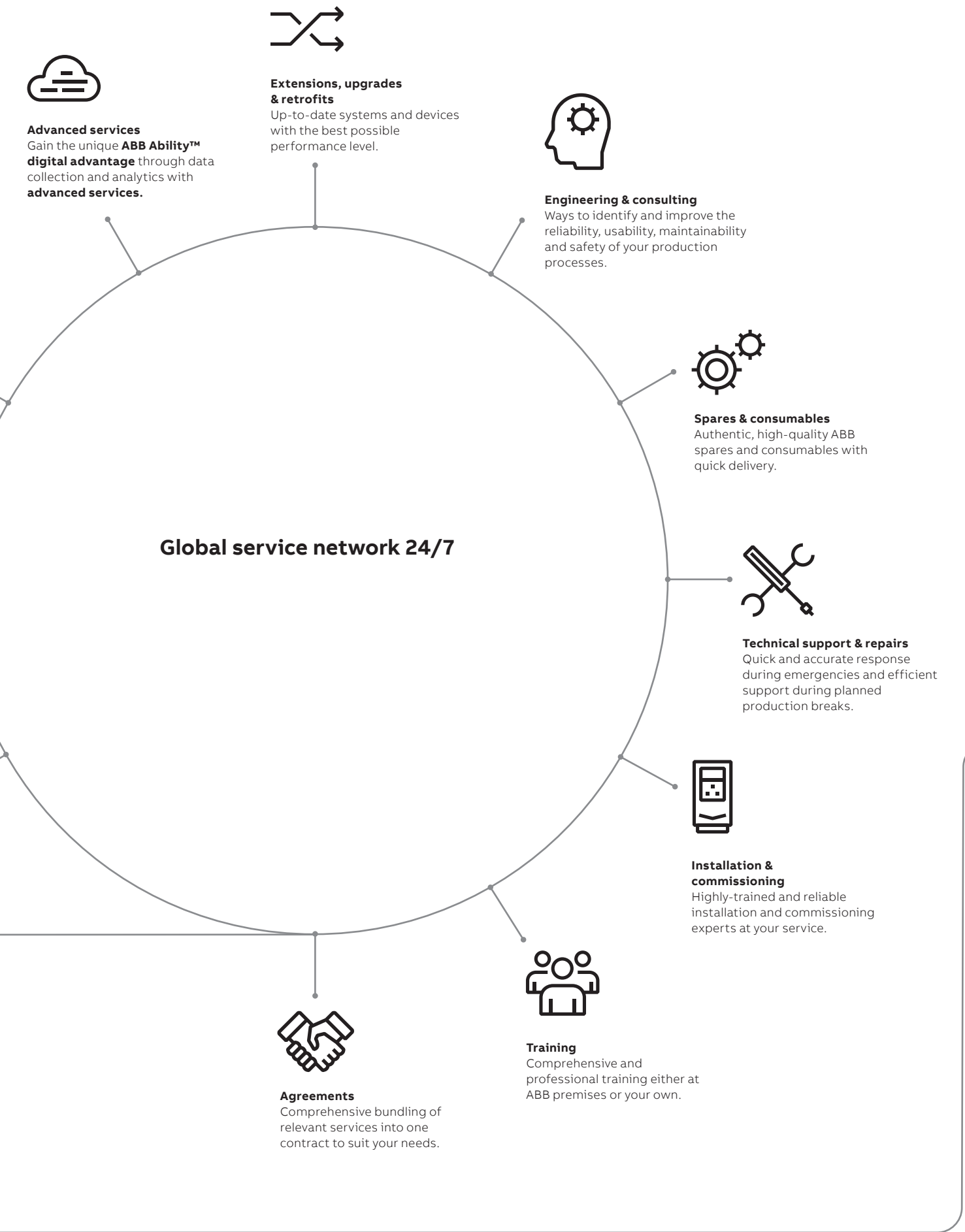
Data gathered from drives' inbuilt sensors and loggers together with that collected from ABB Ability™ Smart Sensors fitted to motors, bearings and pumps, can be aggregated, stored and further accessed via the cloud. The ability to gather and analyze this data can reveal information on the status and condition of your equipment, so that you can schedule service activities more effectively.



ABB Ability™ Condition Monitoring service for powertrains optimizes the performance and efficiency of rotating equipment. It enables full transparency on key parameters for drives, motors, mounted bearings and pumps, and can also be used in applications such as compressors, conveyors, mixers and extruder main shafts.

3 Accessing data for analytics

You have access to a monitoring portal to view key operational parameters of individual assets as one unified system. Detailed dashboards give full transparency so that you can take actions that lead to less downtime, extended equipment lifetime, lower costs, safer operations and increased profitability.

4 Gain a digital advantage

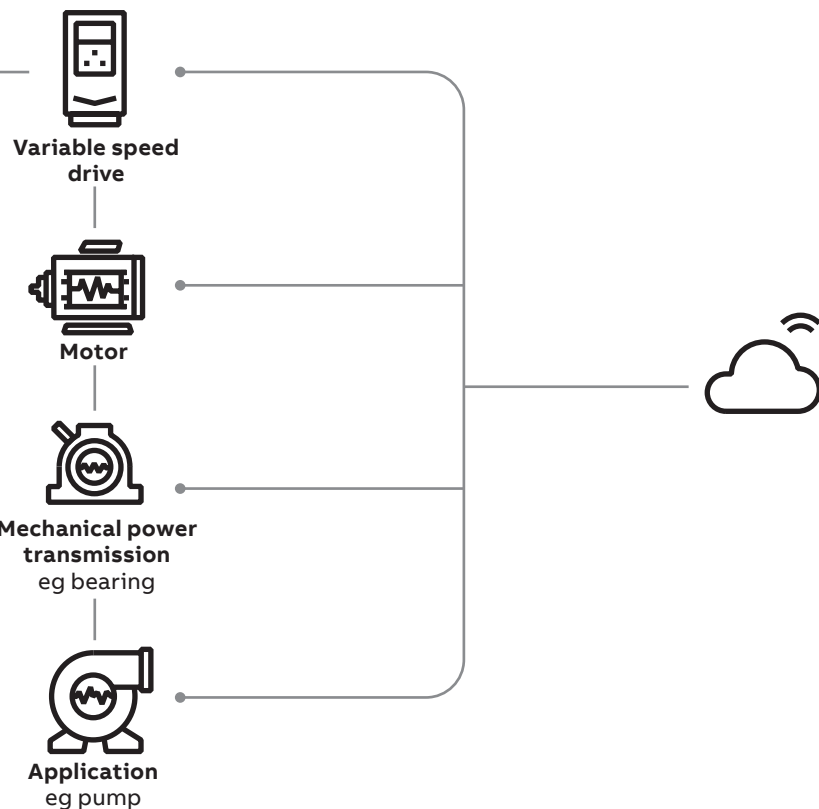
Ensuring that the right person has the right information to at the right time brings:

- Appropriate response to production challenges, minimizing operating costs and wastage of products
- Greater insight into various aspects of your process, thereby improving quality and reducing variations, errors and waste
- Lower risk of production downtime and change of the maintenance from reactive to predictive



Summary of features and options

ACS880 air-cooled single drives

	Ordering code	ACS880-01 R1 to R9	ACS880-11/31 R3 to R8	ACS880-07 R6 to R11	ACS880-07 nxR8i	ACS880-17/37 R8 to R11	ACS880-17/37 nxR8i ⁹⁾
Mounting							
Wall-mounting		●	●	-	-	-	-
For cabinet mounting	+P940	□	□	-	-	-	-
	+P944	□	-	-	-	-	-
Cabinet-built		-	-	●	●	●	●
Flange mounting	+C135	□ ¹⁶⁾	□ ¹⁶⁾	-	-	-	-
Cabling							
Bottom entry and exit		●	●	●	●	●	●
Top entry and exit	+H351, +H353	-	-	□	□	□	□
Degree of protection							
IP20 (UL open type)	+P940 +P944	□	□	-	-	-	-
IP21 (UL type 1)		●	●	-	-	-	-
IP22 (UL type 1)		-	-	●	●	●	●
IP42 (UL type 1)	+B054	-	-	□	□	□	□
IP54 (UL type 12)	+B055	-	-	□	□	□	□
IP55 (UL type 12)	+B056	□	□ ⁵⁾	-	-	-	-
Motor control							
DTC motor control		●	●	●	●	●	●
Control panel							
Intuitive control panel		● ¹⁾	● ¹⁾	●	●	●	●
Integrated control panel holder in the drive		●	●	●	●	●	●
Control panel mounting platform DPMP-01 (flush) / DPMP-02 (surface)		■	■	●	●	●	●
EMC filters							
EMC 1 st environment, restricted distribution, C2, grounded network (TN)	+E202	□ ²⁾	□ ¹⁷⁾	□ ²⁾	□ ¹⁸⁾	□ ²¹⁾	□ ²⁴⁾
EMC 2 nd environment, C3, grounded network (TN)	+E200	□ ³⁾	□	□ ³⁾	●	□ ²²⁾	●
EMC 2 nd environment, C3, ungrounded network (IT)	+E201	□ ⁴⁾	□	□ ⁴⁾	●	□ ²⁵⁾	●
Line filter							
AC or DC choke		●	-	●	●	-	-
Advanced line harmonic filter (LCL)		-	●	-	-	●	●
Output filter							
Common mode filter	+E208	□	□	□	●	□ ³⁰⁾	●
du/dt filters	+E205	■	■	□	●	□	●
Braking (see braking unit table)							
Brake chopper	+D150	□ ⁶⁾	■ ⁹⁾	□	□ ⁷⁾	□	□
Brake resistor	+D151	■	■ ⁹⁾	□	□ ⁷⁾	□	□

● Standard

□ Selectable option, with plus code

■ Selectable option, external, no plus code

ACS880 air-cooled single drives

	Ordering code	ACS880-01 R1 to R9	ACS880-11/31 R3 to R8	ACS880-07 R6 to R11	ACS880-07 nxR8i	ACS880-17/37 R8 to R11	ACS880-17/37 nxR8i ⁹⁾
Software							
Primary control program		●	●	●	●	●	●
Drive application programming based on IEC 61131-3 using Drive Application Builder (available for primary control program)	+N8010	□	□	□	□	□	□
Application control program for winder	+N5000	□	□	□	□	□	□
Application control program for crane	+N5050	□	□	□	□	□	□
Application control program for winch	+N5100	□	□	□	□	□	□
Application control program for centrifuge/decanter	+N5150	□	□	□	□	□	□
Application control program for PCP pump	+N5200	□	□	□	□	□	□
Application control program for Rod pump	+N5250	□	□	–	–	–	–
Application control program for test bench	+N5300	□	□	□	□	□	□
Application control program for cooling tower direct drive	+N5350	□	□	□	□	□	□
Application control program for override control	+N5450	□	□	□	□	–	□
Application control program for spinning and traverse	+N5500	□	¹⁹⁾	–	–	□	–
Application control program for chemical industry process control	+N5550	□	¹⁹⁾	–	–	–	–
Application control program for ESP pumps	+N5600	□	□	□	□	□	□
Application control program for tower cranes	+N5650	□	□	–	–	–	–
Application control program for position control	+N5700	□	□ ²⁶⁾	□	□	¹⁹⁾	¹⁹⁾
Support for asynchronous motor		●	●	●	●	●	●
Support for permanent magnet motor		●	●	●	●	●	●
Support for synchronous reluctance motor (SynRM)	+N7502	□	□	□	□	□	□
High speed license. Allows high speed operation above 598 Hz output frequency.	+N8200	□ ²⁶⁾	–	□ ²⁶⁾	□ ²⁶⁾	□ ²⁶⁾	□ ²⁶⁾
Rectifier bridge							
12-pulse	+A004	–	–	–	□	–	–
Line side apparatus							
aR line fuses		–	–	●	●	●	●
Main switch		–	–	●	●	●	●
Line contactor	+F250	–	–	□	□ ¹¹⁾	●	● ¹²⁾
Air circuit breaker	+F255	–	–	–	□ ⁸⁾	–	● ¹³⁾
Earthing switch	+F259	–	–	–	□	–	□
Cabinet options							
Cabinet heater (ext. supply)	+G300	–	–	□	□	□	□
Output for motor heater (ext. supply)	+G313	–	–	□	□	□	□
Customized options	+P902	–	–	□	□	□	□

● Standard

□ Selectable option, with plus code

■ Selectable option, external, no plus code

ACS880 air-cooled single drives

	Ordering code	ACS880-01 R1 to R9	ACS880-11/31 R3 to R8	ACS880-07 R6 to R11	ACS880-07 nxR8i	ACS880-17/37 R8 to R11	ACS880-17/37 nxR8i ⁹⁾
Safety functions²⁰⁾							
Safe torque off (STO)		●	●	●	●	●	●
Safety functions module, FSO-12, without encoder, configurable functions: - Safe stop 1 (SS1-t, SS1-r), - Safely-limited speed (SLS) - Safe brake control (SBC) - Safe maximum speed (SMS) - Safe stop emergency (SSE) - Prevention of unexpected start-up (POUS) - Safe torque off (STO)	+Q973	□	□	□	□	□	□
Safety functions module, FSO-21, with encoder support, configurable functions: - Safe stop 1 (SS1-t, SS1-r) - Safely-limited speed (SLS) - Safe brake control (SBC) - Safe maximum speed (SMS) - Safe stop emergency (SSE) - Prevention of unexpected start-up (POUS) - Safe direction (SDI), requires encoder feedback, FSE-31 - Safe speed monitoring (SSM) - Safe torque off (STO)	+Q972	□	□	□	□	□	□
Pulse encoder interface module, FSE-31	+L521	□	□	□	□	□	□
PROFIsafe over PROFINET	+Q982	□	□	□	□	□	□
PROFIsafe safety functions module, FSPS-21	+Q986	□	□	□	□	□ ⁹⁾	□ ⁹⁾
Prevention of unexpected start-up with safety relay (preconfigured)	+Q957	-	-	□	□	□	□
Prevention of unexpected start-up with FSO-12 and -21 (preconfigured)	+Q950	-	-	□	□	□	□
Emergency stop, category 0 with opening the main contactor/breaker, with safety relay (preconfigured)	+Q951	-	-	□	□	□	□
Emergency stop, category 1 with opening the main contactor/breaker, with safety relay (preconfigured)	+Q952	-	-	□	□	□	□
Emergency stop, category 0 with STO, with safety relay (preconfigured)	+Q963	-	-	□	□	□	□
Emergency stop, category 1 with STO, with safety relay (preconfigured)	+Q964	-	-	□	□	□	□
Emergency stop, configurable category 0 or 1 with opening the main contactor/breaker, with FSO-12 and -21 (preconfigured)	+Q978	-	-	□	□	□	□
Emergency stop, configurable category 0 or 1 with STO and FSO-12 and -21 (preconfigured)	+Q979	-	-	□	□	□	□
Safely-limited speed with encoder, with FSO-21 and FSE-31 (preconfigured)	+Q965	-	-	□	□	□	□
ATEX certified thermistor protection module, FPTC-02, Ex II (2) GD	+L537 +Q971	□	□	□	□	□	□
ATEX thermal motor protection PTC/PT100, Ex II (2) GD	+L513/+L514 +Q971	-	-	□	□	□	□
Earth fault protection							
Earth fault monitoring, earthed mains		●	●	●	●	●	●
Earth fault monitoring, unearthed mains	+Q954	-	-	□	□	□	□

● Standard

□ Selectable option, with plus code

■ Selectable option, external, no plus code

ACS880 air-cooled single drives

	Ordering code	ACS880-01 R1 to R9	ACS880-11/31 R3 to R8	ACS880-07 R6 to R11	ACS880-07 nxR8i	ACS880-17/37 R8 to R11	ACS880-17/37 nxR8i ⁹⁾
Control connections (I/O) and communications							
2 pcs analog inputs, programmable, galvanically isolated		●	●	●	●	●	●
2 pcs analog outputs, programmable		●	●	●	●	●	●
6 pcs digital inputs, programmable, galvanically isolated – can be divided into two groups		●	●	●	●	●	●
2 pcs digital inputs/outputs		●	●	●	●	●	●
1 pcs digital input interlock		●	●	●	●	●	●
3 pcs relay outputs programmable		●	●	●	●	●	●
Drive-to-drive link/Built-in Modbus		●	●	●	●	●	●
Assistant control panel/PC tool connection		●	●	●	●	●	●
Possibility for external power supply for control unit		●	●	●	●	●	●
Built-in I/O extension and speed feedback modules: for more details see sections: "Input/output extension modules", "Speed feedback interfaces for precise process control" and "DDCS communication option modules" ²⁷⁾		□	□	□	□	□	□
Built-in adapters for several communication protocols: for more details see section "Communication protocol adapters" ²⁸⁾		□	□	□	□	□	□
Approvals							
CE		●	●	●	●	●	●
UL, cUL	+C129	●	●	□	□	□	□
CSA	+C134	●	●	□	□	□	□
EAC/GOST R ¹⁰⁾		●	●	●	●	●	●
RoHS		●	●	●	●	●	●
RCM		●	●	●	●	●	●
Marine type approvals ¹⁴⁾	+C132	□ ¹⁴⁾	–	□ ¹⁴⁾	□ ¹⁴⁾	□ ¹⁴⁾	□ ¹⁴⁾
Marine construction	+C121	–	–	□	□	□	□
Marine product certification for essential applications		□ ⁹⁾	–	□ ⁹⁾	□ ⁹⁾	–	–
TÜV nord certificate for safety functions		●	●	●	●	●	●
ATEX certified safe disconnection function, Ex II (2) GD (notified body: Eurofins)	+Q971	□	□	□	□	□	□
SEMI F47		●	●	●	●	●	●

● Standard

□ Selectable option, with plus code

■ Selectable option, external, no plus code

– Not available

¹⁾ Without control panel, +0J400²⁾ For frame sizes R1 to R9, 380 to 500 V (-01). For frame sizes R6 to R11, 380 to 500 V (-07).³⁾ For frame sizes R1 to R9, 380 to 500 V, and frame sizes R3 to R9, 690 V (-01). For frame sizes R6 to R11, 380 to 690 V (-07).⁴⁾ For frame sizes R6 to R9, 380 to 500 V, and frame sizes R7 to R9, 690 V (-01). For frame sizes R6 to R9, 380 to 500 V and frame size R6, 690 V and frame sizes R10 to R11, 380 to 690 V (-07).⁵⁾ 2nd environment C4 for frame sizes R1 to R5, 380 to 500 V, and frame sizes R3 to R6, 690 V (-01).⁶⁾ IP55 for R6: Please contact ABB to check availability.⁷⁾ Frame sizes R1 to R4 built-in and R5 to R9 as selectable option⁸⁾ 2×R8i⁹⁾ 2×D8T to 4×D8T¹⁰⁾ Check availability from local ABB¹¹⁾ EAC has replaced GOST R¹²⁾ D8T, 2×D7T and 2×D8T¹³⁾ R8i to 2×R8i, 400 to 500 V. R8i to 3×R8i, 690 V¹⁴⁾ 3×R8i, 400 to 500 V. 4×R8i and 6×R8i, 690 V¹⁵⁾ ACS880 marine type approvals and type approved drives are listed at <https://new.abb.com/drives/segments/marine/marine-type-approvals>.¹⁶⁾ For cabinet-built drives (-07)¹⁷⁾ Available only with IP20 (+P940 or +P944)¹⁸⁾ +E202 for frame size R6: Please contact ABB to check availability.¹⁹⁾ For 1140A-3 and 1070A-5 (-07 nxR8i).²⁰⁾ Pending²¹⁾ Three option slots are available for I/O extension, speed feedback, communication protocol and functional safety options. FSO-xx can also be mounted on a DIN rail by using a separate installation kit. DIN rail mounting does not consume the drive's option slots. With frames R6 to R11 it is possible to mount the FSO-xx inside the drive without using the drive's option slots.²²⁾ For frame sizes R8 and R11, 380 to 500 V (-17, -37).²³⁾ For frame size R8, 380 to 500 V (-17, -37). As standard for R11, 380 to 690 V.²⁴⁾ Only for frame size R11.²⁵⁾ Only for frame size 1xR8i, 380 to 500 V (-17, -37).²⁶⁾ For frame size R8, 380 to 500 V (-17, -37). For R11, 380 to 690 V, please contact your local ABB.²⁷⁾ For availability and further information, please contact your local ABB office.²⁸⁾ Three option slots are available for I/O extension, speed feedback, communication protocol and functional safety options.

The slot number for I/O and encoder options can be extended with FEA-03 option. Please note that functional safety and communication protocol adapters cannot be used with FEA-03.

²⁹⁾ Three option slots are available for I/O extension, speed feedback, communication protocol and functional safety options.³⁰⁾ For ACS880-37LC.³¹⁾ Common mode filter (+E208) is standard for 690 V devices.

ACS880 liquid-cooled single drives

	Ordering code	ACS880-07LC nxR8i	ACS880-07CLC nxR8i	ACS880-17/37LC nxR8i
Mounting				
Wall-mounting		–	–	–
For cabinet mounting	+P940 +P944	– –	– –	– –
Cabinet-built		●	●	●
Flange mounting	+C135	–	–	–
Cabling				
Bottom entry and exit		●	●	●
Top entry and exit		□	–	□
Degree of protection				
IP20 (UL open type)	+P940 +P944	– –	– –	– –
IP21 (UL type 1)		–	–	–
IP22 (UL type 1)		–	–	–
IP42 (UL type 1)	+B054	●	●	●
IP54 (UL type 12)	+B055	□	□	□
IP55 (UL type 12)	+B056	–	–	–
Motor control				
DTC motor control		●	●	●
Control panel				
Intuitive control panel		●	●	●
Integrated control panel holder in the drive		–	–	–
Control panel mounting platform DPMP-01 (flush) / DPMP-02 (surface)		–	–	–
EMC filters				
EMC 1 st environment, restricted distribution, C2, grounded network (TN)	+E202	–	–	–
EMC 2 nd environment, C3, grounded network (TN)	+E200	–	–	–
EMC 2 nd environment, C3, ungrounded network (IT)	+E201	–	–	–
EMC 2 nd environment, C3, grounded (TN) and ungrounded (IT)	+E210	●	●	●
Line filter				
AC or DC choke		●	–	–
Advanced line harmonic filter (LCL)		–	–	●
Output filter				
Common mode filter	+E208	●	●	●
du/dt filters	+E205	●	●	●
Braking (see braking unit table)				
Brake chopper	+D150	□	□	□ ²⁹⁾
Brake resistor	+D151	□	□	□ ²⁹⁾

● Standard

□ Selectable option, with plus code

■ Selectable option, external, no plus code

ACS880 liquid-cooled single drives

	Ordering code	ACS880-07LC nxR8i	ACS880-07CLC nxR8i	ACS880-17/37LC nxR8i
Software				
Primary control program		●	●	●
Drive application programming based on IEC 61131-3 using Drive Application Builder (available for primary control program)	+N8010	□	□	□
Application control program for winder	+N5000	□	–	□
Application control program for crane	+N5050	□	□	□
Application control program for winch	+N5100	□	□	□
Application control program for centrifuge/decanter	+N5150	□	□	□
Application control program for PCP pump	+N5200	□	□	□
Application control program for Rod pump	+N5250	□	–	□
Application control program for test bench	+N5300	□	–	□
Application control program for cooling tower direct drive	+N5350	–	–	–
Application control program for override control	+N5450	□	–	□
Application control program for spinning and traverse	+N5500	–	–	–
Application control program for chemical industry process control	+N5550	–	–	–
Application control program for ESP pumps	+N5600	□	□	□
Application control program for tower cranes	+N5650	–	–	–
Application control program for position control	+N5700	□ ²⁶⁾	□ ²⁶⁾	□ ²⁶⁾
Support for asynchronous motor		●	●	●
Support for permanent magnet motor		●	●	●
Support for synchronous reluctance motor (SynRM)	+N7502	□	□	□
High speed license. Allows high speed operation above 598 Hz output frequency.	+N8200	□ ²⁶⁾	□ ²⁶⁾	□ ²⁶⁾
Rectifier bridge				
12-pulse	+A004	□	□	–
24-pulse		–	□	–
Line side apparatus				
aR line fuses		●	●	●
Main switch		–	–	–
Line contactor	+F250	–	–	–
Air circuit breaker	+F255	●	–	●
Earthing switch	+F259	□	–	□
Cabinet options				
Cabinet heater (ext. supply)	+G300	□	□	□
Output for motor heater (ext. supply)	+G313	□	□	□
Customized options	+P902	●	●	●

● Standard

□ Selectable option, with plus code

■ Selectable option, external, no plus code

ACS880 liquid-cooled single drives

	Ordering code	ACS880-07LC nxR8i	ACS880-07CLC nxR8i	ACS880-17/37LC nxR8i
Safety functions ²⁰⁾				
Safe torque off (STO)		●	●	●
Safety functions module, FSO-12, without encoder, configurable functions: - Safe stop 1 (SS1-t, SS1-r), - Safely-limited speed (SLS) - Safe brake control (SBC) - Safe maximum speed (SMS) - Safe stop emergency (SSE) - Prevention of unexpected start-up (POUS) - Safe torque off (STO)	+Q973	□	-	□
Safety functions module, FSO-21, with encoder support, configurable functions: - Safe stop 1 (SS1-t, SS1-r) - Safely-limited speed (SLS) - Safe brake control (SBC) - Safe maximum speed (SMS) - Safe stop emergency (SSE) - Prevention of unexpected start-up (POUS) - Safe direction (SDI), requires encoder feedback, FSE-31 - Safe speed monitoring (SSM) - Safe torque off (STO)	+Q972	□	-	□
Pulse encoder interface module, FSE-31	+L521	□	-	□
PROFIsafe over PROFINET	+Q982	□	-	□
PROFIsafe safety functions module, FSPS-21	+Q986	□	-	□
Prevention of unexpected start-up with safety relay (preconfigured)	+Q957	□	-	□
Prevention of unexpected start-up with FSO-12 and -21 (preconfigured)	+Q950	□	-	□
Emergency stop, category 0 with opening the main contactor/breaker, with safety relay (preconfigured)	+Q951	□	□	□
Emergency stop, category 1 with opening the main contactor/breaker, with safety relay (preconfigured)	+Q952	□	-	□
Emergency stop, category 0 with STO, with safety relay (preconfigured)	+Q963	□	-	□
Emergency stop, category 1 with STO, with safety relay (preconfigured)	+Q964	□	-	□
Emergency stop, configurable category 0 or 1 with opening the main contactor/breaker, with FSO-12 and -21 (preconfigured)	+Q978	□	-	□
Emergency stop, configurable category 0 or 1 with STO and FSO-12 and -21 (preconfigured)	+Q979	□	-	□
Safely-limited speed with encoder, with FSO-21 and FSE-31 (preconfigured)	+Q965	□	-	□
ATEX certified thermistor protection module, FPTC-02, Ex II (2) GD	+L537 +Q971	□	-	□
ATEX thermal motor protection PTC/PT100, Ex II (2) GD	+L513/+L514 +Q971	□	-	□
Earth fault protection				
Earth fault monitoring, earthed mains		●	●	●
Earth fault monitoring, unearthed mains	+Q954	□	□	□

● Standard

□ Selectable option, with plus code

■ Selectable option, external, no plus code

ACS880 liquid-cooled single drives

	Ordering code	ACS880-07LC nxR8i	ACS880-07CLC nxR8i	ACS880-17/37LC nxR8i
Control connections (I/O) and communications				
2 pcs analog inputs, programmable, galvanically isolated		●	●	●
2 pcs analog outputs, programmable		●	●	●
6 pcs digital inputs, programmable, galvanically isolated – can be divided into two groups		●	●	●
2 pcs digital inputs/outputs		●	●	●
1 pcs digital input interlock		●	●	●
3 pcs relay outputs programmable		●	●	●
Drive-to-drive link/Built-in Modbus		●	●	●
Assistant control panel/PC tool connection		●	●	●
Possibility for external power supply for control unit		●	●	●
Built-in I/O extension and speed feedback modules: for more details see sections: "Input/output extension modules", "Speed feedback interfaces for precise process control" and "DDCS communication option modules" ²⁷⁾		□	□	□
Built-in adapters for several communication protocols: for more details see section "Communication protocol adapters" ²⁸⁾		□	□	□
Approvals				
CE		●	●	●
UL, cUL	+C129	□ ¹⁹⁾	□ ¹⁹⁾	□ ¹⁹⁾
CSA	+C134	□ ¹⁹⁾	□ ¹⁹⁾	□ ¹⁹⁾
EAC/GOST R ¹⁰⁾		●	–	●
RoHS		●	●	●
RCM		●	●	●
Marine type approvals ¹⁴⁾	+C132	□	□	□
Marine construction	+C121	□	□	□
Marine product certification for essential applications		□ ⁹⁾	□ ⁹⁾	□ ⁹⁾
TÜV nord certificate for safety functions		●	●	●
ATEX certified safe disconnection function, Ex II (2) GD (notified body: Eurofins)	+Q971	–	–	–
SEMI F47		●	●	●

● Standard

□ Selectable option, with plus code

■ Selectable option, external, no plus code

– Not available

¹⁾ Without control panel, +0J400²⁾ For frame sizes R1 to R9, 380 to 500 V (-01). For frame sizes R6 to R11, 380 to 500 V (-07).³⁾ For frame sizes R1 to R9, 380 to 500 V, and frame sizes R3 to R9, 690 V (-01). For frame sizes R6 to R11, 380 to 690 V (-07).⁴⁾ For frame sizes R6 to R9, 380 to 500 V, and frame sizes R7 to R9, 690 V (-01). For frame sizes R6 to R9, 380 to 500 V and frame size R6, 690 V and frame sizes R10 to R11, 380 to 690 V (-07).⁵⁾ 2nd environment C4 for frame sizes R1 to R5, 380 to 500 V, and frame sizes R3 to R6, 690 V (-01).⁶⁾ IP55 for R6: Please contact ABB to check availability.⁷⁾ Frame sizes R1 to R4 built-in and R5 to R9 as selectable option⁸⁾ 2×R8i⁹⁾ 2×D8T to 4×D8T¹⁰⁾ Check availability from local ABB¹¹⁾ EAC has replaced GOST R¹²⁾ D8T, 2×D7T and 2×D8T¹³⁾ R8i to 2×R8i, 400 to 500 V. R8i to 3×R8i, 690 V¹⁴⁾ 3×R8i, 400 to 500 V. 4×R8i and 6×R8i, 690 V¹⁵⁾ ACS880 marine type approvals and type approved drives are listed at <https://new.abb.com/drives/segments/marine/marine-type-approvals>.¹⁶⁾ For cabinet-built drives (-07)¹⁷⁾ Available only with IP20 (+P940 or +P944)¹⁸⁾ +E202 for frame size R6: Please contact ABB to check availability.¹⁹⁾ For 1140A-3 and 1070A-5 (-07 nxR8i).²⁰⁾ Pending²¹⁾ Three option slots are available for I/O extension, speed feedback, communication protocol and functional safety options. FSO-xx can also be mounted on a DIN rail by using a separate installation kit. DIN rail mounting does not consume the drive's option slots. With frames R6 to R11 it is possible to mount the FSO-xx inside the drive without using the drive's option slots.²²⁾ For frame sizes R8 and R11, 380 to 500 V (-17, -37).²³⁾ For frame size R8, 380 to 500 V (-17,-37). As standard for R11, 380 to 690 V.²⁴⁾ Only for frame size R11.²⁵⁾ Only for frame size 1xR8i, 380 to 500 V (-17,-37).²⁶⁾ For frame size R8, 380 to 500 V (-17,-37). For R11, 380 to 690 V, please contact your local ABB.²⁷⁾ For availability and further information, please contact your local ABB office.²⁸⁾ Three option slots are available for I/O extension, speed feedback, communication protocol and functional safety options.²⁹⁾ The slot number for I/O and encoder options can be extended with FEA-03 option. Please note that functional safety and communication protocol adapters cannot be used with FEA-03.³⁰⁾ Three option slots are available for I/O extension, speed feedback, communication protocol and functional safety options.³¹⁾ For ACS880-37LC.³²⁾ Common mode filter (+E208) is standard for 690 V devices.

Additional information

We reserve the right to make technical changes or modify the contents of this document without prior notice. With regard to purchase orders, the agreed particulars shall prevail. ABB does not accept any responsibility whatsoever for potential errors or possible lack of information in this document.

We reserve all rights in this document and in the subject matter and illustrations contained therein. Any reproduction, disclosure to third parties or utilization of its contents – in whole or in parts – is forbidden without prior written consent of ABB.



—
For more information, please contact
your local ABB representative or visit

new.abb.com/drives/ACS880

new.abb.com/drives

new.abb.com/drives/drivespartners

new.abb.com/motors-generators

Video playlist:
ACS880 how-to videos

