

ozito

LAMINATE TRIMMER

350W

INSTRUCTION MANUAL

SPECIFICATIONS

Voltage:	230-240V ~ 50Hz
Power:	350W
No Load Speed:	30,000/min
Collet Size:	6.35mm (1/4")
Weight:	1.7kg

ozito.com.au

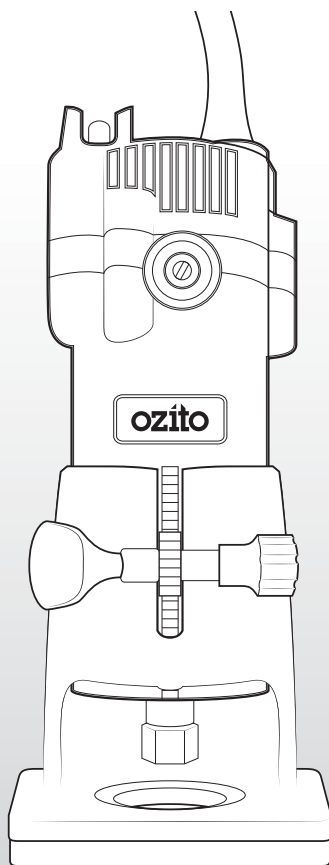

STANDARD EQUIPMENT

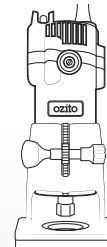

Laminate Trimmer

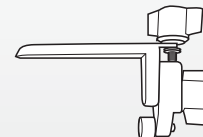

Trimming Guide

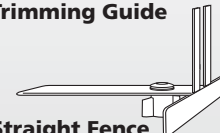

Straight Fence



Template Guide

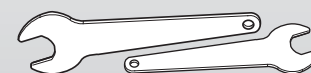

Collet Spanners

3 YEAR REPLACEMENT WARRANTY

LTM-3000

WARRANTY

IN ORDER TO MAKE A CLAIM UNDER THIS WARRANTY YOU MUST RETURN THE PRODUCT TO YOUR NEAREST BUNNINGS WAREHOUSE WITH YOUR BUNNINGS REGISTER RECEIPT. PRIOR TO RETURNING YOUR PRODUCT FOR WARRANTY PLEASE TELEPHONE OUR CUSTOMER SERVICE HELPLINE:

Australia 1800 069 486

New Zealand 0508 069 486

TO ENSURE A SPEEDY RESPONSE PLEASE HAVE THE MODEL NUMBER AND DATE OF PURCHASE AVAILABLE. A CUSTOMER SERVICE REPRESENTATIVE WILL TAKE YOUR CALL AND ANSWER ANY QUESTIONS YOU MAY HAVE RELATING TO THE WARRANTY POLICY OR PROCEDURE.

The benefits provided under this warranty are in addition to other rights and remedies which are available to you at law.

Our goods come with guarantees that cannot be excluded at law. You are entitled to a replacement or refund for a major failure and for compensation for any other reasonably foreseeable loss or damage. You are also entitled to have the goods repaired or replaced if the goods fail to be of acceptable quality and the failure does not amount to a major failure.

Generally you will be responsible for all costs associated with a claim under this warranty, however, where you have suffered any additional direct loss as a result of a defective product you may be able to claim such expenses by contacting our customer service helpline above.

3 YEAR REPLACEMENT WARRANTY

Your product is guaranteed for a period of **36 months from the original date of purchase** and is intended for DIY (Do It Yourself) use only. If a product is defective it will be replaced in accordance with the terms of this warranty. Warranty excludes consumable parts, for example: carbon brushes, spanners etc

WARNING

The following actions will result in the warranty being void.

- If the tool has been operated on a supply voltage other than that specified on the tool.
- If the tool shows signs of damage or defects caused by or resulting from abuse, accidents or alterations.
- Failure to perform maintenance as set out within the instruction manual.
- If the tool is disassembled or tampered with in any way.
- Professional, industrial or high frequency use.

KNOW YOUR PRODUCT

LAMINATE TRIMMER

- | | |
|---------------------|-----------------------------|
| 1 On/Off Switch | 5 Depth Adjusting Screw |
| 2 Base Locking Knob | 6 Trimmer Guide Base |
| 3 Collet Nut | 7 Fence/Guide Locking Screw |
| 4 Spindle | |

FRONT VIEW

SIDE VIEW

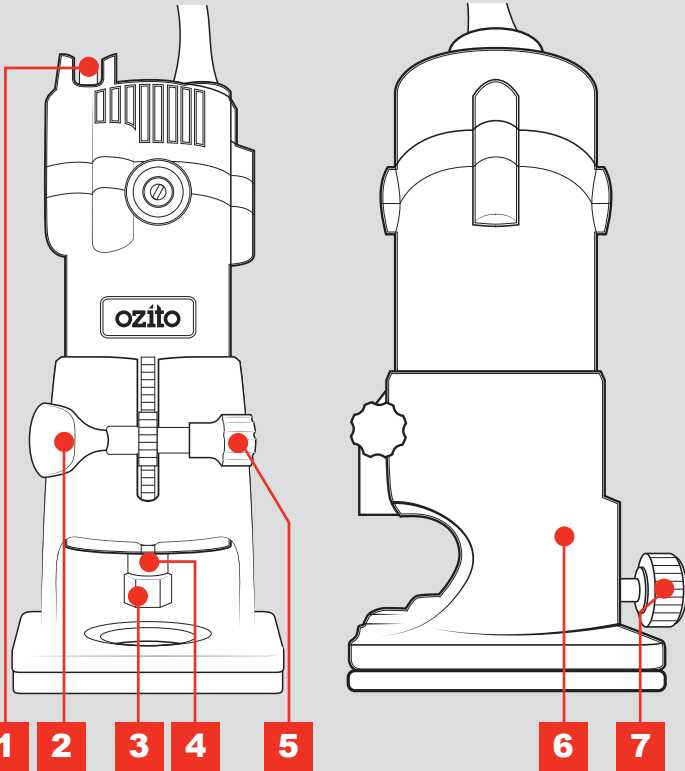

ACCESSORIES

- | | |
|-----------------------------|-----------------------|
| 8 Trimming Guide | 12 Straight Fence |
| 9 Trimming Locking Knob | 13 Fence Locking Knob |
| 10 Trimming Adjustment Knob | 14 Template Guide |
| 11 Collet Spanners x 2 | |

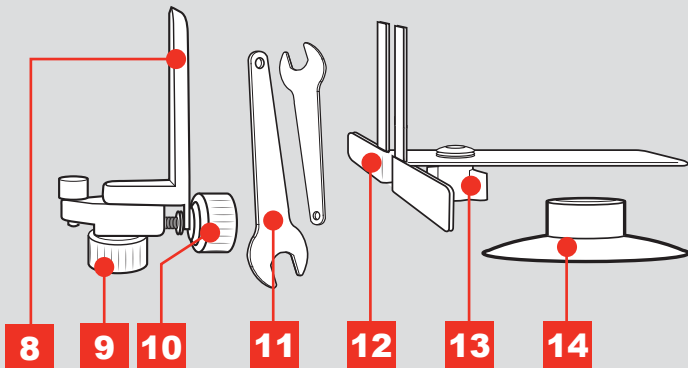

ONLINE MANUAL

Scan this QR Code with your mobile device to take you to the online manual.



SETUP & PREPARATION

1. SETUP

WARNING! ENSURE THE TOOL IS SWITCHED OFF AND DISCONNECTED FROM THE POWER SUPPLY BEFORE PERFORMING ANY OF THE FOLLOWING OPERATIONS.

Removing the Trimmer Guide Base

- 1 Loosen the base locking knob by rotating anti-clockwise.

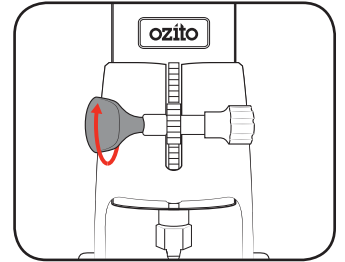

- 2 Slide the trimmer guide base off the housing.

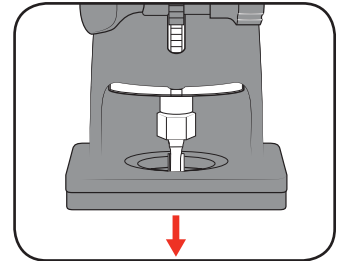

WARNING! NEVER USE THE LAMINATE TRIMMER WITHOUT THE SAFETY GUARD FITTED.

Fitting the Trimmer Guide Base

- 1 Slide the trimmer guide base onto the housing.

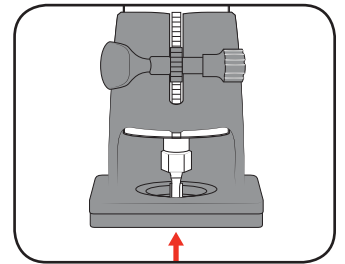

- 2 Secure in place by fastening the base locking knob.

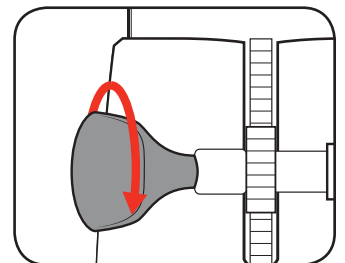

3 YEAR REPLACEMENT WARRANTY

2. CHANGING ROUTER BITS

Note: Adjust the trimmer base to the top position (0cm) or remove completely to access the collet.

Removing Router Bits

- 1 Place the small spanner onto the spindle and the large spanner onto the collet nut.
- 2 Loosen and remove the collet nut by rotating anti-clockwise with the large spanner.

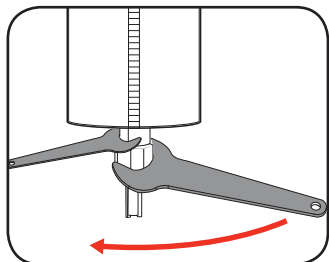
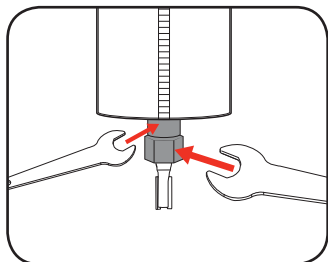

- 3 Remove the router bit from the spindle.

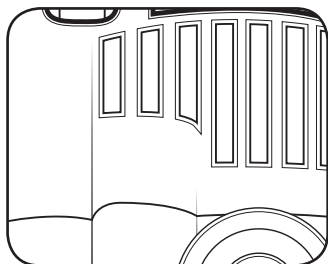

Installing a Router Bit

- 1 Place the router bit into the spindle.
- 2 Screw the collet nut finger tight over the spindle.

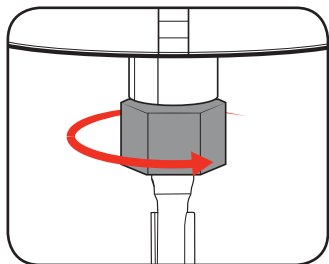
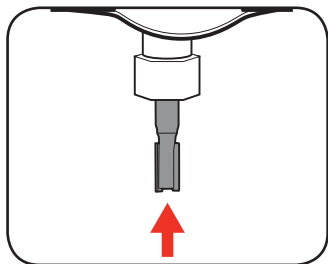

- 3 Place the small spanner onto the spindle and large spanner onto the collet nut.
- 4 Tighten the collet using the large spanner.

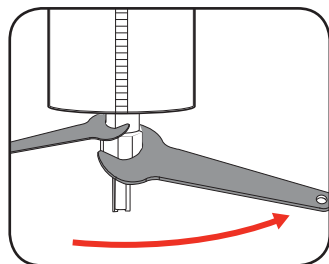
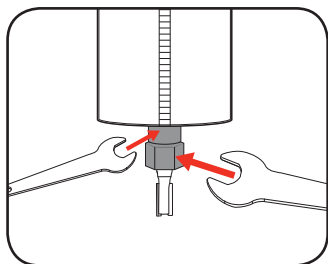

3. TRIMMING GUIDE

The trimming guide allows you to trim off a precise amount of material off the edge of the workpiece.

Fitting the Trimming Guide

- 1 Loosen the fence/guide locking screw and insert the trimming guide.
- 2 Set the height of the trimming guide just below the router bit when it is completely lowered.

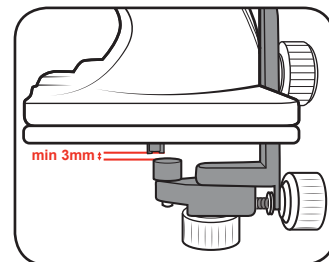
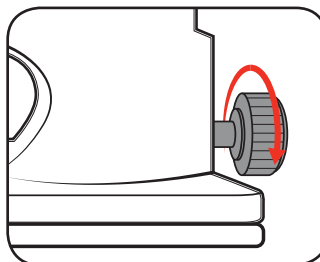

- 3 Secure in place by tightening the fence/guide locking screw.

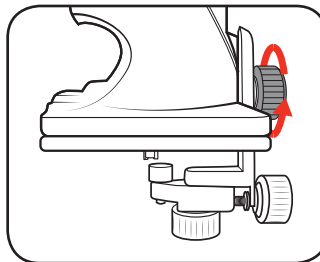

Adjusting the Trimming Guide

- 1 Loosen the trimming locking knob to allow the lower plate to slide.
- 2 Set the trimming size by rotating the trimming adjustment knob. (Clockwise for a larger trim)

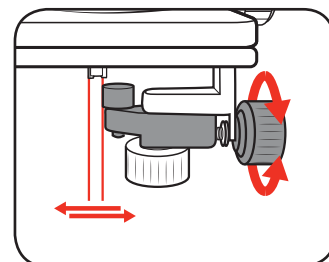
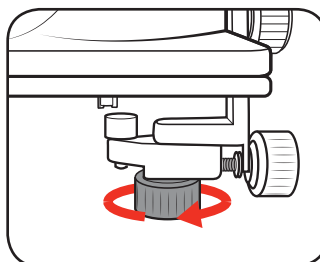

- 3 Once the distance has been set, secure in place with the trimming locking knob.

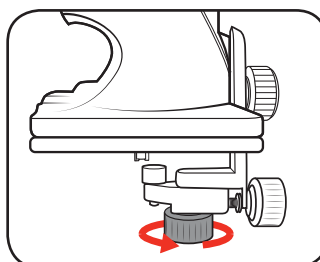

4. STRAIGHT FENCE

The straight fence is an effective aid when cutting in a straight line when chamfering or grooving.

Fitting the Straight Fence

- 1 Loosen the fence/guide locking screw and insert the straight fence.
- 2 Slide the straight fence all the way up so that the bottom of the "L" shape is flush with the base of the trimmer.

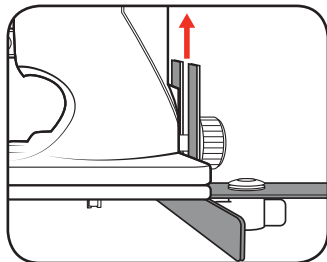
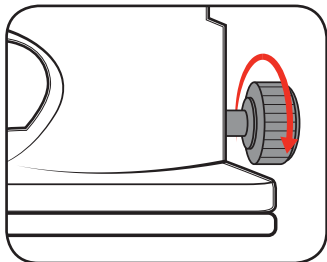

- 3 Secure in place by tightening the fence/guide locking screw.

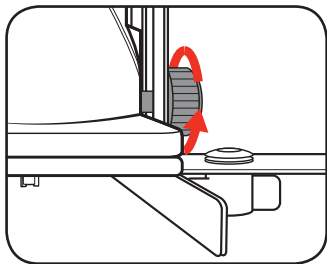

Adjusting the Straight Fence

- 1 Loosen the fence locking knob to allow it to slide.
- 2 Place the fence along the side of the workpiece.

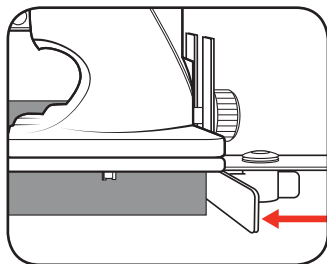
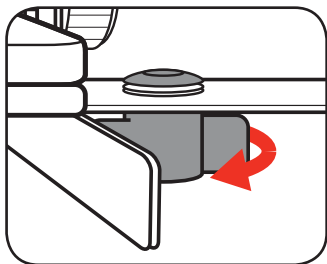

- 3 Set the cutting distance by sliding the trimmer to the desired cutting position.
- 4 Secure in place with the fence locking knob.

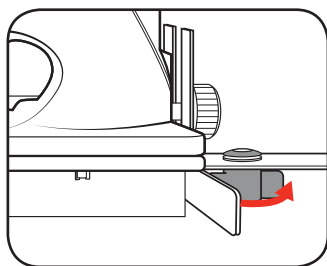
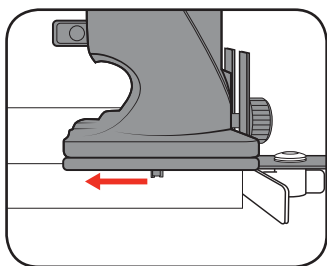

5. TEMPLATE GUIDE

The template guide allows you to easily follow the contour of a template when cutting copies of a pattern.

Fitting the Template Guide

- 1 Undo the four screws on the base of the safety guard and remove the lower plate.

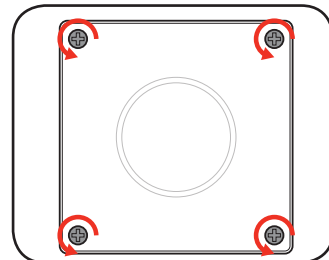

- 2 Insert the template guide into the cutout in the upper plate of the safety guard.

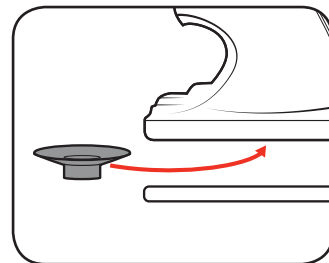

- 3 Place the lower plate back onto the upper plate, securing the template guide in between the two plates.

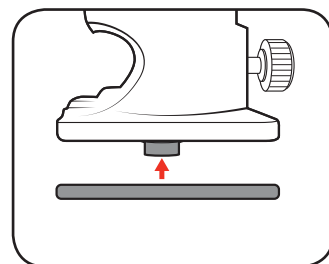

- 4 Fasten the four screws on the base of the safety guard.

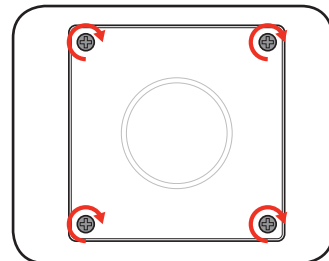

OPERATION

6. CONTROLS

WARNING! TO REDUCE THE RISK OF ELECTRICAL SHOCK, WE RECOMMEND THE USE OF A RESIDUAL CURRENT DEVICE (RATED 30mA OR LESS).

Adjusting the Cutting Depth

WARNING! ENSURE THE TRIMMER IS SWITCHED OFF BEFORE ADJUSTING THE CUTTING DEPTH.

- 1 Loosen the guard locking knob.

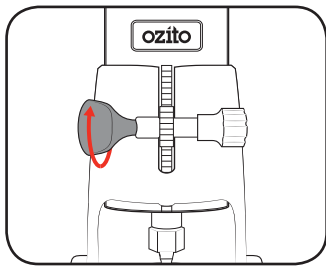

- 2 Adjust the cutting depth by rotating the depth adjusting screw.

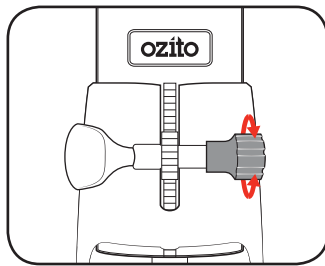

- 3 Secure in place by tightening the guard locking knob.

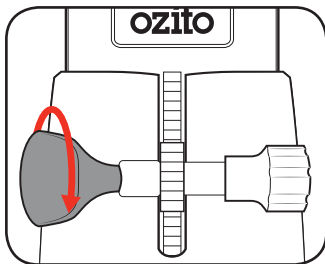

Switching On and Off

- 1 To start the trimmer, push the on/off switch into the on position.

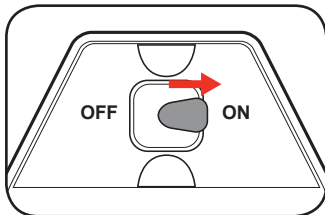

- 2 To stop the trimmer, push the on/off switch into the off position.

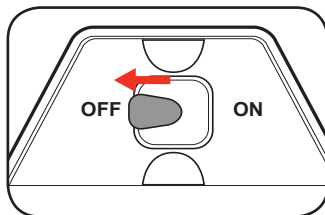

7. MAKING A CUT

Before starting, perform a few quick checks:

- * Ensure the correct router bit is installed.
- * Ensure the trimmer guide base is secure.
- * Check the depth of cut is set to your desired depth.
- * If using any of the guides or fences, check they are properly fixed to the laminate trimmer.
- * Make sure the workpiece is secure and won't move during operation.

- 1 Hold the laminate trimmer, making sure your fingers are clear of the opening in the trimmer guide base.

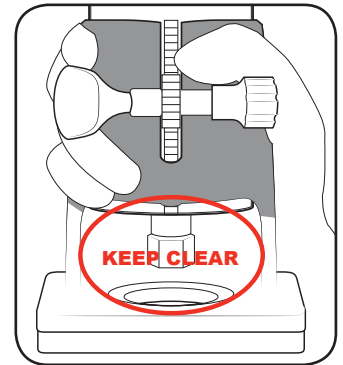

WARNING! INJURY MAY OCCUR IF YOU HOLD THE TRIMMER INCORRECTLY. KEEP FINGERS CLEAR OF THE ROUTER BIT AT ALL TIMES.

- 2 Place the trimmer guide base onto the workpiece so that the router bit overhangs the edge.

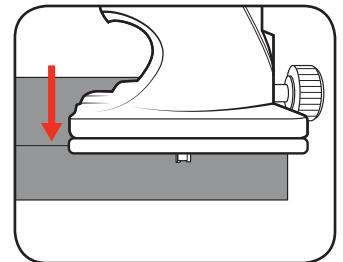

- 3 Switch the laminate trimmer on by pushing the on/off switch into the on position.

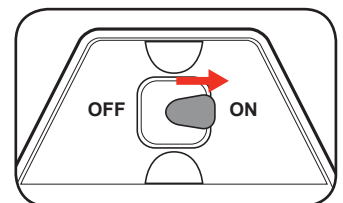

- 4 Follow the below guide to assist you when cutting or trimming your workpiece. This is to ensure the chips are removed away from the operator.

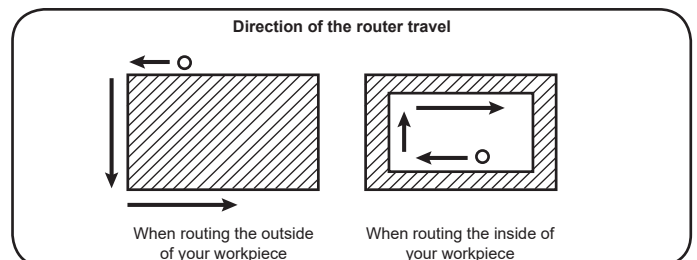

Note: On harder woods it may be necessary to make more than one pass at progressive cutting depths until the desired depth is achieved.

ROUTER BITS

Below is a list of the router bits that can be used with this laminate trimmer.

This laminate trimmer is designed for use only with 1/4" (6.35mm) bits. The max diameter of the head of the bit should be less than 32mm to fit the trimmer base.

STRAIGHT BITS

Straight router bits are ideal for making plunge cuts into a material to form a groove or to hollow out an area for a mortise or inlay.

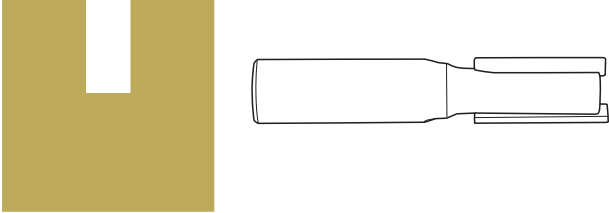

V GROOVE BITS

Used to create V shaped channels or flutes in a workpiece.

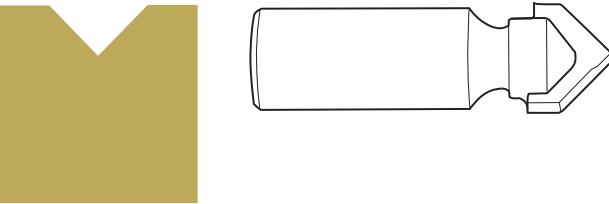

ROUND NOSE BITS

Similar to the V-groove bit in that it creates channels or flutes in a workpiece.

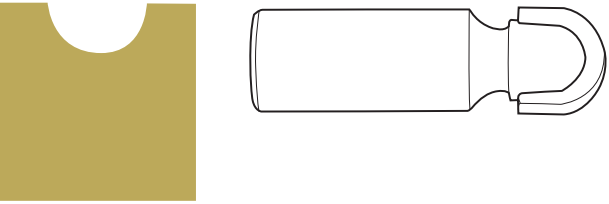

DOVE TAIL

Most commonly used to create tails for dovetail joinery. Plunge cuts a flat bottom with angled sides into a workpiece.

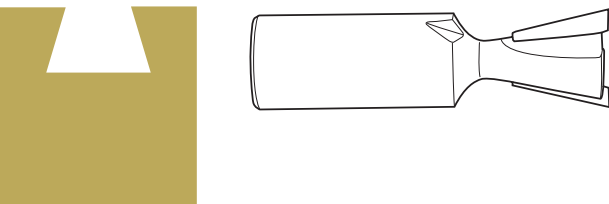

COVE BIT

Used to create a concave, rounded edge to a piece of timber. Often used in conjunction with a round over bit.

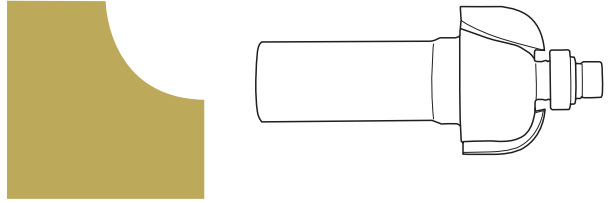

ROUND OVER BIT

Creates a rounded edge on a piece.

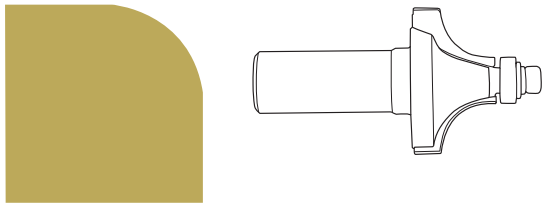

CHAMFER

Cuts a 45-degree angle on a square edge.

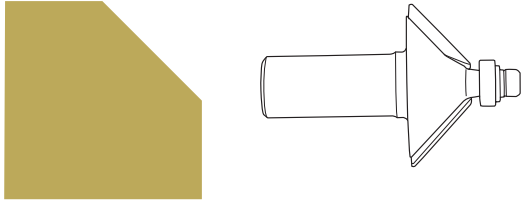

FLUSH TRIM BITS

Suited to trimming the edge of one piece flush with the edge of another piece. A common use is using a pattern or template to create multiple identical shapes of the pattern.

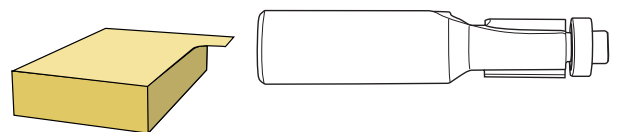

MAINTENANCE

- Keep the ventilation vents of the trimmer clean at all times, if possible, prevent foreign matter from entering the vents.
- After each use, blow air through the trimmer housing to ensure it is free from all dust particles which may build up. Build up of dust particles may cause the trimmer to overheat and fail.
- If the enclosure of the trimmer requires cleaning, do not use solvents but a moist soft cloth only. Never let any liquid get inside the trimmer; never immerse any part of the trimmer into a liquid.

Carbon Brushes

When the carbon brushes wear out, the trimmer will spark and/or stop. Discontinue use as soon as this happens. They should be replaced prior to recommencing use of the trimmer. Carbon brushes are a wearing component of the trimmer therefore not covered under warranty. Continuing to use the trimmer when carbon brushes need to be replaced may cause permanent damage to the trimmer. Carbon brushes will wear out after many uses but when the carbon brushes need to be replaced, take the trimmer to an electrician or a power tool repairer for a quick and low cost replacement. Always replace both carbon brushes at the same time.



Note: Ozito Industries will not be responsible for any damage or injuries caused by the repair of the trimmer by an unauthorised person or by mishandling of the trimmer.

TROUBLESHOOTING

SYMPTOM	POSSIBLE CAUSE	REMEDY
Trimmer will not operate or trimmer runs slowly.	No power supply	Check that the power is available at source
	Blunt or damaged router bits	Resharpen or replace router bits
	Motor is overloaded	Reduce excessive load or force on trimmer
Excessive Vibration	Bent router bit shaft	Replace router bit
Light sparking visible inside the housing	This does not indicate a problem	There is no remedy required
Heavy sparking occurs inside the motor housing	Brushes not moving freely	Disconnect power, remove brushes, clean or replace

DESCRIPTION OF SYMBOLS

V	Volts	Hz	Hertz
~	Alternating Current	W	Watts
/min	Revolutions or reciprocations per minute	n₀	No load speed
	Regulatory Compliance Mark (RCM)		Warning
	Read Instruction Manual		Wear eye protection

CARING FOR THE ENVIRONMENT



Power tools that are no longer usable should not be disposed of with household waste but in an environmentally friendly way. Please recycle where facilities exist. Check with your local council authority for recycling advice.



Recycling packaging reduces the need for landfill and raw materials. Reuse of recycled material decreases pollution in the environment. Please recycle packaging where facilities exist. Check with your local council authority for recycling advice.

SPARE PARTS

Spare parts can be ordered from the Special Orders Desk at your local Bunnings Warehouse.

For further information, or any parts not listed here, visit

www.ozito.com.au or contact Ozito Customer Service:

Australia 1800 069 486

New Zealand 0508 069 486

E-mail: enquires@ozito.com.au

ELECTRICAL SAFETY

 **WARNING!** When using mains-powered tools, basic safety precautions, including the following, should always be followed to reduce risk of fire, electric shock, personal injury and material damage.

Read the whole manual carefully and make sure you know how to switch the tool off in an emergency, before operating the tool.

Save these instructions and other documents supplied with this tool for future reference.

The electric motor has been designed for 230V and 240V only. Always check that the power supply corresponds to the voltage on the rating plate.

Note: The supply of 230V and 240V on Ozito tools are interchangeable for Australia and New Zealand.



This tool is double insulated in accordance with AS/NZS 60745-1; therefore no earth wire is required.

If the supply cord of this power tool is damaged, it must be replaced by a specially prepared cord available through the service organization.

Note: Double insulation does not take the place of normal safety precautions when operating this tool. The insulation system is for added protection against injury resulting from a possible electrical insulation failure within the tool.

Using an Extension Lead

Always use an approved extension lead suitable for the power input of this tool. Before use, inspect the extension lead for signs of damage, wear and ageing. Replace the extension lead if damaged or defective.

When using an extension lead on a reel, always unwind the lead completely. Use of an extension lead not suitable for the power input of the tool or which is damaged or defective may result in a risk of fire and electric shock.

To reduce the risk of electrical shock, we recommend the use of a residual current device (rated 30mA or less).

GENERAL POWER TOOL SAFETY WARNINGS

 **WARNING!** Read all safety warnings and all instructions. Failure to follow the warnings and instructions may result in electric shock, fire and/or serious injury.

Save all warnings and instructions for future reference. The term "power tool" in the warnings refers to your mains-operated (corded) power tool or battery-operated (cordless) power tool.

1. Work area safety

a. Keep work area clean and well lit. Cluttered or dark areas invite accidents.

b. Do not operate power tools in explosive atmospheres, such as in the presence of flammable liquids, gases or dust. Power tools create sparks which may ignite the dust or fumes.

c. Keep children and bystanders away while operating a power tool. Distractions can cause you to lose control.

2. Electrical safety

a. Power tool plugs must match the outlet. Never modify the plug in any way. Do not use any adapter plugs with earthed (grounded) power tools. Unmodified plugs and matching outlets will reduce risk of electric shock.

b. Avoid body contact with earthed or grounded surfaces, such as pipes, radiators, ranges and refrigerators. There is an increased risk of electric shock if your body is earthed or grounded.

c. Do not expose power tools to rain or wet conditions. Water entering a power tool will increase the risk of electric shock.

d. Do not abuse the cord. Never use the cord for carrying, pulling or unplugging the power tool. Keep cord away from heat, oil, sharp edges or moving parts. Damaged or entangled cords increase the risk of electric shock.

e. When operating a power tool outdoors, use an extension cord suitable for outdoor use. Use of a cord suitable for outdoor use reduces the risk of electric shock.

3. Personal safety

a. Stay alert, watch what you are doing and use common sense when operating a power tool. Do not use a power tool while you are tired or under the influence of drugs, alcohol or medication. A moment of inattention while operating power tools may result in serious personal injury.

b. Use personal protective equipment. Always wear eye protection. Protective equipment such as dust mask, non-skid safety shoes, hard hat, or hearing protection used for appropriate conditions will reduce personal injuries.

c. Prevent unintentional starting. Ensure the switch is in the off-position before connecting to power source and/or battery pack, picking up or carrying the tool. Carrying power tools with your finger on the switch or energising power tools that have the switch on invites accidents.

d. Remove any adjusting key or wrench before turning the power tool on. A wrench or a key left attached to a rotating part of the power tool may result in personal injury.

e. Do not overreach. Keep proper footing and balance at all times. This enables better control of the power tool in unexpected situations.

f. Dress properly. Do not wear loose clothing or jewellery. Keep your hair, clothing and gloves away from moving parts. Loose clothes, jewellery or long hair can be caught in moving parts.

g. If devices are provided for the connection of dust extraction and collection facilities, ensure these are connected and properly used. Use of dust collection can reduce dust-related hazards.

h. Do not let familiarity gained from frequent use of tools allow you to become complacent and ignore tool safety principles. A careless action can cause severe injury within a fraction of a second.

4. Power tool use and care

a. Do not force the power tool. Use the correct power tool for your application. The correct power tool will do the job better and safer at the rate for which it was designed.

b. Do not use the power tool if the switch does not turn it on and off. Any power tool that cannot be controlled with the switch is dangerous and must be repaired.

c. Disconnect the plug from the power source and/or the battery pack from the power tool before making any adjustments, changing accessories, or storing power tools. Such preventive safety measures reduce the risk of starting the power tool accidentally.

d. Store idle power tools out of the reach of children and do not allow persons unfamiliar with the power tool or these instructions to operate the power tool. Power tools are dangerous in the hands of untrained users.

e. Maintain power tools. Check for misalignment or binding of moving parts, breakage of parts and any other condition that may affect the power tool's operation. If damaged, have the power tool repaired before use. Many accidents are caused by poorly maintained power tools.

f. Keep cutting tools sharp and clean. Properly maintained cutting tools with sharp cutting edges are less likely to bind and are easier to control.

g. Use the power tool, accessories and tool bits etc. in accordance with these instructions, taking into account the working conditions and the work to be performed. Use of the power tool for operations different from those intended could result in a hazardous situation.

h. Keep handles and grasping surfaces dry, clean and free from oil and grease. Slippery handles and grasping surfaces do not allow for safe handling and control of the tool in unexpected situations.

5. Service

a. Have your power tool serviced by a qualified repair person using only identical replacement parts. This will ensure that the safety of the power tool is maintained.

LAMINATE TRIMMER SAFETY WARNINGS

 **WARNING!** This appliance is not intended for use by persons (including children) with reduced physical, sensory or mental capabilities, or lack of experience and knowledge, unless they have been given supervision or instruction concerning use of the appliance by a person responsible for their safety.

a) Wait for the cutter to stop before setting the tool down. An exposed rotating cutter may engage the surface leading to possible loss of control and serious injury.

b) Hold power tool by insulated gripping surface, because the cutter may contact its own cord. Cutting a "live" wire may make exposed metal parts of the power tool "live" and shock the operator.

c) Use clamps or another practical way to secure and support the workpiece to a stable platform. Holding the work by hand or against the body leaves it unstable and may lead to loss of control.

Using an Extension Lead

Always use an approved extension lead suitable for the power input of this tool. Before use, inspect the extension lead for signs of damage, wear and ageing. Replace the extension lead if damaged or defective.

When using an extension lead on a reel, always unwind the lead completely. Use of an extension lead not suitable for the power input of the tool or which is damaged or defective may result in a risk of fire and electric shock.

It is recommended that the extension lead is a maximum of 25m in length. Do not use multiple extension leads.

- Wear safety glasses or goggles when operating this tool.
- Only use router bits with a shank diameter equal to the size of the collet installed in the tool.
- Only use router bits suitable for the no-load speed of the tool.
- Do not use the tool in an inverted position.
- Do not attempt to use the tool in a stationary mode.
- Take special care when cutting MDF or surfaces coated with lead-based paint.
- Wear a dust mask specifically designed for protection against lead paint dust and fumes and ensure that persons within or entering the work area are also protected.
- Do not let children or pregnant women enter the work area.
- Do not eat, drink or smoke in the work area.
- Dispose of dust particles and any other debris safely.
- Draw attention to the necessity for using bits of the correct shank diameter suitable for the speed of the tool.